

NASA Conference Publication 10098

# Automation and Robotics for Space-Based Systems—1991

*Edited by*  
Robert L. Williams II  
NASA Langley Research Center  
Hampton, Virginia

Proceedings of a workshop  
sponsored by the National  
Aeronautics and Space  
Administration and held at  
Langley Research Center  
Hampton, Virginia  
December 10, 1991

MAY 1992

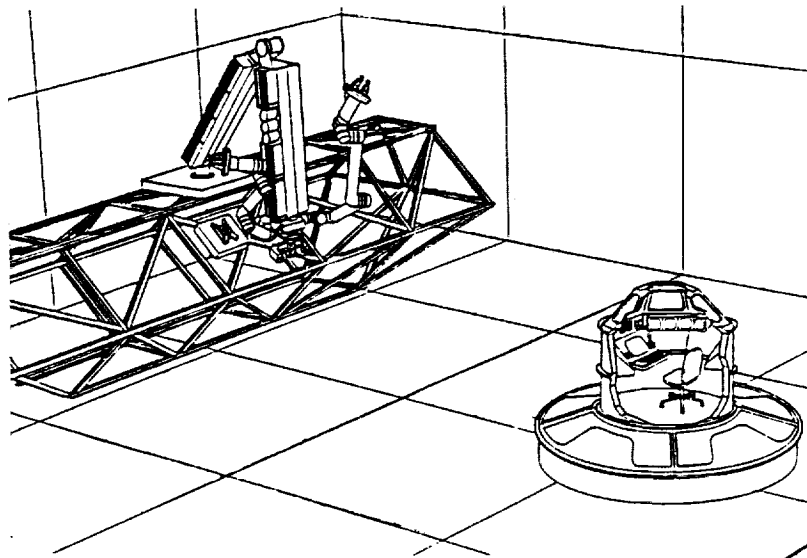

N92-27763  
--THRU--  
N92-27782  
Unclass  
0092910

63/63

(NASA-CP-10098) AUTOMATION AND ROBOTICS FOR  
SPACE-BASED SYSTEMS, 1991 (NASA) 254 p

X

**NASA**

National Aeronautics and  
Space Administration

Langley Research Center  
Hampton, Virginia 23665-5225

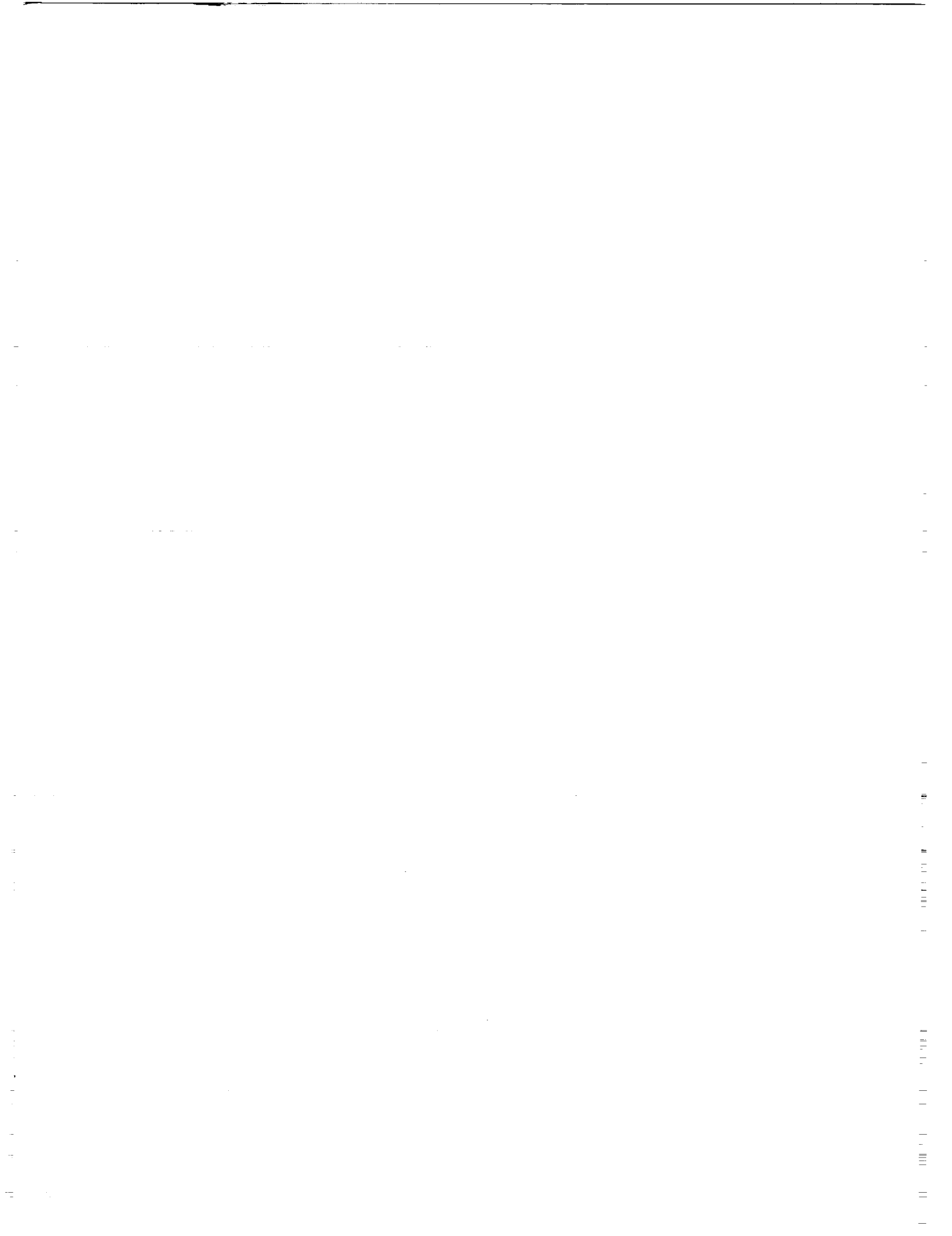

# Automation and Robotics for Space-Based Systems - 1991

## *Preface*

A NASA Langley workshop on Automation and Robotics for Space-Based Systems was held on December 10, 1991, from 8:30 a.m. to 4:00 p.m. This conference proceedings document presents the overhead slides from each speaker at this event. The purpose of this in-house workshop was to assess the state-of-the-art of automation and robotics for space operations from a Langley Research Center perspective and to identify areas of opportunity for future research. The workshop was sponsored by the Guidance, Navigation, and Control Technical Committee, chaired by Dr. Raymond C. Montgomery.

Nineteen talks were given, reflecting a high level of interest in the field of automation and robotics at NASA Langley. Over half of the presentations came from the Automation Technology Branch, covering telerobotic control, EVA and IVA telerobotics, hand controllers for teleoperation, sensors, neural networks, and automated structural assembly, all applied to space telerobotic missions. Other talks covered RMS active damping augmentation, space crane work, modeling, simulation, and control of large, flexible space manipulators, and virtual passive controller designs for space robots.

The 1991 NASA Langley Workshop on Automation and Robotics for Space-Based Systems provided a good overview of current effort in this field at NASA Langley. The workshop served to open or renew lines of communication between various researchers working in diverse areas of automation and robotics. This document summarizes the talks of this workshop using the presentation overheads.

Robert L. Williams II



# Automation and Robotics for Space-Based Systems - 1991

## Table of Contents

<i>"Summary of Compliant and Multi-Arm Control at Langley Research Center"</i>	
Fenton W. Harrison . . . . .	1
<i>"EVA Robotics for Space Station Freedom"</i>	
Robert L. Williams II . . . . .	19
<i>"IVA Robotics for Space Station Freedom"</i>	
Sharon M. Jones . . . . .	35
<i>"Hand Controller Study of Force and Control Mode"</i>	
A. Terry Morris . . . . .	47
<i>"Coherent Laser RADAR Vision System and Taskspace Identification"</i>	
Hal Aldridge . . . . .	59
<i>"Neural Networks Modeling and Control of Dynamical Systems"</i>	
Don Soloway . . . . .	67
<i>"Adaptive Artificial Neural Network for Autonomous Robot Control"</i>	
Michael K. Arras . . . . .	85
<i>"RMS Active Damping Augmentation"</i>	
Michael G. Gilbert . . . . .	93
<i>"A Space Crane Concept for Performing On-Orbit Assembly"</i>	
John T. Dorsey . . . . .	111
<i>"Analysis and Testing of a Space Crane Articulating Joint Testbed"</i>	
Thomas R. Sutter and K. Chauncey Wu . . . . .	123

## *Table of Contents (Con't)*

<i>"Automated Assembly of Large Space Structures"</i>	
Overview, Marvin D. Rhodes . . . . .	137
Machine Vision, Eric G. Cooper . . . . .	153
End-Effector Microprocessor, William R. Doggett . . . . .	179
Panel Installation, Cuong Quach . . . . .	187
Expert System, Cheryl L. Allen . . . . .	195
Future Work, Ralph Will . . . . .	203
<i>"On the Use of Torque-Wheels For the Control of Large, Flexible, Space-Based Telerobotic Arms"</i>	
Dave Ghosh . . . . .	207
<i>"Modeling, Control, and Simulation of Flexible Link Robotic Systems"</i>	
Sean P. Kenny . . . . .	223
<i>"Passive Dynamic Controllers for Non-Linear Mechanical Systems"</i>	
Minh Phan . . . . .	233

**Summary of Compliant and Multi-Arm Control at  
Langley Research Center**

**by**

**Fenton W. Harrison**

**N92-27764**

# Single Arm System

## Single Arm Philosophy

- a. Axis Systems
- b. Control Systems
- c. Results



# Single Arm Axis System

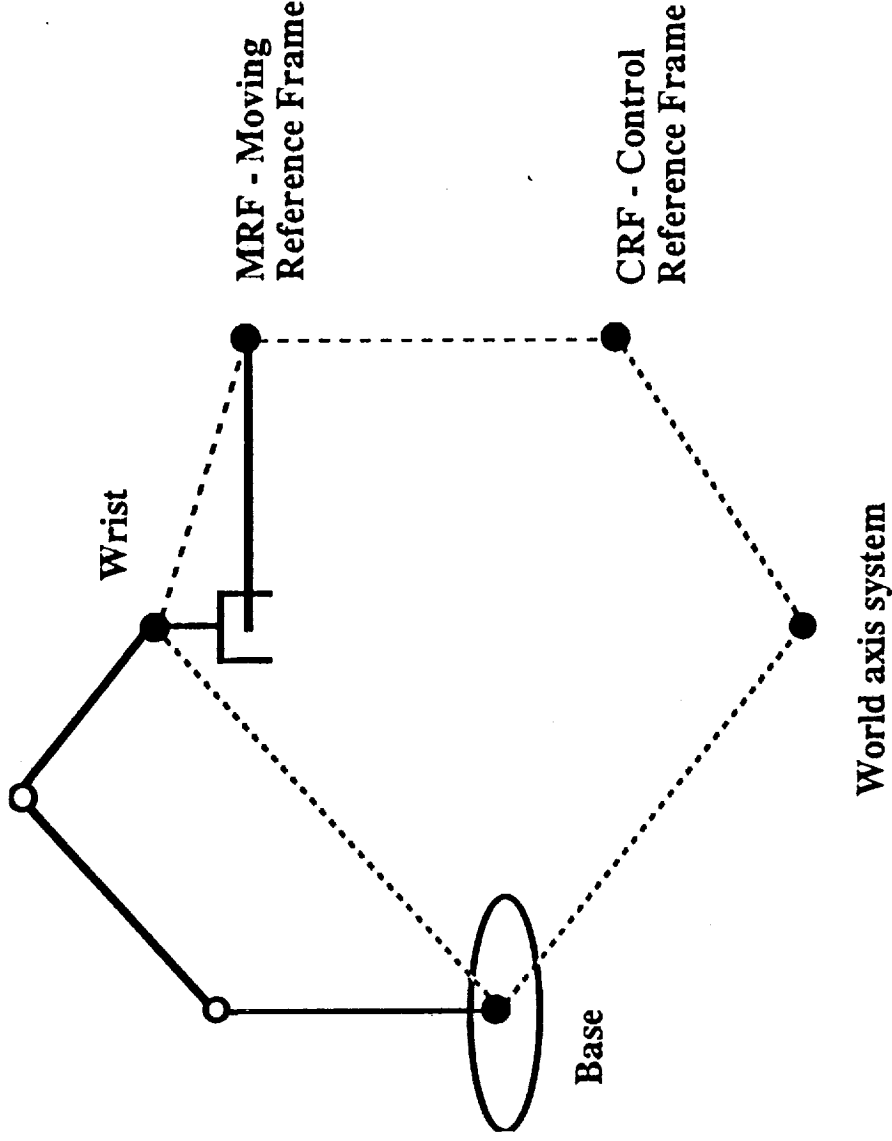

# Single Arm Control Systems

1. Manual Control
2. Position control
3. Vision control
4. Force control

# Single Arm Hand Controller Axis System

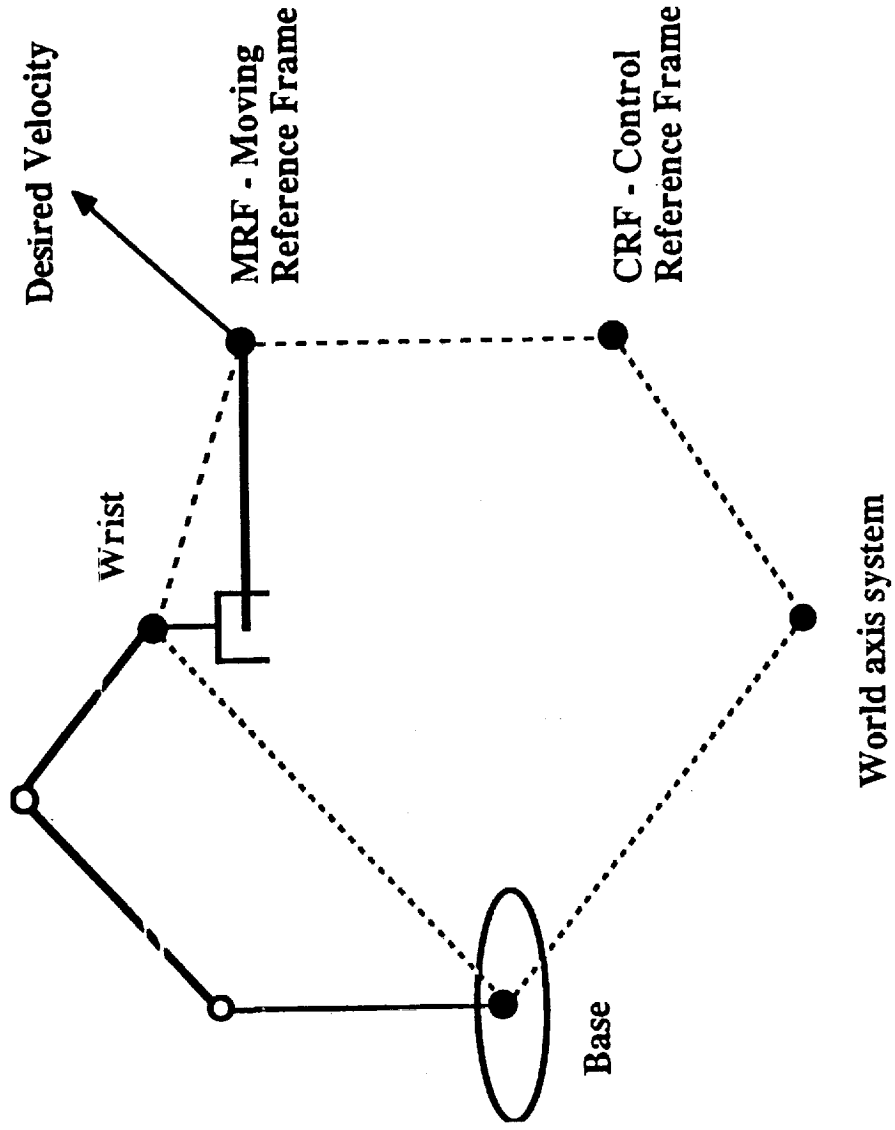

# ISRL HAND CONTROL FLOW DIAGRAM

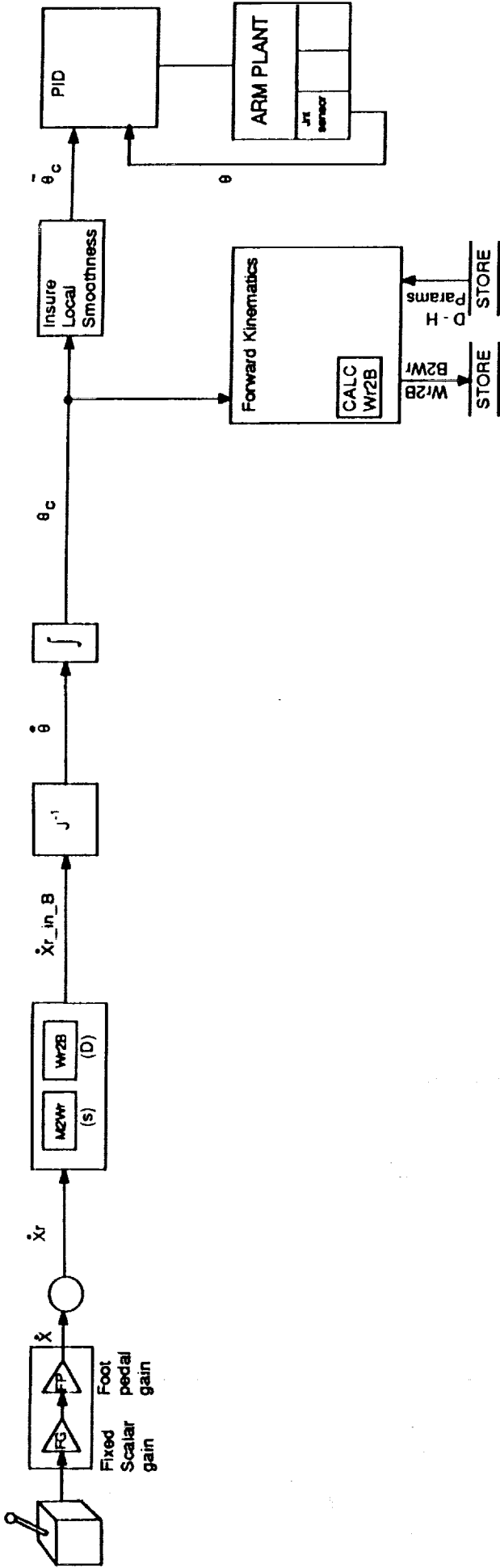

# Single Arm Position Axis System

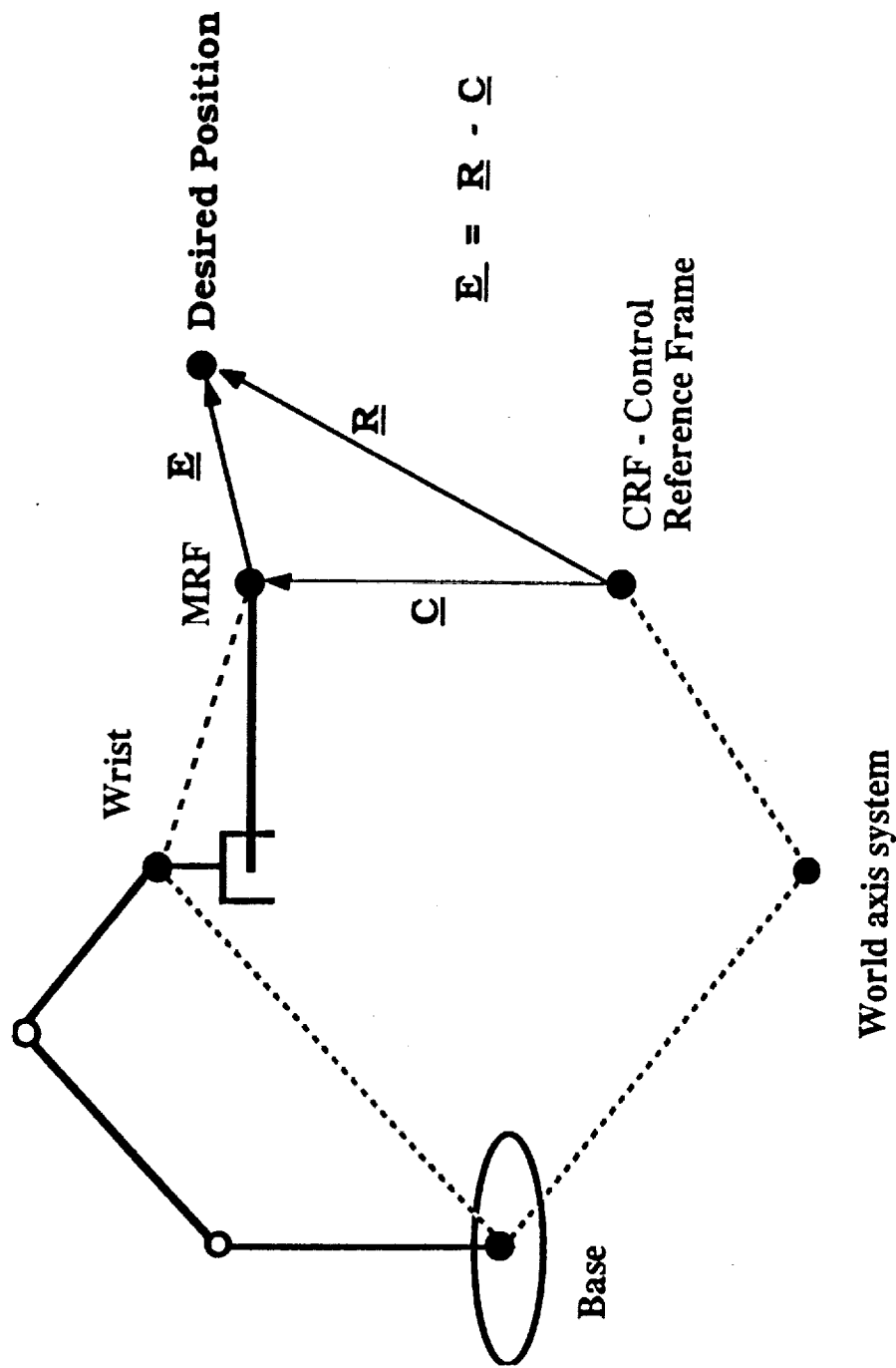

# ISRL POSITION FLOW DIAGRAM

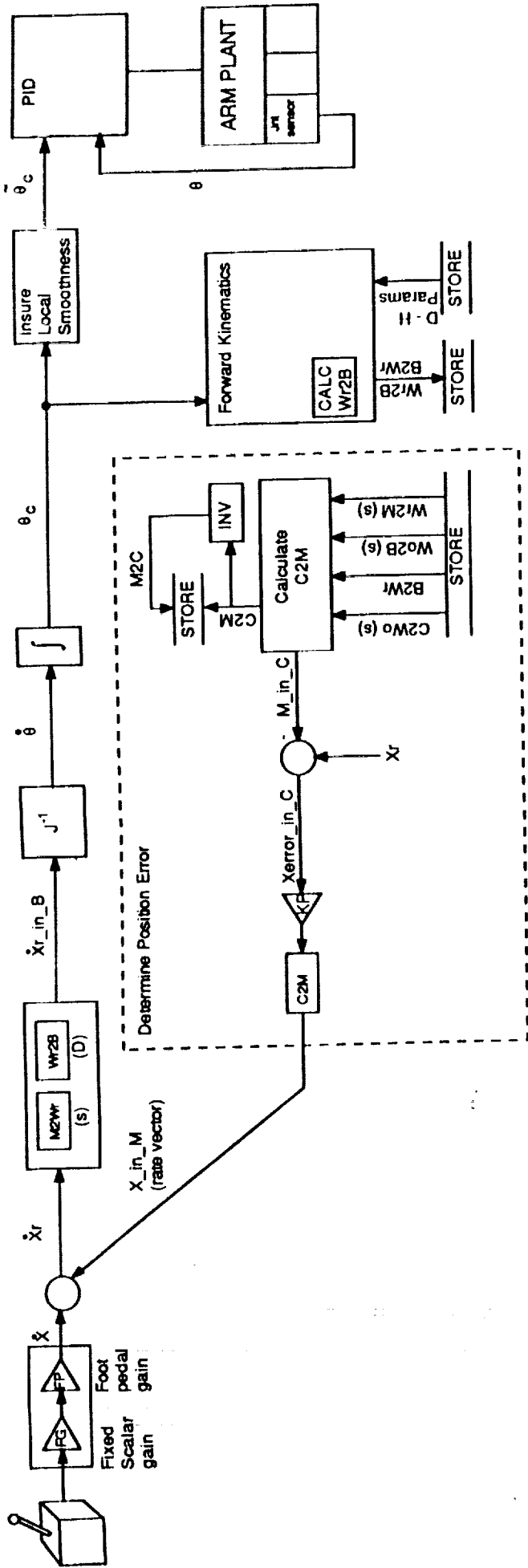

# Single Arm Vision Axis System

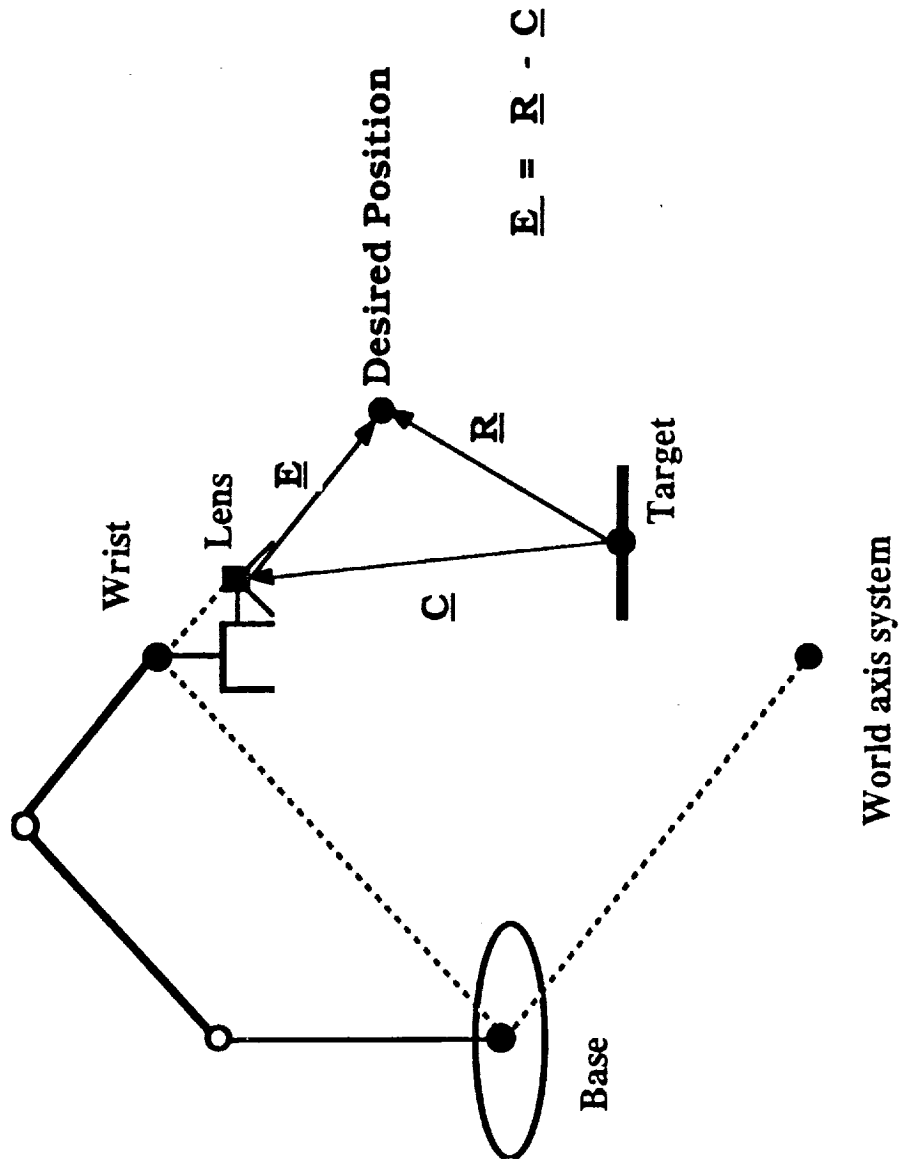

ISRL VISION CONTROL FLOW DIAGRAM

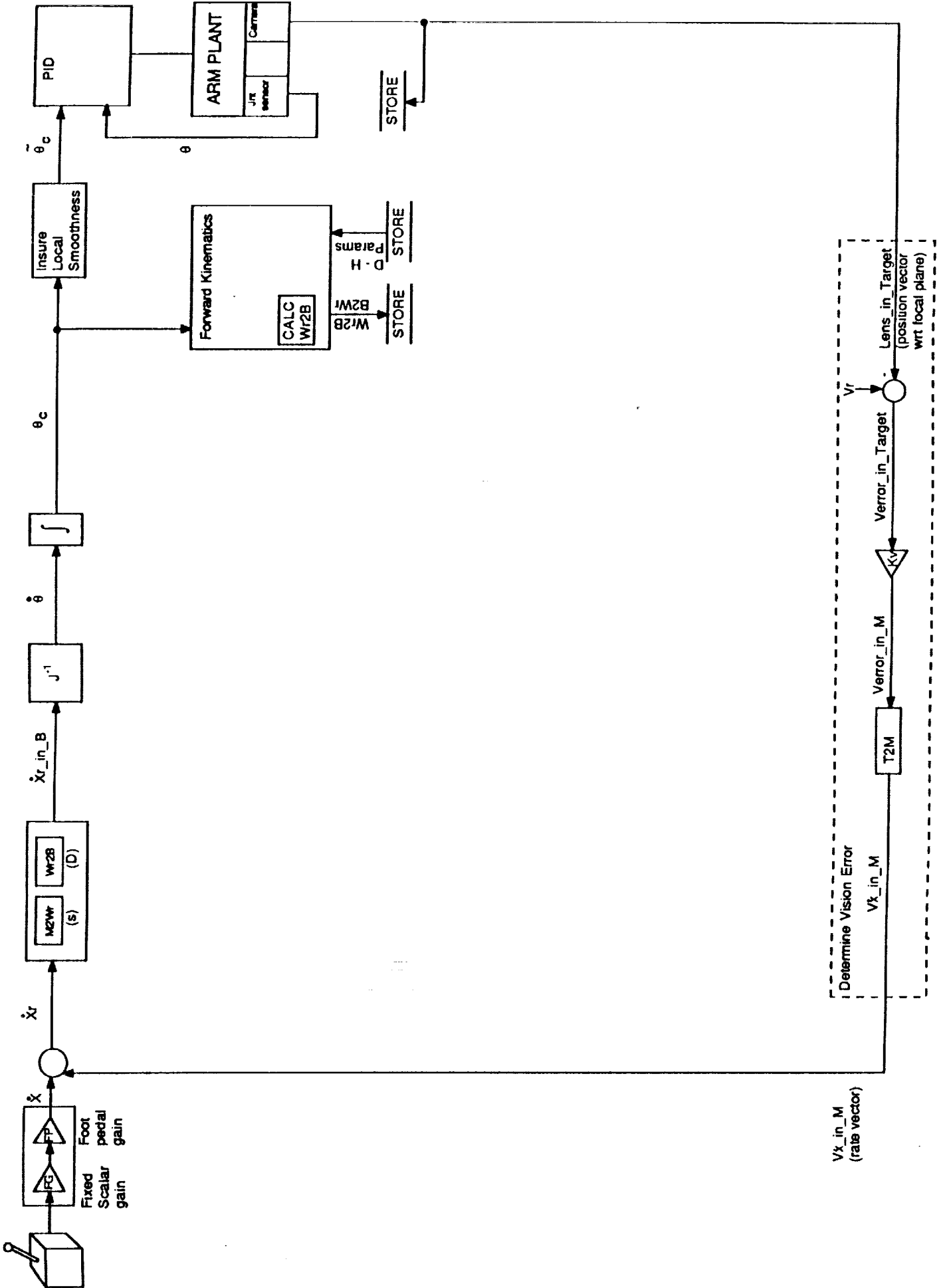



# Single Arm Force Axis System

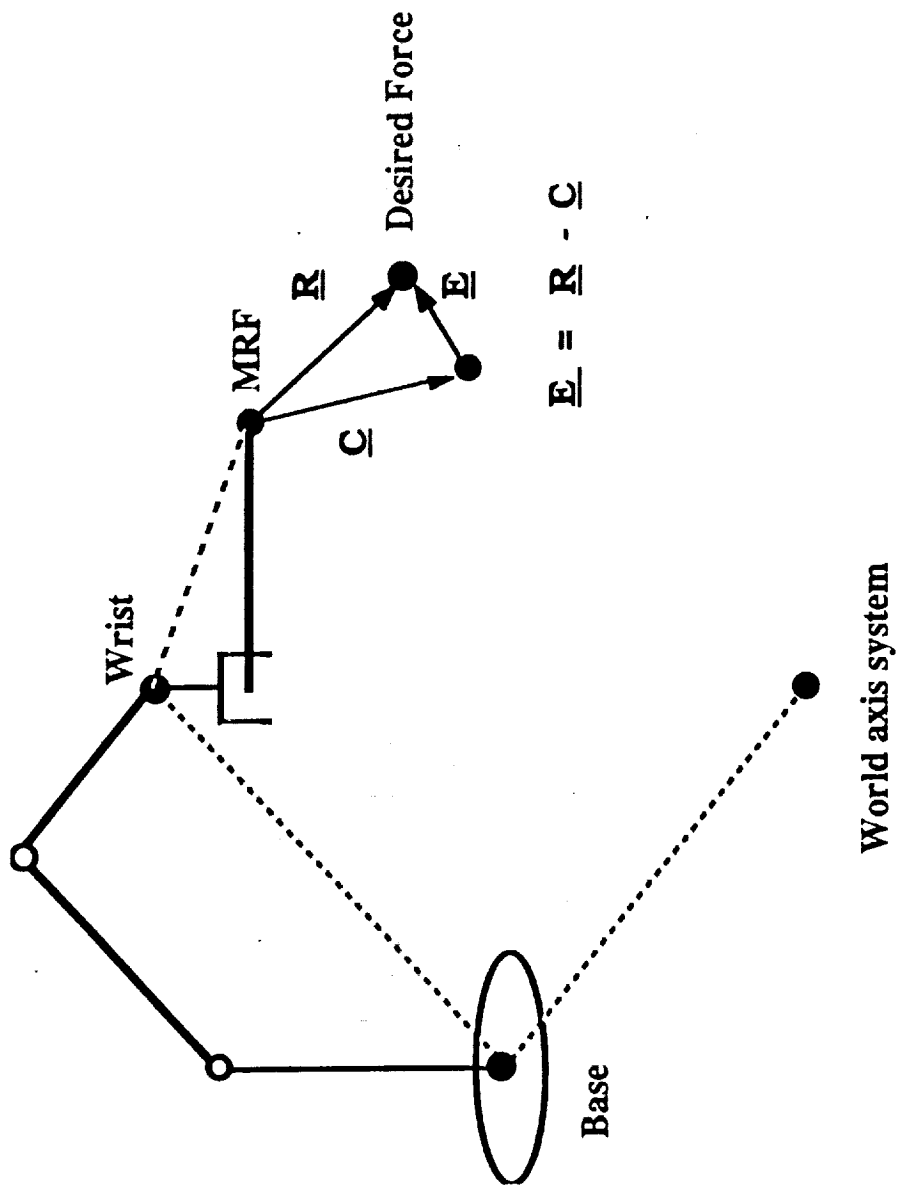

ISRL SINGLE ARM FORCE CONTROL FLOW DIAGRAM

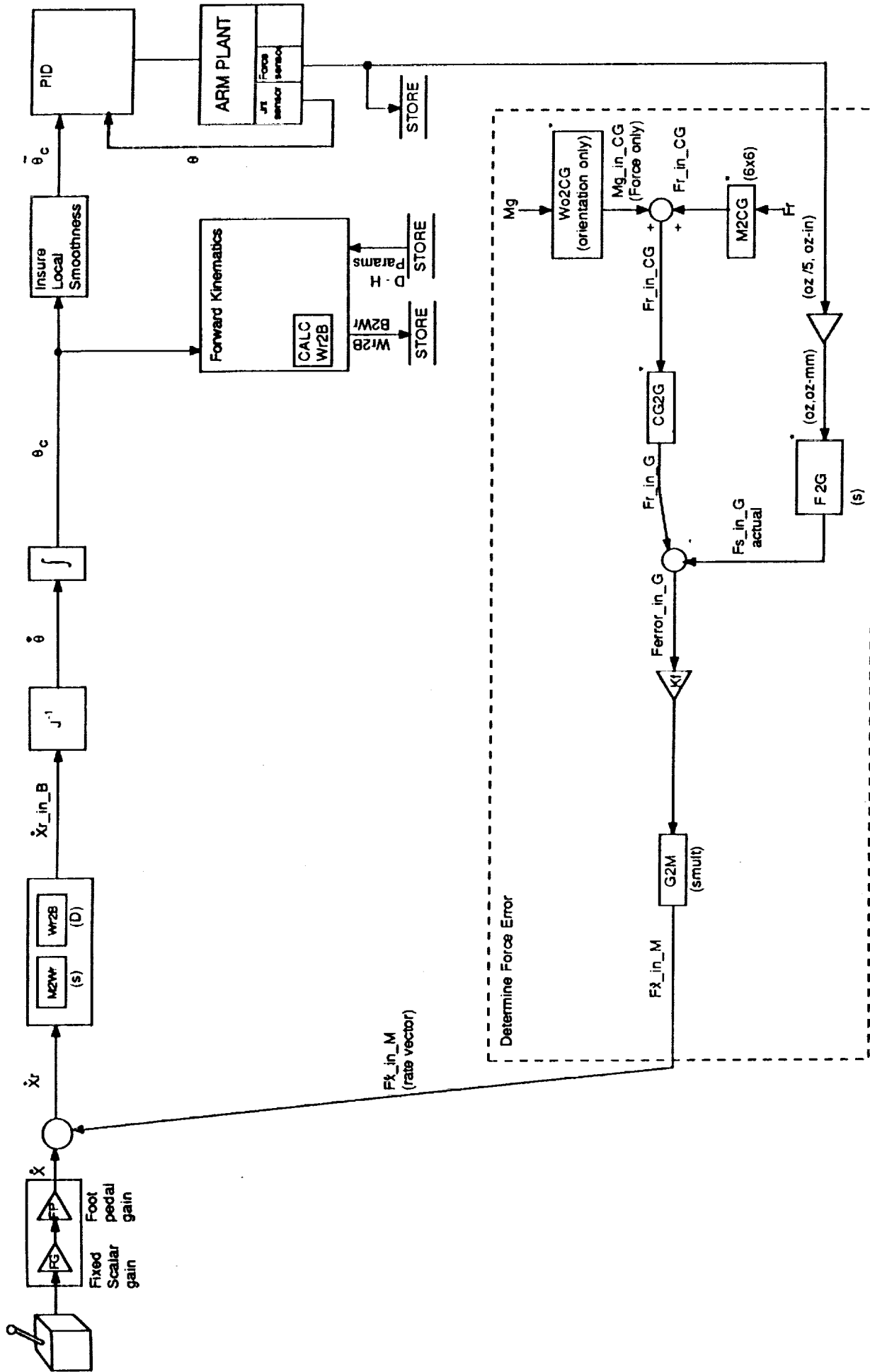

# ISRL SINGLE ARM SYSTEM FLOW DIAGRAM

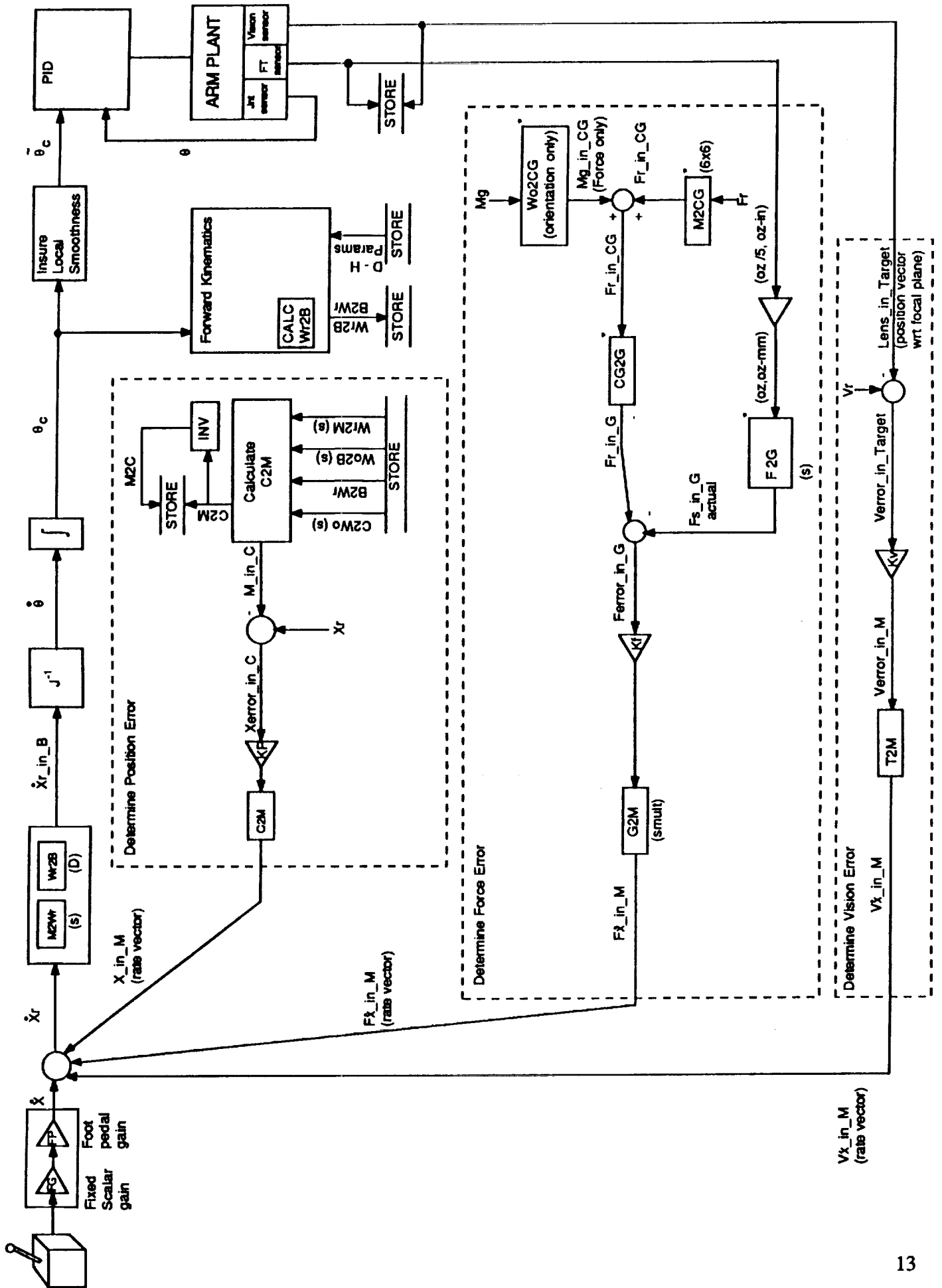

# **Multi Arm System**

## **Multi Arm Philosophy**

- a. Axis Systems
- b. Control Systems
- c. Results

# Multi Arm Axis System

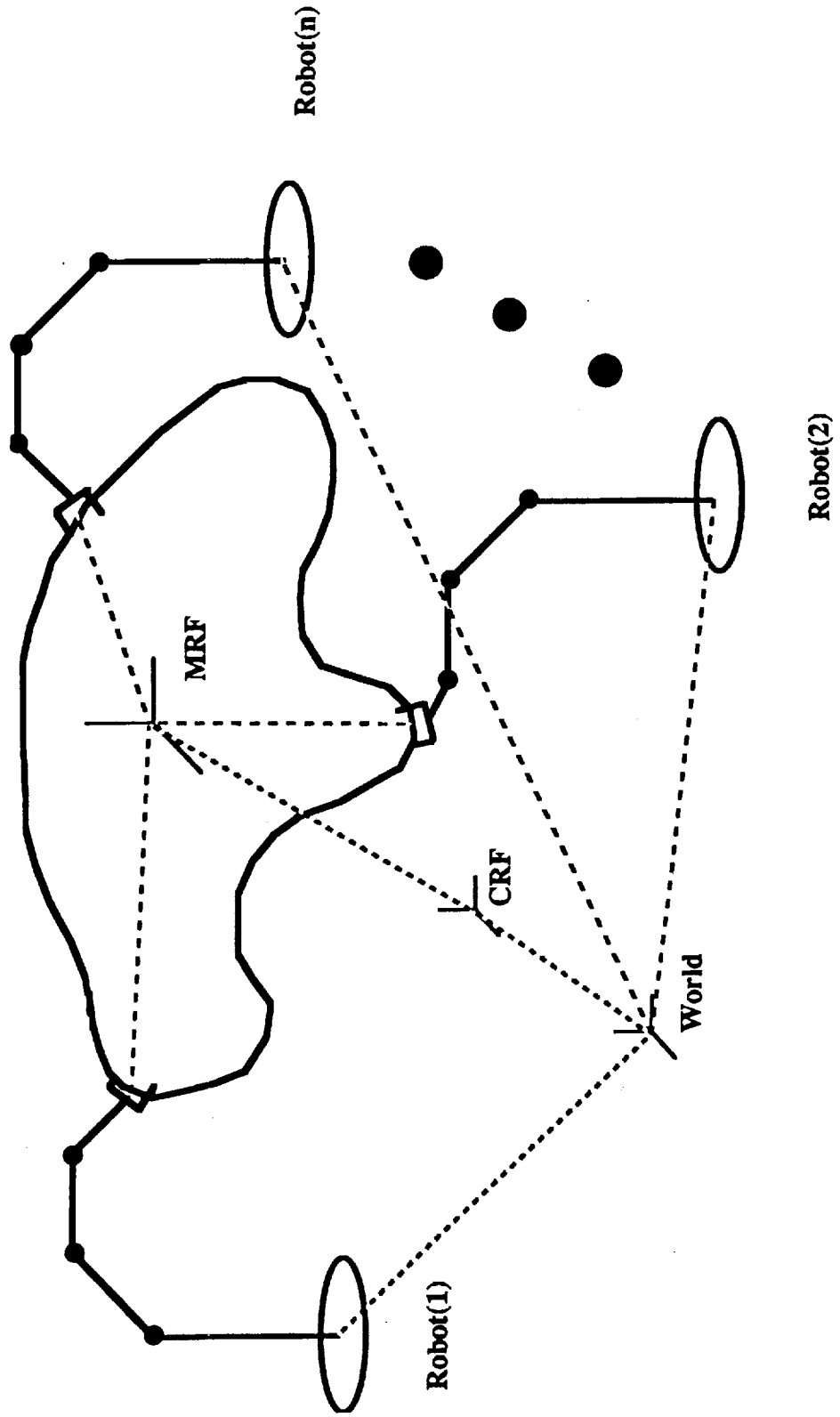

# Dual Arm Hand Control Axis System with Control Signals

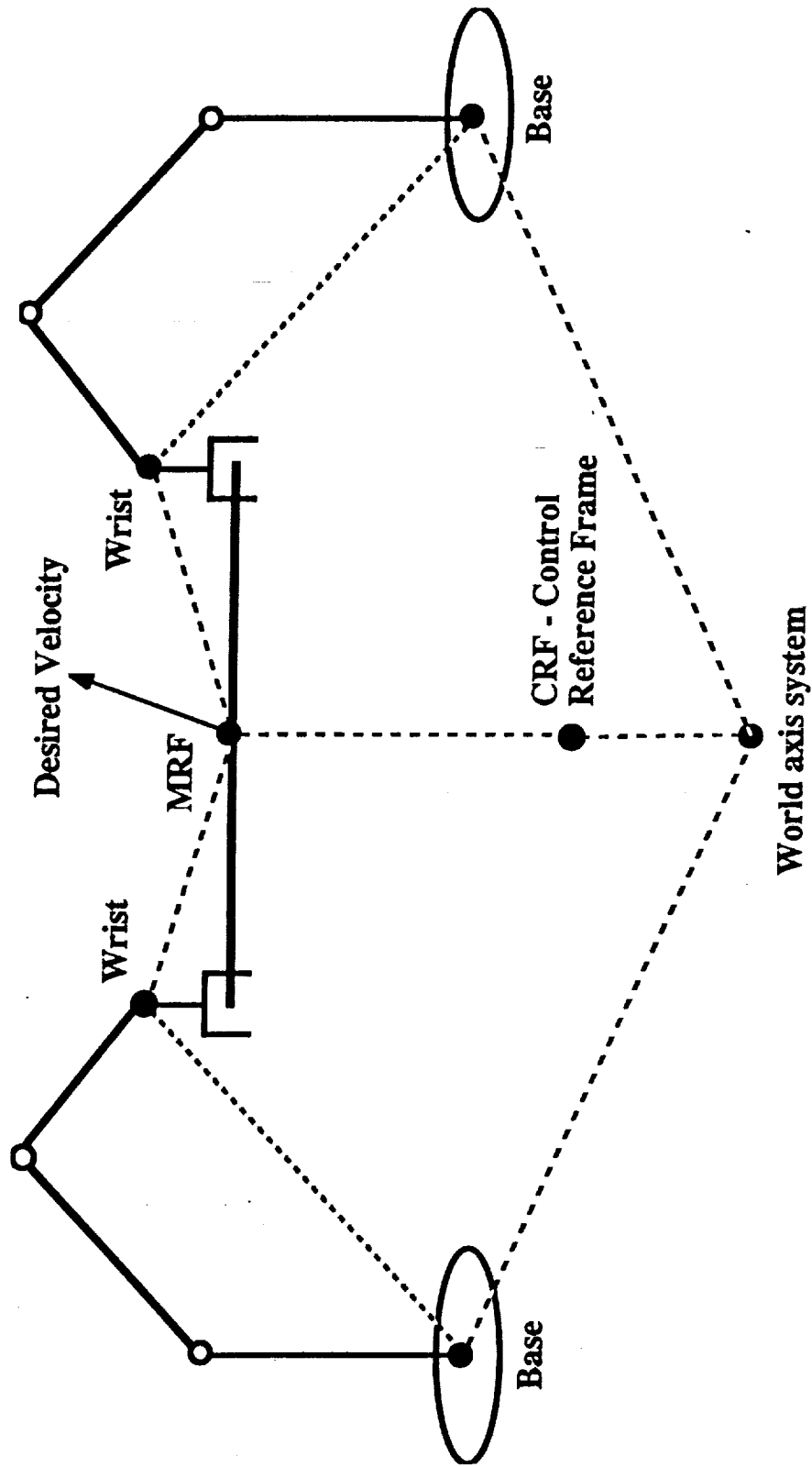

# **SUMMARY**

## **Velocity Control**

- Natural for operator input.
- Summing of sensor input.

## **Single Arm Philosophy**

- Uses of sensors to correct for errors.
- Precise calibration is eliminated.

## **Multi Arm Philosophy**

- Use many independent single arm systems to make one multi arm system.

## **Use of MRF and CRF**

- Decouples operator from the manipulators.
- Take advantage of symmetry of task.
- To control compound manipulators.
- Tracking of objects.

**Use of optimal load distribution.**





**EVA ROBOTICS FOR  
SPACE STATION FREEDOM**

**Dextrous Manipulator Development  
(DEMAND)**

**Bob Williams  
Automation Technology Branch**

N92-27765

# Dexterous Manipulator Development

(DeManD)

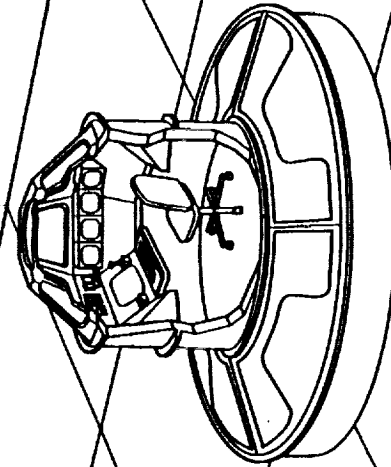
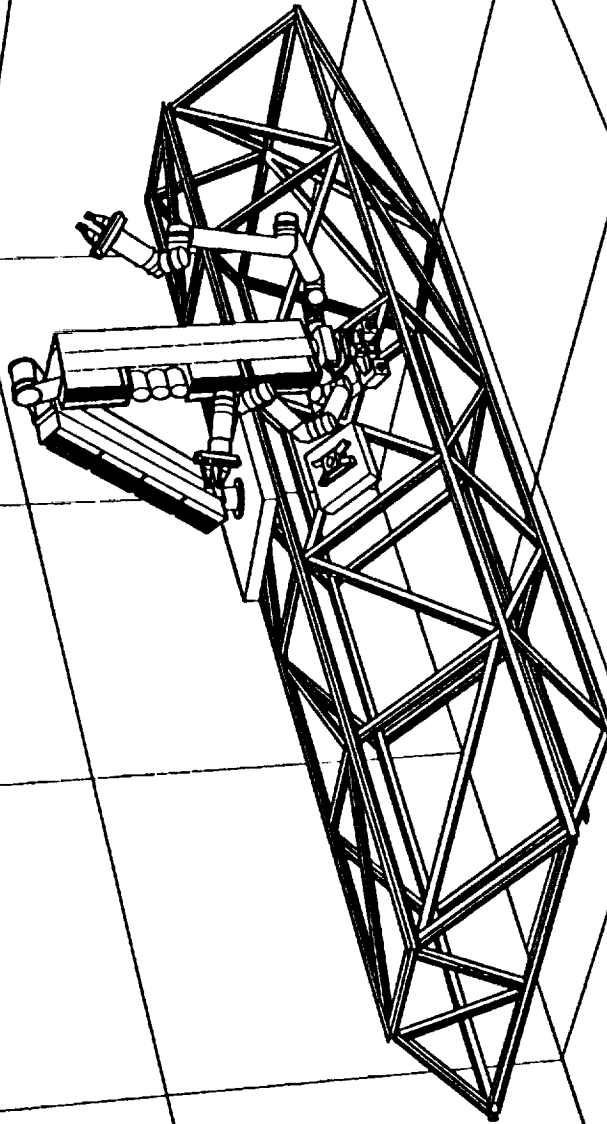

Automation Technology Branch  
NASA Langley Research Center  
October 1991

ATB/ISD/ESD 8-NOV-1991

# The Problem

- **Current Space Station Maintenance demand exceeds capability.**
- **Increasing interest in utilizing telerobotics but limited confidence.**
- **Canadian SPDM would have to do the work.**

# Projected EVA Backlog

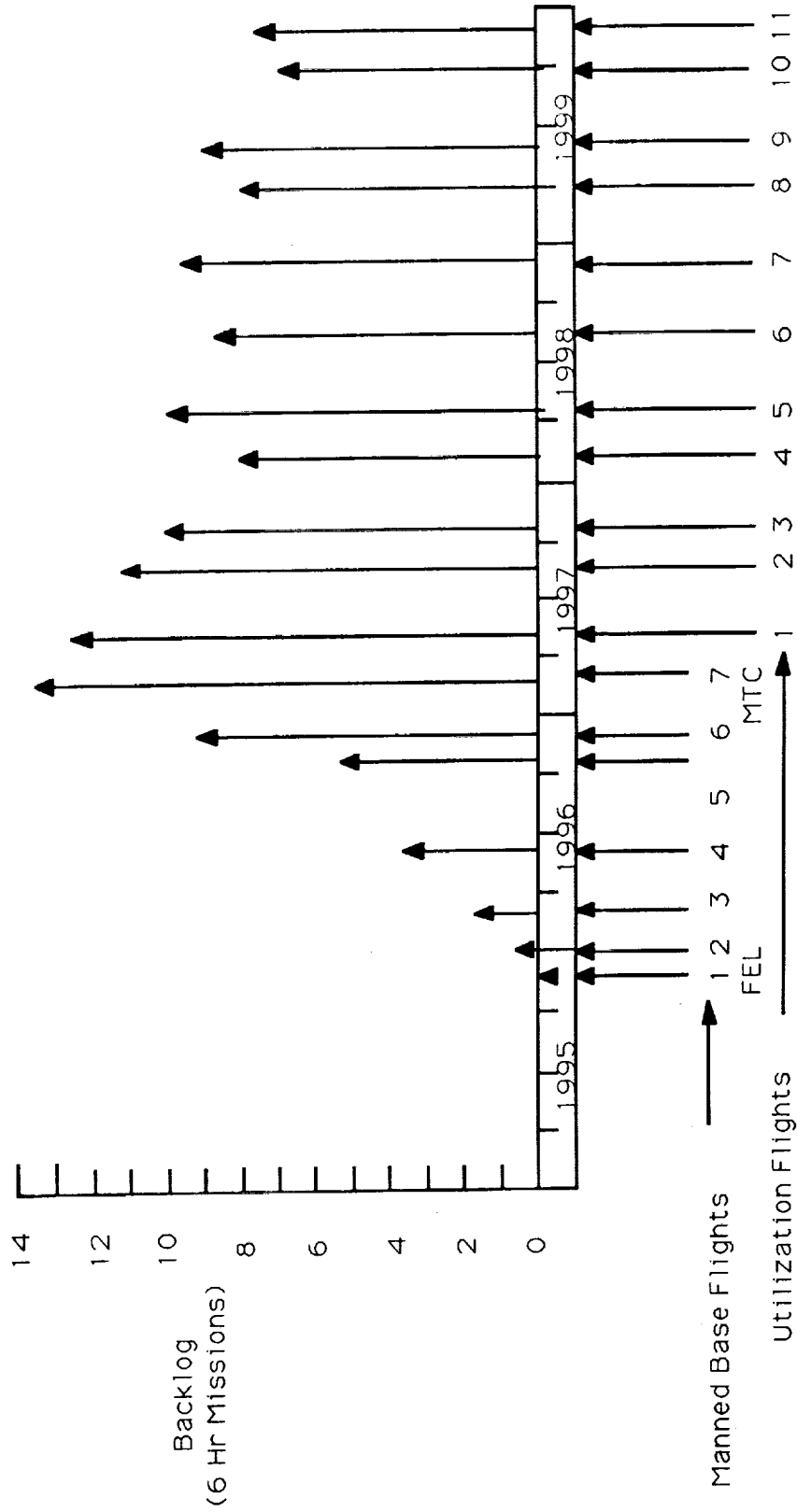

# Objective

Evaluate and enhance Special Purpose Dexterous Manipulator (SPDM) utilization in realistic Space Station Freedom tasks.

# Approach

- Identify opportunities to enhance SPDM operations for Space Station Freedom (SSF).
- Construct a functionally equivalent segment of SSF including SPDM.
- Apply and enhance technology to accomplish SPDM tasks.
- Demonstrate SPDM operations in a realistic environment.

# Potential SPDM Tasks

- Inspection
- ORU Change Out
- Work Site Setup
- Repair

**CURRENTLY PROJECTED SPDM TASKS DO NOT USE THE SPDM'S FULL CAPABILITY!**

# Dexterous Manipulator Development Laboratory - FY92

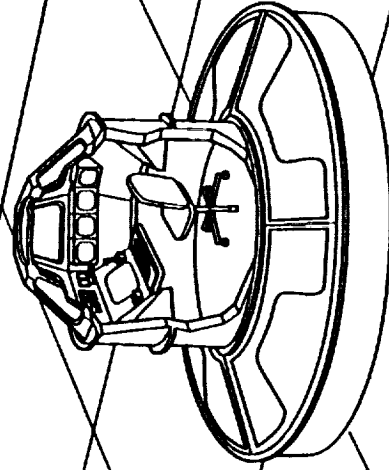
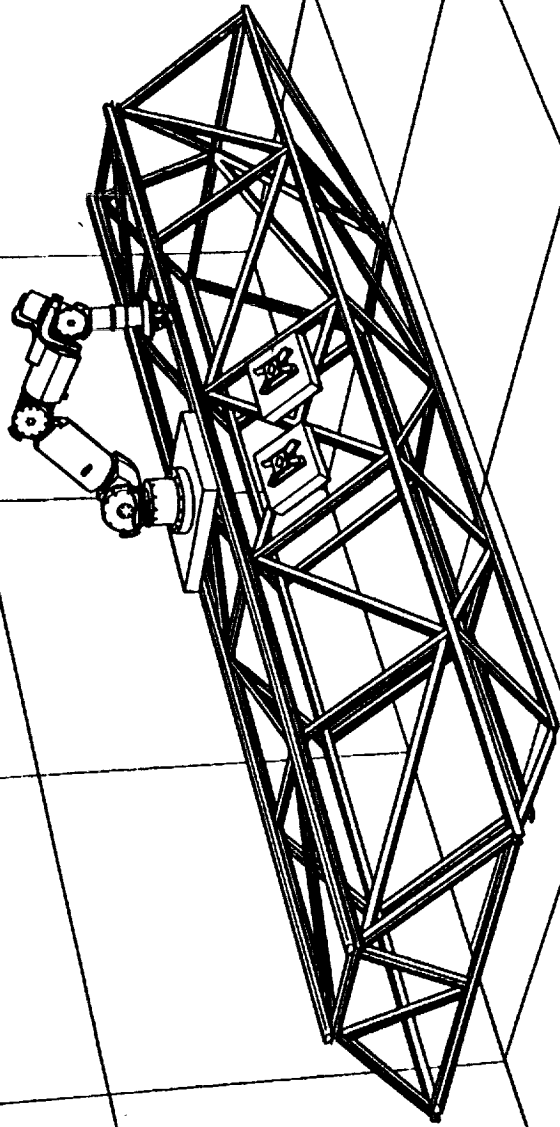

AT&TSD/FSD 8-NOV-1991



# Dexterous Manipulator Development Laboratory - FY93

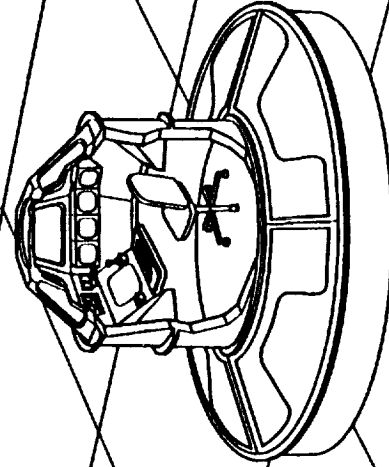
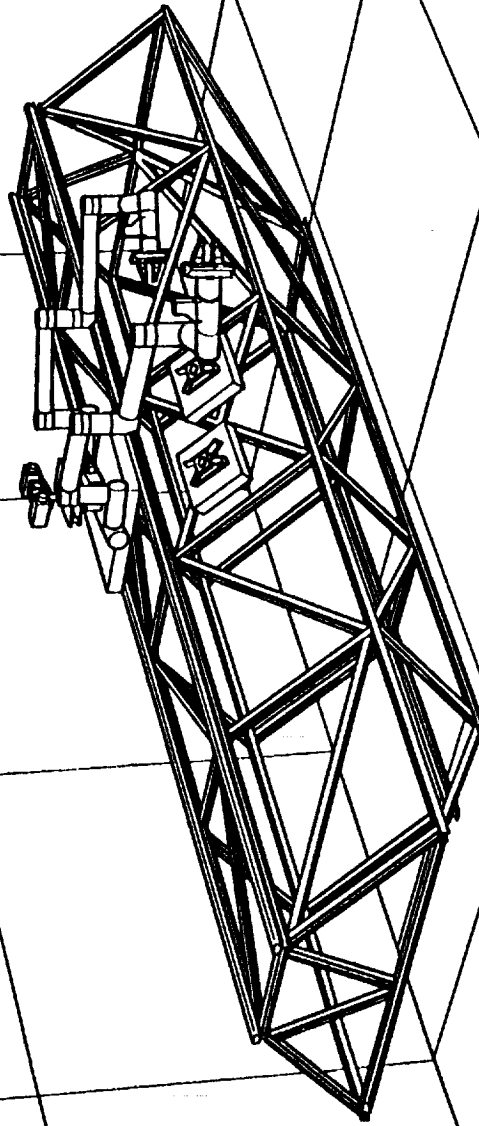

# Dexterous Manipulator Development Laboratory - FY94

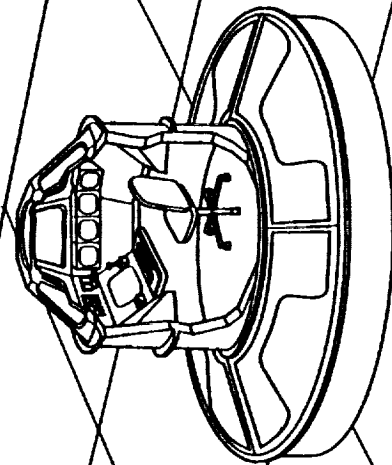
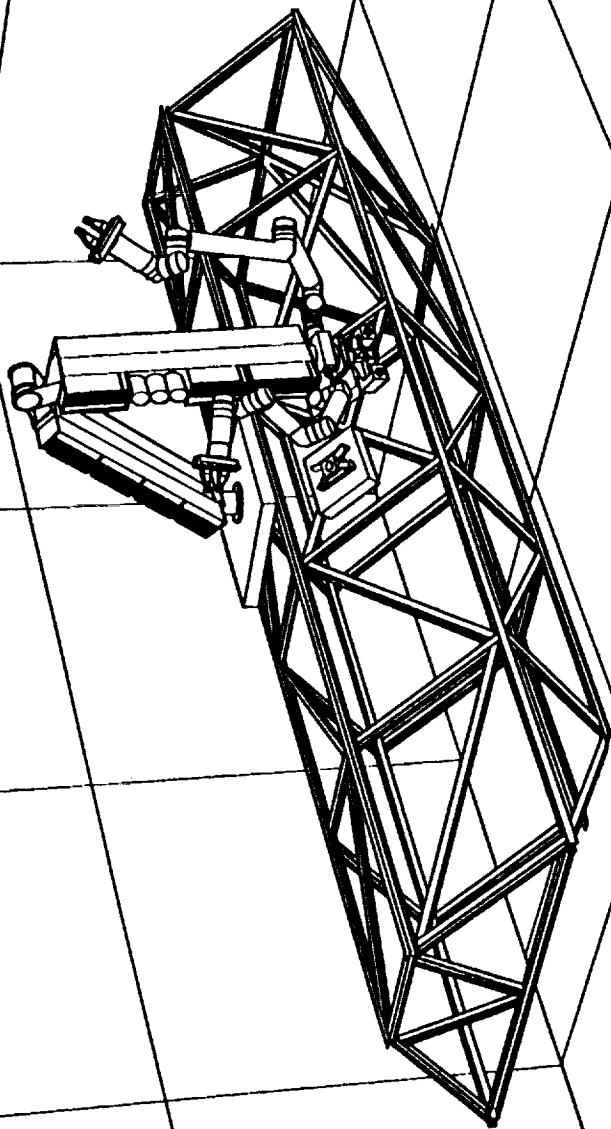

ATB/ISD/FSD 8-NOV-1991

# Apply and Enhance Technology

- Rate Control
- Position Control
- Hand Controllers
- Simultaneous Shared Control
- Degree-of-Automation
- Multiple Arm Control
- Computer Hardware, Software, Communications

# Apply and Enhance Technology (con't)

- Force Accommodation
- Force Reflection
- Vision Control
- Laser Ranging Control
- Redundancy, Hyper-Redundancy
- Dynamics
- Disturbance Compensation

# Program Goals

- Determine reliable and efficient strategies for use of SPDM
- Offer suggestions for SPDM development and usage based on hard operational data
- Develop techniques for non-standard uses of SPDM such as
  - Inspection
  - Maintenance of robot unfriendly components
  - Emergency repairs
- Provide an open resource to test innovative ideas in a realistic environment

# Summary

- Space Station Office has identified robotics as a desired approach for reducing EVA backlog.
- Telerobotic worksite setup has high potential for EVA savings.
- SSF repair is not anticipated, but capability should be available
- Program will add to existing technology base and give confidence to potential robot users.

# Footnote

- FTS Hardware
- Electromagnetic "Glue Gun"

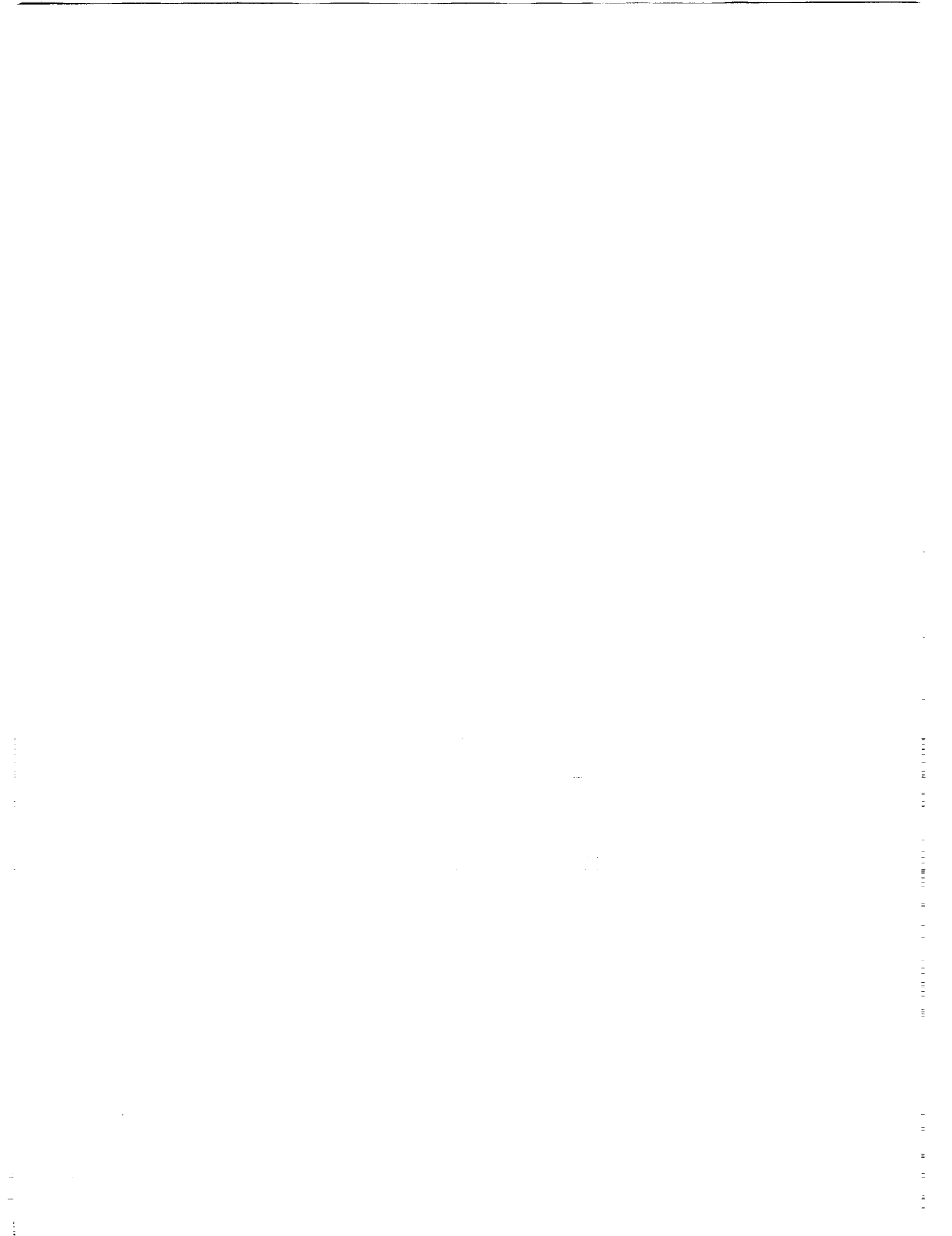



# IVA Robotics for Space Station Freedom

Sharon Monica Jones  
Automation Technology Branch

December 10, 1991

# Objective

To increase the scientific productivity of Space Station Freedom (Spacelab) during the man-tended phase and beyond

# Space Station Freedom Background

- Volume decreased
- Communication capability decreased
- Limited crew visits
- Man-tended phase
  - begins in 1996
  - will last approximately 3 years

# Man-Tended Phase U.S. Lab Module Volume

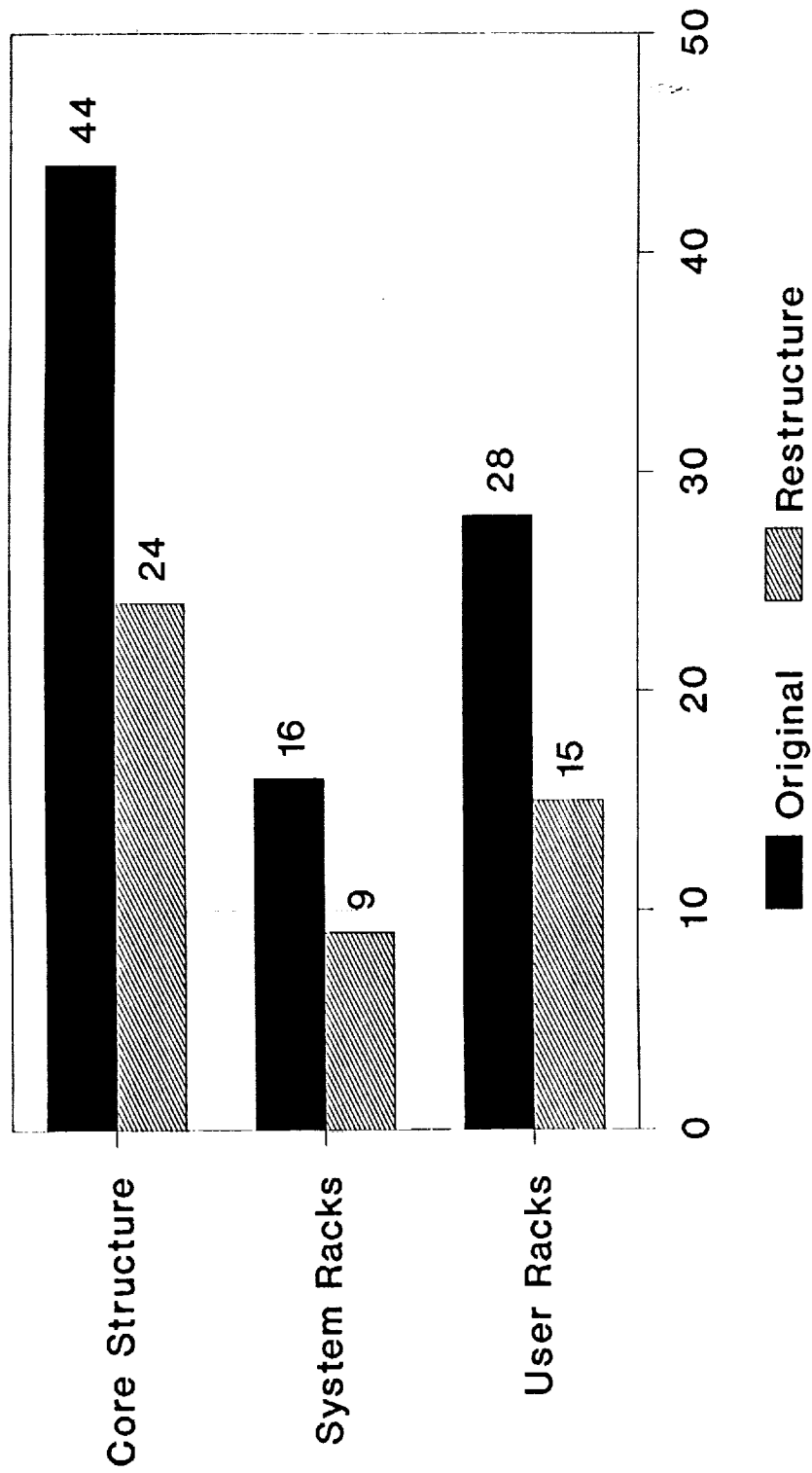

source: LaRC SSFO

# **IVA Robotics**

## **Goals**

- **Increase scientific productivity**
  - more and/or extended experiments
  - less microgravity disturbance
  - in situ monitoring and inspection
  - more efficient rack support utilization
- **Maintain U.S. space telerobotics capability**

# **IVA Robotics**

## **ATB Program Purpose**

**Demonstrate an increase in the productivity of Space Station Freedom experiments through the application of automation technology in a realistic environment**

# **IVA Robotics**

## **Approach**

- **Obtain background information**
- **Construct full scale laboratory module mockup**
- **Install telerobotic system in mockup**
- **Develop functional experiment hardware**
- **Define space IVA telerobotic criteria**

# Experiment Protein Crystal Growth

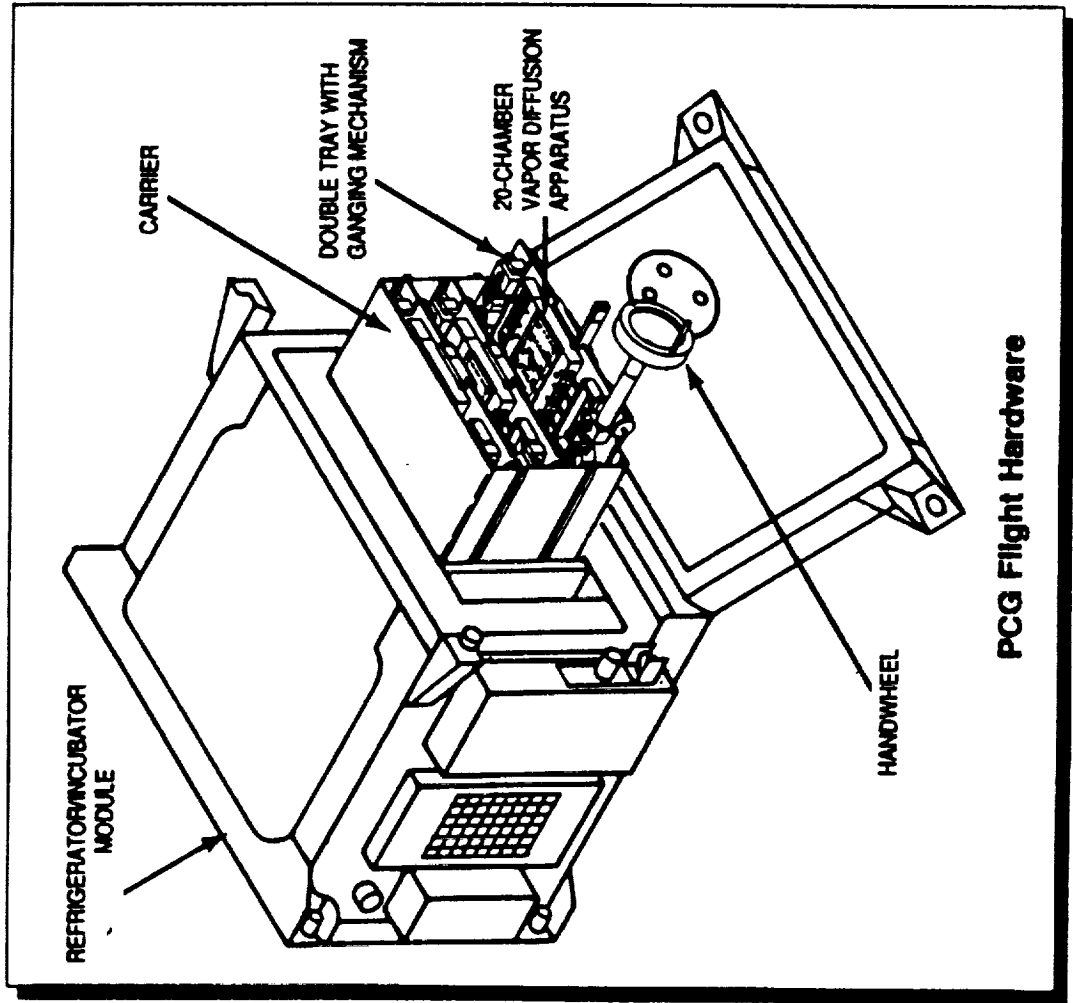



# Equipment Thermal Enclosure System

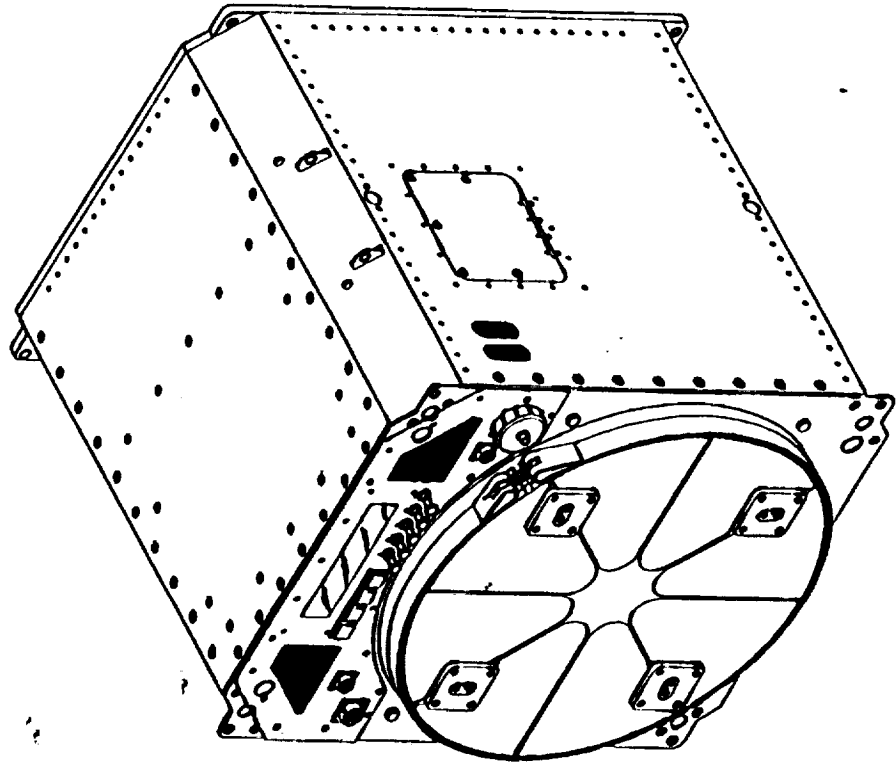

# Candidate Mockup Demonstrations

SPACE STATION EXPERIMENT	SEMICONDUCTOR MATERIALS SOLIDIFICATION	PROTEIN CRYSTAL GROWTH	FLUID PHYSICS	COMBUSTION RESEARCH	FLOAT ZONE CRYSTAL GROWTH	GAS GRAIN SIMULATION	GRAVITATIONAL BIOLOGY
<b>DEMO NO. TASK</b>							
<b>1 SAMPLE CHANGEOUT</b>	DEMO 2	DEMO 1	DEMO 3		DEMO 3		
<b>2 INSPECTION</b>	DEMO 2	DEMO 2			DEMO 3		
<b>2 WASTE GAS DISPOSAL</b>	DEMO 2			DEMO 3			
<b>3 DATA REMOVAL AND STORAGE</b>	DEMO 3						
<b>3 UTILITY HOOK-UPS</b>			DEMO 3				
<b>4 ANIMAL AND PLANT CARE</b>						DEMO 4	DEMO 4

Preliminary Concept for IVAR

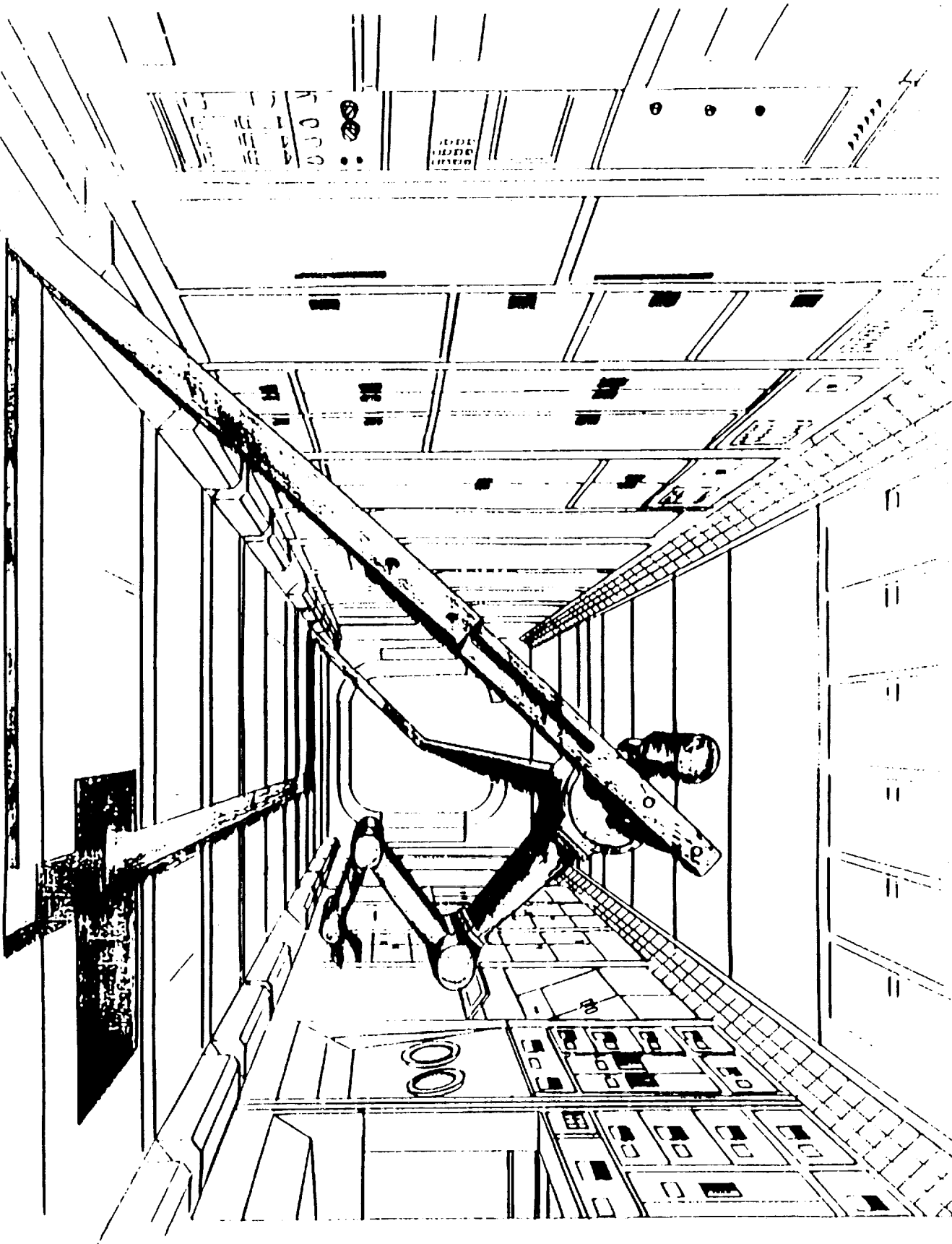

# **IVA Robotics**

## **IVAR Team Members**

- **L. Keith Barker**
- **Walter Hankins**
- **Sharon Monica Jones**
- **Randy Mixon**
- **A. Terry Morris**
- **Kelli Willshire**

# **HAND CONTROLLER STUDY OF FORCE AND CONTROL MODE**

1991 NASA Langley Workshop on Automation and  
Robotics for Space-Based Systems

December 10, 1991

Information Systems Division  
Automation and Technology Branch  
A. Terry Morris

**N 9 2 - 2 7 7 6 7**

# **HAND CONTROLLER STUDY OF FORCE AND CONTROL MODE**

## **O OBJECTIVES**

- COMPARE AND EVALUATE UTILITY AND EFFECTIVENESS OF VARIOUS INPUT CONTROL DEVICES, E.G., HAND CONTROLLERS, WITH RESPECT TO THE RELATIVE IMPORTANCE OF FORCE AND OPERATIONAL CONTROL MODE (E.G., RATE OR POSITION) FOR SPACE STATION RELATED TASKS.

## **O APPROACH**

- STUDIES WERE DONE WITH TWO DIFFERENT MANIPULATOR SYSTEMS  
INTELLIGENT RESEARCH SYSTEMS LAB (ISRL) WITH A PUMA ROBOT AND THE TELEROBOTIC SYSTEMS RESEARCH LABORATORY (TSRL) WITH THE LABORATORY TELEROBOTIC MANIPULATOR (LTM), A MASTER SLAVE SYSTEM
- THREE STUDIES WERE PERFORMED: ONE PILOT STUDY IN ISRL, ONE FULL STUDY IN ISRL, AND ONE FULL STUDY IN TSRL

## **METHOD**

- O SUBJECTS**
  - UNDERGRADUATE ENGINEERING/SCIENCE STUDENTS, AGES 18-29 YEARS, EIGHT IN ISRL, AND EIGHT IN TSRL. AND FOUR OTHER SUBJECTS FOR ISRL PILOT STUDY  
PRACTICED TO PREDETERMINED LEVELS OF PERFORMANCE
- O INDEPENDENT VARIABLES**
  - UP TO FOUR TYPES OF FORCE INFORMATION: NONE, REFLECTION, ACCOMMODATION, REFLECTION PLUS ACCOMMODATION
  - THREE HAND CONTROLLERS: KRAFT, HONEYWELL, TWO 3 DOFS
  - THREE TASKS: STRUT INSERTION, THERMAL BLANKET, DUAL-PEG-IN-HOLE
  - TWO CONTROL MODES: RATE AND POSITION
- O DEPENDENT VARIABLES**
  - TASK AND SUB TASK COMPLETION TIMES, FORCES EXERTED, SUBJECTIVE ASSESSMENTS
- O DATA COLLECTION**
  - DEPENDENT VARIABLE DATA COLLECTED AUTOMATICALLY BY THE SYSTEM.
  - VIDEO AND AUDIO RECORDING.

**ISRL EXPERIMENTAL DESIGN - PILOT EXP**

COMPLETELY RANDOMIZED REPEATED MEASURES DESIGN

(2) HAND CNTRL		KRAFT			HONEYWELL			
(3) TASK		1	2	3	1	2	3	
(2) FORCE		0,1	0,1	0,1	0,1	0,1	0,1	
GENDER	SUBS	TRIALS						
1	1	1-3						
	...							
2	2	1-3						
	3	1-3						
	...							
2	4	1-3						

Do all tasks (in randomized order) within each hand controller, counter balance for force and not force  
 Total of 12 conditions per subject, three trials each.



# ISRL EXPERIMENTAL DESIGN

(3) HAND CNTRL	NON - FORCE REFLECTING	FORCE REFLECTING	
	1 TWO 3 DOFS	2 HONEYWELL	3 KRAFT
(4) FORCE	0 1	0, 1, 2, 3	0, 1, 2, 3
SUBS TRIALS			
1 1-3			
.			
.			
.			
8 1-3			

Counter balance for force conditions  
 Total of 10 conditions per subject, three trials each.  
 Levels of force are : none (0), force accommodation (1),  
 force reflection with accommodation (2),  
 modified force reflection with accommodation (3)

# TSRL FINAL EXPERIMENTAL DESIGN

(2) TASK		1 (peg)	2 (blanket)
(2) FORCE		0,1	0,1
GENDER	SUBS TRIALS		
1	1 1-3		
	2 1-3		
	3 1-3		
	4 1-3		
2	5 1-3		
	6 1-3		
	7 1-3		
	8 1-3		

One-half subjects practice with force reflection, and one-half practice without it.  
 Test with opposite conditions.  
 Do both tasks (in randomized order) , counter balance for force and not force  
 Total of 4 conditions per subject, three trials each. (8 subjects)  
 Force: 0 = no force reflection, 1 = force reflection

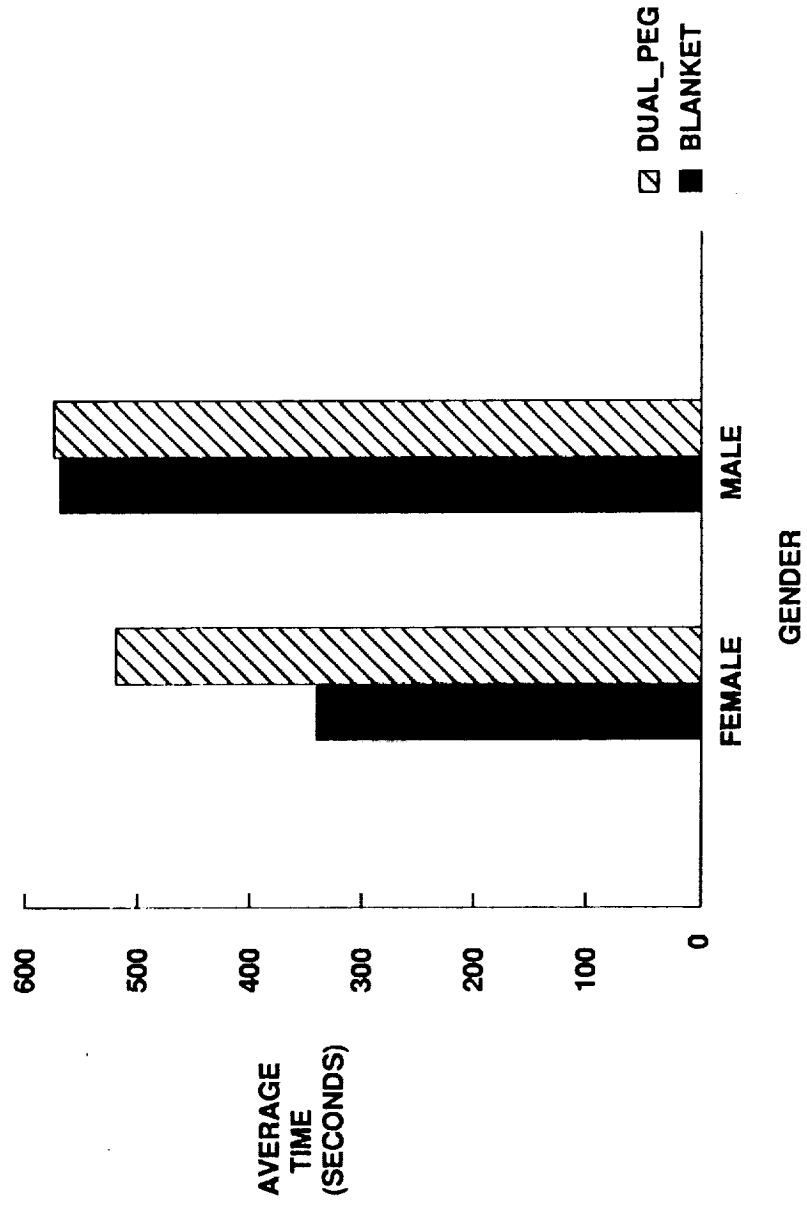

**SIGNIFICANT TASK BY GENDER INTERACTION IN TSRL**

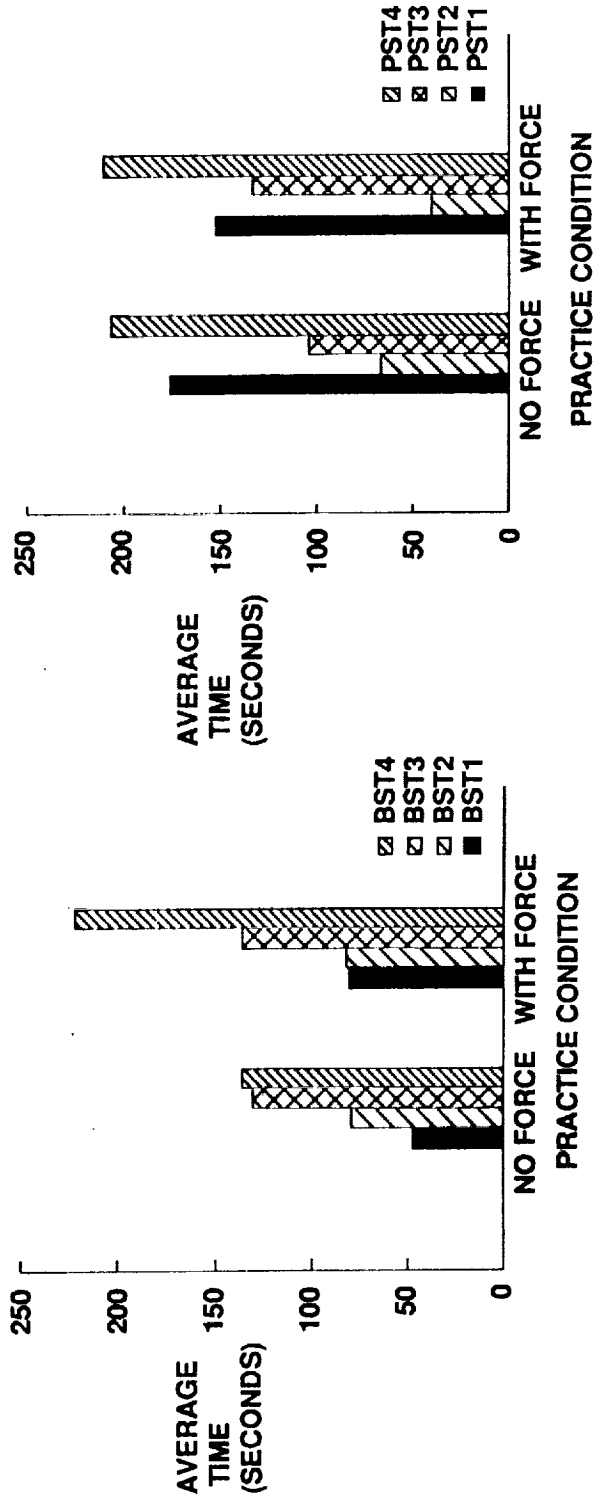

(a) Thermal blanket task

(b) Dual peg task

**SIGNIFICANT PRACTICE BY TASK BY SUBTASK INTERACTION IN TSRL**

# FACTOR ANALYSIS SUMMARY OF RESULTS

TOP THREE OUT OF SEVEN PRINCIPAL COMPONENTS (LINEAR COMPOSITES) FOR EACH CONDITION AND PERCENT OF VARIANCE EXPLAINED BY THEM

	<u>BLANKET. NO FORCE</u>	<u>BLANKET. FORCE</u>	<u>DUAL-PEG. NO FORCE</u>	<u>DUAL-PEG. FORCE</u>
COMPONENT 1	HC CHAR (22.9%)	DEMANDS&TIME (22.775 %)	FRUSTRATION, TASK LOAD (24.896 %)	OVERALL CONDIT, AND TASK LOAD (20.202 %)
COMPONENT 2	TASK RANK/LOAD (20.826)	HC CHAR (18.979)	RANK (15.269)	TEMP DEMAND & EFFORT (PHYS) (NEG) (20.167)
COMPONENT 3	HANDSIZE (17.601)	HANDSIZE (15.823)	PERFORMANCE BY HANDSIZE (14.477 )	HANDSIZE BY PERFORMANCE (19.271)
CUMMULATIVE PERCENT VARIANCE	61.327	57.577	54.637	59.64

# **SUMMARY AND CONCLUSIONS**

## **O TSRL STUDY**

**THERE WAS NO DIFFERENCE BETWEEN FORCE REFLECTION AND NO FORCE FOR THE TASK TIME DATA HOWEVER, SUBJECTIVELY MORE PARTS OF THE BODY WERE IDENTIFIED AS EXPERIENCING DISCOMFORT AND THE FORCE REFLECTION CONDITIONS HAD SOMEWHAT MORE SUBJECTIVE TASK LOAD DEMANDS**

**FEMALES PERFORMED THE THERMAL BLANKET TASK MORE QUICKLY THAN MALES EVEN THOUGH GENDER WAS NOT CORRELATED WITH QUESTIONS ABOUT COORDINATED MOVEMENTS**

**THERE WAS LITTLE RELATIONSHIP BETWEEN AVERAGE TASK TIMES AND MENTAL WORKLOAD RATINGS OR TOTAL TASK LOAD INDEX MEASURES**

**THE KRAFT CONTROLLER WAS SIGNIFICANTLY MORE ACCEPTABLE FOR PERFORMING THE THERMAL BLANKET TASK THAN THE DUAL PEG TASK IN THE AREAS OF TRANSLATION, SINGLE AXIS MOVEMENTS, FINE MOVEMENT, AND GRIP ACCEPTABILITY.**

## **O CONCLUSIONS**

**RESULTS FROM THE TSRL STUDY AGREE WITH JSC STUDY IN THAT NO DIFFERENCE WAS FOUND BETWEEN FORCE REFLECTION AND NO FORCE FOR TASK TIME DATA**

**HOWEVER, GENDER DIFFERENCE HAS NOT BEEN PREVIOUSLY REPORTED AND IS AN AREA FOR FUTURE INVESTIGATION**

**RESULTS FROM TSRL AND ISRL STUDIES WILL BE AVAILABLE FOR THE SPACE STATION PROGRAM TO USE IN MAKING DECISIONS AND DESIGNING FOR SPACE TELEROBOTS**

## RESULTS OF TELEROBOTIC HAND CONTROLLER STUDY USING FORCE INFORMATION AND RATE CONTROL

Kelli F. Willshire, F. Wallace Harrison, and Edward F. Hogge

Automation Technology Branch

Ext. 41965 December 1991

RTOP 595-11-22-01

Code RC

WBS 43

### Research Objective

To evaluate the operator task performance and subjective workload of kinesthetic force feedback and/or local force accommodation as used with three different input control devices (e.g., hand controllers) operating in rate control mode for a Space Station Freedom related task.

### Approach

Two studies were performed in the Intelligent Systems Research Laboratory with PUMA robots remotely operated under rate control using only video camera views without any direct vision. The first, a pilot study, consisted of four inexperienced subjects performing three tasks with two hand controllers, both with and without kinesthetic force feedback, e.g., force reflection. The results were used to select the dual-peg-in-hole task for the second study. For that study, eight new subjects performed the dual-peg task using three hand controllers without any force assistance, with local force accommodation, force reflection combined with local accommodation, and a modified force reflection with local accommodation.

### Accomplishments

All testing has been completed, and the data (except energy) has been reduced. Statistical analysis has been started. Preliminary analysis indicates that there may be a difference between the force conditions for one of the hand controllers (e.g., Honeywell six degree-of-freedom). For that hand controller, the condition of force reflection combined with local force accommodation had the longest average task completion time. Further analyses will more closely investigate these differences as well as their relationship to subjective workload measures.

### Significance

Few studies have investigated the effect of combining force reflection with local force accommodation in a rate control mode. The Space Station Freedom Program is interested in such results and may use this information in deciding upon telerobotic options for the Space Station.

### Future

Further analysis will test the significance of these and other results and their implications for telerobot design.

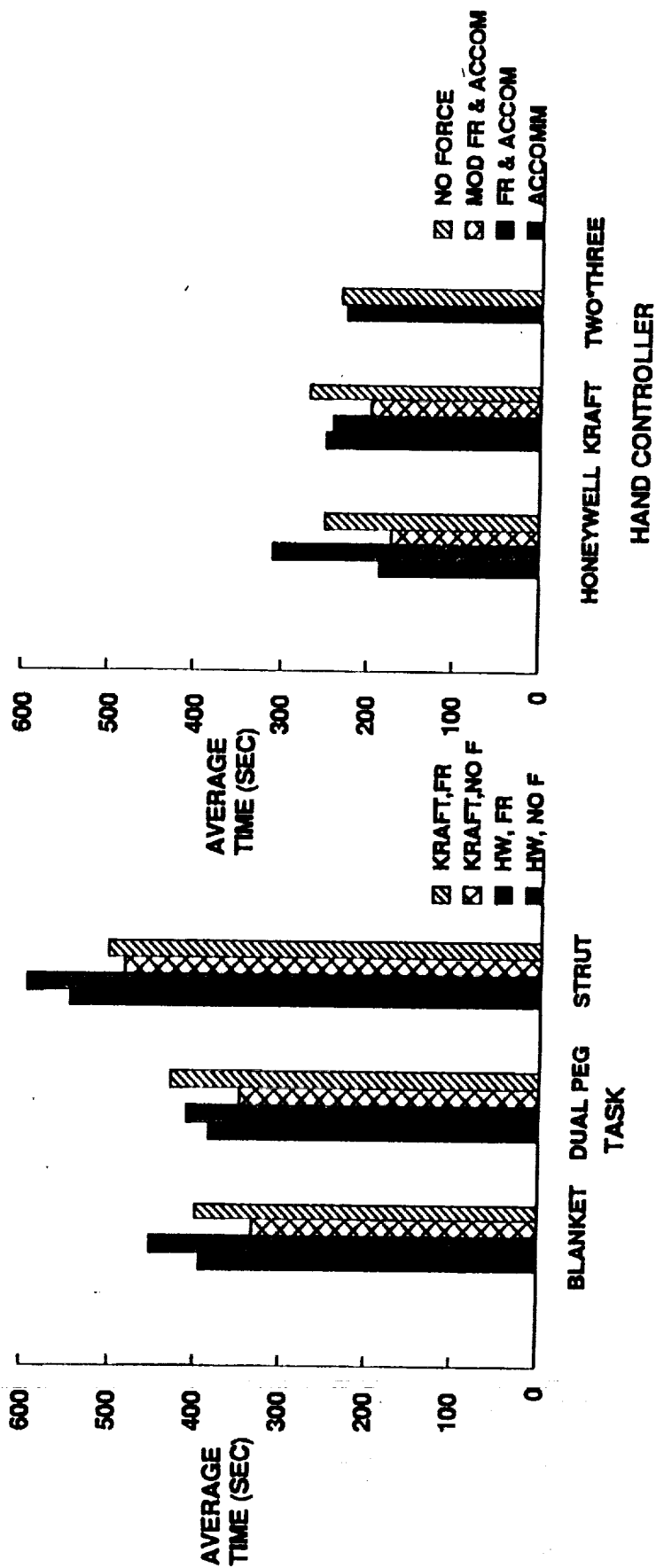

(a) ISRL pilot study mean task times.

(b) ISRL second experiment mean times for dual-peg task.

### ISRL HAND CONTROLLER STUDY MEAN TIMES ACROSS TRIALS



# Coherent Laser RADAR Vision System and Taskspace Identification

Hal Aldridge

NASA Langley Workshop on Automation and  
Robotics for Space-Based Systems  
December 10, 1991

N 9 2 - 2 7 7 6 8

# Why Laser Radar

- Need for quick and accurate 3-D information to complete telerobotic tasks
- Advantages over radio wave based RADAR
  - Shorter minimum range
  - Smaller beamwidth for higher resolution
- Video 3-D imaging techniques are computationally intensive and require a light source
- SONAR cannot be used in space applications

# COHERENT LASER RADAR

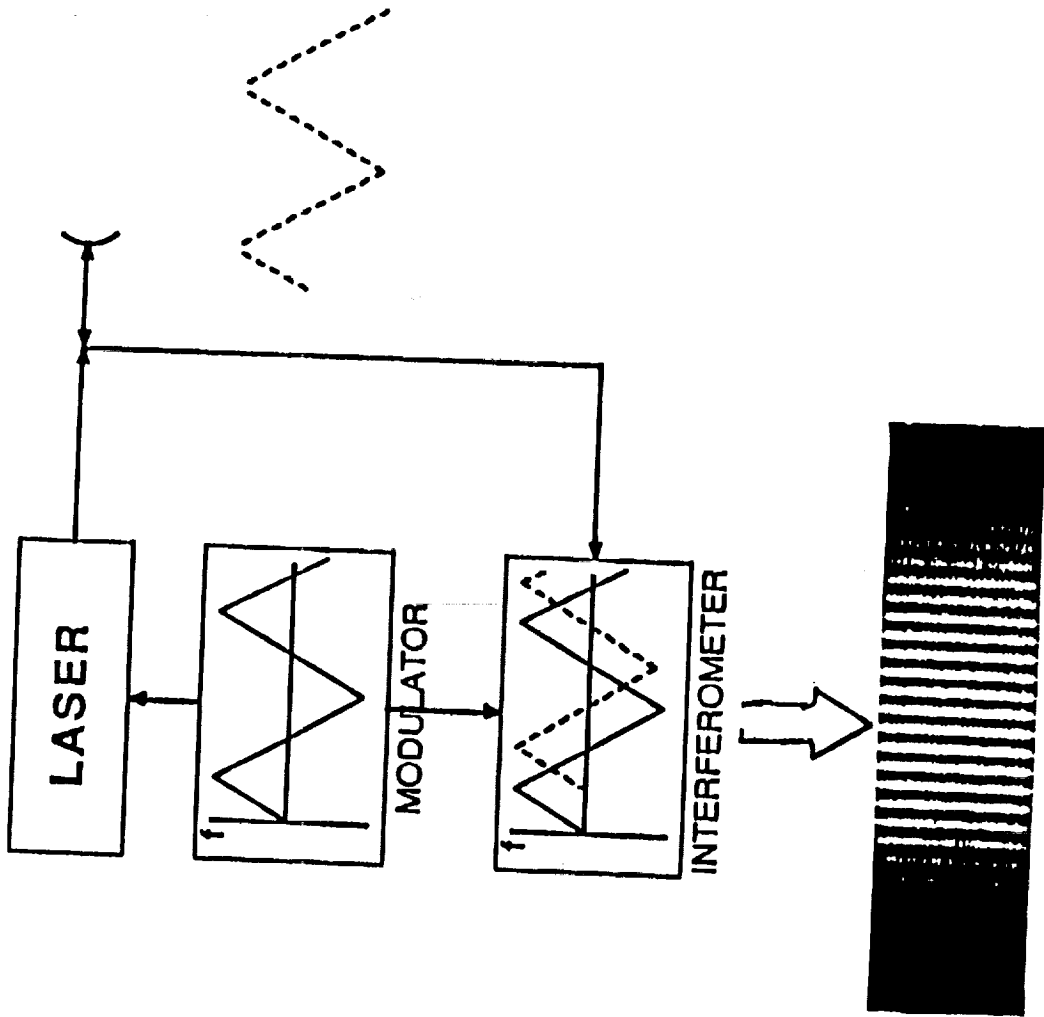

# Why Frequency Modulated Continuous Wave (FMCW) Laser Radar

- Unambiguous Range Measurement
- High Resolution
- Faster and more accurate than Amplitude Modulated (AM) laser radars
- Insensitive to lighting conditions

# FMCW LASER BLOCK DIAGRAM

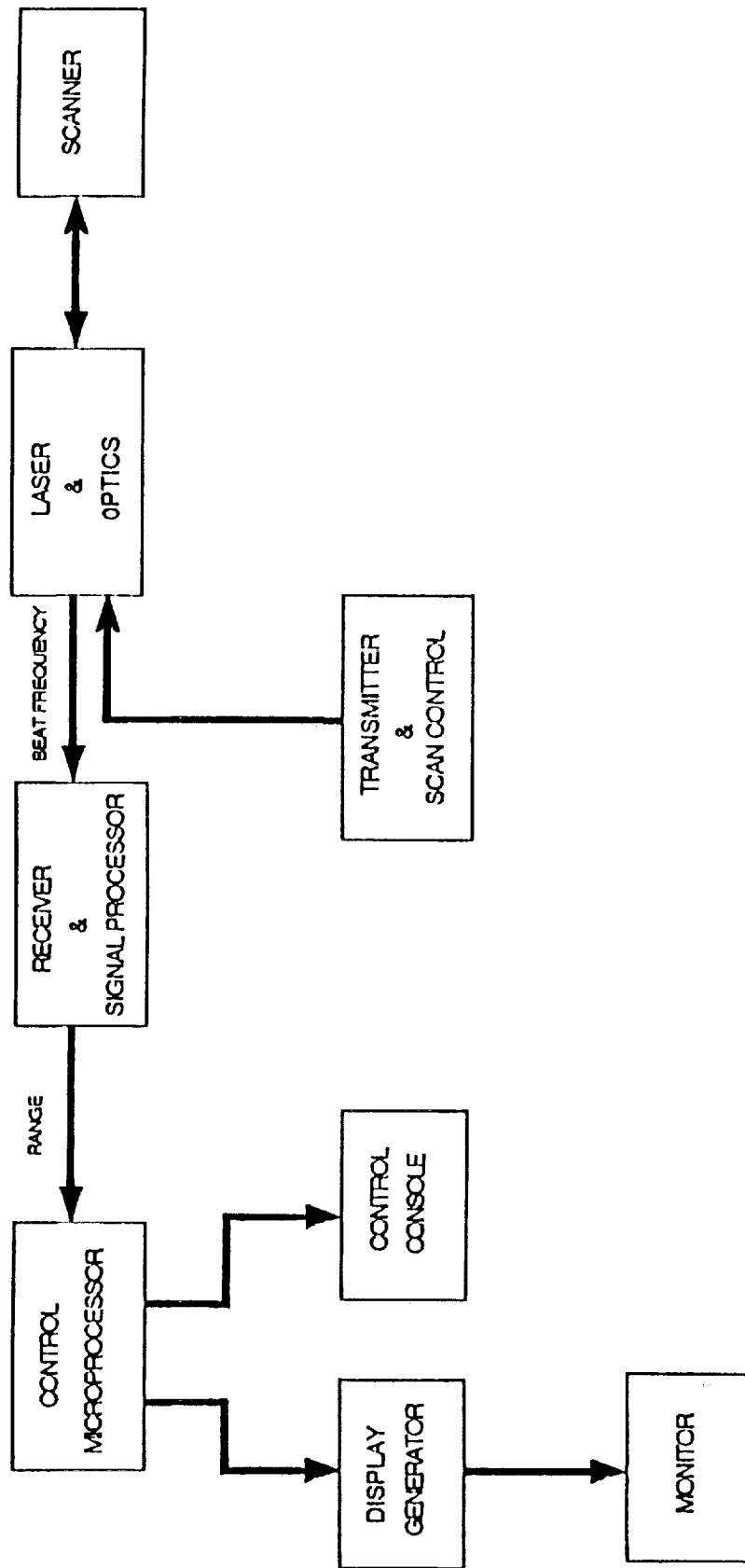

# Current Problems

- Radar too large to be moved by robot
- Delicate scanning mechanism
- Doppler Effect
- Solution - Fiber Optic Based Radar

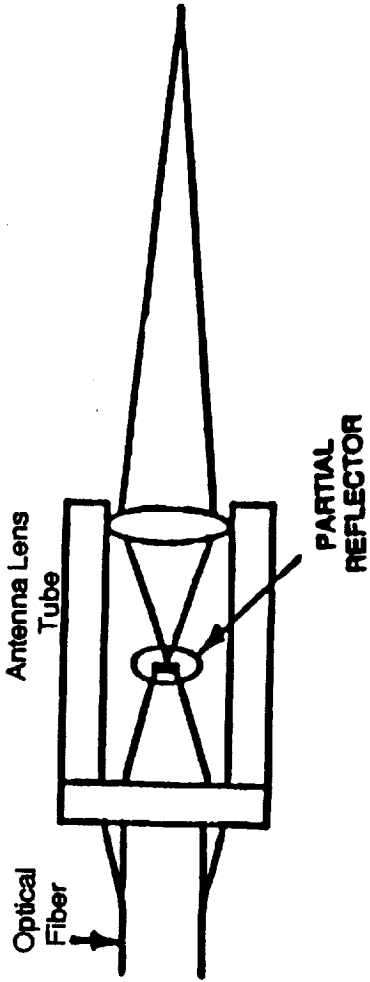

**INDIVIDUAL FIBER SENSOR**

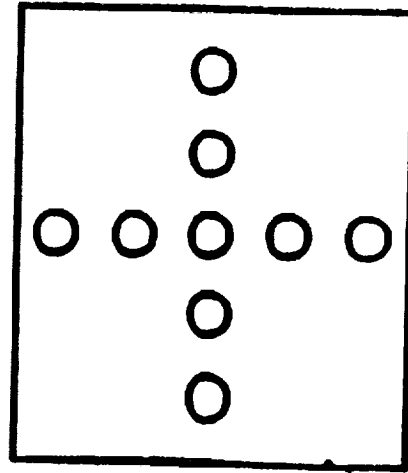

**NINE SENSOR MATRIX  
(Front View)**

# LASER RADAR

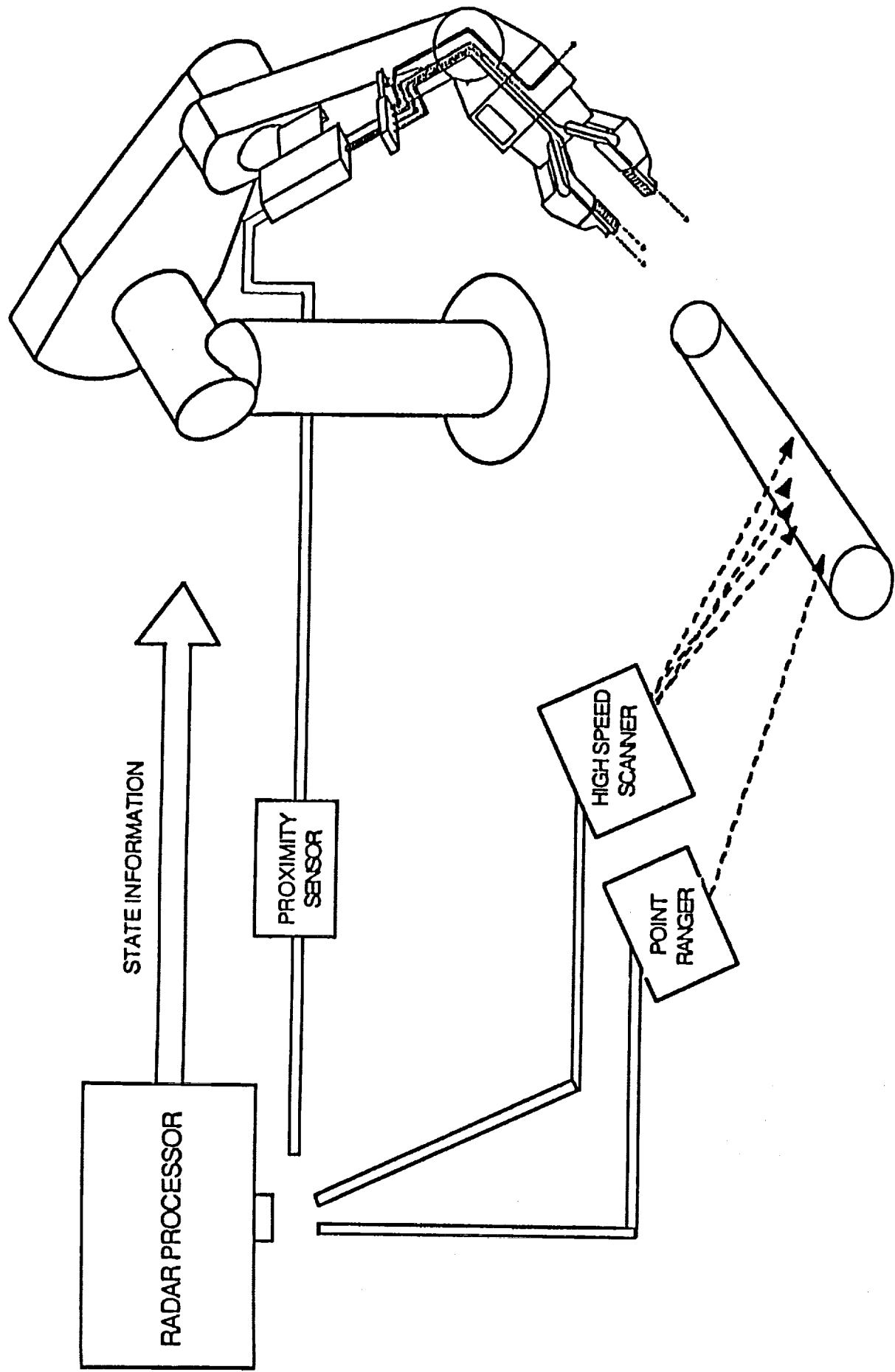



# Neural Networks Modeling and Control of Dynamical Systems

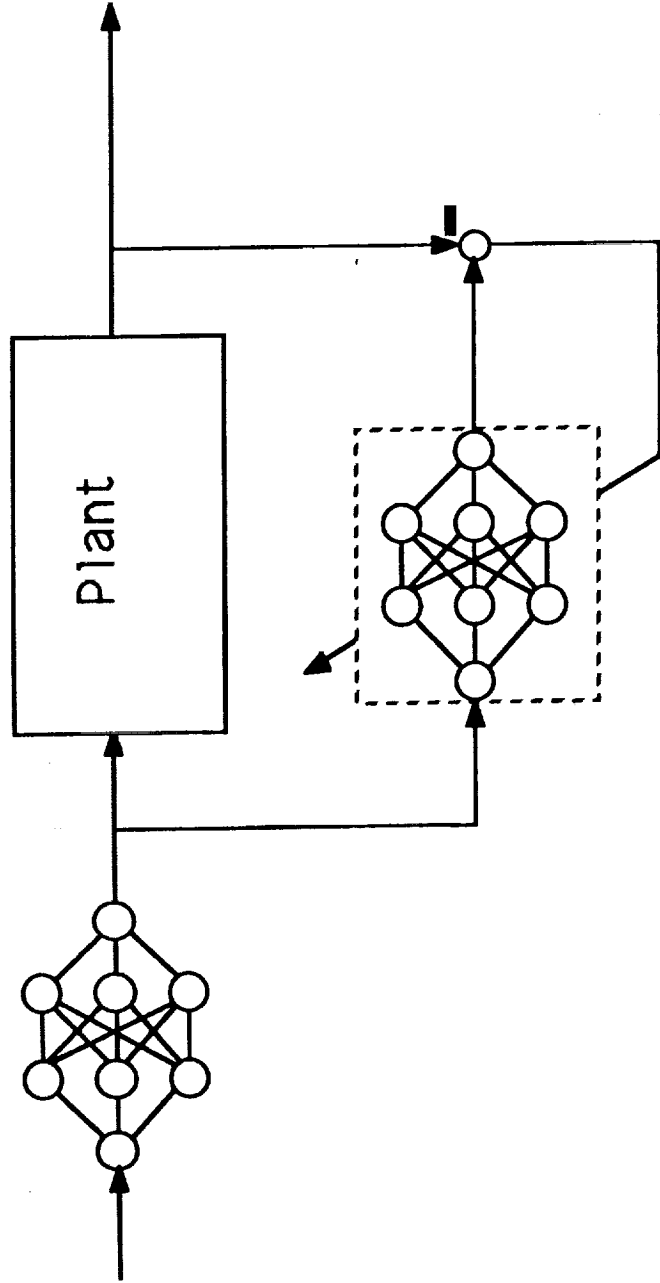

Don Soloway  
Automation Technology Branch

# Outline

1. Overview of Research
2. First Year Research Objectives - Started 5/91
3. Background
4. Current Work
5. Accomplishments from 5/91-9/91
6. Second Year Research Objectives

# Overview

1. **Determine Nonlinear modeling capabilities**
2. **Develop and demonstrate a network controller**
3. **Implement controller in hardware for realtime use**

# **First Year Research Objective**

- 1. Determine capabilities and limitation of neural networks as non-linear modelers**
- 2. Determine the applicability of neural networks as system controllers.**

# Background

1. The initial problem
2. Overview of Neural Networks

# The Problem

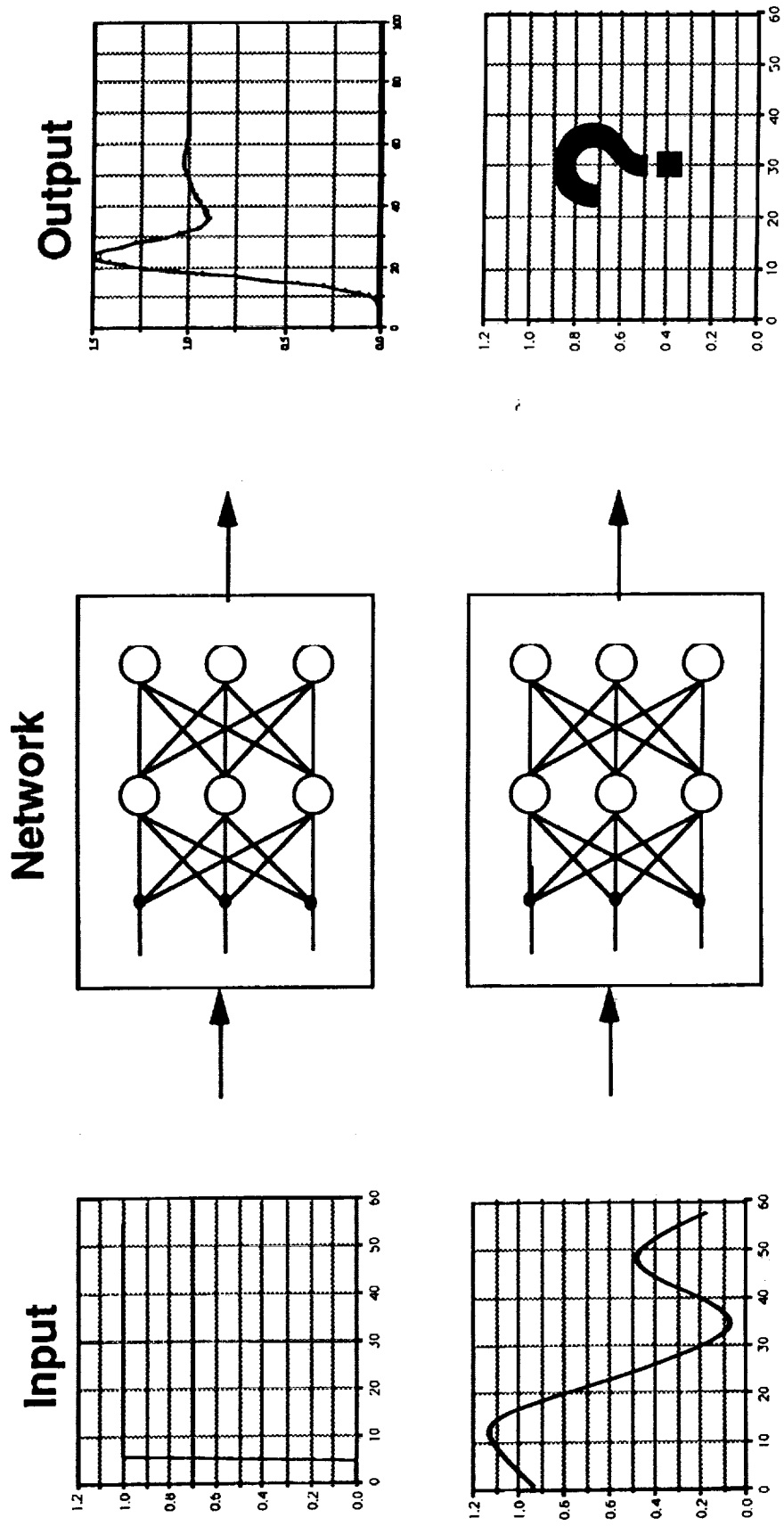

# Network Architecture

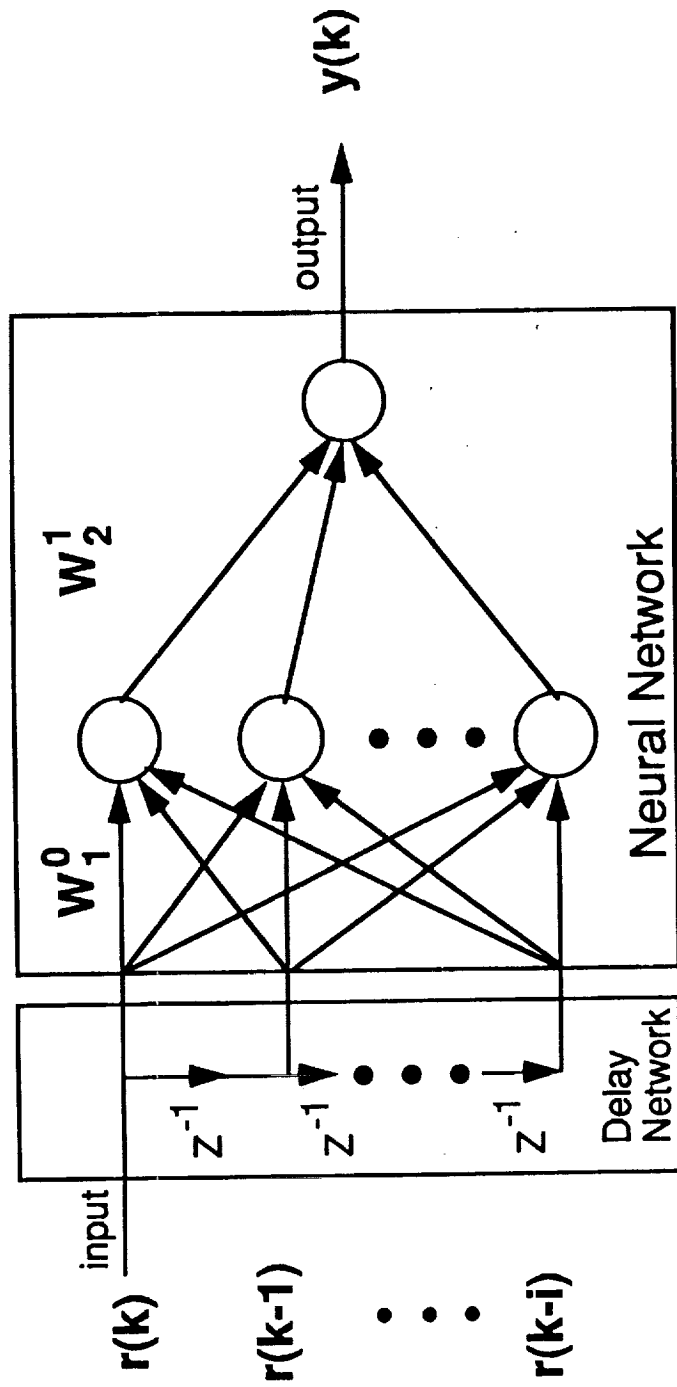

# APPROACH

1. Train the network on the dynamics of a known system.
2. Analyze the learned weights and compare with the dynamic model.

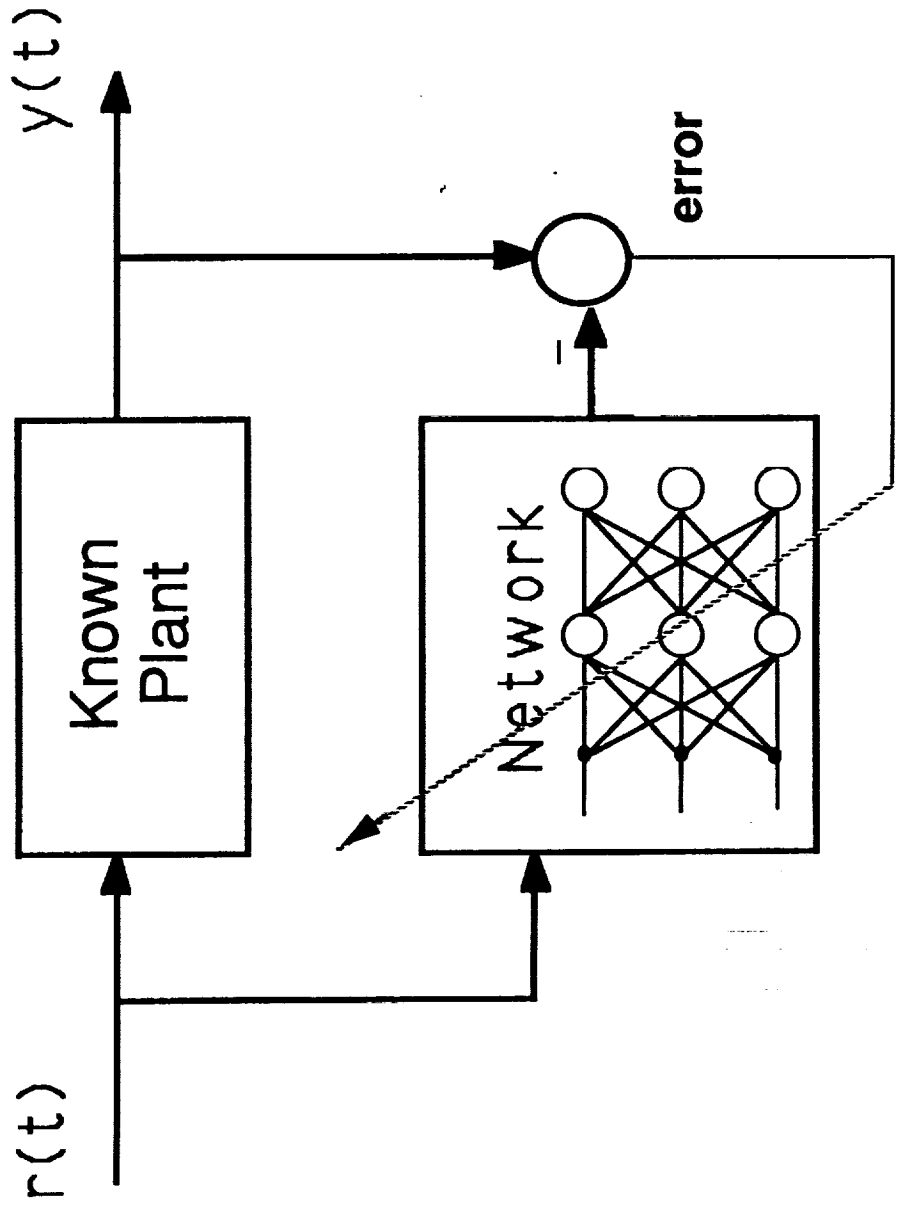



# Step Response of Network

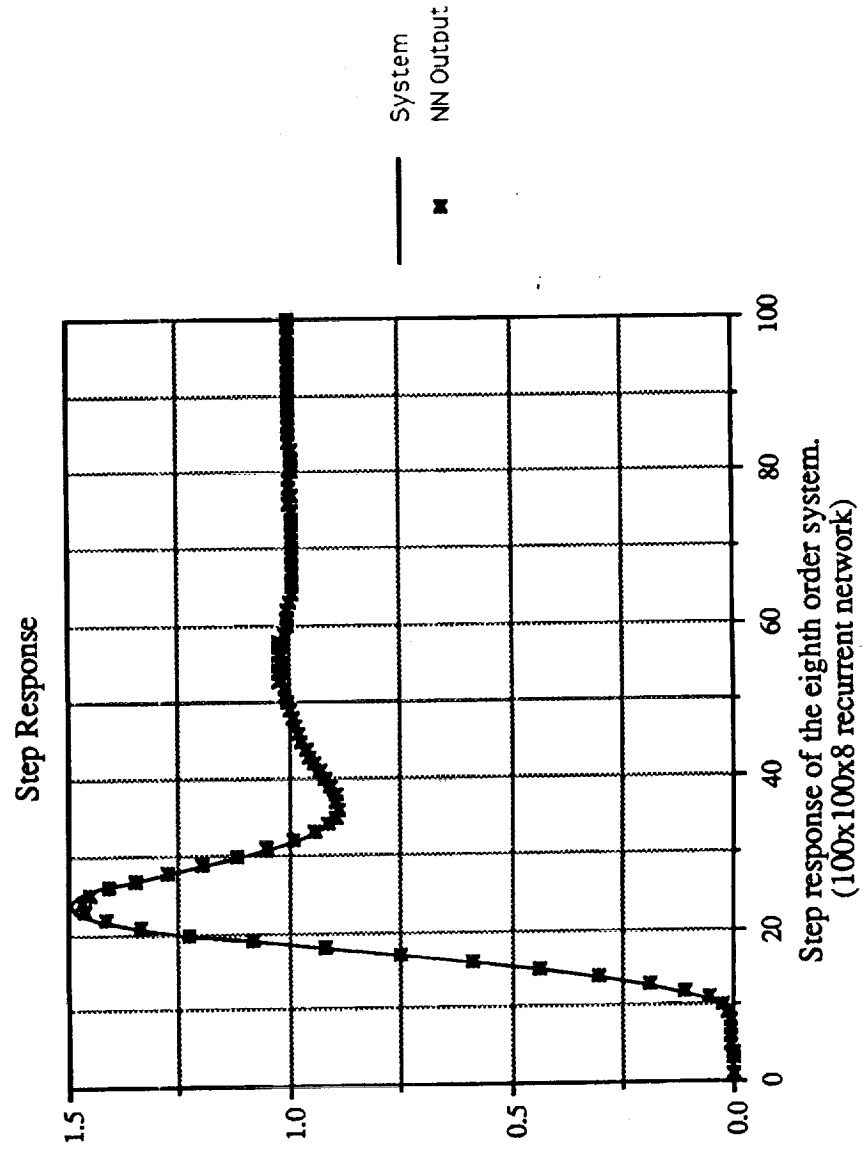

# Analysis

## Linear System

$$y(k) = ( h(0) + h(1) z^{-1} + \dots + h(N) z^{-N} ) r(k)$$

Let us define the operator  $Z^{-1}$

$$Z^{-1} r(k) = [ r(k) \quad r(k-1) \quad \dots \quad r(k-N) ]$$

So

$$y(k) = [ h(0) \quad h(1) \quad \dots \quad h(N) ] [ Z^{-1} r(k) ]$$

## Neural Network

Let us assume linear node, then

$$y(k) = W_2^0 [ Z^{-1} r(k) ]$$

where

$$W_2^0 = W_1^0 W_2^1$$

so

$$[ h(0) \quad h(1) \quad \dots \quad h(N) ] = W_2^0$$

# Impulse Response

After being trained on a step response.

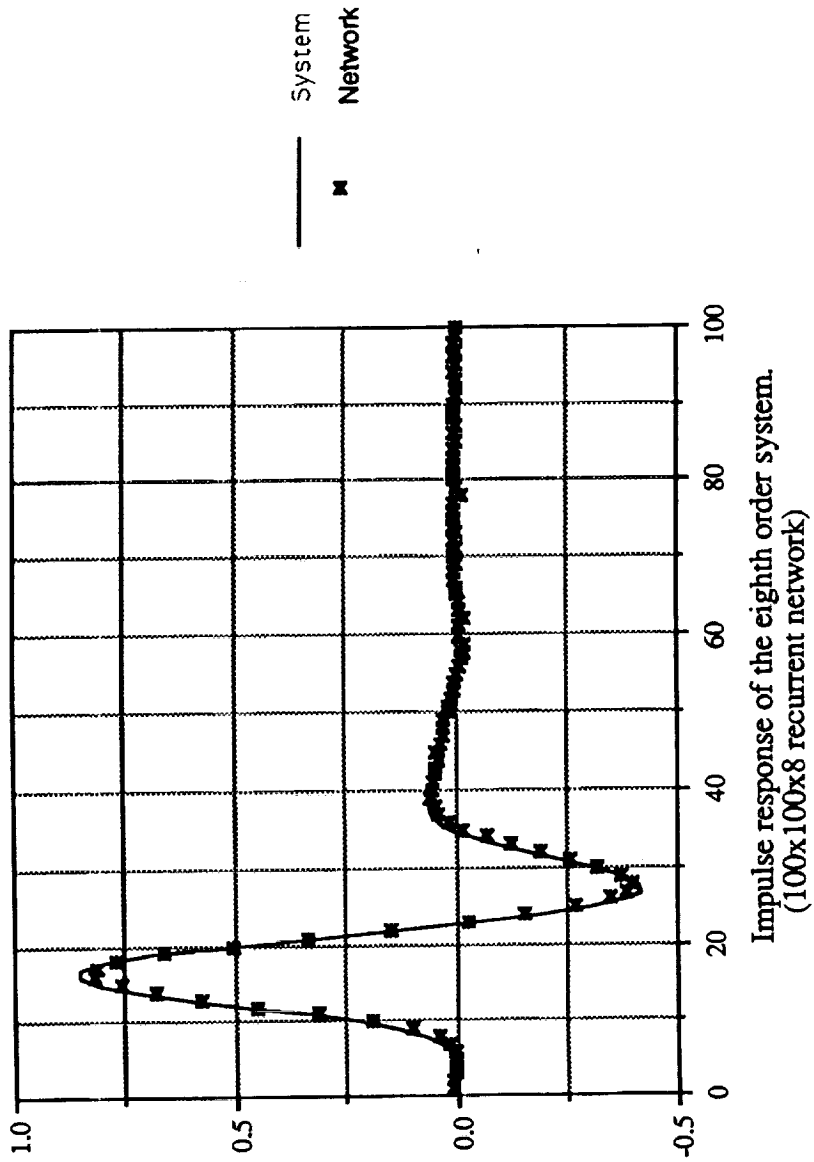

# Extending The Work to Non-linear

We have shown for a linear dynamical system

$$\dot{y}(t) = f(t, y(t), u(t)) \quad , \quad y(t) = \int h(\tau) u(t-\tau) d\tau$$

where  $y$  is the state vector

$f(\cdot)$  is the dynamical system

$h(t)$  is the impulse

$u(t)$  is the input

That  $h(t)$  can be extracted out of the neural network.

If the system  $f$  is non-linear and analytic, then

The general solution is

$$y(t) = \int h(\tau) u(t-\tau) d\tau + \iint h(\tau_1, \tau_2) u(t-\tau_1) u(t-\tau_2) d\tau_1 d\tau_2 + \iiint h(\tau_1, \tau_2, \tau_3) u(t-\tau_1) u(t-\tau_2) u(t-\tau_3) d\tau_1 d\tau_2 d\tau_3 \dots$$

# Discrete Volterra Series

$$y(t) = \int h_1(t) x(t-\tau) d\tau + \iint h_2(\tau_1, \tau_2) x(t-\tau_1) x(t-\tau_2) d\tau_1 d\tau_2 + \dots$$

Discreteizing we get

$$y(k) = \sum_n h_1(n) x(k-n) + \sum_{n_1 n_2} h_2(n_1, n_2) x(k-n_1) x(k-n_2) + \dots$$

Where  $h_1$  is a one dimensional finite impulse response  
and  $h_2$  is a two dimensional finite impulse response.

# Neural Networks and Volterra Series

We have shown that by taking the Taylor expansion of the neural network equations and matching the terms in the Volterra series we get:

$$h_1(k) = \sum_j W_j W_{j,k} (1 - \tanh^2(b_j))$$

$$h_2(k,l) = \sum_j W_j W_{j,k} W_{j,l} (2 \tanh(b_j) - 2 \tanh^3(b_j))$$

$$h_3(k,l,m) = \sum_j W_j W_{j,k} W_{j,l} W_{j,m} (-2 + 8 \tanh(b_j) - 6 \tanh^3(b_j))$$

Where  $W_j$  is the weight from the internal node to the output node.

$W_{j,k}$  is the weight from the  $k$  input node to the  $j$  internal node.

$b_j$  is the bias on the  $j$  hidden node.

# Example

## Imperfect Square - Law Device

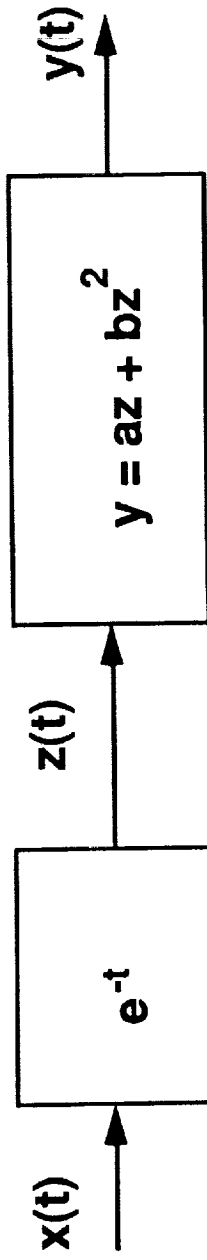

$$y(t) = f(t, x(t))$$

The solution is

$$h_1(t_1) = ae^{-t_1}$$

$$\text{and } h_2(t_1, t_2) = be^{-(t_1+t_2)}$$

# Results

$$h_2(\tau_1, \tau_2) = 0.04 e^{-(\tau_1 + \tau_2)} \sum_j W_j W_{j, \tau_1} W_{j, \tau_2} (2 \tanh^3(b_j) - 2 \tanh(b_j))$$

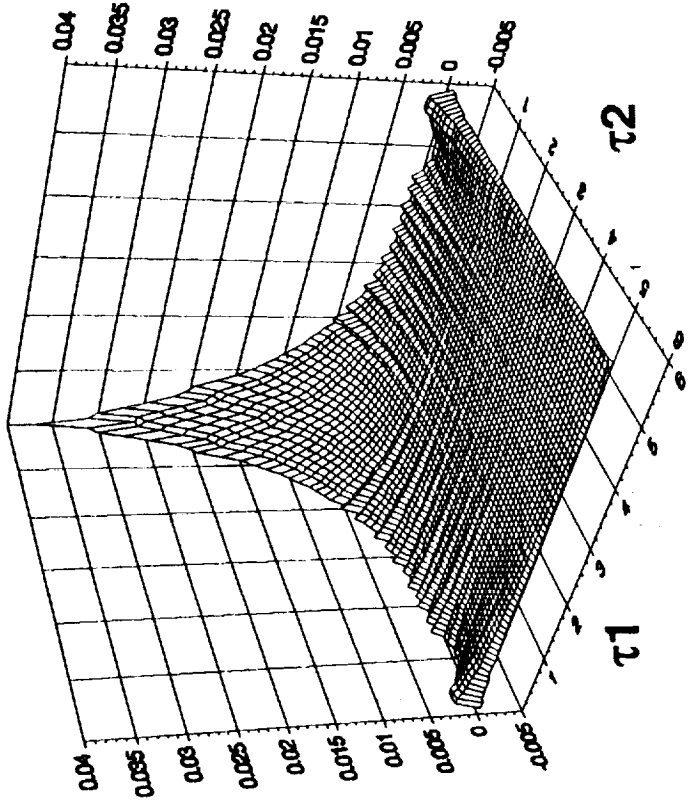
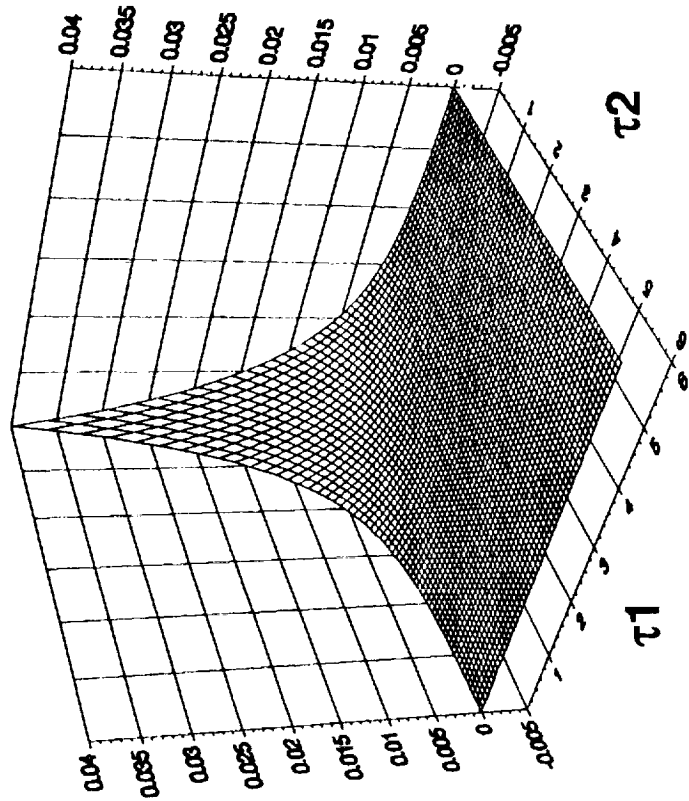



# **Accomplishments**

**In First Five Months 5/91 - 9/91**

- 1. Analyzed analytic nonlinear systems with neural networks**
- 2. Found analytical approach to the modelling**
- 3. Extended linear theory to nonlinear theory**  
**Generating two publications**
  - 1. Submitting to the IEEE Conference on Intelligent control**
  - 2. Submitting to the International Journal of Neural Networks**
- 4. Began beta testing of neural network control code.**

# Objectives for the Next Year

1. Finish Volterra series analysis
2. Investigate capabilities and limitations of a Neural Network with feedback.  
( this configuration should allow the neural network to learn models that the volterra series cannot model )
3. Start Investigating the Neural Network as a Controller
4. Develop neural network hardware

# **Adaptive Artificial Neural Network for Autonomous Robot Control\***

**Michael K. Arras, Peter W. Protzel, Daniel L. Palumbo**

**Institute for Computer Applications in Science  
and Engineering (ICASE)  
NASA Langley Research Center, Hampton, Virginia**

**N 9 2 - 2 7 7 7 0**

---

\* This research was supported by the National Aeronautics and Space Administration under NASA Contract No. NAS1-18605.

# Neural Network Controller for Robot Arm Positioning with Visual Feedback

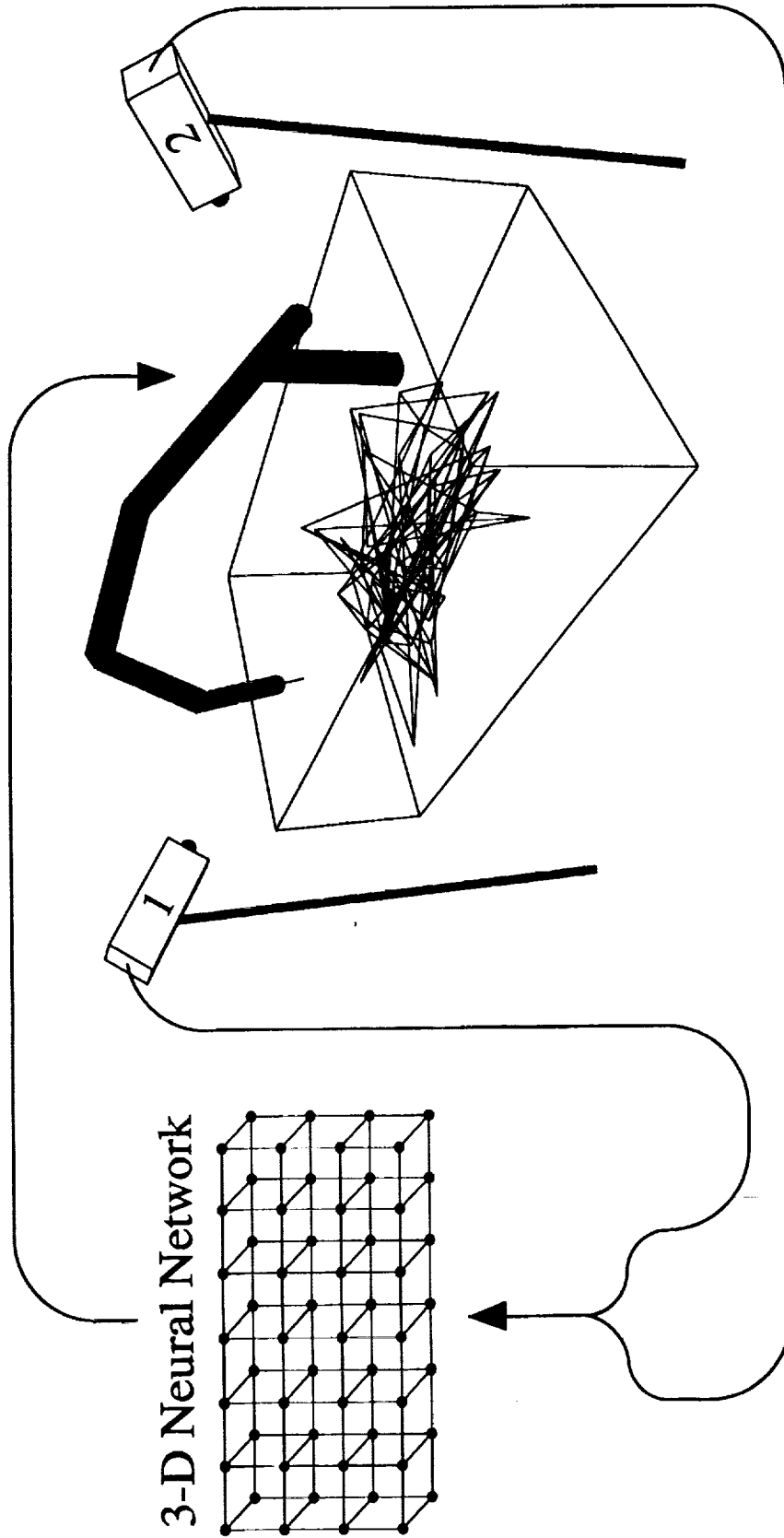

Initial State of the Network

# View from both Cameras

Camera 1

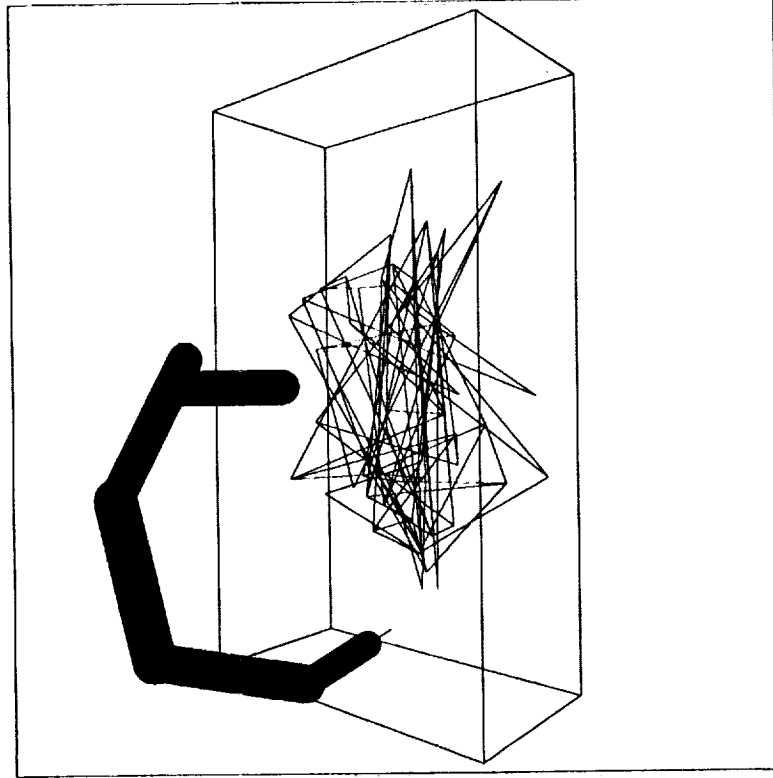

Camera 2

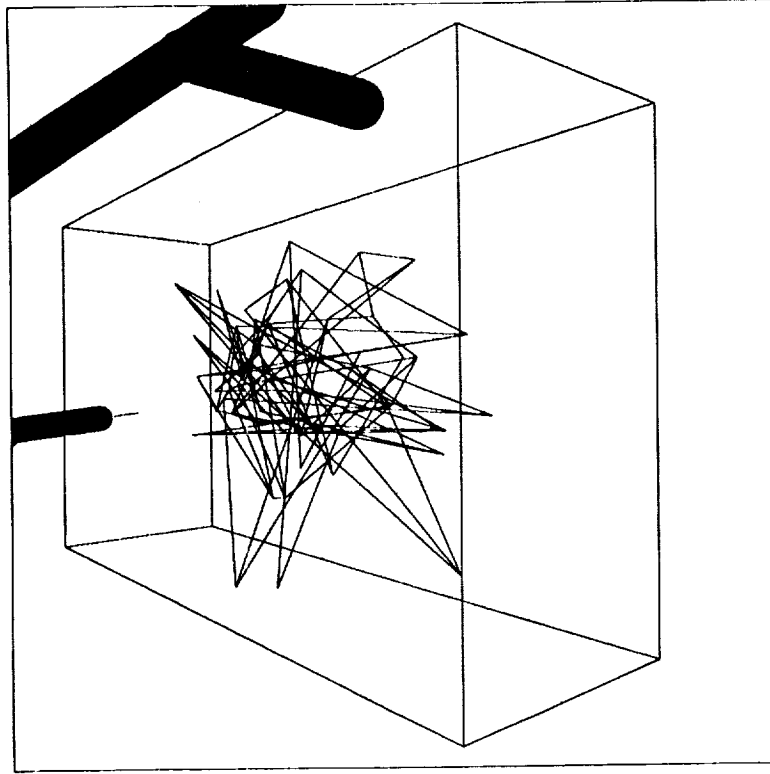

# Initial State of the Network

# Neural Network Controller for Robot Arm Positioning with Visual Feedback

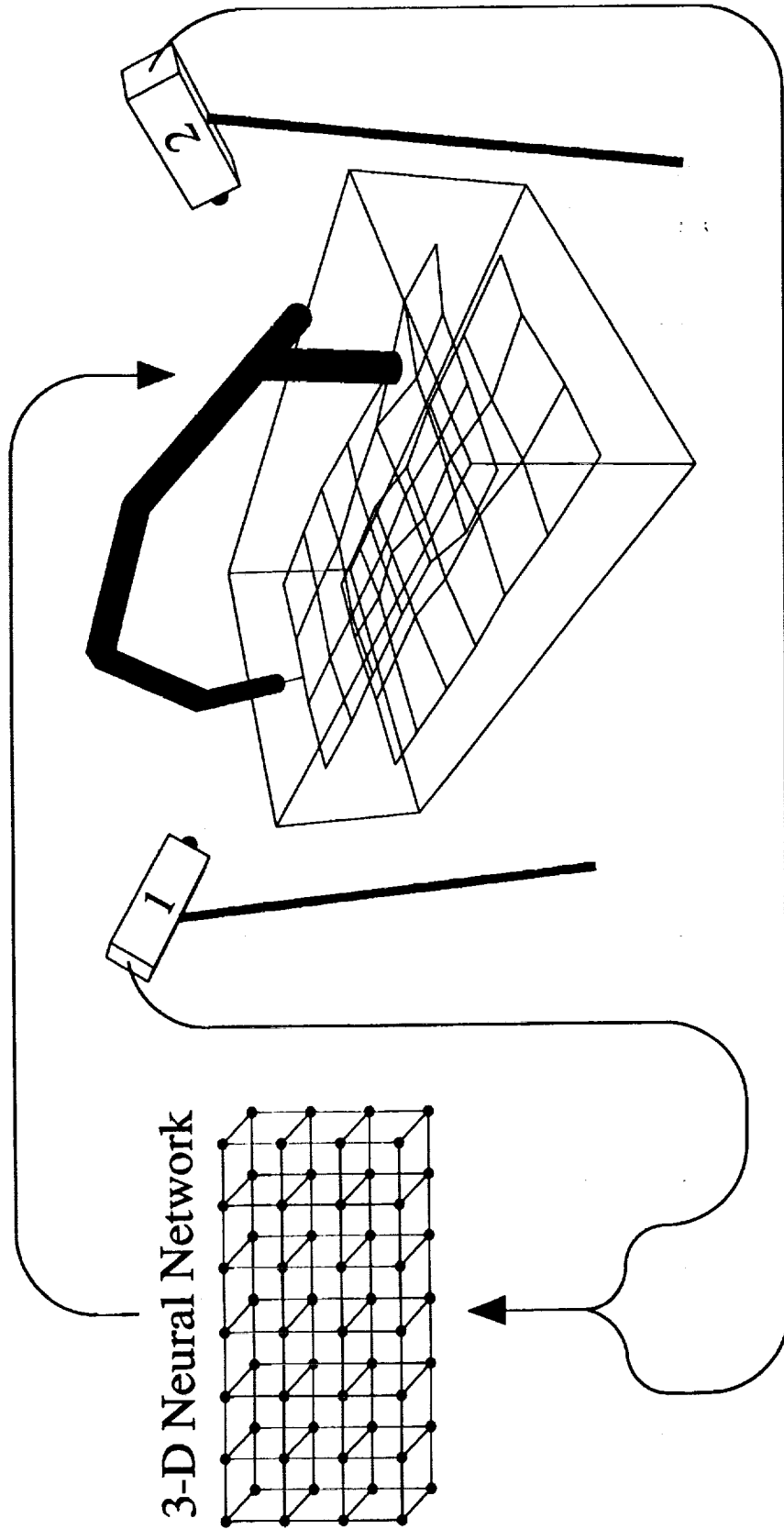

State of the Network After Training

# Initial Training of the Arm

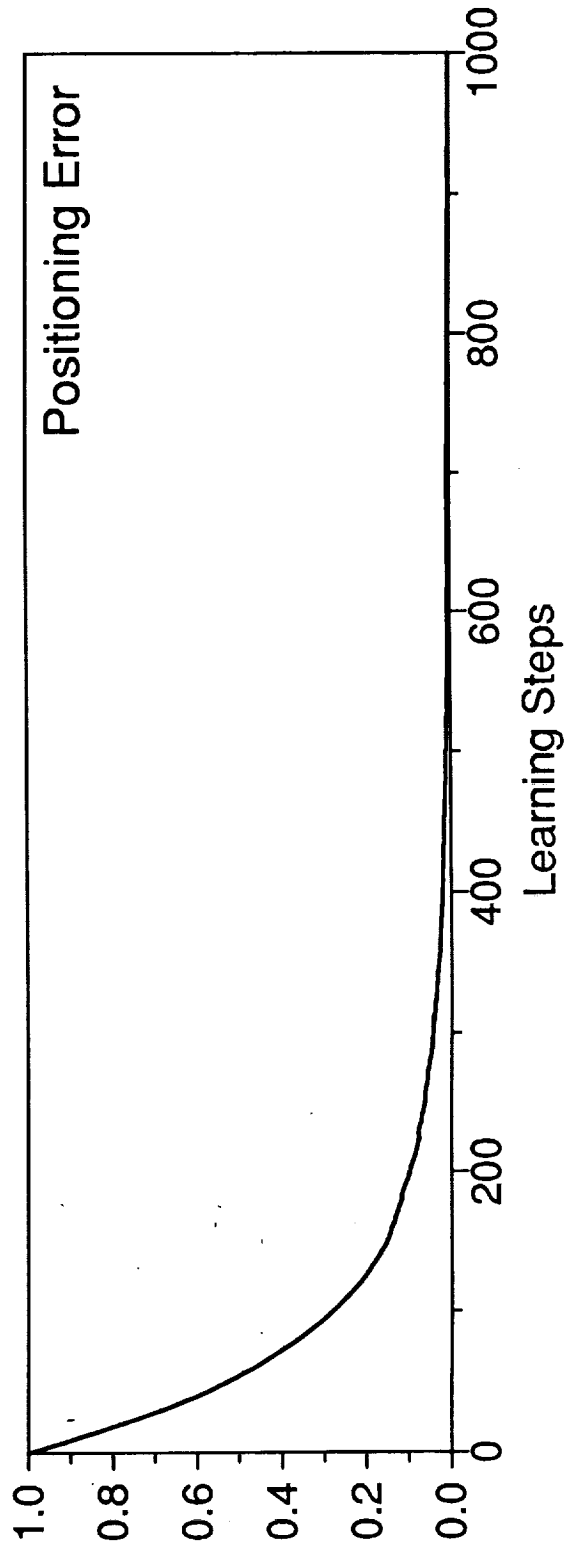
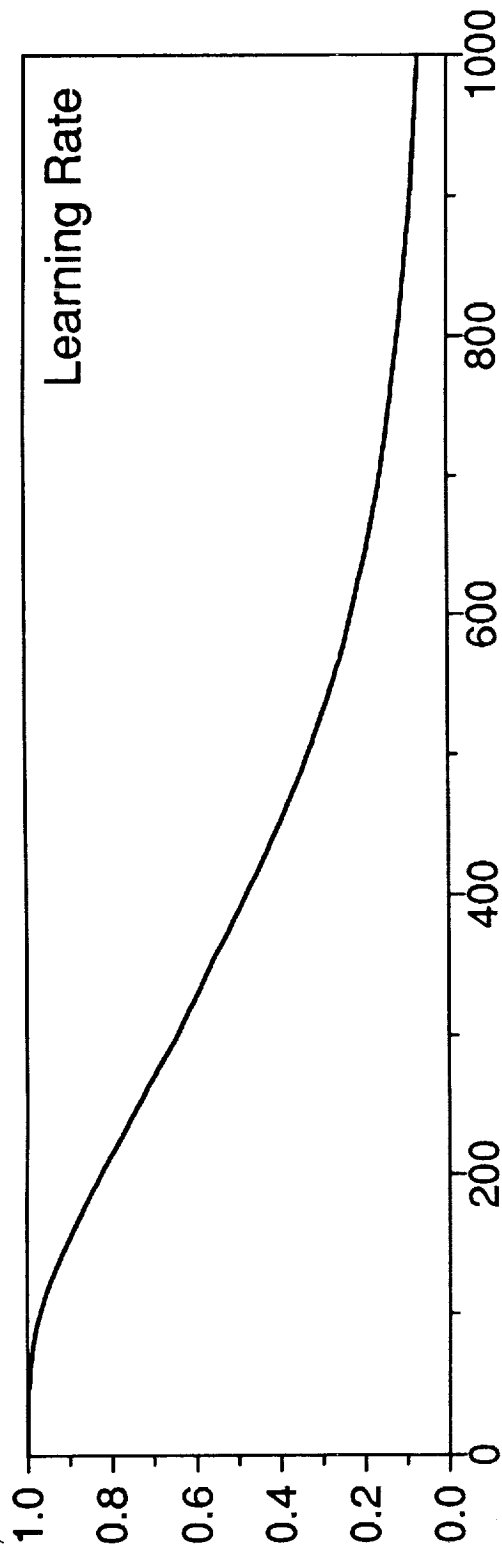

# Automatic Recovery From Cumulative Fault-Scenarios

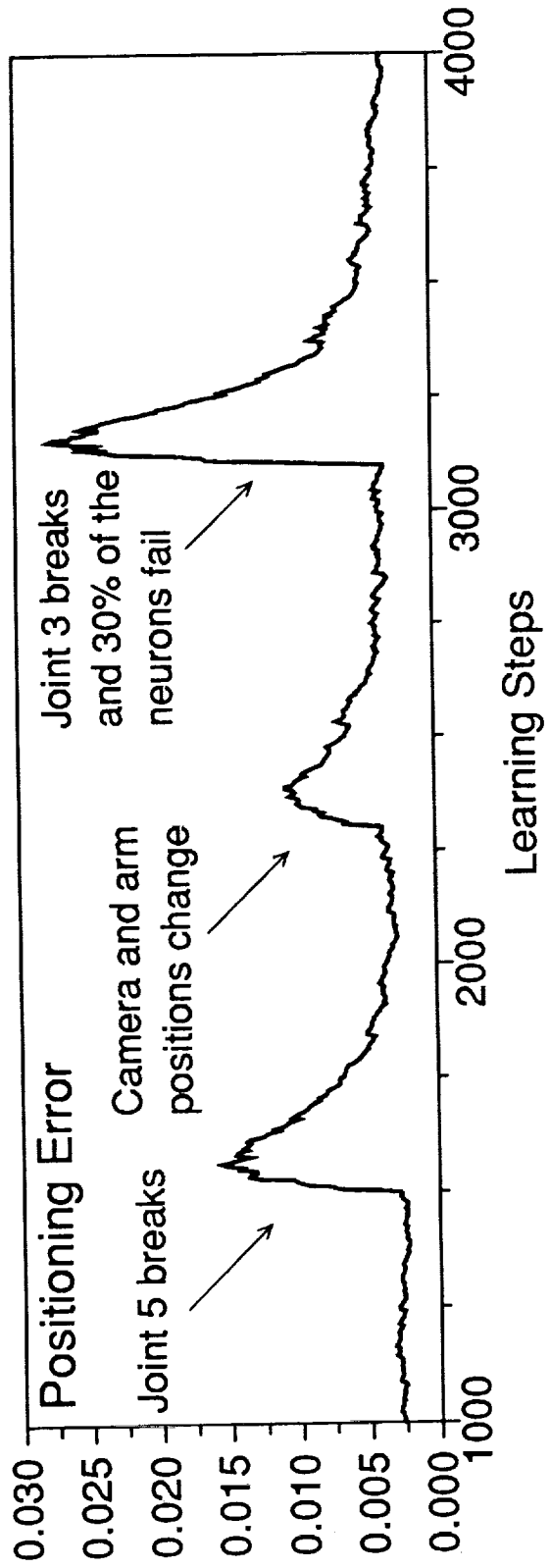
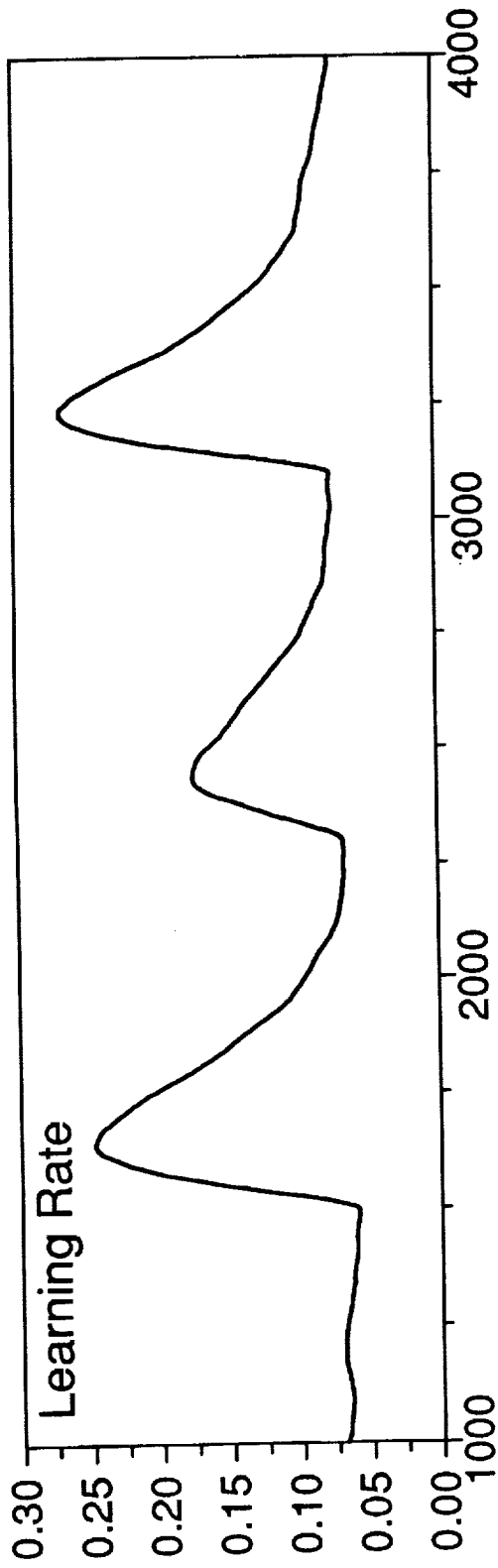



# Error Reduction by Iterative Fine Movements

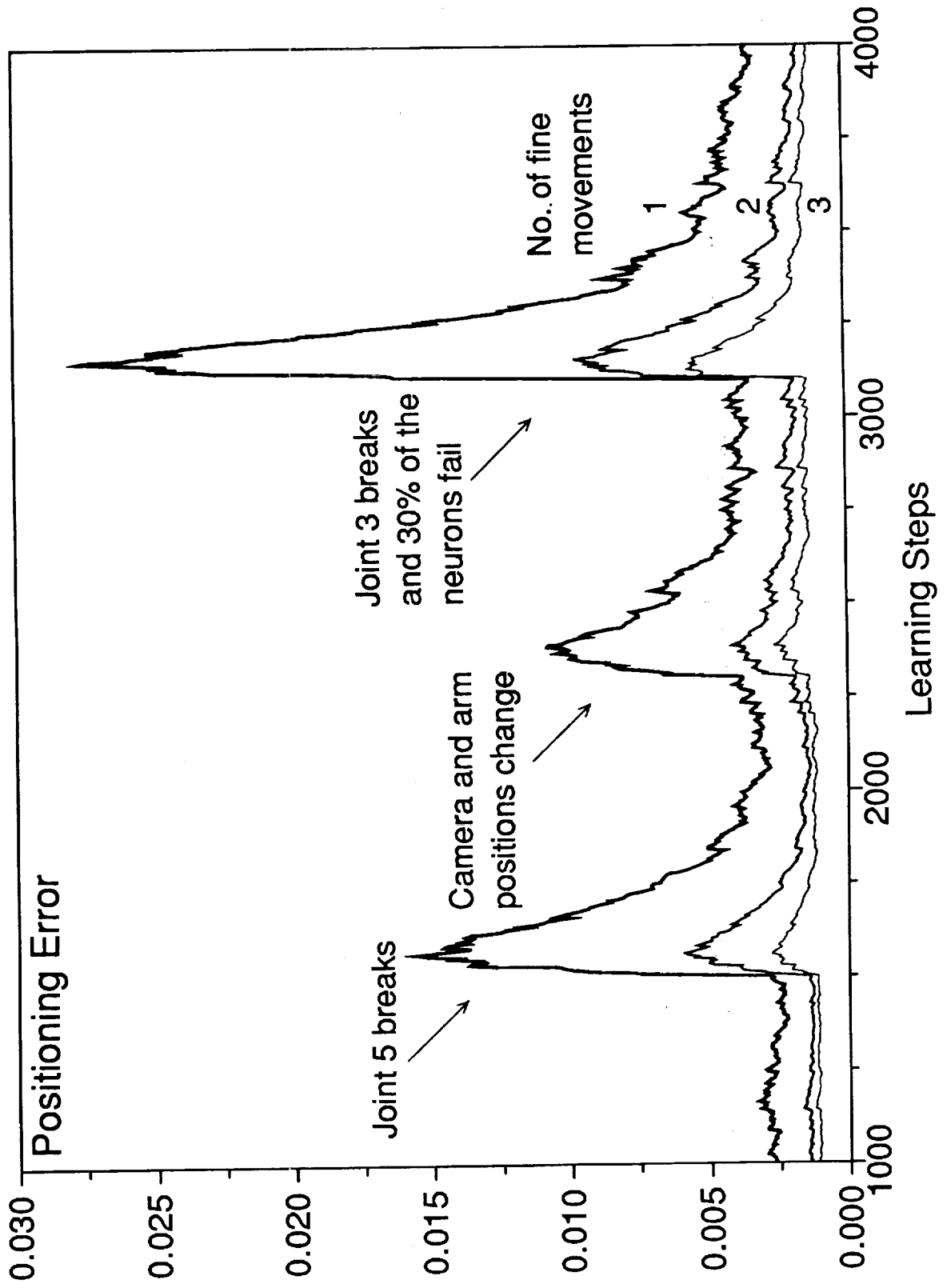

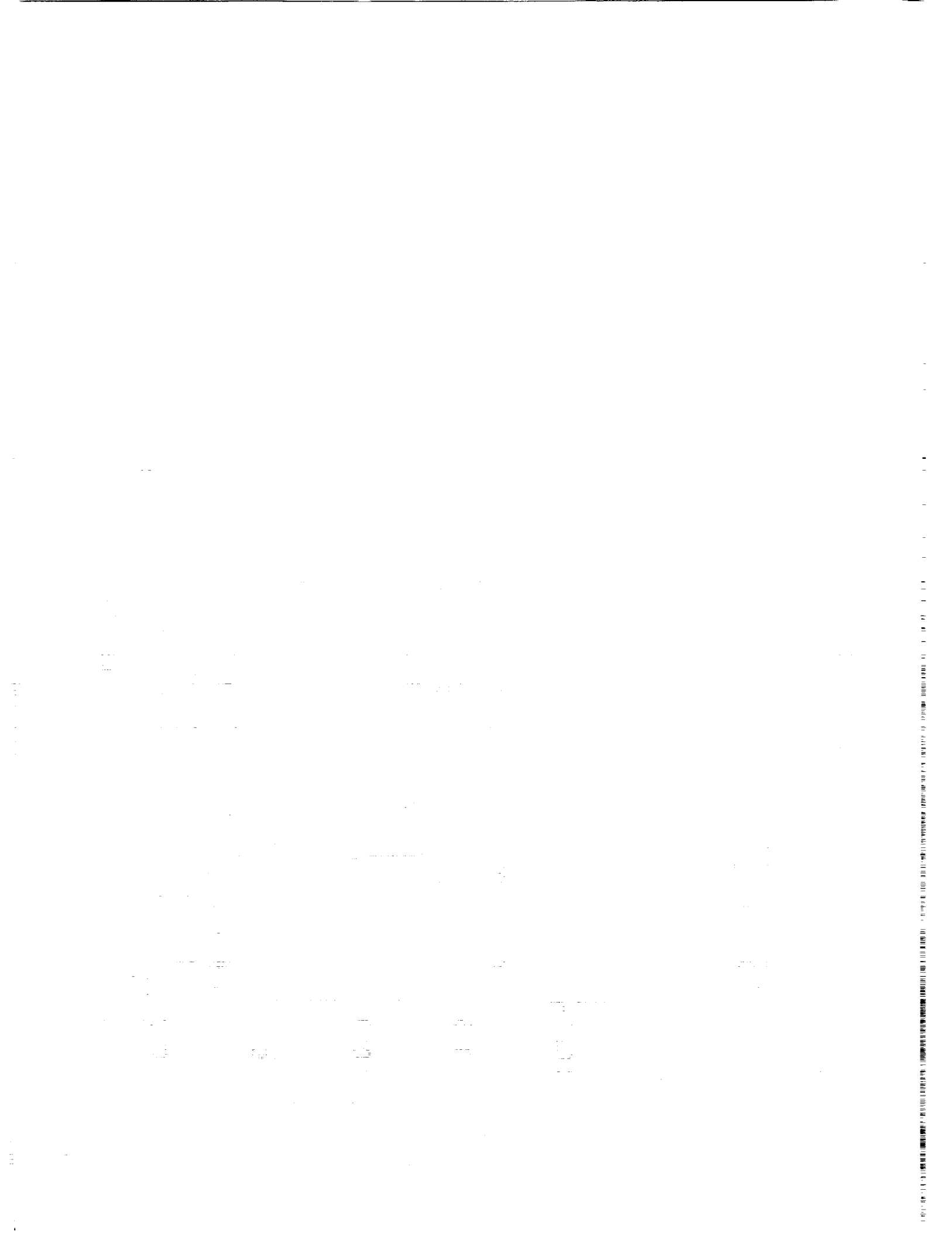

# **RMS ACTIVE DAMPING AUGMENTATION**

**Michael G. Gilbert  
Michael A. Scott  
Martha E. Demeo**

**Langley Workshop on Automation and  
Robotics for Space-Based Systems**

**December 10, 1991**

**N92-27771**

**RMS ACTIVE DAMPING AUGMENTATION**

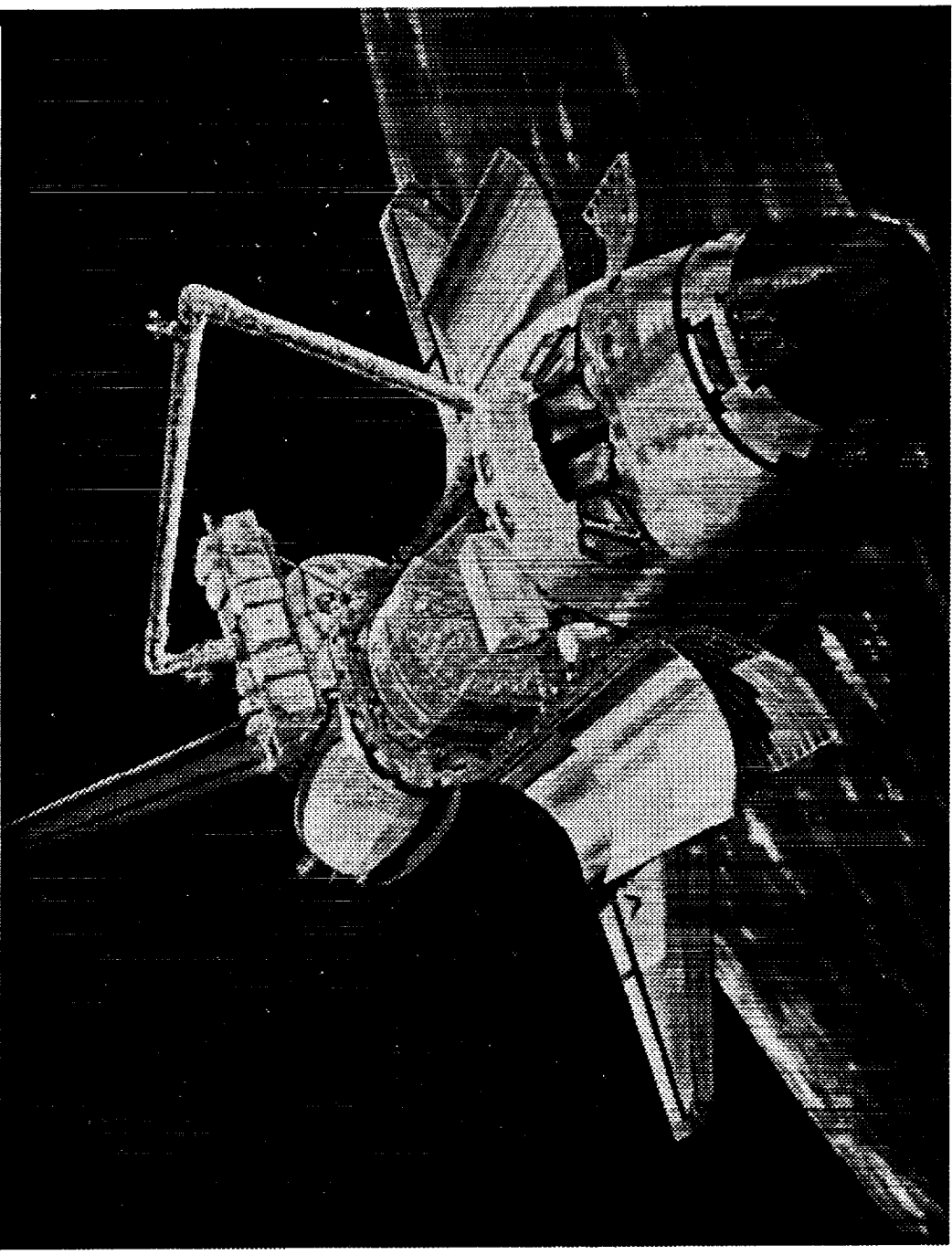

# POTENTIAL SPACE STATION ASSEMBLY BENEFITS DUE TO CSI (Timeline)

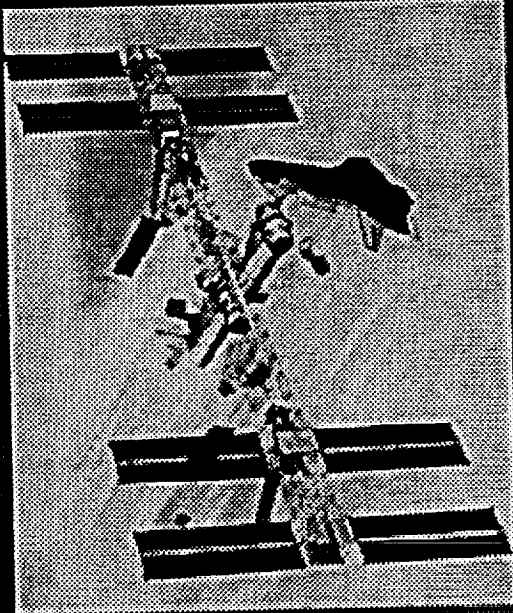

Draper RMS Simulator response  
Payload 3500 lbs

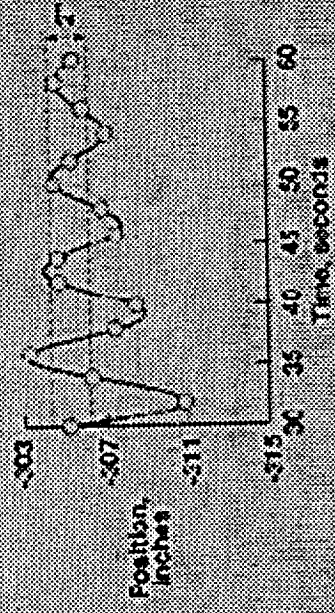

RMS settling time



Potential CSI benefits

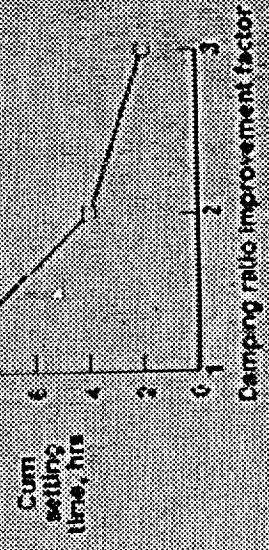

# LaRC / JSC BRIDGE PROGRAM

**TASK 1:** Determine active damping control feasibility using existing hardware

**TASK 2:** Active damping controller design with (minimum) hardware changes

**TASK 3:** Ground evaluation of active damping control

**TASK 4:** Flight Demonstration

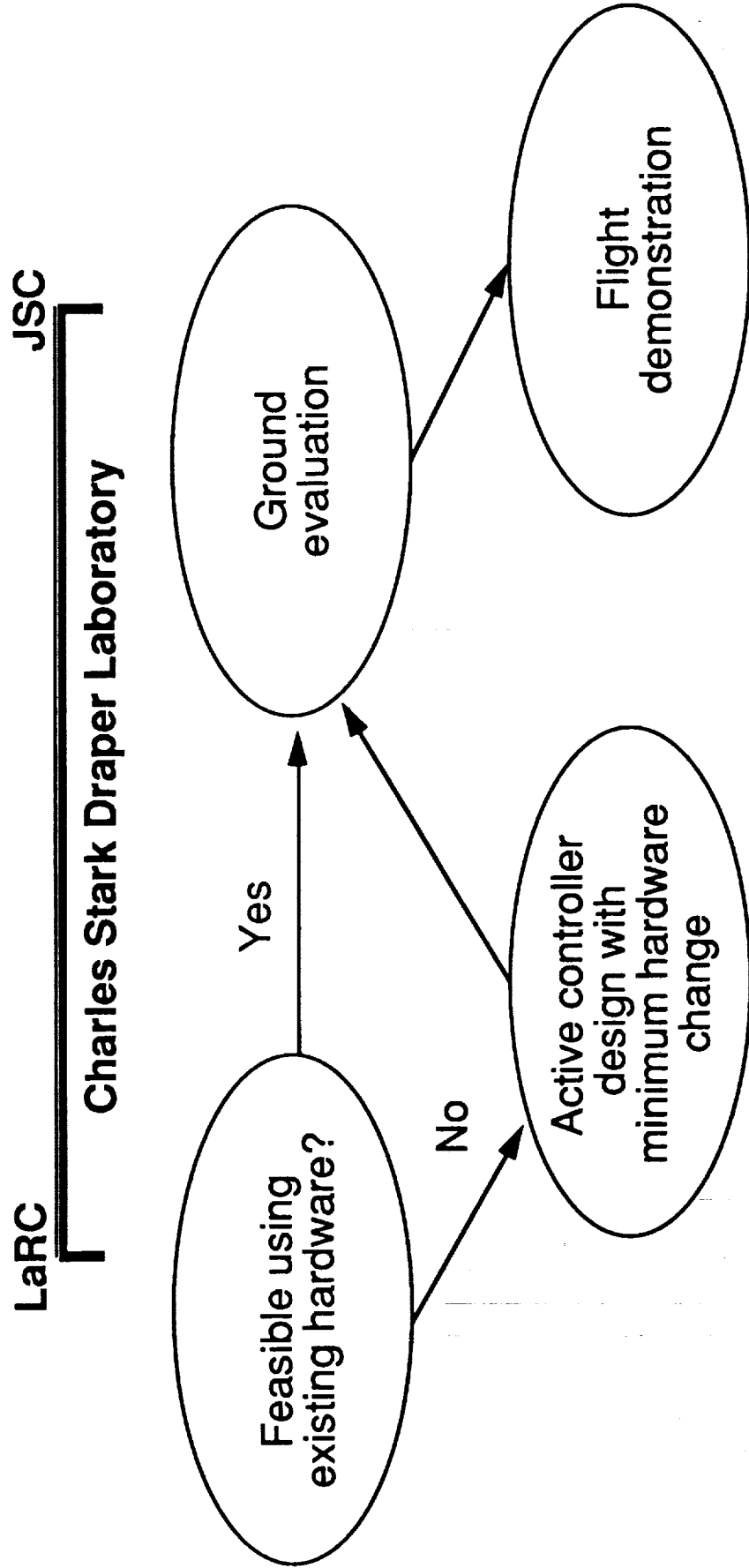

# OUTLINE

Introduction

**Analytical Accomplishments**

Initiation of Man-in-the-Loop Simulations

Schedule

Concluding Remarks

# CONTROL LAW DESIGN PROCESS

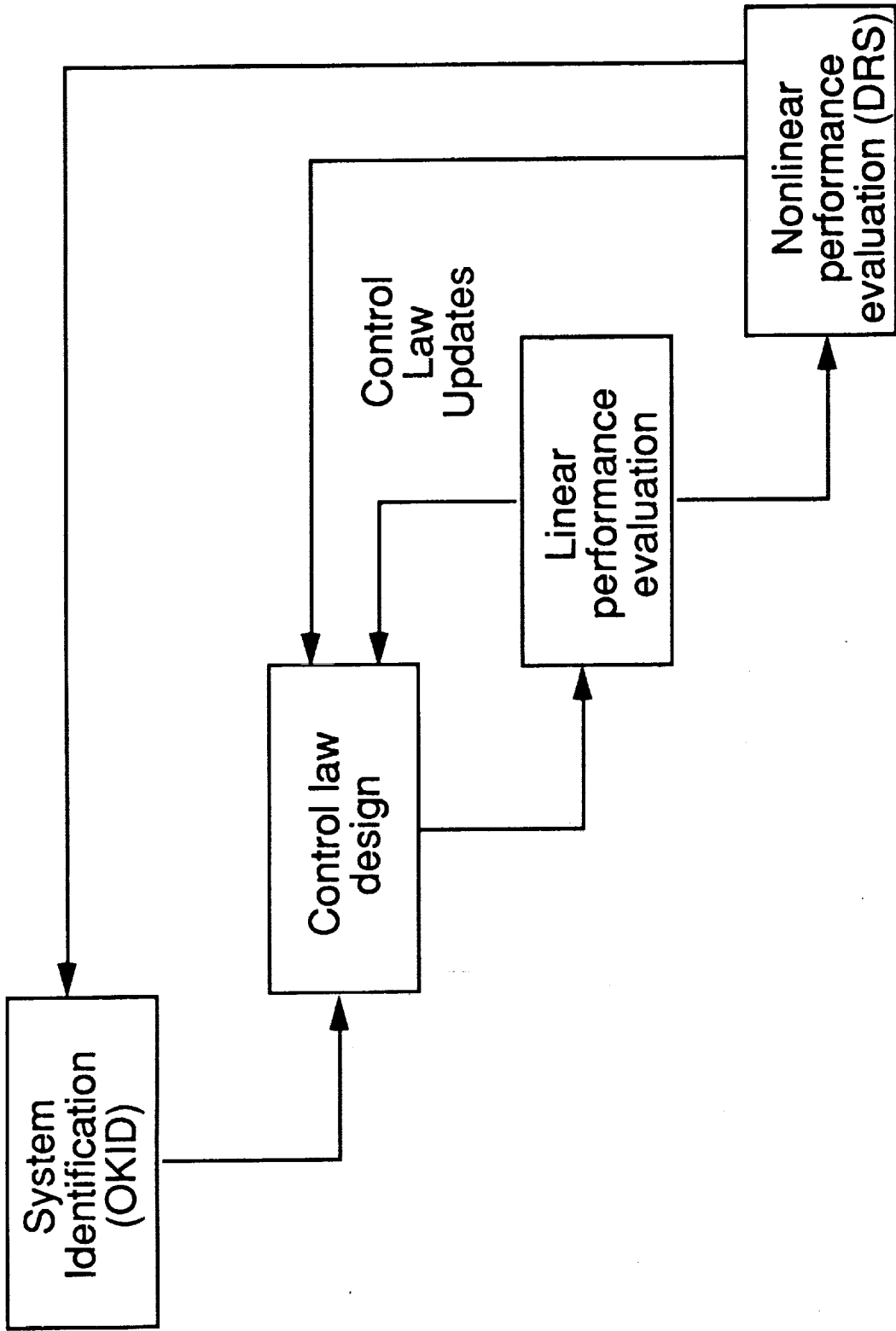



# DRAPER RMS SIMULATOR

## **Baseline Simulation**

- Includes flexibility of booms, joint housings, grapple, and orbiter sidewall
- Simulation of RMS operation software in orbiter GPC
- Models nonlinear gearbox effects, friction and stiction, time delays
- Includes joint encoders, tachometers, joint motors and servos

## **External Input Simulation**

- Allows arbitrary external joint rate command inputs for Sys ID

## **CSI Controller Simulation**

- Added 3-axis acceleration at tip, tachometer, and encoder feedback
- Digital dynamic compensator structure
- CSI controller implementation logic

# MIMO ACCELERATION CONTROL LAWS IMPROVE DAMPING

## Frequency and Damping Comparisons

RMS Position	Open-Loop		Closed-Loop	
	$\omega$ (hz)	$\zeta$ (%)	$\omega$ (hz)	$\zeta$ (%)
1	0.18	0.12	0.19	0.25
2	0.17	0.09	0.18	0.28
3	0.14	0.13	0.15	0.38

(Results using SPAS payload accelerometer model)

# POTENTIAL LOAD REDUCTION BENEFIT IDENTIFIED

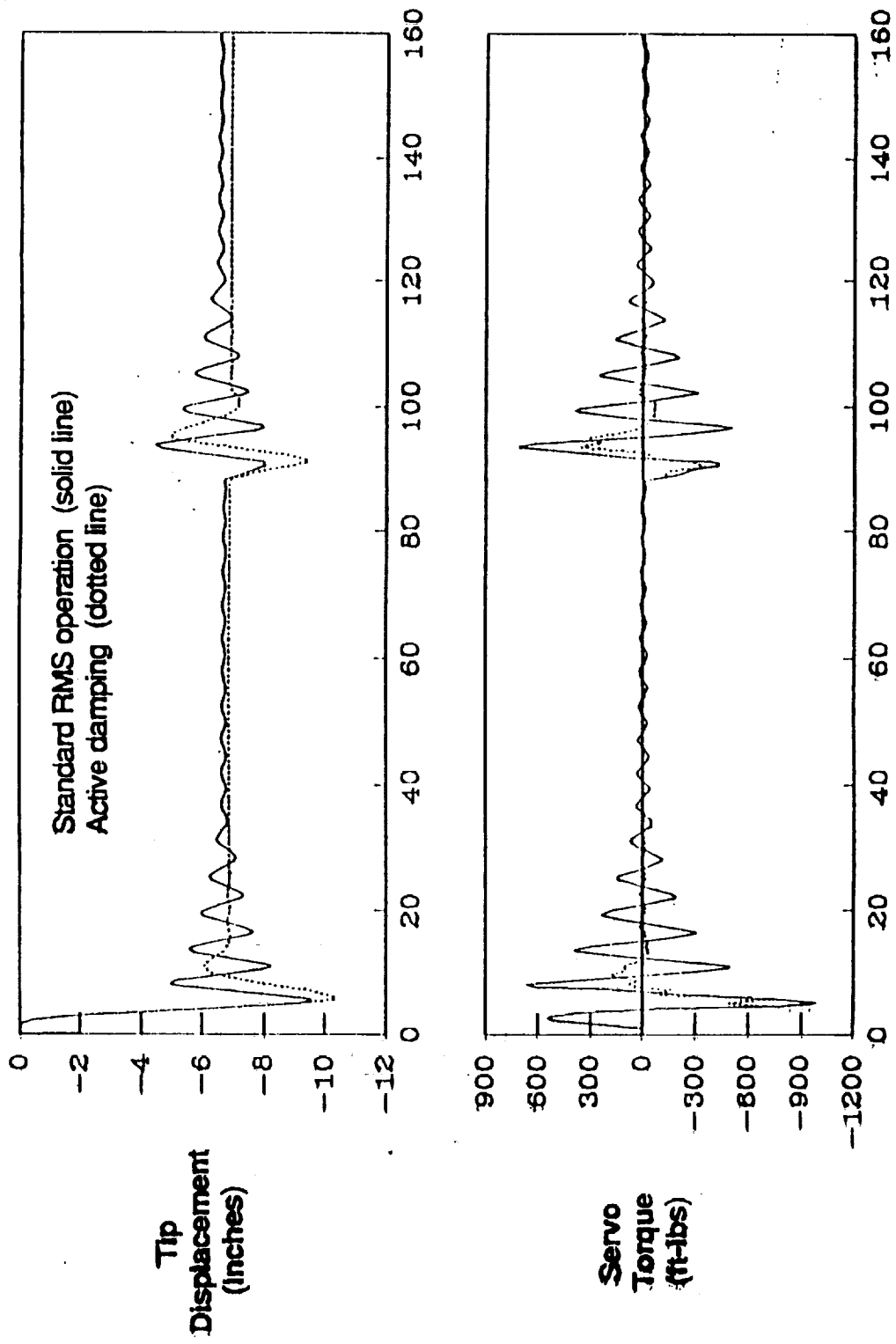

# **DRS MODIFIED TO MODEL DISTRIBUTED ACCELERATIONS**

## **CSDL formulated accelerometer equations**

- Two mid-boom and three link end locations
- Three axis accelerations at each location
- Full accounting of interbody forces and nonlinear motions

## **CSDL modified DRS delivered**

- Optional inclusion of omega-cross terms
- Calculations validated by CSDL and LaRC

**Used to define feedback acceleration locations**

# ACCELEROMETER LOCATION DEFINED

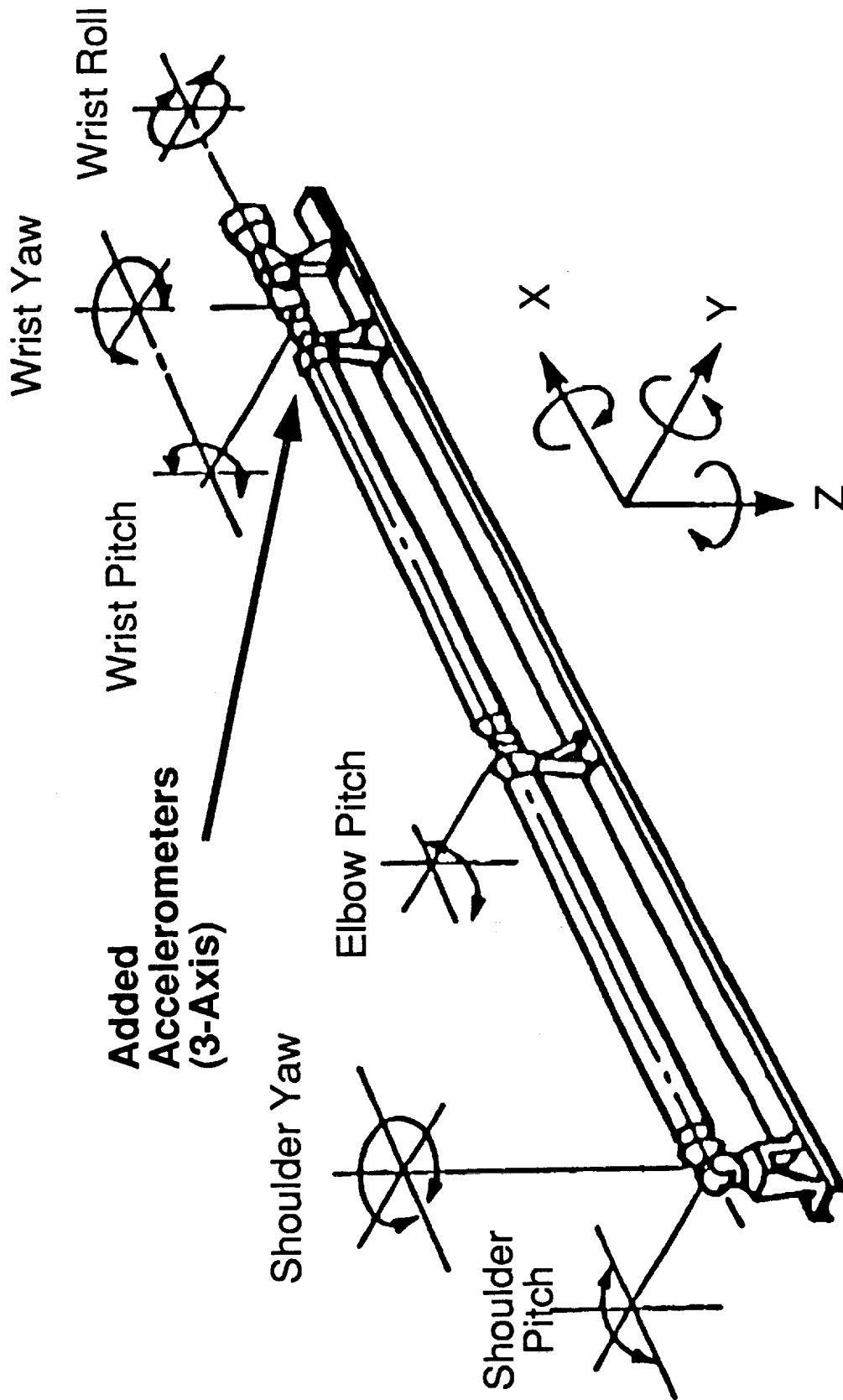

# OUTLINE

Introduction

Analytical Accomplishments

**Initiation of Man-in-the-Loop Simulations**

Schedule

Concluding Remarks

SHUTTLE AFT COCKPIT SIMULATOR

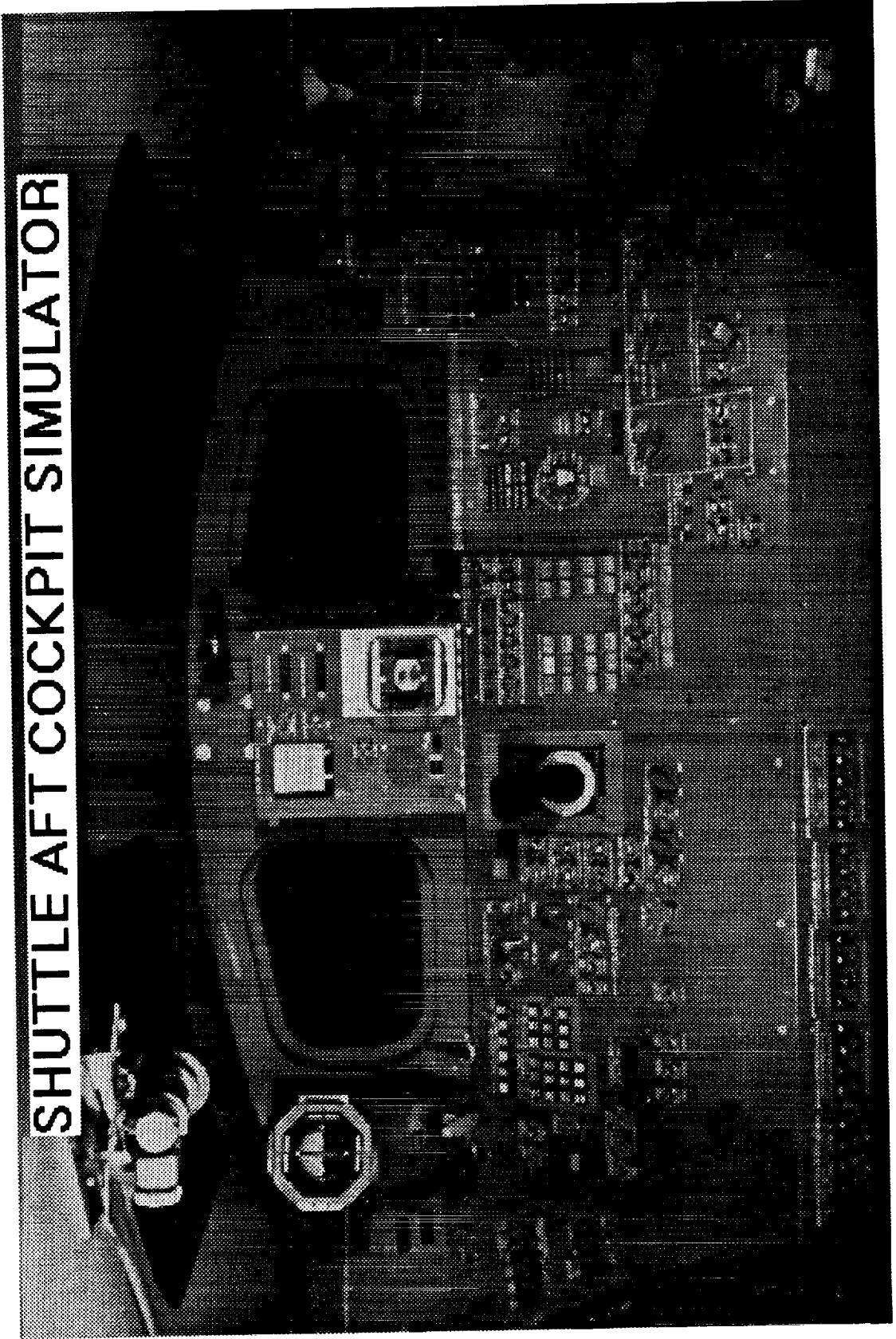

# SIMULATED SHUTTLE VIDEO DISPLAYS

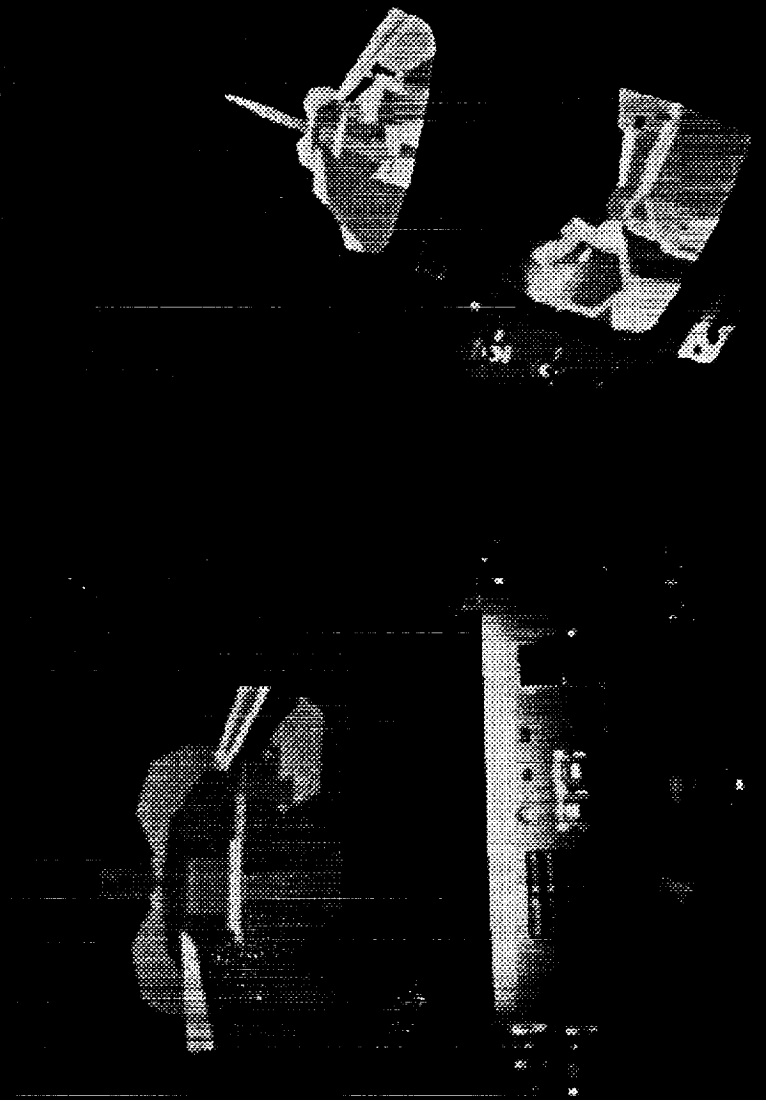

Figure 1. Shuttle simulator cockpit. The crew members are seated in the front seats, looking forward. The cockpit is filled with various instruments, control panels, and displays. The lighting is dim, highlighting the crew members and the illuminated instruments.



# SES TEST GOALS AND OBJECTIVES

## **Goal:**

Obtain quantitative and qualitative SES data supporting advocacy of RMS active damping augmentation flight demonstration

## **Objectives:**

- Measurable reductions in RMS vibration decay time
- Quantitative reductions in predicted RMS loads due to payload handling and Shuttle FCS thruster firings
- No adverse Shuttle FCS interaction
- Qualitative performance improvements defined by trained RMS operators (flight crew members)

# SES MODIFICATIONS TO SUPPORT RMS ACTIVE DAMPING AUGMENTATION

## **Arm dynamics simulation (Phase 1):**

- Calculation of arm accelerations at limited locations
- Damping model for flexible booms
- Off-line structural loads analysis capability

## **Flight software simulation (Phase 2):**

- Implementation of active damping controller concept
  - Acceleration feedback signals
  - Damping joint rate commands added to position hold
  - Maximum 36th order controller
  - Gain scheduling (Phase 2b)
- Operational logic and interfaces to RMS and FCS software

Activities	1991												1992											
	S	O	N	D	J	F	M	A	M	J	J	A	S	O	N	D								
SES Interfaces																								
Requirements Document																								
Test Plan																								
Meetings																								
Phase 1 - Accelerometer Simulation																								
Formulation Delivery																								
Simulation Development																								
JSC Validation																								
Engineering Study																								
Phase 2a - Point Design Controller																								
Control CR Delivery																								
Simulation Development																								
JSC Validation																								
Engineering Study																								
Phase 2b - Gain Scheduled Controller																								
Modified Control CR Delivery																								
Simulation Development																								
JSC Validation																								
Engineering Study																								
Final Report																								

Legend:  
Red - Planned  
Blue - Accomplished  
Green - SES Testing

# CONCLUDING REMARKS

## **Analysis and control law design work progressing:**

- Applying advanced system identification methods (OKID)
- MIMO control laws and implementation logic
- Accelerometer calculations have been added to the non-real time simulation code
- Potential RMS loads reduction benefit from active damping

## **Man-in-the-loop simulation effort has been initiated:**

- Working with JSC to use the Systems Engineering Simulator
- Requirements document near signature
- Engineering assessment of accelerations scheduled for April 1992
- Active Damping Augmentation testing in June and August 1992

# **A SPACE CRANE CONCEPT FOR PERFORMING ON-ORBIT ASSEMBLY**

**JOHN T. DORSEY  
SPACECRAFT STRUCTURES BRANCH**

**PRESENTED AT:  
1991 NASA Langley Workshop on Automation and  
Robotics for Space-based Systems**

**December 10, 1991**

**N 9 2 - 2 7 7 7 2**

# BRIEFING OUTLINE

---

- WHY IS IN-SPACE CONSTRUCTION NEEDED?
- SPACE CRANE CONCEPT
- CONCLUDING REMARKS

# IN-SPACE ASSEMBLY AND CONSTRUCTION ENHANCES FUTURE MISSIONS PLANNING FLEXIBILITY

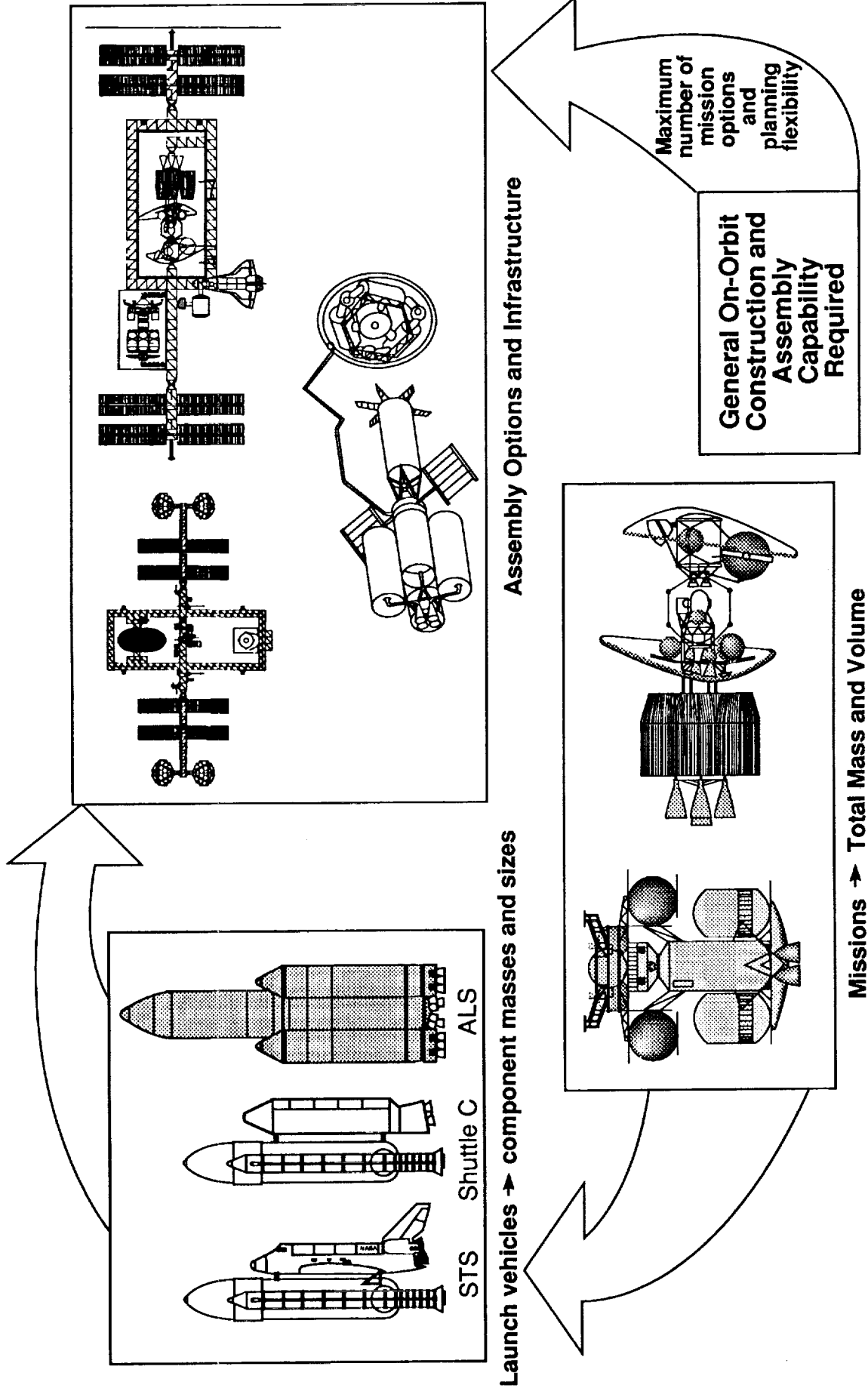

# IN-SPACE ASSEMBLY AND CONSTRUCTION FACILITY CONCEPT

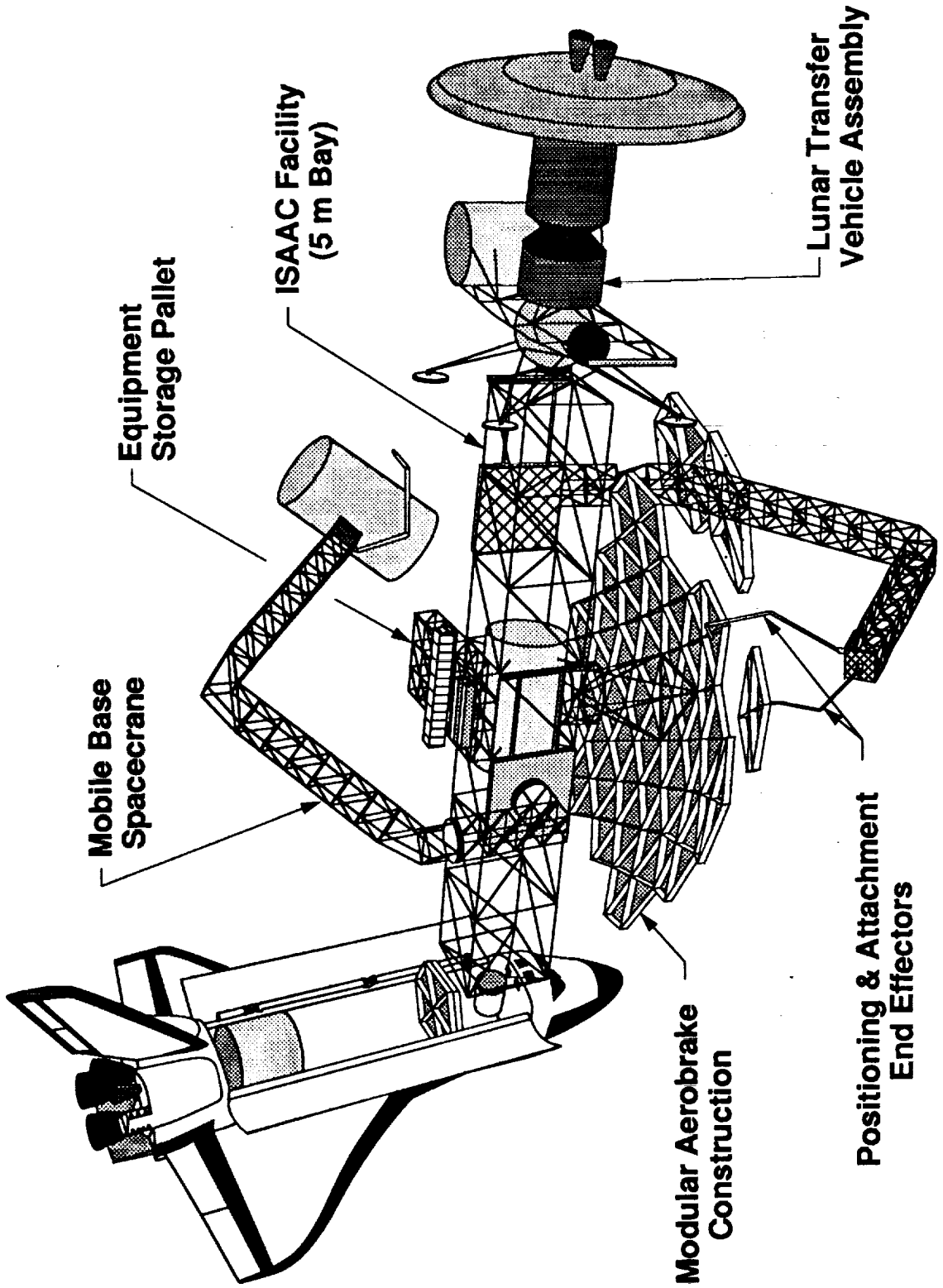



# SPACE CRANE CONCEPT WITH MOBILE BASE

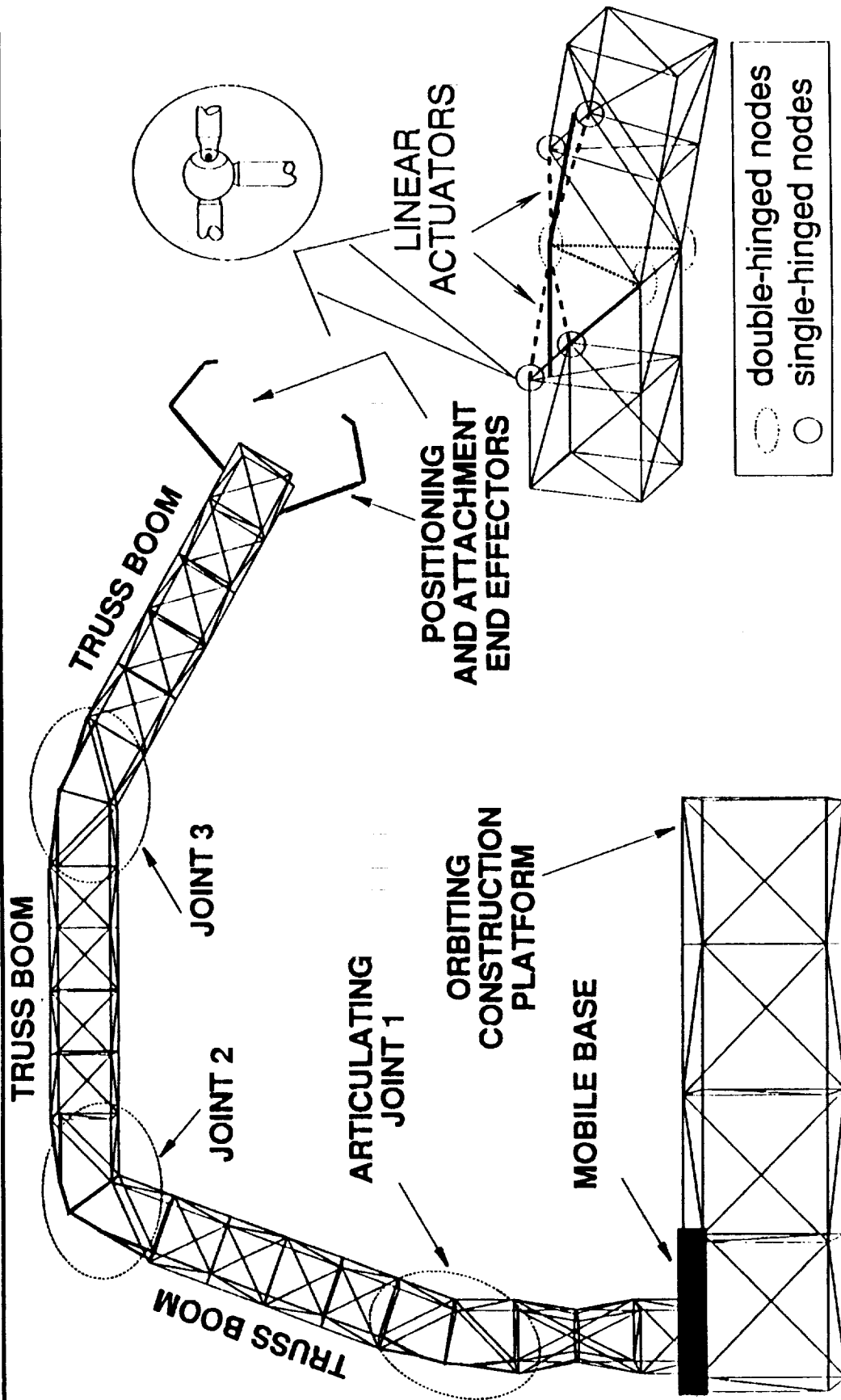
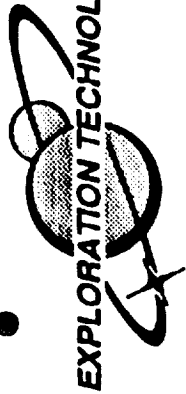

**ARTICULATING JOINT**

**SPACE CRANE CONCEPT**

## SPACE CRANE

The Capability to Position and Control Spacecraft Components Precisely and Safely During Assembly Will be Achieved by Developing a Structural Space Crane Type Arm, Having Multiple Articulating Joints for Dexterity, and that can Ultimately be Operated in an Automated Mode

### FEATURES

- Strength to Move and Control Large Spacecraft Components Safely
- Passive and Active "Stiffness" to Maintain a Stable and Secure Position
- Highly Controllable Large Angle Motion with Dynamic Control for Stable Trajectories
- Passive and Active Vibration Damping to Achieve Required Precision
- Reconfigurable/Adaptable Geometry to Reduce the Amount of Required On-Orbit Infrastructure
- Scaleability (Larger or Smaller Sizes) for a Variety of Applications
- Robustness and Reuseability for Long Life

The NASA logo, consisting of the word "NASA" in a bold, sans-serif font.

# FUNDAMENTAL CHARACTERISTIC

---

---

DURING NORMAL OPERATIONS, THE SPACE CRANE IS A SYSTEM THAT IS CONTINUOUSLY CHANGING IT'S STATE (STIFFNESS, VIBRATION MODES, VIBRATION FREQUENCIES) DUE TO:

- PAYLOADS
- ARTICULATION ANGLES

HOW DO WE CONTROL THIS DEVICE?

# SPACE CRANE RESEARCH APPROACH

---

## DEVELOPMENT PHILOSOPHY

- KEEP IT SIMPLE: START WITH BASIC STRUCTURE AND ADD ONLY THOSE SYSTEMS WHICH ARE REQUIRED TO MEET THE PERFORMANCE OBJECTIVES.
- ASSESS AND CHARACTERIZE THE PERFORMANCE AT EACH LEVEL OF COMPLEXITY WITH ANALYSIS AND TESTS.

## HIERARCHY

- POSITIONING CONTROL
  - Open Loop - Hardware Accuracy
  - Closed Loop - Sensor Feedback (Vision for example)
- VIBRATION CONTROL
  - Bare Structure Performance
  - "D" Strut Passive Dampers
  - Preshaped Command Input
  - Active Damping (Feedback)

# SPACECRAFT COMPONENT POSITIONING AND ASSEMBLY TEST-BED

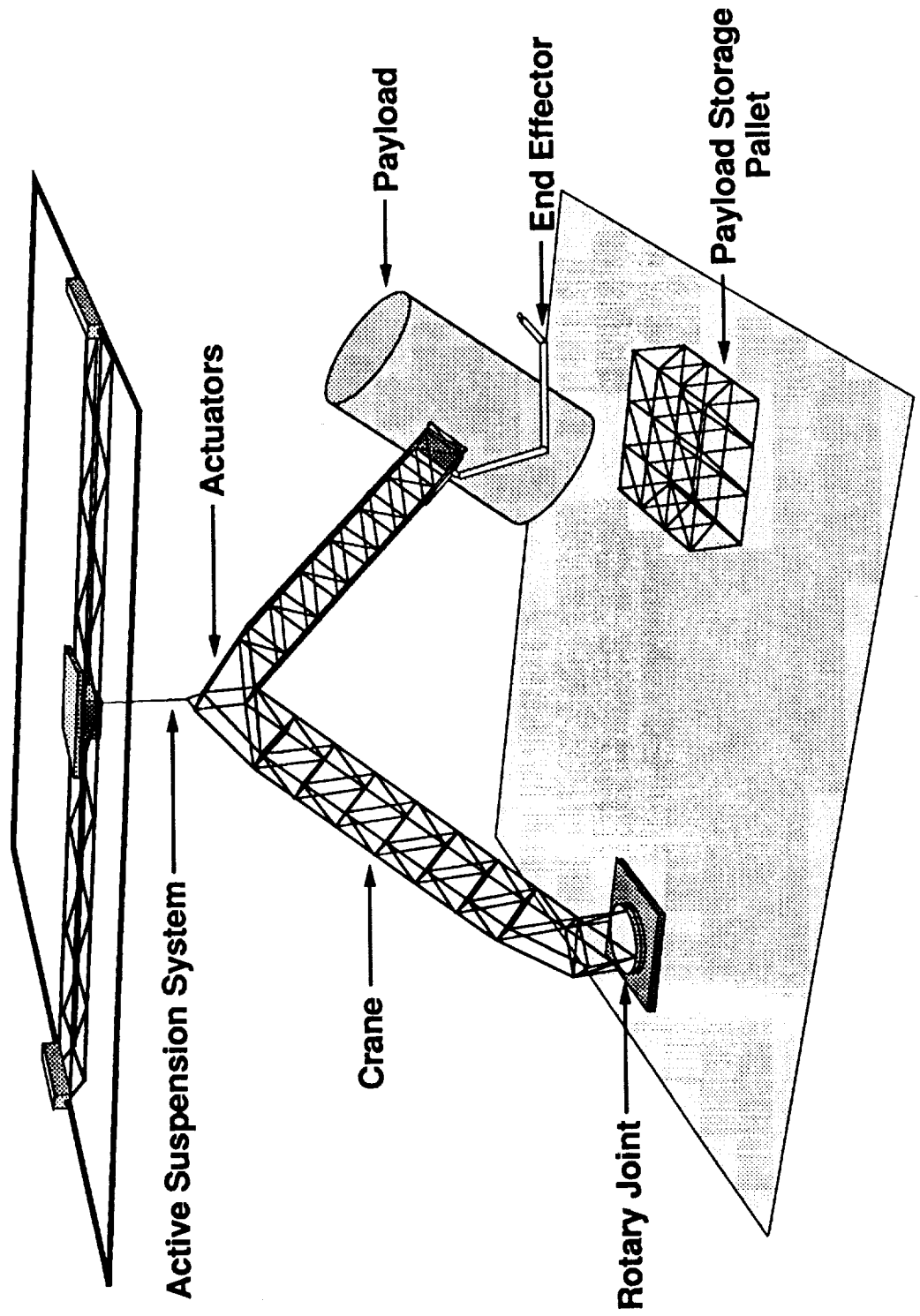

## **ARTICULATING JOINT TESTBED**

---

- USES PREVIOUSLY DEVELOPED HARDWARE, WITH EXCELLENT PERFORMANCE CHARACTERISTICS, FOR THE TRUSS BOOMS**
- ALLOWS RESEARCH TO FOCUS ON THE ARTICULATING JOINT AND SPACE CRANE CONTROLS PROBLEMS**
- CAN BE RAPIDLY RECONFIGURED**
- GIVES RAPID COMPONENT REPLACEMENT AND/OR MODIFICATION CAPABILITY**

## **CONCLUDING REMARKS**

**NASA**

---

- HAVING IN-SPACE ASSEMBLY AND CONSTRUCTION CAPABILITY WILL PROVIDE A GREAT DEAL OF FLEXIBILITY FOR FUTURE MISSION PLANNING AND SPACECRAFT DESIGN**
- THE SPACE CRANE HAS MANY DESIRABLE FEATURES AND CAPABILITIES FOR AN ON-ORBIT ASSEMBLY DEVICE AND THUS, SHOULD BE AN INTEGRAL COMPONENT IN ON-ORBIT ASSEMBLY SCENARIOS**

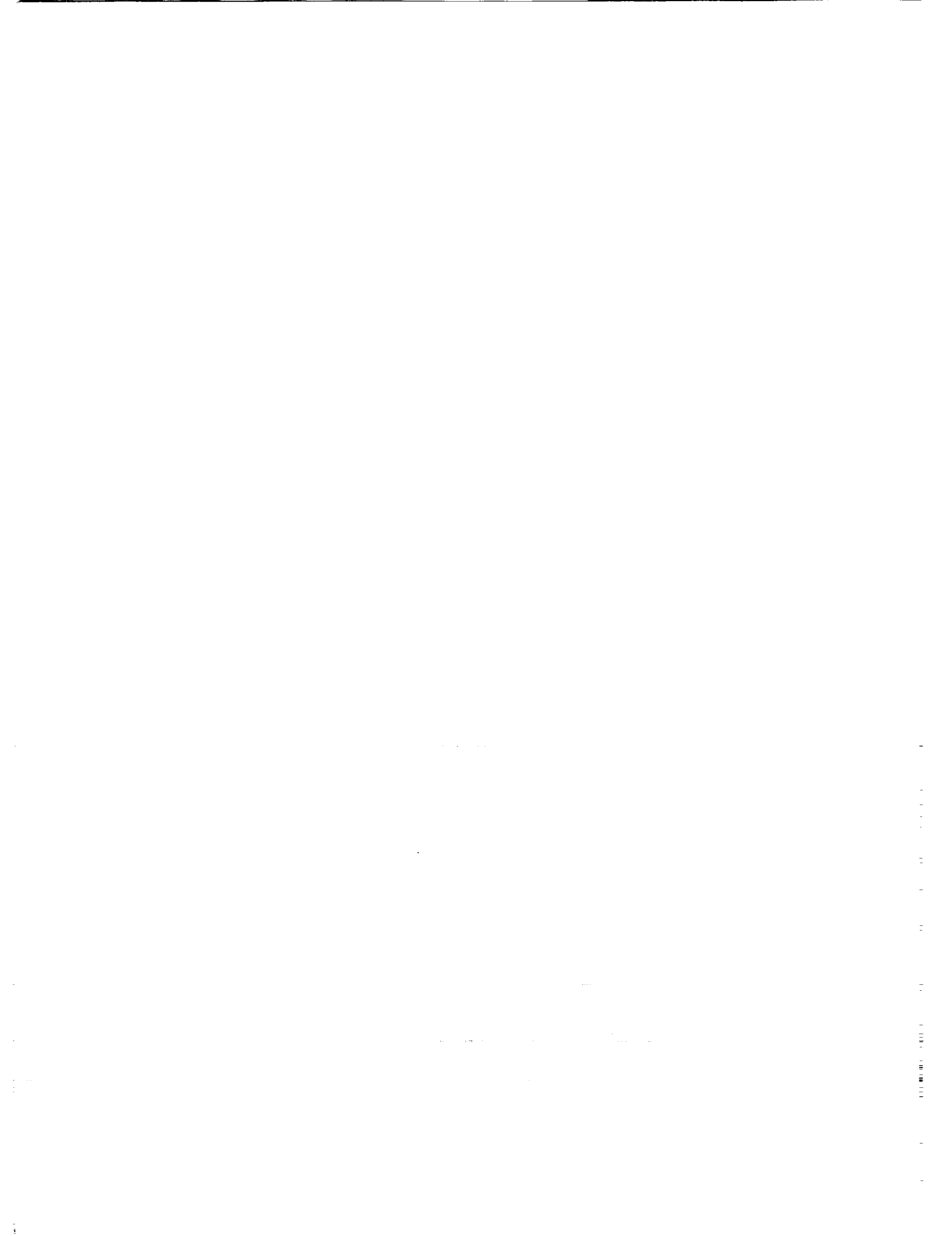



# ANALYSIS AND TESTING OF A SPACE CRANE ARTICULATING JOINT TESTBED

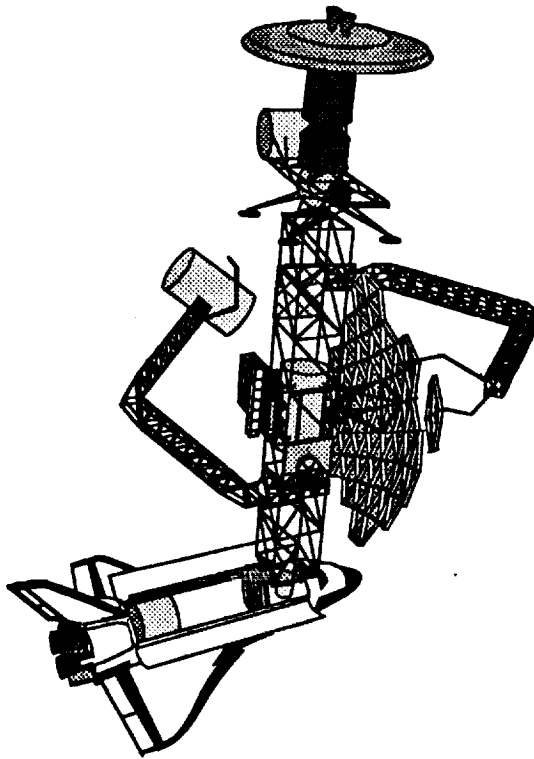

"Finite Element" Dynamic Model

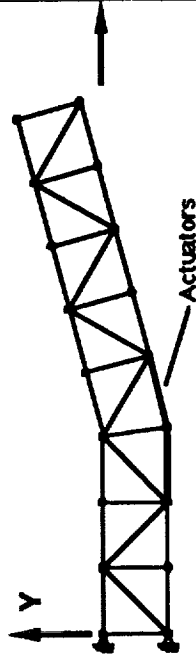

PRESENTED BY

THOMAS R. SUTTER AND K. CHAUNCEY WU  
SPACECRAFT STRUCTURES BRANCH

# SPACE CRANE CONCEPT WITH MOBILE BASE

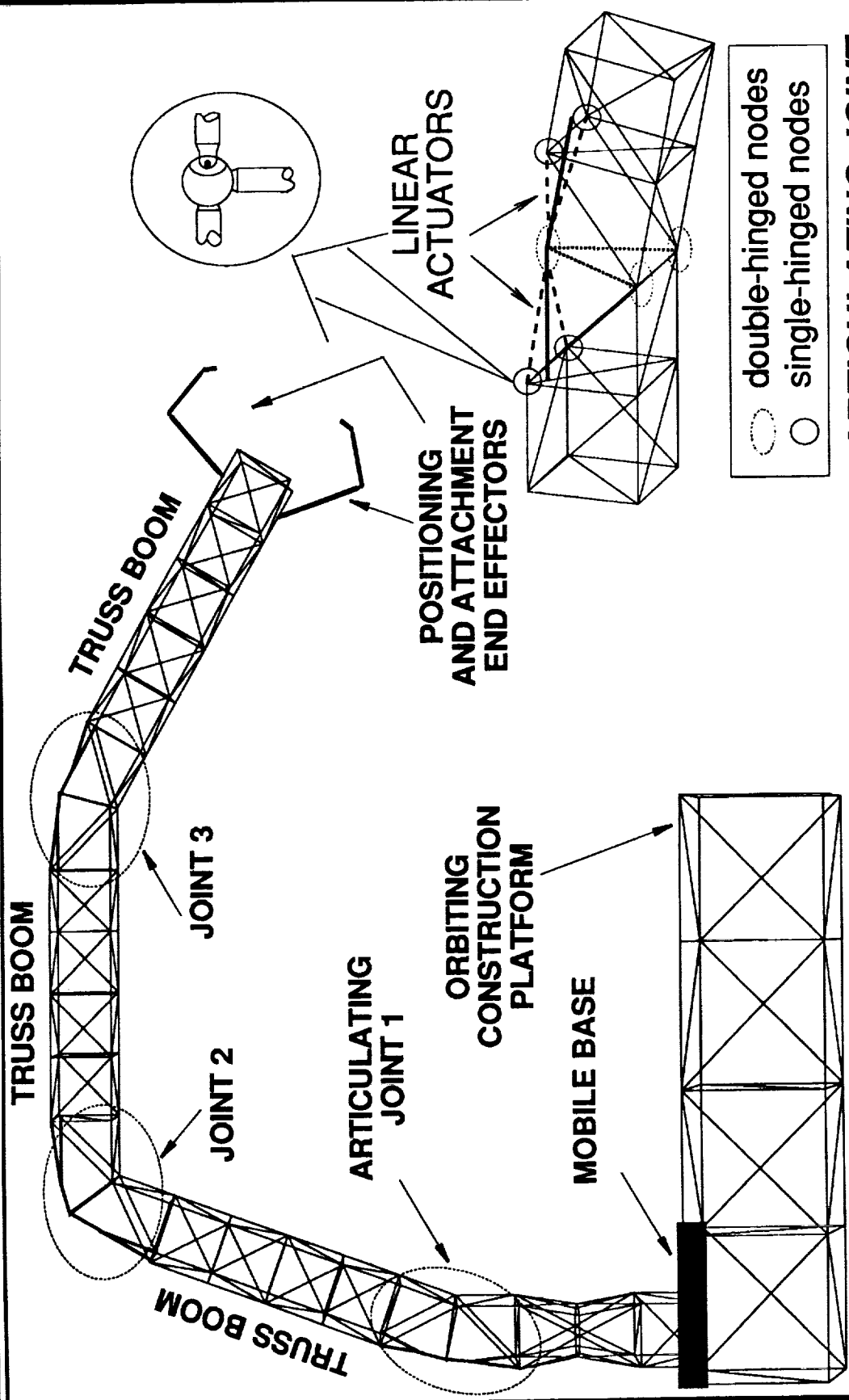

## ARTICULATING JOINT

## SPACE CRANE CONCEPT

# MECHANICAL VERSUS STRUCTURAL ARTICULATING JOINT

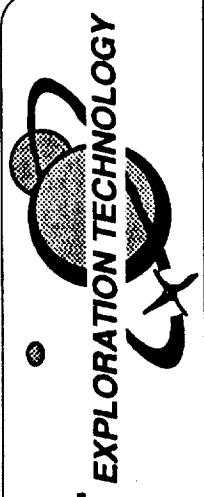

**SHUTTLE RMS**

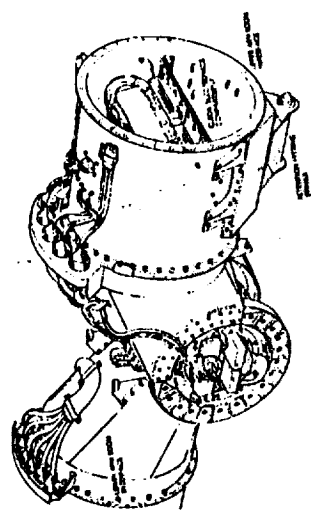

**ELBOW JOINT  
(MECHANICAL)**

**SPACE CRANE**

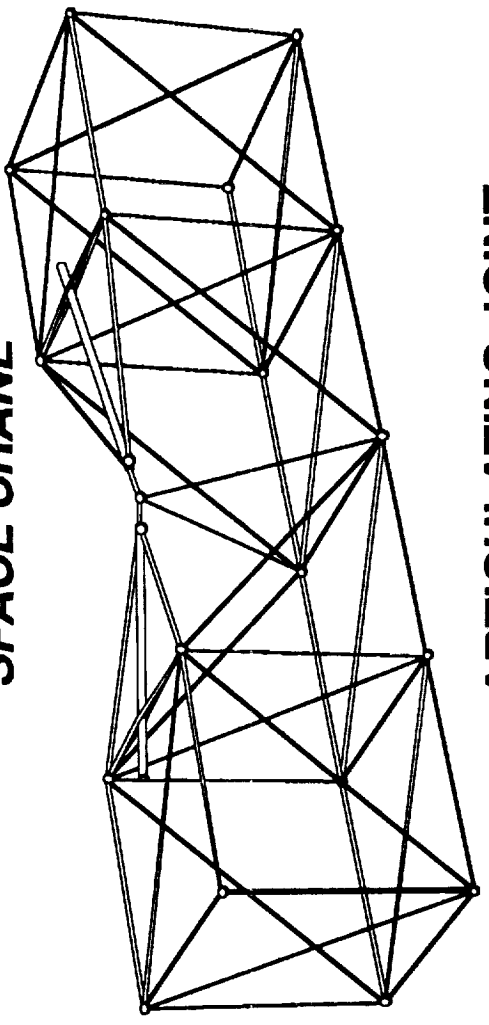

**ARTICULATING JOINT  
(STRUCTURAL)**

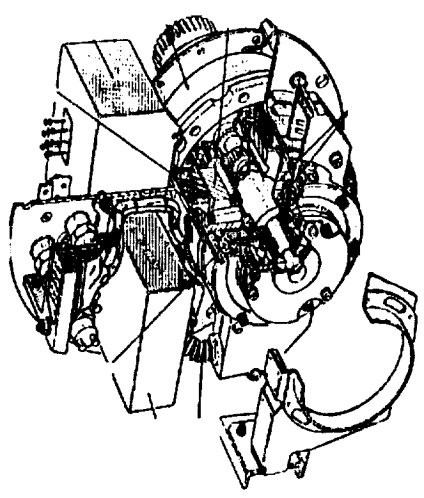

**MOTOR MODULE**

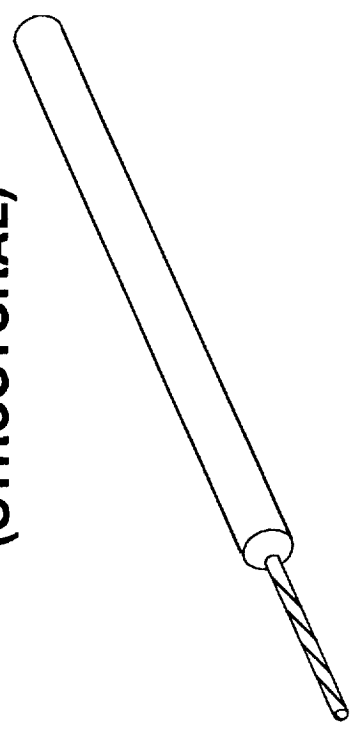

**LINEAR BALL SCREW  
ACTUATOR**

SPACE CRANE ARTICULATING JOINT TEST BED FABRICATED

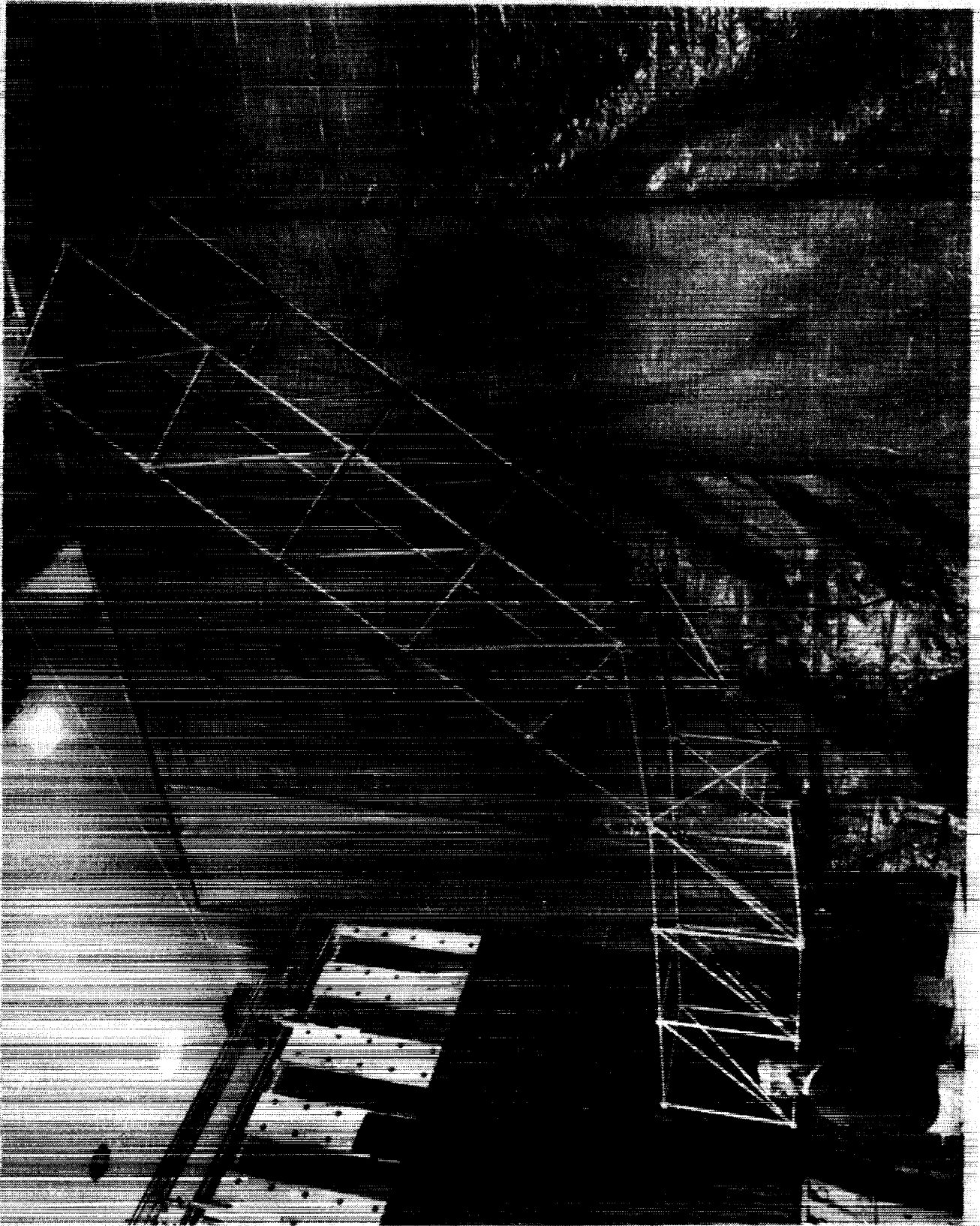

# ARTICULATING JOINT TEST BED AND REFERENCE TRUSS

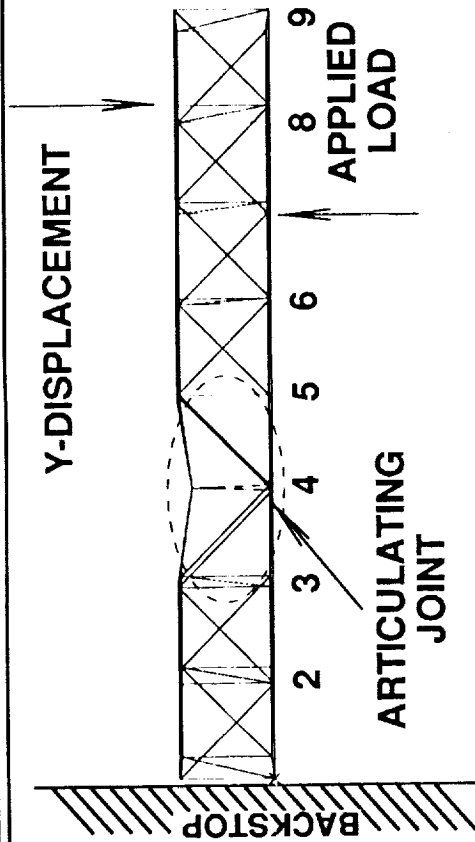
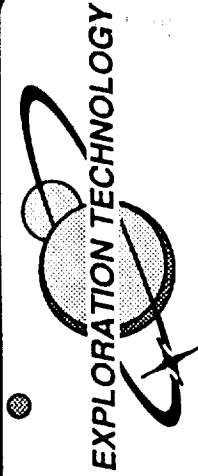

ARTICULATING JOINT TEST BED

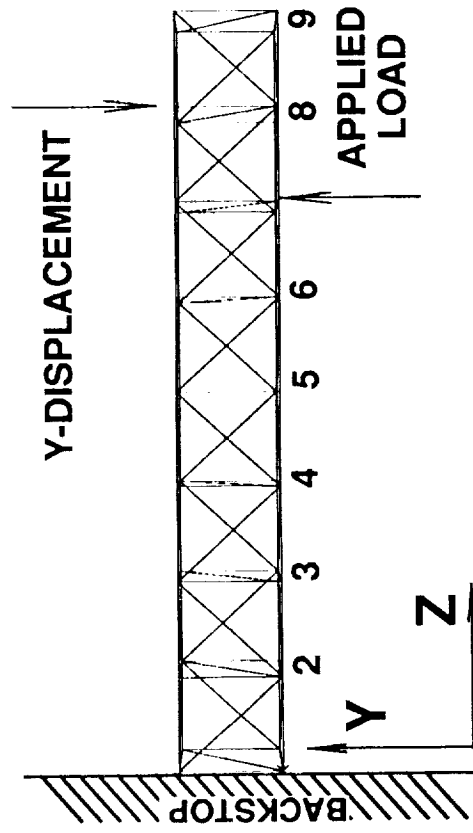

REFERENCE TRUSS

# STATIC AND DYNAMIC CHARACTERIZATION COMPLETED FOR SPACE CRANE REFERENCE TRUSS CONFIGURATION

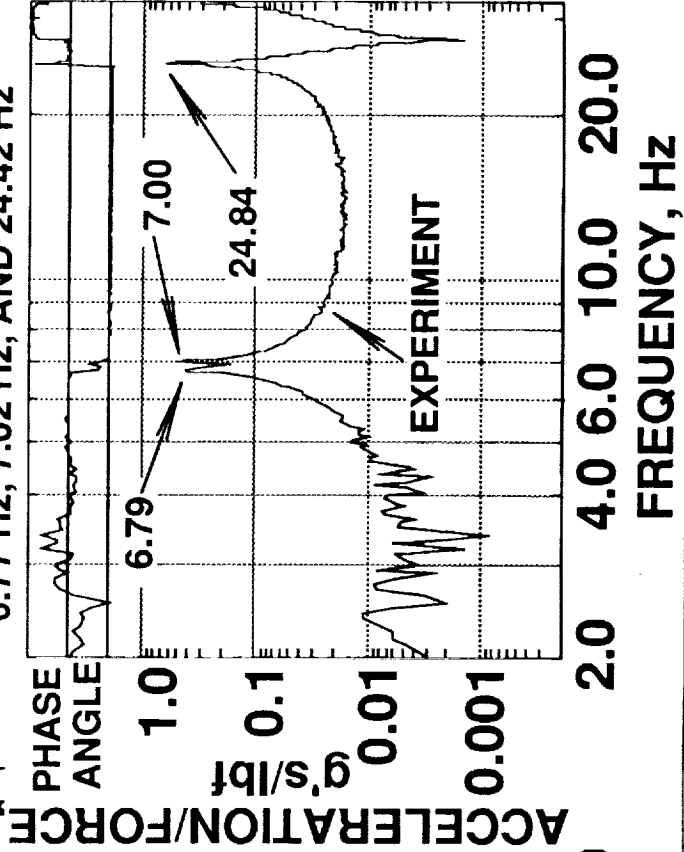
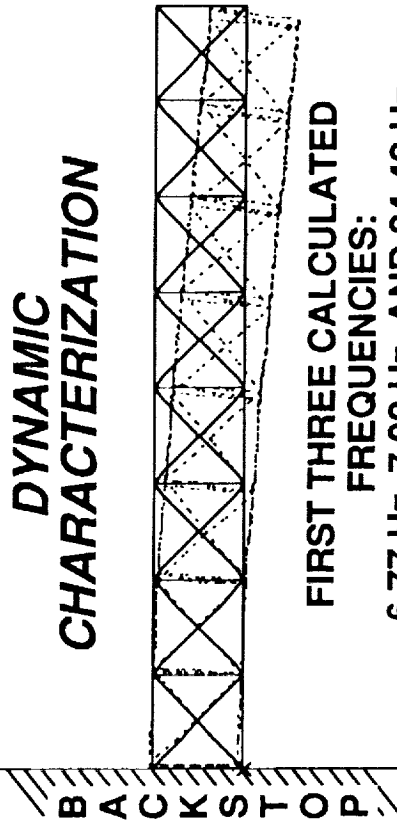
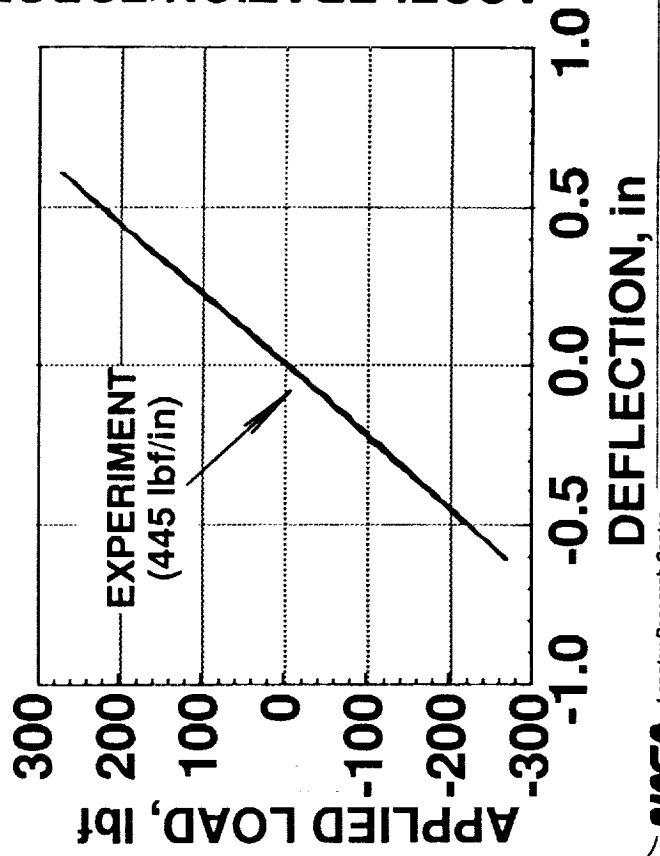
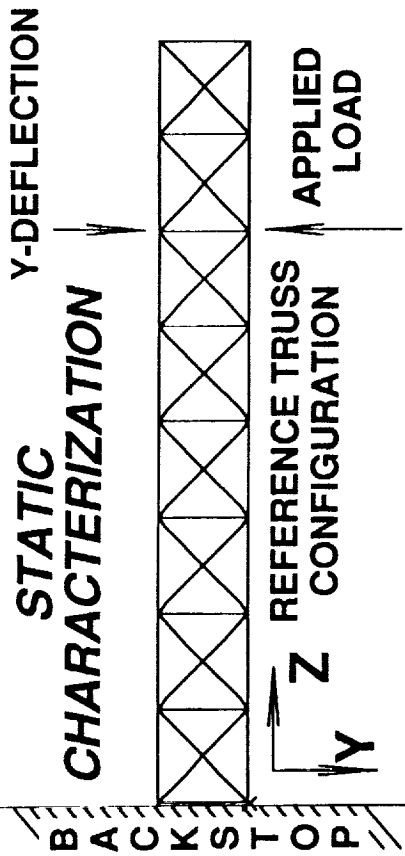

# IMPROVED LINEAR ACTUATORS REDUCE ARTICULATING JOINT TEST BED BACKLASH

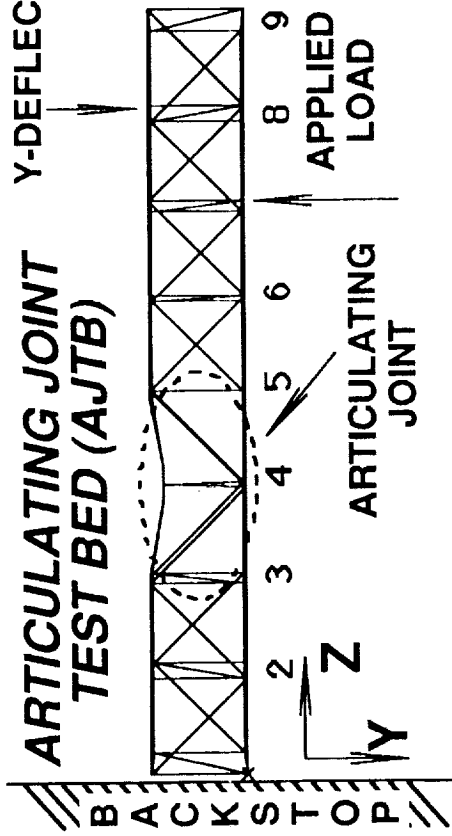

LINEAR ACTUATORS

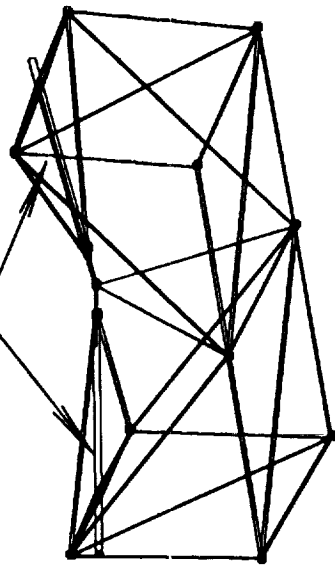

ARTICULATING JOINT DETAIL

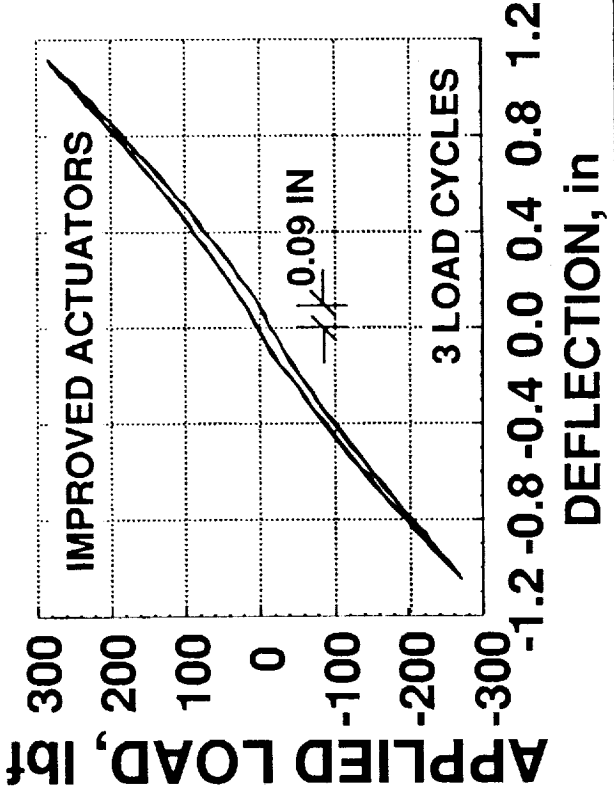
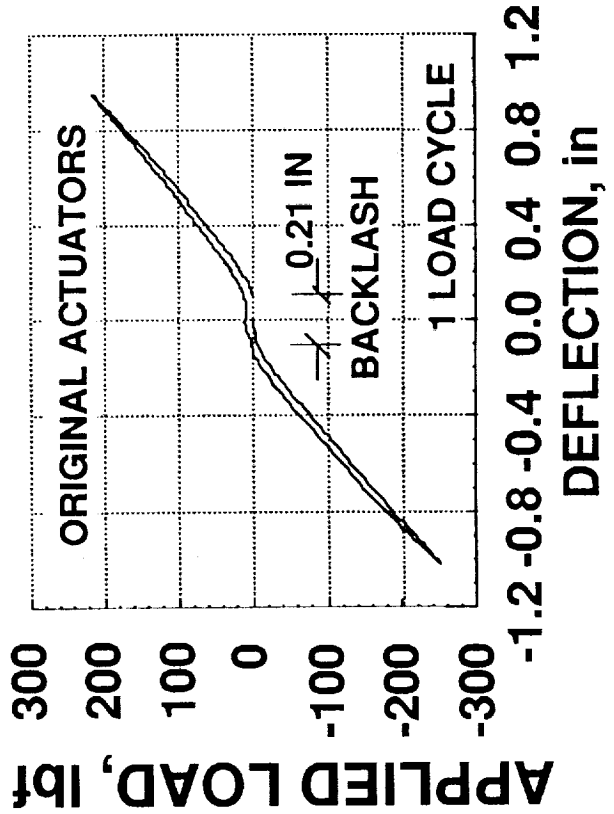

# 1-DOF SPACE CRANE SLEW MANEUVER

"Finite Element" Dynamic Model

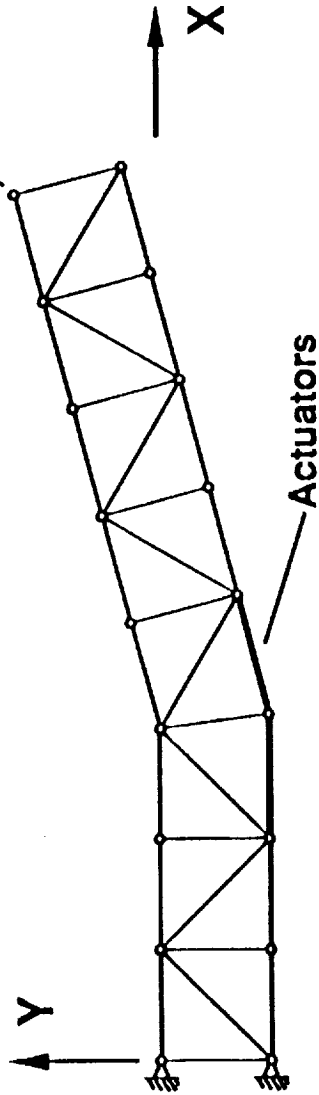

- Motion in X-Y plane only
- Truss members modeled as axial springs
- No EAL interface required
- Easy to model discrete dampers

Actuator Extension Time History

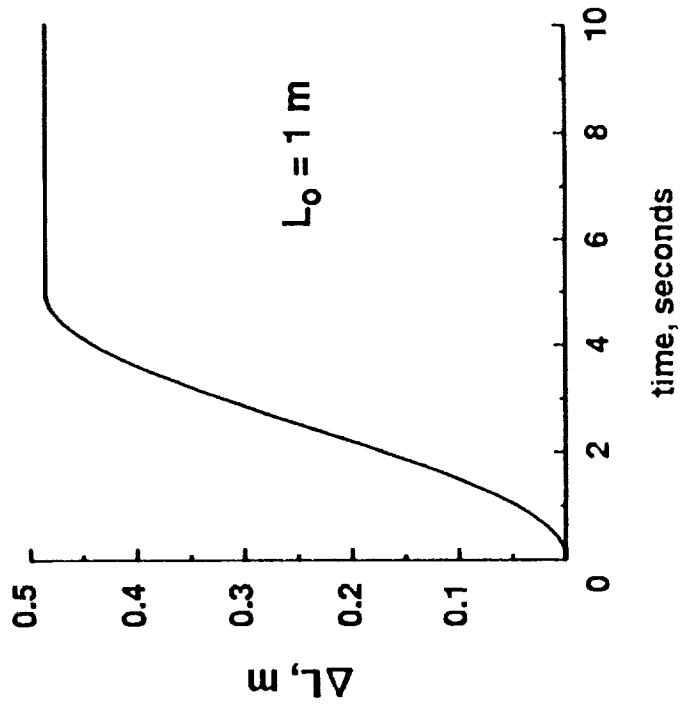

Node 18 Position

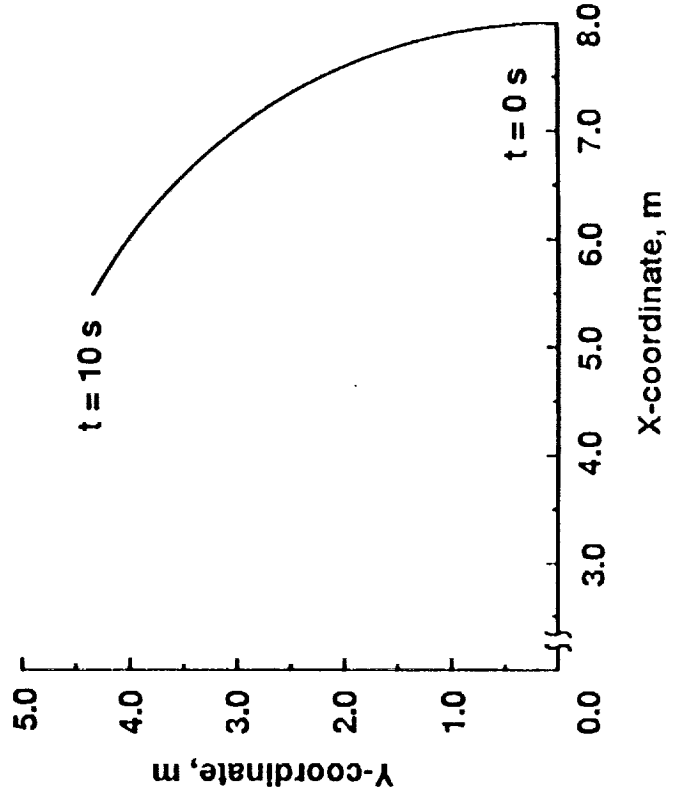



# Boom 2 Tip Transient Response Finite Element Dynamic Model

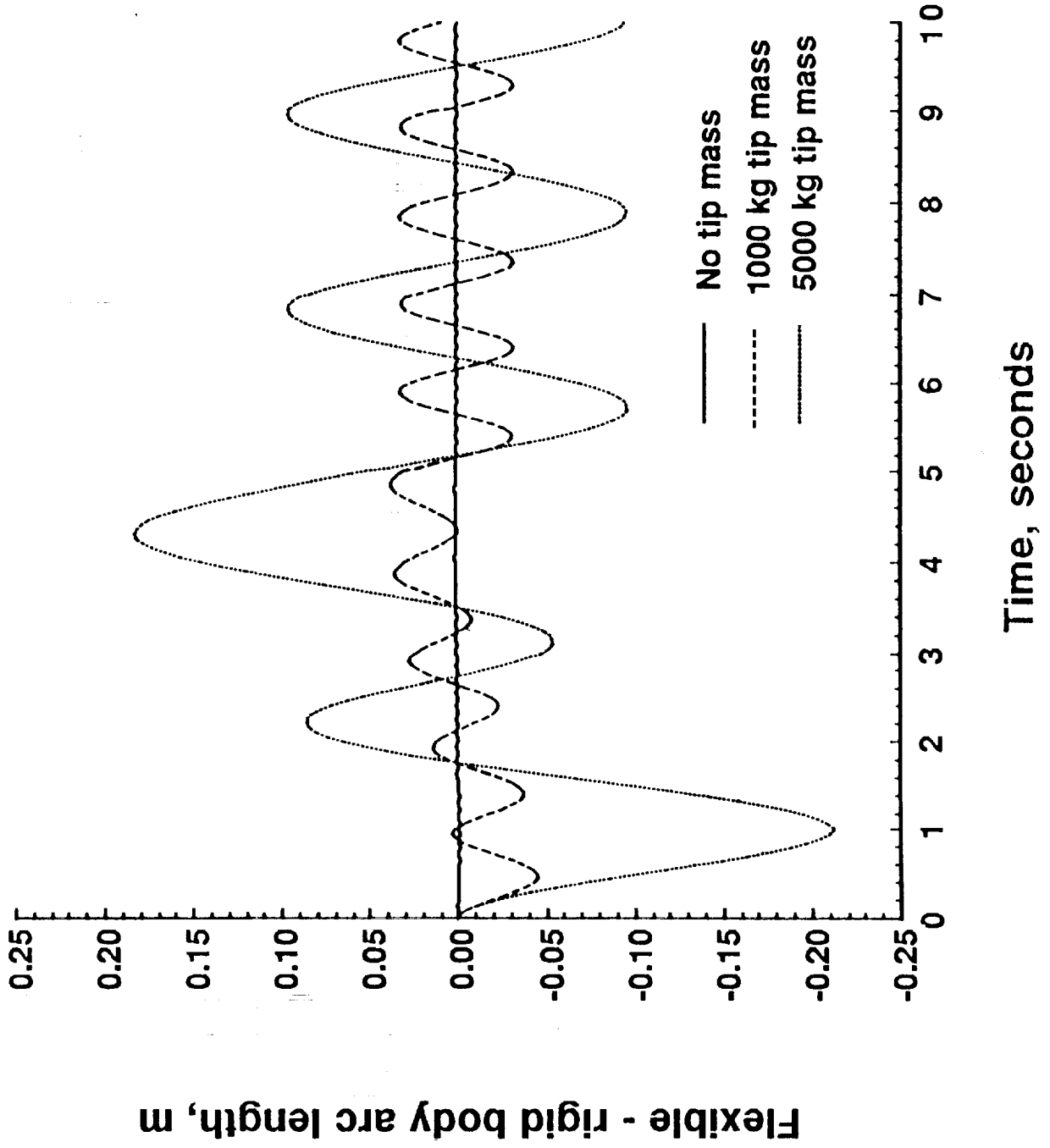

**Boom 2 Tip Transient Response  
Finite Element Dynamic Model  
D-Struts in Bay 1**

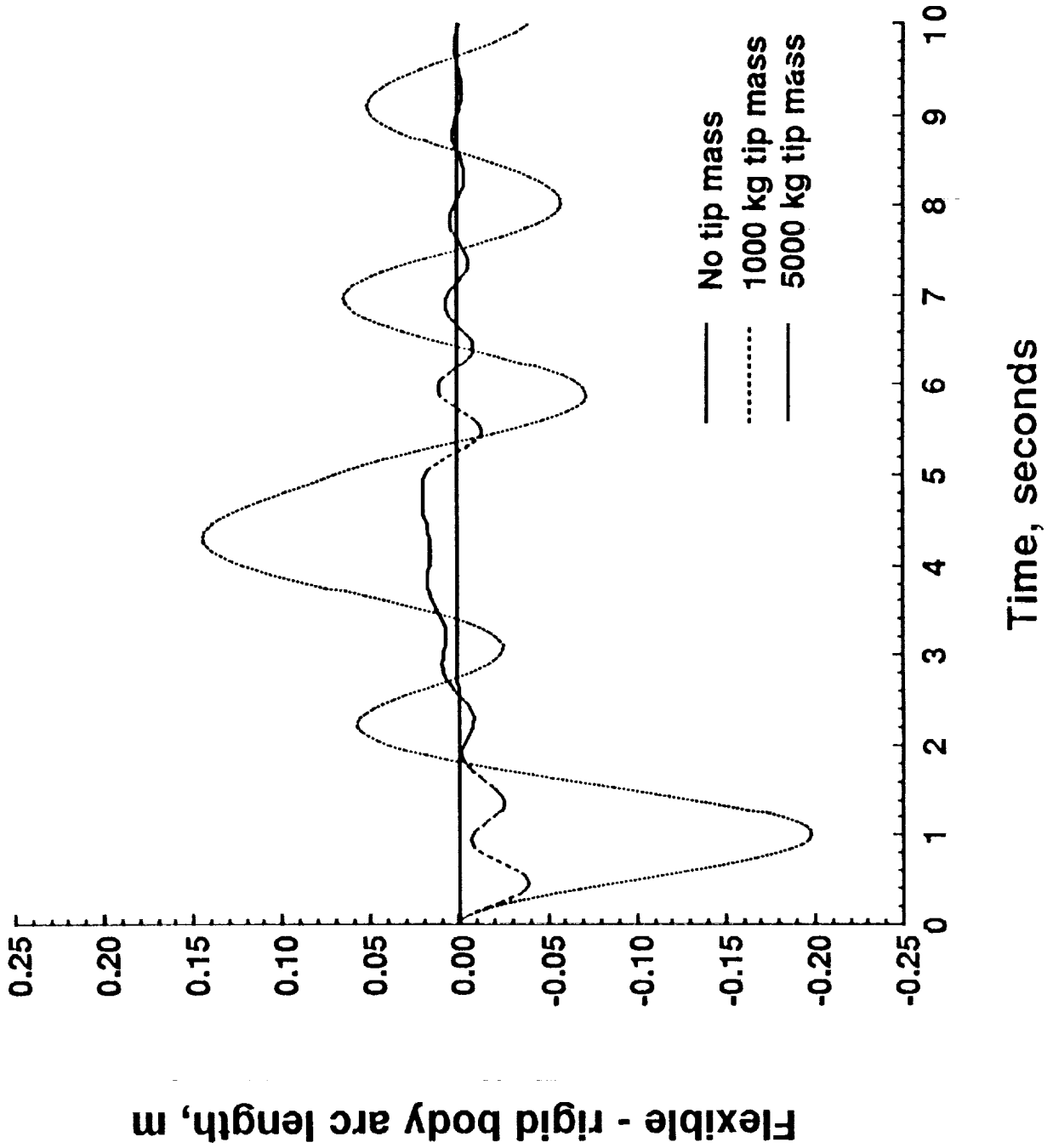

# 1-DOF SPACE CRANE SLEW MANEUVER

## "Component Mode" Structural Dynamics

- Booms modeled with beam elements
- Transverse shearing of beams included
- Lowest three flexible-body modes used
- Clamp-free boundary conditions applied

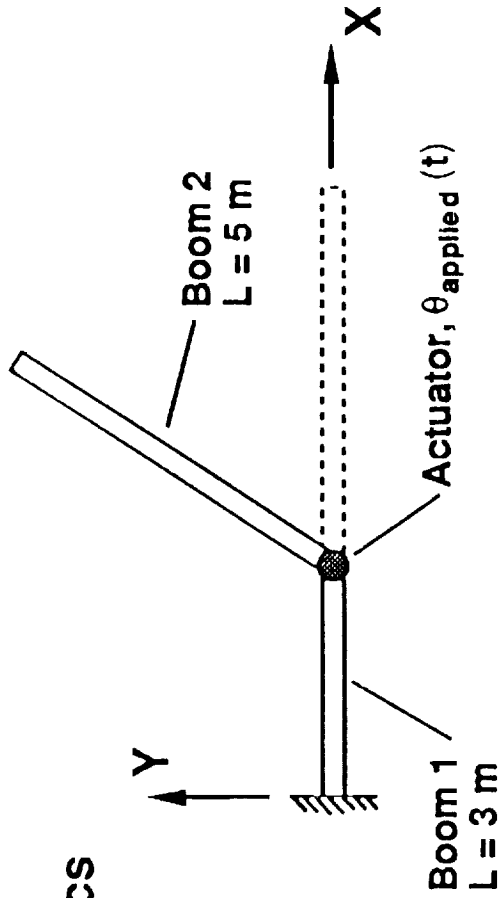
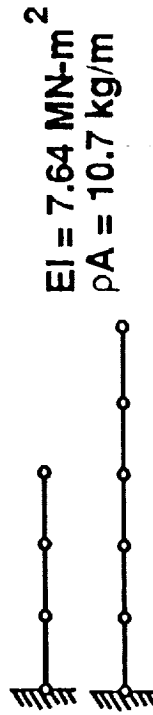

## Applied Rotation Time History

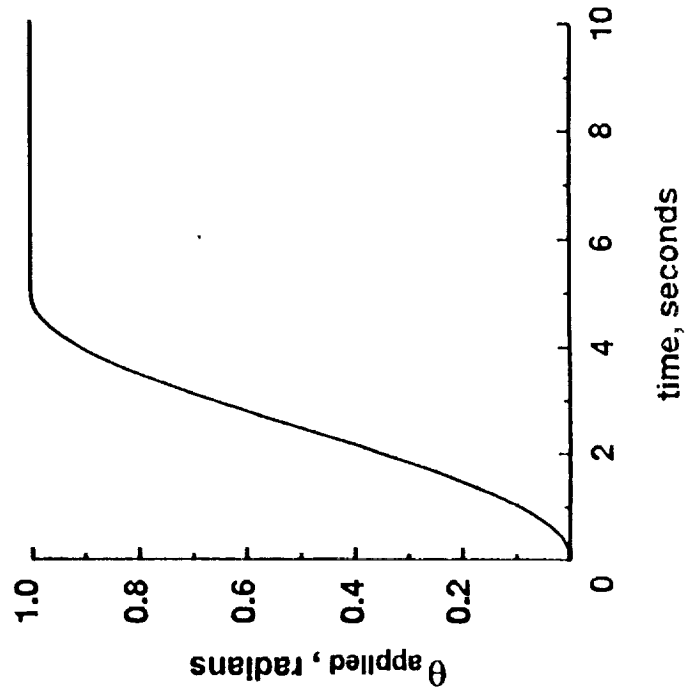

## Boom 2 Tip Position

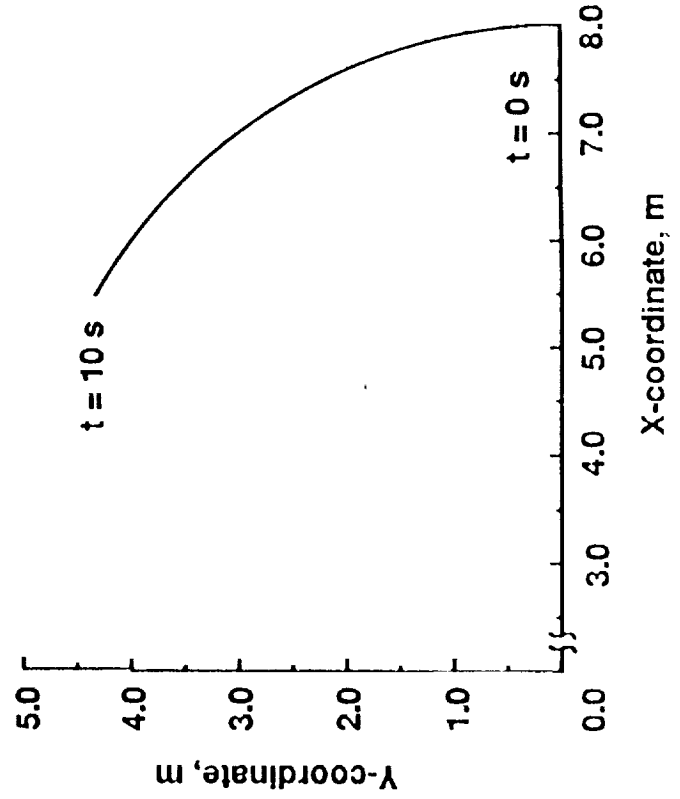

# Boom 2 Tip Transient Response Shear-Corrected Component Modes Torque Driver Profile

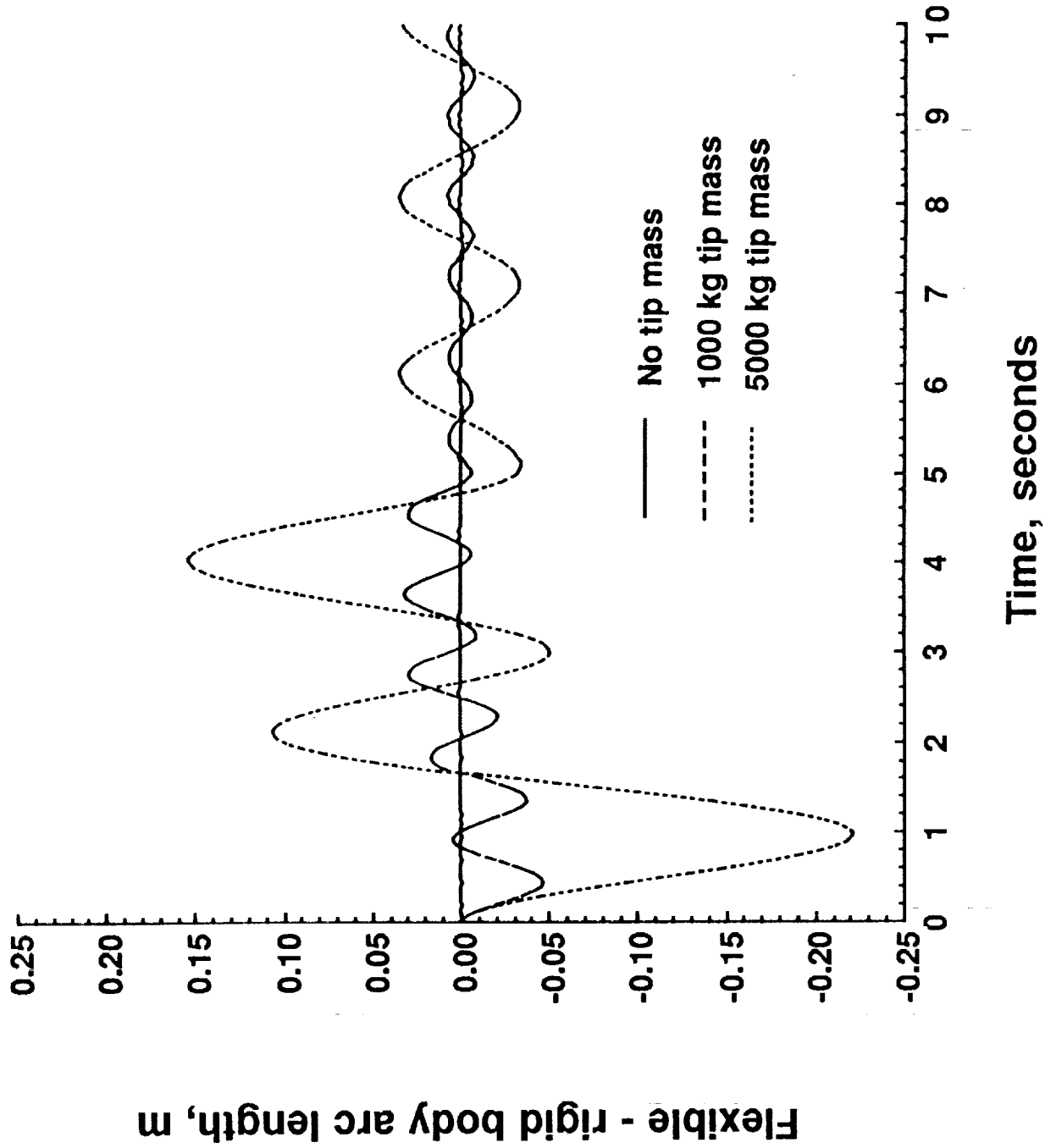

# Peak Root Member Force vs. Slew Time Torque Driver Profile

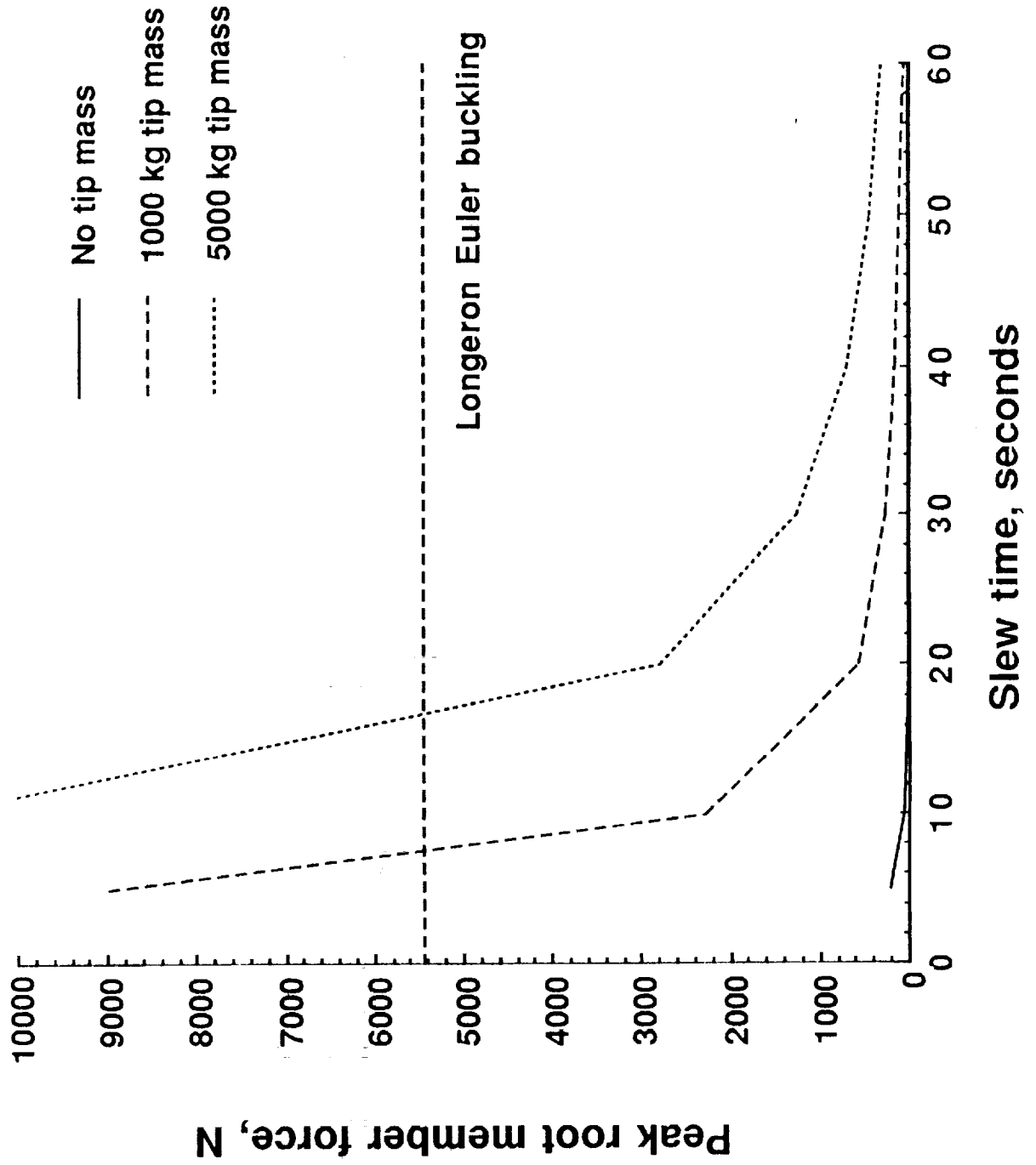

# OPEN-LOOP CONTROL OF SPACE CRANE MOTION

**Proposed Approach:** Design actuator extension profile externally

Use LabVIEW 2 to implement the extension profile and measure the transient response and loads

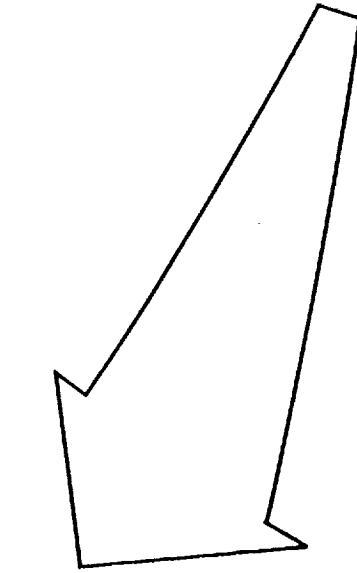
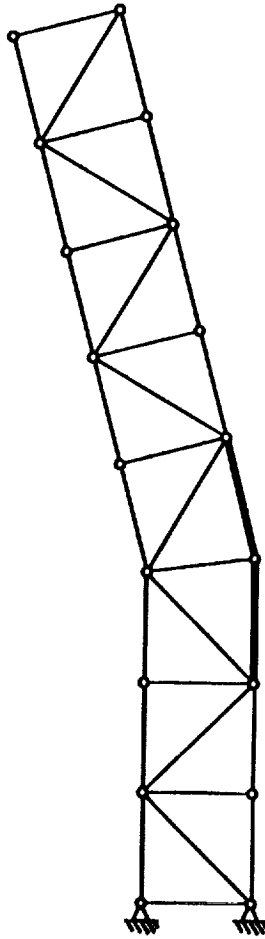

**Actuator Extension Time History**

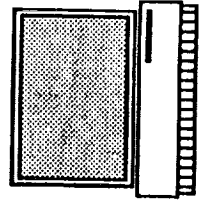
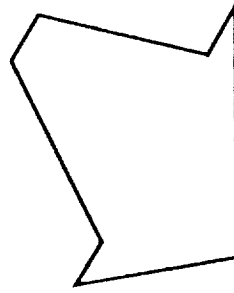
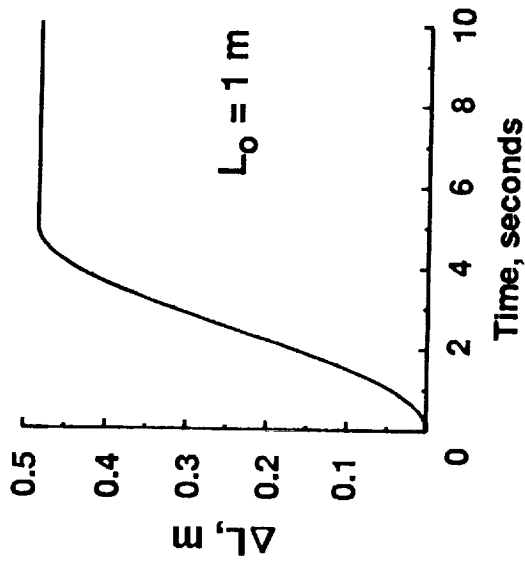

LabVIEW 2

# Automated Assembly of Large Space Structures

Marvin D. Rhodes

Spacecraft Structures Branch

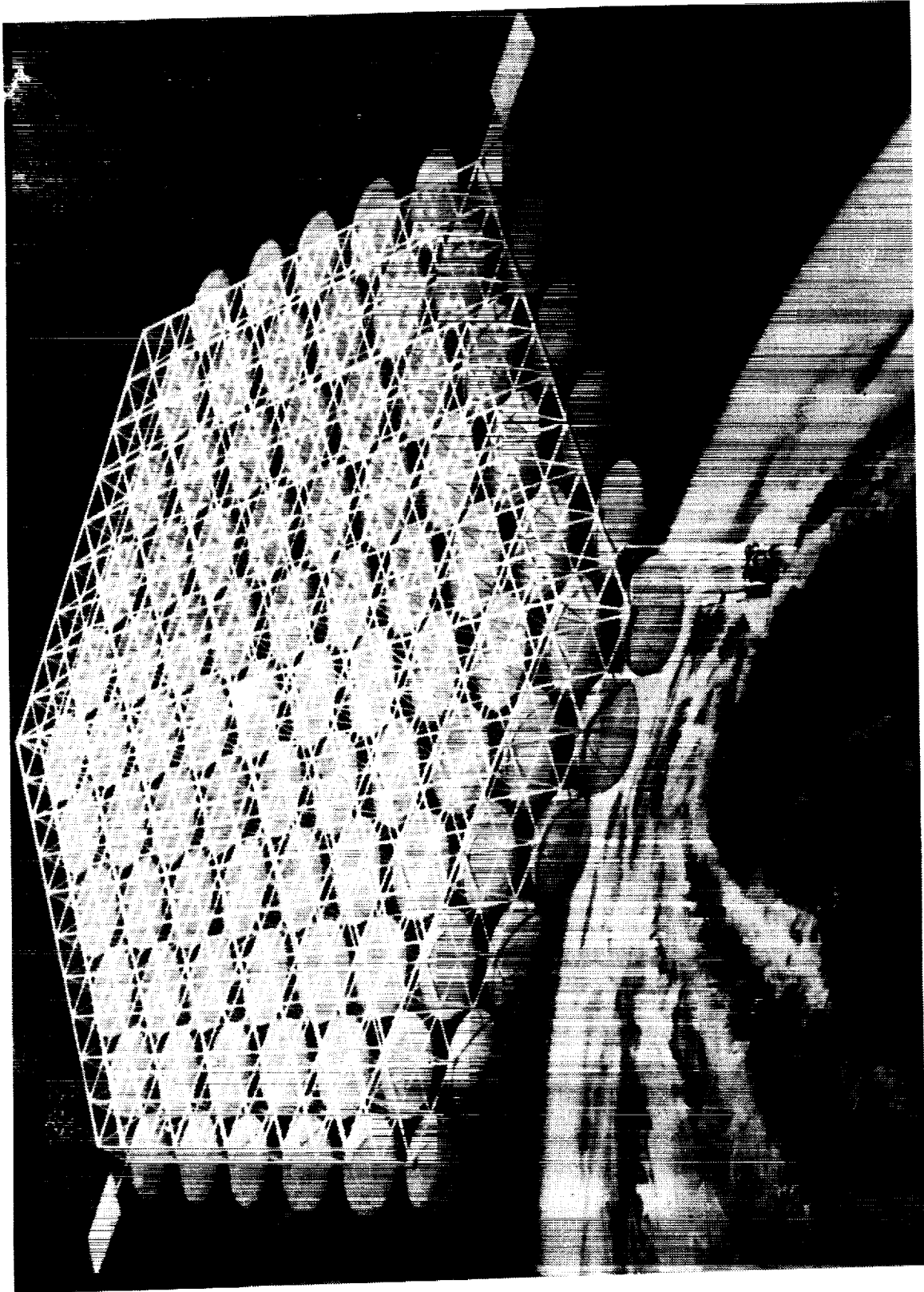

Sketch of Proposed Satellite Supported by Tetrahedral Truss Platform



# TELEROBOTIC ASSEMBLY FACILITY

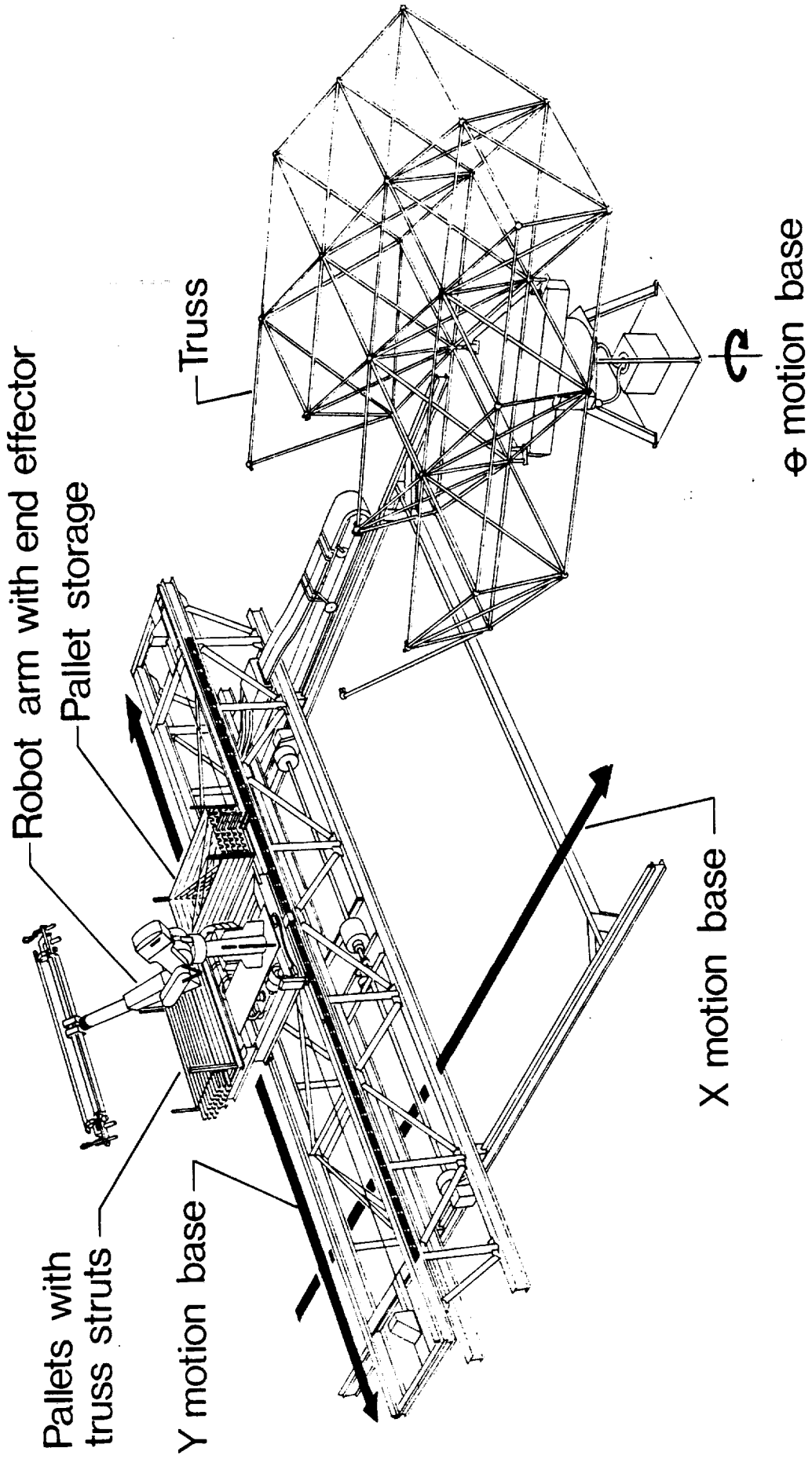

ORIGINAL PAGE  
BLACK AND WHITE PHOTOGRAPH

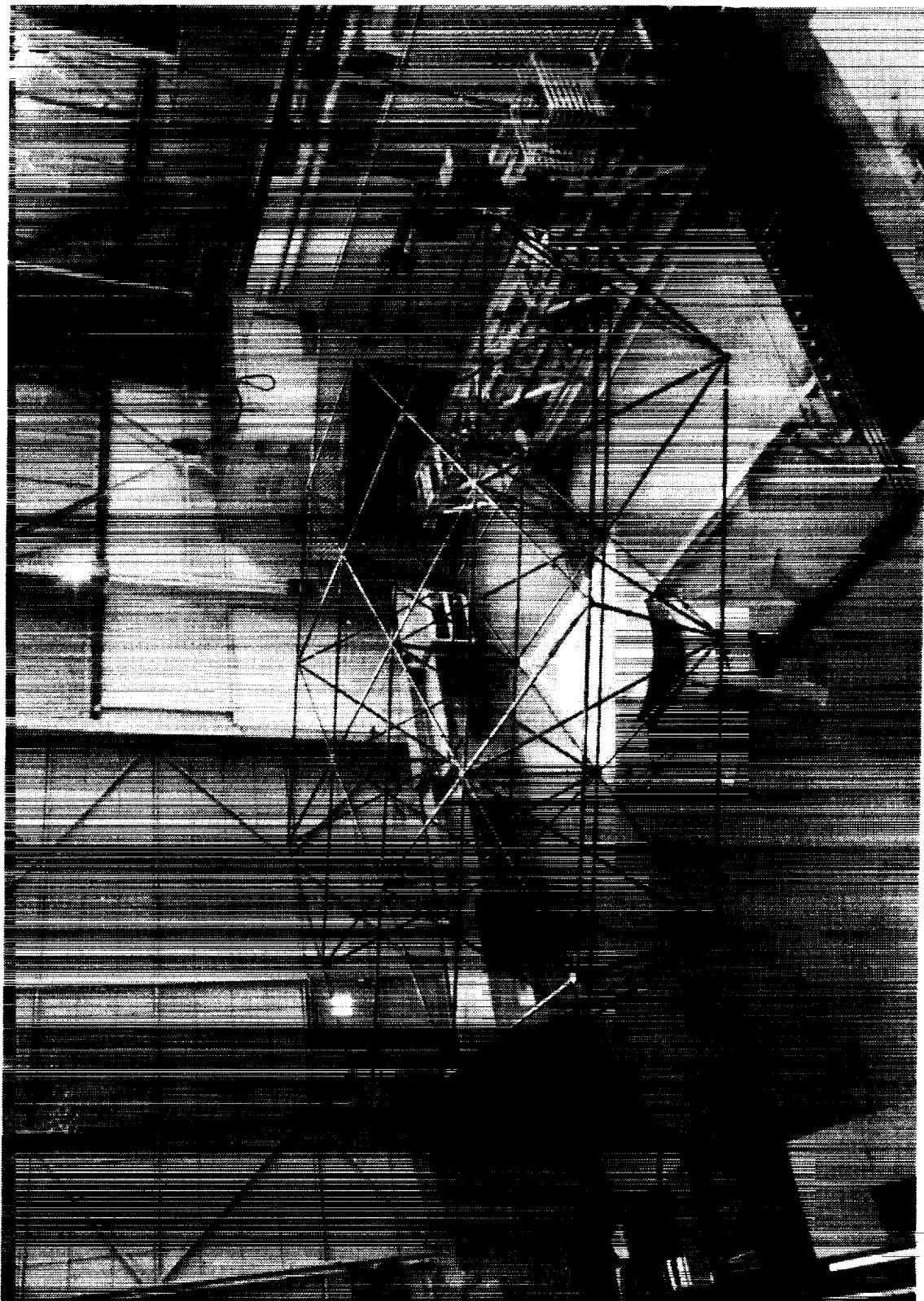

**Photo of Test Lab for Automated Assembly of Large Space Structures**

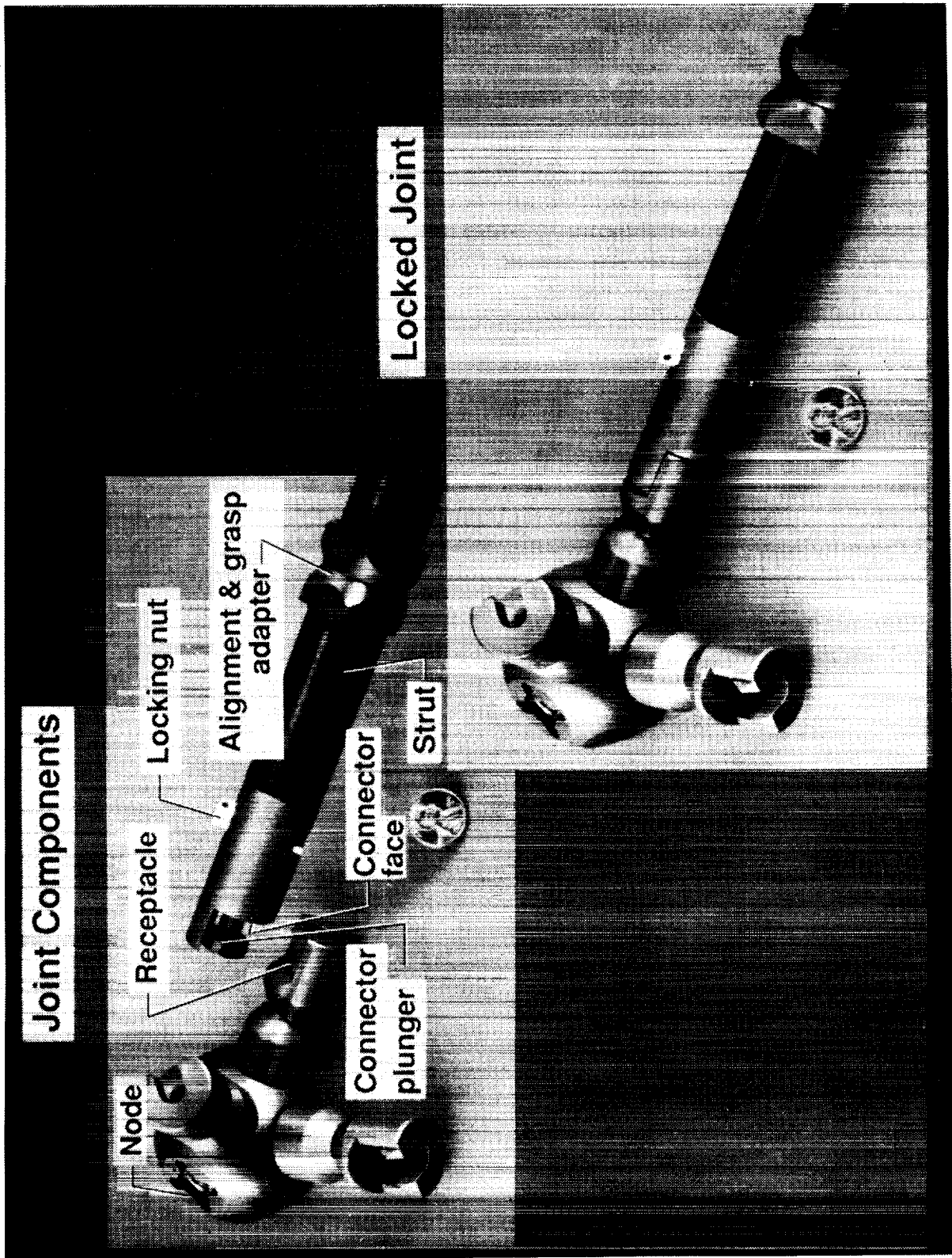
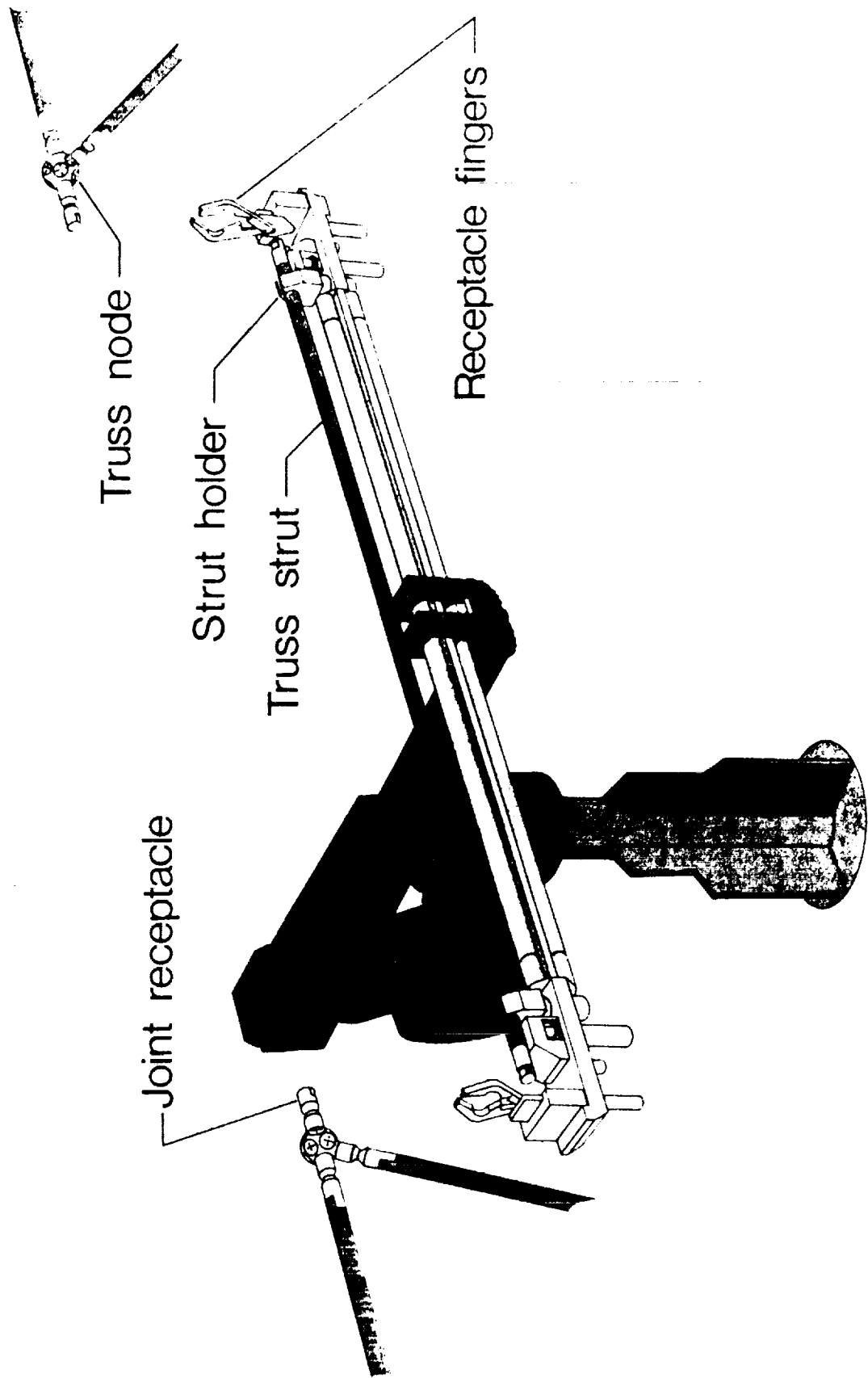
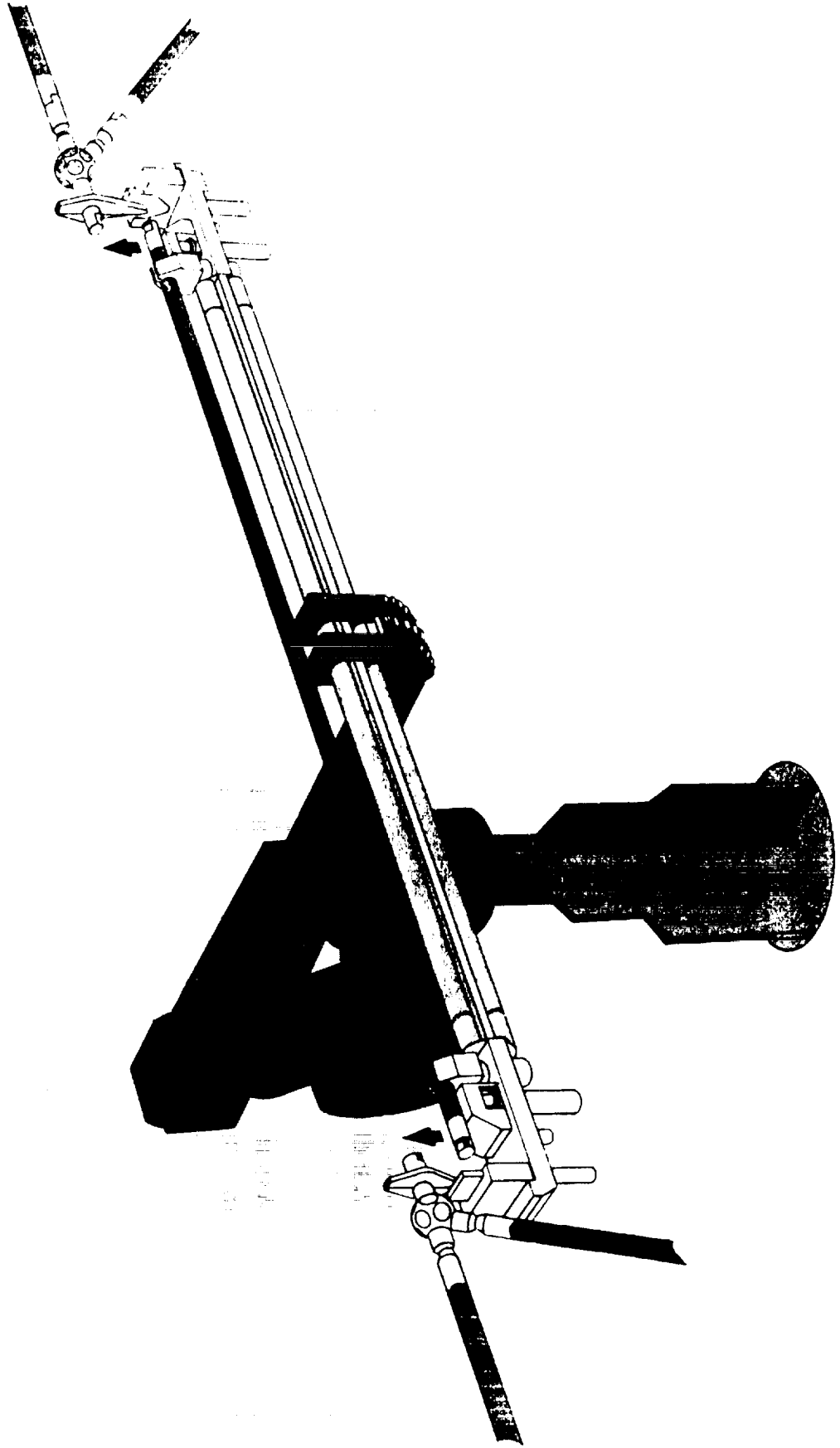

Photo of Truss Joint Connector in the Locked and Unlocked Condition

# ROBOT END EFFECTOR



# ROBOT END EFFECTOR



## Assembly Projected Time

Activity	Current Test (Min-Sec)	Projected (Min-Sec)
Move to Canister Acquire Point	0-37	0-20
Acquire Strut in End Effector	2-08	0-41
Move Arm To Rest Position	0-07	0-07
Position Motion Base Components	0-46	....
Move Arm to Install Position	1-30	1-15
Install Strut	2-49	0-43
Return Arm to Rest Position	<u>1-13</u>	<u>1-00</u>
Total Assembly Time	9-10	4-06

Projected Time Assumes Parallel Processing and Distributed Control  
 Current Operation Involves 48 Communication Commands/Strut @ 1 Sec/Command

# Typical Truss Assembly Break Down

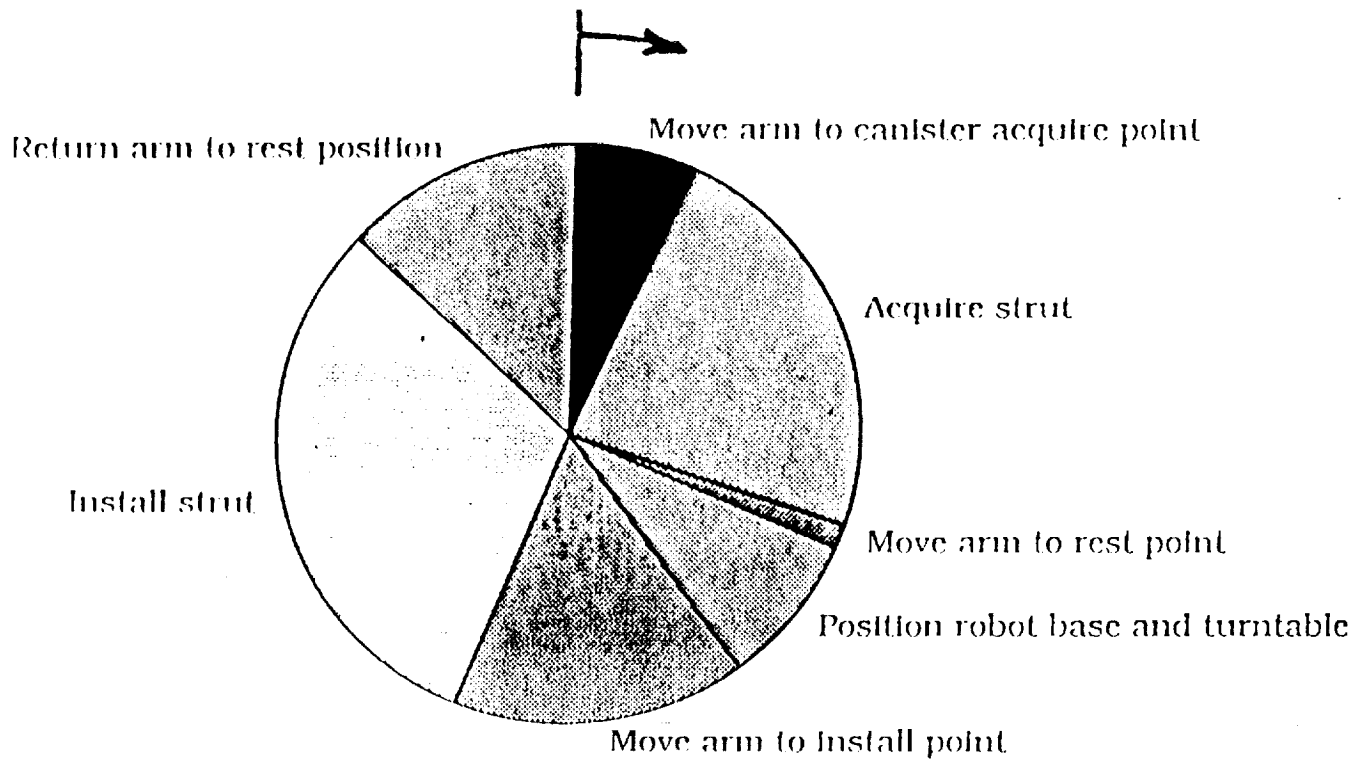

	Time (Min)	Percent
Move arm to canister	62.98	6.71%
Acquire strut	218.30	23.26%
Move arm to rest point	12.13	1.29%
Position robot base and turntable	79.27	8.45%
Move arm to Install point	153.62	16.37%
Install strut	287.63	30.65%
Return arm to rest position	124.48	13.27%
Total:	938.42	

**AUTOMATED STRUCTURES ASSEMBLY FACILITY**  
**CURRENT CONTROL HIERARCHY**

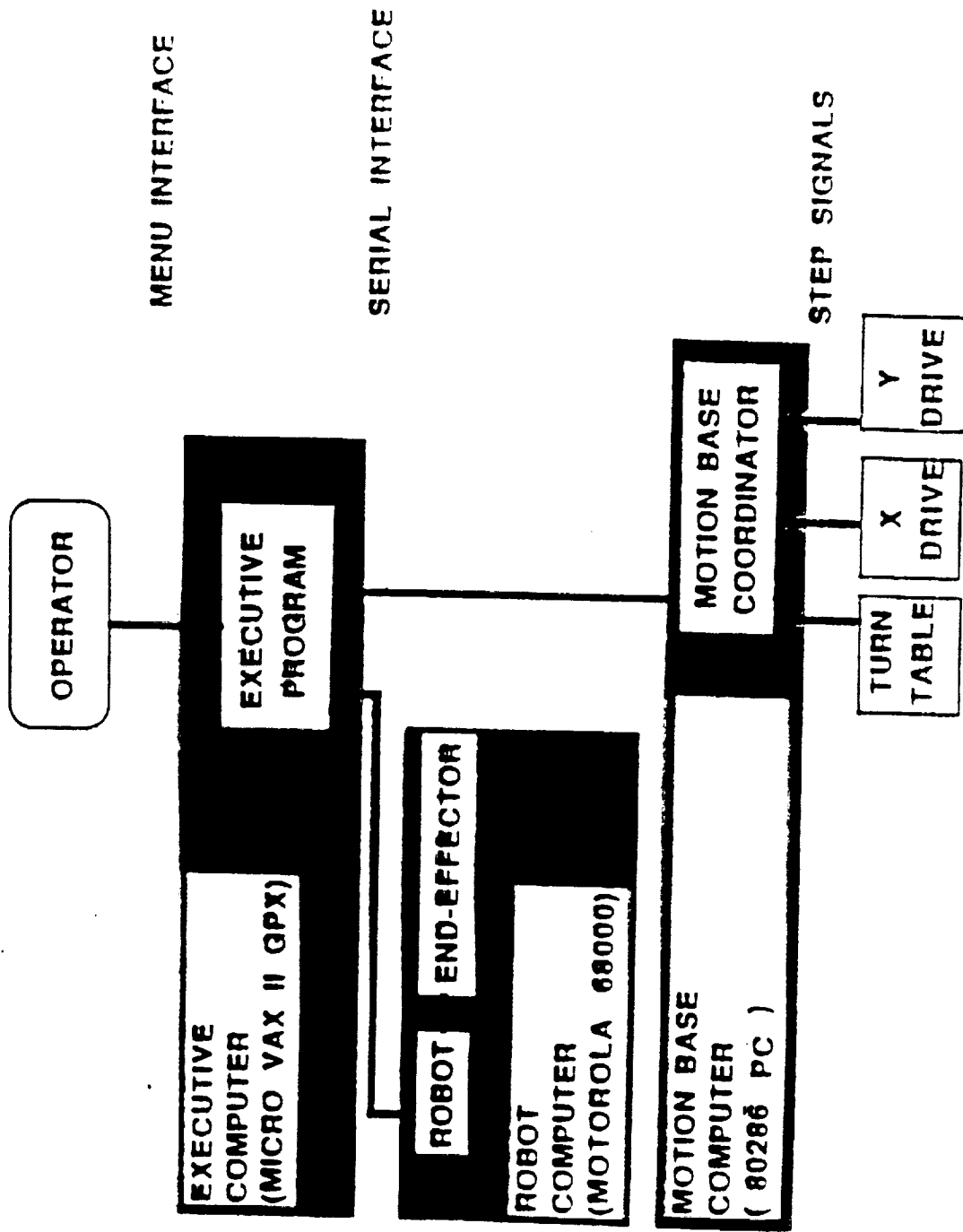



## Assembly Problem Summary

On Average There Are 30-50 Operator Intervention Problems Encountered During an Assembly/Disassembly Test

66% Are Positioning Errors Associated with Joint Receptacle Capture

33% Are Positioning Errors Associated with Inserting the Strut into the Receptacle

1% Result from Struts Length Errors

Correction of All Except Strut Length Errors Are Handled by the Operator from the Console by Adjusting the Robot Position or Force/Torque Balance Repositioning (Corrected by Accurate Positioning Using the Proposed Vision System)

Strut Length Errors Require Going-Over-The-Fence (Corrected by Better Guidance in Joint)

# Observations and Results

## Hardware Design

Grappling the receptacle for strut installation is recommended

Passive guidance is required for positioning of mating components

Positive actuation required for mechanism operation

## Software Design and System Control

Complete system data base required to control all operations

Operator's role in system control key to software design

Every operation must be interruptible and reversible

System must be under computer control

Concise naming conventions is vital to operator control

## **Sensor Monitoring and Error Recovery**

**Full instrumentation of each end-effector component is essential**

**Video camera coverage is necessary for error recovery operations**

**Automatic roll-back to preexisting state is very desirable feature**

**Compliant moves provided by force/torque feedback**

## **Recommendations/Conclusions**

**Graphic simulations and component bench testing will not substitute for full hardware test experience**

**Significant portion of system capability empirically developed**

**Automated assembly is a viable option for in-space construction**

## **Current Plans/Developments**

**Automated Machine Vision Guidance-E. Cooper**

**Distributed Microprocessor Control-B. Doggett**

**Installation of Large Panels-P. Quach**

**Rule Based Expert System Programming-C. Allen**

**Future Work-R. Will**

**Parallel System Control**

**Computer Graphics**

**Automated Path and Sequence Planning**

**Other Structural Configurations**

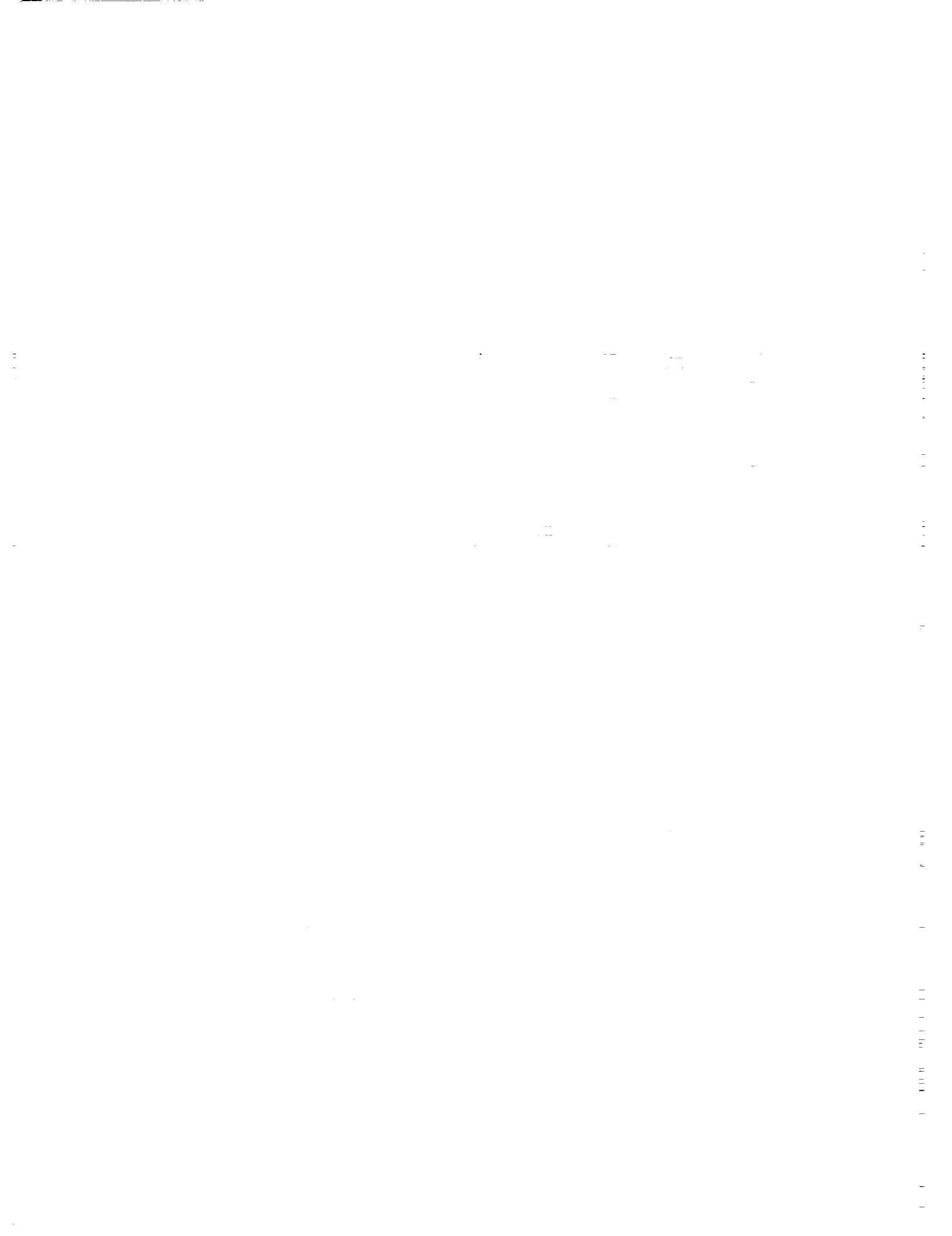

# **Development of a Machine Vision Guidance System for Automated Assembly of Space Structures**

**Eric G. Cooper**  
Automation Technology Branch

**P. Daniel Sydow**  
Spacecraft Structures Branch

**N 9 2 - 2 7 7 7 5**

# Automated Structural Assembly Robot Vision

## **Objective:**

Provide position verification of the node receptacle with respect to the end effector

## **Approach:**

Fabricate custom camera/lighting hardware and adapt the 4 point target location algorithm developed in the Intelligent Systems Research Laboratory (ISRL)

Develop robust target discrimination techniques

## **Results:**

Consistent and robust target identification and position estimation in the ASAL environment



## **Machine Vision Requirements**

Camera and light assembly must be attached to robot end-effector

Enable the operator to monitor and provide assistance

Provide position information with no manipulator servoing to locate the target

Discriminate between similar targets within the field of view

Provide positional accuracy of at least 0.25 inches

# Vision Hardware and Targets

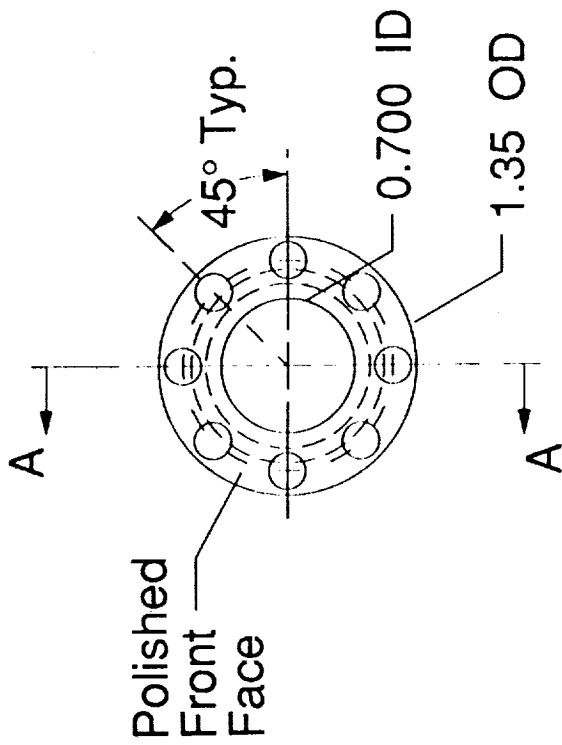

Ring Light Mount

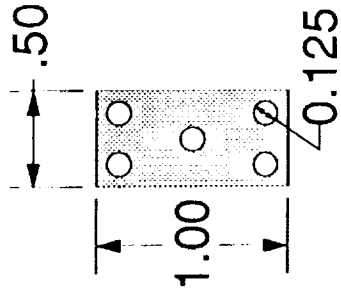

Old Target

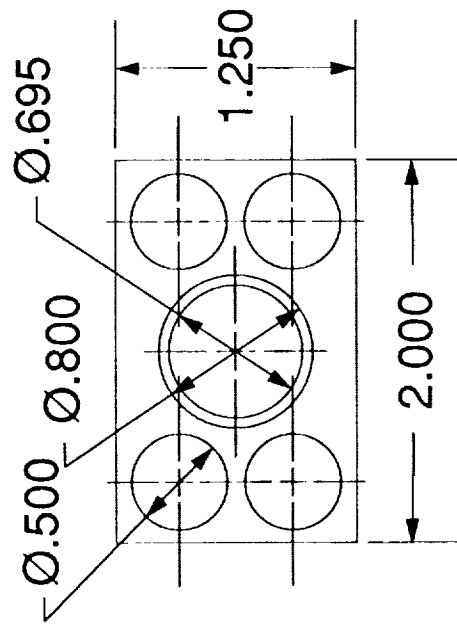

Focused Light Mount

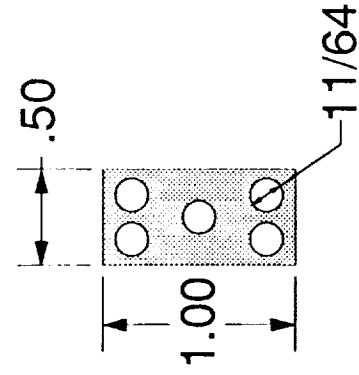
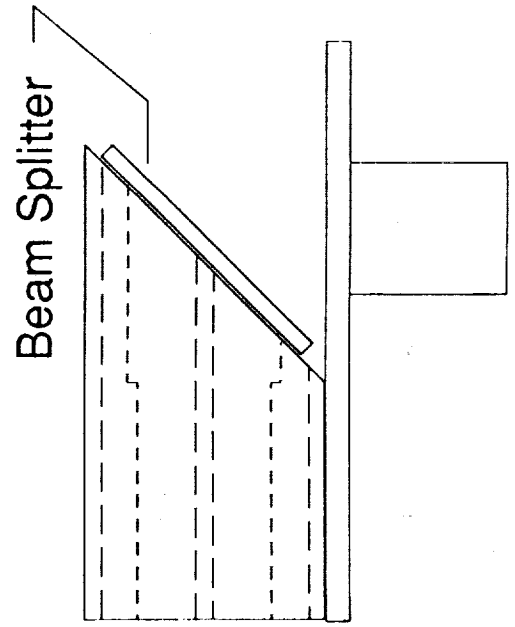

New Target

# Reflective Efficiency

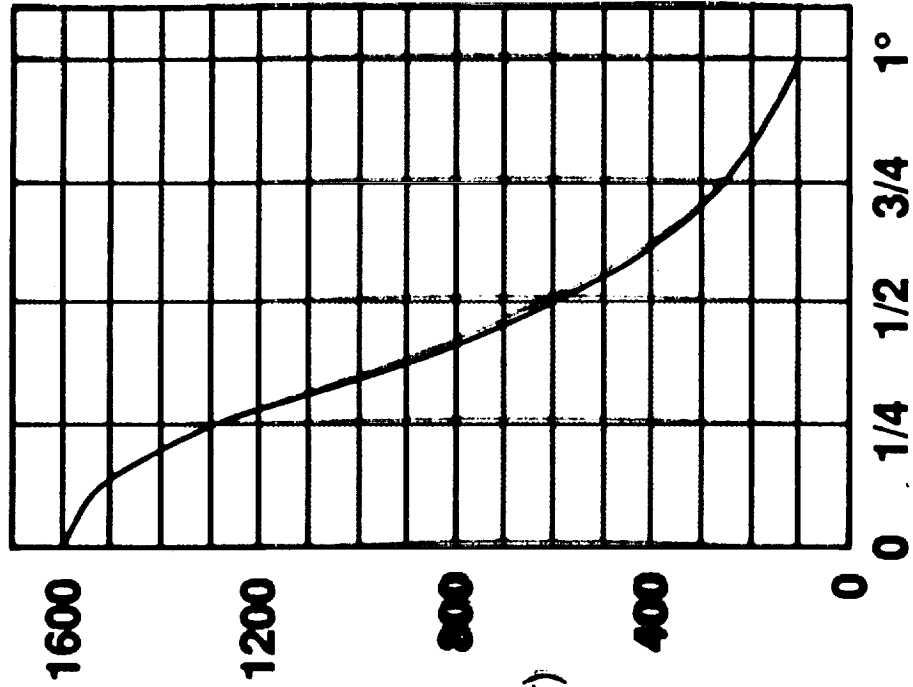

**Luminance Factor**

(Number of times brighter than a perfect white diffuser)

**Observation Angle**

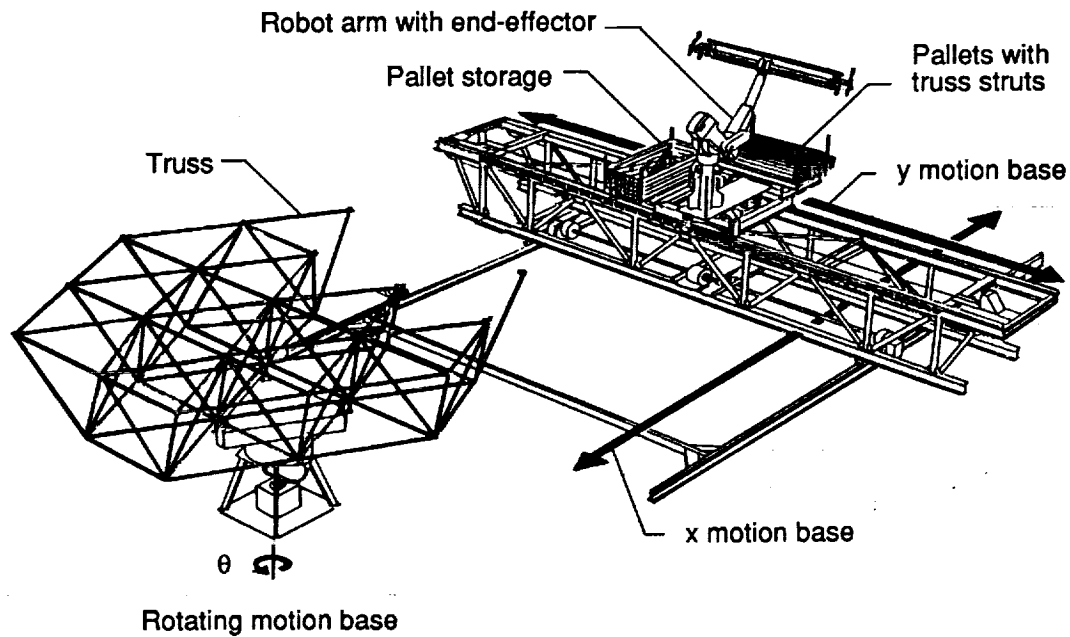

(a) Schematic of Automated Structural Assembly Laboratory.

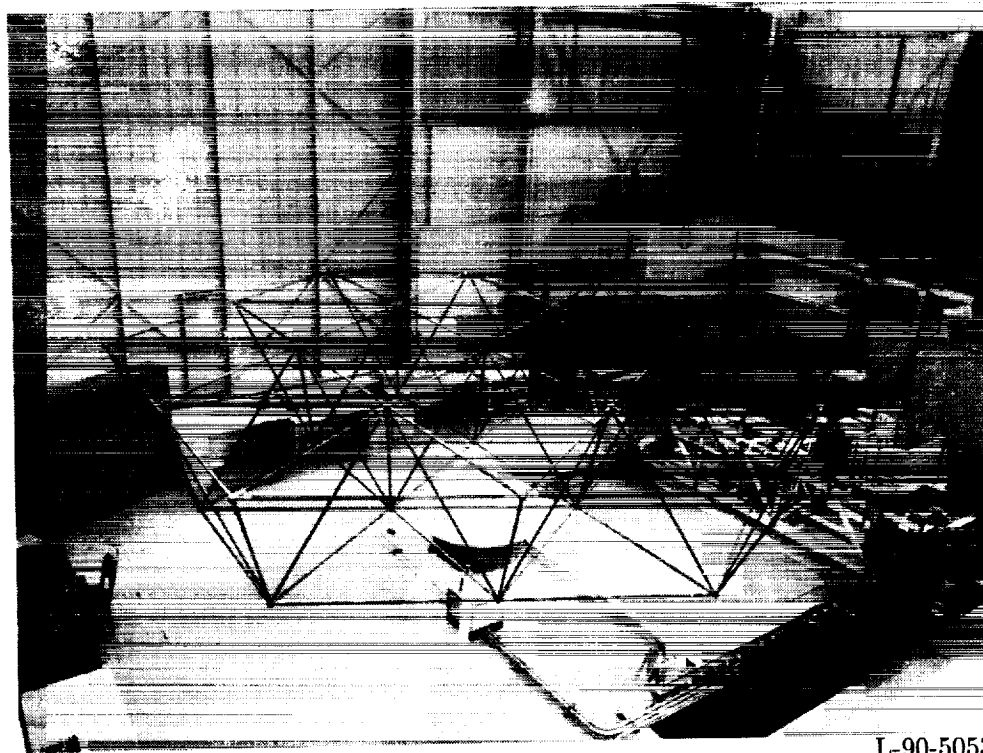

L-90-5053

(b) Hardware in Automated Structural Assembly Laboratory.

Figure 1. Automated Structural Assembly Laboratory.

# Target Identification

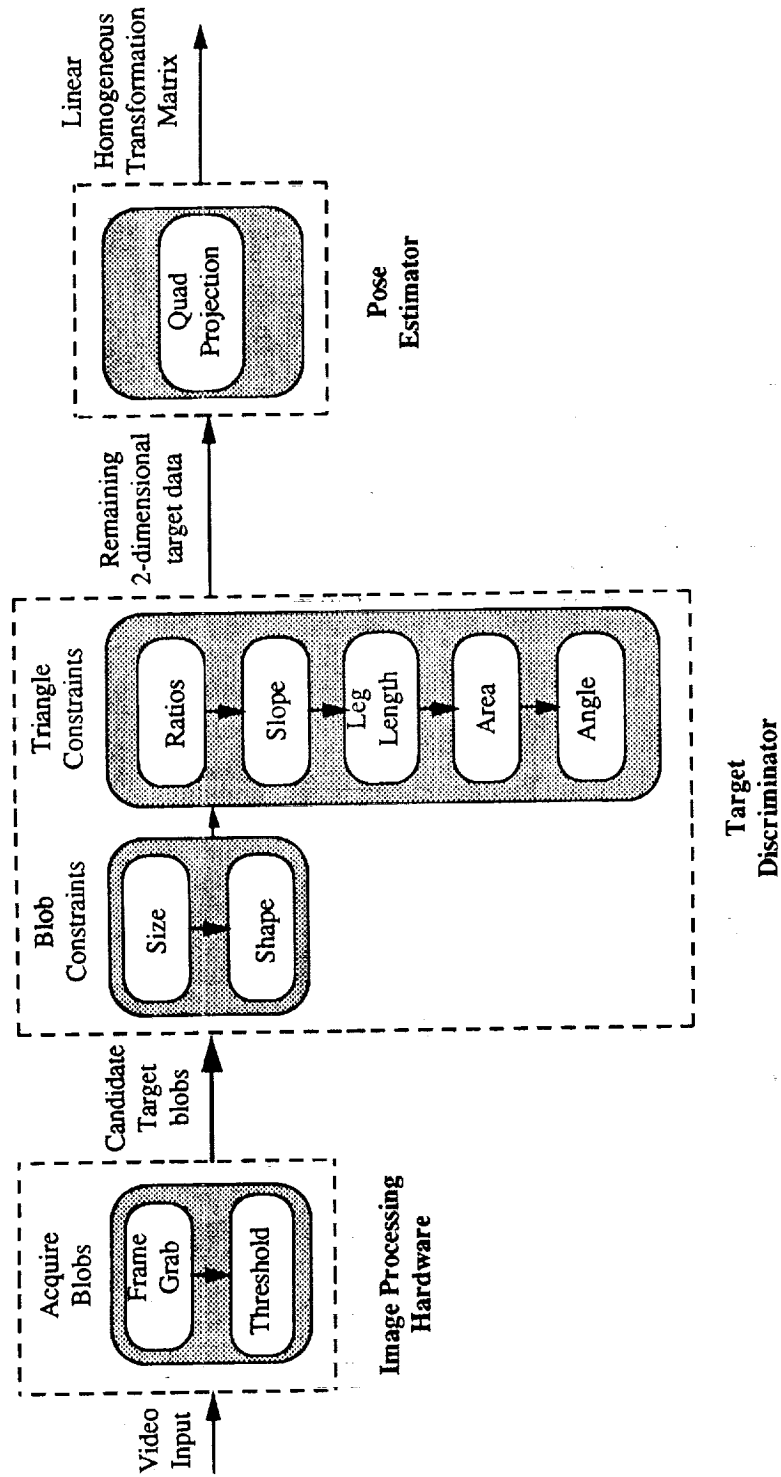

### Pose Estimation Algorithms - Functional Description

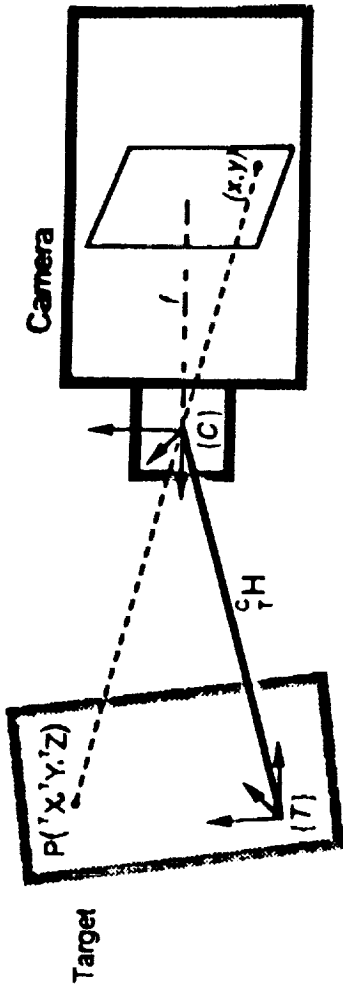

**INPUT:**

- Target points in target coordinate system  $\{(x', y', z')\}$
- Corresponding image point projections  $\{(x, y)\}$

**PROCESSING:**

- Algorithms differ, but all are based on the perspective projection equations:  

$$x = f \frac{c_x x'}{z'}, \quad y = f \frac{c_y y'}{z'}$$
- where 
$$\begin{bmatrix} c_x \\ c_y \\ c_z \end{bmatrix} = {}^C_H \begin{bmatrix} x' \\ y' \\ z' \end{bmatrix}$$
- Given a sufficient number of feature points, the pose can be determined
- Additional points increase the accuracy of the pose estimation

**OUTPUT:**

- Target pose with respect to the camera frame; i.e.,  ${}^C_H$

# Triangle Constraints

• Ratios

• Slope

• Leg Length

• Area

• Angle

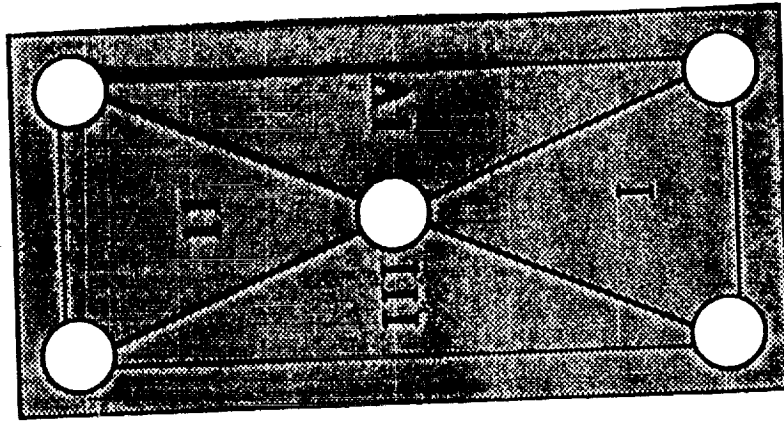

**5 Point Target**

ORIGINAL PAGE  
BLACK AND WHITE PHOTOGRAPH

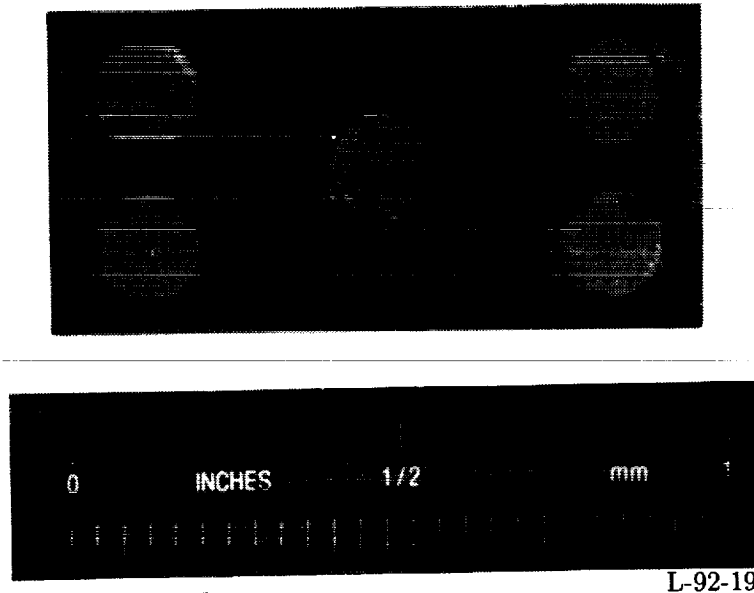

Figure 2. Joint receptacle target.

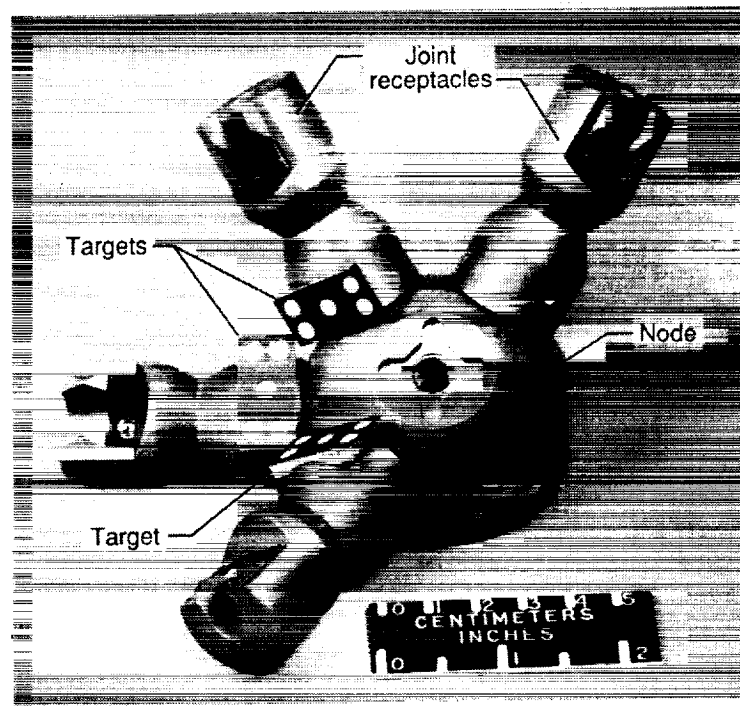
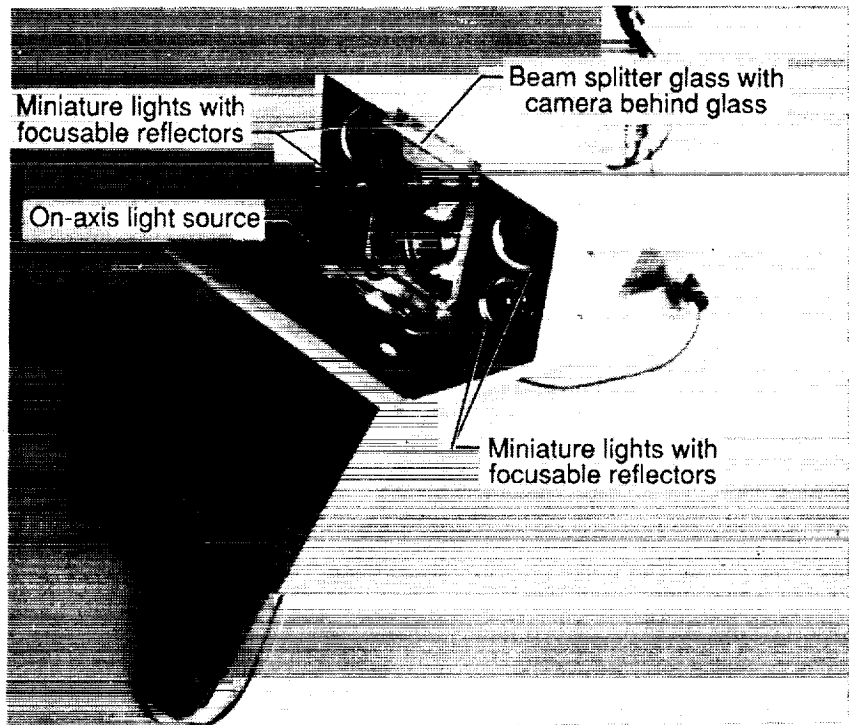

Figure 3. Truss node with joint receptacle targets.





L-91-6331

Figure 4. Camera and light assembly.

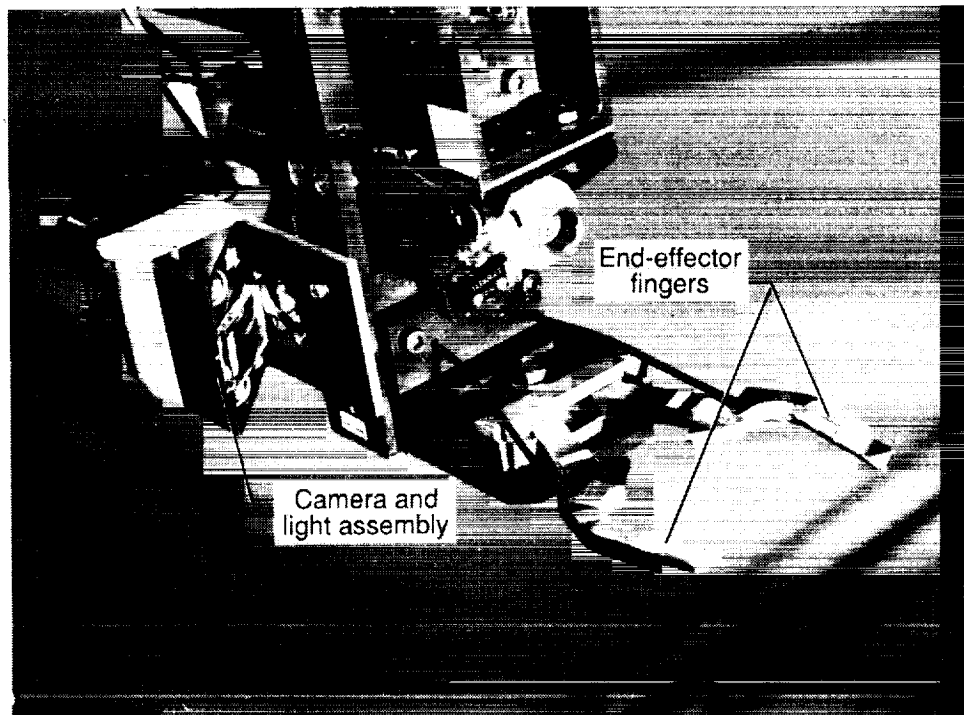

L-91-05738

Figure 5. End-effector mounted camera and light assembly.

ORIGINAL PAGE  
BLACK AND WHITE PHOTOGRAPH

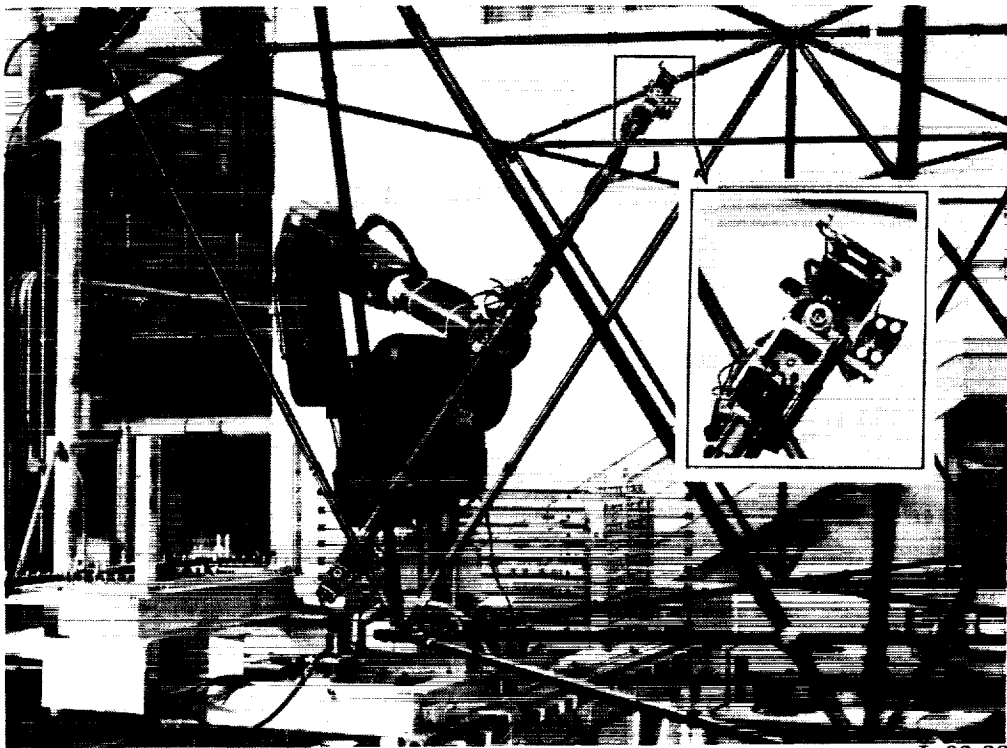

L-92-20

Figure 6. Robot arm at typical vision approach point.



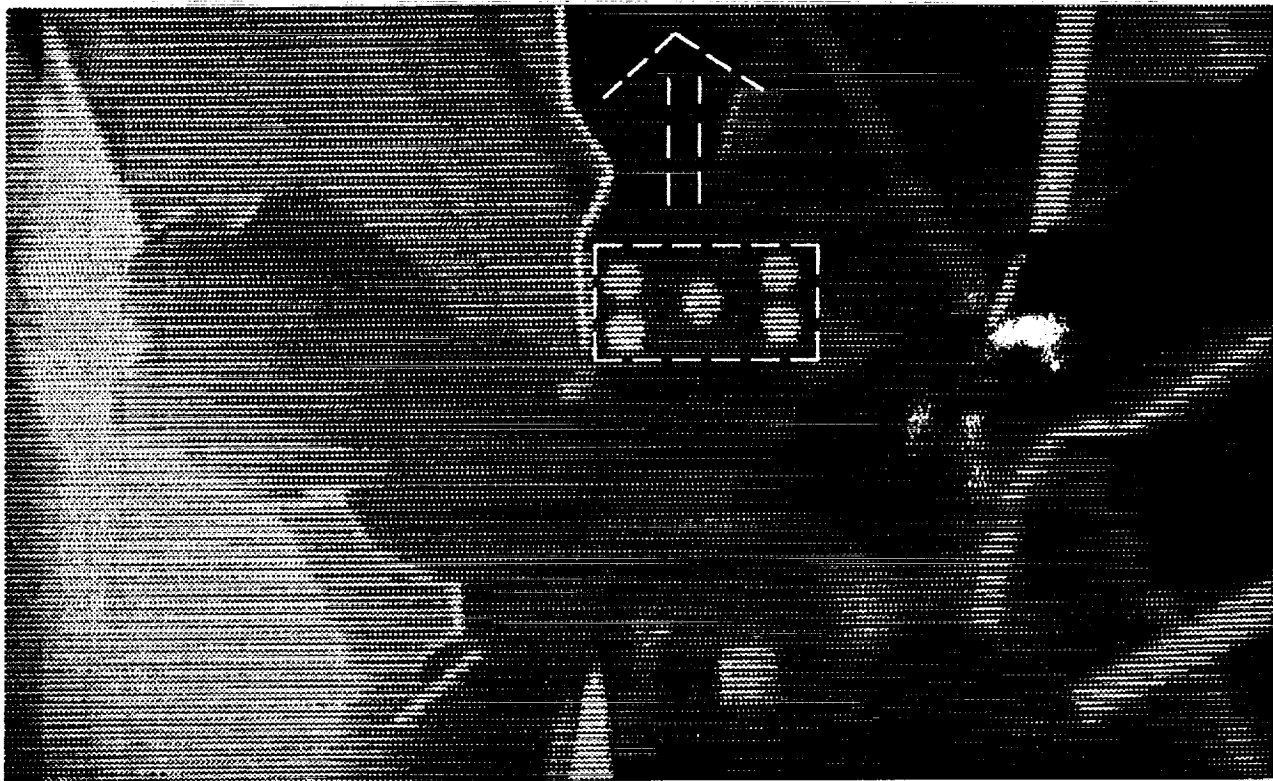

(b) After illumination.

Figure 7. Concluded.

L-91-6380

83 80 79 79 79 80 82 82 80 79 76 76 77 77 79 83 89 95 101 103 100 94 87 83 81 81  
81 78 77 79 84 92 98 99 95 88 81 77 77 80 85 95 112 130 143 145 157 120 103 89 82 82  
84 80 83 93 110 132 147 147 133 113 96 80 84 97 123 158 187 203 206 195 172 138 105 87 84  
82 83 93 115 143 166 177 177 166 145 116 82 84 95 151 180 200 210 221 226 210 169 118 87 80  
82 89 110 142 167 178 179 180 181 170 143 88 88 108 143 176 195 201 207 219 229 225 193 145 102 83  
84 94 126 159 177 180 178 181 184 179 157 93 89 116 159 190 201 200 206 219 231 230 205 158 108 81  
86 103 133 163 178 180 180 183 186 182 167 102 89 114 160 193 200 198 204 217 229 233 218 174 118 81  
87 107 140 167 179 180 183 185 182 169 105 92 118 164 194 198 193 198 211 225 232 220 176 118 80  
87 107 139 166 177 178 182 185 183 171 108 88 107 153 189 198 194 195 208 223 231 217 171 113 79  
87 106 138 166 178 178 181 184 181 167 104 86 104 148 185 198 196 198 208 226 226 206 156 103 77  
80 94 122 155 173 177 178 180 175 158 97 83 95 130 167 189 195 196 202 212 213 185 135 92 77  
80 90 114 147 171 180 180 180 180 171 145 89 82 91 114 146 175 191 195 198 201 191 157 111 83 79  
79 83 97 125 155 173 177 176 170 154 124 81 81 85 93 111 140 164 175 174 164 143 115 91 81 81  
78 80 88 104 128 150 162 161 147 124 100 80 82 82 85 91 104 121 132 131 118 101 90 85 82 80  
78 79 81 85 91 100 108 108 100 89 82 80 80 79 80 82 84 86 87 87 88 86 85 83 80 78  
79 79 80 82 82 83 83 83 82 80 78 78 78 79 81 81 82 82 82 84 85 85 84 82 80 78  
78 78 79 81 81 82 82 82 82 77 77 78 80 81 81 82 82 83 84 84 83 81 79 78  
79 78 79 81 81 81 80 80 80 78 78 78 78 78 78 78 78 78 78 78 78 78 78 78 77  
77 78 78 79 80 81 81 81 82 82 80 77 77 77 78 78 78 78 78 78 78 78 78 78 78 77  
78 79 79 79 81 81 81 82 82 80 77 77 77 78 78 78 78 78 78 78 78 78 78 78 78 77  
77 77 77 78 79 80 80 80 79 78 78 79 78 79 80 80 80 81 81 80 79 78 78 78 77  
77 77 77 77 78 77  
76 77 77 78 77  
78 78 78 79 81 81 81 81 80 80 80 78 78 78 78 78 78 78 78 78 78 78 78 78 77  
77 78 78 79 80 81 81 81 80 80 80 77 77 77 78 78 78 78 78 78 78 78 78 78 78 77  
77 77 77 78 79 80 80 80 79 78 78 79 78 79 80 80 80 81 81 80 79 78 78 78 77  
76 77 77 78 77  
77 78 77  
77 78 79 80 80 80 80 79 81 81 81 82 82 178 166 142 112 92 85 85 84 82 82 82 80 80  
77 78 78 79 80 81 81 82 91 113 147 196 185 185 187 160 127 99 87 87 84 83 82 82  
77 78 78 79 80 81 81 82 94 120 154 185 183 183 187 175 149 117 92 83 85 87 85 83 81  
79 80 80 80 79 84 102 133 165 182 184 184 186 190 181 159 125 95 84 86 88 85 82 81  
78 79 79 79 79 85 102 133 165 181 181 180 183 188 190 185 167 134 100 84 83 86 84 81 81  
80 80 79 79 80 82 88 106 137 168 183 183 183 188 190 185 164 130 97 84 85 89 87 83 82  
80 80 79 79 80 81 84 98 126 158 178 182 181 196 189 182 159 124 94 83 84 87 84 81 82  
80 80 80 81 81 84 95 121 154 178 186 184 185 190 191 176 145 111 90 85 88 88 86 84 83  
80 79 80 80 81 86 104 134 164 180 182 183 187 184 165 130 100 86 86 86 85 83 83 83  
80 80 81 81 81 81 81 84 95 119 150 171 179 179 176 164 139 108 89 86 87 85 82 82 83 83  
82 81 81 81 80 80 82 83 85 89 106 110 106 98 91 87 85 83 83 83 83 83 83 81 81  
80 80 80 80 80 80 80 82 83 84 84 85 85 85 84 84 83 82 81 81 81 81 81 81 81  
80 81 82 82 81 81 81 82 82 82 82 83 83 84 84 84 84 84 84 84 84 84 84 84 84 81  
79 79 80 81 81 81 80 80 81 82 83 83 84 84 84 84 84 84 84 84 84 84 84 84 81  
79 80  
79 80 82 82 82 81 81 81 80 80 81 82 82 83 83 83 83 83 83 83 83 83 83 83 82  
79 81 81 81 81 80 80 80 79 79 79 80 81 81 81 81 81 81 81 81 81 81 81 81 81  
80 80 81 81 81 80  
80 81 81 81 81 80  
77 79 80 80 81 81 81 82 82 80 80 80 80 80 80 80 80 80 80 80 80 80 80 80  
79 81 83 83 83 83 85 85 83 83 82 82 82 82 83 84 84 84 84 84 84 84 84 84 84  
79 81 82 84 90 100 111 115 112 102 94 88 84 83 85 93 111 141 169 183 182 171 151 126 103  
79 80 84 94 114 139 158 161 154 140 123 105 91 85 87 95 115 146 178 198 207 211 197 161 120  
80 83 91 110 138 165 178 179 178 176 163 136 106 89 89 104 132 165 203 206 210 217 225 225 199 152  
79 85 100 127 160 180 186 184 184 176 150 118 94 92 113 150 184 204 209 213 222 230 231 212 169  
78 84 103 136 167 184 185 183 184 187 183 165 134 103 92 111 152 188 204 207 211 221 231 234 223 188  
80 90 115 150 178 189 188 186 187 188 185 171 142 108 96 118 164 198 209 215 226 234 232 228 185  
79 80 116 151 178 188 186 184 185 187 186 177 150 113 93 112 158 195 210 212 217 226 233 232 218 181  
81 93 119 154 178 186 184 184 187 189 186 172 143 107 91 112 158 197 212 214 219 229 236 234 215 169  
79 89 111 144 173 184 183 186 184 168 140 109 83 106 144 184 207 216 220 228 235 233 209 162  
81 89 109 140 170 184 185 184 188 190 181 157 124 98 92 104 133 171 203 219 225 230 232 223 189 140  
79 85 97 121 153 177 186 186 186 184 171 143 112 93 90 95 109 138 175 206 221 223 217 197 160 119  
83 86 93 109 137 162 186 181 171 150 122 99 91 92 96 100 115 146 180 201 200 180 153 124 103  
81 84 87 93 104 122 141 150 146 132 115 101 93 90 90 92 94 103 116 128 130 122 109 98 92  
81 84 87 90 93 98 104 108 107 101 95 90 88 86 88 88 88 88 88 88 88 88 88 88 88

ORIGINAL PAGE  
BLACK AND WHITE PHOTOGRAPH

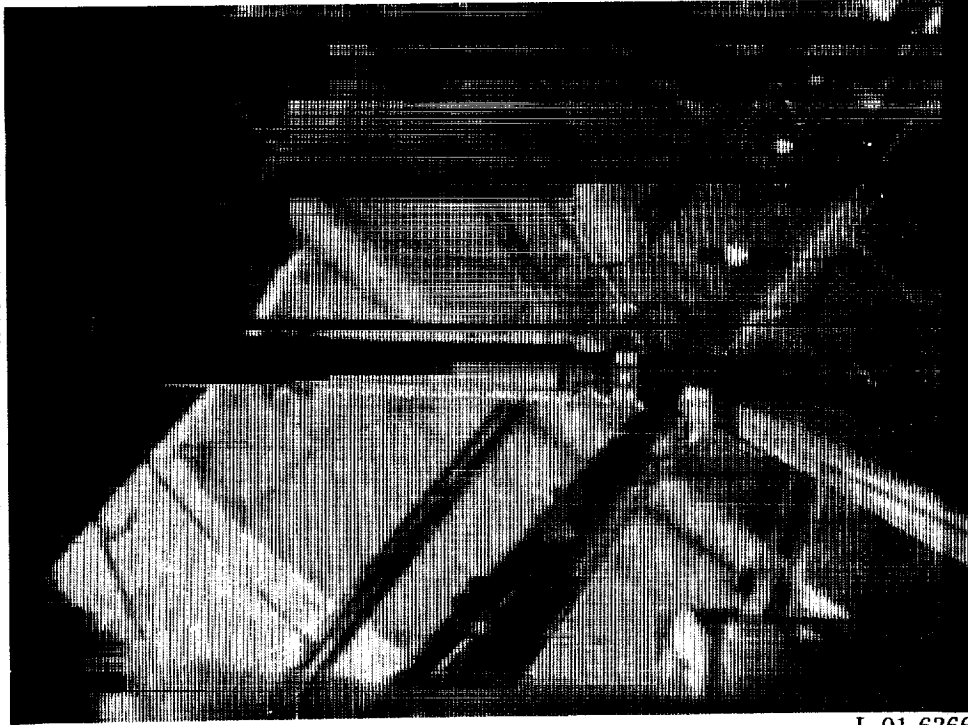

L-91-6366

(a) Vision system view at range of  $\approx 24$  in.

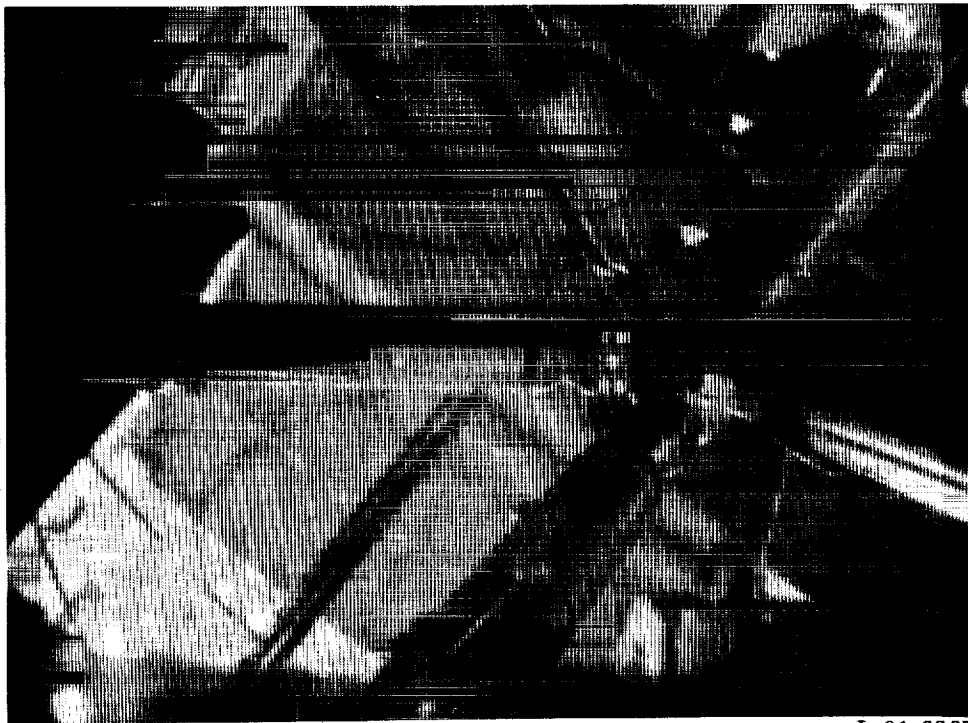

L-91-6367

(b) Vision system view at range of  $\approx 18$  in.

Figure 8. Typical incremental approach.

ORIGINAL PAGE  
BLACK AND WHITE PHOTOGRAPH



L-91-6368

(c) Vision system at range of  $\approx 12$  in.

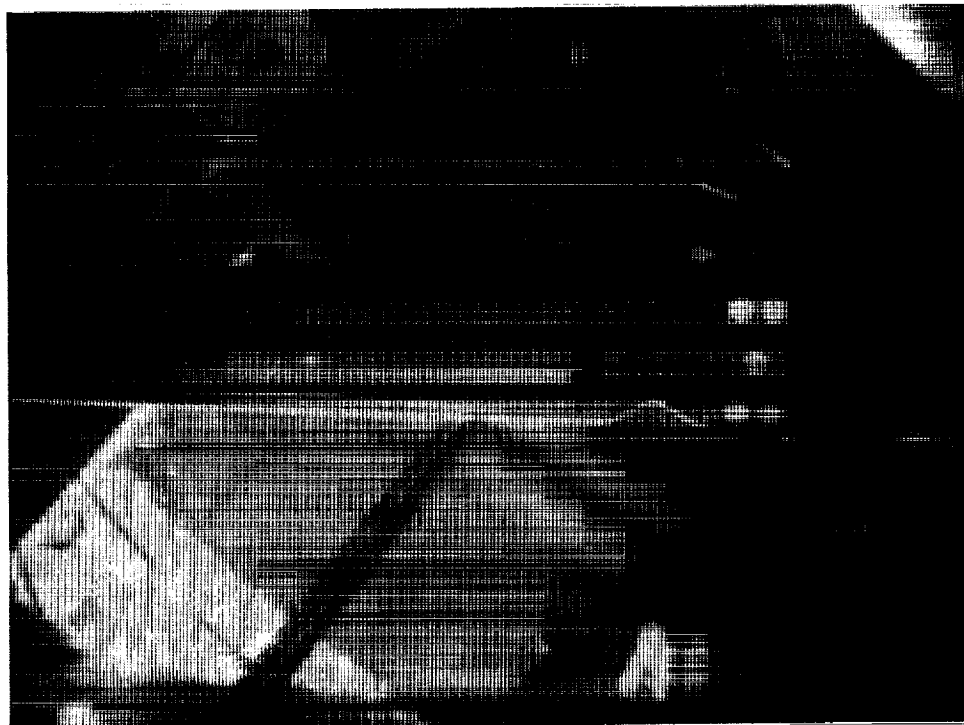

L-91-6369

(d) Vision system view at range of  $\approx 6$  in.

Figure 8. Concluded.

ORIGINAL PAGE  
BLACK AND WHITE PHOTOGRAPH

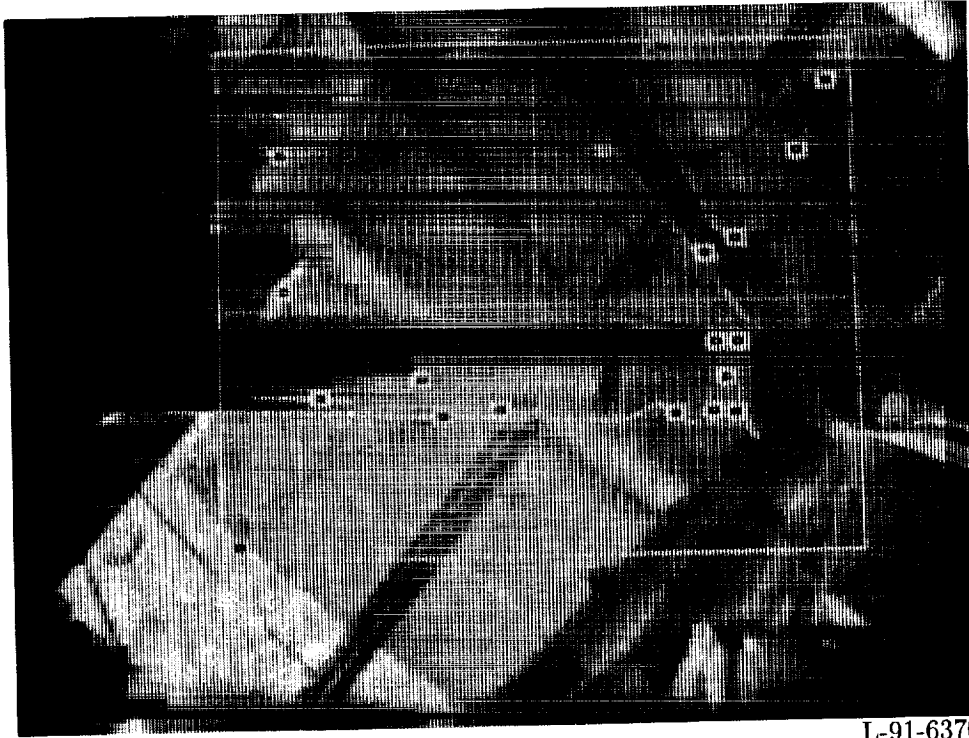

(a) Processed image after blob-size constraint applied.

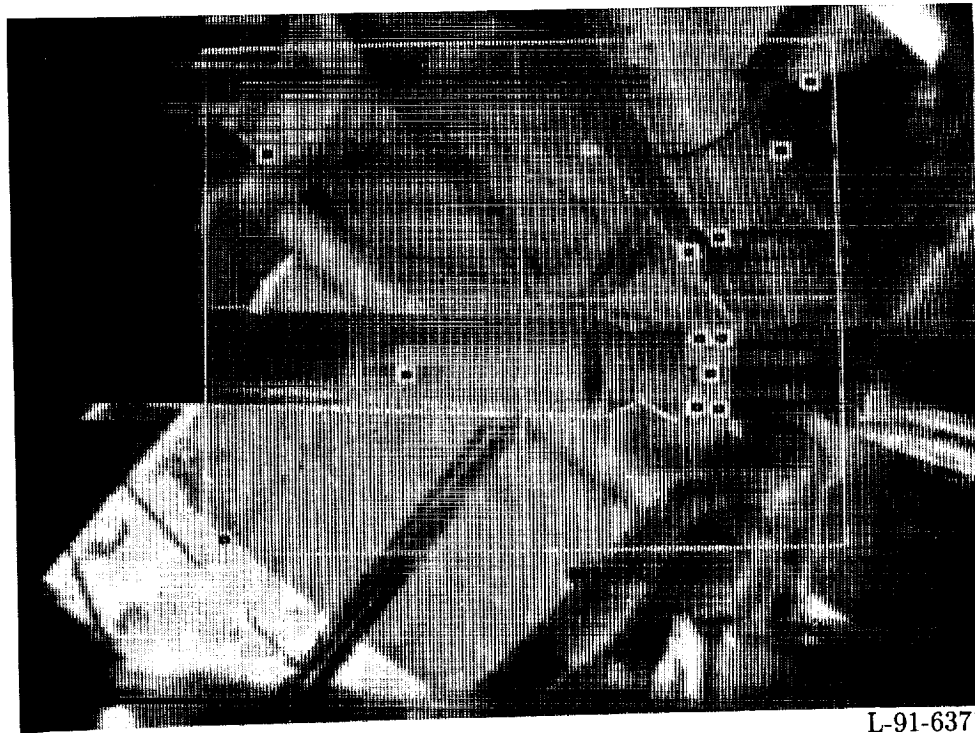

(b) Processed image after blob shape constraint applied.

Figure 9. Sequential discrimination of target from background.

ORIGINAL PAGE  
BLACK AND WHITE PHOTOGRAPH



L-91-6372

(c) Processed image after exhaustive triangle generation.

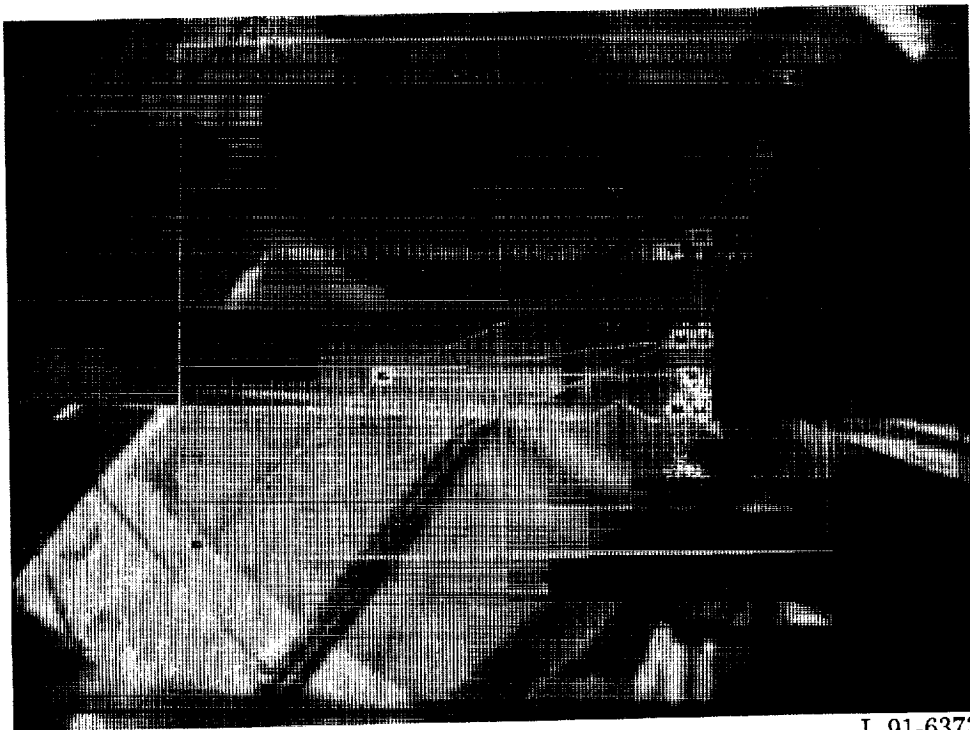

L-91-6373

(d) Processed image after application of ratio test equations.

Figure 9. Continued.



ORIGINAL PAGE  
BLACK AND WHITE PHOTOGRAPH

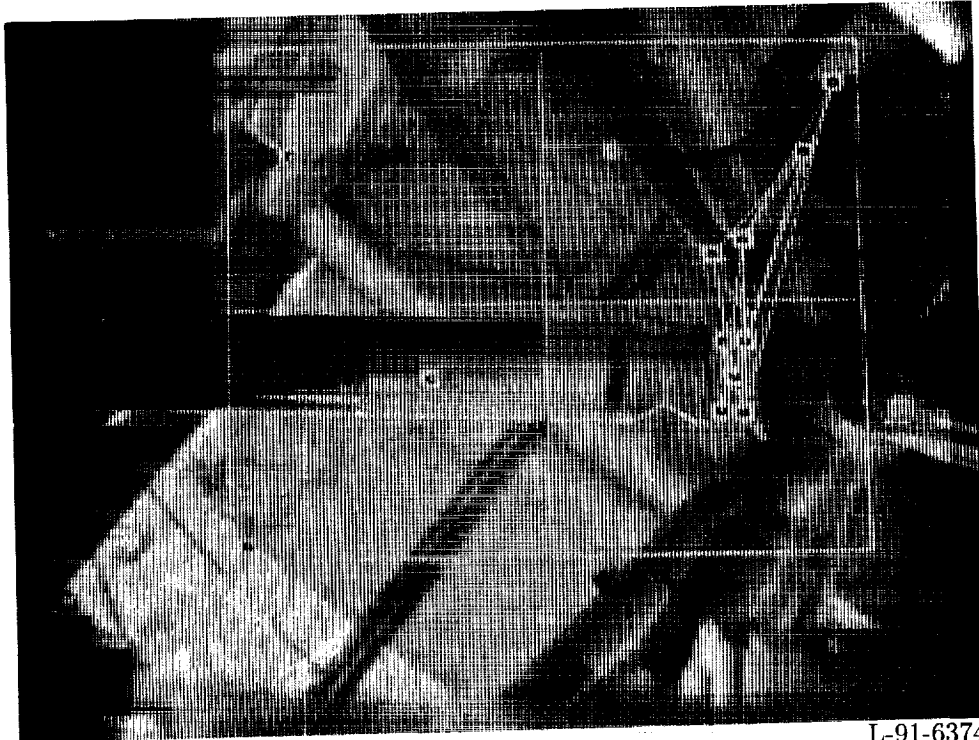

L-91-6374

(e) Processed image after triangle slope constraint applied.

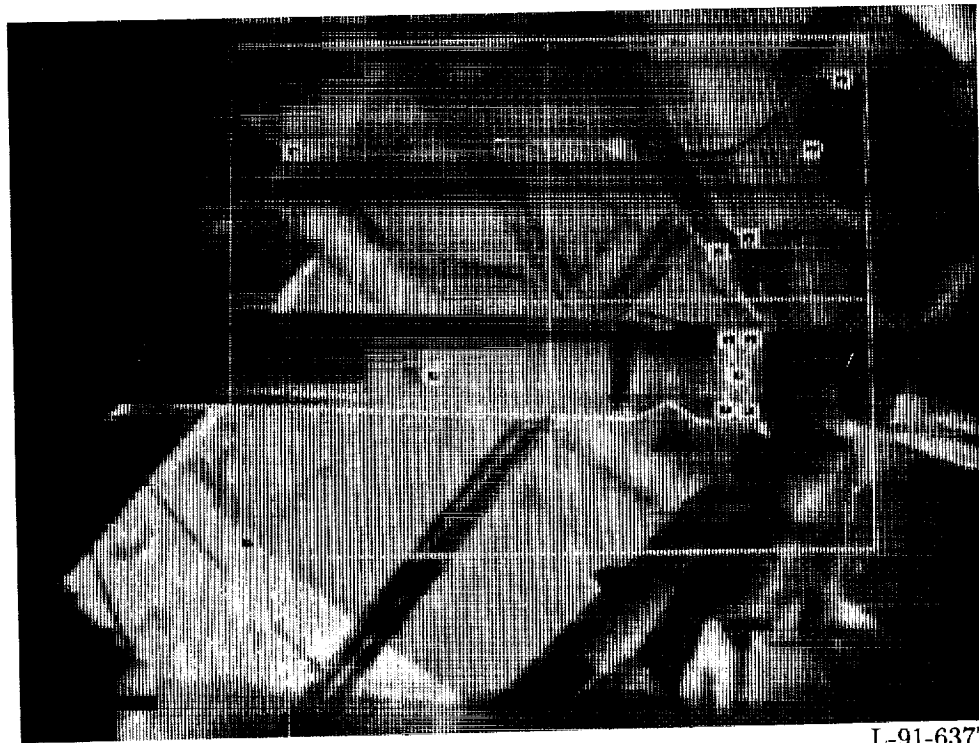

L-91-6377

(f) Processed image after length, area, and angle constraints applied.

Figure 9. Continued.

ORIGINAL PAGE  
BLACK AND WHITE PHOTOGRAPH

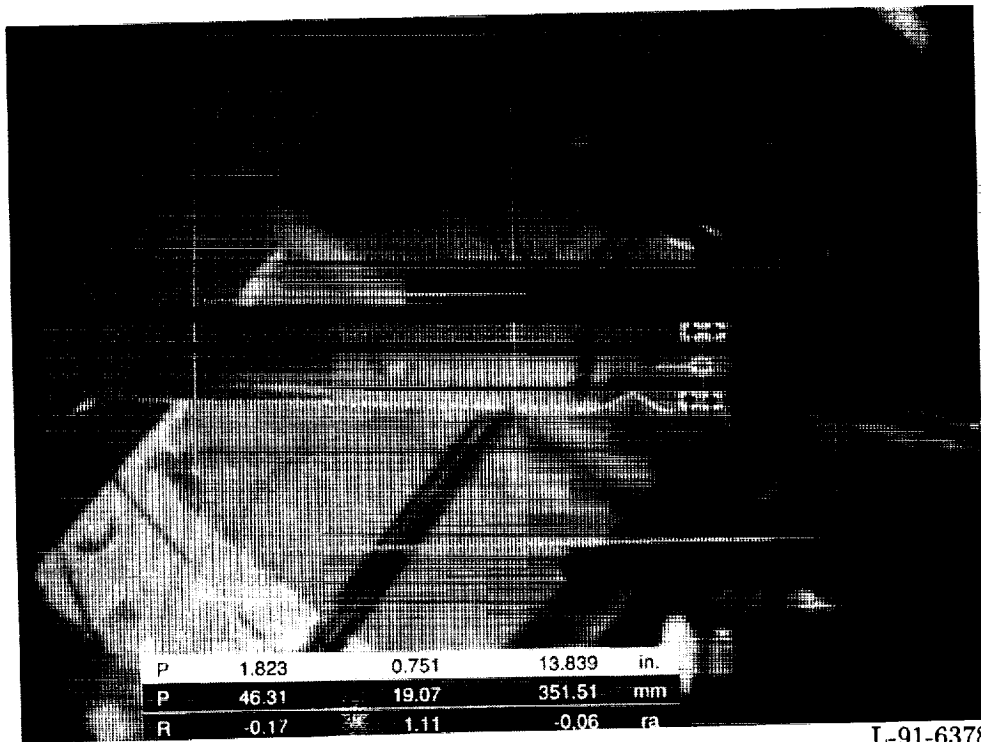

L-91-6378

(g) Processed image after target lock-on and pose estimation. Top two lines of key give position vector in inches and millimeters, respectively. The bottom line gives rotation vector in radians.

Figure 9. Concluded.

# Camera Axis

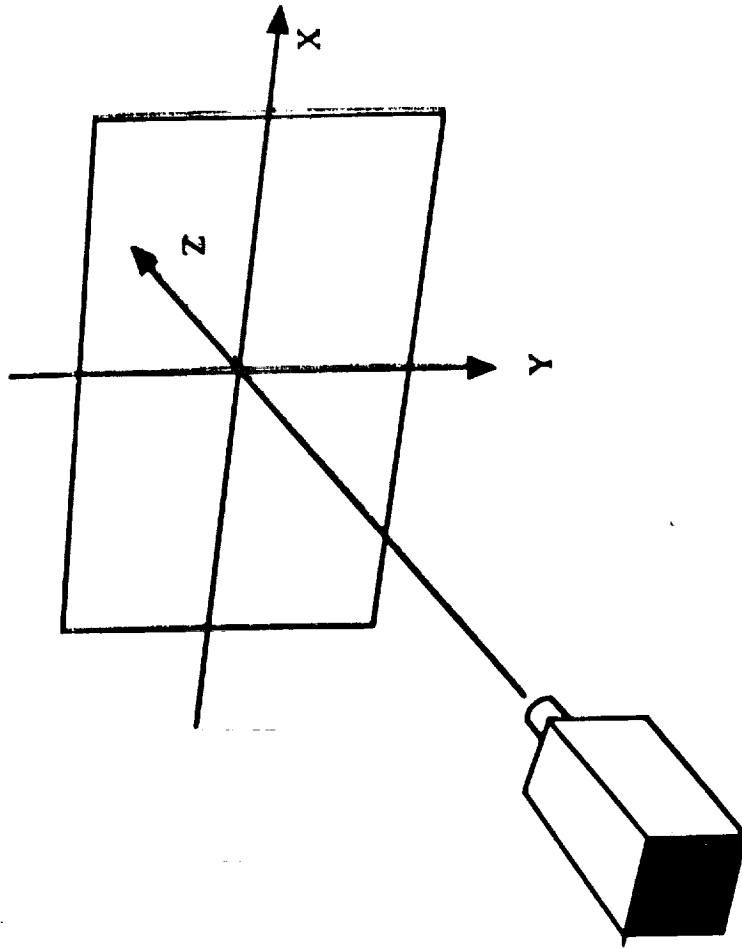

# Vision System Results from Optical Bench Tests (X Axis)

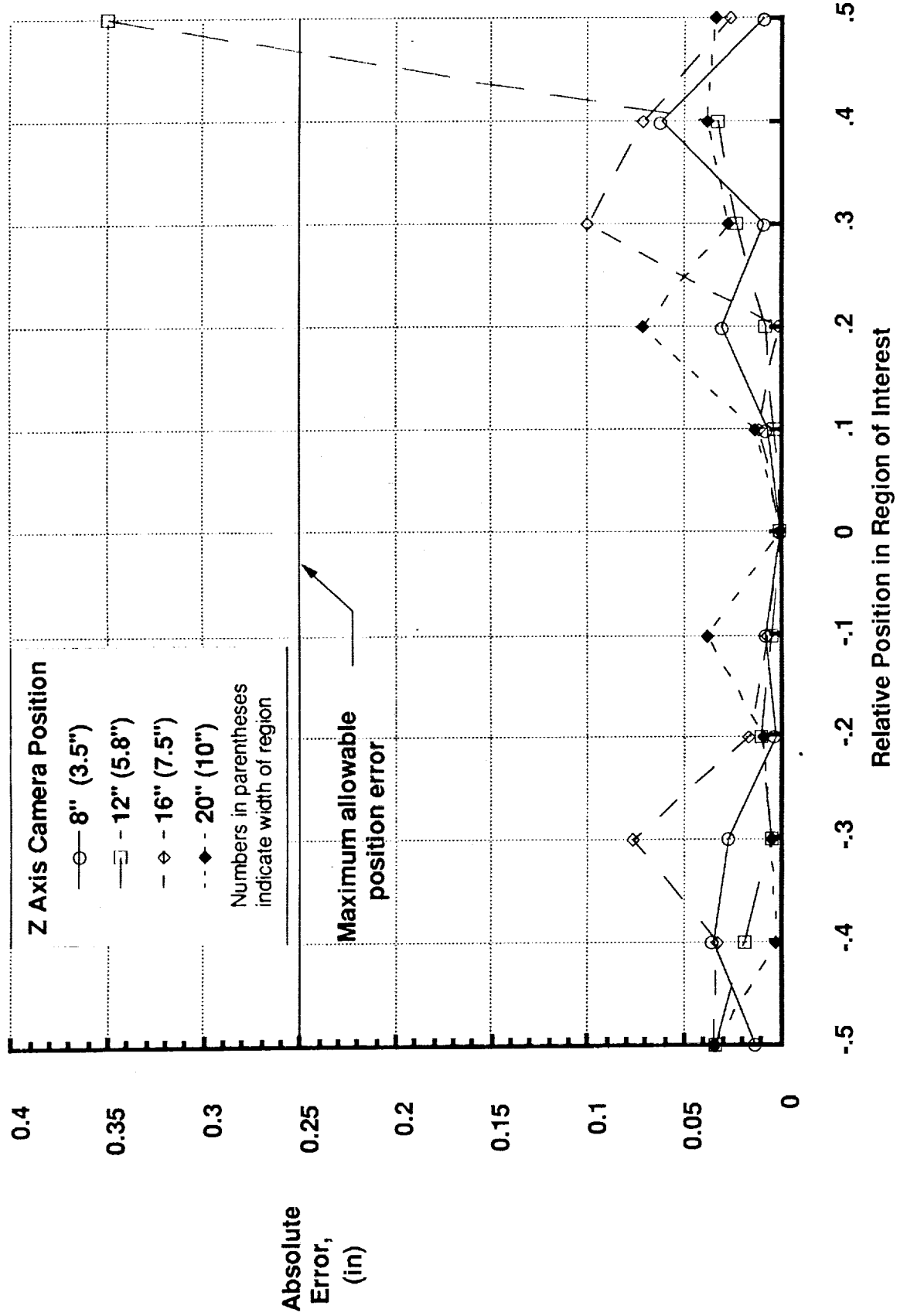

# Vision System Results from Optical Bench Tests (Y Axis)

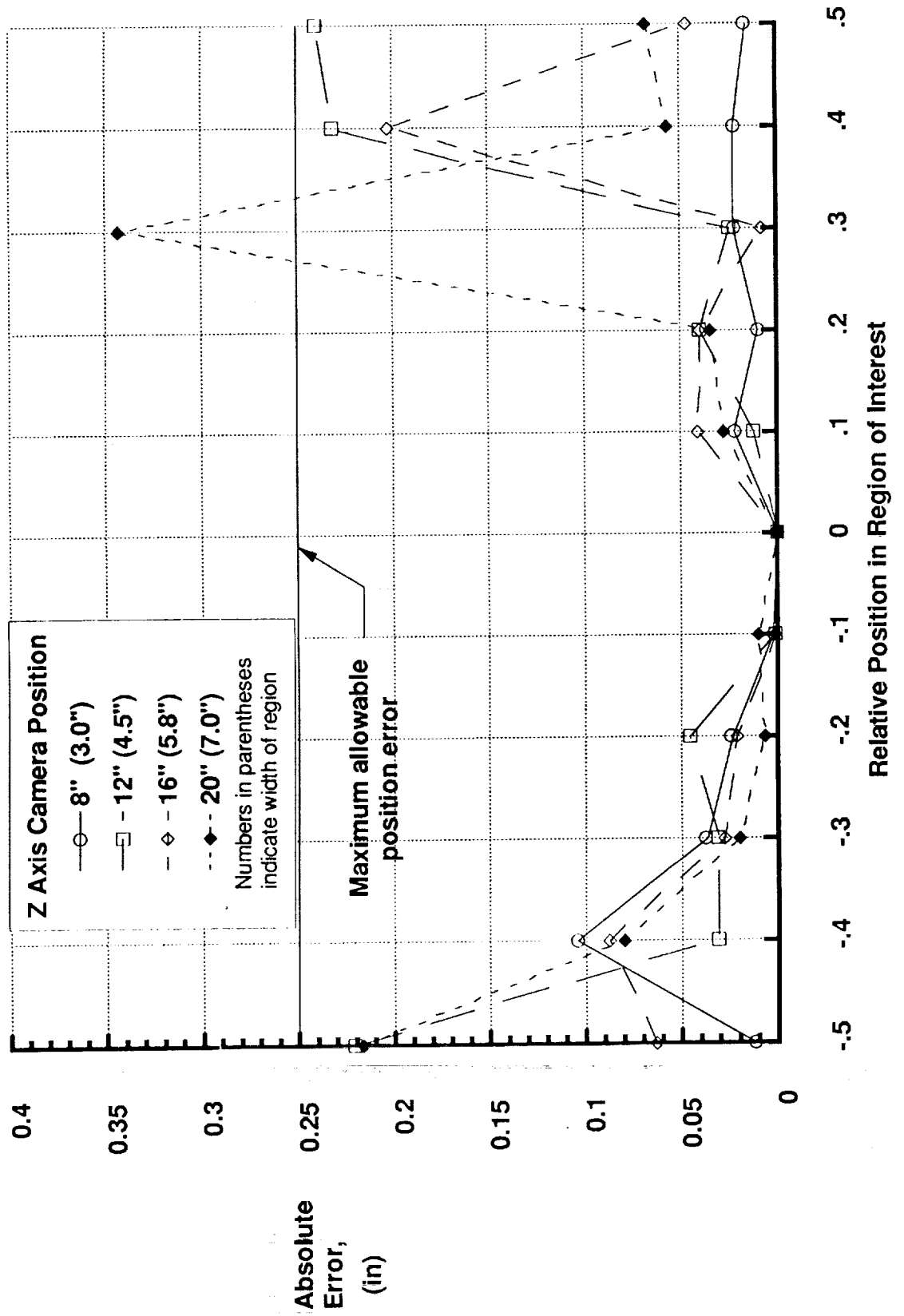

# Vision System Results from Optical Bench Tests (Z Axis)

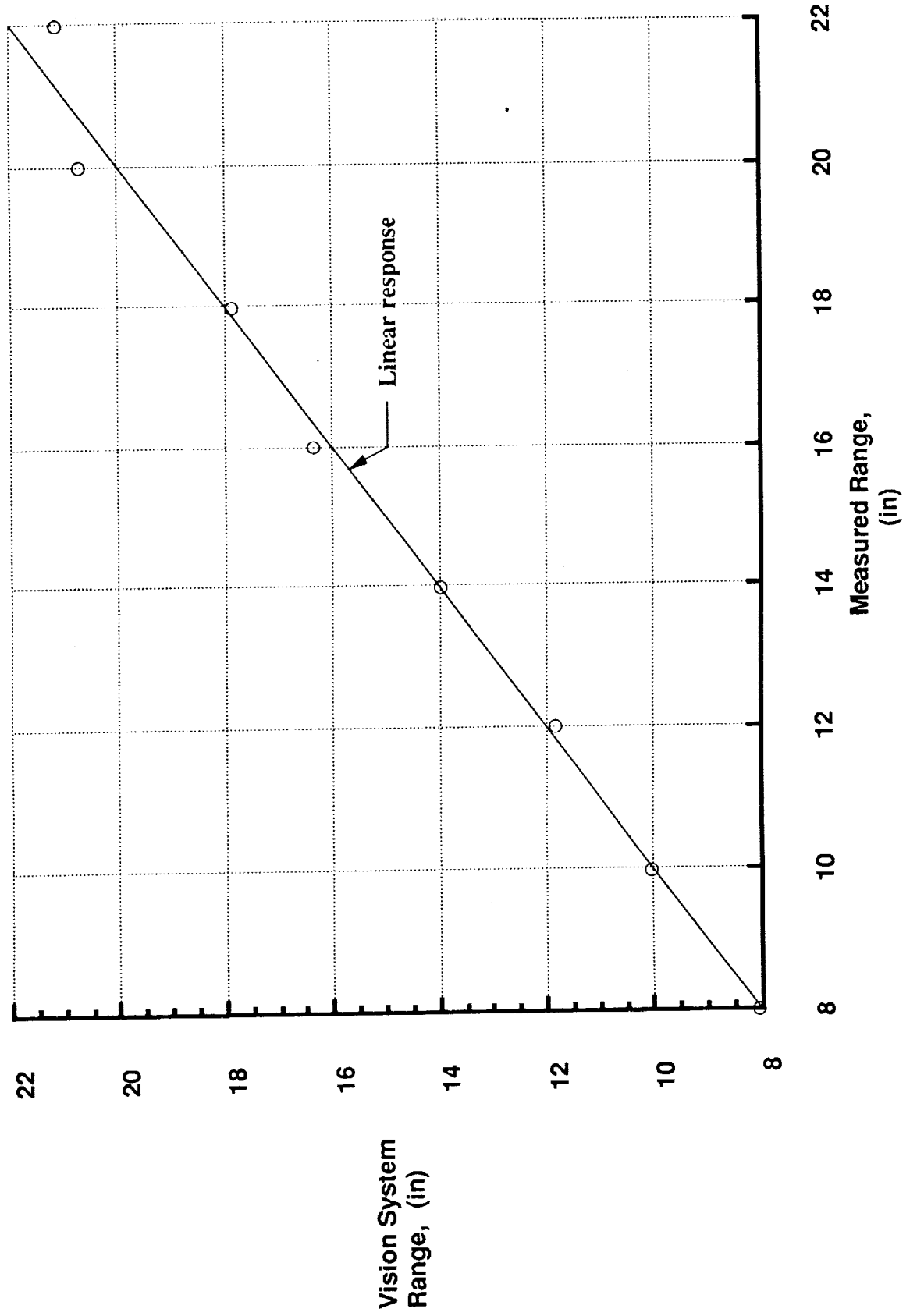

## **Future Work**

Implement remote light control to both enhance automation and provide an additional tool for operator assistance

Fabricate a camera alignment fixture

Demonstrate vision control on a complete assembly / disassembly of the ASAL truss structure

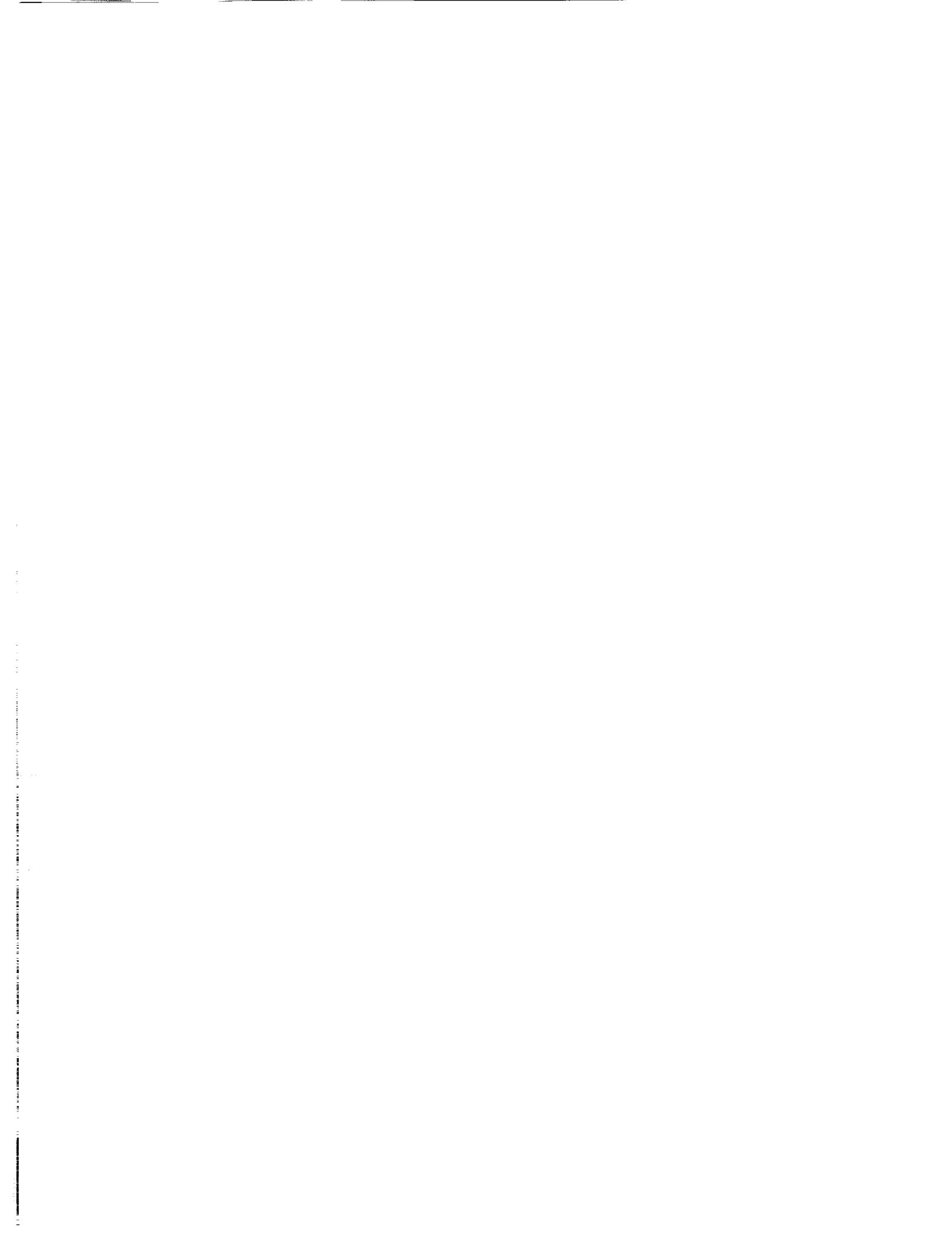



N 9 2 - 2 7 7 7 6

**END-EFFECTOR  
MICROPROCESSOR**

**b y**

**WILLIAM R. DOGGETT**

## **Why?**

- **require one interface to all end-effectors in ASAL**
  - **each with unique control and sensing requirements**
  - **common command interface**
- **require concurrent capability**
- **must reduce number of signal lines required to operate each end-effector**
- **desire to relieve merlin robot of end-effector responsibility**

# AUTOMATED STRUCTURES ASSEMBLY FACILITY

## CURRENT CONTROL HIERARCHY

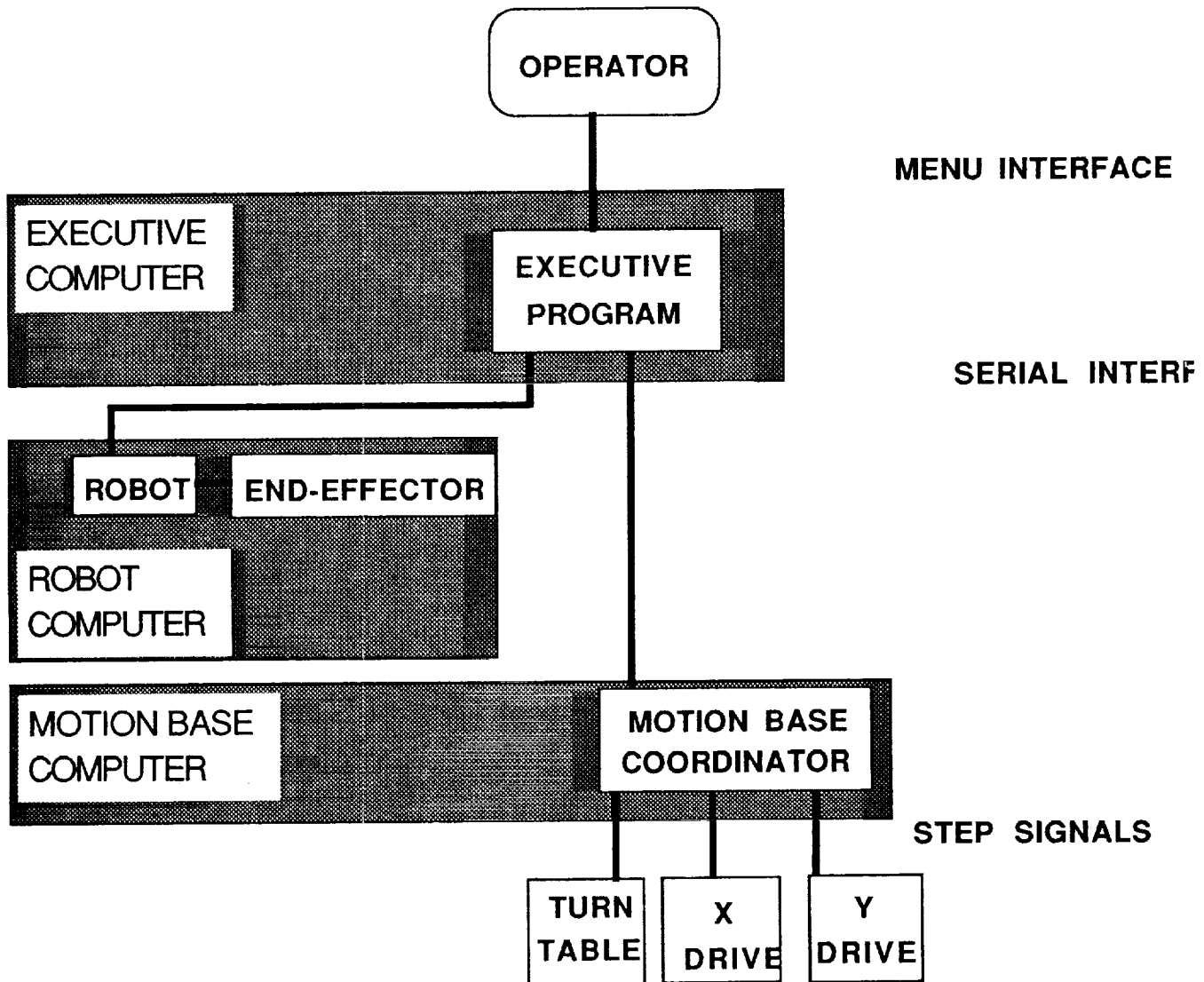

# AUTOMATED STRUCTURES ASSEMBLY FACILITY

## PURPOSED CONTROL HIERARCHY

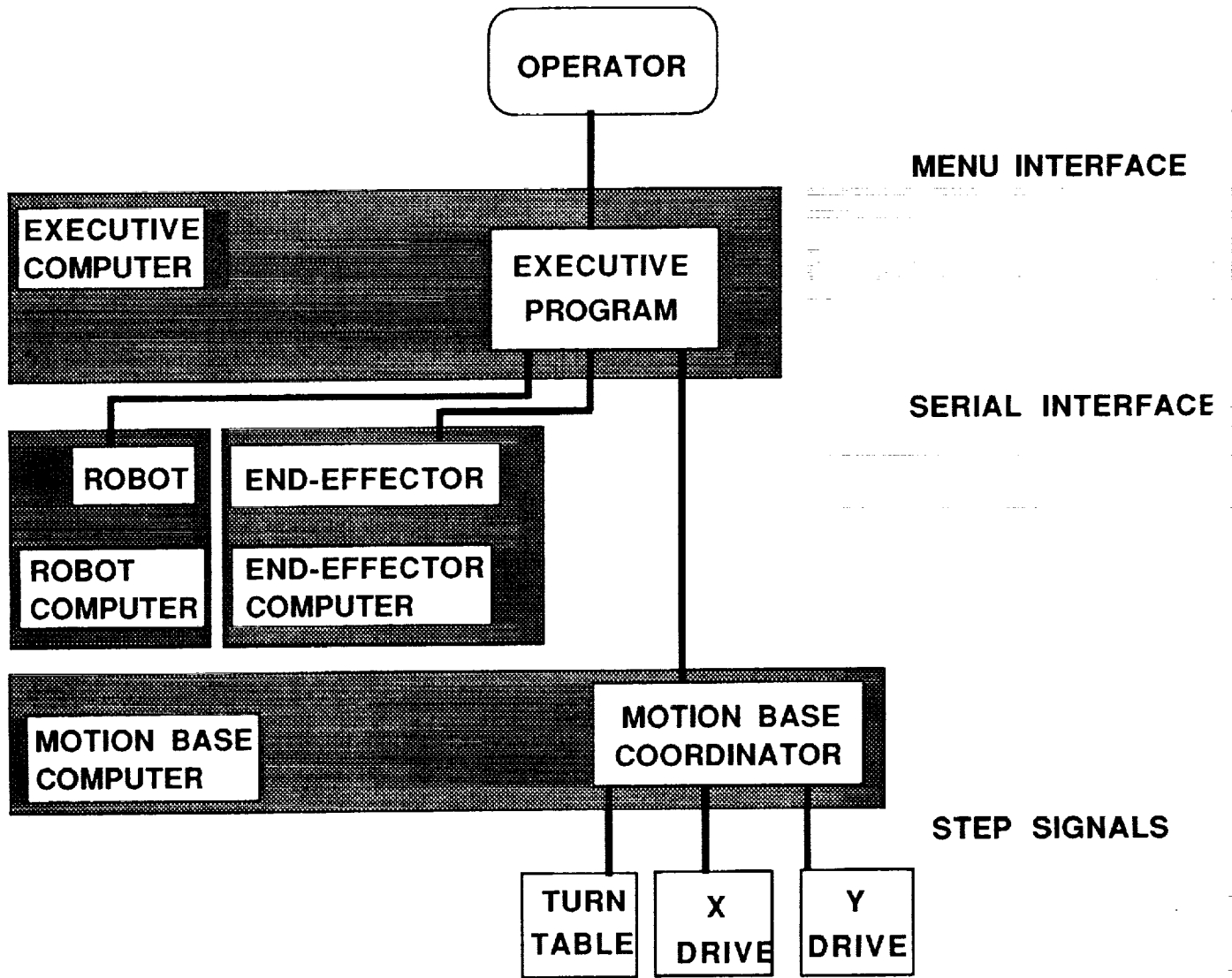

# END-EFFECTOR SOFTWARE STATE TRANSITION DIAGRAM

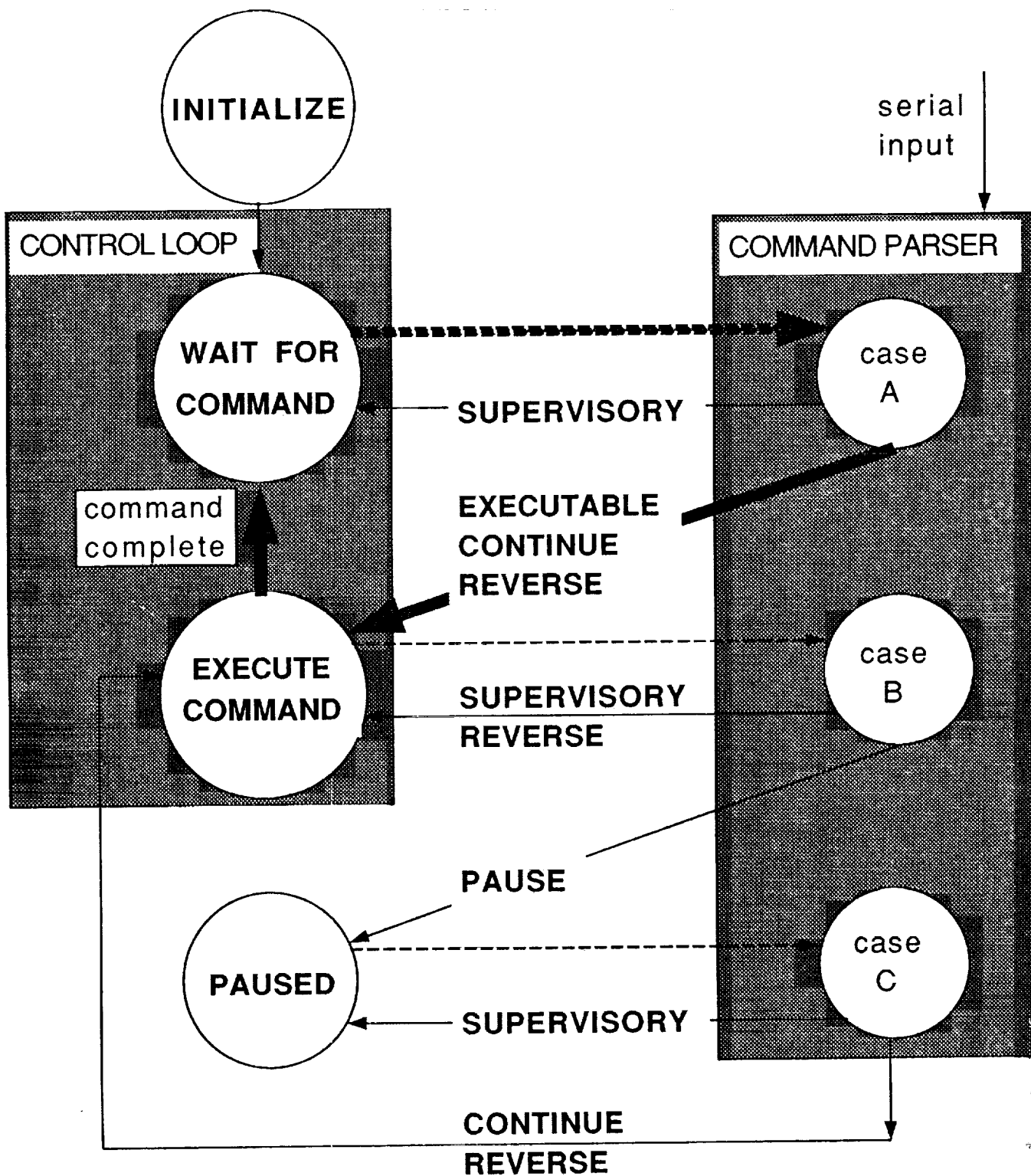

## LEGEND

- dashed lines indicate interrupts
- bold lines indicate normal operation

# BLOCK DIAGRAM FOR IDEAL INSTALL COMPOSITE

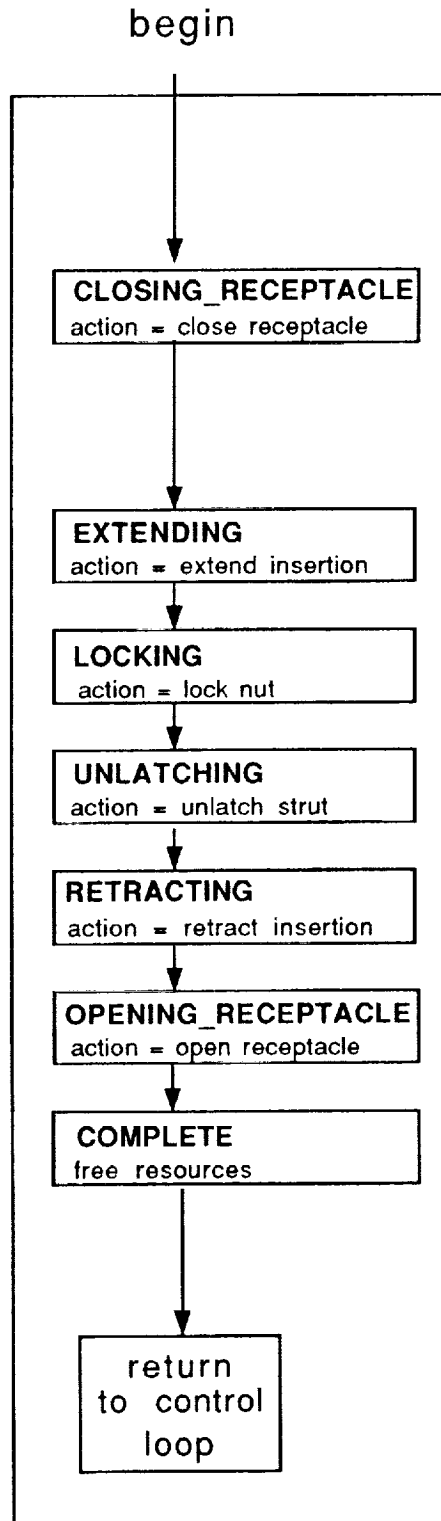

# BLOCK DIAGRAM FOR INSTALL COMPOSITE

## LEGEND

**BOLD** software states

*ITALIC* function names

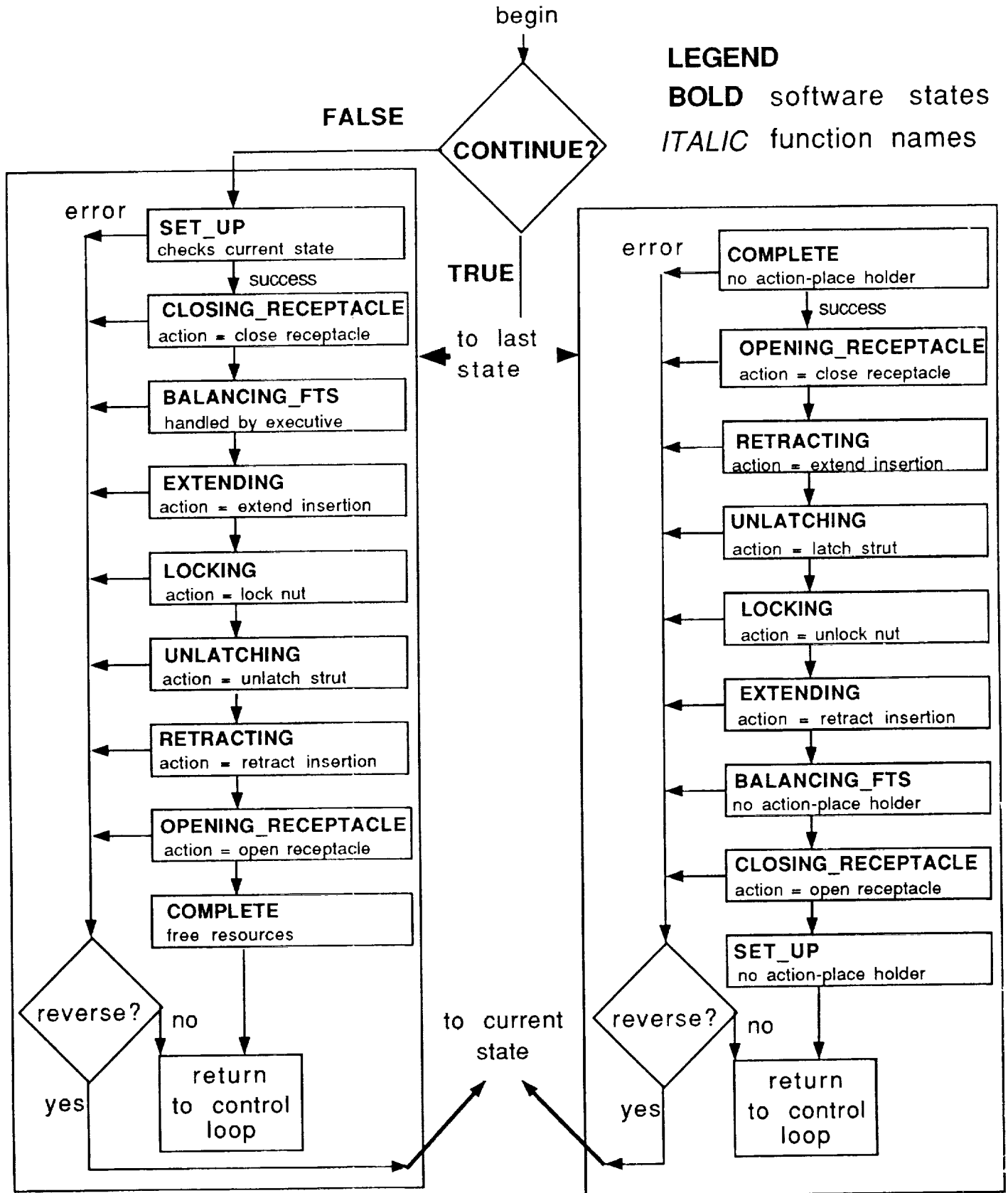

*INSTALL*

*INSTALL\_REVERSE*

## **CONCLUSIONS**

**IMPROVED MODULARITY**

**CONSISTENT INTERFACE TO THE 3 END-EFFECTORS**

**SUPPORT FOR CONCURRENT OPERATIONS**

**SUPPORT FOR PAUSE/REVERSE AT ANYTIME**

**SUPPORT FOR OPERATOR OVERRIDE**

**POTENTIAL FOR INCREASED RELIABILITY**



**Panel Installation Development  
in  
Automated Structures Assembly Lab**

N 9 2 - 2 7 7 7 7

Cuong Quach

## **Design Requirements for Panel Installation Process**

- **High packing efficiency of panels in canister imparative**
- **Panels must fit into existing truss hardware with minimum modification to nodes.**
- **The inter-panel gap minimized to about .15 in.**
- **Minimize the number of mechanisms on the end effector**
- **End effector must be attachable to current robot**

ORIGINAL PAGE  
BLACK AND WHITE PHOTOGRAPH

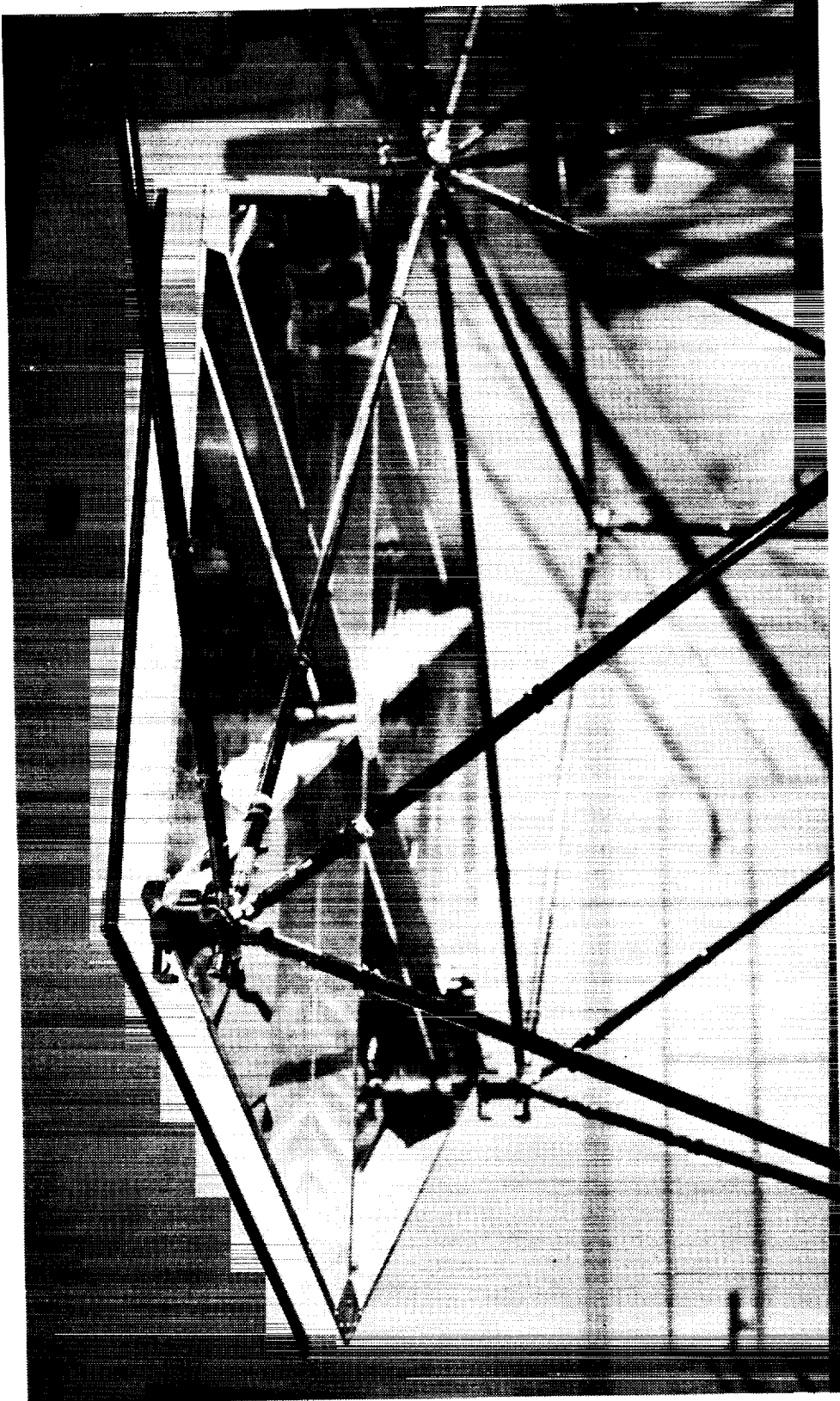

Panel latches to truss via adaptors

ORIGINAL PAGE  
BLACK AND WHITE PHOTOGRAPH

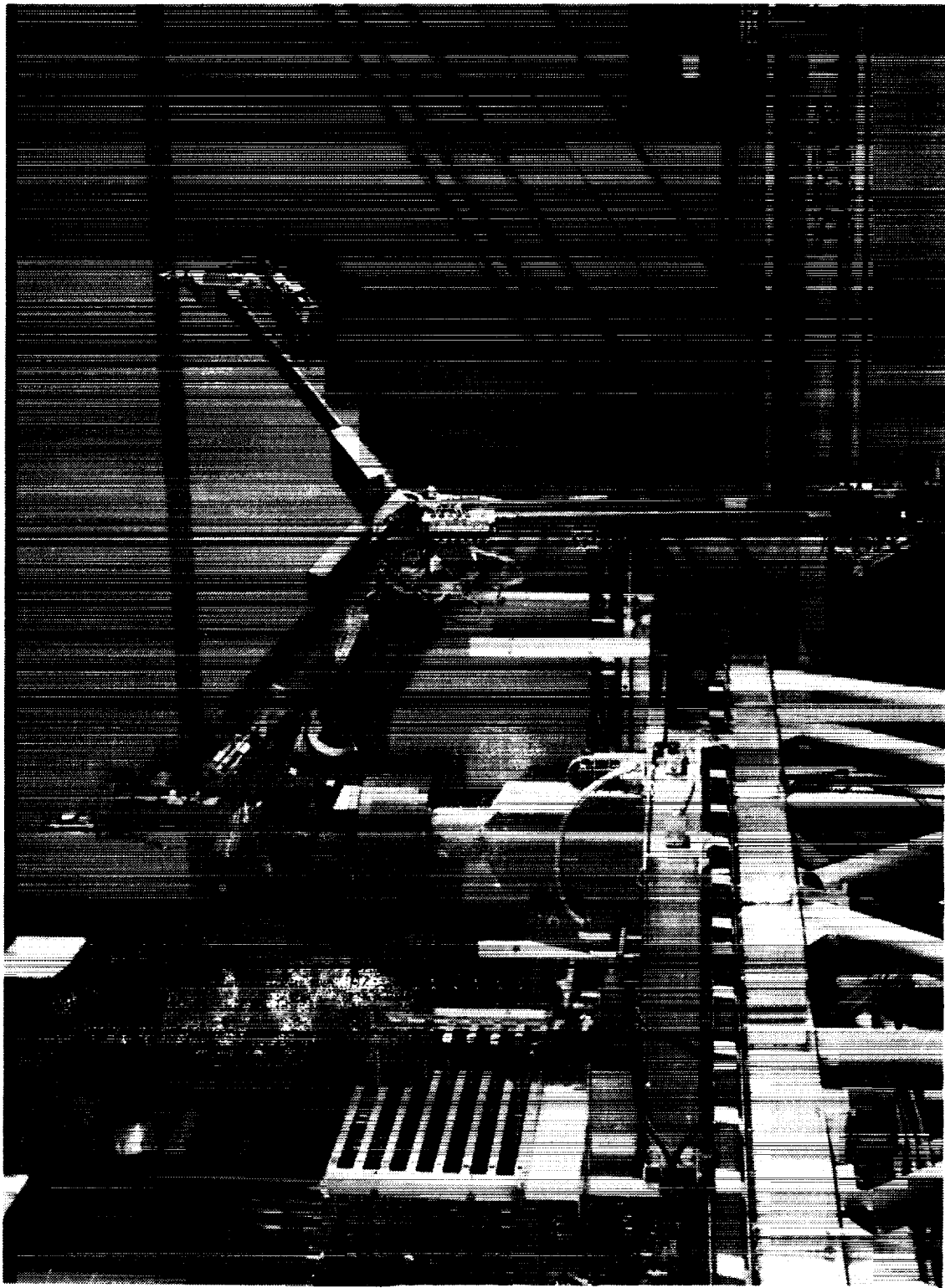

Panel end effector

ORIGINAL PAGE  
BLACK AND WHITE PHOTOGRAPH

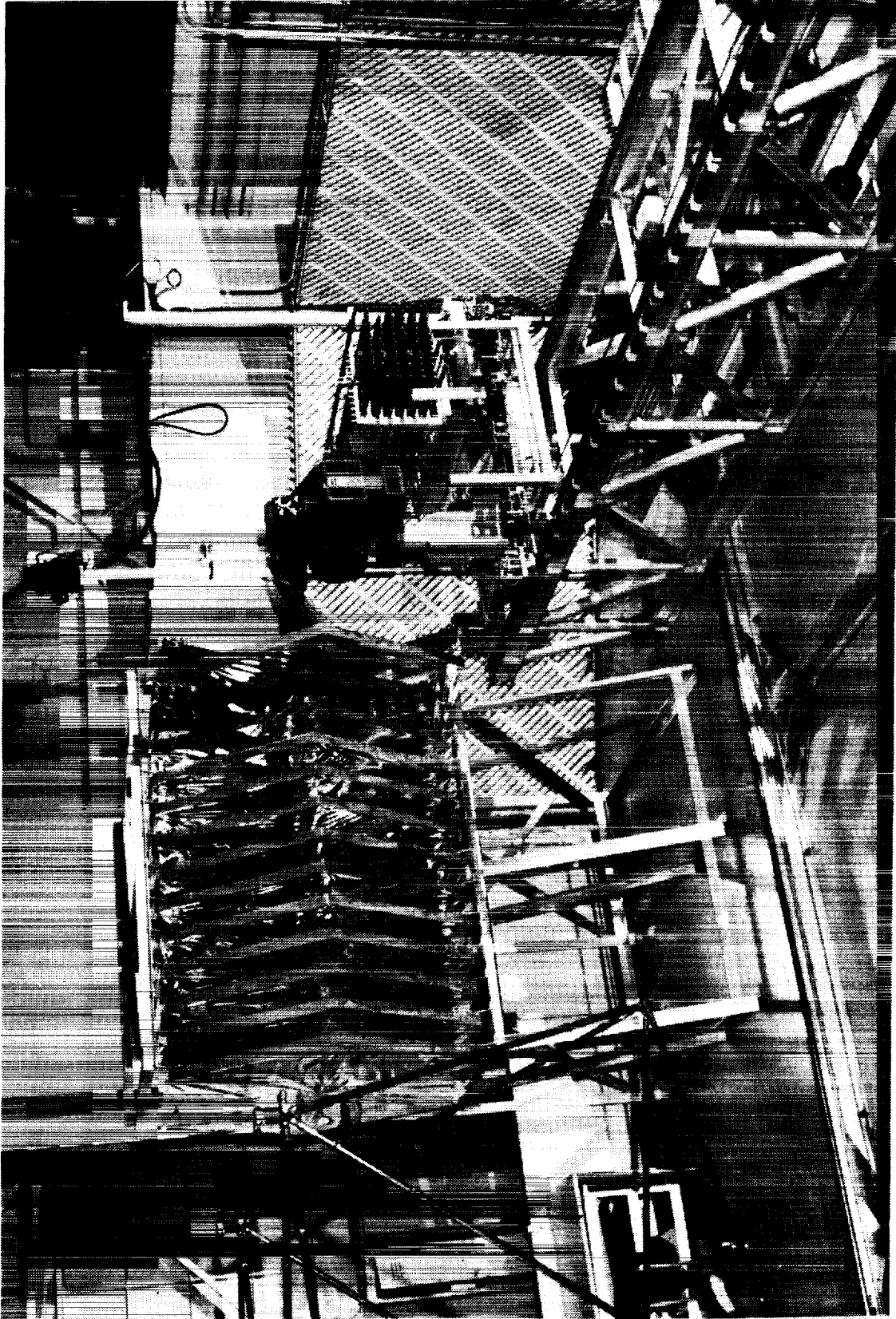

Arm retrieving panel from canister

ORIGINAL PAGE  
BLACK AND WHITE PHOTOGRAPH

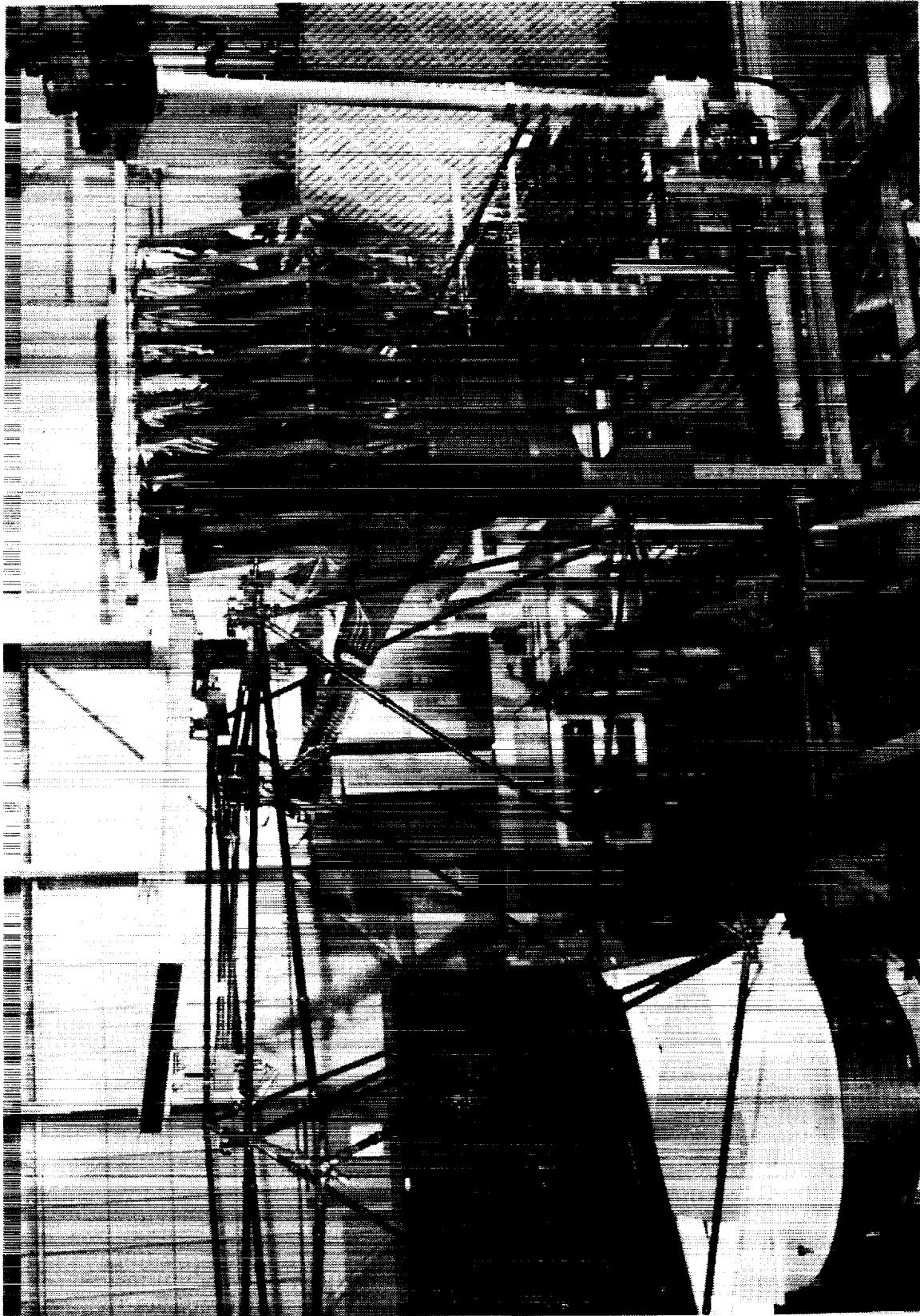

Arm installing panel

ORIGINAL PAGE  
BLACK AND WHITE PHOTOGRAPH



Facility view with panel installed





N92-27778

**Executive System Software Design  
and  
Expert System Implementation**

Cheryl L. Allen

## SOFTWARE REQUIREMENTS

- \* Assemble and disassemble a tetrahedral truss in an automated mode
- \* Display and control information in support of a supervised autonomy mode of operation
- \* Support advanced system integration
- \* Accommodate hardware and procedural upgrades

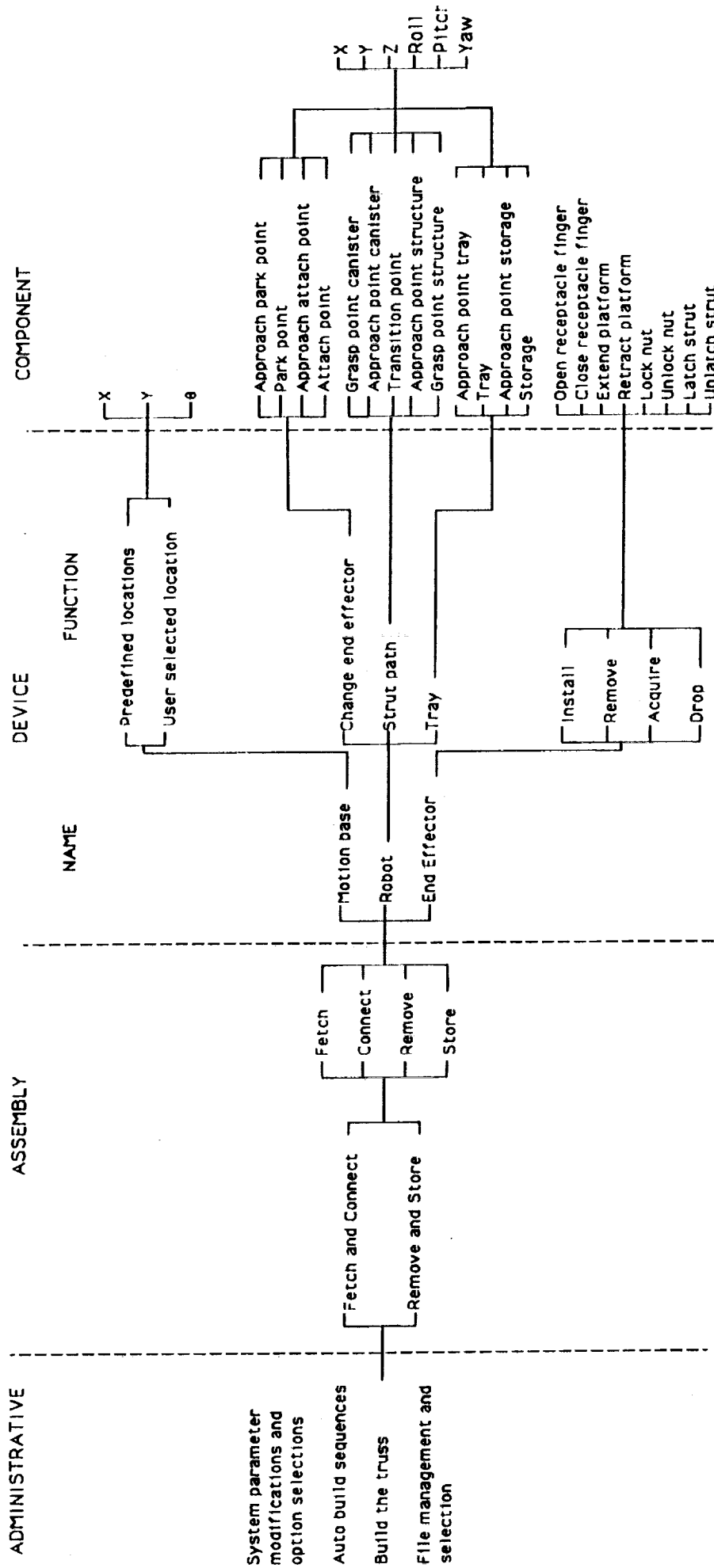

Design layout of the automated assembly system.

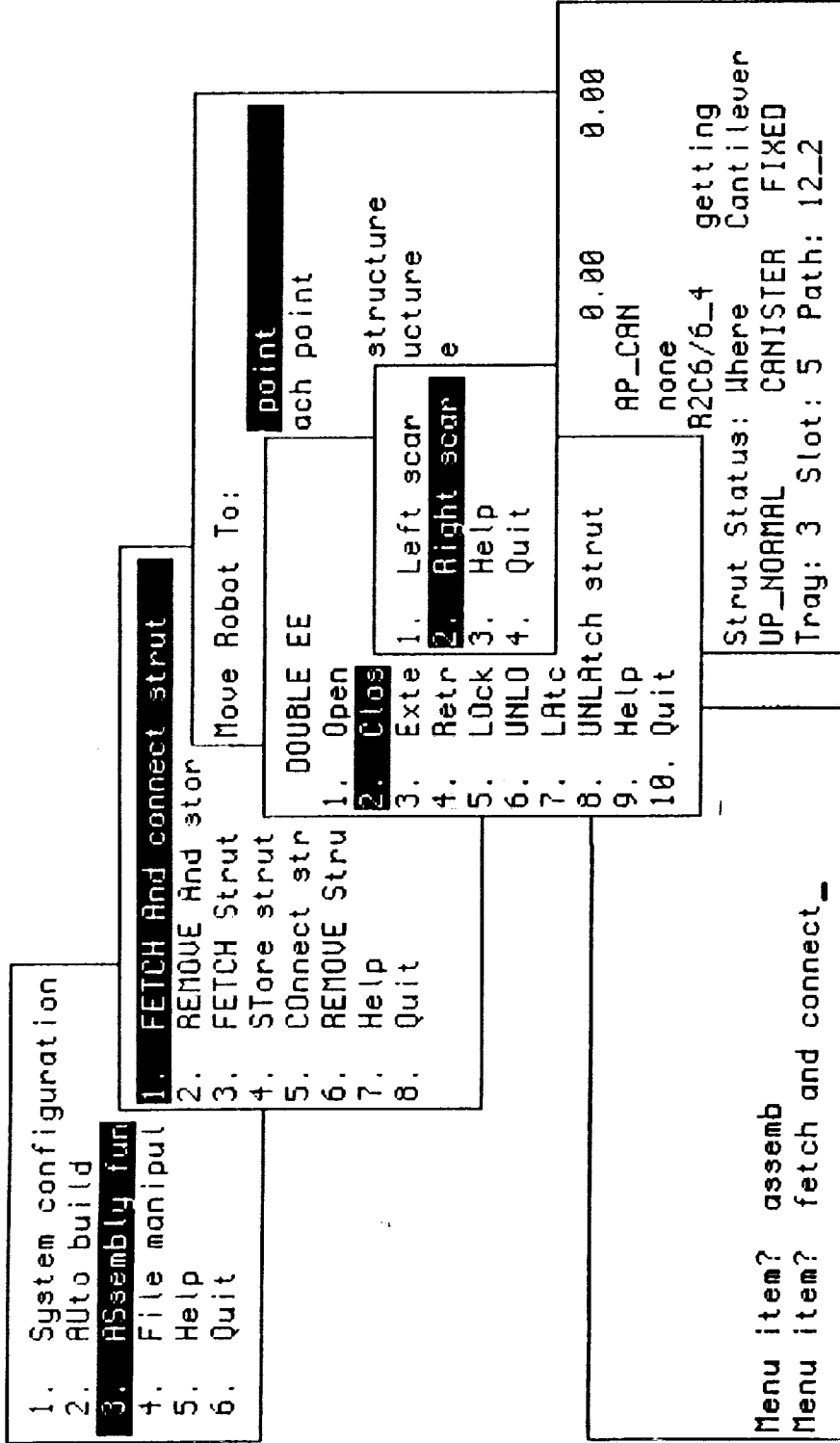

Menu display for automated composite command (Fetch & Connect).

## EXPERT SYSTEM FEATURES

An expert system is a computer program which uses knowledge and reasoning techniques to solve problems that normally require the services of a human expert.

- \* Inference Engine
  - program that applies domain knowledge to known facts to solve problems
  - KES uses a goal-directed method of inferencing
  
- \* Knowledge Base
  - contains known facts that make up the experts knowledge
  - KES contains attributes, classes, rules, and demons
  
- \* Rules
  - infer attribute values
  - KES uses If/Then constructs to represent rules

Legend

Strut installation/removal:

1. Direct
2. Capture sequence
3. Pyramid completion
4. Free

End effector actions:

- a. Capture or release second cantilevered node
- b. Close fingers on end with no node
- c. No nodes on either end of strut, close remaining end
- d. Capture or release end of strut
- e. No strut in hand

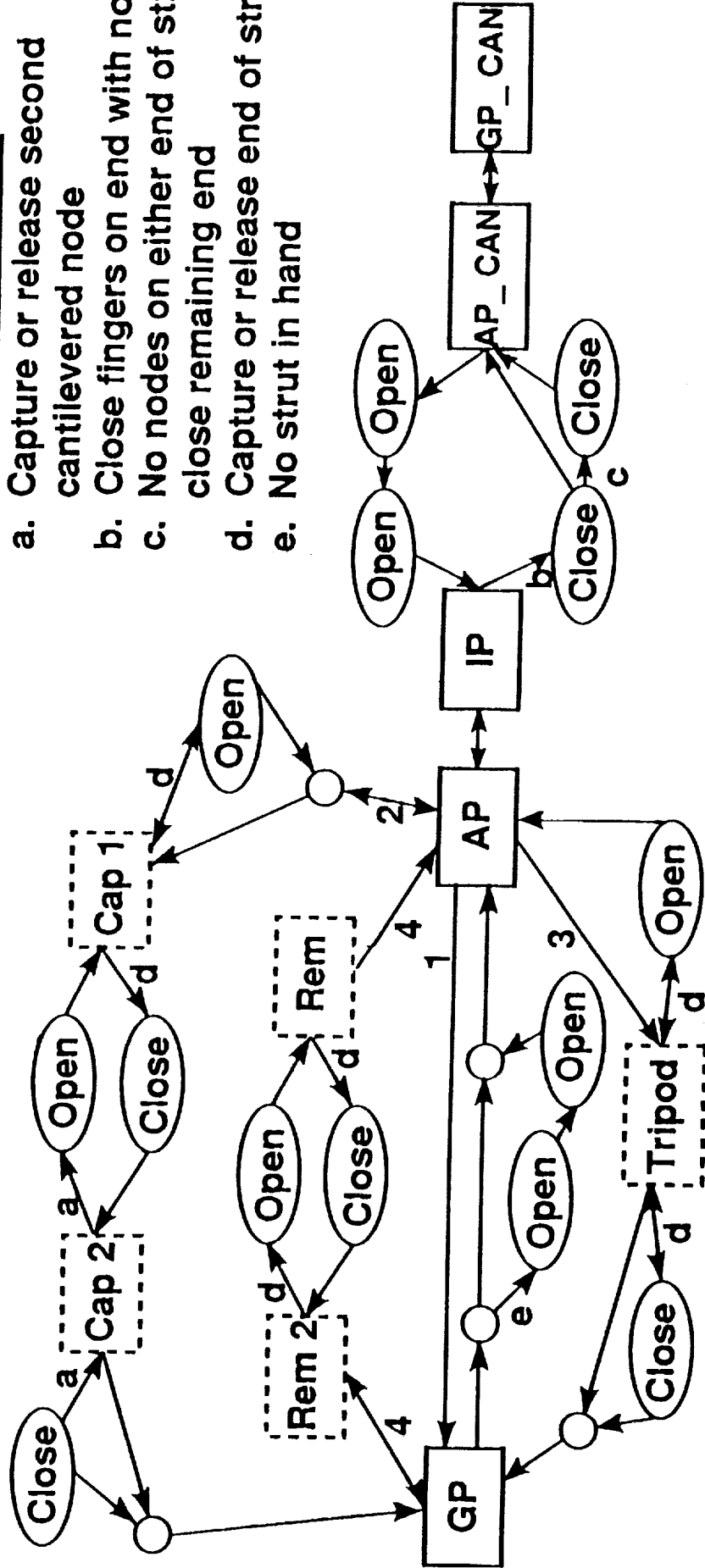

Complete robot arm state diagram and logic.

## EXPERT SYSTEM BENEFITS

- \* Concise encapsulation of logic into rules
  - directs sequence of moves necessary to assemble and disassemble a strut, determine tray operations, control panel installation/removal, command motion base and end effector at the device level
  
- \* Embedded within existing Fortran executive
  - uses KES for decision making while leaving familiar operator interface intact
  
- \* Reduced amount of code for maintenance
  - 20 if/then rules replaced approximately 850 lines of Fortran code
  
- \* Eased system upgrades
  - implemented panel functions in just over 1 month

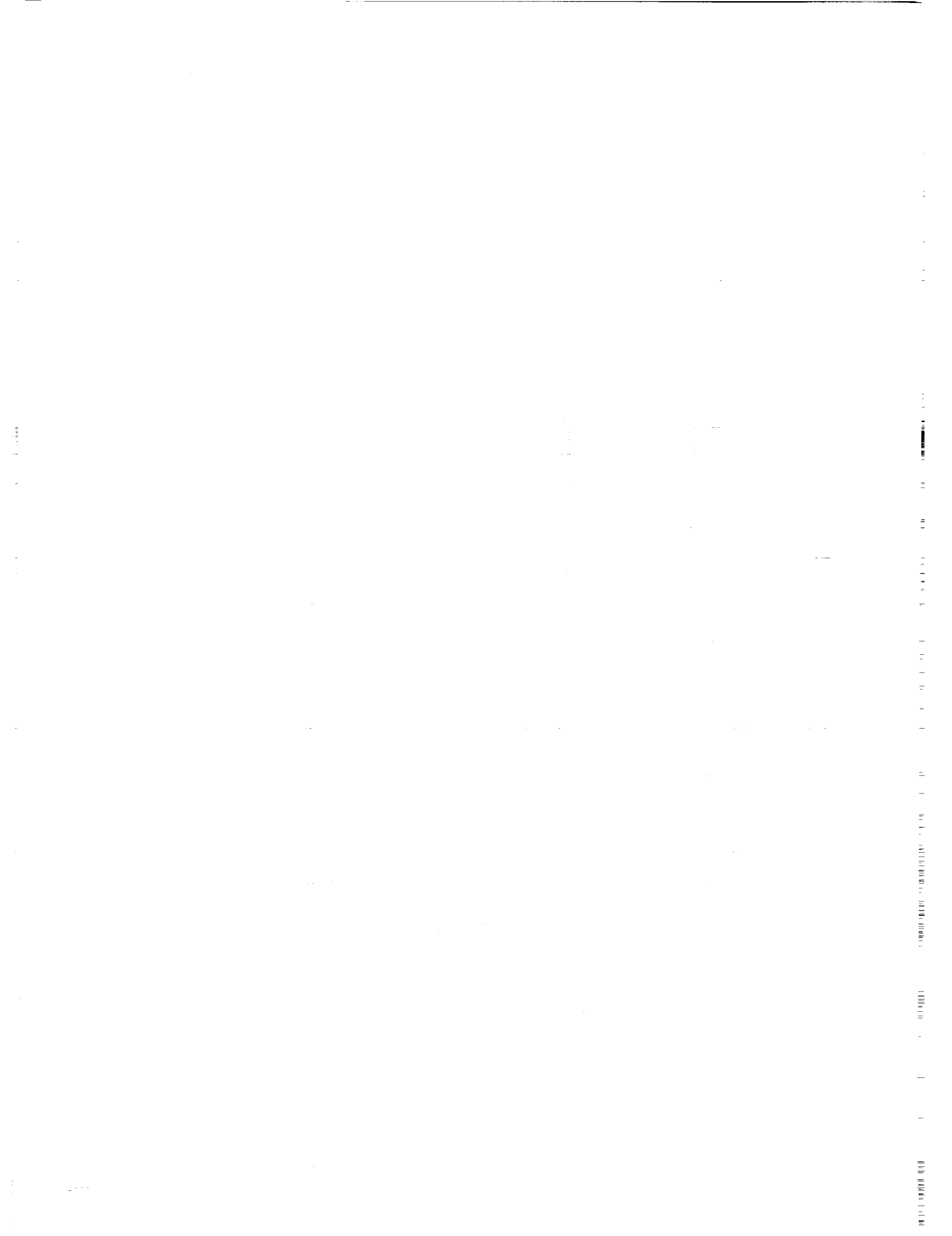



**FUTURE WORK IN  
AUTOMATED ASSEMBLY OF  
LARGE SPACE STRUCTURES**

**Ralph Will**

# Automated Assembly of Large Space Structures

## Project Development

"Dumb" assembly of planar truss using taught points & dedicated robot positions



Expanded truss assembly with payloads, panels, sensor guidance and graphics simulation



Curved truss structure, system dynamics and coordinated motion



"Smart" assembly of complex integrated system with sensor guidance and collision avoidance path planner

# Current System Upgrade Requirements

## \* Taught Paths and Points Are Not Viable

- Sensor/Vision Feedback
- Path Planner/Collision Avoidance

## \* Flat Truss Is Not Useful

- Curved Truss/Generalized End Effector

## \* Serial System with Excessive Communication

- Distributed Architecture & Embedded Microprocessors

## \* Single-Task Operation

- Panel Installation
- Beam Assembly

## \* Need Flexibility of Knowledge-Based Artificial Intelligence

- Expert System Executive
- Automated Path Planning
- Automated Sequence Planning

## ASAL 1992 OBJECTIVES

- I. Complete end-to-end assembly/disassembly of combination Truss/Panel structure using:
  - Machine vision for struts
  - Expert system executive
  - End effector microprocessors
  
- II. Static manipulator arm will develop:
  - Generalized end effector sequences & procedures for curved truss, supported by expert system
  - VX-Works based distributed architecture for in-loop force/torque & path planning
  
- III. Real-time graphics simulation to:
  - Develop generalized end effector paths
  - Study assembly sequence planning
  - study operator interfaces
  
- IV. Design end effector for curved Precision Segmented Reflector (PSR) truss joints which are not specifically designed for robotic operations
  
- V. Assemble tetrahedral beam

# **On the Use of Torque-Wheels For the Control of Large, Flexible, Space-based Telerobotic Arms**

D. Ghosh, R. C. Montgomery and S. P. Kenny  
NASA Langley Research Center  
Hampton, VA 23665

1991 NASA Langley Workshop on Automation and Robotics  
for Space-based Systems

December 10, 1991  
Hampton, Va

N92-27780

# Presentation Outline

- PROBLEM
- POTENTIAL SOLUTION -- END-POINT CONTROL
- MODELLING, ANALYSIS, AND CONTROL SYSTEM
- EVALUATION TASK
- SYSTEM SIMULATOR
- STUDIES WITH-AND-WITHOUT TORQUE-WHEELS
- CONCLUSIONS AND FUTURE PLANS

# THE PROBLEM

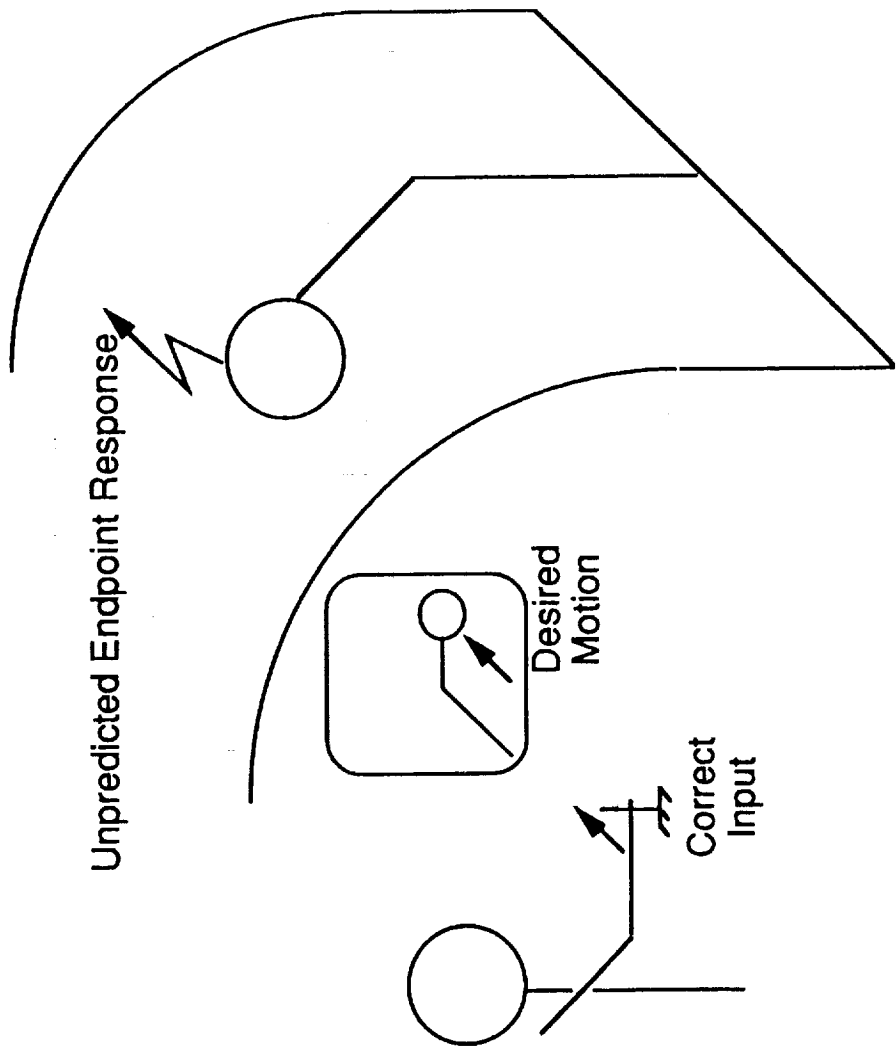

# Potential Solution

- End-Point Control with Inertial Components -

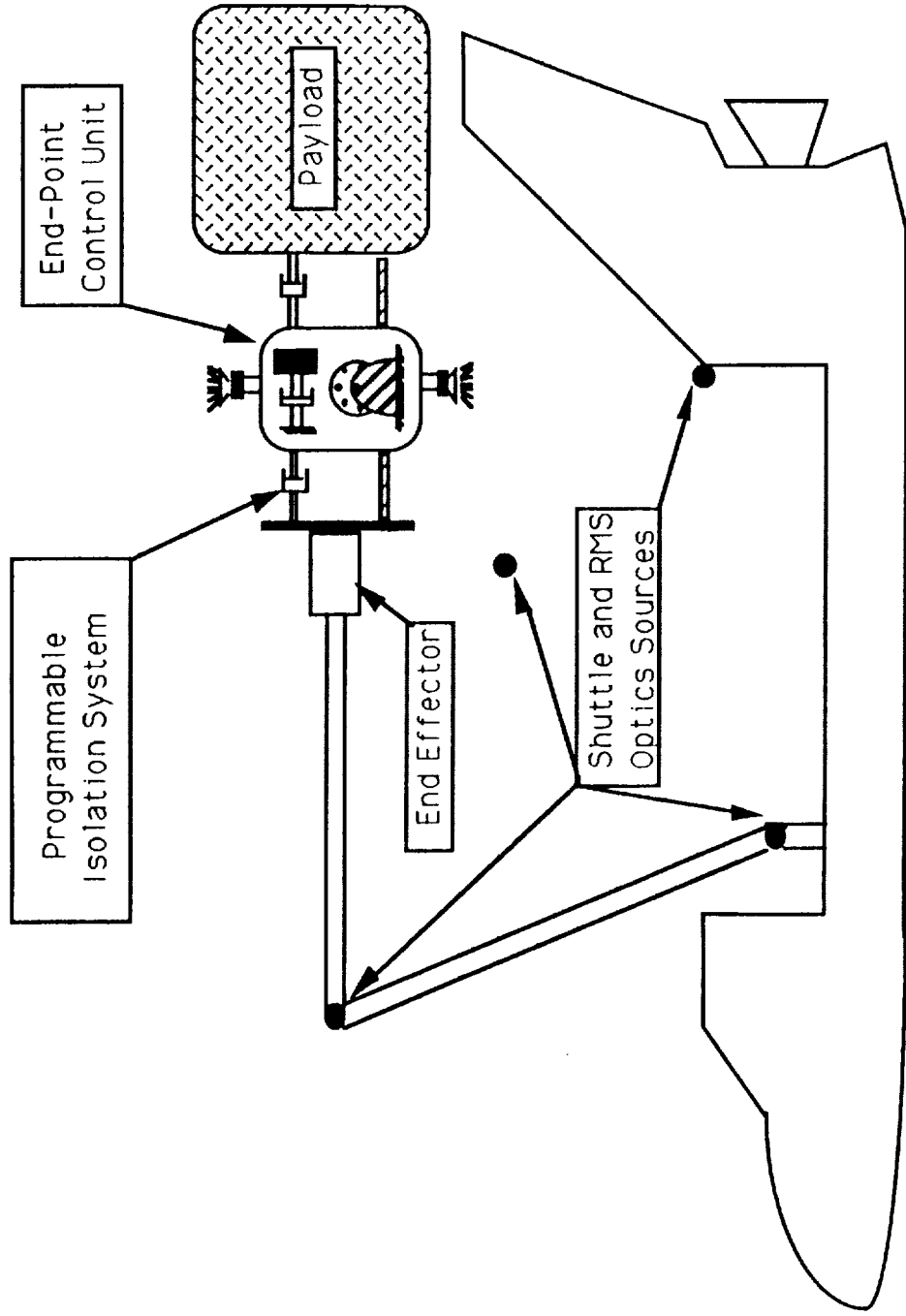



# System Model Used

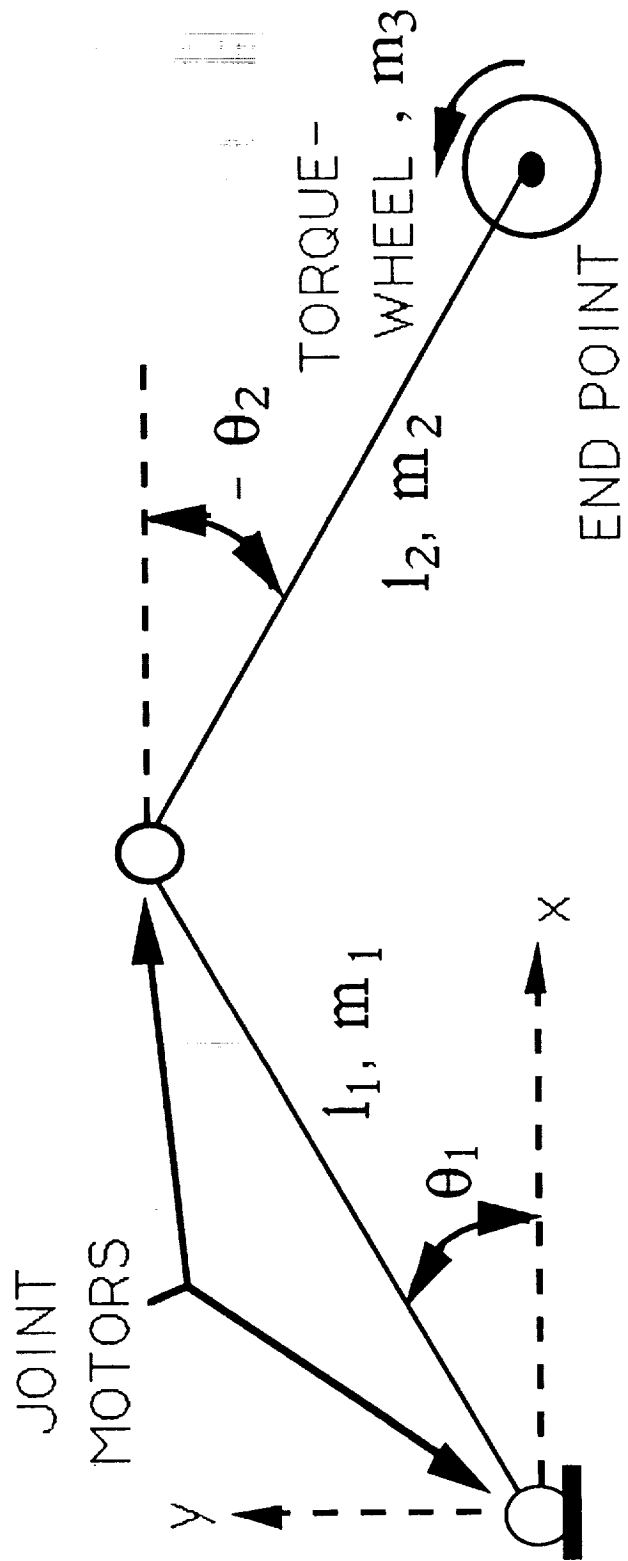

# Joint Motor Modelling

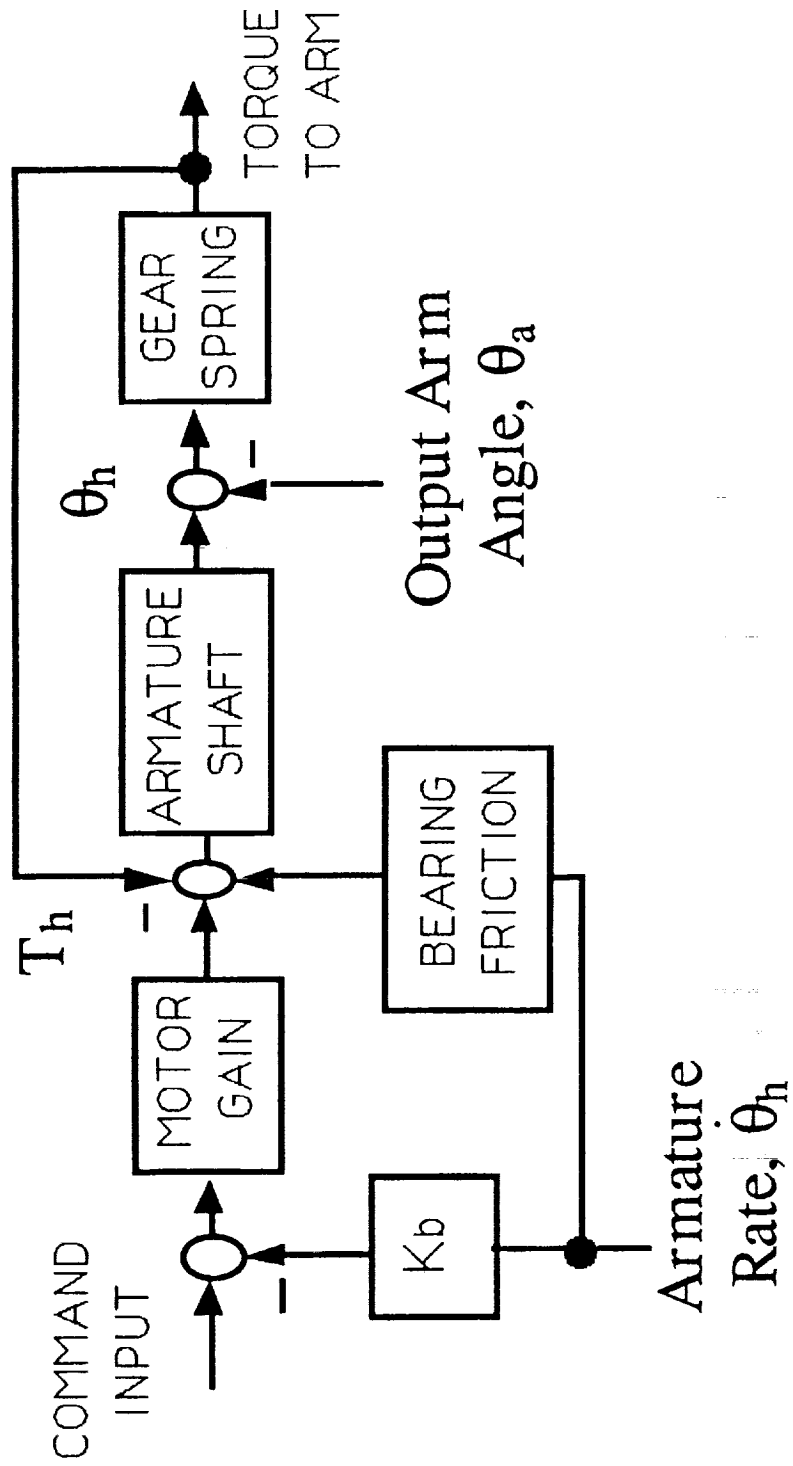

# Analysis Equations

## Energy Method Used

Equations of Motion

$$\frac{d}{dt} \left( \frac{\partial L}{\partial \dot{q}_i} \right) - \frac{\partial L}{\partial q_i} = \frac{\partial W}{\partial q_i} - \frac{\partial F}{\partial \dot{q}_i}$$

Lagrangian  $L = T - V$

Raleigh Dissipation  $F$

Virtual Work  $W$

# Analysis Equations

## Energy Method Used

### (Continued)

Shoulder Joint Motor

$$I_{s1} \ddot{\theta}_{s1} = k_{x1} (\theta_1 - \theta_{s1}) + k_{v1} (\dot{\theta}_1 - \dot{\theta}_{s1}) + T_{E1}$$

Shoulder Link

$$\begin{aligned} & \left( \frac{m_1}{3} + m_2 + m_3 \right) l_1^2 \ddot{\theta}_1 \\ & + \left( \frac{m_2}{2} + m_3 \right) l_1 l_2 \ddot{\theta}_2 \cos(\theta_1 - \theta_2) \\ & + \left( \frac{m_2}{2} + m_3 \right) l_1 l_2 \dot{\theta}_2^2 \sin(\theta_1 - \theta_2) \\ & + k_{x1} (\theta_1 - \theta_{s1}) = -k_{v1} (\dot{\theta}_1 - \dot{\theta}_{s1}) - T_{E2} \end{aligned}$$

# Analysis Equations

## Energy Method Used (Continued)

Elbow Joint Motor

$$I_{s2} \ddot{\theta}_{s2} = k_{x2} (\theta_1 - \theta_{s1}) + k_{v2} (\dot{\theta}_1 - \dot{\theta}_{s1}) + T_{E2}$$

Forearm Link

$$\begin{aligned} & \left( \frac{m_2}{3} + m_3 \right) l_2^2 \ddot{\theta}_2 + \left( \frac{m_2}{2} + m_3 \right) l_1 l_2 [\ddot{\theta}_1 \cos(\theta_1 - \theta_2) \\ & \quad - \dot{\theta}_1^2 \sin(\theta_1 - \theta_2)] + k_{x2} (\theta_2 - \theta_{s2}) = \\ & \quad = -k_{v2} (\dot{\theta}_2 - \dot{\theta}_{s2}) + T_{TW} \end{aligned}$$

# Control System

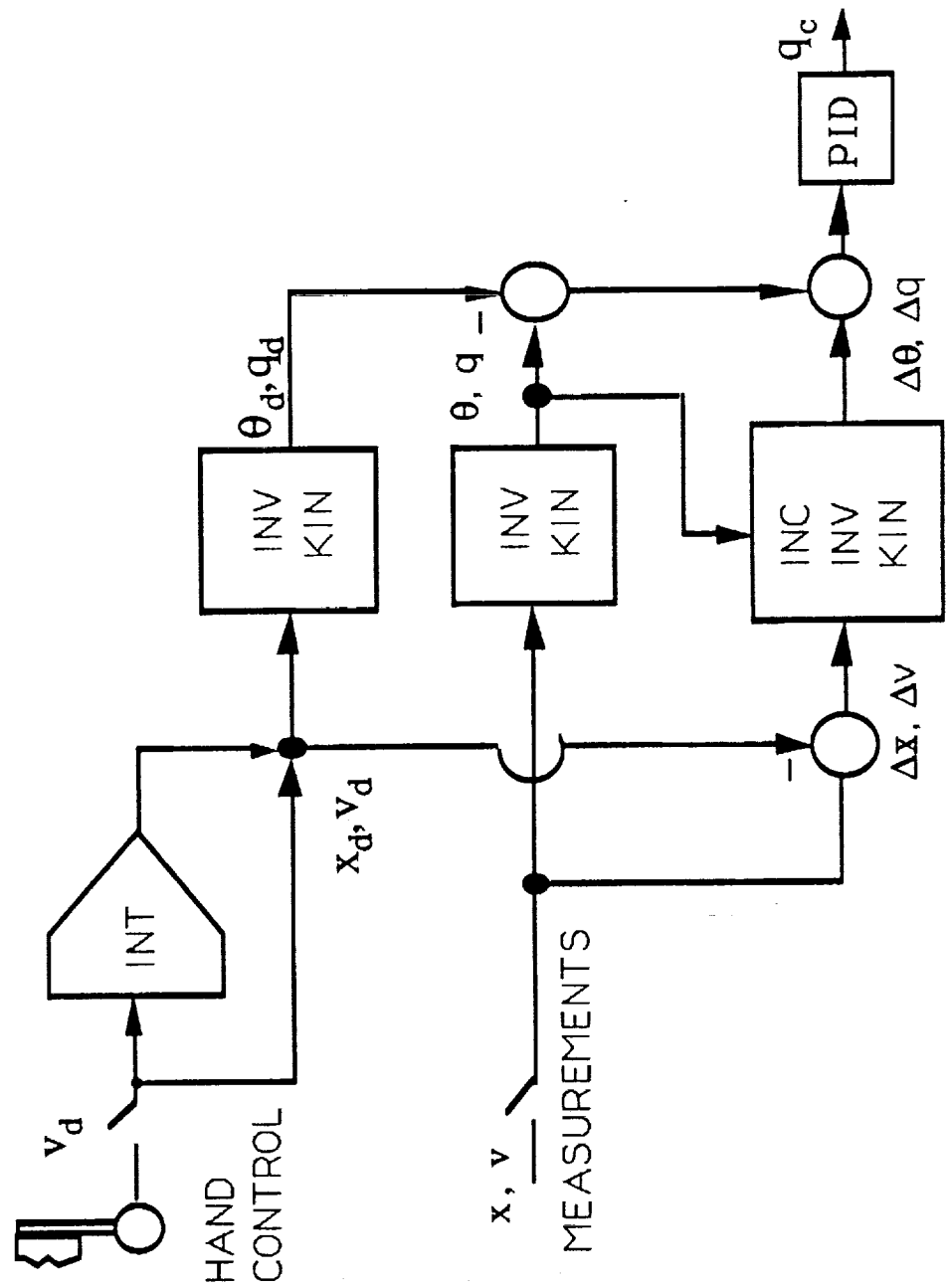

# Evaluation Task

## Arrest the Motion of the Arm

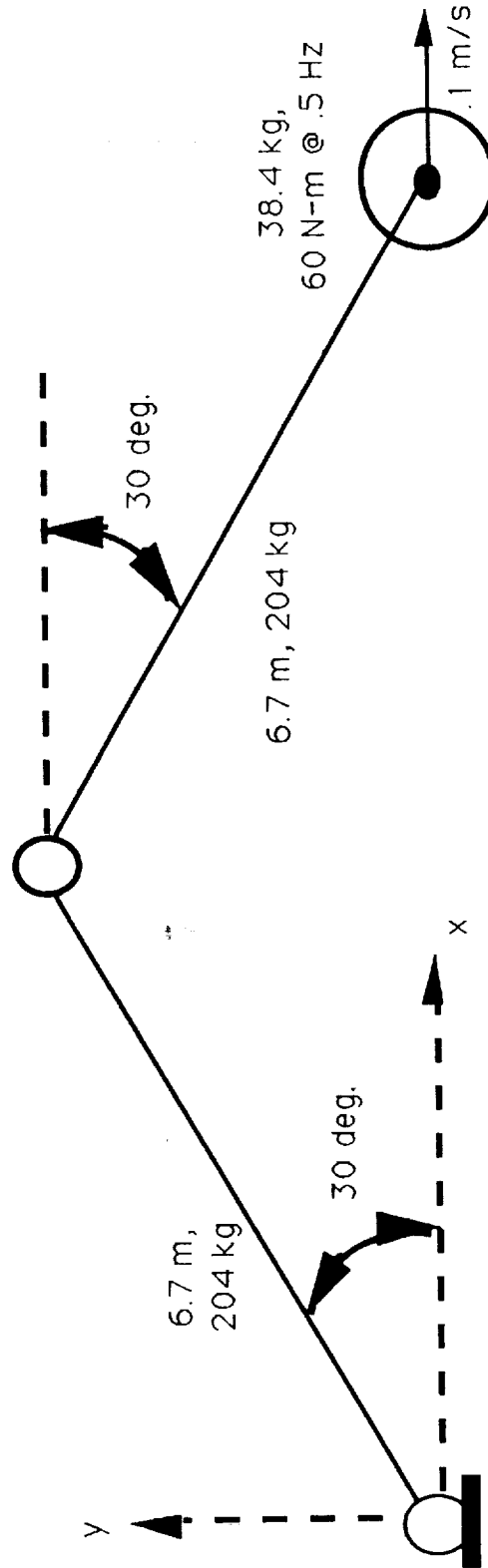

# System Simulator

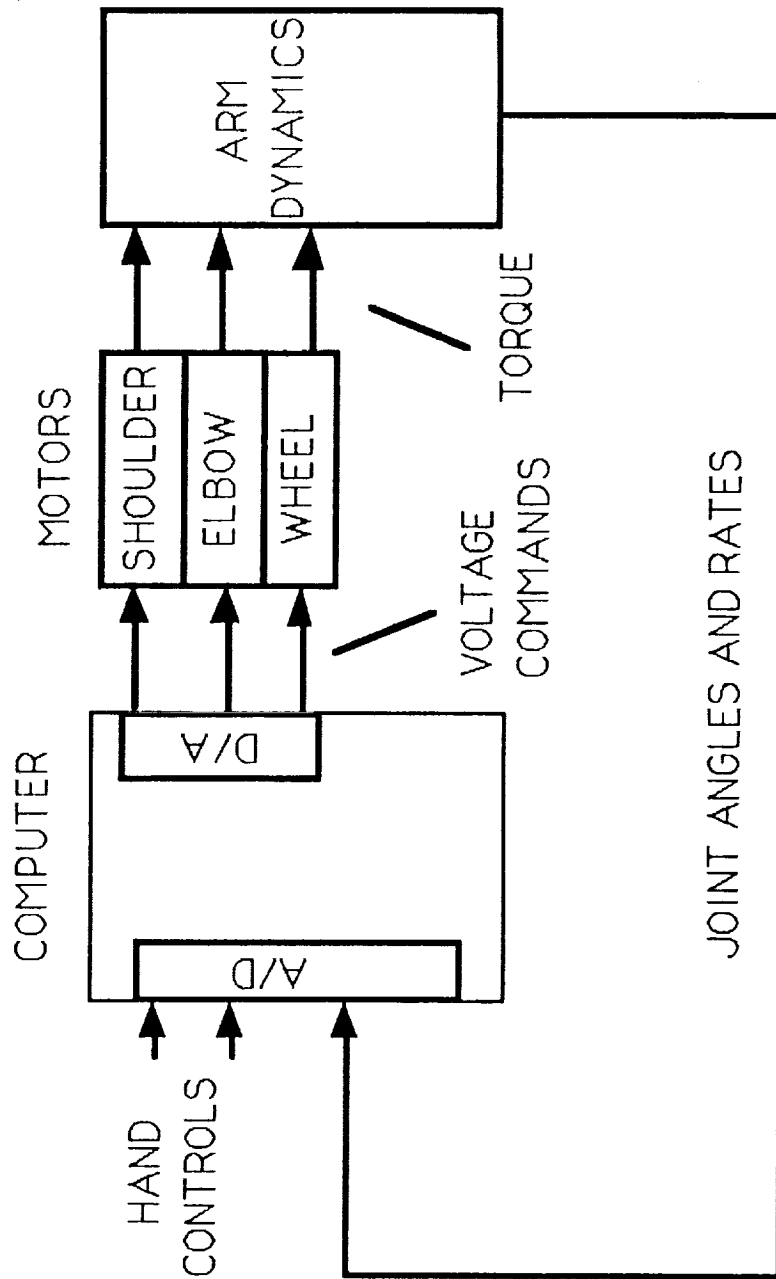



# Torque-Wheel Commands

## Arresting Task

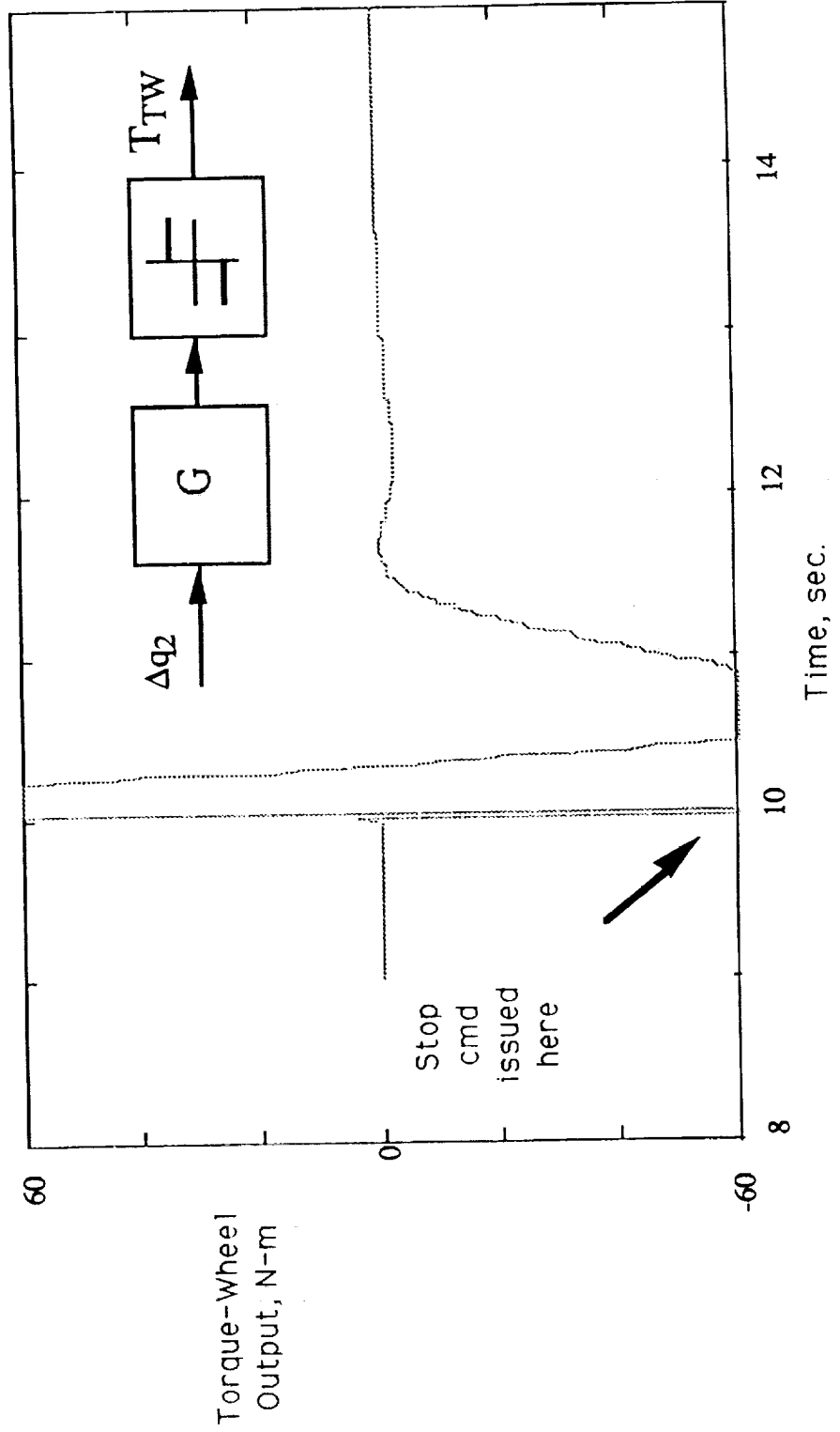

# Performance With and Without Torque-Wheels

## End-Point Motion for Arresting Task

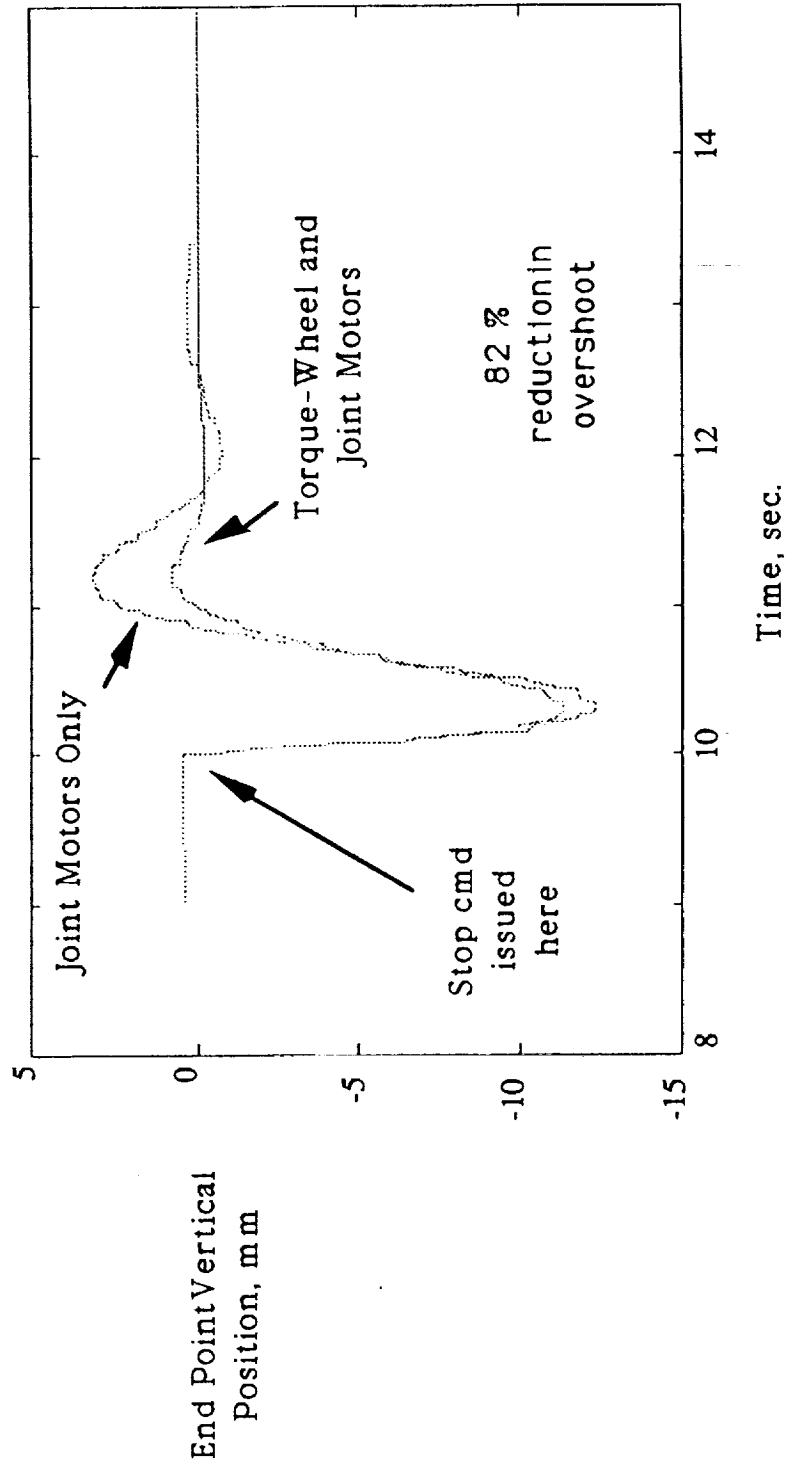

# Experimental Facility Planned

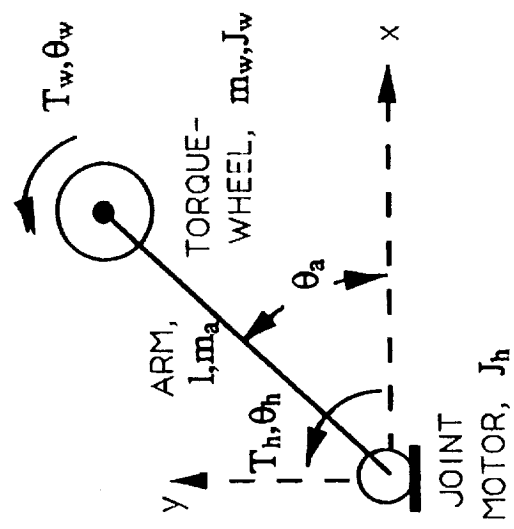
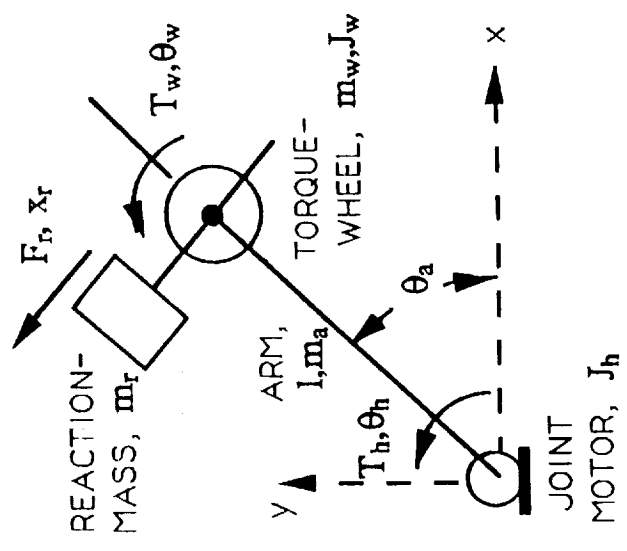

## Conclusions and Future Plans

Conclusion -- Torque-wheels can be of value in suppressing vibrations -- 82% reduction in overshoot for abrupt stop commands.

- Future simulator evaluations:
  - include reaction mass actuators
  - manual control
  - detailed models of flexibility
- Hardware evaluations

# Modeling, Control, and Simulation of Flexible Link Robotic Systems

Sean P. Kenny

Spacecraft Controls Branch  
NASA Langley Research Center

December 10, 1991

N92-27781

# WBS PROGRAM GOAL ROADMAP

## WBS 40 - 1

### Advanced System Modeling and Control

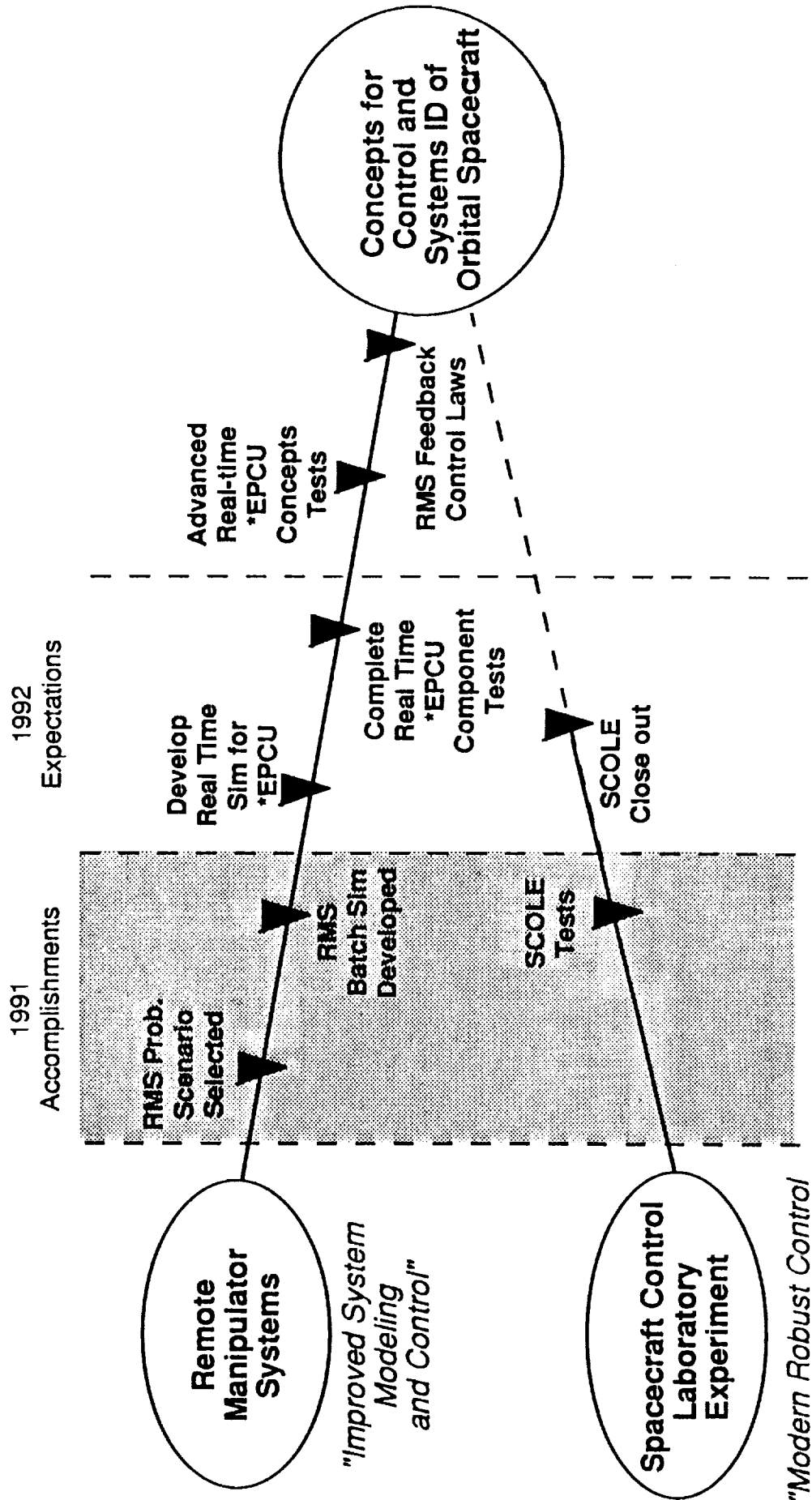

\* EPCU End Point Control Unit

# INTEGRATED SOFTWARE ENVIRONMENT

MODELING	CONTROL	SIMULATION
MAPLE <i>( Symbolic Mathematics )</i>	MATLAB <i>( Control Design )</i>	GRAPHICS WORKSTATION
<ul style="list-style-type: none"> <li>• Automated Model Development.</li> <li>• Symbolic Matrix Inversion for Nonlinear Models.</li> <li>• Automated "C" Code generator.</li> </ul>	<ul style="list-style-type: none"> <li>• Utilize Callable "C" Subroutines Generated in MAPLE.</li> <li>• Classical State Space</li> <li>• Robust Digital</li> </ul>	<ul style="list-style-type: none"> <li>• Real Time Graphics.</li> <li>• Interactive. (man-in-the-loop control)</li> <li>• Interface to MATLAB and MAPLE.</li> <li>• "X Windows" Portability.</li> </ul>

# MODELING SOFTWARE: MAPLE (*SYMBOLIC MATHEMATICS*)

- **OBJECTIVE:**
  - Develop a software environment to automate the process of implementing Hamilton's or Lagrange's equations of motion.
- **ADVANTAGES:**
  - Fewer errors.
  - Reduce the number of floating point operations in simulations by simplifying complex expressions, e.g. symbolic matrix inversion, and matrix-vector multiplication.
  - Provide a practical way to generate reliable equations.
- **DISADVANTAGES:**
  - Extremely memory intensive.
  - Difficulties handling multiple complex mode shape expressions.



# MODELING SOFTWARE: MAPLE

## M.I.T. developed applications package

- CAPABILITIES:
  - > Planar motion of a flexible manipulator (base fixed relative to inertia space.)
  - > Up to 9 links.
  - > Inertial or relative coordinates
  - > Individual links can be rigid or flexible, but:
    - I. A Bernoulli-Euler is assumed (no shear.)
    - II. An assumed modes method (user specifies mode shapes.)
  - > Stiffening effects due to rotation can be included.
  - > Joints can have masses (including tip mass), and flexibility but no inertias.

# MODELING SOFTWARE: M.I.T. sample input data file

COORDS:= inertial	# Coordinate system used
FORESHORTEN:= no;	# Foreshortening effect
ORTHOG:= yes;	# Orthogonal mode shapes
NL:= 1;	# Number of links
n1:= 2;	# Number of modes per link
qstar1:= [TH1,Q11,Q12];	# List of generalized coords.
m01:= 0;	# Root mass
mL1:= m0;	# Tip mass
k1:= infinity;	# Joint stiffness
EI1:= EI;	# Beam stiffness
rhoA1:= rhoA;	# Beam mass per unit length
phi11:= < sin(Pi*x/L)  x >;	# Mode shape 1
phi12:= < sin(2*Pi*x/L)  x >;	# Mode shape 2

# CONTROL DESIGN INTERFACE

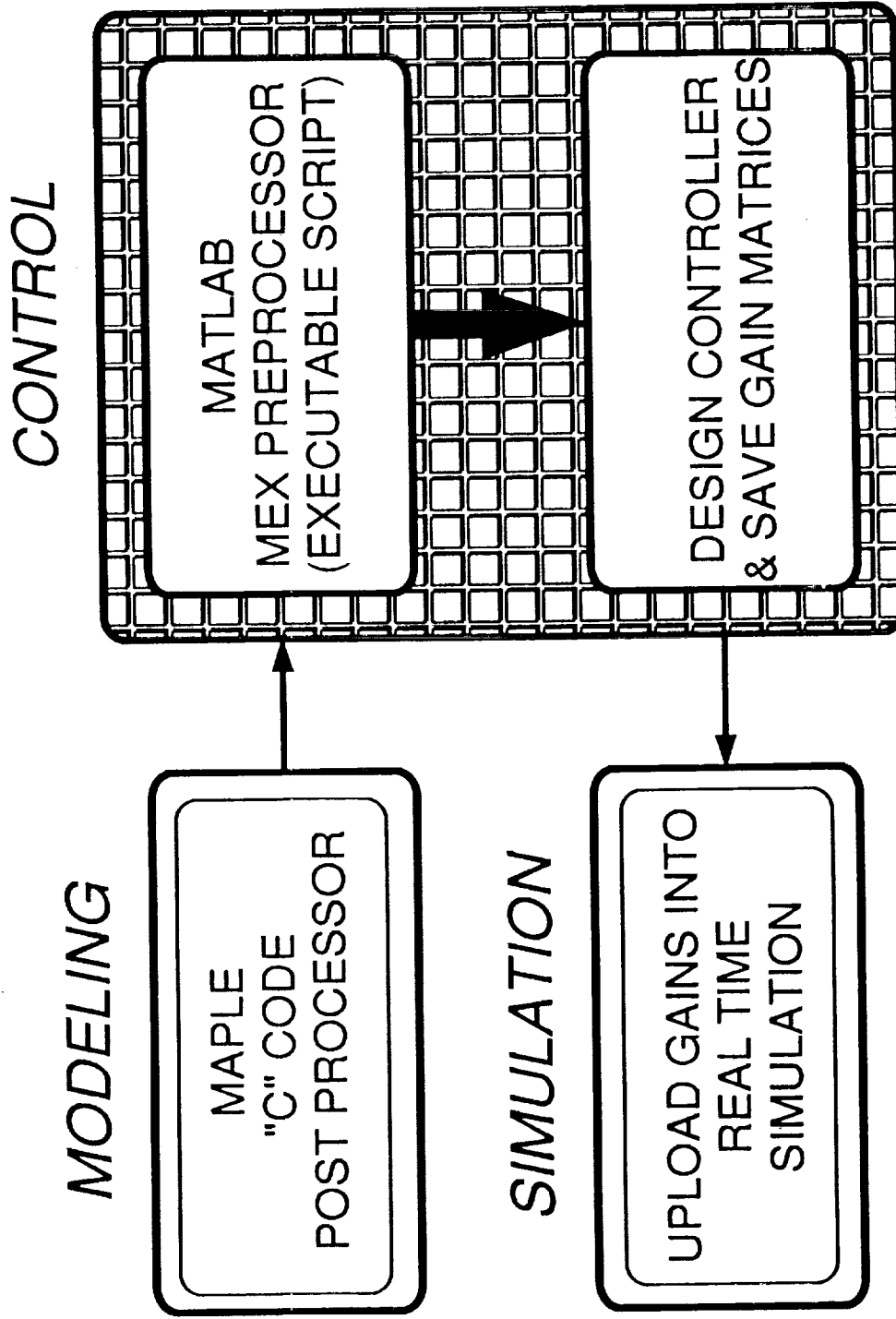

# REAL TIME SIMULATION

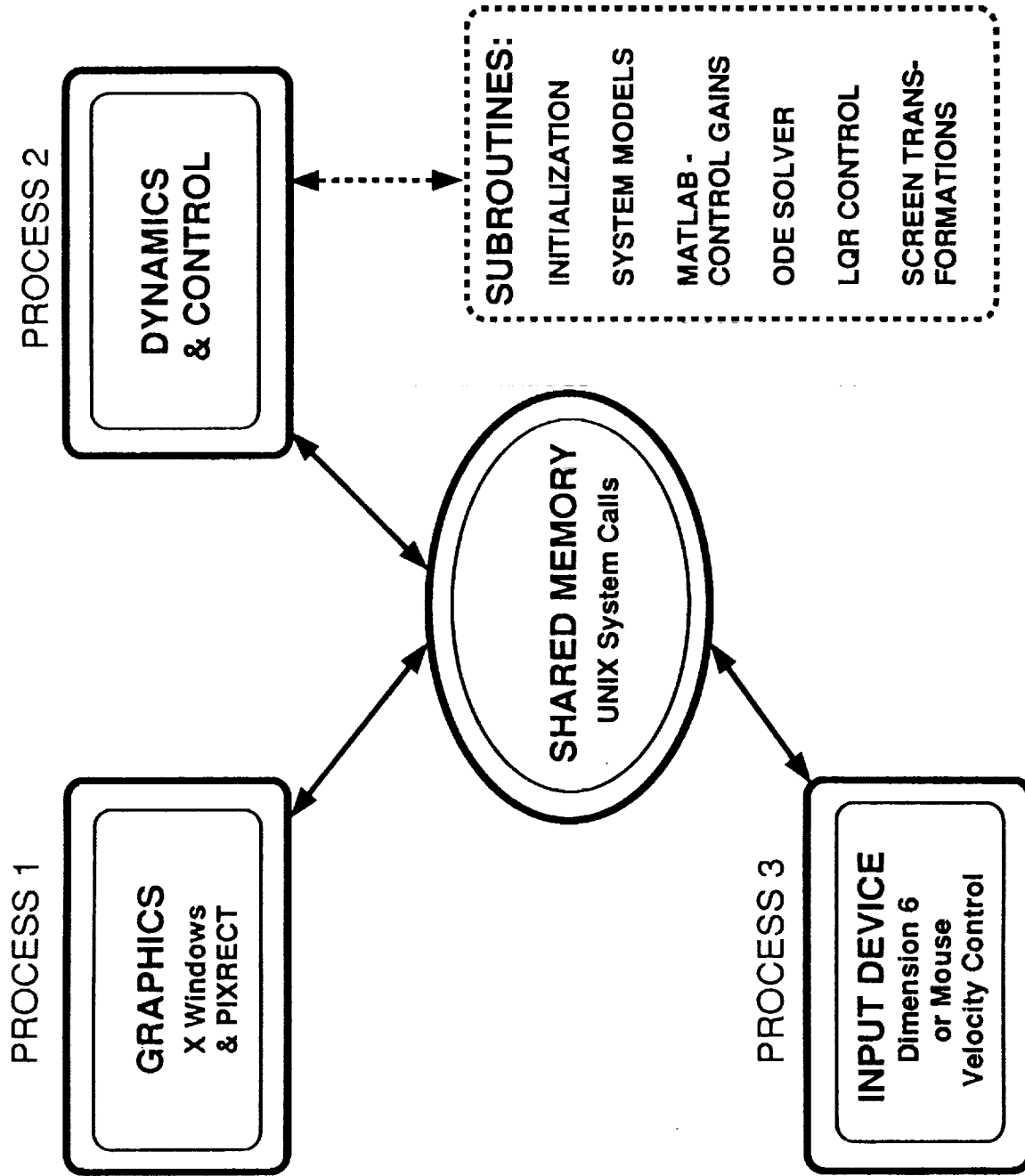

# GRAPHICS WORKSTATION

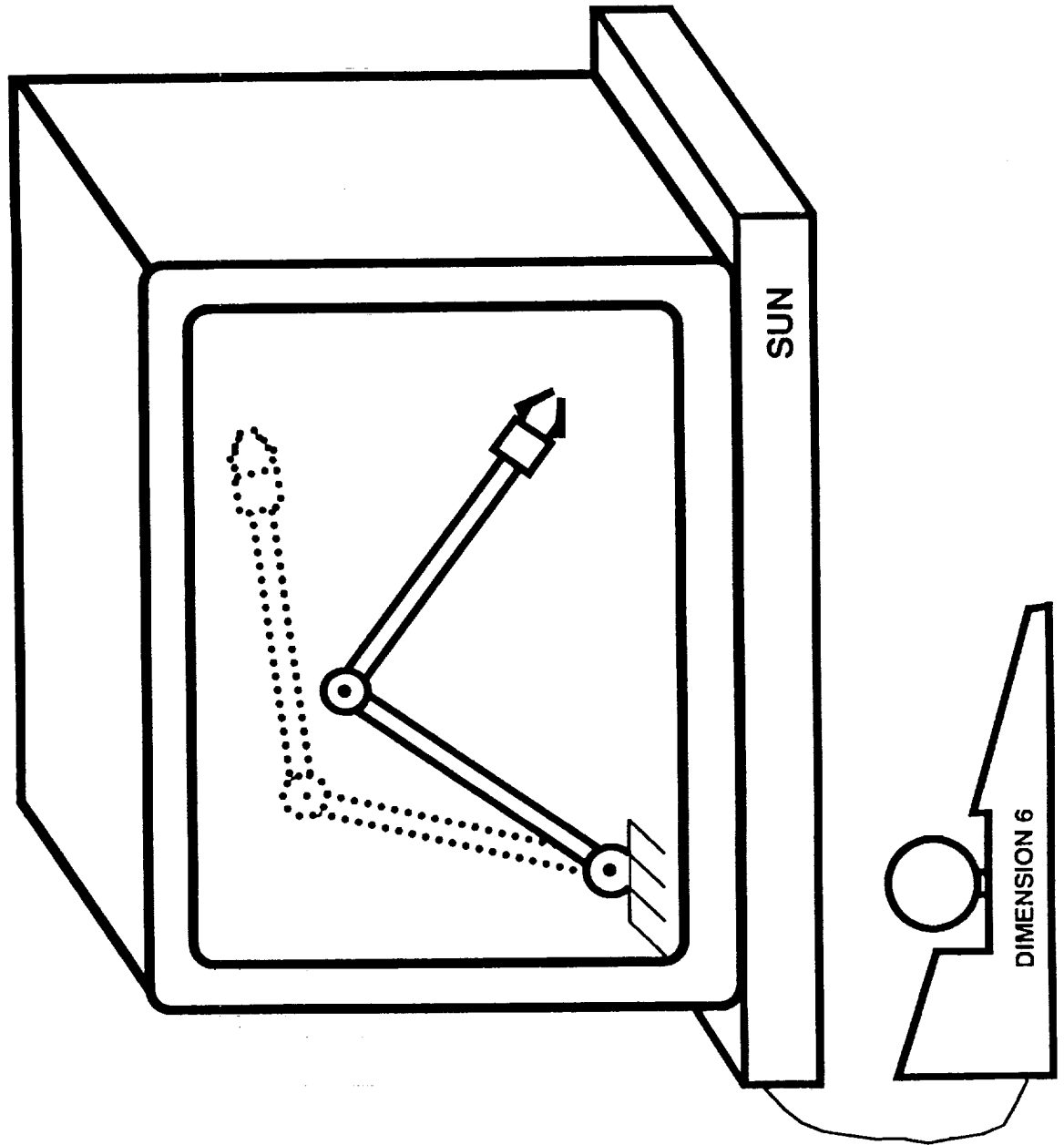

## CLOSING REMARKS

- While not a panacea for all robotics modeling problems, symbolic mathematics programs represent a valuable tool for generating equations of motion for flexible link robotic systems.
- Desk top workstation simulators provide an economical environment to evaluate man-in-the-loop control, as well as the active damping characteristics of robotic systems.

**PASSIVE DYNAMIC CONTROLLERS FOR  
NON-LINEAR MECHANICAL SYSTEMS**

**Jer-Nan Juang, Shih-Chin Wu,  
Minh Phan, and Richard W. Longman**

**NASA Langley Research Center  
Hampton, VA 23665**

**N92-27782**

# OUTLINE

- MOTIVATION
- OBJECTIVE
- APPROACH
- BASIC CONCEPTS
- PHYSICAL INTERPRETATION
- APPLICATION
- CONCLUSIONS



# MOTIVATION

- **FEATURES OF A DEVELOPED VIRTUAL PASSIVE CONTROLLER FOR VIBRATION CONTROL OF LINEAR SYSTEMS**
  - energy dissipative
  - robust in stability to system uncertainties
  - interpreted physically
- **PROPOSED MODEL-INDEPENDENT SECOND-ORDER DYNAMIC CONTROLLER IS EXTENDED TO NON-LINEAR MULTI-BODY MECHANICAL SYSTEMS**

# OBJECTIVE

- DEVELOP ACTIVE MODEL-INDEPENDENT CONTROLLERS FOR SLEWING AND VIBRATION CONTROL OF NON-LINEAR MULTI-BODY FLEXIBLE SYSTEMS, INCLUDING FLEXIBLE ROBOTS

# PASSIVE STABILIZATION

## PASSIVE STABILIZING ELEMENTS

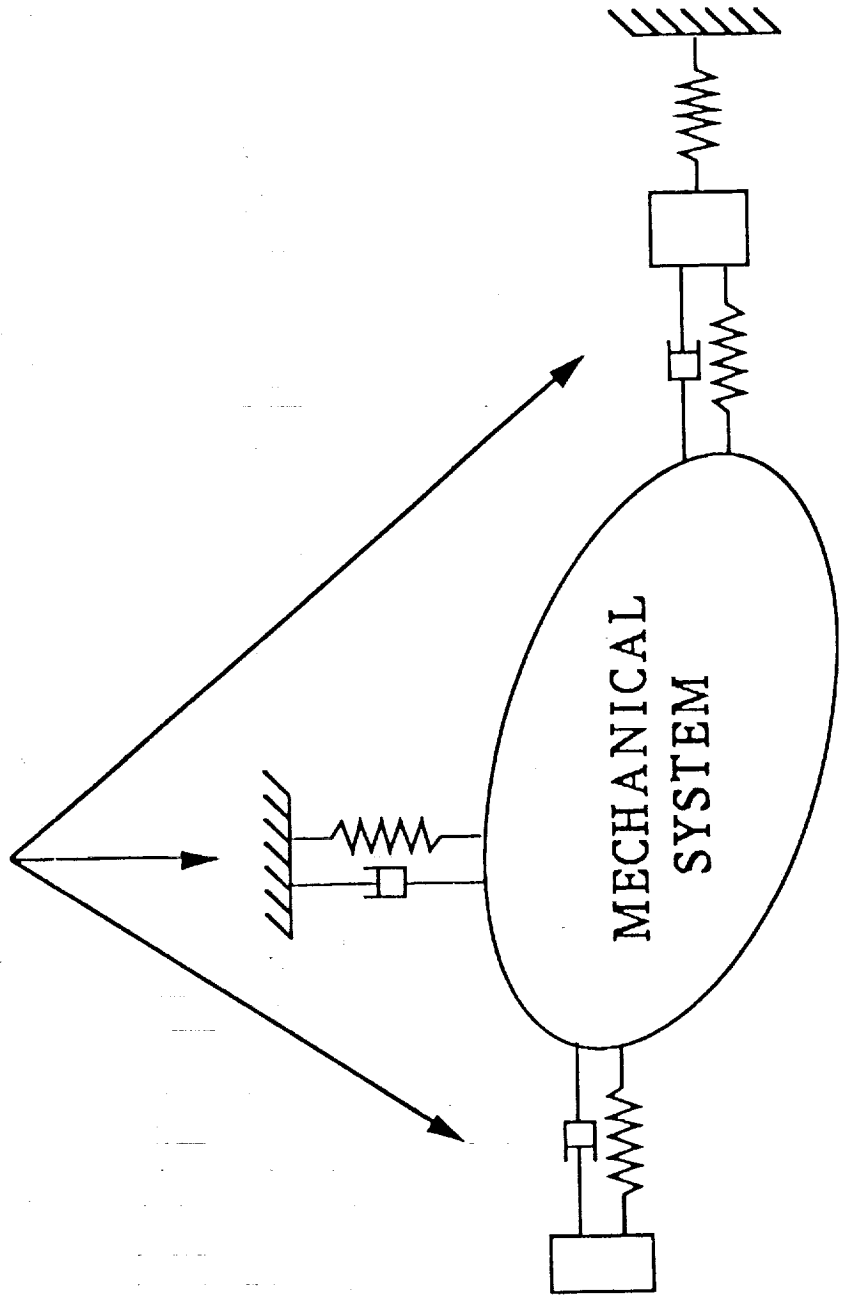

# APPROACH

- **THEORY FOR LINEAR SYSTEMS**
  - second-order differential equations
  - energy dissipative
  - robust in stability to system uncertainties
  - interpreted physically
- **EXTENSION TO NON-LINEAR SYSTEMS IS BASED ON**
  - Work-Energy Rate principle
  - Liapunov stability theory

# BASIC CONCEPT (Work-Energy)

- WORK-ENERGY RATE PRINCIPLE
- For holonomic and scleronomic mechanical systems

$$\frac{dT}{dt} = u^T \dot{x}_a$$

where

$T$  = Total kinetic energy

$u$  = Generalized control force

$x_a$  = Vector of generalized coordinates

where control force is applied

# BASIC CONCEPT (Liapunov Theory)

## ● STANDARD LIAPUNOV STABILITY THEORY

- Positive definite Liapunov function

$$L = L(x_a, \dot{x}_a, \bar{x}, \dot{\bar{x}})$$

where  $\bar{x}$  = Vector of remaining generalized coordinates

- System is asymptotically stable if

$$\frac{dL}{dt} < 0$$

# LIAPUNOV FUNCTION (Displacement Feedback)

- POSITIVE SEMI-DEFINITE LIAPUNOV FUNCTION

$$L = T + \frac{1}{2} \dot{x}_c^T M_c \dot{x}_c + \frac{1}{2} (x_a - x_c)^T K_{c1} (x_a - x_c) + \frac{1}{2} x_c^T K_{c2} x_c$$

where  $x_c$  = controller coordinates

- NEGATIVE SEMI-DEFINITE TIME DERIVATIVE OF LIAPUNOV FUNCTION

$$\frac{dL}{dt} = -\dot{x}_c^T D_c \dot{x}_c \leq 0$$

- Asymptotic stability can be accomplished even though the Liapunov function is only positive semi-definite and its time derivative is only negative semi-definite.

# DYNAMIC CONTROLLER (Displacement Feedback)

## ● SYSTEM

$$M\ddot{x} + f(x, \dot{x}) = Bu ; \quad x = \begin{bmatrix} x_a \\ \bar{x} \end{bmatrix}$$

## ● DYNAMIC CONTROLLER

$$M_c \ddot{x}_c + D_c \dot{x}_c + (K_{c1} + K_{c2}) x_c = K_{c1} x_a$$

$$u = -K_{c1} (x_a - x_c)$$



# LIAPUNOV FUNCTION (Displacement & Acceleration Feedback)

- POSITIVE SEMI-DEFINITE LIAPUNOV FUNCTION

$$L = T + \frac{1}{2}(\dot{x}_a + \dot{x}_c)^T M_c(\dot{x}_a + \dot{x}_c) + \frac{1}{2}x_c^T K_{c1}x_c + \frac{1}{2}(x_a + x_c)^T K_{c2}(x_a + x_c)$$

where  $x_c$  = controller coordinates

- NEGATIVE SEMI-DEFINITE TIME DERIVATIVE OF LIAPUNOV FUNCTION

$$\frac{dL}{dt} = -\dot{x}_c^T D_c \dot{x}_c \leq 0$$

- Asymptotic stability can be accomplished even though the Liapunov function is only positive semi-definite and its time derivative is only negative semi-definite.

# DYNAMIC CONTROLLER (Displacement & Acceleration Feedback)

## ● SYSTEM

$$M\ddot{x} + f(x, \dot{x}) = Bu ; \quad x = \begin{bmatrix} x_a \\ \bar{x} \end{bmatrix}$$

## ● DYNAMIC CONTROLLER

$$M_c \ddot{x}_c + D_c \dot{x}_c + (K_{c1} + K_{c2}) x_c = -M_c \ddot{x}_a - K_{c2} x_a$$

$$u = -M_c (\ddot{x}_a + \ddot{x}_c) - K_{c2} (x_a + x_c)$$

# PHYSICAL INTERPRETATION (Velocity Feedback)

- VELOCITY FEEDBACK IMITATES

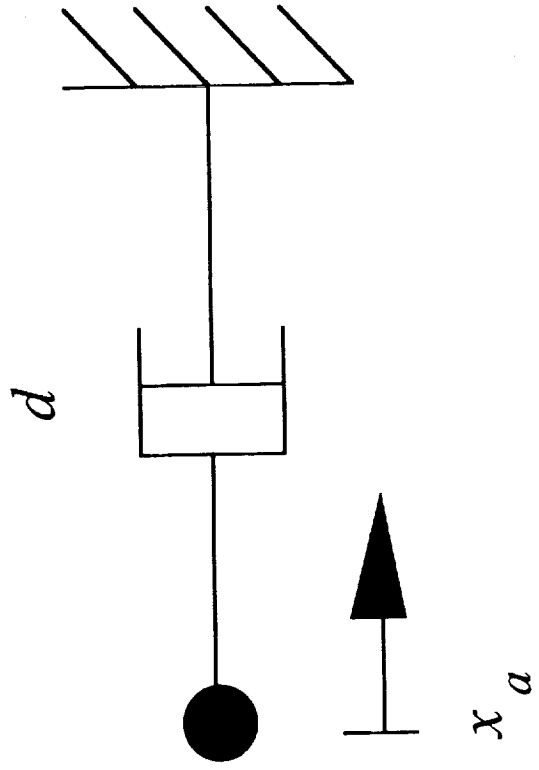

# PHYSICAL INTERPRETATION (Displacement Feedback)

- VELOCITY FEEDBACK IMITATES

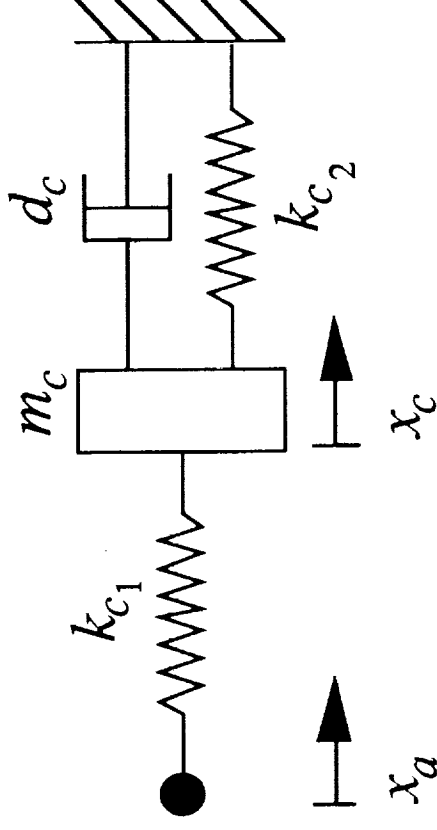

- EMULATION OF VELOCITY FEEDBACK BY MAKING

$k_{c1}$  large,  $k_{c2}$  small,  $m_c$  small

# PHYSICAL INTERPRETATION (Displacement & Acceleration Feedback)

- DISPLACEMENT AND ACCELERATION FEEDBACK IMITATES

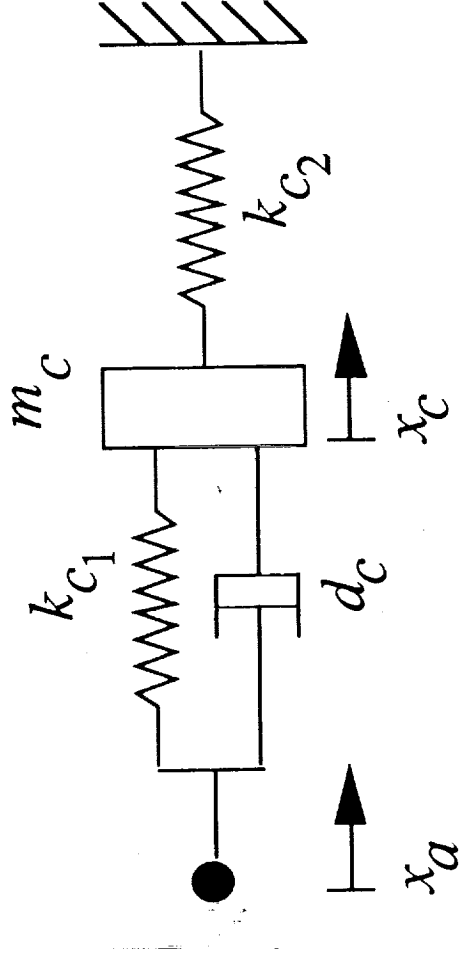

- EMULATION OF VELOCITY FEEDBACK BY MAKING

$k_{c1}$  small,  $k_{c2}$  large,  $m_c$  small

# APPLICATION

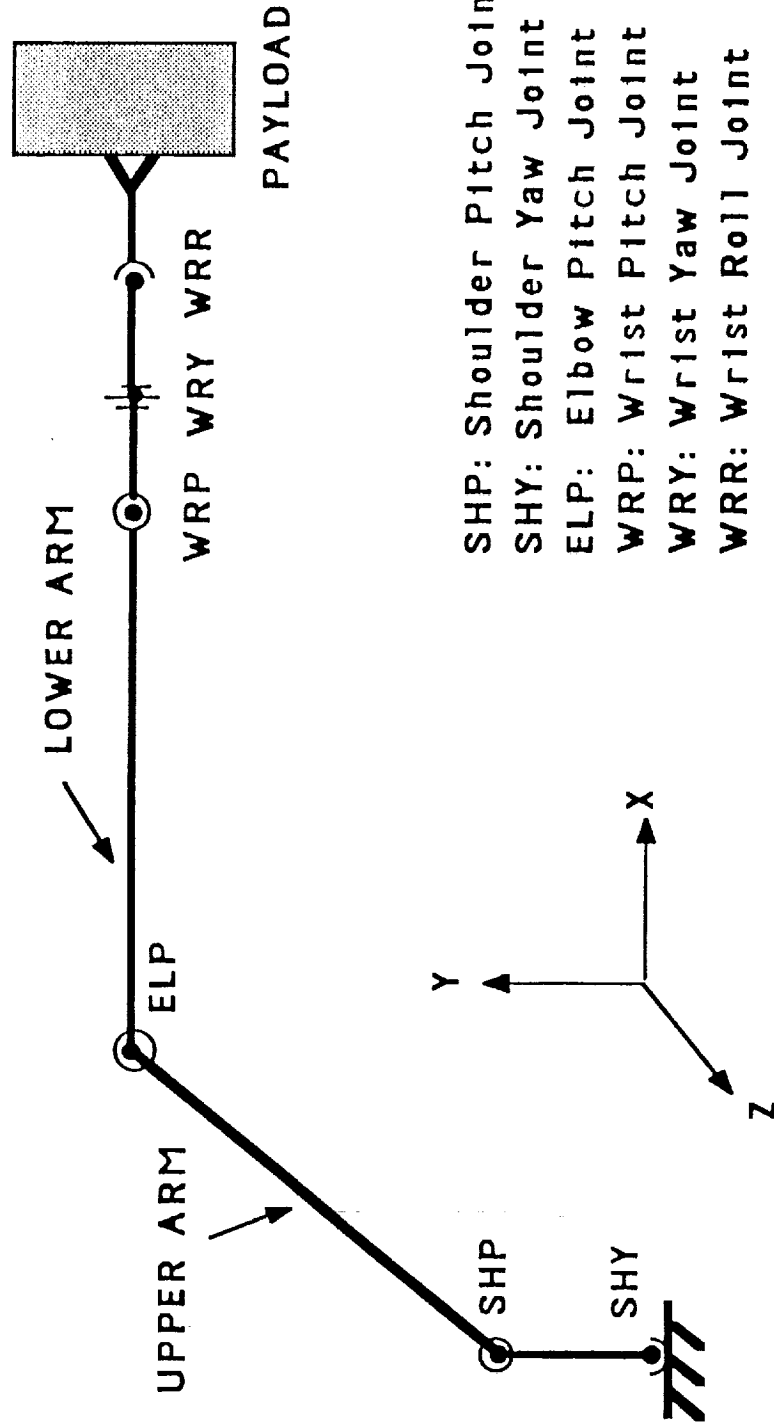

- SHP: Shoulder Pitch Joint
- SHY: Shoulder Yaw Joint
- ELP: Elbow Pitch Joint
- WRP: Wrist Pitch Joint
- WRY: Wrist Yaw Joint
- WRR: Wrist Roll Joint

## A Six-Degree-of-Freedom Robot

# CASE STUDY

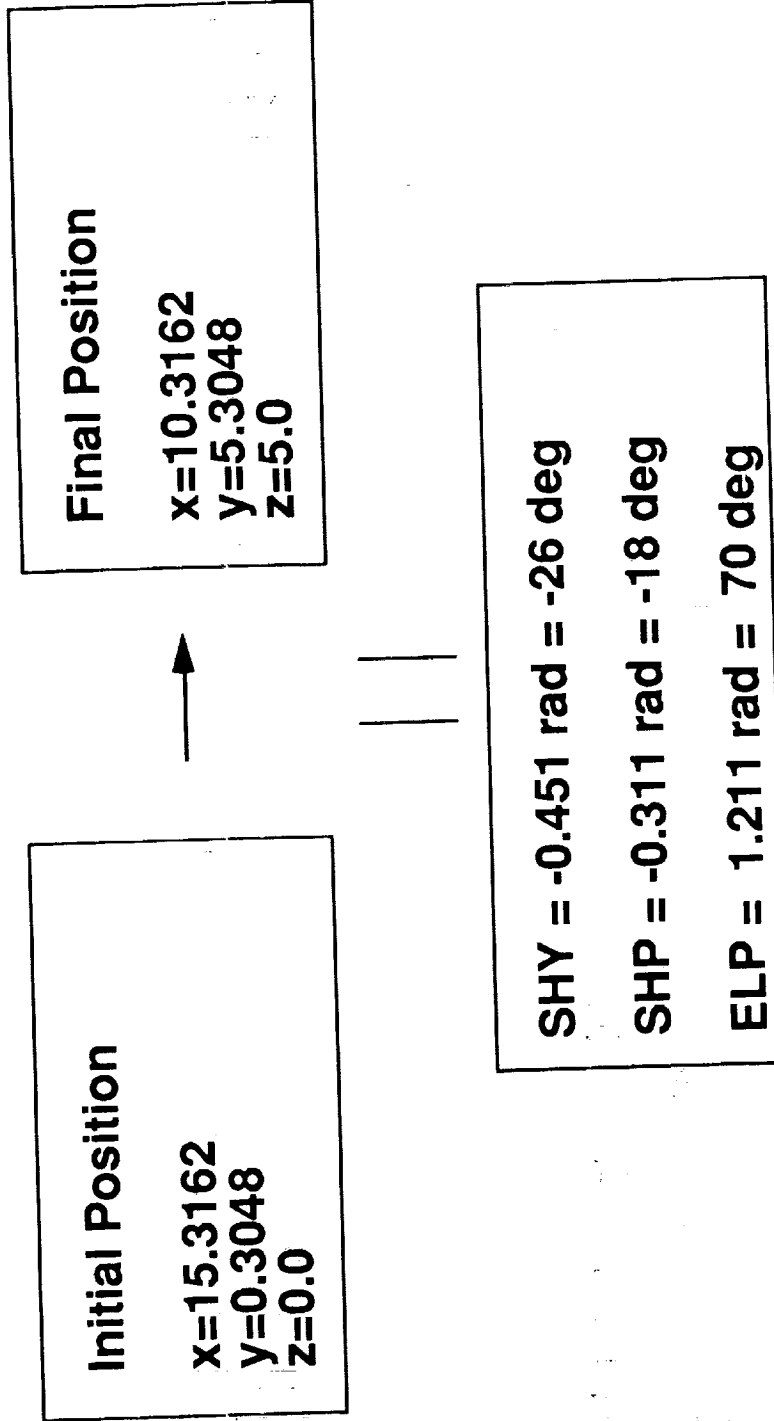

**Angular displacement, velocities and/or acceleration of SHY, SHP and ELP joints are used for feedback**

# CASE STUDY (continued)

- Case 1 :  
Displacement and  
velocity feedback

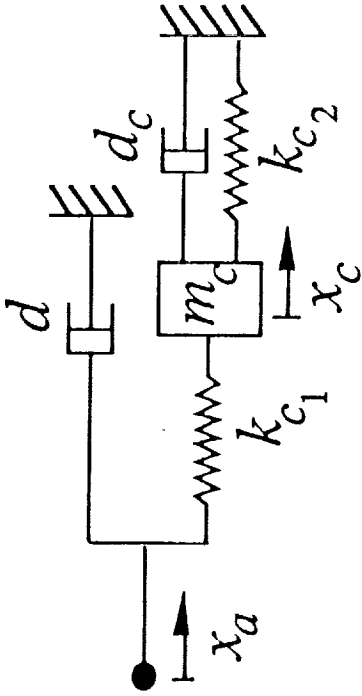

- Case 2 :  
Displacement feedback

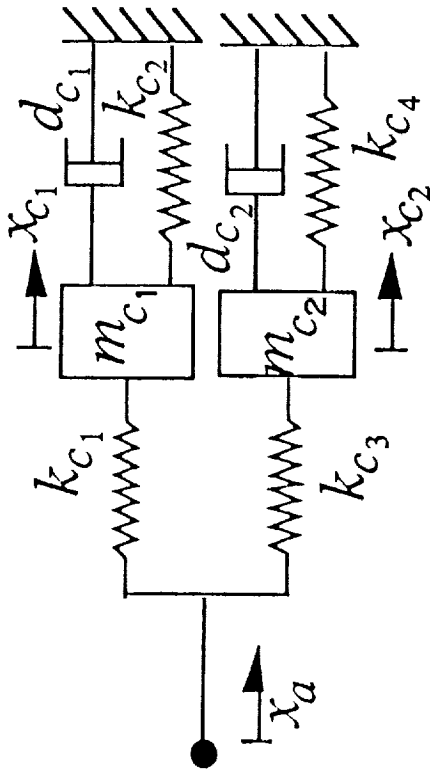

- Case 3 :  
Displacement and  
acceleration feedback

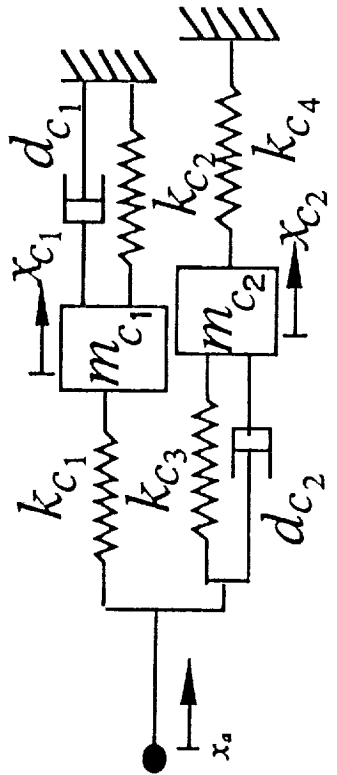



# SIMULATION RESULTS

## (Displacement and velocity feedback)

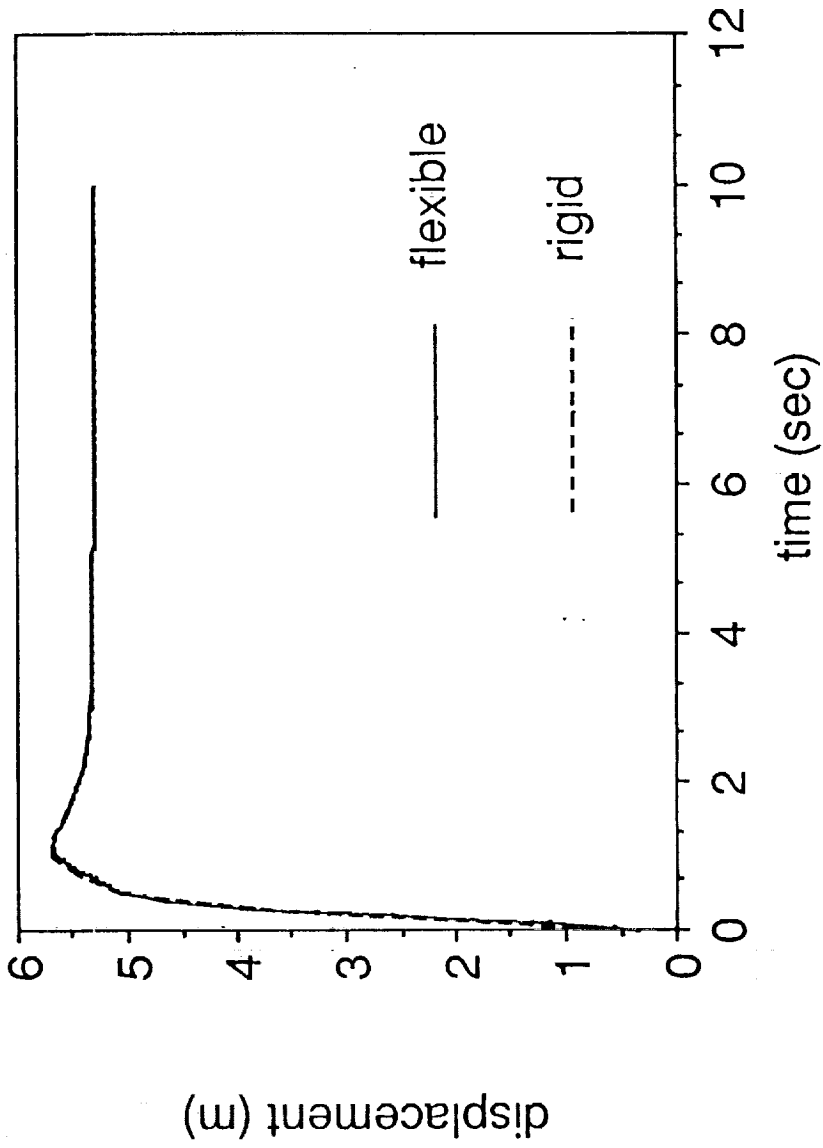

**y-Position of the End Effector**

# SIMULATION RESULTS

## (Displacement and velocity feedback)

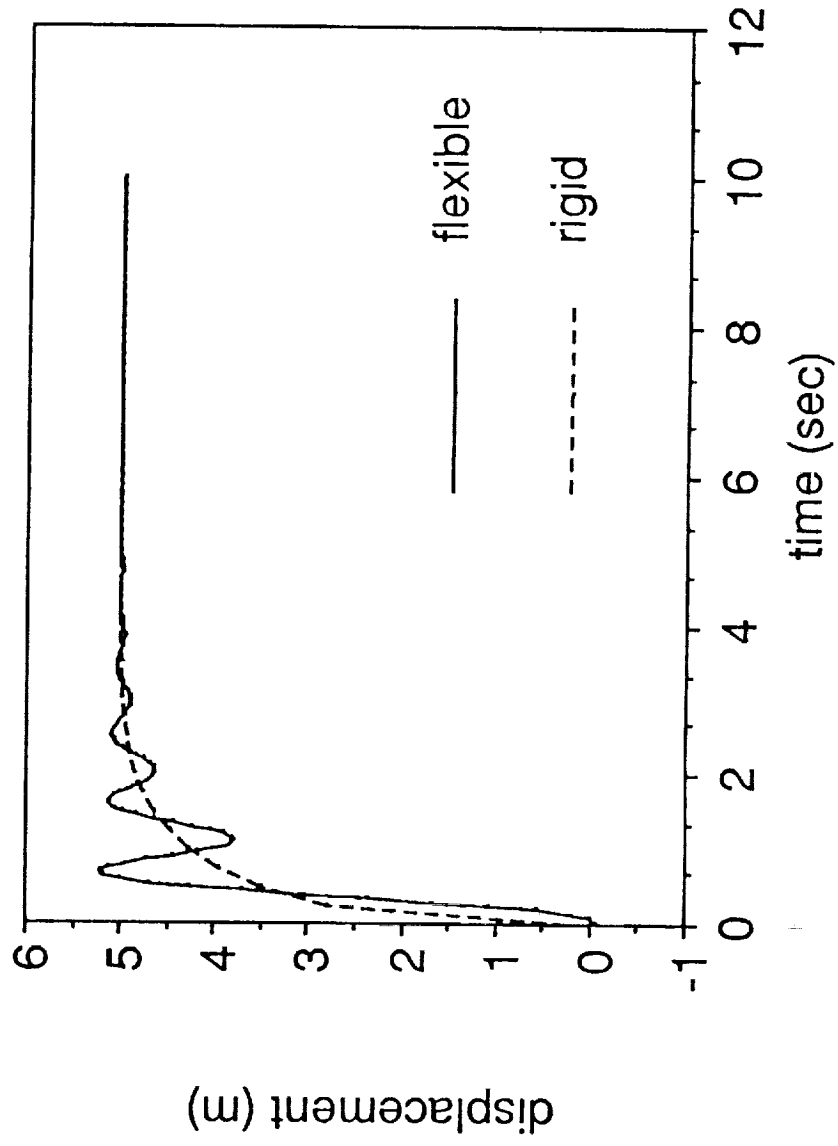

**z-Position of the End Effector**

# **SIMULATION RESULTS**

## **(Displacement and velocity feedback)**

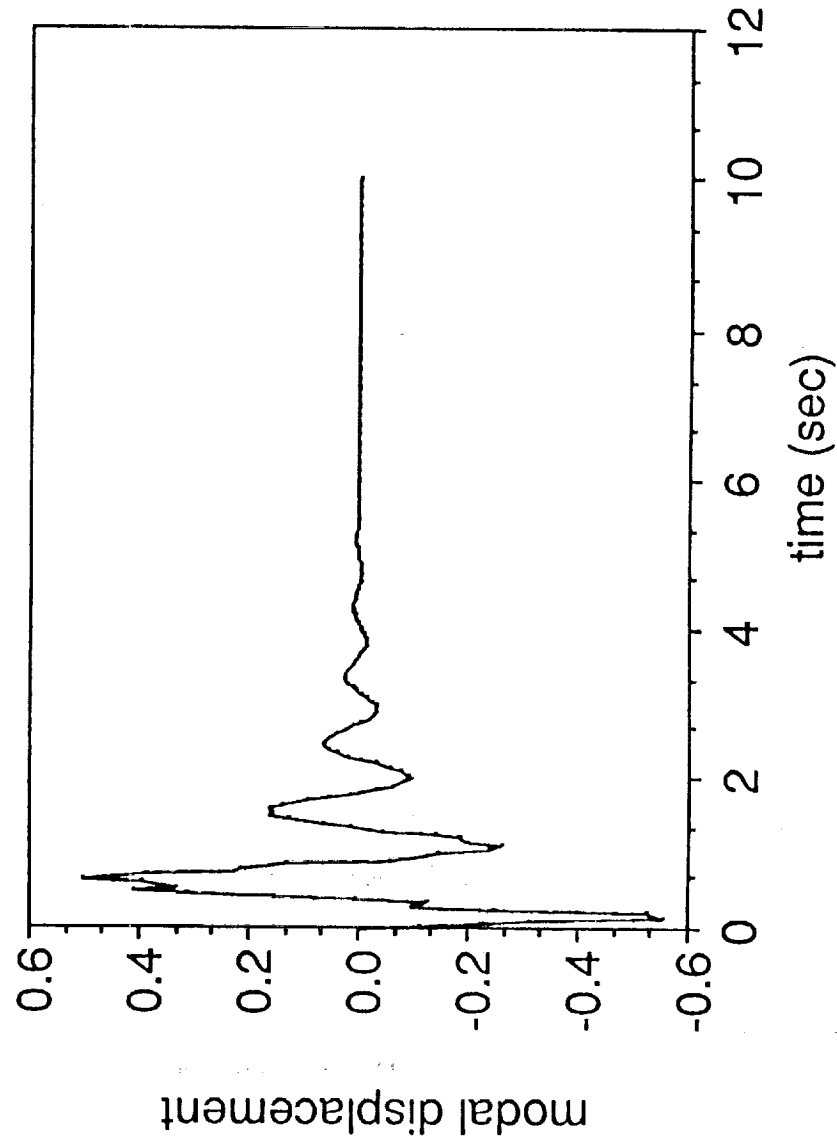

**Modal Displacement of First Mode of the Lower Arm**

# SIMULATION RESULTS (Displacement feedback)

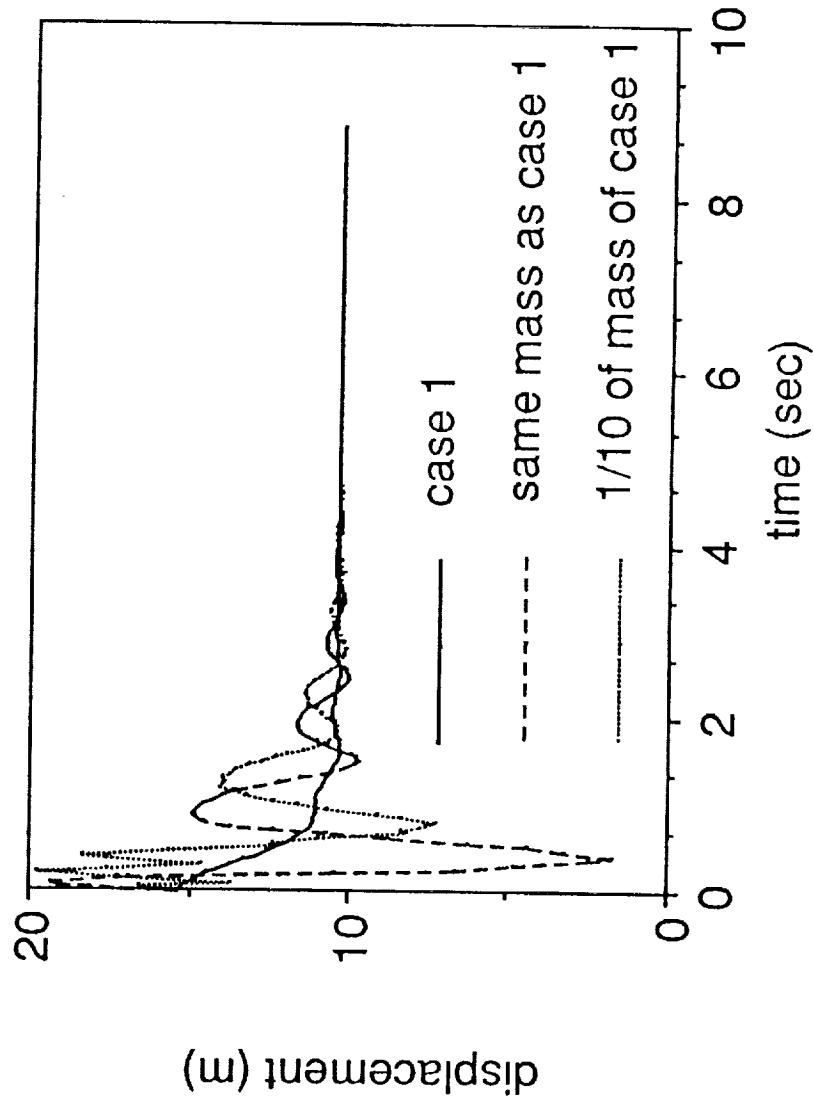

**x-Position of the End Effector for Different Values of  
Control mass with Large Control Stiffness**

# SIMULATION RESULTS (Acceleration & displacement feedback)

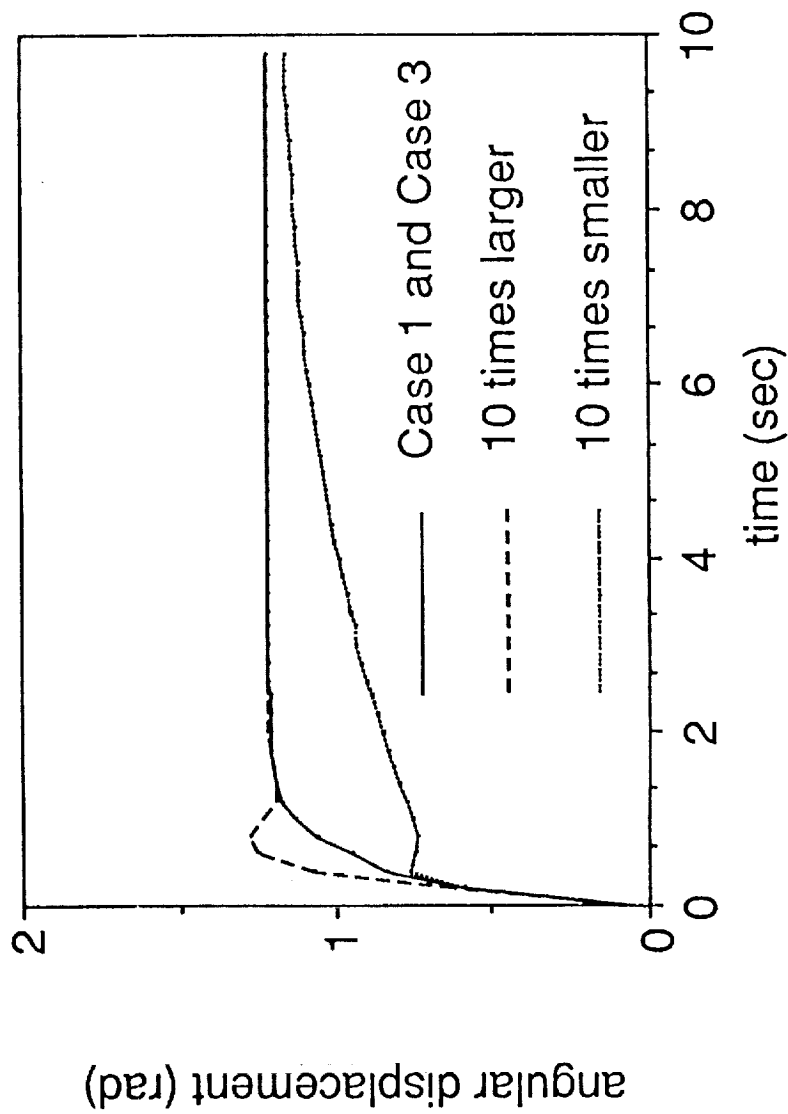

**Elbow Pitch Displacement for Different Values  
of Control Stiffness**

# SIMULATION RESULTS (Acceleration & displacement feedback)

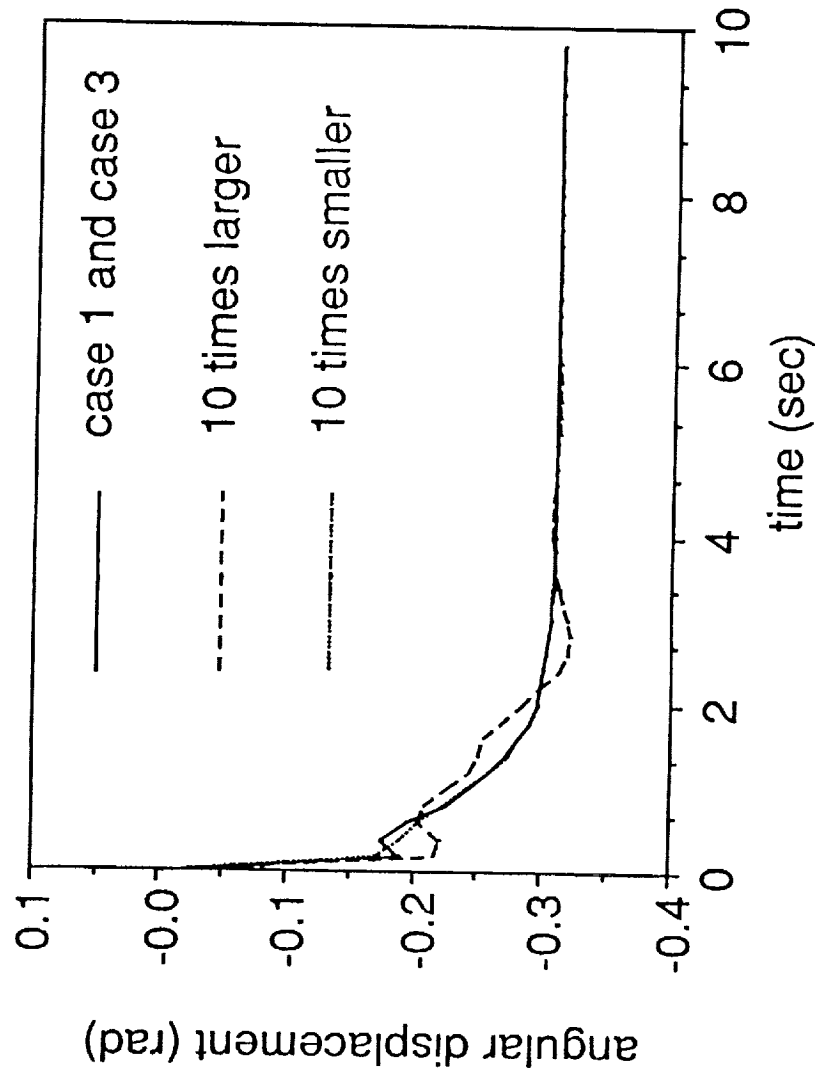

**Shoulder Pitch Displacement for Different Values  
of Control Mass**

# SIMULATION RESULTS (Acceleration & displacement feedback)

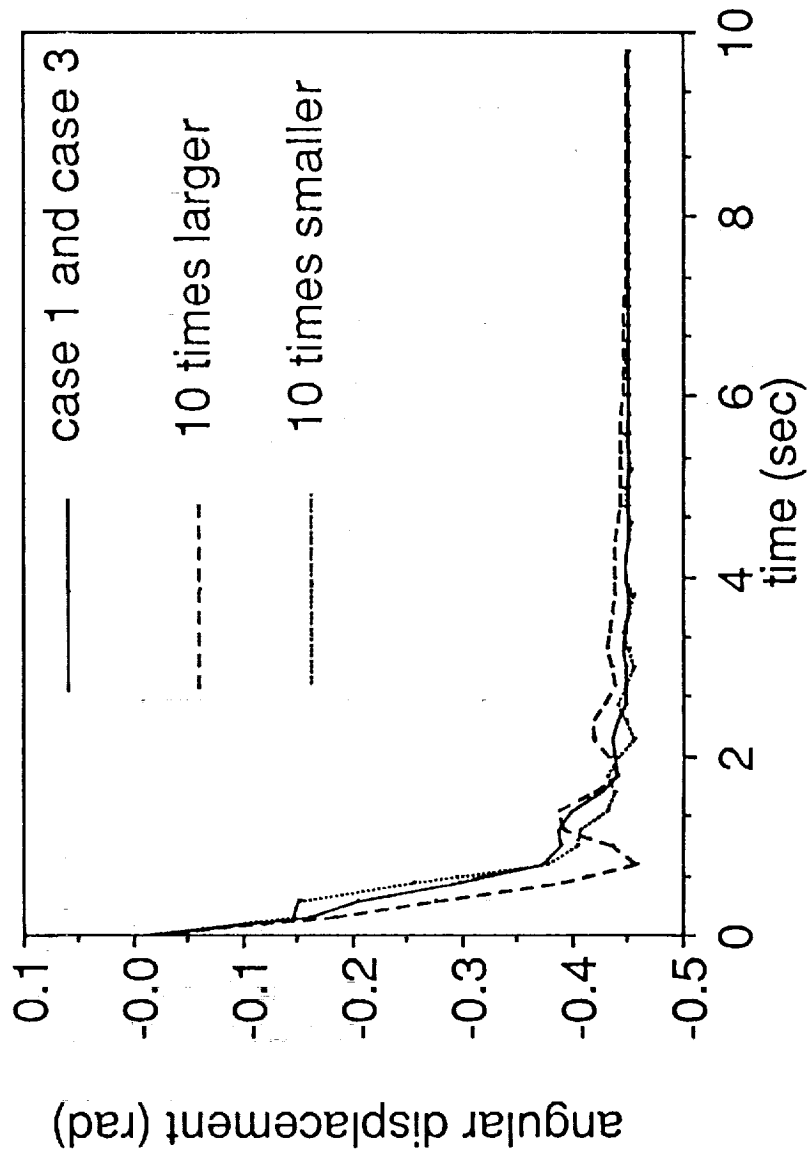

**Shoulder Yaw Displacement for Different Values  
of Control Damping**

## CONCLUSIONS

- **A ROBUST CONTROL DESIGN HAS BEEN DEVELOPED**
  - **For large angle position control and vibration suppression**
  - **Applicable to multiple-body flexible dynamic systems**
  - **Model-independent**
  - **Guaranteed stability**
  - **Can use position, velocity, and/or acceleration measurements**
  - **Physical meaning of controller parameters useful for tuning**



# REPORT DOCUMENTATION PAGE

*Form Approved*  
OMB No. 0704-0188

Public reporting burden for this collection of information is estimated to average 1 hour per response, including the time for reviewing instructions, searching existing data sources, gathering and maintaining the data needed, and completing and reviewing the collection of information. Send comments regarding this burden estimate or any other aspect of this collection of information, including suggestions for reducing this burden, to Washington Headquarters Services, Directorate for Information Operations and Reports, 1215 Jefferson Davis Highway, Suite 1204, Arlington, VA 22202-4302, and to the Office of Management and Budget, Paperwork Reduction Project (0704-0188), Washington, DC 20503.

<b>1. AGENCY USE ONLY (Leave blank)</b>		<b>2. REPORT DATE</b> May 1992	<b>3. REPORT TYPE AND DATES COVERED</b> Conference Publication	
<b>4. TITLE AND SUBTITLE</b> Automation and Robotics for Space-Based Systems - 1991			<b>5. FUNDING NUMBERS</b> WU 595-11-22	
<b>6. AUTHOR(S)</b>  Robert L. Williams II, Editor				
<b>7. PERFORMING ORGANIZATION NAME(S) AND ADDRESS(ES)</b>  NASA Langley Research Center Hampton, VA 23665-5225			<b>8. PERFORMING ORGANIZATION REPORT NUMBER</b>	
<b>9. SPONSORING / MONITORING AGENCY NAME(S) AND ADDRESS(ES)</b>  National Aeronautics and Space Administration Washington, DC 20546-0001			<b>10. SPONSORING / MONITORING AGENCY REPORT NUMBER</b>  NASA CP-10098	
<b>11. SUPPLEMENTARY NOTES</b>				
<b>12a. DISTRIBUTION / AVAILABILITY STATEMENT</b>  Unclassified-Unlimited  Subject Category 63			<b>12b. DISTRIBUTION CODE</b>	
<b>13. ABSTRACT (Maximum 200 words)</b>  A NASA Langley workshop on Automation and Robotics for Space-Based Systems was held on December 10, 1991. This conference proceedings document presents the overhead slides from each speaker at this event. The purpose of this in-house workshop was to assess the state-of-the-art of automation and robotics for space operations from a LaRC perspective and to identify areas of opportunity for future research. The workshop was sponsored by the Guidance, Navigation, and Control Technical Committee, chaired by Mr. Raymond C. Montgomery. Nineteen talks were given, reflecting a high level of interest in the field of automation at NASA Langley. Over half of the presentations came from the Automation Technology Branch, covering telerobotic control, EVA and IVA robotics, hand controllers for teleoperation, sensors, neural networks, and automated structural assembly, all applied to space missions. Other talks covered RMS active damping augmentation, space crane work, modeling, simulation, and control of large, flexible space manipulators, and virtual passive controller designs for space robots.				
<b>14. SUBJECT TERMS</b>  Automation, Robotics, Telerobotics, Teleoperation, Manipulator Control, Flexible Manipulators			<b>15. NUMBER OF PAGES</b> 263	
			<b>16. PRICE CODE</b> A12	
<b>17. SECURITY CLASSIFICATION OF REPORT</b> Unclassified	<b>18. SECURITY CLASSIFICATION OF THIS PAGE</b> Unclassified	<b>19. SECURITY CLASSIFICATION OF ABSTRACT</b> Unclassified	<b>20. LIMITATION OF ABSTRACT</b> Unlimited	

