

NASA Technical Memorandum

107580

JN-15
115659
P.423

Real-Time Simulation Model of the HL-20 Lifting Body

E. Bruce Jackson, Christopher I. Cruz, and W. A. Ragsdale

JULY 1992

(NASA-TM-107580) REAL-TIME
SIMULATION MODEL OF THE HL-20
LIFTING BODY (NASA) 423 p

N92-31160

Unclass

G3/15 0115659

NASA

National Aeronautics and
Space Administration
Langley Research Center
Hampton, Virginia 23665-5225



Real-Time Simulation Model of the HL-20 Lifting Body

TM 107580

E. Bruce Jackson
Christopher I. Cruz
W. A. Ragsdale

NASA Langley Research Center
Hampton, Virginia

Initial Release
(model version 2.0)

July 1992



Table of Contents

Summary	1
Introduction	1
Symbols and Abbreviations	2
Model Description.....	4
Description of Vehicle	4
Axes, units of measure and sign conventions	5
Atmospheric data	5
Model assumptions and limitations.....	5
Aerodynamic model	6
Aircraft geometry and inertial characteristics	6
Reference quantities	6
Pilot eyepoint location (relative to c.g.)	6
Landing gear geometry	6
Inertial data	7
Pilot Interface	8
Pilot hand controller characteristics	8
Cockpit displays	11
Guidance and control system	14
Glossary of Terms	14
Guidance laws	14
Control Laws	15
Controls mixer.....	15
Control surface actuators	16
Verification Data	16
Trimmed flight conditions	16
Autoland trajectory	16
Dynamic Check Case data	18
Remarks about implementation	18
Version numbering.....	19
Equations of motion	19
Landing gear model	19
Validation method.....	20
Electronic distribution of portions of this model	20
Concluding Remarks	21
References	21
Appendices	22
A. Guidance and Control Law glossary	A-1
B. Guidance and Control Law diagrams	B-1
C. Guidance and Control Law listings	C-1
D. Trimmed Flight Condition check case data	D-1
E. Aero Data Base for HL-20 Flight Simulation Studies	E-1
F. Dynamic checks for validation purposes	F-1



Real-Time Simulation Model of the HL-20 Lifting Body

E. Bruce Jackson
Christopher I. Cruz
W. A. Ragsdale

NASA Langley Research Center
Hampton, Virginia

Summary

This report documents the current real-time simulation model of the HL-20 lifting body vehicle, known as version 2.0, presently in use at NASA Langley Research Center. Included are data on vehicle aerodynamics, inertias, geometries, guidance and control laws, and cockpit displays and controllers. In addition, trim case and dynamic check case data are provided.

The intent of this document is to provide the reader with sufficient information to develop and validate an equivalent simulation of the HL-20 for use in real-time or analytical studies.

Introduction

A recent NASA effort to provide an alternative vehicle for manned access to space has resulted in the proposal of a new lifting body vehicle designated the HL-20. Patterned after the HL-10, this lifting-body aircraft is characterized by low aspect ratio, canted winglets, a small rudder, and both reaction and aerodynamic controls. It is intended to be launched vertically and return for a horizontal landing, and will include energy management guidance and control laws patterned after the Space Transportation System Shuttle Orbiter control laws.

A requirement for such a vehicle is the capability to perform the entire return flight, from deorbit burn through reentry to landing, automatically. This will provide increased reliability and allow for safe return of crews that are either pilotless or in which the pilot-qualified crewmembers are incapacitated.

A simulation study utilizing both the Transport Systems Research Vehicle (TSRV) and the Visual Motion Simulator (VMS) simulation cockpits at Langley Research Center (LaRC) has demonstrated the feasibility of both piloted and automatic landing methods. This report documents that simulation model in its most recent production version. This report is intended to provide other NASA Centers and other agencies with a vehicle model and checkcases to assist in building simulations of the HL-20 to be used in further development of the vehicle.

Symbols and Abbreviations

a	Parabolic preflare curvature constant, rad/ft
a_{n_1}	Initial normal acceleration increment in preflare, ft/sec ²
b	Reference wing span, feet
\bar{c}	Mean aerodynamic chord, feet
h_0	Initial center of gravity altitude, feet
h_1	Parabolic slope intercept altitude, feet
h_2	Inner glideslope capture height, feet
h_c	Commanded altitude, feet
h_{cg}	Height of center of gravity above runway, feet
h_p	Parabolic zero-slope altitude, feet
I_{xx}	Moment of inertia about body X-axis, slug-ft ²
I_{yy}	Moment of inertia about body X-axis, slug-ft ²
I_{zz}	Moment of inertia about body X-axis, slug-ft ²
N_z	Acceleration in body Z-axis, ft/sec ²
q_b	Body axis pitch rate, rad/sec
S	Reference area, feet ²
V_1	Initial flare velocity, ft/sec
x_0	Initial center of gravity location in runway coordinates, feet
x_1	Parabolic slope intercept range, feet
x_2	Inner glideslope capture range, feet
x_3	Inner glideslope runway intercept point, feet
x_{ap}	Outer glideslope aimpoint range, feet
x_{cg}	Location of center of gravity in runway coordinates, feet
x_{ep}	X-axis location of pilot's eyepoint in aircraft coordinates, feet
x_p	Parabolic zero-slope range, feet

y_{ep}	Y-axis location of pilot's eyepoint in aircraft coordinates, feet
z_{ep}	Z-axis location of pilot's eyepoint in aircraft coordinates, feet
γ_1	Outer glideslope angle, degrees
$\dot{\gamma}_1$	Initial preflare curvature rate, rad/sec
γ_2	Inner glideslope angle, degrees
CGI	Computer Generated Imagery
DEL	Left wing flap deflection, degrees
DER	Right wing flap deflection, degrees
DLL	Left lower body flap deflection, degrees
DLR	Right lower body flap deflection, degrees
DME	Distance Measuring Equipment
DR	Vertical tail deflection, degrees
DUL	Left upper body flap deflection, degrees
DUR	Right upper body flap deflection, degrees
DCPILOT	Manual pitch control signal, units
DWPILOT	Manual roll control signal, units
EADI	Electronic Attitude Display Indicator
FORTTRAN	FORmula TRANslator, a computer programming language
HAC	Heading Alignment Cylinder
HUD	Heads-Up Display
HSI	Horizontal Situation Indicator
NZQ	Pitch control law using acceleration and pitch rate feedback
PLS	Personnel Launch System
RWD	Right wing down
SAS	Stability Augmentation System
TACAN	TACTical Air Navigation

TSRV	Transport Systems Research Vehicle
TED	Trailing Edge Down
TEL	Trailing Edge Left
TEU	Trailing Edge Up
VMS	Visual Motion Simulator

Model Description

Description of Vehicle

The HL-20 vehicle has been designed as a component of the proposed Personnel Launch System (PLS) (see figure 1). This vehicle would be launched into orbit by a booster rocket or carried within the payload bay of the Space Transportation System (Space Shuttle) orbiter. The vehicle would then deorbit, using an on-board propulsion system, and perform a gliding reentry and horizontal unpowered landing.

The HL-20 lifting body has been designed to carry up to ten people and/or small amounts of cargo. New construction techniques will facilitate maintenance of the vehicle and permit rapid turnaround between landing and launching [1].

A lifting-body concept was chosen for the PLS role to provide sufficient cross-range capability to allow a higher number of landing opportunities, while keeping aerodynamic heating and deceleration during reentry at acceptable levels [2].

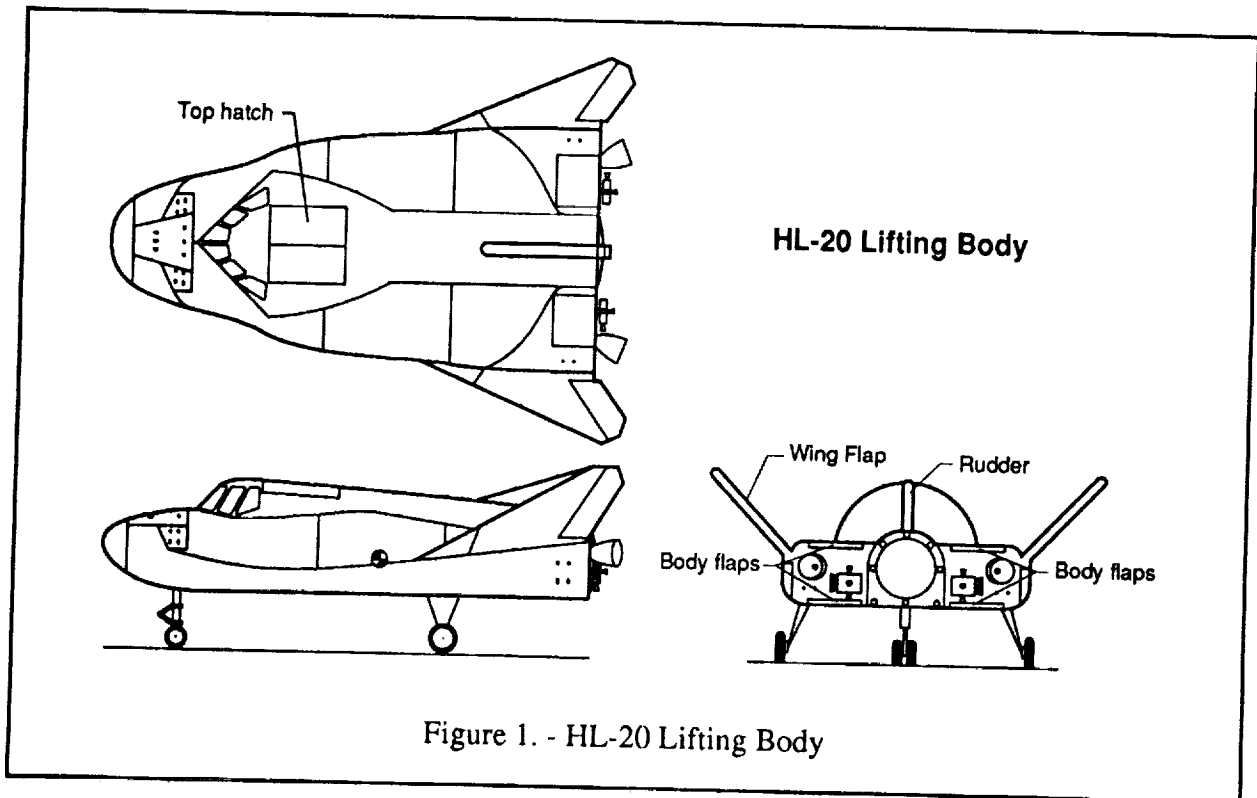

Axes, units of measure and sign conventions

This simulation model uses conventional measurement axes and sign conventions, as defined in [3]. Units of measure are English customary, e.g. pound-foot-second, units. The diagram below (figure 2) illustrates the sign convention for the aerodynamic actuators.

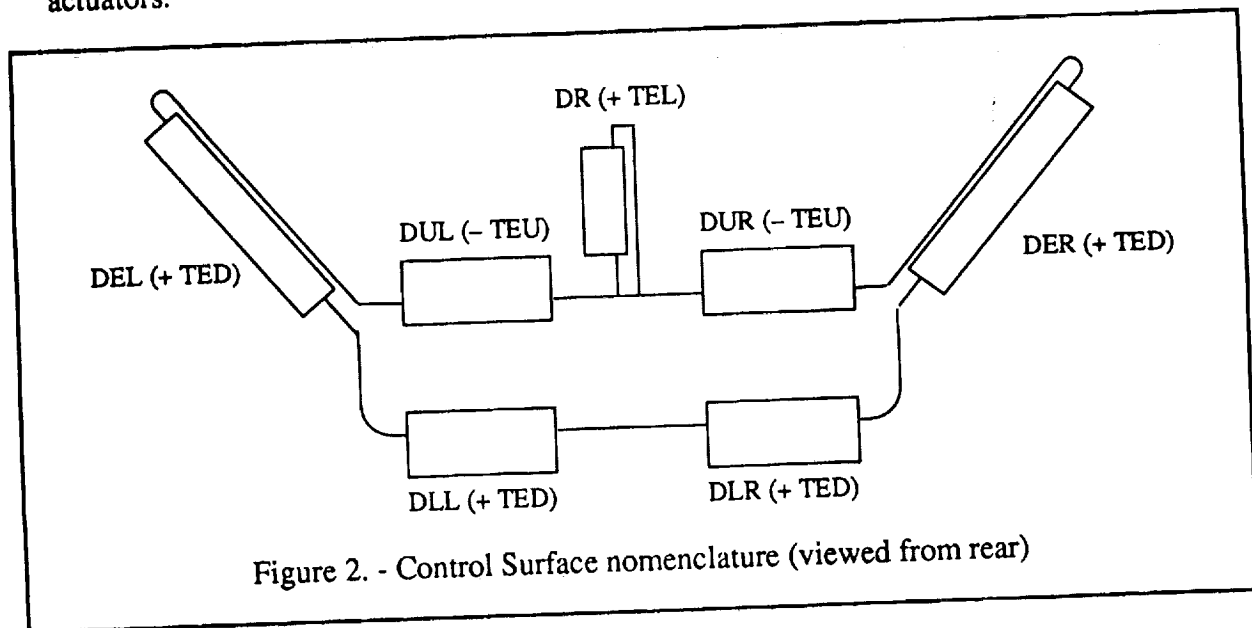

Figure 2. - Control Surface nomenclature (viewed from rear)

Atmospheric data

No atmosphere model is provided in this document; however, the Langley simulation utilized the 1962 U.S. Standard Atmosphere model for all analysis to date and for the trimmed flight condition sets and the dynamic check case data.

Model assumptions and limitations

The configuration to be studied is described as the baseline configuration in [4], with the smaller all-moving rudder.

The aerodynamic envelope will be limited to less than 105,000 feet and Mach numbers between 0 and 4.0. No reaction control system model is provided.

Assumptions include vehicle X-Z plane symmetry and rigid body dynamics. No hinge moment limits are modeled for the actuators. The actuators have yet to be specified so the actuator model included herein is provided for validation purposes only. Perfect navigation sensors are assumed.

All landings in the TSRV and VMS have been flown to a runway similar to Denver-Stapleton runway 26L, which is 10,004 by 150 ft, with at 1,000 ft approach end overrun and a 600 ft overrun on the departure end. For this study, however, the runway has been conveniently placed at sea level, so that cockpit altimeter indications are both height above ground level and height above sea level.

Aside from scaled Shuttle landing gear aerodynamic effects, no landing gear model is provided since the design of this subsystem is very preliminary. This report provides some basic landing gear geometry in case a facility desires to develop an interim gear model.

Aerodynamic model

Appendix E contains the current aerodynamic data in use at Langley Research Center for the HL-20 simulation and analytical models. This is referred to as "version 2.0" of the aerodynamics. (Version 1 was a preliminary model used for some initial control development and flying qualities studies. [5]) Version 2.0 includes data from Mach 0 to 4, angle of attack between -2 and $+16$ degrees (sometimes higher), and sideslip between ± 5 degrees. Actuator position limits are as follows:

± 30 degrees (rudder & wing flaps)

+ 60 degrees (lower body flaps)

- 60 degrees (upper body flaps)

The data are presented in both tabular and graphical format. The tables are usually parameters for a polynomial equation in angle of attack, based upon Mach number and deflection angle.

The aerodynamic coefficients provided in the model are measured at a moment reference center located at 54 % of body length, along the X-axis, where 0 % corresponds to the nose of the vehicle.

Refer to Appendix E for more information on the aerodynamics model.

Aircraft geometry and inertial characteristics

Reference quantities

The current HL-20 aerodynamic reference quantities are given below:

chord,	\bar{c}	28.24 ft
area,	S	286.45 ft ²
span,	b	13.89 ft

Pilot eyepoint location (relative to c.g.)

x_{ep}	7.87 ft
y_{ep}	-1.35 ft
z_{ep}	-3.42 ft

Landing gear geometry

A sketch of the HL-20, giving the location of the landing gear in body coordinates, is given in Figure 3. This can serve as a basis for interim site-specific landing gear models until a more formal landing gear dynamics model is developed.

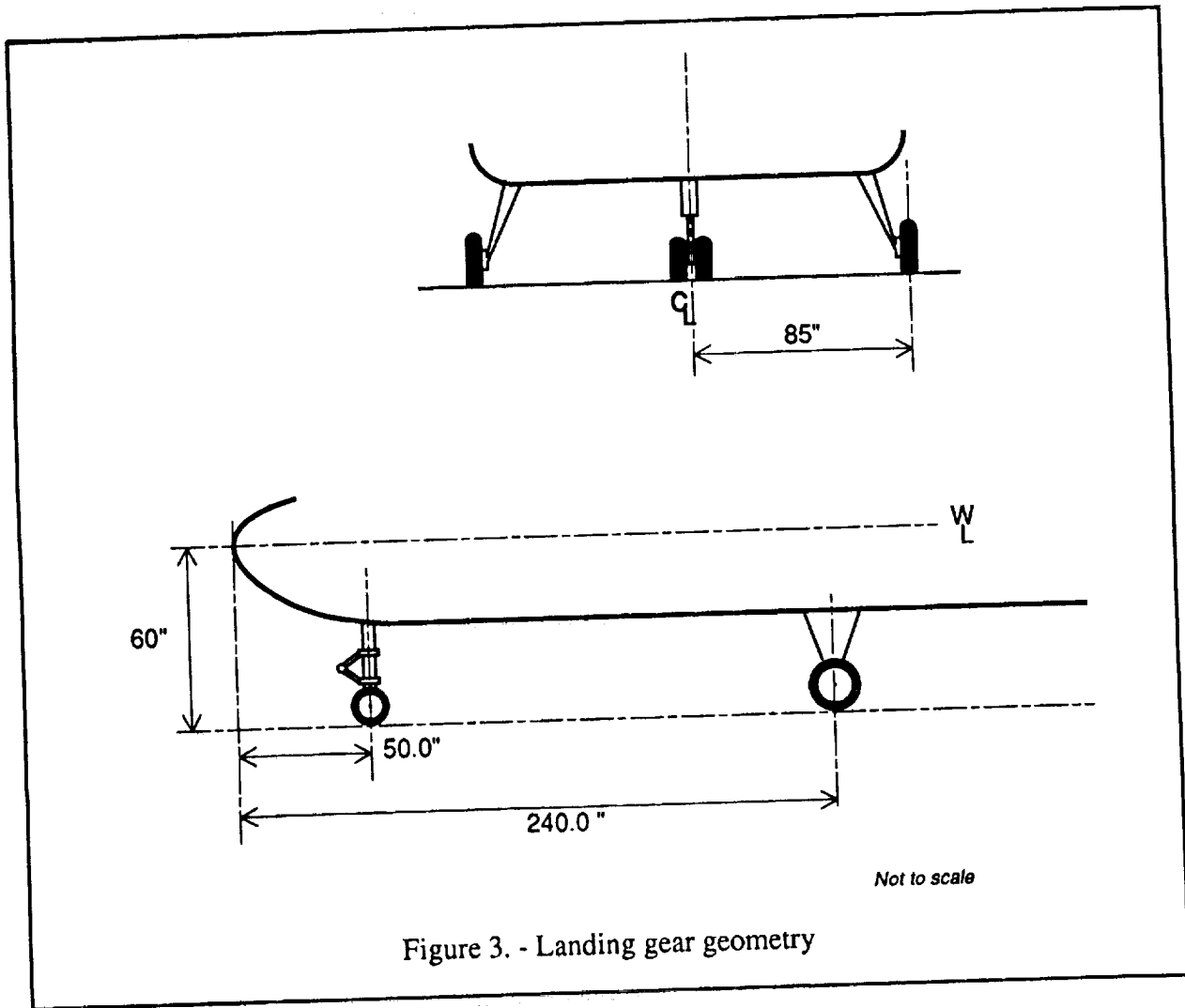

Figure 3. - Landing gear geometry

Inertial data

Current HL-20 landing weights and inertias are listed below:

Weight	19,100 lbs
x_{cg}	55.5 %
I_{xx}	7,512 slug-ft ²
I_{yy}	33,594 slug-ft ²
I_{zz}	35,644 slug-ft ²

Pilot Interface

Pilot hand controller characteristics

The HL-20 simulation at Langley Research Center utilized a left-handed side stick with a McFadden hydraulic control loader in both the fixed-base and motion-base simulators. Rudder pedals are rarely used in the simulation, and have not been optimized; the current rudder pedal dynamic characteristics are not quantified here. The speedbrake control lever is a simple spring-loaded lever that will automatically close (retract) the speedbrake handle if released by the pilot. The speedbrake handle is located on the right side of the pilot.

Design settings for the McFadden control loader are given below:

<u>Parameter</u>	<u>Pitch</u>	<u>Roll</u>
Breakout	± 1 lb	± 1 lb
Displacement	18° fwd 20° aft	± 20°
Max Force	12 lb fwd 13 lb aft	± 6.5 lb
Velocity Limit	35 in/sec	35 in/sec

The length of the side stick is 7.5 inches (pivot point to top of grip).

The measured control stick characteristics are given below.

Pitch axis: Figure 4 below gives the force/displacement curve for the VMS hand controller in the pitch axis. Figure 5 gives the calibration of displacement in inches to pitch control signal DCPILOT.

By time history measurement, the pitch axis hand controller frequency and damping are 23 rad/sec and 0.85, respectively.

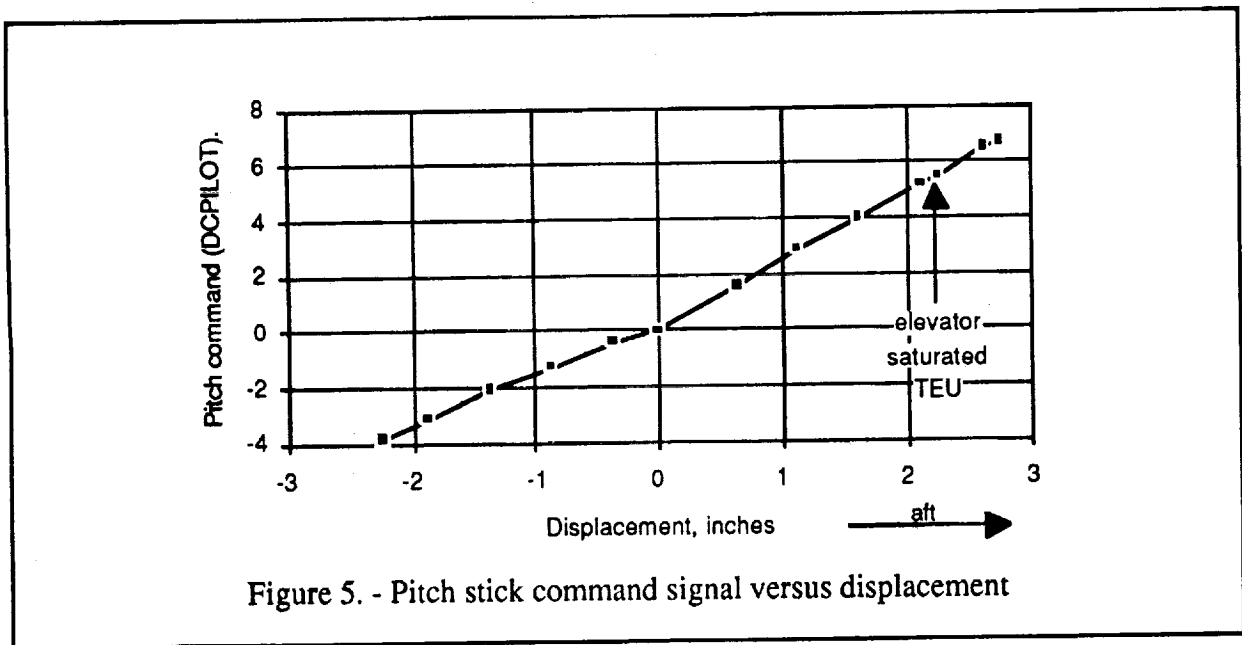
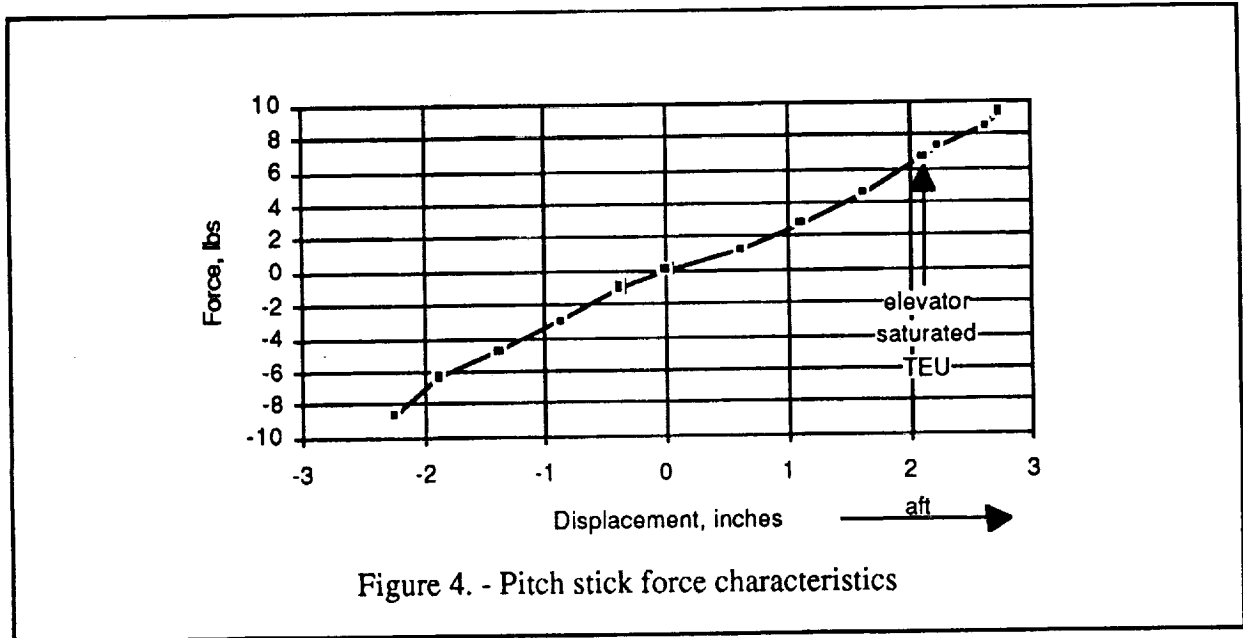

Roll axis: Figure 6 below gives the force/displacement curve for the VMS hand controller in the roll axis. Figure 7 gives the calibration of displacement in inches to roll control signal DWPILOT.

By time history measurement, the roll axis hand controller frequency and damping are 16 rad/sec and 1.4, respectively.

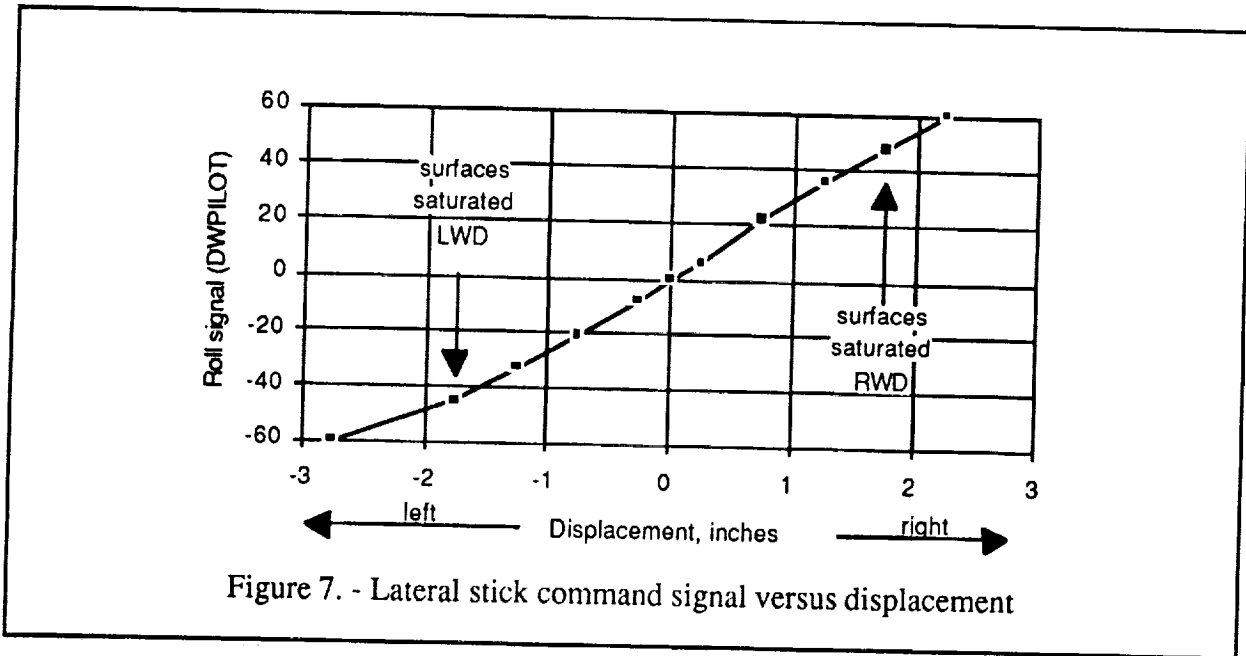
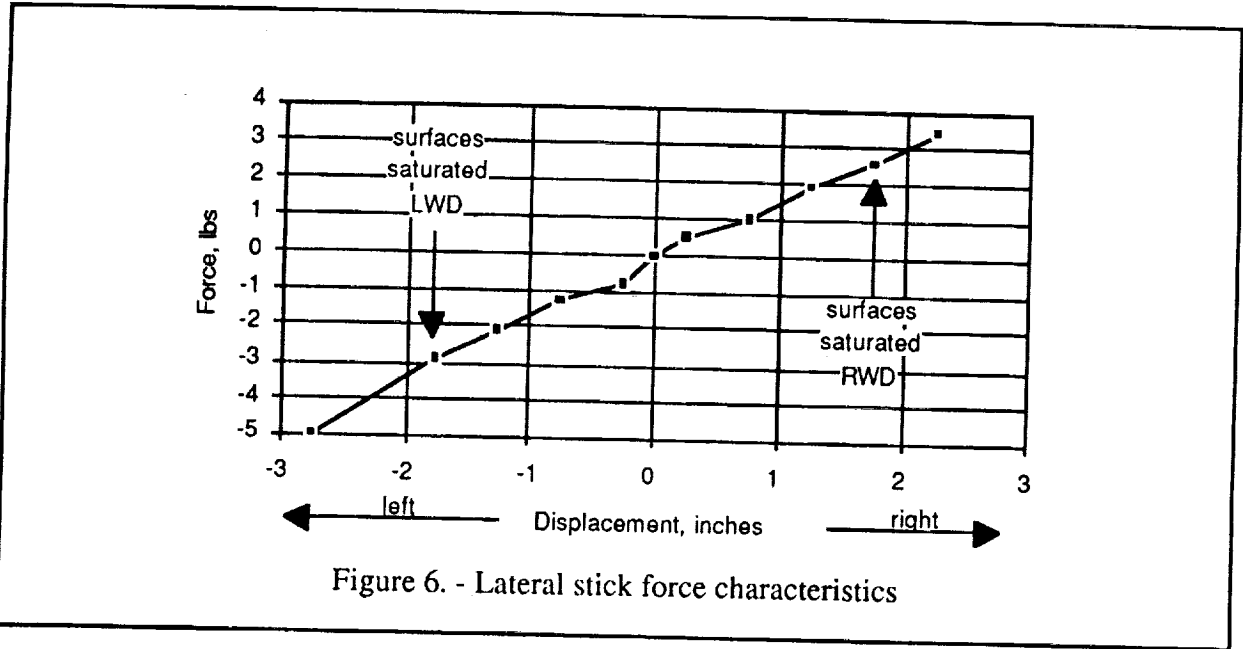

Cockpit displays

Heads Up Display. The heads up display (HUD) symbology, depicted below in figure 8, is mixed electronically with the out-the-window visual scene and presented to the pilot in the forward field of view. This is equivalent to the projection of an actual heads-up display in the cockpit.

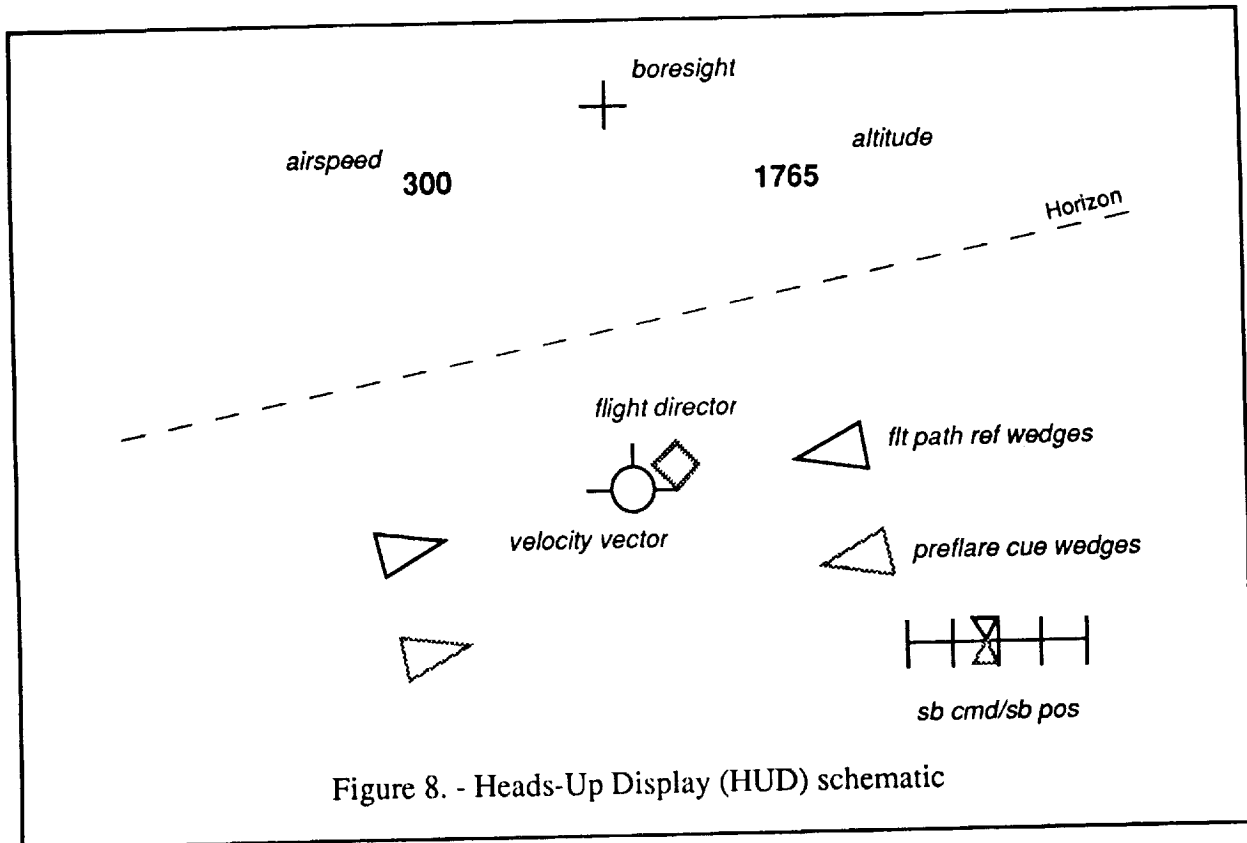

Figure 8. - Heads-Up Display (HUD) schematic

Key symbology includes airspeed (knots equivalent) on the left, altitude in feet on the right, a boresight symbol (+), a velocity vector symbol (\ominus), all shown in white, and a red (for commanded) flight director symbol (\diamond). When situated on final approach, a pair of white flight path reference wedges appear at -17° below the horizon. When approaching the preflare point, a pair of red preflare reference wedges move up from the bottom of the HUD. The reference wedges merge with and obscure the flight path reference wedges at the beginning of preflare. The reference wedges then trace the nominal preflare flight path angle until the inner glideslope is reached, at which point all reference markers are removed, leaving altitude, airspeed, and velocity vector for the final flare maneuver.

In addition to those symbols, a speedbrake bar is shown in the lower right hand corner of the HUD, with two triangle markers. The upper marker, colored red, shows the autospeed logic commanded speedbrake position (in percent) and the lower marker, colored white, shows the current speedbrake position command from either the autospeed logic or the manual speedbrake handle in the cockpit. The left side of the bar corresponds to retracted speedbrake, and the right side of the bar corresponds to fully extended speedbrakes.

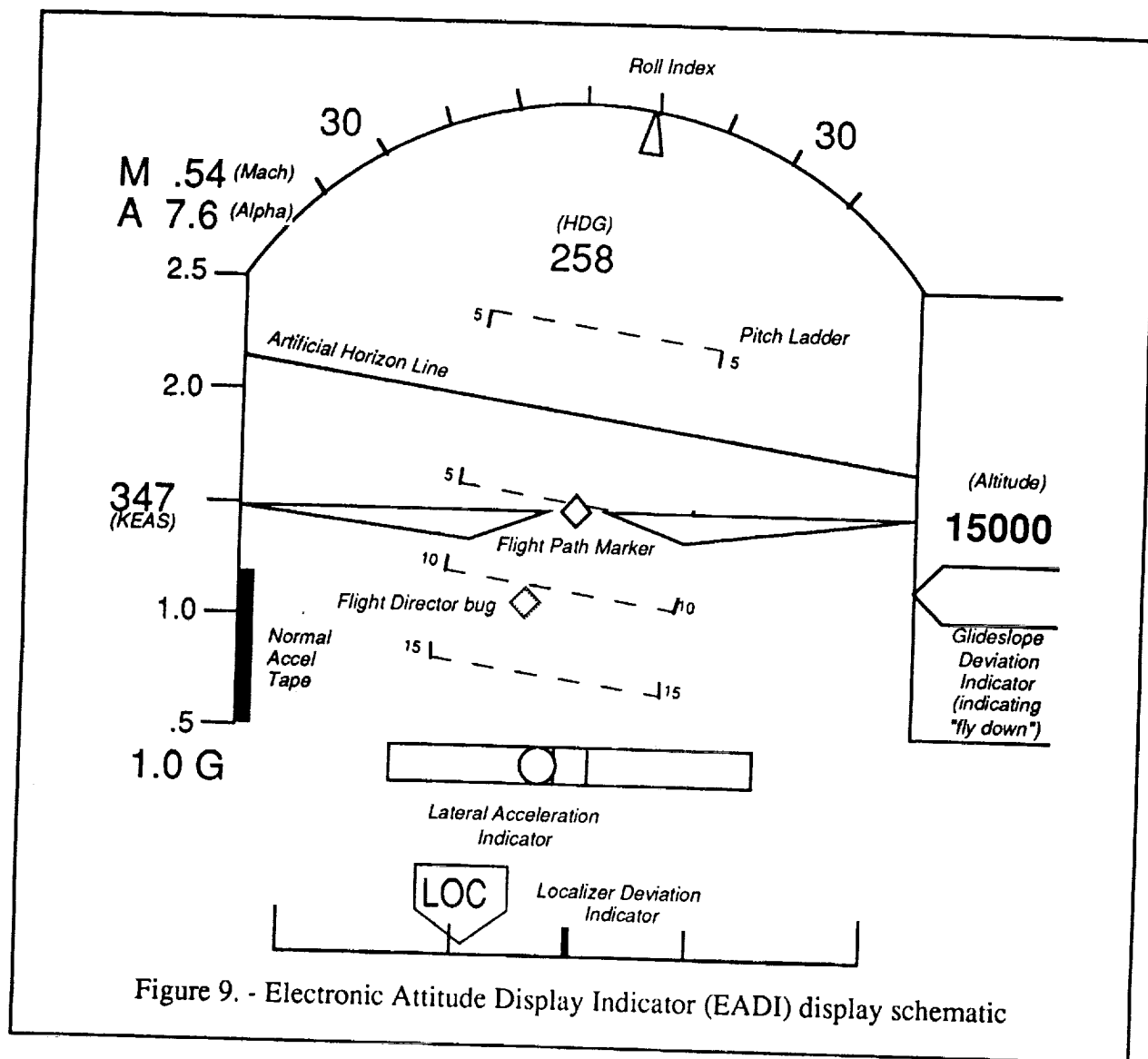

Figure 9. - Electronic Attitude Display Indicator (EADI) display schematic

Electronic Attitude Display. The primary heads-down display is the electronic attitude display indicator (EADI) (figure 9). This display duplicates much of the information given in the HUD, including airspeed, altitude, and pitch/roll attitude and steering information. In addition, a digital readout of angle of attack, Mach, and normal acceleration (g) is given, as well as a normal acceleration tape on the left side of the display and a sink rate tape and ground proximity warning bar on the right side of the display. Glideslope and localizer indicators are also incorporated in the EADI. A runway is depicted in perspective as well to aid in instrument approaches.

Horizontal Situation Display. A conventional horizontal situation display (HSD) is also provided in the cockpit for runway orientation and includes a winds indicator, distance to the runway (DME), and redundant glideslope and localizer information. Figure 10 depicts this display for a typical flight condition.

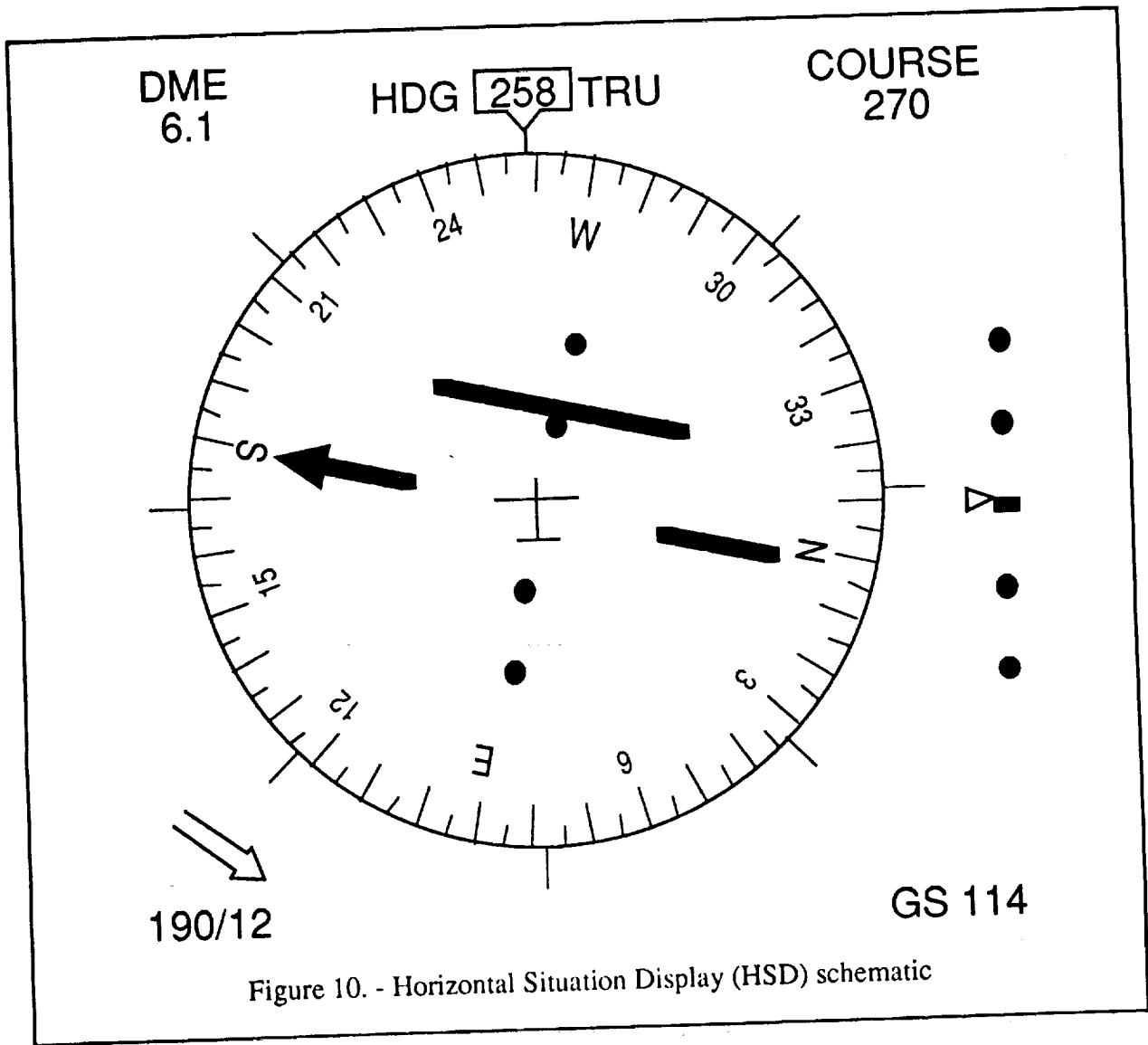
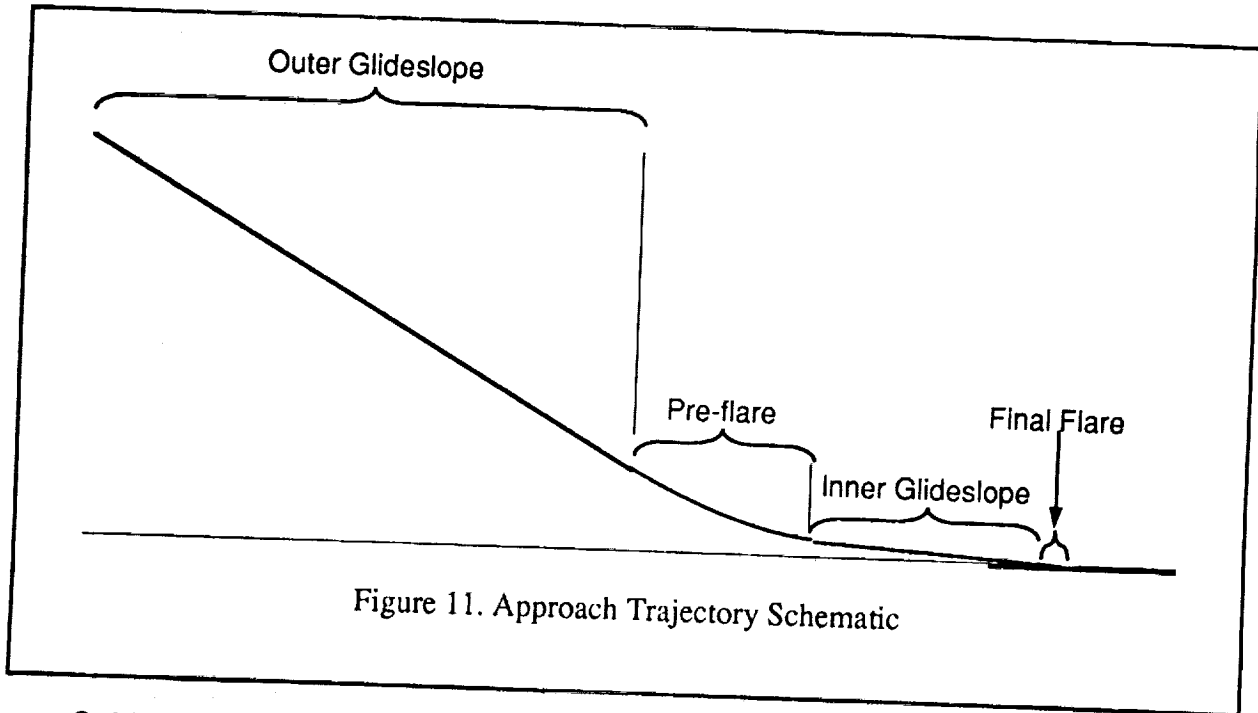

Figure 10. - Horizontal Situation Display (HSD) schematic

Guidance and control system

Glossary of Terms

A comprehensive list of FORTRAN variable names used in the guidance and control law listings and diagrams is given in Appendix A.



Guidance laws

The VMS/PLS guidance laws provide for automatic steering and flight director commands to guide the vehicle from Mach 4 to landing. All guidance modes generate flight path angle and bank angle commands. Two guidance laws are selectable, one based on TACAN, and the other using a Heading Alignment Cylinder.

The TACAN guidance law uses relative bearing inputs to direct the vehicle to fly over the landing site, then a downwind teardrop pattern to line up with the runway on the glideslope. An angle of attack versus Mach number profile is flown until on final approach. Energy is controlled by varying the turn commands depending on altitude and DME.

A more complex Heading Alignment Cylinder (HAC) algorithm resembles the approach geometry used in the Space Shuttle. Energy is managed by comparing altitude with distance to go to touchdown, flying tangent to the HAC, around it, and then to the runway.

Final approach guidance includes a steep outer glideslope, a parabolic pullup maneuver, and a shallow inner glideslope (figure 11). Touchdown sink rate is controlled by limiting the sink rate as a function of altitude. More information about the final approach trajectory is given in Appendix B.

A set of block diagrams of the current PLS guidance and control laws are shown in Appendix B. A complete CYBER FORTRAN listing of the current VMS guidance and control laws is given in Appendix C.

Control Laws

The control laws detailed in this report include control laws for both the subsonic and supersonic flight regimes. The subsonic control laws have been optimized with pilot opinion studies and are fairly well defined. The supersonic control laws, however, are very preliminary and are provided for checkcase comparisons and initial piloted investigations.

Pitch control law. The NZQ pitch control law in the VMS/PLS simulation provides good handling qualities through the flight envelope from supersonic speeds to landing. Commands from the pilot's stick (or automatic guidance) are summed with a filtered combination of vertical acceleration, N_z , and pitch rate, q_b , to generate an elevator deflection. This provides a pitch rate response that holds N_z to maintain a nearly constant flight path angle when the command is nulled. Turns are automatically coordinated, and trim is maintained via a lagged elevator position feedback. Gains vary with dynamic pressure and Mach number to provide the same response to commands throughout the flight regime.

Roll/Yaw control law. The roll/yaw channels are simple rate feedback control systems. Both roll and yaw rates are fed back into the appropriate signal for artificial stabilization, and drive aileron and rudder commands, respectively. The yaw rate feedback signal is passed through a two second washout filter to allow for steady state turns.

Speed control law. The speed control law operates on an error in equivalent airspeed. If equivalent airspeed increases or decreases from the desired outer glideslope trim value (presently 300 knots) a value proportional to the speed error is added or subtracted to the nominal (trimmed) speedbrake command. A one second lag filter is applied to the resulting command to reduce control activity to wind gusts.

Controls mixer

Incorporated in the control laws described above is mixing logic that performs several functions. The primary function of the mixer is to mix speedbrake and roll (aileron) commands into four separate body flap actuator commands.

Subsonic roll mechanization uses diagonally opposite body flaps to provide an aerodynamic rolling moment (e.g. upper left and lower right for a left roll).

Supersonic aerodynamic roll control is provided by using upper and lower body flaps to act as yaw generators (e.g. upper and lower left body flaps will cause left yaw). The resulting sideslip generates a rolling moment in the direction of the yaw, due to the dihedral effect of the lifting body shape (left roll in this case).

Speed control is achieved through simultaneous deployment of all four surfaces, with a bias between upper and lower deflections to reduce pitch coupling.

To ensure controllability, the mixer ensures that the use of body flaps for roll function has priority over speedbrake function. This is mechanized by reducing the speed brake authority by an amount equal to the absolute value of the aileron command.

Pitch control is performed by deflection of the wing flaps, with assistance for large nose up pitching moment provided by upper body flaps.

At supersonic speeds, the mixer provides artificial stabilization by feeding sideslip and sideslip rate back to the lower body flaps.

The rudder command is fed directly to the rudder actuator.

Control surface actuators

The baseline simulation of the HL-20/PLS uses the same actuator model for all seven control surfaces. The present actuator model is a first-order lag with a 20 rad/sec bandwidth (0.05 time constant) and a 20-degree-per-second rate limit.

Verification Data

Trimmed flight conditions

Appendix D lists three realistic quasi-trimmed flight conditions for validation purposes. Since the vehicle is descending at approximately constant equivalent airspeed, these conditions do not represent inertially unaccelerated flight, due to atmospheric density gradients. Instead, the vehicle experiences an almost constant deceleration. The "trimmed" flight conditions given in Appendix D are more appropriately termed "equivalent trim" points, or "constant dynamic pressure trim" points. The procedure used to generate these points was to specify angle of attack, Mach number and flight path angle, and to vary altitude and control surface positions until a normal acceleration of 1 g was achieved.

Autoland trajectory

A representative HL-20 approach trajectory, commencing at Mach 4 and 105,000 feet, was simulated using the autoland control laws and heading alignment cylinder guidance laws presented earlier in this report. Figure 12 shows the cross range, altitude, Mach number and indicated airspeed plotted against downrange distance for this simulated approach trajectory.

Since the landing gear is normally deployed at 200 feet, this trajectory is performed almost entirely gear up.

Mach 4 trajectory to landing

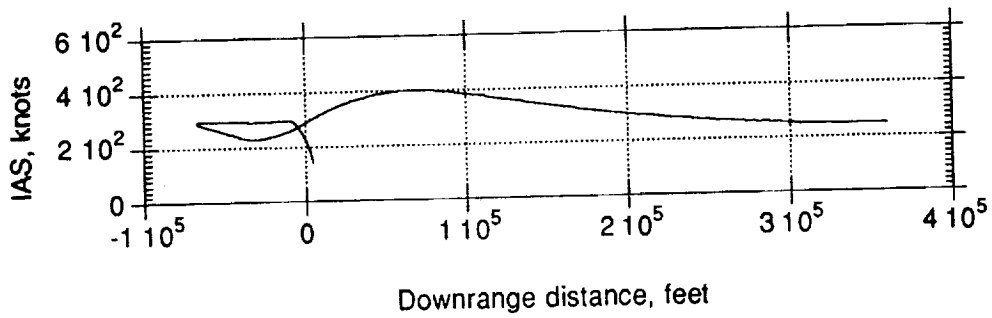
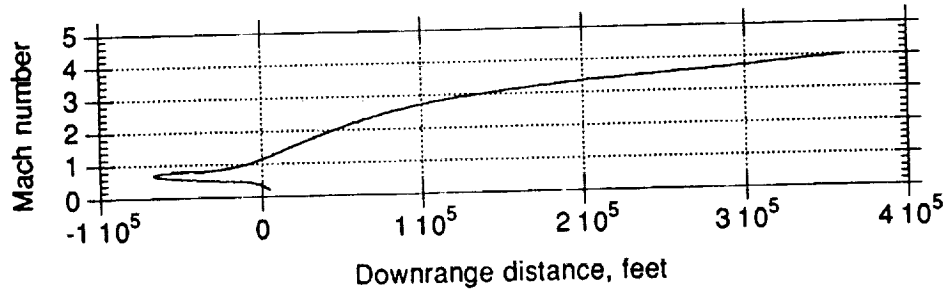
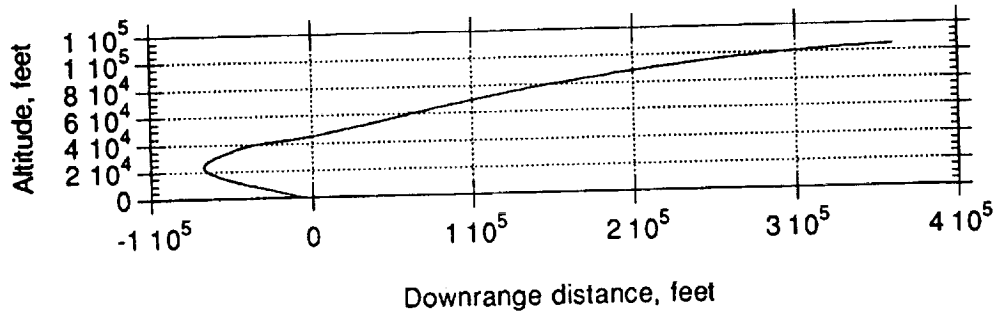
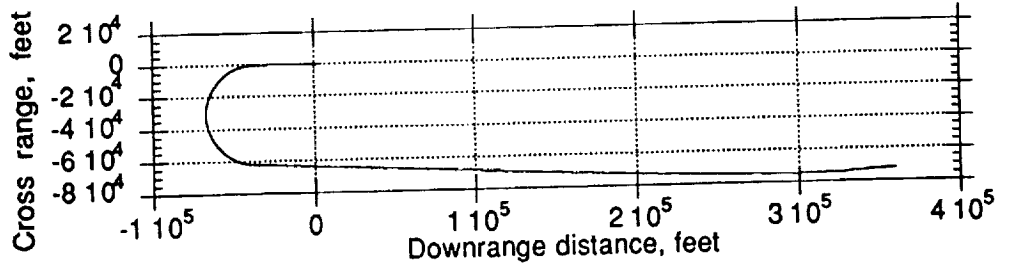

Figure 12. - Mach 4 autoland trajectory (HAC guidance)

Dynamic Check Case data

Appendix F contains time history plots that show vehicle responses to separate control input pulses in the four pilot controls (pitch stick, roll stick, rudder pedals, and speedbrake handle) in three different flight conditions (Mach 0.8, 2.0, and 4.0). These pulses, of varying duration, are input after the simulation has run for one second from the initial conditions (given in Appendix D). The magnitude and duration of the pulses are as follows:

Control Input	Mag.	Sense	Duration seconds	Run Length seconds
Pitch Stick	1.0	AFT†	1	10
Roll Stick	20.0	RIGHT	1	10
Yaw (Pedal)	0.2	RIGHT	1	10
Speed brake	100%	EXTEND	3	20

†For the Mach 2 initial condition, the pitch stick input is forward, since the pitch control surfaces are nearly saturated in this flight condition.

For these tests, the vehicle was configured as described in this report with autospeed engaged (except for the speedbrake pulses), with the manual flight control mode (stability augmented system, or SAS) engaged and landing gear retracted.

Remarks about implementation

The HL-20/PLS simulation at NASA Langley is presently implemented on a Control Data Corporation CYBER Model 175 at a major frame size of 32 milliseconds. The model is written in FORTRAN 5.

An Evans and Sutherland CT-6 provides an out-the-window computer generated image (CGI) to three mirror-beam-splitter XKD monitors at an update rate of 50 Hz (interlaced) with a line rate of 771. These monitors provide two forward out-the-window displays and a left- or right-side out-the-window display. The forward scene is approximately 54.5° (vertical) by 40.5° (horizontal). The side is 48.5° (vertical) by 35.5° (horizontal).

A Terabit Eagle 1000 symbology generator is used to provide cockpit graphics, and its output is mixed with the forward CGI visual scene through a Terabit R-mix unit. The cockpit heads down displays are XYtron calligraphic color monitors.

The measured average visual scene latency (from a stick pulse) is 170 ± 35 ms, (including full vehicle model computational load, but not including modeled aircraft dynamics).

The motion platform is a synergistic six degree of freedom Singer-Link motion platform with dual actuators in each leg. The measured average motion response latency (from a stick pulse to motion onset) is 82 ± 30 ms. The table below gives the design performance of the motion platform:

Degree of Freedom	Position		Velocity	Acceleration
Horizontal	Forward	4.1 ft	± 2 ft/sec	± 0.6 g
	Aft	4.0 ft		
Lateral	Left	4.0 ft	± 2 ft/sec	± 0.6 g
	Right	4.0 ft		
Vertical	Up	3.25 ft	± 2 ft/sec	± 0.6 g
	Down	2.50 ft		
Yaw	$\pm 32^\circ$		$\pm 15^\circ/\text{sec}$	$\pm 50^\circ/\text{sec}^2$
Pitch	$+30^\circ$		$\pm 15^\circ/\text{sec}$	$\pm 50^\circ/\text{sec}^2$
Roll	$\pm 22^\circ$		$\pm 15^\circ/\text{sec}$	$\pm 50^\circ/\text{sec}^2$

The cockpit is a generic transport-category cockpit with two side-by-side pilot stations and an observer jump seat. The left seat includes a left hand McFadden side stick controller and was used for the majority of work in the HL-20/PLS simulation. The right seat has a conventional center stick with an F-14 stick grip, controlled by a separate McFadden hydraulic control system. Both seats have hydraulic rudder pedals that are interconnected. The left seat pilot uses a speedbrake lever on his right side; the right seat pilot uses a flap lever on his left side to control speedbrakes. The left seat pilot's speedbrake lever has a return (to retracted position) spring; the right seat pilot's flap handle does not have a return spring.

Version numbering

Each subsequent update to the HL-20 simulation model will be identified by a unique version number. This initial release outside of Langley is version 2.0.

Equations of motion

The equations used in this simulation are six-degree-of-freedom equations of motion which describe the accelerations along and about the body system of axes. The equations include provisions for the effects of a rotating round Earth (reference 1); however, for the range of airspeeds involved in this study, flat, non-rotating earth is assumed.

Landing gear model

No landing gear dynamics are provided with this model. The present landing gear design is not complete enough to use to predict any landing dynamics. It is recommended that each site modify an existing landing gear model from a similar vehicle and use that model to support landing rollouts in the interim. Landing gear geometry was given in figure 3.

Validation method.

It is recommended that the HL-20 simulation at each site be validated against data provided in this report using the following techniques:

1. Function table data comparison. The real-time simulation code should be used to generate plots of the stored function table values as a function of Mach, angles of attack and sideslip and control surface deflections. These plots should be compared to plots of the aerodynamic data, included in Appendix E, to ensure no errors occurred in implementation of the aerodynamic model.
2. Equivalent Trim check cases. - The static check cases provided in Appendix D list trimmed airspeed, altitude, glide angle, vehicle attitudes and control surface deflections. The HL-20 simulation, when initialized to these values, should result in accelerations (UDOT, VDOT, WDOT, and QDOT) close to those listed in Appendix D.
3. Dynamic check cases. - Following successful equivalent trim validation, the simulation should be tested to see if dynamic responses match the dynamic check cases included in Appendix F. These maneuvers consist of step inputs of specified amplitude and duration applied to a single pilot control, with the vehicle initially in an trimmed condition.
4. Qualitative evaluation. The real-time simulation of the HL-20 should be subjected to a short qualitative evaluation program by the Langley project pilot. The purpose of this evaluation would be to detect obvious modeling or implementation errors.

Electronic distribution of portions of this model

Portions of this model are available electronically via anonymous file transfer protocol (FTP) on the Internet, at host `grissom.larc.nasa.gov`, directory `pub/hl-20/`. These files are described below:

- | | |
|-----------------------------------|--|
| (a) <code>README.TXT</code> | read for the latest information concerning the model. |
| (b) <code>doc.wrd4.hqx</code> | Stuffed, BinHexed (for Macintosh) version of this document (in Microsoft Word 4 format) |
| (c) <code>plsdict.txt</code> | Symbol table dictionary (duplicated in appendix A below) |
| (d) <code>plsgnc.txt</code> | Guidance and control system FORTRAN model (written in CYBER FORTRAN-V) |
| (e) <code>pls_aerov2.txt</code> | Aero tables for version 2.0 in original text table format |
| (f) <code>aero_v20_pts.ftp</code> | Aero data in NASA-Ames Function Table Processor format for version 2.0 |
| (g) <code>getData.txt</code> | getData format description |
| (h) <code>ccXXXN.asc2</code> | Dynamic checkcase data in getData asc2 format, where XXX is pit, rol, yaw, spd to indicate |

- | | |
|------------------|--|
| | control being pulsed, and N is 0, 2, or 4 to indicate subsonic, Mach 2, and Mach 4 initial conditions, respectively (total of 12 files). |
| (i) cctrimN.txt | Check case trim "shots" for subsonic, Mach 2 and Mach 4 initial conditions, respectively (total of 3 files) |
| (j) cctraj4.asc2 | Autoland approach time history in getData asc2 format, commencing at Mach 4 |

These files will be updated as modifications are made to the HL-20 simulation at Langley. Comments may be directed to bjax@grissom.larc.nasa.gov, using conventional SMTP mail systems.

Concluding Remarks

This report documents the present aerodynamics, inertia, guidance laws, control laws, pilot controls and displays, and physical geometry models used at NASA Langley Research Center to study the dynamic characteristics and flying qualities of the HL-20 vehicle concept and to perform trade-off studies for candidate design changes. Included in this report are sufficient data to validate the proper implementation of these models at other simulation facilities.

Details on electronic distribution of these data, via the Internet, are included.

This report is provided to support additional explorations via simulation of the flight characteristics of the HL-20 vehicle. It is intended to be updated as additional information about the HL-20 configuration is obtained.

References

- [1] Ehrlich, Carl F., Jr. et al: *Personnel Launch System (PLS) Study Final Report (DRD 12)*. NASA Contractor Report 187620, 1991.
- [2] Naftel, J. Chris; Powell, Richard W.; and Talay, Theodore A.: *Ascent, Abort, and Entry Capability Assessment of a Space Station Rescue and Personnel/Logistics Vehicle*. AIAA Paper 89-0635, January 1989.
- [3] McFarland, Richard E.: *A Standard Kinematic Model for Flight Simulation at NASA-Ames*. NASA CR 2497, 1975.
- [4] Cruz, Christopher I.; Ware, George M.; Grafton, Sue B.; Woods, William C.; Young, James C.: *Aerodynamic Characteristics of a Proposed Personnel Launch System (PLS) Lifting-Body Configuration at Mach Numbers From 0.05 to 20.3*. NASA TM 101641, 1991.
- [5] Jackson, E. Bruce; and Cruz, Christopher I.: *Preliminary Subsonic Aerodynamic Model for Simulation Studies of the HL-20 Lifting Body*. NASA TM-4302, 1992.

Appendices

- A. Guidance and Control Law glossary
- B. Guidance and Control Law diagrams
- C. Guidance and Control Law listings
- D. Trimmed Flight Condition check case data
- E. Aero Data Base for HL-20 Flight Simulation Studies
- F. Dynamic checks for validation purposes

Appendix A
Guidance and Control Law glossary

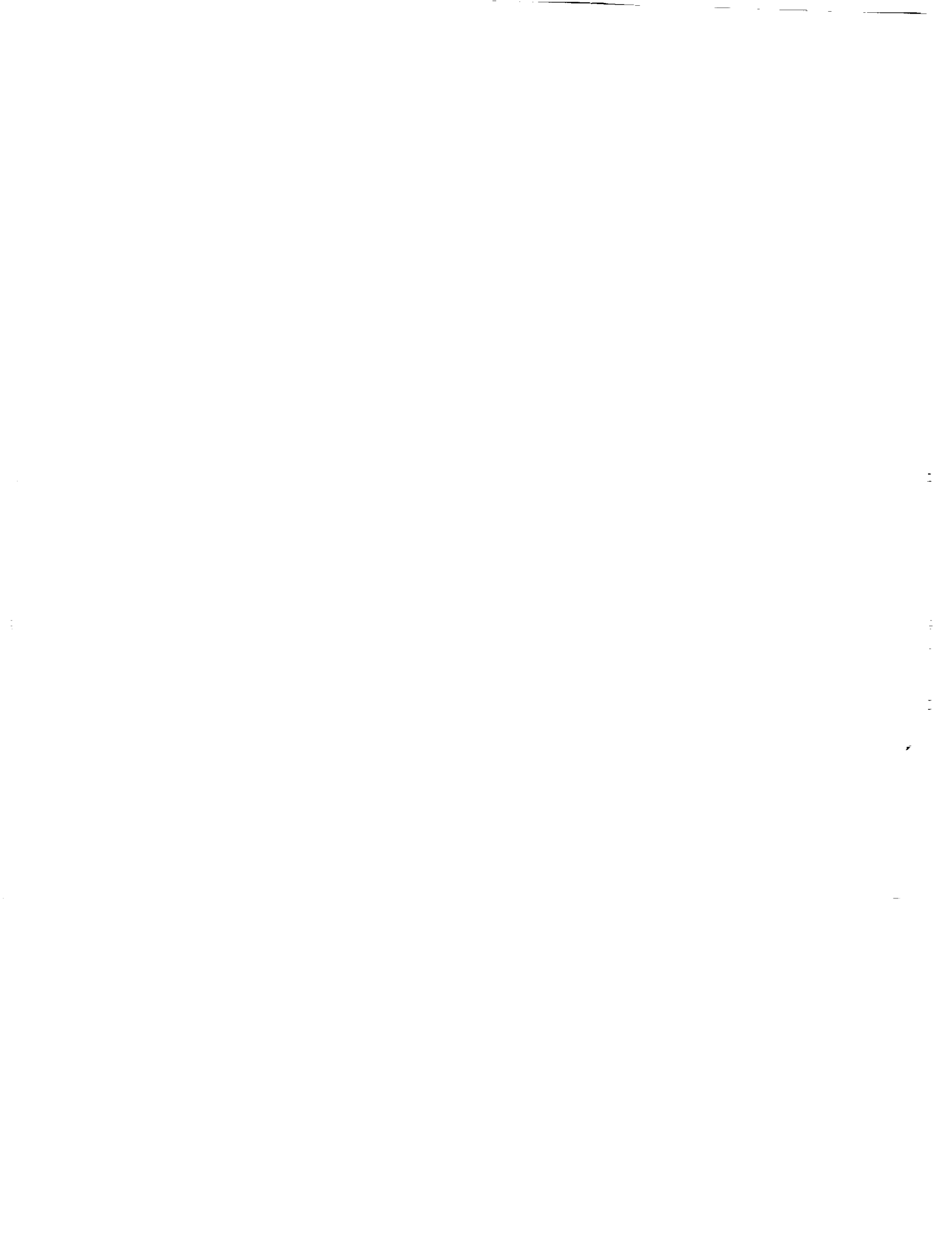

* V M S / P L S G N & C S Y M B O L D I C T I O N A R Y 920323

* NOTES

* POSITION, VELOCITY, AND ATTITUDE (EULER ANGLES) ARE BASED ON
 * THE EARTH REFERENCE FRAME, ORIGIN AT THE RUNWAY THRESHOLD
 * X-TRUE NORTH, Y-TRUE EAST, Z-DOWN

* THE BODY REFERENCE FRAME ORIGIN IS AT THE CENTER OF MASS,
 * X-FORWARD, Y-RIGHT, Z-FLOOR OF AIRCRAFT (DOWN)

* THE RUNWAY HEADING IS TRUE NORTH, SO THE RUNWAY FRAME IS THE
 * SAME AS THE EARTH REFERENCE FRAME IN THIS SIMULATION

* ABBREVIATIONS

* AKA - ALSO KNOWN AS
 * DEG - DEGREES
 * DPS - DEGREES PER SECOND
 * FPS - FEET PER SECOND
 * FT - FEET
 * HAC - HEADING ALIGNMENT CIRCLE
 * IN - INCHES
 * LB - POUNDS
 * MAX - MAXIMUM
 * MIN - MINIMUM
 * NEG - NEGATIVE
 * NMI - NAUTICAL MILES
 * NOM - NOMINAL (USUAL OR EXPECTED VALUE)
 * POS - POSITIVE
 * PSF - POUNDS PER SQUARE FOOT
 * RAD - RADIANS
 * RPS - RADIANS PER SECOND
 * TED - TRAILING EDGE DOWN
 * TEL - TRAILING EDGE LEFT
 * TER - TRAILING EDGE RIGHT
 * TEU - TRAILING EDGE UP

* (T/F) MEANS THE VARIABLE IS LOGICAL (TRUE OR FALSE)
 * (X...Y) MEANS THE VARIABLE IS LIMITED BETWEEN X AND Y

* ALPDEG ANGLE OF ATTACK, DEG
 * ALPHA ANGLE OF ATTACK, RAD
 * ALT ALTITUDE ABOVE RUNWAY, FT
 * ALTREF REFERENCE ALTITUDE ON DESIRED PATH, FT
 * ANX BODY FRAME ACCELERATION FORWARD, G'S
 * ANY BODY FRAME ACCELERATION TO RIGHT, G'S
 * ANZ BODY FRAME ACCELERATION UPWARD, G'S (NOT BODY Z AXIS!)
 * AOACMD COMMANDED ANGLE OF ATTACK, DEG
 * AOAMLD ANGLE OF ATTACK FOR MAXIMUM LIFT/DRAG RATIO, DEG
 * AOANOM NOMINAL ANGLE OF ATTACK VERSUS MACH NUMBER, DEG
 * AUTOSB AUTO SPEEDBRAKE MODE SELECTED (T/F)

* BEDOT ESTIMATED SIDESLIP RATE, DPS (AKA BETA DOT)
 * BETA SIDESLIP ANGLE, RAD +RELATIVE WIND FROM RIGHT
 * BETADEG SIDESLIP ANGLE, DEG +RELATIVE WIND FROM RIGHT

* CDTOT TOTAL DRAG COEFFICIENT
 * CLTOT TOTAL LIFT COEFFICIENT
 * CLLTOT TOTAL ROLL (LITTLE L) COEFFICIENT
 * CLNTOT TOTAL YAW (LITTLE N) COEFFICIENT
 * COLMAX MAXIMUM ABSOLUTE PITCH STICK DEFLECTION, + AFT
 * COLSHC COLUMN PITCH COMMAND AFTER SHAPING, + AFT OR PITCH UP
 * COORDNZ NORMAL ACCELERATION IN COORDINATED TURN, G'S
 * COSALP COSINE OF ANGLE OF ATTACK (ALPHA)
 * COSPHI COSINE OF BANK ANGLE

* COSTHE COSINE OF PITCH ANGLE
 * CYTOT TOTAL SIDE FORCE COEFFICIENT

 * DACL AILERON COMMAND LOWER LIMIT, DEG
 * DACMD AILERON COMMAND TO CONTROL MIXER, DEG (-30...30)
 * DACMDL LIMITED AILERON MIXER COMMAND, DEG
 * DACU AILERON COMMAND UPPER LIMIT, DEG
 * DADIR AILERON RESPONSE TO WHEEL INPUT, DEG +RIGHT TEU
 * DAGC AILERON RESPONSE TO GUIDANCE COMMAND, DEG
 * DAP AILERON RESPONSE TO ROLL RATE, DEG + RIGHT TEU
 * DATRIM AILERON TRIM DEFLECTION, DEG +RIGHT TEU
 * DBFMAX MAXIMUM ABSOLUTE VALUE OF SPEEDBRAKE DEFLECTION, DEG
 * DBFSBLC LOWER BODY FLAP DUE TO SPEEDBRAKE COMMAND, DEG +TED
 * DBFSBUC UPPER BODY FLAP DUE TO SPEEDBRAKE COMMAND, DEG +TED
 * DCPILOT PITCH STICK (COLUMN) DEFLECTION, IN +AFT (-5...9)
 * DECL ELEVATOR COMMAND LOWER LIMIT, DEG + TED
 * DECMD ELEVATOR COMMAND TO ACTUATORS, DEG + TED
 * DECMDL LIMITED ELEVATOR ACTUATOR COMMAND, DEG +TED
 * DECU ELEVATOR COMMAND UPPER LIMIT, DEG +TED
 * DEDSB ELEVATOR COMMAND TO TRIM SPEEDBRAKE PITCH MOMENT, DEG
 * DEGC ELEVATOR RESPONSE TO GAMMA COMMAND, DEG + TED
 * DEQ ELEVATOR RESPONSE TO PITCH RATE, DEG + TED
 * DETRIM ELEVATOR TRIM ANGLE, DEG +TED
 * DETRIMO ELEVATOR TRIM ANGLE AT INITIAL CONDITION, DEG +TED
 * DLE LEFT ELEVON DEFLECTION, DEG +TED
 * DLEC LEFT ELEVON ACTUATOR COMMAND, DEG
 * DLEDEG ELEVATOR DEFLECTION, DEG +TED
 * DLEDEGF FILTERED ELEVATOR DEFLECTION, DEG +TED (NOT USED)
 * DLEDEGP PAST ELEVATOR DEFLECTION, DEG +TED
 * DLEL LEFT ELEVON DEFLECTION LOWER LIMIT, DEG +TED
 * DLEP LEFT ELEVON PAST DEFLECTION, DEG +TED
 * DLEPP LEFT ELEVON PAST PAST DEFLECTION, DEG +TED
 * DLERL LEFT ELEVON DEFLECTION RATE LIMIT, DPS +TED
 * DLETAU LEFT ELEVON ACTUATOR TIME CONSTANT, SEC
 * DLEU LEFT ELEVON DEFLECTION UPPER LIMIT, DEG +TED
 * DLEZ1 LEFT ELEVON Z TRANSFORM PAST OUTPUT COEFFICIENT
 * DLEZ2 LEFT ELEVON Z TRANSFORM PRESENT INPUT COEFFICIENT
 * DLEZ3 LEFT ELEVON Z TRANSFORM PAST INPUT COEFFICIENT
 * DLFDA LOWER BODY FLAP AS AILERON COMMAND, DEG +LEFT TED
 * DLFDE LOWER BODY FLAP COMMAND TO ASSIST ELEVATOR, DEG +TED
 * DLGPCT LANDING GEAR DEFLECTION, PERCENT
 * DLL LOWER LEFT BODY FLAP COMMAND, DEG +TED
 * DLLC LOWER LEFT BODY FLAP COMMAND, DEG +TED
 * DLLCL LOWER LEFT BODY FLAP COMMAND LOWER LIMIT, DEG +TED
 * DLLCMD LOWER LEFT BODY FLAP COMMAND AS AILERON, DEG +TED
 * DLLCMDL LOWER LEFT BODY FLAP COMMAND LIMITED, DEG + TED
 * DLLCU LOWER LEFT BODY FLAP COMMAND UPPER LIMIT, DEG +TED
 * DLLL LOWER LEFT BODY FLAP DEFLECTION LOWER LIMIT, DEG +TED
 * DLLP LOWER LEFT BODY FLAP PAST DEFLECTION, DEG +TED
 * DLLPP LOWER LEFT BODY FLAP PAST PAST DEFLECTION, DEG +TED
 * DLLRL LOWER LEFT BODY FLAP DEFLECTION RATE LIMIT, DPS +TED
 * DLLTAU LOWER LEFT BODY FLAP ACTUATOR TIME CONSTANT, SEC
 * DLLU LOWER LEFT BODY FLAP DEFLECTION UPPER LIMIT, DEG +TED
 * DLLZ1 LOWER LEFT BODY FLAP Z TRANSFORM PAST OUTPUT COEFFICIENT
 * DLLZ2 LOWER LEFT BODY FLAP Z TRANSFORM PRESENT INPUT COEFFICIENT
 * DLLZ3 LOWER LEFT BODY FLAP Z TRANSFORM PAST INPUT COEFFICIENT
 * DLR LOWER RIGHT BODY FLAP DEFLECTION, DEG +TED
 * DLRC LOWER RIGHT BODY FLAP COMMAND, DEG +TED
 * DLRCCL LOWER RIGHT BODY FLAP COMMAND LOWER LIMIT, DEG +TED
 * DLRCMD LOWER RIGHT BODY FLAP COMMAND AS AILERON, DEG +TED
 * DLRCMDL LOWER RIGHT BODY FLAP COMMAND LIMITED, DEG +TED
 * DLRCU LOWER RIGHT BODY FLAP COMMAND UPPER LIMIT, DEG +TED
 * DLRDEG RUDDER DEFLECTION TO AERO, DEG +TEL
 * DLRL LOWER RIGHT BODY FLAP DEFLECTION LOWER LIMIT, DEG +TED
 * DLRP LOWER RIGHT BODY FLAP PAST DEFLECTION, DEG +TED
 * DLRPP LOWER RIGHT BODY FLAP PAST PAST DEFLECTION, DEG +TED

* DLRRL	LOWER RIGHT BODY FLAP DEFLECTION RATE LIMIT, DPS +TED
* DLRTAU	LOWER RIGHT BODY FLAP ACTUATOR TIME CONSTANT, SEC
* DLRU	LOWER RIGHT BODY FLAP DEFLECTION UPPER LIMIT, DEG +TED
* DLRZ1	LOWER RIGHT BODY FLAP Z TRANSFORM PAST OUTPUT COEFFICIENT
* DLRZ2	LOWER RIGHT BODY FLAP Z TRANSFORM PRESENT INPUT COEFFICIENT
* DLRZ3	LOWER RIGHT BODY FLAP Z TRANSFORM PAST INPUT COEFFICIENT
* DLSBCOM	SPEEDBRAKE HANDLE DEFLECTION (0...40)
* DLSBDEG	SPEEDBRAKE DEFLECTION TO AERO, DEG
* DPPILOT	RUDDER PEDAL DEFLECTION, +RIGHT (-2.7...2.7)
* DR	RUDDER DEFLECTION, DEG +TEL
* DRC	RUDDER COMMAND, DEG +TEL
* DRCG1	COMMANDED RUDDER GAIN
* DRCL	RUDDER COMMAND LOWER LIMIT, DEG +TEL
* DRCMD	RUDDER COMMAND TO ACTUATORS, DEG +TEL
* DRCMDL	LIMITED RUDDER COMMAND, DEG +TEL
* DRCU	RUDDER COMMAND UPPER LIMIT, DEG +TEL
* DRDIR	RUDDER RESPONSE TO PEDAL DEFLECTION, DEG +TEL
* DRE	RIGHT ELEVON DEFLECTION, DEG +TED
* DREC	RIGHT ELEVON ACTUATOR COMMAND, DEG +TED
* DREL	RIGHT ELEVON DEFLECTION LOWER LIMIT, DEG +TED
* DREP	RIGHT ELEVON PAST DEFLECTION, DEG +TED
* DREPP	RIGHT ELEVON PAST PAST DEFLECTION, DEG +TED
* DRERL	RIGHT ELEVON DEFLECTION RATE LIMIT, DPS +TED
* DRETAU	RIGHT ELEVON ACTUATOR TIME CONSTANT, SEC
* DREU	RIGHT ELEVON DEFLECTION UPPER LIMIT, DEG +TED
* DREZ1	RIGHT ELEVON Z TRANSFORM PAST OUTPUT COEFFICIENT
* DREZ2	RIGHT ELEVON Z TRANSFORM PRESENT INPUT COEFFICIENT
* DREZ3	RIGHT ELEVON Z TRANSFORM PAST INPUT COEFFICIENT
* DRL	RUDDER DEFLECTION LOWER LIMIT, DEG +TEL
* DRP	RUDDER PAST DEFLECTION, DEG +TEL
* DRPP	RUDDER PAST PAST DEFLECTION, DEG +TEL
* DRRL	RUDDER DEFLECTION RATE LIMIT, DPS +TEL
* DRASAS	RUDDER RESPONSE TO YAW DAMPER, DEG
* DRTAU	RUDDER ACTUATOR TIME CONSTANT, SEC
* DRU	RUDDER DEFLECTION UPPER LIMIT, DEG +TEL
* DRZ1	RUDDER Z TRANSFORM PAST OUTPUT COEFFICIENT
* DRZ2	RUDDER Z TRANSFORM PRESENT INPUT COEFFICIENT
* DRZ3	RUDDER Z TRANSFORM PAST INPUT COEFFICIENT
* DSBAUTO	UNFILTERED SPEEDBRAKE SPEED HOLD COMMAND, DEG
* DSBCMD	SPEEDBRAKE COMMAND TO CONTROL MIXER, DEG
* DSBCMDL	LIMITED SPEEDBRAKE MIXER COMMAND, DEG
* DSBDIR	SPEEDBRAKE RESPONSE TO HANDLE DEFLECTION, DEG
* DSBP	PAST VALUE OF SPEEDBRAKE DEFLECTION, DEG (NOT USED)
* DSBSAS	FILTERED SPEEDBRAKE RESPONSE TO SPEED ERROR, DEG
* DSBSF1	SPEEDBRAKE SHAPING FUNCTION GAIN PER HANDLE
* DSBSF2	SPEEDBRAKE SHAPING FUNCTION GAIN PER HANDLE SQUARED
* DSBTRIM	SPEEDBRAKE TRIM DEFLECTION, DEG
* DTOGO	TOTAL GROUND TRACK DISTANCE TO GO TO TOUCHDOWN, FT
* DUFDE	UPPER BODY FLAP COMMAND TO ASSIST ELEVATORS, DEG +TED
* DUL	UPPER LEFT BODY FLAP DEFLECTION, DEG +TED
* DULC	UPPER LEFT BODY FLAP COMMAND, DEG +TED
* DULCL	UPPER LEFT BODY FLAP COMMAND LOWER LIMIT, DEG +TED
* DULCMD	UPPER LEFT BODY FLAP COMMAND AS AILERON, DEG +TED
* DULCMDL	UPPER LEFT BODY FLAP LIMITED COMMAND, DEG +TED
* DULCU	UPPER LEFT BODY FLAP COMMAND UPPER LIMIT, DEG +TED
* DULL	UPPER LEFT BODY FLAP DEFLECTION LOWER LIMIT, DEG +TED
* DULP	UPPER LEFT BODY FLAP PAST DEFLECTION, DEG +TED
* DULPP	UPPER LEFT BODY FLAP PAST PAST DEFLECTION, DEG +TED
* DULRL	UPPER LEFT BODY FLAP DEFLECTION RATE LIMIT, DPS +TED
* DULTAU	UPPER LEFT BODY FLAP ACTUATOR TIME CONSTANT, SEC
* DULU	UPPER LEFT BODY FLAP DEFLECTION UPPER LIMIT, DEG +TED
* DULZ1	UPPER LEFT BODY FLAP Z TRANSFORM PAST OUTPUT COEFFICIENT
* DULZ2	UPPER LEFT BODY FLAP Z TRANSFORM PRESENT INPUT COEFFICIENT
* DULZ3	UPPER LEFT BODY FLAP Z TRANSFORM PAST INPUT COEFFICIENT
* DUR	UPPER RIGHT BODY FLAP DEFLECTION, DEG +TED
* DURC	UPPER RIGHT BODY FLAP COMMAND, DEG +TED

* DURCL	UPPER RIGHT BODY FLAP COMMAND LOWER LIMIT, DEG +TED
* DURCMD	UPPER RIGHT BODY FLAP COMMAND AS AILERON, DEG +TED
* DURCMDL	UPPER RIGHT BODY FLAP COMMAND LIMITED, DEG +TED
* DURCU	UPPER RIGHT BODY FLAP COMMAND UPPER LIMIT, DEG +TED
* DURL	UPPER RIGHT BODY FLAP DEFLECTION LOWER LIMIT, DEG +TED
* DURP	UPPER RIGHT BODY FLAP PAST DEFLECTION, DEG +TED
* DURPP	UPPER RIGHT BODY FLAP PAST PAST DEFLECTION, DEG +TED
* DURRL	UPPER RIGHT BODY FLAP DEFLECTION RATE LIMIT, DPS +TED
* DURTAU	UPPER RIGHT BODY FLAP ACTUATOR TIME CONSTANT, SEC
* DURU	UPPER RIGHT BODY FLAP DEFLECTION UPPER LIMIT, DEG +TED
* DURZ1	UPPER RIGHT BODY FLAP Z TRANSFORM PAST OUTPUT COEFFICIENT
* DURZ2	UPPER RIGHT BODY FLAP Z TRANSFORM PRESENT INPUT COEFFICIENT
* DURZ3	UPPER RIGHT BODY FLAP Z TRANSFORM PAST INPUT COEFFICIENT
* DWPILOT	ROLL STICK (WHEEL) DEFLECTION, +RIGHT (-60...60)
* ELOC	LOCALIZER ERROR, DEG +RIGHT OF CENTERLINE (-2.5...2.5)
* FAT1	Z TRANSFORM GAIN ON PAST OUTPUT OF AUTO TRIM FILTER
* FAT2	Z TRANSFORM GAIN ON PRESENT INPUT TO AUTO TRIM FILTER
* FAT3	Z TRANSFORM GAIN ON PAST INPUT TO AUTO TRIM FILTER
* FATA	AUTO TRIM LEAD GAIN (AS+B / TS+1 FILTER)
* FATB	AUTO TRIM LAG GAIN
* FATT	AUTO TRIM TIME CONSTANT, SEC
* FATTA	AUTO TRIM TIME CONSTANT FOR MANUAL MODES, SEC
* FATTM	AUTO TRIM TIME CONSTANT FOR AUTO MODES, SEC
* FNZ1	Z TRANSFORM GAIN ON PAST OUTPUT OF NZ FILTER
* FNZ2	Z TRANSFORM GAIN ON PRESENT INPUT TO NZ FILTER
* FNZ3	Z TRANSFORM GAIN ON PAST INPUT TO NZ FILTER
* FNZA	NZ FILTER LEAD GAIN (AS+B / TS+1 FILTER)
* FNZB	NZ FILTER LAG GAIN
* FNZT	NZ FILTER TIME CONSTANT, SEC
* FQB1	Z TRANSFORM GAIN ON PAST OUTPUT OF Q-BODY FILTER
* FQB2	Z TRANSFORM GAIN ON PRESENT INPUT TO Q-BODY FILTER
* FQB3	Z TRANSFORM GAIN ON PAST INPUT TO Q-BODY FILTER
* FQBA	PITCH RATE (Q-BODY) FILTER LEAD GAIN (AS+B / TS+1 FILTER)
* FQBB	PITCH RATE FILTER LAG GAIN
* FQBT	PITCH RATE FILTER TIME CONSTANT, SEC
* GAMCMD	FLIGHT PATH ANGLE (GAMMA) COMMAND, DEG
* GAMCLL	GAMMA COMMAND LOWER LIMIT, DEG
* GAMCOR	FLIGHT PATH ANGLE CORRECTION, DEG
* GAMCUL	GAMMA COMMAND UPPER LIMIT, DEG
* GAMDOT	ESTIMATED FLIGHT PATH ANGLE RATE, DPS (AKA GAMMA DOT)
* GAMDOTF	GAMMA DOT FILTER OUTPUT, DPS
* GAMDOTP	PAST VALUE OF GAMMA DOT, DPS
* GAMFFL	FLIGHT PATH ANGLE FLOOR VALUE, DEG
* GAMFILT	GAMMA FILTER OUTPUT, DEG (NOT USED)
* GAMFLR	FLIGHT PATH ANGLE DURING FLARE, DEG
* GAMMA	FLIGHT PATH ANGLE, DEG +CLIMBING
* GAMMA1	OUTER GLIDE SLOPE ANGLE, DEG
* GAMMA2	INNER GLIDE SLOPE ANGLE, DEG
* GAMMAD	FLIGHT PATH ANGLE (GAMMA), DEG +CLIMBING
* GAMMAP	PAST VALUE OF GAMMA, DEG (NOT USED)
* GAMREF	FLIGHT PATH ANGLE ON THE GLIDESLOPE, DEG
* GBFA	GAIN, LOWER BODY FLAPS AS AILERONS, DEG/DEG
* GBFB	GAIN, LOWER BODY FLAPS VERSUS BETA, DEG/DEG
* GBFBD	GAIN, LOWER BODY FLAPS VERSUS BETA DOT, DEG/DPS
* GDADWL	GAIN, AILERON PER LEFT WHEEL DEFLECTION, DEG/DEG
* GDADWR	GAIN, AILERON PER RIGHT WHEEL DEFLECTION, DEG/DEG
* GDAGC	GAIN, AILERON PER BANK ERROR, DEG/DEG
* GDAKP	GAIN, HEADING PER CROSSTRACK ERROR, DEG/FT
* GDAP	GAIN, AILERON PER ROLL RATE, DEG/DPS
* GDAPS	GAIN, BANK ANGLE PER HEADING ERROR, DEG/DEG
* GDEGCA	GAIN, ELEVATOR PER GAMMA ERROR, DEG/DEG
* GDEGCM	GAIN, ELEVATOR PER GAMMA DOT, DEG/DPS
* GDLDA	GAIN, LOWER BODY FLAP AILERON 'REVERSAL' FUNCTION OF MACH

* GDQDC	GAIN, PITCH RATE COMMAND PER COLUMN DEFLECTION, DPS/IN
* GDRDA	GAIN, AILERON TO RUDDER CROSSFEED NOMINAL, DEG/DEG
* GDRDAX	GAIN, AILERON TO RUDDER CROSSFEED, DEG/DEG
* GDRDP	GAIN, RUDDER PER PEDAL DEFLECTION, DEG/IN
* GDUDA	GAIN, UPPER BODY FLAPS AS AILERONS VERSUS MACH
* GDUDE	GAIN, UPPER BODY FLAPS AS ELEVATORS VERSUS MACH
* GGFFL	FINAL FLARE GAMMA, DEG
* GGFLR	GAIN, FLOOR GAMMA PER FT, DEG/FT
* GGHER	GAIN, GAMMA PER ALTITUDE ERROR, DEG/FT
* GGLL	GAMMA COMMAND LOWER LIMIT, DEG
* GGUL	GAMMA COMMAND UPPER LIMIT, DEG
* GMACH	ELEVATOR GAIN AS FUNCTION OF MACH NUMBER
* GOBAR	ELEVATOR GAIN AS FUNCTION OF DYNAMIC PRESSURE
* GOBAR1	GAIN, ELEVATOR OVER DYNAMIC PRESSURE, 1/PSF
* GRND	1 - WHEELS ON THE GROUND (0 OR 1)
* GRRLIM	GAIN TO REDUCE ROLL RATE LIMIT AT HIGH MACH
* GRSAS	GAIN, YAW DAMPER DEG/DPS
* GSLAP	SLAPDOWN (DEROTATION) PITCH RATE GAIN
* H	INTEGRATION TIME STEP, SEC
* HACCX	DOWNRANGE LOCATION OF HAC CENTER, FT (USUALLY NEG)
* HACCY	CROSSRANGE LOCATION OF HAC CENTER, FT
* HACDC	DISTANCE TO CENTER OF HAC, FT
* HACDT	DISTANCE TO TANGENT POINT ON HAC, FT
* HACDT2	SQUARE OF HACDT
* HACGAM	FLIGHT PATH ANGLE ON HAC, DEG +CLIMBING
* HACRAD	HEADING ALIGNMENT CIRCLE RADIUS, FT
* HACXTK	DISTANCE TO EDGE OF HAC, FT
* HDOT	ALTITUDE RATE, FPS
* HER	ALTITUDE ERROR, FT, + BELOW GLIDESLOPE
* HFPCAPT	NOMINAL ALTITUDE AT FINAL GLIDESLOPE CAPTURE, FT
* HGS	ALTITUDE OF THE GLIDESLOPE, FT
* HPLOC0	ALTITUDE AT PARABOLIC FLARE ZERO SLOPE, FT
* HPSINTC	ALTITUDE AT PREFLARE INTERCEPT, FT
* HSTEP	INTEGRATION TIME STEP FOR ACTUATORS, SEC
* I	DUMMY INDEX
* IAS	INDICATED AIRSPEED, KNOTS - EQUIVALENT AIRSPEED IN THIS SIMULATION
* L	TOTAL ROLLING MOMENT, FT-LB RIGHT WING DOWN
* LFCS	FLIGHT CONTROL LAW 0-BASELINE 1-GAMMA HOLD 2-NZ+Q 3-RCAH 4-STATE
* M	TOTAL PITCHING MOMENT, FT-LB NOSE UP
* MACH	MACH NUMBER
* MCONFIG	MASS CONFIGURATION 0-ENTRY/LANDING 1-BOOSTER ATTACHED 2-ADAPTER ATTACHED 3-ADAPTER SEPARATED
* MFCS	FLIGHT CONTROL MODE 0-DIRECT 1-PITCH RATE CMD 2-ROLL RATE CMD 3-PITCH & ROLL RATE CMD 4-PITCH AUTO & ROLL RATE 5-PITCH RATE & ROLL AUTO 6-PITCH & ROLL AUTO
* MGUID	GUIDANCE MODE 1-FINAL 2-TURN TO FINAL 3-DOWNWIND 4-TACAN HOMING 5-ON HAC 6-TO HAC 7-MINIMUM ENERGY
* MODE	SIMULATOR MODE 1-RESET 2-HOLD 3-OPERATE
* MPAUTO	PITCH CONTROL AUTOMATIC MODE
* N	TOTAL YAWING MOMENT, FT-LB NOSE RIGHT
* NZ	VERTICAL BODY AXIS ACCELERATION, G, POSITIVE UP
* P	BODY ROLL RATE, RPS
* PCURVC	PARABOLIC FLARE SHAPING PARAMETER
* PDEG	BODY ROLL RATE, DPS
* PDOT	BODY ROLL ACCELERATION, RAD/SEC/SEC
* PHI	EULER ROLL ANGLE (BANK), RAD
* PHICLHI	BANK COMMAND LIMIT AT HIGH ALTITUDE, DEG
* PHICLLO	BANK COMMAND LIMIT AT LOW ALTITUDE, DEG

* PHID	EULER ROLL ANGLE (BANK), DEG
* PHICMD	BANK ANGLE COMMAND, DEG
* PHIHAC	NOMINAL BANK ANGLE ON HAC, DEG +RIGHT WING DOWN
* PSI	EULER YAW ANGLE (HEADING), RAD
* PSICMD	HEADING COMMAND, DEG
* PSICOR	HEADING CORRECTION, DEG
* PSID	EULER YAW ANGLE (HEADING), DEG
* PSIERR	HEADING ERROR, DEG, POSITIVE FOR RIGHT TURN NEEDED
* PSIHACC	HEADING TO HAC CENTER, DEG
* PSIREF	RUNWAY HEADING, DEG
* Q	BODY PITCH RATE, RPS
* QBAR	DYNAMIC PRESSURE, PSF
* QCOORD	COORDINATED TURN BODY PITCH RATE, DPS
* QDEG	BODY PITCH RATE, DPS (AKA Q-BODY)
* QDEGF	BODY PITCH RATE FILTER OUTPUT, DPS
* QDEGP	PAST VALUE OF PITCH RATE FILTER, DPS
* QDOT	BODY PITCH ACCELERATION, RAD/SEC/SEC
* R	BODY YAW RATE, RPS
* RBWASH	YAW RATE WASHOUT FILTER, RPS
* RBWOZ1	YAW RATE WASHOUT Z TRANSFORM COEFFICIENT
* RDEG	BODY YAW RATE, DPS
* RDEGP	PAST BODY YAW RATE, DPS
* RDOT	BODY YAW ACCELERATION, RAD/SEC/SEC
* RSQLAW	QUADRATIC STICK SHAPING RATIO 0-LINEAR 1-SQUARE
* SBAUTH	MAXIMUM ALLOWABLE SPEEDBRAKE DEFLECTION, DEG
* SINALP	SINE OF ANGLE OF ATTACK
* SINPHI	SINE OF BANK ANGLE
* SLAPRT	COMMANDED SLAPDOWN (DEROTATION) PITCH RATE, DPS
* SX	AIRCRAFT LOCATION NORTH OF RUNWAY THRESHOLD, FT
* SXDOT	AIRCRAFT NORTHWARD VELOCITY, FPS
* SY	AIRCRAFT LOCATION EAST OF RUNWAY THRESHOLD, FT
* SYDOT	AIRCRAFT EASTWARD VELOCITY, FPS
* TACBRG	BEARING TO RUNWAY THRESHOLD (OR TACAN), DEG
* TACDAZ	RELATIVE BEARING TO RUNWAY THRESHOLD (OR TACAN), DEG
* TACDME	LINE OF SIGHT RANGE TO RUNWAY THRESHOLD (OR TACAN), NMI
* TACE	AIRCRAFT LOCATION EAST OF TACAN, FT
* TACN	AIRCRAFT LOCATION NORTH OF TACAN, FT
* TANPHIL	TANGENT OF BANK ANGLE, (-1...1)
* THETA	EULER PITCH ANGLE, RAD
* THETAD	EULER PITCH ANGLE, DEG
* TKANG	TRACK ANGLE ACROSS EARTH SURFACE, DEG
* U	BODY RELATIVE VELOCITY FORWARD, FPS
* UDOT	BODY RELATIVE ACCELERATION FORWARD, FPS/SEC
* V	BODY RELATIVE VELOCITY TO RIGHT, FPS
* VDOT	BODY RELATIVE ACCELERATION TO RIGHT, FPS/SEC
* VTOTAL	BODY RELATIVE VELOCITY MAGNITUDE, FPS
* VTOTALI	EARTH REFERENCE FRAME VELOCITY MAGNITUDE, FPS
* W	BODY RELATIVE VELOCITY DOWNWARD, FPS
* WDOT	BODY RELATIVE ACCELERATION DOWNWARD, FPS
* WONG	WEIGHT ON NOSE GEAR (T/F)
* WOW	WEIGHT ON WHEELS (T/F)
* X	SUM OF BODY FRAME FORCES FORWARD, LB
* X	DUMMY VALUE IN CLAMP LIMIT FUNCTION
* XAPCAPT	DISTANCE TO THRESHOLD AT INNER GLIDESLOPE INTERCEPT, FT
* XPLOCO	DISTANCE TO THRESHOLD AT PARABOLIC CURVE ZERO SLOPE, FT
* XPSINTC	DISTANCE TO THRESHOLD AT PREFLARE INTERCEPT, FT
* XTCHDN	DISTANCE FROM THRESHOLD TO TOUCHDOWN AIM POINT, FT
* XTK	DISTANCE TO THE EDGE OF THE HEADING ALIGNMENT CIRCLE, FT

- * Y SUM OF BODY FRAME FORCES TO RIGHT, LB
- * Y DUMMY VALUE IN CLAMP LIMIT FUNCTION

- * Z SUM OF BODY FRAME FORCES DOWNWARD, LB
- * Z DUMMY VALUE IN CLAMP LIMIT FUNCTION

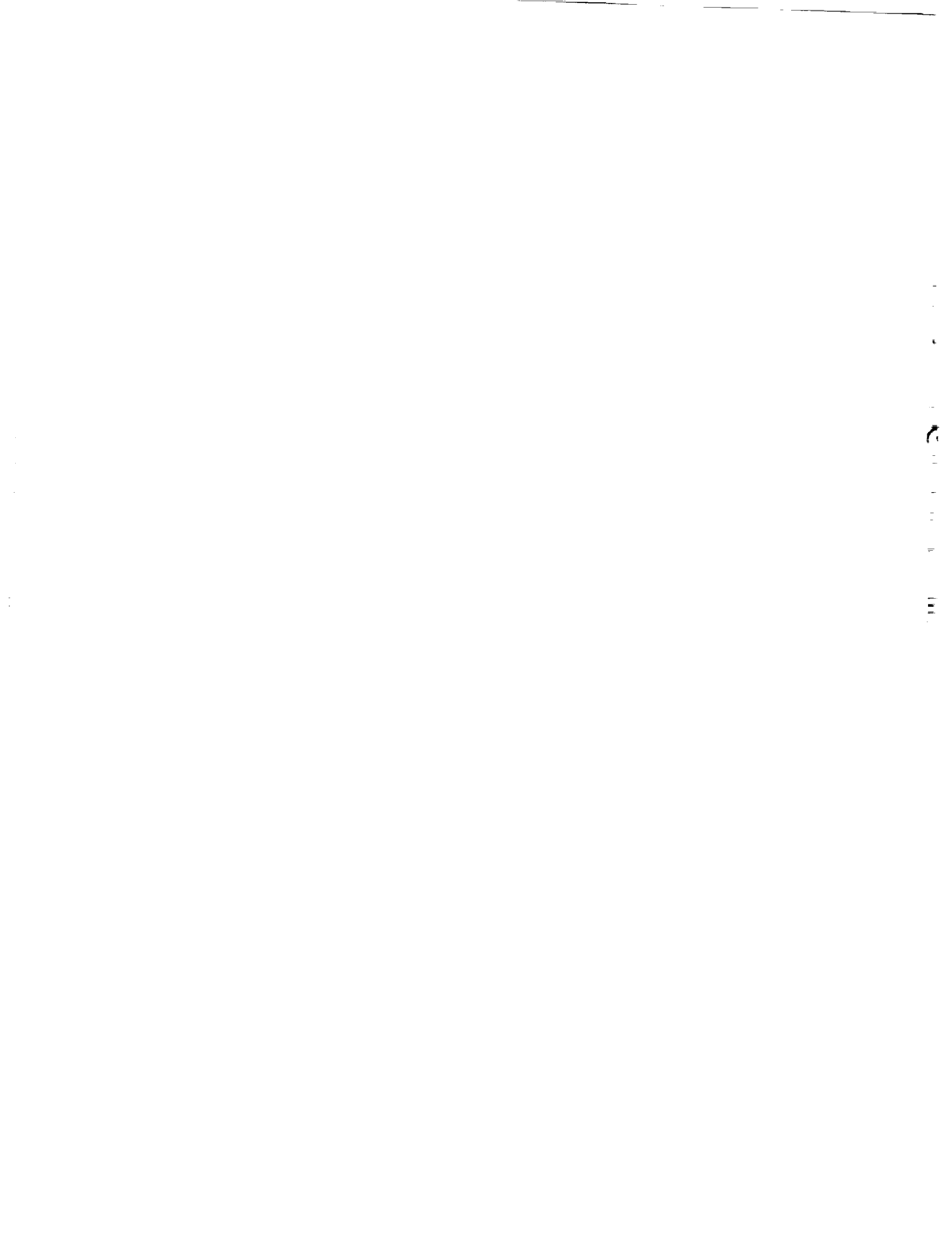

Appendix B
Guidance and Control Law diagrams

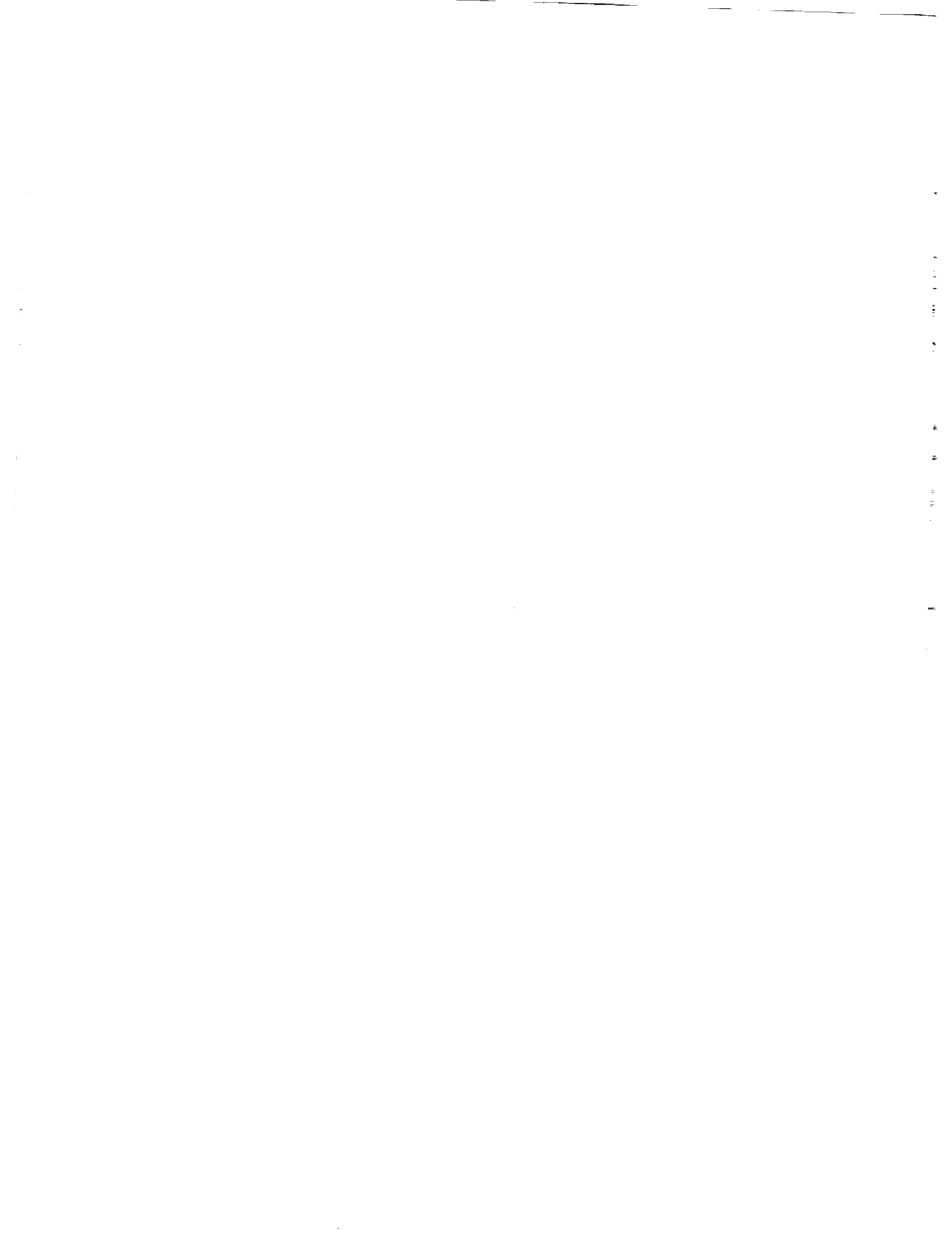

Final approach path trajectory guidance

The HL-20 autoland guidance laws use a trajectory generator that calculates desired altitude as a function of distance from the runway threshold. This same trajectory is used to provide approach path guidance for manual operation.

The approach path described by the trajectory generator consists of three sections: a steep initial approach, a parabolic flare maneuver, and a shallower final approach path leading to the touchdown point of the runway, as shown in figure B-1.

Since this trajectory is affected by changes to the vehicle configuration, such as weight and lift-to-drag ratio, it is important that the capability to modify the approach parameters at run time be provided. It is therefore suggested that the intermediate equations (given as equations (4) through (15) on the following pages) be provided in some initialization portion of the guidance software. The trajectory equations themselves (equations (1) through (3)) should be executed in the run mode portion of the software to provide continuous updates to the nominal approach path altitude.

The independent parameters which define the approach trajectory are the outer and inner glideslope angles (γ_1 and γ_2), inertial velocity at initiation of preflare (V_1), initial preflare normal acceleration increment, (a_{n_1}), altitude of inner glideslope capture, (h_2), and inner glideslope runway intercept point, (x_3).

The run-time equations are used to calculate commanded altitude (h_c) as a function of distance downrange from the runway threshold, x_{cg} , depending on where the aircraft is located in approach path, as follows:

during the initial approach ($x_{cg} > x_1$):

$$h_c = h_1 + (x_{cg} - x_1) \tan \gamma_1 \quad (1)$$

during the parabolic flare maneuver ($x_1 \geq x_{cg} > x_2$):

$$h_c = h_p + a (x_{cg} - x_p)^2 \quad (2)$$

during the final approach to touchdown ($x_{cg} \geq x_2$):

$$h_c = \max \left\{ \begin{array}{l} (x_{cg} - x_3) \tan \gamma_2 \\ 0 \end{array} \right. \quad (3)$$

In order to provide this altitude guidance at run time, some intermediate calculations must be made prior to run time. These calculations relate the specified trajectory parameters (γ_1 , γ_2 , V_1 , a_{n_1} , h_2 , and x_3) to the parameters (a , h_1 , h_p , x_1 , x_2 , and x_p) found in the real-time guidance equations (1) through (3) above. In addition, the aimpoint location x_{ap} is determined.

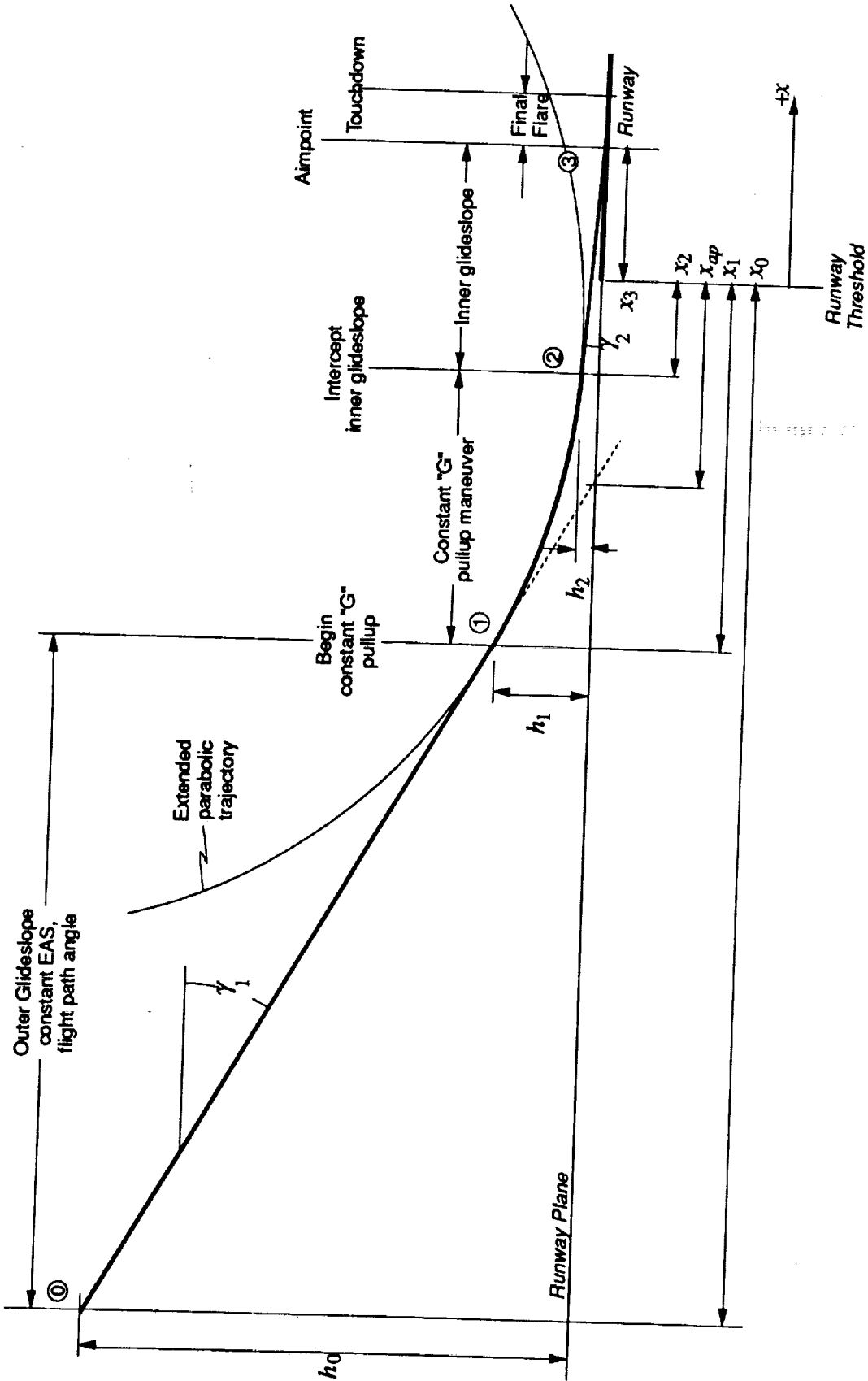

Figure B-1. Final approach path trajectory and nomenclature

The downrange location at which the inner glideslope intercepts the parabolic preflare, x_2 , is calculated from basic geometry in equation (4):

$$x_2 = \frac{h_2}{\tan \gamma_2} + x_3 \quad (4)$$

The initial flight path angular rate can be calculated from the nominal velocity at point 1 and the desired incremental normal acceleration, as given in equation (5):

$$\dot{\gamma}_1 = \frac{a_{n1}}{V_1} \quad (5)$$

A parabolic preflare maneuver was chosen to more closely follow a trajectory with nearly constant incremental normal acceleration. To find the proper parabola in the form of equation (2), the flight path curvature must yield the same flight path angular rate required by equation (5):

$$\dot{\gamma}_1 = \frac{d\gamma}{dt} = \frac{d\gamma}{dx} \frac{dx}{dt} \quad (6)$$

Since, for a parabola with the vertex at $x = x_p$ and $h = h_p$:

$$h = h_p + a(x - x_p)^2 \quad (7)$$

$$\tan \gamma = \frac{dh}{dx} = 2a(x - x_p) \quad (8)$$

$$\gamma = \arctan [2a(x - x_p)]$$

$$\begin{aligned} \frac{d\gamma}{dx} &= \frac{d}{dx} \{ \arctan [2a(x - x_p)] \} \\ &= \frac{2a}{1 + [2a(x - x_p)]^2} \end{aligned}$$

$$\frac{d\gamma}{dx} = \frac{2a}{1 + \tan^2 \gamma} \quad (9)$$

by substitution of equation (8).

Substituting equation (9) and the relationship

$$\frac{dx}{dt} = V \cos \gamma$$

into equation (6) and rearranging the result yields an expression for the parabolic curvature constant, a , at point 1:

$$a = \frac{\dot{\gamma}_1 (1 + \tan^2 \gamma_1)}{2 V_1 \cos \gamma_1} \quad (10)$$

Equation (8) can be rearranged and applied at point 2 to yield an expression for the parabolic vertex downrange coordinate, x_p :

$$x_p = x_2 - \frac{\tan \gamma_2}{2a} \quad (11)$$

Equation (8) can then be applied to point 1 to determine the downrange location at which the preflare maneuver begins:

$$x_1 = x_p + \frac{\tan \gamma_1}{2a} \quad (12)$$

Since h_2 was given and x_2 and x_p are now known, the altitude of the vertex of the parabola, h_p , can be determined by using equation (7) at point 2:

$$h_p = h_2 - a(x_2 - x_p)^2 \quad (13)$$

In a similar fashion, the parabolic intercept altitude h_1 can be calculated using equation (7):

$$h_1 = h_p + a(x_1 - x_p)^2 \quad (14)$$

Finally, the location of the aimpoint (the point at which the outer glideslope intersects the extended runway centerline) can be calculated by geometry:

$$x_{ap} = x_1 - \frac{h_1}{\tan \gamma_1} \quad (15)$$

Nominal trajectory parameters

For this study, the nominal values to be used in the trajectory profile model are as follows:

Initial flare velocity	$V_1 =$	502.3 ft/sec
Initial normal accel. limit	$a_{n_1} =$	0.25 g
	$=$	8.05 ft/sec ²
Initial flight path angle	$\gamma_1 =$	-17 degrees
Final flight path angle	$\gamma_2 =$	-1 degrees
Final flight path capture height	$h_2 =$	75 ft
Target touchdown point	$x_3 =$	2200 ft

Using these constants in the equations (4) through (15) yield the following parameter values:

Final approach capture location	x_2	=	- 2,096	ft
Initial preflare rate	$\dot{\gamma}_1$	=	0.016	rps
Parabolic curvature constant	a	=	1.823×10^{-5}	rad/ft
Parabolic zero-slope x location	x_p	=	- 1617.2	ft
Parabolic slope intercept range	x_1	=	- 10,004	ft
Parabolic zero-slope h location	h_p	=	70.8	ft
Parabolic slope intercept alt.	h_1	=	1,352.7	ft
Outer glideslope aimpoint	x_{ap}	=	-5,580	ft

Control law diagrams (pages B-7 through B-13)

Page B-7 shows the baseline pitch guidance laws in block diagram form. Inputs to pitch guidance include altitude and flight path reference values, obtained by the equations described previously in this appendix, and shown on page B-7 as variables ALTREF and GAMREF, respectively. These inputs, along with current altitude (ALT), flight path in degrees (GAMMAD), angle of attack in degrees (ALPDEG), and Mach number (MACH), are used to provide flight path steering (GAMCMD) to both the autopilot and the flight director symbology on the head-up and head-down displays. Guidance mode selection (MGUID) is performed separately.

Page B-8 describes the baseline roll guidance and flight control. Using navigation information from a number of sources, a commanded heading angle is generated (PSICMD) in the guidance portion of this combined diagram. The commanded heading angle is compared to actual track angle (TKANG) to generate an error signal (PSIERR), which is then used to generate a commanded bank angle (PHICMD). The commanded bank angle is compared to actual bank angle (PHID) to generate a bank angle error signal that drives the flight director and, if autopilot is selected, the aileron command (DACMD).

Page B-9 depicts the NZQ pitch control law. The primary input is the pilot's pitch stick position (DCPILOT). Feedback signals include pitch rate (QDEG), normal acceleration (NZ), elevator position (DLEDEG) and commanded and actual flight path angles (GAMCMD, GAMMAD). Small compensations in the pitch axis are made using bank angle (COSPFI and SINPFI), pitch angle (COSTHE) and roll rate (PDEG). Gains are scheduled using Mach number, dynamic pressure (QBAR), and total airspeed (VTOTALI). Logic selection is performed based upon weight-on-wheels (WOW), weight on nose gear (WONG) and control mode (SAS or AUTO). Output from the pitch control law is commanded elevator position (DECMD).

Page B-10 shows the yaw and speed control laws. The yaw control system adds rate damping and roll command compensation, using roll rate (RDEG) and commanded aileron (DACMD) signals, to the pilot's pedal command (DPPILOT), to generate a commanded rudder signal (DRCMD). The speed control law combines the pilot's speedbrake command (DLSBCOM) with an optional autospeed function, using an indicated airspeed (IAS) feedback, to drive the speedbrake actuator command (DSBCMD).

Page B-11 describes the control surface mixer logic. This system drives the wing flaps directly from the commanded elevator position (DECMD) after appropriate limits are applied. The aileron command (DACMD) is combined with the speedbrake command (DSBCMD), and if necessary, the elevator command (DECMD) to drive the four body flaps, with appropriate position limiting. The rudder is driven directly from the rudder command (DRCMD) with appropriate position limiting. At supersonic Mach numbers, roll control is obtained using the lower body flaps as "ruddervators" in a reverse-aileron fashion, and yaw stability is enhanced using a sideslip rate signal (BETADOT).

Page B-12 and B-13 depict the navigation geometry to obtain and intercept the heading alignment circle (HAC), and gives the equations used to calculate the commanded heading angle to intercept the HAC.

VMS/PLS PITCH GUIDANCE

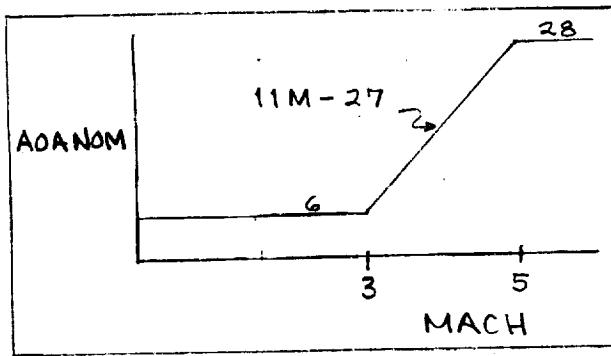

- MGUID
= Guidance Mode
- 1 = Final
 - 2 = Turn to Final
 - 3 = Downwind
 - 4 = TACAN Homing
 - 5 = On HAC
 - 6 = To HAC
 - 7 = Minimum Energy

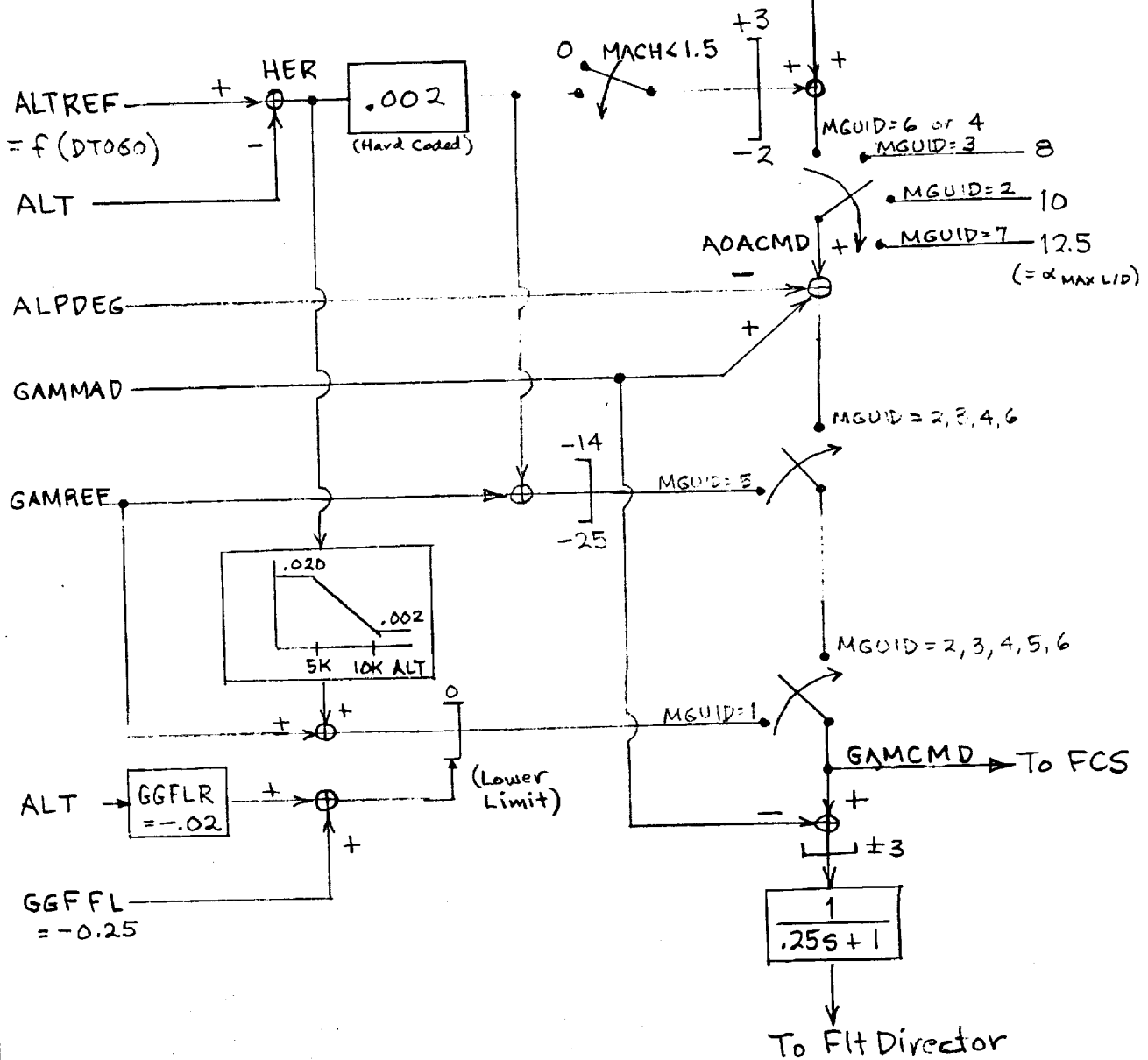

VMS/PLS ROLL GUIDANCE & FLIGHT CONTROL

- MGUID
- 1 = Final Approach
 - 2 = Turn to Final
 - 3 = Downwind
 - 4 = Homing
 - 5 = On HAC
 - 6 = Toward HAC
 - 7 = Minimum Energy

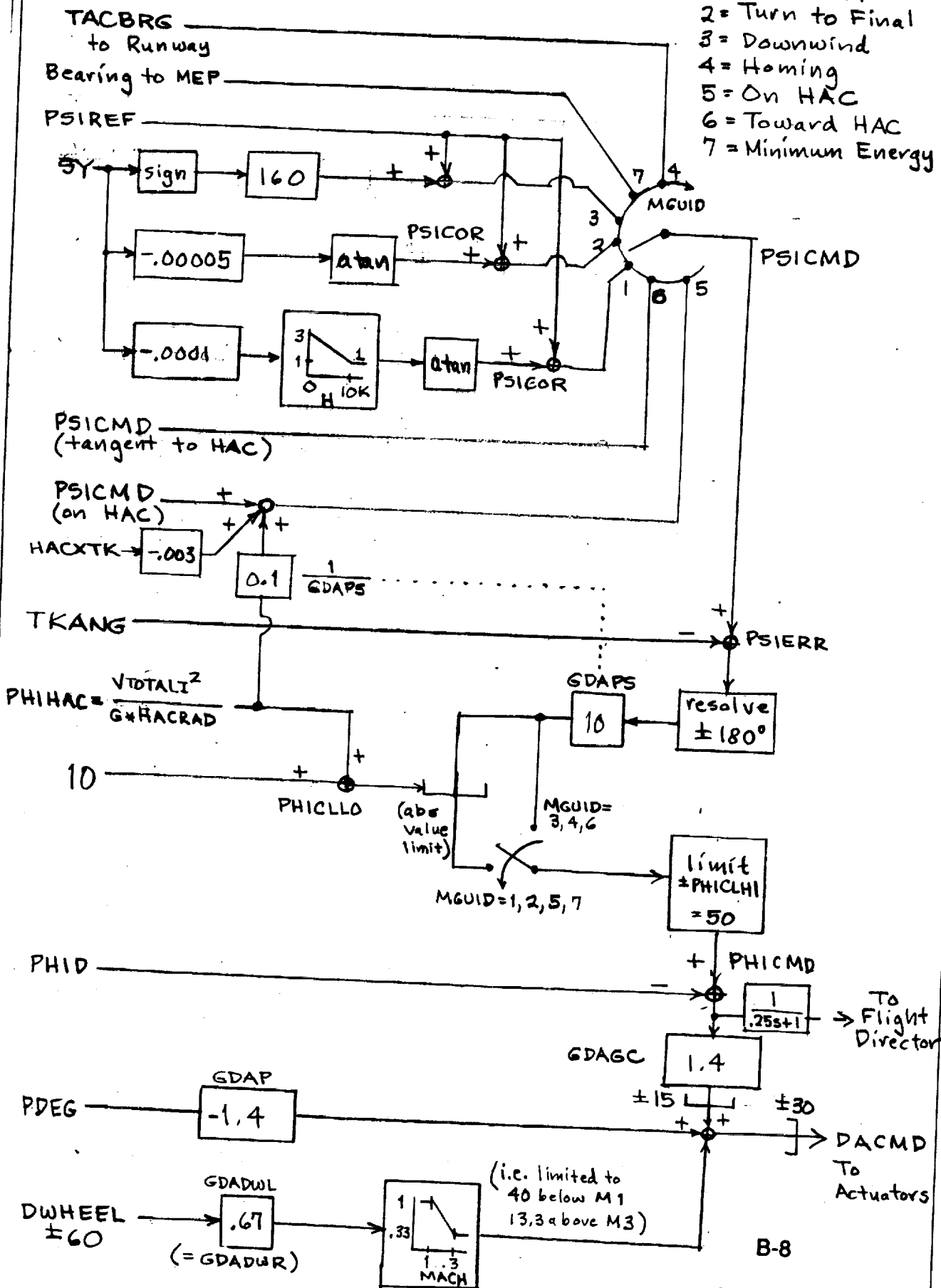

VMS/PLS NZQ PITCH CONTROL LAW

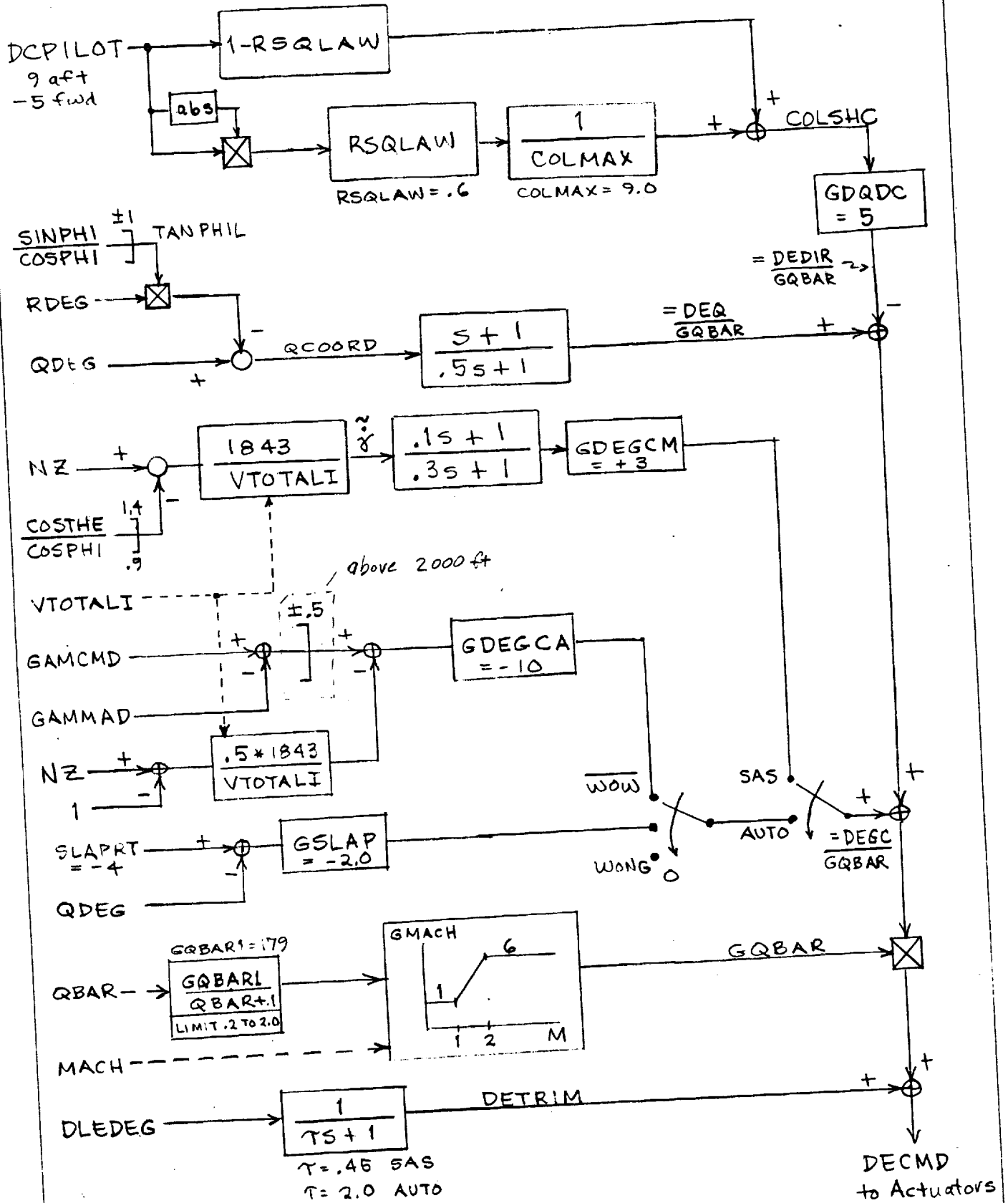

VMS/PLS YAW & SPEED CONTROL

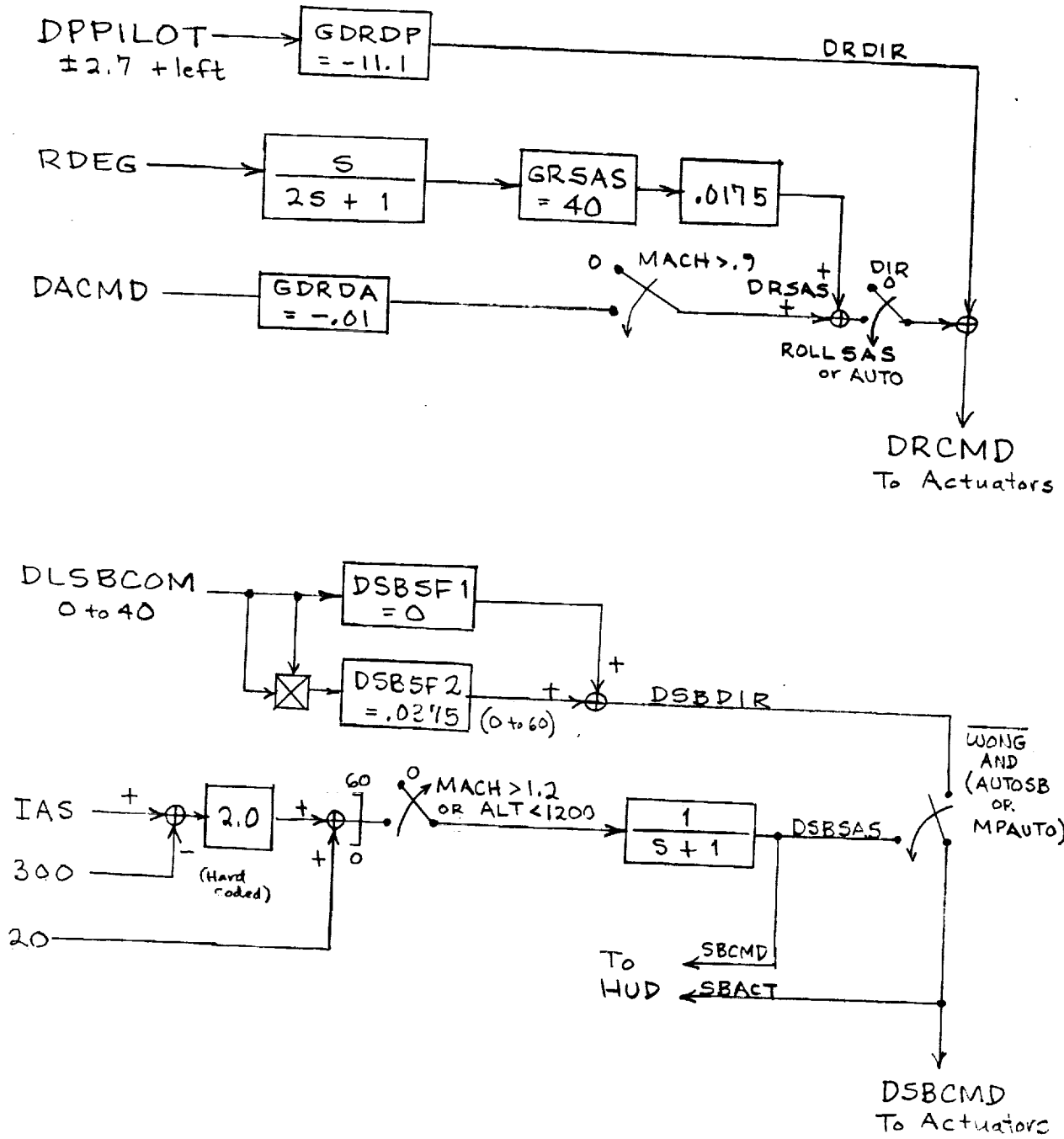

HEADING ALIGNMENT CIRCLE GEOMETRY

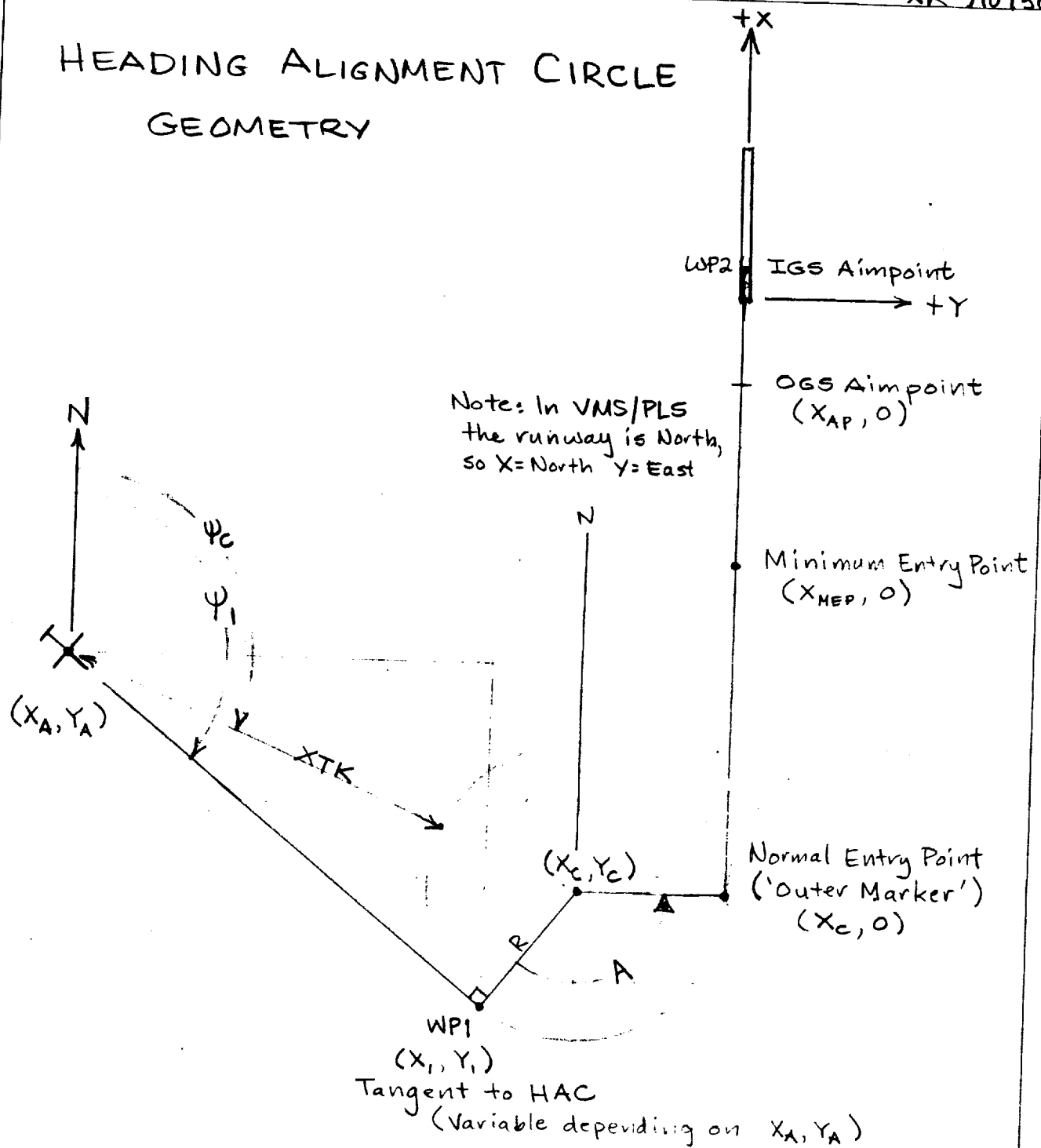

DTOGO is groundtrack range from aircraft to WPI, around the HAC to 'outer Marker', and then to WP2.

$$ALTREF = \tan(GAMREF) * (DTOGO - X_{AP})$$

Appendix B: Guidance and Control Law Diagrams

HEADING TO INTERCEPT HAC

GIVEN (X_A, Y_A) and (X_C, Y_C) and R

FIND (X_I, Y_I)

$A = \psi_I =$ turn angle

$$X_I = X_C + R * \cos(A + 90) = X_C - R \sin A$$

$$Y_I = Y_C + R * \sin(A + 90) = Y_C + R \cos A$$

$$A = \text{atan}_2 \left(\frac{Y_I - Y_A}{X_I - X_A} \right)$$

$$A = \text{atan}_2 \left(\frac{Y_C - Y_A + R \cos A}{X_C - X_A - R \sin A} \right)$$

$$\psi_C = \text{atan}_2 \left(\frac{Y_C - Y_A}{X_C - X_A} \right) = \text{bearing to HAC center}$$

$$\psi_I = \psi_C + \sin^{-1} \left(\frac{R}{\sqrt{(X_C - X_A)^2 + (Y_C - Y_A)^2}} \right)$$

- for right turn HAC

+ for left turn HAC

limit quantity in parentheses to ± 1.0

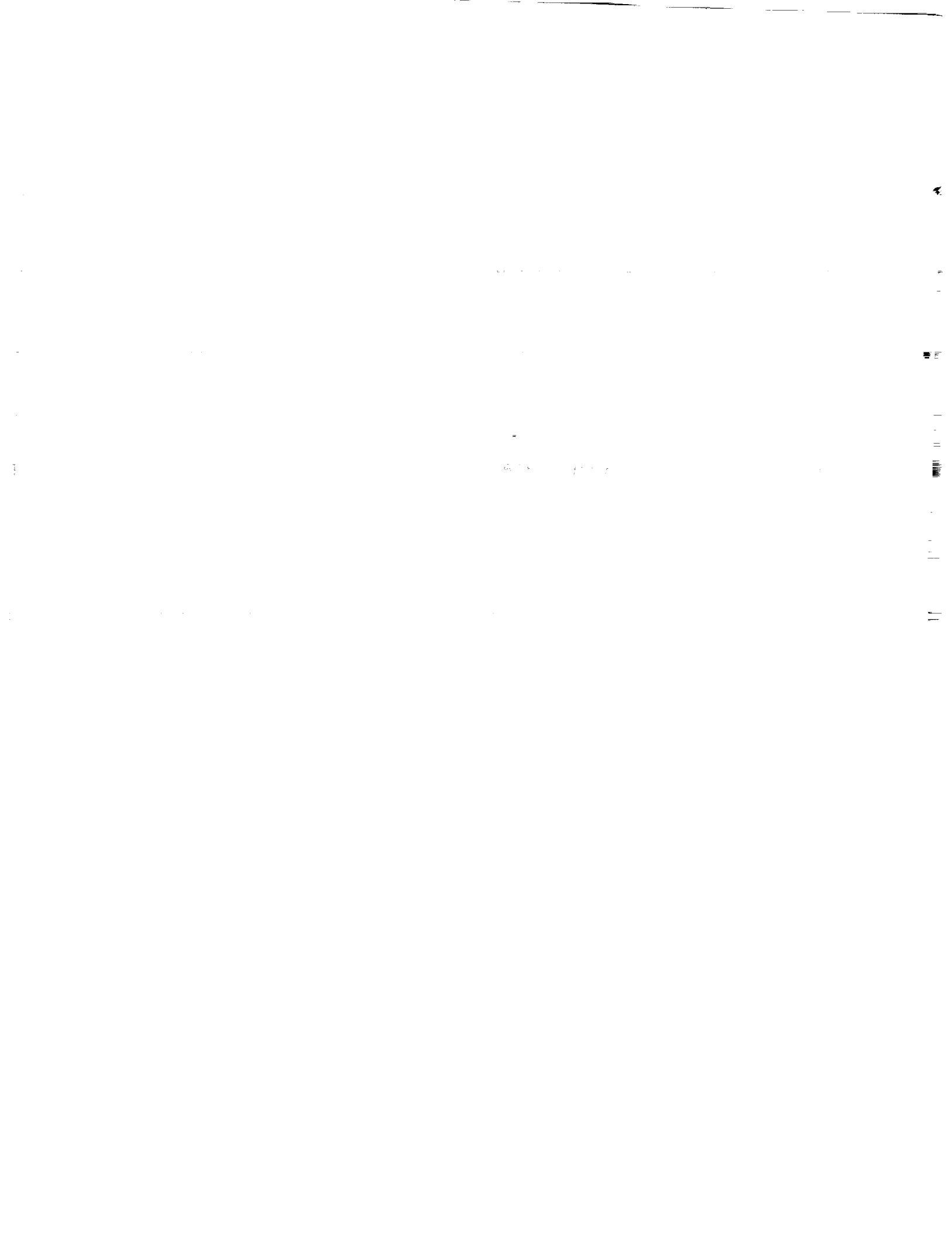

Appendix C
Guidance and Control Law listings



```

* MGUID   GUIDANCE MODE 1-FINAL 2-BASE 3-DOWNWIND 4-HOMING
*         5-TO HAC  6-ON HAC
* PHICMD  BANK ANGLE COMMAND, DEG
*
* ***** GUIDANCE MODING *****
*
* INITIALIZE MGUID WHEN IN RESET (MODE=1)
* MGUID IS GUIDANCE MODE
* 1-FINAL APPROACH & FLARE  2-TURN TO FINAL  3-DOWNWIND TEARDROP
* 4-TACAN HOMING           5-ON HAC          6-TANGENT TO HAC
* MODES CASCADE AUTOMATICALLY WHEN CONDITIONS ARE SATISFIED
* USUAL SEQUENCE IS EITHER 4,3,2,1 OR 6,5,1
*
*   IF (MODE.EQ.1) THEN
*     MGUID = 4
*     IF (ALT.GT.5000.*TACDME .OR. MACH.LT. 1.0) MGUID = 3
*     IF (ALT.LT.32000.) MGUID = 2
*     IF (ALT.LT.12000.) MGUID = 1
*   DEFAULTS TO HAC TANGENT GUIDANCE -- CHANGE TO 4 FOR TACAN HOMING
*   IF (ALT.GT.29000.) MGUID = 6
*
*   GAMCMD = GAMMAD
*   ENDIF
*
* ALPHA SCHEDULE VS MACH      MATCHES POWELL ABOVE MACH 3
* MACH   0.0   3.0   4.0   >5.0
* ALPHA  6.0   6.0   17.0  28.0
* NOTE THAT BELOW MACH 1.5 ALPHA VARIES FOR ENERGY MANAGEMENT
*
*   IF (MACH.LE.3.0) AOANOM = 6.0
*   IF (MACH.GT.3.0) AOANOM = 11.*MACH-27.
*   IF (AOANOM.GT.28.) AOANOM = 28.
*
* GLIDESLOPE ALTITUDE ERROR
* NOTE HER IS POSITIVE WHEN A/C IS BELOW THE GLIDESLOPE!!!!
*   ALTREF = HGS
*   HER = ALTREF - ALT
*
* ***** MGUID = 6 HEADING ALIGNMENT CIRCLE STEERING
*
*   DATA HACCX,HACRAD / -36300., 31000. /
*
*   IF (MGUID.EQ.5.OR.MGUID.EQ.6) THEN
*
*     DISTANCE TO CENTER OF HAC
*     HACCY = -HACRAD
*     HACDC = SQRT ((HACCX-SX)**2 + (HACCY-SY)**2)
*
*     CROSSTRACK DISTANCE FROM EDGE OF HAC
*     HACXTK = HACDC - HACRAD
*
*     HEADING TO CENTER OF HAC
*     PSIHACC = 57.3*ATAN2 ( (HACCY - SY), (HACCX - SX) )
*     IF (PSIHACC.GT.360.) PSIHACC = PSIHACC - 360.
*     IF (PSIHACC.LT. 0.) PSIHACC = PSIHACC + 360.
*
*     IF (MGUID.EQ.6) THEN
*     FLYING TO INTERCEPT HAC
*     IF (HACXTK.LT.20. .OR. ALT.LT.20000.) MGUID = 5
*
*     DISTANCE TO HAC TANGENT
*     HACDT2 = HACDC**2 - HACRAD**2
*     IF (HACDT2.GT.0) HACDT = SQRT (HACDT2)
*

```

```

*   HEADING COMMAND
      PSICMD = PSIHACC + 57.3*ASIN(HACRAD/HACDC)
*
*   DISTANCE TO GO TO RUNWAY THRESHOLD
      DTOGO = HACDT + .01745*ABS(PSICMD)*HACRAD - HACCX
*
*   REFERENCE ALTITUDE AND ALTITUDE ERROR
      ALTREF = .305 * (DTOGO - 5577.)
      HER = ALTREF - ALT
*
*   ANGLE OF ATTACK COMMAND
      AOACMD = AOANOM
*
*   BELOW MACH 1.5 MODIFY ALPHA TO CORRECT ALTITUDE ERROR
      IF (MACH.LT.1.5) AOACMD = CLIMIT (AOANOM+.002*HER,4.0,9.0)
*
*   GAMMA COMMAND FILTER      TAU = 6 SEC
      GAMCMD = .995*GAMCMD + .005*(GAMMAD + AOACMD - ALPDEG)
*
      ELSE
*
*   FLYING AROUND THE HAC
      IF (ALT.LT.12000..OR.ALT.LT.20000..AND.ABS(SY).LT.1000.) MGUID=1
*
*   NOMINAL BANK ANGLE AND HEADING COMMAND ON HAC
      PHIHAC = 57.3*ATAN(VTOTALI**2 / (32.2*HACRAD) )
      PSICMD = PSIHACC+90. -.003*HACXTK - PHIHAC/GDAPS
      PSICMD = SIGN(PSICMD,-SY)
      IF (PSICMD.GT.180.) PSICMD = PSICMD - 360.
      IF (PSICMD.LT.-180.) PSICMD = PSICMD + 360.
*
*   DISTANCE TO GO AROUND HAC TO RUNWAY THRESHOLD
      DTOGO = .01745*ABS(PSICMD)*HACRAD - HACCX
*   REFERENCE ALTITUDE AND ALTITUDE ERROR
      ALTREF = .305 * (DTOGO-5577.)
      HER = ALTREF - ALT
*   GAMMA COMMAND ON HAC
      HACGAM = CLIMIT (-17.+.002*HER,-25.,-14.)
*
*   MINIMUM ENTRY POINT STEERING
*   AIM TO INTERCEPT CENTERLINE 20000 FT BEFORE THRESHOLD
*   WHILE FLYING MAXIMUM L/D GAMMA
*
      IF (ALT.LT.1300.*TACDME + 50.*TACDAZ) THEN
        HACGAM = -12.5
        PSICMD = 57.3*ATAN(SY/(SX+20000.))
      ENDIF
*
*   GAMMA COMMAND FILTER      TAU = 3 SEC
      GAMCMD = .990*GAMCMD + .010*HACGAM
      ENDIF
*
*   END OF HEADING ALIGNMENT CYLINDER GUIDANCE
      ENDIF
*
**** MGUID = 4   TACAN HOMING
*   FOLLOWS ALPHA VS MACH SCHEDULE UNTIL MODE 3
*
      IF (MGUID.EQ.4) THEN
        IF (TACDME.LT.15.0 .OR. MACH.LT. 1.0) MGUID = 3
        GAMCMD = .997*GAMCMD + .003*(GAMMAD + AOACMD - ALPDEG)
        PSICMD = TACBRG
      ENDIF
*
**** MGUID = 3   DOWNWIND MODE
*

```



```

IF (MGUID.EQ.3) THEN
  IF (ABS(TACDAZ).GT.120. .AND. ALT.LT.3300.*TACDME) MGUID = 2
  AOACMD = 8.0
  GAMCMD = .995*GAMCMD + .005*(GAMMAD + AOACMD - ALPDEG )
  PSICMD = PSIREF + SIGN(160.,SY)
ENDIF
*
**** MGUID = 2  TURN TO FINAL
*
  IF (MGUID.EQ.2) THEN
    IF (ABS(SY).LT.18000. .OR. ALT.LT.15000.) MGUID = 1
    AOACMD = 10.0
    GAMCMD = .990*GAMCMD + .010*(GAMMAD + AOACMD - ALPDEG )
    PSICOR = 57.3*ATAN(-.00005*SY)
    PSICMD = PSIREF + PSICOR
  ENDIF
*
**** MGUID = 1  FINAL APPROACH AND FLARE
DATA GGHER,GGFLR,GGFFL / .020 , -.020 , -0.25 /
DATA GGLL,GGUL,AOAMLD / -22.0 , -12.0 , 12.0 /
*
  IF (MGUID.EQ.1) THEN
    RAMP GAIN IN .002 AT 10K .020 AT 5K
    GGHER = CLIMIT (.038-.0000036*ALT, .002, .020)
    GAMCOR = GGHER * HER
    GAMCMD = CLIMIT (GAMREF + GAMCOR , GGLL, 0.0 )
    IF (ALT.GT.2000.) GAMCMD = CLIMIT (GAMCMD,GGLL,GGUL)
    * IF FAR BELOW GLIDESLOPE COMMAND ALPHA = AOAMLD = ALPHA FOR MAX L/D
    IF (HER.GT.2000.) GAMCMD = GAMMAD + AOAMLD - ALPDEG
  *
  ***** FINAL FLARE TO TOUCHDOWN
  GAMFFL = GGFLR*ALT + GGFFL
  IF (ALT.LT.HFPCAPT .AND. GAMCMD.LT.GAMFFL) GAMCMD = GAMFFL
  IF (MPAUTO .AND. GAMCMD.LT.GAMFFL) GAMCMD = GAMFFL
  *
  GDAKP = -.00010
  IF (ALT.LT.10000.) GDAKP = -.00010 * (3.0-.0002*ALT)
  PSICOR = CLIMIT (57.3*ATAN(GDAKP*SY), -90., 90.)
  PSICMD = PSIREF + PSICOR
  *
  ENDIF
  *
  **** *  COMMAND LIMITERS  ALL MODES
  *
  DATA GAMCLL, GAMCUL, GDAPS / -22., 0.0, 10. /
  DATA GDAPS,PHICLHI,PHICLLO / 10. , 50., 35. /
  *
  GAMCMD = CLIMIT (GAMCMD, GAMCLL, GAMCUL )
  *
  GAMCMD SMOOTHING (TAKE OUT BEFORE FLARE!)
  IF (ALT.GT.2000.) THEN
    IF (GAMCMD-GAMMAD .GT. 0.5) GAMCMD = GAMMAD + 0.5
    IF (GAMCMD-GAMMAD .LT.-0.5) GAMCMD = GAMMAD - 0.5
  ENDIF
  *
  IF (PSICMD.LT.0. ) PSICMD = PSICMD + 360.
  IF (PSICMD.GT.360.) PSICMD = PSICMD - 360.
  *
  PSIERR = PSICMD - TKANG
  IF (PSIERR.GT. 180.) PSIERR = PSIERR - 360.
  IF (PSIERR.LT.-180.) PSIERR = PSIERR + 360.
  *
  PHIHAC = 57.3*ATAN(VTOTALI**2 / (32.2*HACRAD) )
  PHICLLO = CLIMIT(PHIHAC+10., -PHICLHI, PHICLHI)
  *
  PHICMD = CLIMIT( GDAPS * PSIERR, -PHICLHI, PHICLHI)

```

IF (MGUID.LE.2) PHICMD = CLIMIT (GDAPS * PSIERR, -PHICLLO, PHICLLO)
 IF (MGUID.EQ.5) PHICMD = CLIMIT (GDAPS * PSIERR, -PHICLLO, PHICLLO)

PLS FLIGHT CONTROL LAWS NZQ ALGORITHM

EXTERNAL INPUTS TO FLIGHT CONTROL LAWS

AUTOSB AUTO SPEEDBRAKE MODE (T/F)
 COSPHI COSINE OF ROLL ANGLE
 COSTHE COSINE OF PITCH ANGLE
 GAMCMD FLIGHT PATH ANGLE COMMAND, DEG
 GAMMAD FLIGHT PATH ANGLE, DEG
 DCPILOT COLUMN (STICK) DEFLECTION, IN +AFT
 DLEDEG ELEVATOR ANGLE FEEDBACK, DEG
 DLSBCOM SPEEDBRAKE HANDLE DEGLECTION, DEG
 DPPILOT RUDDER PEDAL DEFLECTION, IN +LEFT
 DWPILOT WHEEL (STICK) DEFLECTION, DEG +RIGHT
 GRND 1 - WHEELS ON GROUND
 IAS INDICATED AIRSPEED (ACTUALLY EQUIVALENT AIRSPEED)
 MACH MACH NUMBER
 MFCS FLIGHT CONTROL MODE 0-DIRECT 1-PITCH RATE 2-ROLL RATE
 3-RATE CMD 4-PITCH AUTO 5-ROLL AUTO 6-AUTOLAND
 NZ BODY AXIS VERTICAL ACCELERATION, G'S
 PDEG BODY ROLL RATE, DPS
 PHICMD ROLL ANGLE COMMAND, DEG
 PHID ROLL ANGLE, DEG
 QBAR DYNAMIC PRESSURE, PSF
 QDEG BODY PITCH RATE, DPS
 RDEG BODY YAW RATE, DPS
 SINPHI SINE OF ROLL ANGLE
 THETAD PITCH ANGLE, DEG
 VTOTALI MAGNITUDE OF EARTH RELATIVE VELOCITY, FPS
 WONG WEIGHT ON NOSE GEAR (T/F)

EXTERNAL OUTPUTS FROM FLIGHT CONTROL LAWS

DACMD AILERON COMMAND, DEG +TO ROLL RIGHT
 DECMD ELEVATOR COMMAND, DEG +TRAILING EDGE DOWN
 DRCMD RUDDER COMMAND, DEG +TRAILING EDGE LEFT
 DSBCMD SPEEDBRAKE COMMAND, DEG

 Z-TRANSFORM FORMULA USED IN 1ST ORDER FILTERS
 INITIALIZE OUT AND INPAST IN RESET DT = INTEGRATION TIME STEP
 (AS+B)/(CS+1) -> K=Z1-EXP(-DT/C) Z3=-K*A/* Z2=B*(1-K)+K*A/C
 OUT = Z1*OUT + Z2*IN + Z3*INPAST 'PAST VALUE OF OUT IMPLIED
 INPAST = IN

MFCS: 1-PITCH RATE CMD 2-ROLL RATE CMD 3-PITCH AND ROLL RATE CMD
 4-PITCH AUTO ROLL RATE 5-ROLL AUTO PITCH RATE 6-AUTOLAND

 INITIAL VALUES

DATA DSBSAS, DEDSB / 20.0 , 0. /
 DATA H, DATRIM / 0.03 , 0.0 /

100 MPAUTO = MFCS.EQ.4 .OR. MFCS.EQ.6

***** PITCH CONTROL *****

```

*
*
*   ELEVATOR TRIM AT RESET
*   IF (MODE.EQ.1) DETRIM = DETRIMO
*
*   FILTERS           AS + B / TS + 1
*
*   FILTER VALUES FOR NZ, QBODY, AND AUTOTRIM
*   DATA FNZA, FNZB, FNZT / 0.10, 1.00, 0.30 /
*   DATA FQBA, FQBB, FQBT / 1.00, 1.00, 0.50 /
*   DATA FATA, FATB, FATTM, FATTA / 0. , 1.0 , 0.45 , 2.00 /
*
*   CHANGE TRIM TAU IN AUTOLAND
*   FATT = FATTM
*   IF (MPAUTO) FATT = FATTA
*
*   INITIAL VALUES FOR FILTERS IN RESET (MODE=1)
*   IF (MODE.EQ.1) THEN
*   QDEGF = QDEG
*   QDEGP = QDEG
*   GAMDOTF = 0.
*   GAMDOTP = 0.0
*   DLEDEGF = DLEDEG
*   DLEDEGP = DLEDEG
*   GAMFILT = GAMMAD
*   DSBP = DLSBDEG
*   ENDIF
*
*   Z-TRANSFORM COEFFICIENTS FOR FILTERS
*
*   IF (FNZT.EQ.0) THEN
*   FNZ1 = 0.0
*   FNZ2 = FNZB
*   FNZ3 = 0.0
*   ELSE
*   FNZ1 = EXP (-.03/FNZT)
*   FNZ3 = -FNZA*FNZ1/FNZT
*   FNZ2 = FNZB*(1.0-FNZ1) - FNZ3
*   ENDIF
*
*   IF (FQBT.EQ.0) THEN
*   FQB1 = 0.0
*   FQB2 = FQBB
*   FQB3 = 0.0
*   ELSE
*   FQB1 = EXP (-.03/FQBT)
*   FQB3 = -FQBA*FQB1/FQBT
*   FQB2 = FQBB*(1.0-FQB1) - FQB3
*   ENDIF
*
*   IF (FATT.EQ.0) THEN
*   FAT1 = 0.0
*   FAT2 = FATB
*   FAT3 = 0.0
*   ELSE
*   FAT1 = EXP (-.03/FATT)
*   FAT3 = -FATA*FAT1/FATT
*   FAT2 = FATB*(1.0-FAT1) - FAT3
*   ENDIF
*
* ***** OPERATE LOOP *****
*
*   DEQ = DEGC = 0.
*
*   QUADRATIC STICK SHAPING  0=LINEAR  1 = SQUARE LAW
*   DATA RSQLAW, COLMAX / 0.6 , 7.5 /

```

```

COLSHC = (1.0-RSQLAW)*DCPILOT + RSQLAW*DCPILOT*ABS(DCPILOT)/COLMAX
*
* NZ CONTROL LAW
*
* QBAR AND MACH GAIN COMPENSATION
  DATA QBAR1 / 179. /
  QBAR = CLIMIT (QBAR1/(QBAR+.1),0.2,2.0)
  GMACH = CLIMIT (5.0*MACH-4.0,1.0,6.0)
  QBAR = QBAR * GMACH
*
* PITCH RATE COMMAND, FEEDBACK & FILTER
  DATA GDQDC,GDEGCM,GDEGCA / 5.0, -3.0, -10.0 /

  TANPHIL = CLIMIT ( SINPHI/COSPHI, -1.0, 1.0 )
  QCOORD = QDEG - RDEG * TANPHIL
  QDEGF = FQB1*QDEGF + FQB2*QCOORD + FQB3*QDEGP
  QDEGP = QCOORD
  DEQ = QBAR * (QDEGF - GDQDC*COLSHC)
*
* NZ FEEDBACK USED TO ESTIMATE GAMMA DOT
*
  COORDNZ = CLIMIT (COSTHE/COSPHI, 0.90 , 1.41 )
  GAMDOT = 1843. * (NZ-COORDNZ) / VTOTALI
  IF (.NOT.MPAUTO) THEN
    GAMDOTF = FNZ1*GAMDOTF + FNZ2*GAMDOT + FNZ3*GAMDOTP
    GAMDOTP = GAMDOT
    DEGC = -GDEGCM * QBAR * GAMDOTF
  ENDIF
*
* PITCH AUTOLAND
  DATA GSLAP,SLAPRT / -2.0, -4.0 /
  IF (MPAUTO) THEN
    DEGC = GDEGCA*QBAR*(GAMCMD-GAMMAD- 922.*(NZ-1.)/VTOTALI)
    IF (GRND.EQ.1.) DEGC = GSLAP*QBAR*(SLAPRT-QDEG)
    IF (GRND.EQ.1. .AND. THETAD.LT.5.) DEGC = 0.
  ENDIF
*
* AUTO TRIM -- LAGGED ELEVATOR FEEDBACK
* TRIMS ONLY IN OPERATE AND OFF THE GROUND
  IF (MODE.EQ.3 .AND. GRND.EQ.0) THEN
    DETRIM = FAT1*DETRIM + FAT2*DLEDEG + FAT3*DLEDEGP
    DLEDEGP = DLEDEG
  ENDIF
*
*
* TOTAL ELEVATOR COMMAND
  DECMD = DEQ + DEGC + DETRIM
*
*
***** ROLL CONTROL *****
*
  DATA GDAP, GDAGC / -1.4, 1.4 /
  DATA GDADWL, GDADWR / 0.67, 0.67 /
*
200 DADIR = DAP - DAGC = 0.
*
* DIRECT AILERON COMMAND
* STICK LEFT -60.0 DEG --> -30.0 DEG LEFT AILERON COMMAND
* STICK RIGHT +60.0 DEG --> +30.0 DEG RIGHT AILERON COMMAND
  IF (DWPILOT.LT.0.) DADIR = GDADWL * DWPILOT
  IF (DWPILOT.GE.0.) DADIR = GDADWR * DWPILOT
*
* REDUCE MAX RATE COMMAND AT SUPERSONIC SPEED
  GRRLIM = CLIMIT (1.33-.33*MACH,0.33,1.00)
  DADIR = GRRLIM*DADIR

```



```

*** -U          UPPER LIMIT
*** -Z#         Z-TRANSFORM COEFFICIENT #
**
*****
**
*** LIMITS AND INITIAL VALUES
**
*****
**
DATA DLEU,DLEL,DLERL/ 30., -30., 200. /
DATA DREU,DREL,DRERL/ 30., -30., 200. /
DATA DULU,DULL,DULRL/ 0., -60., 200. /
DATA DURU,DURL,DURRL/ 0., -60., 200. /
DATA DLLU,DLLL,DLLRL/ 60., 0., 200. /
DATA DLRU,DLRL,DLRRL/ 60., 0., 200. /
DATA DRU ,DRL ,DRRL / 30., -30., 200. /

**
DATA DECL,DECU          / -30.0 , 30.0 /
DATA DACL,DACU          / -30.0 , 30.0 /
DATA DRCL,DRCU          / -30.0 , 30.0 /

**
DATA DULC,DULCU,DULCL / 0. ,0. , -100.0 /
DATA DURC,DURCU,DURCL / 0. ,0. , -100.0 /
DATA DLLC,LLCU,DLCL / 0. ,100.0 ,0. /
DATA DLRC,DLRCU,DLRCL / 0. ,100.0 ,0. /

**
DATA DLEP,DLEPP,DREP,DREPP / 0.0 , 0.0 , 0.0 , 0.0 /
DATA DULP,DULPP,DURP,DURPP / 0.0 , 0.0 , 0.0 , 0.0 /
DATA DLLP,DLLPP,DLRP,DLRPP / 0.0 , 0.0 , 0.0 , 0.0 /
DATA DRP,DRPP          / 0.0 , 0.0 /

*
**
*****
* CLAMP LIMITING FUNCTION LIMITS X BETWEEN Y AND Z
* CLIMIT (X, Y, Z) = AMIN1 (Z, AMAX1 (X, Y))
*****
*
***** ELEVON COMMANDS *****
**
*** LIMITED ELEVATOR COMMAND
**
DECMDL = CLIMIT (DECMD, DECL, DECU)
**
*** COMMANDED ELEVONS
**
DLEC = DECMDL
DREC = DECMDL

*
***** RUDDER COMMAND *****
**
*** LIMITED RUDDER COMMAND
**
DRCMDL = CLIMIT (DRCMD, DRCL, DRCU)
**
*** COMMANDED RUDDER
*
NOTE DRCG1 ALLOWS QUICK SCALING CHANGE
DRC = DRCMDL * DRCG1
**
***** AILERON COMMAND *****
**
*** LIMITED AILERON COMMAND
**
DACMDL = CLIMIT (DACMD, DACL, DACU)
*
***** SPEEDBRAKE COMMAND *****

```

```

*
*** LIMITED SPEED BRAKE COMMAND
**
    SBAUTH = DBFMAX - ABS(DACMDL)
    DSBCMDL = CLIMIT(DSBCMD, 0.001, SBAUTH)
**
***** BODY FLAP COMMAND MIXER *****
**
*   BODY FLAPS AS SPEEDBRAKES
*   SHAPED TO MINIMIZE SUBSONIC PITCHING MOMENT
*
    DBFSBLC = DSBCMDL
    DBFSBUC = -0.333 * DBFSBLC
    IF (DBFSBLC.GT.15.) DBFSBUC = 10. - DBFSBLC
    IF (WONG) DBFSBUC = - DBFSBLC
**
*** BREAK AILERON COMMAND INTO BODY FLAP COMMANDS
**
*   BODY FLAPS FUNCTION AS CONVENTIONAL AILERONS BELOW MACH 1.2
*
    IF (MACH .LT. 1.2) THEN
*
        DULCMD = DACMDL
        DLLCMD = DACMDL
        DURCMD = -DACMDL
        DLRCMD = -DACMDL
*
    ELSE
*
* 'REVERSE AILERON' LOWER BODY FLAP CONTROL METHOD   AT MACH > 1.2
*
    DATA GBFA, GBFB, GBFBD / 2.0 , 10.0 , 20.0 /
*
    UPPER BODY FLAP GAIN SCHEDULE VS MACH   1 AT M1   4 AT MACH > 4
    GDUDA = CLIMIT (MACH, 1.0, 4.0)
*
    LOWER BODY FLAP GAIN SCHEDULE VS MACH 'REVERSE AILERON'
* LOWER BODY FLAPS FUNCTION AS YAW MOMENT GENERATORS IN THIS MODE
*   -1 AT M2, 0 AT M1.5, 1 AT M1
    GDLDA = CLIMIT (3. - 2.*MACH, -1. , 1.)
*
    ESTIMATED BETA DOT
    BEDOT = PDEG*SINALP - RDEG*COSALP
*
* LOWER BODY FLAP AS AILERON DEFLECTION COMMAND
    DLFDA = GBFA*GDLDA*DACMD - GBFB*BETADEG - GBFBD*BEDOT
*
    DLLCMD = DLFDA
    DLRCMD = -DLFDA
    DULCMD = GDUDA*DACMDL
    DURCMD = -GDUDA*DACMDL
*
*
*   ENDIF
**
*** BODY FLAP AS AILERON COMMAND LIMITS
**
    DULCMDL = CLIMIT(DULCMD, DULCL, DULCU)
    DLLCMDL = CLIMIT(DLLCMD, DLLCL, DLLCU)
    DURCMDL = CLIMIT(DURCMD, DURCL, DURCU)
    DLRCMDL = CLIMIT(DLRCMD, DLRCL, DLRCU)
**
*** BODY FLAP TO ASSIST ELEVATORS
**
*   GAIN SCHEDULE 1 AT MACH 1 4 ABOVE MACH 1.5
    GDUDE = CLIMIT (6.*MACH-5., 1., 4.)

```



```

*
*   DUFDE = 0.
*   IF (DLEC.LT.-15.) DUFDE = GDUDE*(DLEC + 15.)
*
*
*   DLFDE = 0.
*   IF (DLEC.GT.15.) DLFDE = DLEC - 15.
**
***  TOTAL BODY FLAP COMMANDS
**
*   DULC = DULCMDL + DBFSBUC + DUFDE
*   DURC = DURCMDL + DBFSBUC + DUFDE
*   DLLC = DLLCMDL + DBFSBLC + DLFDE
*   DLRC = DLRCMDL + DBFSBLC + DLFDE
*
*****
*
*   FIRST ORDER RATE AND POSITION LIMITED ACTUATOR MODEL
*
*****
*
*   Z-TRANSFORM FORMULA USED IN 1ST ORDER FILTERS
*   INITIALIZE OUT AND INPAST IN RESET          DT = INTEGRATION TIME STEP
*   (AS+B)/(CS+1)  =>  K-Z1=EXP(-DT/C)  Z3=-K*A/*  Z2=B*(1-K)+K*A/C
*   OUT = Z1*OUT + Z2*IN + Z3*INPAST  'PAST VALUE OF OUT IMPLIED
*   INPAST = IN
*
*
***  WHILE IN RESET (MODE = 1) INITIALIZE Z-TRANSFORM COEFFICIENTS
***  FOR ACTUATOR TRANSFER FUNCTIONS
*
*   IF (MODE.EQ.1) THEN
**
*       HSTEP = H * 0.5
**
***  LEFT ELEVON Z-TRANSFORM COEFFICIENTS
**
*       DLEZ1 = EXP(-1.0 * HSTEP / DLETAU)
*       DLEZ2 = 0.0
*       DLEZ3 = 1.0 - DLEZ1 - DLEZ2
**
***  RIGHT ELEVON Z-TRANSFORM COEFFICIENTS
**
*       DREZ1 = EXP(-1.0 * HSTEP / DRETAU)
*       DREZ2 = 0.0
*       DREZ3 = 1.0 - DREZ1 - DREZ2
**
***  UPPER LEFT BODY FLAP Z-TRANSFORM COEFFICIENTS
**
*       DULZ1 = EXP(-1.0 * HSTEP / DULTAU)
*       DULZ2 = 0.0
*       DULZ3 = 1.0 - DULZ1 - DULZ2
**
***  UPPER RIGHT BODY FLAP Z-TRANSFORM COEFFICIENTS
**
*       DURZ1 = EXP(-1.0 * HSTEP / DURTAU)
*       DURZ2 = 0.0
*       DURZ3 = 1.0 - DURZ1 - DURZ2
**
***  LOWER LEFT BODY FLAP Z-TRANSFORM COEFFICIENTS
**
*       DLLZ1 = EXP(-1.0 * HSTEP / DLLTAU)
*       DLLZ2 = 0.0
*       DLLZ3 = 1.0 - DLLZ1 - DLLZ2
**
***  LOWER RIGHT BODY FLAP Z-TRANSFORM COEFFICIENTS
**

```

```

DLRZ1 = EXP(-1.0 * HSTEP / DLRTAU)
DLRZ2 = 0.0
DLRZ3 = 1.0 - DLRZ1 - DLRZ2
**
***  RUDDER Z-TRANSFORM COEFFICIENTS
**
DRZ1 = EXP(-1.0 * HSTEP / DRTAU)
DRZ2 = 0.0
DRZ3 = 1.0 - DRZ1 - DRZ2
**
ENDIF
**
**
***  RUN ACTUATOR LOGIC AT 60 HZ (MAIN SIM RUNS AT 30 HZ)
**
DO 10 I=1,2
**
***  ELEVON DEFLECTIONS
**
DLE = DLEZ1 * DLEP + DLEZ2 * DLEPP + DLEZ3 * DLEC
DRE = DREZ1 * DREP + DREZ2 * DREPP + DREZ3 * DREC
**
***  RATE LIMITS - ELEVONS
**
IF ((DLE - DLEP) .GT. (HSTEP * DLRL)) THEN
  DLE = DLEP + HSTEP * DLRL
ELSEIF ((DLEP - DLE) .GT. (HSTEP * DLRL)) THEN
  DLE = DLEP - HSTEP * DLRL
ENDIF
IF ((DRE - DREP) .GT. (HSTEP * DRRL)) THEN
  DRE = DREP + HSTEP * DRRL
ELSEIF ((DREP - DRE) .GT. (HSTEP * DRRL)) THEN
  DRE = DREP - HSTEP * DRRL
ENDIF
**
***  POSITION LIMITS - ELEVONS
**
DLE = CLIMIT(DLE, DLEL, DLEU)
DRE = CLIMIT(DRE, DREL, DREU)
**
***  PAST VALUES FOR ELEVON DEFLECTIONS
**
DLEPP = DLEP
DLEP = DLE
DREPP = DREP
DREP = DRE
**
***  BODY FLAP DEFLECTIONS
**
DUL = DULZ1 * DULP + DULZ2 * DULPP + DULZ3 * DULC
DUR = DURZ1 * DURP + DURZ2 * DURPP + DURZ3 * DURC
DLL = DLLZ1 * DLLP + DLLZ2 * DLLPP + DLLZ3 * DLLC
DLR = DLRZ1 * DLRP + DLRZ2 * DLRPP + DLRZ3 * DLRC
**
***  RATE LIMITS - BODY FLAPS
**
IF ((DUL - DULP) .GT. (HSTEP * DULRL)) THEN
  DUL = DULP + HSTEP * DULRL
ELSEIF ((DULP - DUL) .GT. (HSTEP * DULRL)) THEN
  DUL = DULP - HSTEP * DULRL
ENDIF
IF ((DUR - DURP) .GT. (HSTEP * DURRL)) THEN
  DUR = DURP + HSTEP * DURRL
ELSEIF ((DURP - DUR) .GT. (HSTEP * DURRL)) THEN
  DUR = DURP - HSTEP * DURRL
ENDIF

```

```

IF ((DLL - DLLP) .GT. (HSTEP * DLLRL)) THEN
  DLL = DLLP + HSTEP * DLLRL
ELSEIF ((DLLP - DLL) .GT. (HSTEP * DLLRL)) THEN
  DLL = DLLP - HSTEP * DLLRL
ENDIF
IF ((DLR - DLRP) .GT. (HSTEP * DLRL)) THEN
  DLR = DLRP + HSTEP * DLRL
ELSEIF ((DLRP - DLR) .GT. (HSTEP * DLRL)) THEN
  DLR = DLRP - HSTEP * DLRL
ENDIF
**
*** POSITION LIMITS - BODY FLAPS
**
  DUL = CLIMIT(DUL, DULL, DULU)
  DUR = CLIMIT(DUR, DURL, DURU)
  DLL = CLIMIT(DLL, DLLL, DLLU)
  DLR = CLIMIT(DLR, DLRL, DLRU)
**
*** PAST VALUES FOR BODY FLAP DEFLECTIONS
**
  DULPP = DULP
  DULP = DUL
  DURPP = DURP
  DURP = DUR
  DLLPP = DLLP
  DLLP = DLL
  DLRPP = DLRP
  DLRP = DLR
**
*** RUDDER DEFLECTION
**
  DR = DRZ1 * DRP + DRZ2 * DRPP + DRZ3 * DRC
**
*** RATE LIMITS - RUDDER
**
  IF ((DR - DRP) .GT. (HSTEP * DRRL)) THEN
    DR = DRP + HSTEP * DRRL
  ELSEIF ((DRP - DR) .GT. (HSTEP * DRRL)) THEN
    DR = DRP - HSTEP * DRRL
  ENDIF
**
*** POSITION LIMITS - RUDDER
**
  DR = CLIMIT(DR, DRL, DRU)
  DLRDEG = DR
**
*** PAST VALUES FOR RUDDER DEFLECTION
**
  DRPP = DRP
  DRP = DR
*
**
10 CONTINUE
**
  END

```



Appendix D
Trimmed Flight Condition check case data



Appendix D: Trimmed Flight Condition Check Case Data Sets

"cctrim0.txt" - Subsonic trim shot

IC CASE 10K, Y1, 10H, 10L, HK, 2D, 4D, 4B, 4S, P1, P2, P3, P4, M? 10K
 TEST DESCRIPTION ? 10K TRIM

NZQ SAS MODE		T		IAS	THETA	ALT	ALPHA	DE	DSB	HER	XRWY	ICMD
MACH	HDG	PHI	HDOT	NZ	DAC	DR	GAMMA	YRWY	MODE			
.00	298.2	-11.3	10000.	5.7	5.5	16.4	0.	-38285.	0			
.544	330.0	.0	-171.2	.99	.0	.0	-17.0	0.	132			
03/30/92. 09.26.22. PLT=BATMAN LFT-T FCSLM=23 WND= 0. 0. TRB= 0.												
DME, BRG, XT, AC, GC, PSC, PHC= 6.5 330.0 0. 4.5 -18.2 330.0 .0												

WEIGHT, AREA, CBAR, SPAN, QBAR, MACH
 .1910D+05 .2865D+03 .2824D+02 .1389D+02 .3010D+03 .5435D+00
 BODY AXIS F&M XB, YB, ZB, LB, MB, NB
 -.4689D+04 -.2359D-13 -.1894D+05 -.6667D-10 -.1481D+03 .5903D-13
 STAB AXIS F&M XS, YS, ZS, LS, MS, NS
 -.6540D+04 -.2359D-13 -.1838D+05 -.6633D-10 -.1481D+03 .6656D-11
 ACCEL UDOT, VDOT, WDOT, PDOT, QDOT, RDOT FPS**2 OR RPS**2
 -.1583D+01 .7143D-14 -.3529D+00 .0000D+00 -.4049D-02 .0000D+00
 NBP (1-12) = 1 4 2 4 2 3 3 1 8 1 1 1
 WN (1-12) = .8116733002521 .5720564112974 .09461025536921
 .5720564112974 .09461025536921 .3637276570303 .3637276570303
 0. -286.8191850114 0. -2941.167058824 .00032
 ALPHA= 5.679390868367 BETA= 2.236532855333E-17
 P, Q, R RPS=0. -.0001295822729791 0.
 DUL= -6.419153830538 DUR= -6.419153830538
 DLL= 16.41915383054 DLR= 16.41915383054
 DLE= 5.455914855455 DRE= 5.455914855455
 DR= 0. DXCG= -.4236
 H/B= 719.5479625286 GEAR= 0.

Appendix D: Trimmed Flight Condition Check Case Data Sets

Aerodynamic coefficient buildups

CLBAS, CLULBF, CLURBF, CLLLBF, CLLRBF, CLDR	.1647D+00	-.1508D-01	-.1508D-01	.2586D-01	.2586D-01	.0000D+00
CLDLE, CLDRE, CLGE, CLLG	.1345D-01	.1345D-01	.0000D+00	.0000D+00	.0000D+00	.0000D+00
CDBAS, CDULBF, CDURBF, CDLLBF, CDLRBF, CDDR	.6400D-01	.3183D-03	.3183D-03	.3466D-02	.3466D-02	.0000D+00
CDDLE, CDDRE, CDGE, CDLG	.2135D-02	.2135D-02	.0000D+00	.0000D+00	.0000D+00	.0000D+00
CMBAS, CMULBF, CMURBF, CMLLBF, CMLRBF, CMDR	.4680D-02	.5097D-02	.5097D-02	-.4750D-02	-.4750D-02	.0000D+00
CMDLE, CMDRE, CMQ, CMGE, CMLG	-.4365D-02	-.4365D-02	-.1557D+00	.0000D+00	.0000D+00	.0000D+00
CYBAS, CYULBF, CYURBF, CYLLBF, CYLRBF, CYDR	-.1223D-01	.1530D-02	-.1530D-02	.5641D-02	-.5641D-02	.0000D+00
CYDLE, CYDRE, CYGE, CYLG	.1978D-01	-.1978D-01	.0000D+00	.0000D+00	.0000D+00	.0000D+00
CLNBAS, CLNULBF, CLNURBF, CLNLLBF, CLNLRBF, CLNDR	.2576D-02	-.5295D-03	.5295D-03	-.2574D-02	.2574D-02	.0000D+00
CLNDLE, CLNDRE, CLNP, CLNR, CLNGE, CLNLG	-.1744D-01	.1744D-01	.3116D+00	-.5042D+00	.0000D+00	.0000D+00
CLLBAS, CLLULBF, CLLURBF, CLLLRF, CLLRBF, CLLDR	-.6502D-02	-.1827D-02	.1827D-02	.8275D-02	-.8275D-02	.0000D+00
CLLDLE, CLLDRE, CLLP, CLLR, CLLGE, CLLG	.1519D-01	-.1519D-01	-.8578D+00	.6856D+00	.0000D+00	.0000D+00
CLTOT, CLBAS, DCLBF, DCLDE, CLDR, CLGE, CLLG	.2131D+00	.1647D+00	.2157D-01	.2690D-01	.0000D+00	.0000D+00
.0000D+00						
CDTOT, CDBAS, DCDBF, DCDDE, CDDR, CDGE, CDLG	.7584D-01	.6400D-01	.7568D-02	.4271D-02	.0000D+00	.0000D+00
.0000D+00						
CMTOT, CMBAS, DCMBF, DCMDE, CMDR, CMGE, CMLG, DCMQ	-.3355D-02	.4680D-02	.6949D-03	-.8730D-02	.0000D+00	.0000D+00
.0000D+00	.4864D-06					
CYTOT, DCYBAS, DCYBF, DCYDE, DCYDR, DCYGE, DCYLG	-.2735D-18	-.2735D-18	.0000D+00	.0000D+00	.0000D+00	.0000D+00
.0000D+00						
CLNTOT, DCLNBAS, DCLNBF, DCLNDE, DCLNDR, DCLNGE, DCLNLG, DCLNDMP	.5762D-19	.5762D-19	.0000D+00	.0000D+00	.0000D+00	.0000D+00
.0000D+00	.0000D+00					
CLLTOT, DCLLBAS, DCLLBF, DCLLDE, DCLLDR, DCLLGE, DCLLLG, DCLLDMP	-.5566D-16	-.1454D-18	-.5551D-16	.0000D+00	.0000D+00	.0000D+00
.0000D+00	.0000D+00					

Appendix D: Trimmed Flight Condition Check Case Data Sets

"cctrim2.txt" - Mach 2 trim shot

IC CASE 10K,Y1,10H,10L,HK,2D,4D,4B,4S,P1,P2,P3,P4,M? 2D
 TEST DESCRIPTION ? MACH 2 TRIM

NZQ SAS MODE										
T	IAS	THETA	ALT	ALPHA	DE	DSB	HER	XRWY	ICMD	
MACH	HDG	PHI	HDOT	NZ	DAC	DR	GAMMA	YRWY	MODE	
.00	364.0	-8.0	58700.	6.0	-24.5	.0	5628.	46430.	0	
1.997	147.0	.0	-467.7	1.00	.0	.0	-14.0	-66309.	632	
DME, BRG, XT, AC, GC, PSC, PHC=				16.5	95.0	58894.	6.0	-14.0	147.1	1.2
WEIGHT, AREA, CBAR, SPAN, QBAR, MACH				.1910D+05	.2865D+03	.2824D+02	.1389D+02	.4485D+03	.1996D+01	
BODY AXIS F&M XB, YB, ZB, LB, MB, NB				-.1848D+05	-.4005D-14	-.1920D+05	.9899D-11	-.1959D+03	.4695D-11	
STAB AXIS F&M XS, YS, ZS, LS, MS, NS				-.2039D+05	-.4005D-14	-.1716D+05	.1034D-10	-.1959D+03	.3634D-11	
ACCEL UDOT, VDOT, WDOT, PDOT, QDOT, RDOT				FPS**2 OR RPS**2						
				-.2664D+02	.4223D-16	-.4731D+00	.9968D-15	-.7551D-02	-.1324D-15	
NBP (1-12) = 8 2 1 2 1 1 1 1 8 1 1 1										
WN (1-12) = .989927582443 .4672603256935 .00004813084663607										
.4672603256935 .00004813084663684 .3668190883164 .3668190883164										
4.454701521235E-18 -1688.993867273 0. -2941.167058824										
.00032										
ALPHA= 6.002195965025 BETA= 4.007150396168E-20										
P, Q, R RPS=3.189616514552E-17 -.0002416216751572 -4.237438306065E-18										
DUL= -37.9910951146 DUR= -37.9910951146										
DLL= .000721962699541 DLR= .0007219626995526										
DLE= -24.49771367525 DRE= -24.49771367525										
DR= -6.682052281852E-17 DXCG= -.4236										
H/B= 4224.984668183 GEAR= 0.										

Appendix D: Trimmed Flight Condition Check Case Data Sets

Aerodynamic coefficient buildups

CLBAS, CLULBF, CLURBF, CLLLBF, CLLRBF, CLDR	.1617D+00	-.8236D-02	-.8236D-02	.5932D-06	.5932D-06	-.2505D-19
CLDLE, CLDRE, CLGE, CLLG	-.5813D-02	-.5813D-02	.0000D+00	.0000D+00	.0000D+00	.0000D+00
CDBAS, CDULBF, CDURBF, CDLLBF, CDLRBF, CDDR	.1477D+00	.2273D-02	.2273D-02	.3116D-06	.3116D-06	-.9801D-20
CDDLE, CDDRE, CDGE, CDLG	.3195D-02	.3195D-02	.0000D+00	.0000D+00	.0000D+00	.0000D+00
CMBAS, CMULBF, CMURBF, CMLLBF, CMLRBF, CMDR	-.1841D-01	.3706D-02	.3706D-02	-.2009D-06	-.2009D-06	.7871D-20
CMDLE, CMDRE, CMQ, CMGE, CMLG	.4350D-02	.4350D-02	-.1543D+00	.0000D+00	.0000D+00	.0000D+00
CYBAS, CYULBF, CYURBF, CYLLBF, CYLRBF, CYDR	-.1231D-01	-.1438D-03	.1438D-03	.2015D-07	-.2015D-07	.8214D-19
CYDLE, CYDRE, CYGE, CYLG	-.9213D-02	.9213D-02	.0000D+00	.0000D+00	.0000D+00	.0000D+00
CLNBAS, CLNULBF, CLNURBF, CLNLLBF, CLNLRBF, CLNDR	.4720D-03	-.1191D-02	.1191D-02	-.6316D-07	.6316D-07	-.7932D-19
CLNDLE, CLNDRE, CLNP, CLNR, CLNGE, CLNLG	.6980D-02	-.6980D-02	.3067D+00	-.5033D+00	.0000D+00	.0000D+00
CLLBAS, CLLULBF, CLLURBF, CLLLRF, CLLRBF, CLLDR	-.2845D-02	-.4593D-02	.4593D-02	.1162D-06	-.1162D-06	.1276D-19
CLLDLE, CLLDRE, CLLP, CLLR, CLLGE, CLLLG	-.8373D-02	.8373D-02	-.8609D+00	.6920D+00	.0000D+00	.0000D+00
CLTOT, CLBAS, DCLBF, DCLDE, CLDR, CLGE, CLLG	.1336D+00	.1617D+00	-.1647D-01	-.1163D-01	-.2505D-19	.0000D+00
	.0000D+00					
CDTOT, CDBAS, DCDBF, DCDDE, CDDR, CDGE, CDLG	.1587D+00	.1477D+00	.4546D-02	.6391D-02	-.9801D-20	.0000D+00
	.0000D+00					
CMTOT, CMBAS, DCMBF, DCMDE, CMDR, CMGE, CMLG, DCMQ	-.2296D-02	-.1841D-01	.7411D-02	.8699D-02	.7871D-20	.0000D+00
	.0000D+00	.2725D-06				
CYTOT, DCYBAS, DCYBF, DCYDE, DCYDR, DCYGE, DCYLG	-.3117D-19	-.4931D-21	.5146D-19	.0000D+00	-.8214D-19	.0000D+00
	.0000D+00					
CLNTOT, DCLNBAS, DCLNBF, DCLNDE, DCLNDR, DCLNGE, DCLNLG, DCLNDMP	.2632D-17	.1891D-22	.2510D-17	.0000D+00	.7932D-19	.0000D+00
	.0000D+00	.4283D-19				
CLLTOT, DCLLBAS, DCLLBF, DCLLDE, DCLLDR, DCLLGE, DCLLLG, DCLLDMP	.5548D-17	-.1140D-21	.5670D-17	.0000D+00	-.1276D-19	.0000D+00
	.0000D+00	-.1092D-18				

Appendix D: Trimmed Flight Condition Check Case Data Sets

"cctrim4.txt" - Mach 4 trim shot

IC CASE 10K, Y1, 10H, 10L, HK, 2D, 4D, 4B, 4S, P1, P2, P3, P4, M? 4D
 TEST DESCRIPTION ? MACH 4 TRIM

NZQ SAS MODE	T	IAS	THETA	ALT	ALPHA	DE	DSB	HER	XRWY	ICMD
MACH	HGD	PHI	HDOT	NZ	DAC	DR	GAMMA	YRWY	MODE	
	.00	253.4	14.0	104000.	17.0	4.0	.055557.	360000.		0
	3.999	154.0	.0	-208.0	1.00	.0	.0	-3.0	-72000.	632
DME, BRG, XT, AC, GC, PSC, PHC=				62.9	138.7	367290.	17.0	-3.0	148.6	-50.0
WEIGHT, AREA, CBAR, SPAN, QBAR, MACH										
	.1910D+05	.2865D+03	.2824D+02			.1389D+02		.2174D+03		.3999D+01
BODY AXIS F&M XB, YB, ZB, LB, MB, NB										
	-.5852D+04	-.2020D-14	-.1917D+05			-.9424D-14		.2203D+03		.4467D-14
STAB AXIS F&M XS, YS, ZS, LS, MS, NS										
	-.1120D+05	-.2020D-14	-.1662D+05			-.7706D-14		.2203D+03		.7028D-14
ACCEL UDOT, VDOT, WDOT, PDOT, QDOT, RDOT						FPS**2 OR RPS**2				
	-.1764D+02	.7143D-14	-.1064D+01			.0000D+00		.7188D-02		.0000D+00
NBP(1-12) =	12	4	1	4	1	3	3	1	8	1
WN(1-12) =	.9979171698185	.9999839724281	.00004813084663645			.00004813084663645		.2755537001452		.2755537001452
	.9999839724281	.00004813084663645	.2755537001452			.00032				
ALPHA=	17.00190977982	BETA=	3.296392158263E-18							
P, Q, R RPS=	0.	.0002300295188416	0.							
DUL=	-.0002404135789491	DUR=	-.0002404135789491							
DLL=	.0007219626995468	DLR=	.0007219626995468							
DLE=	4.133305502178	DRE=	4.133305502178							
DR=	0.	DXCG=	-.4236							
H/B=	7486.921781187	GEAR=	0.							

Aerodynamic coefficient buildups

CLBAS, CLULBF, CLURBF, CLLLBF, CLLRBF, CLDR	.2658D+00	-.5318D-08	-.5318D-08	.3245D-06	.3245D-06	.0000D+00
CLDLE, CLDRE, CLGE, CLLG	.5913D-03	.5913D-03	.0000D+00	.0000D+00	.0000D+00	.0000D+00
CDBAS, CDULBF, CDURBF, CDLLBF, CDLRBF, CDDR	.1785D+00	-.5348D-08	-.5348D-08	.2759D-06	.2759D-06	.0000D+00
CDDLE, CDDRE, CDGE, CDLG	.6887D-03	.6887D-03	.0000D+00	.0000D+00	.0000D+00	.0000D+00
CMBAS, CMULBF, CMURBF, CMLLBF, CMLRBF, CMDR	-.4152D-02	.8306D-08	.8306D-08	-.1559D-06	-.1559D-06	.0000D+00
CMDLE, CMDRE, CMQ, CMGE, CMLG	-.1704D-03	-.1704D-03	-.2044D+00	.0000D+00	.0000D+00	.0000D+00
CYBAS, CYULBF, CYURBF, CYLLBF, CYLRBF, CYDR	-.9792D-02	.4757D-08	-.4757D-08	.6043D-08	-.6043D-08	.0000D+00
CYDLE, CYDRE, CYGE, CYLG	.1235D-02	-.1235D-02	.0000D+00	.0000D+00	.0000D+00	.0000D+00
CLNBAS, CLNULBF, CLNURBF, CLNLLBF, CLNLRBF, CLNDR	.1096D-02	-.2352D-08	.2352D-08	-.5739D-07	.5739D-07	.0000D+00
CLNDLE, CLNDRE, CLNP, CLNR, CLNGE, CLNLG	-.1648D-02	.1648D-02	.1910D+00	-.5530D+00	.0000D+00	.0000D+00
CLLBAS, CLLULBF, CLLURBF, CLLLRF, CLLRBF, CLLDR	-.1763D-02	-.2554D-08	.2554D-08	.1161D-06	-.1161D-06	.0000D+00
CLLDLE, CLLDRE, CLLP, CLLR, CLLGE, CLLG	.8055D-03	-.8055D-03	-.9482D+00	.7158D+00	.0000D+00	.0000D+00
CLTOT, CLBAS, DCLBF, DCLDE, CLDR, CLGE, CLLG	.2669D+00	.2658D+00	.6383D-06	.1183D-02	.0000D+00	.0000D+00
.0000D+00						
CDTOT, CDBAS, DCDBF, DCDE, CDDR, CDGE, CDLG	.1799D+00	.1785D+00	.5412D-06	.1377D-02	.0000D+00	.0000D+00
.0000D+00						
CMTOT, CMBAS, DCMBF, DCMDE, CMDR, CMGE, CMLG, DCMQ	-.4493D-02	-.4152D-02	-.2952D-06	-.3407D-03	.0000D+00	.0000D+00
.0000D+00	-.1671D-06					
CYTOT, DCYBAS, DCYBF, DCYDE, DCYDR, DCYGE, DCYLG	-.3244D-19	-.3228D-19	-.1588D-21	.0000D+00	.0000D+00	.0000D+00
.0000D+00						
CLNTOT, DCLNBAS, DCLNBF, DCLNDE, DCLNDR, DCLNGE, DCLNLG, DCLNDMP	.6154D-20	.3613D-20	.2541D-20	.0000D+00	.0000D+00	.0000D+00
.0000D+00	.0000D+00					
CLLTOT, DCLLBAS, DCLLBF, DCLLDE, DCLLDR, DCLLGE, DCLLLG, DCLLDMP	-.1090D-19	-.5813D-20	-.5082D-20	.0000D+00	.0000D+00	.0000D+00
.0000D+00	.0000D+00					

Appendix E
Aero Data Base for
HL-20 Flight Simulation Studies



Aerodynamic Tables

All aerodynamic functions are encoded as third-order polynomials in angle of attack (alpha):

$$C_i = a_0 + a_1\alpha + a_2\alpha^2 + a_3\alpha^3$$

A good FORTRAN implementation might be:

$$\text{COEFF} = ((A3*\text{ALPHA}) + A2)*\text{ALPHA} + A1)*\text{ALPHA} + A0$$

The polynomial coefficients a_0 , a_1 , a_2 , and a_3 are given in the enclosed tables.

For a given Mach number (and deflection, for control 'delta' tables), the rows of the tables are as follows:

a_0, a_1, a_2, a_3	for coeff. of lift (C_L)
a_0, a_1, a_2, a_3	for coeff. of drag (C_D)
a_0, a_1, a_2, a_3	for coeff. of pitching moment (C_m)
a_0, a_1, a_2, a_3	for coeff. of sideforce (C_Y)
a_0, a_1, a_2, a_3	for coeff. of yawing moment (C_n)
a_0, a_1, a_2, a_3	for coeff. of rolling moment (C_l)

Thus, for a given Mach number (and deflection) there are $6 \times 4 = 24$ entries.

Table 1 is for basic (no controls deflected) aerodynamics [$f(\text{Mach})$].

Tables 2 through 5 given coefficient increments for deflections of the upper left body flap, lower left body flap, left wing flap (elevon), and all-moveable fin (rudder). [$f(\text{deflection}, \text{Mach})$]

Table 6 is slightly unusual: it gives coefficients for damping derivatives in the following order:

a_0, a_1, a_2, a_3	for coeff. of pitch damping (C_{mq})
a_0, a_1, a_2, a_3	for coeff. of yaw damping due to roll rate (C_{np})
a_0, a_1, a_2, a_3	for coeff. of roll damping due to roll rate (C_{lp})
a_0, a_1, a_2, a_3	for coeff. of roll damping due to yaw rate (C_{nr})
a_0, a_1, a_2, a_3	for coeff. of yaw damping due to yaw rate (C_{lr})

These are functions of alpha only! (constant with Mach)

Table 7 gives ground effect deltas, as a function of normalized height above ground (altitude above runway/wing span, or h/b). We are using height of the c.g. as the altitude to be normalized.

Table 8 gives landing gear effect deltas, as a function of gear angle ($0-90^\circ$) where 90° is fully extended.

Deflection angles are in degrees; negative indicates trailing edge up (flaps and elevons) or trailing edge left (rudder).

Control deltas are assumed symmetrical, so the effects for right body flaps and elevons are duplicates of the left surfaces longitudinally and negated for the lateral/directional data. Rudder data is for trailing edge left, and needs to be mirrored for right deflections (long = same, lat/dir = -same).

Database Limits

Angle of attack limits (degrees):

$$0 \leq \text{Mach} < 1.1 : -2 < \alpha \leq 26$$

$$1.1 \leq \text{Mach} < 1.6 : -2 < \alpha \leq 15$$

$$1.6 \leq \text{Mach} < 3.0 : -2 < \alpha \leq 15 @ M=1.6, \text{ ramps to } 30 @ M=3$$

$$3.0 \leq \text{Mach} < 4.0 : -2 < \alpha \leq 30$$

Surface limits (degrees):

$$-60 \leq \text{upper body flaps} \leq 0$$

$$0 \leq \text{lower body flaps} \leq +60$$

$$-30 \leq \text{wing flaps} \leq +30$$

$$-30 \leq \text{all-moveable fin} \leq +30$$

Reference Quantities

Span: 13.89 ft

Area: 286.45 ft²

Chord: 28.24 ft

Center of Gravity - Moment transfer

The aero data presented here was measured at a moment reference center at 54 % of body length, along the Z-axis. For center of gravity locations other than 54 %, the moment coefficients will have to be adjusted to account for the shift in location, using conventional moment reference center transfer relationships. [The current center of gravity being tested in the simulator at Langley is 55.5 %.]

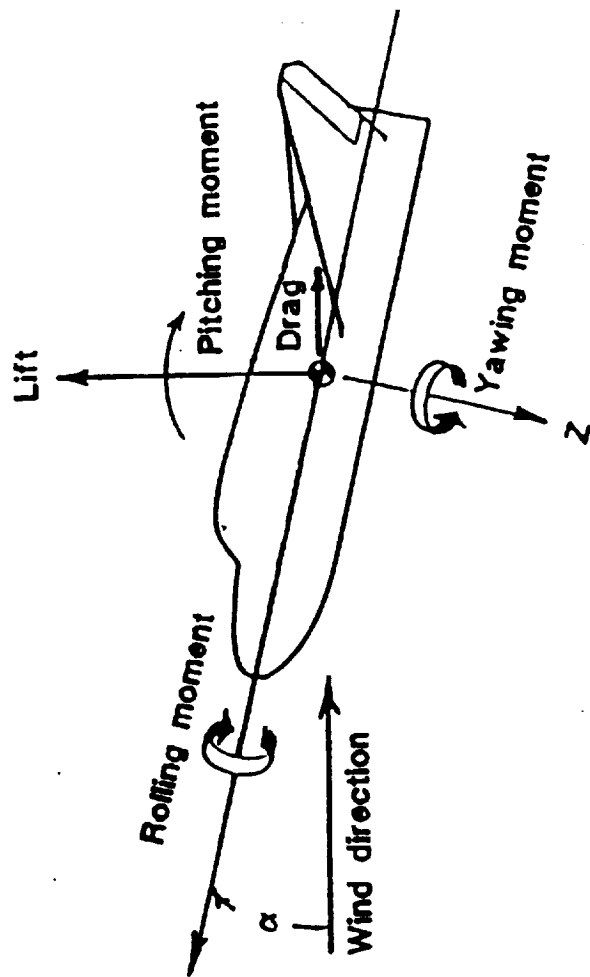
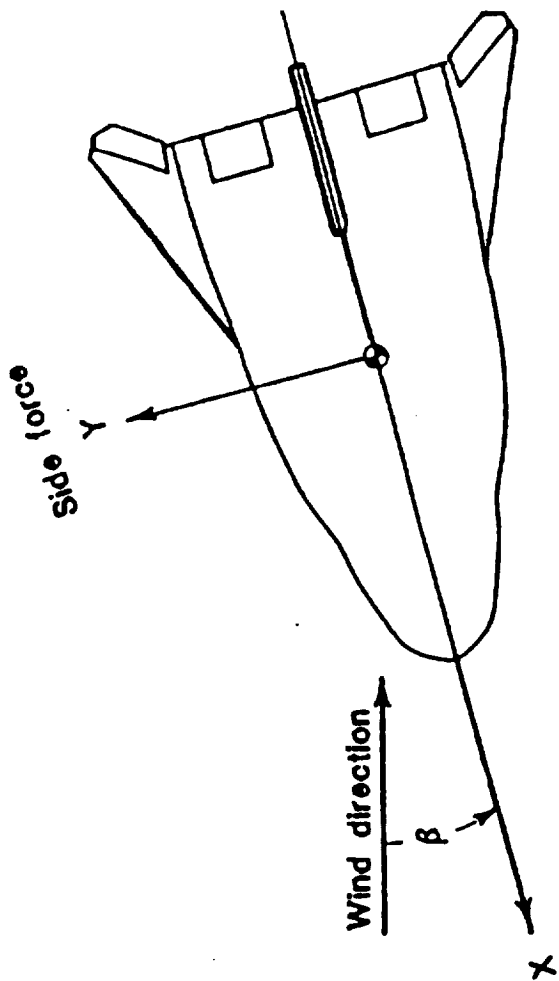

AERO COEFFICIENT DEFINITIONS USED FOR HL-20 DATA BASE

$$C_L = C_{L,BASIC} + \Delta C_{L,BF} + \Delta C_{L,E} + \Delta C_{L,R} + \Delta C_{L,GE} + \Delta C_{L,LG}$$

$$C_D = C_{D,BASIC} + \Delta C_{D,BF} + \Delta C_{D,E} + \Delta C_{D,R} + \Delta C_{D,GE} + \Delta C_{D,LG}$$

$$C_m = C_{m,BASIC} + \Delta C_{m,BF} + \Delta C_{m,E} + \Delta C_{m,R} + \Delta C_{m,GE} + \Delta C_{m,LG} + \left(C_{m_q} \right) \left(\frac{q\bar{c}}{2V} \right)$$

$$C_Y = (C_{Y\beta,BASIC})(\beta) + \Delta C_{Y,BF} + \Delta C_{Y,E} + \Delta C_{Y,R} + (\Delta C_{Y\beta,GE})(\beta) + (\Delta C_{Y\beta,LG})(\beta)$$

$$C_n = (C_{n\beta,BASIC})(\beta) + \Delta C_{n,BF} + \Delta C_{n,E} + \Delta C_{n,R} + (\Delta C_{n\beta,GE})(\beta) + (\Delta C_{n\beta,LG})(\beta) + (\Delta C_{n_p}) \left(\frac{pb}{2V} \right) + (\Delta C_{n_r}) \left(\frac{rb}{2V} \right)$$

$$C_l = (C_{l\beta,BASIC})(\beta) + \Delta C_{l,BF} + \Delta C_{l,E} + \Delta C_{l,R} + (\Delta C_{l\beta,GE})(\beta) + (\Delta C_{l\beta,LG})(\beta) + (\Delta C_{l_p}) \left(\frac{pb}{2V} \right) + (\Delta C_{l_r}) \left(\frac{rb}{2V} \right)$$

- "BF" denotes contributions from 4 separate flaps
- "E" denotes contributions from 2 separate flaps
- $S_{ref} = 286.45 \text{ ft}^2$ $\bar{c}_{ref} = 28.24 \text{ ft}$ $b_{ref} = 13.89 \text{ ft}$
 $x_{cg,ref} = 0.54 \bar{c}_{ref}$ $z_{cg,ref} = 0$ (nose)

AERO DATA BASE FORMAT

Lift
Drag
Pitch
Side
Yaw
Roll

Example: $C_{L,BASIC} = a_0 + a_1\alpha + a_2\alpha^2 + a_3\alpha^3$

$(a_0, a_1, a_2, a_3$ tabulated in data base)

Mach numbers: 0.3, 0.6, 0.9, 0.95, 1.1, 1.2, 1.6, 2.0, 2.5, 3.0, 3.5, 4.0

Basic coefficients	C_L C_D C_m C_Y C_β C_n C_l C_r C_l C_r	13 Mach nos.
Upper left body flap	ΔC_L ΔC_D ΔC_m	13 Mach nos., $\delta = -60^\circ, -45^\circ, -30^\circ, -15^\circ, 0^\circ$
Lower left body flap	ΔC_Y ΔC_n ΔC_l	13 Mach nos., $\delta = 0^\circ, 15^\circ, 30^\circ, 45^\circ, 60^\circ$
Left elevon	C_{mq} C_{np} C_{lp} C_{nr} C_{lr}	13 Mach nos., $\delta = -30^\circ, -15^\circ, 0^\circ, 15^\circ, 30^\circ$
Rudder	ΔC_L ΔC_D ΔC_m	13 Mach nos., $\delta = 0^\circ, 15^\circ, 30^\circ$
Dynamic damping	ΔC_Y ΔC_n ΔC_l ΔC_β	$h/b = 0.2, 0.4, 0.6, 0.8, 1.0, 1.5, 2.0, 2.5$
Ground effects	ΔC_Y ΔC_n ΔC_l ΔC_β	$\theta_{LG} = 0^\circ, 15^\circ, 30^\circ, 60^\circ, 90^\circ$
Landing gear		

AERO DATA BASE IN TABULATED FORM

HL-20 Aerodynamics Tables (version 2.0)

TABLE 1 - AERO FOR BASIC CONFIGURATION

0.30,	-0.53627E-01 ,	0.36236E-01 ,	0.16060E-03 ,	-0.65196E-05 ,
	0.52497E-01 ,	-0.94928E-03 ,	0.25082E-03 ,	0.74058E-05 ,
	0.13877E-01 ,	-0.16690E-02 ,	-0.60058E-04 ,	0.17663E-05 ,
	-0.11965E-01 ,	0.83671E-04 ,	-0.28288E-04 ,	0.93638E-06 ,
	0.28556E-02 ,	-0.14834E-03 ,	0.21107E-04 ,	-0.64189E-06 ,
	-0.49857E-02 ,	-0.14777E-03 ,	-0.26840E-04 ,	0.10307E-05 ,
0.60,	-0.57275E-01 ,	0.38033E-01 ,	0.35047E-03 ,	-0.18509E-04 ,
	0.57938E-01 ,	-0.18023E-02 ,	0.57369E-03 ,	-0.26238E-05 ,
	0.17416E-01 ,	-0.19652E-02 ,	-0.50693E-04 ,	0.27292E-05 ,
	-0.11965E-01 ,	0.83671E-04 ,	-0.28288E-04 ,	0.93638E-06 ,
	0.28556E-02 ,	-0.14834E-03 ,	0.21107E-04 ,	-0.64189E-06 ,
	-0.49857E-02 ,	-0.14777E-03 ,	-0.26840E-04 ,	0.10307E-05 ,
0.80,	-0.73425E-01 ,	0.43347E-01 ,	0.12122E-03 ,	-0.15927E-04 ,
	0.60114E-01 ,	-0.24390E-02 ,	0.80564E-03 ,	-0.83870E-05 ,
	0.25129E-01 ,	-0.30512E-02 ,	-0.48533E-04 ,	0.46453E-05 ,
	-0.13313E-01 ,	-0.13917E-03 ,	0.16040E-04 ,	-0.14751E-06 ,
	0.30814E-02 ,	0.11705E-03 ,	-0.22768E-05 ,	-0.29912E-06 ,
	-0.63969E-02 ,	-0.49202E-03 ,	0.28527E-04 ,	-0.30272E-06 ,
0.90,	-0.79696E-01 ,	0.48235E-01 ,	-0.25581E-03 ,	-0.76994E-05 ,
	0.75138E-01 ,	-0.19735E-02 ,	0.80452E-03 ,	-0.74729E-05 ,
	0.29294E-01 ,	-0.42409E-02 ,	0.54790E-04 ,	0.27028E-05 ,
	-0.15611E-01 ,	-0.62999E-04 ,	0.32037E-04 ,	-0.10789E-05 ,
	0.42835E-02 ,	0.16642E-03 ,	-0.27314E-04 ,	0.52397E-06 ,
	-0.76737E-02 ,	-0.66690E-03 ,	0.66701E-04 ,	-0.13407E-05 ,
0.95,	-0.78830E-01 ,	0.47794E-01 ,	-0.78668E-04 ,	-0.13045E-04 ,
	0.86848E-01 ,	-0.27646E-02 ,	0.10117E-02 ,	-0.13205E-04 ,
	0.32391E-01 ,	-0.37710E-02 ,	-0.56951E-04 ,	0.56053E-05 ,
	-0.15912E-01 ,	-0.16607E-03 ,	0.41530E-04 ,	-0.14669E-05 ,
	0.37185E-02 ,	0.11654E-03 ,	-0.27058E-04 ,	0.66226E-06 ,
	-0.75838E-02 ,	-0.56194E-03 ,	0.46742E-04 ,	-0.72842E-06 ,
1.10,	-0.80420E-01 ,	0.54653E-01 ,	-0.74764E-03 ,	0.35017E-05 ,
	0.15715E+00 ,	-0.22457E-02 ,	0.86140E-03 ,	-0.69411E-05 ,
	0.35408E-01 ,	-0.77162E-02 ,	0.14340E-03 ,	0.14758E-05 ,
	-0.17436E-01 ,	-0.44578E-03 ,	0.52213E-04 ,	-0.13753E-05 ,
	0.42175E-02 ,	0.54026E-03 ,	-0.60263E-04 ,	0.14709E-05 ,
	-0.92197E-02 ,	-0.75813E-03 ,	0.75548E-04 ,	-0.15350E-05 ,
1.20,	-0.44418E-01 ,	0.53040E-01 ,	-0.89926E-03 ,	0.81050E-05 ,
	0.15882E+00 ,	-0.23765E-02 ,	0.86128E-03 ,	-0.73481E-05 ,
	0.19680E-01 ,	-0.81532E-02 ,	0.26234E-03 ,	-0.16246E-05 ,
	-0.17879E-01 ,	-0.19663E-03 ,	0.23113E-04 ,	-0.63930E-06 ,
	0.44383E-02 ,	0.32543E-03 ,	-0.41639E-04 ,	0.10394E-05 ,
	-0.97140E-02 ,	-0.59220E-03 ,	0.69795E-04 ,	-0.15375E-05 ,
1.60,	-0.11257E-01 ,	0.41426E-01 ,	-0.81475E-03 ,	0.15473E-04 ,
	0.14629E+00 ,	-0.23102E-02 ,	0.93921E-03 ,	-0.15616E-04 ,
	-0.72872E-03 ,	-0.55882E-02 ,	0.22895E-03 ,	-0.36716E-05 ,
	-0.15850E-01 ,	0.35817E-03 ,	-0.34719E-04 ,	0.41024E-06 ,
	0.33514E-02 ,	-0.15356E-03 ,	-0.14852E-05 ,	0.49399E-06 ,
	-0.58210E-02 ,	-0.71430E-04 ,	0.20627E-04 ,	-0.78310E-06 ,
2.00,				

HL-20 Aerodynamics Tables (version 2.0)

	-0.15098E-01	, 0.31575E-01	, -0.42347E-03	, 0.93187E-05	,
	0.13571E+00	, -0.14175E-02	, 0.58796E-03	, -0.36904E-05	,
	-0.23853E-02	, -0.33833E-02	, 0.13745E-03	, -0.26807E-05	,
	-0.12972E-01	, 0.40337E-03	, -0.56678E-04	, 0.14443E-05	,
	0.91611E-03	, -0.19773E-03	, 0.22577E-04	, -0.42151E-06	,
2.50,	-0.25787E-02	, -0.75866E-04	, 0.77915E-05	, -0.29080E-06	,
	-0.22501E-01	, 0.25326E-01	, -0.16902E-03	, 0.43368E-05	,
	0.12507E+00	, -0.16493E-02	, 0.45005E-03	, 0.68132E-06	,
	0.63019E-03	, -0.21554E-02	, 0.78695E-04	, -0.18428E-05	,
	-0.11375E-01	, 0.45051E-04	, -0.15653E-04	, 0.45294E-06	,
	0.17560E-03	, -0.87232E-04	, 0.18282E-04	, -0.44906E-06	,
3.00,	-0.11511E-02	, -0.11055E-03	, 0.50955E-05	, -0.15251E-06	,
	-0.26367E-01	, 0.19838E-01	, 0.54004E-04	, -0.74887E-09	,
	0.11655E+00	, -0.15753E-02	, 0.36589E-03	, 0.23178E-05	,
	0.36321E-02	, -0.13864E-02	, 0.33042E-04	, -0.92622E-06	,
	-0.10999E-01	, 0.99710E-04	, -0.14988E-04	, 0.39433E-06	,
	-0.85873E-04	, 0.30454E-05	, 0.94849E-05	, -0.24655E-06	,
	-0.67164E-03	, -0.95497E-04	, 0.20573E-05	, -0.66340E-07	,
3.50,					
	-0.29176E-01	, 0.17125E-01	, 0.62657E-04	, 0.16984E-05	,
	0.10811E+00	, -0.15118E-02	, 0.29883E-03	, 0.41193E-05	,
	0.56630E-02	, -0.92858E-03	, 0.22256E-04	, -0.87723E-06	,
	-0.98676E-02	, 0.99902E-04	, -0.12273E-04	, 0.27149E-06	,
	-0.28449E-03	, 0.32275E-04	, 0.61112E-05	, -0.16268E-06	,
	-0.16431E-03	, -0.10324E-03	, 0.72182E-06	, -0.26927E-07	,
4.00,					
	-0.31811E-01	, 0.14809E-01	, 0.14650E-03	, 0.68917E-06	,
	0.10326E+00	, -0.15572E-02	, 0.27385E-03	, 0.45854E-05	,
	0.73127E-02	, -0.62463E-03	, 0.10139E-04	, -0.76651E-06	,
	-0.89074E-02	, 0.47669E-04	, -0.93184E-05	, 0.20343E-06	,
	-0.29727E-03	, 0.45155E-04	, 0.36455E-05	, -0.87185E-07	,
	0.12999E-03	, -0.11818E-03	, 0.81639E-06	, -0.24418E-07	,

HL-20 Aerodynamics Tables (version 2.0)

TABLE 2 - AERO INCREMENTS DUE TO UPPER LEFT BODY FLAP DEFLECTION

-60.0,				
0.30,	-0.10790E+00 ,	-0.39598E-02 ,	0.34147E-03 ,	-0.76617E-05 ,
	0.28614E-01 ,	-0.17940E-02 ,	0.19064E-04 ,	-0.81583E-06 ,
	0.25390E-01 ,	0.10224E-02 ,	-0.11650E-03 ,	0.30582E-05 ,
	-0.67145E-02 ,	0.25330E-02 ,	-0.11183E-03 ,	0.11335E-05 ,
	-0.37868E-03 ,	-0.54643E-03 ,	0.80448E-05 ,	0.35166E-06 ,
	-0.22137E-01 ,	0.19442E-03 ,	0.18689E-04 ,	-0.13353E-05 ,
0.60,	-0.12121E+00 ,	-0.44484E-02 ,	0.38362E-03 ,	-0.86072E-05 ,
	0.32146E-01 ,	-0.20153E-02 ,	0.21417E-04 ,	-0.91651E-06 ,
	0.28523E-01 ,	0.11485E-02 ,	-0.13088E-03 ,	0.34356E-05 ,
	-0.75431E-02 ,	0.28456E-02 ,	-0.12564E-03 ,	0.12734E-05 ,
	-0.42541E-03 ,	-0.61386E-03 ,	0.90376E-05 ,	0.39506E-06 ,
	-0.24869E-01 ,	0.21841E-03 ,	0.20995E-04 ,	-0.15001E-05 ,
0.80,	-0.13853E+00 ,	-0.50840E-02 ,	0.43843E-03 ,	-0.98371E-05 ,
	0.36739E-01 ,	-0.23033E-02 ,	0.24477E-04 ,	-0.10475E-05 ,
	0.32599E-01 ,	0.13126E-02 ,	-0.14958E-03 ,	0.39265E-05 ,
	-0.86209E-02 ,	0.32522E-02 ,	-0.14359E-03 ,	0.14553E-05 ,
	-0.48620E-03 ,	-0.70157E-03 ,	0.10329E-04 ,	0.45151E-06 ,
	-0.28422E-01 ,	0.24962E-03 ,	0.23995E-04 ,	-0.17144E-05 ,
0.90,	-0.14430E+00 ,	-0.52958E-02 ,	0.45669E-03 ,	-0.10247E-04 ,
	0.38269E-01 ,	-0.23992E-02 ,	0.25497E-04 ,	-0.10911E-05 ,
	0.33956E-01 ,	0.13673E-02 ,	-0.15581E-03 ,	0.40900E-05 ,
	-0.89799E-02 ,	0.33876E-02 ,	-0.14957E-03 ,	0.15159E-05 ,
	-0.50645E-03 ,	-0.73079E-03 ,	0.10759E-04 ,	0.47031E-06 ,
	-0.29606E-01 ,	0.26001E-03 ,	0.24994E-04 ,	-0.17858E-05 ,
0.95,	-0.10621E+00 ,	-0.38978E-02 ,	0.33613E-03 ,	-0.75419E-05 ,
	0.28167E-01 ,	-0.17659E-02 ,	0.18766E-04 ,	-0.80307E-06 ,
	0.24993E-01 ,	0.10064E-02 ,	-0.11468E-03 ,	0.30104E-05 ,
	-0.66094E-02 ,	0.24934E-02 ,	-0.11009E-03 ,	0.11158E-05 ,
	-0.37276E-03 ,	-0.53788E-03 ,	0.79189E-05 ,	0.34616E-06 ,
	-0.21791E-01 ,	0.19138E-03 ,	0.18396E-04 ,	-0.13144E-05 ,
1.10,	-0.91252E-01 ,	-0.26238E-02 ,	0.29091E-03 ,	-0.83573E-05 ,
	0.24318E-01 ,	-0.17354E-02 ,	0.46082E-04 ,	-0.20453E-05 ,
	0.22325E-01 ,	0.61464E-03 ,	-0.91771E-04 ,	0.30159E-05 ,
	-0.58554E-02 ,	0.20673E-02 ,	-0.83844E-04 ,	0.66666E-07 ,
	0.69166E-04 ,	-0.50942E-03 ,	-0.31720E-05 ,	0.13062E-05 ,
	-0.20482E-01 ,	0.33401E-03 ,	0.20587E-04 ,	-0.19550E-05 ,
1.20,	-0.81274E-01 ,	-0.17738E-02 ,	0.26074E-03 ,	-0.89012E-05 ,
	0.21750E-01 ,	-0.17151E-02 ,	0.64305E-04 ,	-0.28740E-05 ,
	0.20546E-01 ,	0.35331E-03 ,	-0.76488E-04 ,	0.30195E-05 ,
	-0.53524E-02 ,	0.17830E-02 ,	-0.66338E-04 ,	-0.63319E-06 ,
	0.36397E-03 ,	-0.49043E-03 ,	-0.10571E-04 ,	0.19466E-05 ,
	-0.19609E-01 ,	0.42915E-03 ,	0.22049E-04 ,	-0.23823E-05 ,
1.60,	-0.41371E-01 ,	0.16248E-02 ,	0.14011E-03 ,	-0.11076E-04 ,
	0.11482E-01 ,	-0.16339E-02 ,	0.13717E-03 ,	-0.61876E-05 ,
	0.13430E-01 ,	-0.69165E-03 ,	-0.15377E-04 ,	0.30342E-05 ,
	-0.33411E-02 ,	0.64622E-03 ,	0.36620E-05 ,	-0.34317E-05 ,
	0.15428E-02 ,	-0.41451E-03 ,	-0.40156E-04 ,	0.45075E-05 ,
	-0.16118E-01 ,	0.80962E-03 ,	0.27893E-04 ,	-0.40911E-05 ,

HL-20 Aerodynamics Tables (version 2.0)

2.00,	-0.18399E-01	0.57860E-03	0.15317E-03	-0.79914E-05
	0.86855E-02	-0.97873E-03	-0.22713E-05	0.17185E-05
	0.72739E-02	-0.36706E-03	-0.50677E-05	0.73619E-06
	0.33443E-02	-0.11476E-02	0.11806E-03	-0.41998E-05
	-0.50035E-02	0.76713E-03	-0.40094E-04	0.94873E-06
	-0.76450E-02	0.14487E-03	0.20025E-04	-0.96058E-06
2.50,	-0.12611E-01	-0.83223E-03	0.11557E-03	-0.25219E-05
	0.68112E-02	-0.10895E-02	0.54363E-04	-0.75053E-06
	0.52912E-02	-0.30220E-03	0.55186E-05	0.46683E-07
	0.65977E-02	-0.11331E-02	0.92328E-04	-0.26551E-05
	-0.69929E-02	0.10304E-02	-0.55069E-04	0.11074E-05
	-0.40981E-02	0.21967E-03	-0.47749E-05	-0.42599E-07
3.00,	-0.12685E-01	0.89264E-03	0.88935E-06	-0.68625E-06
	0.54926E-02	-0.97982E-03	0.60070E-04	-0.12141E-05
	0.51016E-02	-0.44019E-03	0.16512E-04	-0.15121E-06
	0.54385E-02	-0.51322E-03	0.18114E-04	-0.21052E-06
	-0.73359E-02	0.76892E-03	-0.27021E-04	0.31440E-06
	-0.31666E-02	0.24689E-03	-0.10291E-04	0.16195E-06
3.50,	-0.90818E-02	0.42043E-03	0.15249E-04	-0.74779E-06
	0.49866E-02	-0.78690E-03	0.45200E-04	-0.92976E-06
	0.46264E-02	-0.35325E-03	0.11567E-04	-0.77657E-07
	0.49941E-02	-0.55236E-03	0.20563E-04	-0.23765E-06
	-0.66325E-02	0.70494E-03	-0.25463E-04	0.31113E-06
	-0.25868E-02	0.17488E-03	-0.58482E-05	0.85025E-07
4.00,	-0.93313E-02	0.99491E-03	-0.31729E-04	0.39912E-06
	0.51748E-02	-0.67987E-03	0.31988E-04	-0.44387E-06
	0.40946E-02	-0.27479E-03	0.75447E-05	-0.31399E-07
	0.46385E-02	-0.58880E-03	0.29643E-04	-0.50696E-06
	-0.58278E-02	0.66562E-03	-0.26724E-04	0.36859E-06
	-0.21926E-02	0.12091E-03	-0.18185E-05	-0.32951E-09
-45.0,				
0.30,	-0.10016E+00	0.41735E-04	0.13947E-03	-0.47630E-05
	0.25309E-01	-0.17365E-02	0.20302E-04	-0.70720E-06
	0.24664E-01	0.53773E-03	-0.91378E-04	0.26395E-05
	-0.14454E-02	0.12260E-02	-0.40343E-04	-0.95350E-07
	-0.31569E-02	-0.25349E-03	0.11645E-04	0.11762E-07
	-0.17966E-01	-0.75365E-03	0.10746E-03	-0.33509E-05
0.60,	-0.11252E+00	0.46885E-04	0.15668E-03	-0.53508E-05
	0.28432E-01	-0.19507E-02	0.22807E-04	-0.79447E-06
	0.27708E-01	0.60409E-03	-0.10265E-03	0.29652E-05
	-0.16238E-02	0.13773E-02	-0.45321E-04	-0.10712E-06
	-0.35465E-02	-0.28477E-03	0.13082E-04	0.13214E-07
	-0.20184E-01	-0.84666E-03	0.12072E-03	-0.37644E-05
0.80,	-0.12859E+00	0.53583E-04	0.17906E-03	-0.61153E-05
	0.32495E-01	-0.22295E-02	0.26066E-04	-0.90798E-06
	0.31667E-01	0.69041E-03	-0.11732E-03	0.33889E-05
	-0.18558E-02	0.15741E-02	-0.51797E-04	-0.12242E-06
	-0.40533E-02	-0.32546E-03	0.14951E-04	0.15102E-07
	-0.23067E-01	-0.96763E-03	0.13797E-03	-0.43023E-05
0.90,				

HL-20 Aerodynamics Tables (version 2.0)

	-0.13395E+00	0.55814E-04	0.18652E-03	-0.63700E-05
	0.33848E-01	-0.23223E-02	0.27152E-04	-0.94580E-06
	0.32985E-01	0.71916E-03	-0.12221E-03	0.35301E-05
	-0.19331E-02	0.16397E-02	-0.53954E-04	-0.12752E-06
	-0.42221E-02	-0.33902E-03	0.15573E-04	0.15731E-07
	-0.24028E-01	-0.10079E-02	0.14371E-03	-0.44815E-05
0.95,	-0.98590E-01	0.41081E-04	0.13728E-03	-0.46885E-05
	0.24913E-01	-0.17093E-02	0.19984E-04	-0.69613E-06
	0.24278E-01	0.52932E-03	-0.89949E-04	0.25982E-05
	-0.14228E-02	0.12068E-02	-0.39712E-04	-0.93859E-07
	-0.31076E-02	-0.24953E-03	0.11462E-04	0.11578E-07
	-0.17685E-01	-0.74186E-03	0.10578E-03	-0.32985E-05
1.10,	-0.83862E-01	0.34646E-03	0.13276E-03	-0.57533E-05
	0.21391E-01	-0.16316E-02	0.41956E-04	-0.17346E-05
	0.21280E-01	0.27318E-03	-0.72177E-04	0.25868E-05
	-0.17420E-02	0.10537E-02	-0.29841E-04	-0.73722E-06
	-0.20917E-02	-0.27229E-03	0.10365E-05	0.88240E-06
	-0.16729E-01	-0.41382E-03	0.86779E-04	-0.33303E-05
1.20,	-0.74038E-01	0.55017E-03	0.12975E-03	-0.64636E-05
	0.19041E-01	-0.15797E-02	0.56613E-04	-0.24274E-05
	0.19279E-01	0.10230E-03	-0.60322E-04	0.25791E-05
	-0.19550E-02	0.95146E-03	-0.23256E-04	-0.11664E-05
	-0.14140E-02	-0.28747E-03	-0.59187E-05	0.14633E-05
	-0.16091E-01	-0.19499E-03	0.74106E-04	-0.33515E-05
1.60,	-0.34751E-01	0.13648E-02	0.11769E-03	-0.93039E-05
	0.96445E-02	-0.13724E-02	0.11522E-03	-0.51975E-05
	0.11281E-01	-0.58098E-03	-0.12916E-04	0.25486E-05
	-0.28065E-02	0.54282E-03	0.30760E-05	-0.28826E-05
	0.12959E-02	-0.34818E-03	-0.33730E-04	0.37863E-05
	-0.13539E-01	0.68007E-03	0.23430E-04	-0.34364E-05
2.00,	-0.15455E-01	0.48601E-03	0.12866E-03	-0.67126E-05
	0.72957E-02	-0.82212E-03	-0.19079E-05	0.14435E-05
	0.61100E-02	-0.30832E-03	-0.42568E-05	0.61839E-06
	0.28092E-02	-0.96399E-03	0.99170E-04	-0.35278E-05
	-0.42028E-02	0.64438E-03	-0.33678E-04	0.79692E-06
	-0.64217E-02	0.12169E-03	0.16821E-04	-0.80687E-06
2.50,	-0.10593E-01	-0.69906E-03	0.97073E-04	-0.21184E-05
	0.57213E-02	-0.91517E-03	0.45664E-04	-0.63043E-06
	0.44445E-02	-0.25384E-03	0.46355E-05	0.39213E-07
	0.55419E-02	-0.95182E-03	0.77554E-04	-0.22302E-05
	-0.58739E-02	0.86552E-03	-0.46257E-04	0.93016E-06
	-0.34423E-02	0.18452E-03	-0.40109E-05	-0.35782E-07
3.00,	-0.10655E-01	0.74981E-03	0.74704E-06	-0.57644E-06
	0.46137E-02	-0.82303E-03	0.50458E-04	-0.10198E-05
	0.42853E-02	-0.36976E-03	0.13870E-04	-0.12702E-06
	0.45683E-02	-0.43110E-03	0.15215E-04	-0.17683E-06
	-0.61620E-02	0.64588E-03	-0.22697E-04	0.26409E-06
	-0.26599E-02	0.20738E-03	-0.86444E-05	0.13603E-06
3.50,	-0.76286E-02	0.35315E-03	0.12809E-04	-0.62813E-06
	0.41887E-02	-0.66099E-03	0.37967E-04	-0.78098E-06

HL-20 Aerodynamics Tables (version 2.0)

0.38861E-02 , -0.29672E-03 , 0.97163E-05 , -0.65230E-07 ,
 0.41950E-02 , -0.46397E-03 , 0.17272E-04 , -0.19962E-06 ,
 -0.55712E-02 , 0.59214E-03 , -0.21388E-04 , 0.26134E-06 ,
 -0.21729E-02 , 0.14690E-03 , -0.49124E-05 , 0.71420E-07 ,
 4.00,
 -0.78381E-02 , 0.83571E-03 , -0.26652E-04 , 0.33526E-06 ,
 0.43468E-02 , -0.57108E-03 , 0.26869E-04 , -0.37284E-06 ,
 0.34394E-02 , -0.23082E-03 , 0.63375E-05 , -0.26375E-07 ,
 0.38962E-02 , -0.49458E-03 , 0.24899E-04 , -0.42584E-06 ,
 -0.48953E-02 , 0.55911E-03 , -0.22448E-04 , 0.30961E-06 ,
 -0.18418E-02 , 0.10156E-03 , -0.15275E-05 , -0.27676E-09 ,
 -30.0,
 0.30,
 -0.89878E-01 , 0.65844E-02 , -0.42271E-03 , 0.77631E-05 ,
 0.15506E-01 , -0.62231E-03 , -0.37647E-04 , 0.67108E-06 ,
 0.19826E-01 , -0.10549E-03 , -0.29626E-04 , 0.11670E-05 ,
 0.10123E-02 , 0.88953E-03 , -0.22234E-04 , -0.50394E-06 ,
 -0.17404E-02 , -0.17723E-03 , 0.43102E-05 , 0.18689E-06 ,
 -0.12931E-01 , 0.11183E-03 , 0.46844E-04 , -0.21966E-05 ,
 0.60,
 -0.10097E+00 , 0.73970E-02 , -0.47488E-03 , 0.87211E-05 ,
 0.17419E-01 , -0.69911E-03 , -0.42293E-04 , 0.75389E-06 ,
 0.22273E-01 , -0.11851E-03 , -0.33282E-04 , 0.13111E-05 ,
 0.11372E-02 , 0.99930E-03 , -0.24978E-04 , -0.56613E-06 ,
 -0.19552E-02 , -0.19911E-03 , 0.48421E-05 , 0.20996E-06 ,
 -0.14527E-01 , 0.12563E-03 , 0.52625E-04 , -0.24677E-05 ,
 0.80,
 -0.11540E+00 , 0.84539E-02 , -0.54273E-03 , 0.99672E-05 ,
 0.19908E-01 , -0.79900E-03 , -0.48335E-04 , 0.86161E-06 ,
 0.25455E-01 , -0.13545E-03 , -0.38037E-04 , 0.14984E-05 ,
 0.12997E-02 , 0.11421E-02 , -0.28547E-04 , -0.64701E-06 ,
 -0.22346E-02 , -0.22755E-03 , 0.55339E-05 , 0.23996E-06 ,
 -0.16602E-01 , 0.14358E-03 , 0.60144E-04 , -0.28202E-05 ,
 0.90,
 -0.12020E+00 , 0.88060E-02 , -0.56533E-03 , 0.10382E-04 ,
 0.20738E-01 , -0.83228E-03 , -0.50348E-04 , 0.89750E-06 ,
 0.26515E-01 , -0.14109E-03 , -0.39621E-04 , 0.15608E-05 ,
 0.13539E-02 , 0.11896E-02 , -0.29736E-04 , -0.67396E-06 ,
 -0.23277E-02 , -0.23703E-03 , 0.57644E-05 , 0.24995E-06 ,
 -0.17294E-01 , 0.14956E-03 , 0.62649E-04 , -0.29377E-05 ,
 0.95,
 -0.88472E-01 , 0.64815E-02 , -0.41610E-03 , 0.76416E-05 ,
 0.15263E-01 , -0.61258E-03 , -0.37058E-04 , 0.66058E-06 ,
 0.19516E-01 , -0.10384E-03 , -0.29162E-04 , 0.11488E-05 ,
 0.99648E-03 , 0.87561E-03 , -0.21886E-04 , -0.49605E-06 ,
 -0.17132E-02 , -0.17446E-03 , 0.42428E-05 , 0.18397E-06 ,
 -0.12729E-01 , 0.11008E-03 , 0.46112E-04 , -0.21622E-05 ,
 1.10,
 -0.73788E-01 , 0.52111E-02 , -0.30071E-03 , 0.43456E-05 ,
 0.13331E-01 , -0.69741E-03 , -0.95215E-05 , -0.34829E-06 ,
 0.16873E-01 , -0.17562E-03 , -0.24563E-04 , 0.13037E-05 ,
 0.30412E-03 , 0.76306E-03 , -0.16330E-04 , -0.85662E-06 ,
 -0.11044E-02 , -0.19159E-03 , -0.22943E-05 , 0.76545E-06 ,
 -0.12023E-01 , 0.19675E-03 , 0.39335E-04 , -0.22297E-05 ,
 1.20,
 -0.63992E-01 , 0.43636E-02 , -0.22374E-03 , 0.21467E-05 ,
 0.12043E-01 , -0.75401E-03 , 0.88480E-05 , -0.10213E-05 ,
 0.15109E-01 , -0.22351E-03 , -0.21495E-04 , 0.14071E-05 ,

HL-20 Aerodynamics Tables (version 2.0)

	-0.15775E-03	0.68797E-03	-0.12624E-04	-0.10972E-05
	-0.69830E-03	-0.20301E-03	-0.66552E-05	0.11534E-05
	-0.11553E-01	0.25457E-03	0.34814E-04	-0.22747E-05
1.60,	-0.24822E-01	0.97484E-03	0.84065E-04	-0.66457E-05
	0.68889E-02	-0.98031E-03	0.82302E-04	-0.37125E-05
	0.80577E-02	-0.41498E-03	-0.92260E-05	0.18205E-05
	-0.20046E-02	0.38773E-03	0.21971E-05	-0.20590E-05
	0.92568E-03	-0.24870E-03	-0.24093E-04	0.27045E-05
	-0.96708E-02	0.48576E-03	0.16736E-04	-0.24546E-05
2.00,	-0.11039E-01	0.34715E-03	0.91898E-04	-0.47947E-05
	0.52112E-02	-0.58723E-03	-0.13628E-05	0.10311E-05
	0.43643E-02	-0.22023E-03	-0.30406E-05	0.44171E-06
	0.20065E-02	-0.68857E-03	0.70836E-04	-0.25198E-05
	-0.30020E-02	0.46027E-03	-0.24056E-04	0.56923E-06
	-0.45869E-02	0.86918E-04	0.12015E-04	-0.57633E-06
2.50,	-0.75665E-02	-0.49933E-03	0.69338E-04	-0.15131E-05
	0.40866E-02	-0.65369E-03	0.32617E-04	-0.45031E-06
	0.31746E-02	-0.18131E-03	0.33111E-05	0.28009E-07
	0.39585E-02	-0.67987E-03	0.55396E-04	-0.15930E-05
	-0.41956E-02	0.61823E-03	-0.33041E-04	0.66440E-06
	-0.24588E-02	0.13180E-03	-0.28649E-05	-0.25559E-07
3.00,	-0.76107E-02	0.53558E-03	0.53360E-06	-0.41174E-06
	0.32955E-02	-0.58788E-03	0.36042E-04	-0.72842E-06
	0.30609E-02	-0.26411E-03	0.99068E-05	-0.90726E-07
	0.32630E-02	-0.30793E-03	0.10868E-04	-0.12631E-06
	-0.44014E-02	0.46134E-03	-0.16212E-04	0.18864E-06
	-0.18999E-02	0.14813E-03	-0.61746E-05	0.97165E-07
3.50,	-0.54490E-02	0.25225E-03	0.91493E-05	-0.44867E-06
	0.29919E-02	-0.47213E-03	0.27119E-04	-0.55785E-06
	0.27758E-02	-0.21195E-03	0.69402E-05	-0.46593E-07
	0.29964E-02	-0.33141E-03	0.12337E-04	-0.14259E-06
	-0.39794E-02	0.42296E-03	-0.15277E-04	0.18667E-06
	-0.15521E-02	0.10493E-03	-0.35088E-05	0.51014E-07
4.00,	-0.55987E-02	0.59694E-03	-0.19037E-04	0.23947E-06
	0.31048E-02	-0.40791E-03	0.19192E-04	-0.26632E-06
	0.24567E-02	-0.16487E-03	0.45268E-05	-0.18839E-07
	0.27830E-02	-0.35327E-03	0.17785E-04	-0.30417E-06
	-0.34966E-02	0.39936E-03	-0.16034E-04	0.22115E-06
	-0.13156E-02	0.72545E-04	-0.10911E-05	-0.19770E-09
-15.0,				
0.30,	-0.51467E-01	0.51527E-02	-0.34158E-03	0.65331E-05
	0.27959E-02	-0.34519E-03	-0.39727E-05	-0.17002E-06
	0.11831E-01	-0.17213E-03	-0.24608E-05	0.28652E-06
	-0.54650E-02	0.21492E-02	-0.11768E-03	0.16627E-05
	0.35236E-03	-0.35248E-03	0.16846E-04	-0.10143E-06
	-0.97916E-02	0.15113E-02	-0.89653E-04	0.11954E-05
0.60,	-0.57819E-01	0.57886E-02	-0.38373E-03	0.73393E-05
	0.31409E-02	-0.38779E-03	-0.44629E-05	-0.19100E-06
	0.13291E-01	-0.19337E-03	-0.27645E-05	0.32188E-06
	-0.61394E-02	0.24144E-02	-0.13220E-03	0.18679E-05

HL-20 Aerodynamics Tables (version 2.0)

0.80,	0.39584E-03 ,	-0.39598E-03 ,	0.18925E-04 ,	-0.11395E-06 ,
	-0.11000E-01 ,	0.16978E-02 ,	-0.10072E-03 ,	0.13429E-05 ,
	-0.66080E-01 ,	0.66157E-02 ,	-0.43856E-03 ,	0.83880E-05 ,
	0.35897E-02 ,	-0.44319E-03 ,	-0.51006E-05 ,	-0.21829E-06 ,
	0.15190E-01 ,	-0.22100E-03 ,	-0.31595E-05 ,	0.36787E-06 ,
	-0.70166E-02 ,	0.27594E-02 ,	-0.15109E-03 ,	0.21348E-05 ,
	0.45240E-03 ,	-0.45256E-03 ,	0.21629E-04 ,	-0.13023E-06 ,
	-0.12572E-01 ,	0.19404E-02 ,	-0.11511E-03 ,	0.15347E-05 ,
0.90,	-0.68832E-01 ,	0.68912E-02 ,	-0.45682E-03 ,	0.87373E-05 ,
	0.37392E-02 ,	-0.46165E-03 ,	-0.53130E-05 ,	-0.22738E-06 ,
	0.15822E-01 ,	-0.23021E-03 ,	-0.32911E-05 ,	0.38319E-06 ,
	-0.73088E-02 ,	0.28743E-02 ,	-0.15739E-03 ,	0.22237E-05 ,
	0.47125E-03 ,	-0.47141E-03 ,	0.22530E-04 ,	-0.13565E-06 ,
	-0.13095E-01 ,	0.20212E-02 ,	-0.11990E-03 ,	0.15987E-05 ,
0.95,	-0.50662E-01 ,	0.50721E-02 ,	-0.33623E-03 ,	0.64309E-05 ,
	0.27521E-02 ,	-0.33979E-03 ,	-0.39105E-05 ,	-0.16736E-06 ,
	0.11646E-01 ,	-0.16944E-03 ,	-0.24223E-05 ,	0.28204E-06 ,
	-0.53795E-02 ,	0.21156E-02 ,	-0.11584E-03 ,	0.16367E-05 ,
	0.34685E-03 ,	-0.34697E-03 ,	0.16583E-04 ,	-0.99843E-07 ,
	-0.96384E-02 ,	0.14876E-02 ,	-0.88251E-04 ,	0.11767E-05 ,
1.10,	-0.41708E-01 ,	0.38938E-02 ,	-0.24010E-03 ,	0.40609E-05 ,
	0.29590E-02 ,	-0.31976E-03 ,	-0.42816E-05 ,	-0.54487E-07 ,
	0.99310E-02 ,	-0.15804E-03 ,	-0.45030E-05 ,	0.43694E-06 ,
	-0.43327E-02 ,	0.16675E-02 ,	-0.85965E-04 ,	0.82656E-06 ,
	0.32076E-03 ,	-0.30611E-03 ,	0.10922E-04 ,	0.24633E-06 ,
	-0.84922E-02 ,	0.12063E-02 ,	-0.70588E-04 ,	0.86995E-06 ,
1.20,	-0.35735E-01 ,	0.31077E-02 ,	-0.17597E-03 ,	0.24799E-05 ,
	0.30971E-02 ,	-0.30640E-03 ,	-0.45291E-05 ,	0.20807E-07 ,
	0.87871E-02 ,	-0.15044E-03 ,	-0.58910E-05 ,	0.54028E-06 ,
	-0.36343E-02 ,	0.13686E-02 ,	-0.66035E-04 ,	0.28611E-06 ,
	0.30336E-03 ,	-0.27885E-03 ,	0.71464E-05 ,	0.47726E-06 ,
	-0.77277E-02 ,	0.10186E-02 ,	-0.58805E-04 ,	0.66535E-06 ,
1.60,	-0.11849E-01 ,	-0.35551E-04 ,	0.80480E-04 ,	-0.38422E-05 ,
	0.36490E-02 ,	-0.25299E-03 ,	-0.55188E-05 ,	0.32189E-06 ,
	0.42131E-02 ,	-0.12005E-03 ,	-0.11441E-04 ,	0.95348E-06 ,
	-0.84195E-03 ,	0.17330E-03 ,	0.13659E-04 ,	-0.18750E-05 ,
	0.23378E-03 ,	-0.16985E-03 ,	-0.79524E-05 ,	0.14007E-05 ,
	-0.46703E-02 ,	0.26807E-03 ,	-0.11690E-04 ,	-0.15278E-06 ,
2.00,	-0.25822E-02 ,	0.40105E-03 ,	0.19905E-04 ,	-0.16881E-05 ,
	0.31646E-02 ,	-0.24988E-03 ,	-0.84365E-05 ,	0.10462E-05 ,
	0.20480E-02 ,	-0.16439E-03 ,	0.60579E-05 ,	-0.25090E-07 ,
	0.30048E-03 ,	-0.48644E-03 ,	0.64555E-04 ,	-0.22649E-05 ,
	-0.13982E-02 ,	0.34005E-03 ,	-0.22766E-04 ,	0.54172E-06 ,
	-0.24737E-02 ,	0.21928E-04 ,	0.11043E-04 ,	-0.45927E-06 ,
2.50,	-0.38764E-02 ,	-0.18548E-04 ,	0.66212E-04 ,	-0.26379E-05 ,
	0.27617E-02 ,	-0.40062E-03 ,	0.42031E-04 ,	-0.12435E-05 ,
	0.14549E-02 ,	-0.15343E-03 ,	0.45005E-05 ,	0.43206E-07 ,
	0.23038E-02 ,	-0.30964E-03 ,	0.31028E-04 ,	-0.96644E-06 ,
	-0.13986E-02 ,	0.31515E-03 ,	-0.26435E-04 ,	0.71906E-06 ,
	-0.12665E-02 ,	0.86581E-04 ,	0.58071E-06 ,	-0.18005E-06 ,

HL-20 Aerodynamics Tables (version 2.0)

3.00,	-0.31445E-02 ,	0.24328E-03 ,	-0.16826E-05 ,	-0.15769E-06 ,
	0.11485E-02 ,	-0.25321E-03 ,	0.16272E-04 ,	-0.35015E-06 ,
	0.13615E-02 ,	-0.12473E-03 ,	0.55145E-05 ,	-0.57389E-07 ,
	0.95085E-03 ,	-0.50988E-04 ,	0.89390E-06 ,	0.19767E-08 ,
	-0.18568E-02 ,	0.19299E-03 ,	-0.75195E-05 ,	0.10163E-06 ,
	-0.10590E-02 ,	0.96402E-04 ,	-0.41222E-05 ,	0.63835E-07 ,
3.50,	-0.24413E-02 ,	0.24300E-03 ,	-0.11197E-04 ,	0.17090E-06 ,
	0.95718E-03 ,	-0.13543E-03 ,	0.34629E-05 ,	-0.19309E-07 ,
	0.12460E-02 ,	-0.10584E-03 ,	0.47568E-05 ,	-0.56863E-07 ,
	0.91684E-03 ,	-0.78814E-04 ,	0.27947E-05 ,	-0.30737E-07 ,
	-0.14622E-02 ,	0.14759E-03 ,	-0.56149E-05 ,	0.76099E-07 ,
	-0.85556E-03 ,	0.64679E-04 ,	-0.19028E-05 ,	0.19326E-07 ,
4.00,	-0.24461E-02 ,	0.36288E-03 ,	-0.21290E-04 ,	0.42721E-06 ,
	0.10623E-02 ,	-0.17115E-03 ,	0.60147E-05 ,	-0.45677E-07 ,
	0.10464E-02 ,	-0.80676E-04 ,	0.36210E-05 ,	-0.41361E-07 ,
	0.89831E-03 ,	-0.98576E-04 ,	0.54732E-05 ,	-0.10326E-06 ,
	-0.11847E-02 ,	0.13495E-03 ,	-0.59089E-05 ,	0.91918E-07 ,
	-0.73679E-03 ,	0.55242E-04 ,	-0.14643E-05 ,	0.12535E-07 ,
0.0,				
0.30,	0.00000E+00 ,	0.00000E+00 ,	0.00000E+00 ,	0.00000E+00 ,
	0.00000E+00 ,	0.00000E+00 ,	0.00000E+00 ,	0.00000E+00 ,
	0.00000E+00 ,	0.00000E+00 ,	0.00000E+00 ,	0.00000E+00 ,
	0.00000E+00 ,	0.00000E+00 ,	0.00000E+00 ,	0.00000E+00 ,
	0.00000E+00 ,	0.00000E+00 ,	0.00000E+00 ,	0.00000E+00 ,
	0.00000E+00 ,	0.00000E+00 ,	0.00000E+00 ,	0.00000E+00 ,
0.60,	0.00000E+00 ,	0.00000E+00 ,	0.00000E+00 ,	0.00000E+00 ,
	0.00000E+00 ,	0.00000E+00 ,	0.00000E+00 ,	0.00000E+00 ,
	0.00000E+00 ,	0.00000E+00 ,	0.00000E+00 ,	0.00000E+00 ,
	0.00000E+00 ,	0.00000E+00 ,	0.00000E+00 ,	0.00000E+00 ,
	0.00000E+00 ,	0.00000E+00 ,	0.00000E+00 ,	0.00000E+00 ,
	0.00000E+00 ,	0.00000E+00 ,	0.00000E+00 ,	0.00000E+00 ,
0.80,	0.00000E+00 ,	0.00000E+00 ,	0.00000E+00 ,	0.00000E+00 ,
	0.00000E+00 ,	0.00000E+00 ,	0.00000E+00 ,	0.00000E+00 ,
	0.00000E+00 ,	0.00000E+00 ,	0.00000E+00 ,	0.00000E+00 ,
	0.00000E+00 ,	0.00000E+00 ,	0.00000E+00 ,	0.00000E+00 ,
	0.00000E+00 ,	0.00000E+00 ,	0.00000E+00 ,	0.00000E+00 ,
	0.00000E+00 ,	0.00000E+00 ,	0.00000E+00 ,	0.00000E+00 ,
0.90,	0.00000E+00 ,	0.00000E+00 ,	0.00000E+00 ,	0.00000E+00 ,
	0.00000E+00 ,	0.00000E+00 ,	0.00000E+00 ,	0.00000E+00 ,
	0.00000E+00 ,	0.00000E+00 ,	0.00000E+00 ,	0.00000E+00 ,
	0.00000E+00 ,	0.00000E+00 ,	0.00000E+00 ,	0.00000E+00 ,
	0.00000E+00 ,	0.00000E+00 ,	0.00000E+00 ,	0.00000E+00 ,
	0.00000E+00 ,	0.00000E+00 ,	0.00000E+00 ,	0.00000E+00 ,
0.95,	0.00000E+00 ,	0.00000E+00 ,	0.00000E+00 ,	0.00000E+00 ,
	0.00000E+00 ,	0.00000E+00 ,	0.00000E+00 ,	0.00000E+00 ,
	0.00000E+00 ,	0.00000E+00 ,	0.00000E+00 ,	0.00000E+00 ,
	0.00000E+00 ,	0.00000E+00 ,	0.00000E+00 ,	0.00000E+00 ,
	0.00000E+00 ,	0.00000E+00 ,	0.00000E+00 ,	0.00000E+00 ,
	0.00000E+00 ,	0.00000E+00 ,	0.00000E+00 ,	0.00000E+00 ,
1.10,				

HL-20 Aerodynamics Tables (version 2.0)

2.00,	0.00000E+00 ,	0.00000E+00 ,	0.00000E+00 ,	0.00000E+00 ,
	0.00000E+00 ,	0.00000E+00 ,	0.00000E+00 ,	0.00000E+00 ,
	0.00000E+00 ,	0.00000E+00 ,	0.00000E+00 ,	0.00000E+00 ,
	0.00000E+00 ,	0.00000E+00 ,	0.00000E+00 ,	0.00000E+00 ,
	0.00000E+00 ,	0.00000E+00 ,	0.00000E+00 ,	0.00000E+00 ,
	0.00000E+00 ,	0.00000E+00 ,	0.00000E+00 ,	0.00000E+00 ,
2.50,	0.00000E+00 ,	0.00000E+00 ,	0.00000E+00 ,	0.00000E+00 ,
	0.00000E+00 ,	0.00000E+00 ,	0.00000E+00 ,	0.00000E+00 ,
	0.00000E+00 ,	0.00000E+00 ,	0.00000E+00 ,	0.00000E+00 ,
	0.00000E+00 ,	0.00000E+00 ,	0.00000E+00 ,	0.00000E+00 ,
	0.00000E+00 ,	0.00000E+00 ,	0.00000E+00 ,	0.00000E+00 ,
	0.00000E+00 ,	0.00000E+00 ,	0.00000E+00 ,	0.00000E+00 ,
3.00,	0.00000E+00 ,	0.00000E+00 ,	0.00000E+00 ,	0.00000E+00 ,
	0.00000E+00 ,	0.00000E+00 ,	0.00000E+00 ,	0.00000E+00 ,
	0.00000E+00 ,	0.00000E+00 ,	0.00000E+00 ,	0.00000E+00 ,
	0.00000E+00 ,	0.00000E+00 ,	0.00000E+00 ,	0.00000E+00 ,
	0.00000E+00 ,	0.00000E+00 ,	0.00000E+00 ,	0.00000E+00 ,
	0.00000E+00 ,	0.00000E+00 ,	0.00000E+00 ,	0.00000E+00 ,
3.50,	0.00000E+00 ,	0.00000E+00 ,	0.00000E+00 ,	0.00000E+00 ,
	0.00000E+00 ,	0.00000E+00 ,	0.00000E+00 ,	0.00000E+00 ,
	0.00000E+00 ,	0.00000E+00 ,	0.00000E+00 ,	0.00000E+00 ,
	0.00000E+00 ,	0.00000E+00 ,	0.00000E+00 ,	0.00000E+00 ,
	0.00000E+00 ,	0.00000E+00 ,	0.00000E+00 ,	0.00000E+00 ,
	0.00000E+00 ,	0.00000E+00 ,	0.00000E+00 ,	0.00000E+00 ,
4.00,	0.00000E+00 ,	0.00000E+00 ,	0.00000E+00 ,	0.00000E+00 ,
	0.00000E+00 ,	0.00000E+00 ,	0.00000E+00 ,	0.00000E+00 ,
	0.00000E+00 ,	0.00000E+00 ,	0.00000E+00 ,	0.00000E+00 ,
	0.00000E+00 ,	0.00000E+00 ,	0.00000E+00 ,	0.00000E+00 ,
	0.00000E+00 ,	0.00000E+00 ,	0.00000E+00 ,	0.00000E+00 ,
	0.00000E+00 ,	0.00000E+00 ,	0.00000E+00 ,	0.00000E+00 ,
15.0,	0.00000E+00 ,	0.00000E+00 ,	0.00000E+00 ,	0.00000E+00 ,
0.30,	-0.86429E-02 ,	0.86555E-02 ,	-0.69160E-03 ,	0.14799E-04 ,
	-0.14003E-02 ,	0.69679E-03 ,	-0.24105E-04 ,	0.31998E-06 ,
	-0.25705E-02 ,	-0.24743E-03 ,	0.18798E-04 ,	-0.48763E-06 ,
	0.52836E-02 ,	-0.37589E-03 ,	0.43480E-04 ,	-0.13393E-05 ,
	-0.29443E-02 ,	0.25107E-03 ,	-0.15003E-04 ,	0.34057E-06 ,
	0.51340E-02 ,	0.32677E-03 ,	-0.12489E-04 ,	-0.41406E-08 ,
0.60,	-0.10256E-01 ,	0.10271E-01 ,	-0.82071E-03 ,	0.17562E-04 ,
	-0.16617E-02 ,	0.82686E-03 ,	-0.28604E-04 ,	0.37971E-06 ,
	-0.30503E-02 ,	-0.29362E-03 ,	0.22307E-04 ,	-0.57865E-06 ,
	0.62699E-02 ,	-0.44606E-03 ,	0.51597E-04 ,	-0.15893E-05 ,
	-0.34940E-02 ,	0.29794E-03 ,	-0.17803E-04 ,	0.40414E-06 ,
	0.60923E-02 ,	0.38777E-03 ,	-0.14821E-04 ,	-0.49136E-08 ,
0.80,	-0.11189E-01 ,	0.11205E-01 ,	-0.89532E-03 ,	0.19159E-04 ,
	-0.18128E-02 ,	0.90203E-03 ,	-0.31205E-04 ,	0.41423E-06 ,
	-0.33277E-02 ,	-0.32031E-03 ,	0.24335E-04 ,	-0.63126E-06 ,
	0.68399E-02 ,	-0.48661E-03 ,	0.56288E-04 ,	-0.17337E-05 ,
	-0.38116E-02 ,	0.32502E-03 ,	-0.19422E-04 ,	0.44088E-06 ,
	0.66462E-02 ,	0.42302E-03 ,	-0.16168E-04 ,	-0.53602E-08 ,
0.90,				

HL-20 Aerodynamics Tables (version 2.0)

	-0.12121E-01	0.12139E-01	-0.96993E-03	0.20755E-04
	-0.19638E-02	0.97720E-03	-0.33805E-04	0.44875E-06
	-0.36050E-02	-0.34700E-03	0.26363E-04	-0.68386E-06
	0.74099E-02	-0.52717E-03	0.60978E-04	-0.18782E-05
	-0.41292E-02	0.35211E-03	-0.21040E-04	0.47762E-06
	0.72000E-02	0.45827E-03	-0.17516E-04	-0.58070E-08
0.95,	-0.13520E-01	0.13539E-01	-0.10818E-02	0.23150E-04
	-0.21904E-02	0.10900E-02	-0.37706E-04	0.50053E-06
	-0.40209E-02	-0.38704E-03	0.29405E-04	-0.76277E-06
	0.82649E-02	-0.58799E-03	0.68014E-04	-0.20949E-05
	-0.46057E-02	0.39274E-03	-0.23468E-04	0.53273E-06
	0.80308E-02	0.51115E-03	-0.19537E-04	-0.64769E-08
1.10,	-0.86299E-02	0.10423E-01	-0.82007E-03	0.17069E-04
	-0.22915E-03	0.10363E-02	-0.51513E-04	0.11795E-05
	-0.39685E-02	-0.30014E-03	0.18080E-04	-0.37793E-06
	0.63419E-02	-0.40123E-03	0.45730E-04	-0.12605E-05
	-0.39032E-02	0.29226E-03	-0.17691E-04	0.35443E-06
	0.67841E-02	0.41129E-03	-0.17083E-04	0.11533E-06
1.20,	-0.53679E-02	0.83440E-02	-0.64545E-03	0.13012E-04
	0.10792E-02	0.10005E-02	-0.60724E-04	0.16324E-05
	-0.39335E-02	-0.24216E-03	0.10525E-04	-0.12121E-06
	0.50591E-02	-0.27664E-03	0.30864E-04	-0.70377E-06
	-0.34346E-02	0.22522E-03	-0.13837E-04	0.23549E-06
	0.59525E-02	0.34468E-03	-0.15447E-04	0.19659E-06
1.60,	0.76757E-02	0.30896E-04	0.52824E-04	-0.32089E-05
	0.63110E-02	0.85726E-03	-0.97557E-04	0.34435E-05
	-0.37936E-02	-0.10338E-04	-0.19685E-04	0.90536E-06
	-0.70494E-04	0.22157E-03	-0.28579E-04	0.15222E-05
	-0.15609E-02	-0.42818E-04	0.15727E-05	-0.24014E-06
	0.26269E-02	0.78313E-04	-0.89020E-05	0.52152E-06
2.00,	0.11300E-01	-0.13943E-03	0.69327E-04	-0.27902E-05
	0.50538E-02	0.36506E-03	-0.32389E-04	0.17254E-05
	-0.37173E-02	-0.44322E-04	-0.59773E-05	0.12376E-06
	-0.11682E-03	-0.38847E-04	0.29256E-04	-0.13267E-05
	-0.12721E-02	-0.18875E-04	0.33390E-05	-0.19416E-06
	0.21487E-02	0.50483E-04	-0.14850E-05	0.55936E-07
2.50,	0.62992E-02	-0.24581E-04	0.41123E-04	-0.11492E-05
	0.51231E-02	0.21827E-03	-0.67905E-05	0.53028E-06
	-0.29078E-02	0.37412E-05	-0.90139E-05	0.24167E-06
	0.70540E-03	-0.17844E-03	0.28403E-04	-0.96517E-06
	-0.71719E-03	0.35933E-04	-0.76222E-05	0.20263E-06
	0.19629E-02	0.32090E-04	0.28392E-05	-0.12030E-06
3.00,	0.51902E-02	-0.37970E-05	0.18785E-04	-0.56757E-06
	0.20911E-02	0.48645E-04	0.17486E-04	-0.30253E-06
	-0.21732E-02	-0.37161E-04	-0.32138E-05	0.47897E-07
	-0.21530E-03	0.51091E-04	-0.19441E-05	0.35197E-07
	-0.92576E-03	-0.36608E-04	0.19601E-05	-0.84223E-07
	0.13784E-02	0.41243E-04	0.18287E-05	-0.12672E-07
3.50,	0.38813E-02	0.67482E-04	0.92102E-05	-0.27373E-06
	0.14891E-02	0.10671E-03	0.88660E-05	-0.47982E-07

HL-20 Aerodynamics Tables (version 2.0)

	-0.16973E-02	-0.26902E-04	-0.55446E-05	0.89669E-07
	-0.14112E-04	0.16037E-04	-0.13390E-05	0.42099E-07
	-0.62243E-03	-0.32815E-04	0.10570E-07	-0.21680E-07
	0.12032E-02	0.26550E-04	0.37435E-05	-0.53979E-07
4.00,	0.37366E-02	0.63974E-04	0.98744E-05	-0.19059E-06
	0.12674E-02	0.49166E-04	0.13262E-04	-0.41384E-07
	-0.15127E-02	-0.73485E-06	-0.79432E-05	0.11848E-06
	0.16182E-03	0.81133E-06	-0.59660E-06	0.24925E-07
	-0.47958E-03	-0.22109E-04	-0.10978E-05	-0.39269E-08
	0.10237E-02	0.29205E-04	0.38909E-05	-0.47382E-07
30.0,				
0.30,	0.22251E-01	0.44399E-02	-0.36160E-03	0.77367E-05
	0.94981E-02	0.70430E-03	0.30714E-04	-0.14665E-05
	-0.86708E-02	-0.47247E-03	0.29817E-04	-0.58350E-06
	0.70637E-02	0.11628E-02	-0.10844E-03	0.21837E-05
	-0.55153E-02	0.13920E-05	0.15950E-04	-0.38071E-06
	0.94307E-02	0.95405E-03	-0.65878E-04	0.11172E-05
0.60,	0.26405E-01	0.52687E-02	-0.42910E-03	0.91809E-05
	0.11271E-01	0.83577E-03	0.36448E-04	-0.17403E-05
	-0.10289E-01	-0.56067E-03	0.35383E-04	-0.69242E-06
	0.83823E-02	0.13798E-02	-0.12868E-03	0.25914E-05
	-0.65448E-02	0.16518E-05	0.18927E-04	-0.45178E-06
	0.11191E-01	0.11321E-02	-0.78175E-04	0.13258E-05
0.80,	0.28805E-01	0.57477E-02	-0.46811E-03	0.10016E-04
	0.12296E-01	0.91175E-03	0.39761E-04	-0.18985E-05
	-0.11225E-01	-0.61164E-03	0.38600E-04	-0.75537E-06
	0.91443E-02	0.15053E-02	-0.14038E-03	0.28269E-05
	-0.71398E-02	0.18020E-05	0.20648E-04	-0.49285E-06
	0.12209E-01	0.12351E-02	-0.85282E-04	0.14463E-05
0.90,	0.31206E-01	0.62266E-02	-0.50712E-03	0.10850E-04
	0.13320E-01	0.98773E-03	0.43074E-04	-0.20567E-05
	-0.12160E-01	-0.66261E-03	0.41816E-04	-0.81832E-06
	0.99063E-02	0.16307E-02	-0.15208E-03	0.30625E-05
	-0.77348E-02	0.19522E-05	0.22369E-04	-0.53392E-06
	0.13226E-01	0.13380E-02	-0.92389E-04	0.15668E-05
0.95,	0.34806E-01	0.69451E-02	-0.56564E-03	0.12102E-04
	0.14857E-01	0.11017E-02	0.48045E-04	-0.22940E-05
	-0.13563E-01	-0.73906E-03	0.46641E-04	-0.91274E-06
	0.11049E-01	0.18189E-02	-0.16962E-03	0.34159E-05
	-0.86273E-02	0.21774E-05	0.24950E-04	-0.59553E-06
	0.14752E-01	0.14924E-02	-0.10305E-03	0.17476E-05
1.10,	0.31321E-01	0.53355E-02	-0.41864E-03	0.83189E-05
	0.14939E-01	0.11995E-02	0.14996E-05	-0.55320E-06
	-0.12416E-01	-0.59356E-03	0.32216E-04	-0.54453E-06
	0.86426E-02	0.14482E-02	-0.13268E-03	0.27961E-05
	-0.76439E-02	-0.45487E-05	0.17129E-04	-0.49667E-06
	0.12584E-01	0.11736E-02	-0.81592E-04	0.15282E-05
1.20,	0.28996E-01	0.42617E-02	-0.32059E-03	0.57951E-05
	0.14994E-01	0.12648E-02	-0.29551E-04	0.60811E-06
	-0.11650E-01	-0.49650E-03	0.22593E-04	-0.29890E-06

HL-20 Aerodynamics Tables (version 2.0)

	0.70371E-02 ,	0.12010E-02 ,	-0.10803E-03 ,	0.23826E-05 ,
	-0.69879E-02 ,	-0.90358E-05 ,	0.11913E-04 ,	-0.43072E-06 ,
	0.11137E-01 ,	0.96099E-03 ,	-0.67278E-04 ,	0.13819E-05 ,
1.60,	0.19698E-01 ,	-0.32015E-04 ,	0.71525E-04 ,	-0.42966E-05 ,
	0.15211E-01 ,	0.15258E-02 ,	-0.15371E-03 ,	0.52519E-05 ,
	-0.85894E-02 ,	-0.10836E-03 ,	-0.15888E-04 ,	0.68331E-06 ,
	0.61705E-03 ,	0.21229E-03 ,	-0.94769E-05 ,	0.72933E-06 ,
	-0.43648E-02 ,	-0.26978E-04 ,	-0.89482E-05 ,	-0.16702E-06 ,
	0.53524E-02 ,	0.11072E-03 ,	-0.10040E-04 ,	0.79661E-06 ,
2.00,	0.18808E-01 ,	0.54574E-03 ,	-0.21571E-04 ,	-0.40469E-06 ,
	0.12251E-01 ,	0.89933E-03 ,	-0.89467E-04 ,	0.37122E-05 ,
	-0.73197E-02 ,	-0.13207E-03 ,	0.48084E-05 ,	-0.24109E-06 ,
	0.33065E-03 ,	-0.18627E-03 ,	0.47458E-04 ,	-0.18590E-05 ,
	-0.35249E-02 ,	-0.74290E-04 ,	0.74994E-05 ,	-0.45580E-06 ,
	0.44178E-02 ,	0.50094E-04 ,	0.95514E-06 ,	0.95595E-07 ,
2.50,	0.12755E-01 ,	-0.47305E-03 ,	0.11089E-03 ,	-0.33791E-05 ,
	0.10635E-01 ,	0.41097E-03 ,	0.77263E-06 ,	0.30645E-06 ,
	-0.63068E-02 ,	-0.63492E-04 ,	-0.83337E-05 ,	0.19481E-06 ,
	0.11517E-02 ,	-0.12485E-03 ,	0.22102E-04 ,	-0.74424E-06 ,
	-0.23930E-02 ,	0.18751E-04 ,	-0.97268E-05 ,	0.17608E-06 ,
	0.40678E-02 ,	0.86274E-04 ,	-0.19586E-05 ,	0.68056E-07 ,
3.00,	0.10804E-01 ,	-0.12143E-03 ,	0.35324E-04 ,	-0.94190E-06 ,
	0.58745E-02 ,	0.21103E-03 ,	0.26481E-04 ,	-0.38742E-06 ,
	-0.50591E-02 ,	-0.58854E-04 ,	-0.76807E-05 ,	0.97174E-07 ,
	0.15267E-03 ,	0.29711E-04 ,	-0.13111E-05 ,	0.93271E-07 ,
	-0.24712E-02 ,	-0.44214E-04 ,	-0.13193E-05 ,	-0.78554E-07 ,
	0.32094E-02 ,	0.60658E-04 ,	0.35382E-05 ,	0.14775E-07 ,
3.50,	0.98493E-02 ,	0.99384E-04 ,	0.15963E-04 ,	-0.51670E-06 ,
	0.45952E-02 ,	0.23942E-03 ,	0.26738E-04 ,	-0.35833E-06 ,
	-0.42817E-02 ,	-0.60587E-04 ,	-0.11734E-04 ,	0.18015E-06 ,
	0.20676E-03 ,	0.53793E-04 ,	-0.52297E-05 ,	0.18060E-06 ,
	-0.20191E-02 ,	-0.44527E-04 ,	-0.24900E-05 ,	-0.42112E-07 ,
	0.28209E-02 ,	0.59875E-04 ,	0.57868E-05 ,	-0.42597E-07 ,
4.00,	0.83719E-02 ,	0.28164E-03 ,	0.85813E-05 ,	-0.23797E-06 ,
	0.42850E-02 ,	0.13376E-03 ,	0.34985E-04 ,	-0.34278E-06 ,
	-0.37826E-02 ,	-0.41095E-04 ,	-0.16179E-04 ,	0.25925E-06 ,
	0.32371E-03 ,	-0.18071E-04 ,	0.64712E-06 ,	0.40258E-07 ,
	-0.16435E-02 ,	-0.36701E-04 ,	-0.44813E-05 ,	0.43358E-08 ,
	0.25039E-02 ,	0.62613E-04 ,	0.75015E-05 ,	-0.79303E-07 ,
45.0,				
0.30,	0.29416E-01 ,	0.13283E-01 ,	-0.10813E-02 ,	0.22239E-04 ,
	0.20327E-01 ,	0.21376E-02 ,	-0.72343E-04 ,	0.66600E-06 ,
	-0.14813E-01 ,	-0.65267E-03 ,	0.42581E-04 ,	-0.69008E-06 ,
	0.12242E-01 ,	0.17488E-03 ,	0.76254E-05 ,	-0.12653E-05 ,
	-0.92672E-02 ,	0.31784E-03 ,	-0.16634E-04 ,	0.59047E-06 ,
	0.14092E-01 ,	0.23079E-03 ,	0.13644E-04 ,	-0.94755E-06 ,
0.60,	0.34907E-01 ,	0.15763E-01 ,	-0.12831E-02 ,	0.26391E-04 ,
	0.24121E-01 ,	0.25366E-02 ,	-0.85847E-04 ,	0.79033E-06 ,
	-0.17579E-01 ,	-0.77451E-03 ,	0.50529E-04 ,	-0.81890E-06 ,
	0.14527E-01 ,	0.20753E-03 ,	0.90489E-05 ,	-0.15015E-05 ,

HL-20 Aerodynamics Tables (version 2.0)

	-0.10997E-01	0.37717E-03	-0.19739E-04	0.70069E-06
	0.16722E-01	0.27387E-03	0.16191E-04	-0.11244E-05
0.80,	0.38080E-01	0.17195E-01	-0.13998E-02	0.28790E-04
	0.26314E-01	0.27672E-02	-0.93651E-04	0.86217E-06
	-0.19177E-01	-0.84492E-03	0.55123E-04	-0.89335E-06
	0.15848E-01	0.22640E-03	0.98715E-05	-0.16380E-05
	-0.11997E-01	0.41146E-03	-0.21533E-04	0.76439E-06
	0.18242E-01	0.29876E-03	0.17663E-04	-0.12267E-05
0.90,	0.41254E-01	0.18628E-01	-0.15164E-02	0.31189E-04
	0.28507E-01	0.29978E-02	-0.10146E-03	0.93402E-06
	-0.20775E-01	-0.91533E-03	0.59717E-04	-0.96779E-06
	0.17169E-01	0.24526E-03	0.10694E-04	-0.17746E-05
	-0.12997E-01	0.44575E-03	-0.23328E-04	0.82809E-06
	0.19763E-01	0.32366E-03	0.19135E-04	-0.13289E-05
0.95,	0.46014E-01	0.20778E-01	-0.16914E-02	0.34788E-04
	0.31796E-01	0.33437E-02	-0.11316E-03	0.10418E-05
	-0.23172E-01	-0.10209E-02	0.66607E-04	-0.10795E-05
	0.19150E-01	0.27356E-03	0.11928E-04	-0.19793E-05
	-0.14496E-01	0.49718E-03	-0.26020E-04	0.92364E-06
	0.22043E-01	0.36101E-03	0.21343E-04	-0.14822E-05
1.10,	0.42215E-01	0.15973E-01	-0.12764E-02	0.25276E-04
	0.29725E-01	0.31003E-02	-0.14025E-03	0.26189E-05
	-0.20798E-01	-0.82291E-03	0.45743E-04	-0.59397E-06
	0.14945E-01	0.28391E-03	0.58968E-05	-0.12703E-05
	-0.12662E-01	0.37315E-03	-0.23113E-04	0.65276E-06
	0.18810E-01	0.31604E-03	0.12945E-04	-0.86460E-06
1.20,	0.39681E-01	0.12768E-01	-0.99963E-03	0.18930E-04
	0.28343E-01	0.29379E-02	-0.15832E-03	0.36709E-05
	-0.19215E-01	-0.69080E-03	0.31824E-04	-0.27010E-06
	0.12141E-01	0.29082E-03	0.18733E-05	-0.79732E-06
	-0.11439E-01	0.29040E-03	-0.21175E-04	0.47205E-06
	0.16653E-01	0.28604E-03	0.73423E-05	-0.45259E-06
1.60,	0.29547E-01	-0.48022E-04	0.10729E-03	-0.64449E-05
	0.22817E-01	0.22887E-02	-0.23057E-03	0.78778E-05
	-0.12884E-01	-0.16254E-03	-0.23832E-04	0.10250E-05
	0.92558E-03	0.31843E-03	-0.14215E-04	0.10940E-05
	-0.65472E-02	-0.40467E-04	-0.13422E-04	-0.25053E-06
	0.80285E-02	0.16608E-03	-0.15060E-04	0.11949E-05
2.00,	0.28211E-01	0.81861E-03	-0.32357E-04	-0.60703E-06
	0.18377E-01	0.13490E-02	-0.13420E-03	0.55684E-05
	-0.10980E-01	-0.19810E-03	0.72126E-05	-0.36163E-06
	0.49598E-03	-0.27941E-03	0.71187E-04	-0.27885E-05
	-0.52874E-02	-0.11143E-03	0.11249E-04	-0.68370E-06
	0.66267E-02	0.75141E-04	0.14327E-05	0.14339E-06
2.50,	0.19132E-01	-0.70958E-03	0.16633E-03	-0.50686E-05
	0.15952E-01	0.61645E-03	0.11589E-05	0.45967E-06
	-0.94603E-02	-0.95237E-04	-0.12500E-04	0.29222E-06
	0.17276E-02	-0.18727E-03	0.33153E-04	-0.11164E-05
	-0.35895E-02	0.28126E-04	-0.14590E-04	0.26412E-06
	0.61017E-02	0.12941E-03	-0.29380E-05	0.10208E-06

HL-20 Aerodynamics Tables (version 2.0)

3.00,
0.16206E-01 , -0.18214E-03 , 0.52986E-04 , -0.14129E-05 ,
0.88118E-02 , 0.31654E-03 , 0.39721E-04 , -0.58114E-06 ,
-0.75886E-02 , -0.88281E-04 , -0.11521E-04 , 0.14576E-06 ,
0.22900E-03 , 0.44567E-04 , -0.19666E-05 , 0.13991E-06 ,
-0.37068E-02 , -0.66320E-04 , -0.19789E-05 , -0.11783E-06 ,
0.48141E-02 , 0.90986E-04 , 0.53073E-05 , 0.22163E-07 ,

3.50,
0.14774E-01 , 0.14908E-03 , 0.23944E-04 , -0.77505E-06 ,
0.68928E-02 , 0.35912E-03 , 0.40107E-04 , -0.53749E-06 ,
-0.64226E-02 , -0.90880E-04 , -0.17602E-04 , 0.27023E-06 ,
0.31014E-03 , 0.80689E-04 , -0.78445E-05 , 0.27089E-06 ,
-0.30287E-02 , -0.66791E-04 , -0.37350E-05 , -0.63168E-07 ,
0.42313E-02 , 0.89812E-04 , 0.86802E-05 , -0.63895E-07 ,

4.00,
0.12558E-01 , 0.42245E-03 , 0.12872E-04 , -0.35695E-06 ,
0.64275E-02 , 0.20064E-03 , 0.52478E-04 , -0.51417E-06 ,
-0.56739E-02 , -0.61642E-04 , -0.24268E-04 , 0.38887E-06 ,
0.48556E-03 , -0.27107E-04 , 0.97069E-06 , 0.60388E-07 ,
-0.24653E-02 , -0.55051E-04 , -0.67219E-05 , 0.65037E-08 ,
0.37559E-02 , 0.93920E-04 , 0.11252E-04 , -0.11895E-06 ,

60.0,
0.30,
0.63779E-01 , 0.54896E-02 , -0.46771E-03 , 0.90267E-05 ,
0.28995E-01 , 0.21071E-02 , -0.56284E-04 , 0.16263E-06 ,
-0.19156E-01 , -0.34865E-03 , 0.19633E-04 , -0.16309E-06 ,
0.91905E-02 , -0.19226E-03 , 0.49357E-04 , -0.19454E-05 ,
-0.10212E-01 , 0.55057E-03 , -0.41475E-04 , 0.11392E-05 ,
0.13490E-01 , -0.48040E-03 , 0.91564E-04 , -0.26051E-05 ,

0.60,
0.75685E-01 , 0.65144E-02 , -0.55502E-03 , 0.10712E-04 ,
0.34407E-01 , 0.25004E-02 , -0.66791E-04 , 0.19299E-06 ,
-0.22731E-01 , -0.41374E-03 , 0.23298E-04 , -0.19353E-06 ,
0.10906E-01 , -0.22815E-03 , 0.58571E-04 , -0.23085E-05 ,
-0.12118E-01 , 0.65334E-03 , -0.49217E-04 , 0.13519E-05 ,
0.16008E-01 , -0.57008E-03 , 0.10866E-03 , -0.30914E-05 ,

0.80,
0.82566E-01 , 0.71066E-02 , -0.60548E-03 , 0.11686E-04 ,
0.37535E-01 , 0.27277E-02 , -0.72863E-04 , 0.21054E-06 ,
-0.24798E-01 , -0.45135E-03 , 0.25416E-04 , -0.21112E-06 ,
0.11898E-01 , -0.24889E-03 , 0.63896E-04 , -0.25184E-05 ,
-0.13220E-01 , 0.71274E-03 , -0.53691E-04 , 0.14748E-05 ,
0.17464E-01 , -0.62190E-03 , 0.11853E-03 , -0.33724E-05 ,

0.90,
0.89446E-01 , 0.76988E-02 , -0.65593E-03 , 0.12659E-04 ,
0.40663E-01 , 0.29550E-02 , -0.78935E-04 , 0.22808E-06 ,
-0.26864E-01 , -0.48896E-03 , 0.27534E-04 , -0.22872E-06 ,
0.12889E-01 , -0.26963E-03 , 0.69220E-04 , -0.27283E-05 ,
-0.14322E-01 , 0.77213E-03 , -0.58166E-04 , 0.15977E-05 ,
0.18919E-01 , -0.67373E-03 , 0.12841E-03 , -0.36534E-05 ,

0.95,
0.99767E-01 , 0.85871E-02 , -0.73162E-03 , 0.14120E-04 ,
0.45355E-01 , 0.32960E-02 , -0.88043E-04 , 0.25440E-06 ,
-0.29964E-01 , -0.54538E-03 , 0.30711E-04 , -0.25511E-06 ,
0.14376E-01 , -0.30074E-03 , 0.77207E-04 , -0.30431E-05 ,
-0.15974E-01 , 0.86123E-03 , -0.64877E-04 , 0.17820E-05 ,
0.21102E-01 , -0.75146E-03 , 0.14323E-03 , -0.40750E-05 ,

1.10,

HL-20 Aerodynamics Tables (version 2.0)

	0.85587E-01	0.65917E-02	-0.53075E-03	0.89352E-05
	0.41715E-01	0.32200E-02	-0.13668E-03	0.25515E-05
	-0.26904E-01	-0.46817E-03	0.16499E-04	0.11026E-06
	0.11336E-01	-0.13613E-03	0.55144E-04	-0.20139E-05
	-0.14247E-01	0.65044E-03	-0.53924E-04	0.12960E-05
	0.18635E-01	-0.52844E-03	0.10568E-03	-0.27775E-05
1.20,	0.76127E-01	0.52606E-02	-0.39675E-03	0.54764E-05
	0.39287E-01	0.31693E-02	-0.16913E-03	0.40840E-05
	-0.24863E-01	-0.41666E-03	0.70183E-05	0.35400E-06
	0.93086E-02	-0.26326E-04	0.40426E-04	-0.13273E-05
	-0.13095E-01	0.50982E-03	-0.46617E-04	0.97176E-06
	0.16989E-01	-0.37965E-03	0.80635E-04	-0.19120E-05
1.60,	0.38301E-01	-0.62250E-04	0.13907E-03	-0.83543E-05
	0.29577E-01	0.29667E-02	-0.29888E-03	0.10212E-04
	-0.16701E-01	-0.21070E-03	-0.30893E-04	0.13286E-05
	0.11998E-02	0.41277E-03	-0.18427E-04	0.14181E-05
	-0.84869E-02	-0.52456E-04	-0.17399E-04	-0.32476E-06
	0.10407E-01	0.21528E-03	-0.19522E-04	0.15489E-05
2.00,	0.36569E-01	0.10611E-02	-0.41943E-04	-0.78687E-06
	0.23822E-01	0.17487E-02	-0.17396E-03	0.72181E-05
	-0.14232E-01	-0.25679E-03	0.93495E-05	-0.46877E-06
	0.64292E-03	-0.36219E-03	0.92277E-04	-0.36147E-05
	-0.68538E-02	-0.14445E-03	0.14582E-04	-0.88626E-06
	0.85899E-02	0.97403E-04	0.18572E-05	0.18587E-06
2.50,	0.24800E-01	-0.91980E-03	0.21561E-03	-0.65703E-05
	0.20678E-01	0.79909E-03	0.15023E-05	0.59585E-06
	-0.12263E-01	-0.12345E-03	-0.16204E-04	0.37879E-06
	0.22394E-02	-0.24276E-03	0.42975E-04	-0.14471E-05
	-0.46530E-02	0.36459E-04	-0.18913E-04	0.34238E-06
	0.79094E-02	0.16775E-03	-0.38084E-05	0.13233E-06
3.00,	0.21007E-01	-0.23611E-03	0.68684E-04	-0.18314E-05
	0.11422E-01	0.41032E-03	0.51490E-04	-0.75331E-06
	-0.98368E-02	-0.11444E-03	-0.14934E-04	0.18894E-06
	0.29685E-03	0.57770E-04	-0.25493E-05	0.18136E-06
	-0.48050E-02	-0.85969E-04	-0.25652E-05	-0.15274E-06
	0.62404E-02	0.11794E-03	0.68797E-05	0.28729E-07
3.50,	0.19151E-01	0.19324E-03	0.31038E-04	-0.10047E-05
	0.89349E-02	0.46552E-03	0.51989E-04	-0.69673E-06
	-0.83254E-02	-0.11781E-03	-0.22816E-04	0.35028E-06
	0.40202E-03	0.10459E-03	-0.10169E-04	0.35115E-06
	-0.39260E-02	-0.86579E-04	-0.48415E-05	-0.81882E-07
	0.54849E-02	0.11642E-03	0.11252E-04	-0.82825E-07
4.00,	0.16278E-01	0.54761E-03	0.16686E-04	-0.46270E-06
	0.83317E-02	0.26008E-03	0.68025E-04	-0.66651E-06
	-0.73548E-02	-0.79904E-04	-0.31458E-04	0.50408E-06
	0.62942E-03	-0.35138E-04	0.12583E-05	0.78278E-07
	-0.31957E-02	-0.71360E-04	-0.87134E-05	0.84306E-08
	0.48686E-02	0.12175E-03	0.14586E-04	-0.15420E-06

HL-20 Aerodynamics Tables (version 2.0)

TABLE 4 - AERO INCREMENTS DUE TO LEFT ELEVON DEFLECTION

-30.0,				
0.30,	-0.52853E-01	-0.18449E-03	-0.70998E-04	0.41549E-05
	0.95642E-02	-0.55718E-03	-0.65295E-04	0.21654E-05
	0.22805E-01	0.29523E-04	-0.14274E-04	-0.11499E-06
	-0.40406E-01	0.19288E-03	0.56247E-04	-0.12859E-05
	0.23496E-01	-0.64421E-05	-0.14548E-04	0.17997E-06
	-0.32213E-01	0.30037E-03	0.12333E-04	0.16116E-06
0.60,	-0.55962E-01	-0.19534E-03	-0.75175E-04	0.43993E-05
	0.10127E-01	-0.58996E-03	-0.69136E-04	0.22927E-05
	0.24146E-01	0.31260E-04	-0.15113E-04	-0.12176E-06
	-0.42783E-01	0.20423E-03	0.59555E-04	-0.13615E-05
	0.24878E-01	-0.68210E-05	-0.15404E-04	0.19055E-06
	-0.34108E-01	0.31804E-03	0.13058E-04	0.17064E-06
0.80,	-0.65289E-01	-0.22790E-03	-0.87704E-04	0.51326E-05
	0.11815E-01	-0.68829E-03	-0.80659E-04	0.26748E-05
	0.28171E-01	0.36469E-04	-0.17632E-04	-0.14205E-06
	-0.49914E-01	0.23827E-03	0.69481E-04	-0.15884E-05
	0.29025E-01	-0.79577E-05	-0.17972E-04	0.22231E-06
	-0.39793E-01	0.37105E-03	0.15235E-04	0.19908E-06
0.90,	-0.68398E-01	-0.23875E-03	-0.91880E-04	0.53770E-05
	0.12377E-01	-0.72106E-03	-0.84500E-04	0.28022E-05
	0.29512E-01	0.38206E-04	-0.18472E-04	-0.14882E-06
	-0.52291E-01	0.24961E-03	0.72790E-04	-0.16641E-05
	0.30407E-01	-0.83368E-05	-0.18827E-04	0.23290E-06
	-0.41688E-01	0.38872E-03	0.15960E-04	0.20856E-06
0.95,	-0.54407E-01	-0.18992E-03	-0.73086E-04	0.42771E-05
	0.98455E-02	-0.57357E-03	-0.67216E-04	0.22290E-05
	0.23476E-01	0.30391E-04	-0.14694E-04	-0.11838E-06
	-0.41595E-01	0.19856E-03	0.57901E-04	-0.13237E-05
	0.24187E-01	-0.66316E-05	-0.14976E-04	0.18526E-06
	-0.33161E-01	0.30921E-03	0.12696E-04	0.16590E-06
1.10,	-0.47770E-01	-0.12482E-04	0.49607E-05	-0.38073E-06
	0.92737E-02	-0.45916E-03	-0.61645E-04	0.14226E-05
	0.20874E-01	-0.79644E-04	-0.31645E-04	0.12534E-05
	-0.36596E-01	0.25606E-03	0.61356E-04	-0.18929E-05
	0.21075E-01	0.19601E-03	-0.35649E-04	0.93348E-06
	-0.30093E-01	0.34596E-03	0.35636E-04	-0.13944E-05
1.20,	-0.43343E-01	0.10588E-03	0.57026E-04	-0.34880E-05
	0.88923E-02	-0.38283E-03	-0.57929E-04	0.88465E-06
	0.19138E-01	-0.15305E-03	-0.42953E-04	0.21686E-05
	-0.33262E-01	0.29443E-03	0.63660E-04	-0.22727E-05
	0.18999E-01	0.33120E-03	-0.49439E-04	0.14326E-05
	-0.28047E-01	0.37048E-03	0.50940E-04	-0.24353E-05
1.60,	-0.25638E-01	0.57919E-03	0.26522E-03	-0.15913E-04
	0.73670E-02	-0.77631E-04	-0.43071E-04	-0.12665E-05
	0.12197E-01	-0.44657E-03	-0.88171E-04	0.58280E-05
	-0.19929E-01	0.44784E-03	0.72876E-04	-0.37911E-05
	0.10696E-01	0.87176E-03	-0.10458E-03	0.34285E-05
	-0.19864E-01	0.46852E-03	0.11214E-03	-0.65974E-05

HL-20 Aerodynamics Tables (version 2.0)

2.00,	-0.13147E-01	0.59038E-03	0.50250E-04	-0.31624E-05
	0.87545E-02	-0.72754E-03	-0.26316E-04	0.19263E-05
	0.74428E-02	-0.31089E-03	-0.34050E-05	0.37276E-06
	-0.12949E-01	0.16497E-03	0.37729E-04	-0.18506E-05
	0.73581E-02	0.10153E-03	0.20195E-05	-0.20596E-06
	-0.12945E-01	0.46342E-03	-0.23098E-05	-0.15594E-06
2.50,	-0.86206E-02	-0.79618E-03	0.91632E-04	-0.20002E-05
	0.75844E-02	-0.54020E-03	-0.13319E-04	0.85082E-06
	0.61130E-02	-0.14214E-03	-0.85080E-05	0.28818E-06
	-0.89685E-02	-0.16792E-03	0.61226E-04	-0.22749E-05
	0.49668E-02	0.12718E-03	-0.30112E-05	0.39764E-07
	-0.10274E-01	0.27799E-03	0.91035E-05	-0.48310E-06
3.00,	-0.11525E-01	0.18344E-03	0.27191E-04	-0.88048E-06
	0.81816E-02	-0.94638E-03	0.34459E-04	-0.60753E-06
	0.65794E-02	-0.32017E-03	0.51587E-05	0.56706E-07
	-0.10206E-01	0.39431E-03	-0.41857E-05	-0.82738E-07
	0.34203E-02	0.94051E-04	-0.14549E-05	0.20022E-07
	-0.10285E-01	0.47317E-03	-0.83452E-05	0.25306E-08
3.50,	-0.10686E-01	0.38877E-03	0.23037E-05	-0.23333E-06
	0.77848E-02	-0.86601E-03	0.27801E-04	-0.38807E-06
	0.64531E-02	-0.38677E-03	0.10787E-04	-0.76996E-07
	-0.91301E-02	0.53030E-03	-0.18128E-04	0.24087E-06
	0.30885E-02	0.30348E-04	0.13610E-05	-0.22020E-07
	-0.97726E-02	0.57112E-03	-0.16737E-04	0.17855E-06
4.00,	-0.11249E-01	0.87295E-03	-0.41933E-04	0.86766E-06
	0.86633E-02	-0.88642E-03	0.18057E-04	0.51638E-07
	0.65780E-02	-0.46096E-03	0.16753E-04	-0.21298E-06
	-0.88542E-02	0.58207E-03	-0.20594E-04	0.24684E-06
	0.30549E-02	-0.27388E-05	0.15814E-05	-0.41712E-08
	-0.99901E-02	0.66889E-03	-0.21841E-04	0.25622E-06
-15.0,				
0.30,	-0.46403E-01	0.53433E-02	-0.49657E-03	0.12439E-04
	0.18266E-02	-0.44972E-03	-0.17251E-04	0.88610E-06
	0.14548E-01	-0.29567E-03	0.18023E-04	-0.68560E-06
	-0.27962E-01	0.21337E-02	-0.90634E-04	0.14169E-05
	0.17342E-01	-0.76579E-03	0.32836E-04	-0.62637E-06
	-0.20551E-01	0.17961E-02	-0.10052E-03	0.20606E-05
0.60,	-0.49133E-01	0.56576E-02	-0.52578E-03	0.13171E-04
	0.19341E-02	-0.47618E-03	-0.18266E-04	0.93823E-06
	0.15403E-01	-0.31306E-03	0.19084E-04	-0.72593E-06
	-0.29607E-01	0.22592E-02	-0.95965E-04	0.15003E-05
	0.18362E-01	-0.81083E-03	0.34768E-04	-0.66322E-06
	-0.21760E-01	0.19017E-02	-0.10643E-03	0.21818E-05
0.80,	-0.57322E-01	0.66005E-02	-0.61341E-03	0.15366E-04
	0.22564E-02	-0.55554E-03	-0.21310E-04	0.10946E-05
	0.17971E-01	-0.36524E-03	0.22264E-04	-0.84692E-06
	-0.34542E-01	0.26357E-02	-0.11196E-03	0.17503E-05
	0.21422E-01	-0.94597E-03	0.40562E-04	-0.77375E-06
	-0.25386E-01	0.22187E-02	-0.12417E-03	0.25455E-05
0.90,				

HL-20 Aerodynamics Tables (version 2.0)

	-0.60051E-01	0.69148E-02	-0.64262E-03	0.16097E-04
	0.23639E-02	-0.58199E-03	-0.22325E-04	0.11467E-05
	0.18826E-01	-0.38263E-03	0.23324E-04	-0.88725E-06
	-0.36187E-01	0.27612E-02	-0.11729E-03	0.18337E-05
	0.22442E-01	-0.99102E-03	0.42494E-04	-0.81060E-06
	-0.26595E-01	0.23243E-02	-0.13008E-03	0.26667E-05
0.95,	-0.47768E-01	0.55004E-02	-0.51117E-03	0.12805E-04
	0.18803E-02	-0.46295E-03	-0.17758E-04	0.91216E-06
	0.14975E-01	-0.30437E-03	0.18553E-04	-0.70577E-06
	-0.28785E-01	0.21964E-02	-0.93300E-04	0.14586E-05
	0.17852E-01	-0.78831E-03	0.33802E-04	-0.64479E-06
	-0.21155E-01	0.18489E-02	-0.10347E-03	0.21212E-05
1.10,	-0.39377E-01	0.43585E-02	-0.38378E-03	0.91876E-05
	0.26009E-02	-0.52252E-03	-0.11039E-04	0.80688E-06
	0.12824E-01	-0.29550E-03	0.10601E-04	-0.27944E-06
	-0.24584E-01	0.17912E-02	-0.76166E-04	0.13514E-05
	0.15369E-01	-0.53804E-03	0.17215E-04	-0.24303E-06
	-0.18500E-01	0.15036E-02	-0.77449E-04	0.14675E-05
1.20,	-0.33779E-01	0.35967E-02	-0.29880E-03	0.67745E-05
	0.30816E-02	-0.56227E-03	-0.65564E-05	0.73664E-06
	0.11388E-01	-0.28959E-03	0.52965E-05	0.49683E-08
	-0.21782E-01	0.15208E-02	-0.64736E-04	0.12798E-05
	0.13712E-01	-0.37109E-03	0.61493E-05	0.24992E-07
	-0.16729E-01	0.12732E-02	-0.60088E-04	0.10315E-05
1.60,	-0.11394E-01	0.55060E-03	0.41023E-04	-0.28745E-05
	0.50036E-02	-0.72118E-03	0.11368E-04	0.45578E-06
	0.56489E-02	-0.26595E-03	-0.15916E-04	0.11422E-05
	-0.10578E-01	0.43979E-03	-0.19030E-04	0.99373E-06
	0.70887E-02	0.29651E-03	-0.38098E-04	0.10967E-05
	-0.96455E-02	0.35207E-03	0.93346E-05	-0.71224E-06
2.00,	-0.46116E-02	0.61775E-03	0.35134E-05	-0.11215E-05
	0.44379E-02	-0.40179E-03	-0.48778E-05	0.88573E-06
	0.32521E-02	-0.19123E-03	0.39122E-05	0.37451E-07
	-0.70458E-02	0.34892E-04	0.30858E-04	-0.14007E-05
	0.45282E-02	0.14837E-03	-0.96352E-05	0.20633E-06
	-0.61276E-02	0.15838E-03	0.80239E-05	-0.44725E-06
2.50,	-0.33766E-02	-0.30056E-03	0.72963E-04	-0.21943E-05
	0.39502E-02	-0.23169E-03	0.24571E-05	0.96710E-07
	0.22199E-02	-0.33818E-04	-0.10759E-04	0.45415E-06
	-0.47423E-02	-0.10564E-04	0.31367E-04	-0.11881E-05
	0.34983E-02	0.13751E-03	-0.11066E-04	0.28224E-06
	-0.45102E-02	0.13804E-03	-0.10710E-05	-0.86989E-07
3.00,	-0.41676E-02	0.18177E-04	0.14708E-04	-0.42351E-06
	0.19059E-02	-0.31223E-03	0.11808E-04	-0.21165E-06
	0.22390E-02	-0.97424E-04	0.23626E-05	0.37739E-08
	-0.46554E-02	0.16554E-03	-0.37444E-05	0.58694E-08
	0.23638E-02	0.50393E-04	-0.19557E-05	0.52310E-07
	-0.40074E-02	0.14675E-03	-0.22772E-05	-0.18418E-07
3.50,	-0.33996E-02	0.70132E-04	0.54515E-05	-0.20952E-06
	0.16740E-02	-0.25283E-03	0.83265E-05	-0.15536E-06

HL-20 Aerodynamics Tables (version 2.0)

	0.21116E-02	-0.93988E-04	0.25476E-05	0.39782E-09
	-0.36562E-02	0.15615E-03	-0.47560E-05	0.37327E-07
	0.21982E-02	-0.23401E-04	0.25553E-05	-0.26202E-07
4.00,	-0.35367E-02	0.16854E-03	-0.49245E-05	0.40177E-07
	-0.39003E-02	0.36008E-03	-0.16386E-04	0.29334E-06
	0.18636E-02	-0.29197E-03	0.10391E-04	-0.13599E-06
	0.20028E-02	-0.11138E-03	0.38811E-05	-0.25870E-07
	-0.34807E-02	0.15779E-03	-0.50524E-05	0.39590E-07
	0.21647E-02	-0.51909E-04	0.37691E-05	-0.46833E-07
	-0.34999E-02	0.20348E-03	-0.72971E-05	0.85370E-07
0.0,				
0.30,				
	0.00000E+00	0.00000E+00	0.00000E+00	0.00000E+00
	0.00000E+00	0.00000E+00	0.00000E+00	0.00000E+00
	0.00000E+00	0.00000E+00	0.00000E+00	0.00000E+00
	0.00000E+00	0.00000E+00	0.00000E+00	0.00000E+00
	0.00000E+00	0.00000E+00	0.00000E+00	0.00000E+00
0.60,	0.00000E+00	0.00000E+00	0.00000E+00	0.00000E+00
	0.00000E+00	0.00000E+00	0.00000E+00	0.00000E+00
	0.00000E+00	0.00000E+00	0.00000E+00	0.00000E+00
	0.00000E+00	0.00000E+00	0.00000E+00	0.00000E+00
	0.00000E+00	0.00000E+00	0.00000E+00	0.00000E+00
	0.00000E+00	0.00000E+00	0.00000E+00	0.00000E+00
0.80,	0.00000E+00	0.00000E+00	0.00000E+00	0.00000E+00
	0.00000E+00	0.00000E+00	0.00000E+00	0.00000E+00
	0.00000E+00	0.00000E+00	0.00000E+00	0.00000E+00
	0.00000E+00	0.00000E+00	0.00000E+00	0.00000E+00
	0.00000E+00	0.00000E+00	0.00000E+00	0.00000E+00
	0.00000E+00	0.00000E+00	0.00000E+00	0.00000E+00
0.90,	0.00000E+00	0.00000E+00	0.00000E+00	0.00000E+00
	0.00000E+00	0.00000E+00	0.00000E+00	0.00000E+00
	0.00000E+00	0.00000E+00	0.00000E+00	0.00000E+00
	0.00000E+00	0.00000E+00	0.00000E+00	0.00000E+00
	0.00000E+00	0.00000E+00	0.00000E+00	0.00000E+00
	0.00000E+00	0.00000E+00	0.00000E+00	0.00000E+00
0.95,	0.00000E+00	0.00000E+00	0.00000E+00	0.00000E+00
	0.00000E+00	0.00000E+00	0.00000E+00	0.00000E+00
	0.00000E+00	0.00000E+00	0.00000E+00	0.00000E+00
	0.00000E+00	0.00000E+00	0.00000E+00	0.00000E+00
	0.00000E+00	0.00000E+00	0.00000E+00	0.00000E+00
	0.00000E+00	0.00000E+00	0.00000E+00	0.00000E+00
1.10,	0.00000E+00	0.00000E+00	0.00000E+00	0.00000E+00
	0.00000E+00	0.00000E+00	0.00000E+00	0.00000E+00
	0.00000E+00	0.00000E+00	0.00000E+00	0.00000E+00
	0.00000E+00	0.00000E+00	0.00000E+00	0.00000E+00
	0.00000E+00	0.00000E+00	0.00000E+00	0.00000E+00
	0.00000E+00	0.00000E+00	0.00000E+00	0.00000E+00
1.20,	0.00000E+00	0.00000E+00	0.00000E+00	0.00000E+00
	0.00000E+00	0.00000E+00	0.00000E+00	0.00000E+00
	0.00000E+00	0.00000E+00	0.00000E+00	0.00000E+00

HL-20 Aerodynamics Tables (version 2.0)

	0.00000E+00 ,	0.00000E+00 ,	0.00000E+00 ,	0.00000E+00 ,
	0.00000E+00 ,	0.00000E+00 ,	0.00000E+00 ,	0.00000E+00 ,
	0.00000E+00 ,	0.00000E+00 ,	0.00000E+00 ,	0.00000E+00 ,
1.60,	0.00000E+00 ,	0.00000E+00 ,	0.00000E+00 ,	0.00000E+00 ,
	0.00000E+00 ,	0.00000E+00 ,	0.00000E+00 ,	0.00000E+00 ,
	0.00000E+00 ,	0.00000E+00 ,	0.00000E+00 ,	0.00000E+00 ,
	0.00000E+00 ,	0.00000E+00 ,	0.00000E+00 ,	0.00000E+00 ,
	0.00000E+00 ,	0.00000E+00 ,	0.00000E+00 ,	0.00000E+00 ,
	0.00000E+00 ,	0.00000E+00 ,	0.00000E+00 ,	0.00000E+00 ,
2.00,	0.00000E+00 ,	0.00000E+00 ,	0.00000E+00 ,	0.00000E+00 ,
	0.00000E+00 ,	0.00000E+00 ,	0.00000E+00 ,	0.00000E+00 ,
	0.00000E+00 ,	0.00000E+00 ,	0.00000E+00 ,	0.00000E+00 ,
	0.00000E+00 ,	0.00000E+00 ,	0.00000E+00 ,	0.00000E+00 ,
	0.00000E+00 ,	0.00000E+00 ,	0.00000E+00 ,	0.00000E+00 ,
	0.00000E+00 ,	0.00000E+00 ,	0.00000E+00 ,	0.00000E+00 ,
2.50,	0.00000E+00 ,	0.00000E+00 ,	0.00000E+00 ,	0.00000E+00 ,
	0.00000E+00 ,	0.00000E+00 ,	0.00000E+00 ,	0.00000E+00 ,
	0.00000E+00 ,	0.00000E+00 ,	0.00000E+00 ,	0.00000E+00 ,
	0.00000E+00 ,	0.00000E+00 ,	0.00000E+00 ,	0.00000E+00 ,
	0.00000E+00 ,	0.00000E+00 ,	0.00000E+00 ,	0.00000E+00 ,
	0.00000E+00 ,	0.00000E+00 ,	0.00000E+00 ,	0.00000E+00 ,
3.00,	0.00000E+00 ,	0.00000E+00 ,	0.00000E+00 ,	0.00000E+00 ,
	0.00000E+00 ,	0.00000E+00 ,	0.00000E+00 ,	0.00000E+00 ,
	0.00000E+00 ,	0.00000E+00 ,	0.00000E+00 ,	0.00000E+00 ,
	0.00000E+00 ,	0.00000E+00 ,	0.00000E+00 ,	0.00000E+00 ,
	0.00000E+00 ,	0.00000E+00 ,	0.00000E+00 ,	0.00000E+00 ,
	0.00000E+00 ,	0.00000E+00 ,	0.00000E+00 ,	0.00000E+00 ,
3.50,	0.00000E+00 ,	0.00000E+00 ,	0.00000E+00 ,	0.00000E+00 ,
	0.00000E+00 ,	0.00000E+00 ,	0.00000E+00 ,	0.00000E+00 ,
	0.00000E+00 ,	0.00000E+00 ,	0.00000E+00 ,	0.00000E+00 ,
	0.00000E+00 ,	0.00000E+00 ,	0.00000E+00 ,	0.00000E+00 ,
	0.00000E+00 ,	0.00000E+00 ,	0.00000E+00 ,	0.00000E+00 ,
	0.00000E+00 ,	0.00000E+00 ,	0.00000E+00 ,	0.00000E+00 ,
4.00,	0.00000E+00 ,	0.00000E+00 ,	0.00000E+00 ,	0.00000E+00 ,
	0.00000E+00 ,	0.00000E+00 ,	0.00000E+00 ,	0.00000E+00 ,
	0.00000E+00 ,	0.00000E+00 ,	0.00000E+00 ,	0.00000E+00 ,
	0.00000E+00 ,	0.00000E+00 ,	0.00000E+00 ,	0.00000E+00 ,
	0.00000E+00 ,	0.00000E+00 ,	0.00000E+00 ,	0.00000E+00 ,
	0.00000E+00 ,	0.00000E+00 ,	0.00000E+00 ,	0.00000E+00 ,
15.0,				
0.30,	-0.19362E-02 ,	0.79443E-02 ,	-0.57025E-03 ,	0.10626E-04 ,
	0.44291E-02 ,	-0.41459E-03 ,	0.79391E-04 ,	-0.21284E-05 ,
	-0.80529E-02 ,	-0.16572E-03 ,	0.93501E-05 ,	0.80210E-07 ,
	0.41254E-01 ,	-0.41953E-03 ,	0.22186E-04 ,	-0.13890E-05 ,
	-0.37182E-01 ,	0.42032E-03 ,	0.19537E-05 ,	0.34096E-06 ,
	0.30962E-01 ,	-0.18369E-03 ,	0.15658E-04 ,	-0.12039E-05 ,
0.60,				
	-0.28496E-02 ,	0.11692E-01 ,	-0.83926E-03 ,	0.15639E-04 ,
	0.65185E-02 ,	-0.61017E-03 ,	0.11684E-03 ,	-0.31325E-05 ,
	-0.11852E-01 ,	-0.24390E-03 ,	0.13761E-04 ,	0.11805E-06 ,
	0.60715E-01 ,	-0.61744E-03 ,	0.32652E-04 ,	-0.20443E-05 ,

HL-20 Aerodynamics Tables (version 2.0)

	-0.54722E-01	0.61860E-03	0.28753E-05	0.50180E-06
	0.45569E-01	-0.27035E-03	0.23044E-04	-0.17719E-05
0.80,	-0.25330E-02	0.10393E-01	-0.74601E-03	0.13901E-04
	0.57942E-02	-0.54237E-03	0.10386E-03	-0.27845E-05
	-0.10535E-01	-0.21680E-03	0.12232E-04	0.10493E-06
	0.53969E-01	-0.54884E-03	0.29024E-04	-0.18171E-05
	-0.48642E-01	0.54986E-03	0.25558E-05	0.44605E-06
	0.40506E-01	-0.24031E-03	0.20483E-04	-0.15750E-05
0.90,	-0.15831E-02	0.64955E-02	-0.46625E-03	0.86884E-05
	0.36214E-02	-0.33898E-03	0.64913E-04	-0.17403E-05
	-0.65844E-02	-0.13550E-03	0.76450E-05	0.65582E-07
	0.33731E-01	-0.34302E-03	0.18140E-04	-0.11357E-05
	-0.30401E-01	0.34366E-03	0.15974E-05	0.27878E-06
	0.25316E-01	-0.15019E-03	0.12802E-04	-0.98437E-06
0.95,	-0.25330E-02	0.10393E-01	-0.74601E-03	0.13901E-04
	0.57942E-02	-0.54237E-03	0.10386E-03	-0.27845E-05
	-0.10535E-01	-0.21680E-03	0.12232E-04	0.10493E-06
	0.53969E-01	-0.54884E-03	0.29024E-04	-0.18171E-05
	-0.48642E-01	0.54986E-03	0.25558E-05	0.44605E-06
	0.40506E-01	-0.24031E-03	0.20483E-04	-0.15750E-05
1.10,	-0.72006E-03	0.80498E-02	-0.56416E-03	0.97087E-05
	0.55310E-02	-0.29254E-03	0.75492E-04	-0.22420E-05
	-0.87923E-02	-0.14146E-03	0.69728E-05	0.22475E-06
	0.44323E-01	-0.38557E-03	0.86722E-05	-0.87531E-06
	-0.40669E-01	0.32278E-03	0.20074E-04	-0.30744E-06
	0.33176E-01	-0.20810E-03	0.87656E-05	-0.89091E-06
1.20,	0.48935E-03	0.64867E-02	-0.44285E-03	0.69117E-05
	0.53554E-02	-0.12588E-03	0.56567E-04	-0.18801E-05
	-0.76298E-02	-0.91203E-04	0.34644E-05	0.30468E-06
	0.37888E-01	-0.27665E-03	-0.49043E-05	-0.24701E-06
	-0.35351E-01	0.17129E-03	0.31760E-04	-0.81009E-06
	0.28286E-01	-0.18662E-03	0.94862E-06	-0.43456E-06
1.60,	0.53254E-02	0.23647E-03	0.42240E-04	-0.42726E-05
	0.46532E-02	0.54055E-03	-0.19109E-04	-0.43294E-06
	-0.29812E-02	0.10977E-03	-0.10565E-04	0.62430E-06
	0.12157E-01	0.15889E-03	-0.59193E-04	0.22654E-05
	-0.14084E-01	-0.43446E-03	0.78490E-04	-0.28200E-05
	0.87339E-02	-0.10070E-03	-0.30309E-04	0.13902E-05
2.00,	0.62128E-02	0.76926E-04	0.22241E-04	-0.14603E-05
	0.41987E-02	0.49459E-03	-0.51381E-04	0.19935E-05
	-0.21355E-02	0.62003E-04	-0.33525E-05	0.10890E-06
	0.70823E-02	-0.67951E-04	0.25709E-04	-0.11238E-05
	-0.89889E-02	-0.25018E-03	0.20396E-04	-0.51626E-06
	0.51330E-02	-0.90873E-04	0.50917E-05	-0.13573E-06
2.50,	0.70562E-02	-0.25642E-03	0.23875E-04	-0.37584E-06
	0.37003E-02	0.38064E-03	-0.15420E-04	0.37461E-06
	-0.18740E-02	0.79974E-04	-0.88226E-05	0.29440E-06
	0.63378E-02	0.28673E-04	0.17941E-04	-0.77960E-06
	-0.65935E-02	-0.14434E-03	-0.34576E-07	0.11358E-06
	0.39646E-02	0.19487E-04	0.13280E-05	-0.12387E-06

HL-20 Aerodynamics Tables (version 2.0)

3.00,
0.37325E-02 , -0.24430E-03 , 0.17874E-04 , -0.42945E-06 ,
0.10488E-02 , 0.16831E-03 , -0.22033E-05 , -0.21849E-07 ,
-0.13159E-02 , 0.46816E-04 , -0.83535E-06 , 0.14623E-07 ,
0.40923E-02 , 0.54765E-04 , 0.91308E-06 , -0.32807E-07 ,
-0.58563E-02 , -0.97235E-04 , 0.11070E-05 , 0.18030E-08 ,
0.31212E-02 , -0.20082E-04 , 0.29750E-05 , -0.63591E-07 ,

3.50,
0.28591E-02 , -0.20966E-03 , 0.10490E-04 , -0.22731E-06 ,
0.33315E-03 , 0.13230E-03 , 0.72906E-06 , -0.10174E-06 ,
-0.10672E-02 , 0.50567E-04 , -0.25385E-05 , 0.58714E-07 ,
0.38489E-02 , -0.23916E-05 , 0.42747E-05 , -0.90059E-07 ,
-0.47724E-02 , -0.83970E-04 , -0.25519E-05 , 0.97698E-07 ,
0.28018E-02 , -0.37094E-04 , 0.48504E-05 , -0.10028E-06 ,

4.00,
0.26032E-02 , -0.34550E-04 , 0.35026E-07 , 0.24785E-07 ,
0.48726E-03 , 0.11275E-03 , 0.57344E-06 , -0.14278E-07 ,
-0.10930E-02 , 0.67872E-04 , -0.34810E-05 , 0.66552E-07 ,
0.37364E-02 , -0.61348E-04 , 0.98108E-05 , -0.21338E-06 ,
-0.43023E-02 , -0.15131E-04 , -0.86198E-05 , 0.21822E-06 ,
0.26607E-02 , -0.61659E-04 , 0.68595E-05 , -0.13677E-06 ,

30.0,
0.30,
0.59318E-01 , 0.88160E-02 , -0.90020E-03 , 0.17718E-04 ,
0.21180E-01 , 0.45188E-03 , -0.23486E-05 , -0.71075E-06 ,
-0.18166E-01 , -0.11348E-02 , 0.10299E-03 , -0.14788E-05 ,
0.79717E-01 , 0.17022E-02 , -0.24498E-03 , 0.40779E-05 ,
-0.74818E-01 , -0.65004E-03 , 0.16754E-03 , -0.29825E-05 ,
0.52354E-01 , 0.28104E-02 , -0.25466E-03 , 0.34674E-05 ,

0.60,
0.87301E-01 , 0.12975E-01 , -0.13249E-02 , 0.26076E-04 ,
0.31171E-01 , 0.66505E-03 , -0.34565E-05 , -0.10460E-05 ,
-0.26735E-01 , -0.16702E-02 , 0.15158E-03 , -0.21765E-05 ,
0.11732E+00 , 0.25052E-02 , -0.36054E-03 , 0.60017E-05 ,
-0.11011E+00 , -0.95670E-03 , 0.24657E-03 , -0.43894E-05 ,
0.77052E-01 , 0.41362E-02 , -0.37480E-03 , 0.51031E-05 ,

0.80,
0.77601E-01 , 0.11533E-01 , -0.11777E-02 , 0.23179E-04 ,
0.27708E-01 , 0.59115E-03 , -0.30725E-05 , -0.92981E-06 ,
-0.23765E-01 , -0.14846E-02 , 0.13474E-03 , -0.19346E-05 ,
0.10429E+00 , 0.22268E-02 , -0.32048E-03 , 0.53348E-05 ,
-0.97877E-01 , -0.85040E-03 , 0.21918E-03 , -0.39017E-05 ,
0.68491E-01 , 0.36766E-02 , -0.33315E-03 , 0.45361E-05 ,

0.90,
0.48501E-01 , 0.72083E-02 , -0.73603E-03 , 0.14487E-04 ,
0.17317E-01 , 0.36947E-03 , -0.19203E-05 , -0.58113E-06 ,
-0.14853E-01 , -0.92786E-03 , 0.84211E-04 , -0.12091E-05 ,
0.65179E-01 , 0.13918E-02 , -0.20030E-03 , 0.33343E-05 ,
-0.61173E-01 , -0.53150E-03 , 0.13698E-03 , -0.24386E-05 ,
0.42807E-01 , 0.22979E-02 , -0.20822E-03 , 0.28351E-05 ,

0.95,
0.77601E-01 , 0.11533E-01 , -0.11777E-02 , 0.23179E-04 ,
0.27708E-01 , 0.59115E-03 , -0.30725E-05 , -0.92981E-06 ,
-0.23765E-01 , -0.14846E-02 , 0.13474E-03 , -0.19346E-05 ,
0.10429E+00 , 0.22268E-02 , -0.32048E-03 , 0.53348E-05 ,
-0.97877E-01 , -0.85040E-03 , 0.21918E-03 , -0.39017E-05 ,
0.68491E-01 , 0.36766E-02 , -0.33315E-03 , 0.45361E-05 ,

1.10,

HL-20 Aerodynamics Tables (version 2.0)

	0.62989E-01	0.87401E-02	-0.89576E-03	0.17198E-04
	0.23760E-01	0.79026E-03	-0.30302E-04	0.13123E-07
	-0.19550E-01	-0.10671E-02	0.97262E-04	-0.12128E-05
	0.85559E-01	0.17863E-02	-0.26548E-03	0.47141E-05
	-0.81933E-01	-0.91151E-03	0.20477E-03	-0.41721E-05
1.20,	0.56341E-01	0.27752E-02	-0.26169E-03	0.36973E-05
	0.53241E-01	0.68767E-02	-0.70771E-03	0.13208E-04
	0.21127E-01	0.92308E-03	-0.48468E-04	0.64215E-06
	-0.16738E-01	-0.78862E-03	0.72262E-04	-0.73134E-06
	0.73066E-01	0.14925E-02	-0.22878E-03	0.43000E-05
	-0.71297E-01	-0.95228E-03	0.19516E-03	-0.43524E-05
1.60,	0.48236E-01	0.21738E-02	-0.21402E-03	0.31377E-05
	0.14262E-01	-0.57430E-03	0.44260E-04	-0.27462E-05
	0.10596E-01	0.14542E-02	-0.12110E-03	0.31575E-05
	-0.54949E-02	0.32500E-03	-0.27705E-04	0.11941E-05
	0.23109E-01	0.31743E-03	-0.82055E-04	0.26441E-05
	-0.28765E-01	-0.11153E-02	0.15674E-03	-0.50735E-05
2.00,	0.15828E-01	-0.23082E-03	-0.23395E-04	0.90005E-06
	0.18469E-01	0.14000E-03	0.39088E-04	-0.20304E-05
	0.82981E-02	0.10573E-02	-0.69909E-04	0.26513E-05
	-0.45391E-02	0.36181E-04	-0.11608E-04	0.35229E-06
	0.14597E-01	0.15263E-03	0.15706E-04	-0.11630E-05
	-0.20079E-01	-0.76259E-03	0.53392E-04	-0.11162E-05
2.50,	0.10014E-01	-0.61072E-04	0.29545E-05	-0.17028E-06
	0.11304E-01	-0.10759E-02	0.14995E-03	-0.46090E-05
	0.78121E-02	0.53750E-03	0.11104E-04	-0.82392E-06
	-0.34254E-02	0.13773E-03	-0.16632E-04	0.55752E-06
	0.13224E-01	0.11346E-03	0.76059E-05	-0.38132E-06
	-0.15551E-01	-0.49143E-03	0.70042E-05	0.21795E-06
3.00,	0.83182E-02	0.22455E-04	0.46389E-06	-0.71705E-07
	0.53634E-02	-0.30421E-03	0.24265E-04	-0.62794E-06
	0.32057E-02	0.30236E-03	-0.41340E-05	-0.35109E-07
	-0.19808E-02	0.72374E-04	-0.33542E-05	0.88484E-07
	0.80792E-02	0.33394E-04	0.78014E-05	-0.22024E-06
	-0.11175E-01	-0.21721E-03	0.84232E-06	0.72884E-07
3.50,	0.54989E-02	-0.15398E-04	0.60903E-05	-0.15883E-06
	0.51469E-02	-0.11230E-03	0.66521E-05	-0.28433E-06
	0.24146E-02	0.23487E-03	0.42076E-05	-0.28746E-06
	-0.16211E-02	0.60726E-04	-0.42994E-05	0.11295E-06
	0.74572E-02	0.69281E-04	0.69953E-05	-0.21238E-06
	-0.95470E-02	-0.16391E-03	-0.72604E-05	0.25665E-06
4.00,	0.48707E-02	-0.18696E-04	0.76938E-05	-0.18701E-06
	0.48448E-02	0.21213E-03	-0.29325E-04	0.75126E-06
	0.21824E-02	0.30604E-03	-0.11453E-04	0.32596E-06
	-0.16041E-02	0.56623E-04	-0.29449E-05	0.61262E-07
	0.68196E-02	0.49787E-05	0.12879E-04	-0.33939E-06
	-0.87831E-02	-0.66390E-04	-0.17779E-04	0.49760E-06
	0.45740E-02	-0.51972E-04	0.11292E-04	-0.26728E-06

HL-20 Aerodynamics Tables (version 2.0)

2.00,	0.00000E+00	0.00000E+00	0.00000E+00	0.00000E+00
	0.00000E+00	0.00000E+00	0.00000E+00	0.00000E+00
	0.00000E+00	0.00000E+00	0.00000E+00	0.00000E+00
	0.00000E+00	0.00000E+00	0.00000E+00	0.00000E+00
	0.00000E+00	0.00000E+00	0.00000E+00	0.00000E+00
2.50,	0.00000E+00	0.00000E+00	0.00000E+00	0.00000E+00
	0.00000E+00	0.00000E+00	0.00000E+00	0.00000E+00
	0.00000E+00	0.00000E+00	0.00000E+00	0.00000E+00
	0.00000E+00	0.00000E+00	0.00000E+00	0.00000E+00
	0.00000E+00	0.00000E+00	0.00000E+00	0.00000E+00
3.00,	0.00000E+00	0.00000E+00	0.00000E+00	0.00000E+00
	0.00000E+00	0.00000E+00	0.00000E+00	0.00000E+00
	0.00000E+00	0.00000E+00	0.00000E+00	0.00000E+00
	0.00000E+00	0.00000E+00	0.00000E+00	0.00000E+00
	0.00000E+00	0.00000E+00	0.00000E+00	0.00000E+00
3.50,	0.00000E+00	0.00000E+00	0.00000E+00	0.00000E+00
	0.00000E+00	0.00000E+00	0.00000E+00	0.00000E+00
	0.00000E+00	0.00000E+00	0.00000E+00	0.00000E+00
	0.00000E+00	0.00000E+00	0.00000E+00	0.00000E+00
	0.00000E+00	0.00000E+00	0.00000E+00	0.00000E+00
4.00,	0.00000E+00	0.00000E+00	0.00000E+00	0.00000E+00
	0.00000E+00	0.00000E+00	0.00000E+00	0.00000E+00
	0.00000E+00	0.00000E+00	0.00000E+00	0.00000E+00
	0.00000E+00	0.00000E+00	0.00000E+00	0.00000E+00
	0.00000E+00	0.00000E+00	0.00000E+00	0.00000E+00
15.0,	0.00000E+00	0.00000E+00	0.00000E+00	0.00000E+00
0.30,	-0.13646E-01	0.81105E-02	-0.70197E-03	0.15341E-04
	0.48574E-03	-0.59253E-03	0.78507E-04	-0.19218E-05
	0.37241E-02	-0.32643E-03	0.17728E-04	-0.40951E-06
	0.89759E-02	0.30575E-02	-0.15466E-03	0.22353E-05
	-0.12496E-01	-0.76389E-03	0.32148E-04	-0.41948E-06
0.60,	-0.20471E-02	0.18705E-02	-0.12021E-03	0.21859E-05
	0.26486E-01	0.56887E-02	-0.10650E-02	0.32543E-04
	-0.10948E-01	0.17510E-02	-0.19287E-03	0.59425E-05
	-0.50575E-02	-0.80859E-03	0.16214E-03	-0.51378E-05
	0.37134E-01	-0.12940E-02	0.39452E-03	-0.13678E-04
	-0.29443E-01	0.41547E-03	-0.56307E-05	-0.51736E-06
0.80,	0.48498E-02	-0.87596E-03	0.17117E-04	0.16763E-05
	0.16977E-01	-0.29680E-02	-0.40849E-04	0.54696E-05
	-0.45378E-03	0.64347E-04	-0.12167E-03	0.50234E-05
	-0.51199E-02	0.88543E-03	-0.33473E-04	0.38241E-07
	0.29612E-01	-0.30008E-03	0.31330E-03	-0.12739E-04
	-0.27206E-01	-0.10755E-03	0.39228E-04	-0.22372E-05
0.90,	0.16086E-02	-0.15300E-03	0.39553E-04	-0.99083E-06

HL-20 Aerodynamics Tables (version 2.0)

	-0.16891E-01	-0.56343E-02	0.11940E-02	-0.43161E-04
	-0.16272E-01	-0.44489E-02	0.74156E-03	-0.23953E-04
	0.35337E-02	0.13856E-02	-0.34888E-03	0.12929E-04
	0.35031E-01	0.15026E-02	-0.66012E-04	-0.99138E-07
	-0.27810E-01	-0.51487E-03	0.10278E-03	-0.42776E-05
	0.35497E-03	-0.10408E-04	0.20795E-04	-0.74877E-06
0.95,	0.10682E-01	0.42658E-02	-0.77795E-03	0.24892E-04
	-0.50330E-02	-0.18559E-02	0.12871E-04	0.45520E-05
	-0.36619E-02	-0.80692E-03	0.22583E-03	-0.78536E-05
	0.36842E-01	0.38359E-03	-0.39287E-04	0.15174E-05
	-0.29203E-01	0.10463E-03	0.75812E-04	-0.36532E-05
	0.34746E-02	-0.53328E-03	0.15636E-04	0.30581E-06
1.10,	0.75071E-02	0.43665E-02	-0.95411E-03	0.37593E-04
	-0.29115E-02	-0.53747E-03	-0.21894E-03	0.14552E-04
	-0.30339E-02	-0.90530E-03	0.27427E-03	-0.11276E-04
	0.34959E-01	0.27677E-03	-0.62860E-04	0.24127E-05
	-0.28758E-01	0.12692E-03	0.80943E-04	-0.38633E-05
	0.26925E-02	-0.64001E-03	0.82630E-04	-0.34280E-05
1.20,	0.53891E-02	0.44337E-02	-0.10716E-02	0.46066E-04
	-0.14963E-02	0.34206E-03	-0.37359E-03	0.21223E-04
	-0.26150E-02	-0.97093E-03	0.30659E-03	-0.13559E-04
	0.33703E-01	0.20551E-03	-0.78586E-04	0.30100E-05
	-0.28461E-01	0.14178E-03	0.84366E-04	-0.40036E-05
	0.21708E-02	-0.71121E-03	0.12732E-03	-0.59189E-05
1.60,	-0.30802E-02	0.47024E-02	-0.15415E-02	0.79945E-04
	0.41629E-02	0.38590E-02	-0.99196E-03	0.47899E-04
	-0.93987E-03	-0.12334E-02	0.43580E-03	-0.22689E-04
	0.28681E-01	-0.79435E-04	-0.14147E-03	0.53984E-05
	-0.27275E-01	0.20123E-03	0.98053E-04	-0.45642E-05
	0.84430E-04	-0.99592E-03	0.30603E-03	-0.15879E-04
2.00,	-0.59013E-02	0.28192E-02	-0.58915E-03	0.21540E-04
	-0.57612E-03	-0.71466E-03	0.98221E-04	-0.42327E-05
	0.10229E-02	-0.24922E-04	0.37094E-04	-0.20794E-05
	0.24048E-01	-0.92379E-03	-0.78515E-05	0.73098E-06
	-0.20635E-01	0.72713E-03	-0.54384E-04	0.22320E-05
	0.39686E-02	-0.39895E-03	0.48142E-04	-0.19957E-05
2.50,	-0.95733E-02	-0.26446E-03	-0.42690E-04	0.61894E-06
	-0.40445E-02	0.35343E-03	-0.58303E-04	0.76946E-06
	0.12199E-02	0.25017E-03	-0.15038E-04	0.34154E-06
	0.19109E-01	-0.41719E-03	-0.29668E-04	0.10090E-05
	-0.13872E-01	0.34791E-03	-0.17157E-04	0.61102E-06
	0.31463E-02	-0.16351E-03	0.11918E-05	0.39992E-07
3.00,	0.00000E+00	0.00000E+00	0.00000E+00	0.00000E+00
	0.00000E+00	0.00000E+00	0.00000E+00	0.00000E+00
	0.00000E+00	0.00000E+00	0.00000E+00	0.00000E+00
	0.00000E+00	0.00000E+00	0.00000E+00	0.00000E+00
	0.00000E+00	0.00000E+00	0.00000E+00	0.00000E+00
	0.00000E+00	0.00000E+00	0.00000E+00	0.00000E+00
3.50,	0.00000E+00	0.00000E+00	0.00000E+00	0.00000E+00
	0.00000E+00	0.00000E+00	0.00000E+00	0.00000E+00

HL-20 Aerodynamics Tables (version 2.0)

	0.00000E+00	0.00000E+00	0.00000E+00	0.00000E+00
	0.00000E+00	0.00000E+00	0.00000E+00	0.00000E+00
	0.00000E+00	0.00000E+00	0.00000E+00	0.00000E+00
4.00,	0.00000E+00	0.00000E+00	0.00000E+00	0.00000E+00
	0.00000E+00	0.00000E+00	0.00000E+00	0.00000E+00
	0.00000E+00	0.00000E+00	0.00000E+00	0.00000E+00
	0.00000E+00	0.00000E+00	0.00000E+00	0.00000E+00
	0.00000E+00	0.00000E+00	0.00000E+00	0.00000E+00
	0.00000E+00	0.00000E+00	0.00000E+00	0.00000E+00
30.0,	0.00000E+00	0.00000E+00	0.00000E+00	0.00000E+00
0.30,	-0.12709E-02	0.38650E-02	-0.55108E-03	0.14188E-04
	0.11982E-01	0.88381E-03	-0.57730E-04	0.84814E-06
	0.65176E-02	-0.43028E-03	0.34151E-04	-0.83397E-06
	0.33794E-01	0.39625E-03	0.77186E-04	-0.25222E-05
	-0.26301E-01	-0.33197E-03	-0.18887E-04	0.59731E-06
	0.27752E-03	0.51978E-03	-0.12730E-04	0.16219E-06
0.60,	0.52971E-01	0.11377E-01	-0.21299E-02	0.65086E-04
	-0.21896E-01	0.35020E-02	-0.38573E-03	0.11885E-04
	-0.10115E-01	-0.16172E-02	0.32427E-03	-0.10276E-04
	0.74267E-01	-0.25880E-02	0.78904E-03	-0.27356E-04
	-0.58887E-01	0.83093E-03	-0.11261E-04	-0.10347E-05
	0.96997E-02	-0.17519E-02	0.34234E-04	0.33527E-05
0.80,	0.33953E-01	-0.59361E-02	-0.81698E-04	0.10939E-04
	-0.90757E-03	0.12869E-03	-0.24335E-03	0.10047E-04
	-0.10240E-01	0.17709E-02	-0.66946E-04	0.76482E-07
	0.59224E-01	-0.60016E-03	0.62660E-03	-0.25478E-04
	-0.54412E-01	-0.21510E-03	0.78455E-04	-0.44744E-05
	0.32173E-02	-0.30601E-03	0.79105E-04	-0.19817E-05
0.90,	-0.33782E-01	-0.11269E-01	0.23880E-02	-0.86322E-04
	-0.32545E-01	-0.88978E-02	0.14831E-02	-0.47905E-04
	0.70675E-02	0.27713E-02	-0.69776E-03	0.25858E-04
	0.70063E-01	0.30053E-02	-0.13202E-03	-0.19828E-06
	-0.55619E-01	-0.10297E-02	0.20556E-03	-0.85552E-05
	0.70995E-03	-0.20817E-04	0.41590E-04	-0.14975E-05
0.95,	0.21364E-01	0.85317E-02	-0.15559E-02	0.49785E-04
	-0.10066E-01	-0.37118E-02	0.25742E-04	0.91041E-05
	-0.73238E-02	-0.16138E-02	0.45166E-03	-0.15707E-04
	0.73684E-01	0.76717E-03	-0.78575E-04	0.30347E-05
	-0.58406E-01	0.20927E-03	0.15162E-03	-0.73063E-05
	0.69493E-02	-0.10666E-02	0.31271E-04	0.61163E-06
1.10,	0.15014E-01	0.87331E-02	-0.19082E-02	0.75186E-04
	-0.58230E-02	-0.10749E-02	-0.43789E-03	0.29104E-04
	-0.60679E-02	-0.18106E-02	0.54854E-03	-0.22552E-04
	0.69919E-01	0.55353E-03	-0.12572E-03	0.48255E-05
	-0.57516E-01	0.25384E-03	0.16189E-03	-0.77267E-05
	0.53850E-02	-0.12800E-02	0.16526E-03	-0.68561E-05
1.20,	0.10778E-01	0.88674E-02	-0.21432E-02	0.92131E-04
	-0.29925E-02	0.68412E-03	-0.74718E-03	0.42447E-04
	-0.52300E-02	-0.19419E-02	0.61317E-03	-0.27119E-04

HL-20 Aerodynamics Tables (version 2.0)

	0.67407E-01 ,	0.41102E-03 ,	-0.15717E-03 ,	0.60200E-05 ,
	-0.56923E-01 ,	0.28357E-03 ,	0.16873E-03 ,	-0.80071E-05 ,
	0.43415E-02 ,	-0.14224E-02 ,	0.25464E-03 ,	-0.11838E-04 ,
1.60,	-0.61604E-02 ,	0.94047E-02 ,	-0.30830E-02 ,	0.15989E-03 ,
	0.83257E-02 ,	0.77180E-02 ,	-0.19839E-02 ,	0.95798E-04 ,
	-0.18797E-02 ,	-0.24667E-02 ,	0.87161E-03 ,	-0.45378E-04 ,
	0.57363E-01 ,	-0.15887E-03 ,	-0.28294E-03 ,	0.10797E-04 ,
	-0.54550E-01 ,	0.40245E-03 ,	0.19611E-03 ,	-0.91284E-05 ,
	0.16886E-03 ,	-0.19918E-02 ,	0.61206E-03 ,	-0.31758E-04 ,
2.00,	-0.11803E-01 ,	0.56383E-02 ,	-0.11783E-02 ,	0.43079E-04 ,
	-0.11522E-02 ,	-0.14293E-02 ,	0.19644E-03 ,	-0.84655E-05 ,
	0.20458E-02 ,	-0.49844E-04 ,	0.74188E-04 ,	-0.41588E-05 ,
	0.48097E-01 ,	-0.18476E-02 ,	-0.15703E-04 ,	0.14620E-05 ,
	-0.41269E-01 ,	0.14543E-02 ,	-0.10877E-03 ,	0.44639E-05 ,
	0.79371E-02 ,	-0.79789E-03 ,	0.96285E-04 ,	-0.39914E-05 ,
2.50,	-0.19147E-01 ,	-0.52891E-03 ,	-0.85380E-04 ,	0.12379E-05 ,
	-0.80890E-02 ,	0.70687E-03 ,	-0.11661E-03 ,	0.15389E-05 ,
	0.24397E-02 ,	0.50033E-03 ,	-0.30076E-04 ,	0.68307E-06 ,
	0.38218E-01 ,	-0.83439E-03 ,	-0.59336E-04 ,	0.20179E-05 ,
	-0.27744E-01 ,	0.69581E-03 ,	-0.34314E-04 ,	0.12220E-05 ,
	0.62925E-02 ,	-0.32702E-03 ,	0.23836E-05 ,	0.79984E-07 ,
3.00,	0.00000E+00 ,	0.00000E+00 ,	0.00000E+00 ,	0.00000E+00 ,
	0.00000E+00 ,	0.00000E+00 ,	0.00000E+00 ,	0.00000E+00 ,
	0.00000E+00 ,	0.00000E+00 ,	0.00000E+00 ,	0.00000E+00 ,
	0.00000E+00 ,	0.00000E+00 ,	0.00000E+00 ,	0.00000E+00 ,
	0.00000E+00 ,	0.00000E+00 ,	0.00000E+00 ,	0.00000E+00 ,
	0.00000E+00 ,	0.00000E+00 ,	0.00000E+00 ,	0.00000E+00 ,
3.50,	0.00000E+00 ,	0.00000E+00 ,	0.00000E+00 ,	0.00000E+00 ,
	0.00000E+00 ,	0.00000E+00 ,	0.00000E+00 ,	0.00000E+00 ,
	0.00000E+00 ,	0.00000E+00 ,	0.00000E+00 ,	0.00000E+00 ,
	0.00000E+00 ,	0.00000E+00 ,	0.00000E+00 ,	0.00000E+00 ,
	0.00000E+00 ,	0.00000E+00 ,	0.00000E+00 ,	0.00000E+00 ,
	0.00000E+00 ,	0.00000E+00 ,	0.00000E+00 ,	0.00000E+00 ,
4.00,	0.00000E+00 ,	0.00000E+00 ,	0.00000E+00 ,	0.00000E+00 ,
	0.00000E+00 ,	0.00000E+00 ,	0.00000E+00 ,	0.00000E+00 ,
	0.00000E+00 ,	0.00000E+00 ,	0.00000E+00 ,	0.00000E+00 ,
	0.00000E+00 ,	0.00000E+00 ,	0.00000E+00 ,	0.00000E+00 ,
	0.00000E+00 ,	0.00000E+00 ,	0.00000E+00 ,	0.00000E+00 ,
	0.00000E+00 ,	0.00000E+00 ,	0.00000E+00 ,	0.00000E+00 ,

HL-20 Aerodynamics Tables (version 2.0)

TABLE 6 - DYNAMIC DAMPING COEFFICIENTS

-0.22364E+00 , 0.20457E-01 , -0.16741E-02 , 0.31618E-04 ,
 0.40031E+00 , -0.15518E-01 , -0.12143E-03 , 0.18240E-04 ,
 -0.55242E+00 , 0.14478E-01 , -0.11545E-02 , 0.17706E-04 ,
 -0.79533E+00 , -0.12647E-01 , 0.32696E-03 , -0.65929E-05 ,
 0.44685E+00 , 0.67411E-01 , -0.51866E-02 , 0.12659E-03 ,

TABLE 7 - AERO INCREMENTS DUE TO GROUND EFFECTS

0.20,
 0.10077E-02 , 0.19604E-02 , 0.93753E-04 , -0.37036E-05 ,
 0.60874E-03 , -0.31049E-03 , 0.82571E-04 , -0.20609E-05 ,
 0.11326E-02 , -0.41919E-03 , -0.17272E-04 , 0.71748E-06 ,
 -0.10823E-02 , -0.28966E-04 , -0.32482E-05 , 0.10669E-06 ,
 0.41682E-03 , 0.16561E-04 , 0.20538E-05 , -0.66433E-07 ,
 -0.54252E-03 , -0.38828E-05 , -0.42661E-06 , 0.15216E-07 ,

0.40,
 0.47455E-03 , 0.82421E-03 , 0.39025E-04 , -0.15467E-05 ,
 0.23668E-03 , -0.12906E-03 , 0.33523E-04 , -0.83508E-06 ,
 0.50739E-03 , -0.12736E-03 , -0.40970E-05 , 0.18723E-06 ,
 -0.36936E-03 , -0.11188E-04 , -0.12425E-05 , 0.40870E-07 ,
 0.11028E-03 , 0.63830E-05 , 0.78170E-06 , -0.25271E-07 ,
 -0.16672E-03 , -0.20940E-05 , -0.11555E-06 , 0.47750E-08 ,

0.60,
 0.26716E-03 , 0.45519E-03 , 0.21213E-04 , -0.84572E-06 ,
 0.13195E-03 , -0.77180E-04 , 0.19470E-04 , -0.48333E-06 ,
 0.26914E-03 , -0.48441E-04 , -0.83234E-06 , 0.52247E-07 ,
 -0.17764E-03 , -0.60701E-05 , -0.65181E-06 , 0.21632E-07 ,
 0.41297E-04 , 0.37128E-05 , 0.38371E-06 , -0.12610E-07 ,
 -0.74704E-04 , -0.13747E-05 , -0.39619E-07 , 0.21351E-08 ,

0.80,
 0.16541E-03 , 0.28841E-03 , 0.13070E-04 , -0.52523E-06 ,
 0.79803E-04 , -0.50324E-04 , 0.12743E-04 , -0.31604E-06 ,
 0.16451E-03 , -0.22609E-04 , 0.37014E-06 , 0.35993E-08 ,
 -0.10104E-03 , -0.40132E-05 , -0.38421E-06 , 0.12968E-07 ,
 0.18754E-04 , 0.23532E-05 , 0.23153E-06 , -0.77115E-08 ,
 -0.39922E-04 , -0.10138E-05 , -0.93363E-08 , 0.94863E-09 ,

1.00,
 0.10971E-03 , 0.19906E-03 , 0.88085E-05 , -0.35757E-06 ,
 0.58622E-04 , -0.37645E-04 , 0.92368E-05 , -0.22842E-06 ,
 0.99908E-04 , -0.79090E-05 , 0.41607E-06 , -0.58712E-08 ,
 -0.64524E-04 , -0.27175E-05 , -0.25996E-06 , 0.87593E-08 ,
 0.91868E-05 , 0.17075E-05 , 0.15114E-06 , -0.50597E-08 ,
 -0.24096E-04 , -0.10173E-05 , 0.21477E-07 , -0.20992E-11 ,

1.50,
 0.55280E-04 , 0.96825E-04 , 0.41891E-05 , -0.17078E-06 ,
 0.29373E-04 , -0.20237E-04 , 0.48321E-05 , -0.11916E-06 ,
 0.41900E-04 , -0.53508E-06 , 0.52704E-06 , -0.13116E-07 ,
 -0.27670E-04 , -0.12770E-05 , -0.13321E-06 , 0.44742E-08 ,
 0.21156E-05 , 0.80916E-06 , 0.74727E-07 , -0.24662E-08 ,
 -0.10455E-04 , -0.43728E-06 , 0.12381E-07 , -0.15583E-09 ,

2.00,
 0.28004E-04 , 0.58642E-04 , 0.23064E-05 , -0.97243E-07 ,
 0.13069E-04 , -0.99123E-05 , 0.27011E-05 , -0.66648E-07 ,
 0.19082E-04 , 0.14482E-05 , 0.39303E-06 , -0.11415E-07 ,
 -0.15379E-04 , -0.52832E-06 , -0.98169E-07 , 0.31583E-08 ,
 0.61168E-06 , 0.62216E-06 , 0.19447E-07 , -0.64746E-09 ,
 -0.43880E-05 , -0.64274E-06 , 0.38076E-07 , -0.72546E-09 ,

HL-20 Aerodynamics Tables (version 2.0)

2.50,
 0.00000E+00 , 0.00000E+00 , 0.00000E+00 , 0.00000E+00 ,
 0.00000E+00 , 0.00000E+00 , 0.00000E+00 , 0.00000E+00 ,
 0.00000E+00 , 0.00000E+00 , 0.00000E+00 , 0.00000E+00 ,
 0.00000E+00 , 0.00000E+00 , 0.00000E+00 , 0.00000E+00 ,
 0.00000E+00 , 0.00000E+00 , 0.00000E+00 , 0.00000E+00 ,
 0.00000E+00 , 0.00000E+00 , 0.00000E+00 , 0.00000E+00 ,

TABLE 8 - AERO INCREMENTS DUE TO LANDING GEAR

0.00,
 0.00000E+00 , 0.00000E+00 , 0.00000E+00 , 0.00000E+00 ,
 0.00000E+00 , 0.00000E+00 , 0.00000E+00 , 0.00000E+00 ,
 0.00000E+00 , 0.00000E+00 , 0.00000E+00 , 0.00000E+00 ,
 0.00000E+00 , 0.00000E+00 , 0.00000E+00 , 0.00000E+00 ,
 0.00000E+00 , 0.00000E+00 , 0.00000E+00 , 0.00000E+00 ,
 0.00000E+00 , 0.00000E+00 , 0.00000E+00 , 0.00000E+00 ,

15.00,
 0.27578E-03 , 0.19298E-04 , 0.26786E-05 , -0.82093E-07 ,
 0.14942E-02 , -0.19628E-04 , 0.18435E-05 , -0.38439E-07 ,
 0.12141E-03 , 0.22890E-05 , -0.47874E-06 , 0.12033E-07 ,
 -0.57975E-03 , -0.16929E-05 , -0.23445E-06 , 0.74864E-08 ,
 0.18672E-03 , 0.83805E-06 , 0.14454E-06 , -0.44275E-08 ,
 0.17390E-06 , 0.35055E-08 , -0.30813E-07 , 0.95073E-09 ,

30.00,
 0.56559E-03 , 0.19548E-03 , 0.15689E-04 , -0.53547E-06 ,
 0.29416E-02 , -0.37504E-04 , 0.25096E-05 , -0.45240E-07 ,
 0.29296E-03 , -0.20561E-04 , -0.21799E-05 , 0.70173E-07 ,
 -0.15727E-02 , -0.42029E-05 , -0.68587E-06 , 0.21504E-07 ,
 0.39658E-03 , 0.14724E-05 , 0.46250E-06 , -0.13934E-07 ,
 0.94610E-04 , 0.46810E-06 , -0.11791E-06 , 0.32628E-08 ,

60.00,
 0.92879E-03 , 0.56937E-03 , 0.42266E-04 , -0.14710E-05 ,
 0.51964E-02 , -0.63856E-04 , 0.16969E-05 , -0.67674E-08 ,
 0.57038E-03 , -0.54086E-04 , -0.46249E-05 , 0.15511E-06 ,
 -0.38220E-02 , -0.88574E-05 , -0.17717E-05 , 0.54512E-07 ,
 0.63382E-03 , 0.38020E-05 , 0.10481E-05 , -0.31348E-07 ,
 0.43296E-03 , 0.21707E-05 , -0.38489E-06 , 0.10250E-07 ,

90.00,
 0.92976E-03 , 0.71877E-03 , 0.53370E-04 , -0.18575E-05 ,
 0.60569E-02 , -0.73249E-04 , 0.62029E-06 , 0.28351E-07 ,
 0.69595E-03 , -0.51740E-04 , -0.43182E-05 , 0.14397E-06 ,
 -0.48570E-02 , -0.11288E-04 , -0.23133E-05 , 0.71074E-07 ,
 0.51721E-03 , 0.44366E-05 , 0.13916E-05 , -0.41453E-07 ,
 0.60258E-03 , 0.29572E-05 , -0.51784E-06 , 0.13797E-07 ,

SUBSCRIPTS

GE ground effect
LLBF lower left body flap
LE left elevon
LG landing gear
R rudder
ULBF upper left body flap

SYMBOLS

h height from ground to wing root leading edge
 Δ aero coefficient increment

AERO DATA BASE FOR HL-20 FLIGHT SIMULATION STUDIES



LaRC/SSD
JAN. 1991

BASIC AERODYNAMIC COEFFICIENTS

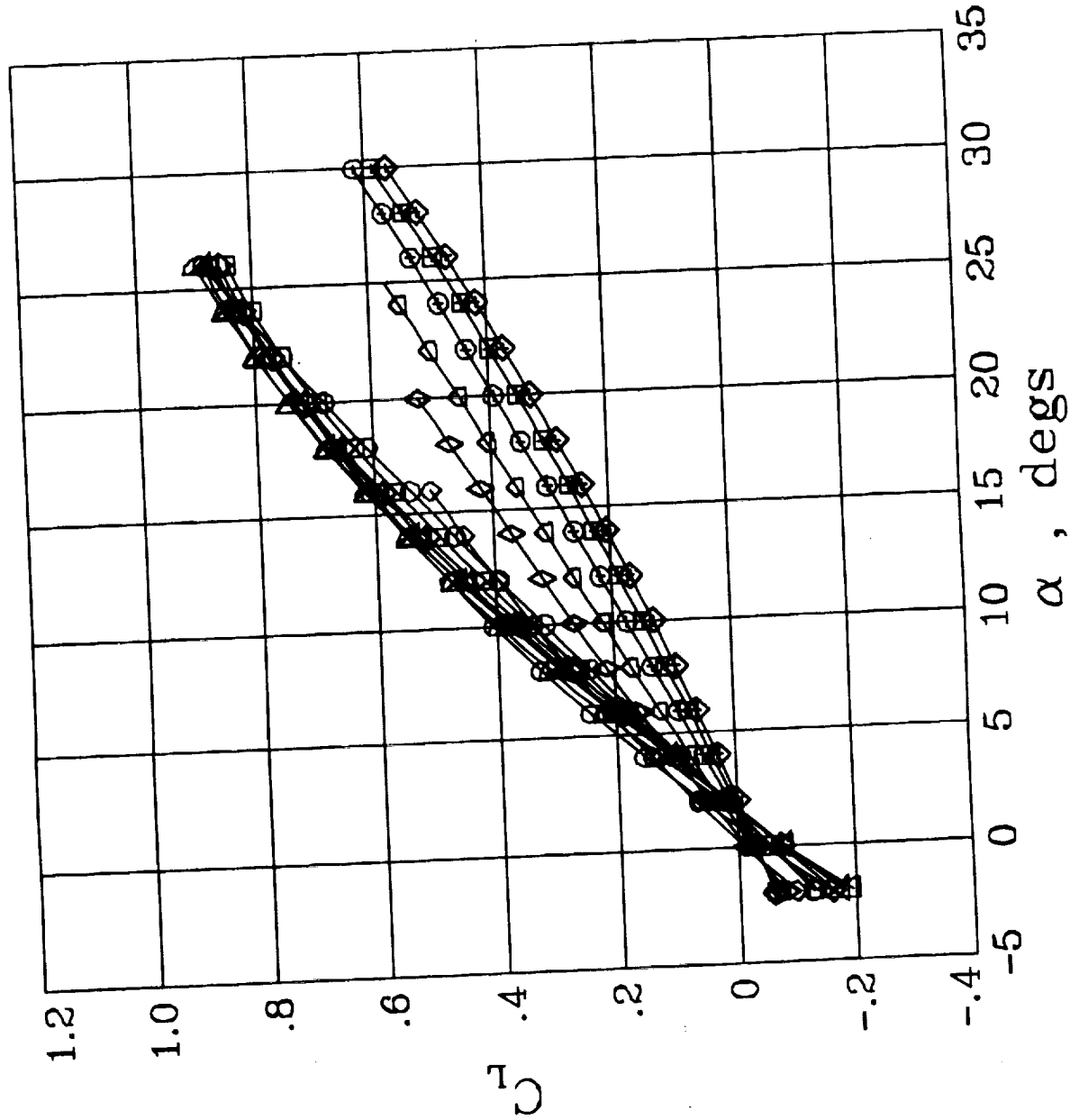

AERO DATA BASE FOR HL-20 FLIGHT SIMULATION STUDIES

BASIC AERODYNAMIC COEFFICIENTS



LaRC/SSD
JAN. 1991

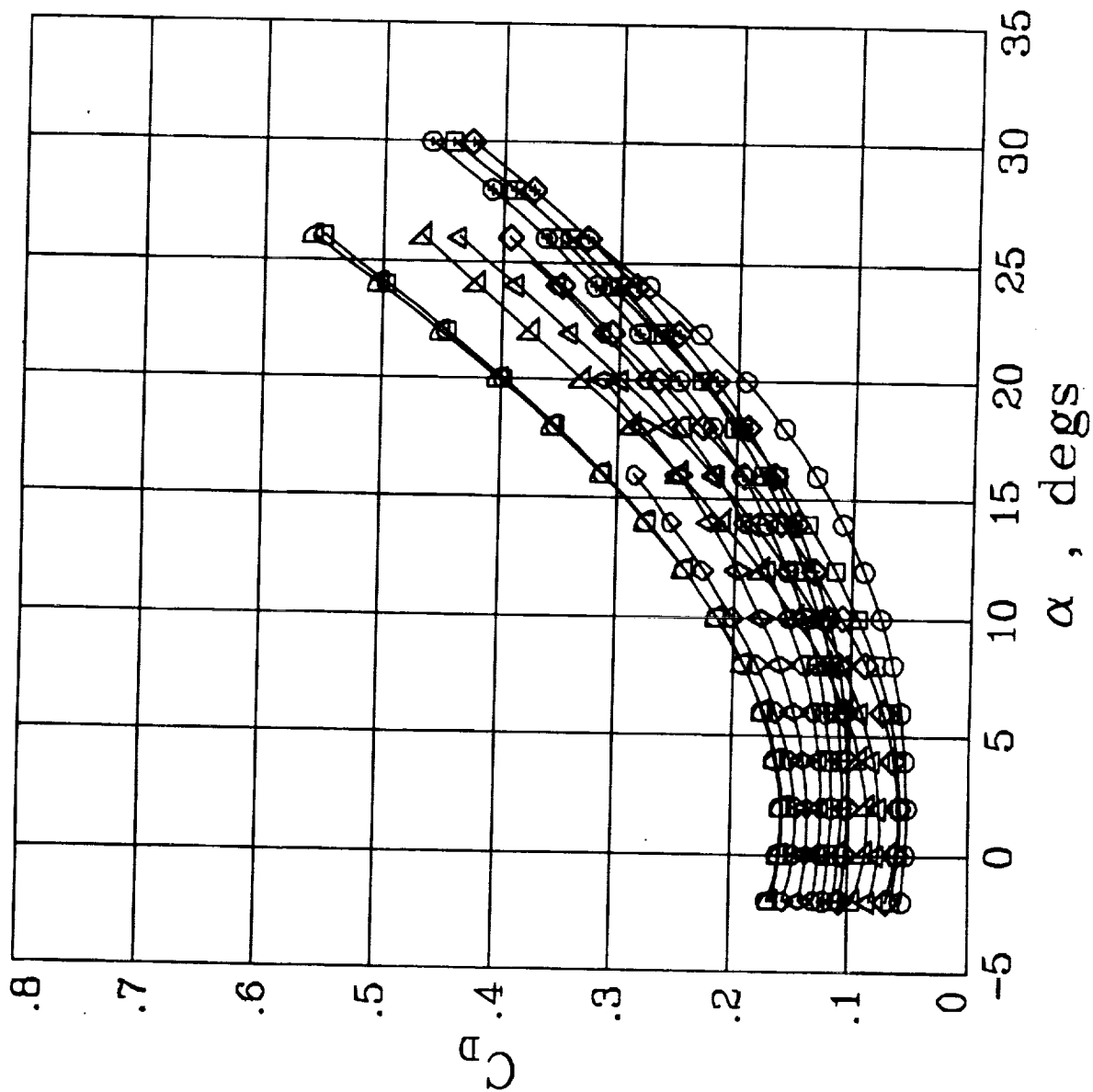

MACH	Symbol
.30	○
.60	□
.80	◇
.90	△
.95	▽
1.10	⊖
1.20	⊕
1.60	⊗
2.00	⊙
2.50	⊚
3.00	⊛
3.50	⊜
4.00	⊝

AERO DATA BASE FOR HL-20 FLIGHT SIMULATION STUDIES



LaRC/SSD
JAN. 1991

BASIC AERODYNAMIC COEFFICIENTS

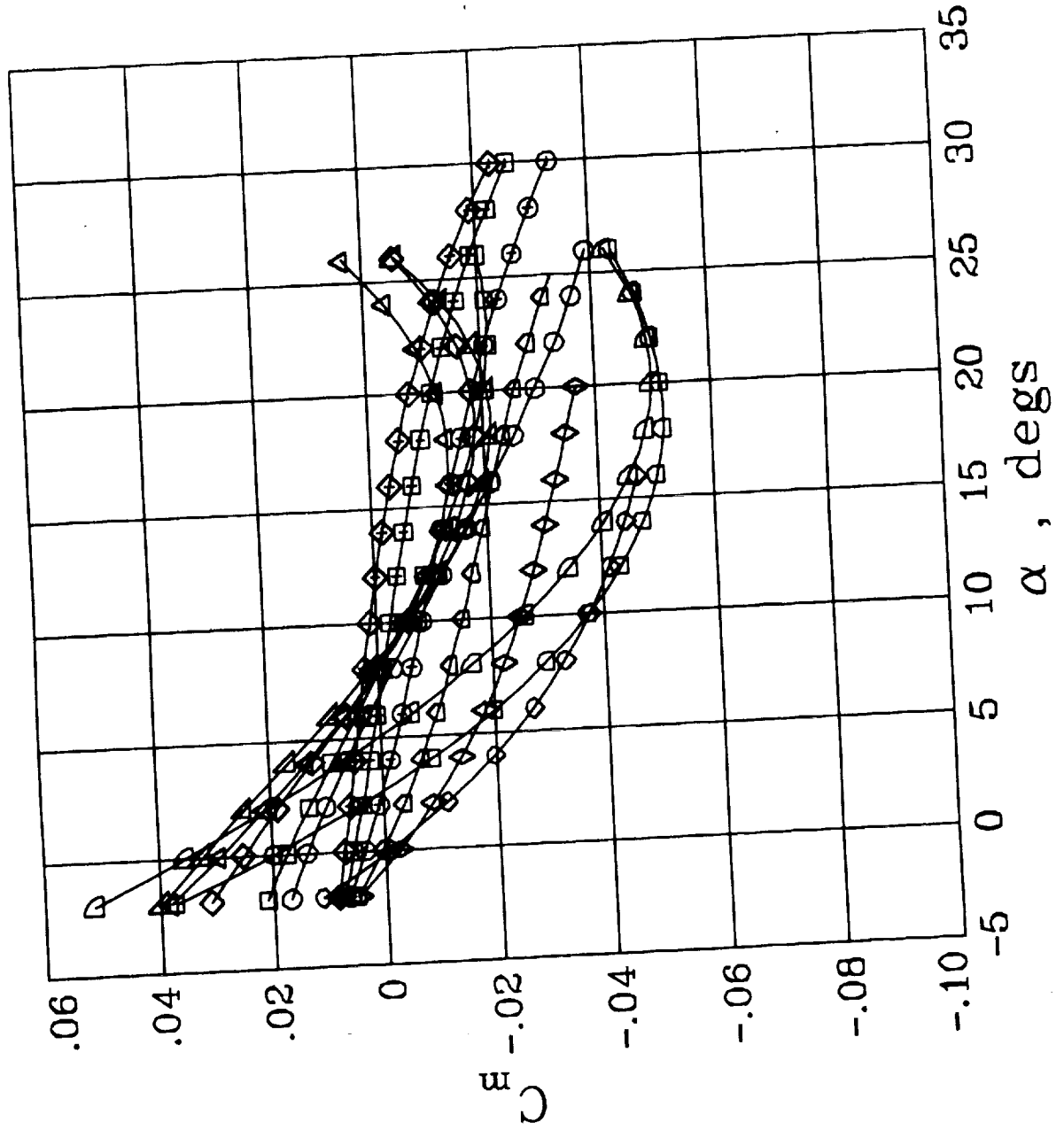

AERO DATA BASE FOR HL-20 FLIGHT SIMULATION STUDIES

BASIC AERODYNAMIC COEFFICIENTS



LaRC/SSD
JAN. 1991

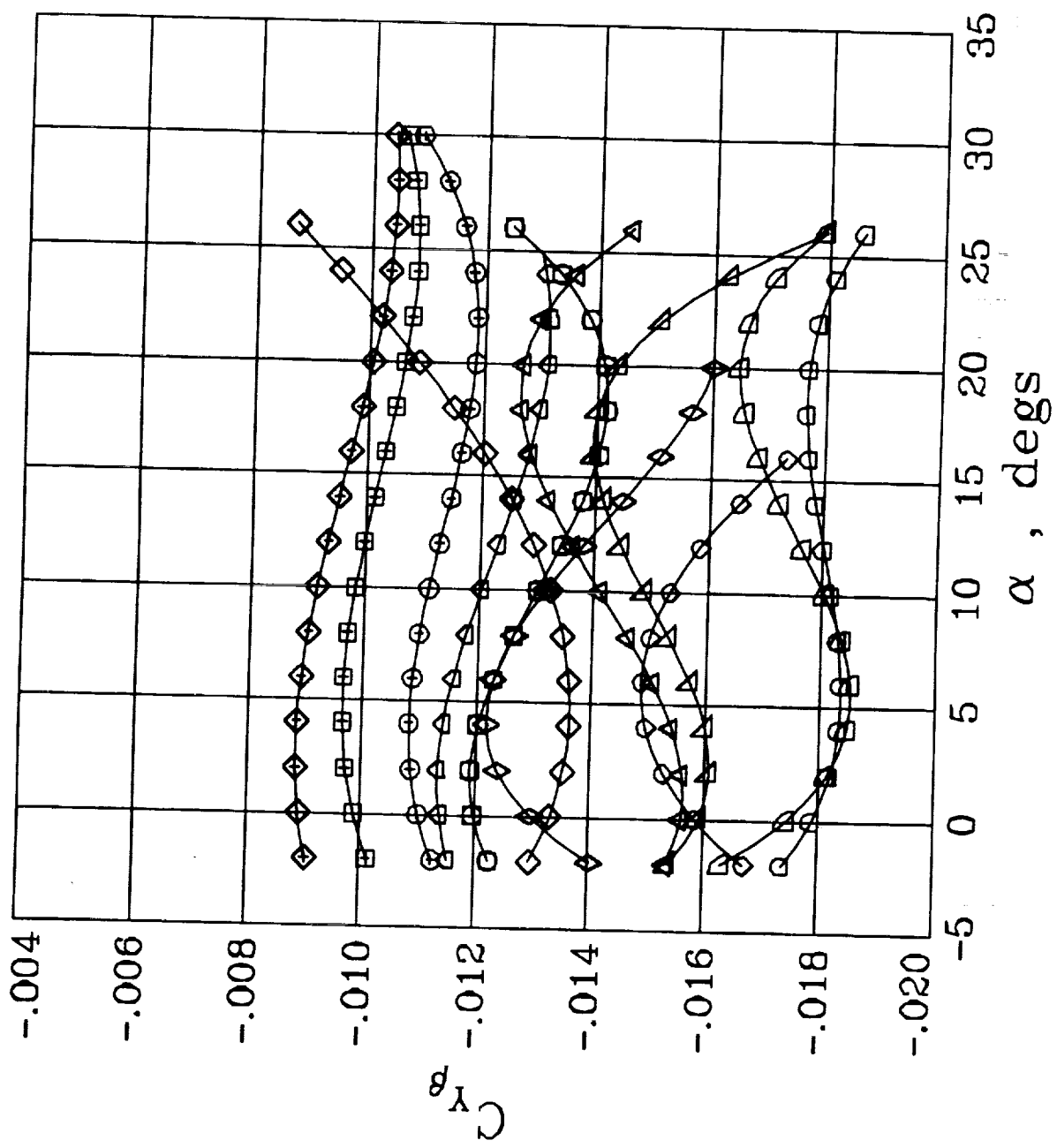

AERO DATA BASE FOR HL-20 FLIGHT SIMULATION STUDIES



LaRC/SSD
JAN. 1991

BASIC AERODYNAMIC COEFFICIENTS

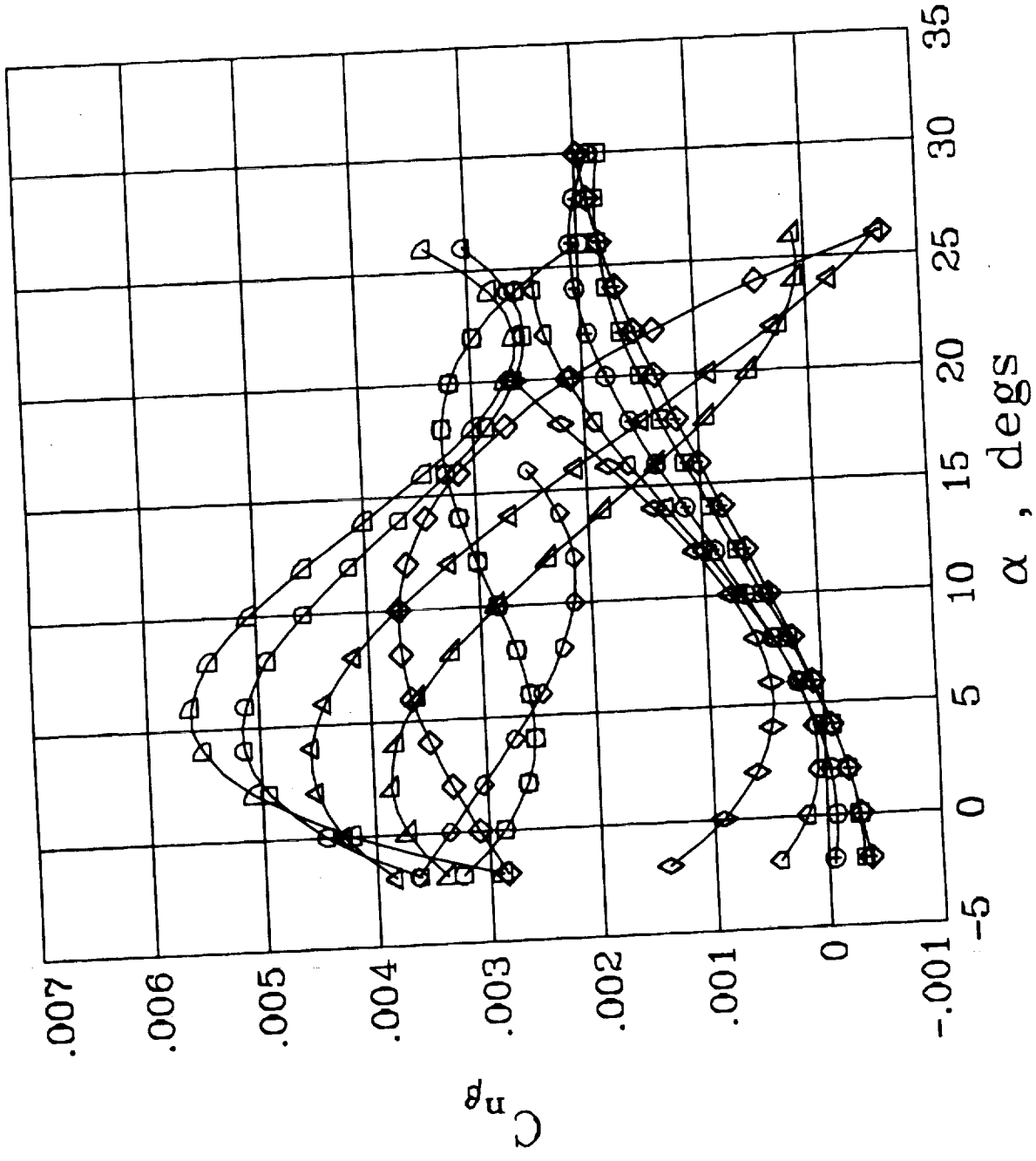

AERO DATA BASE FOR HL-20 FLIGHT SIMULATION STUDIES

BASIC AERODYNAMIC COEFFICIENTS



LaRC/SSD
JAN. 1991

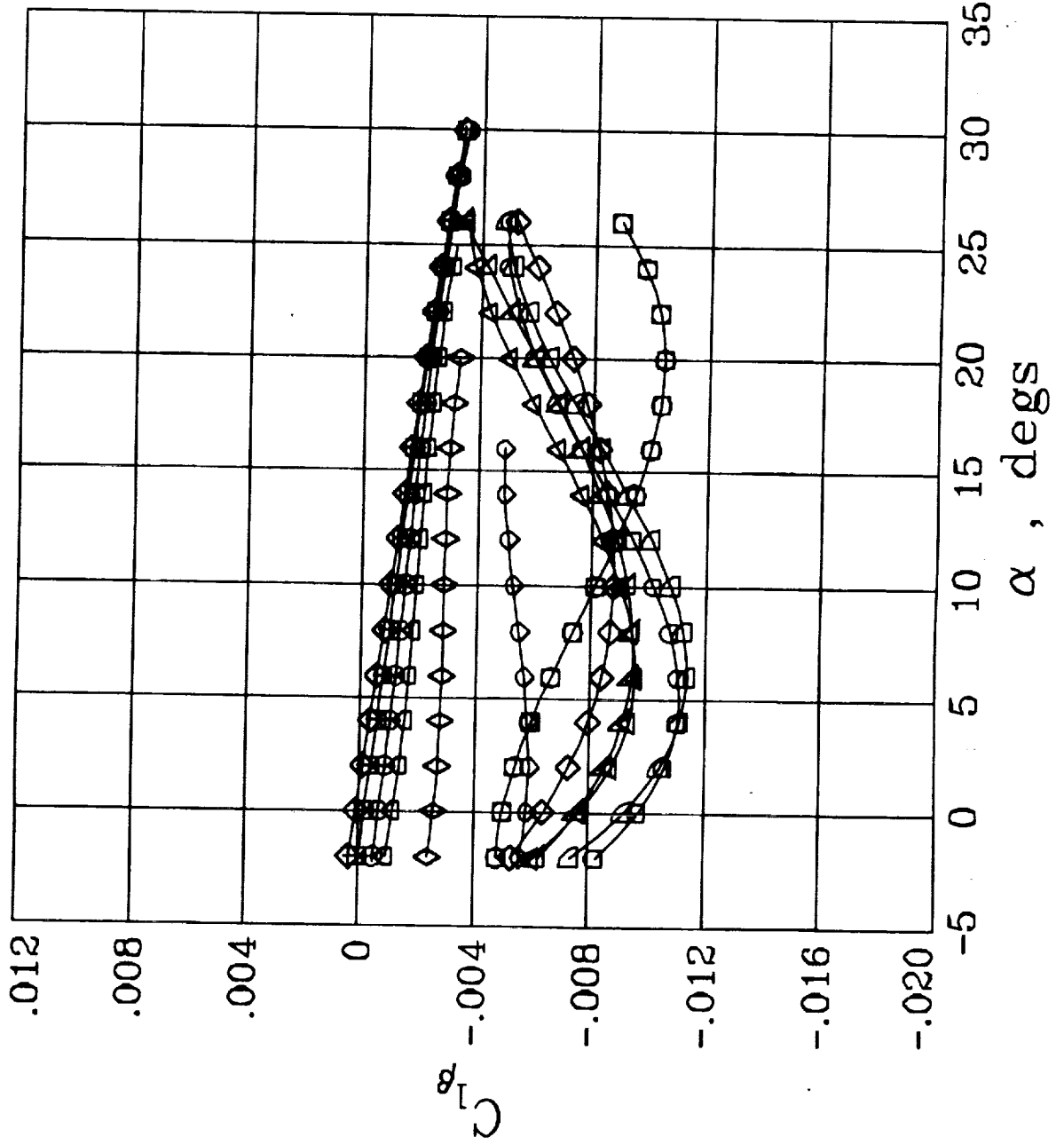

AERO DATA BASE FOR HL-20 FLIGHT SIMULATION STUDIES



LaRC/SSD
JAN. 1991

INCREMENTS DUE TO $\delta_{ULBF} = -60^\circ$

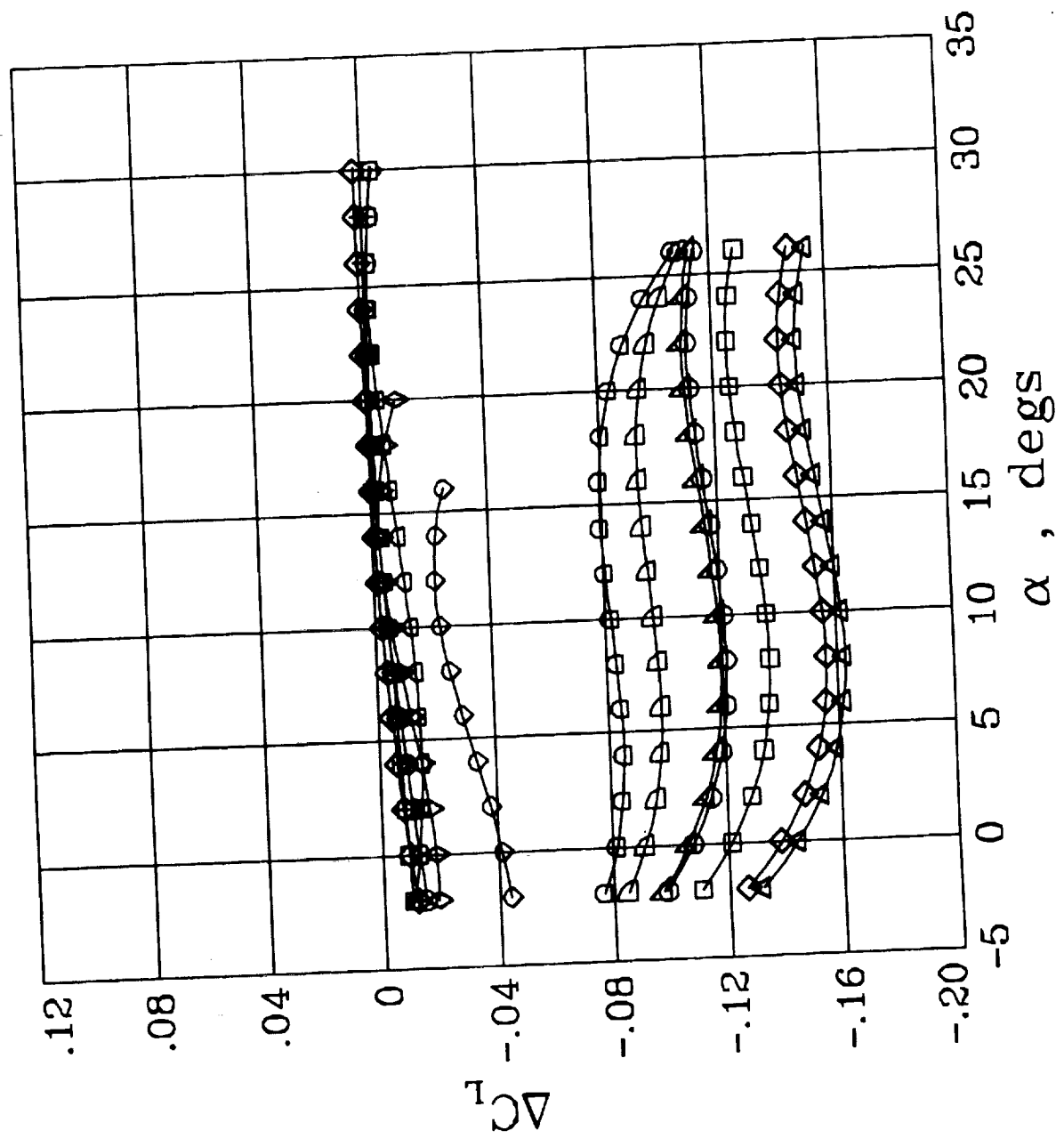

AERO DATA BASE FOR HL-20 FLIGHT SIMULATION STUDIES

INCREMENTS DUE TO $\delta_{ULBF} = -60^\circ$



LaRC/SSD
JAN. 1991

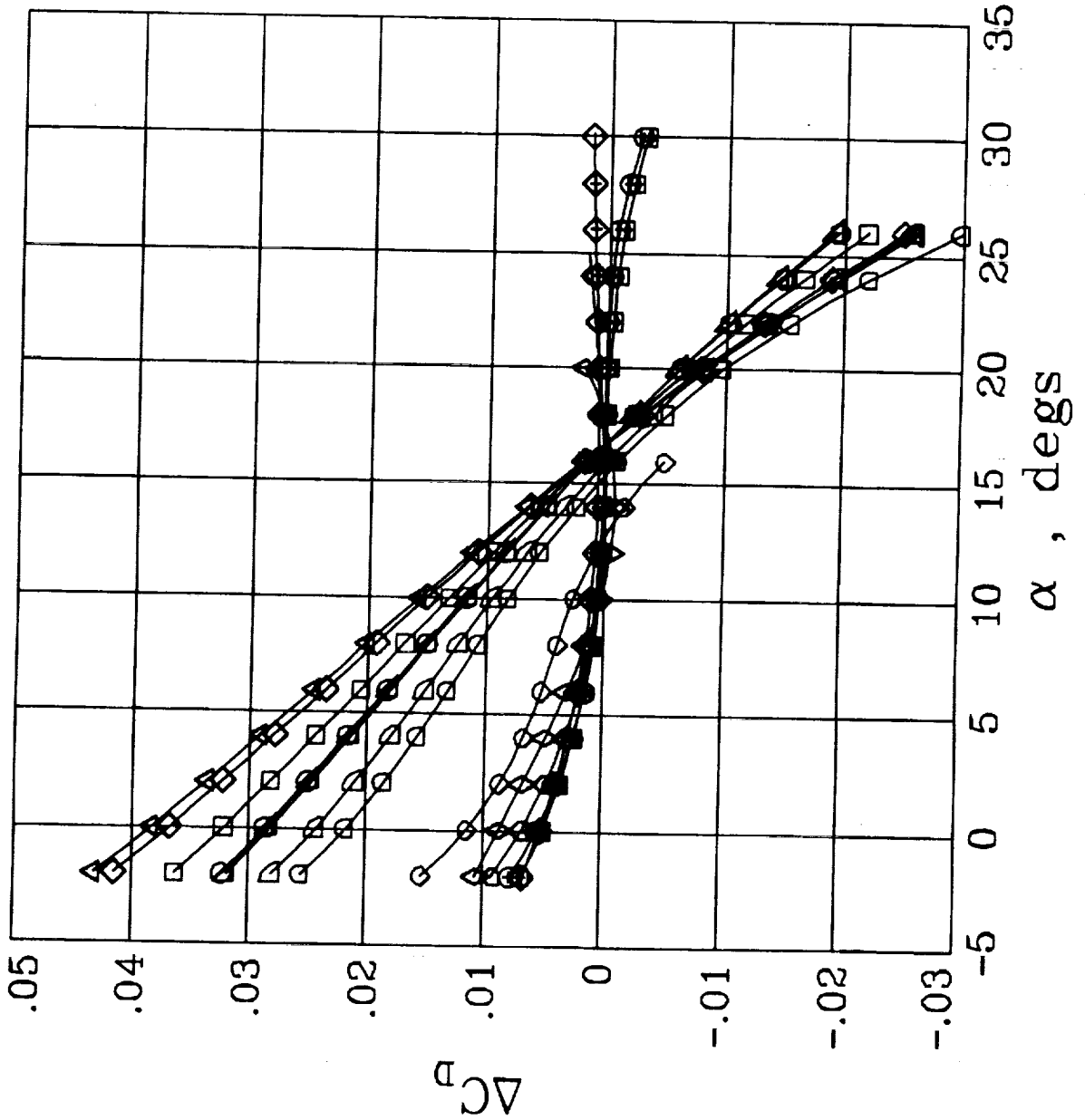

AERO DATA BASE FOR HL-20 FLIGHT SIMULATION STUDIES



LaRC/SSD
JAN. 1991

INCREMENTS DUE TO $\delta_{ULBF} = -60^\circ$

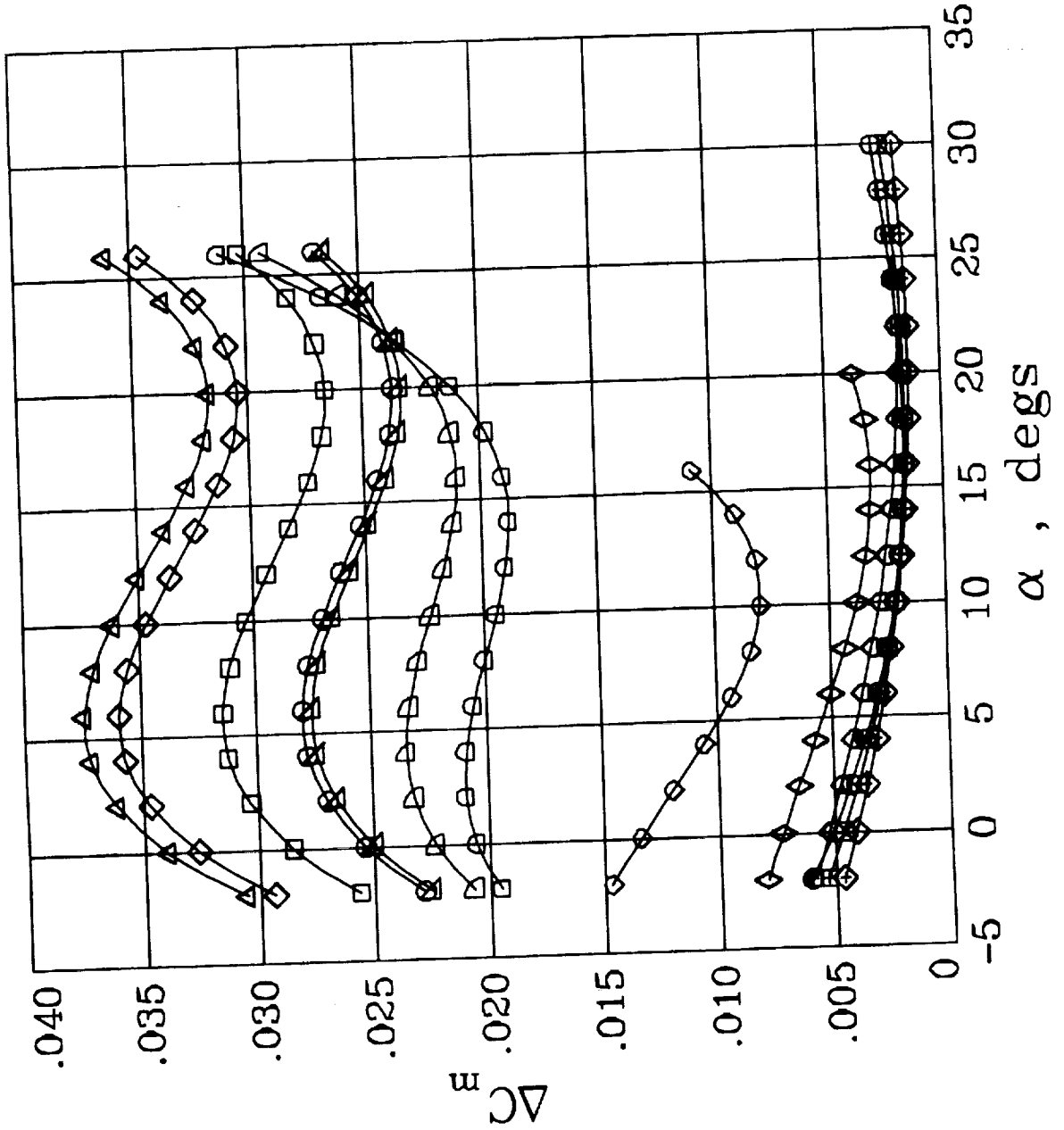

AERO DATA BASE FOR HL-20 FLIGHT SIMULATION STUDIES

INCREMENTS DUE TO $\delta_{ULBF} = -60^\circ$



LaRC/SSD
JAN. 1991

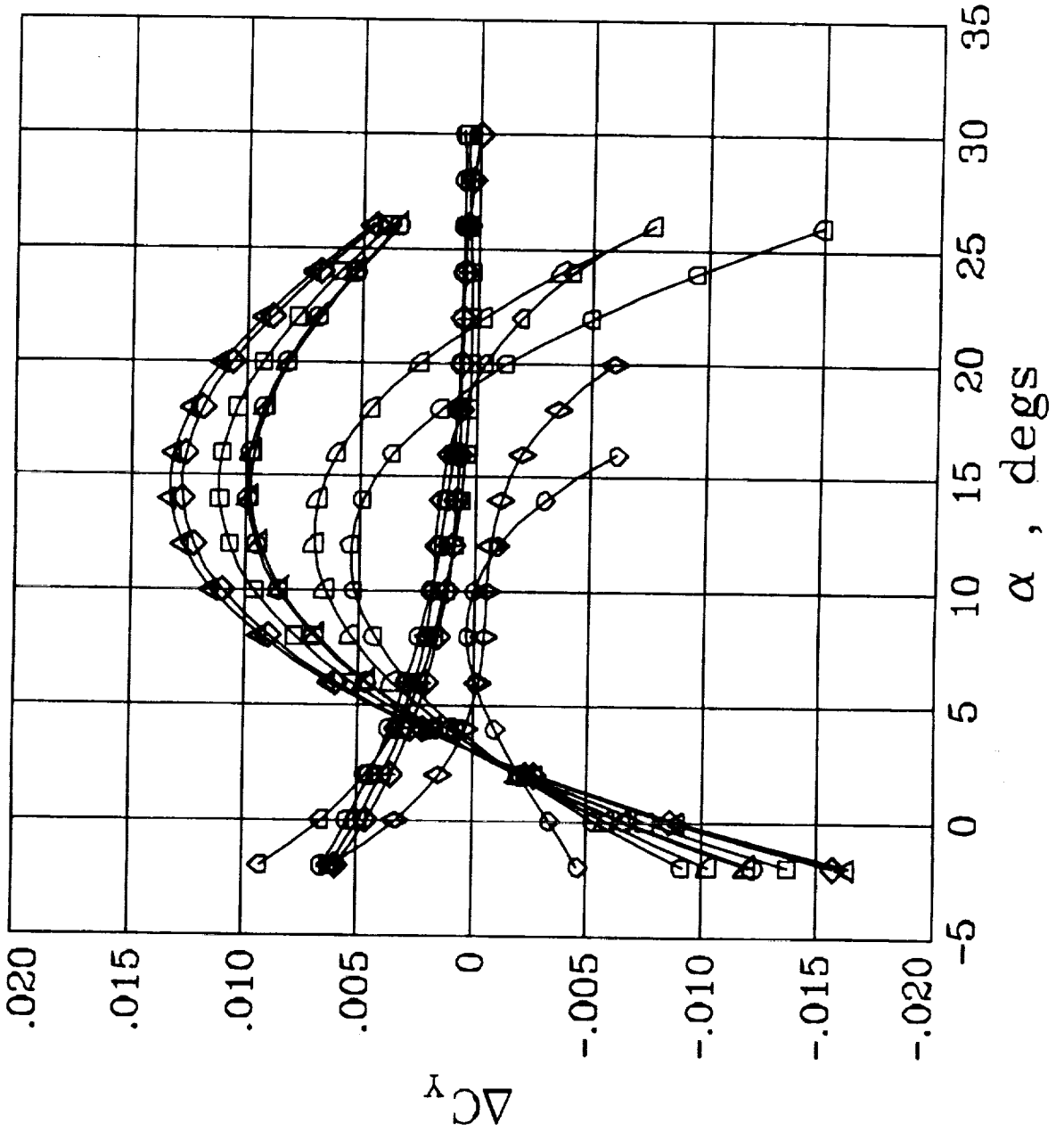

MACH	Symbol
.30	○
.60	□
.80	◇
.90	△
.95	▽
1.10	◻
1.20	⊖
1.60	⊙
2.00	◇
2.50	⊖
3.00	⊕
3.50	⊖
4.00	◇

AERO DATA BASE FOR HL-20 FLIGHT SIMULATION STUDIES



LaRC/SSD
JAN. 1991

INCREMENTS DUE TO $\delta_{ULBF} = -60^\circ$

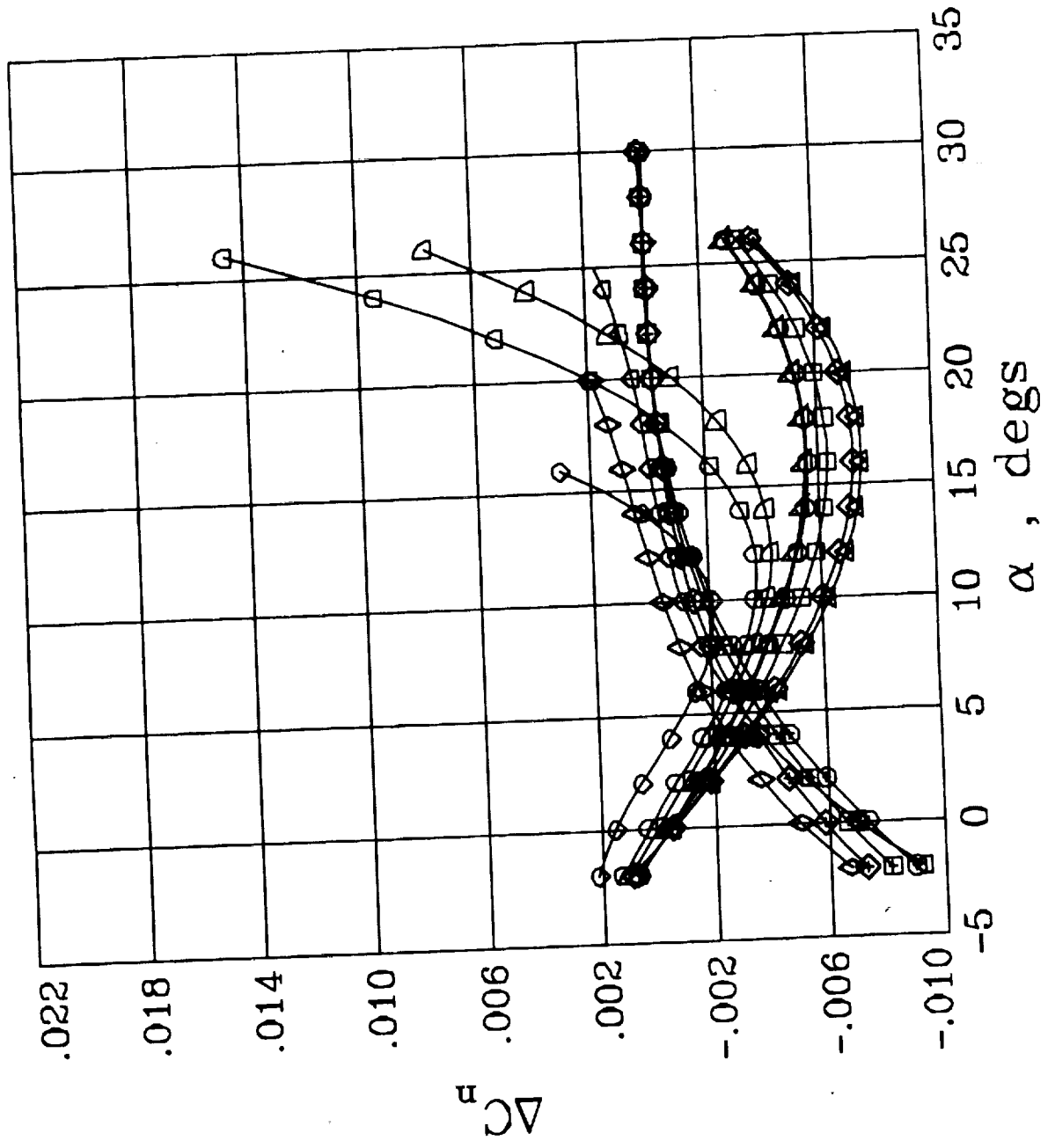

AERO DATA BASE FOR HL-20 FLIGHT SIMULATION STUDIES

INCREMENTS DUE TO $\delta_{ULBF} = -60^\circ$



LaRC/SSD
JAN. 1991

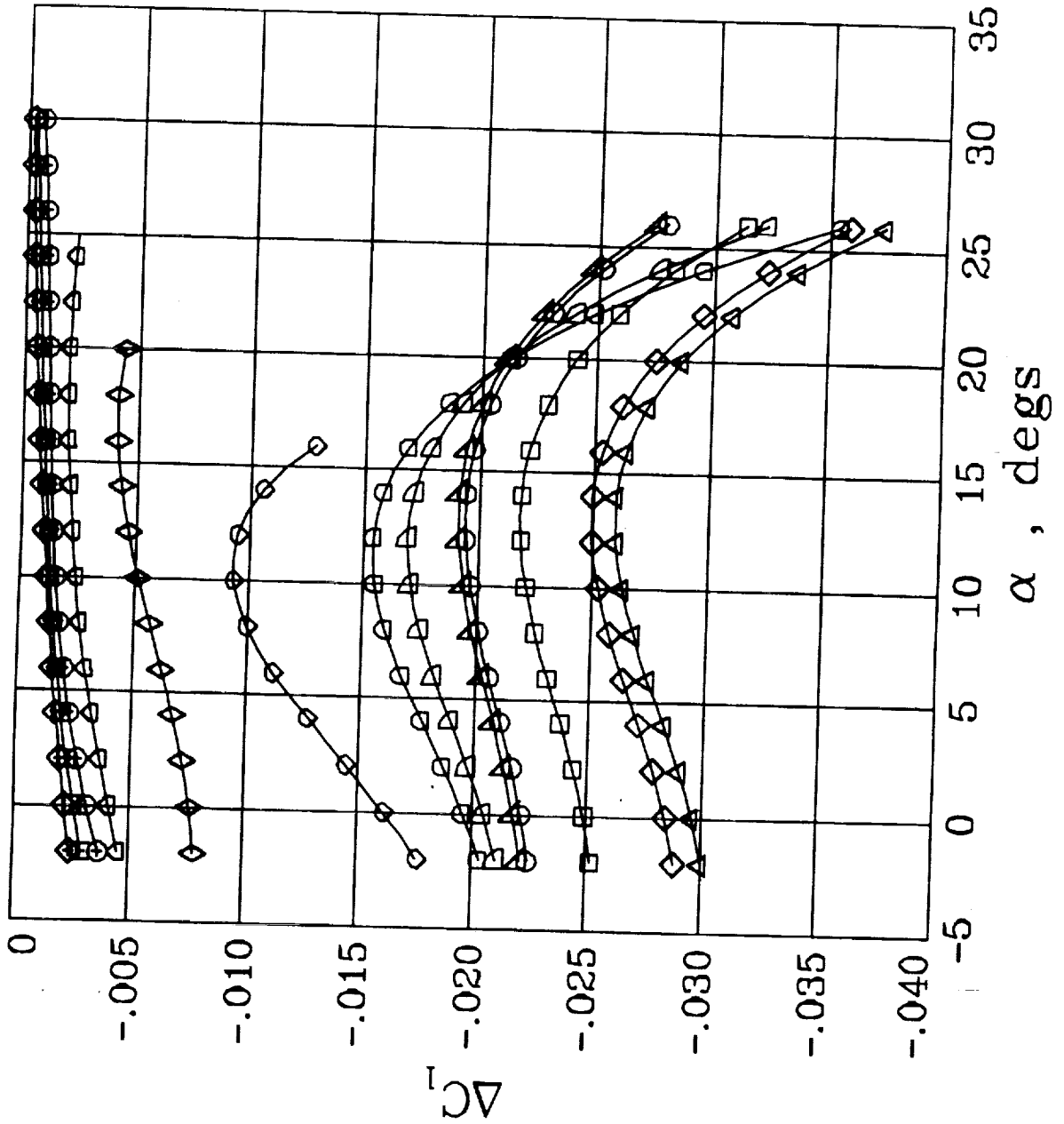

AERO DATA BASE FOR HL-20 FLIGHT SIMULATION STUDIES



LaRC/SSD
JAN. 1991

INCREMENTS DUE TO $\delta_{ULBF} = -45^\circ$

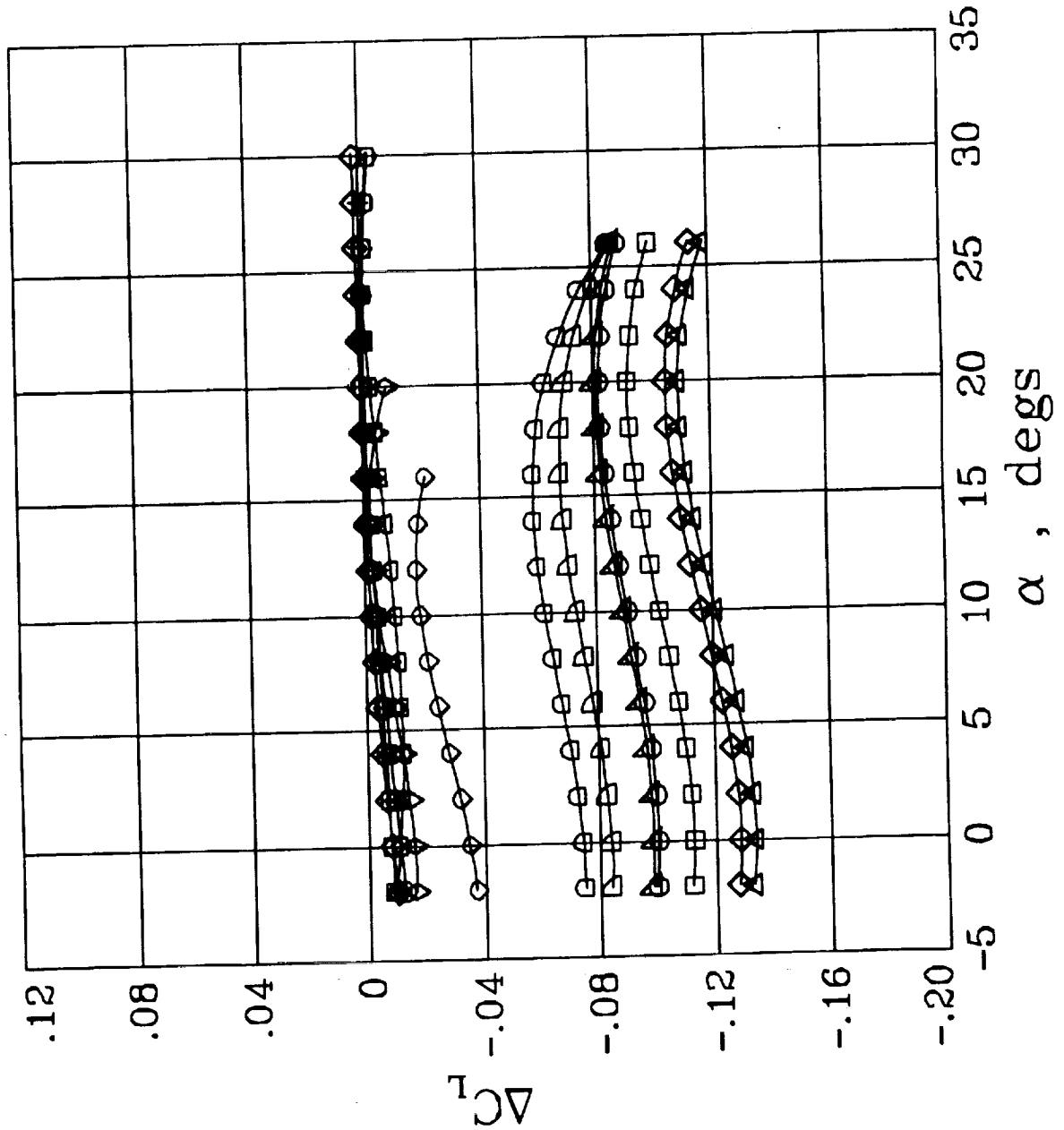

AERO DATA BASE FOR HL-20 FLIGHT SIMULATION STUDIES

INCREMENTS DUE TO $\delta_{ULBF} = -45^\circ$



LaRC/SSD
JAN. 1991

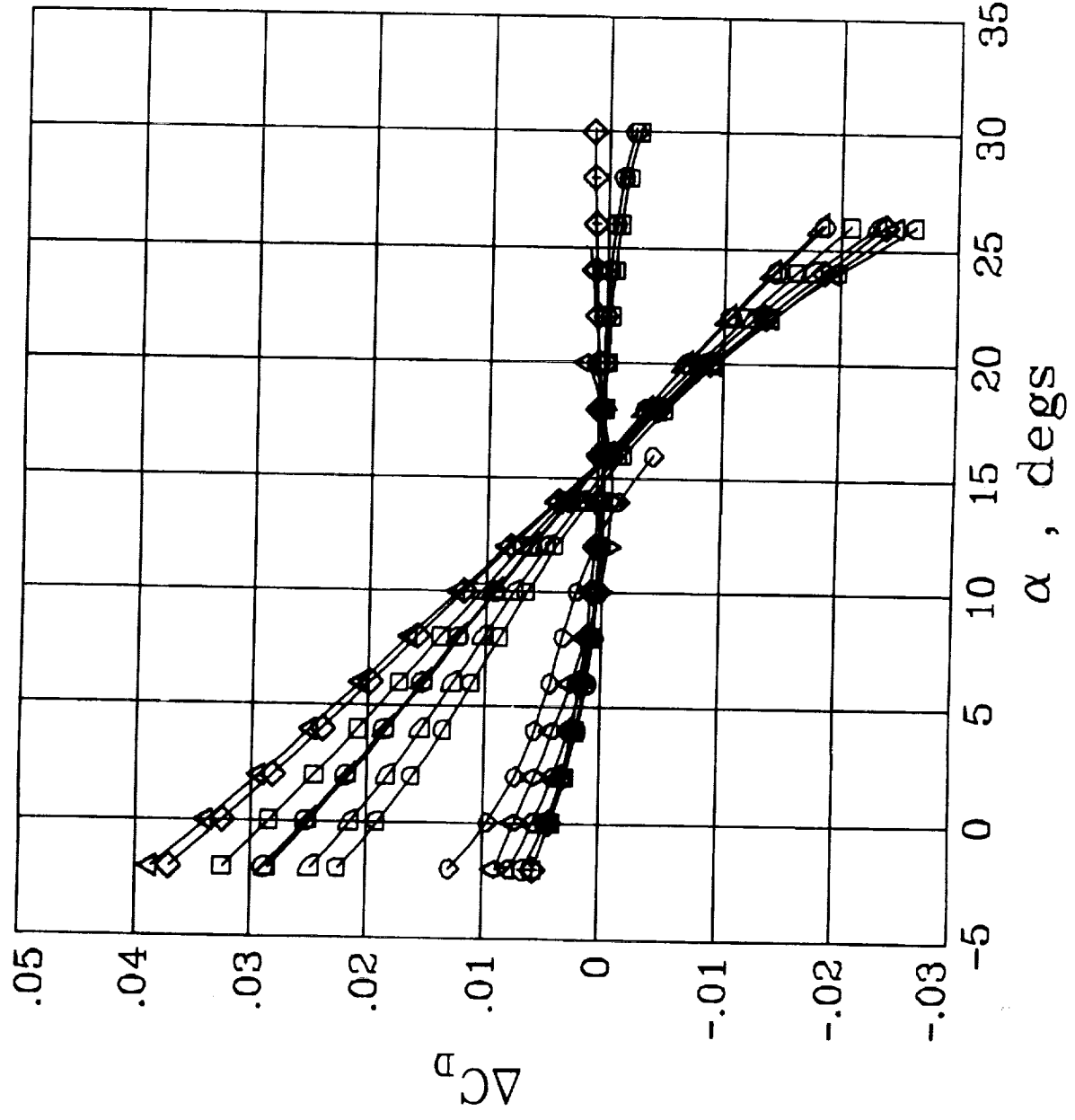

AERO DATA BASE FOR HL-20 FLIGHT SIMULATION STUDIES



LaRC/SSD
JAN. 1991

INCREMENTS DUE TO $\delta_{ULBF} = -45^\circ$

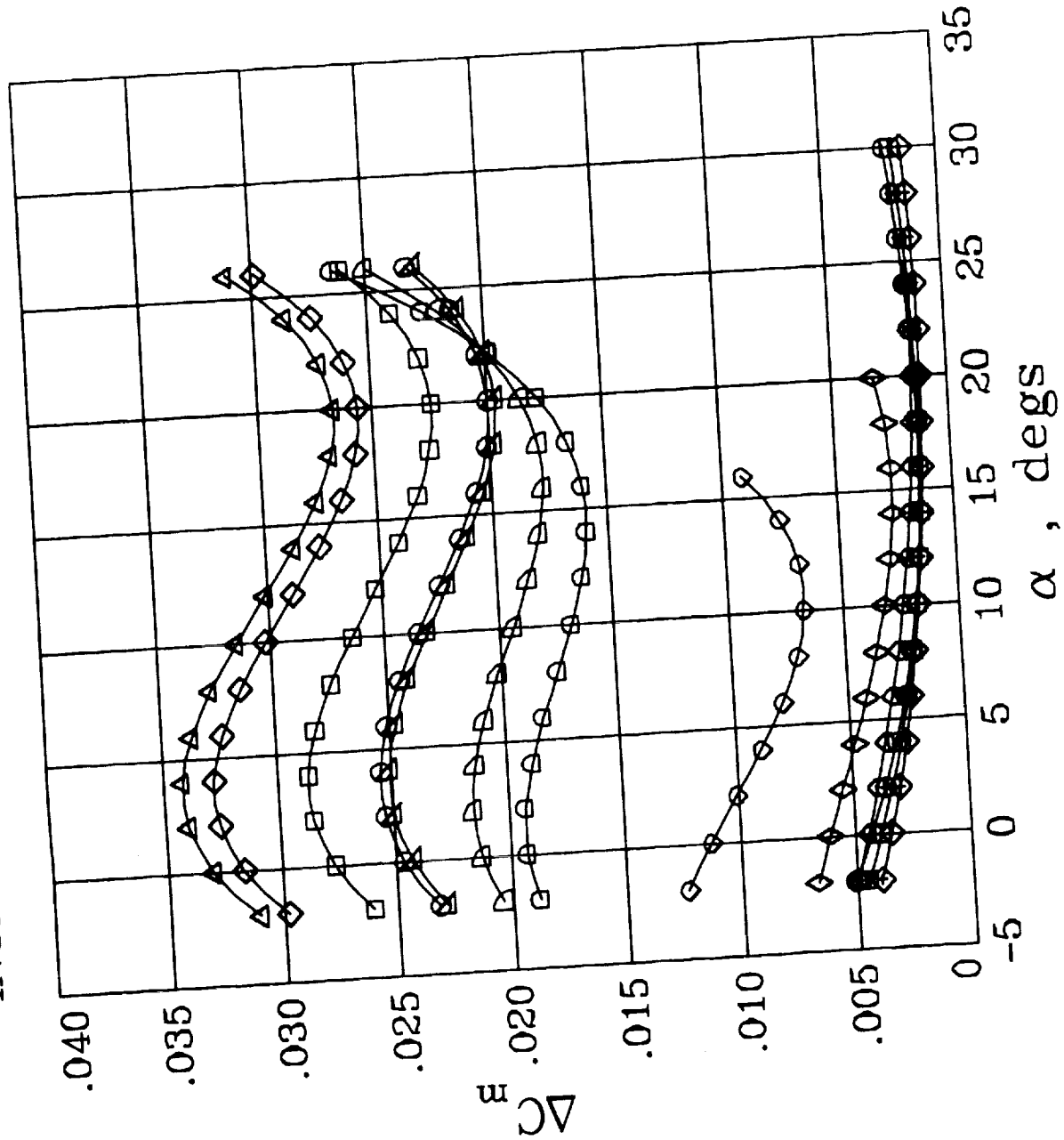

AERO DATA BASE FOR HL-20 FLIGHT SIMULATION STUDIES

INCREMENTS DUE TO $\delta_{ULBF} = -45^\circ$



LaRC/SSD
JAN. 1991

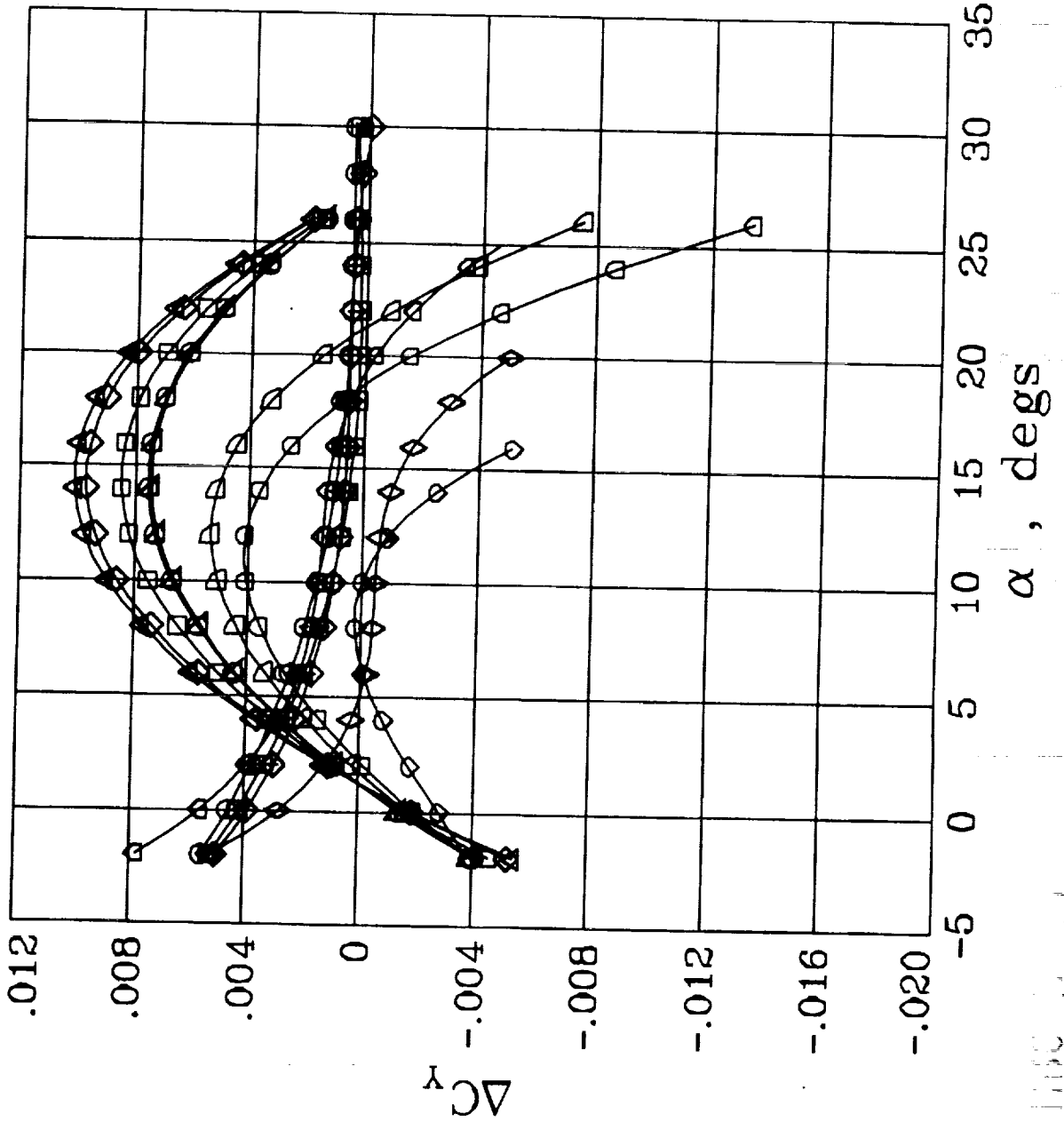

AERO DATA BASE FOR HL-20 FLIGHT SIMULATION STUDIES



LaRC/SSD
JAN. 1991

INCREMENTS DUE TO $\delta_{ULBF} = -45^\circ$

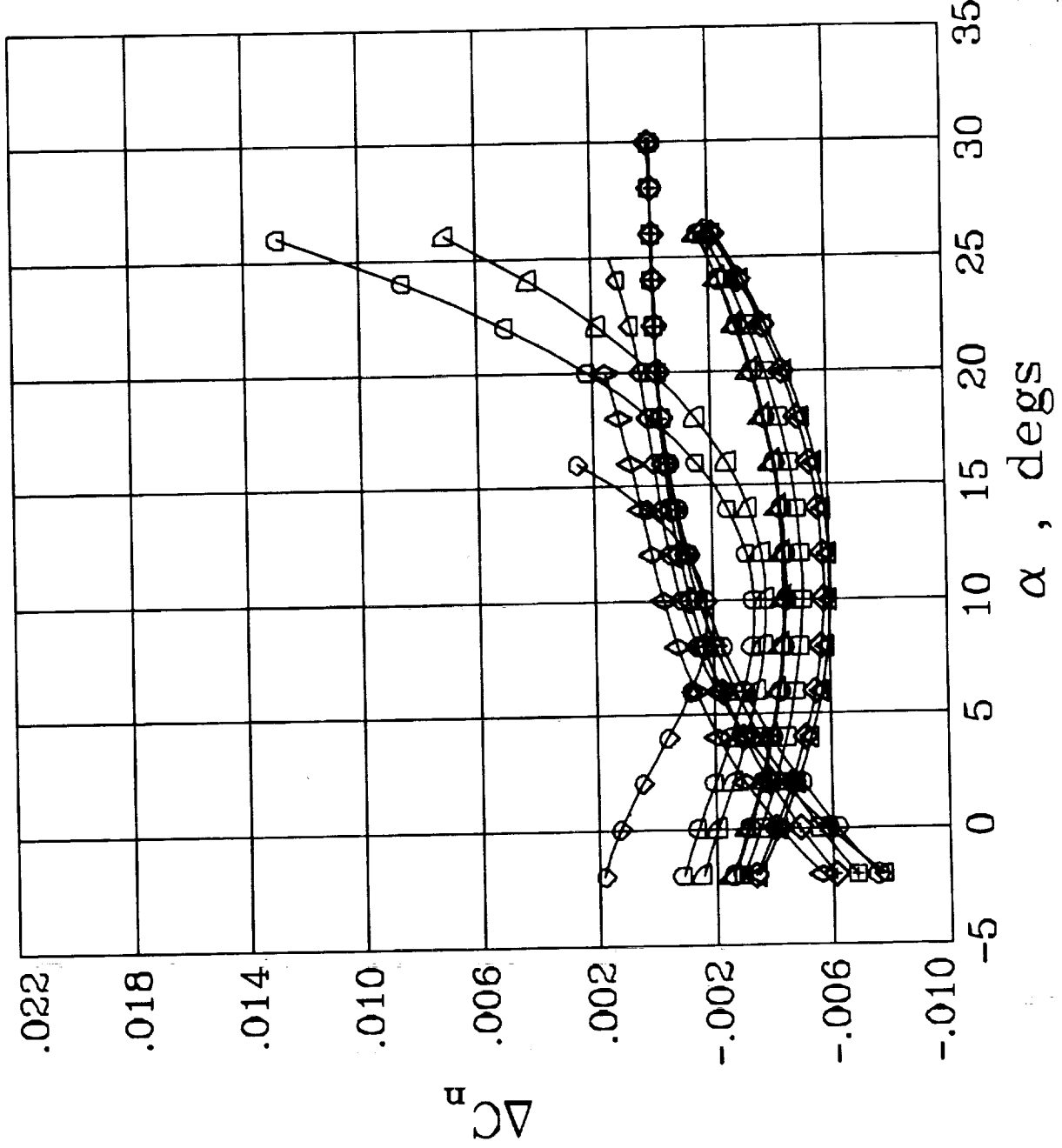

MACH	Symbol
.30	○
.60	□
.80	◇
.90	△
.95	▽
1.10	◻
1.20	◻
1.60	◇
2.00	◇
2.50	⊙
3.00	⊙
3.50	◻
4.00	◻

AERO DATA BASE FOR HL-20 FLIGHT SIMULATION STUDIES

INCREMENTS DUE TO $\delta_{ULBF} = -45^\circ$



LaRC/SSD
JAN. 1991

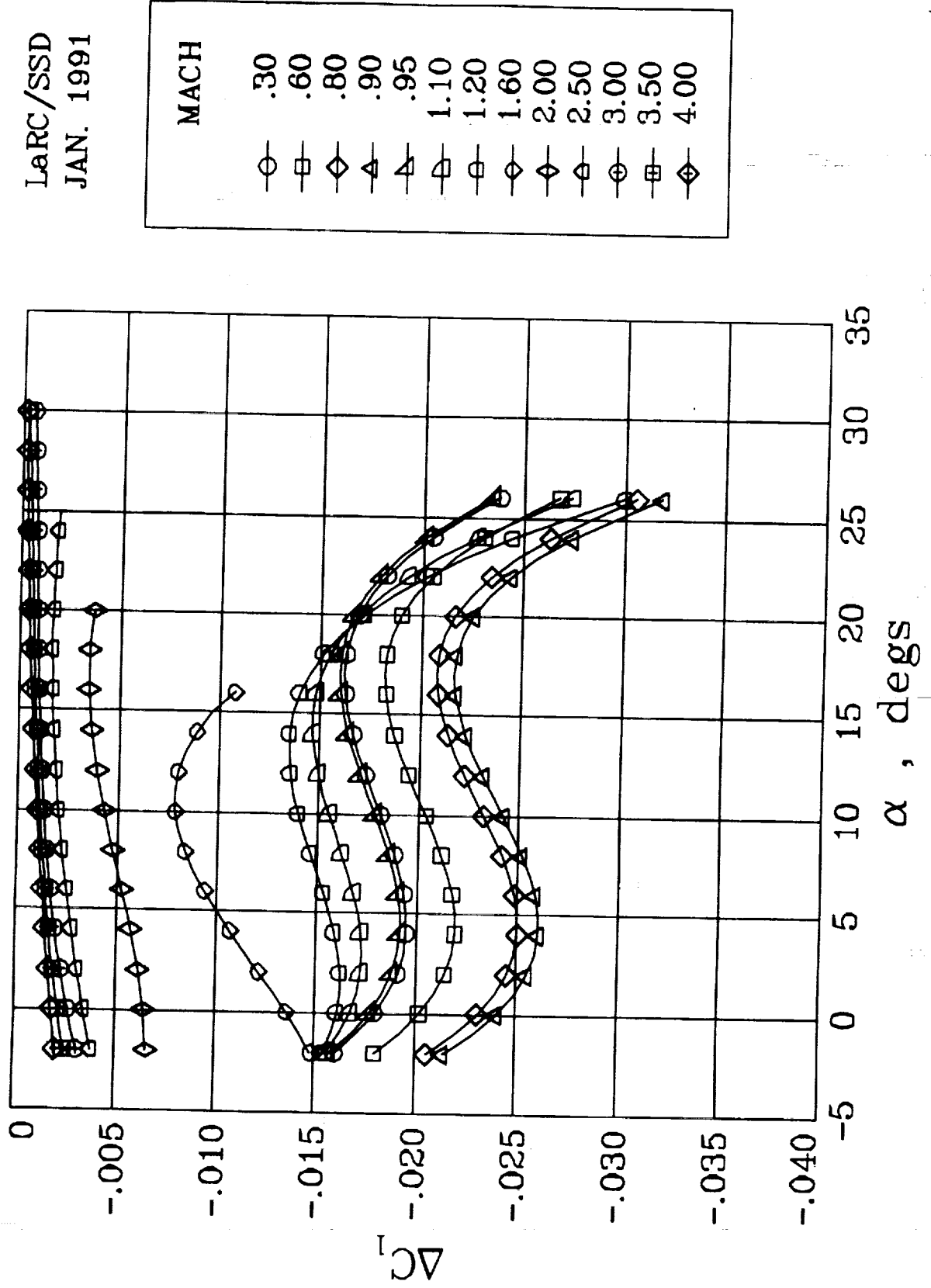

AERO DATA BASE FOR HL-20 FLIGHT SIMULATION STUDIES



LaRC/SSD
JAN. 1991

INCREMENTS DUE TO $\delta_{ULBF} = -30^\circ$

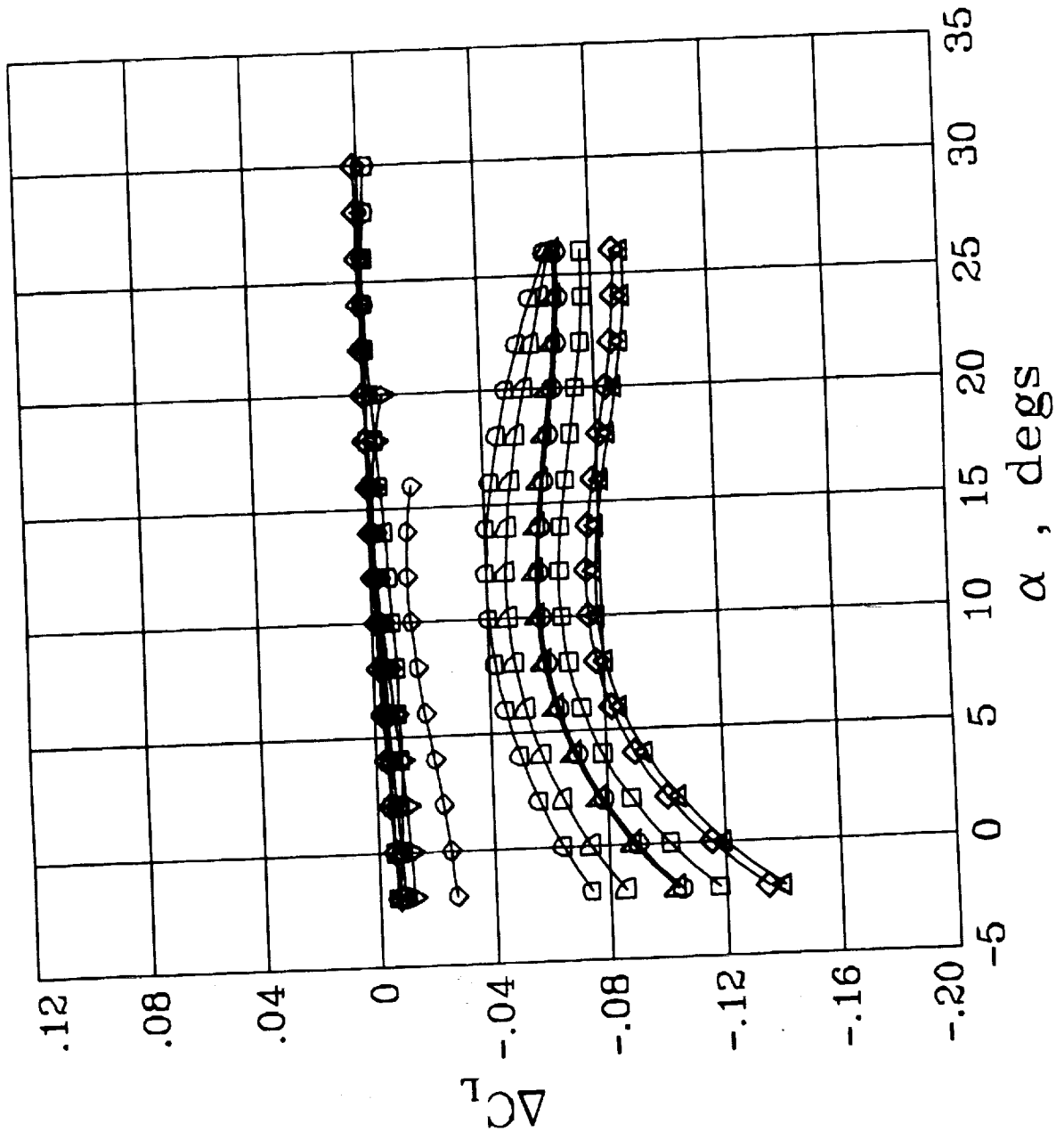

MACH	Symbol
.30	○
.60	□
.80	◇
.90	△
.95	▽
1.10	▽
1.20	◻
1.60	◊
2.00	◈
2.50	◉
3.00	⊕
3.50	⊗
4.00	⊘

AERO DATA BASE FOR HL-20 FLIGHT SIMULATION STUDIES

INCREMENTS DUE TO $\delta_{ULBF} = -30^\circ$



LaRC/SSD
JAN. 1991

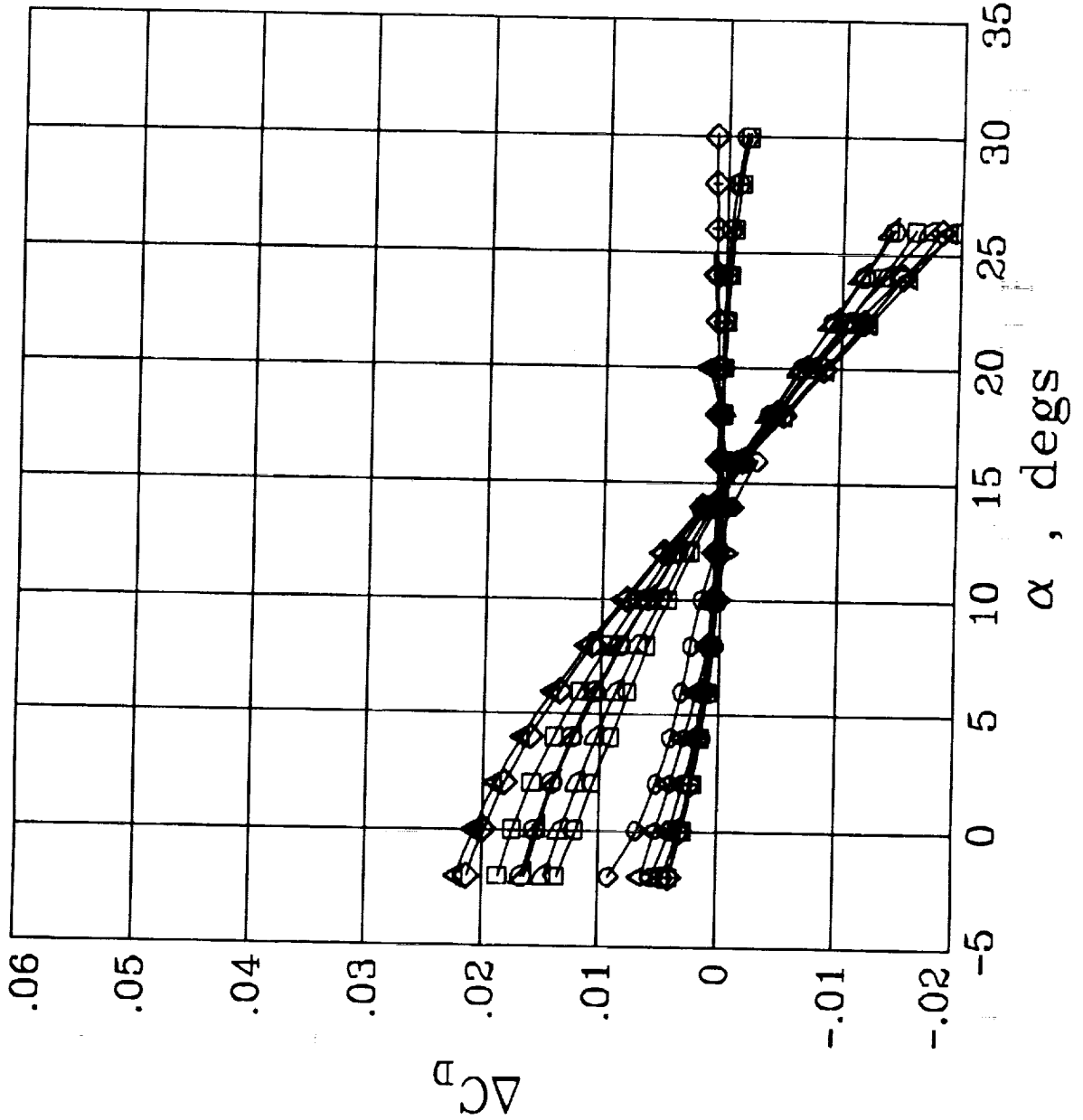

AERO DATA BASE FOR HL-20 FLIGHT SIMULATION STUDIES



LaRC/SSD
JAN. 1991

INCREMENTS DUE TO $\delta_{ULBF} = -30^\circ$

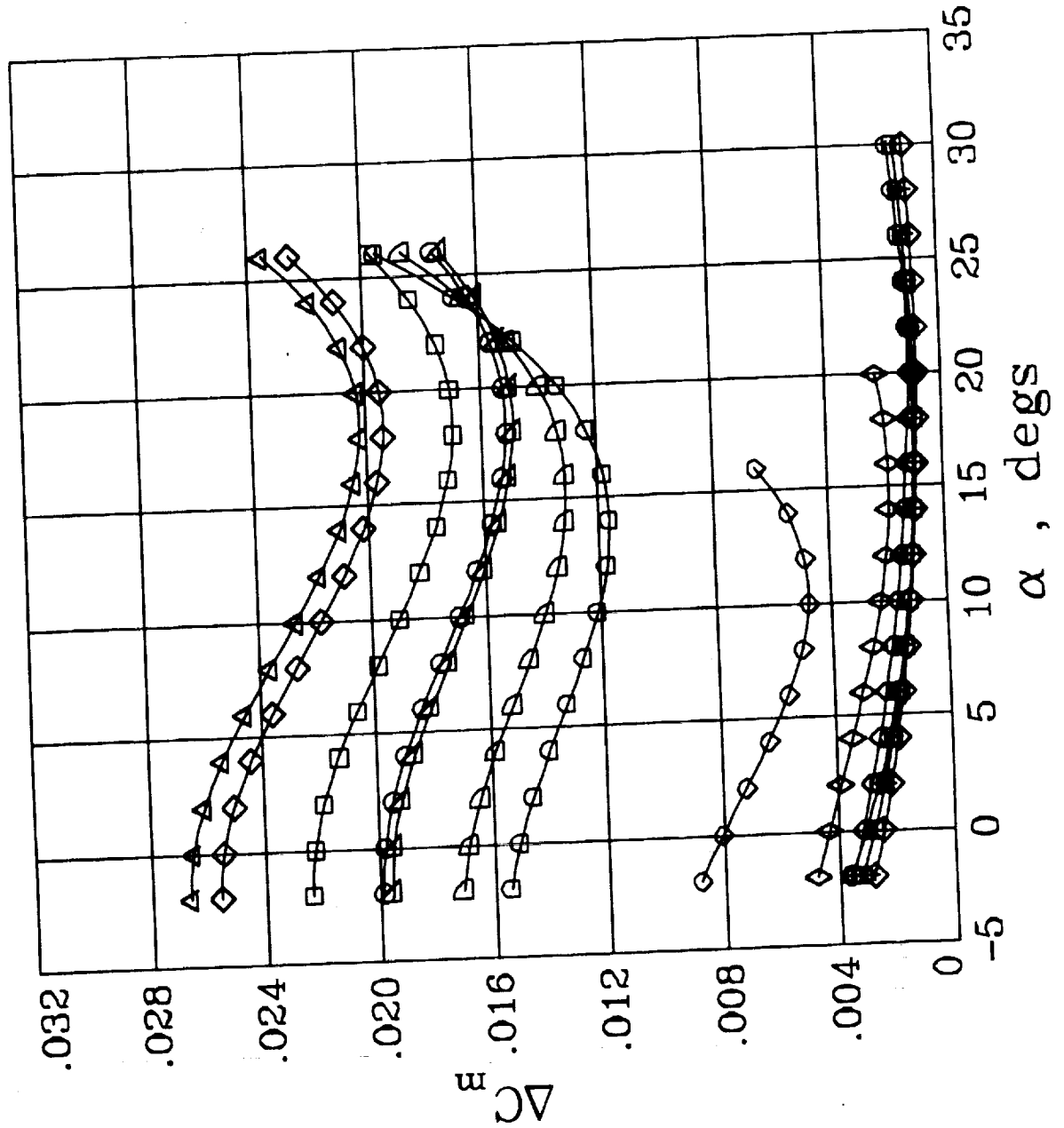

AERO DATA BASE FOR HL-20 FLIGHT SIMULATION STUDIES



LaRC/SSD
JAN. 1991

INCREMENTS DUE TO $\delta_{ULBF} = -30^\circ$

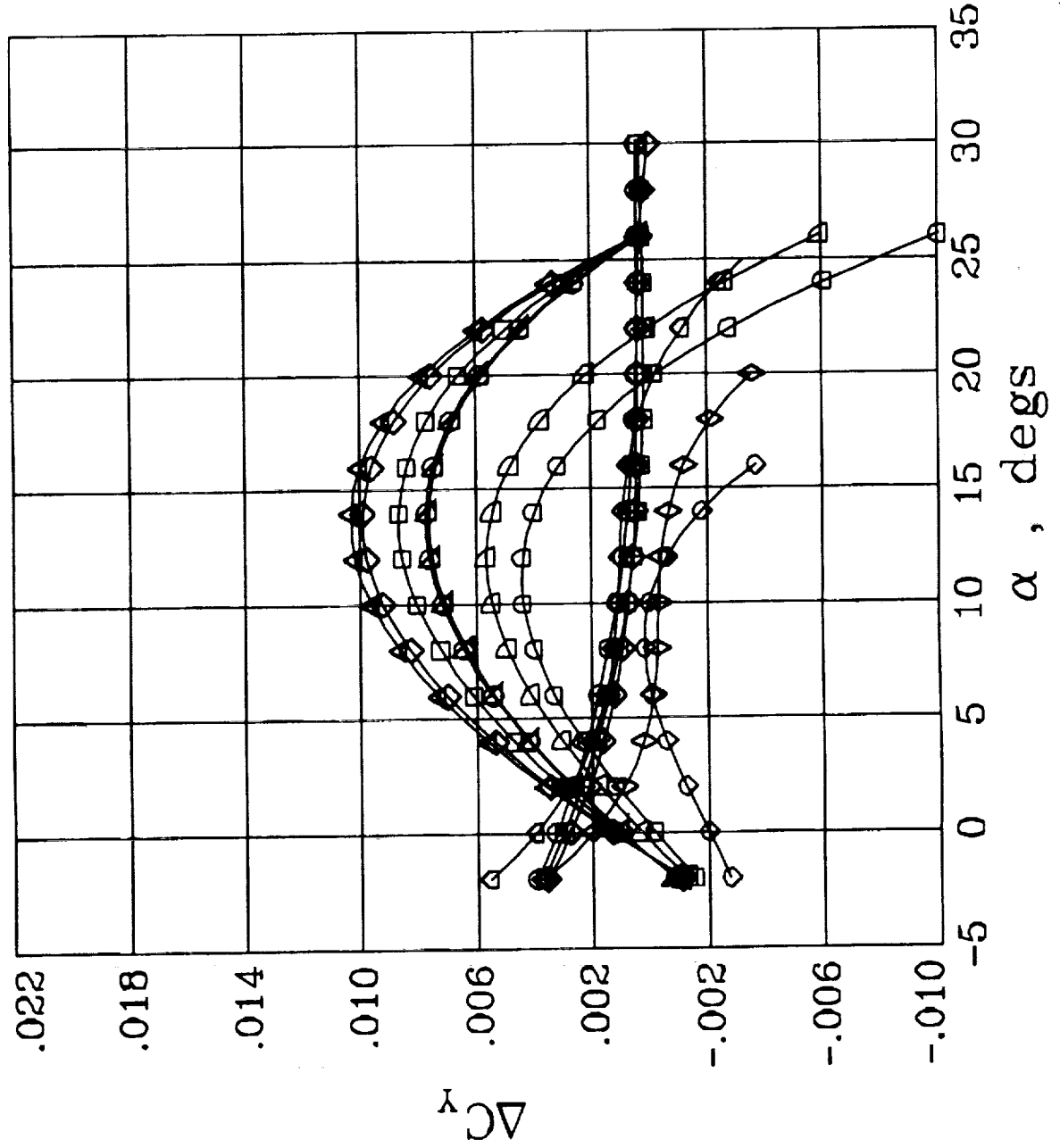

MACH	Symbol
.30	○
.60	□
.80	◇
.90	△
.95	▽
1.10	□
1.20	○
1.60	◇
2.00	○
2.50	○
3.00	○
3.50	□
4.00	◇

AERO DATA BASE FOR HL-20 FLIGHT SIMULATION STUDIES



LaRC/SSD
JAN. 1991

INCREMENTS DUE TO $\delta_{ULBF} = -30^\circ$

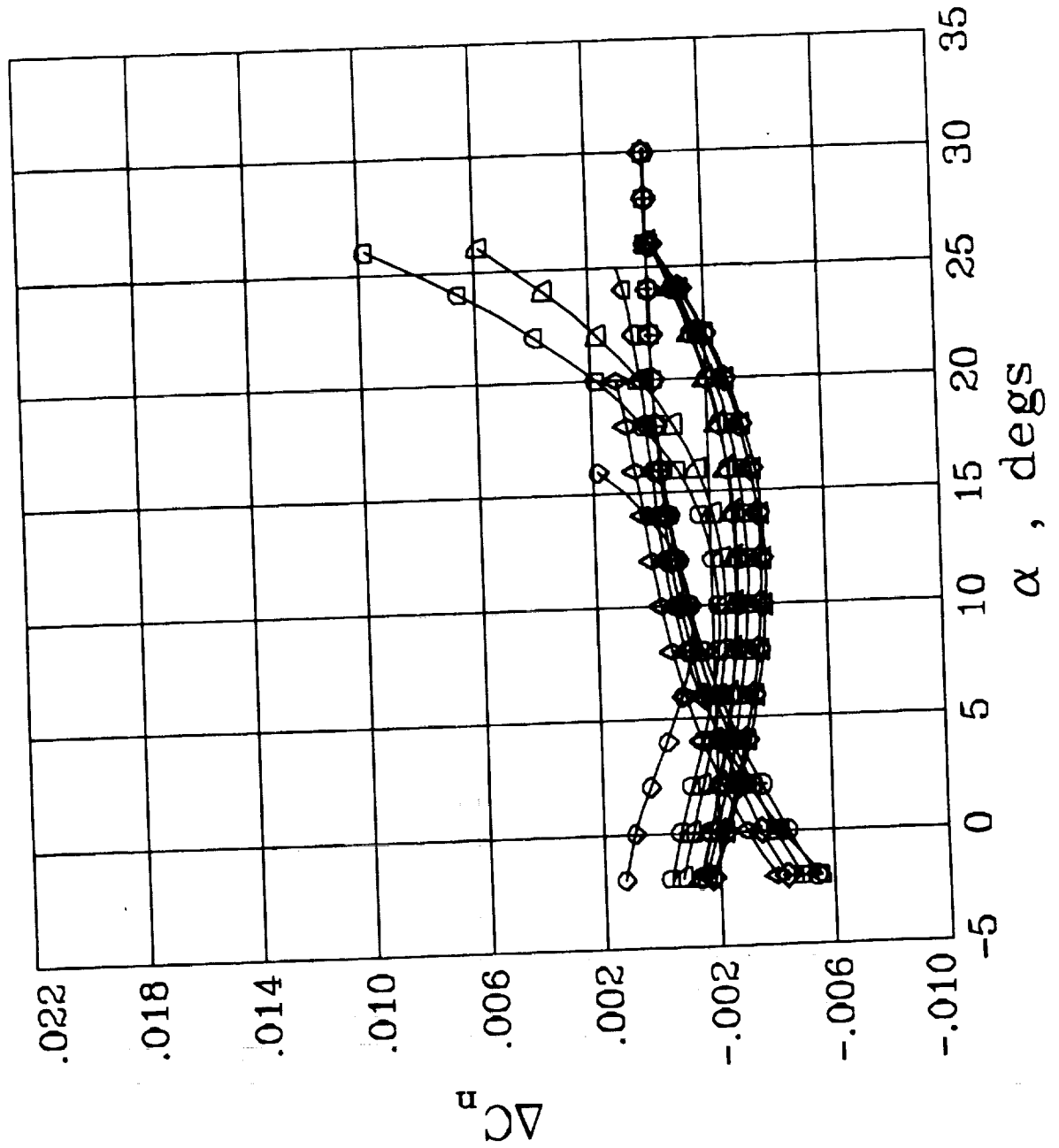

AERO DATA BASE FOR HL-20 FLIGHT SIMULATION STUDIES

INCREMENTS DUE TO $\delta_{ULBF} = -30^\circ$



LaRC/SSD
JAN. 1991

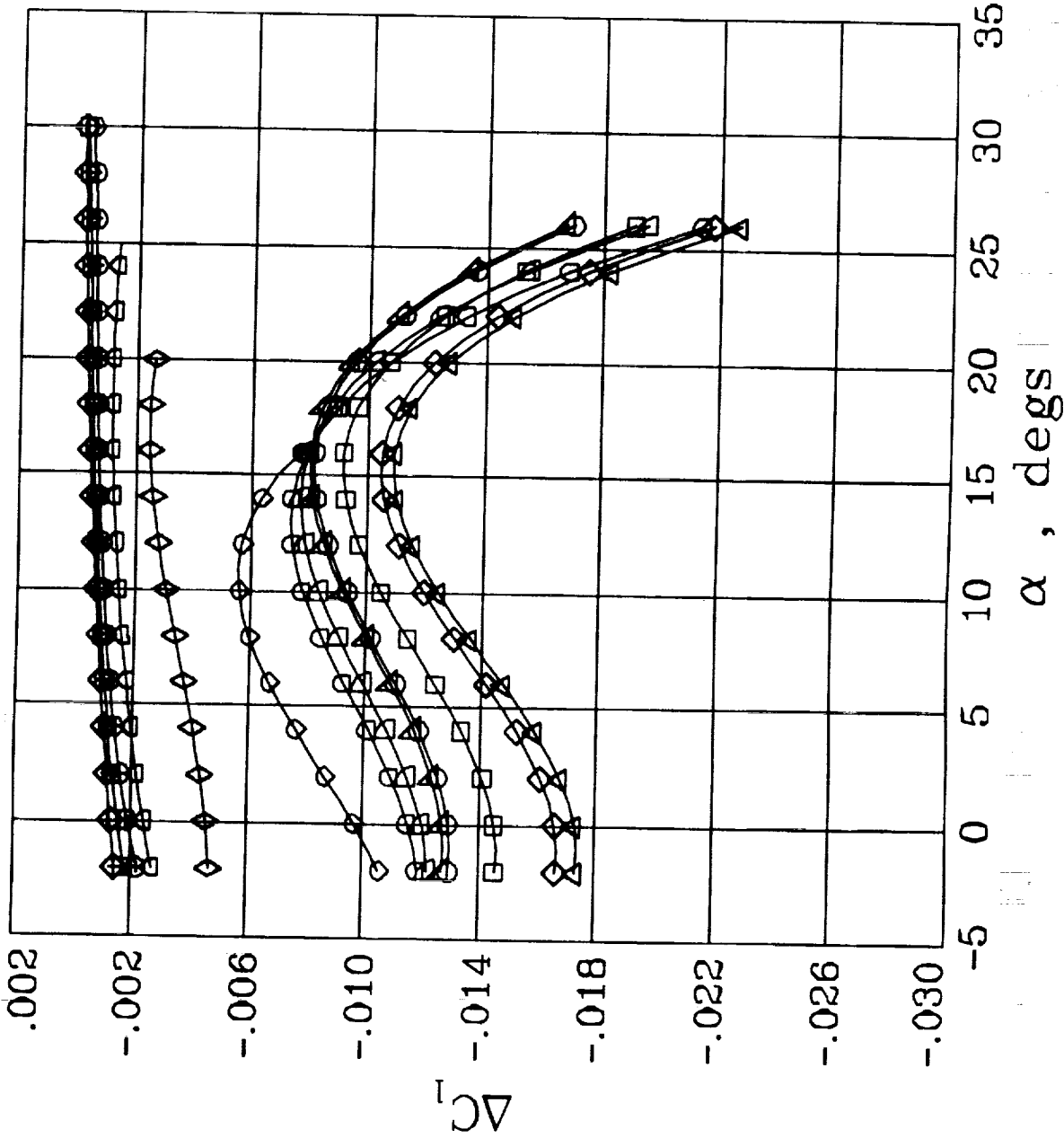

AERO DATA BASE FOR HL-20 FLIGHT SIMULATION STUDIES



LaRC/SSD
JAN. 1991

INCREMENTS DUE TO $\delta_{ULBF} = -15^\circ$

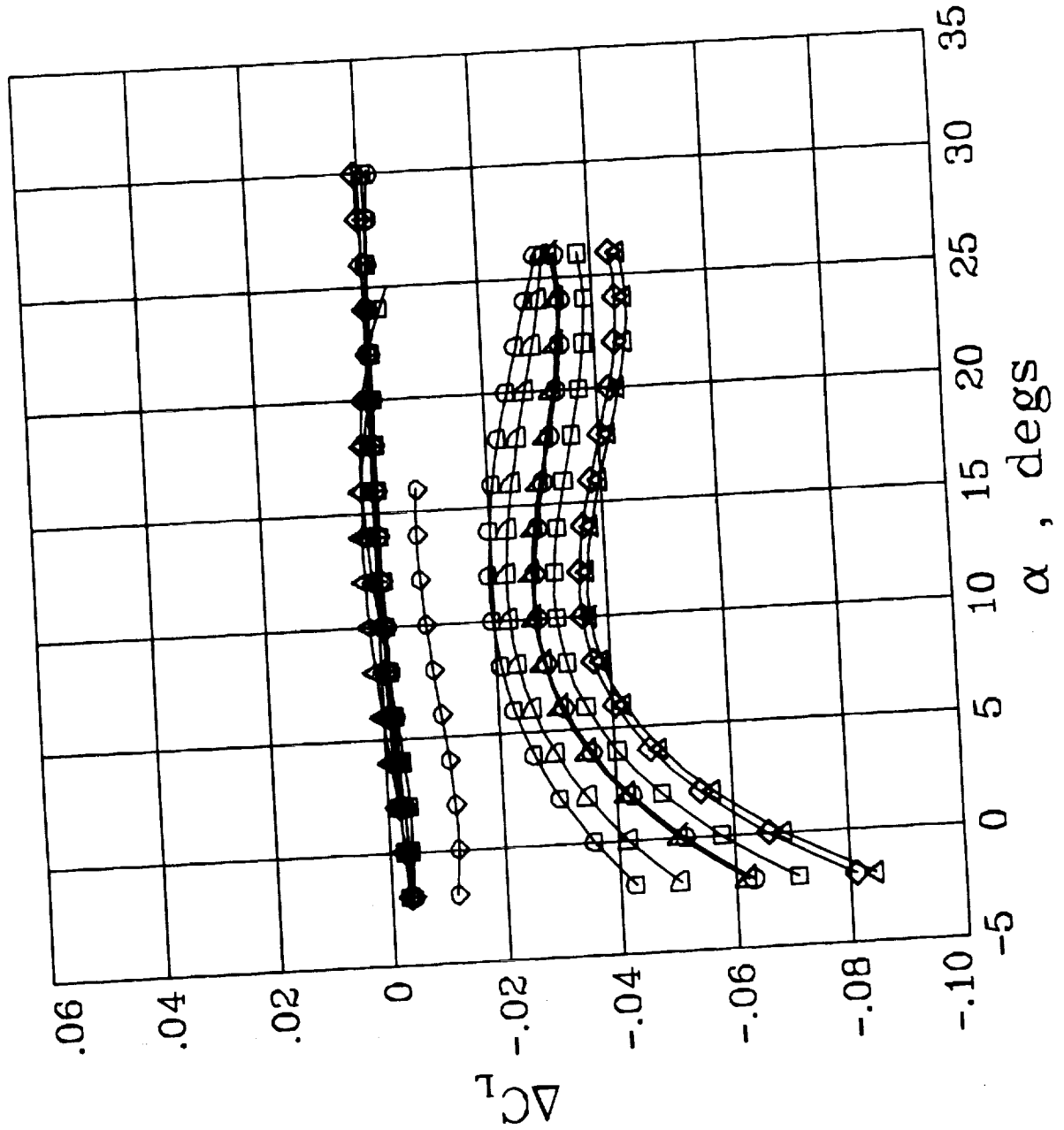

MACH	Symbol
.30	○
.60	□
.80	◇
.90	△
.95	▽
1.10	◇
1.20	□
1.60	◇
2.00	◇
2.50	□
3.00	◇
3.50	□
4.00	◇

AERO DATA BASE FOR HL-20 FLIGHT SIMULATION STUDIES

INCREMENTS DUE TO $\delta_{ULBF} = -15^\circ$



LaRC/SSD
JAN. 1991

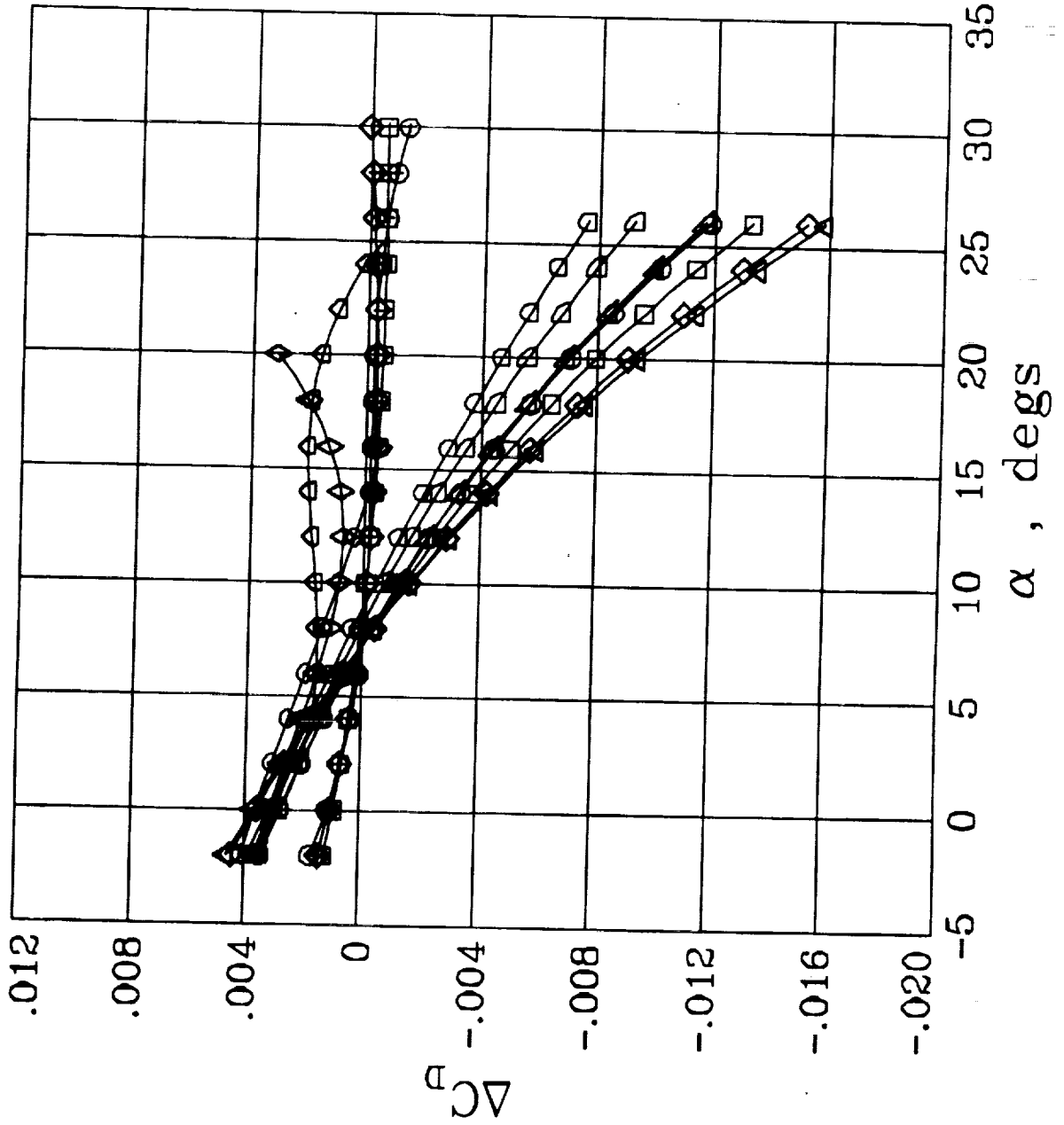

AERO DATA BASE FOR HL-20 FLIGHT SIMULATION STUDIES



LaRC/SSD
JAN. 1991

INCREMENTS DUE TO $\delta_{ULBF} = -15^\circ$

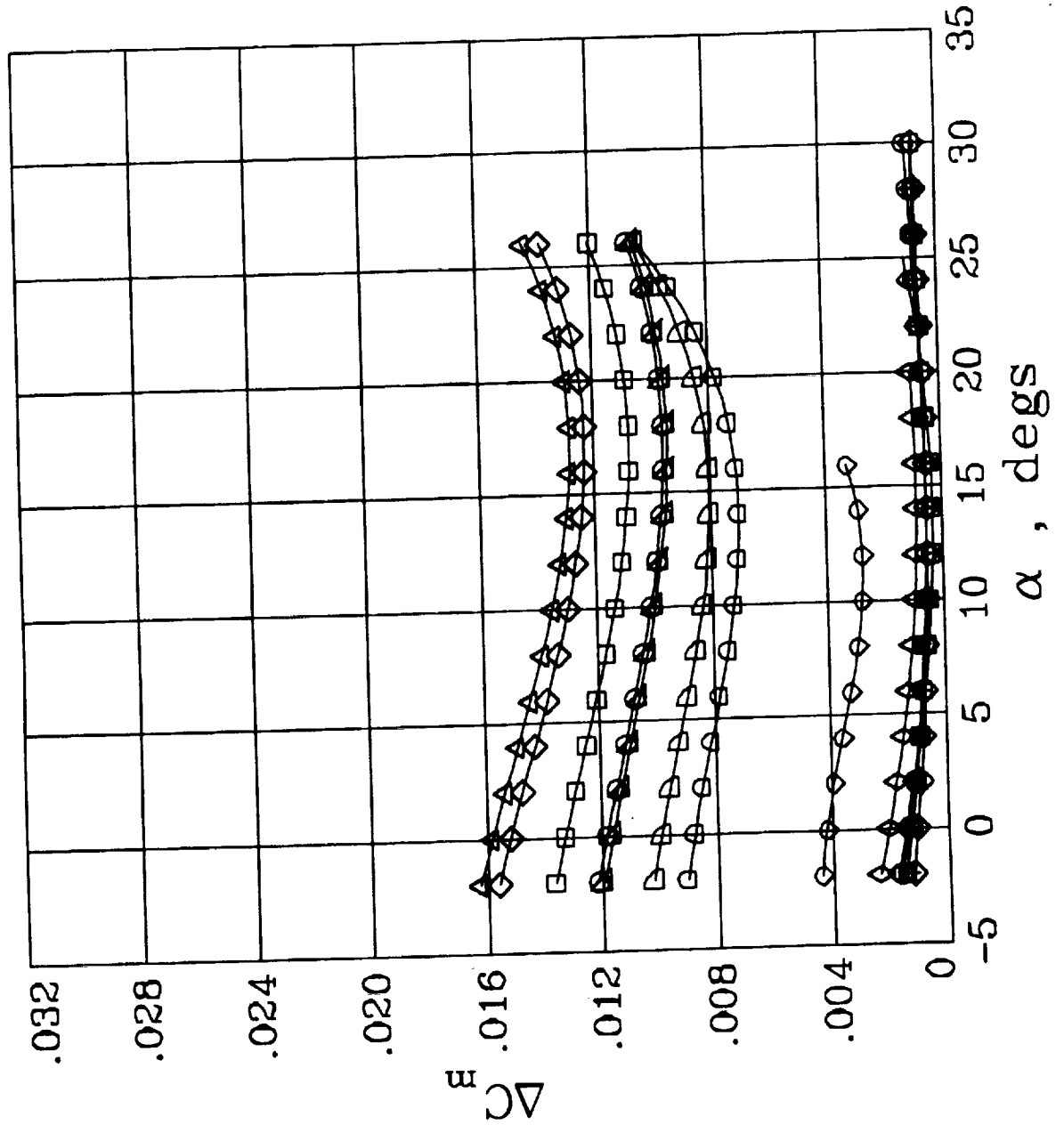

AERO DATA BASE FOR HL-20 FLIGHT SIMULATION STUDIES

INCREMENTS DUE TO $\delta_{ULBF} = -15^\circ$



LaRC/SSD
JAN. 1991

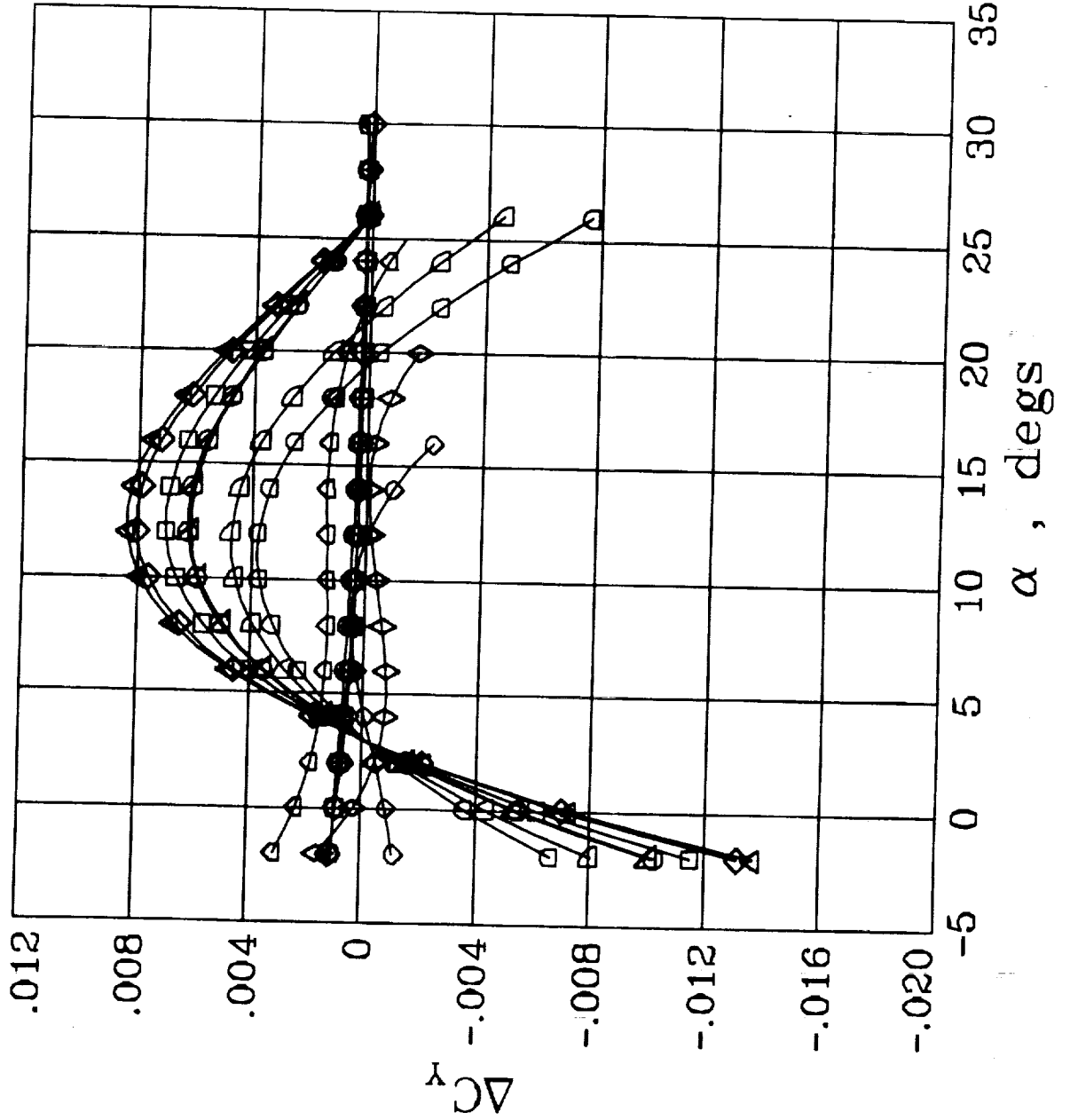

AERO DATA BASE FOR HL-20 FLIGHT SIMULATION STUDIES



LaRC/SSD
JAN. 1991

INCREMENTS DUE TO $\delta_{ULBF} = -15^\circ$

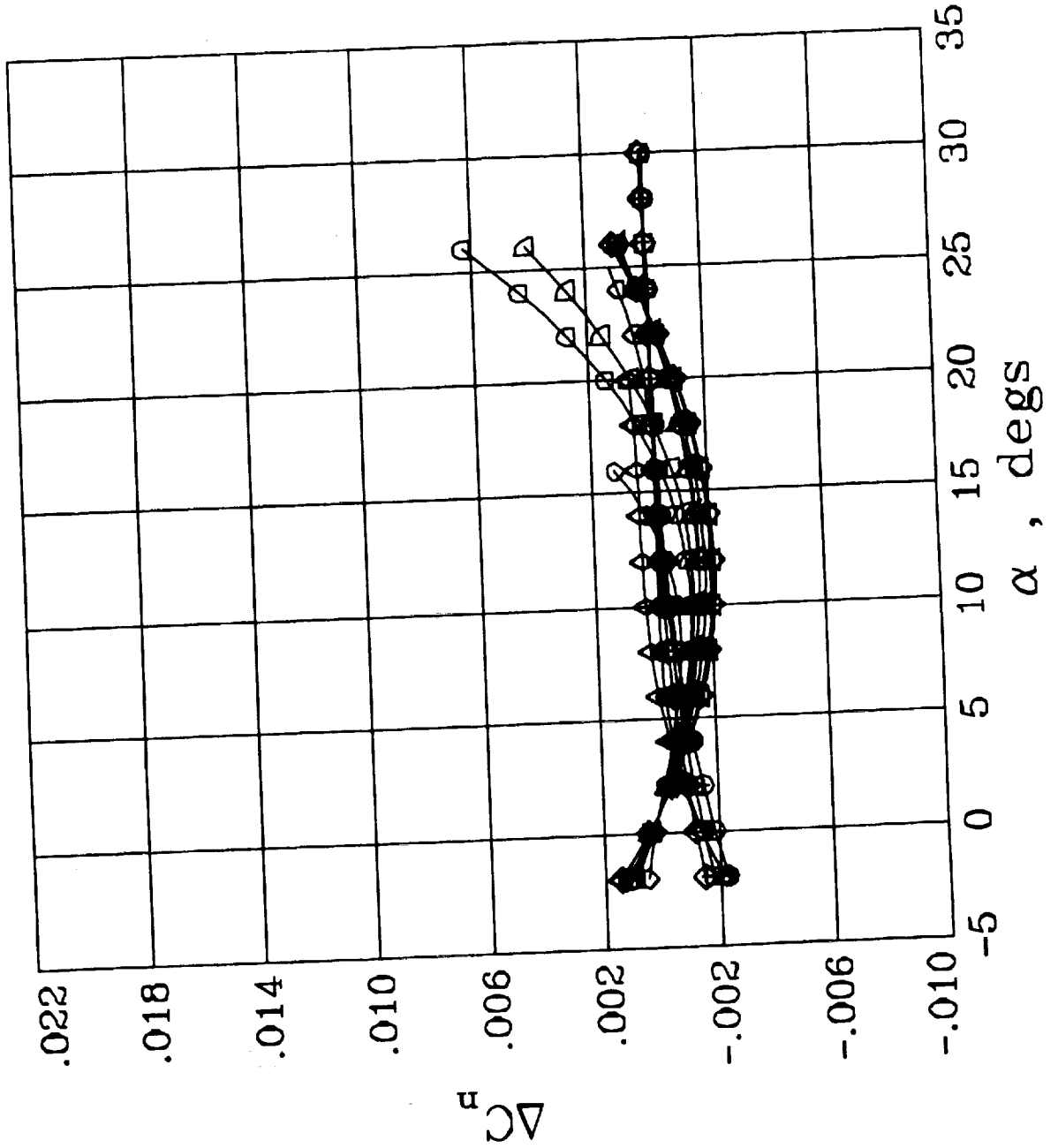

AERO DATA BASE FOR HL-20 FLIGHT SIMULATION STUDIES

INCREMENTS DUE TO $\delta_{ULBF} = -15^\circ$



LaRC/SSD
JAN. 1991

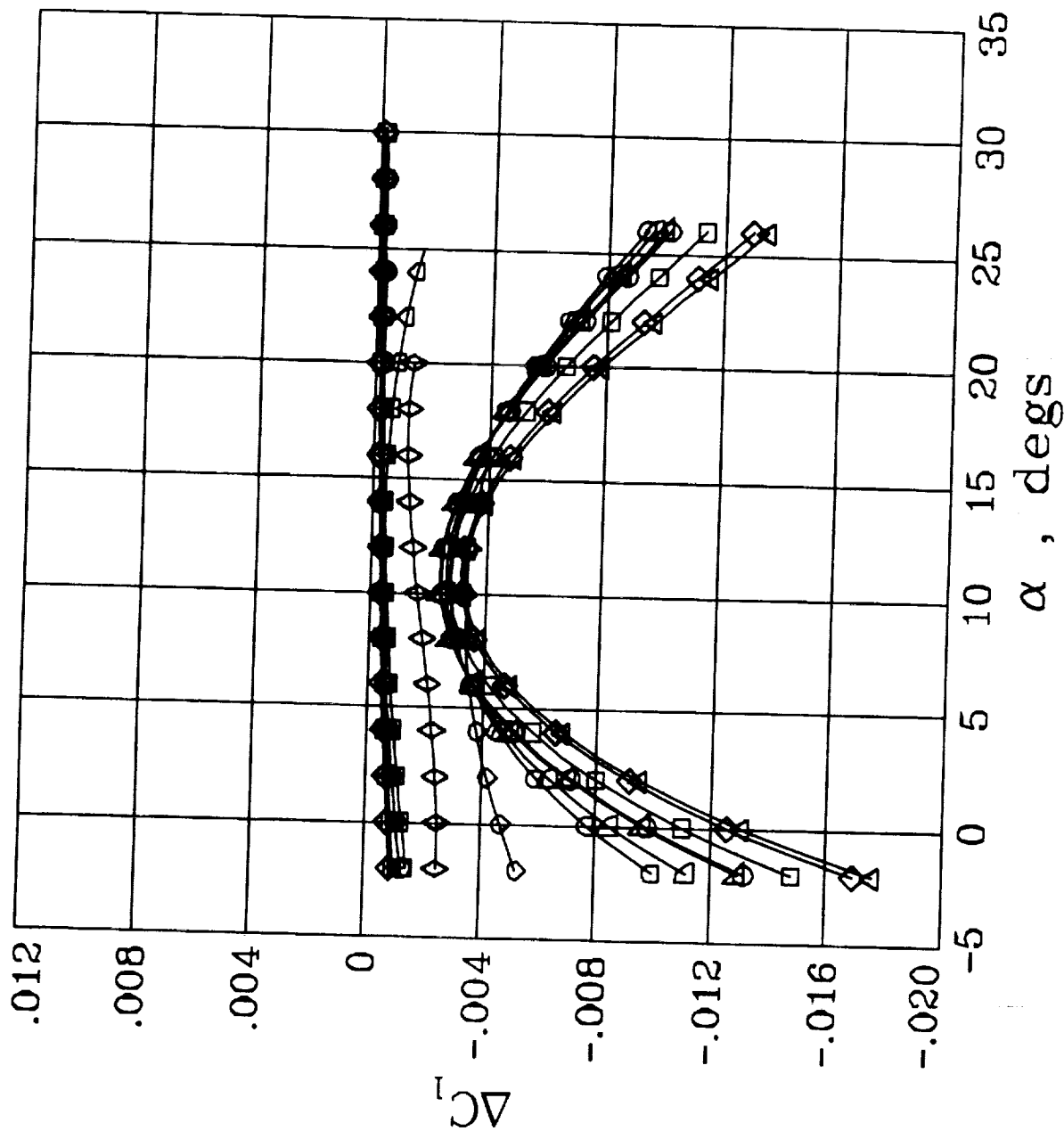

MACH	Symbol
.30	○
.60	□
.80	◇
.90	△
.95	▽
1.10	▢
1.20	⊖
1.60	⊙
2.00	⊕
2.50	⊗
3.00	⊘
3.50	⊙
4.00	⊚

AERO DATA BASE FOR HL-20 FLIGHT SIMULATION STUDIES



LaRC/SSD
 JAN. 1991

INCREMENTS DUE TO $\delta_{LLBF} = +15^\circ$

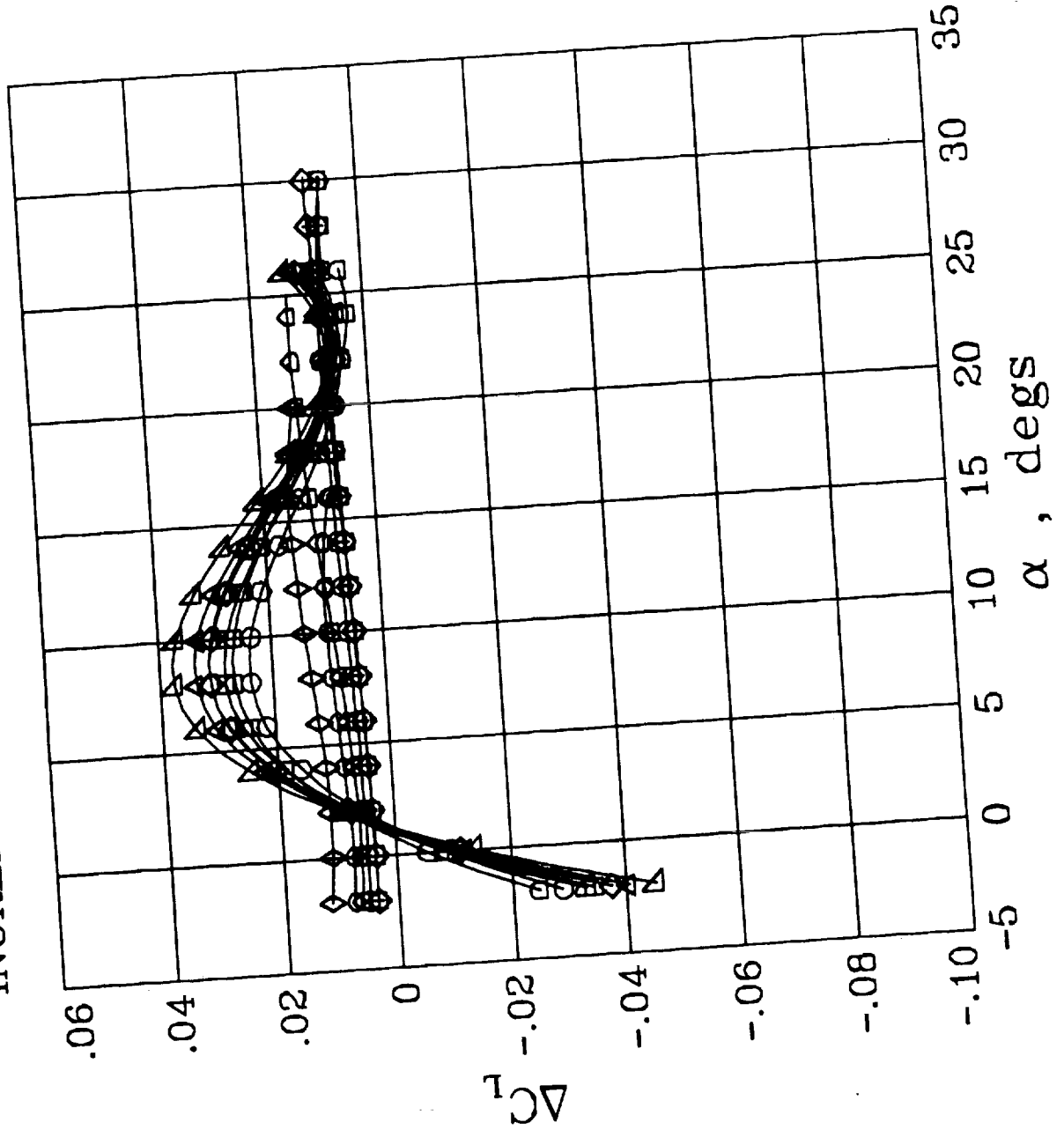

AERO DATA BASE FOR HL-20 FLIGHT SIMULATION STUDIES

INCREMENTS DUE TO $\delta_{LBF} = +15^\circ$



LaRC/SSD
JAN. 1991

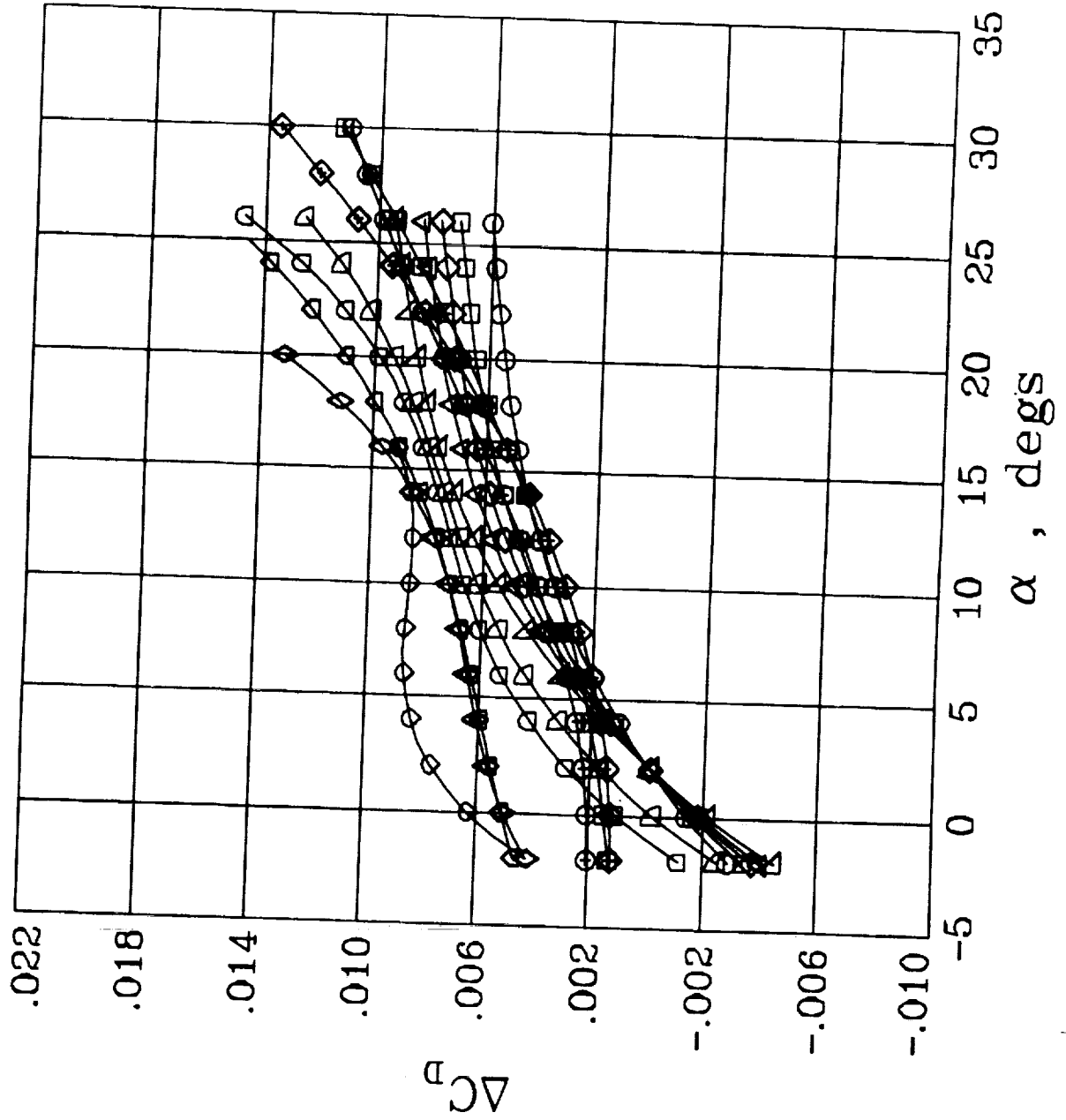

AERO DATA BASE FOR HL-20 FLIGHT SIMULATION STUDIES



LaRC/SSD
JAN. 1991

INCREMENTS DUE TO $\delta_{LBF} = +15^\circ$

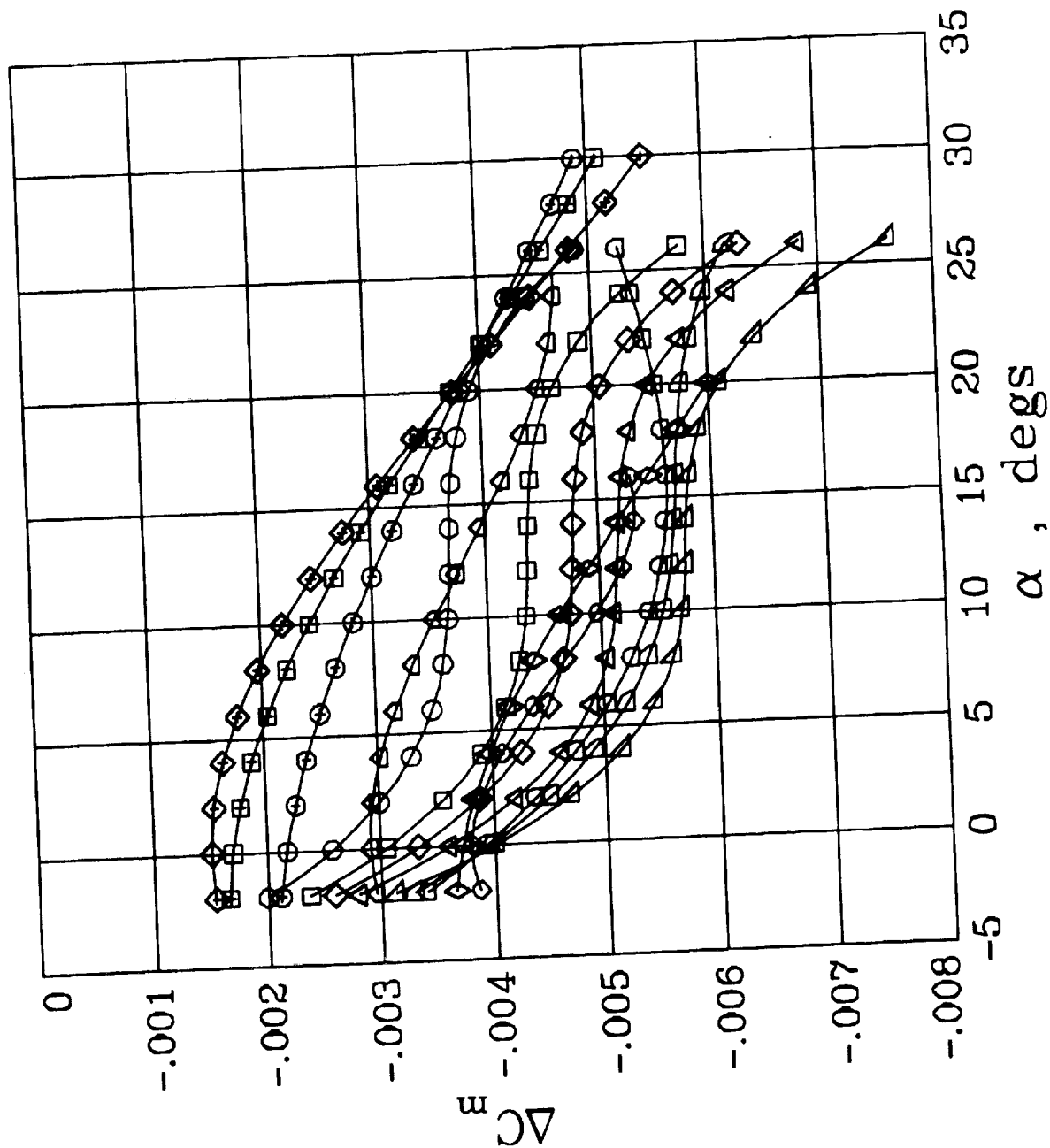

AERO DATA BASE FOR HL-20 FLIGHT SIMULATION STUDIES

INCREMENTS DUE TO $\delta_{LLBF} = +15^\circ$



LaRC/SSD
JAN. 1991

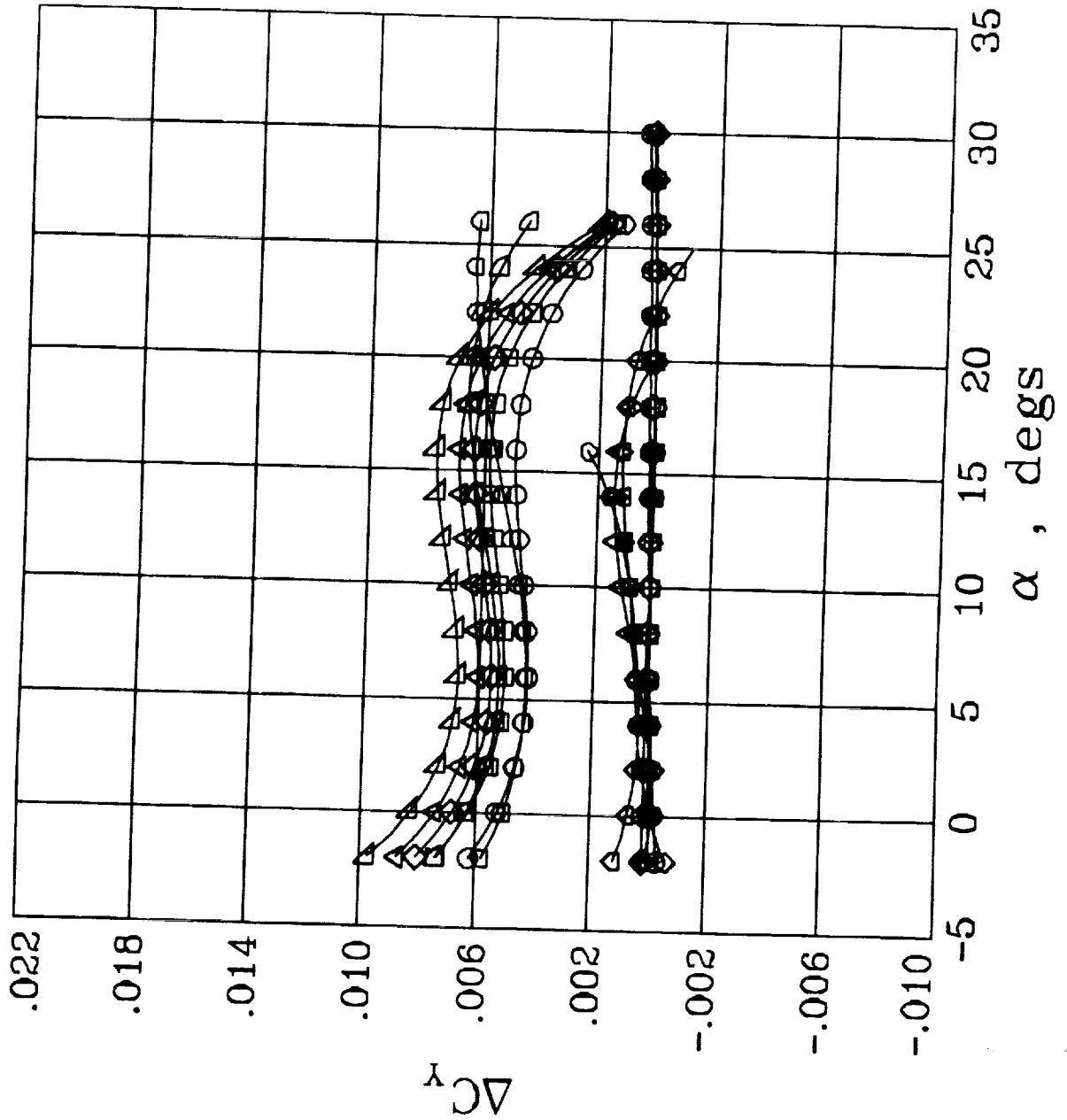

AERO DATA BASE FOR HL-20 FLIGHT SIMULATION STUDIES



LaRC/SSD
JAN. 1991

INCREMENTS DUE TO $\delta_{LLBF} = +15^\circ$

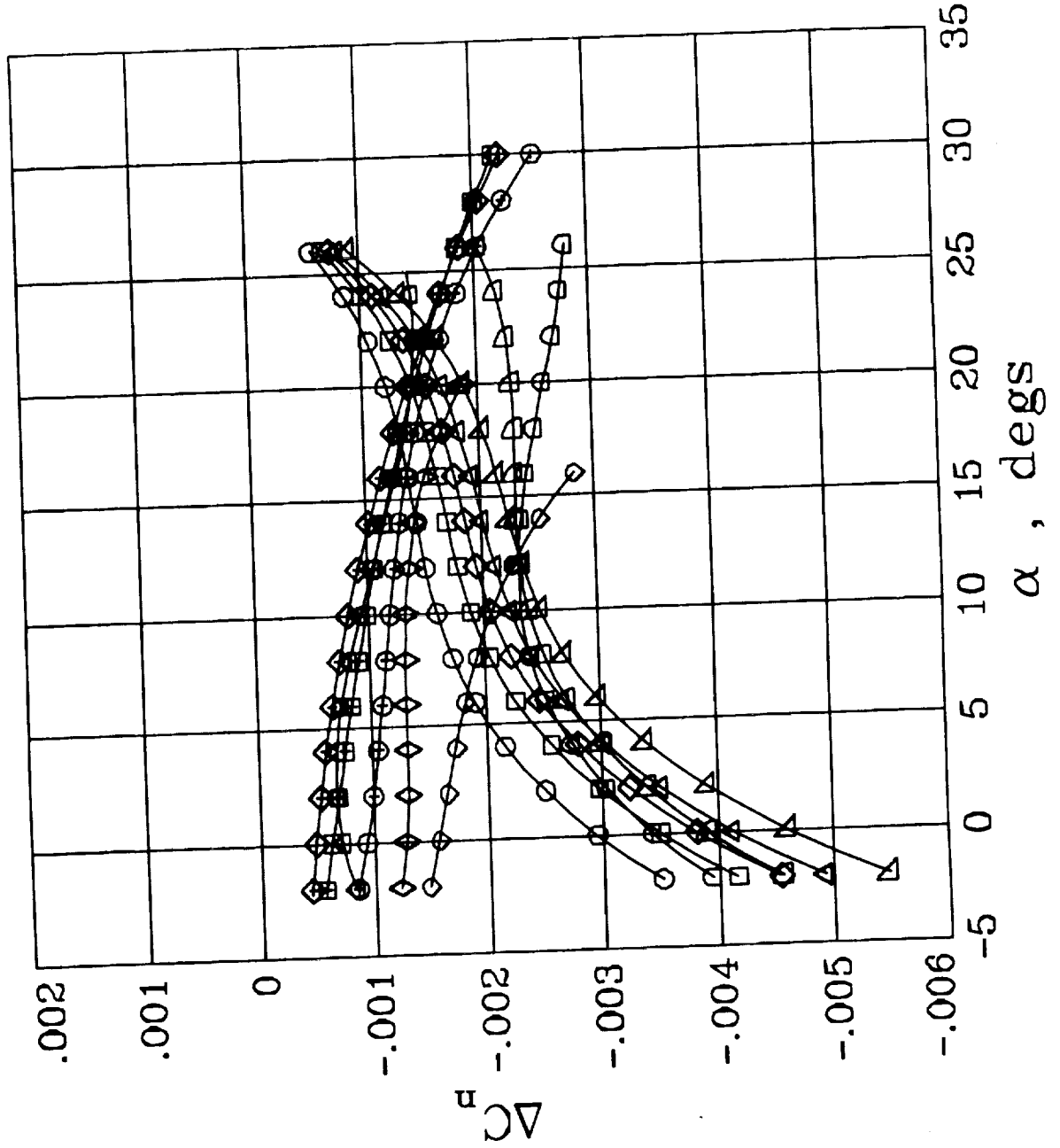

AERO DATA BASE FOR HL-20 FLIGHT SIMULATION STUDIES

INCREMENTS DUE TO $\delta_{LLBF} = +15^\circ$



LaRC/SSD
JAN. 1991

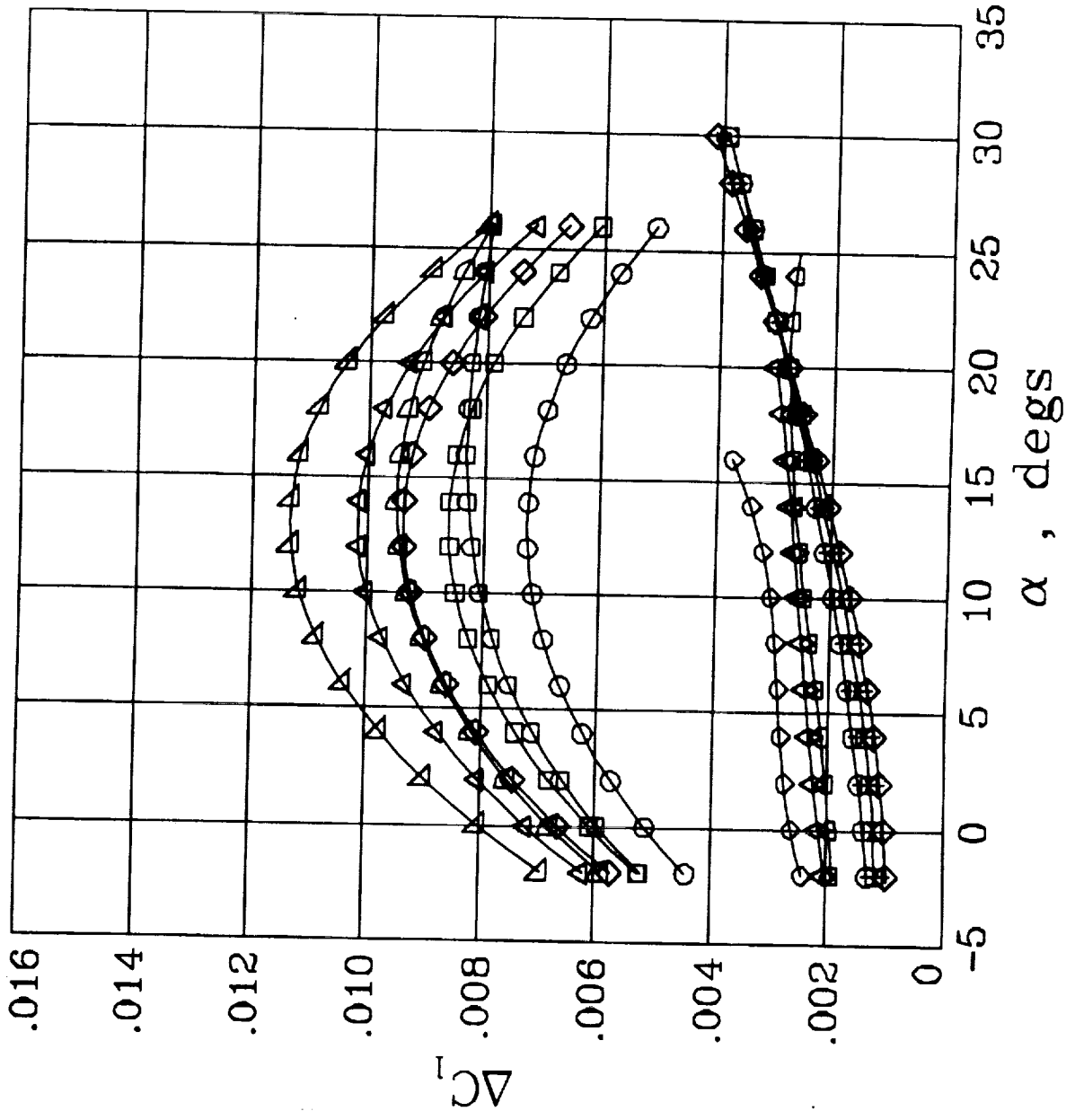

AERO DATA BASE FOR HL-20 FLIGHT SIMULATION STUDIES



LaRC/SSD
JAN. 1991

INCREMENTS DUE TO $\delta_{LLBF} = +30^\circ$

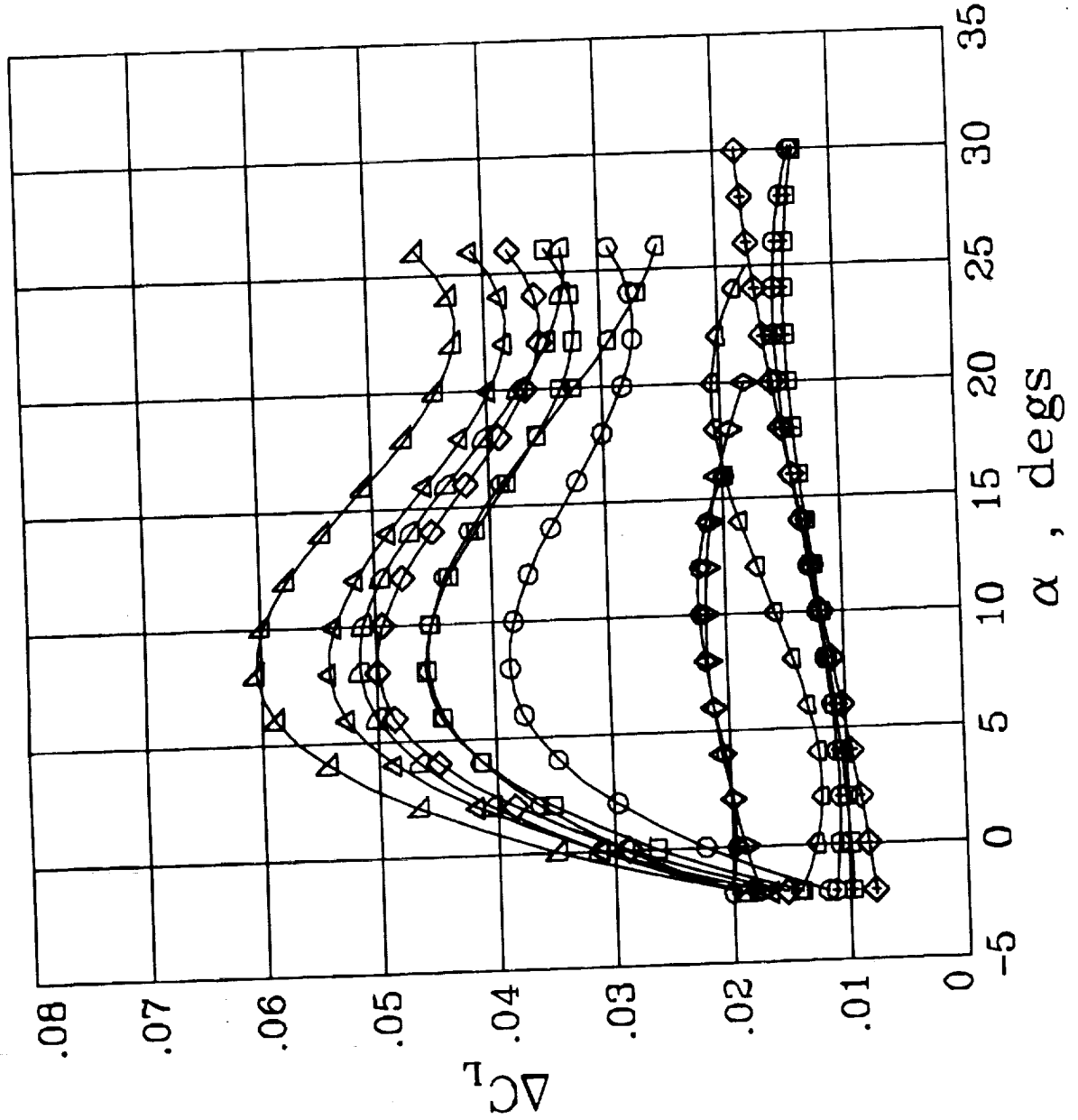

AERO DATA BASE FOR HL-20 FLIGHT SIMULATION STUDIES

INCREMENTS DUE TO $\delta_{LLBF} = +30^\circ$



LaRC/SSD
JAN. 1991

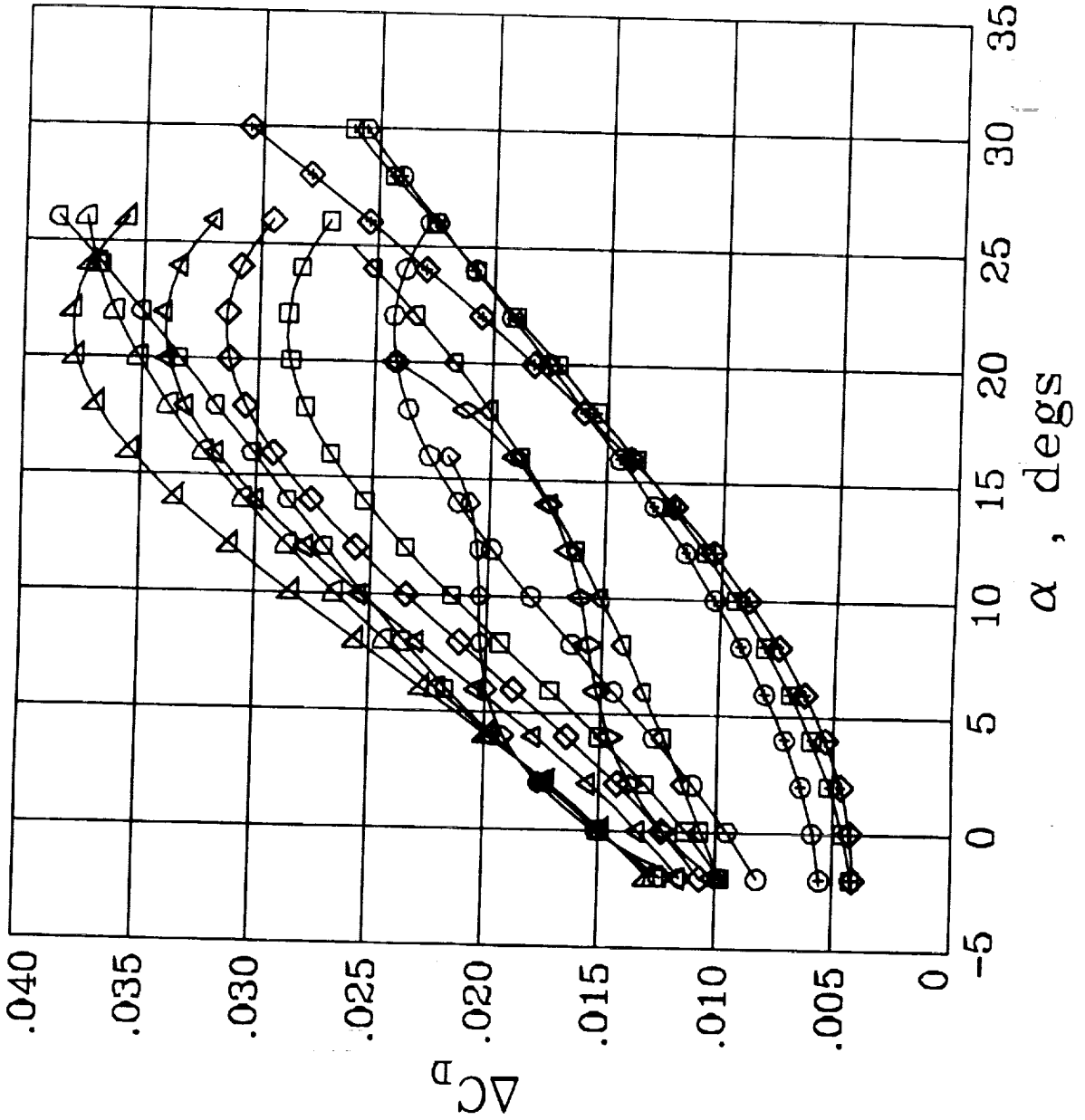

MACH	Symbol
.30	○
.60	□
.80	◇
.90	△
.95	▽
1.10	⬠
1.20	⬡
1.60	⬢
2.00	⬣
2.50	⊠
3.00	⊡
3.50	⊞
4.00	⊞

AERO DATA BASE FOR HL-20 FLIGHT SIMULATION STUDIES



LaRC/SSD
 JAN. 1991

INCREMENTS DUE TO $\delta_{LLBF} = +30^\circ$

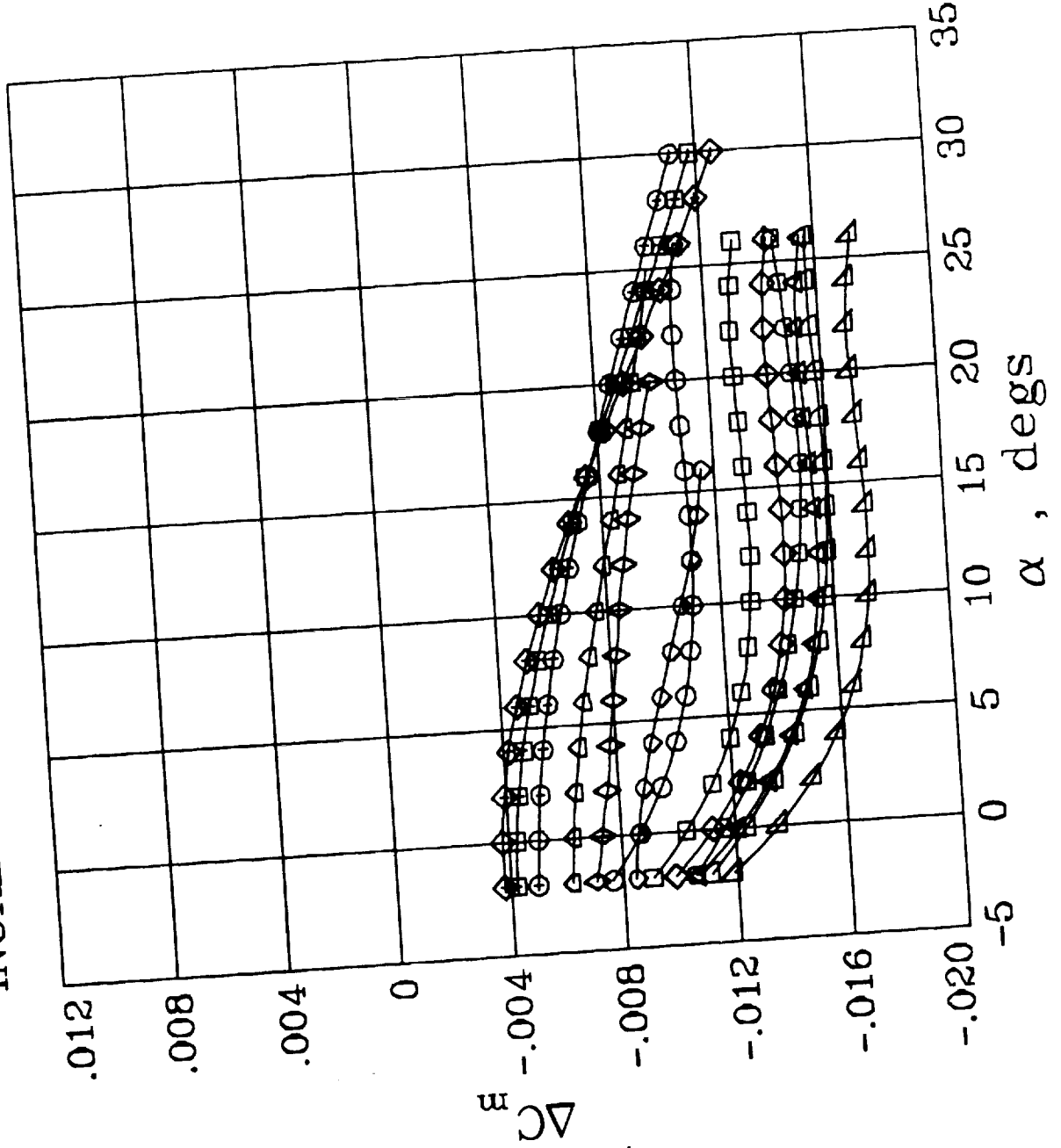

MACH	Symbol
.30	○
.60	□
.80	◇
.90	△
.95	▽
1.10	□
1.20	○
1.60	◇
2.00	○
2.50	□
3.00	○
3.50	□
4.00	◇

AERO DATA BASE FOR HL-20 FLIGHT SIMULATION STUDIES

INCREMENTS DUE TO $\delta_{LLBF} = +30^\circ$



LaRC/SSD
JAN. 1991

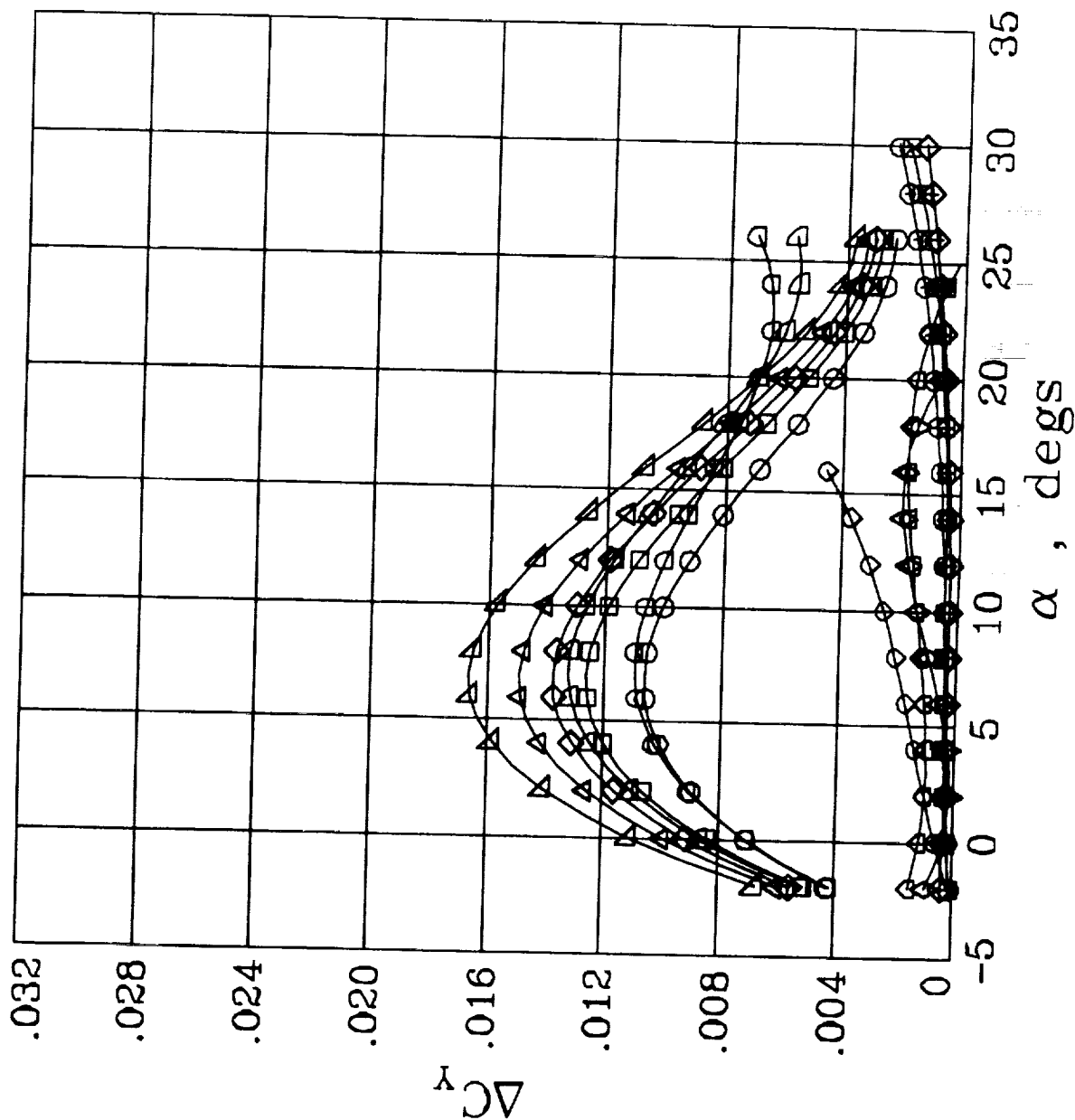

AERO DATA BASE FOR HL-20 FLIGHT SIMULATION STUDIES



LaRC/SSD
JAN. 1991

INCREMENTS DUE TO $\delta_{LLBF} = +30^\circ$

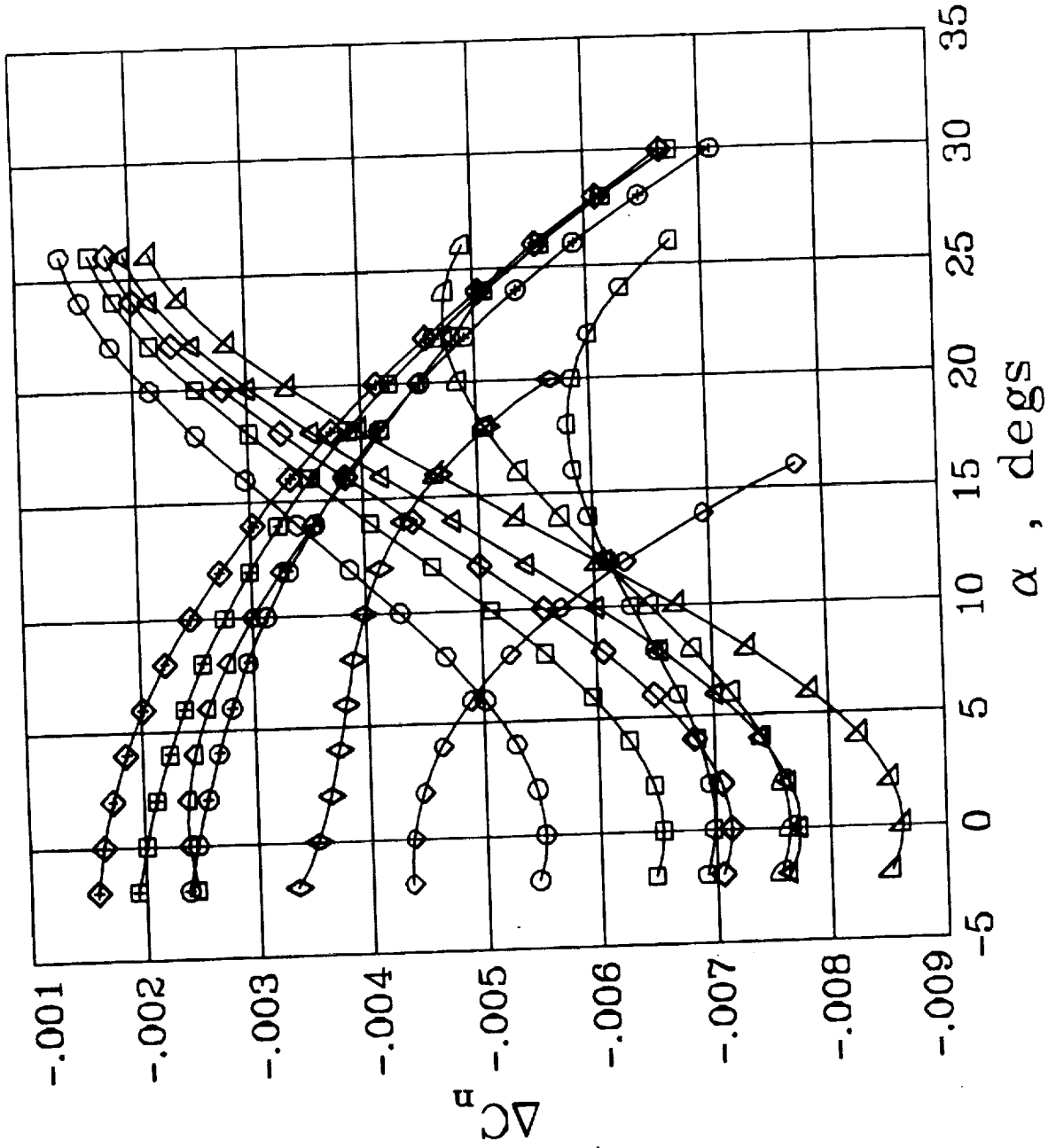

AERO DATA BASE FOR HL-20 FLIGHT SIMULATION STUDIES

INCREMENTS DUE TO $\delta_{LLBF} = +30^\circ$



LaRC/SSD
JAN. 1991

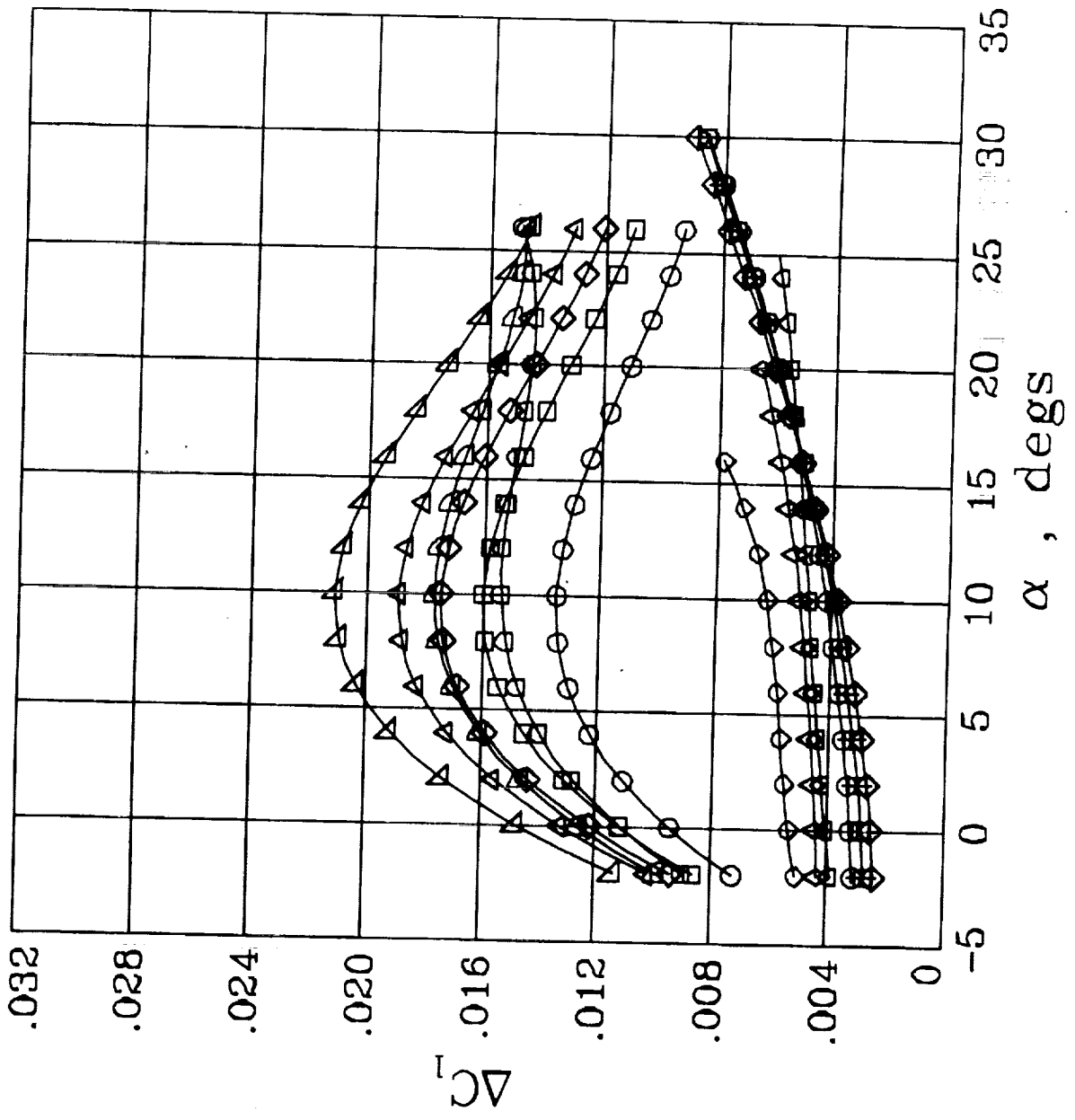

AERO DATA BASE FOR HL-20 FLIGHT SIMULATION STUDIES



LaRC/SSD
JAN. 1991

INCREMENTS DUE TO $\delta_{LLBF} = +45^\circ$

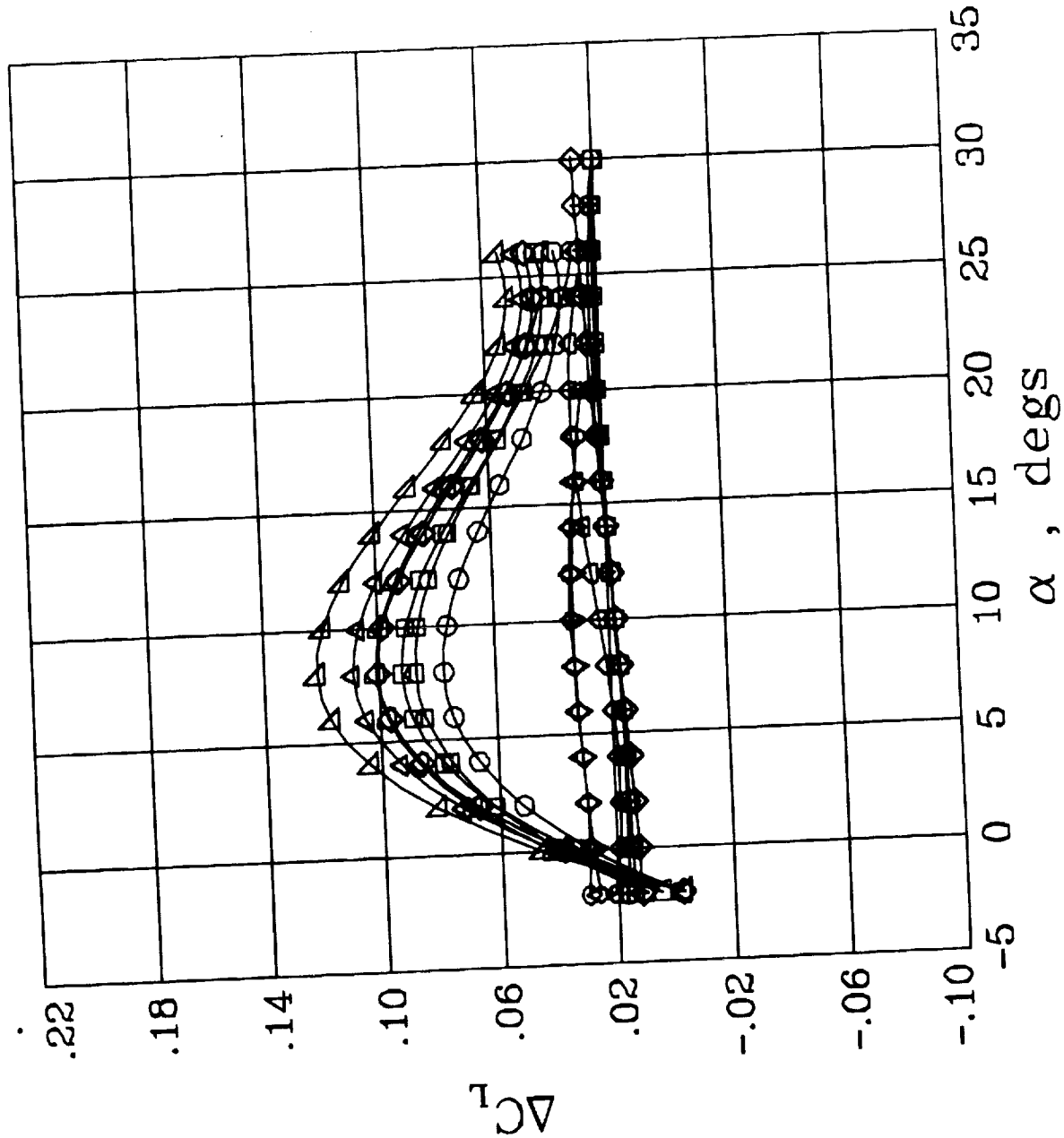

MACH	Symbol
.30	○
.60	□
.80	◇
.90	△
.95	▽
1.10	▾
1.20	⊖
1.60	⊙
2.00	⊕
2.50	⊗
3.00	⊘
3.50	⊙
4.00	⊚

AERO DATA BASE FOR HL-20 FLIGHT SIMULATION STUDIES

INCREMENTS DUE TO $\delta_{LLBF} = +45^\circ$



LaRC/SSD
JAN. 1991

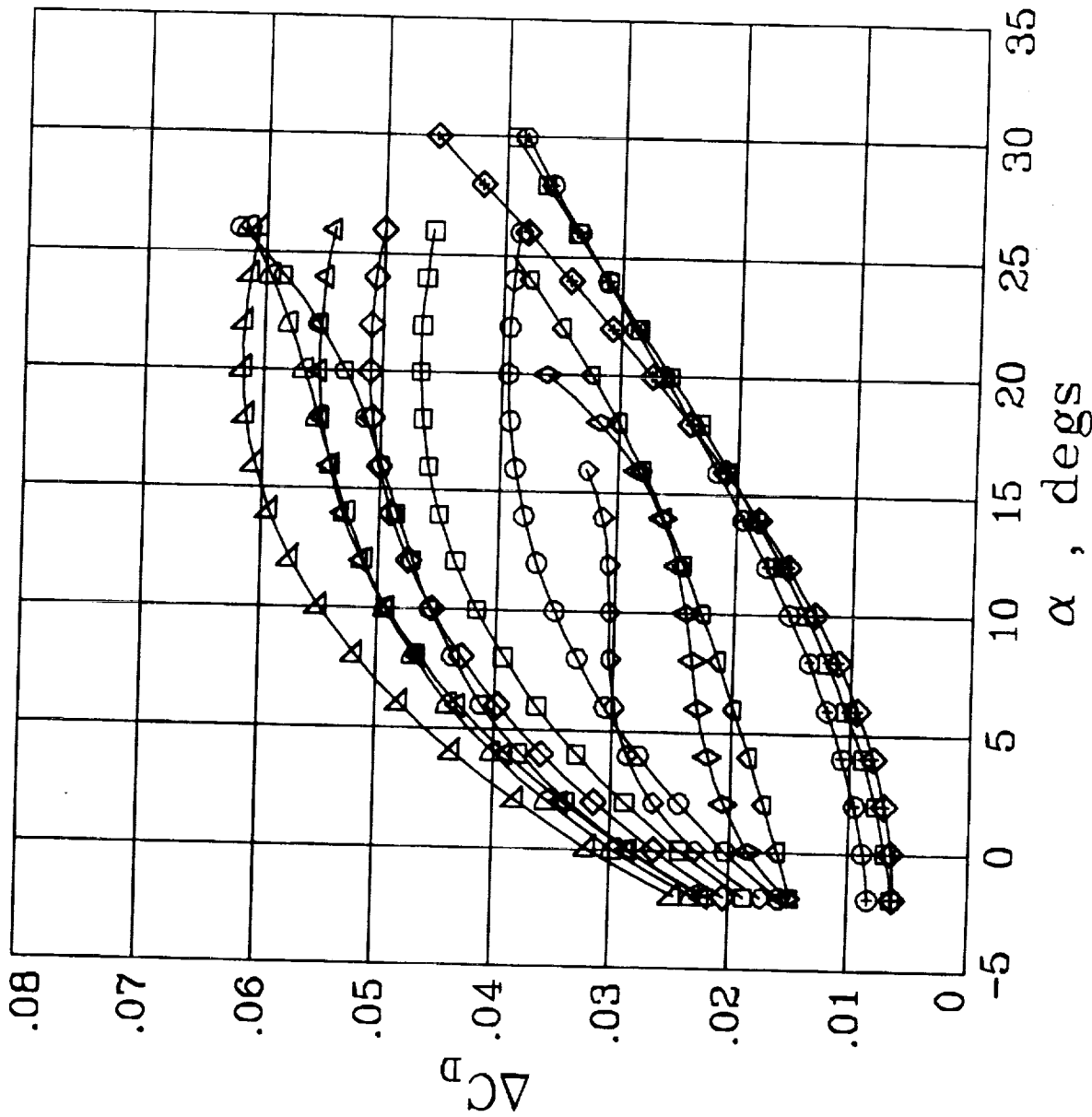

AERO DATA BASE FOR HL-20 FLIGHT SIMULATION STUDIES



LaRC/SSD
JAN. 1991

INCREMENTS DUE TO $\delta_{LLBF} = +45^\circ$

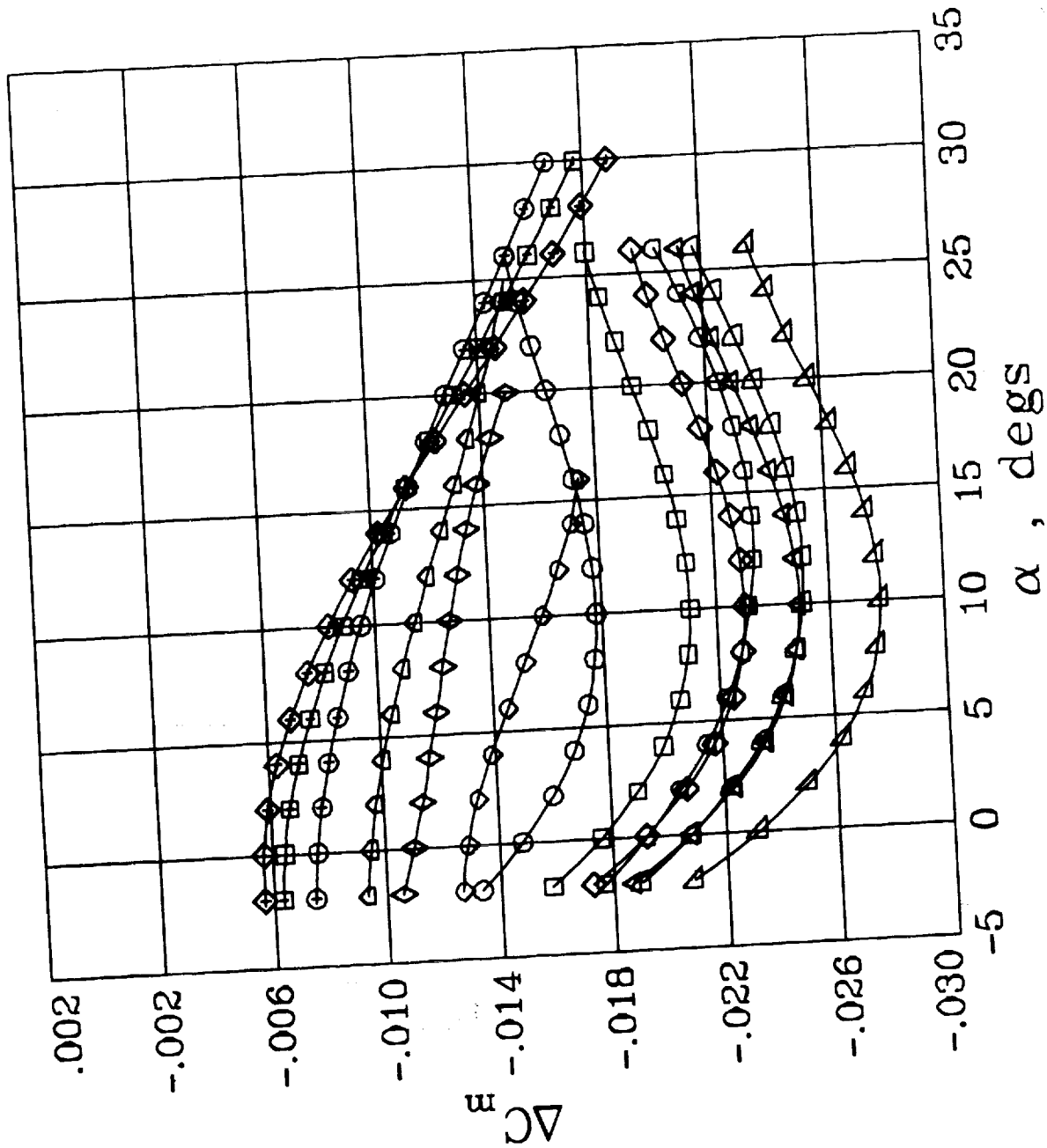

MACH	Symbol
.30	Circle with horizontal line
.60	Square with horizontal line
.80	Diamond with horizontal line
.90	Triangle with horizontal line
.95	Triangle with horizontal line (pointing right)
1.10	Triangle with horizontal line (pointing left)
1.20	Square with horizontal line
1.60	Diamond with horizontal line
2.00	Circle with horizontal line
2.50	Square with horizontal line
3.00	Circle with horizontal line
3.50	Square with horizontal line
4.00	Diamond with horizontal line

AERO DATA BASE FOR HL-20 FLIGHT SIMULATION STUDIES



LaRC/SSD
JAN. 1991

INCREMENTS DUE TO $\delta_{LLBF} = +45^\circ$

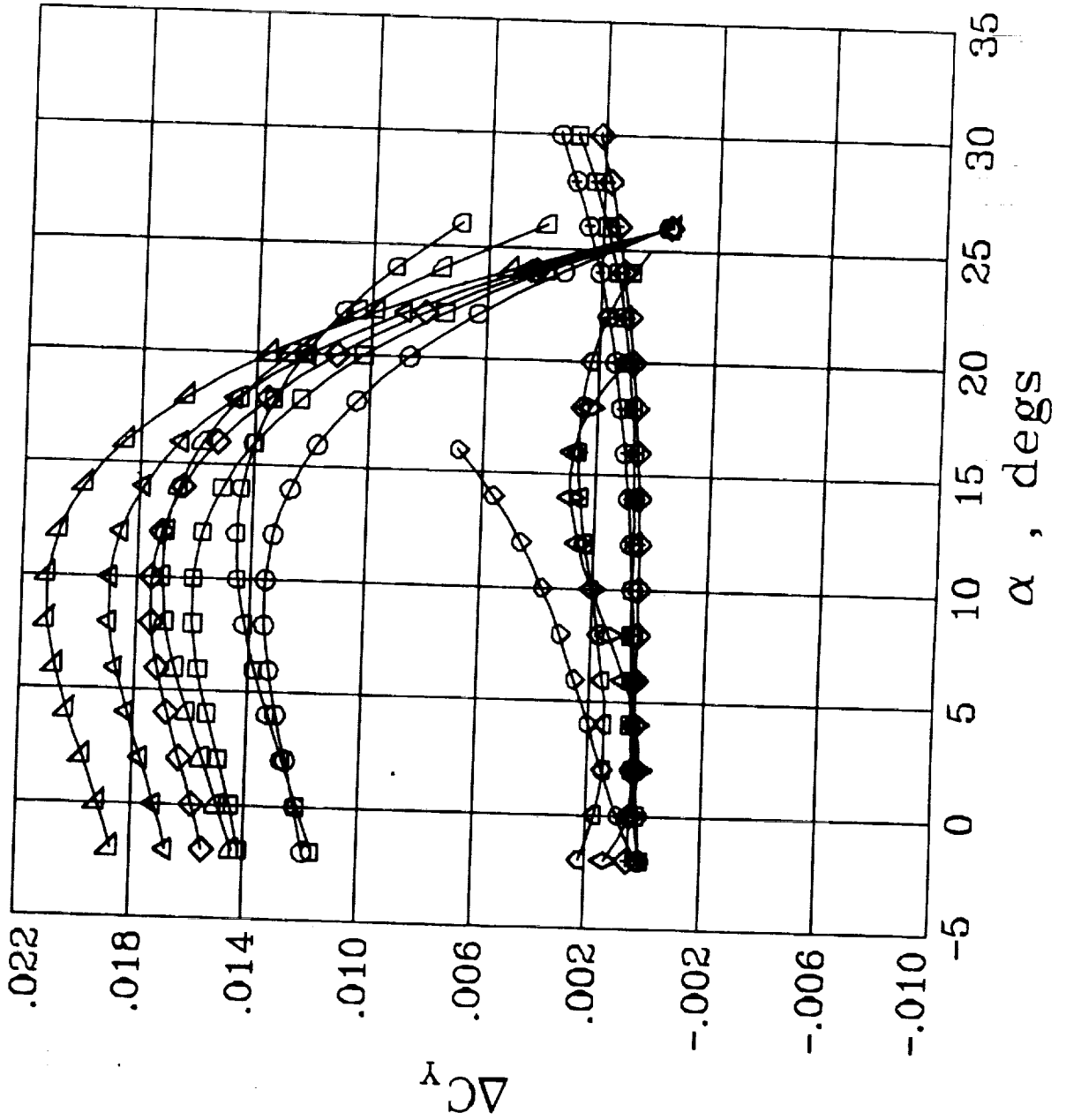

MACH	Symbol
.30	○
.60	□
.80	◇
.90	△
.95	▽
1.10	◻
1.20	◉
1.60	◊
2.00	◻
2.50	◉
3.00	◊
3.50	◻
4.00	◉

AERO DATA BASE FOR HL-20 FLIGHT SIMULATION STUDIES



LaRC/SSD
JAN. 1991

INCREMENTS DUE TO $\delta_{LLBF} = +45^\circ$

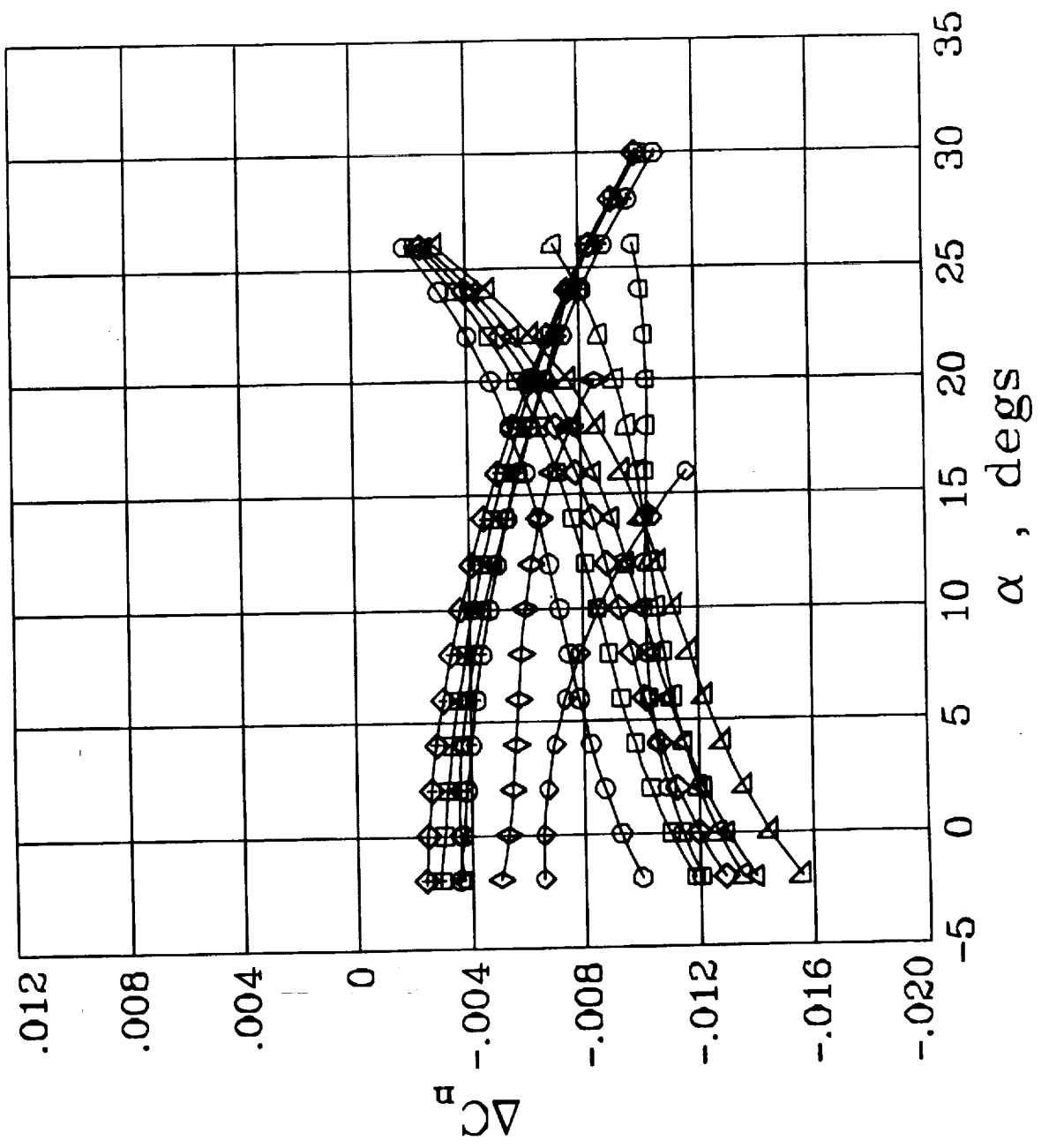

AERO DATA BASE FOR HL-20 FLIGHT SIMULATION STUDIES



LaRC/SSD
JAN. 1991

INCREMENTS DUE TO $\delta_{LLBF} = +45^\circ$

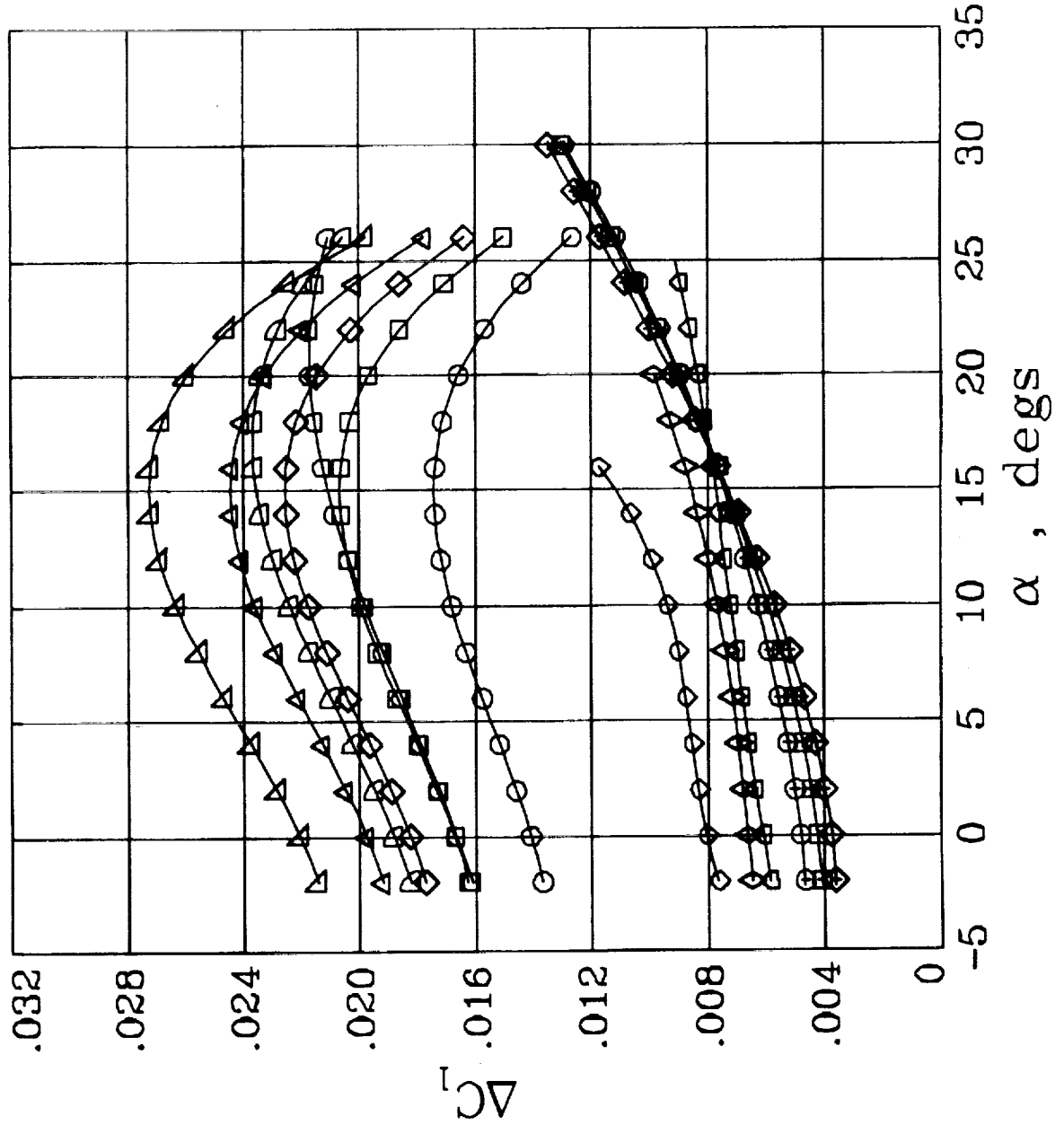

AERO DATA BASE FOR HL-20 FLIGHT SIMULATION STUDIES



LaRC/SSD
JAN. 1991

INCREMENTS DUE TO $\delta_{LBF} = +60^\circ$

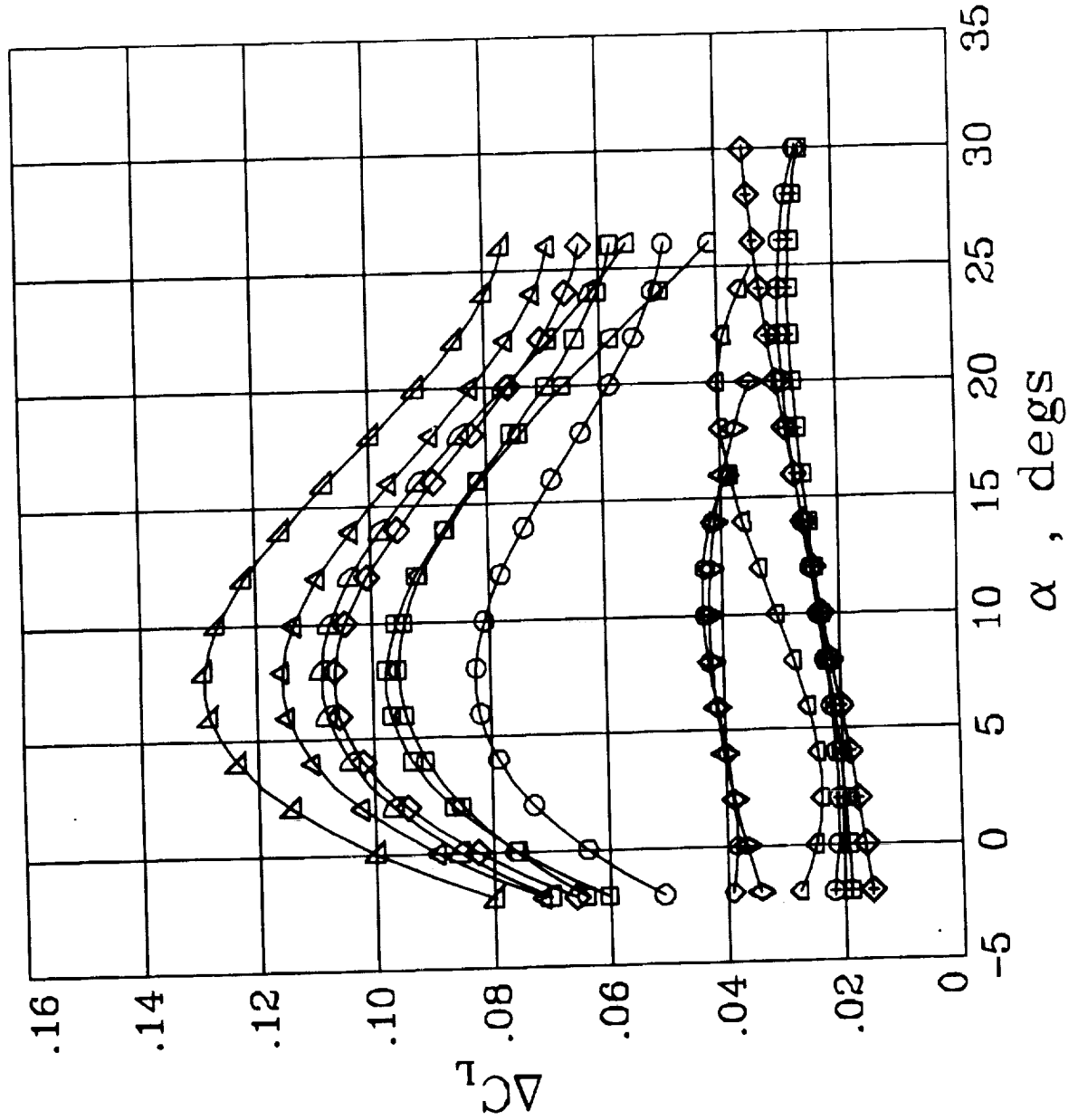

AERO DATA BASE FOR HL-20 FLIGHT SIMULATION STUDIES

INCREMENTS DUE TO $\delta_{LLBF} = +60^\circ$



LaRC/SSD
JAN. 1991

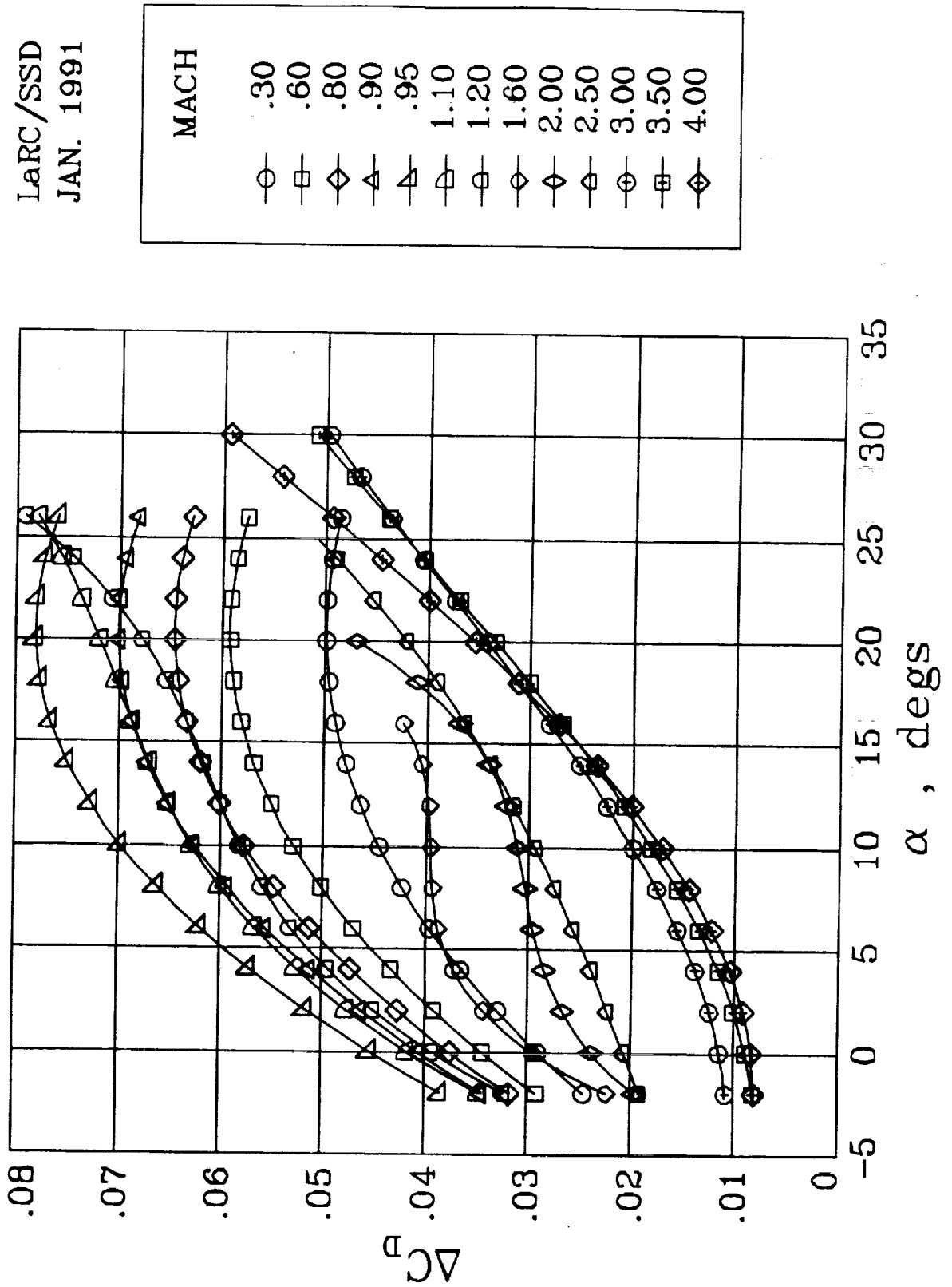

AERO DATA BASE FOR HL-20 FLIGHT SIMULATION STUDIES



LaRC/SSD
JAN. 1991

INCREMENTS DUE TO $\delta_{LLBF} = +60^\circ$

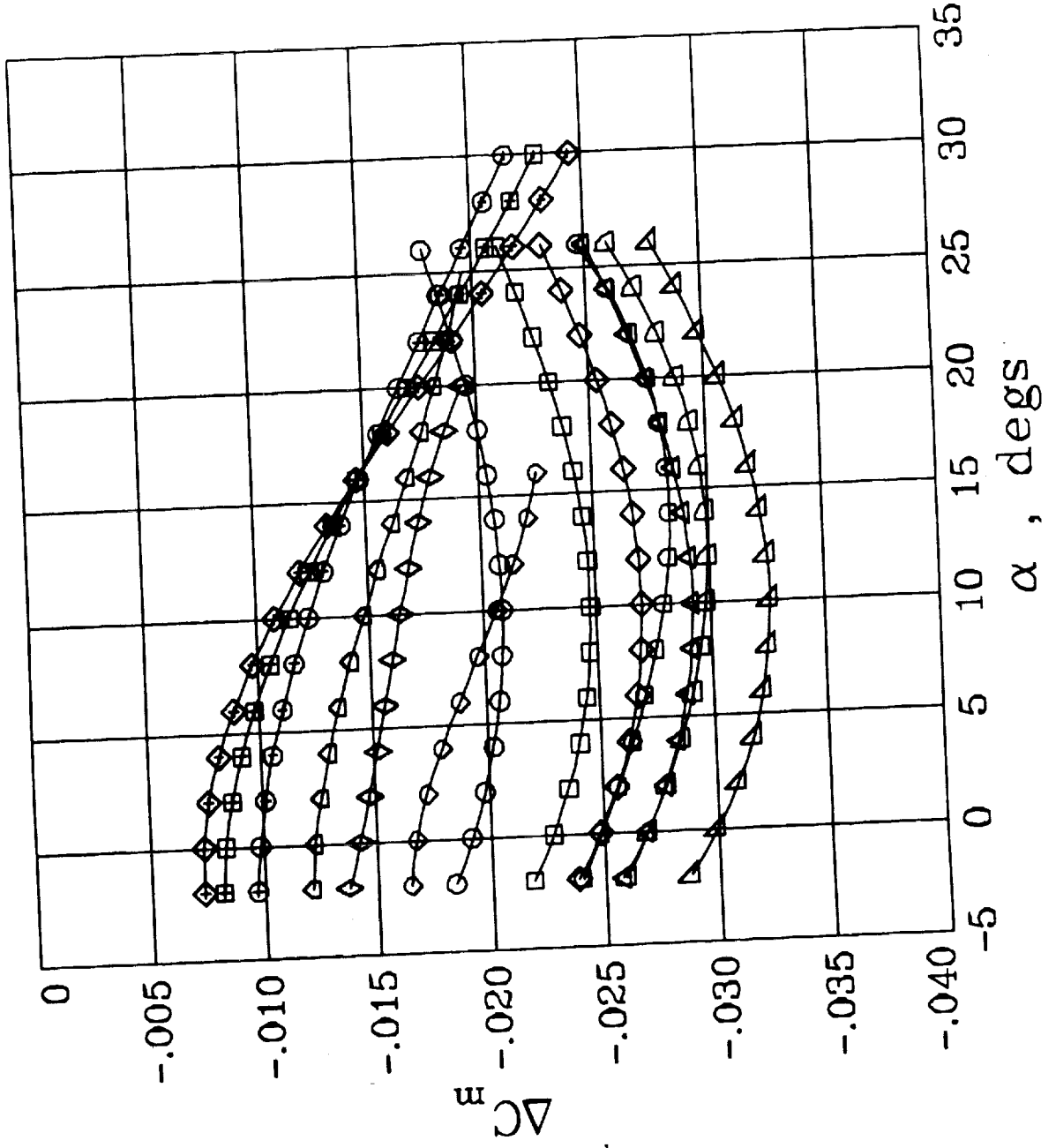

AERO DATA BASE FOR HL-20 FLIGHT SIMULATION STUDIES

INCREMENTS DUE TO $\delta_{LLBF} = +60^\circ$



LaRC/SSD
JAN. 1991

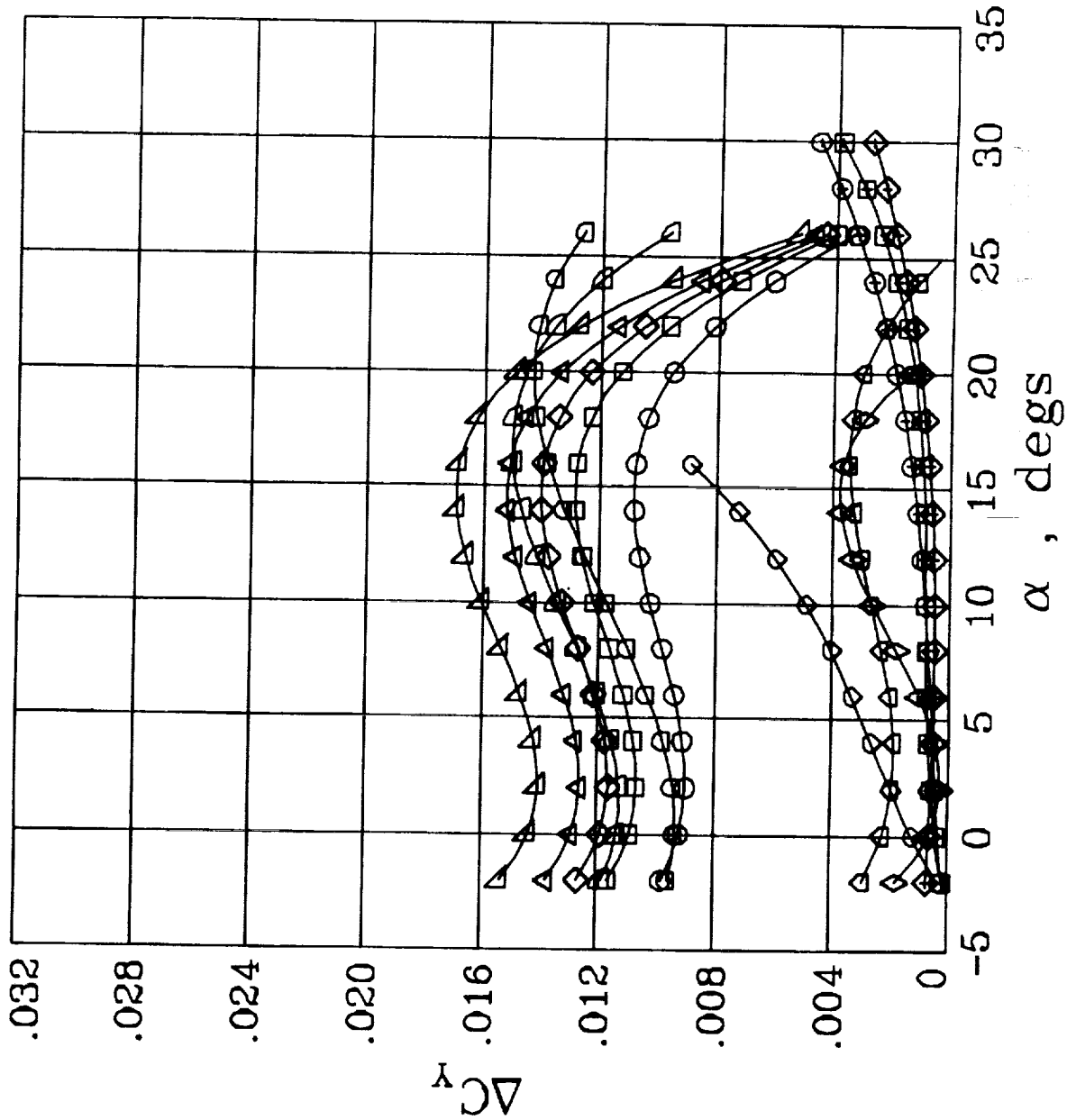

MACH	Symbol
.30	○
.60	□
.80	◇
.90	△
.95	▽
1.10	◁
1.20	▢
1.60	◊
2.00	◈
2.50	⊖
3.00	⊕
3.50	⊗
4.00	⊘

AERO DATA BASE FOR HL-20 FLIGHT SIMULATION STUDIES



LaRC/SSD
JAN. 1991

INCREMENTS DUE TO $\delta_{LLBF} = +60^\circ$

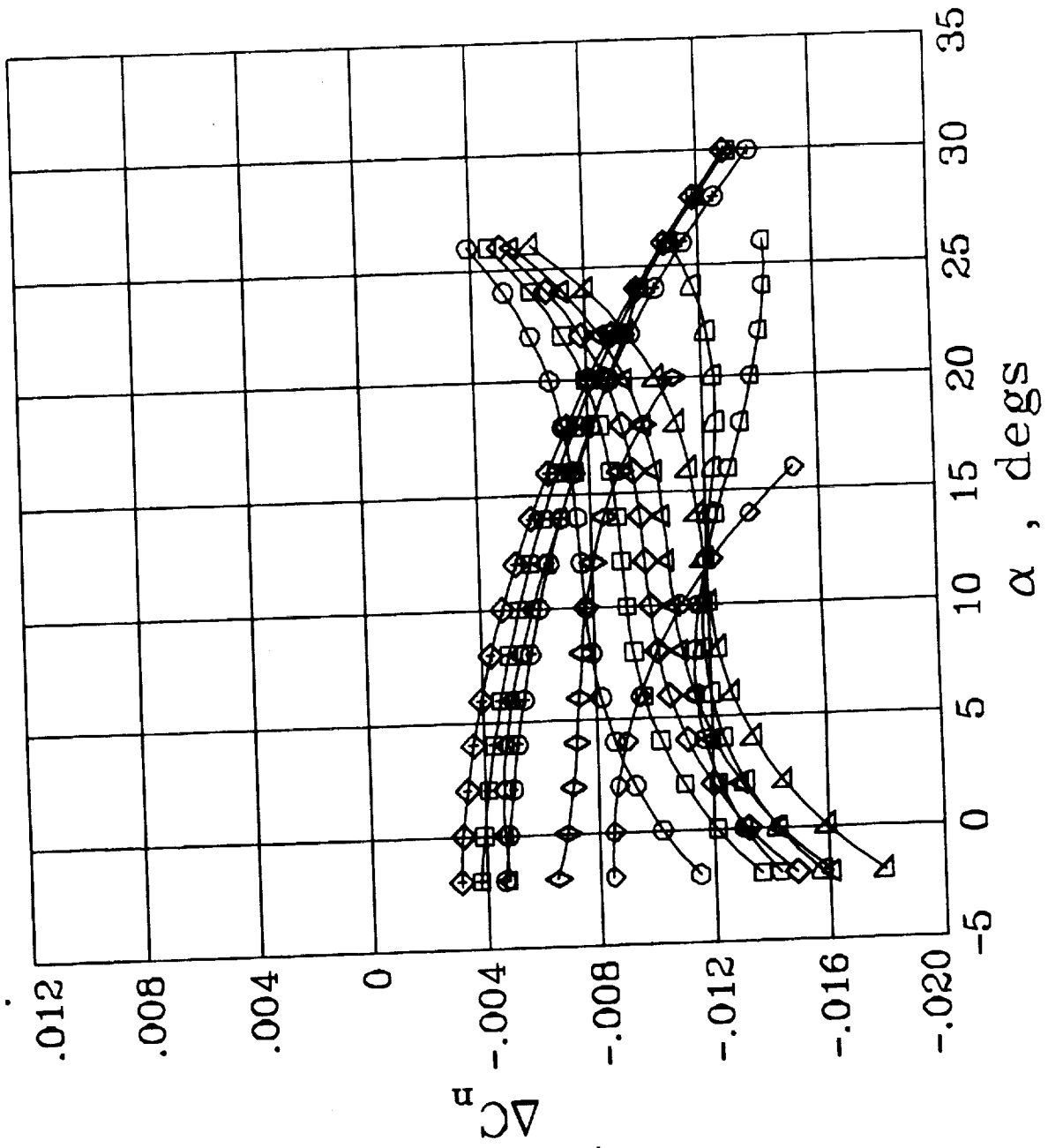

MACH	Symbol
.30	Circle with horizontal line
.60	Square with horizontal line
.80	Diamond with horizontal line
.90	Triangle with horizontal line
.95	Triangle with horizontal line
1.10	Diamond with horizontal line
1.20	Square with horizontal line
1.60	Diamond with horizontal line
2.00	Diamond with horizontal line
2.50	Square with horizontal line
3.00	Square with horizontal line
3.50	Square with horizontal line
4.00	Diamond with horizontal line

AERO DATA BASE FOR HL-20 FLIGHT SIMULATION STUDIES

INCREMENTS DUE TO $\delta_{LLBF} = +60^\circ$



LaRC/SSD
JAN. 1991

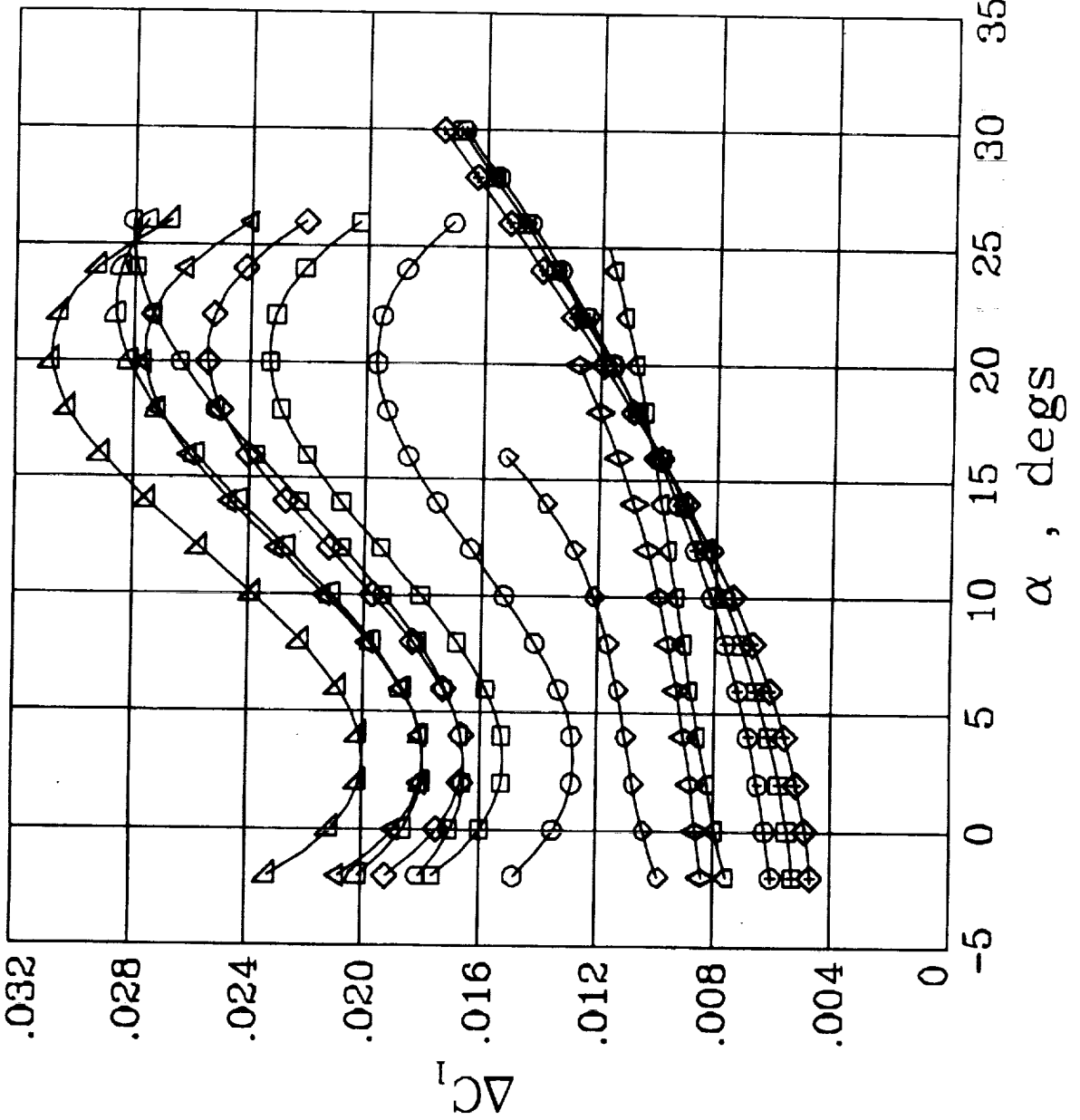

AERO DATA BASE FOR HL-20 FLIGHT SIMULATION STUDIES



LaRC/SSD
JAN. 1991

INCREMENTS DUE TO $\delta_{LE} = -30^\circ$

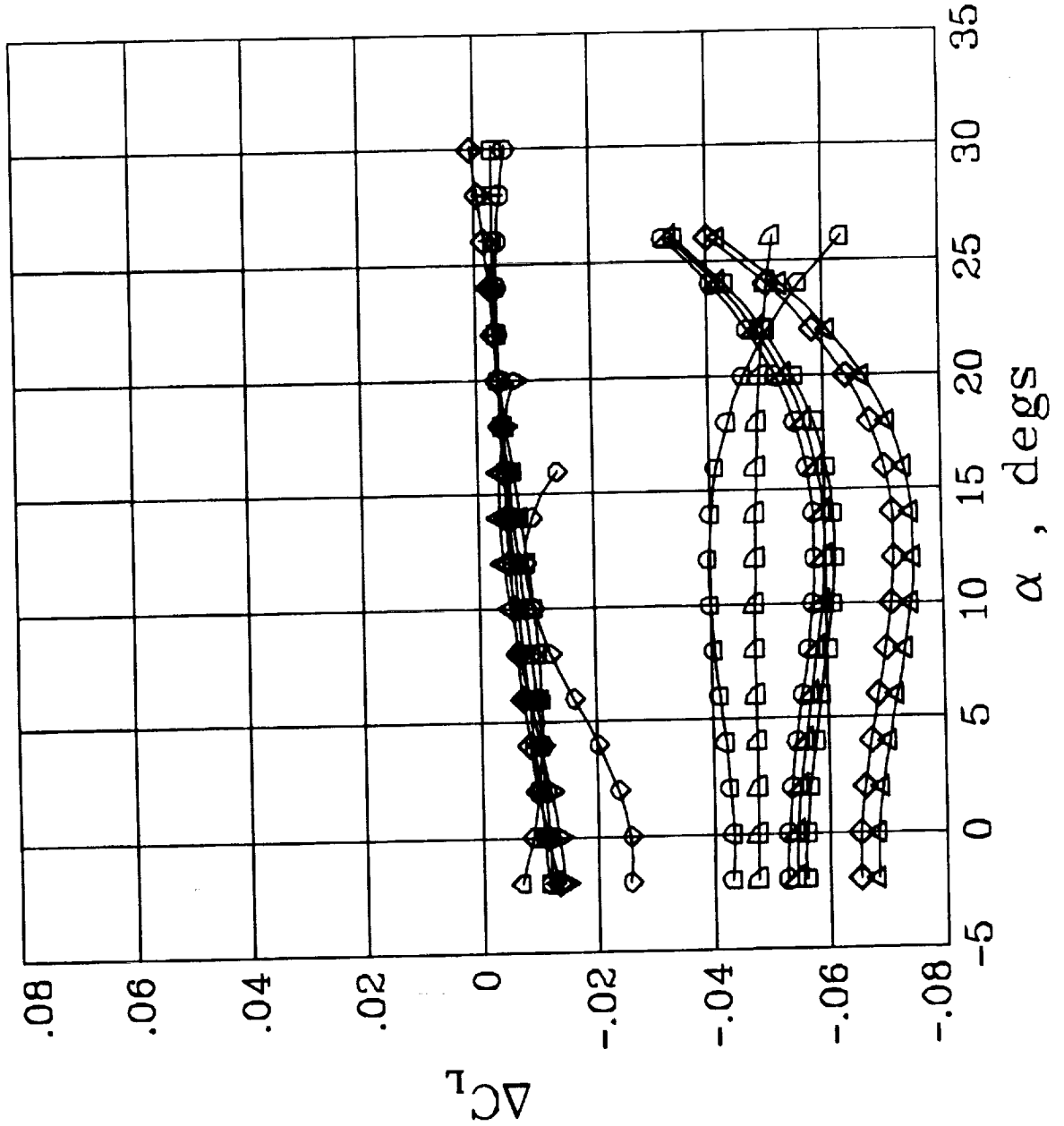

MACH	Symbol
.30	○
.60	□
.80	◇
.90	△
.95	▽
1.10	▽
1.20	⊖
1.60	⊙
2.00	⊕
2.50	⊗
3.00	⊘
3.50	⊙
4.00	⊚

AERO DATA BASE FOR HL-20 FLIGHT SIMULATION STUDIES



LaRC/SSD
 JAN. 1991

INCREMENTS DUE TO $\delta_{LE} = -30^\circ$

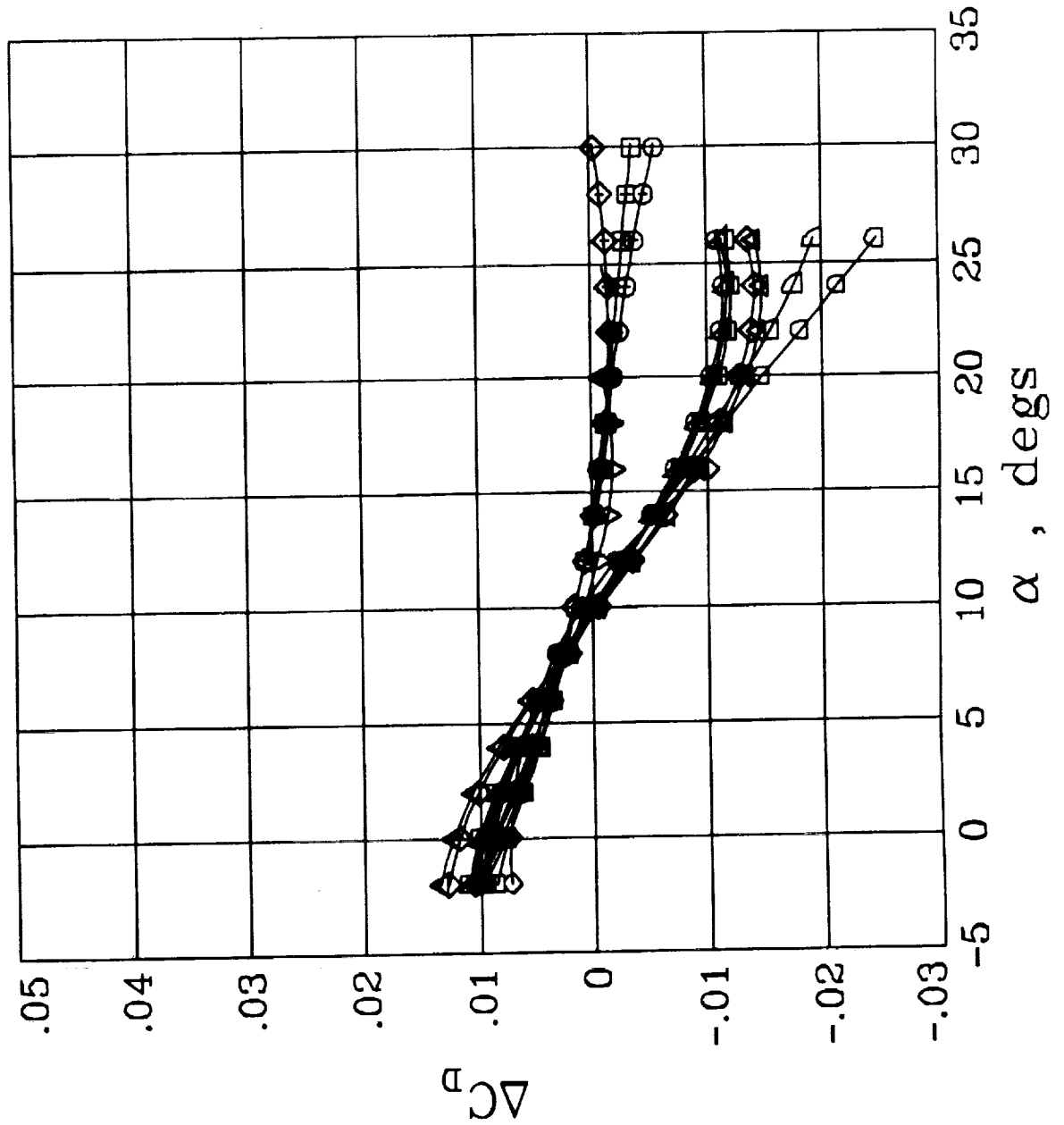

MACH	Symbol
.30	○
.60	□
.80	◇
.90	△
.95	▽
1.10	◻
1.20	◐
1.60	◑
2.00	◒
2.50	◓
3.00	◔
3.50	◕
4.00	◖

AERO DATA BASE FOR HL-20 FLIGHT SIMULATION STUDIES



LaRC/SSD
JAN. 1991

INCREMENTS DUE TO $\delta_{LE} = -30^\circ$

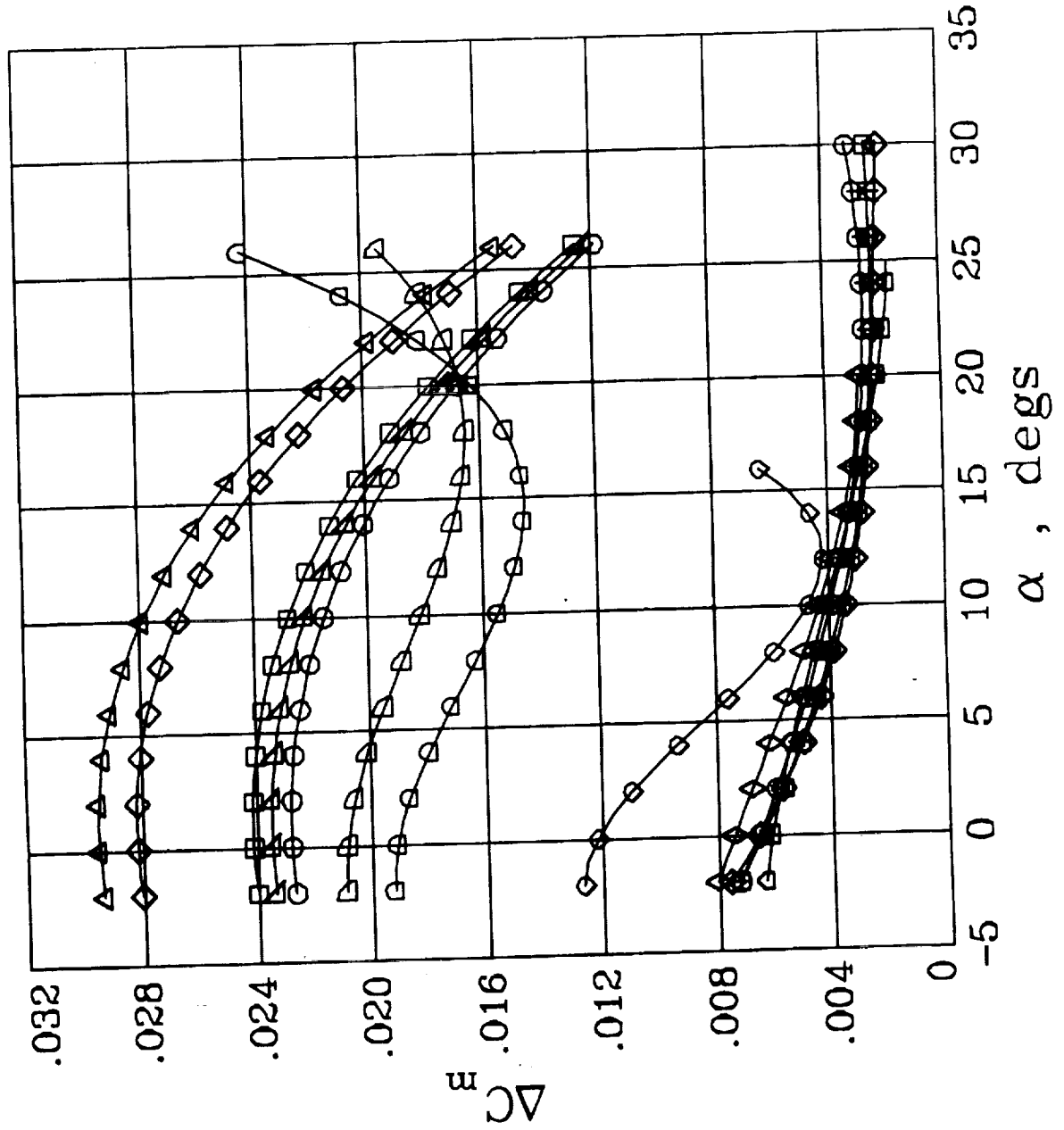

AERO DATA BASE FOR HL-20 FLIGHT SIMULATION STUDIES



LaRC/SSD
JAN. 1991

INCREMENTS DUE TO $\delta_{LE} = -30^\circ$

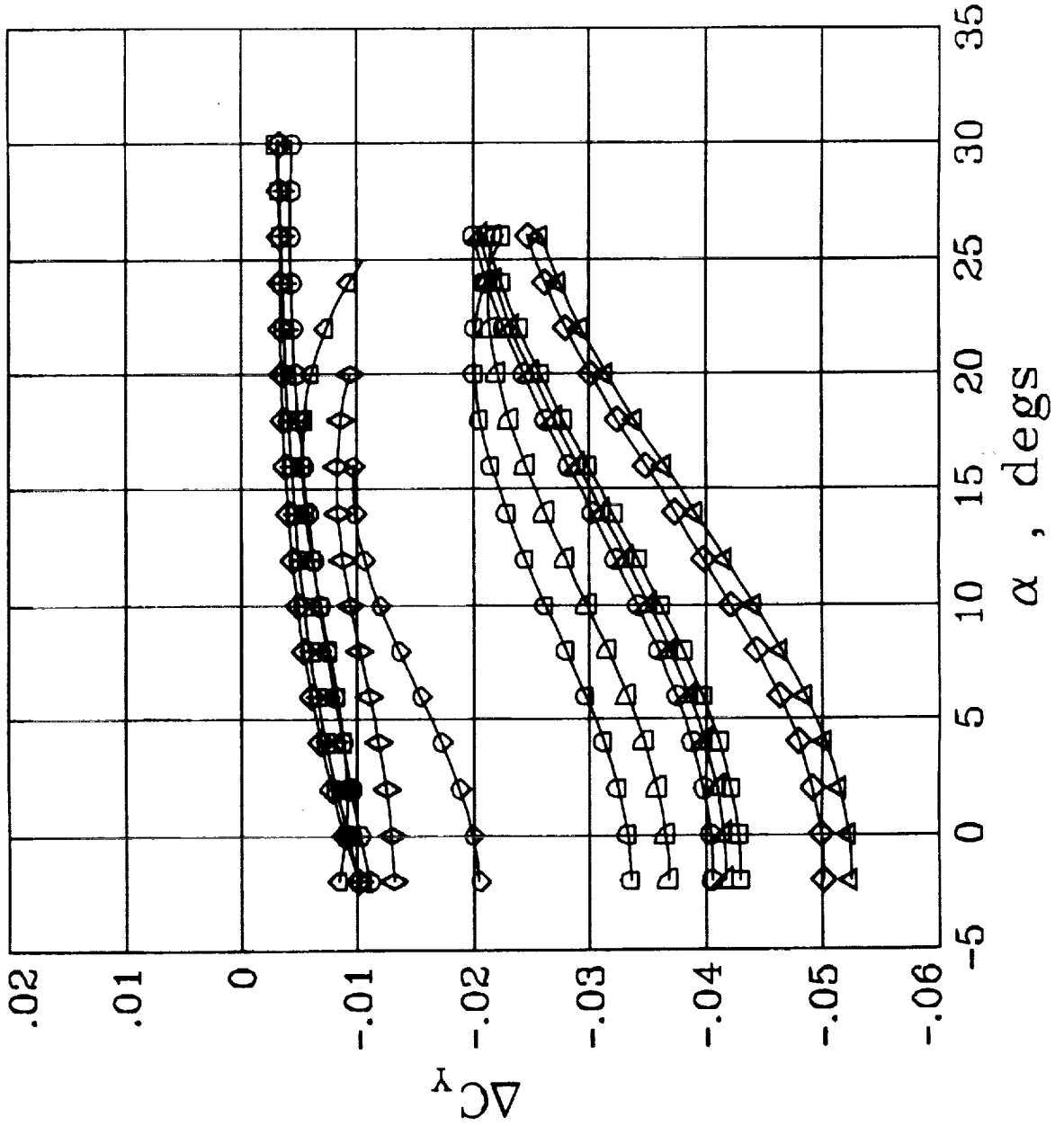

AERO DATA BASE FOR HL-20 FLIGHT SIMULATION STUDIES



LaRC/SSD
JAN. 1991

INCREMENTS DUE TO $\delta_{LE} = -30^\circ$

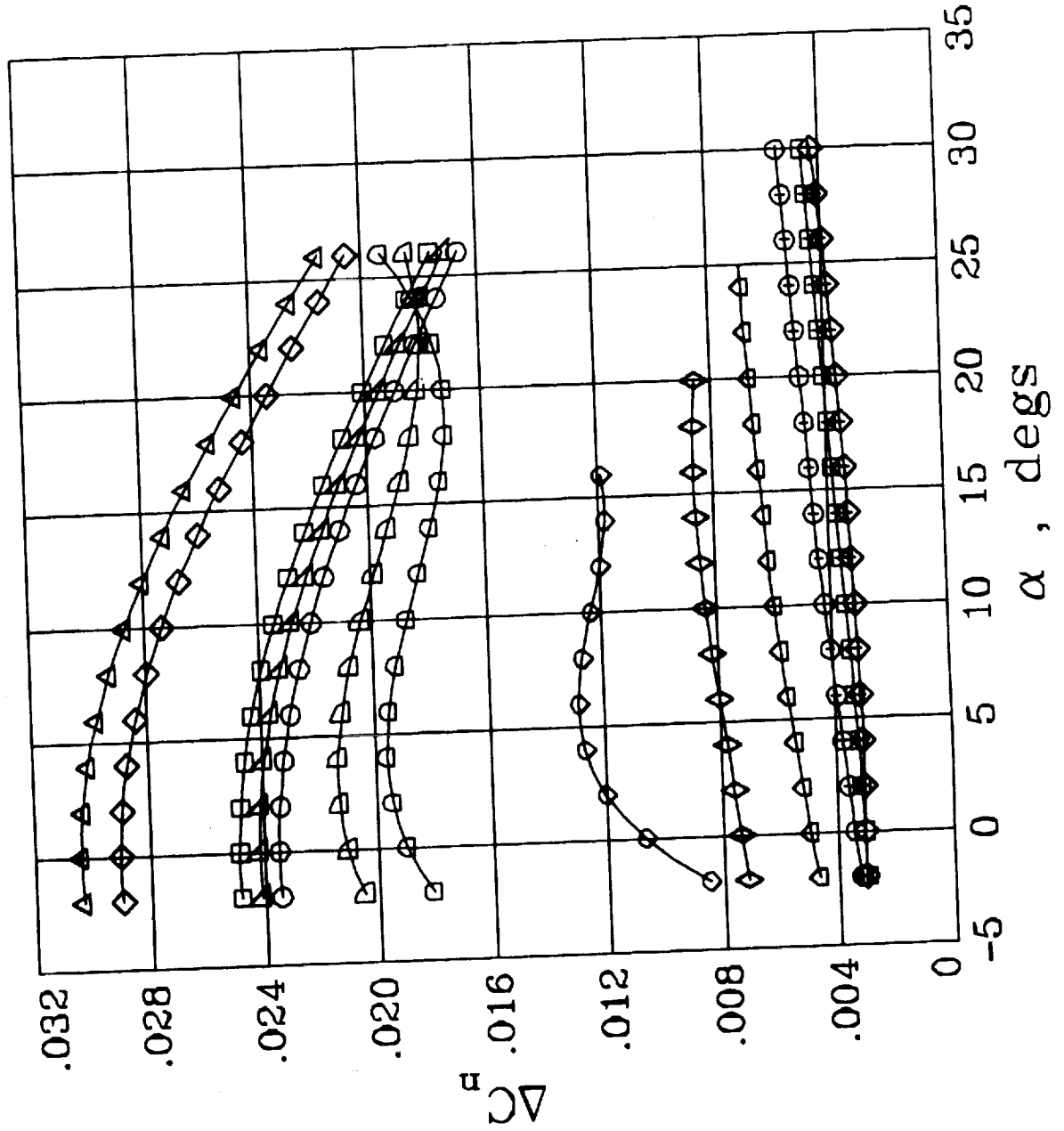

AERO DATA BASE FOR HL-20 FLIGHT SIMULATION STUDIES

INCREMENTS DUE TO $\delta_{LE} = -30^\circ$



LaRC/SSD
JAN. 1991

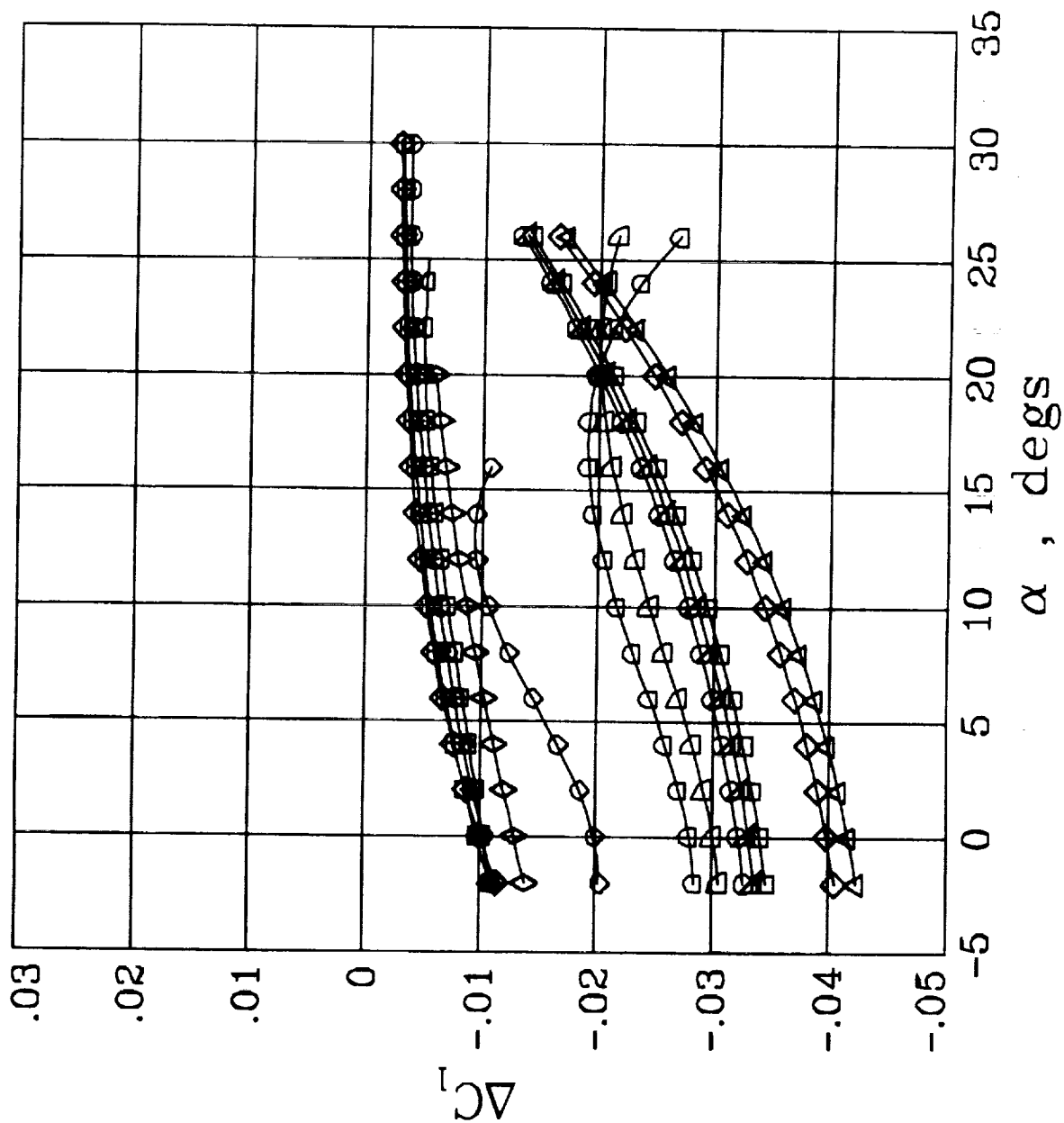

AERO DATA BASE FOR HL-20 FLIGHT SIMULATION STUDIES



LaRC/SSD
JAN. 1991

INCREMENTS DUE TO $\delta_{LE} = -15^\circ$

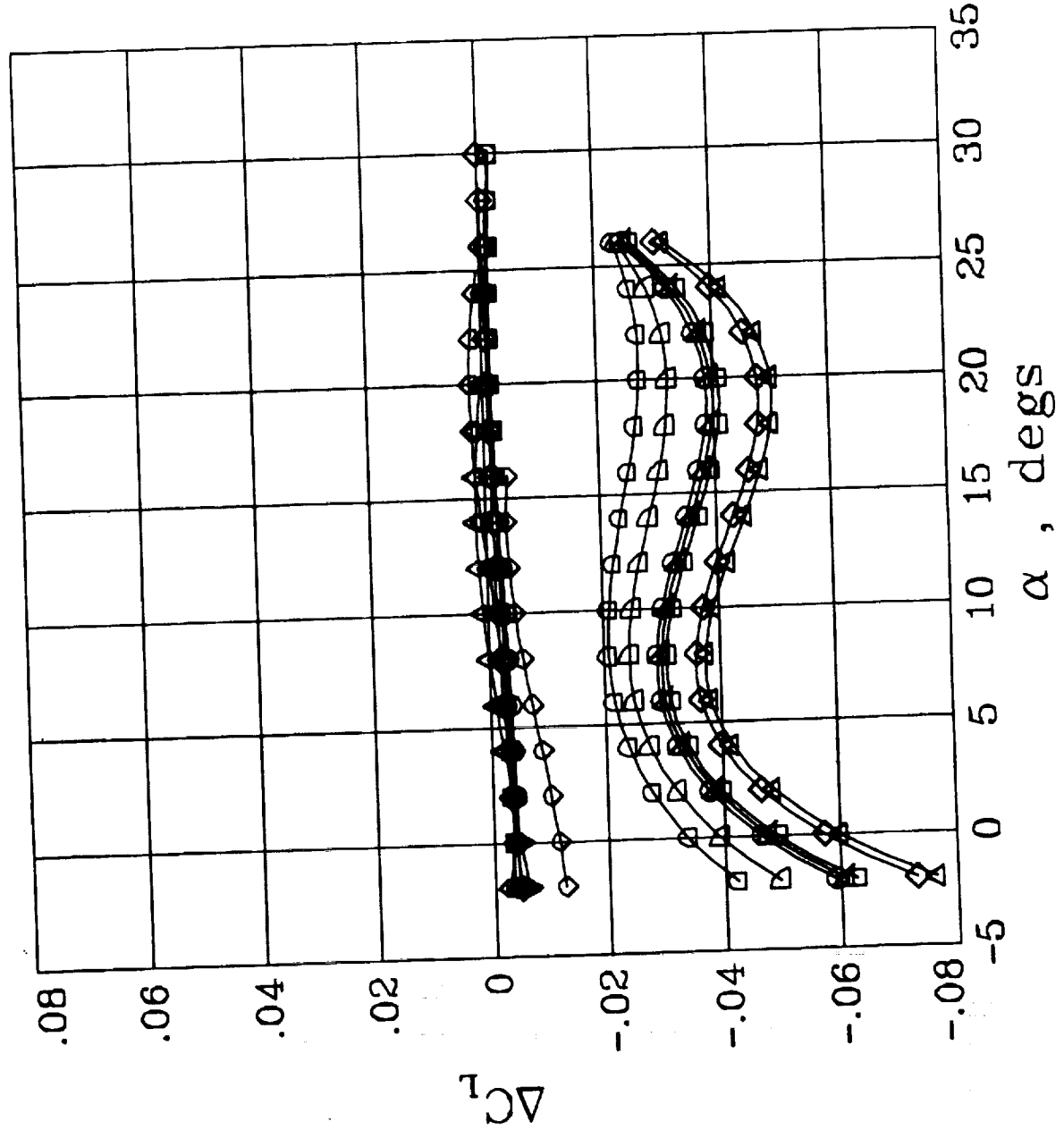

AERO DATA BASE FOR HL-20 FLIGHT SIMULATION STUDIES

INCREMENTS DUE TO $\delta_{LE} = -15^\circ$



LaRC/SSD
JAN. 1991

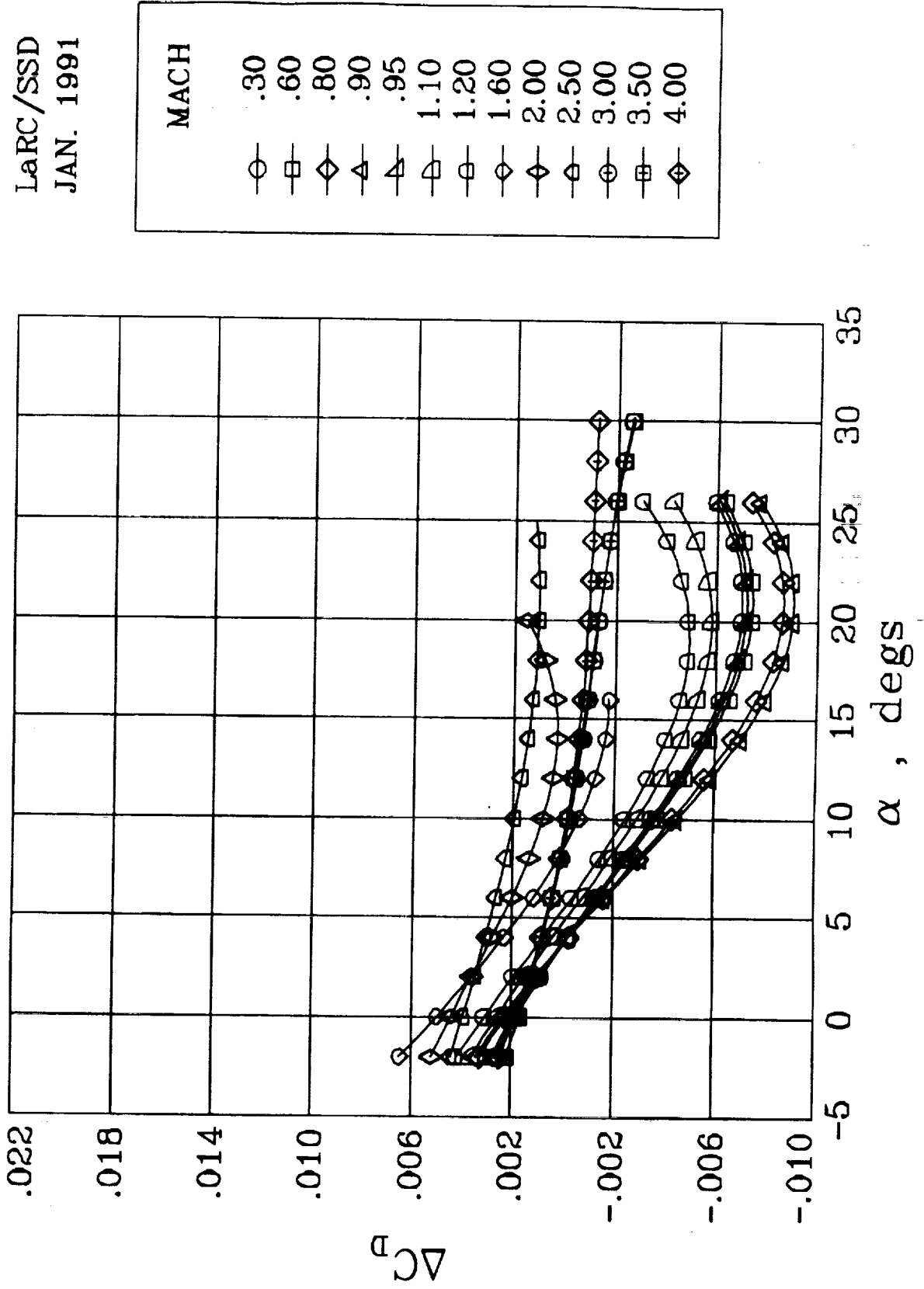

AERO DATA BASE FOR HL-20 FLIGHT SIMULATION STUDIES



LaRC/SSD
JAN. 1991

INCREMENTS DUE TO $\delta_{LE} = -15^\circ$

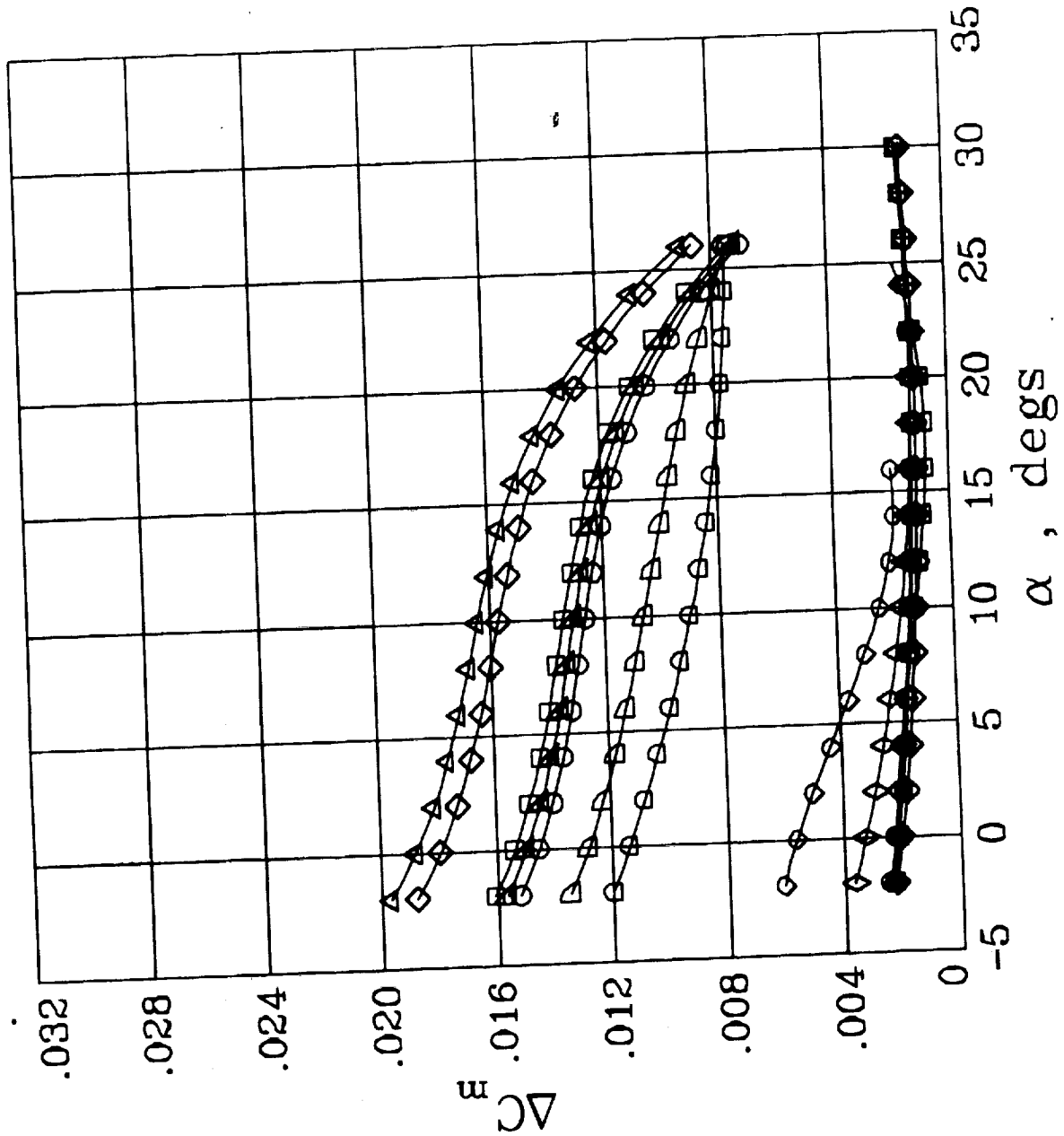

AERO DATA BASE FOR HL-20 FLIGHT SIMULATION STUDIES

INCREMENTS DUE TO $\delta_{LE} = -15^\circ$



LaRC/SSD
JAN. 1991

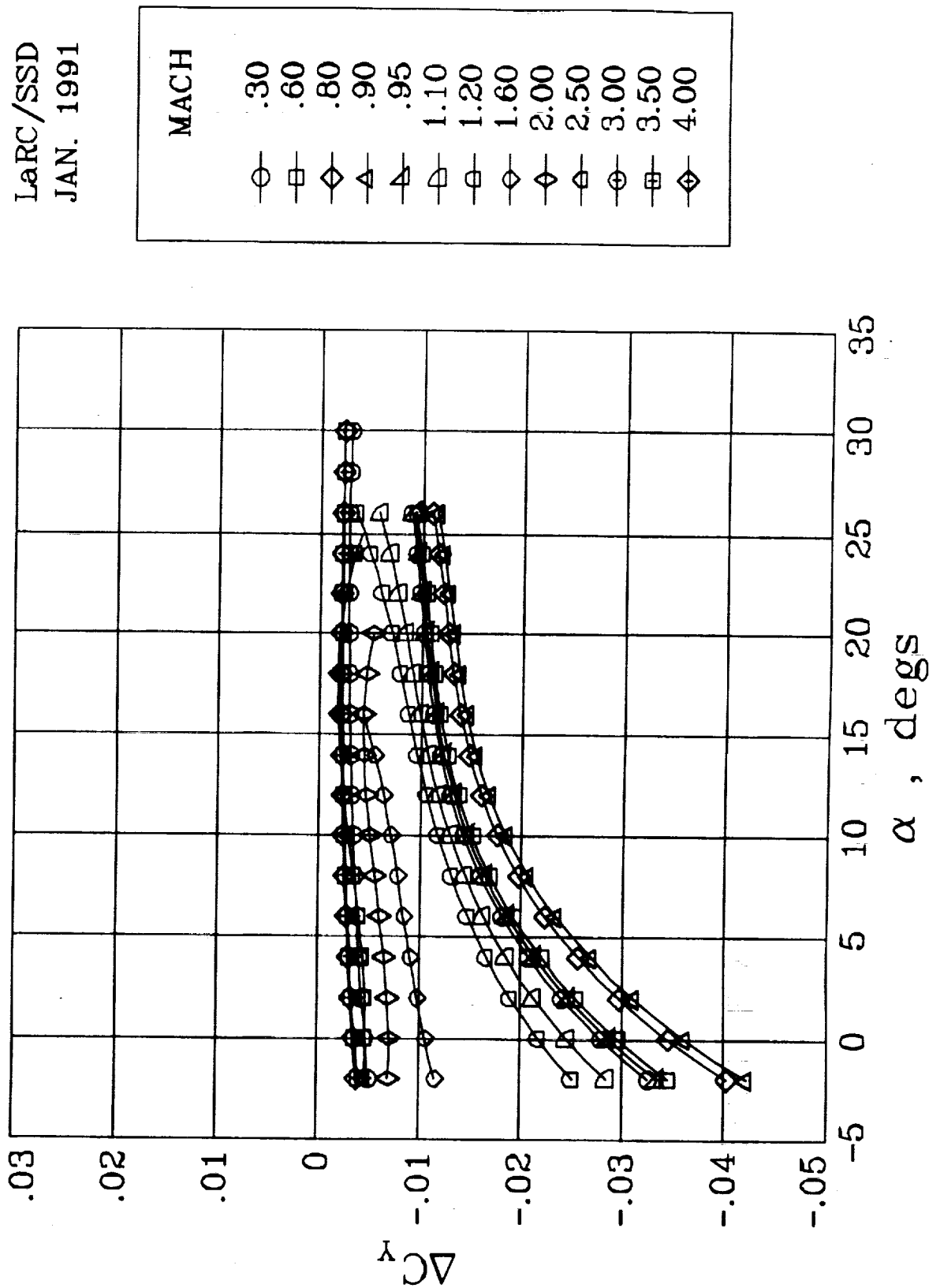

AERO DATA BASE FOR HL-20 FLIGHT SIMULATION STUDIES



LaRC/SSD
JAN. 1991

INCREMENTS DUE TO $\delta_{LE} = -15^\circ$

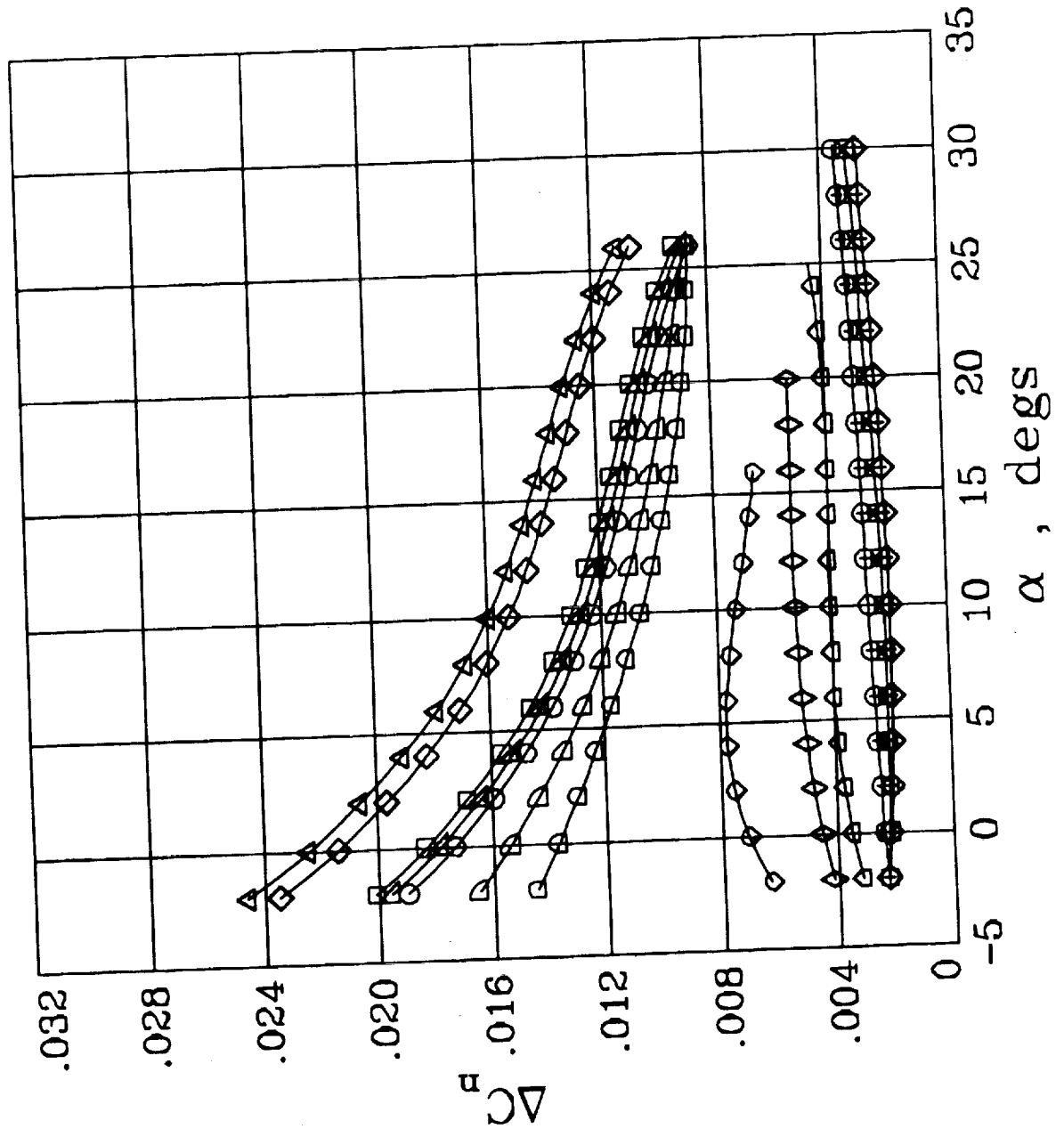

AERO DATA BASE FOR HL-20 FLIGHT SIMULATION STUDIES

INCREMENTS DUE TO $\delta_{LE} = -15^\circ$



LaRC/SSD
JAN. 1991

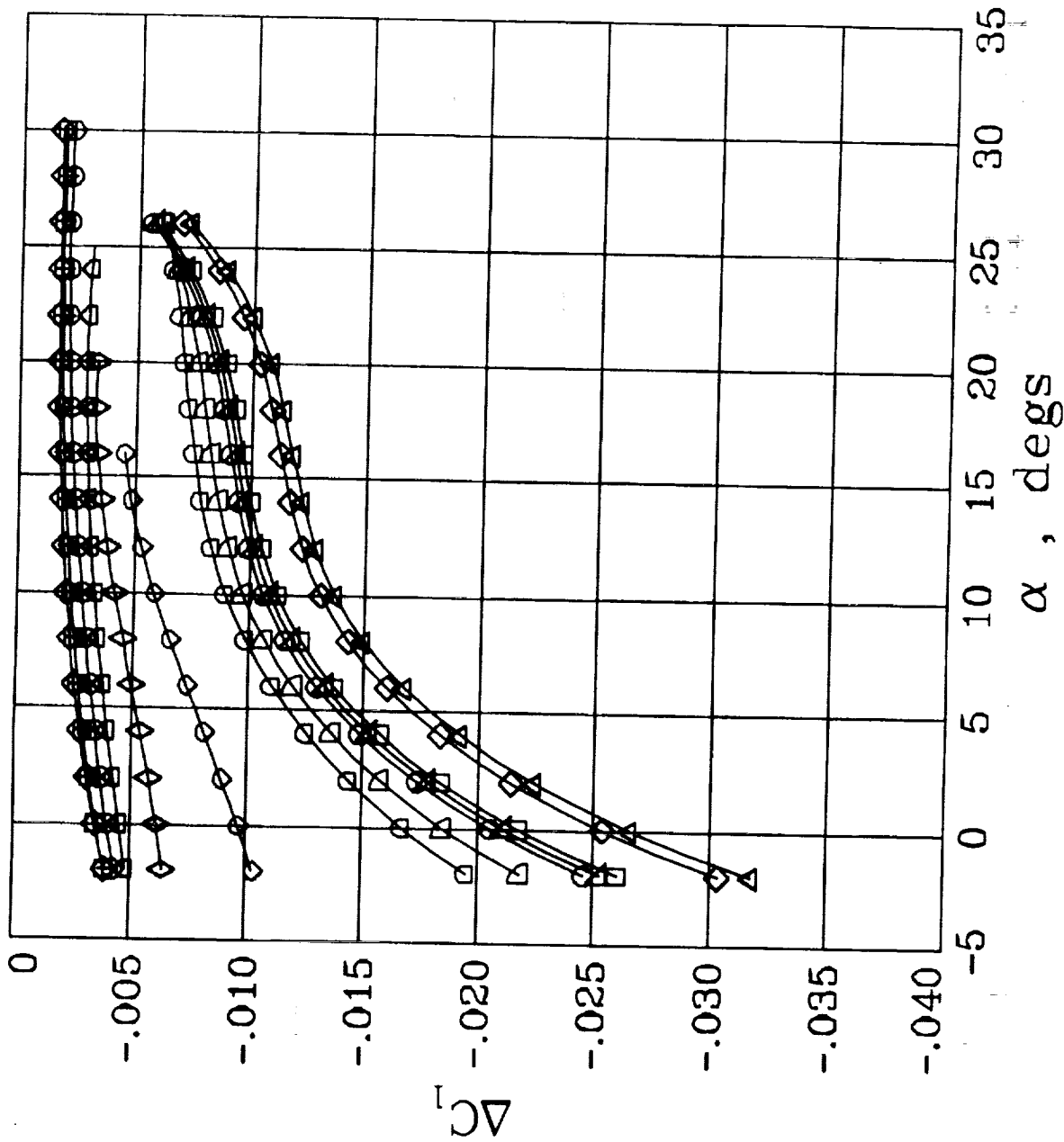

MACH	Symbol
.30	○
.60	□
.80	◇
.90	△
.95	▽
1.10	◻
1.20	◼
1.60	◊
2.00	◈
2.50	◉
3.00	◊
3.50	◈
4.00	◉

AERO DATA BASE FOR HL-20 FLIGHT SIMULATION STUDIES



LaRC/SSD
JAN. 1991

INCREMENTS DUE TO $\delta_{LE} = +15^\circ$

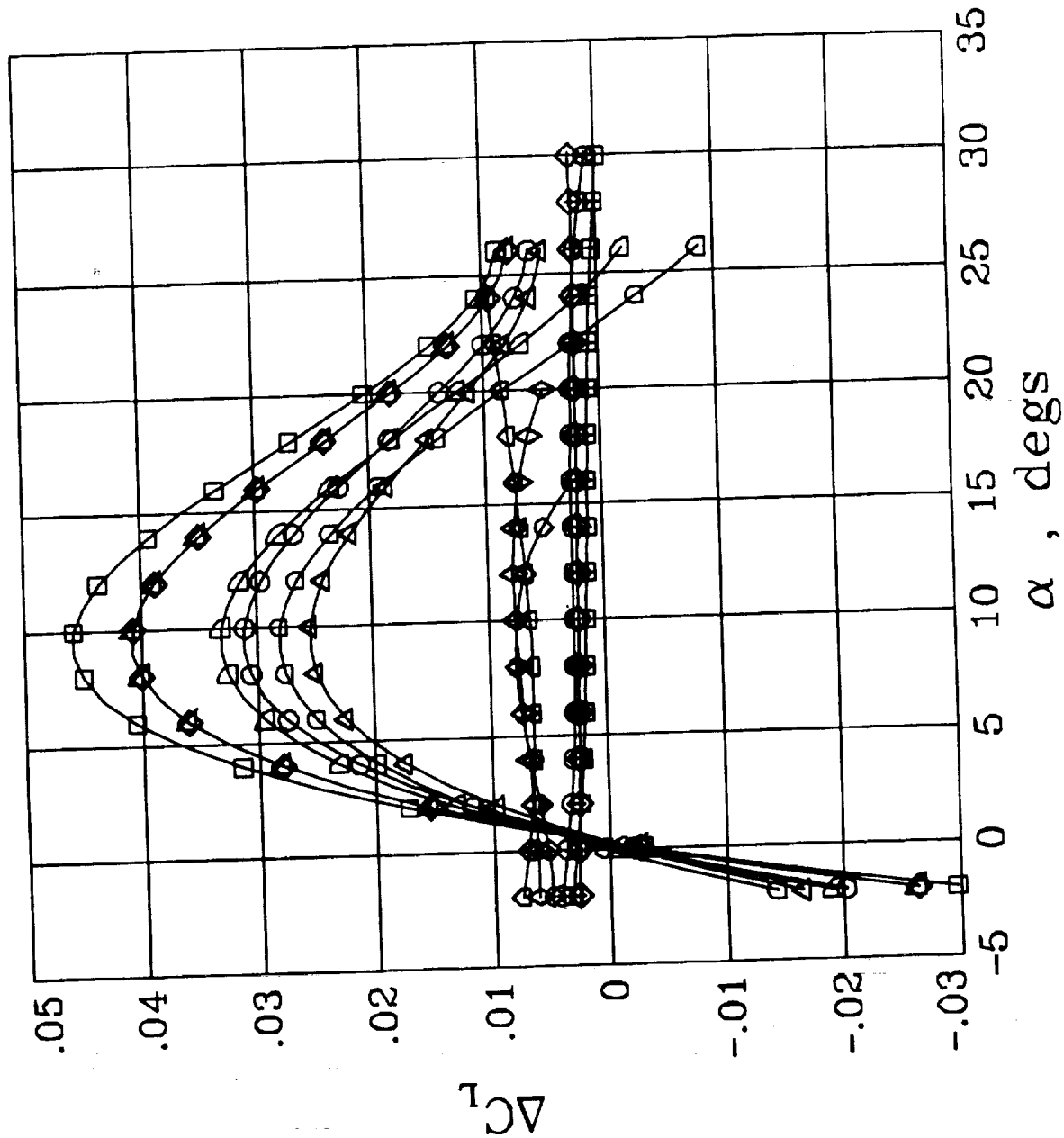

AERO DATA BASE FOR HL-20 FLIGHT SIMULATION STUDIES

INCREMENTS DUE TO $\delta_{LE} = +15^\circ$



LaRC/SSD
JAN. 1991

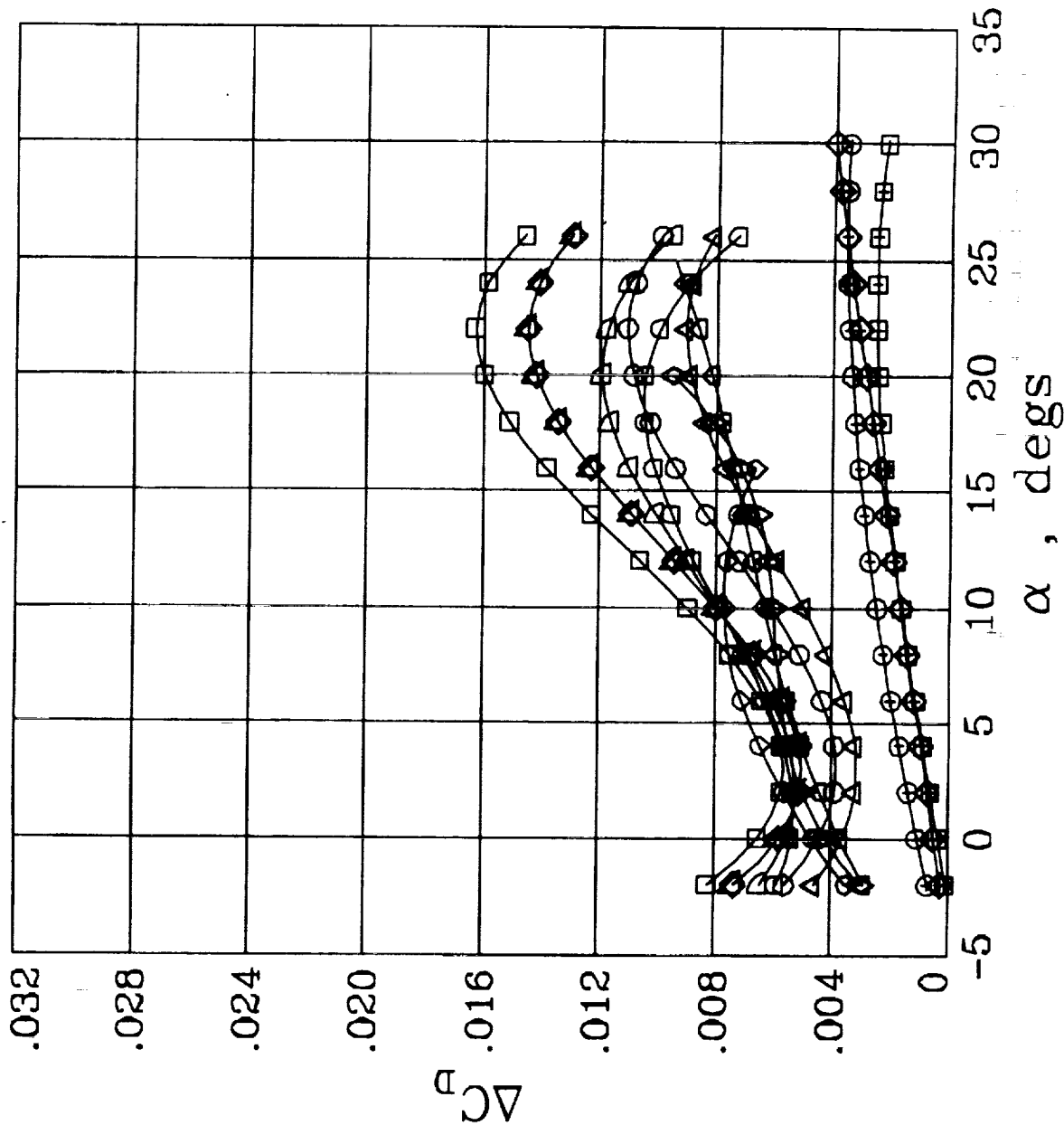

AERO DATA BASE FOR HL-20 FLIGHT SIMULATION STUDIES



LaRC/SSD
JAN. 1991

INCREMENTS DUE TO $\delta_{LE} = +15^\circ$

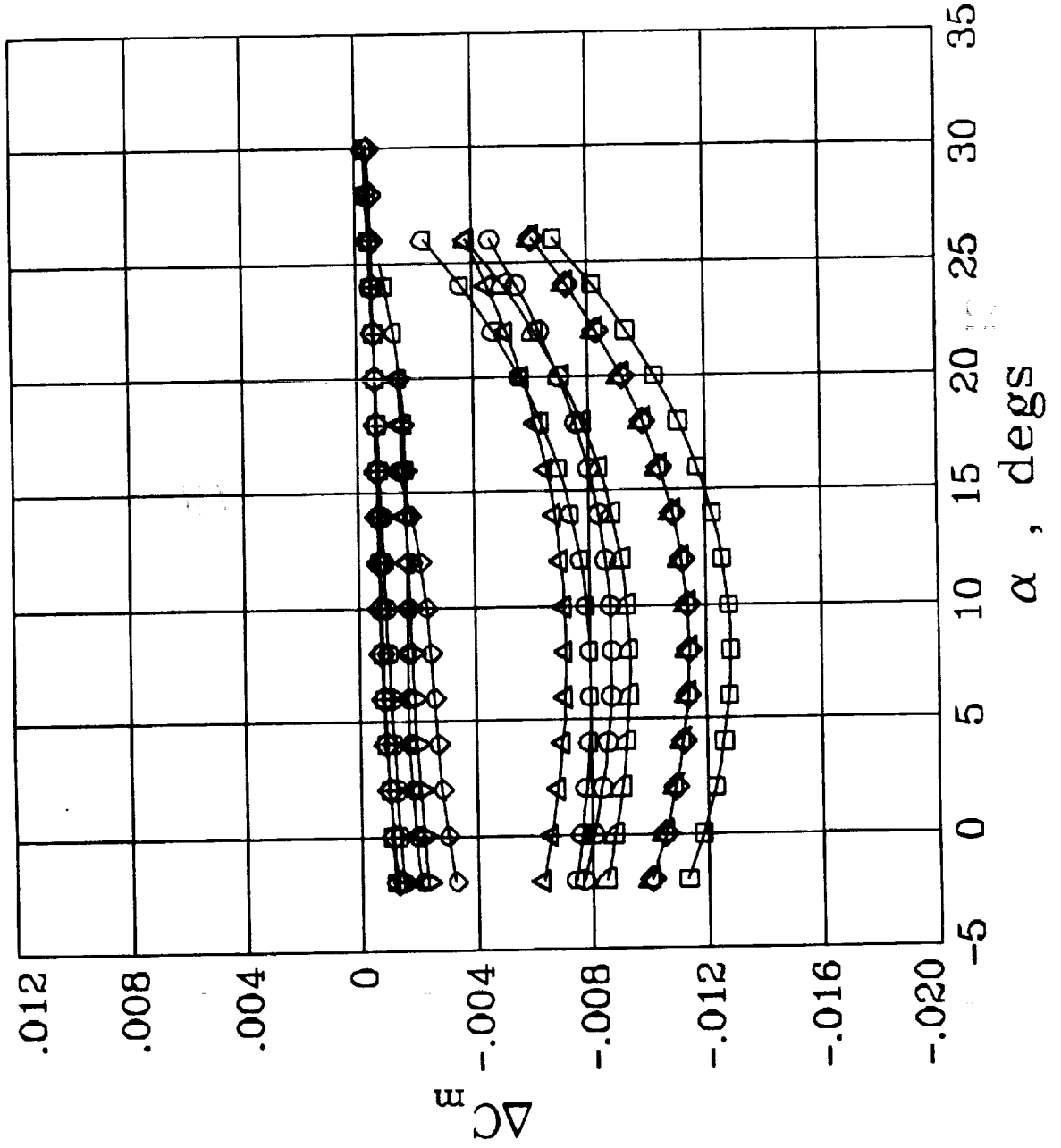

AERO DATA BASE FOR HL-20 FLIGHT SIMULATION STUDIES



LaRC/SSD
JAN. 1991

INCREMENTS DUE TO $\delta_{LE} = +15^\circ$

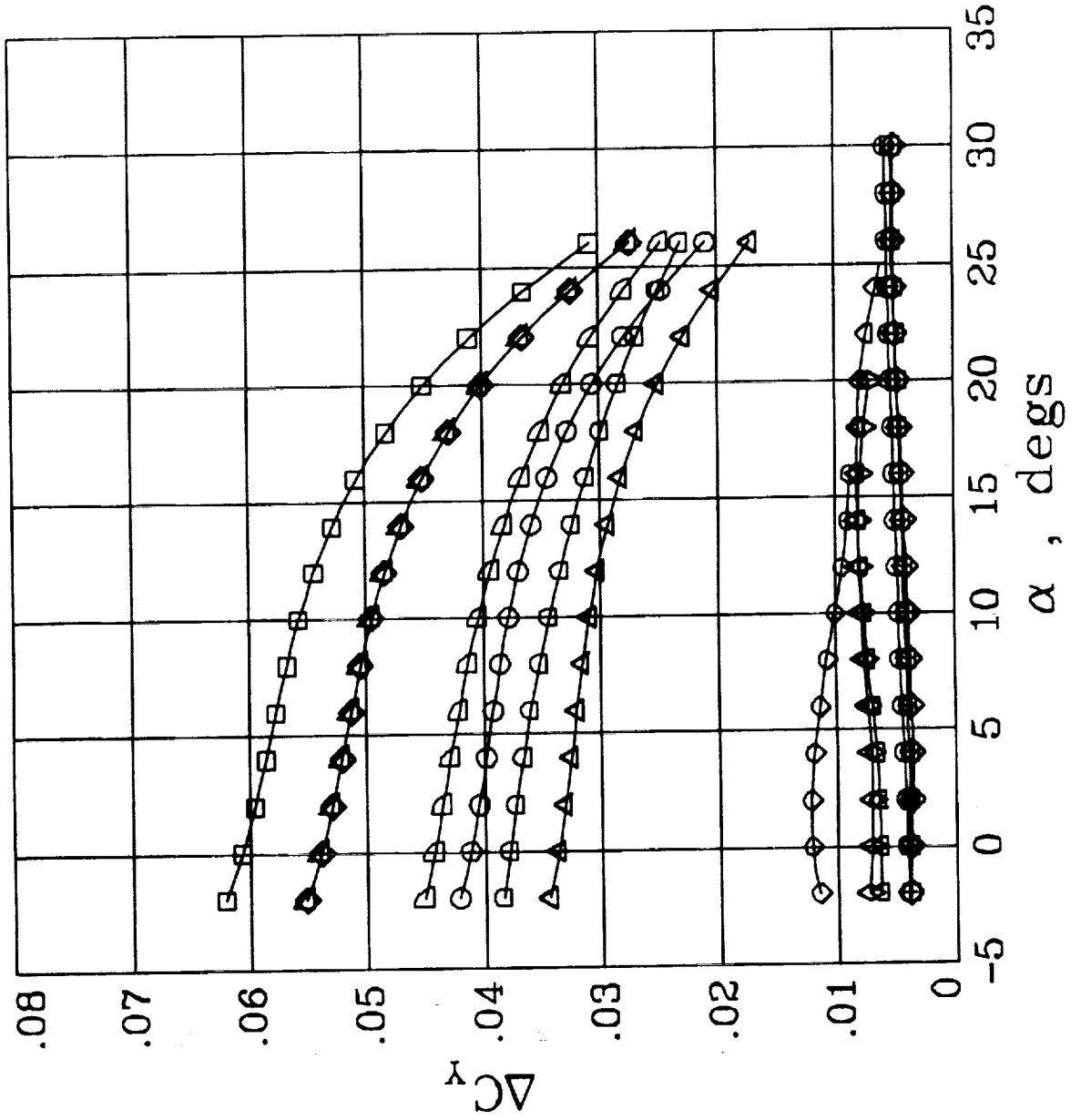

AERO DATA BASE FOR HL-20 FLIGHT SIMULATION STUDIES



LaRC/SSD
JAN. 1991

INCREMENTS DUE TO $\delta_{LE} = +15^\circ$

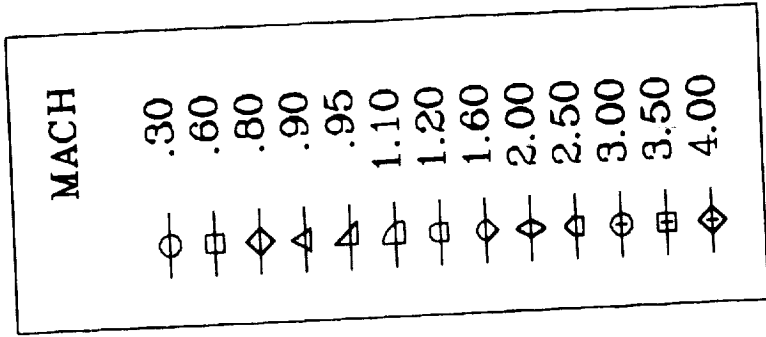
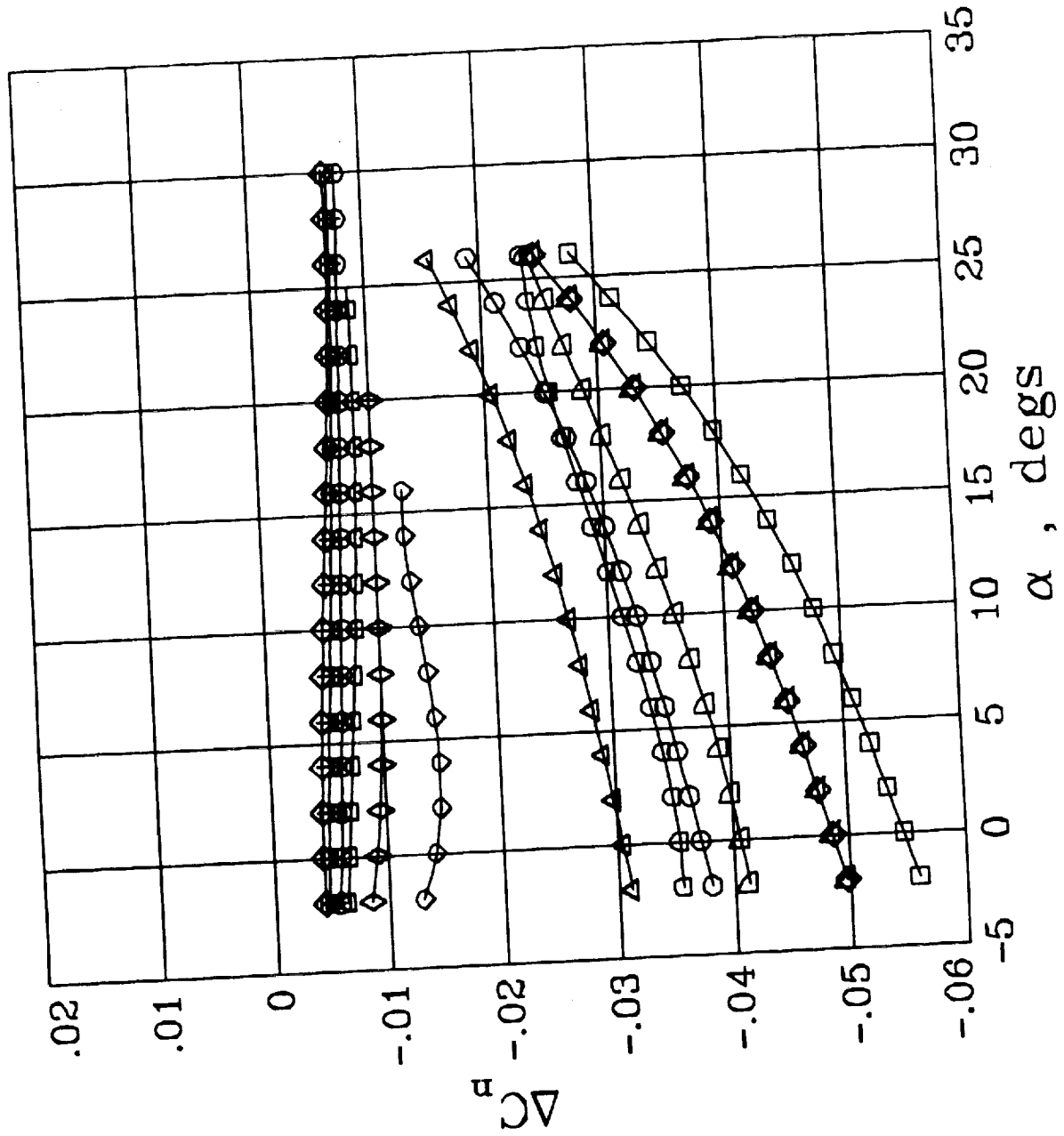

AERO DATA BASE FOR HL-20 FLIGHT SIMULATION STUDIES

INCREMENTS DUE TO $\delta_{LE} = +15^\circ$



LaRC/SSD
JAN. 1991

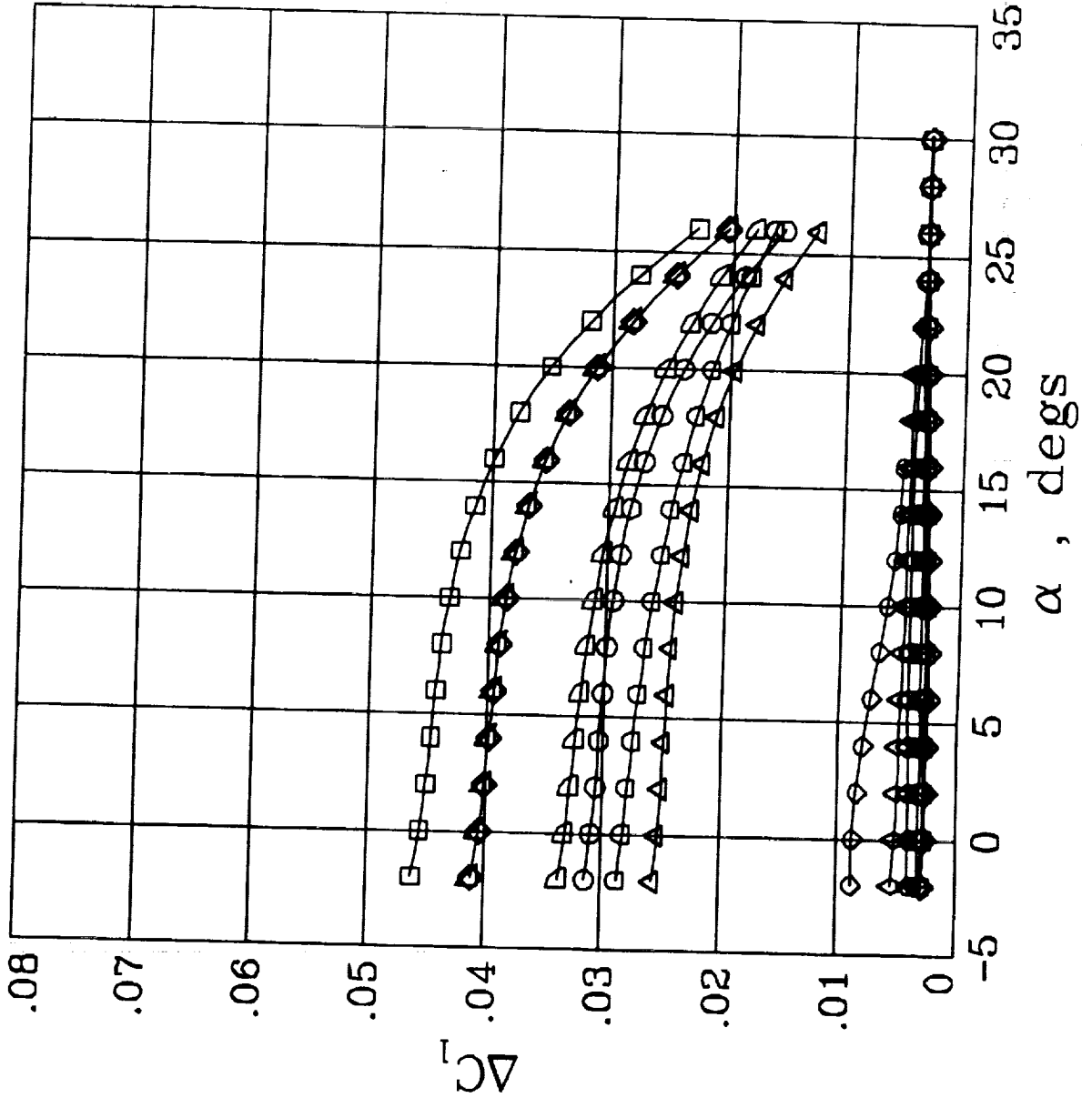

MACH	
○	.30
□	.60
◇	.80
△	.90
▽	.95
◇	1.10
○	1.20
◇	1.60
◇	2.00
○	2.50
○	3.00
□	3.50
◇	4.00

AERO DATA BASE FOR HL-20 FLIGHT SIMULATION STUDIES



LaRC/SSD
JAN. 1991

INCREMENTS DUE TO $\delta_{LE} = +30^\circ$

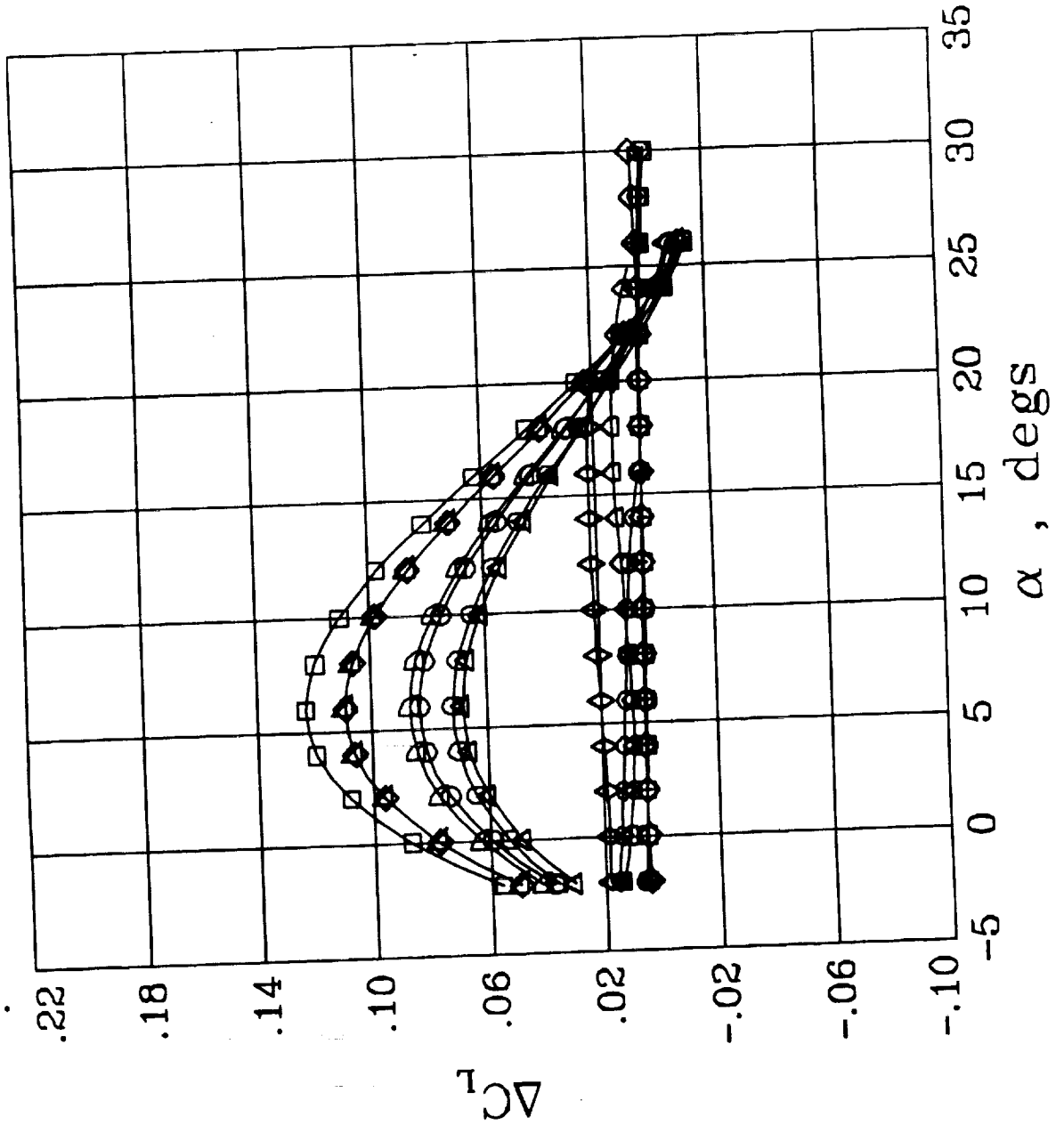

MACH	Symbol
.30	Circle with horizontal line
.60	Square with horizontal line
.80	Diamond with horizontal line
.90	Triangle with horizontal line
.95	Triangle with horizontal line
1.10	Triangle with horizontal line
1.20	Square with horizontal line
1.60	Diamond with horizontal line
2.00	Diamond with horizontal line
2.50	Circle with horizontal line
3.00	Circle with horizontal line
3.50	Square with horizontal line
4.00	Diamond with horizontal line

AERO DATA BASE FOR HL-20 FLIGHT SIMULATION STUDIES

INCREMENTS DUE TO $\delta_{LE} = +30^\circ$



LaRC/SSD
JAN. 1991

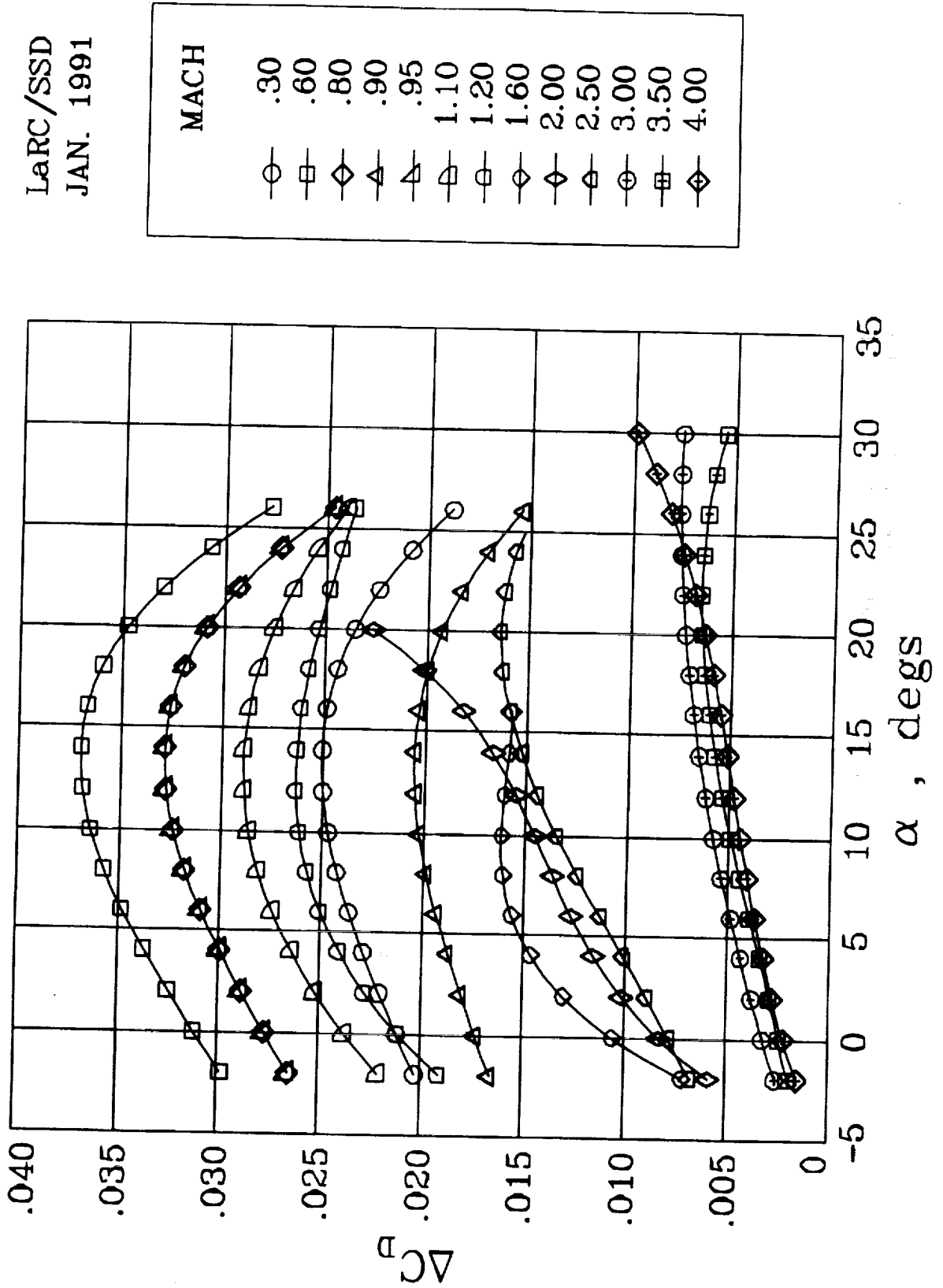

AERO DATA BASE FOR HL-20 FLIGHT SIMULATION STUDIES



LaRC/SSD
JAN. 1991

INCREMENTS DUE TO $\delta_{LE} = +30^\circ$

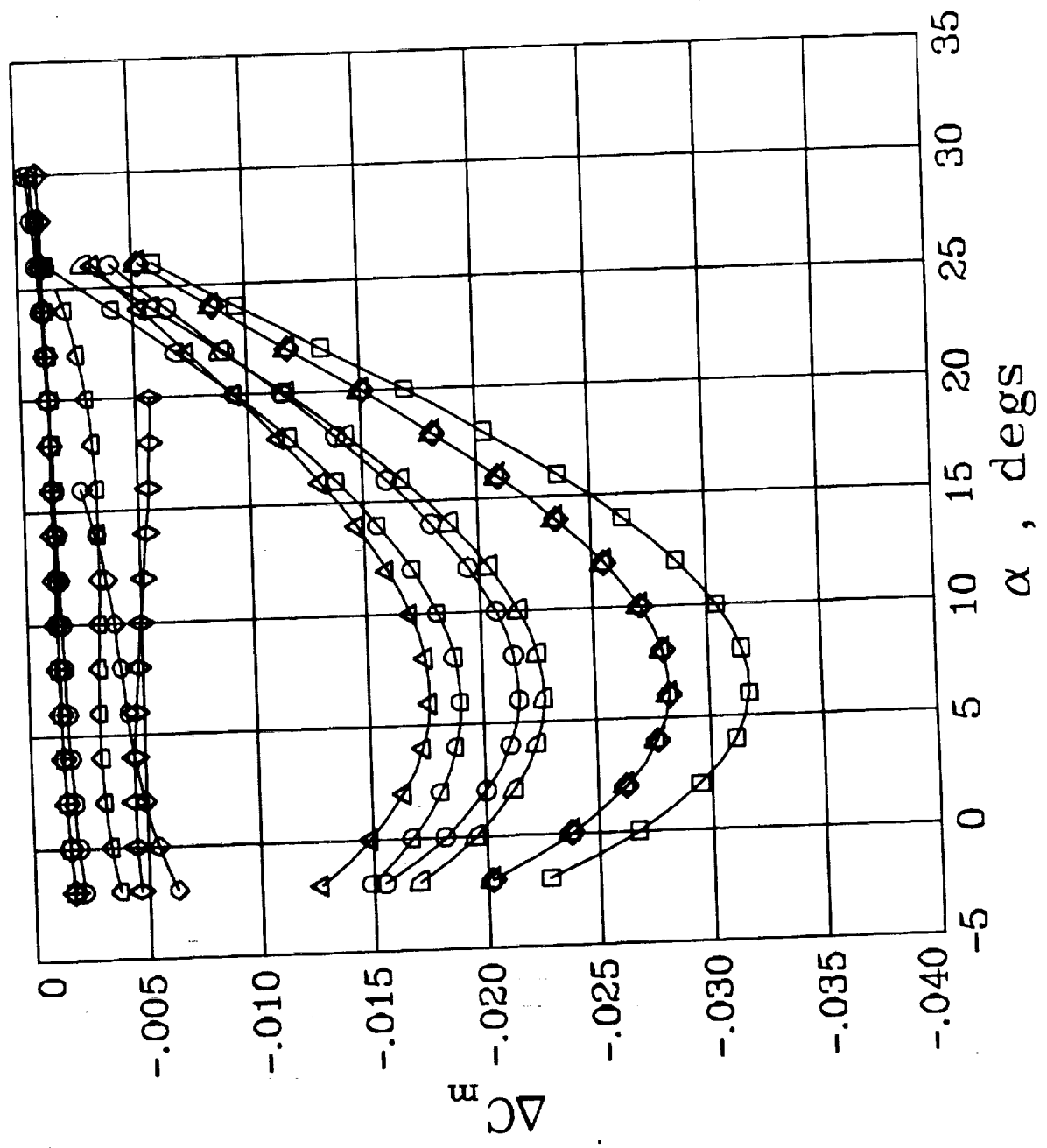

MACH	Symbol
.30	○
.60	□
.80	◇
.90	△
.95	▽
1.10	□
1.20	○
1.60	◇
2.00	○
2.50	○
3.00	○
3.50	□
4.00	◇

AERO DATA BASE FOR HL-20 FLIGHT SIMULATION STUDIES

INCREMENTS DUE TO $\delta_{LE} = +30^\circ$



LaRC/SSD
JAN. 1991

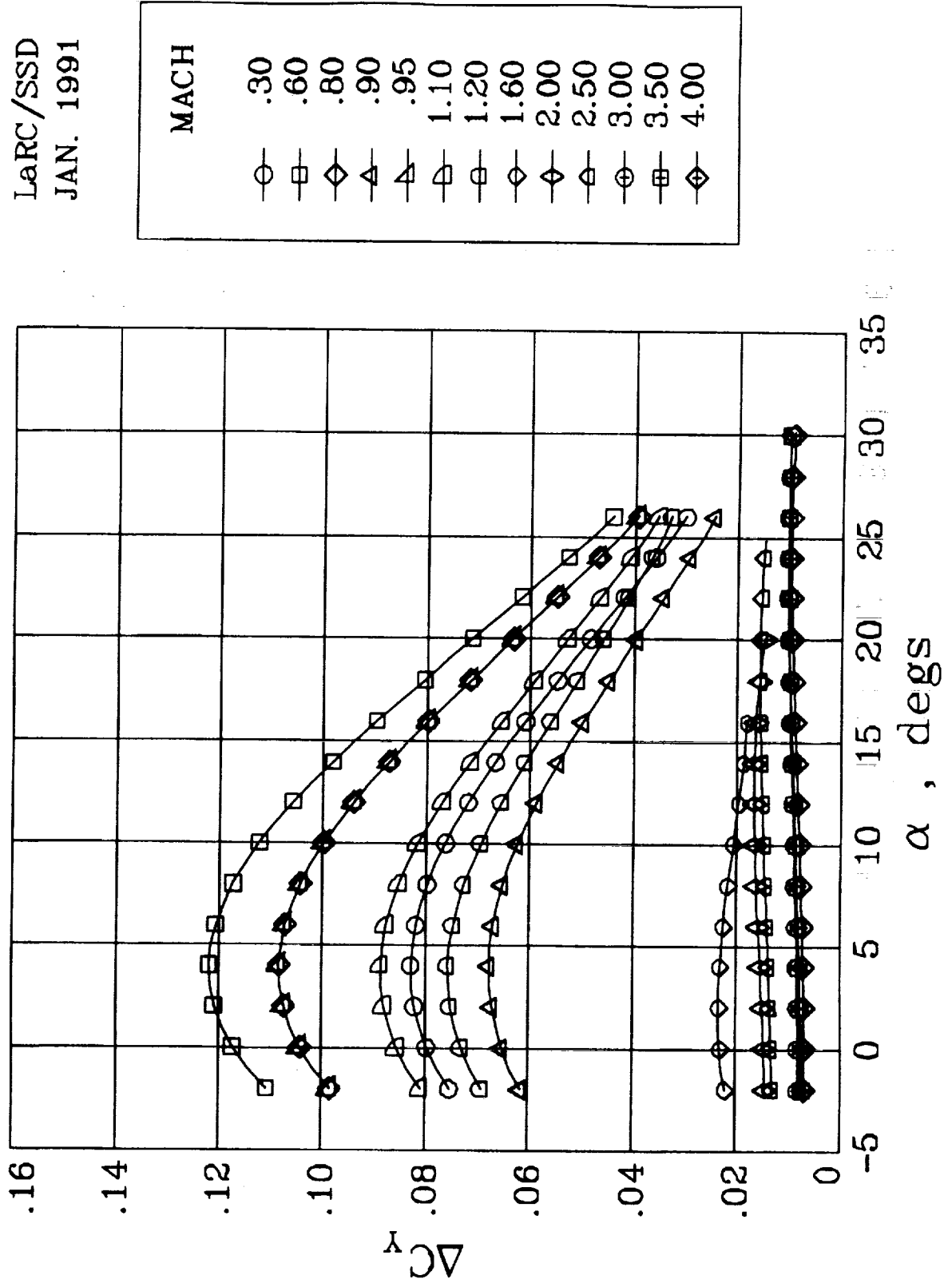

AERO DATA BASE FOR HL-20 FLIGHT SIMULATION STUDIES



LaRC/SSD
JAN. 1991

INCREMENTS DUE TO $\delta_{LE} = +30^\circ$

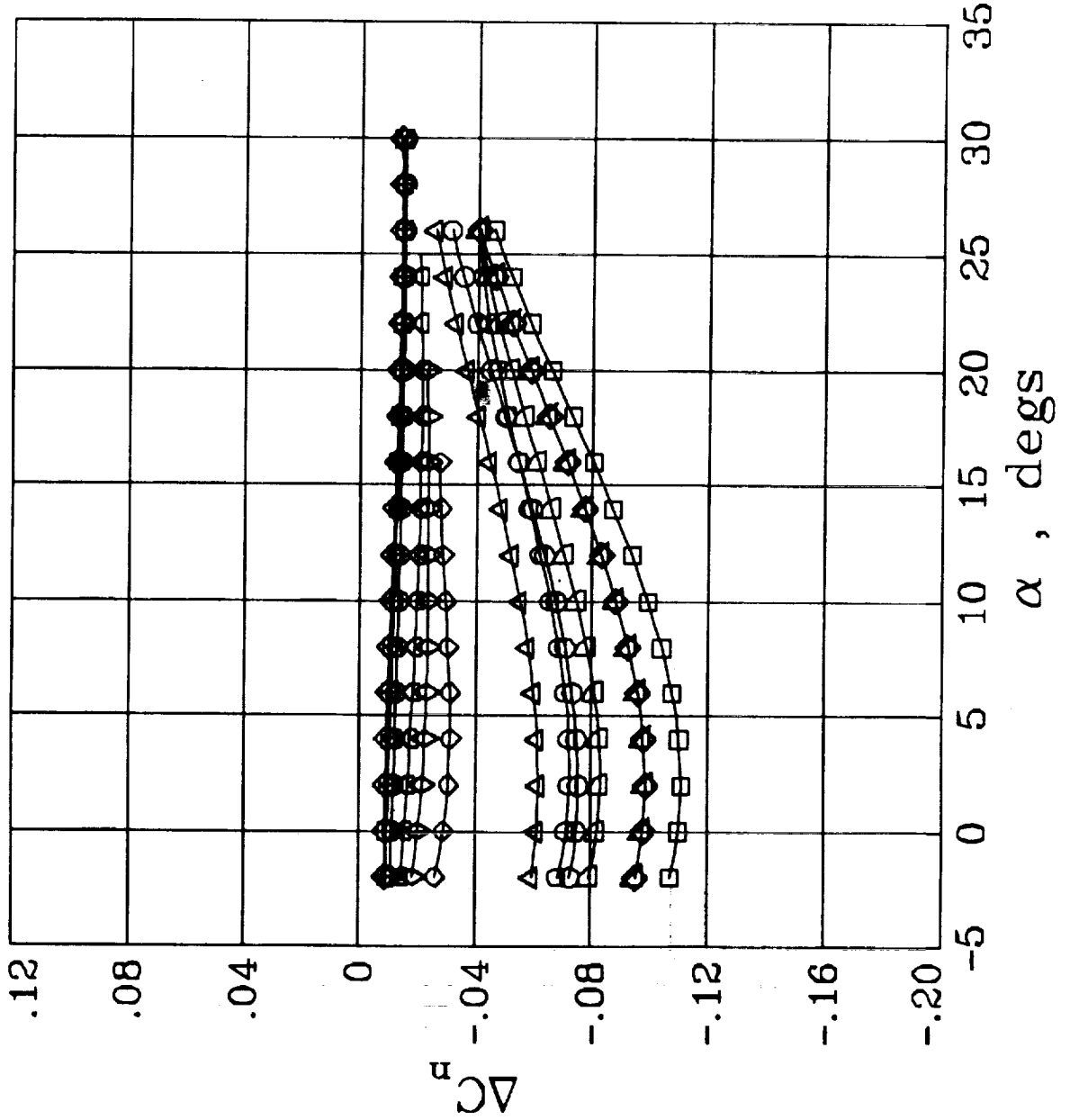

AERO DATA BASE FOR HL-20 FLIGHT SIMULATION STUDIES



LaRC/SSD
JAN. 1991

INCREMENTS DUE TO $\delta_{LE} = +30^\circ$

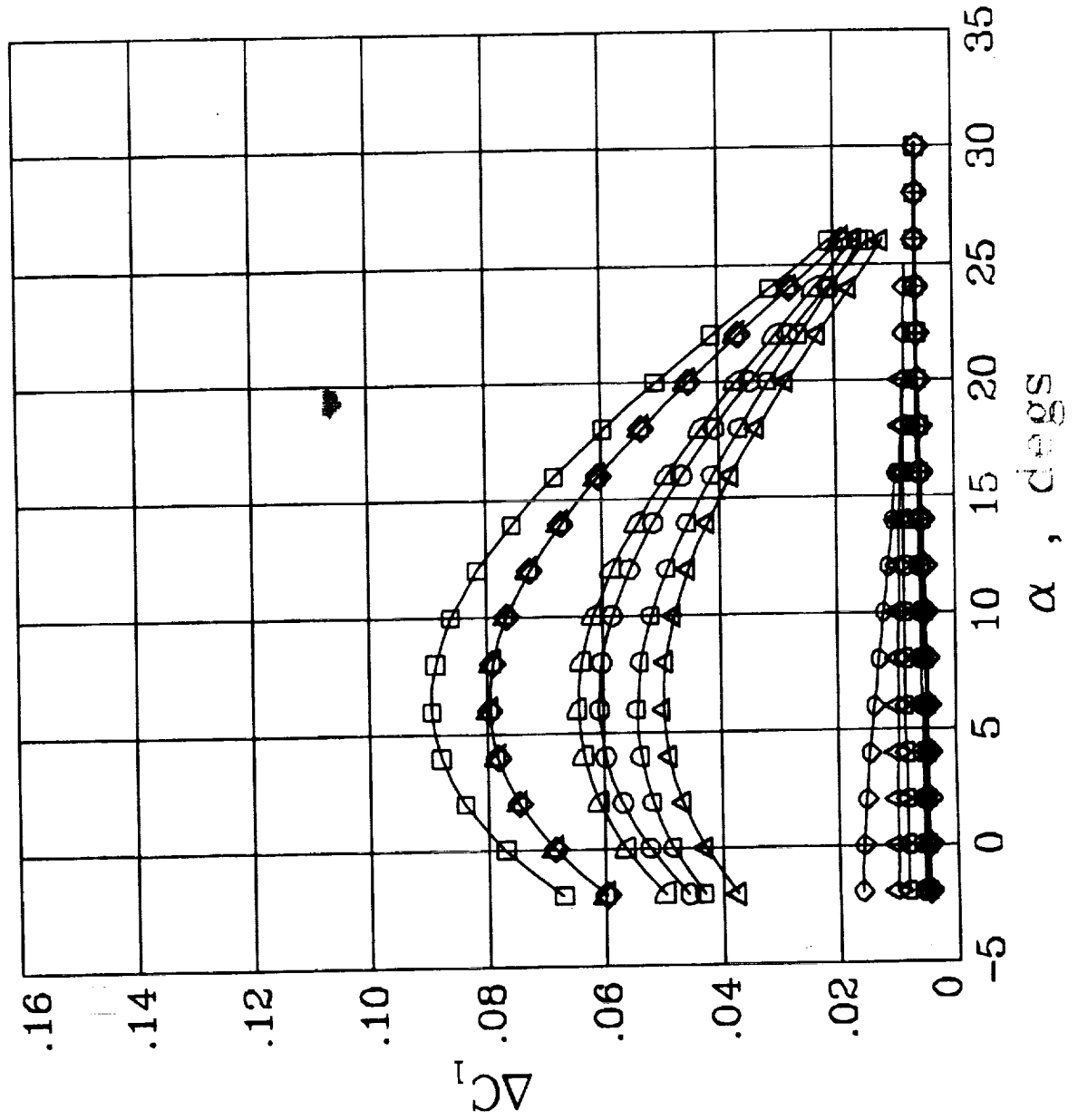

MACH	Symbol
.30	Circle
.60	Square
.80	Diamond
.90	Triangle
.95	Triangle
1.10	Square
1.20	Square
1.60	Diamond
2.00	Diamond
2.50	Circle
3.00	Circle
3.50	Square
4.00	Diamond

AERO DATA BASE FOR HL-20 FLIGHT SIMULATION STUDIES



LaRC/SSD
JAN. 1991

INCREMENTS DUE TO $\delta_R = +15^\circ$

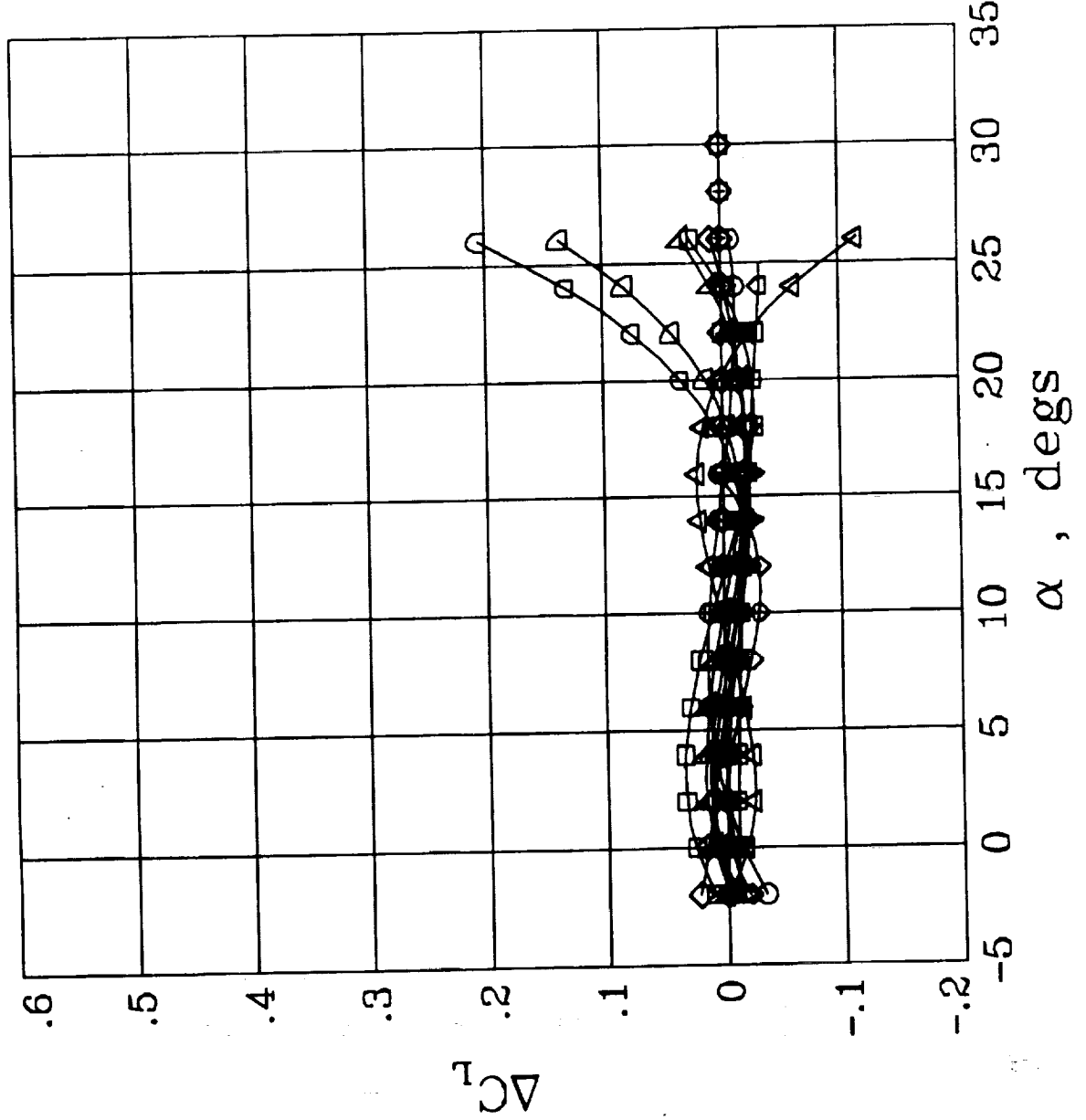

MACH	Symbol
.30	○
.60	□
.80	◇
.90	△
.95	▽
1.10	◻
1.20	◉
1.60	◊
2.00	◈
2.50	◻
3.00	◉
3.50	◻
4.00	◊

AERO DATA BASE FOR HL-20 FLIGHT SIMULATION STUDIES

INCREMENTS DUE TO $\delta_R = +15^\circ$



LaRC/SSD
JAN. 1991

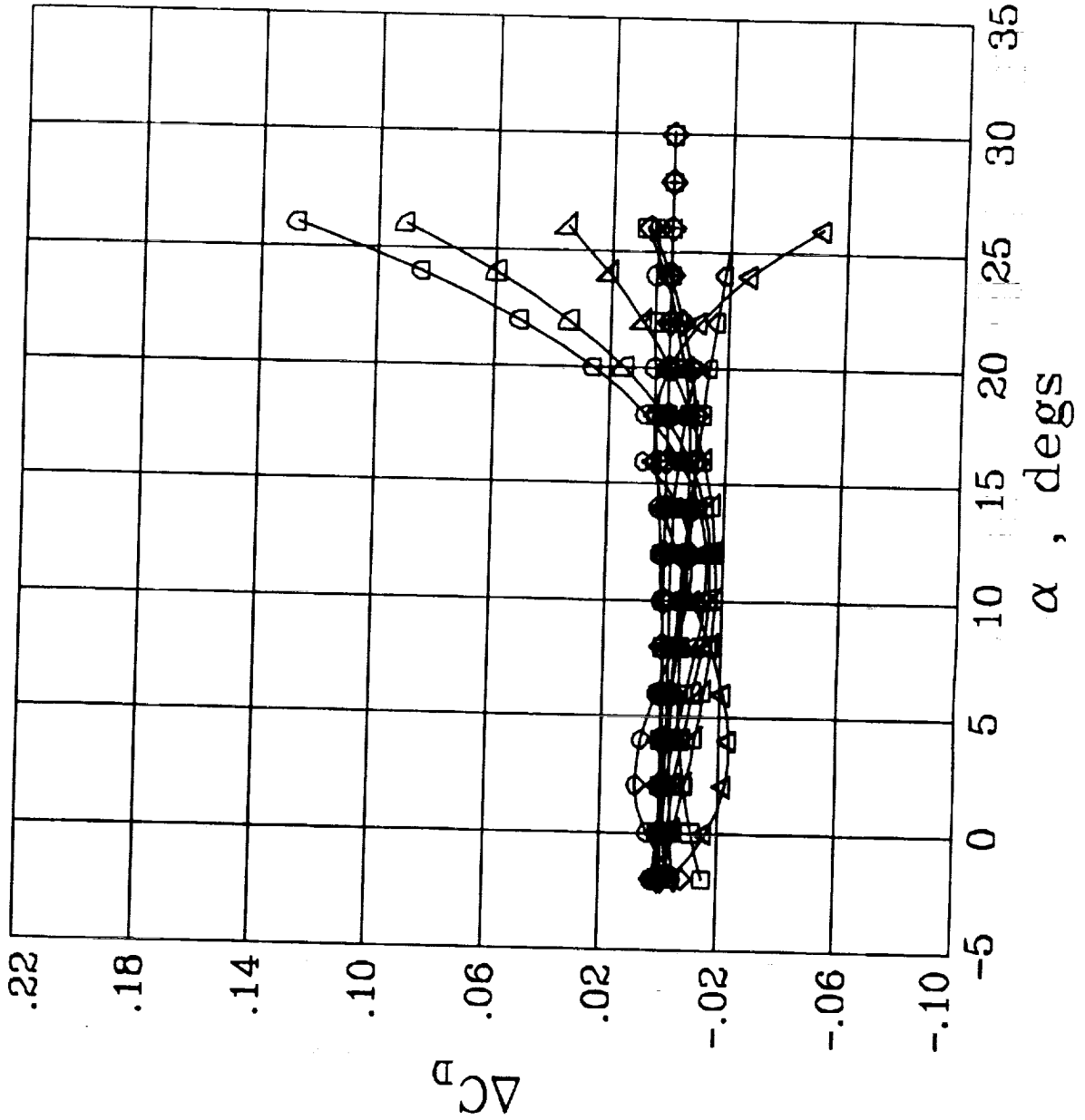

AERO DATA BASE FOR HL-20 FLIGHT SIMULATION STUDIES



LaRC/SSD
JAN. 1991

INCREMENTS DUE TO $\delta_R = +15^\circ$

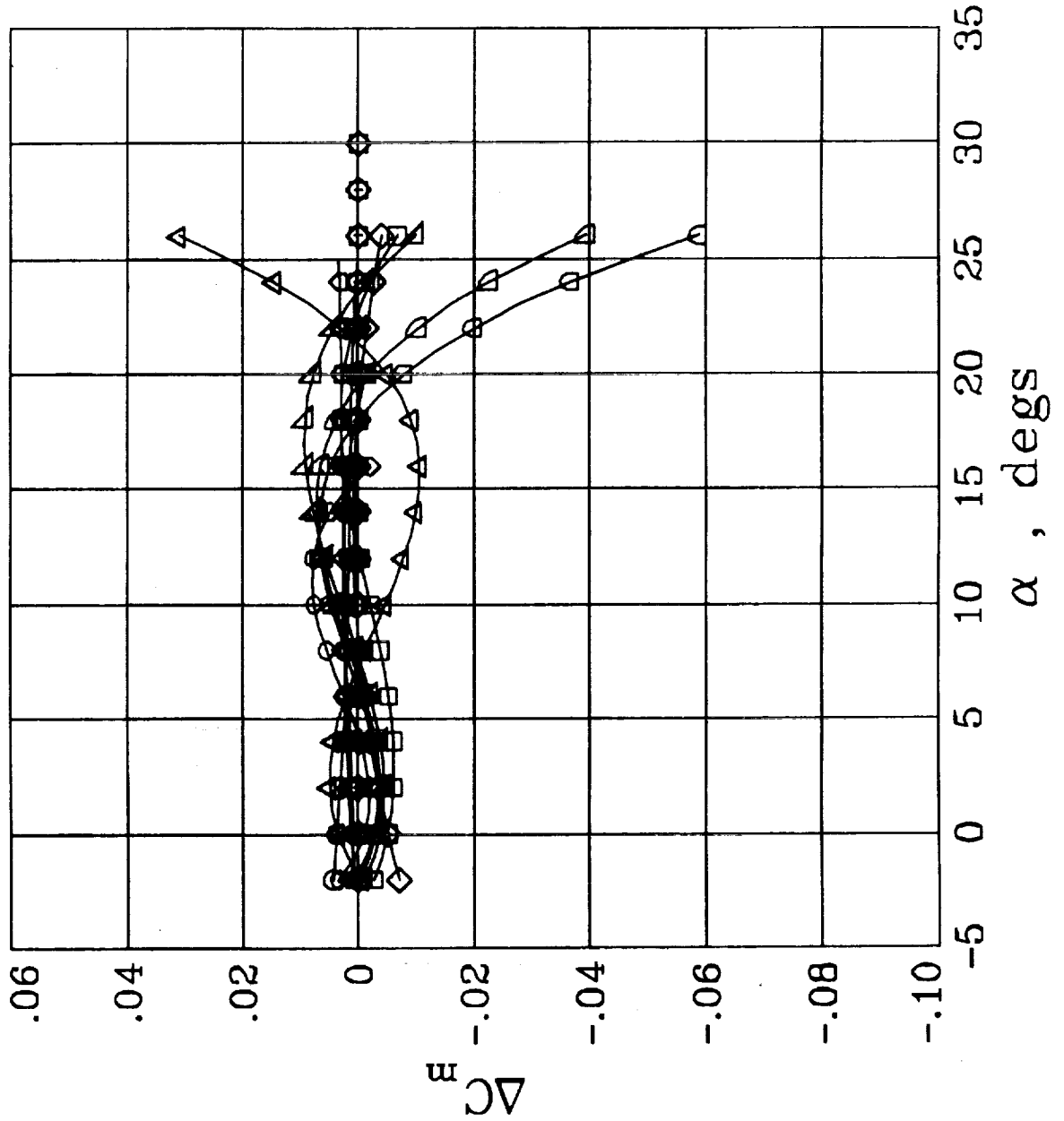

AERO DATA BASE FOR HL-20 FLIGHT SIMULATION STUDIES



LaRC/SSD
JAN. 1991

INCREMENTS DUE TO $\delta_R = +15^\circ$

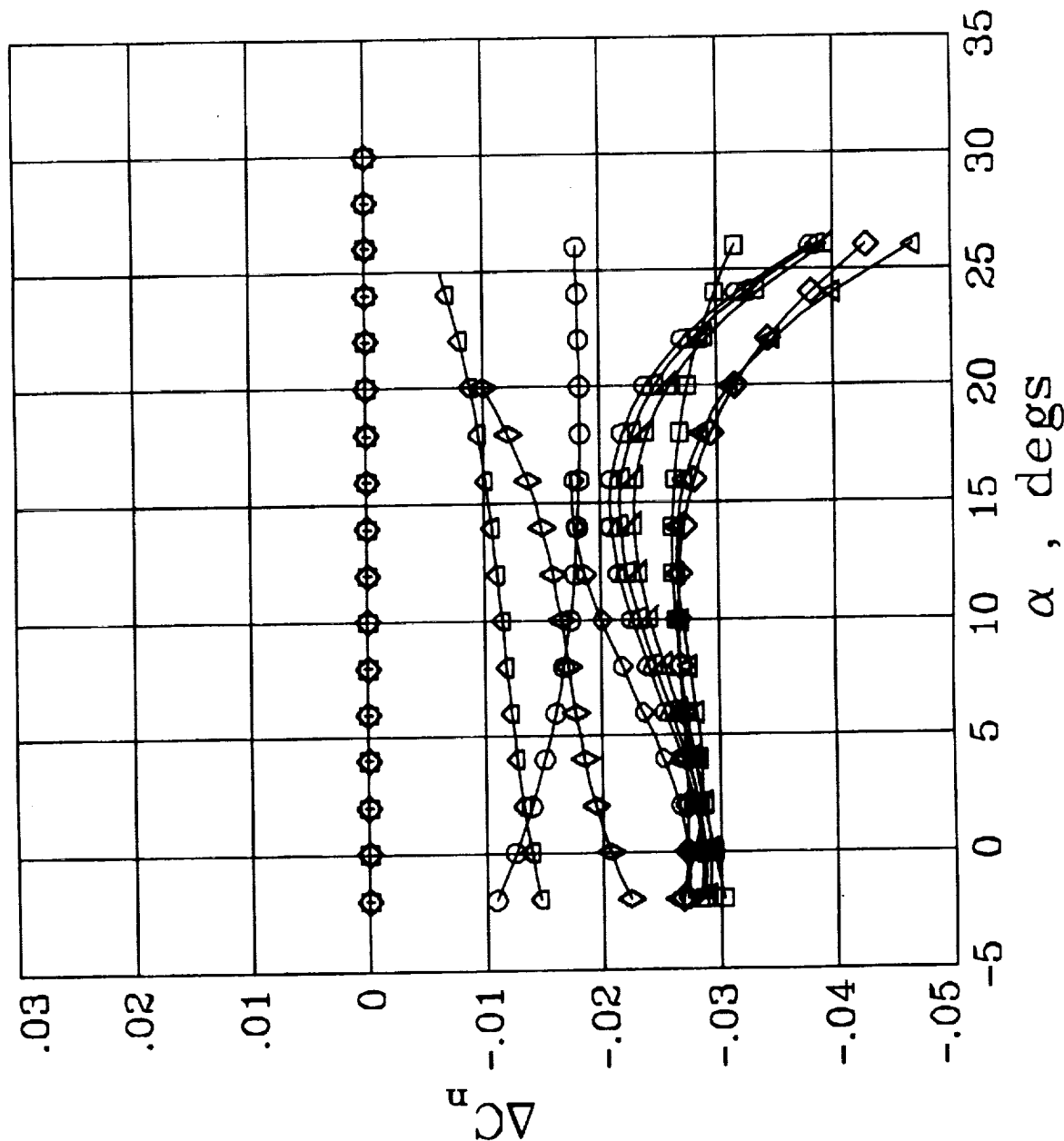

AERO DATA BASE FOR HL-20 FLIGHT SIMULATION STUDIES



LaRC/SSD
JAN. 1991

INCREMENTS DUE TO $\delta_R = +15^\circ$

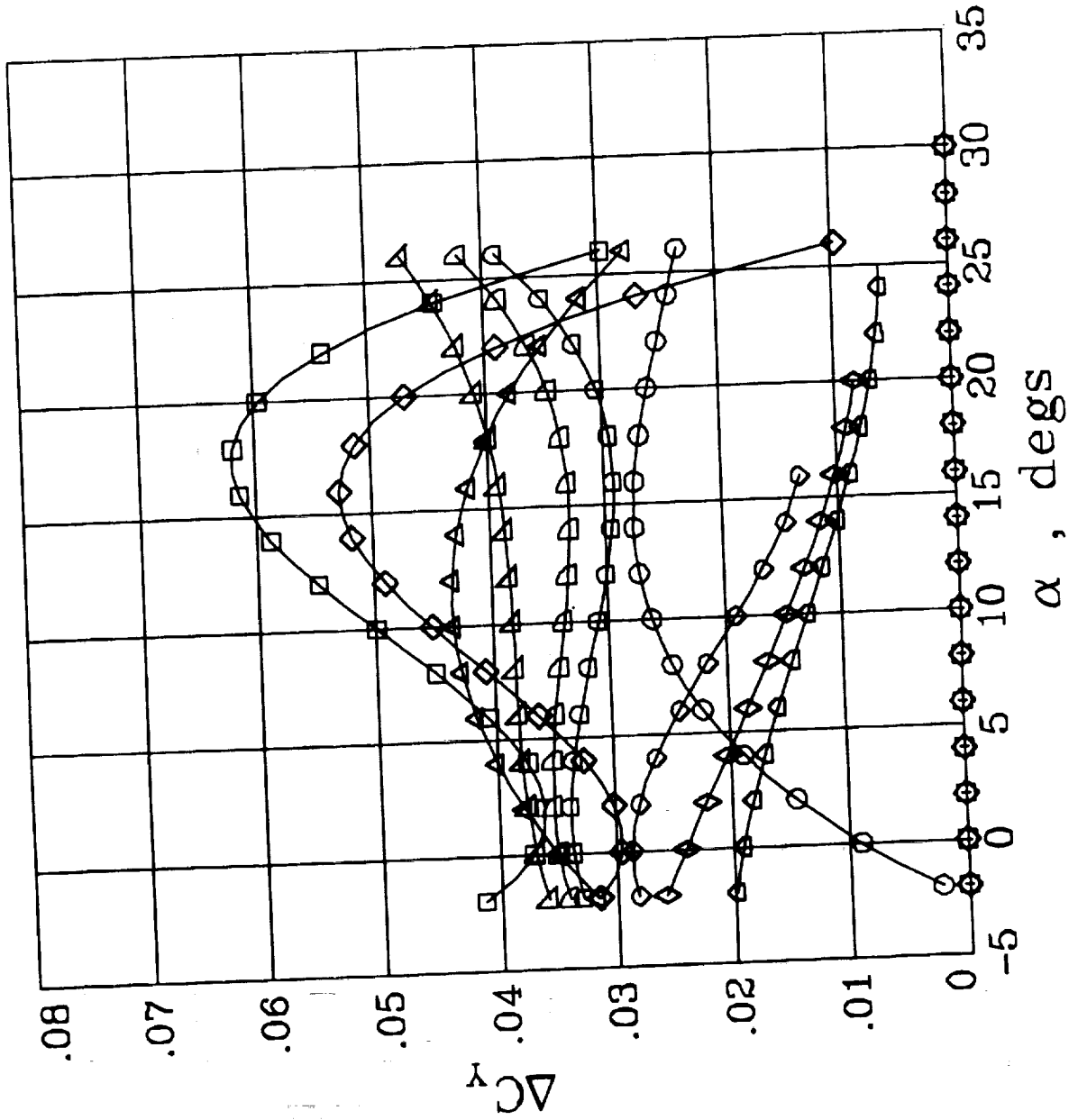

AERO DATA BASE FOR HL-20 FLIGHT SIMULATION STUDIES

INCREMENTS DUE TO $\delta_R = +15^\circ$



LaRC/SSD
JAN. 1991

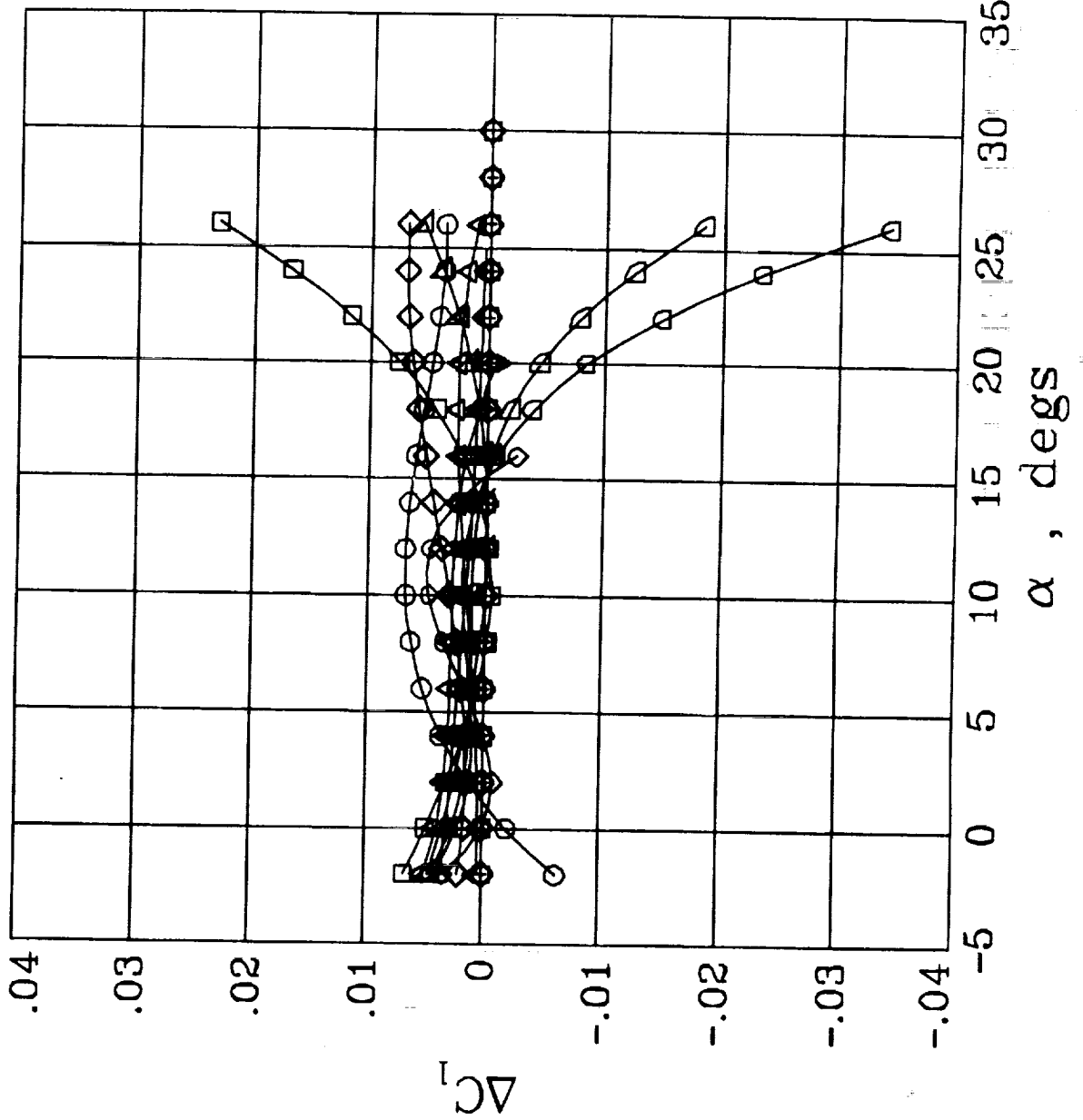

AERO DATA BASE FOR HL-20 FLIGHT SIMULATION STUDIES



LaRC/SSD
JAN. 1991

INCREMENTS DUE TO $\delta_R = +30^\circ$

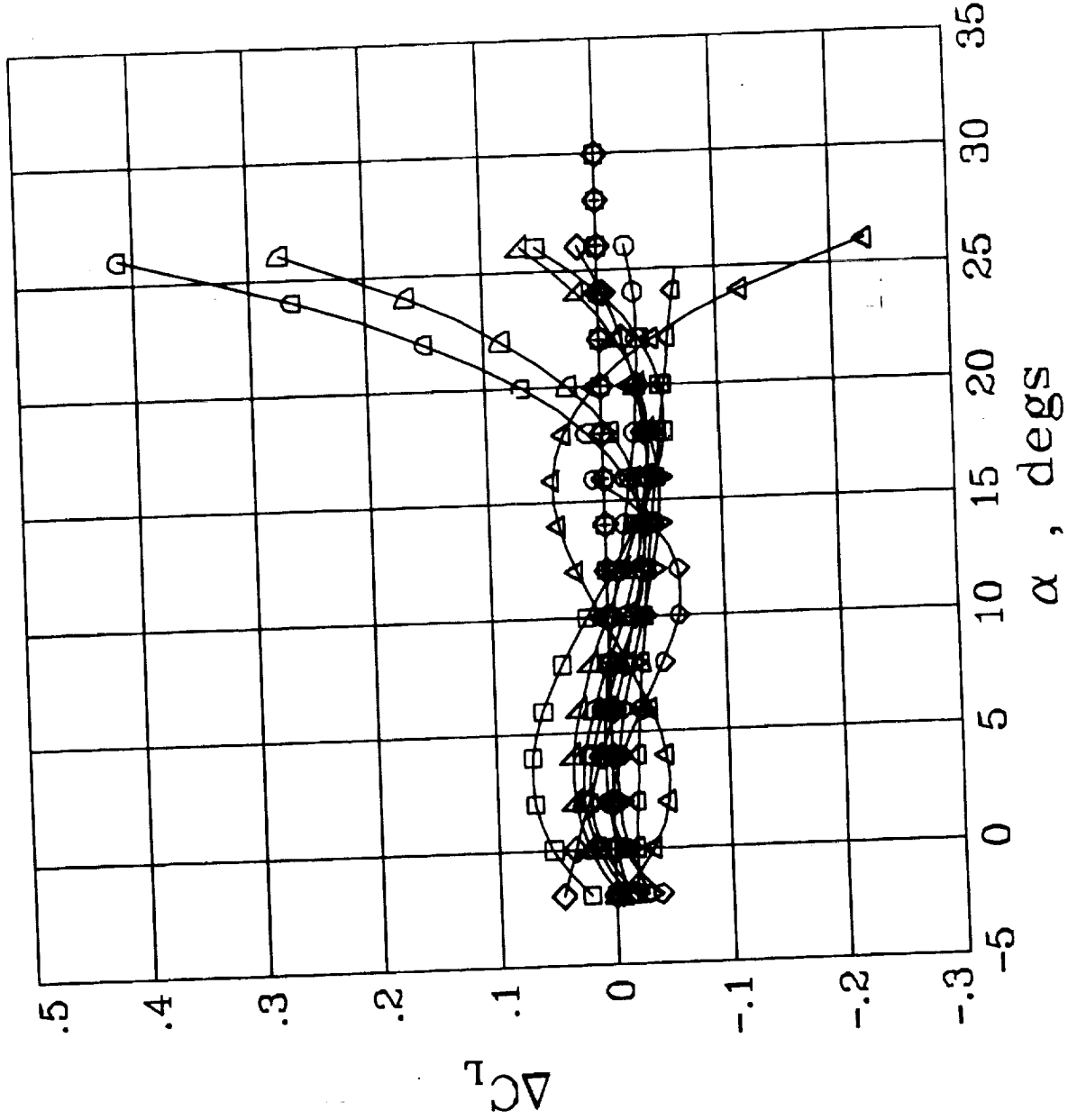

MACH	Symbol
.30	○
.60	□
.80	◇
.90	△
.95	▲
1.10	■
1.20	●
1.60	◊
2.00	⊙
2.50	⊖
3.00	⊞
3.50	⊠
4.00	⊡

AERO DATA BASE FOR HL-20 FLIGHT SIMULATION STUDIES

INCREMENTS DUE TO $\delta_R = +30^\circ$



LaRC/SSD
JAN. 1991

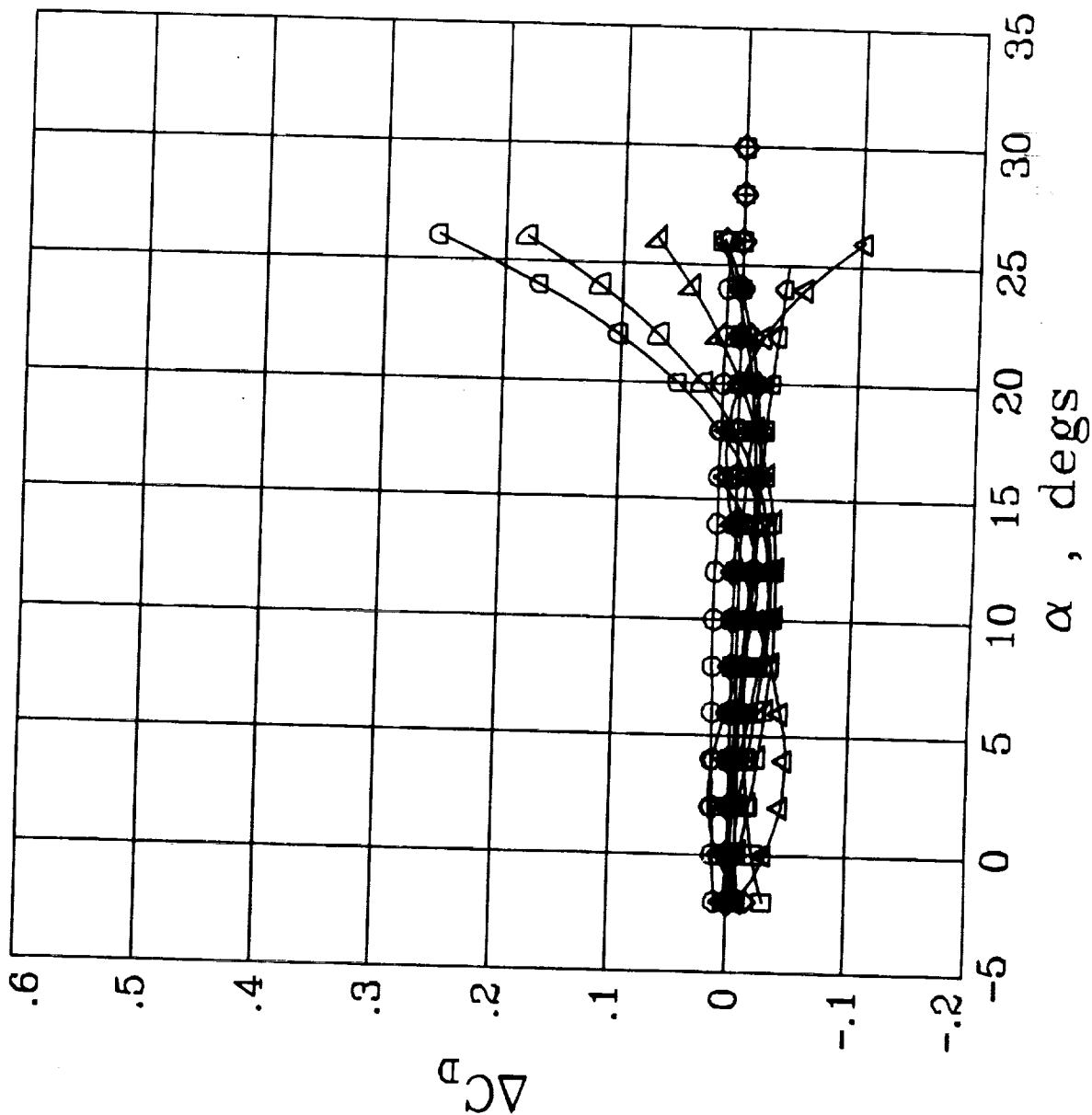

AERO DATA BASE FOR HL-20 FLIGHT SIMULATION STUDIES



LaRC/SSD
JAN. 1991

INCREMENTS DUE TO $\delta_R = +30^\circ$

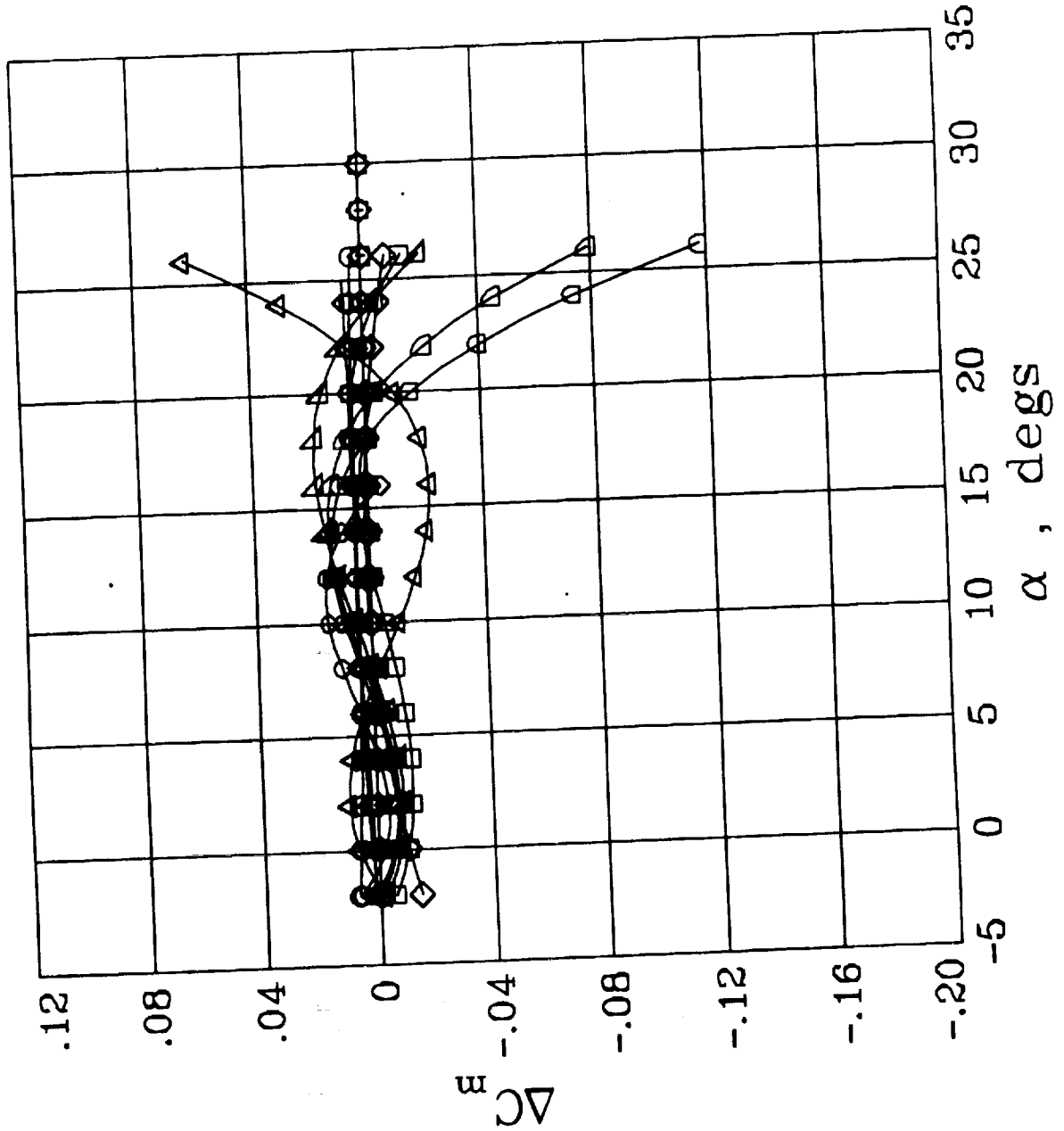

MACH	Symbol
.30	○
.60	□
.80	◇
.90	△
.95	▽
1.10	▽
1.20	⊖
1.60	⊕
2.00	⊗
2.50	⊘
3.00	⊙
3.50	⊚
4.00	⊛

AERO DATA BASE FOR HL-20 FLIGHT SIMULATION STUDIES



LaRC/SSD
JAN. 1991

INCREMENTS DUE TO $\delta_R = +30^\circ$

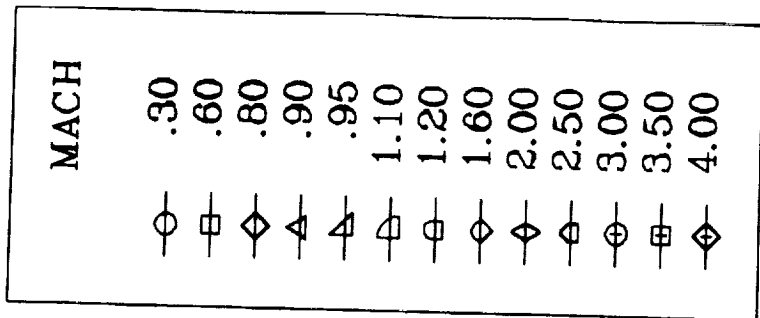
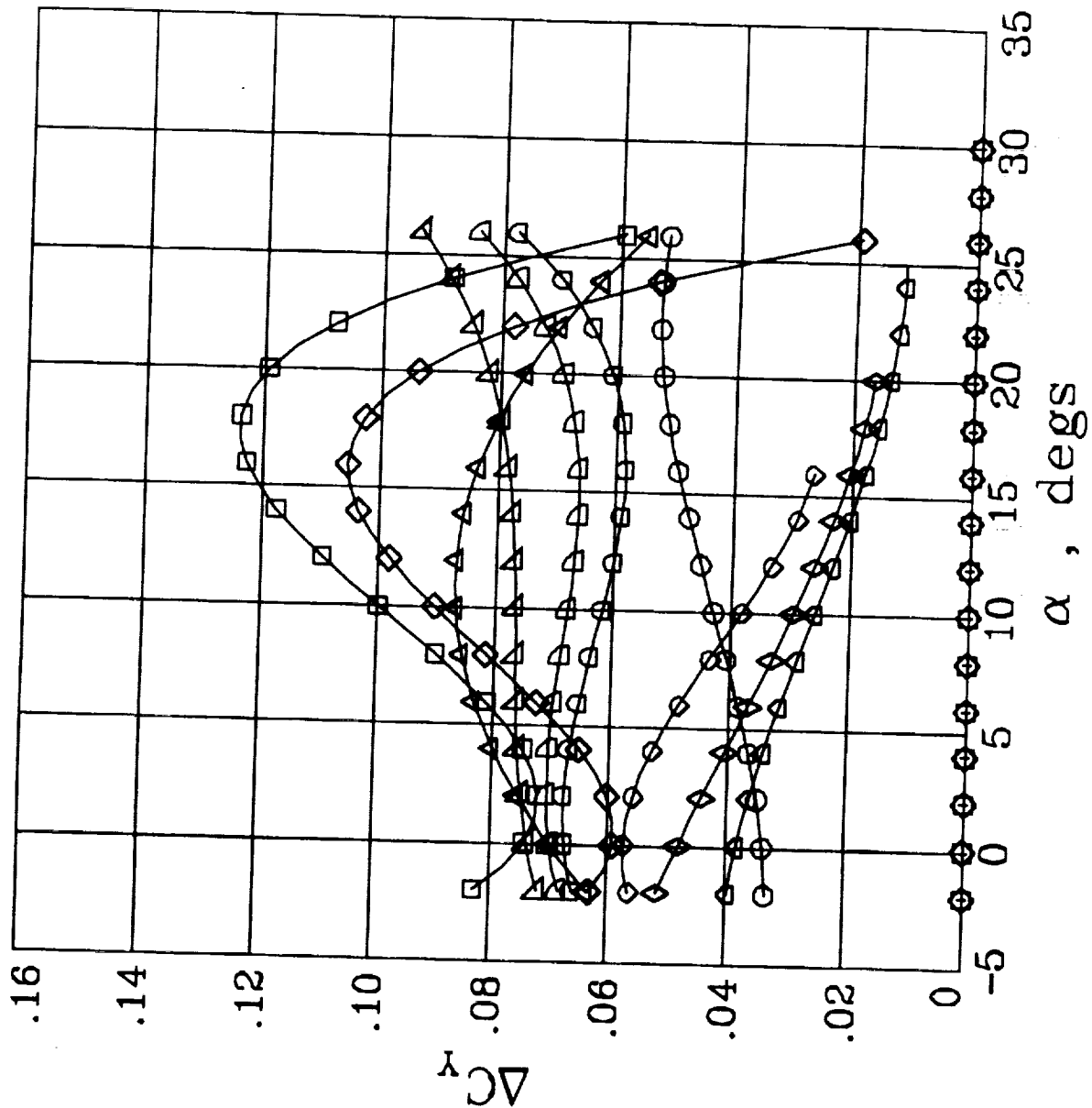

AERO DATA BASE FOR HL-20 FLIGHT SIMULATION STUDIES



LaRC/SSD
JAN. 1991

INCREMENTS DUE TO $\delta_R = +30^\circ$

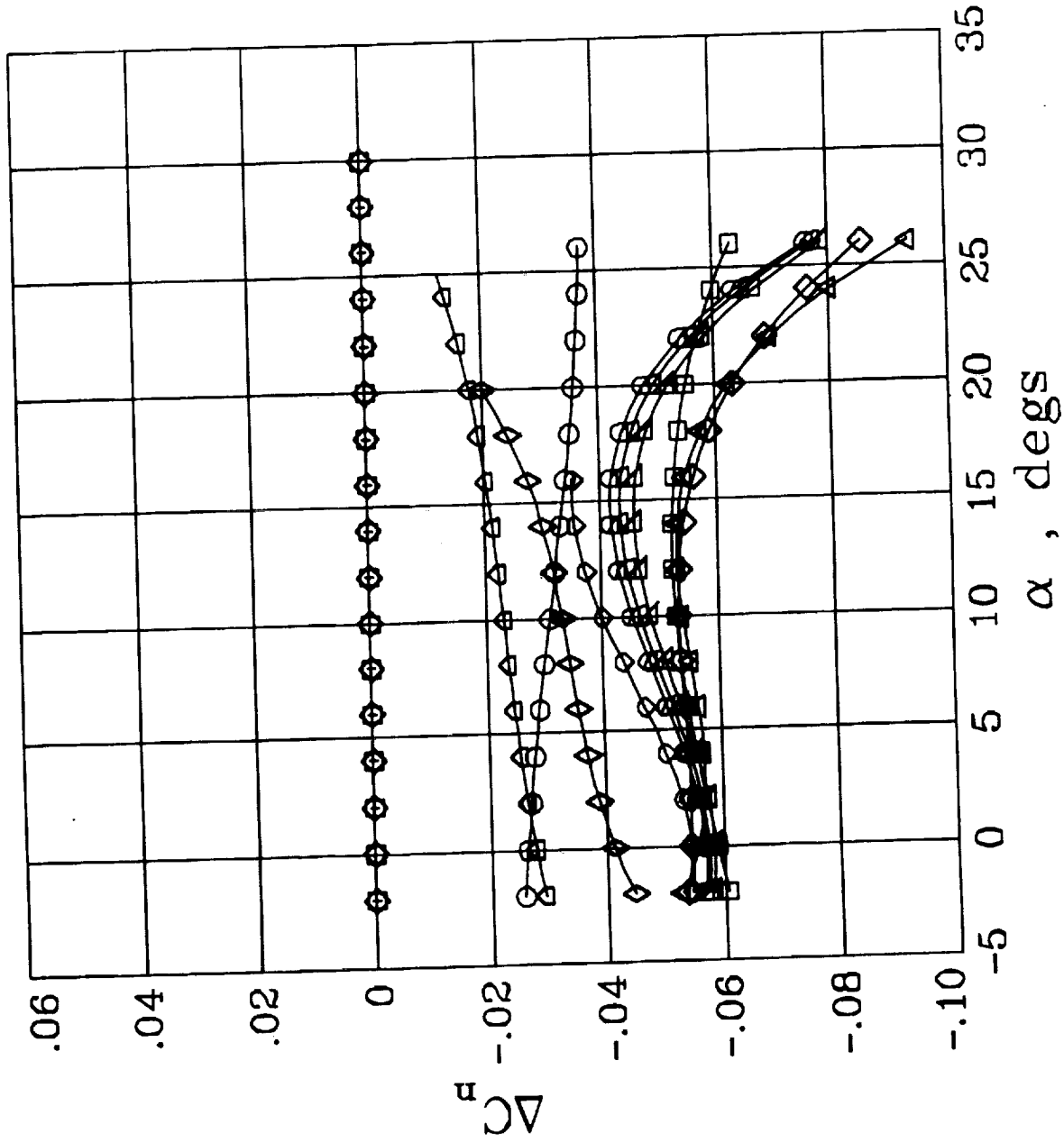

MACH	Symbol
.30	○
.60	□
.80	◇
.90	△
.95	▽
1.10	▽
1.20	⊖
1.60	⊕
2.00	⊗
2.50	⊙
3.00	⊚
3.50	⊛
4.00	⊜

AERO DATA BASE FOR HL-20 FLIGHT SIMULATION STUDIES

INCREMENTS DUE TO $\delta_R = +30^\circ$



LaRC/SSD
JAN. 1991

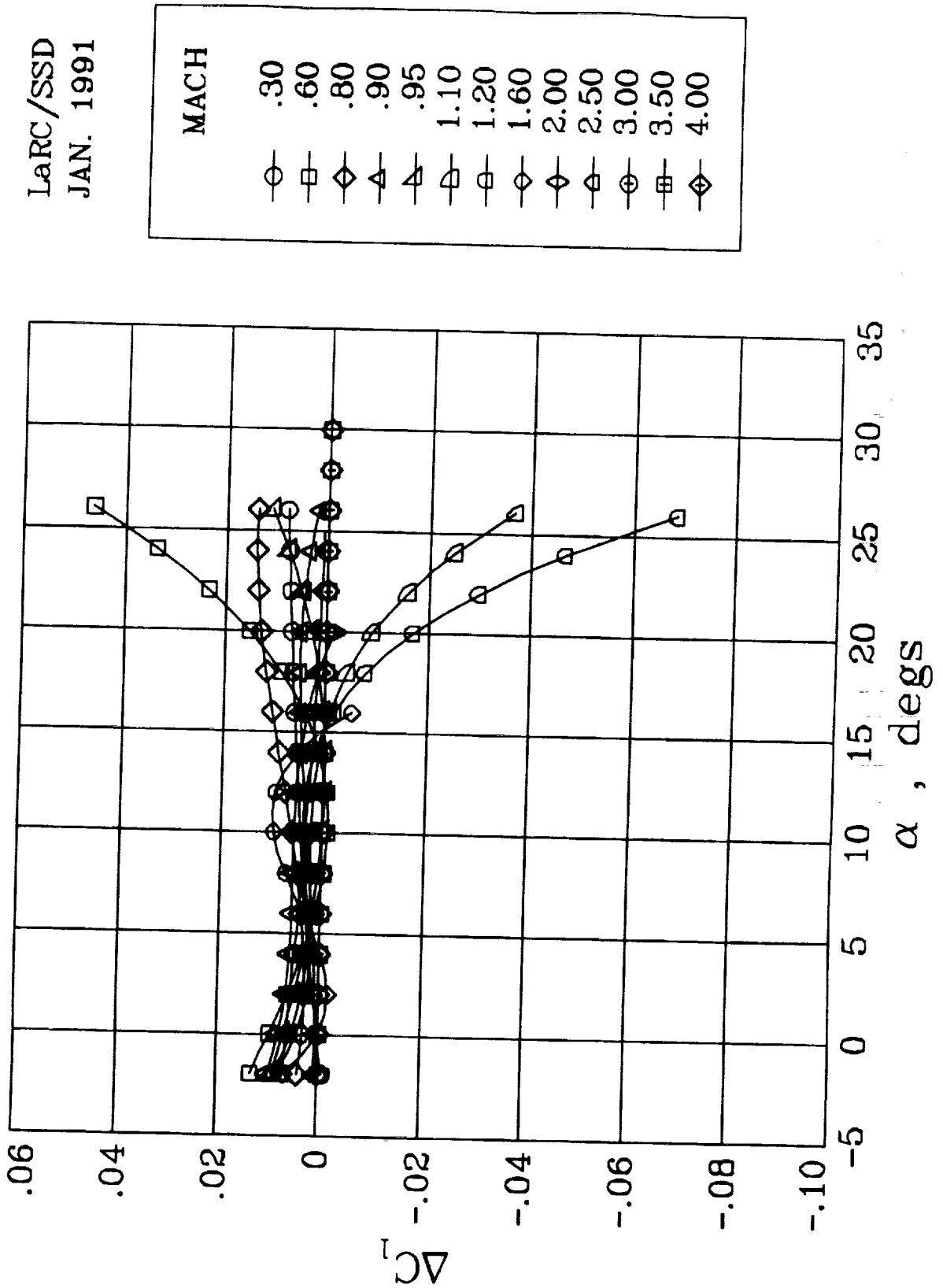

AERO DATA BASE FOR HL-20 FLIGHT SIMULATION STUDIES



LaRC/SSD
JAN. 1991

DYNAMIC DAMPING COEFFICIENTS

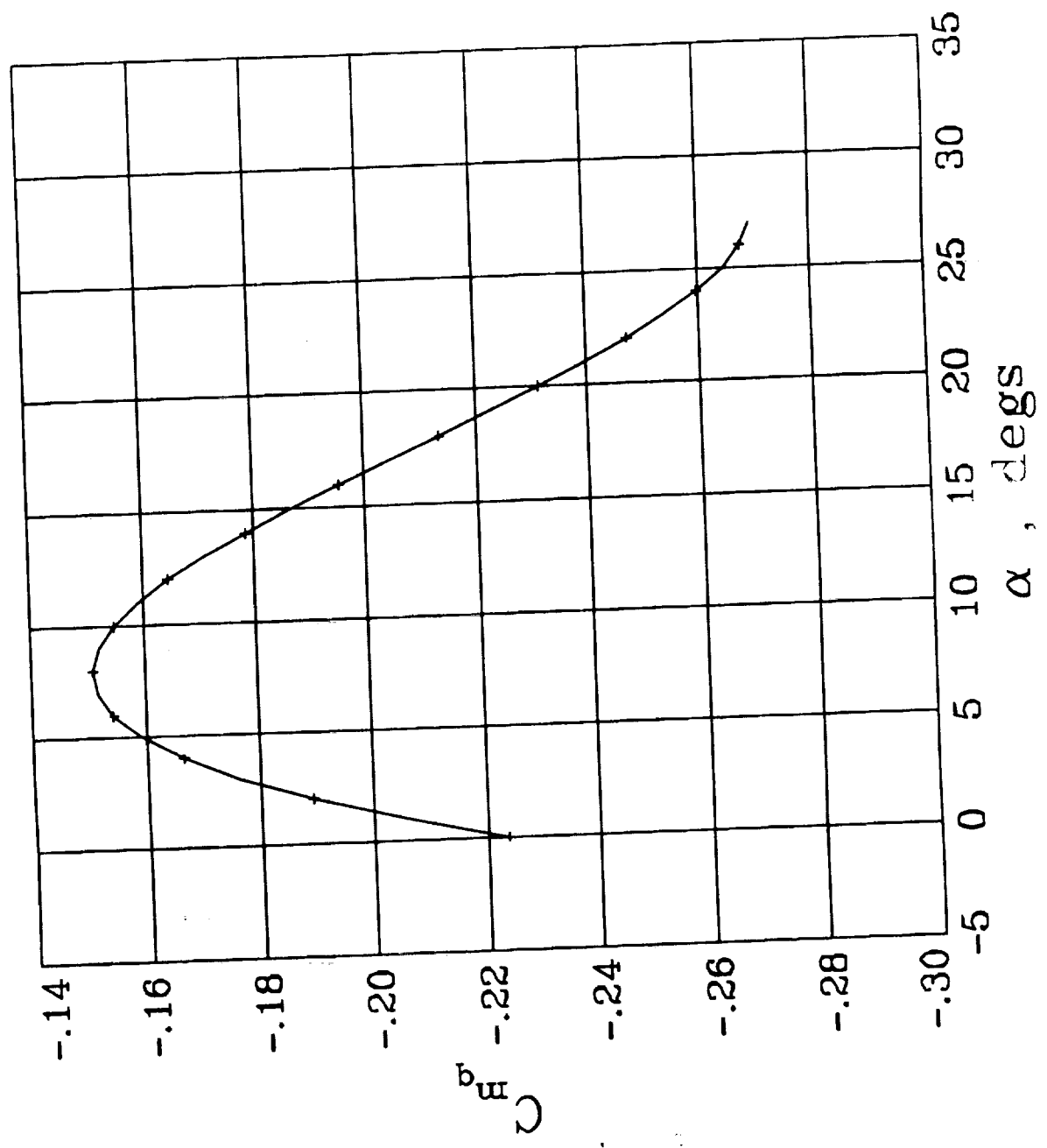

AERO DATA BASE FOR HL-20 FLIGHT SIMULATION STUDIES

DYNAMIC DAMPING COEFFICIENTS



LaRC/SSD
JAN. 1991

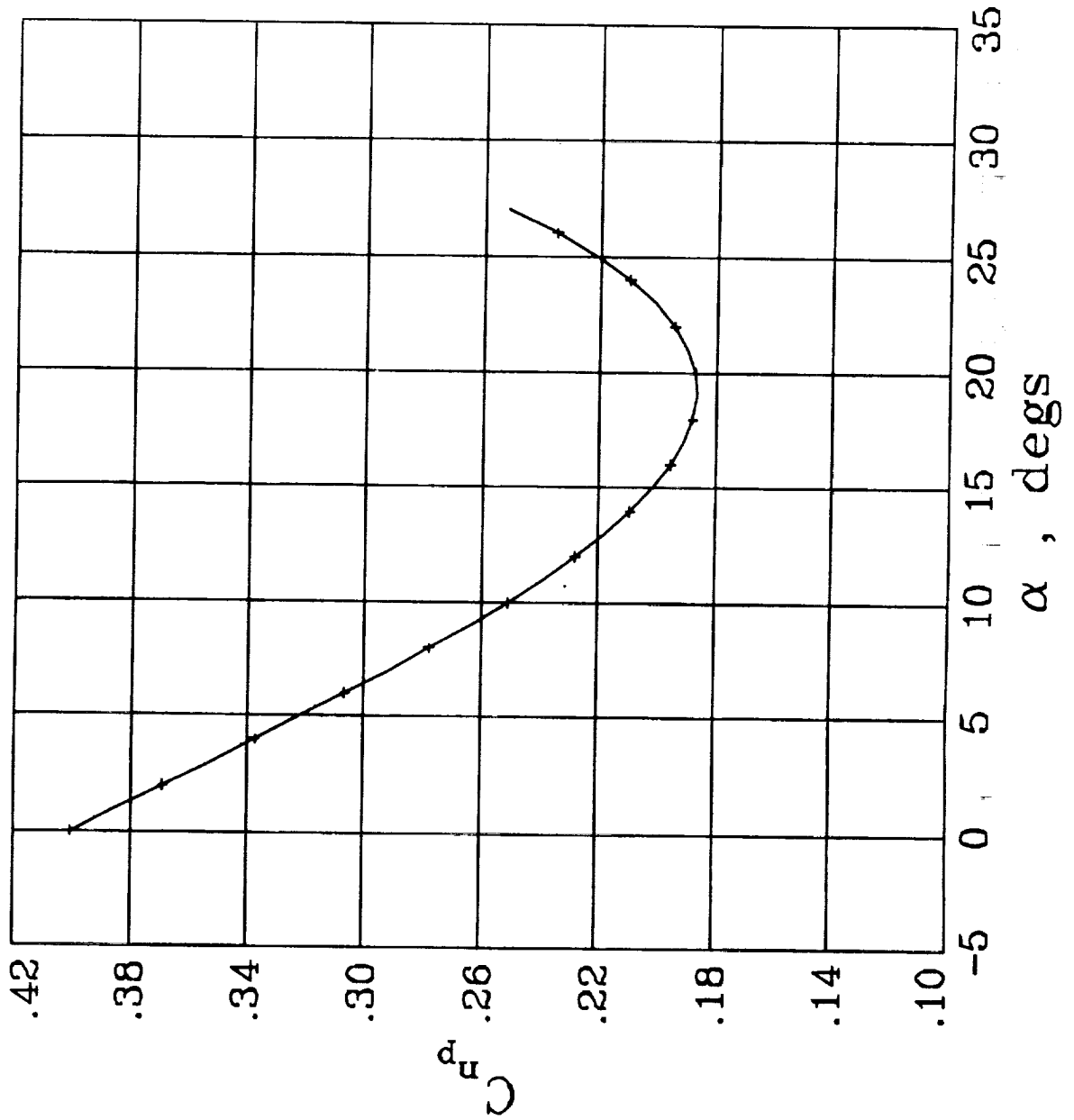

AERO DATA BASE FOR HL-20 FLIGHT SIMULATION STUDIES



LaRC/SSD
JAN. 1991

DYNAMIC DAMPING COEFFICIENTS

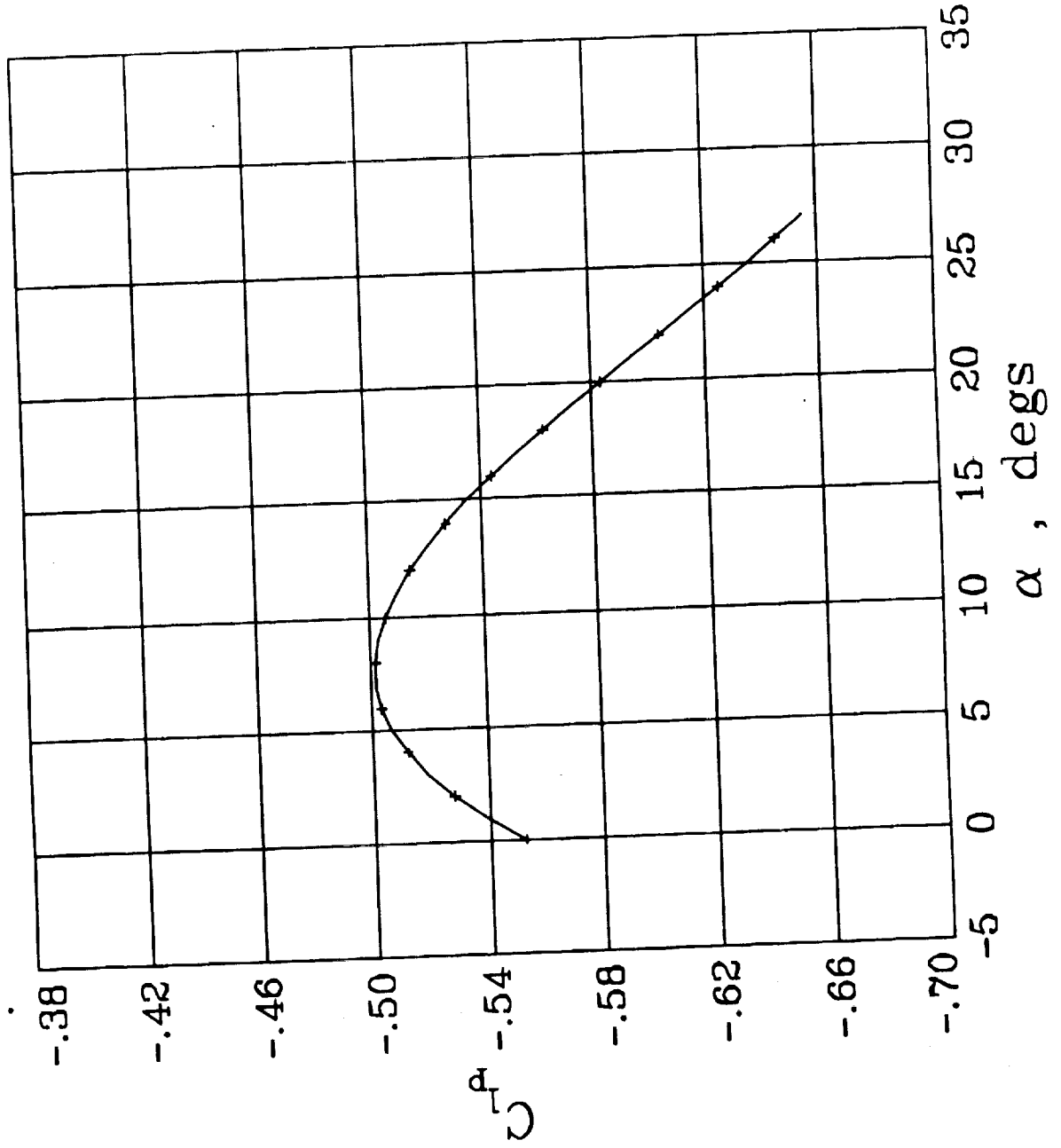

AERO DATA BASE FOR HL-20 FLIGHT SIMULATION STUDIES



LaRC/SSD
JAN. 1991

DYNAMIC DAMPING COEFFICIENTS

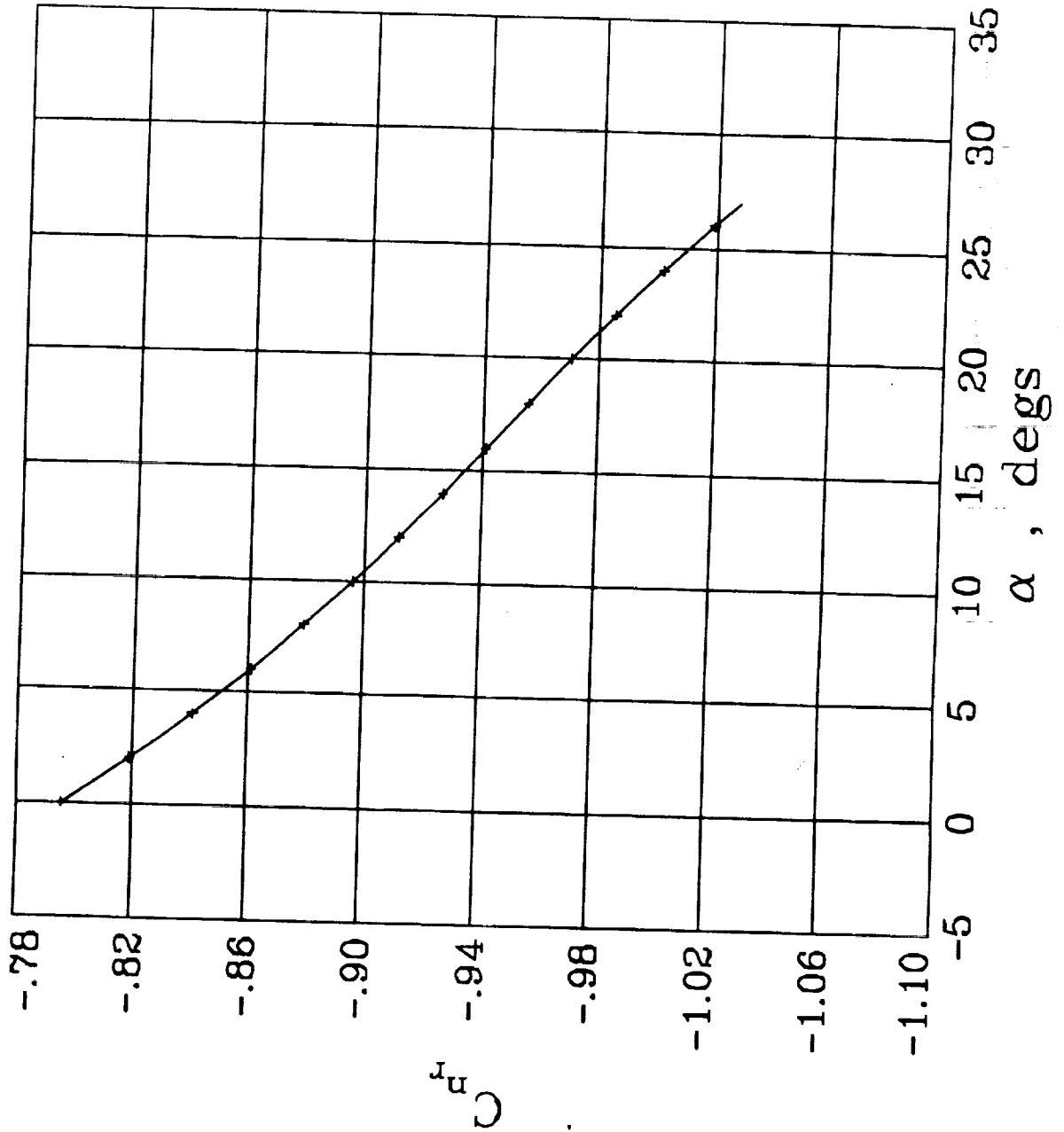

AERO DATA BASE FOR HL-20 FLIGHT SIMULATION STUDIES



LaRC/SSD
JAN. 1991

DYNAMIC DAMPING COEFFICIENTS

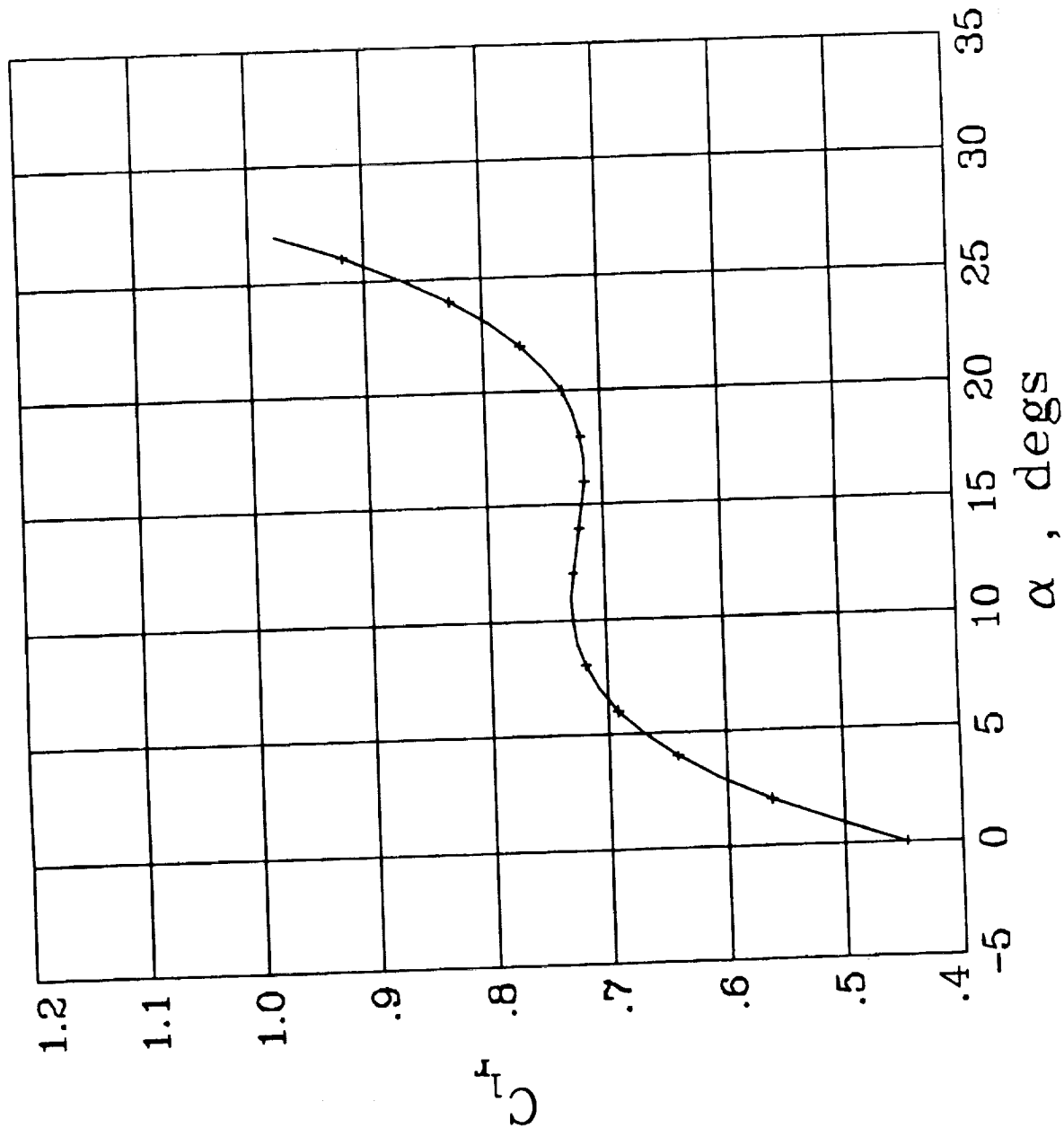

AERO DATA BASE FOR HL-20 FLIGHT SIMULATION STUDIES

INCREMENTS DUE TO GROUND EFFECTS



LaRC/SSD
JAN. 1991

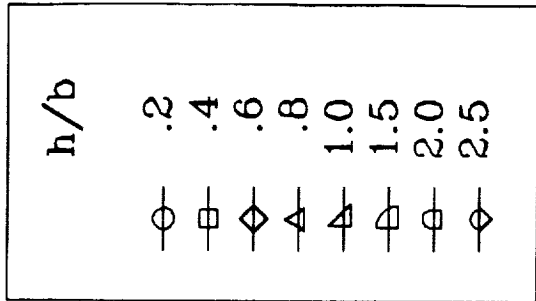
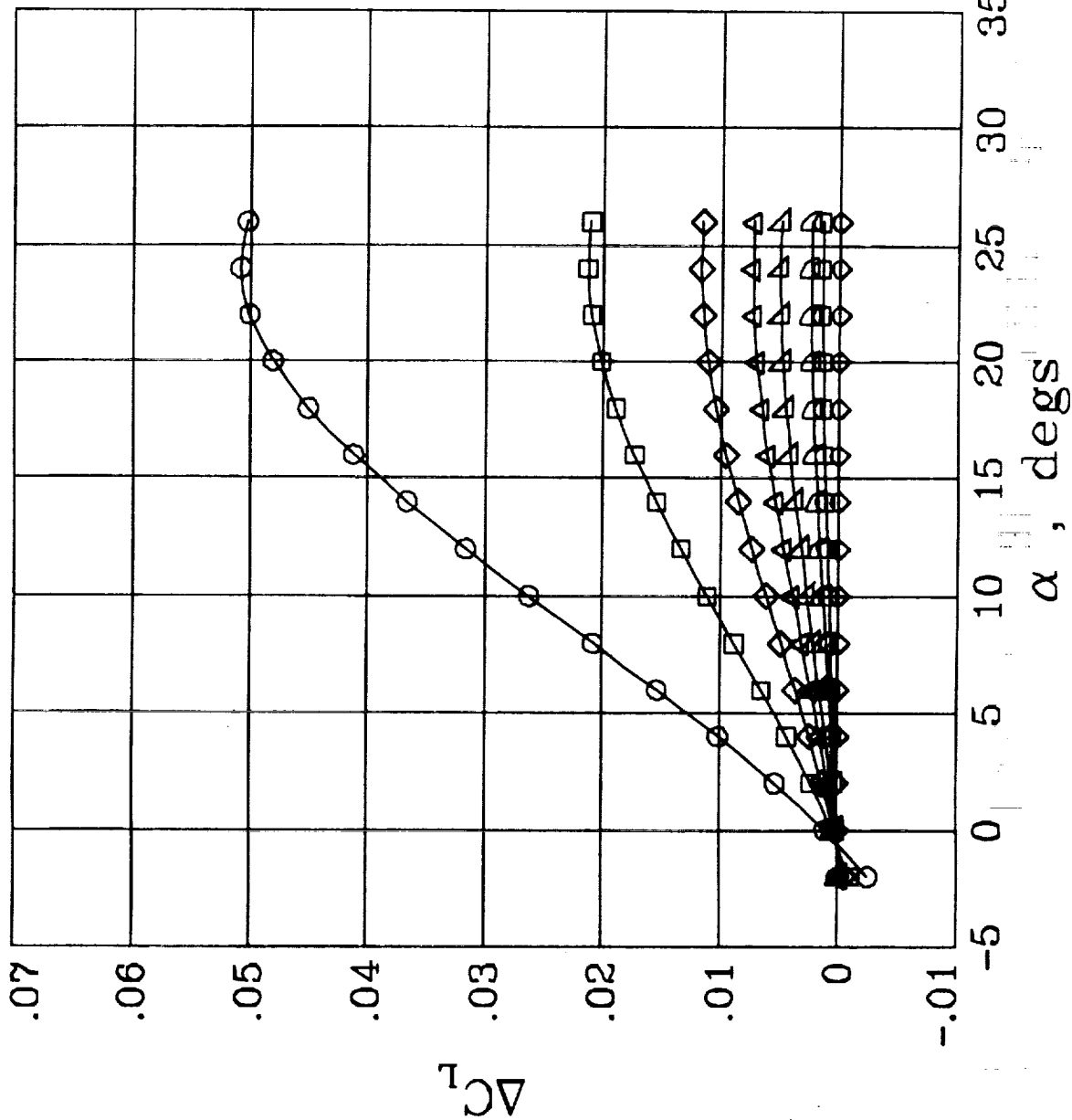

AERO DATA BASE FOR HL-20 FLIGHT SIMULATION STUDIES



LaRC/SSD
JAN. 1991

INCREMENTS DUE TO GROUND EFFECTS

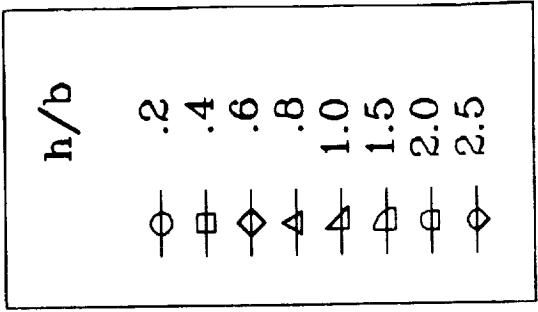
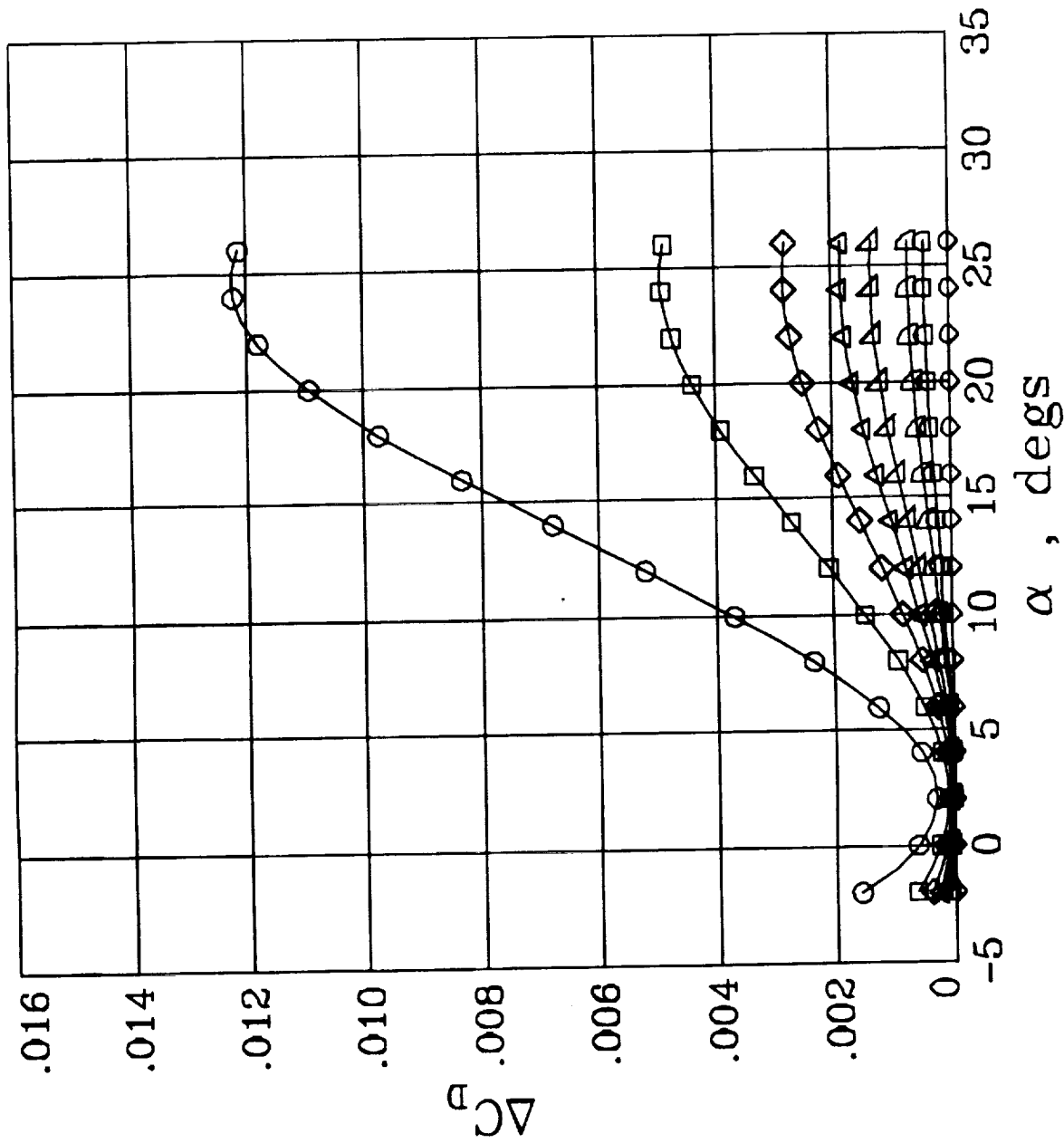

AERO DATA BASE FOR HL-20 FLIGHT SIMULATION STUDIES



LaRC/SSD
JAN. 1991

INCREMENTS DUE TO GROUND EFFECTS

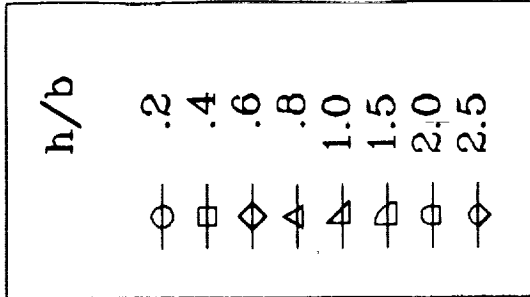
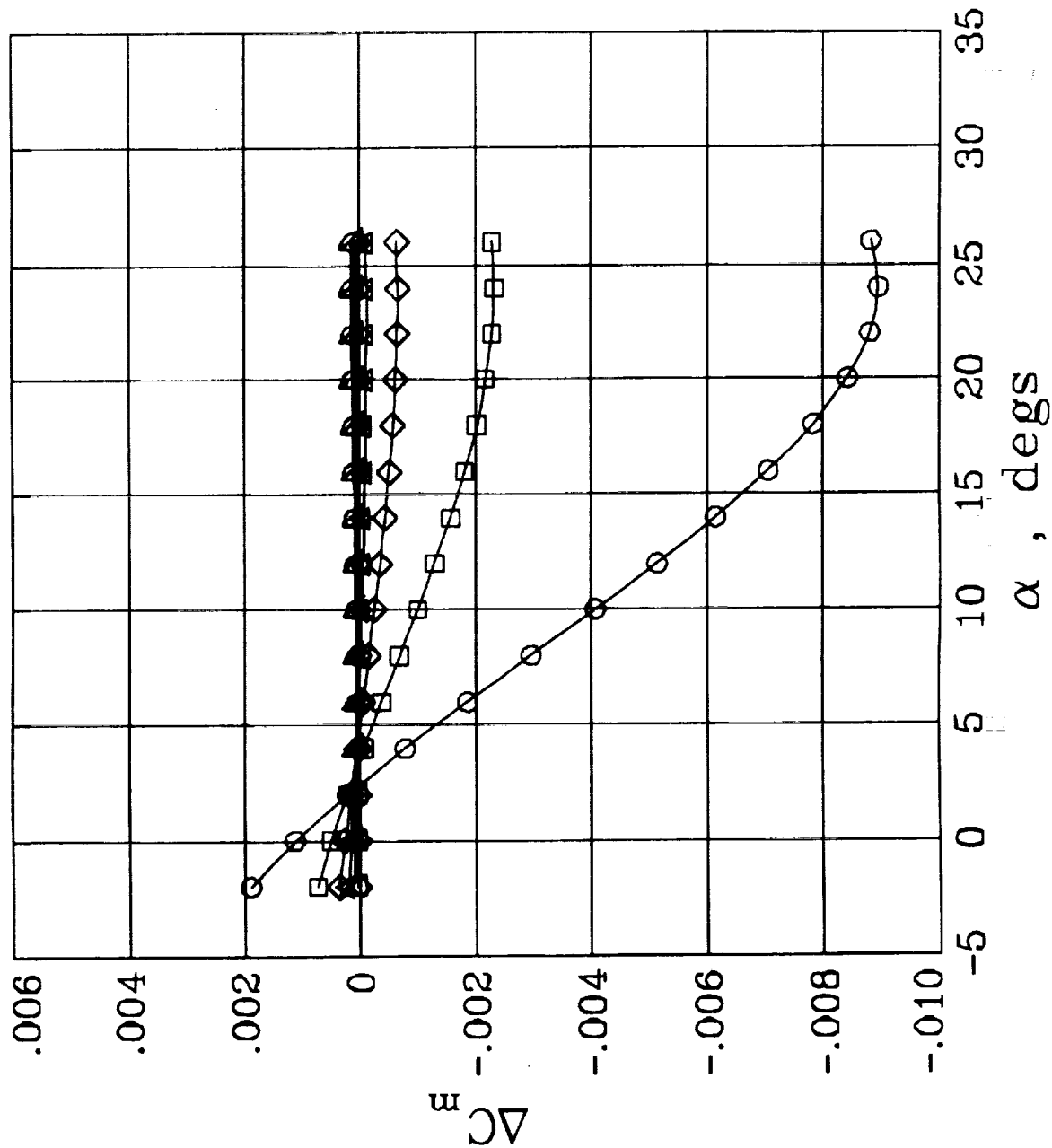

AERO DATA BASE FOR HL-20 FLIGHT SIMULATION STUDIES



LaRC/SSD
JAN. 1991

INCREMENTS DUE TO GROUND EFFECTS

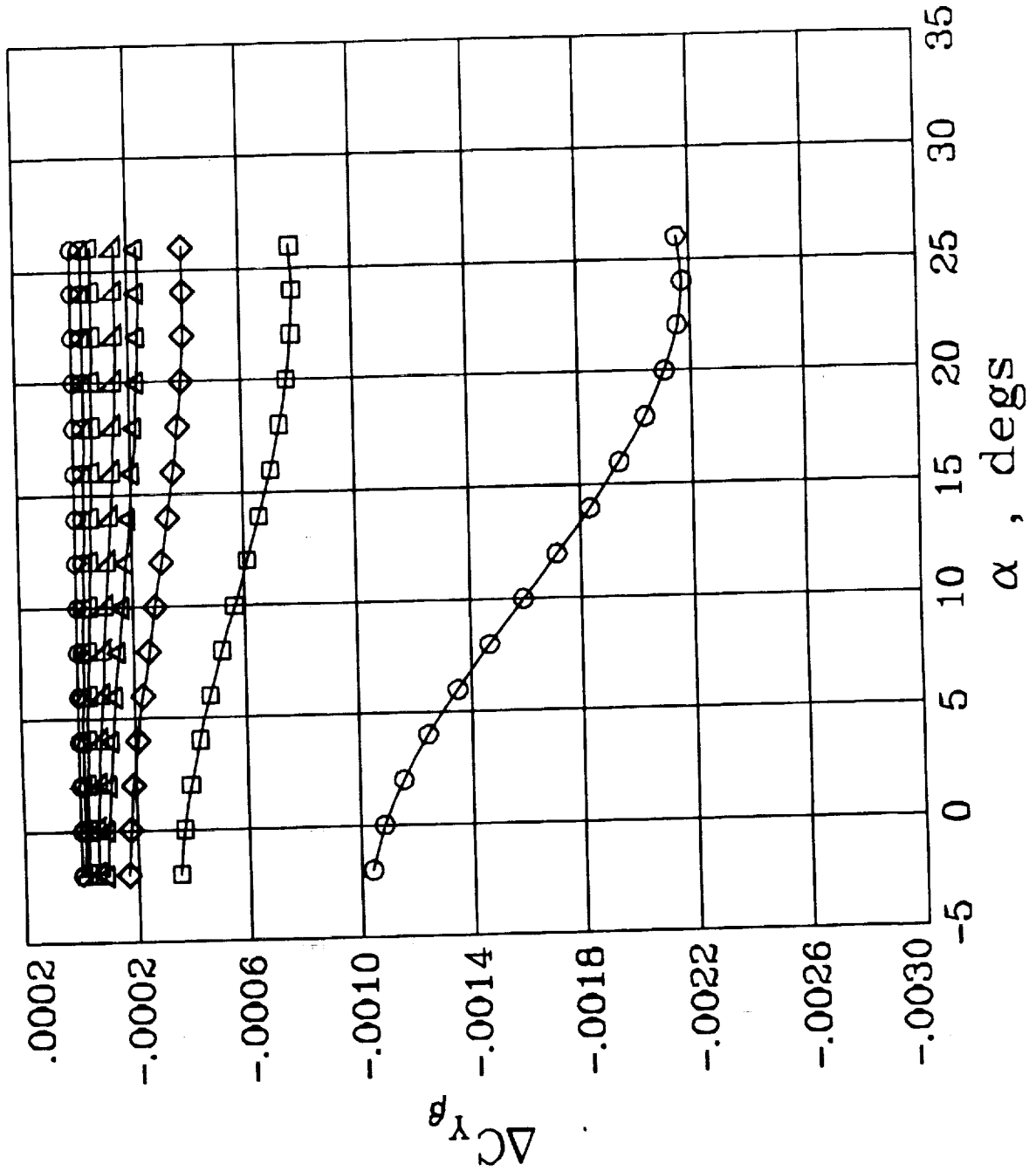

AERO DATA BASE FOR HL-20 FLIGHT SIMULATION STUDIES

INCREMENTS DUE TO GROUND EFFECTS



LaRC/SSD
JAN. 1991

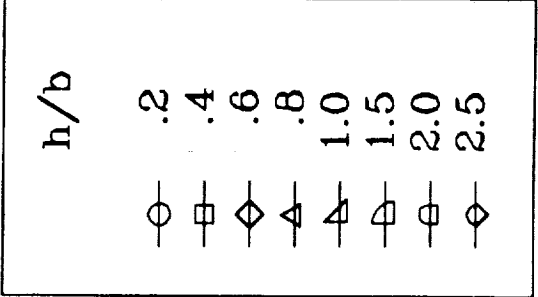
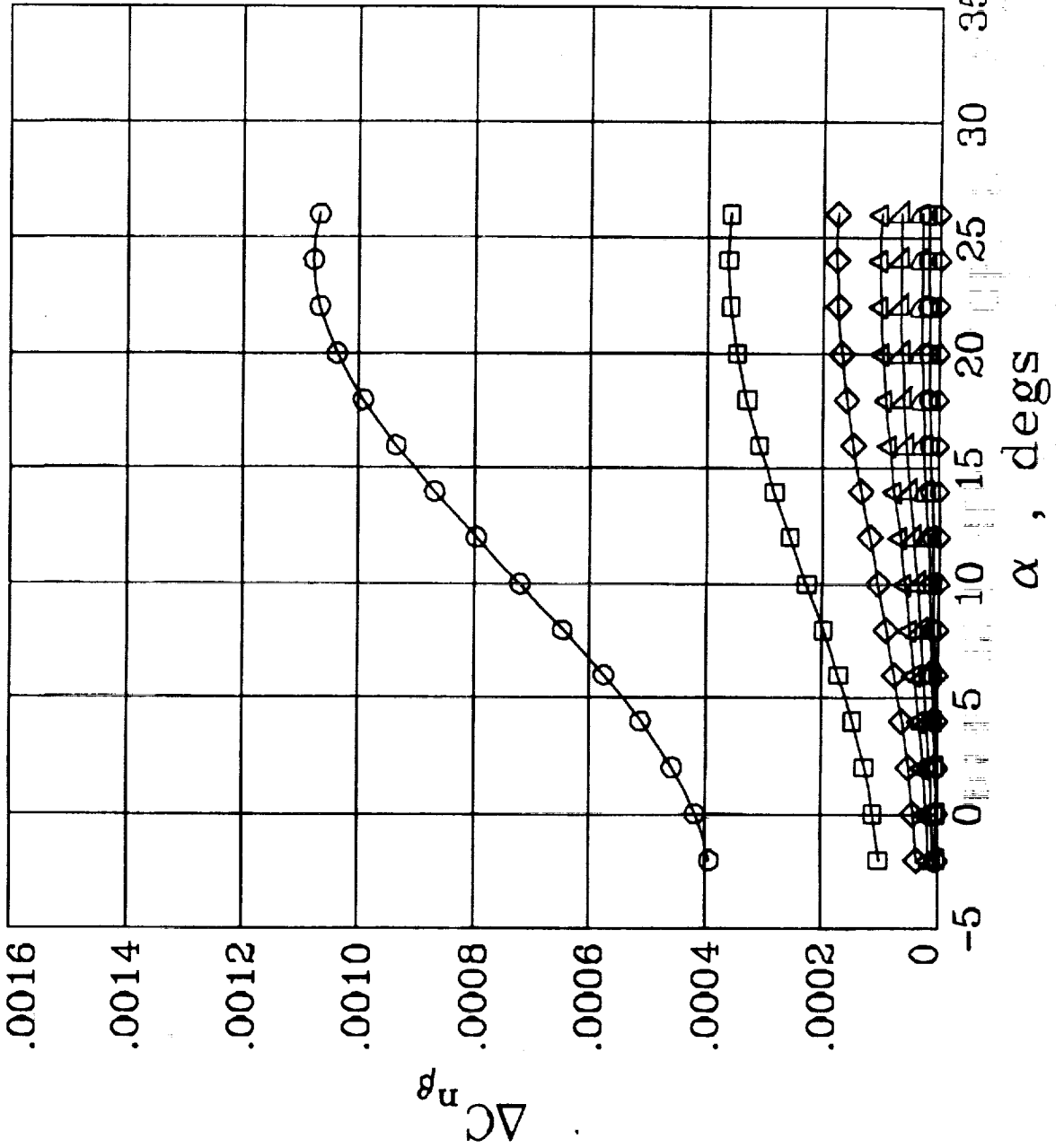

AERO DATA BASE FOR HL-20 FLIGHT SIMULATION STUDIES



LaRC/SSD
JAN. 1991

INCREMENTS DUE TO GROUND EFFECTS

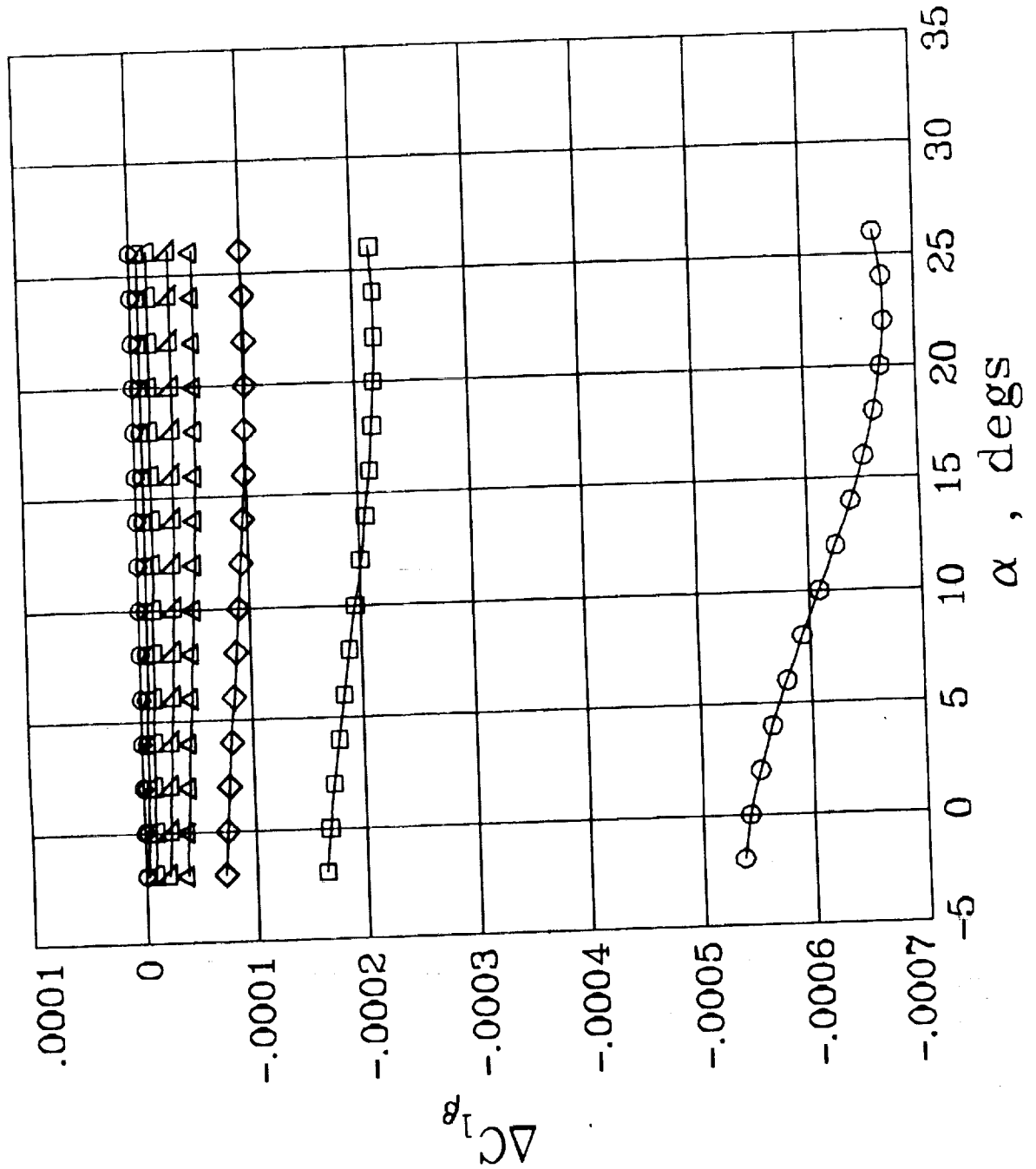

AERO DATA BASE FOR HL-20 FLIGHT SIMULATION STUDIES

INCREMENTS DUE TO LANDING GEAR



LaRC/SSD
JAN. 1991

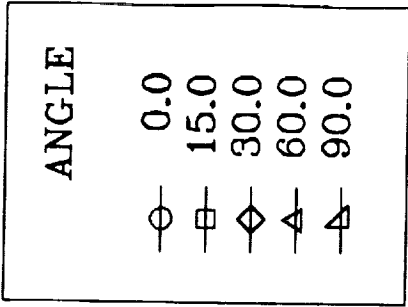
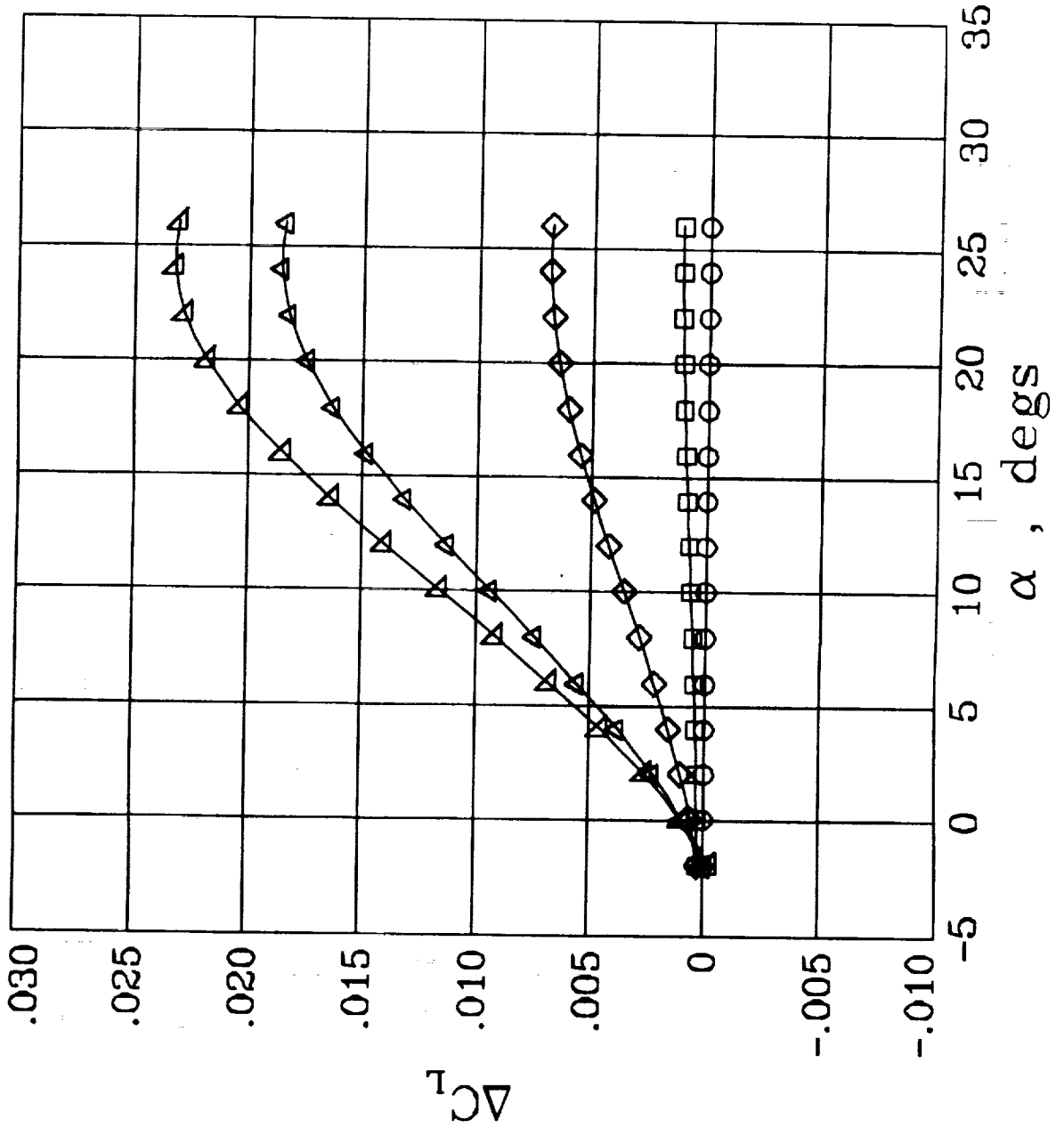

AERO DATA BASE FOR HL-20 FLIGHT SIMULATION STUDIES



LaRC/SSD
JAN. 1991

INCREMENTS DUE TO LANDING GEAR

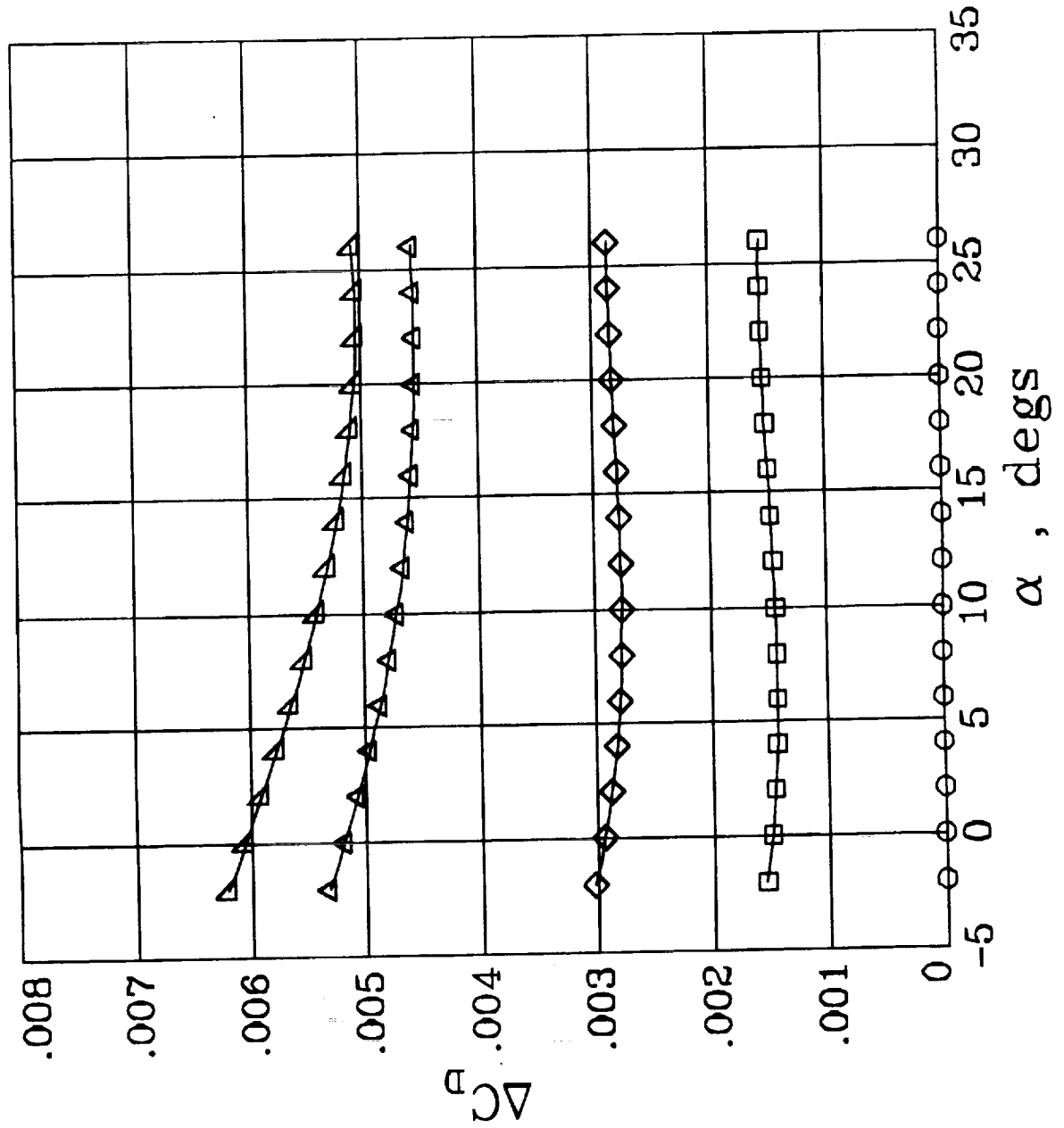

INCREMENTS DUE TO LANDING GEAR



LaRC/SSD
JAN. 1991

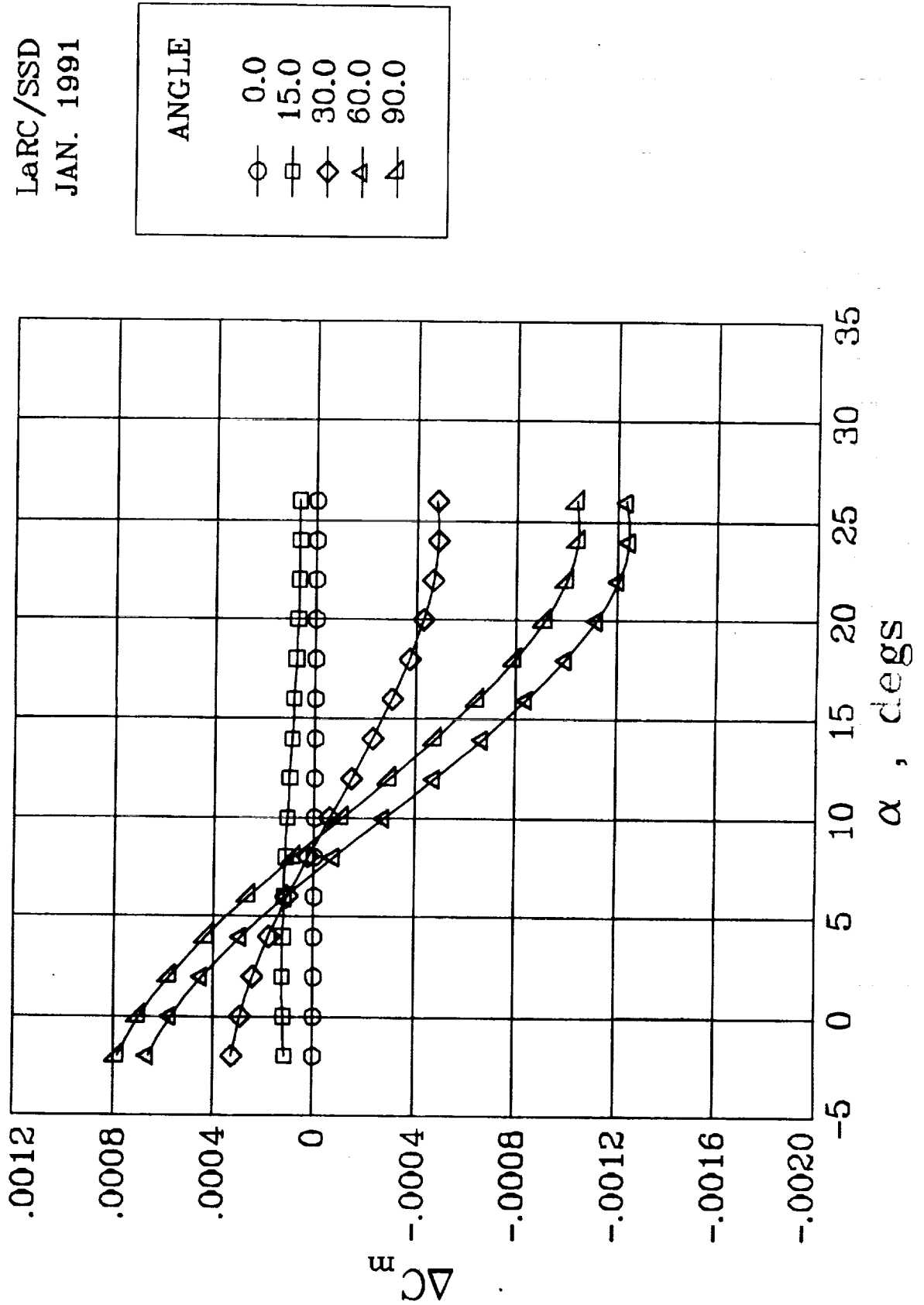

AERO DATA BASE FOR HL-20 FLIGHT SIMULATION STUDIES



LaRC/SSD
JAN. 1991

INCREMENTS DUE TO LANDING GEAR

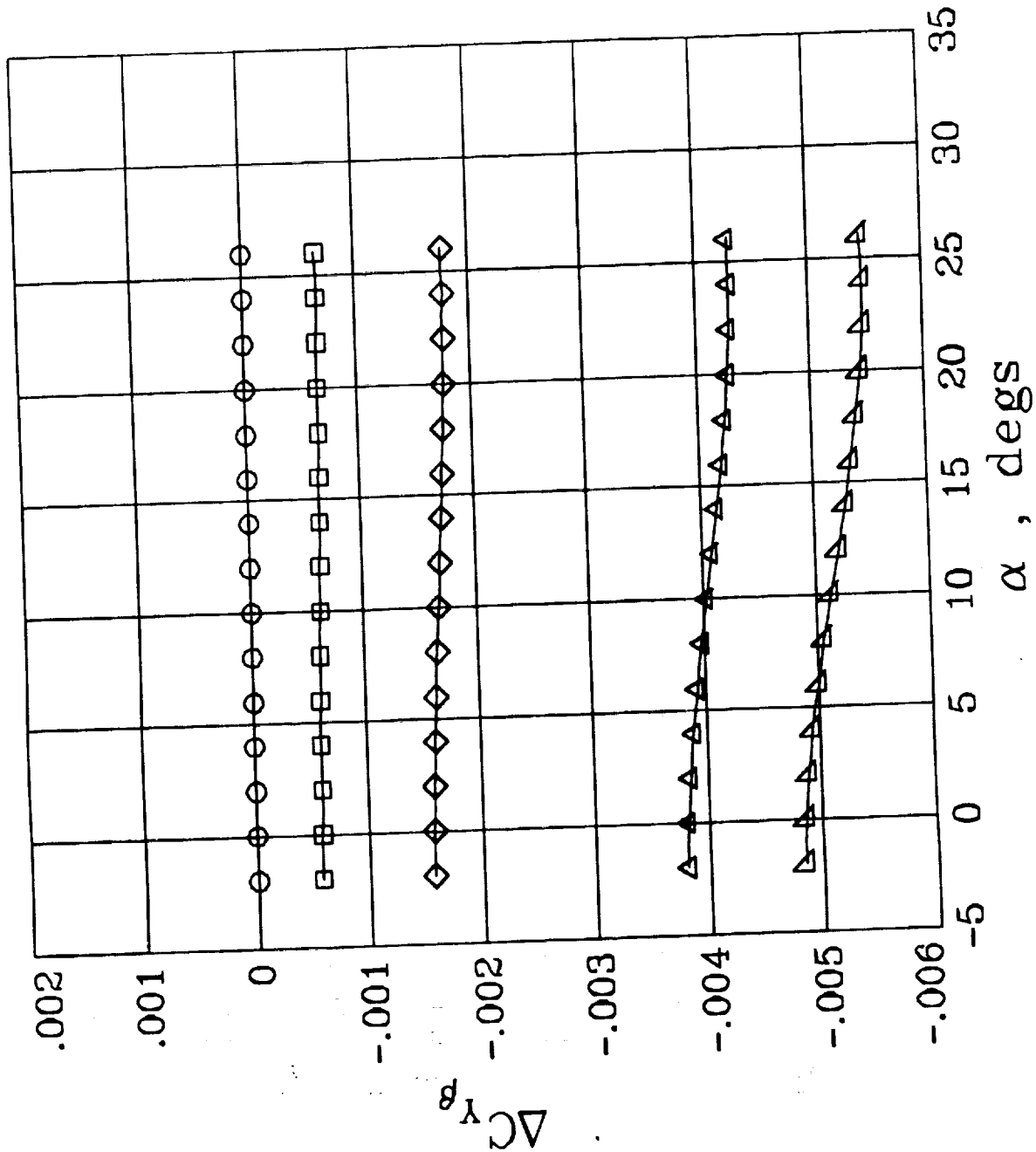

AERO DATA BASE FOR HL-20 FLIGHT SIMULATION STUDIES

INCREMENTS DUE TO LANDING GEAR



LaRC/SSD
JAN. 1991

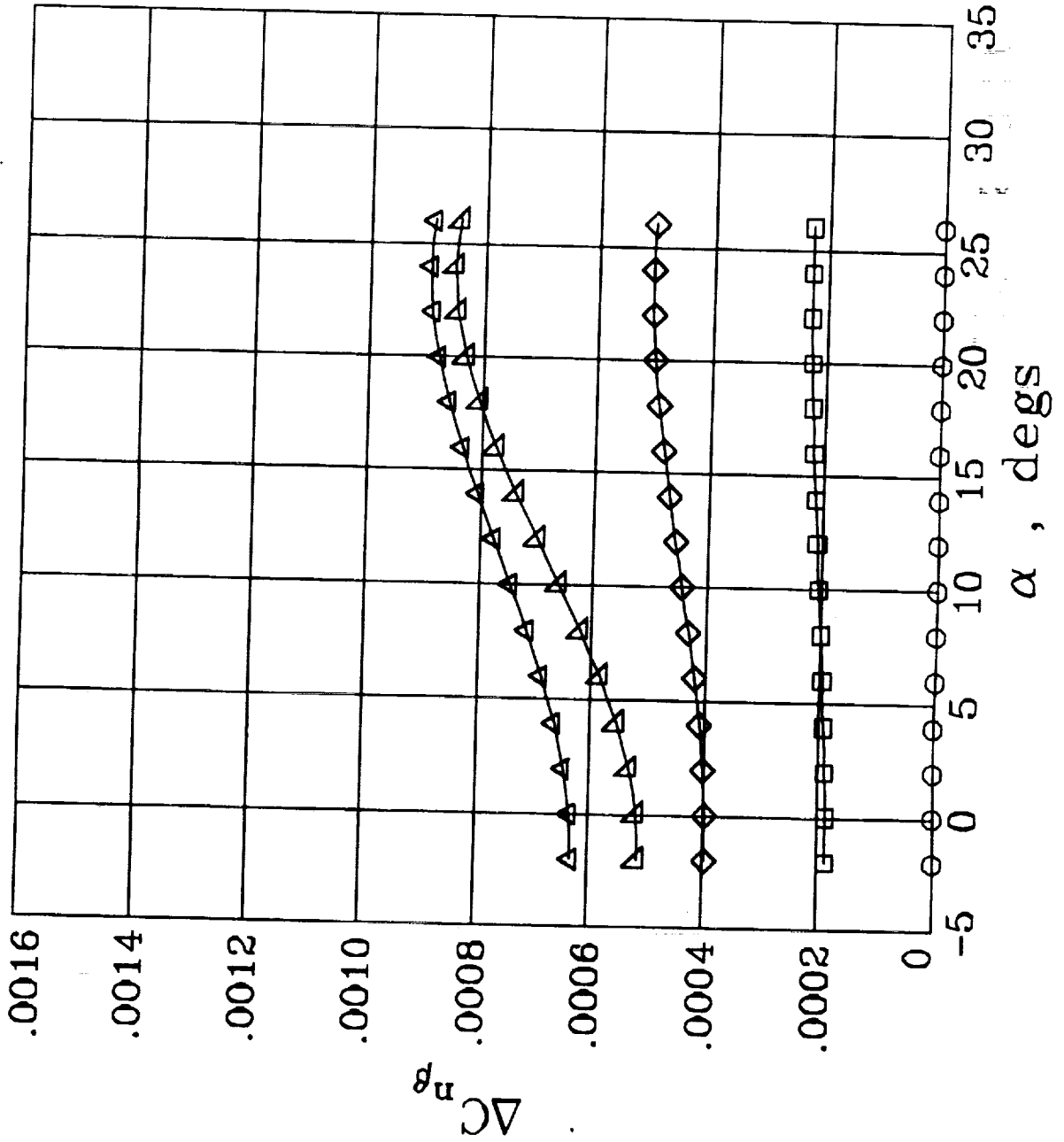
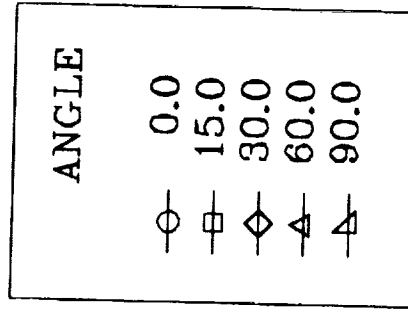

AERO DATA BASE FOR HL-20 FLIGHT SIMULATION STUDIES



LaRC/SSD
JAN. 1991

INCREMENTS DUE TO LANDING GEAR

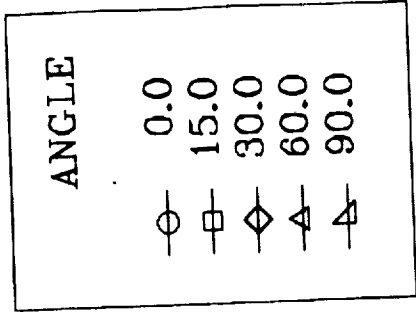
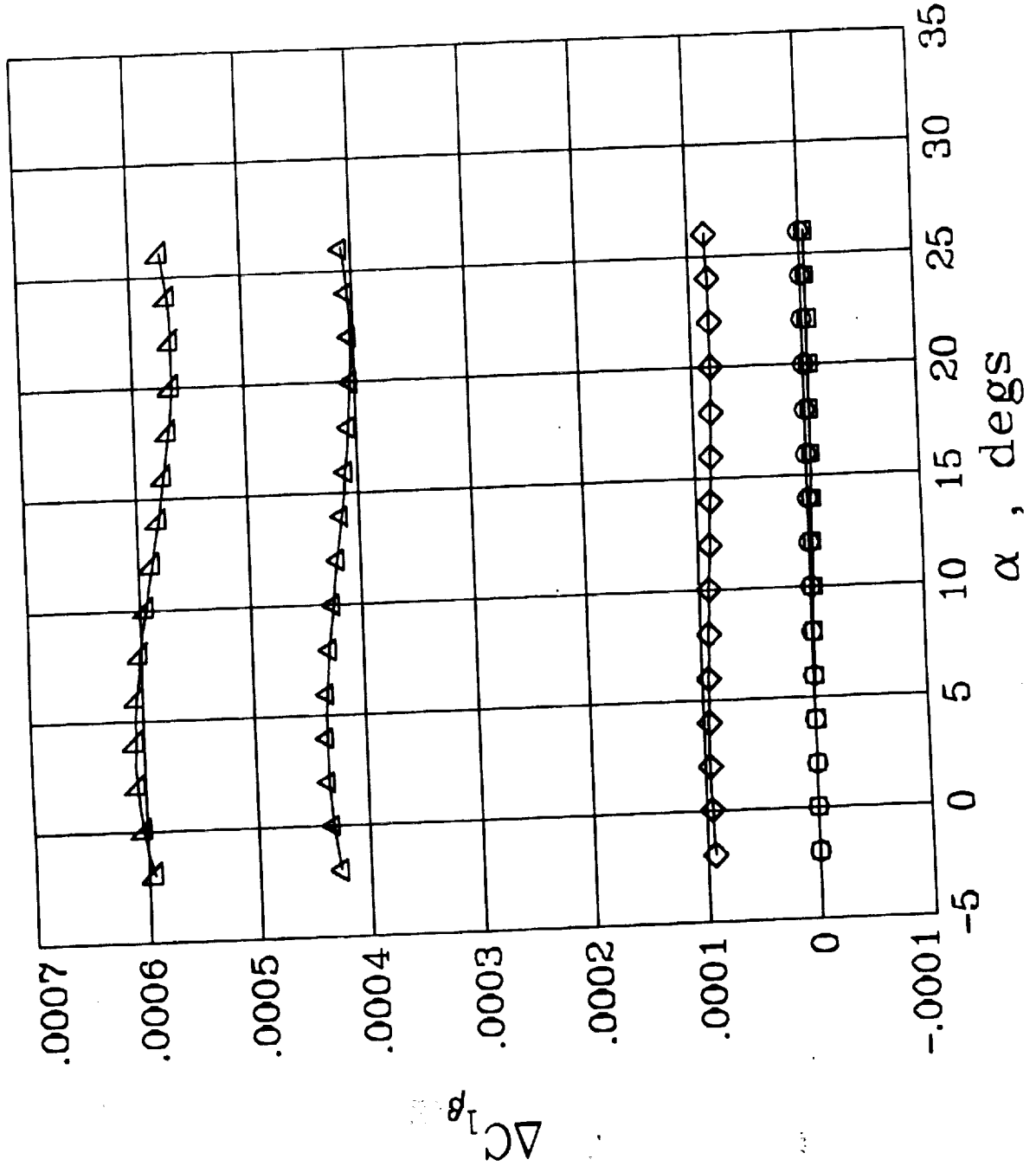

Faint, illegible text, possibly bleed-through from the reverse side of the page. The text is too light to transcribe accurately but appears to be organized into paragraphs or sections.



Appendix F
Dynamic checks for validation purposes

Dynamic check case plots

This appendix contains time history plots of the response of the Langley HL-20 real-time simulation to pulse inputs in each pilot control, conducted in three different flight regimes. They are intended as a "graduation exercise"; that is, an end-to-end comparison between the Langley simulation implementation and HL-20 simulations implemented at other facilities.

As described in the text of the report, these check cases were run with the same aerodynamics, inertias, and control laws described elsewhere in this report. The control laws were configured for manual operation. The center of gravity was 55.5 %, the landing gear was not extended. Note that the autoland system is not engaged, therefore, the guidance errors (plot page 17) are non-zero.

There are three different flight conditions represented, which correspond to the three trim conditions given in the previous appendix (Appendix E):

Trim case '0':	300 KEAS at 10,000 feet altitude
Trim case '2':	Mach 2 at 58,700 feet altitude
Trim case '4':	Mach 4 at 105,000 feet altitude

For each check case, there are four separate maneuvers plotted, corresponding to four different control inputs. For each case, the control inputs occur in the same order:

- Aft pitch stick pulse of one second duration, commencing at $t = 1$ second
- Right roll stick pulse of one second duration, commencing at $t = 1$ second
- Right rudder pedal pulse of one second duration, starting at $t = 1$ second
- Speedbrake handle pulse of three seconds duration, starting at $t = 1$ second

Each set of time history is 10 seconds long (20 seconds for the speedbrake cases). Each set of 69 parameter time histories is given, on 20 different pages, in the following order (see the glossary, appendix A, for a definition of the signal names):

Page	Title	Parameters
1	Pilot inputs	DCPILOT, DWPILOT, DPPILLOT, DLSBCOM (units)
2	Velocities	IAS (knots), QBAR (psf), VTOTALI (fps), MACH
3	Flow & flight path angles	ALPDEG, BETADEG, GAMMAD, TKANG (degrees)
4	C. G. position states	ALT, SX, SY (feet)
5	Euler angles	ALT (feet), PHID, THETAD, PSID (degrees)
6	Body axis velocities	U, B, W, HDOT (ft/sec)
7	Body axis angular rates	PDEG, QDEG, RDEG (degrees/second)
8	Body axis lin. accels	UDOT, VDOT, WDOT (ft/sec ²)
9	Body axis ang. accels	PDOT, QDOT, RDOT (rad/sec ²)
10	Aero coefficients - force	CLTOT, CDTOT, CYTOT

11	Aero coeffs. - moments	CLLTOT, CMTOT, CLNTOT (measured at mom. ref.)
12	Aero forces	X, Y, Z (lbs)
13	Aero moments	L, M, N (ft-lbs)
14	C.G. accelerations	ANX, ANY, ANZ ("g" units)
15	FCS mode flags	LFCS, MFCS, MGUID, MCONFIG (integers)
16	Guidance commands	AOACMD, GAMCMD, PHICMD, PSICMD (degrees)
17	Guidance errors	HER, PSIERR, XTK (various units)
18	FCS surface commands	DECMD, DACMD, DRCMD, DSBCMD (degrees)
19	Surf. positions #1	DLE, DRE, DLRDEG, DLGPCT (degrees)
20	Surf. positions #2	DUL, DUR, DLL, DLR (degrees)

The plots therefore comprise $20 \frac{\text{pages}}{\text{maneuver}} \times 4 \frac{\text{maneuvers}}{\text{trim case}} \times 3 \text{ trim cases} = 240$ pages of time history plots, arranged as follows:

Trim case 0 (subsonic):

Pitch pulse	F-3
Lateral pulse	F-23
Directional pulse	F-43
Speed brake pulse.....	F-63

Trim case 2 (Mach 2):

Pitch pulse	F-83
Lateral pulse	F-103
Directional pulse	F-123
Speed brake pulse.....	F-143

Trim case 4 (Mach 4):

Pitch pulse	F-163
Lateral pulse	F-183
Directional pulse	F-203
Speed brake pulse.....	F-223

HL-20 Dynamic Check Case Data Plots 911206
Aft Pitch Stick Pulse at 300 KEAS, 10,000 ft

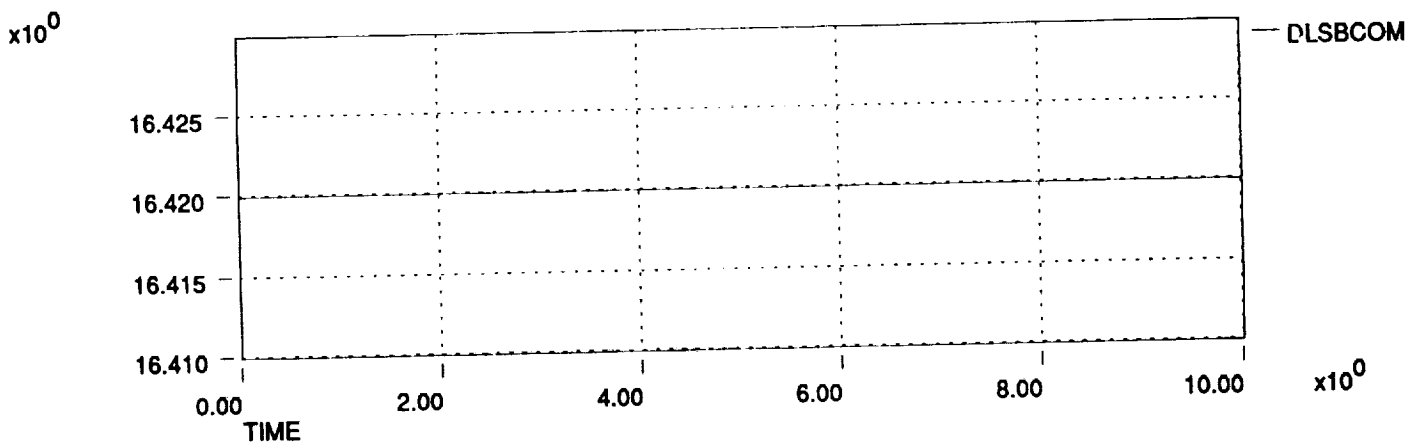
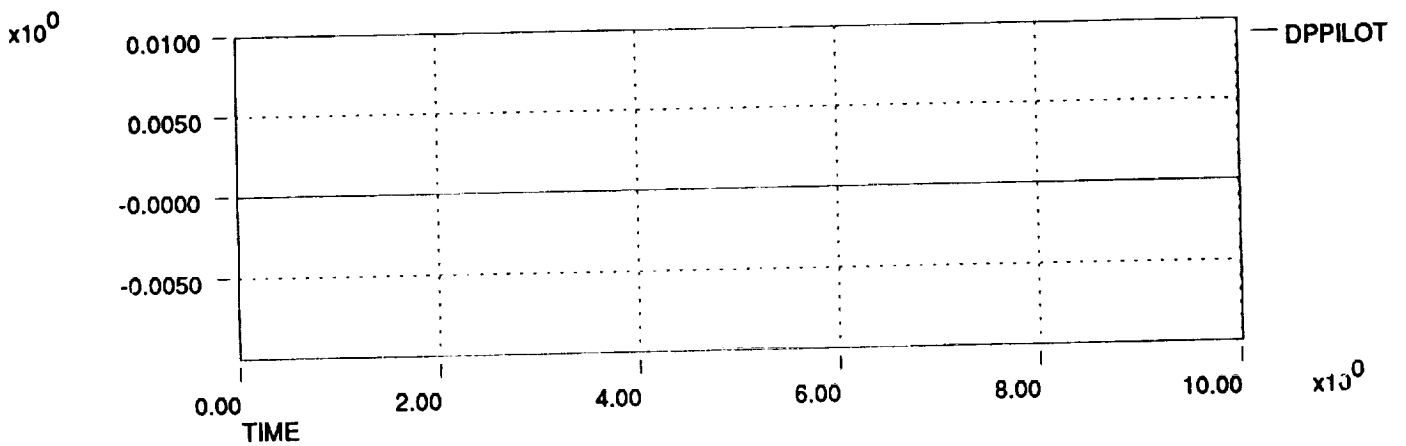
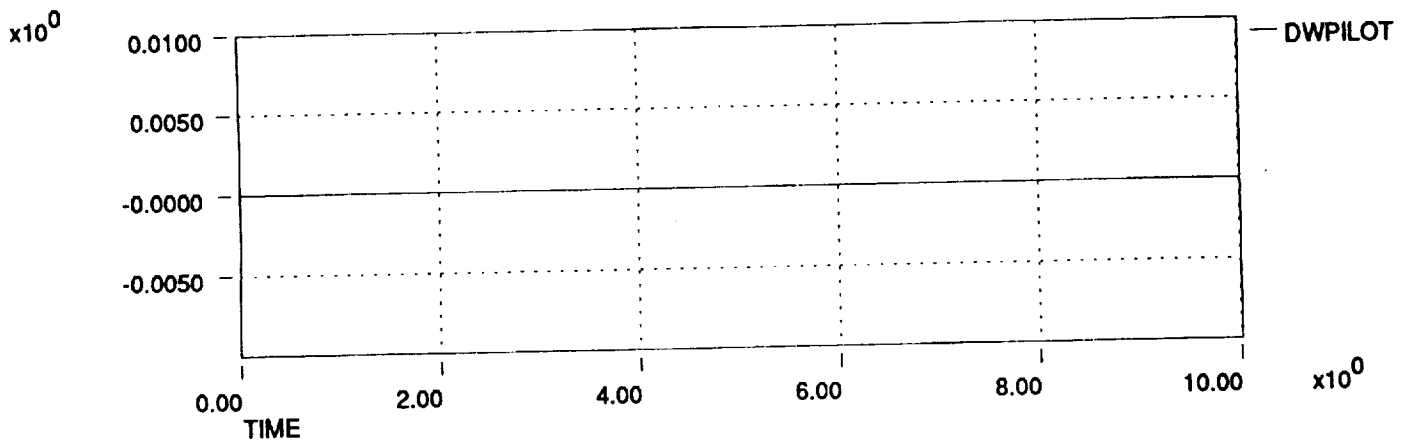
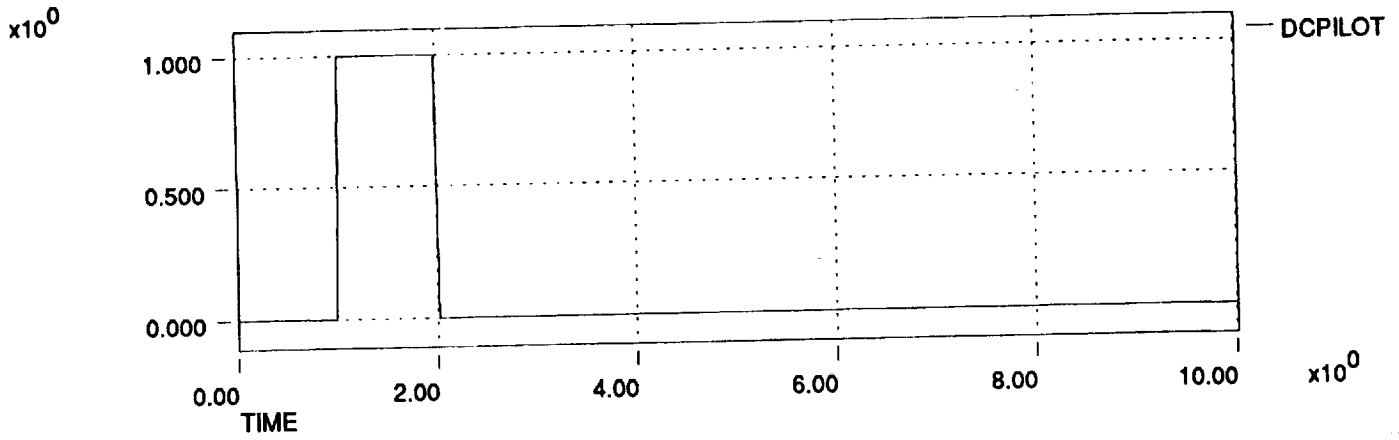

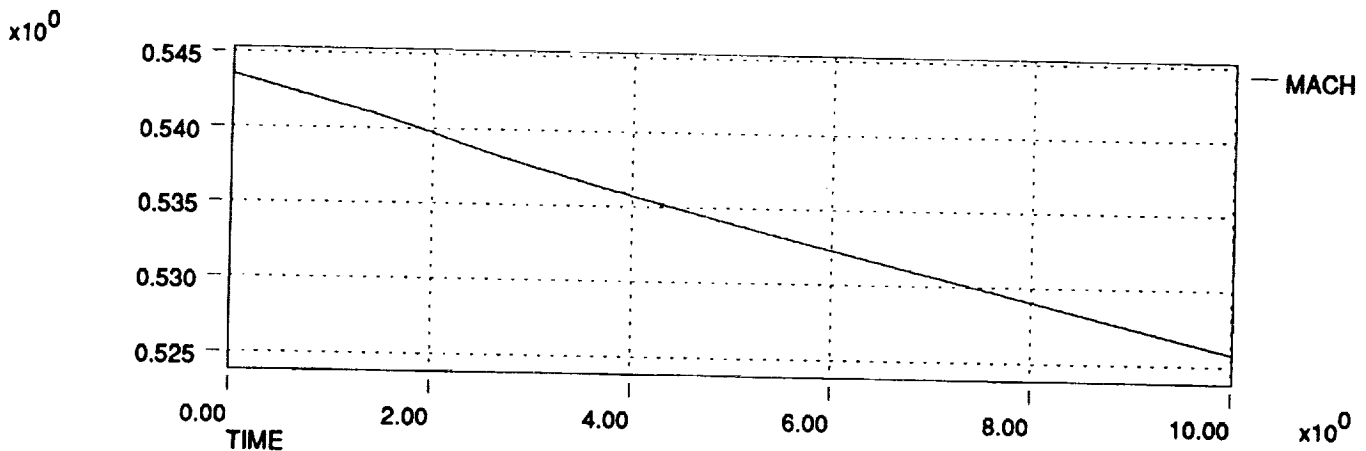
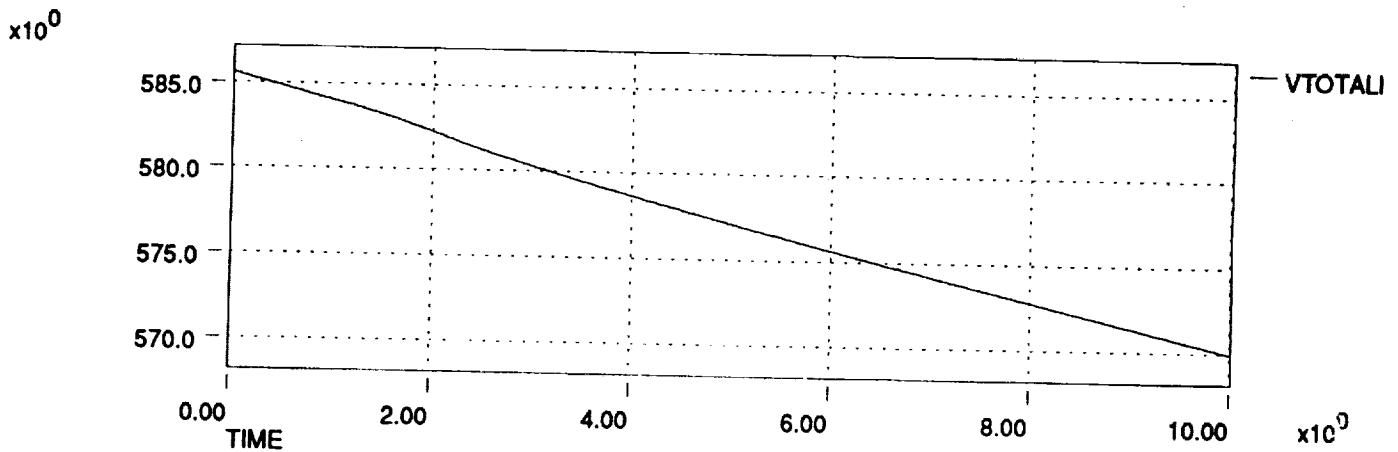
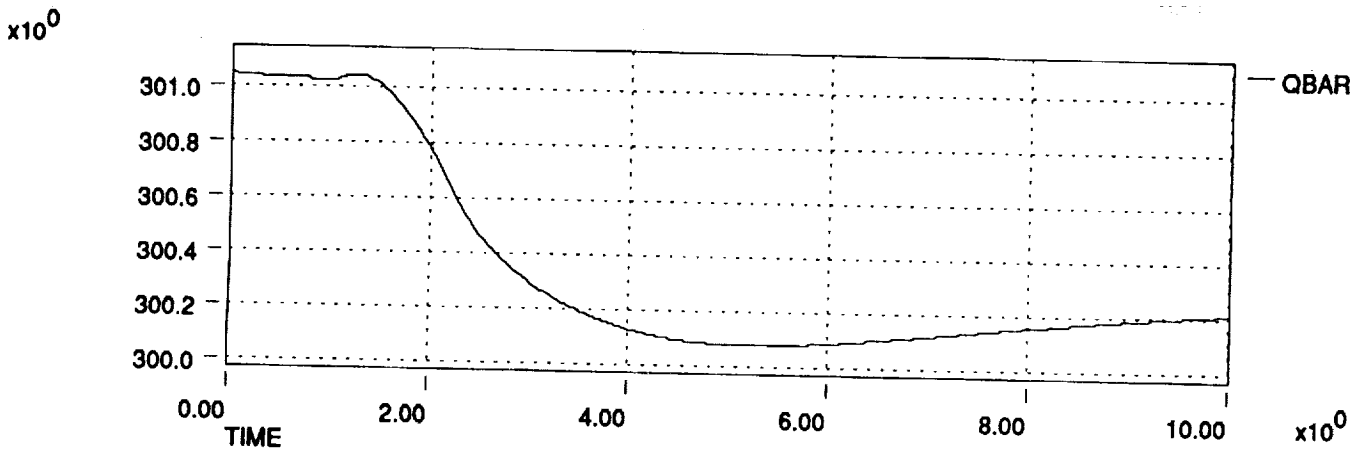
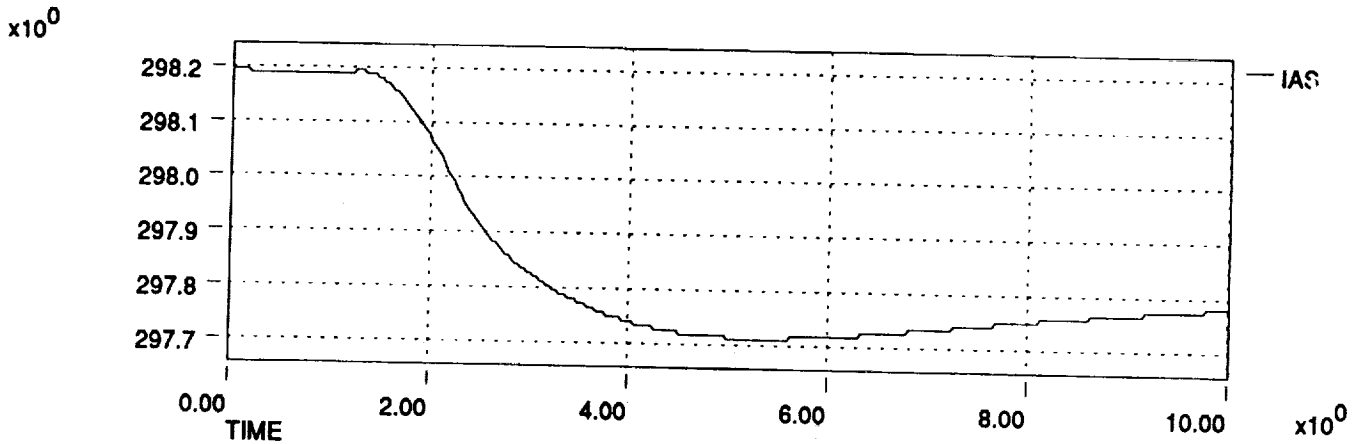

HL-20 Dynamic Check Case Data Plots 911206
Aft Pitch Stick Pulse at 300 KEAS, 10,000 ft

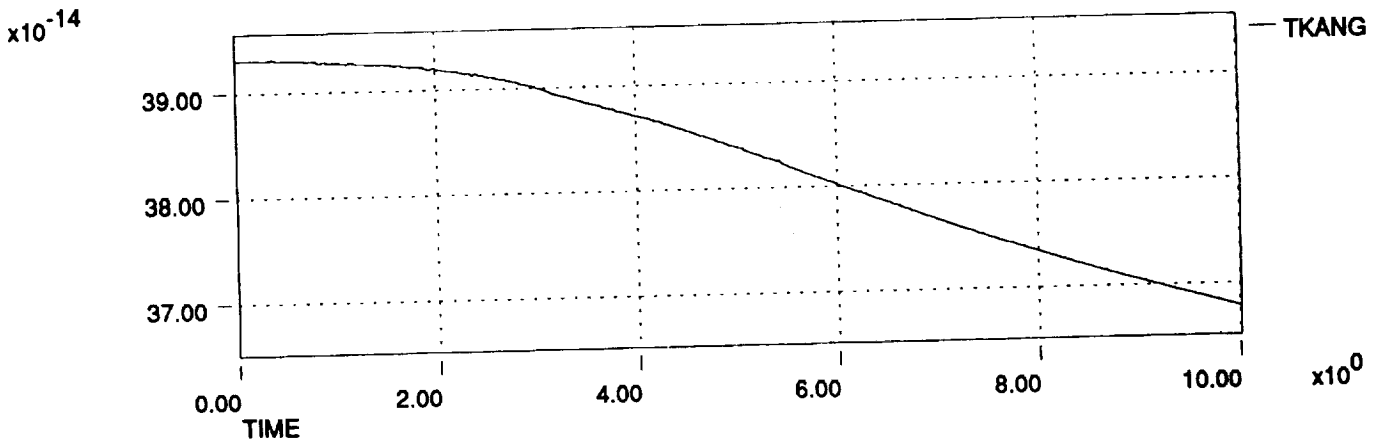
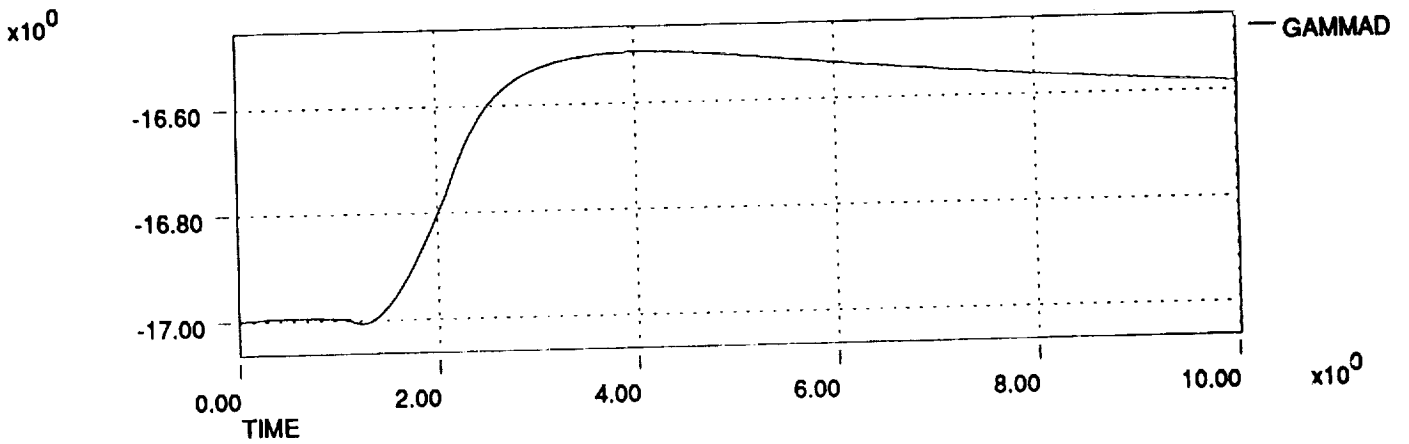
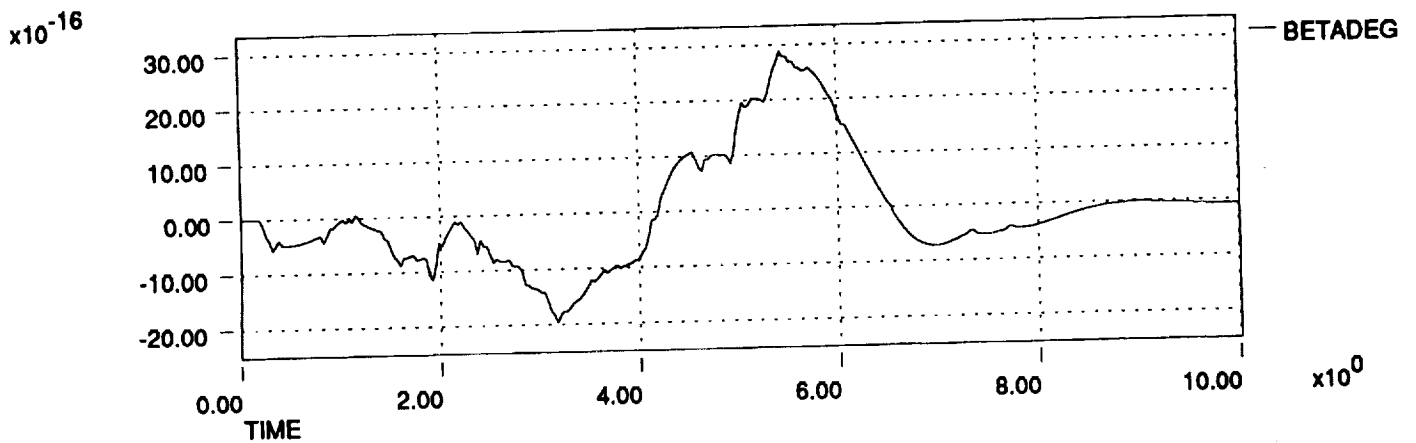
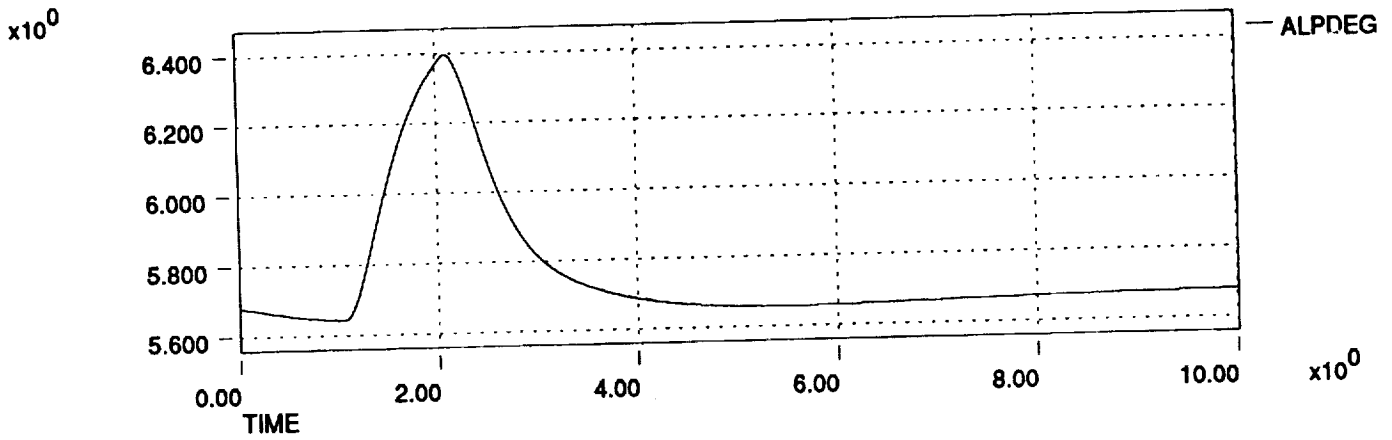

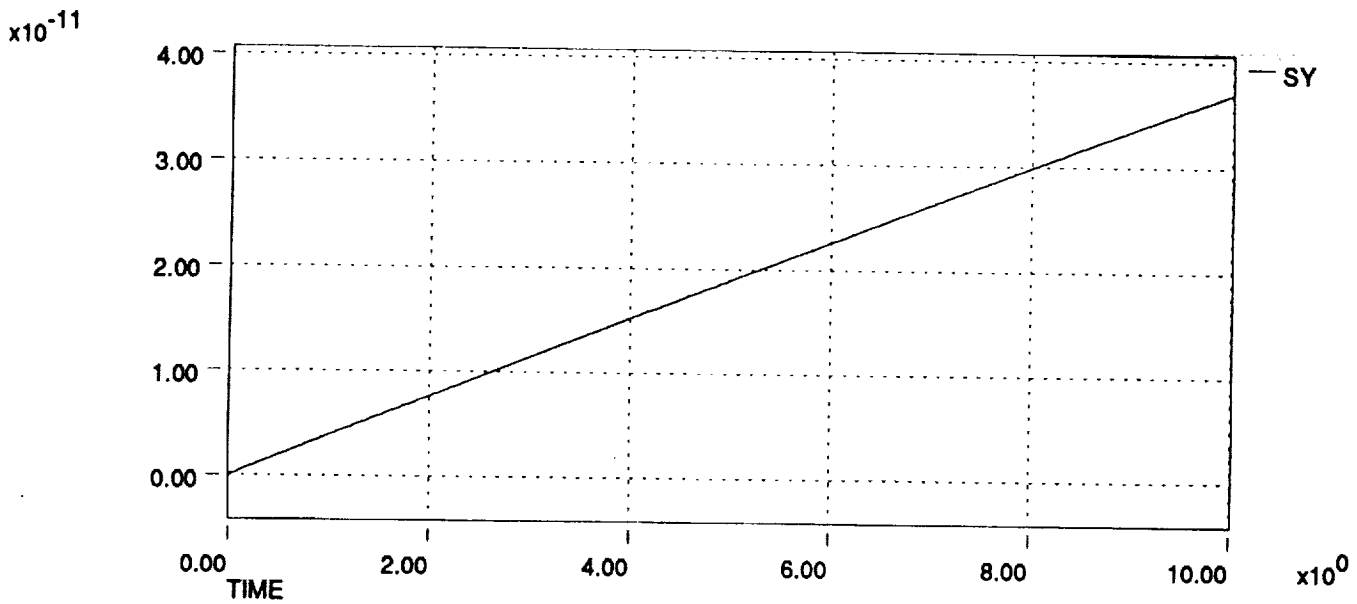
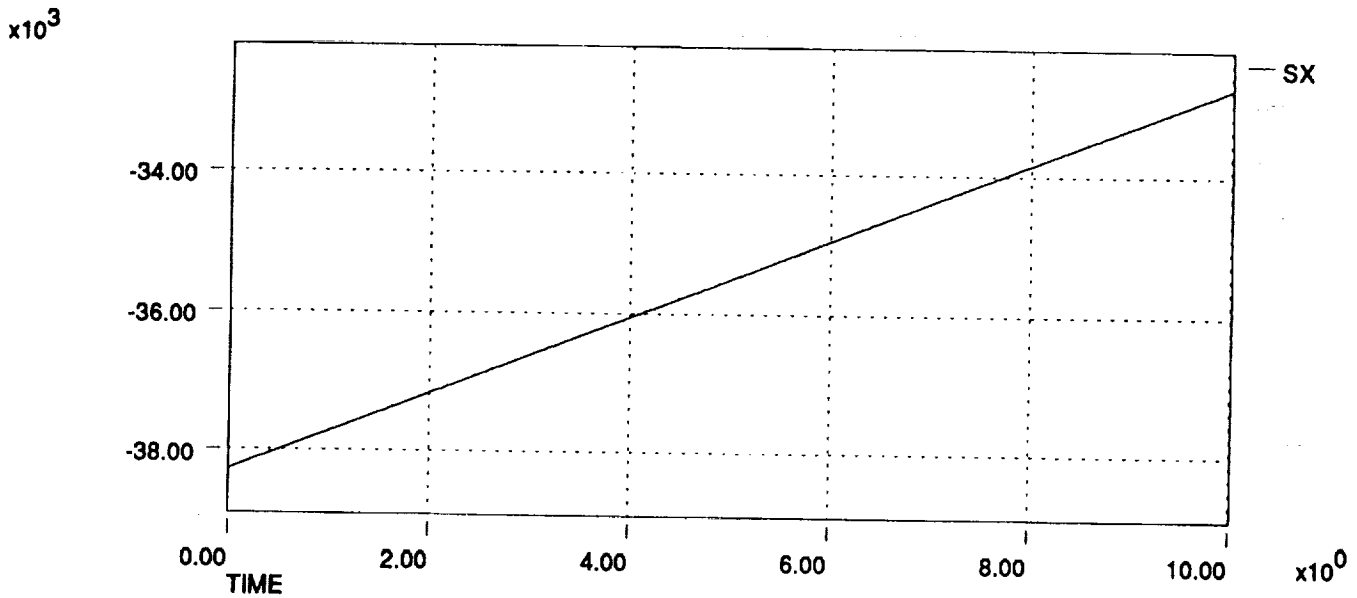
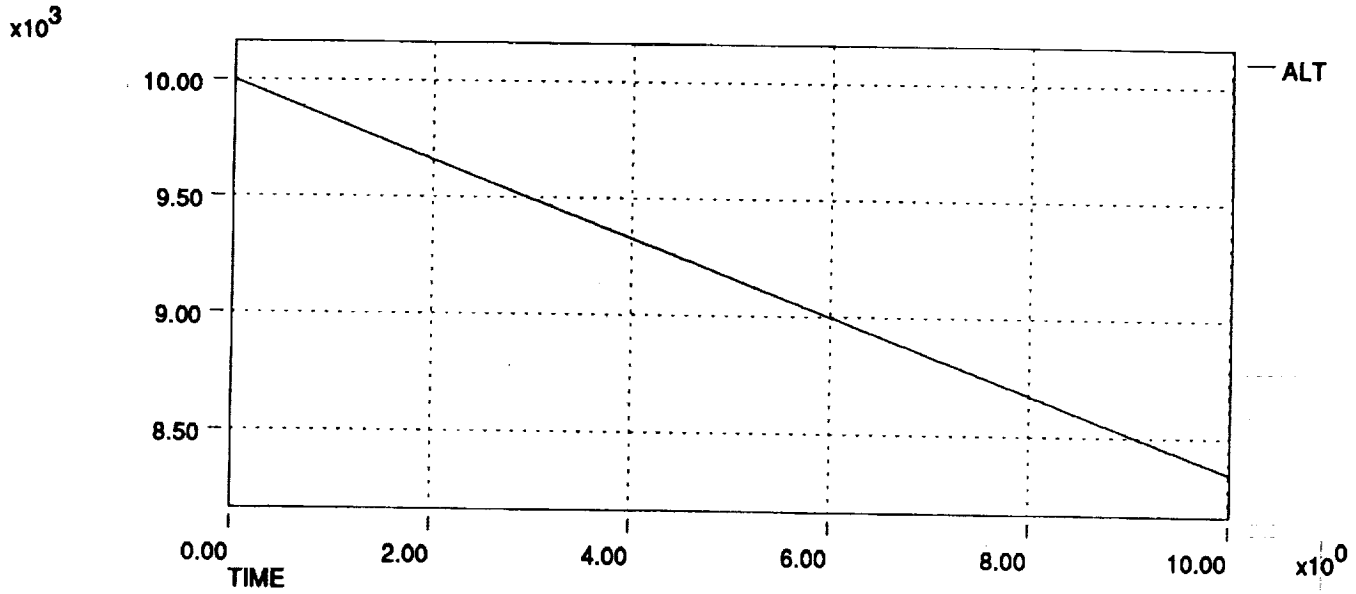

HL-20 Dynamic Check Case Data Plots 911206
Aft Pitch Stick Pulse at 300 KEAS, 10,000 ft

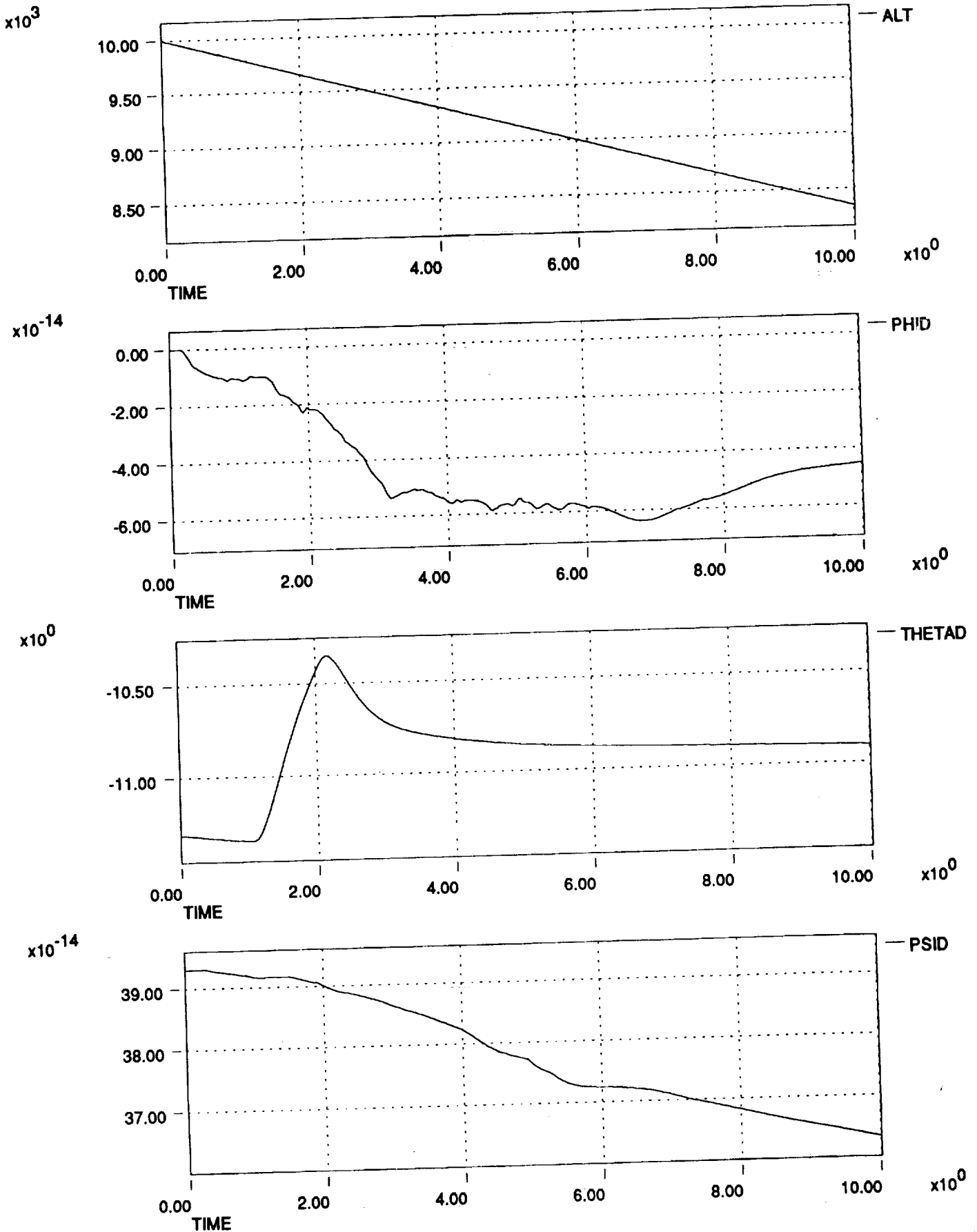

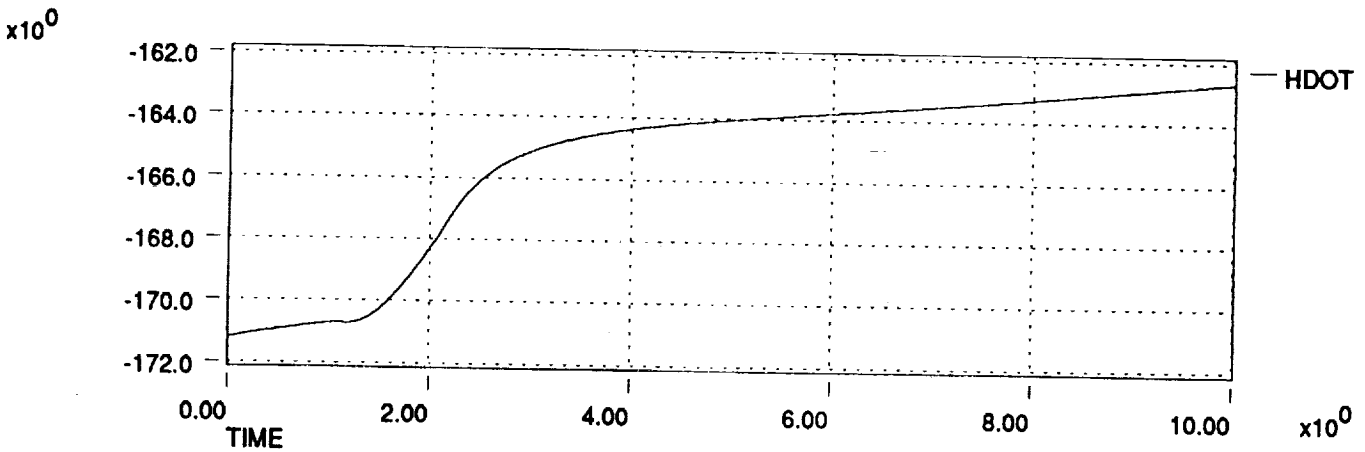
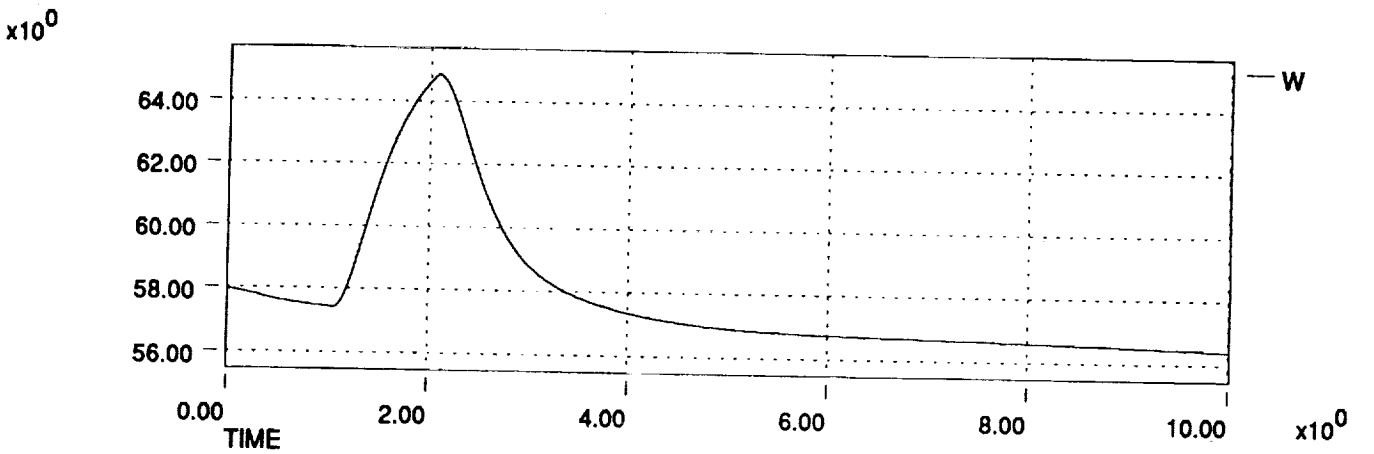
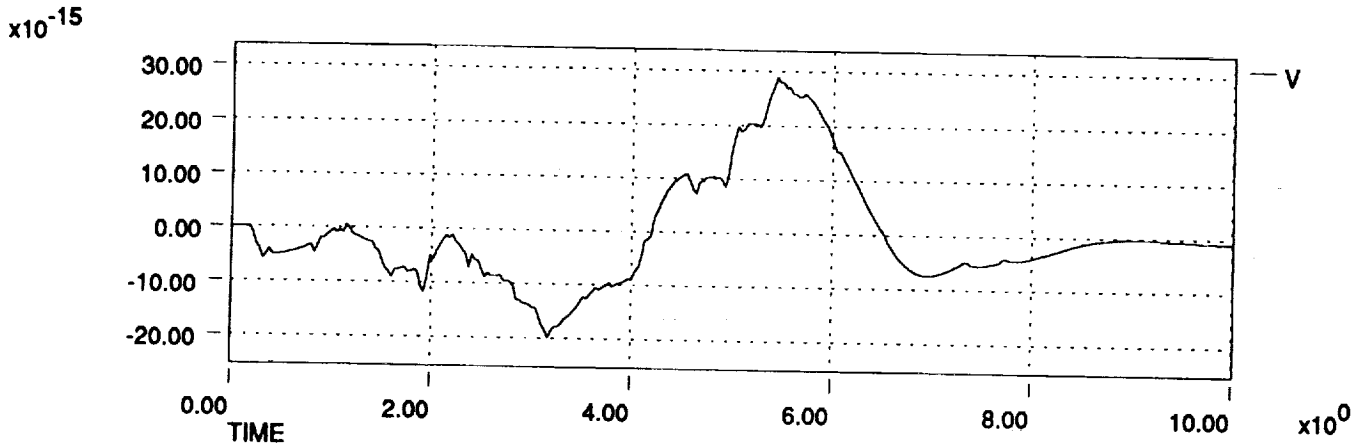
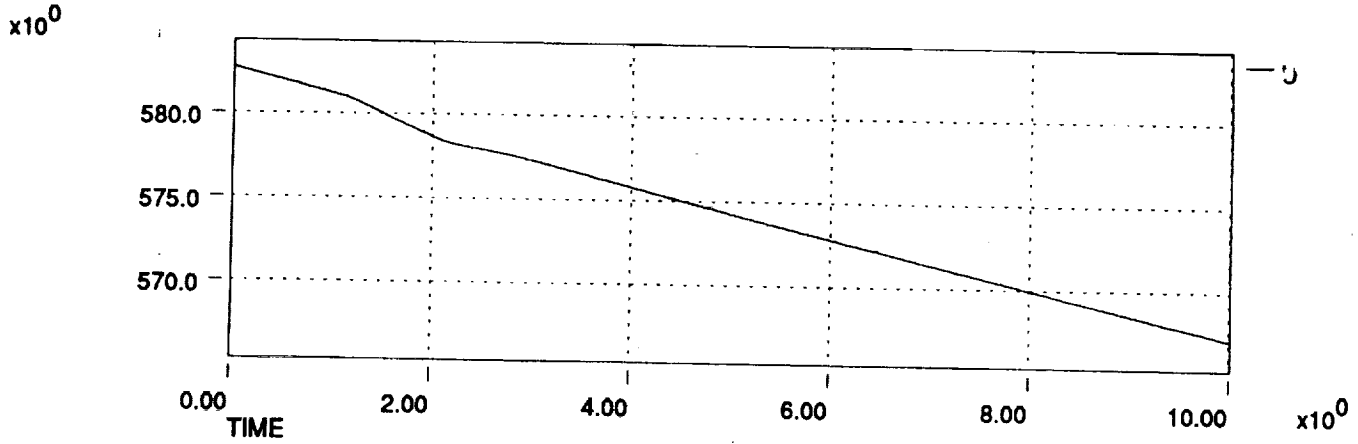

HL-20 Dynamic Check Case Data Plots 911206
Aft Pitch Stick Pulse at 300 KEAS, 10,000 ft

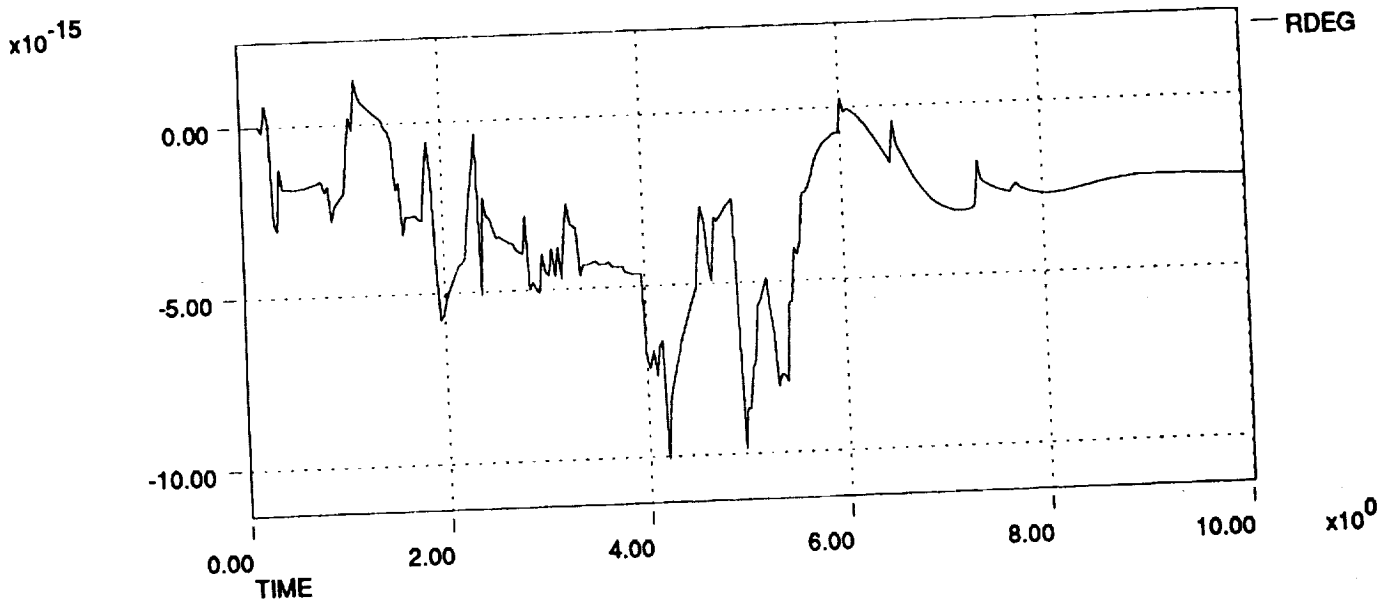
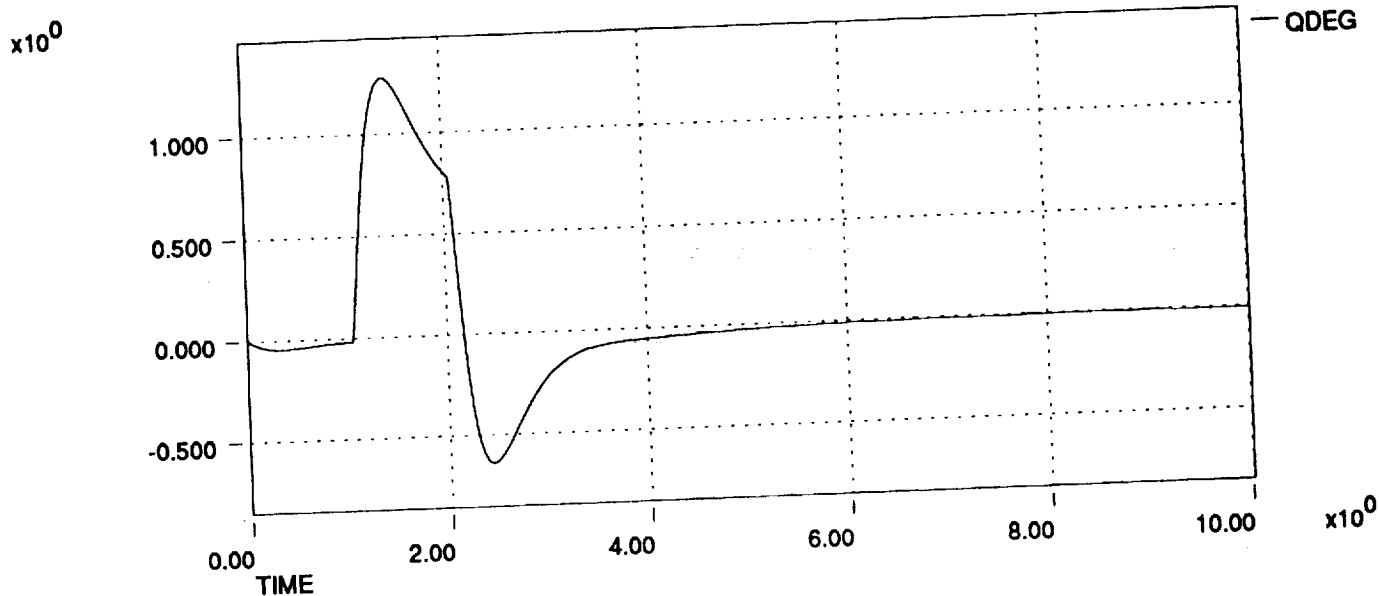
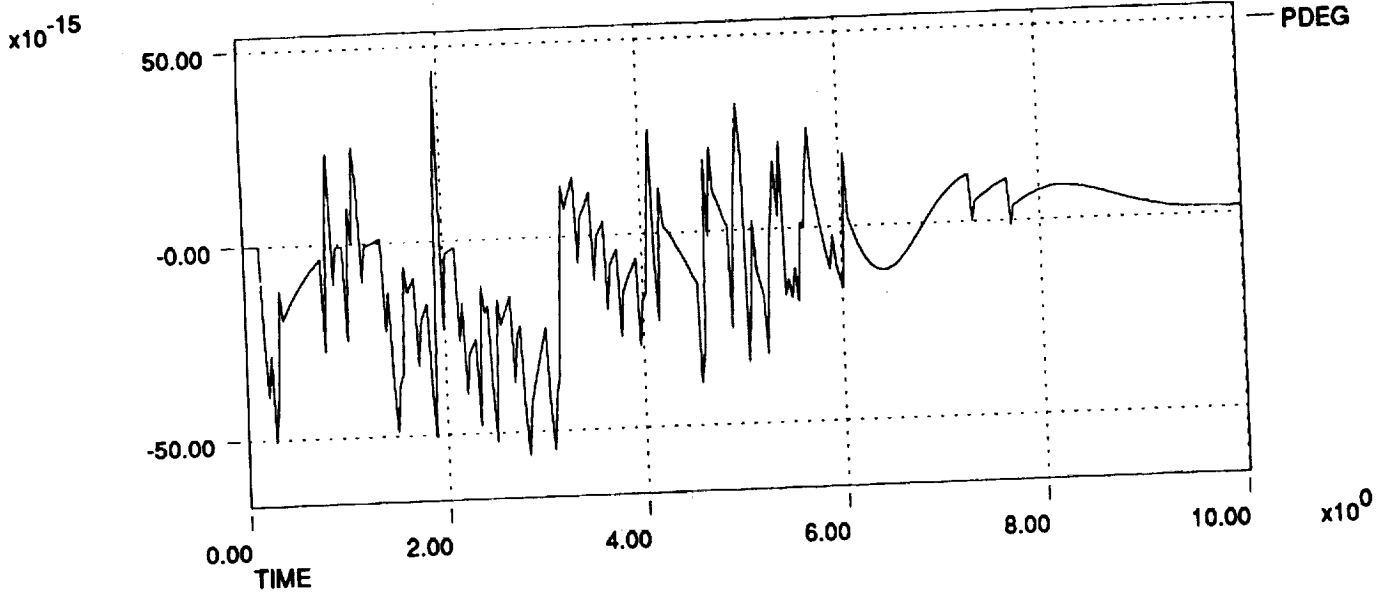

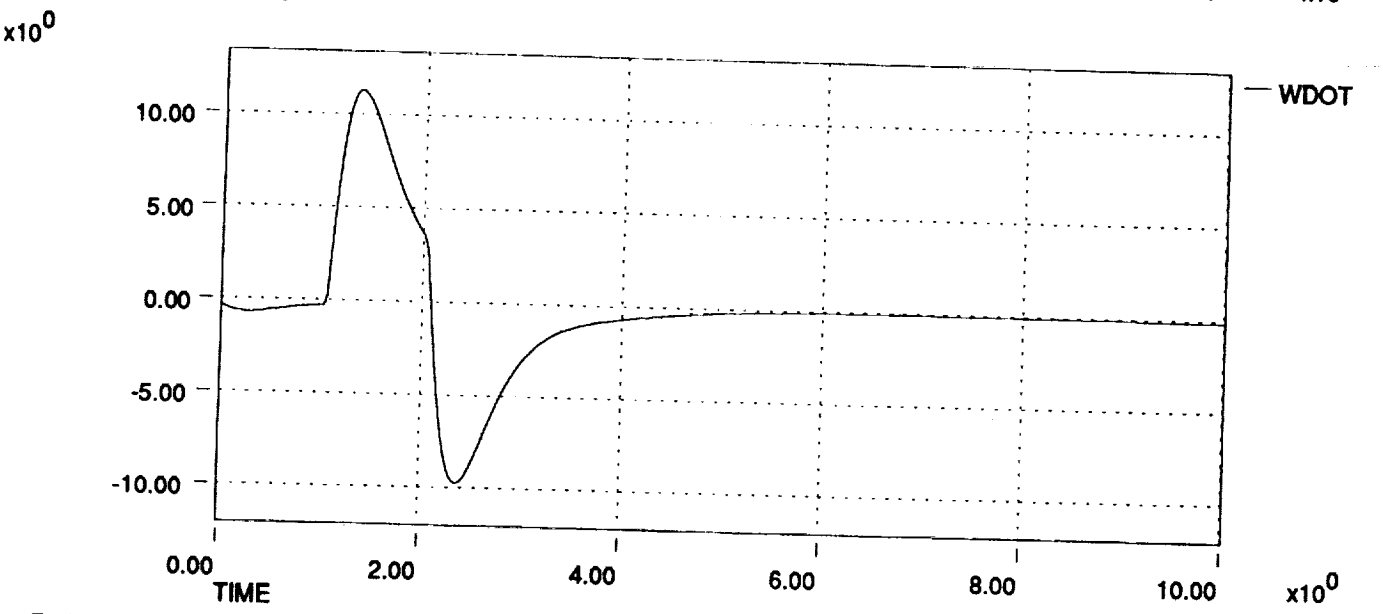
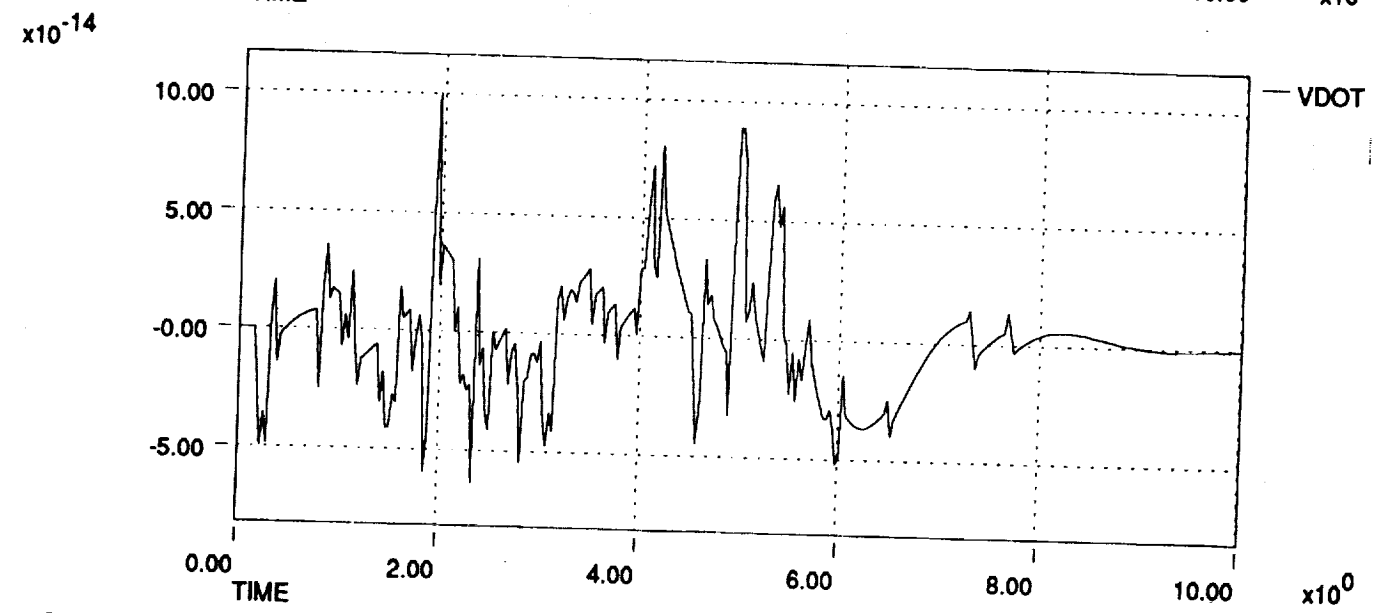
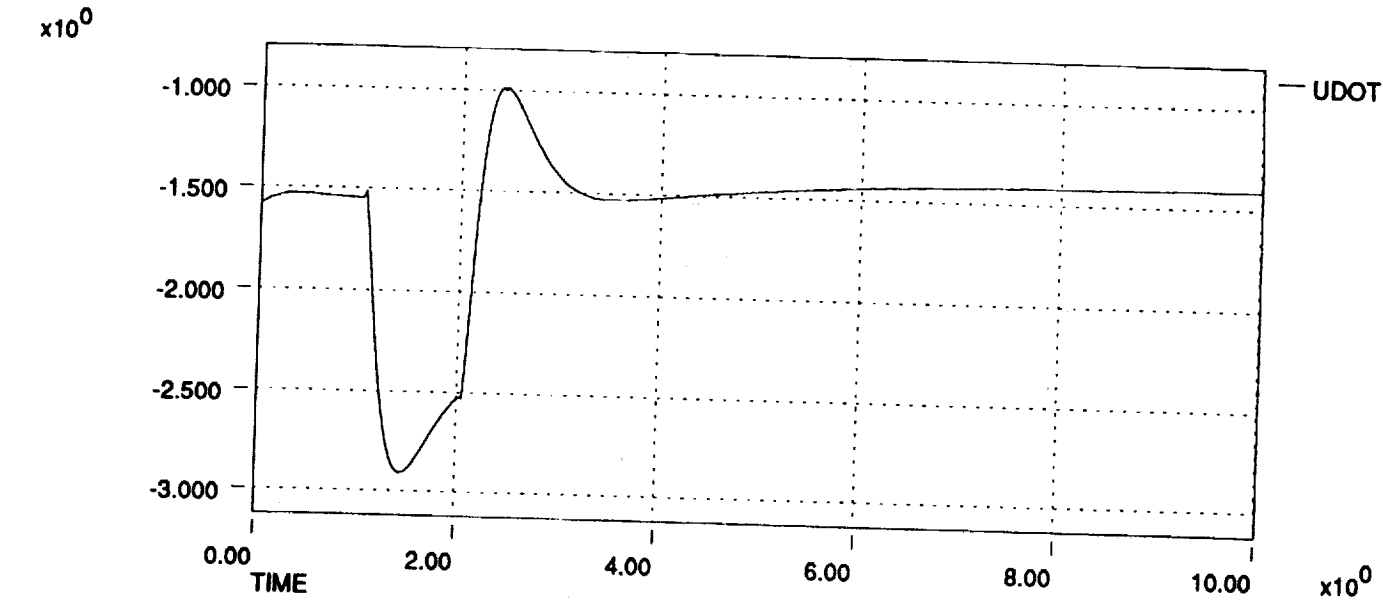

HL-20 Dynamic Check Case Data Plots 911206
Aft Pitch Stick Pulse at 300 KEAS, 10,000 ft

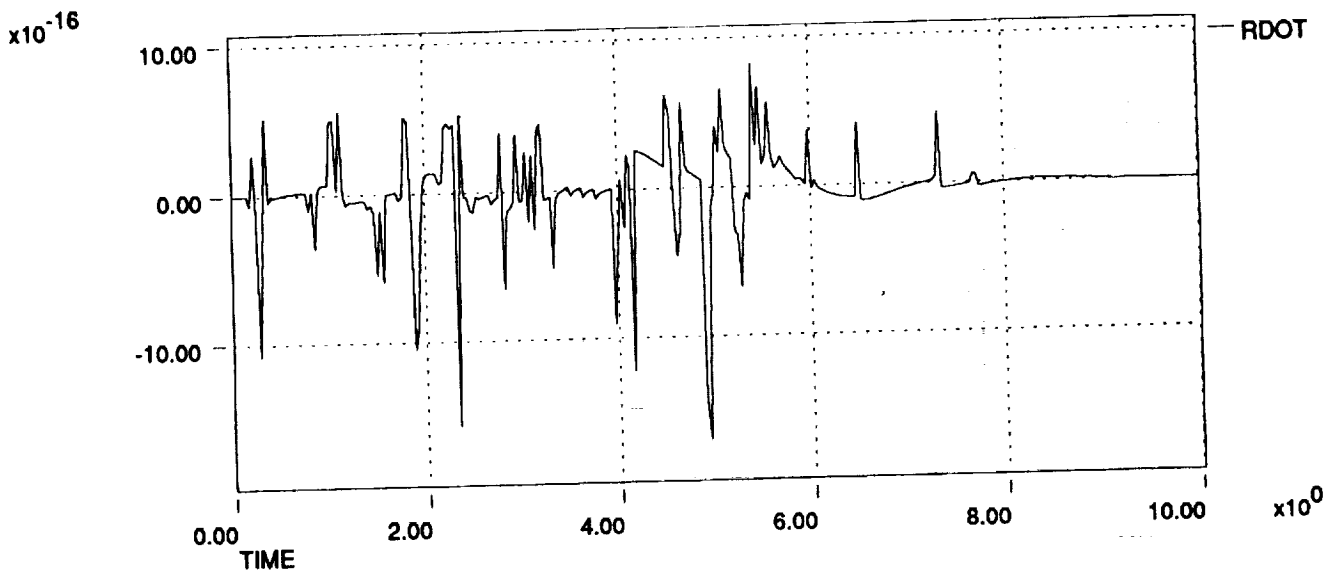
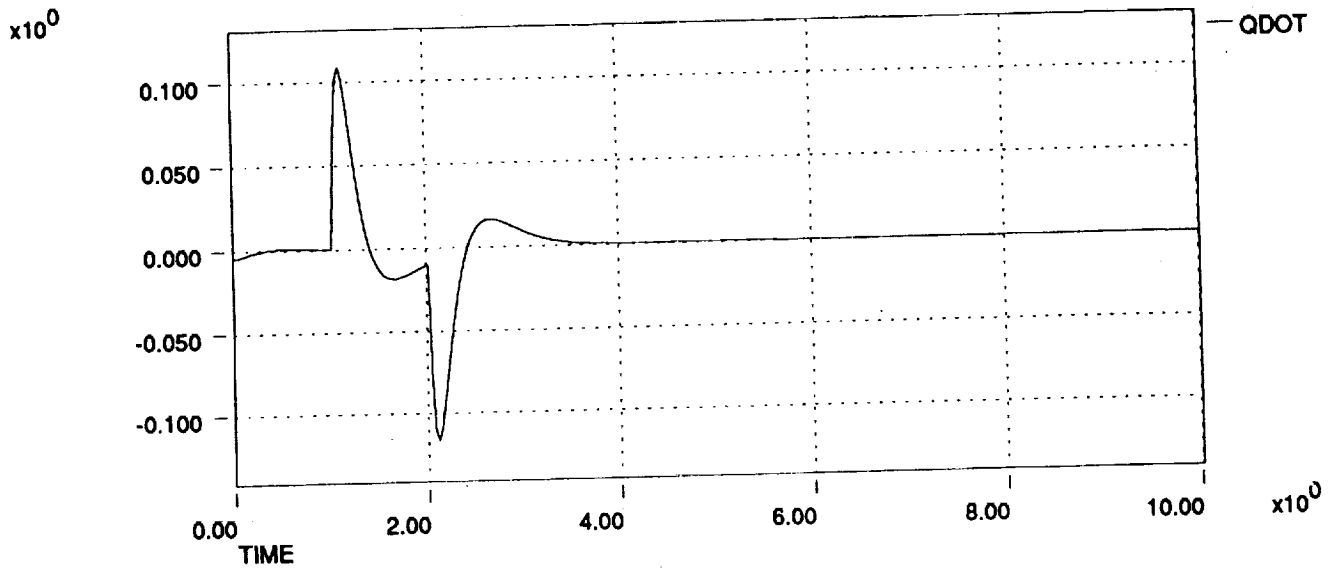
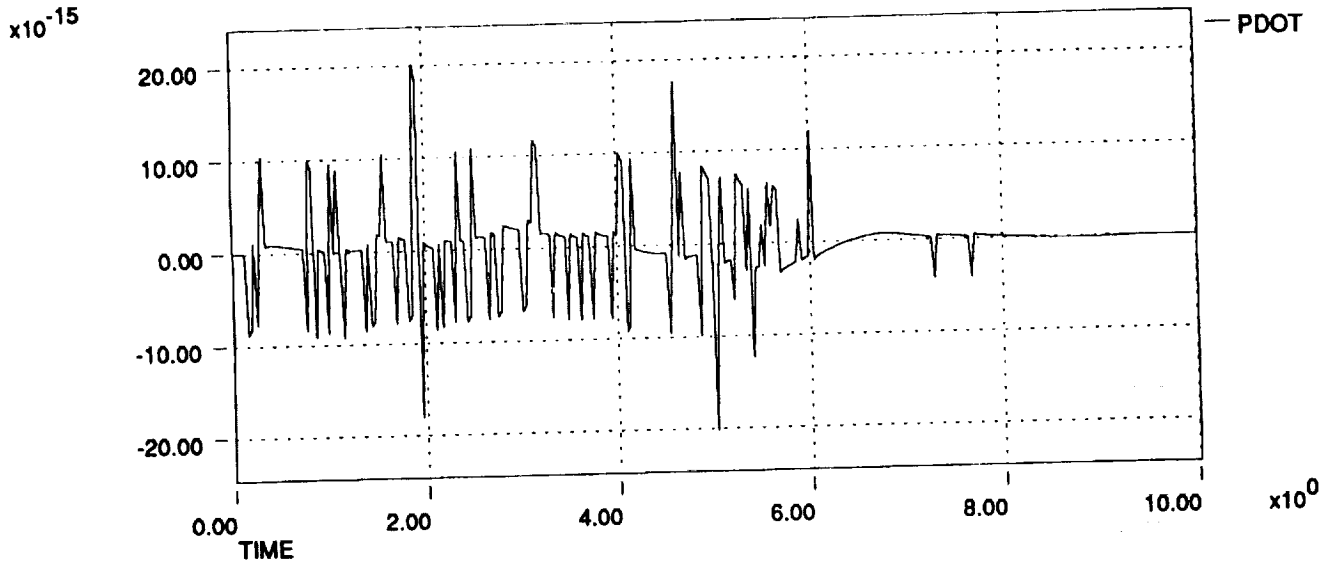

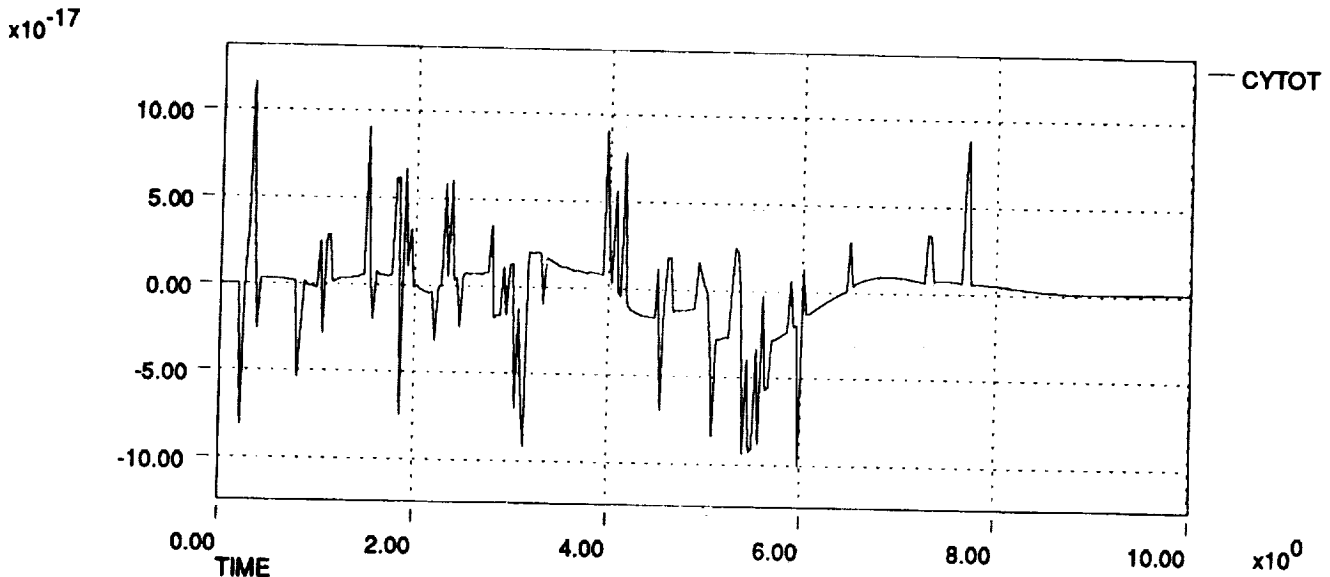
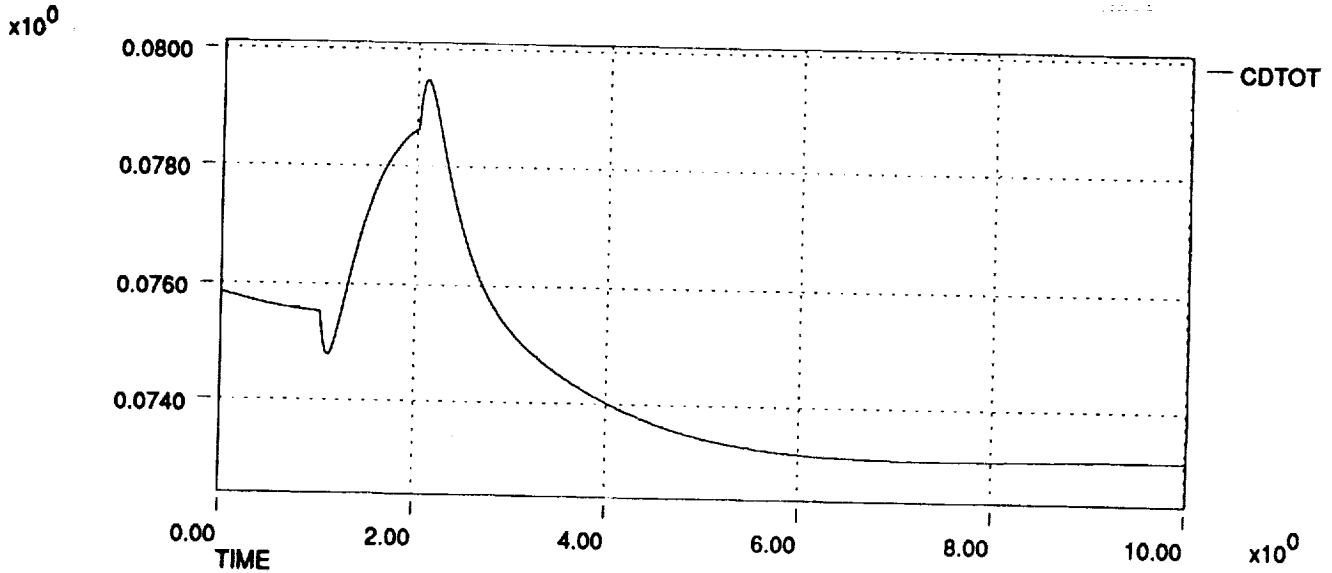
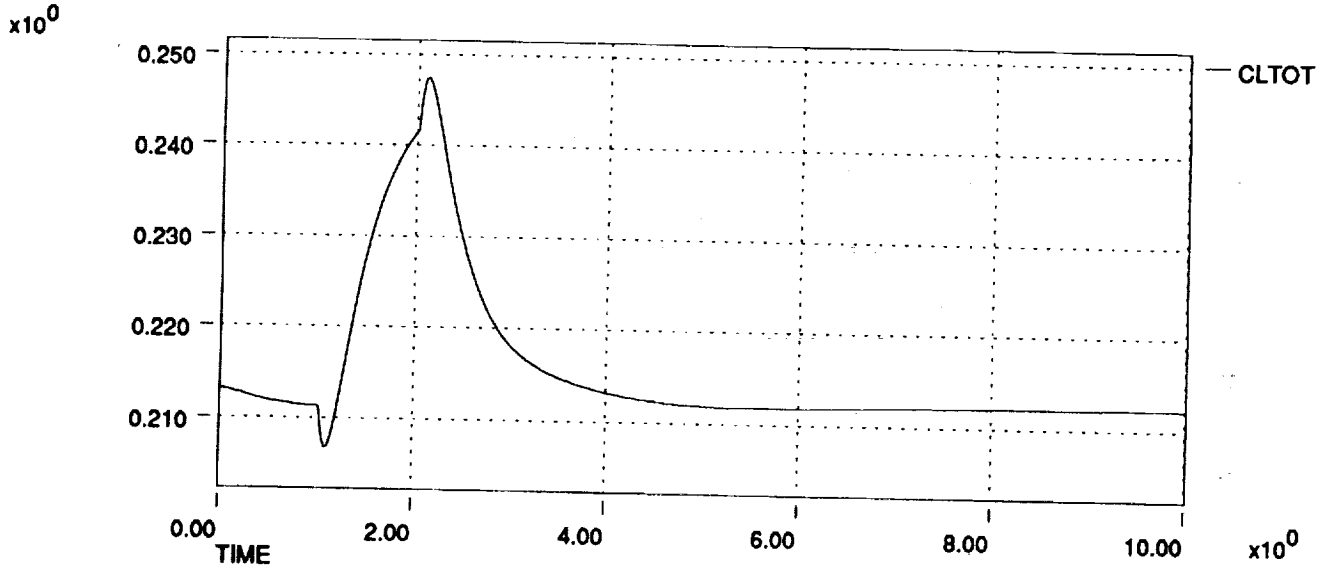

HL-20 Dynamic Check Case Data Plots 911206
Aft Pitch Stick Pulse at 300 KEAS, 10,000 ft

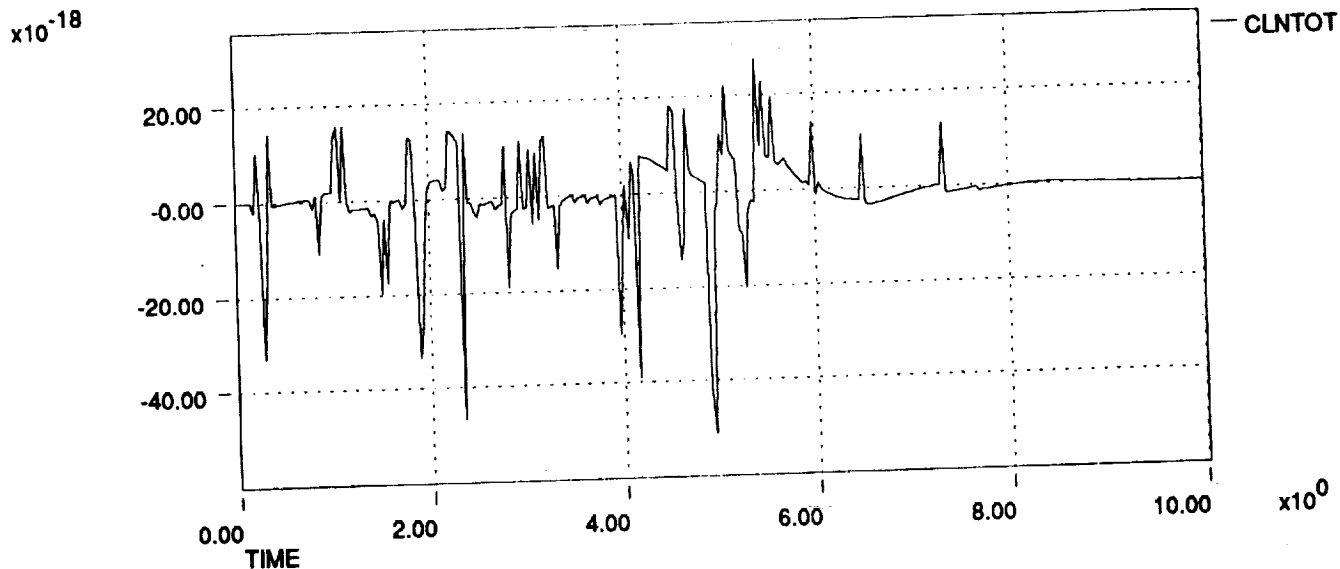
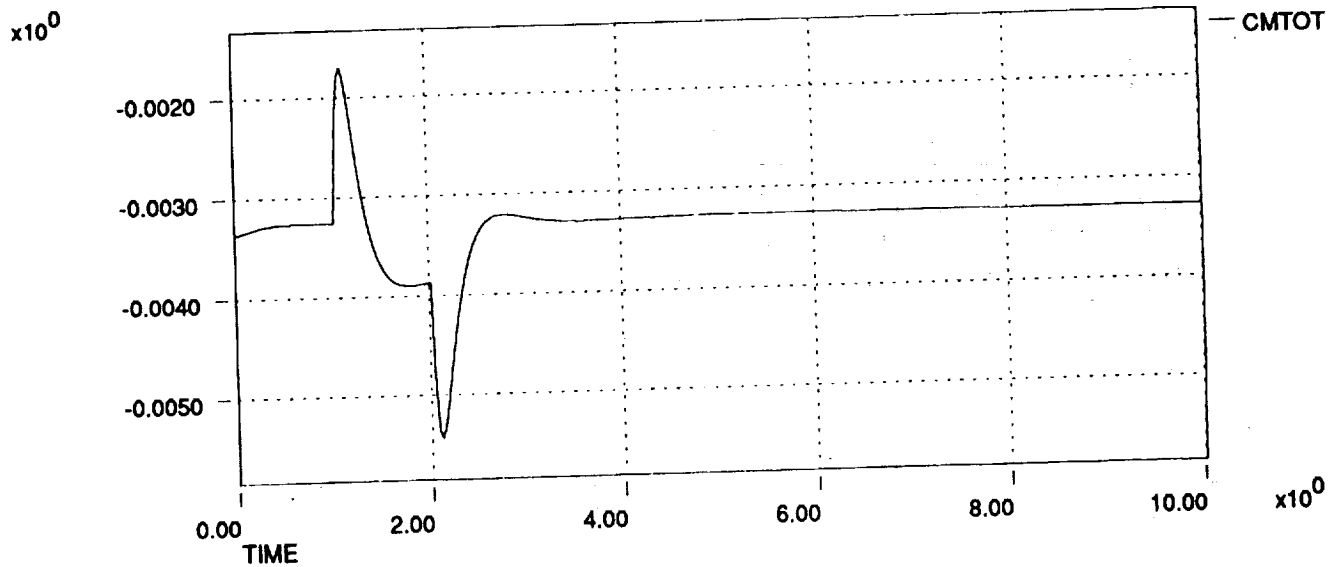
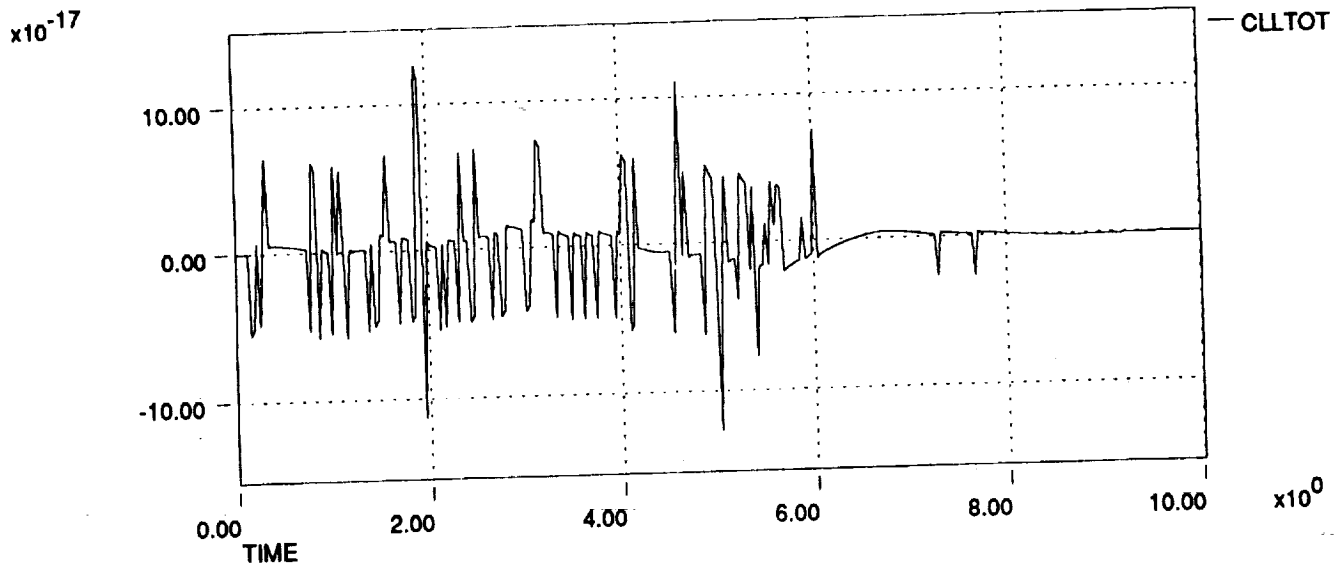

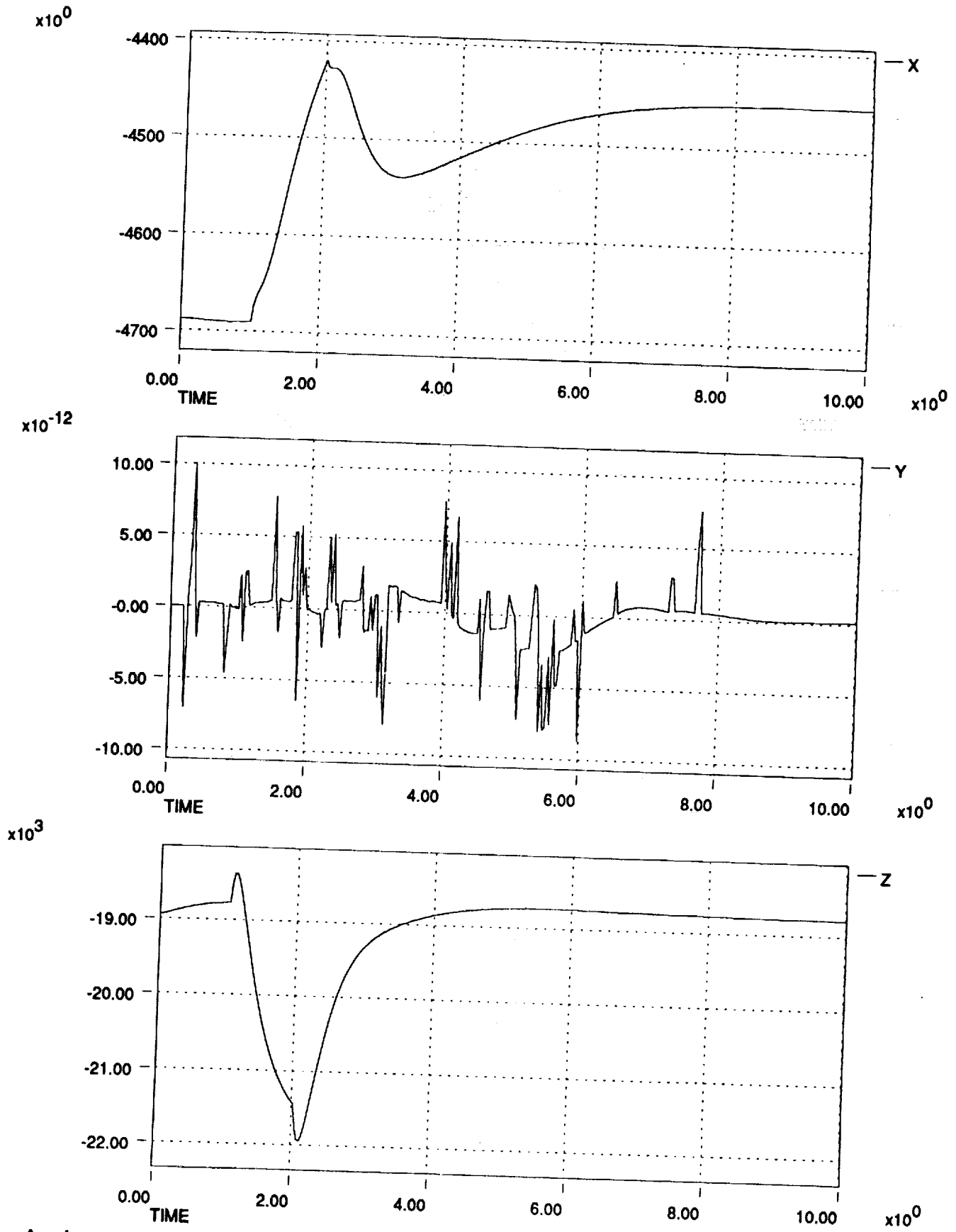

HL-20 Dynamic Check Case Data Plots 911206
Aft Pitch Stick Pulse at 300 KEAS, 10,000 ft

$\times 10^{-11}$

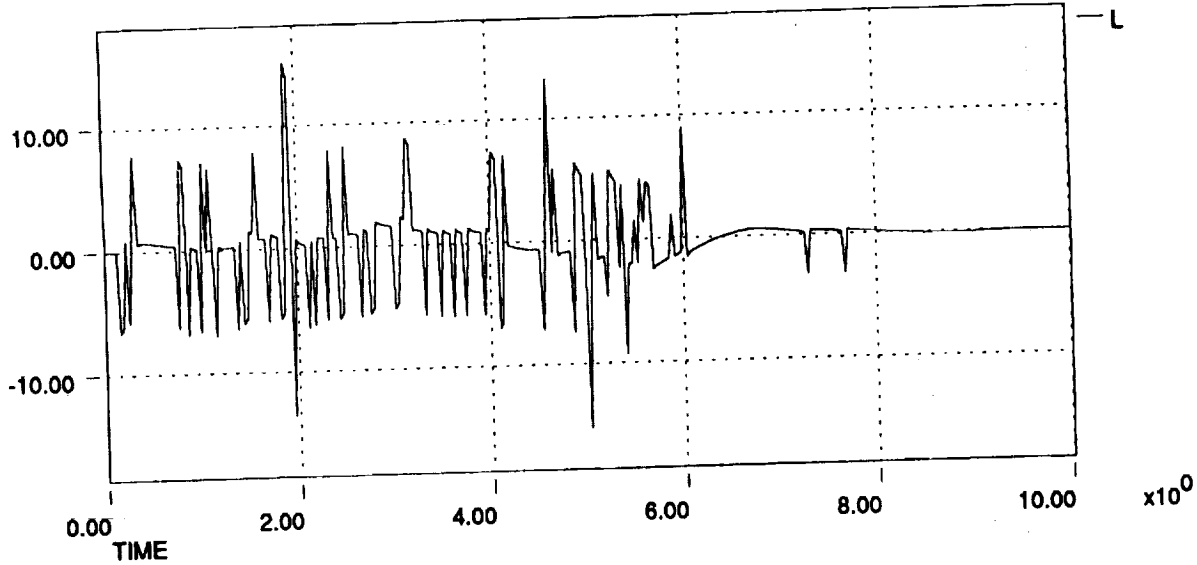

$\times 10^0$

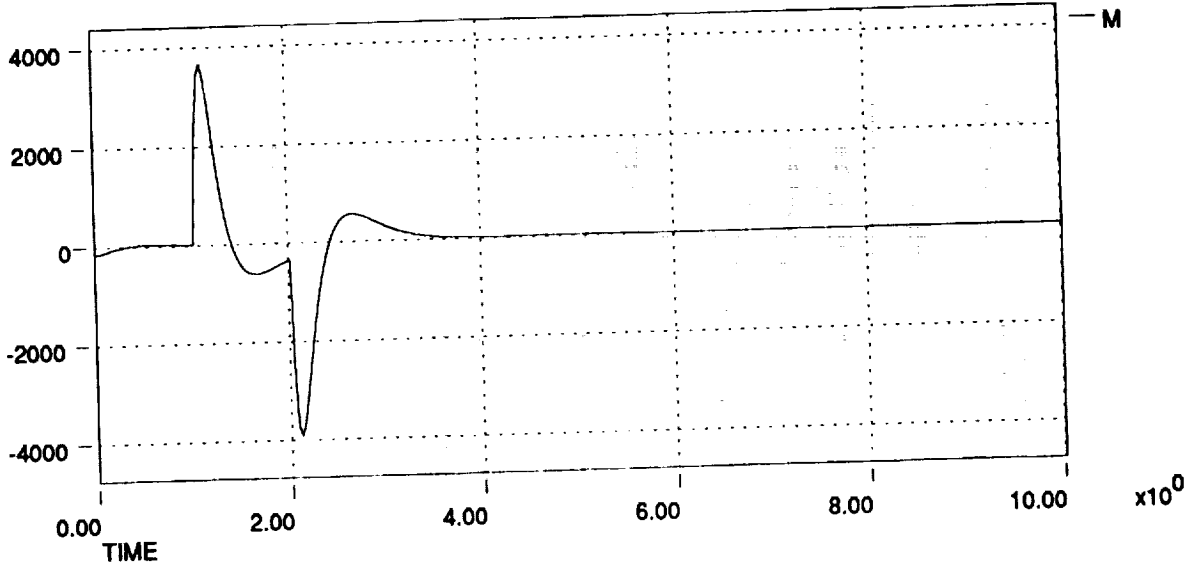

$\times 10^{-12}$

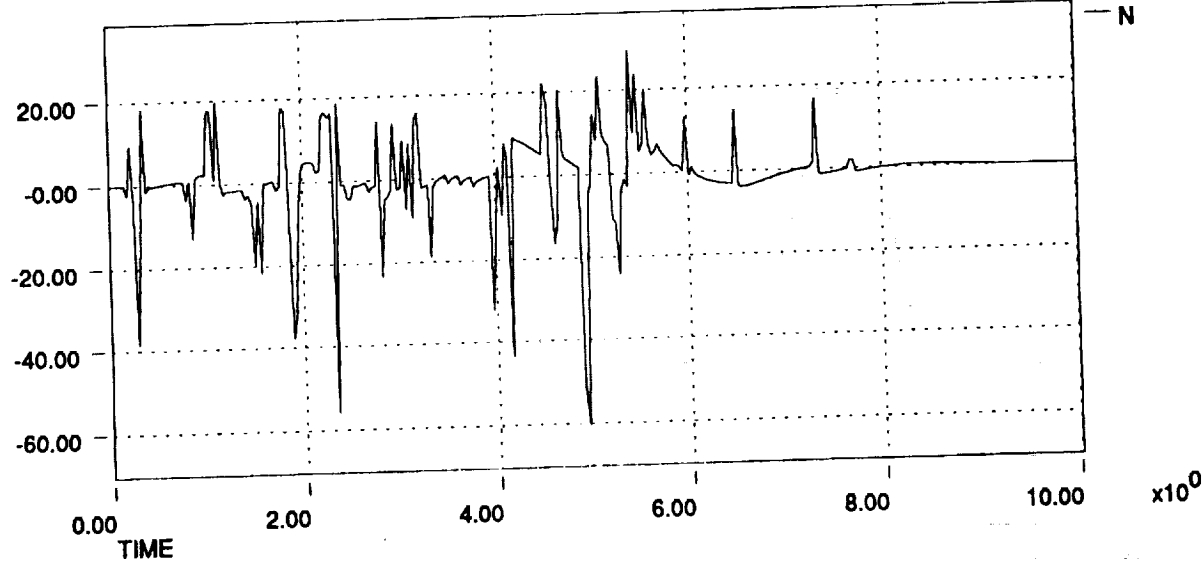

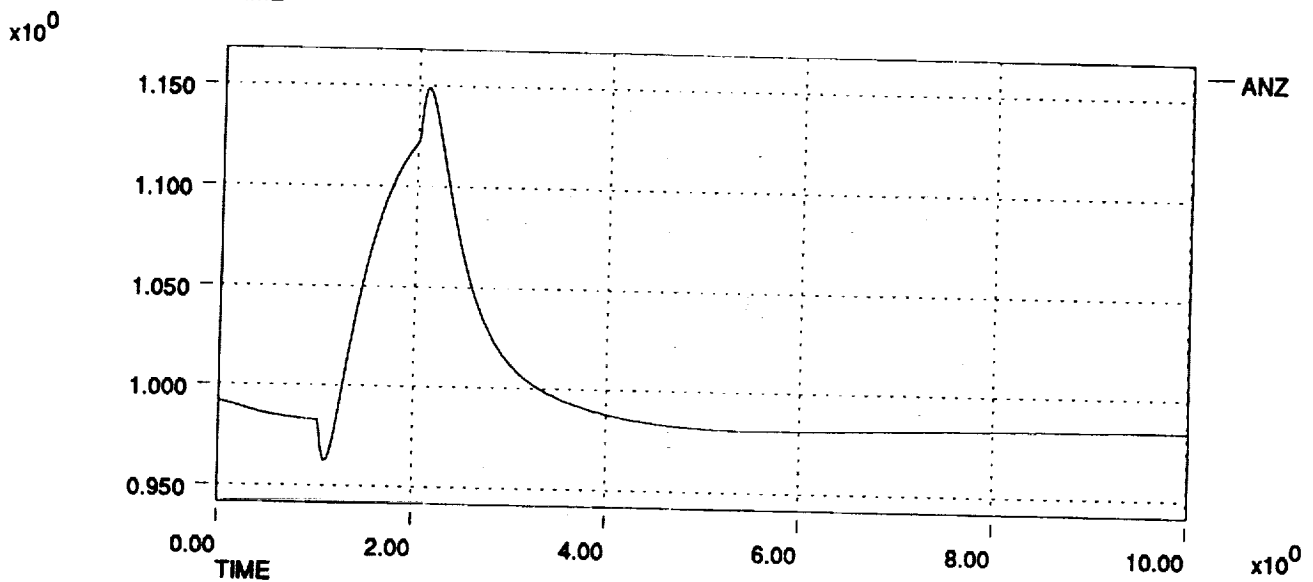
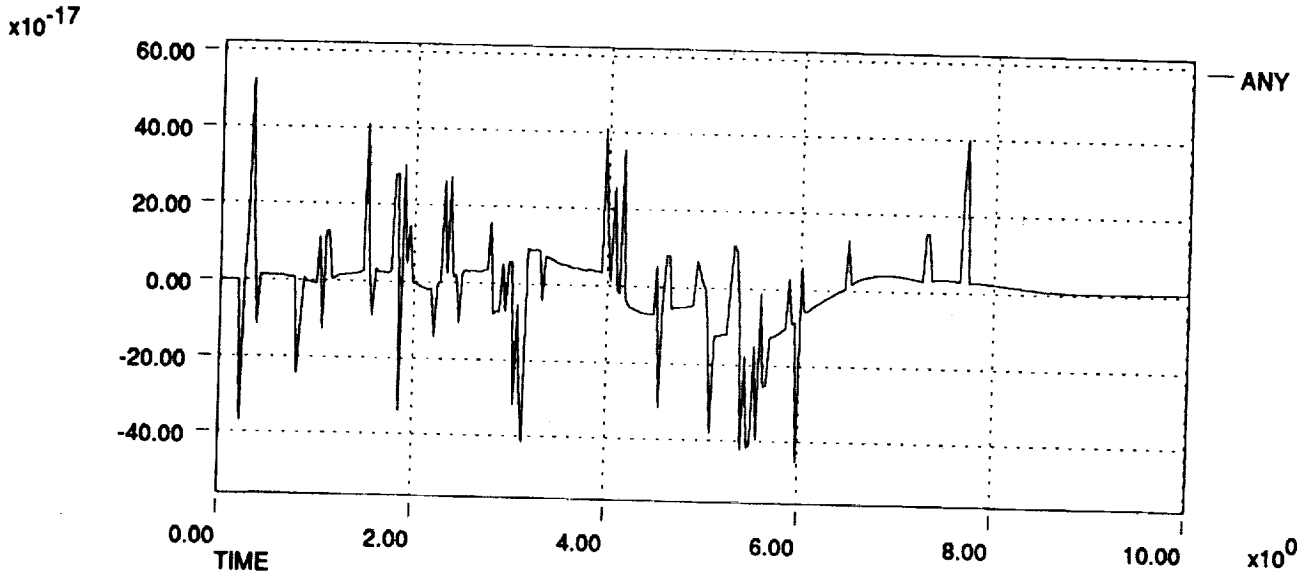
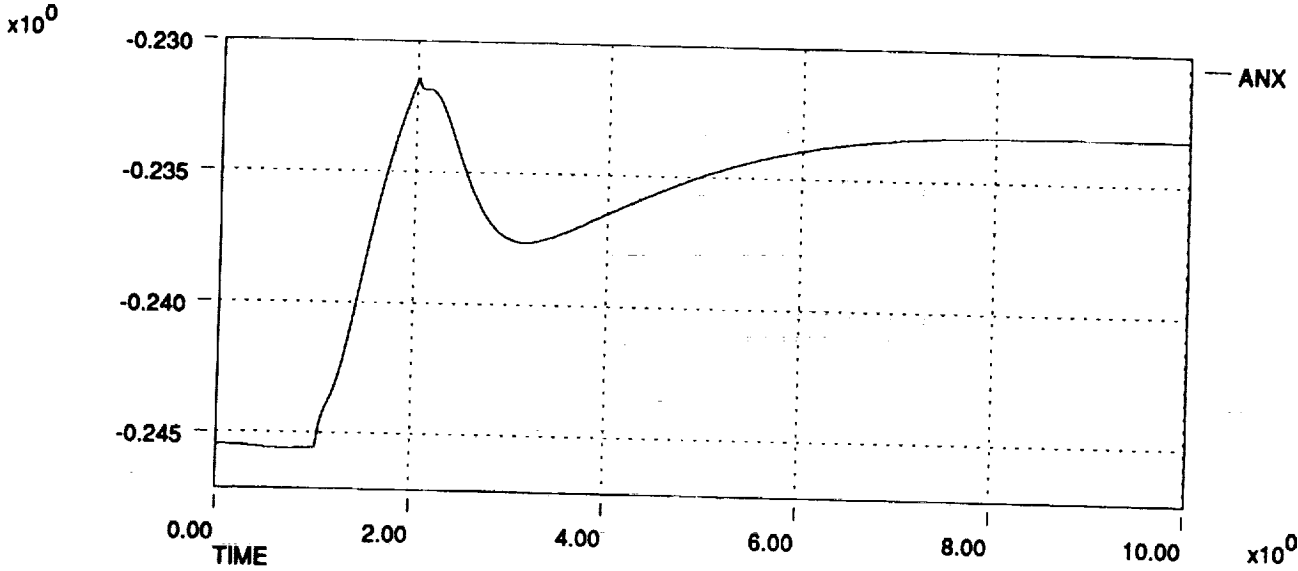

HL-20 Dynamic Check Case Data Plots 911206
Aft Pitch Stick Pulse at 300 KEAS, 10,000 ft

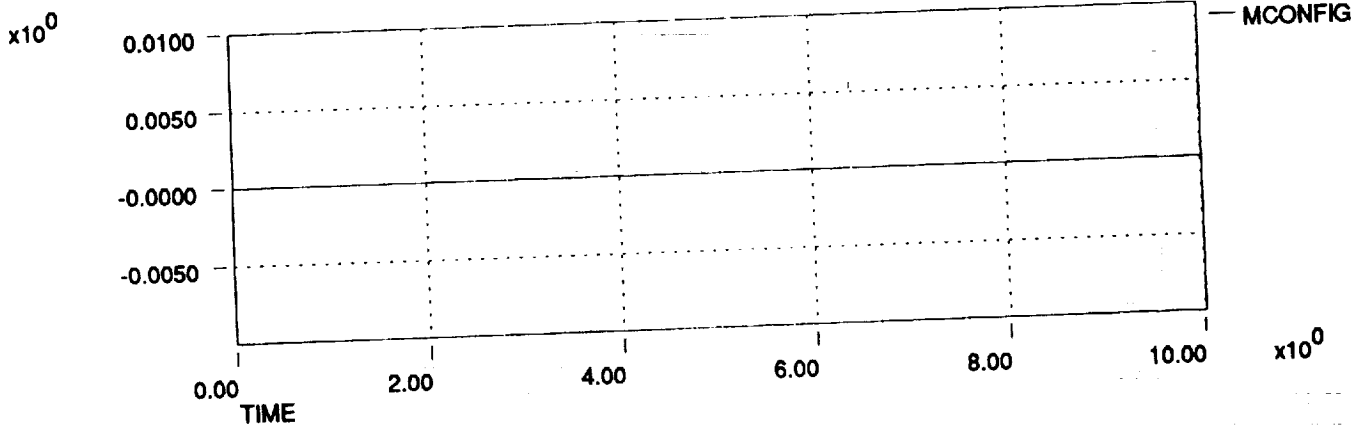
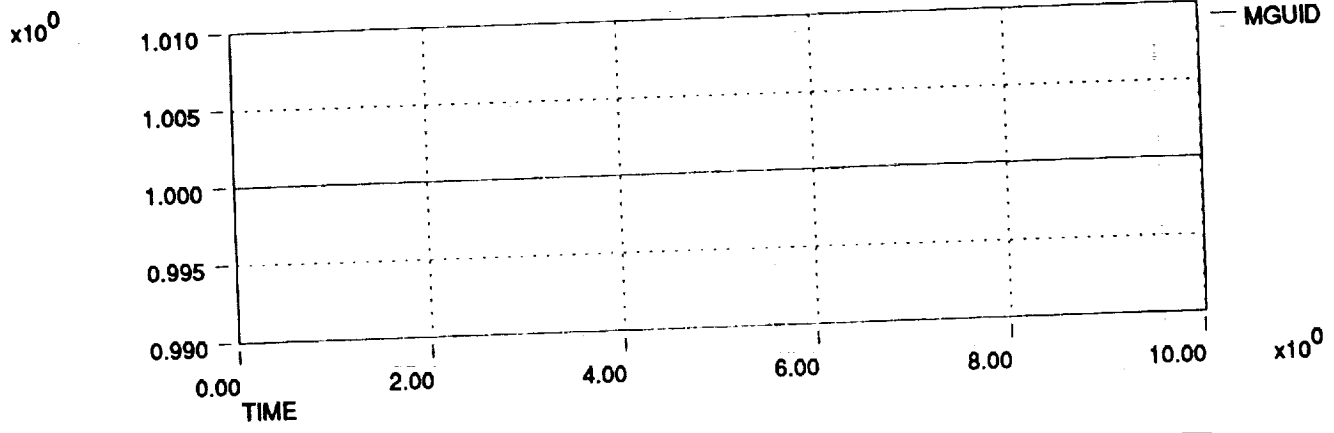
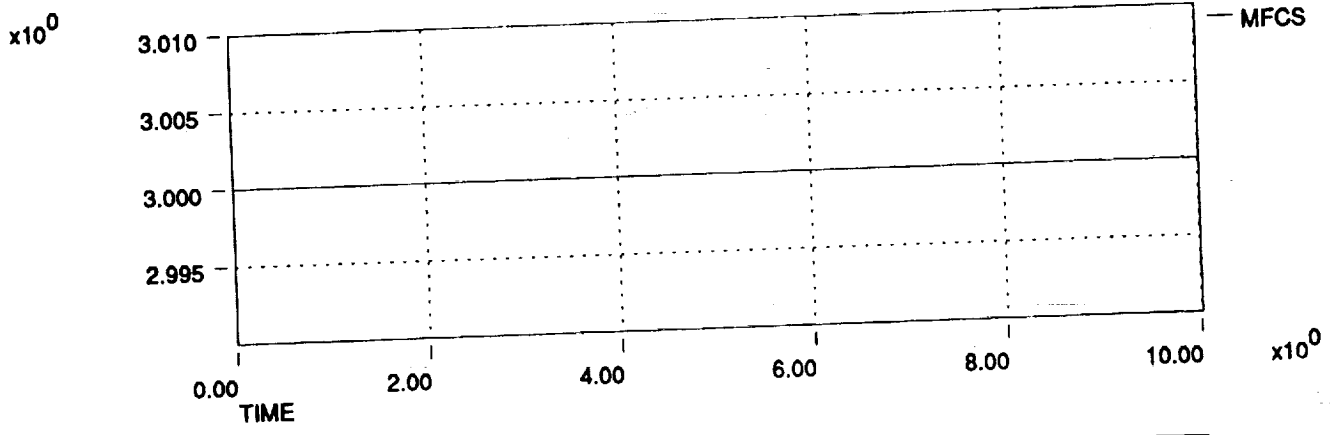
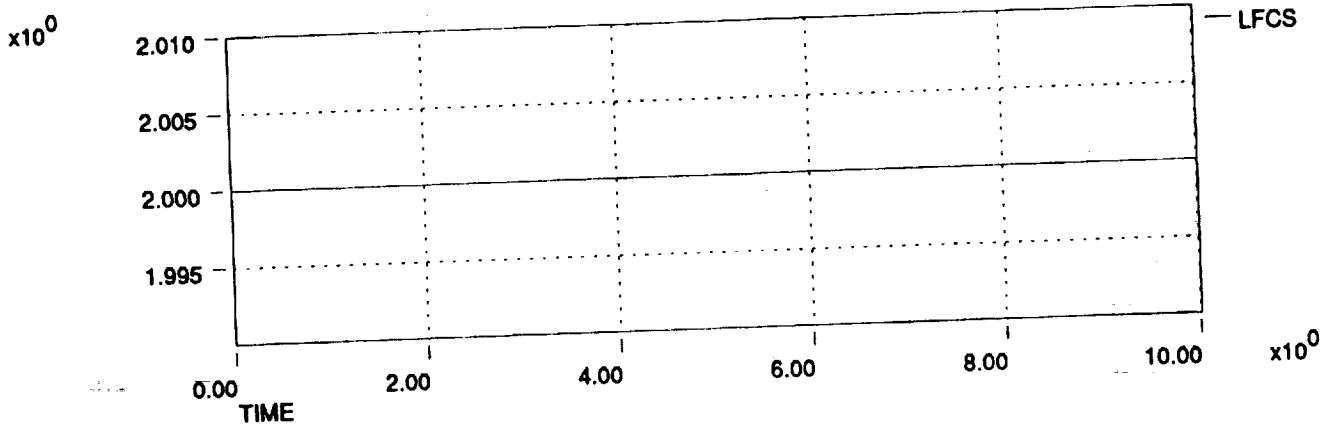

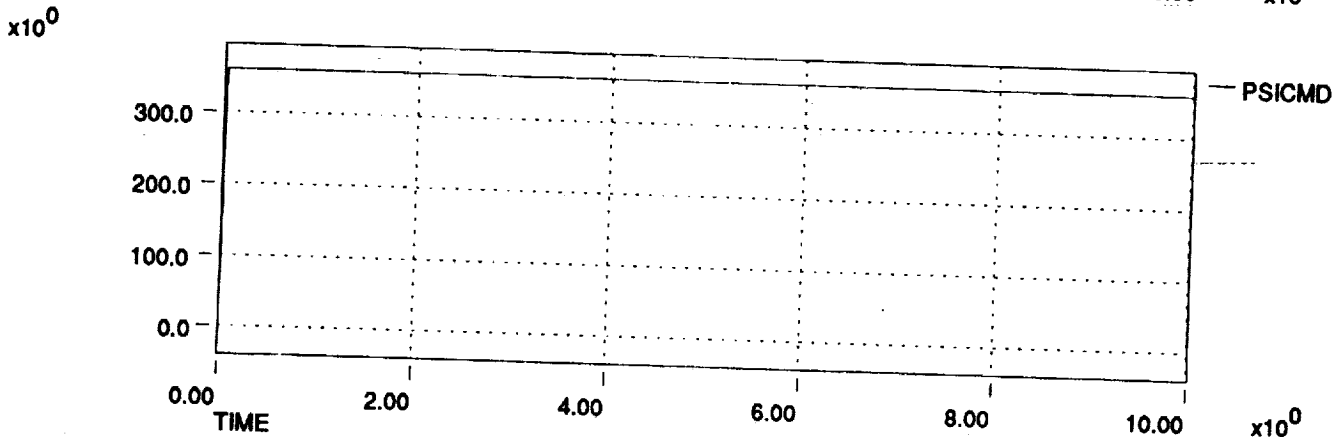
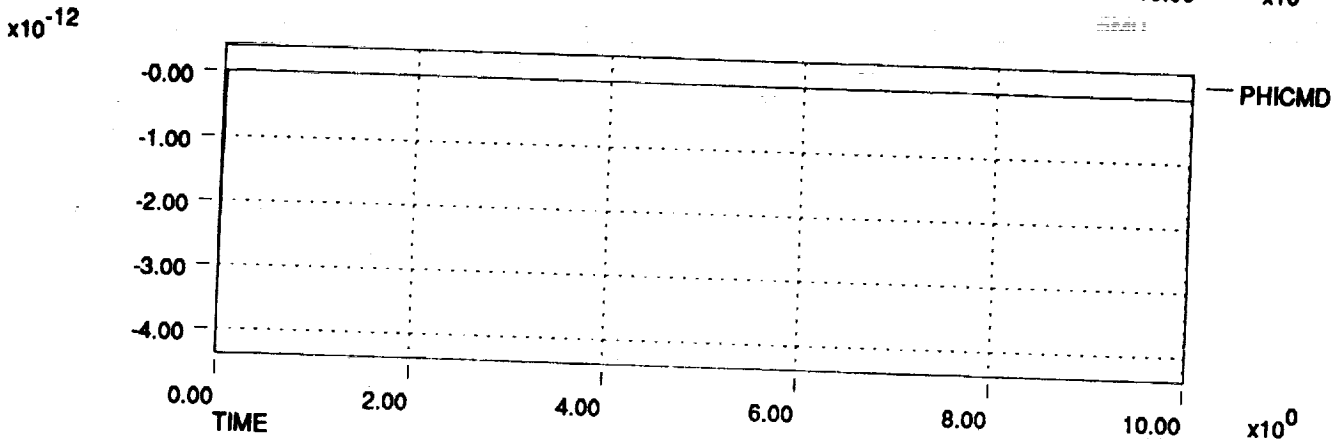
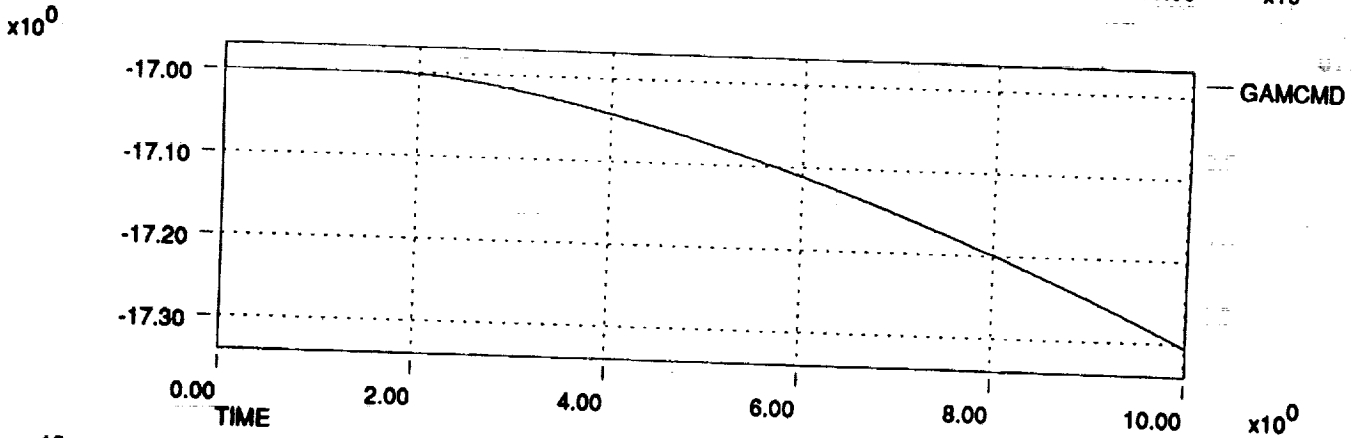
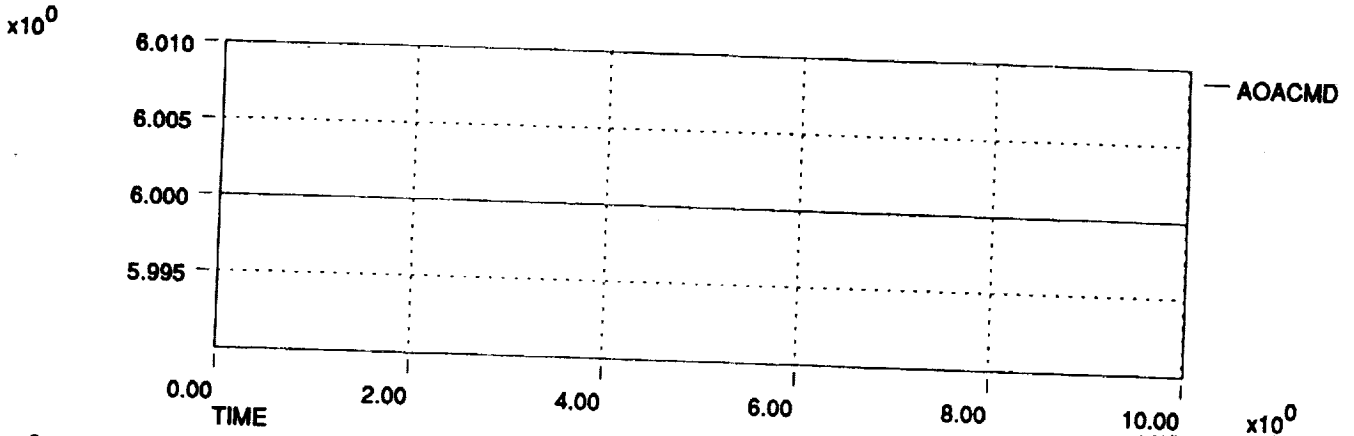

HL-20 Dynamic Check Case Data Plots 911206
Alt Pitch Stick Pulse at 300 KEAS, 10,000 ft

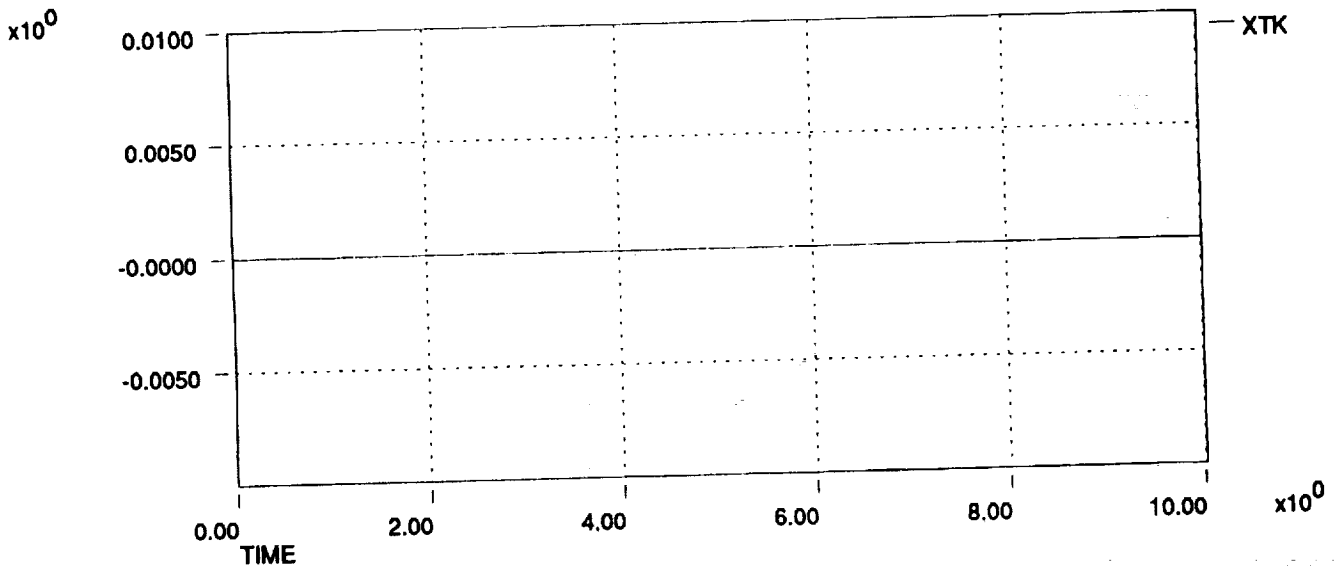
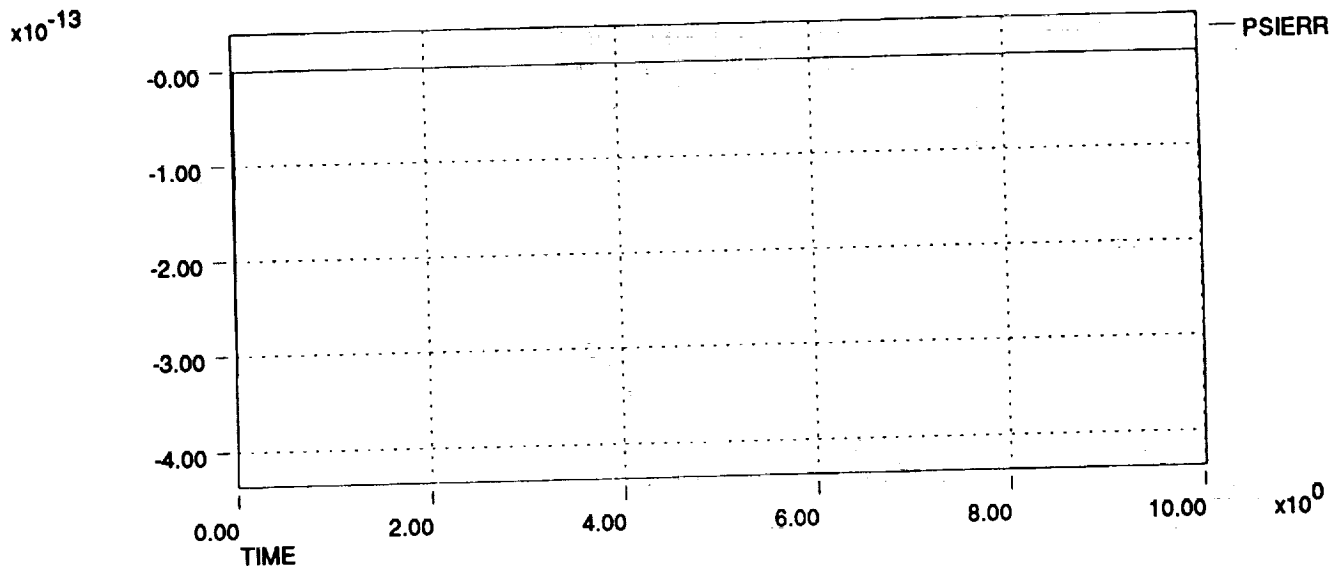
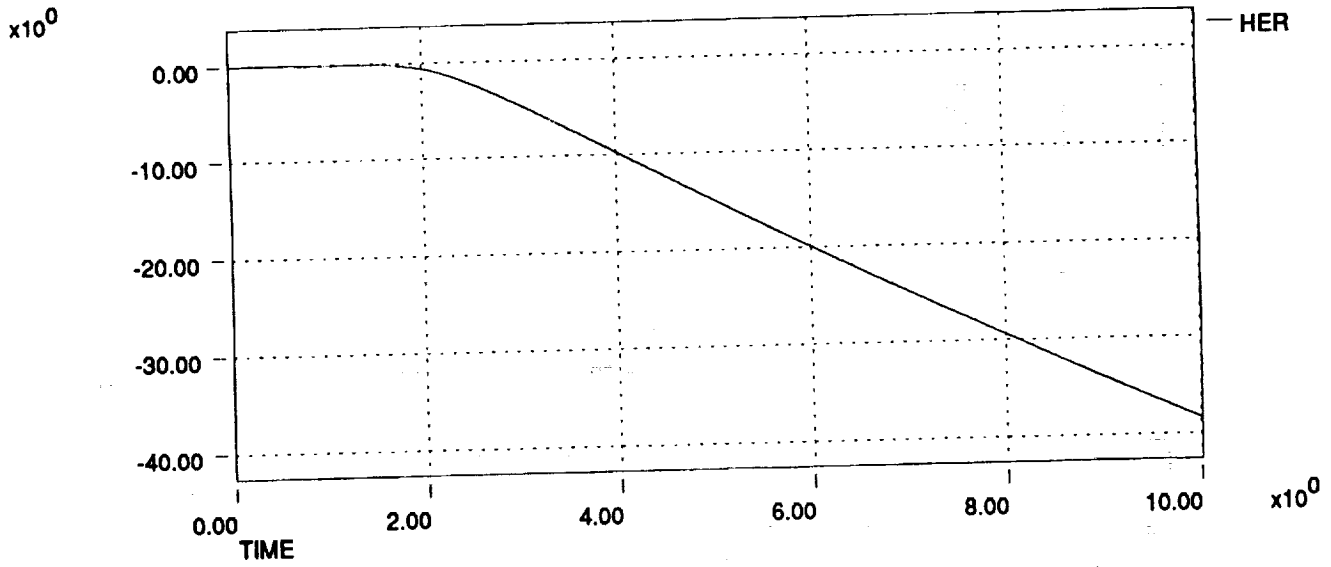

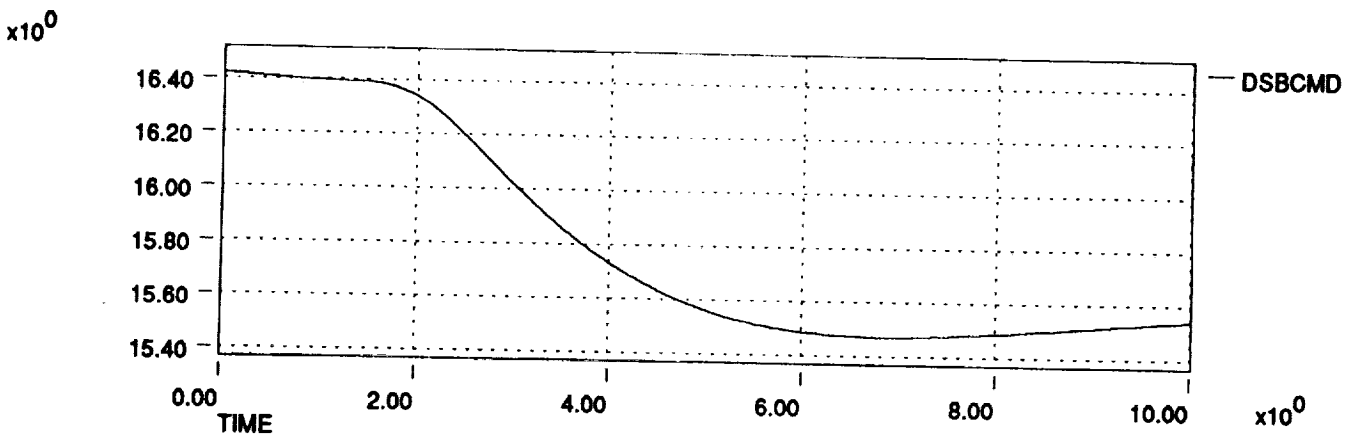
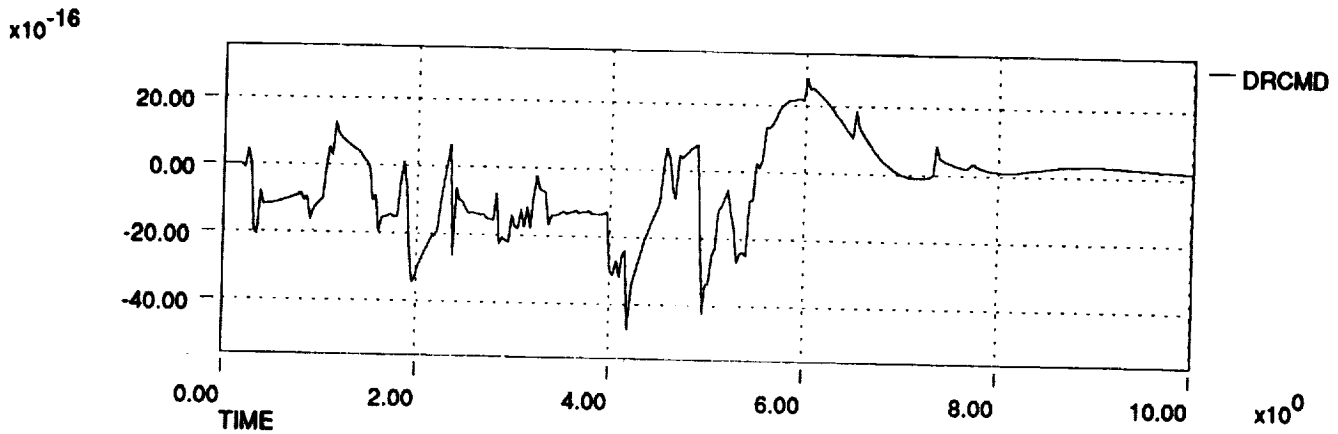
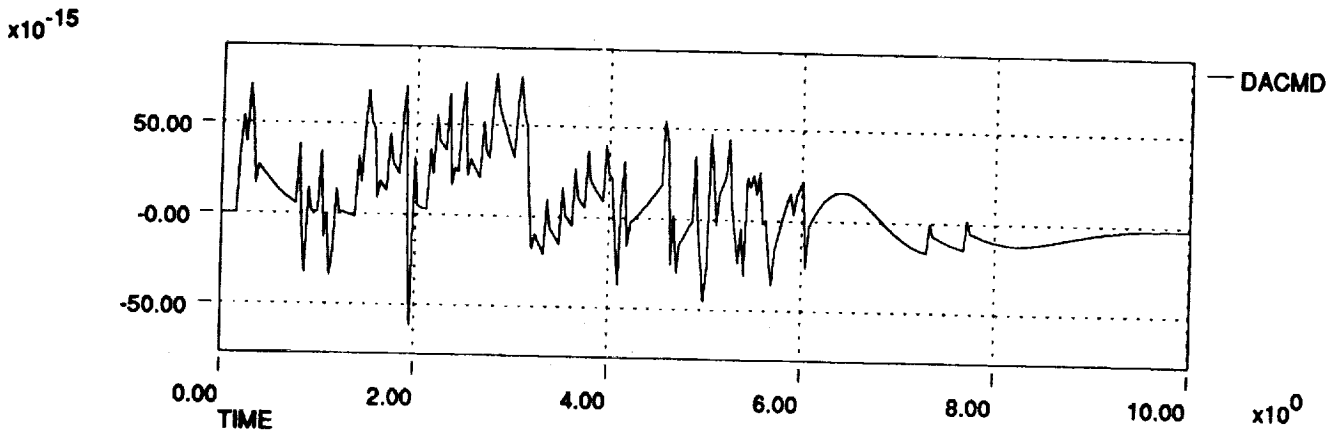
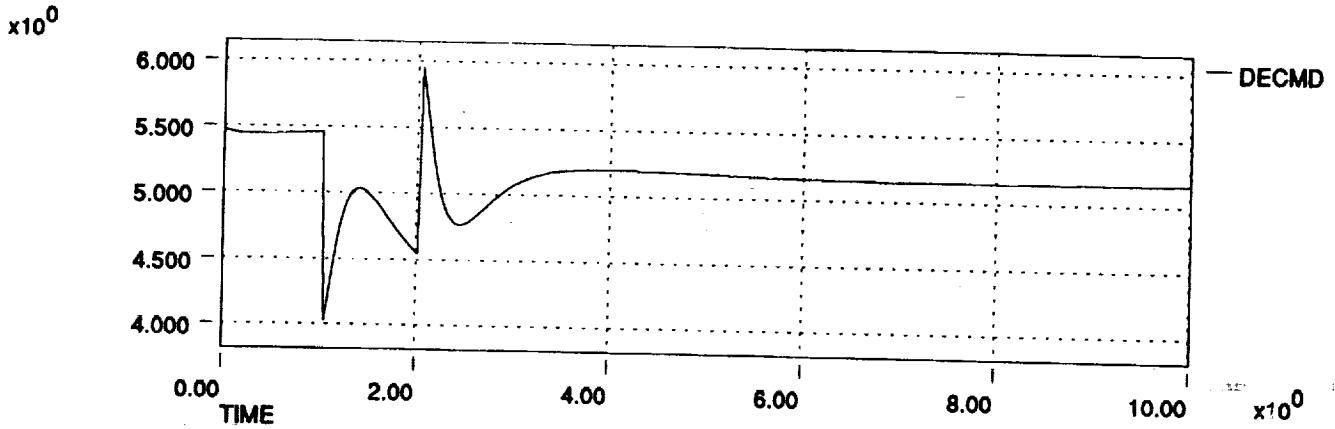

HL-20 Dynamic Check Case Data Plots 911206
Att Pitch Stick Pulse at 300 KEAS, 10,000 ft

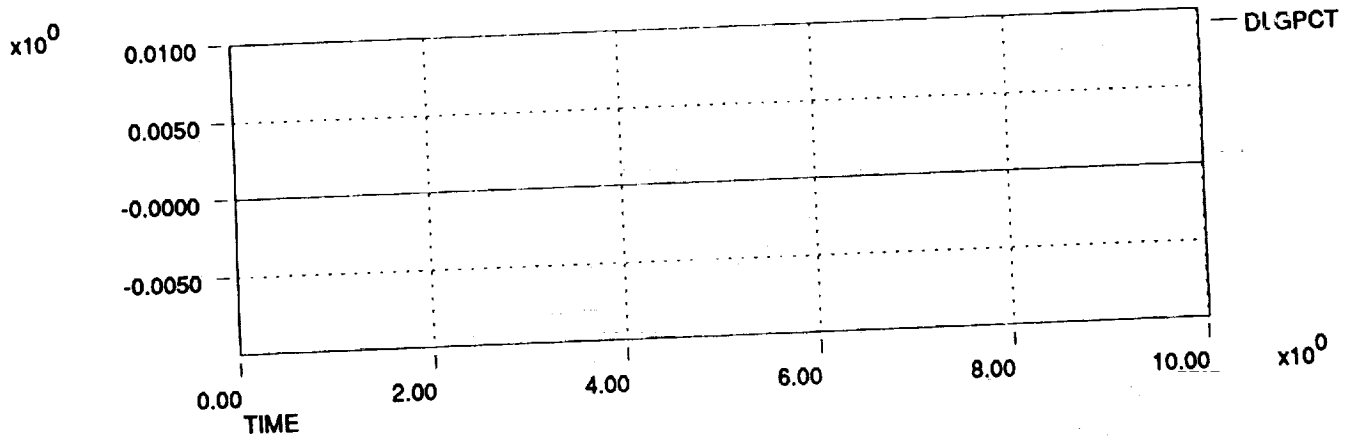
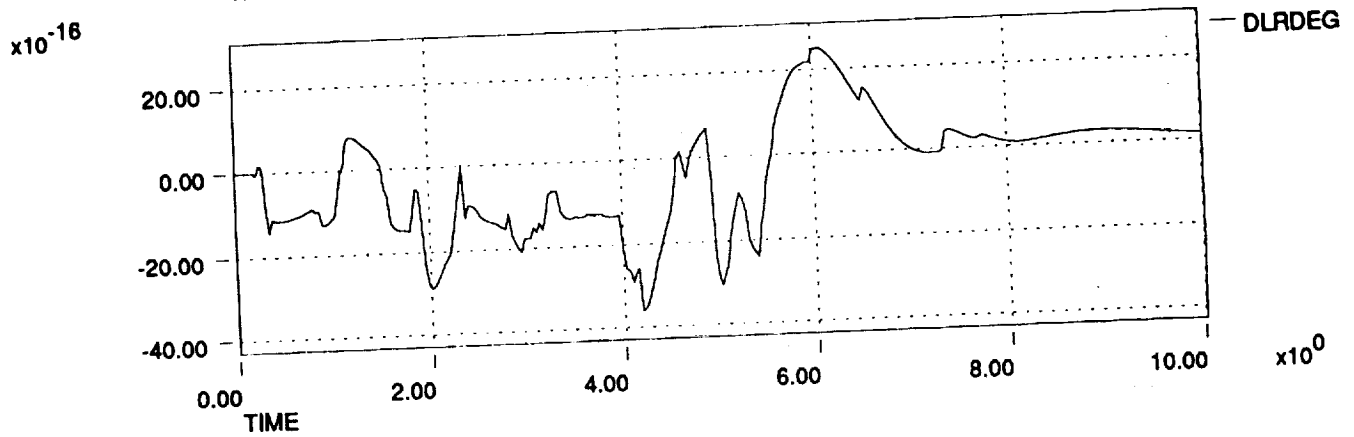
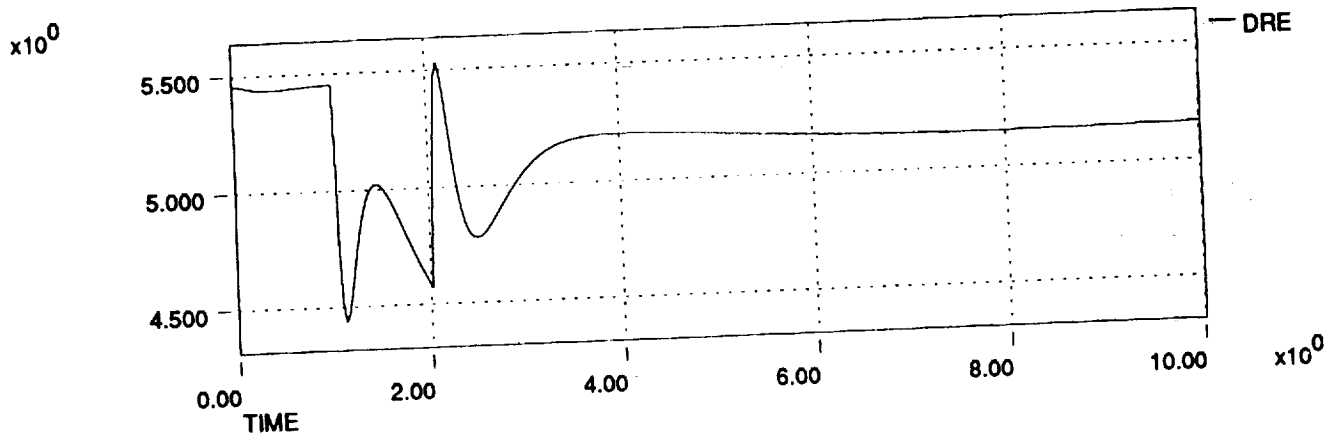
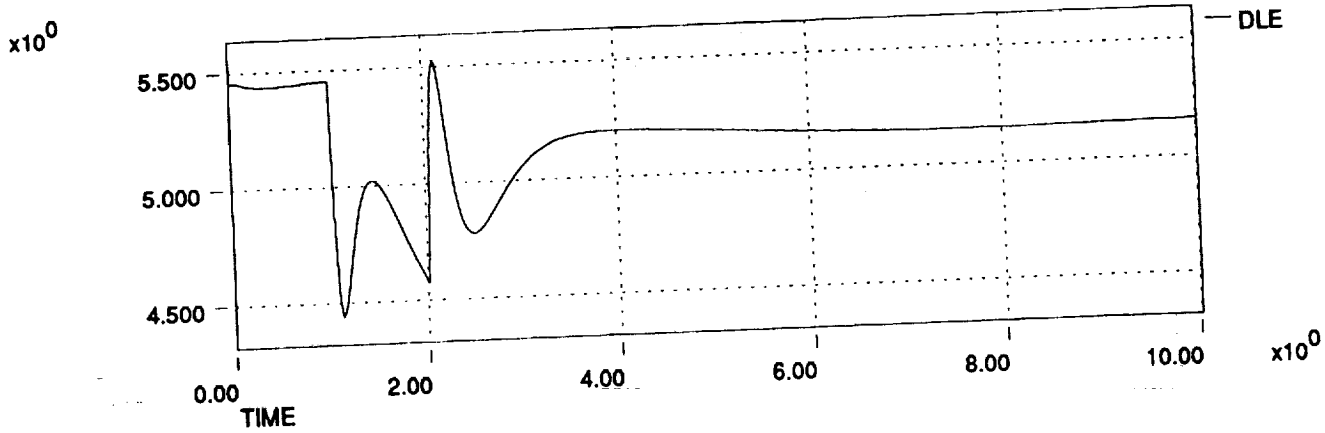

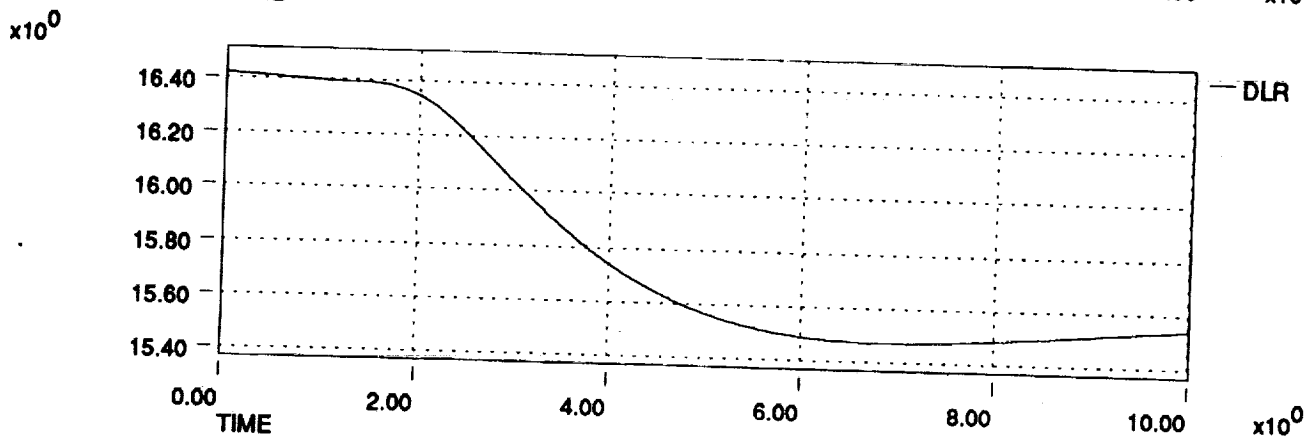
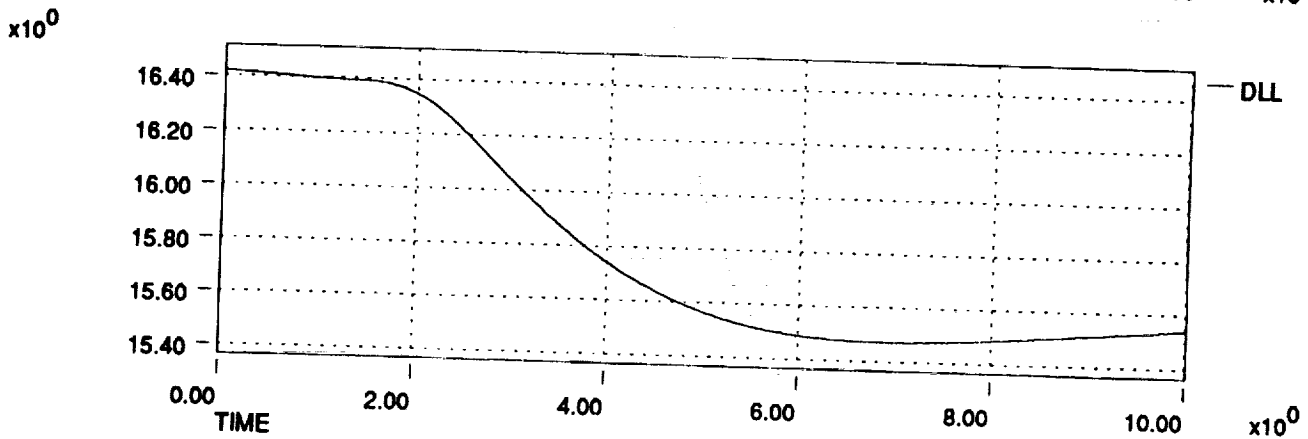
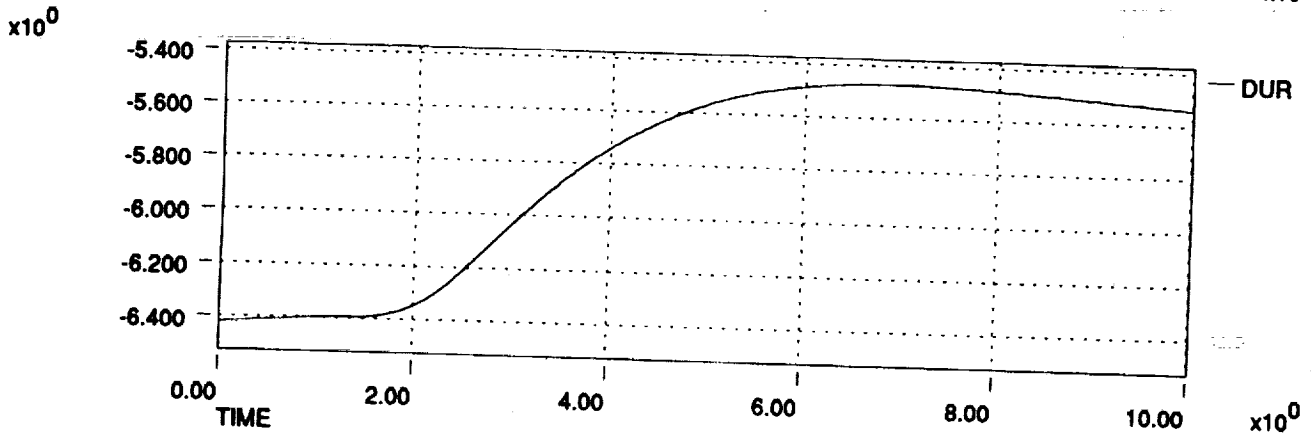
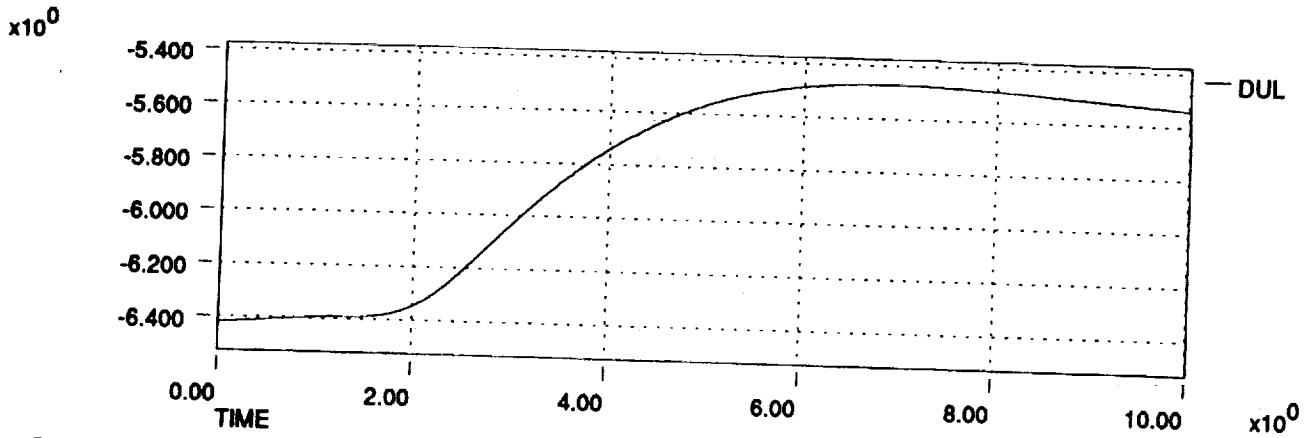

HL-20 Dynamic Check Case Data Plots 911206
Right Roll Stick Pulse at 300 KEAS, 10,000 ft

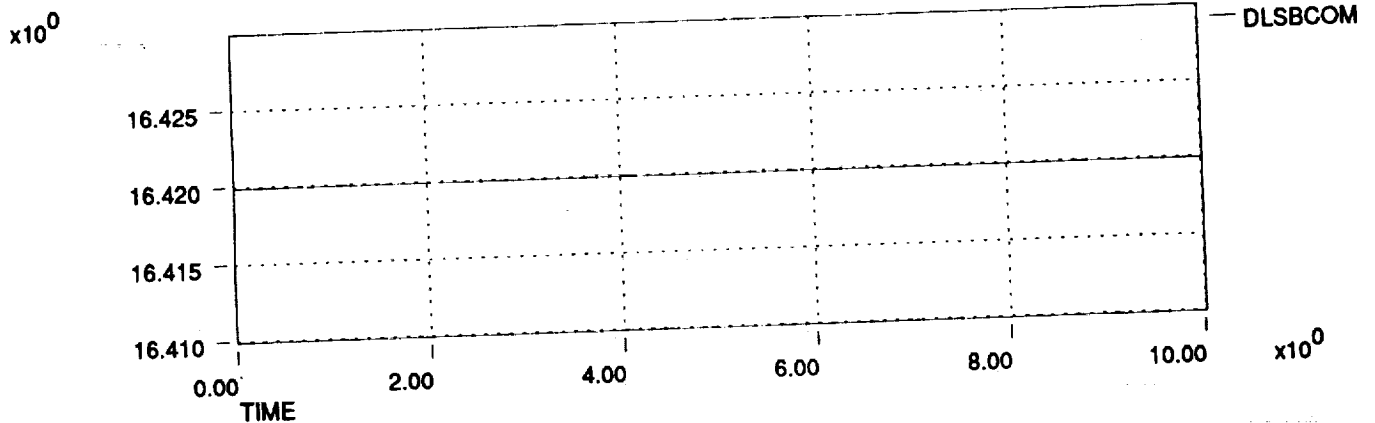
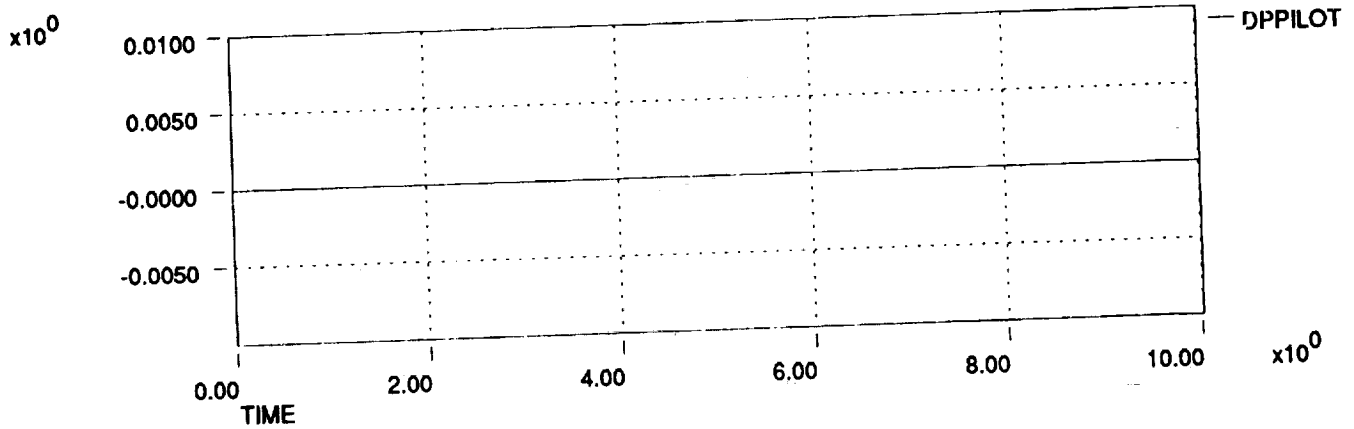
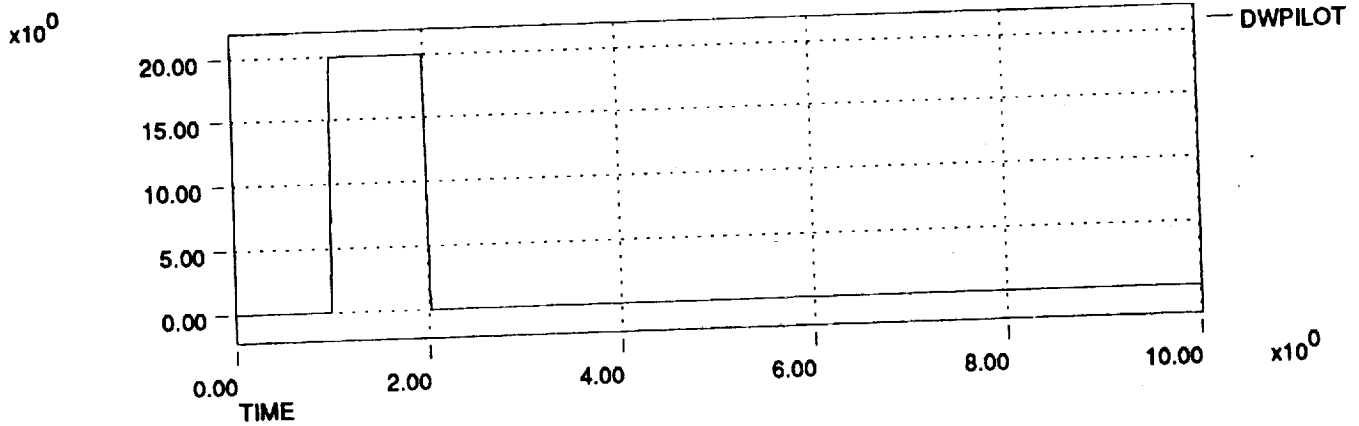
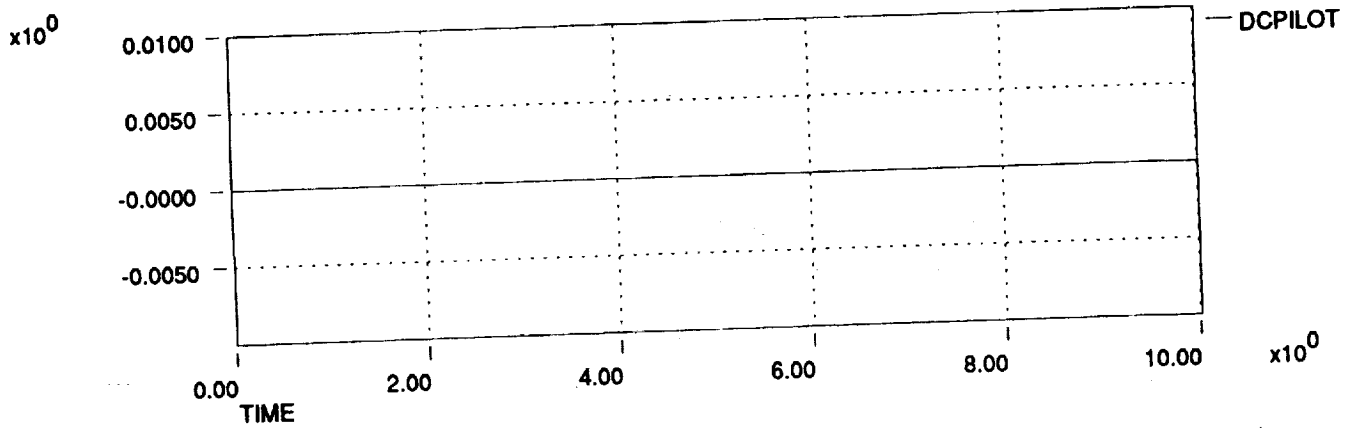

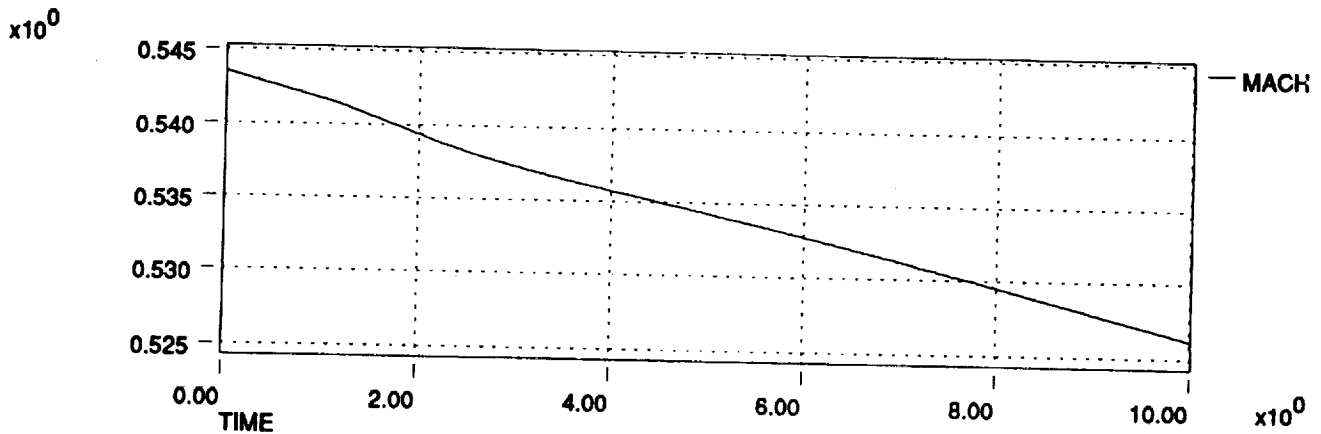
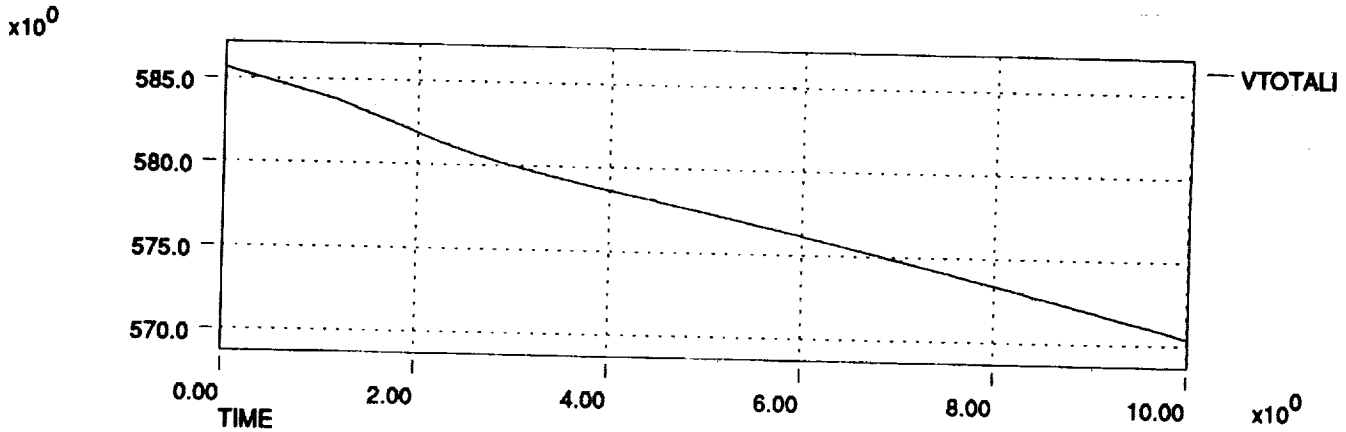
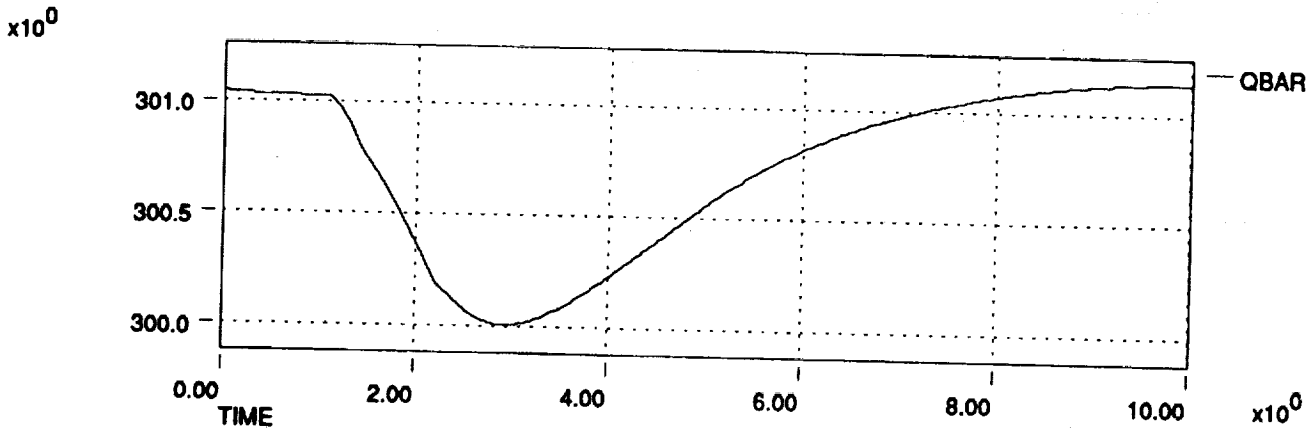
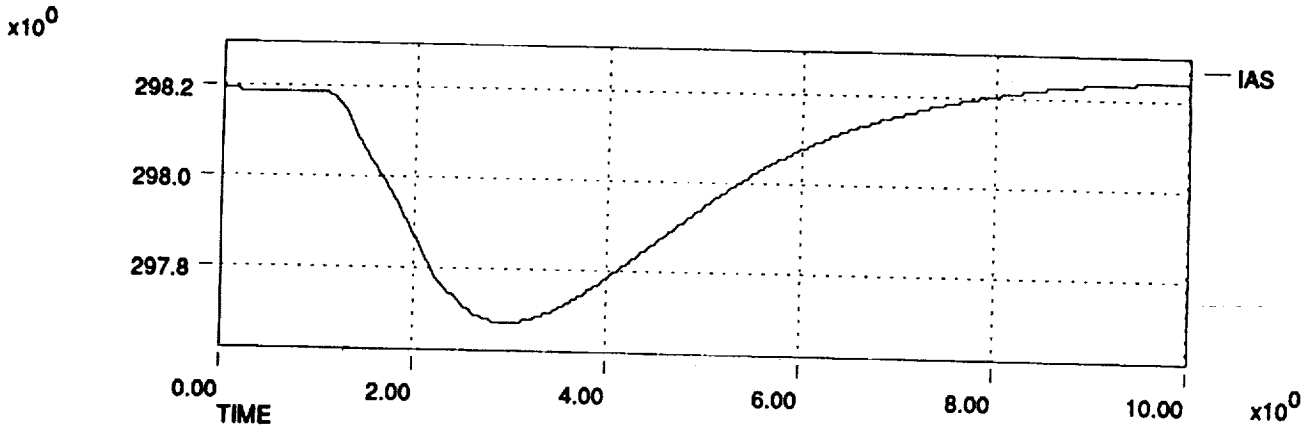

HL-20 Dynamic Check Case Data Plots 911206
Right Roll Stick Pulse at 300 KEAS, 10,000 ft

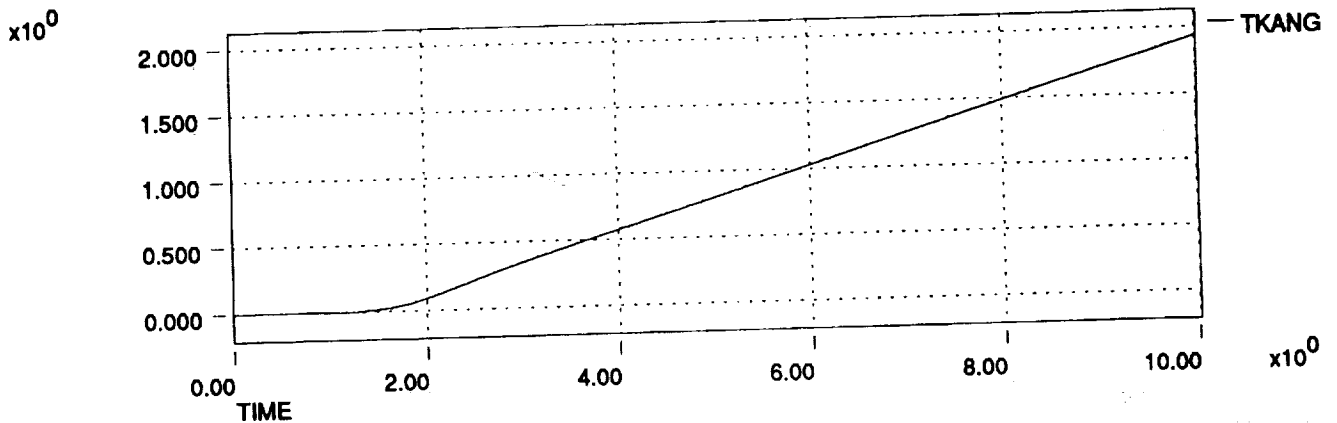
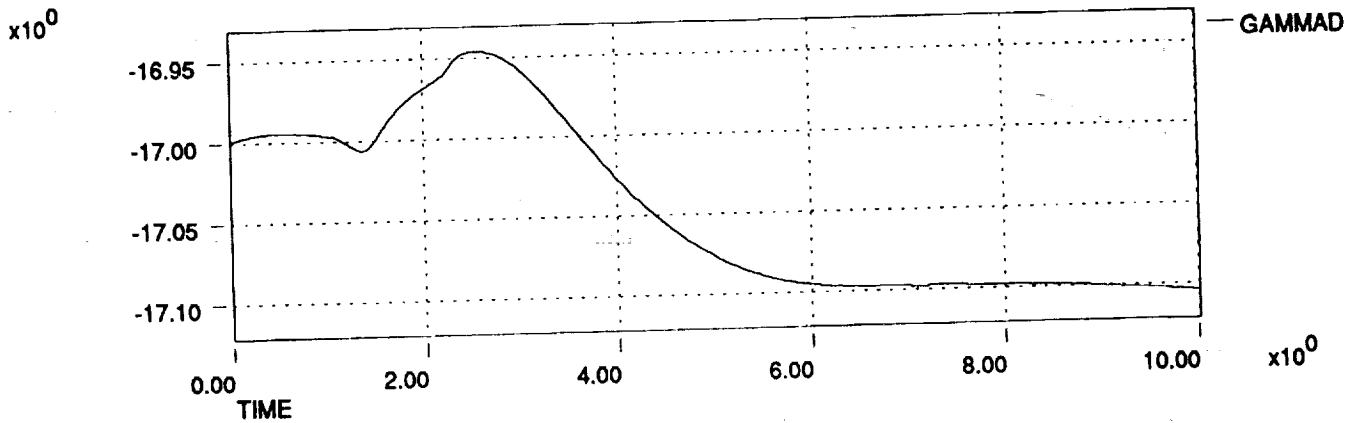
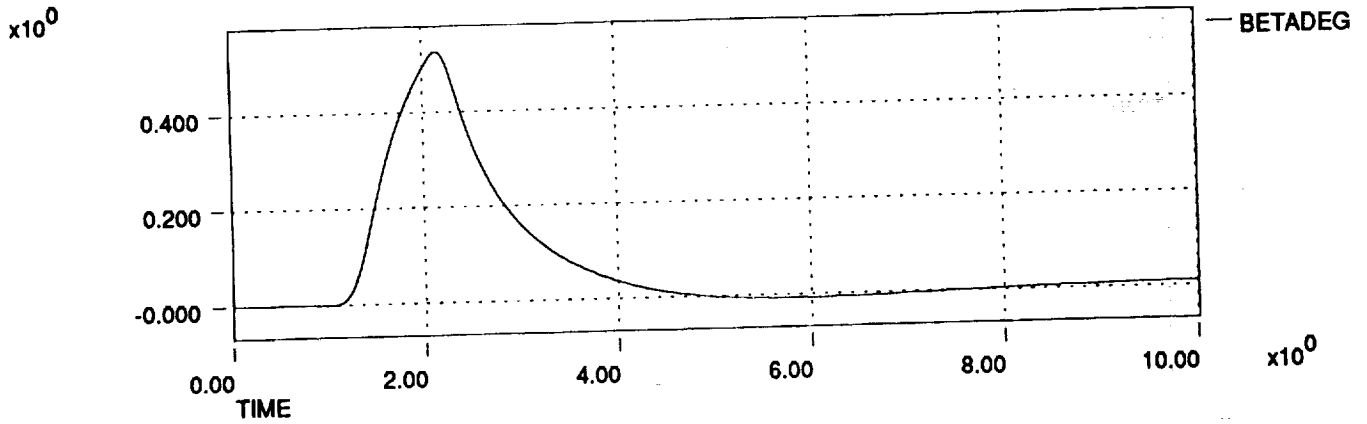
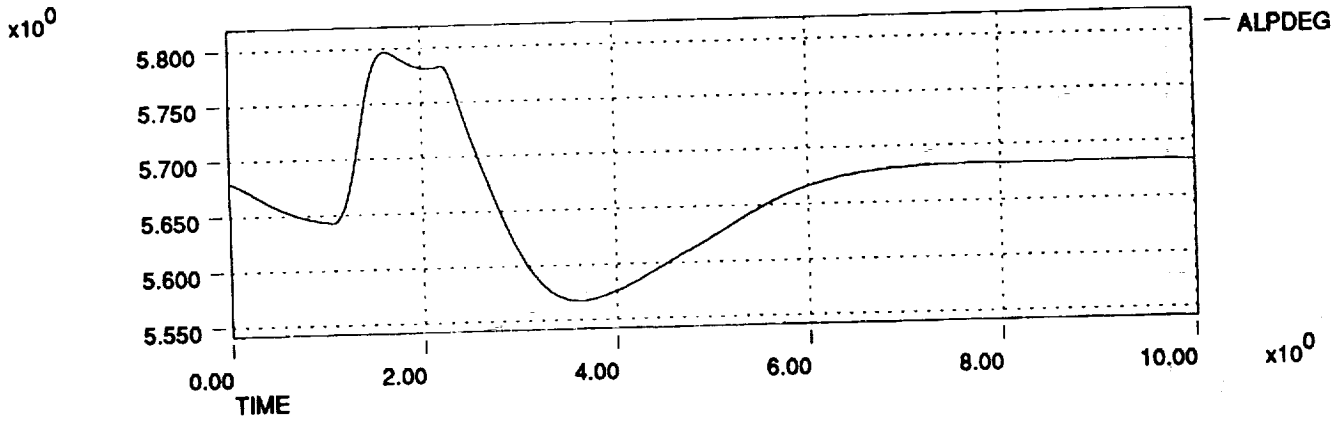

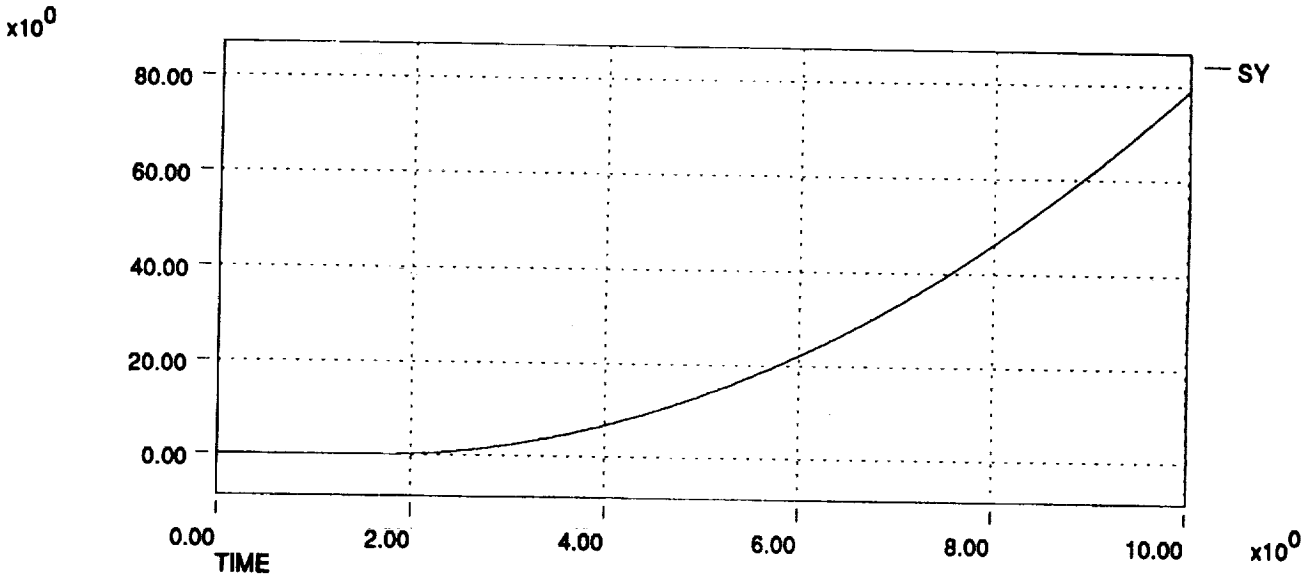
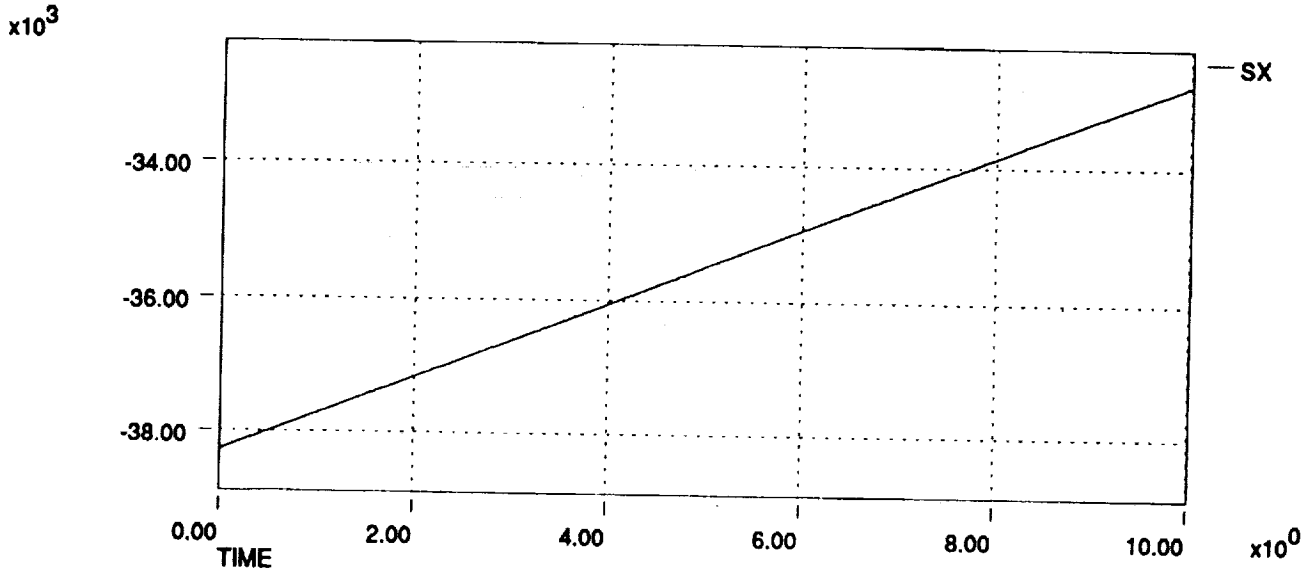
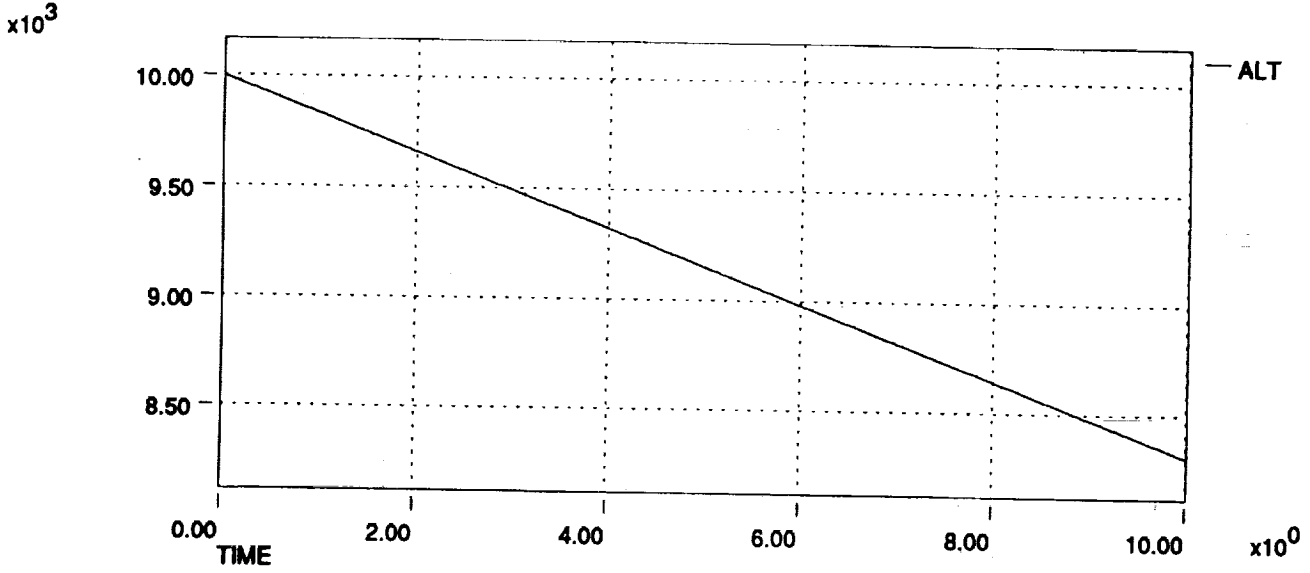

HL-20 Dynamic Check Case Data Plots 911206
Right Roll Stick Pulse at 300 KEAS, 10,000 ft

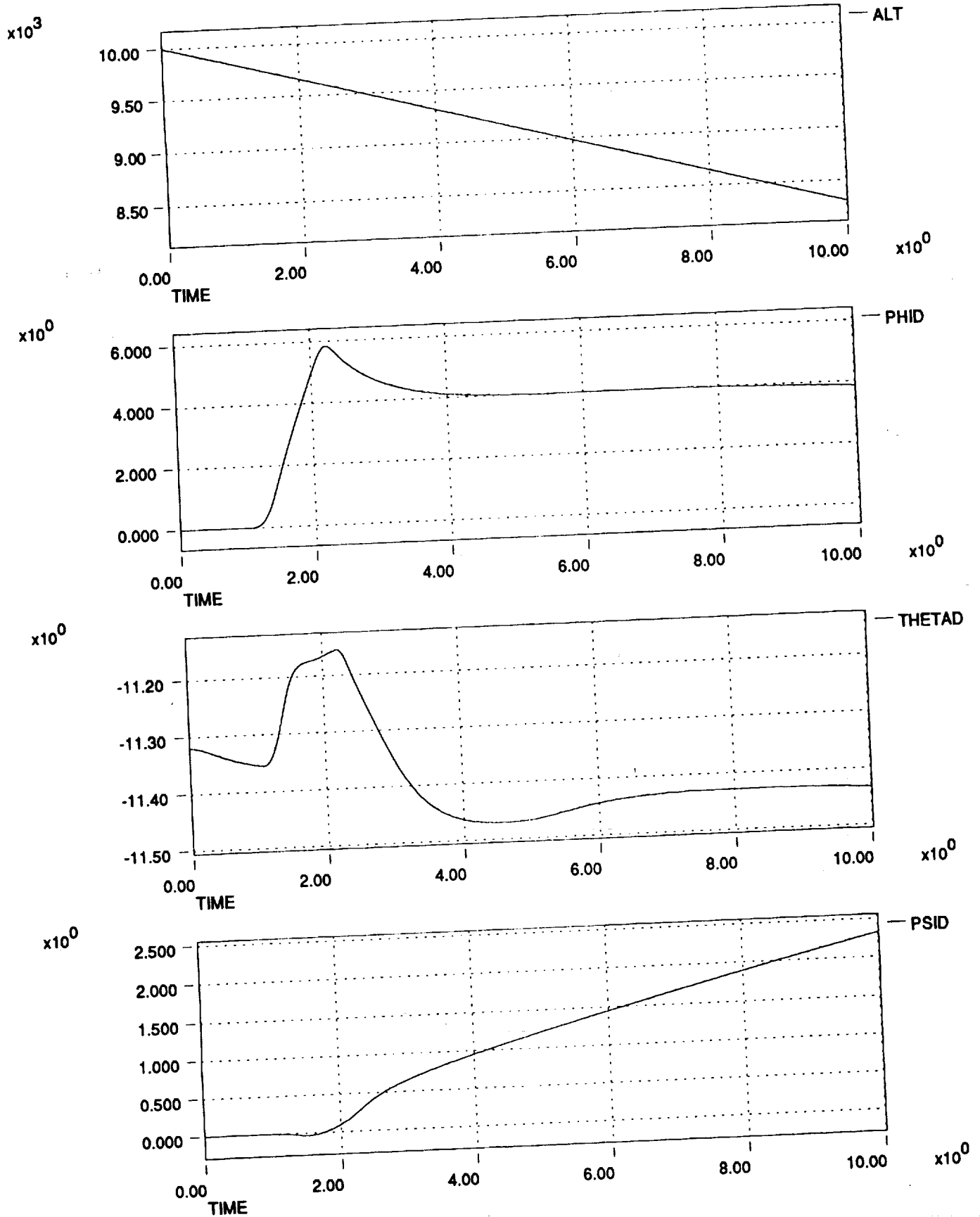

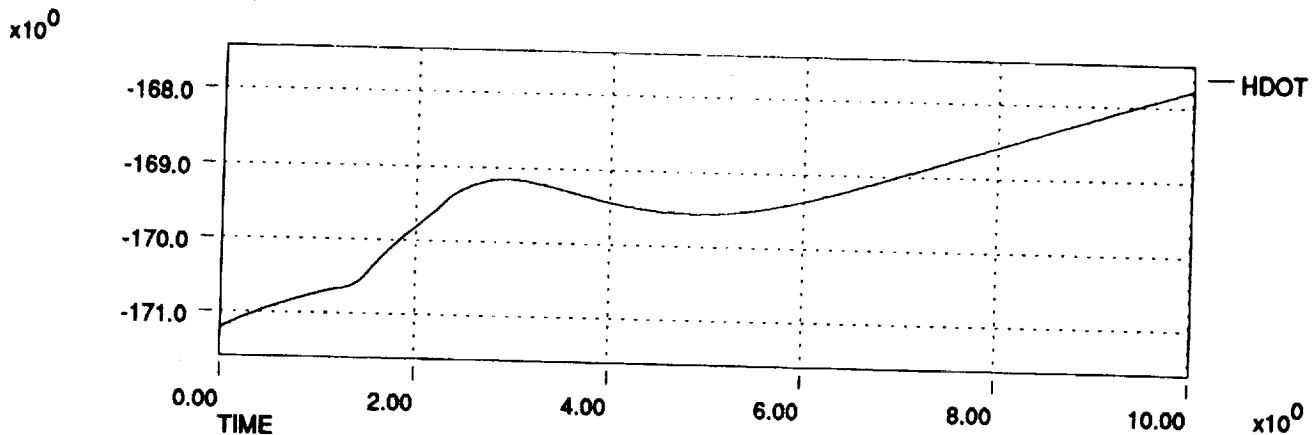
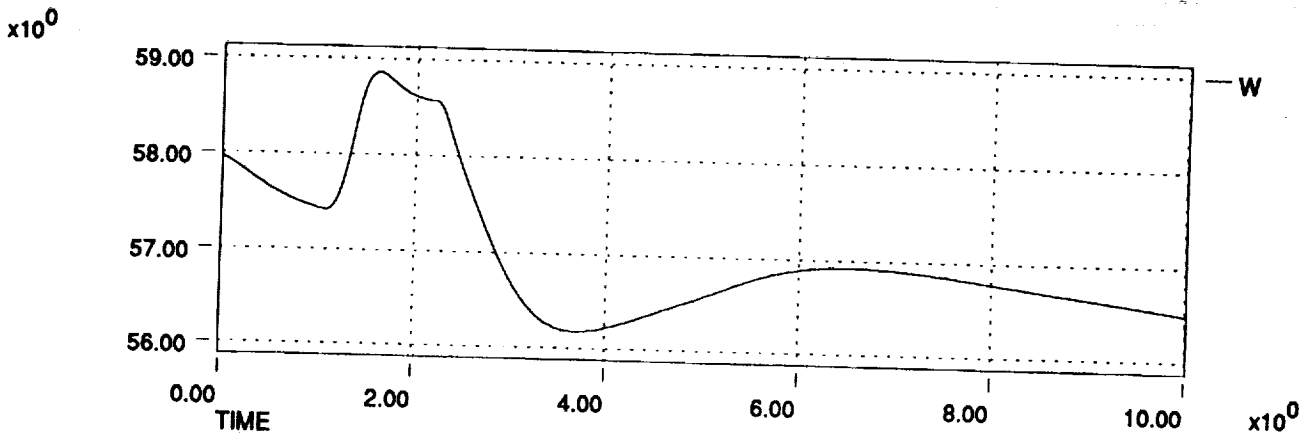
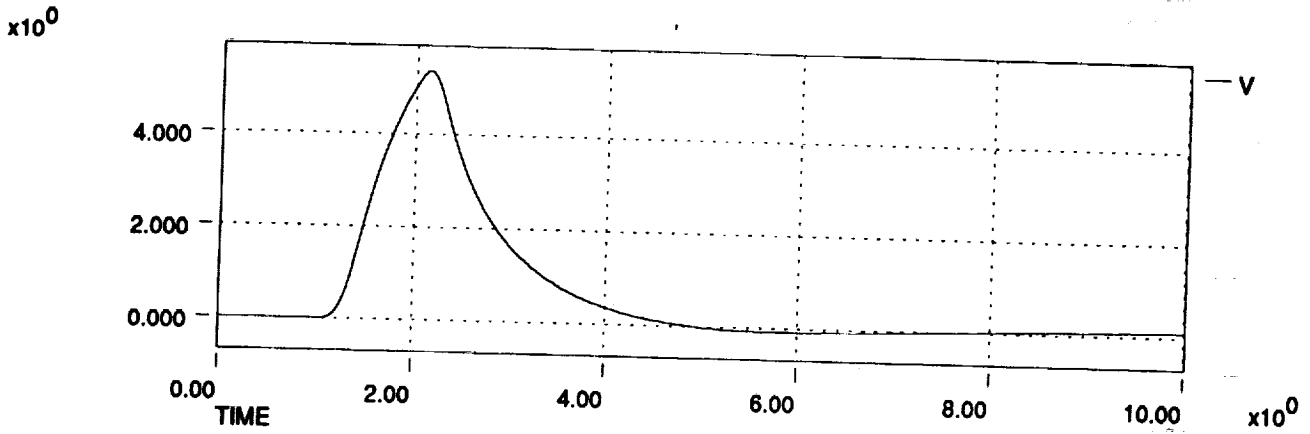
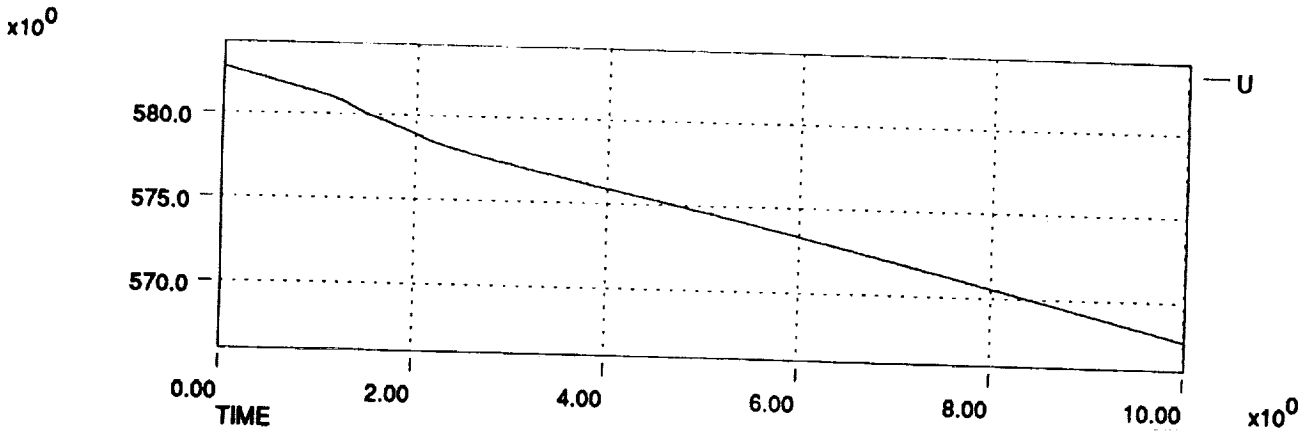

HL-20 Dynamic Check Case Data Plots 911206
Right Roll Stick Pulse at 300 KEAS, 10,000 ft

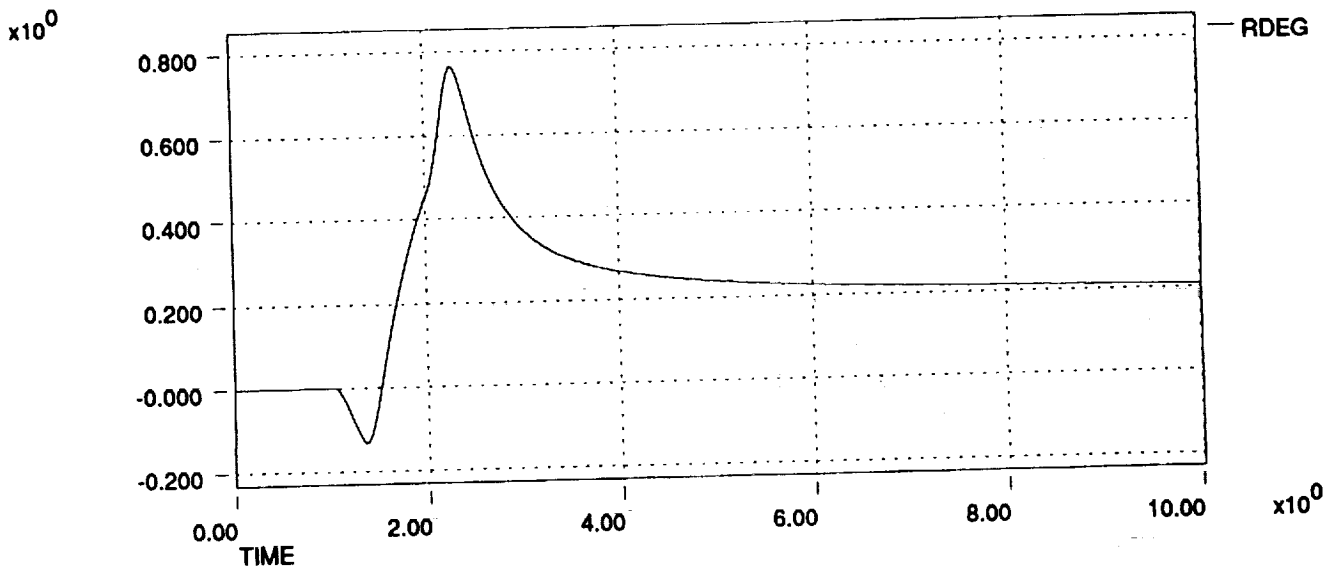
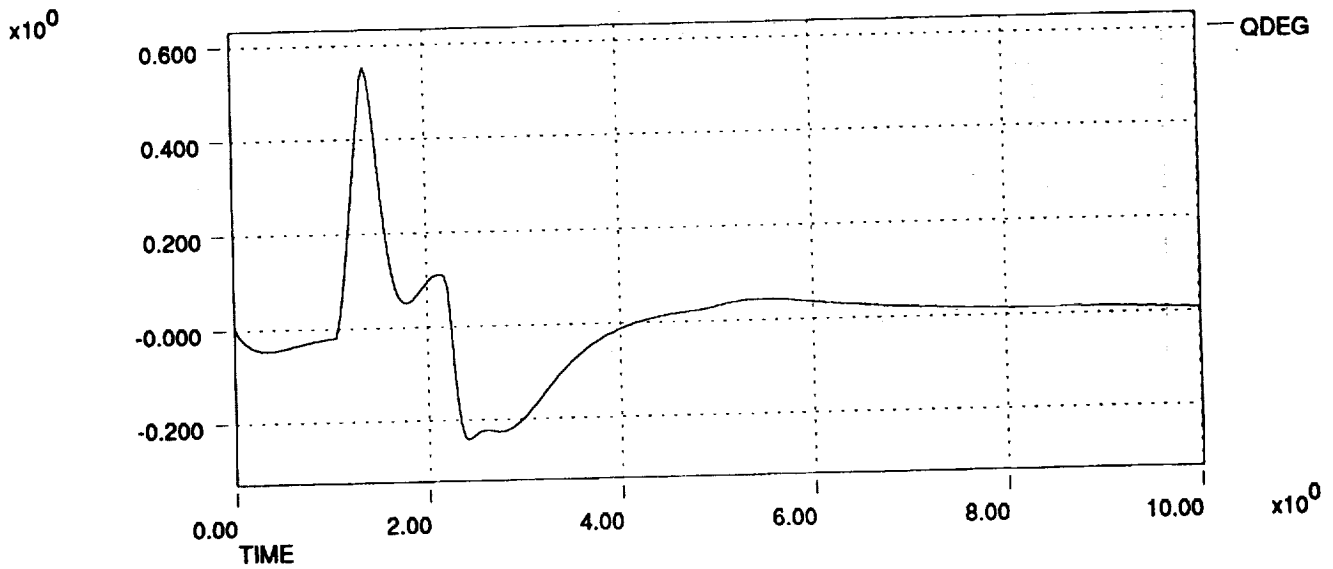
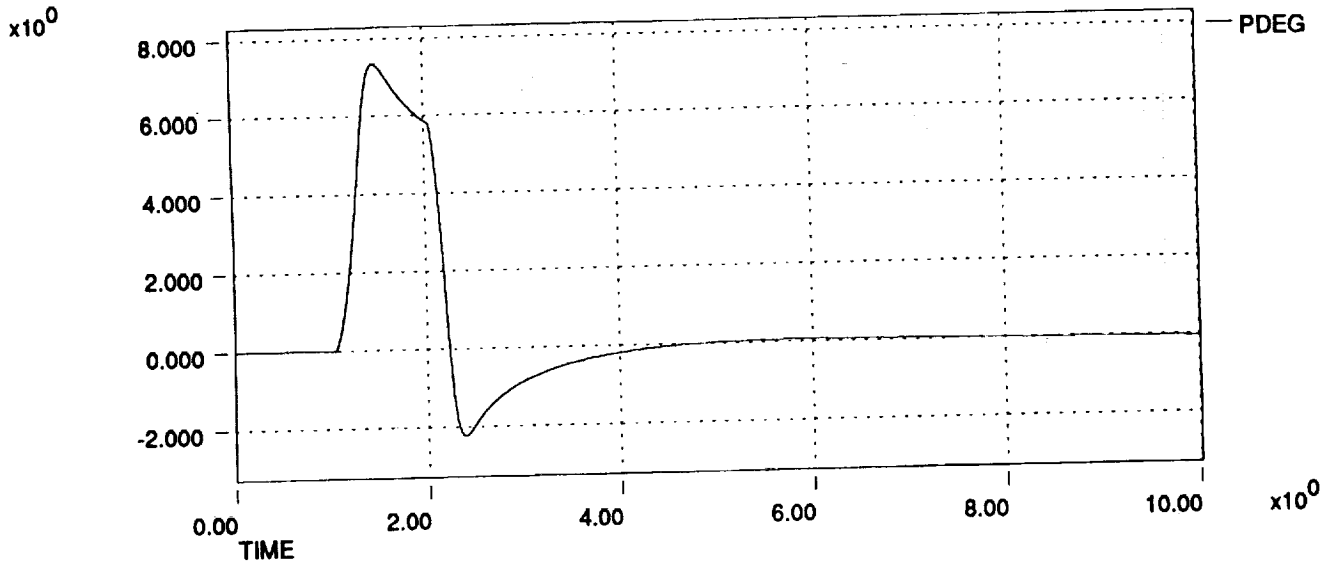

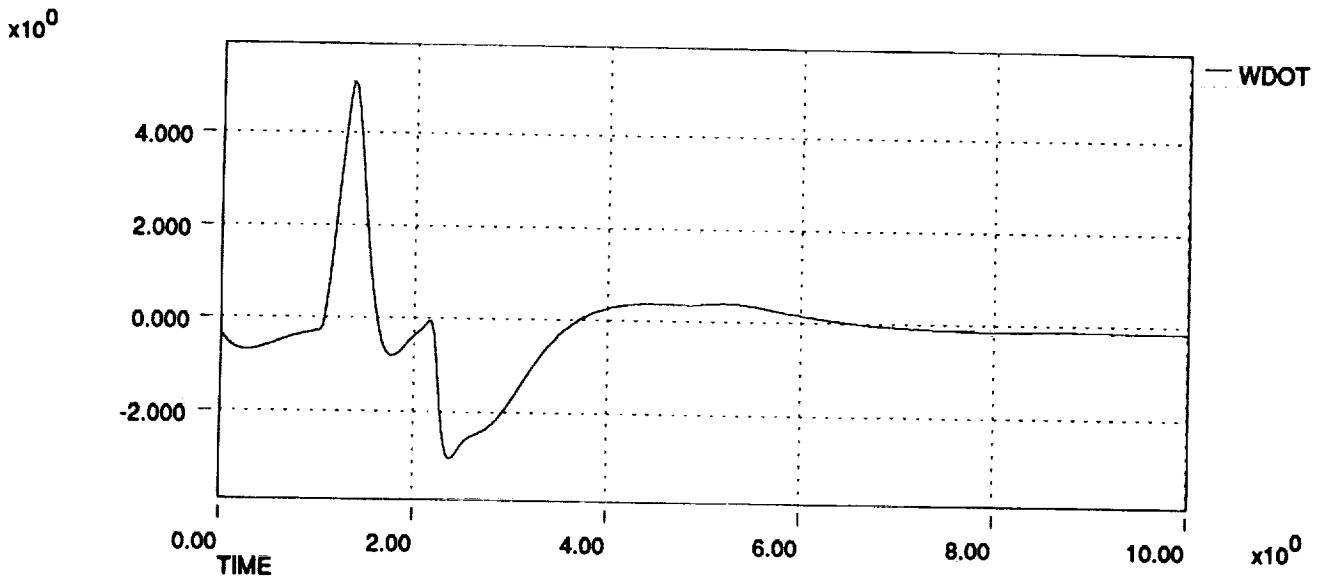
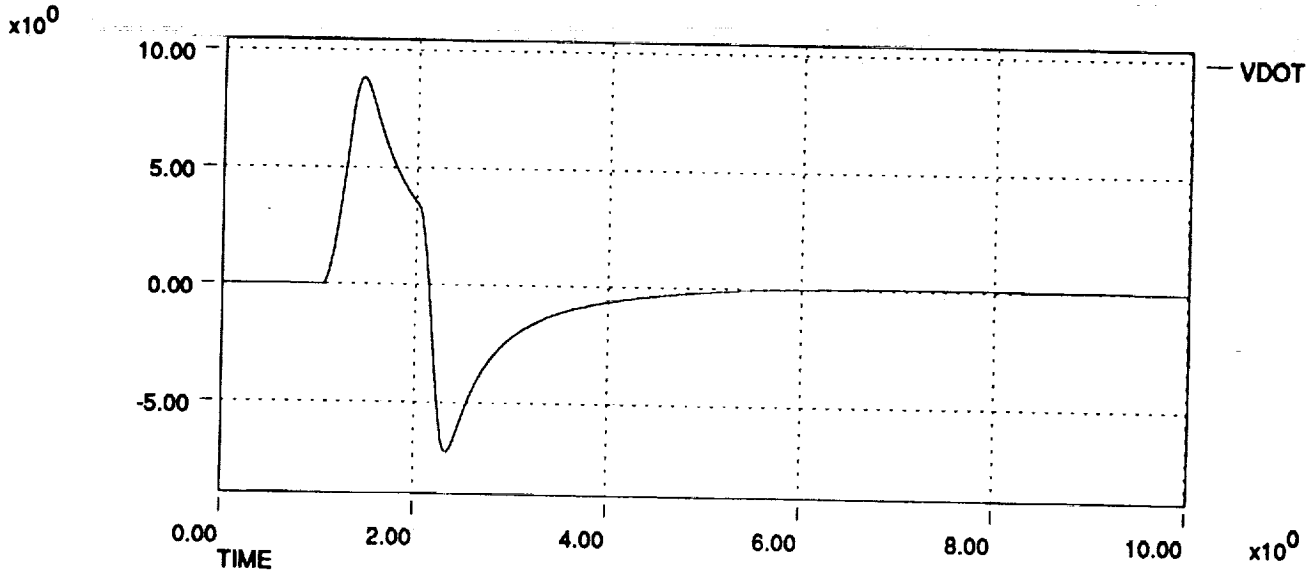
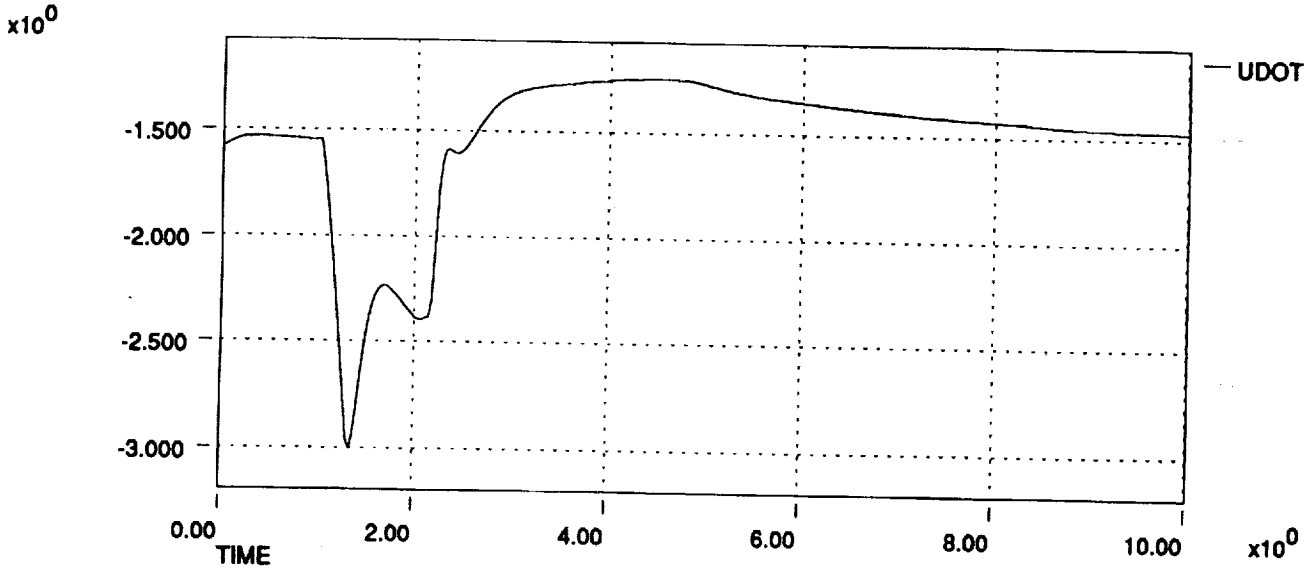

HL-20 Dynamic Check Case Data Plots 911206
Right Roll Stick Pulse at 300 KEAS, 10,000 ft

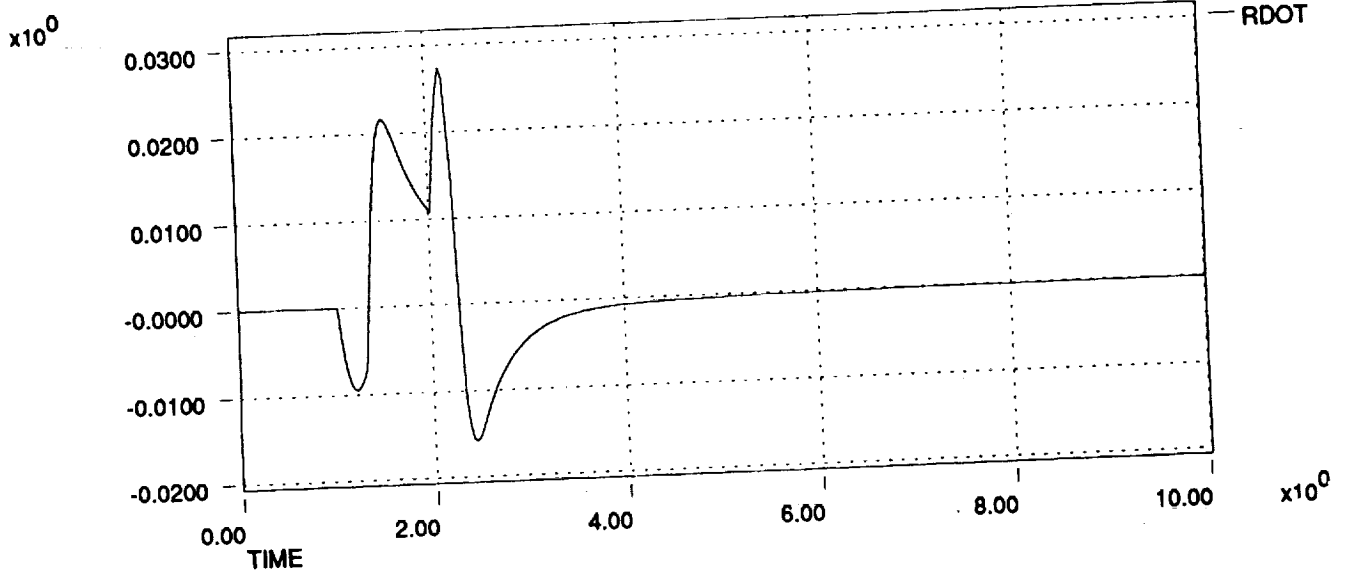
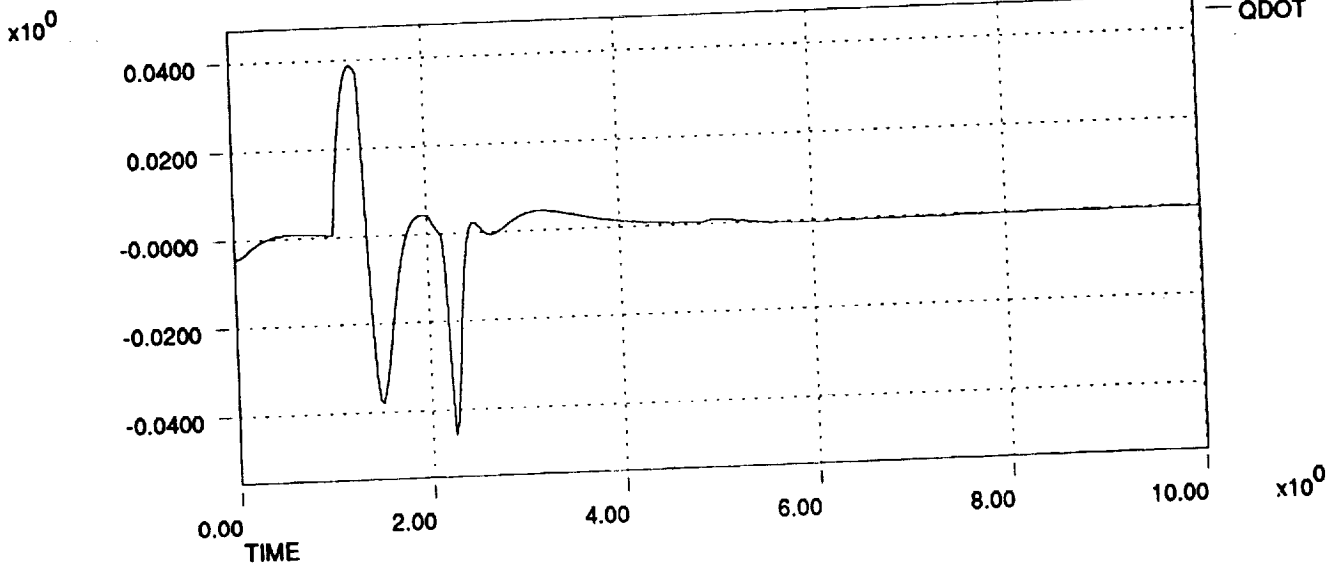
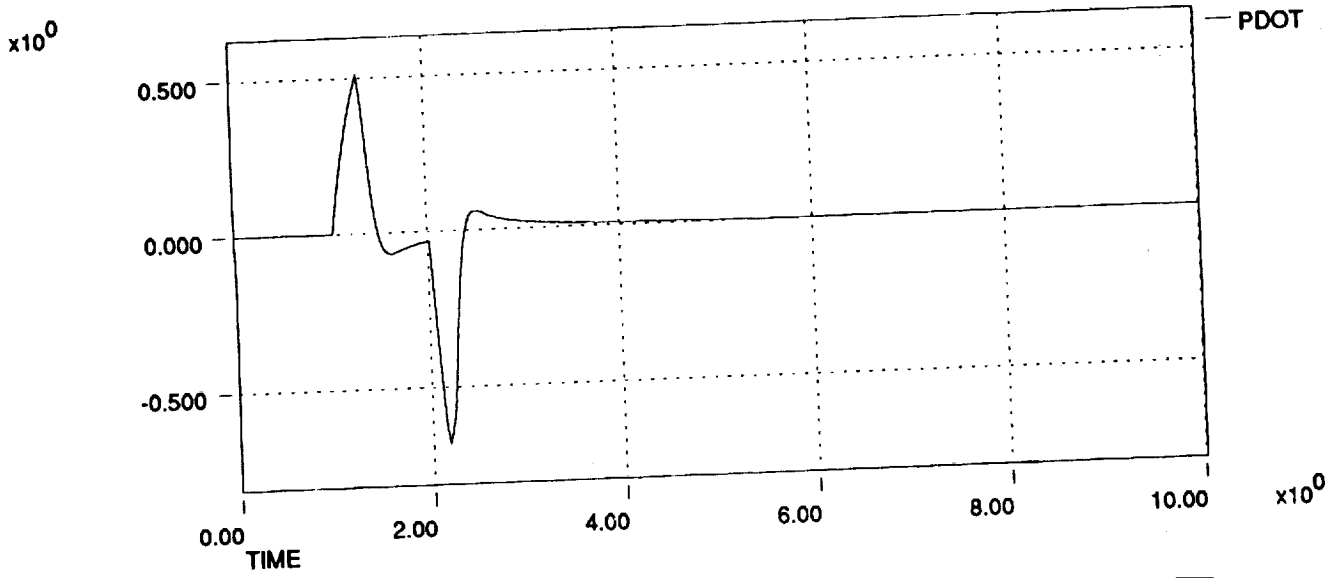

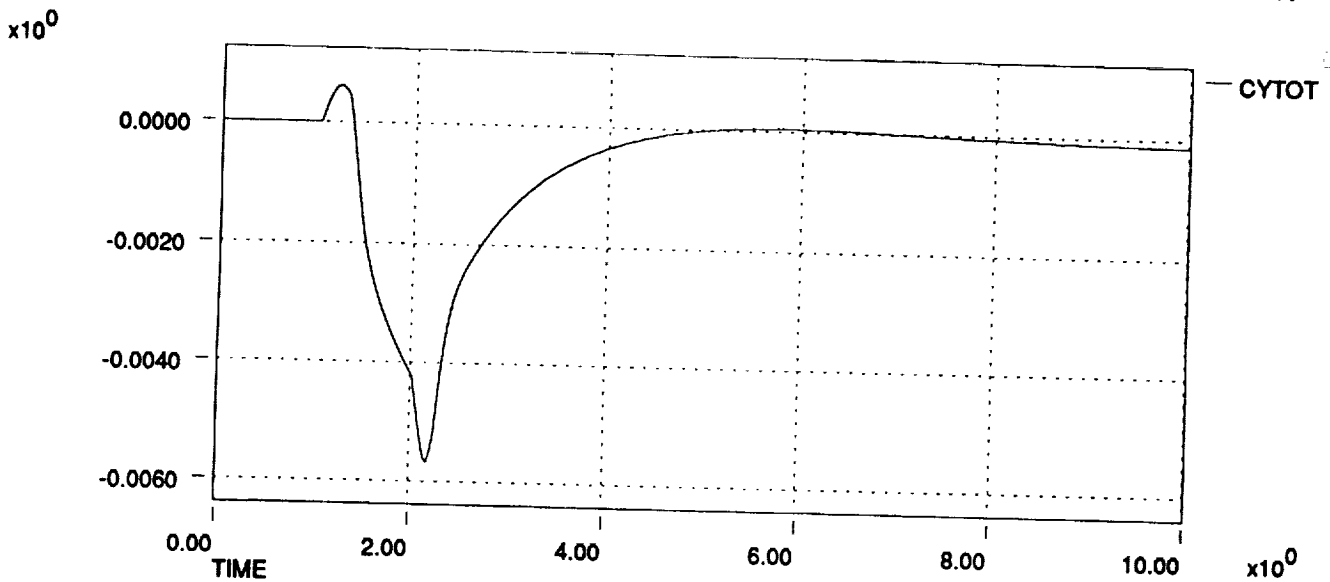
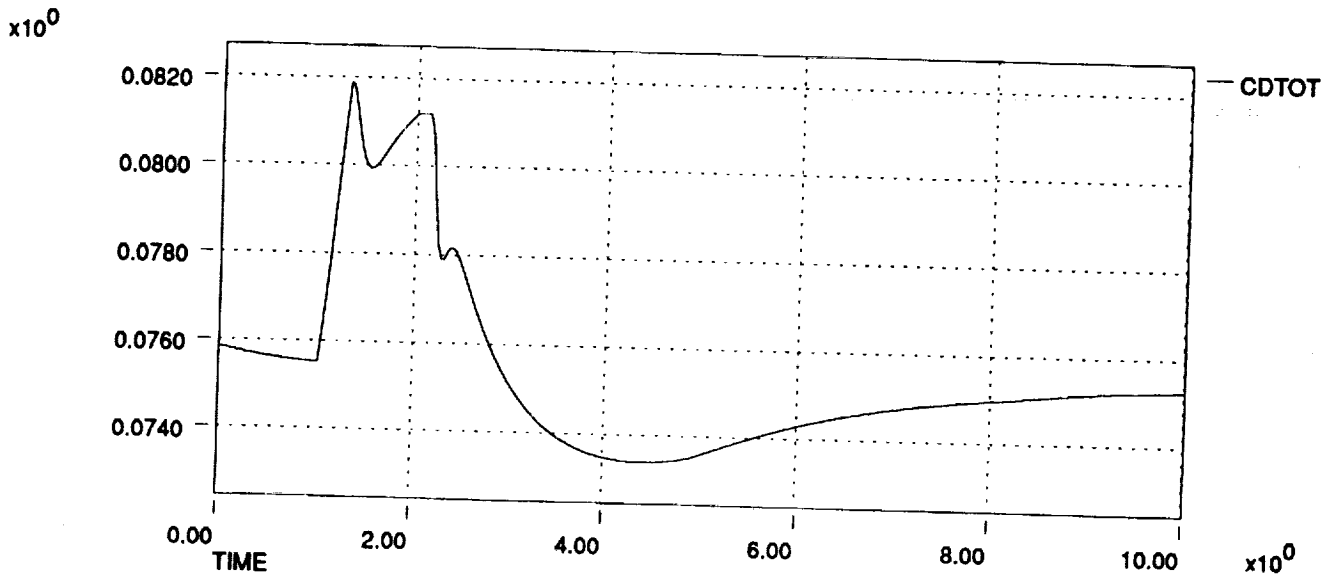
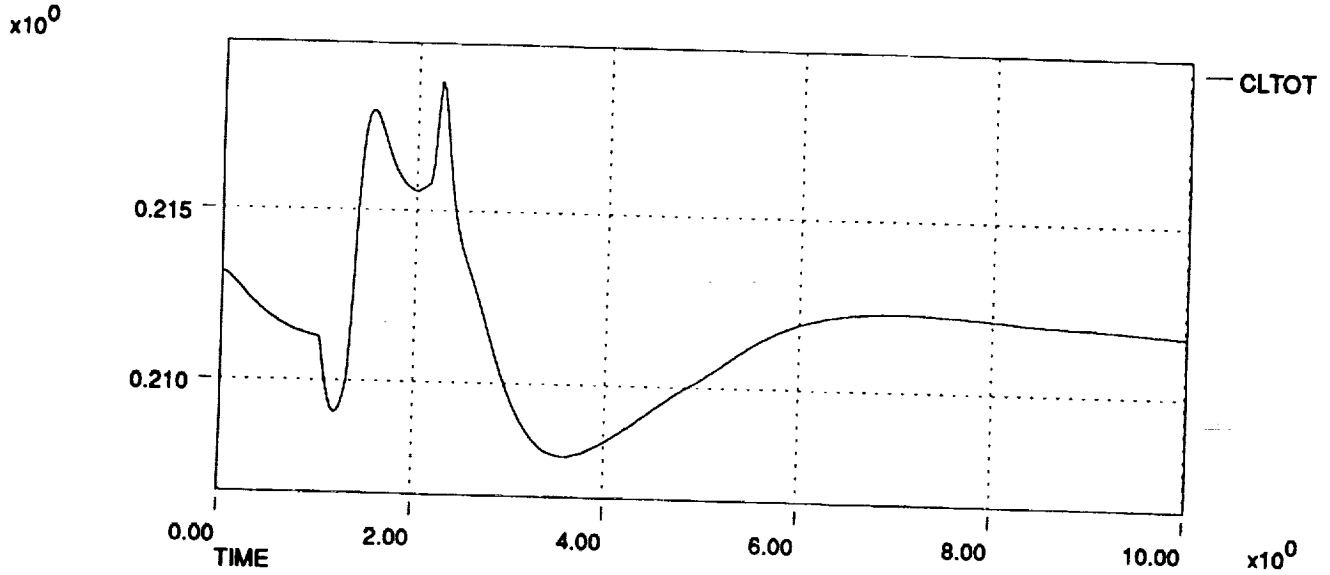

HL-20 Dynamic Check Case Data Plots 911206
Right Roll Stick Pulse at 300 KEAS, 10,000 ft

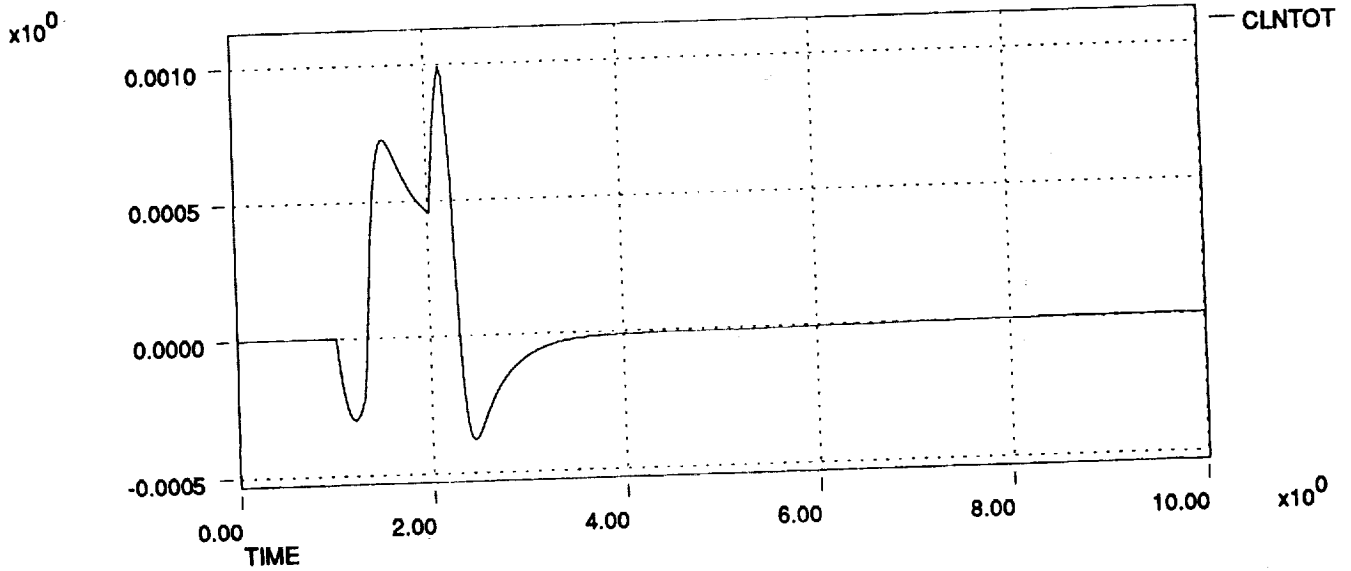
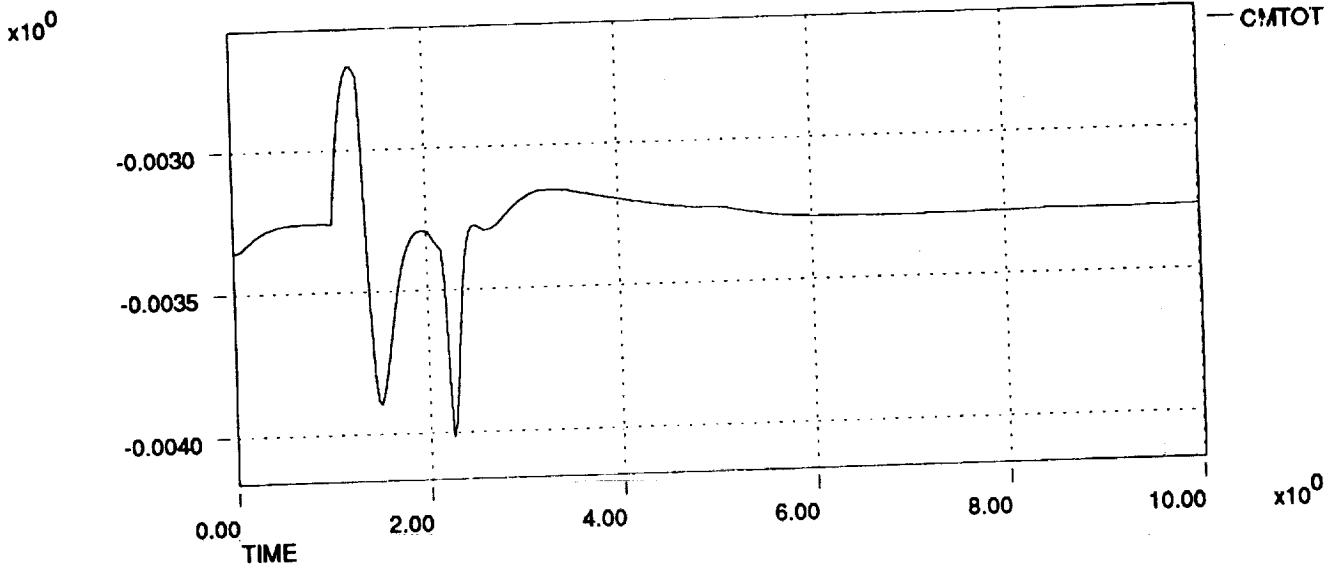
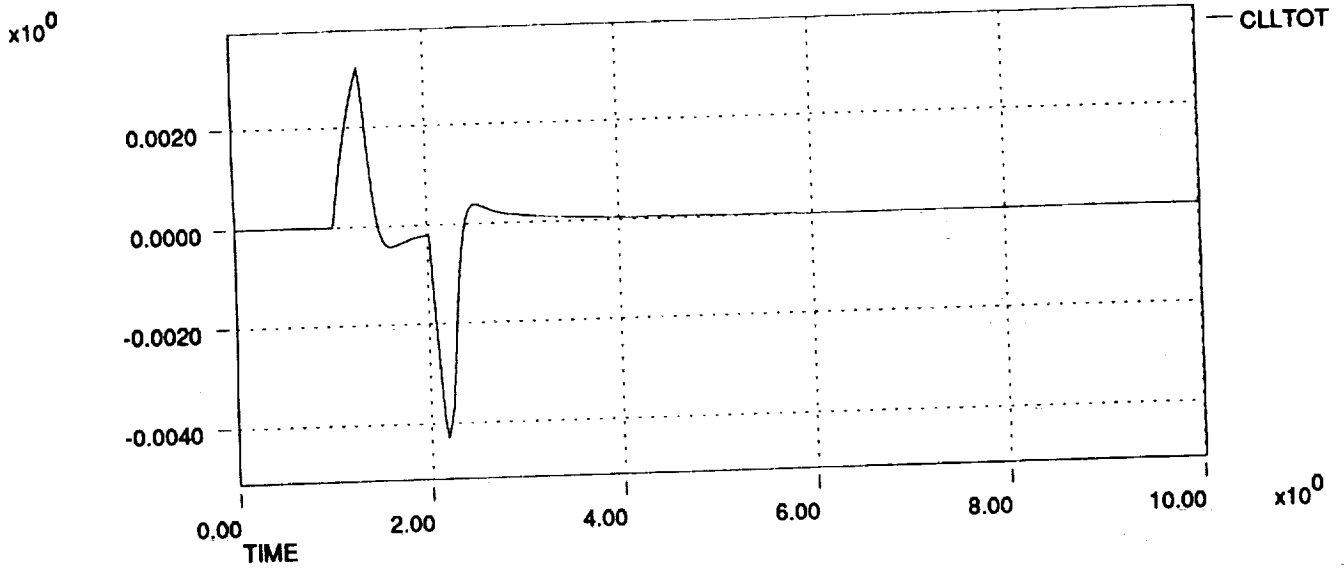

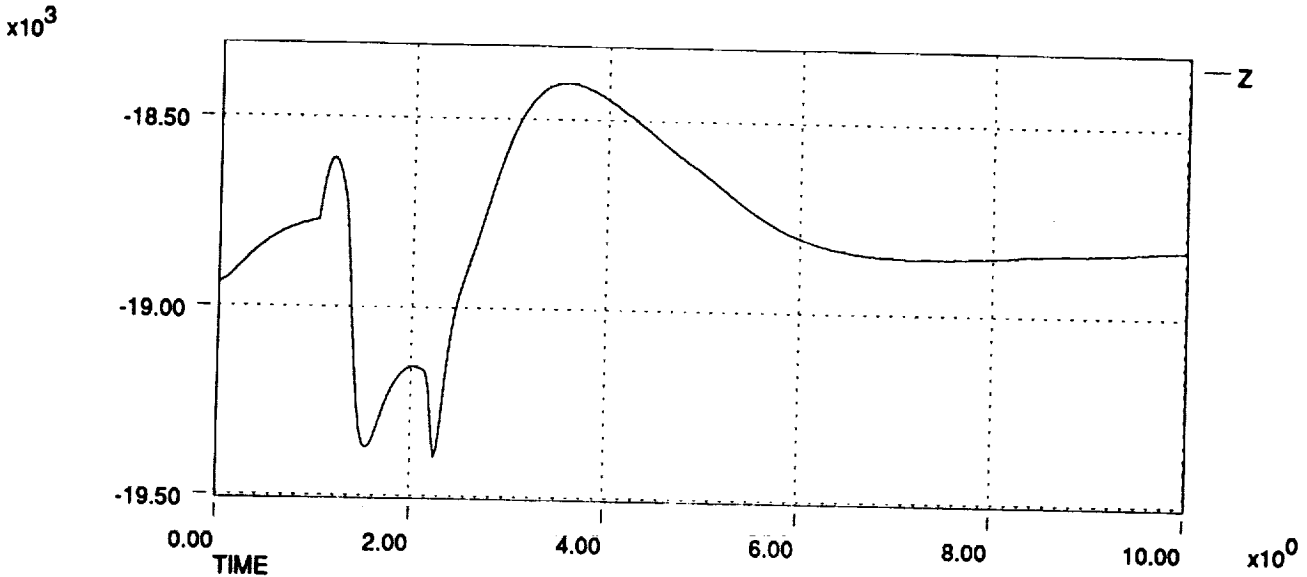
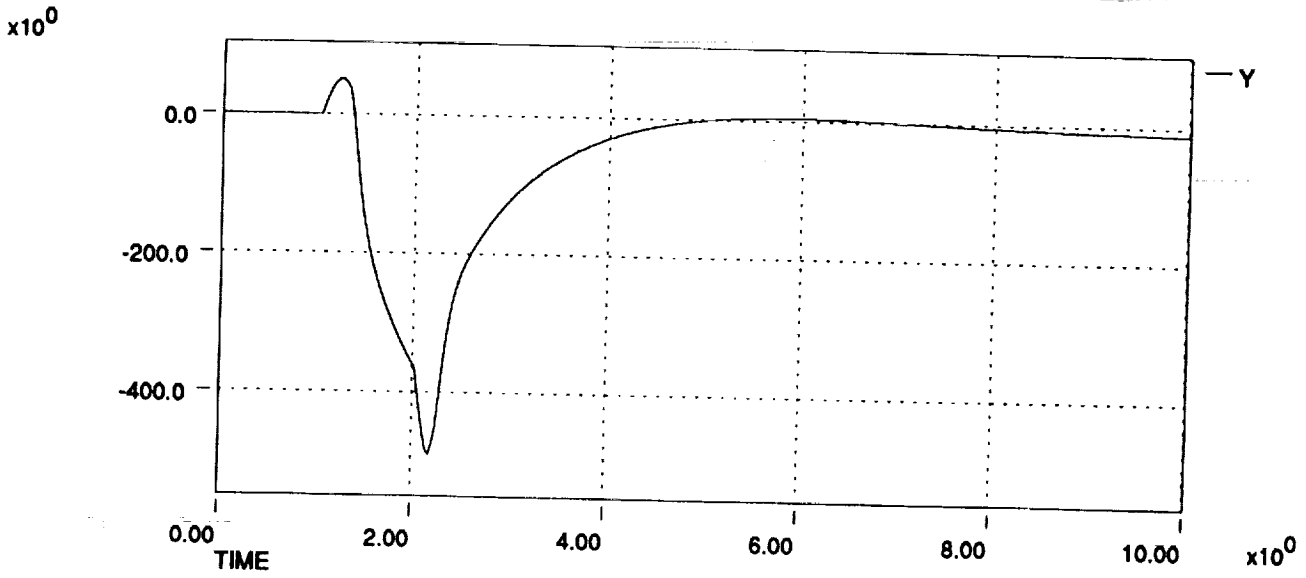
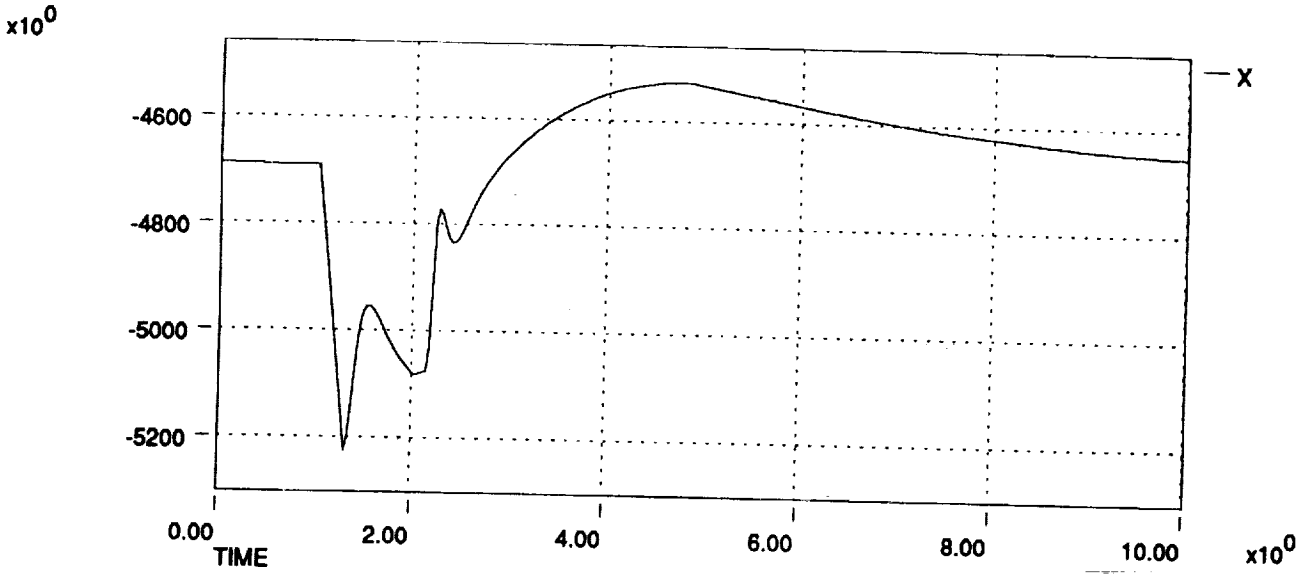

HL-20 Dynamic Check Case Data Plots 911206
Right Roll Stick Pulse at 300 KEAS, 10,000 ft

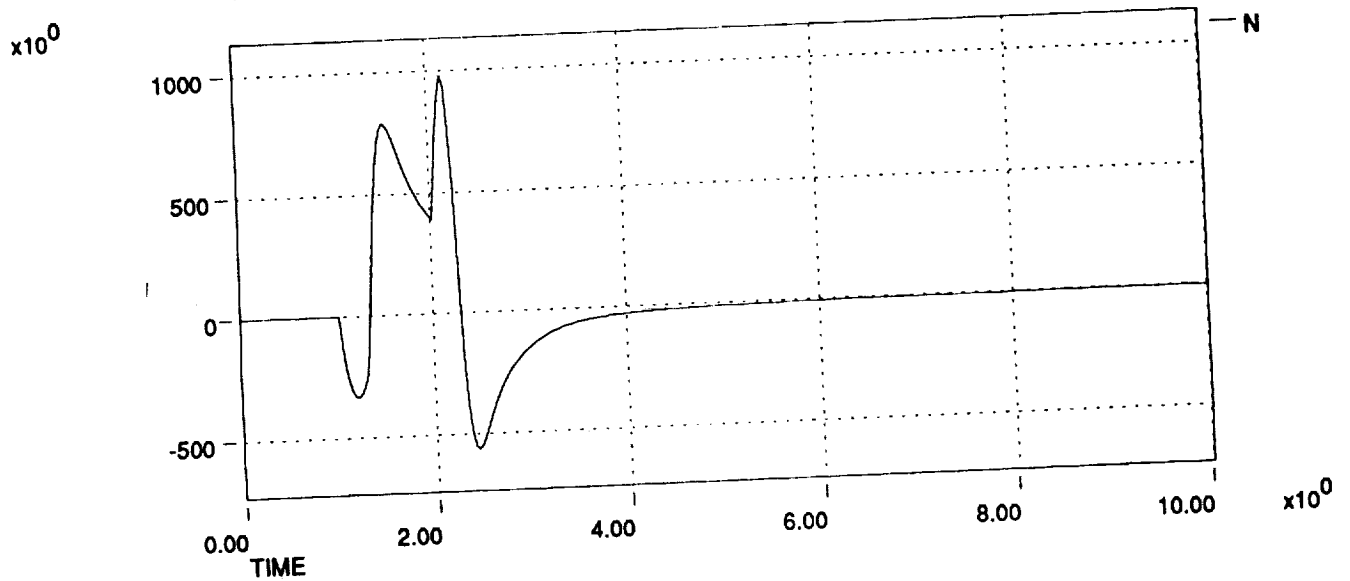
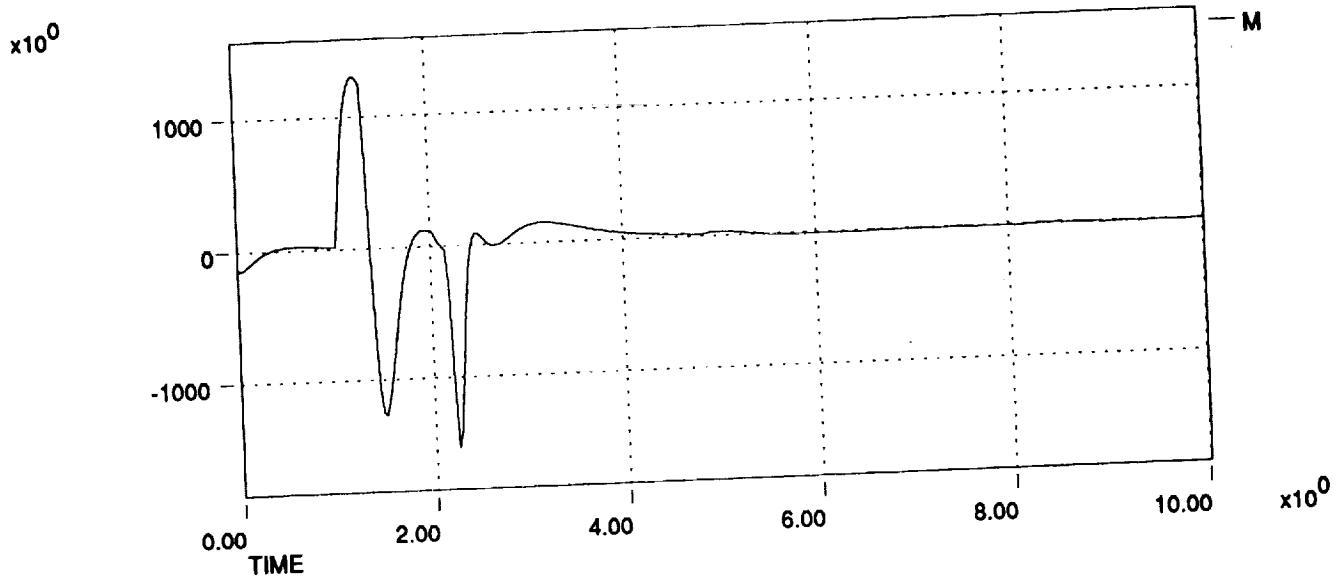
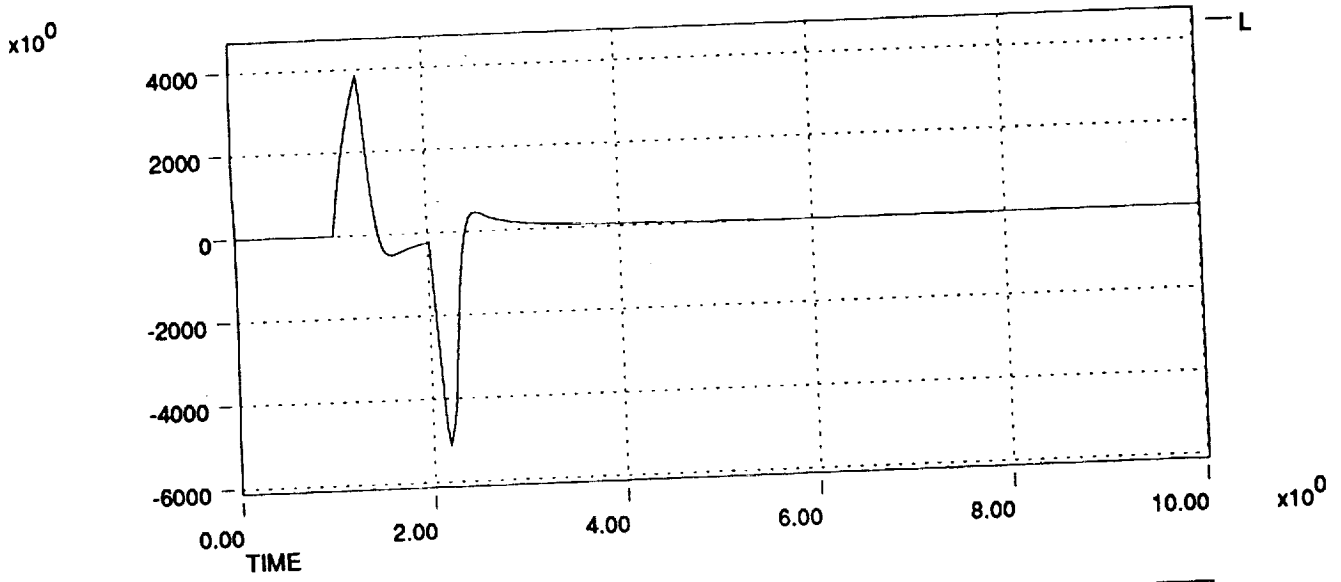

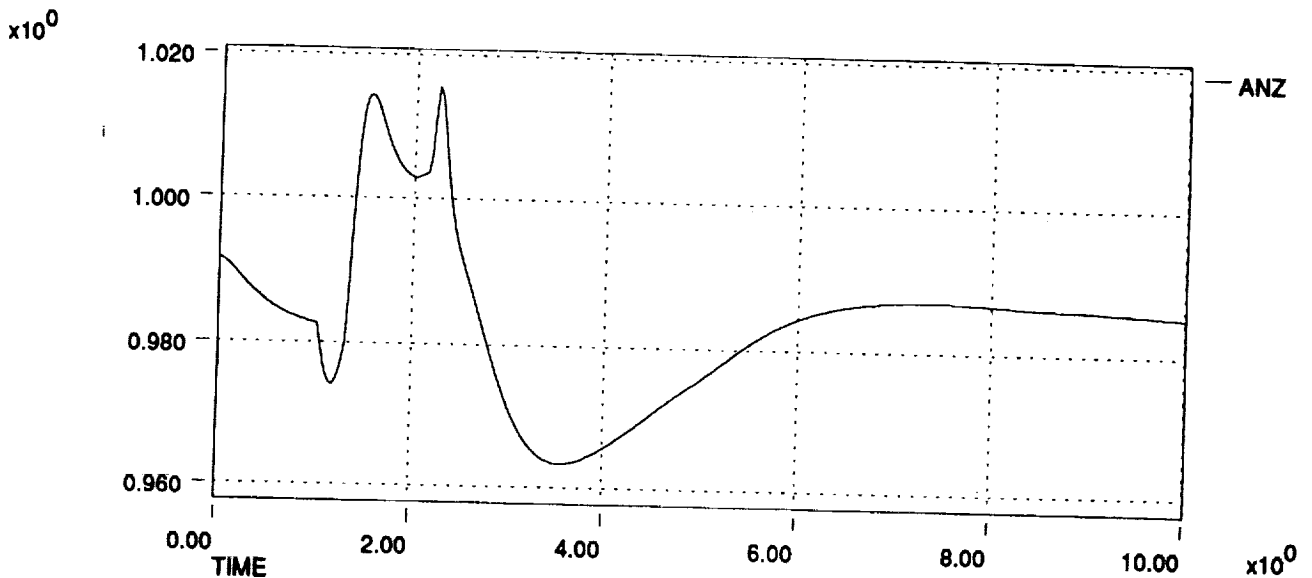
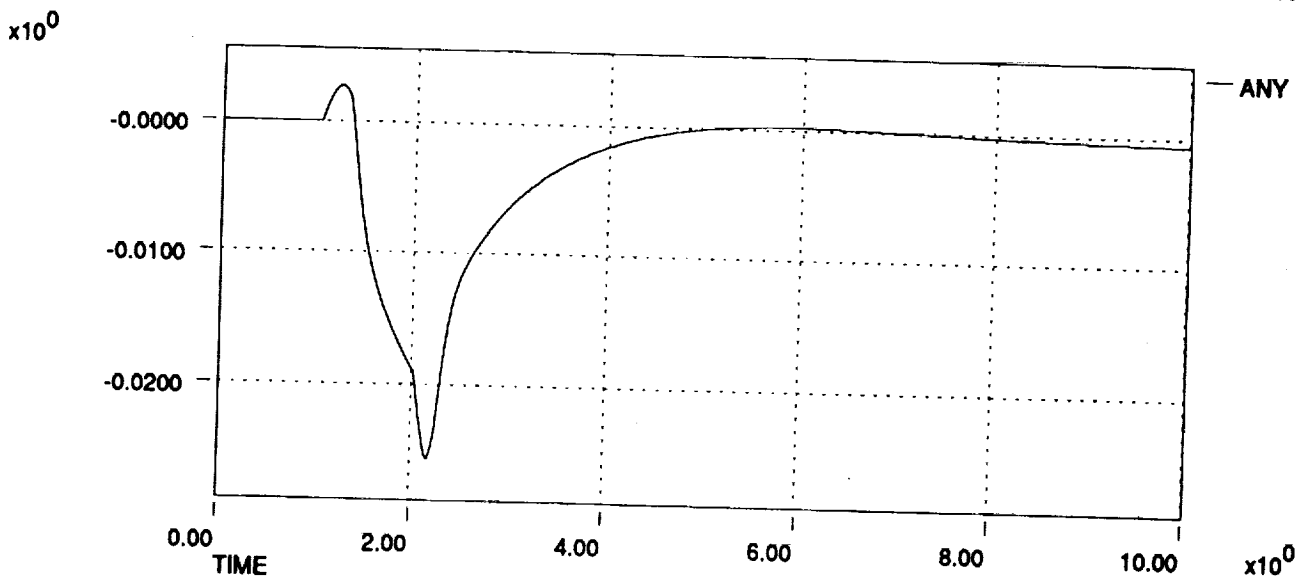
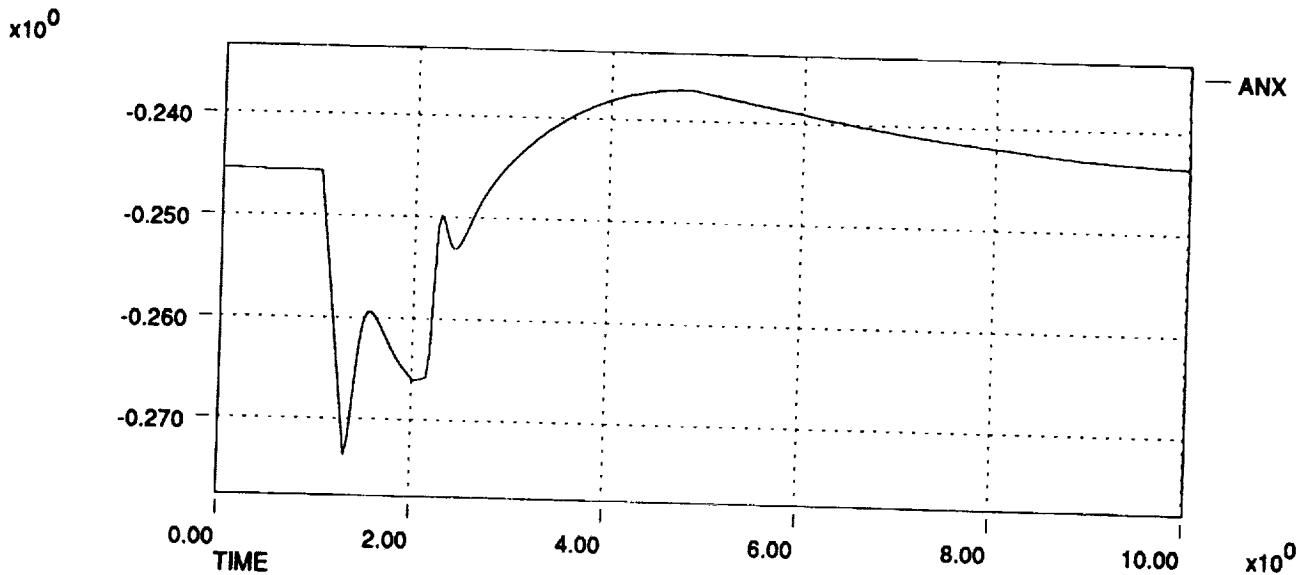

HL-20 Dynamic Check Case Data Plots 911206
Right Roll Stick Pulse at 300 KEAS, 10,000 ft

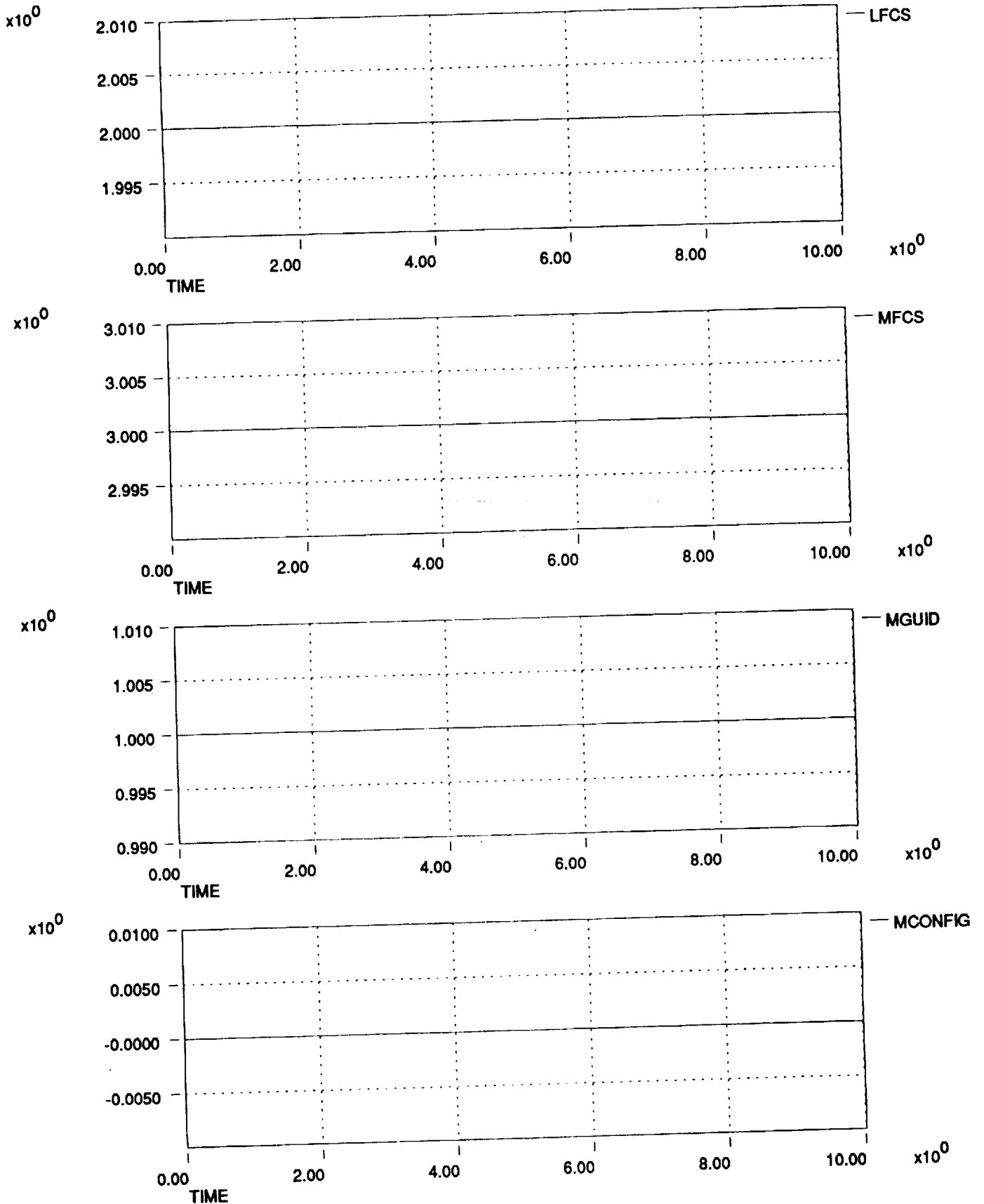

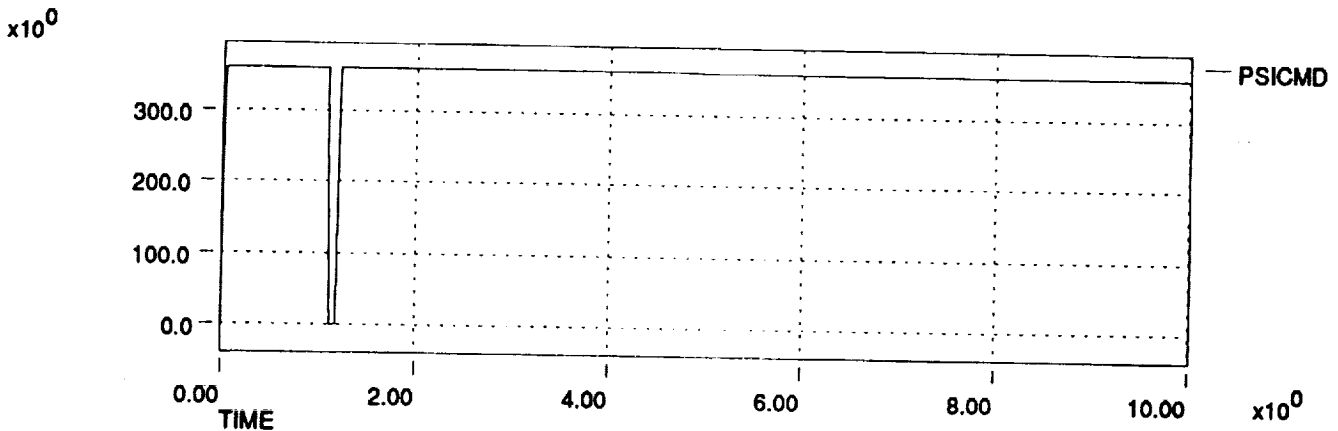
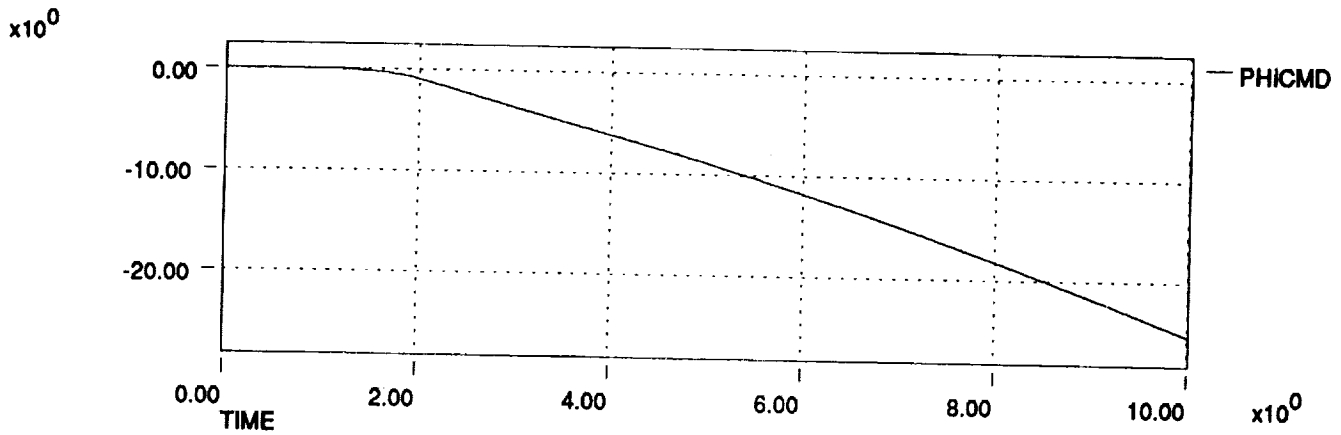
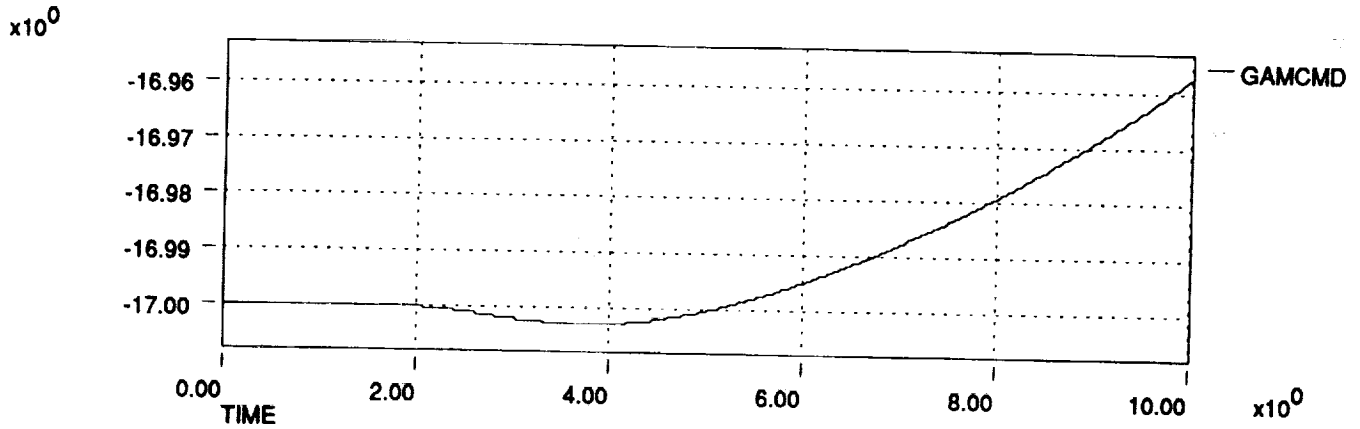
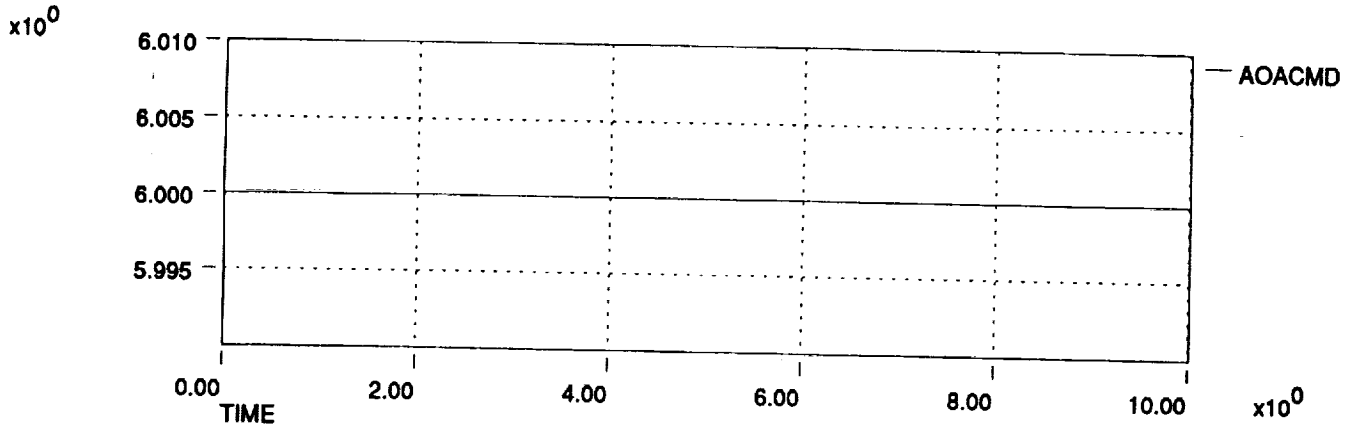

HL-20 Dynamic Check Case Data Plots 911206
Right Roll Stick Pulse at 300 KEAS, 10,000 ft

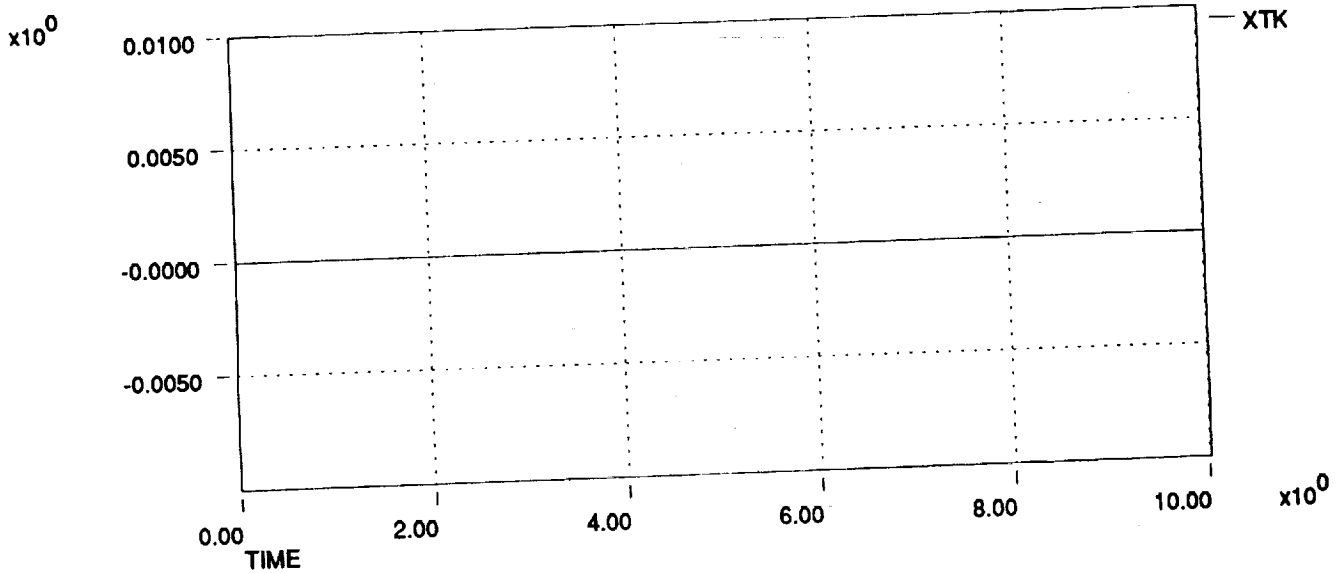
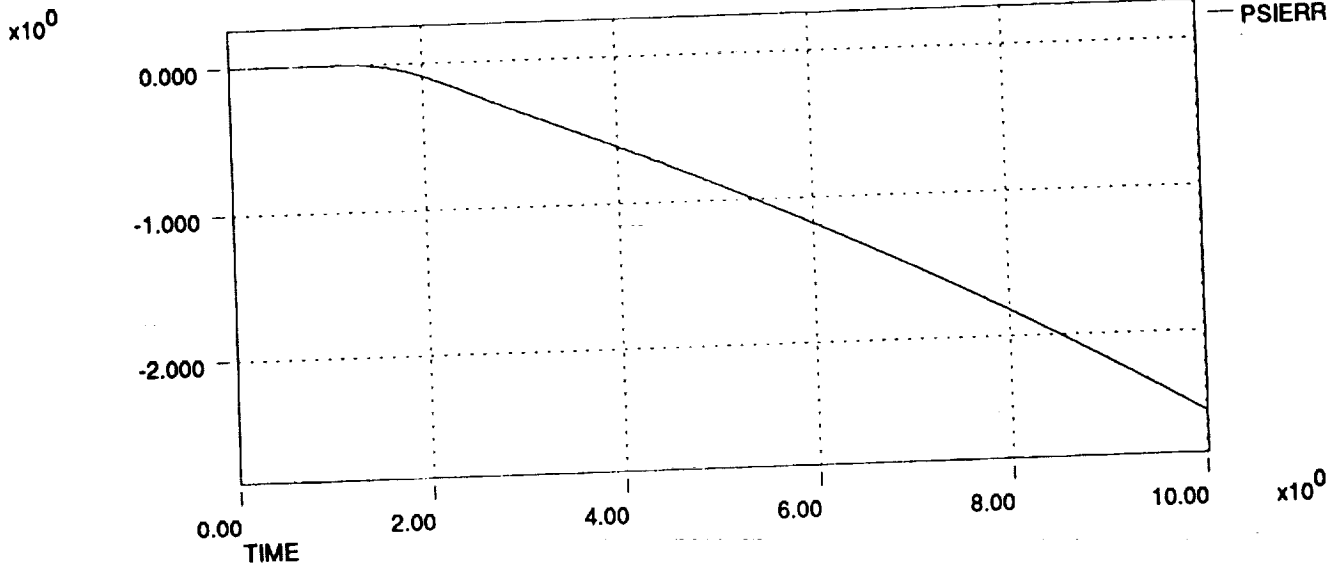
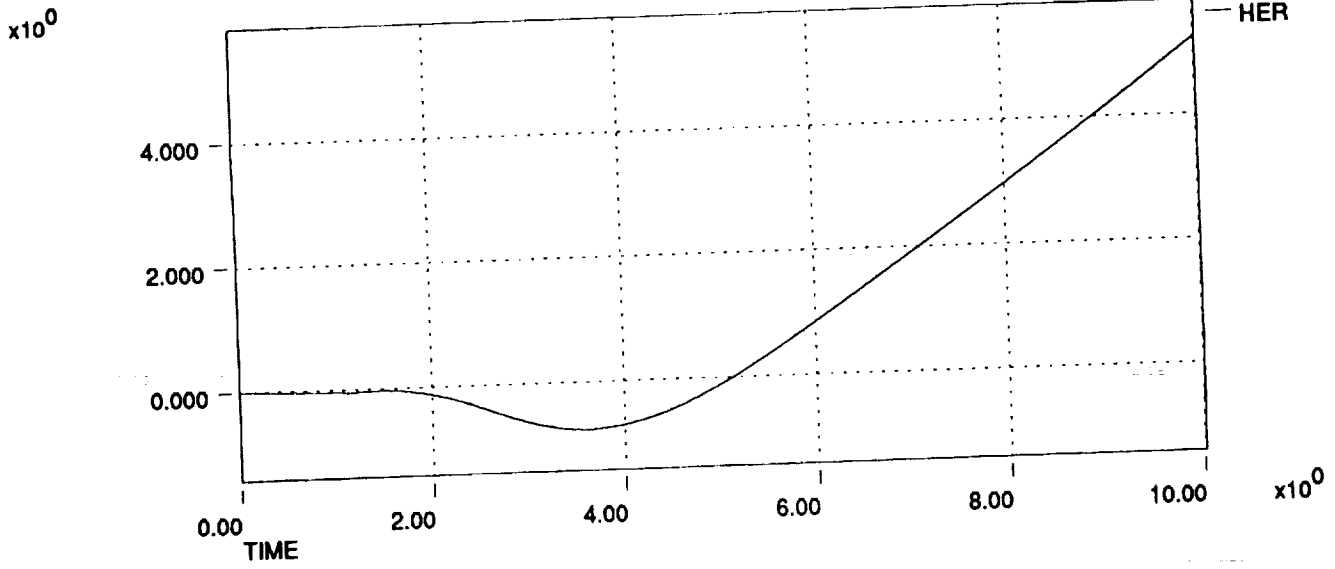

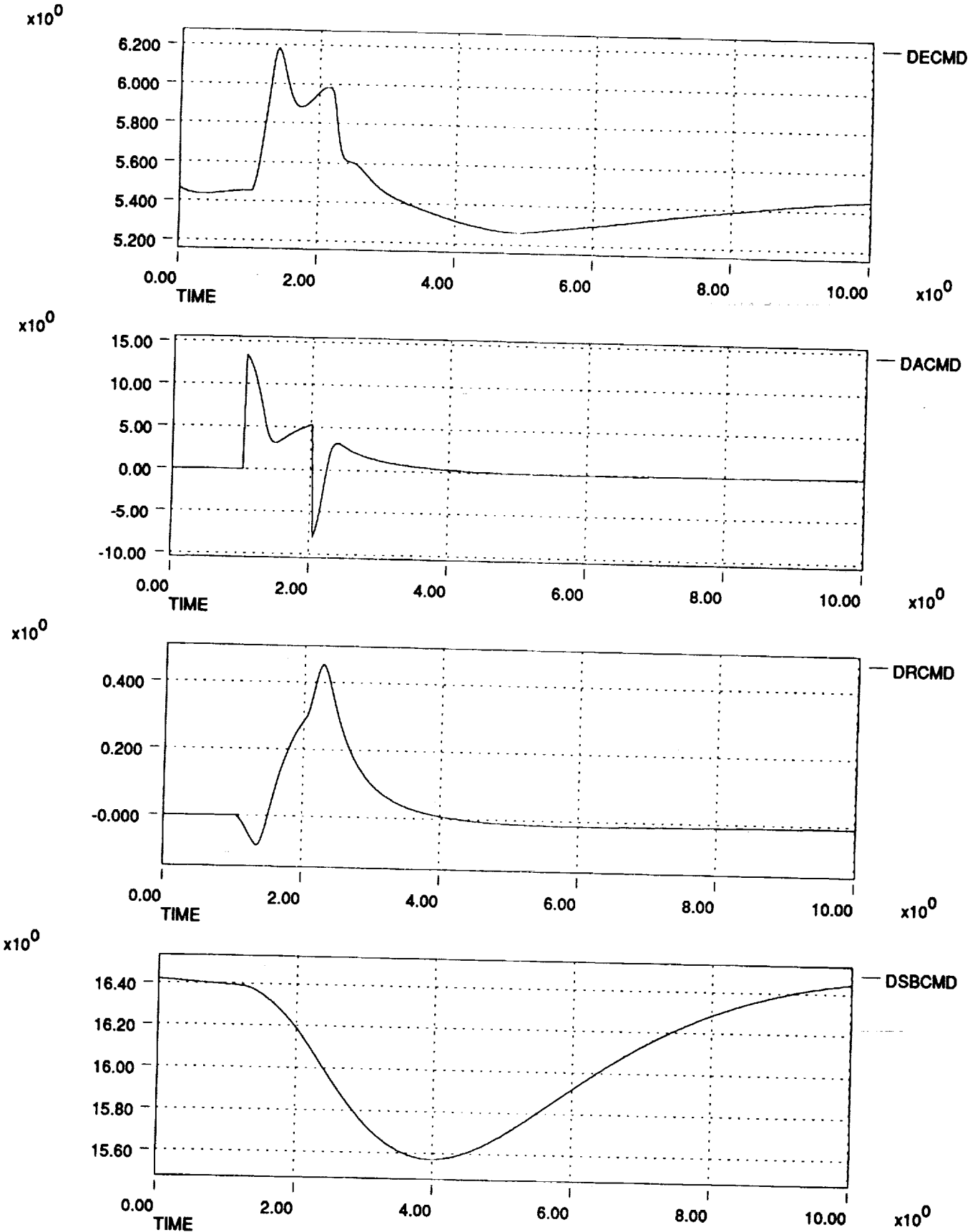

HL-20 Dynamic Check Case Data Plots 911206
Right Roll Stick Pulse at 300 KEAS, 10,000 ft

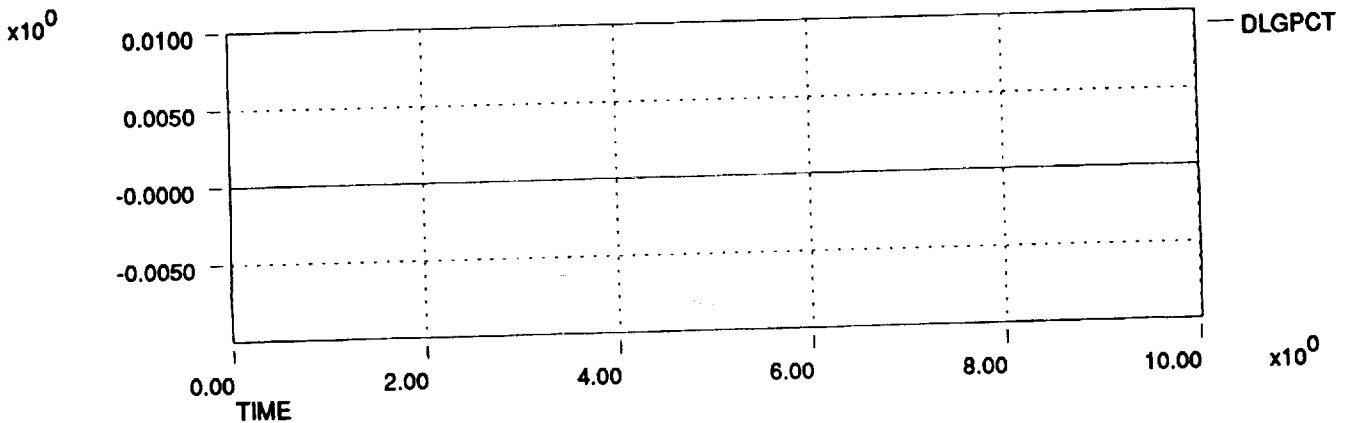
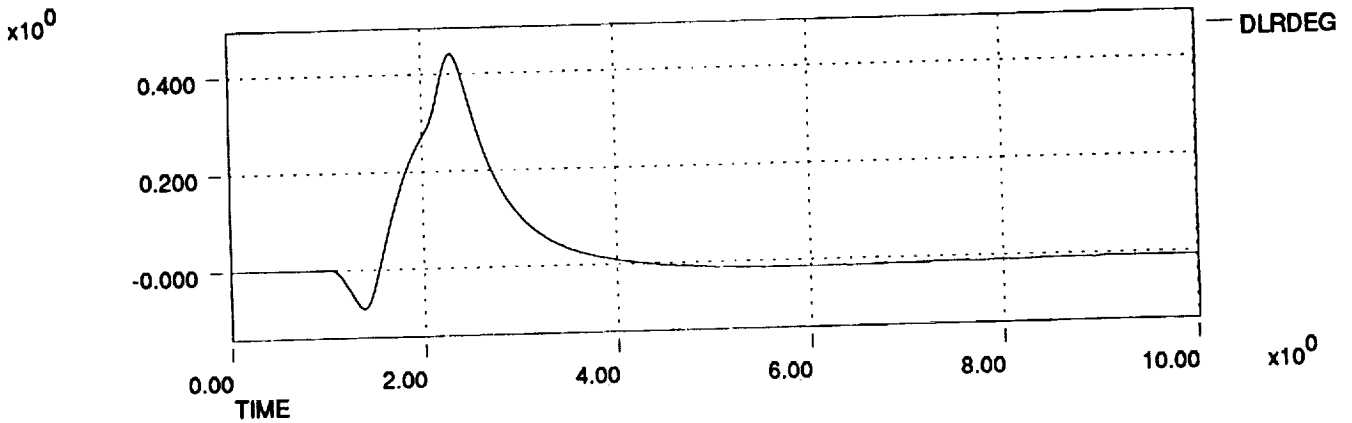
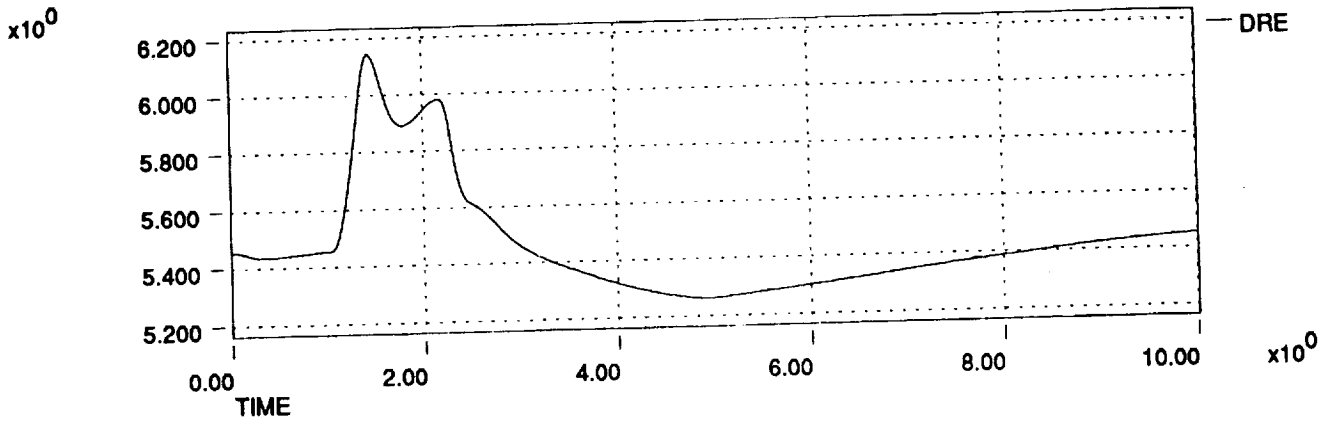
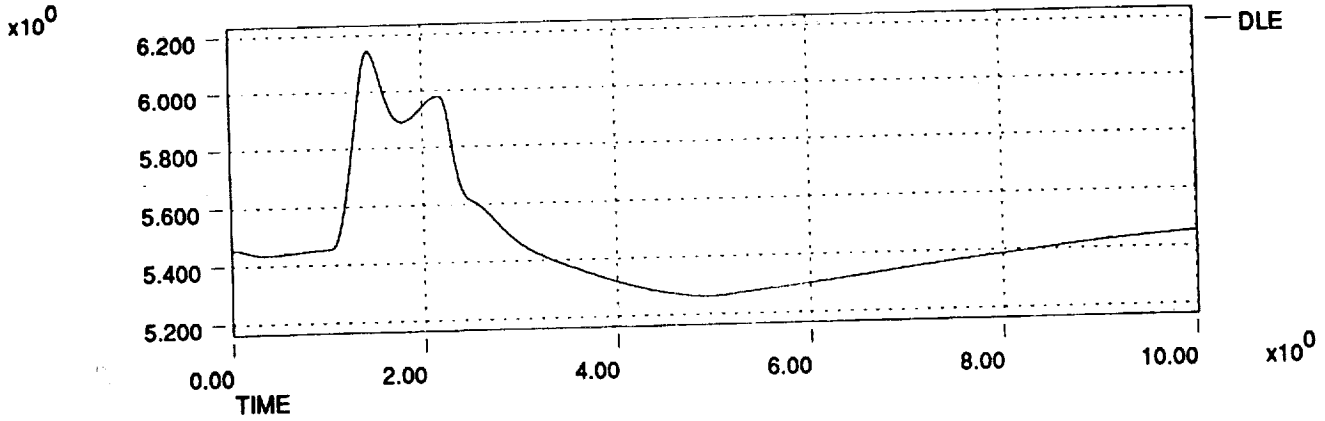

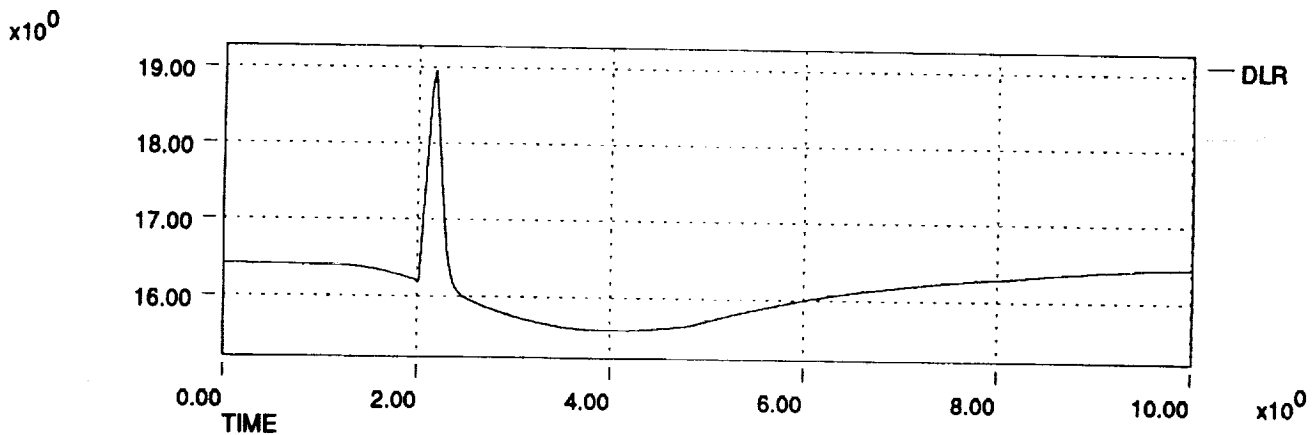
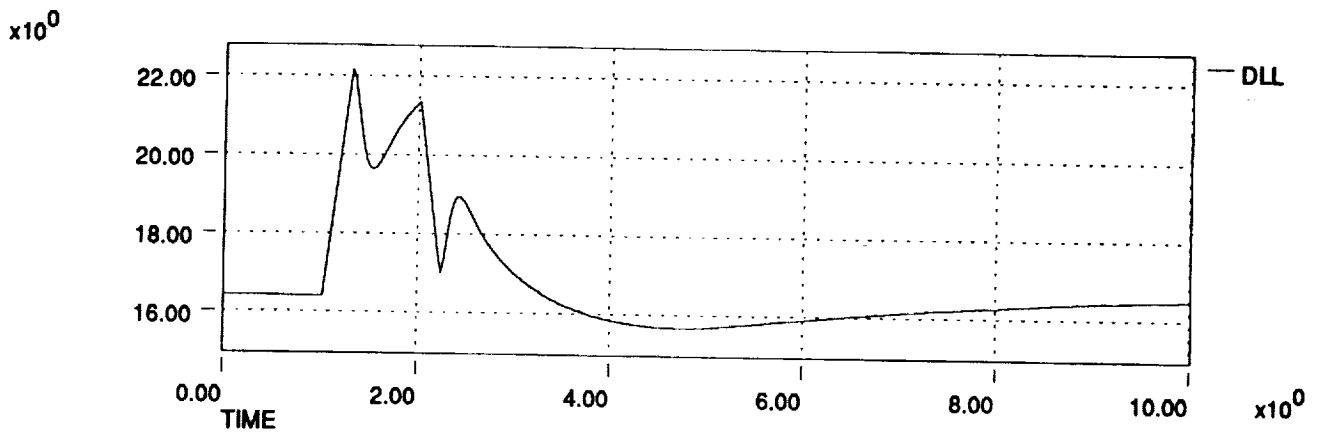
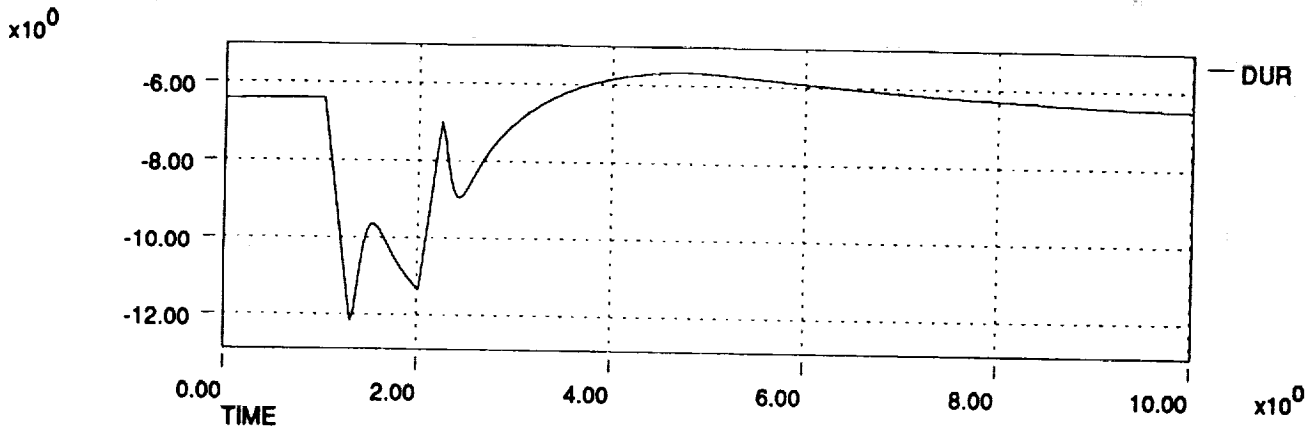
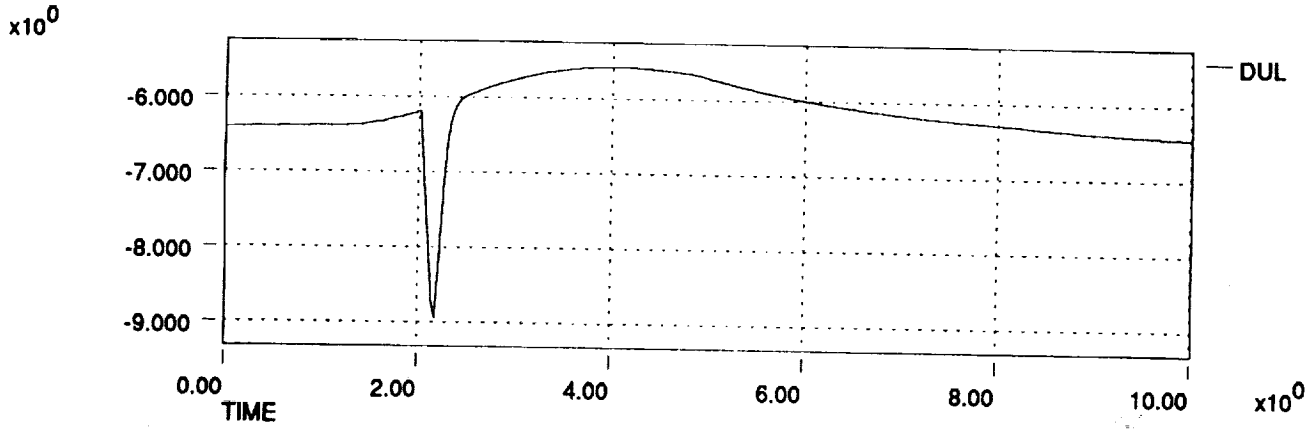

HL-20 Dynamic Check Case Data Plots 911206
Right Rudder Pedal Pulse at 300 KEAS, 10,000 ft

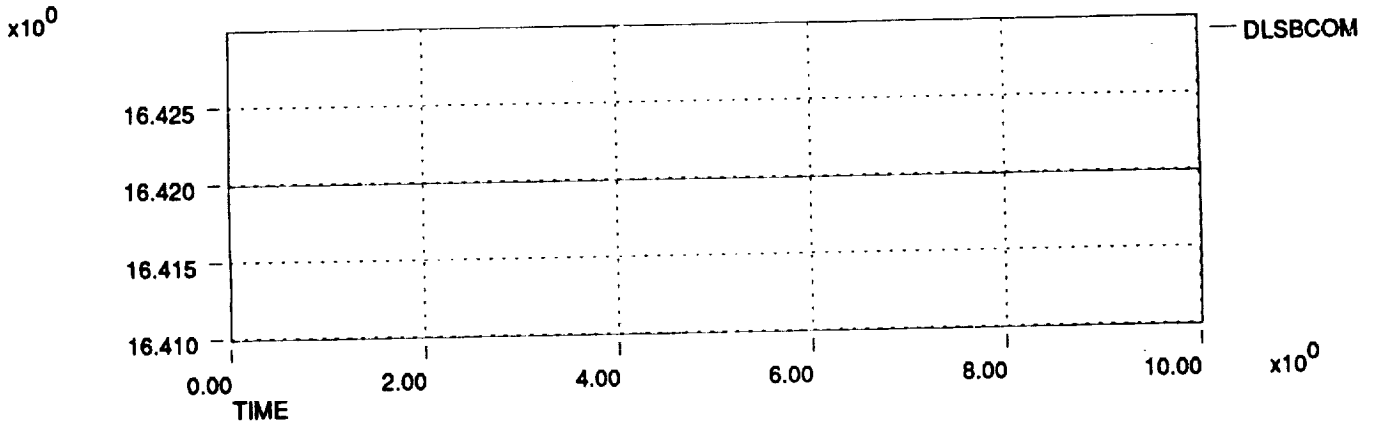
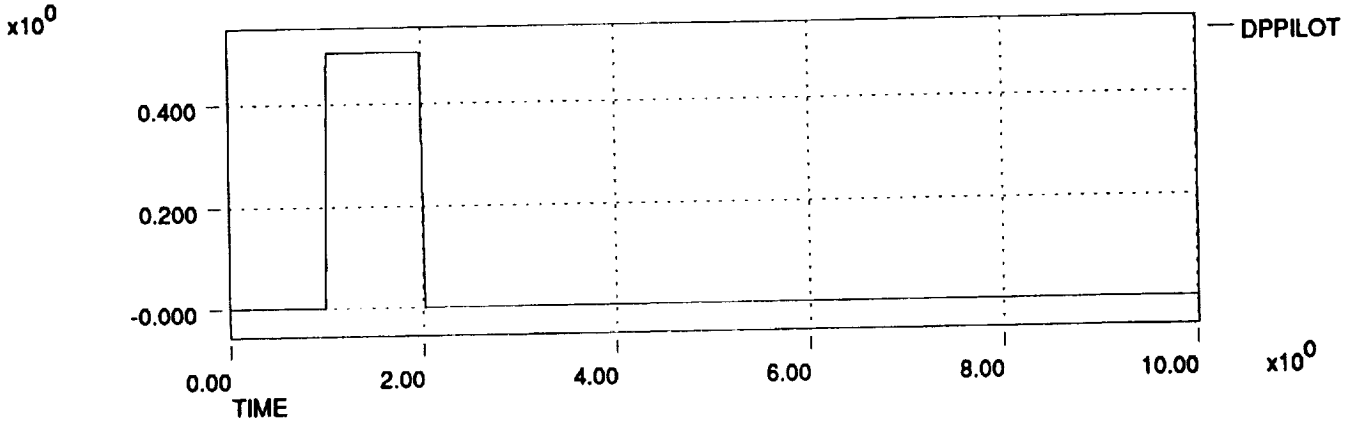
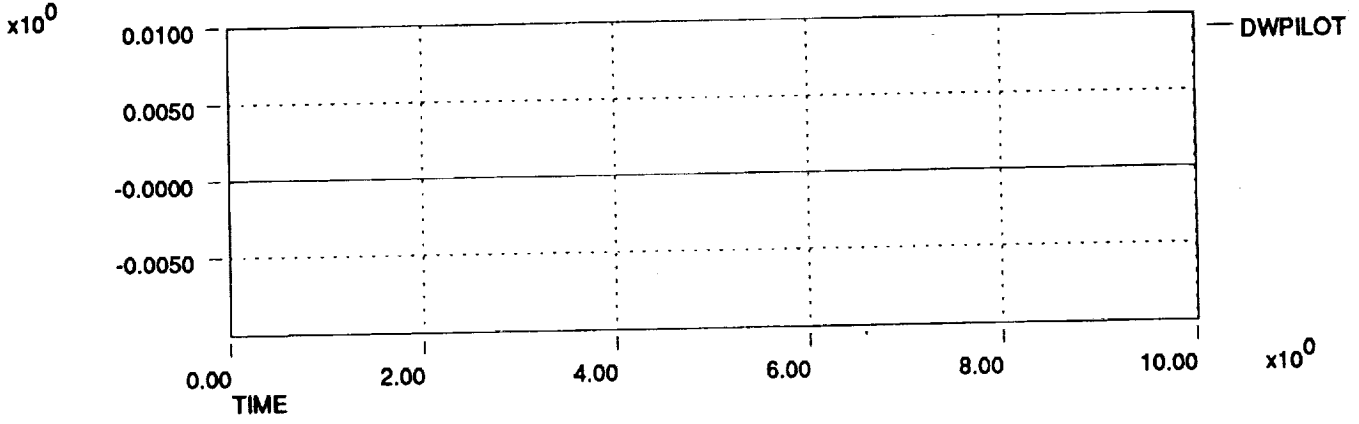
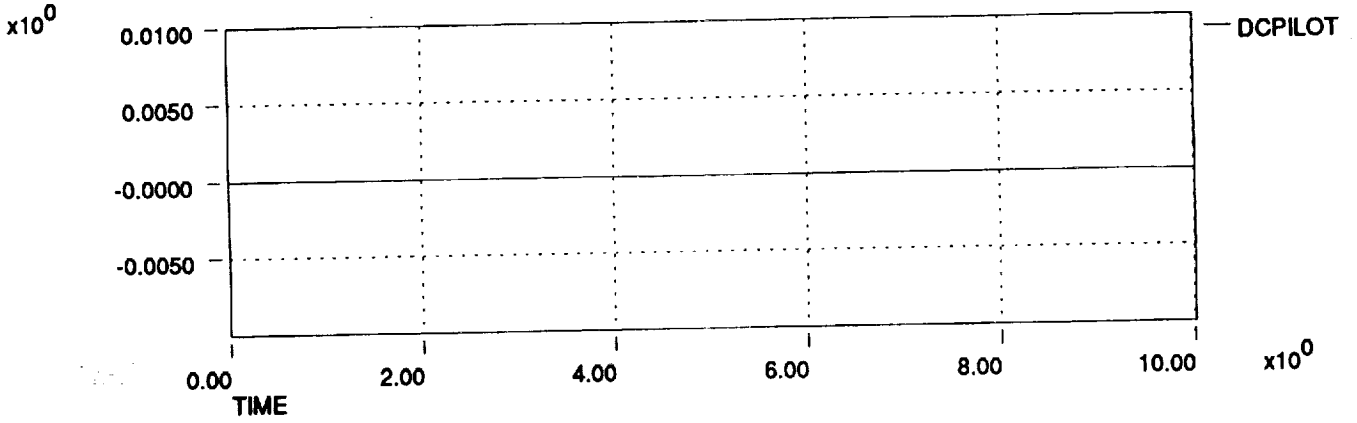

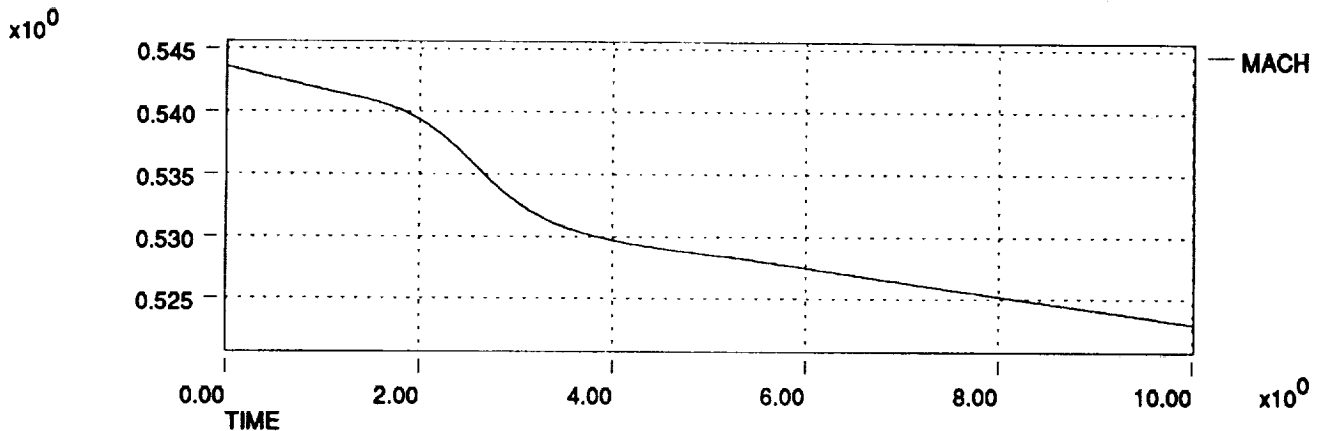
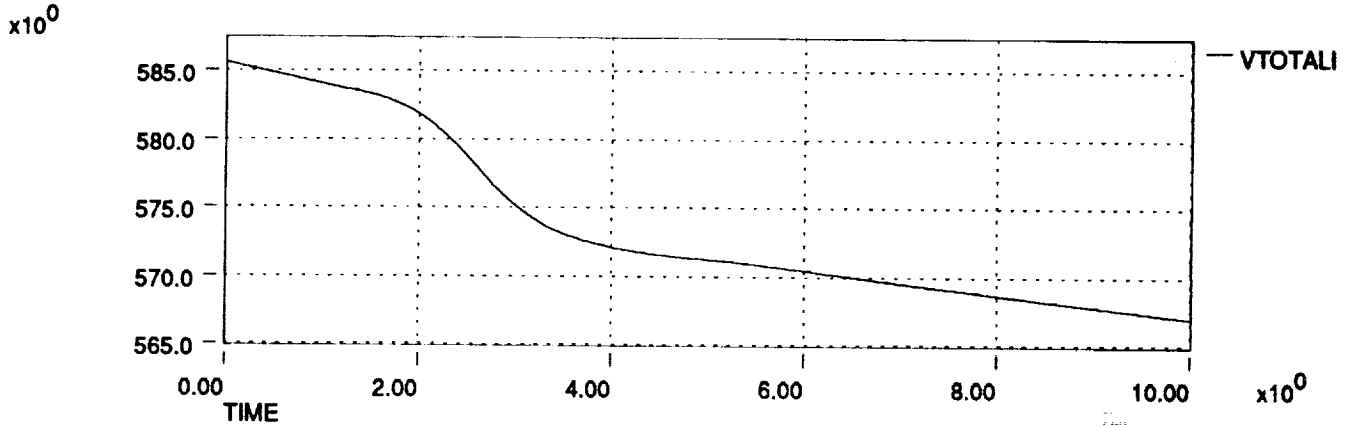
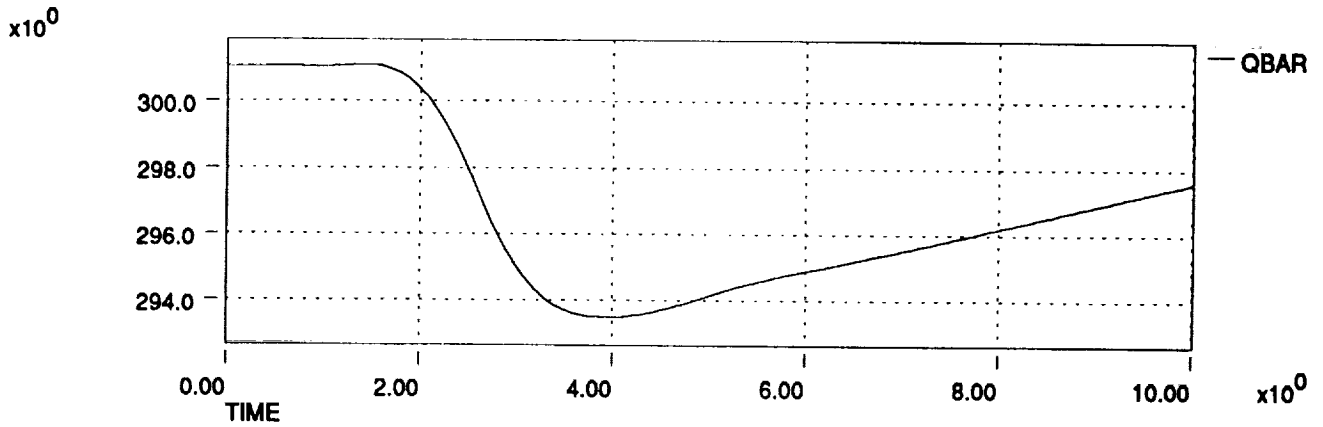
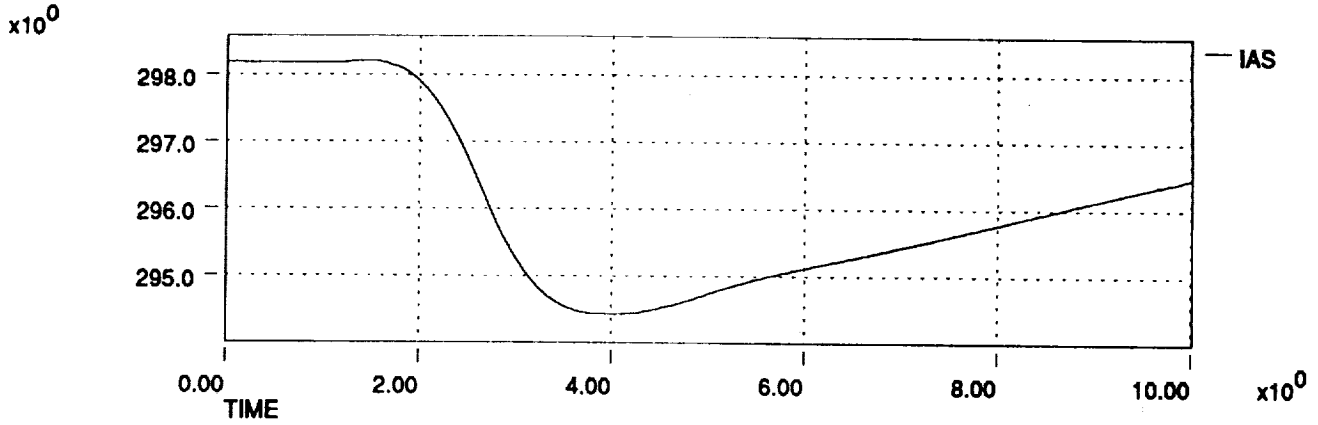

HL-20 Dynamic Check Case Data Plots 911206
Right Rudder Pedal Pulse at 300 KEAS, 10,000 ft

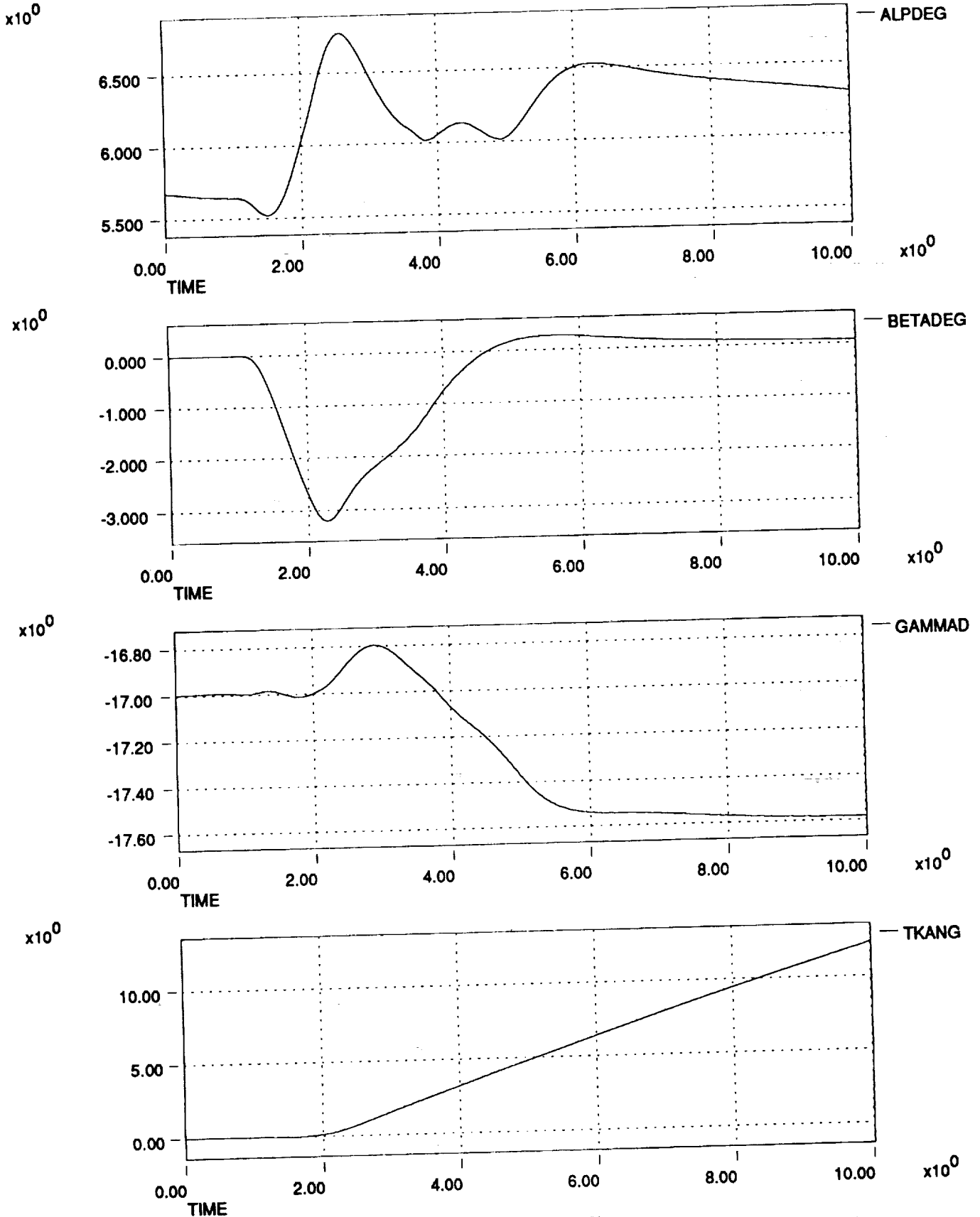

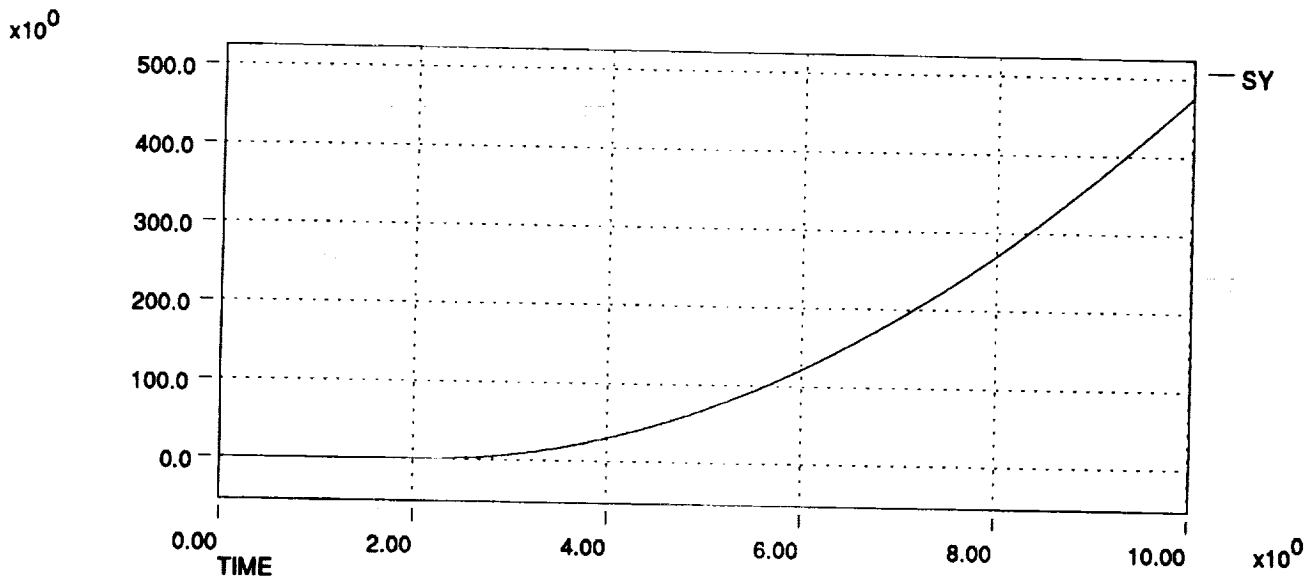
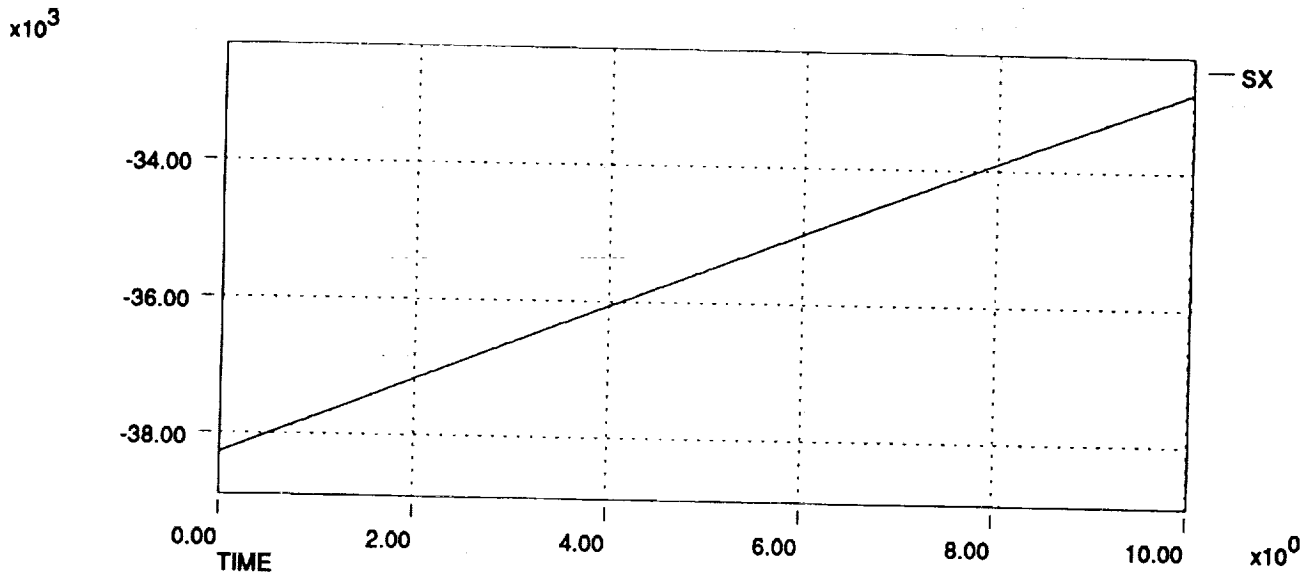
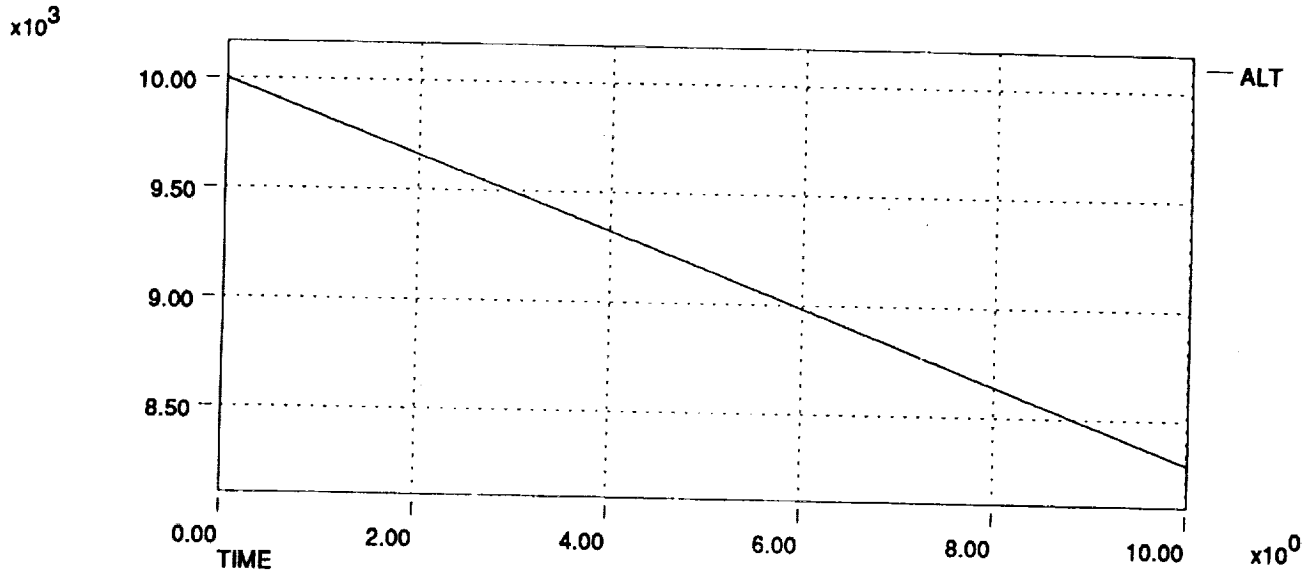

HL-20 Dynamic Check Case Data Plots 911206
Right Rudder Pedal Pulse at 300 KEAS, 10,000 ft

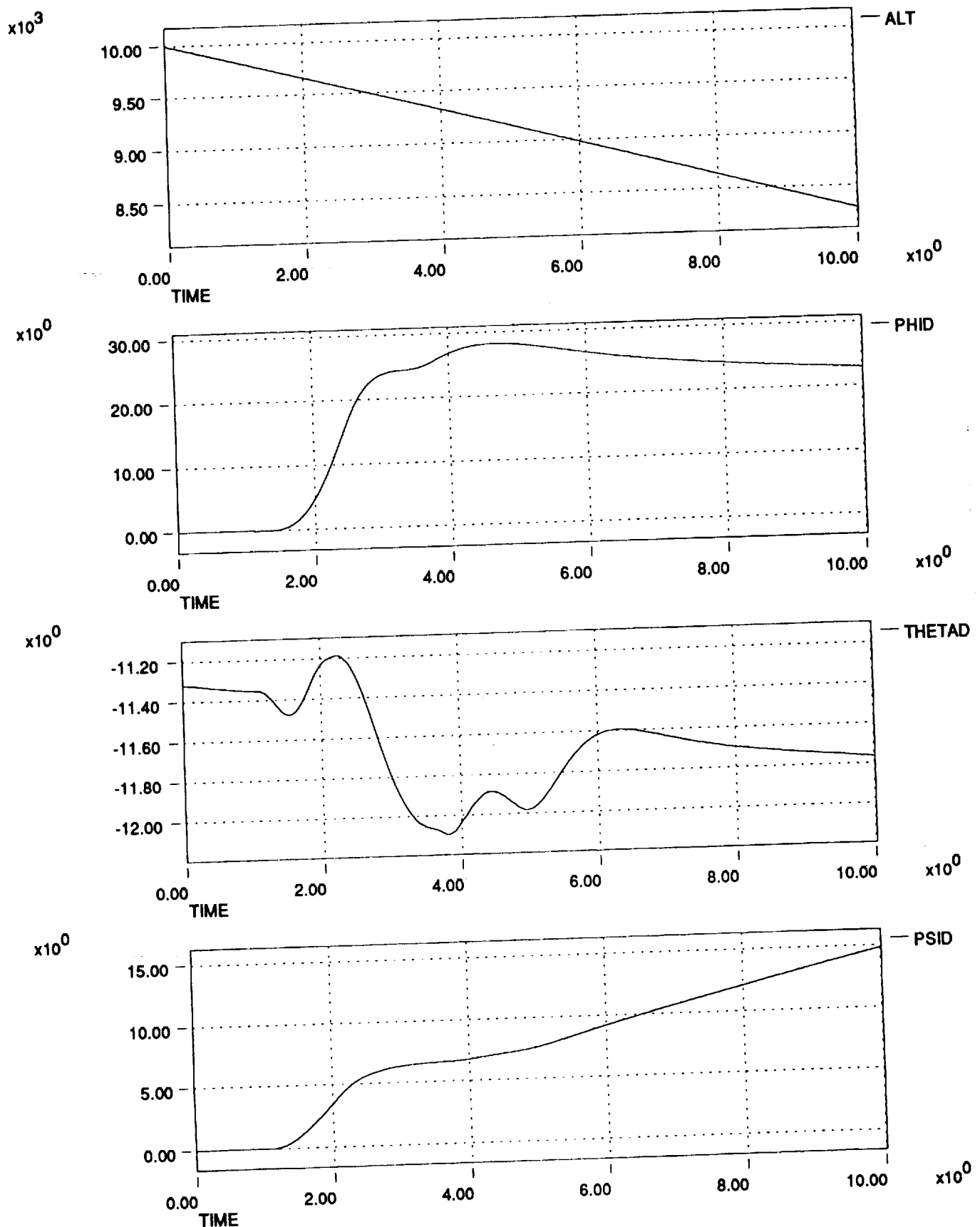

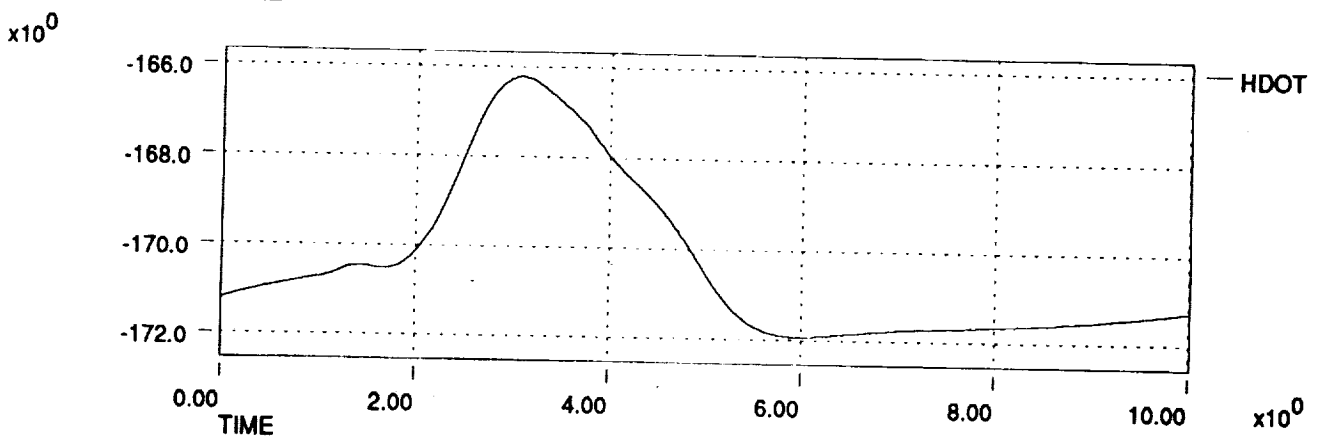
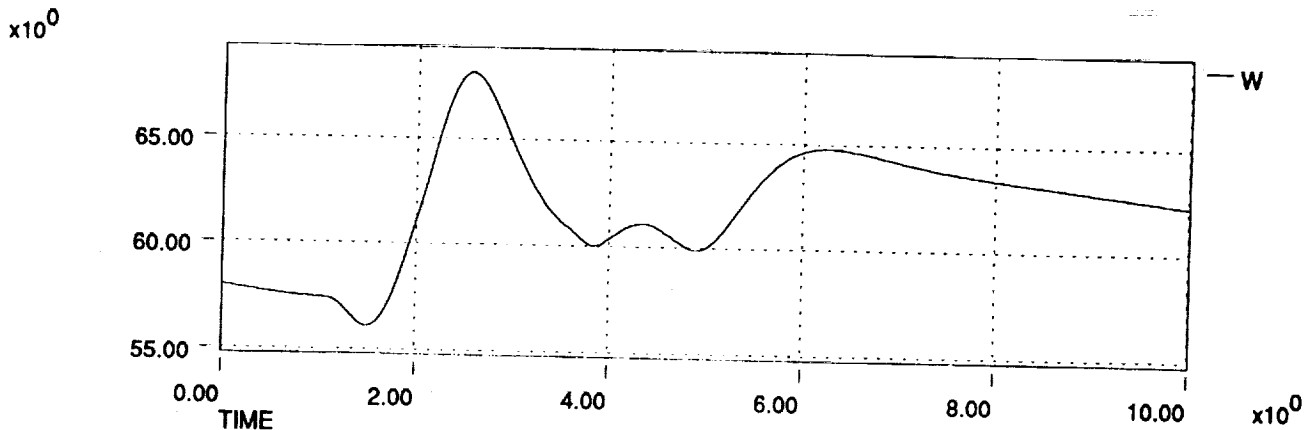
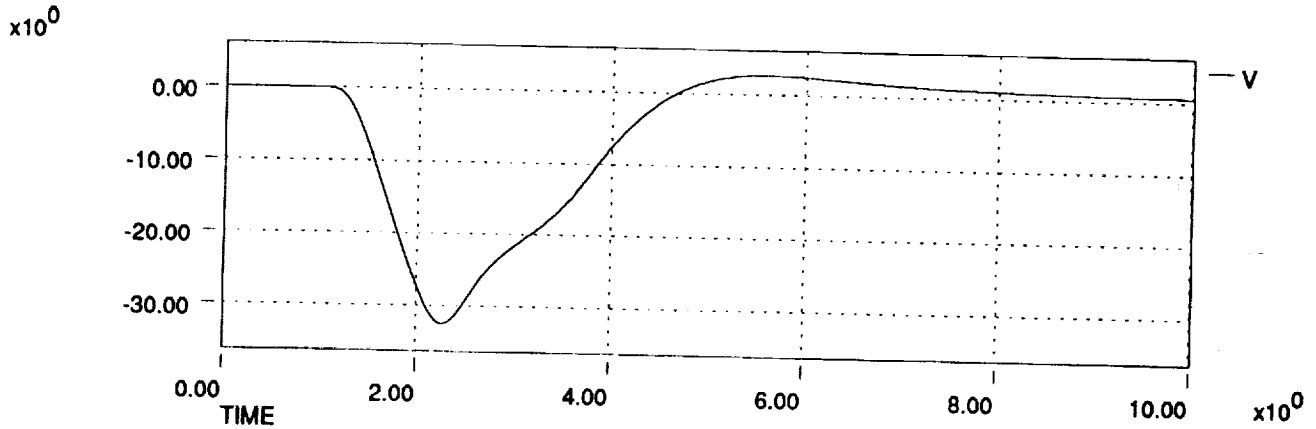
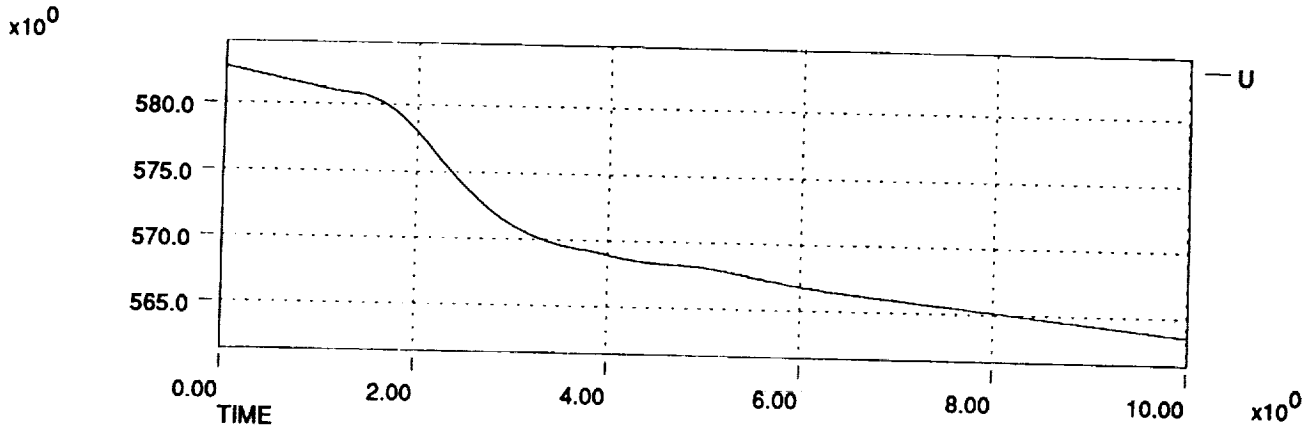

HL-20 Dynamic Check Case Data Plots 911206
Right Rudder Pedal Pulse at 300 KEAS, 10,000 ft

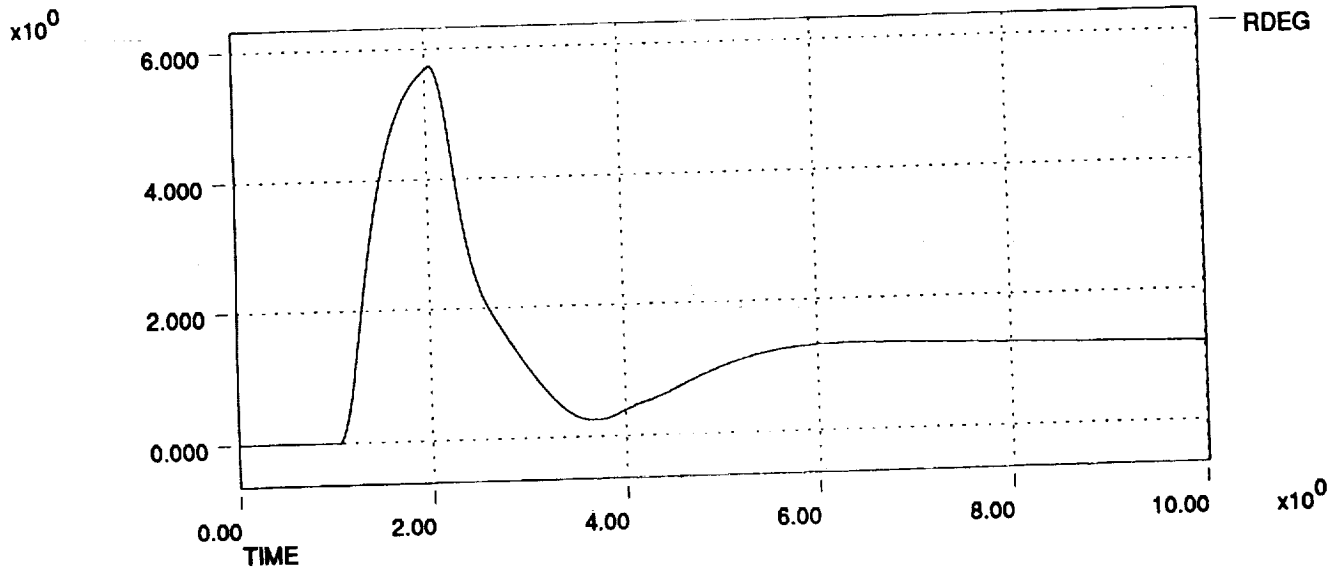
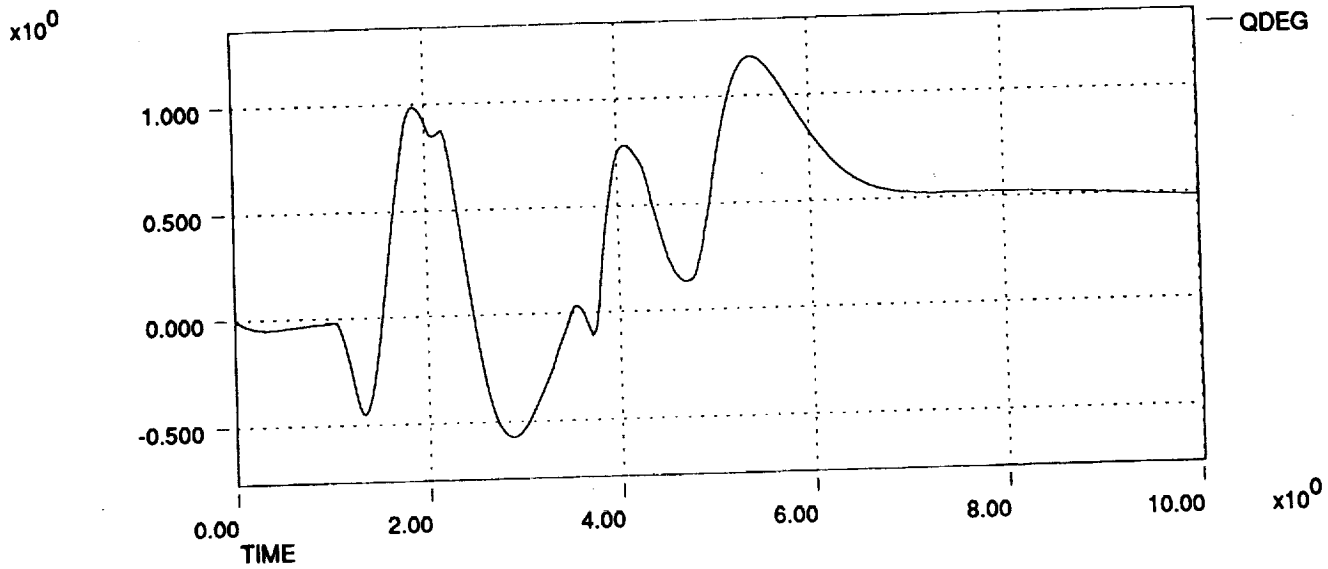
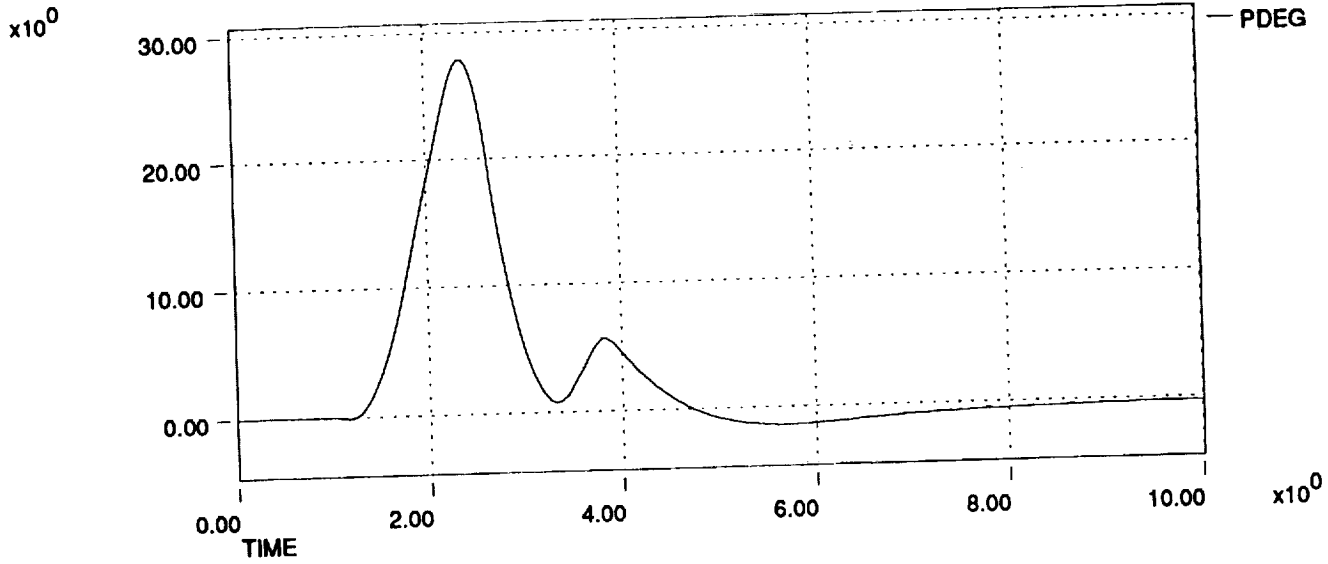

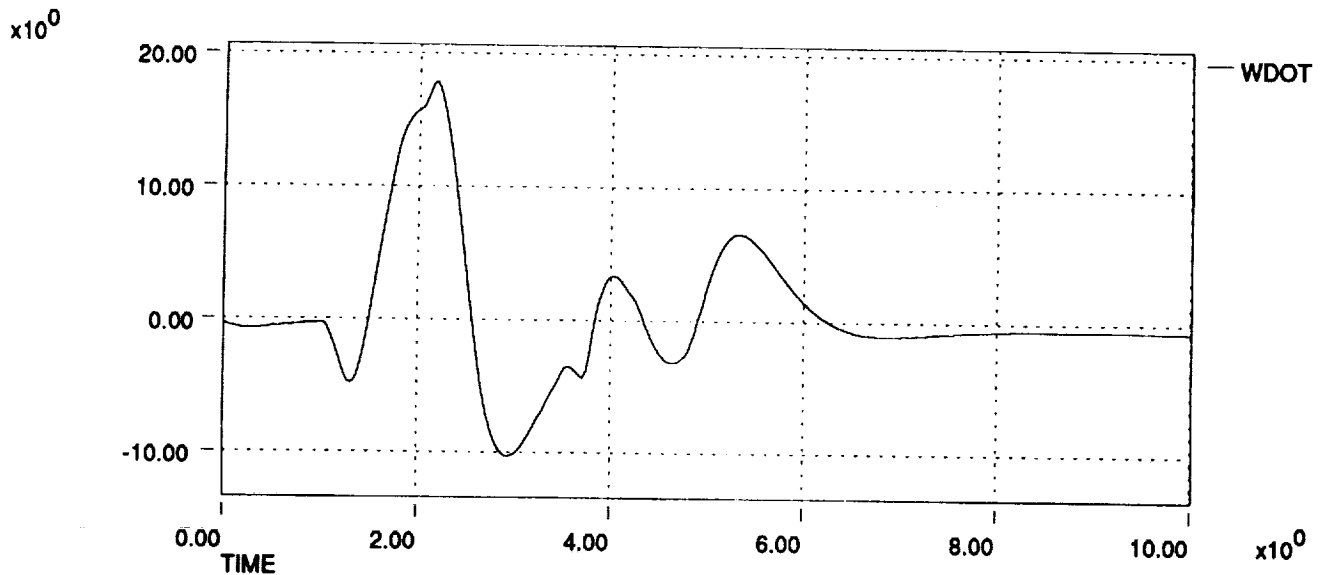
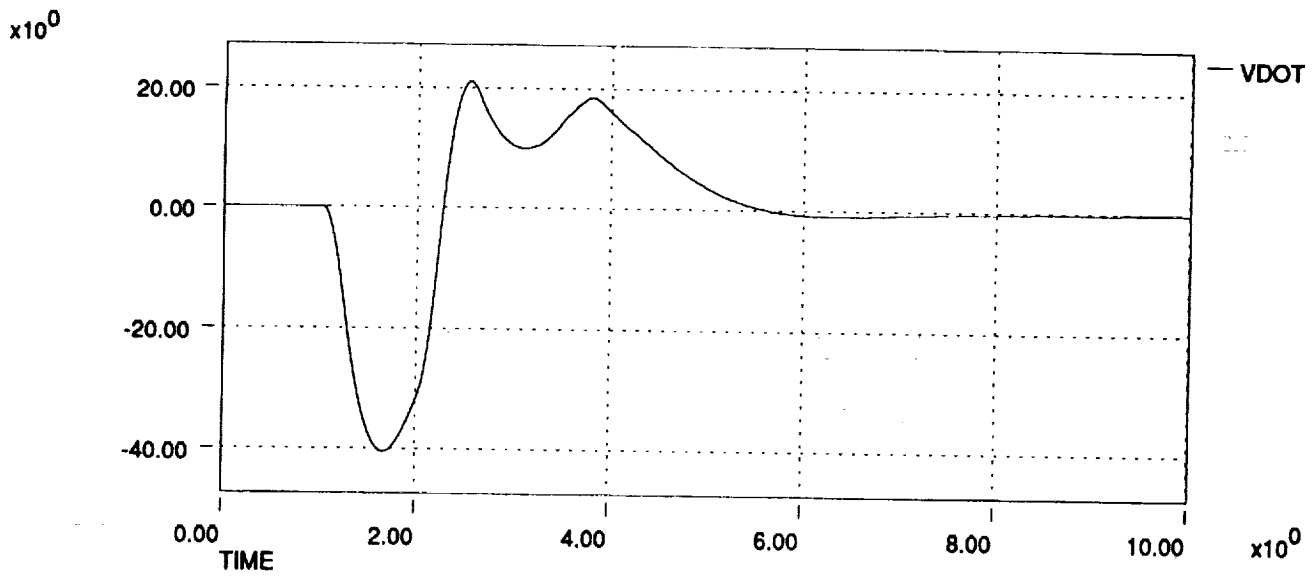
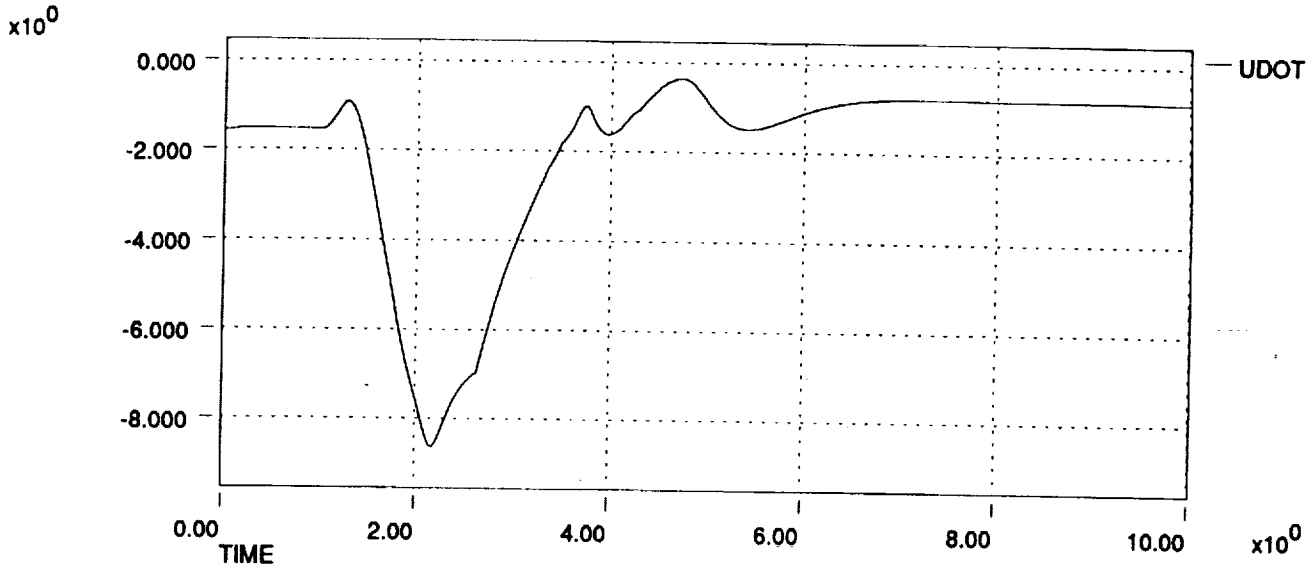

HL-20 Dynamic Check Case Data Plots 911206
Right Rudder Pedal Pulse at 300 KEAS, 10,000 ft

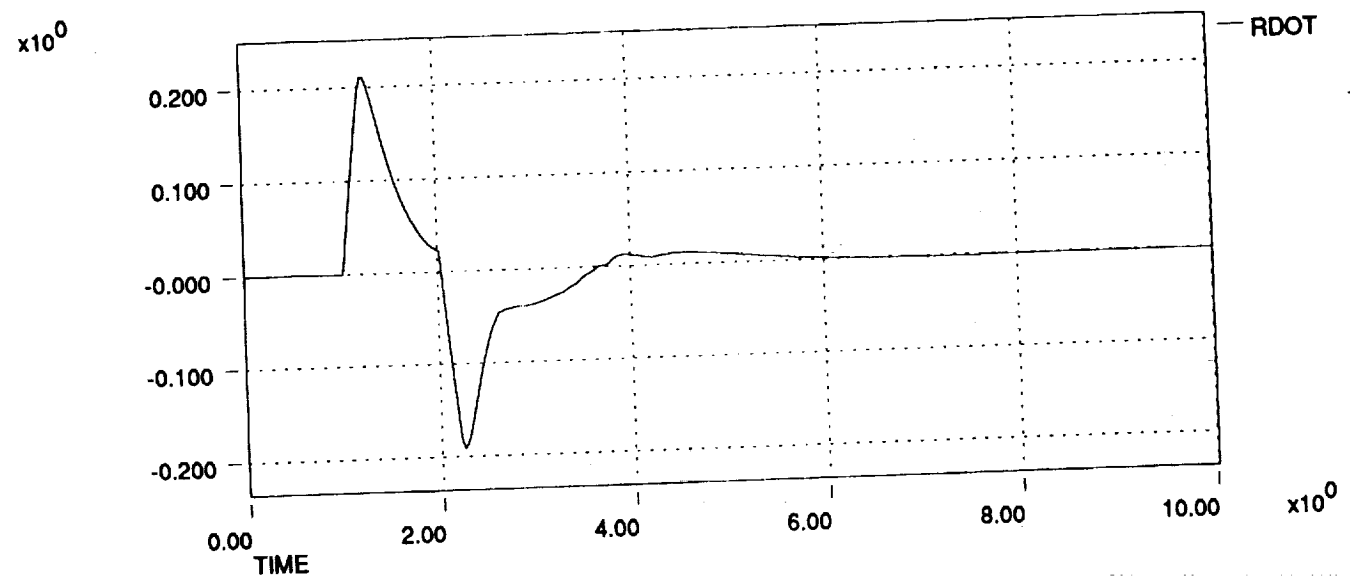
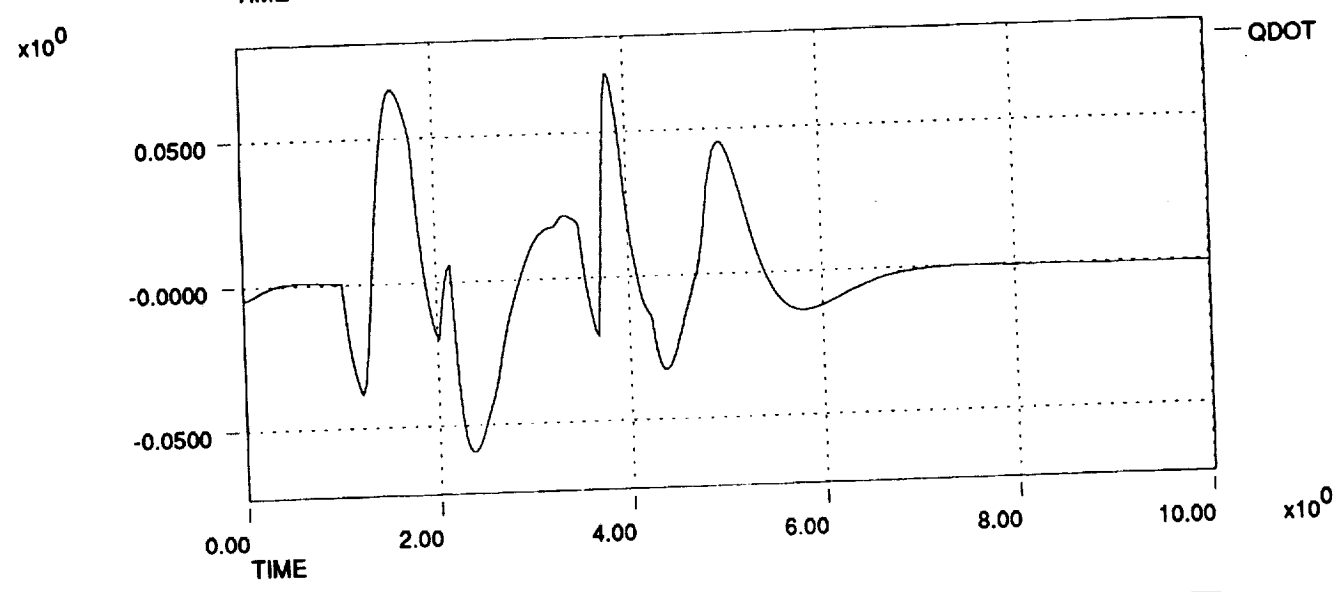
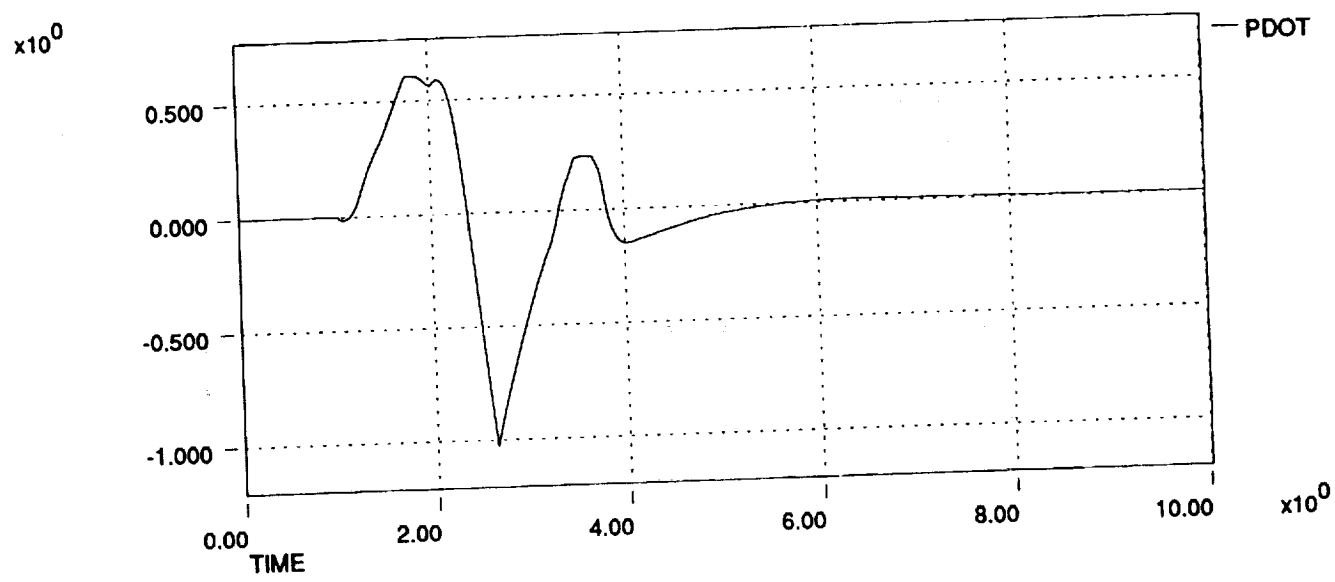

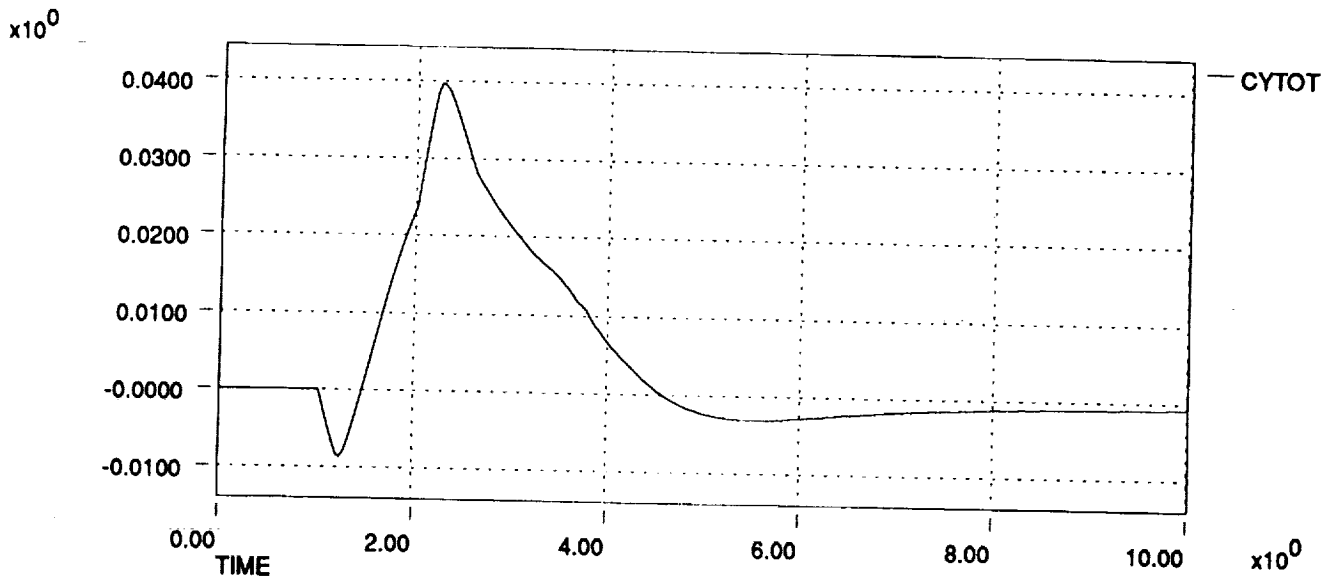
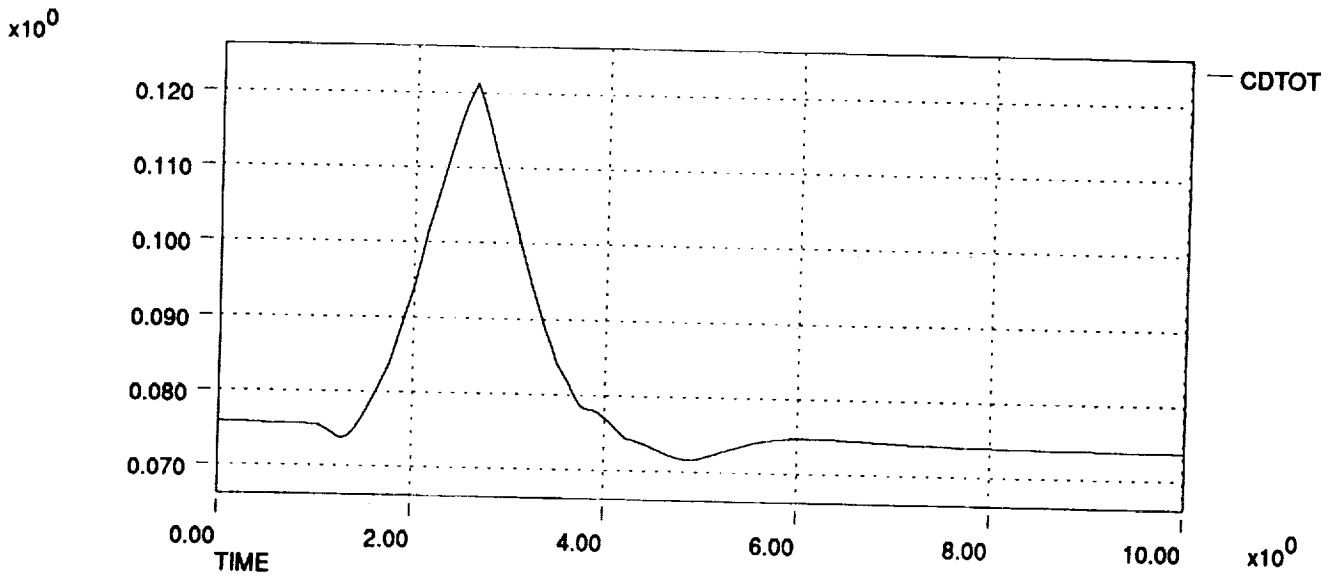
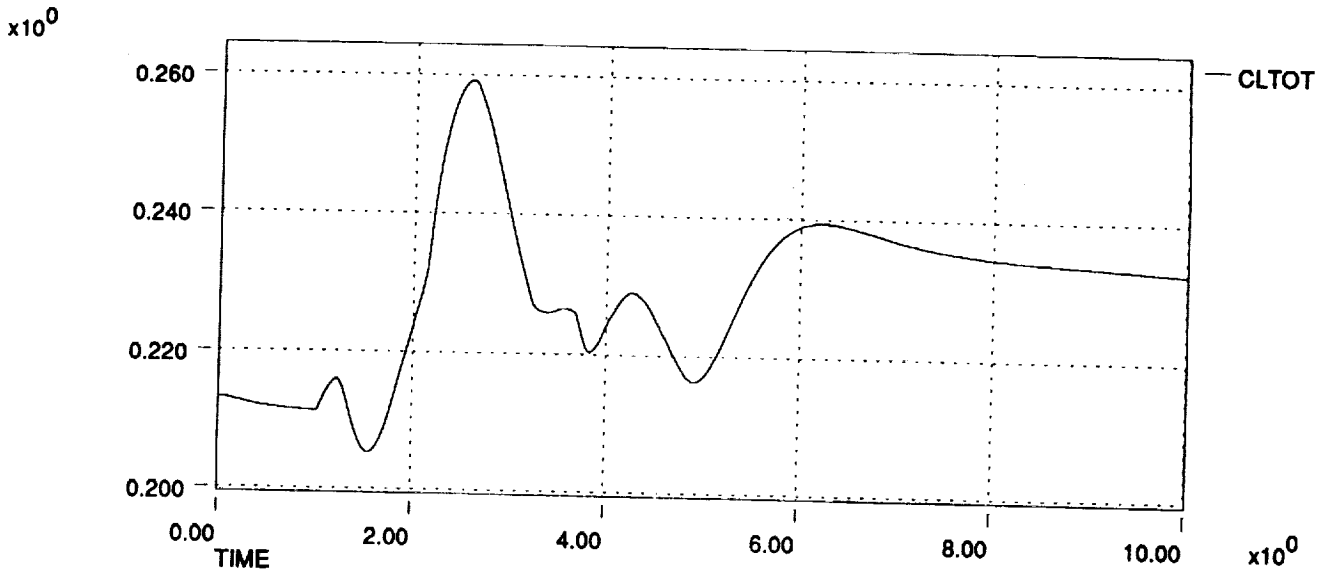

HL-20 Dynamic Check Case Data Plots 911206
Right Rudder Pedal Pulse at 300 KEAS, 10,000 ft

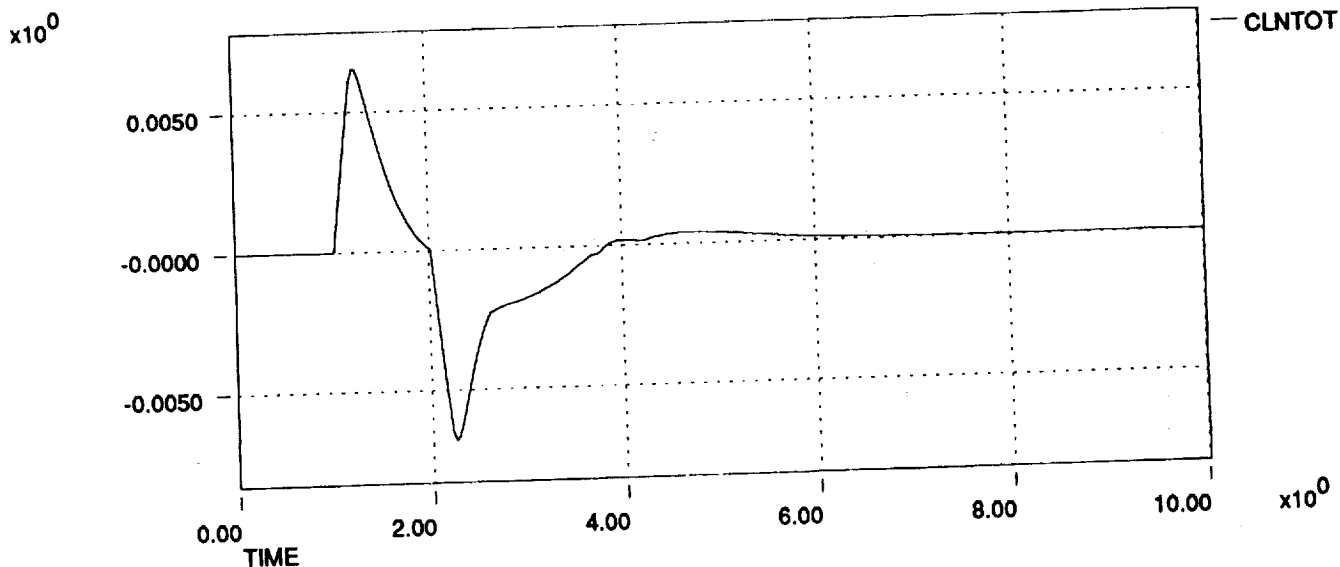
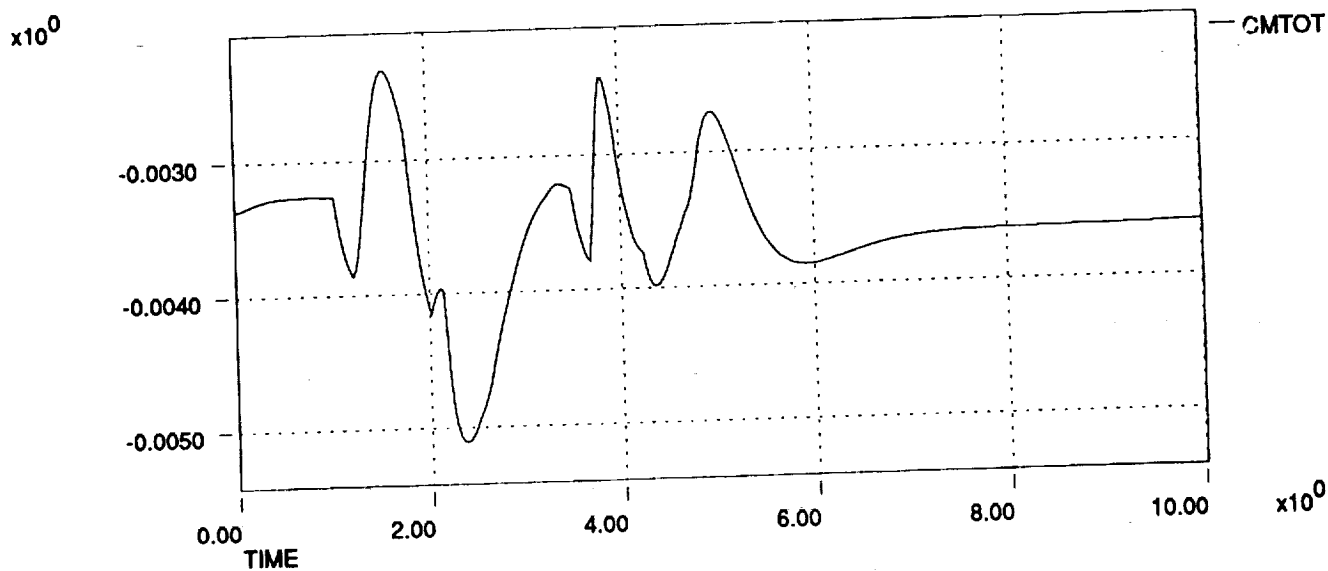
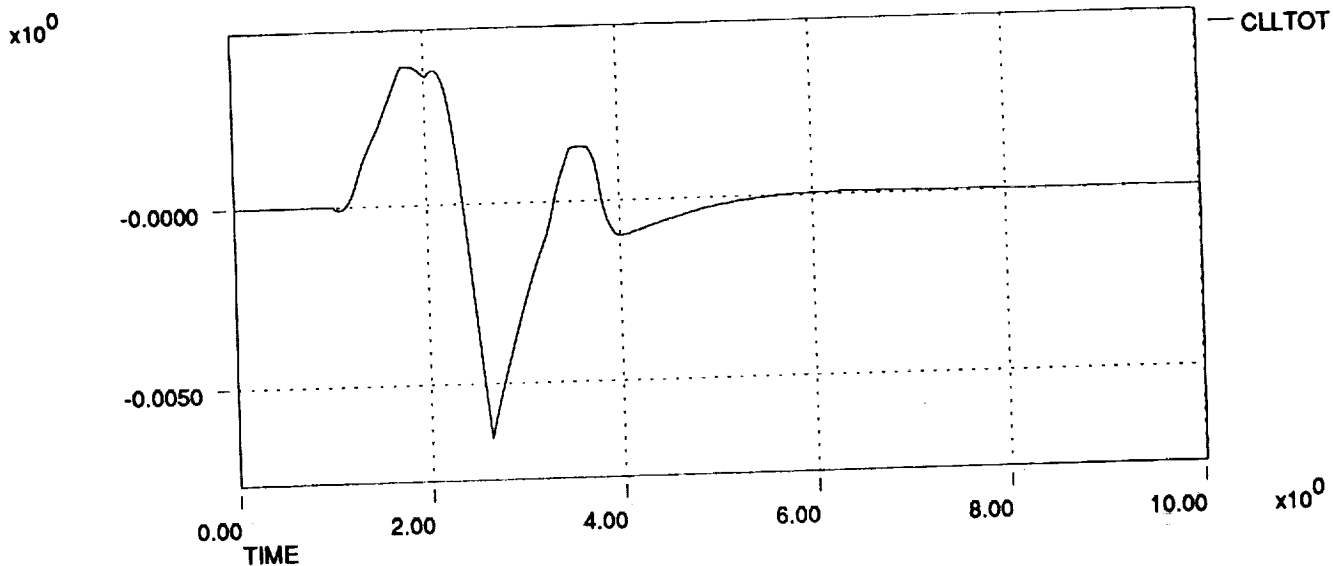

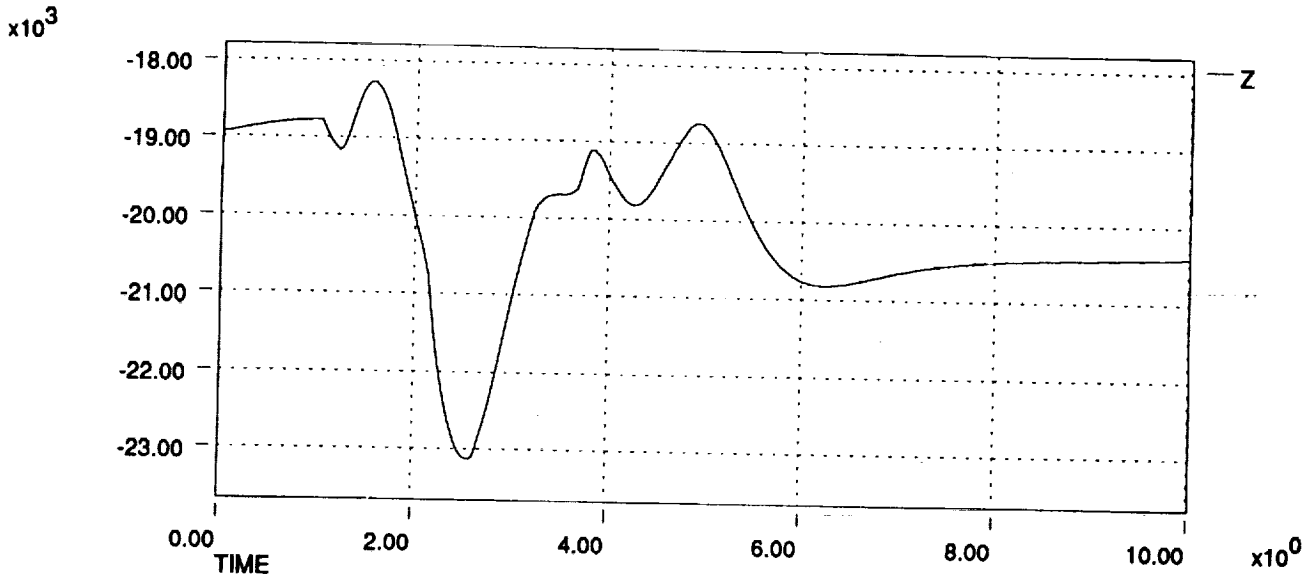
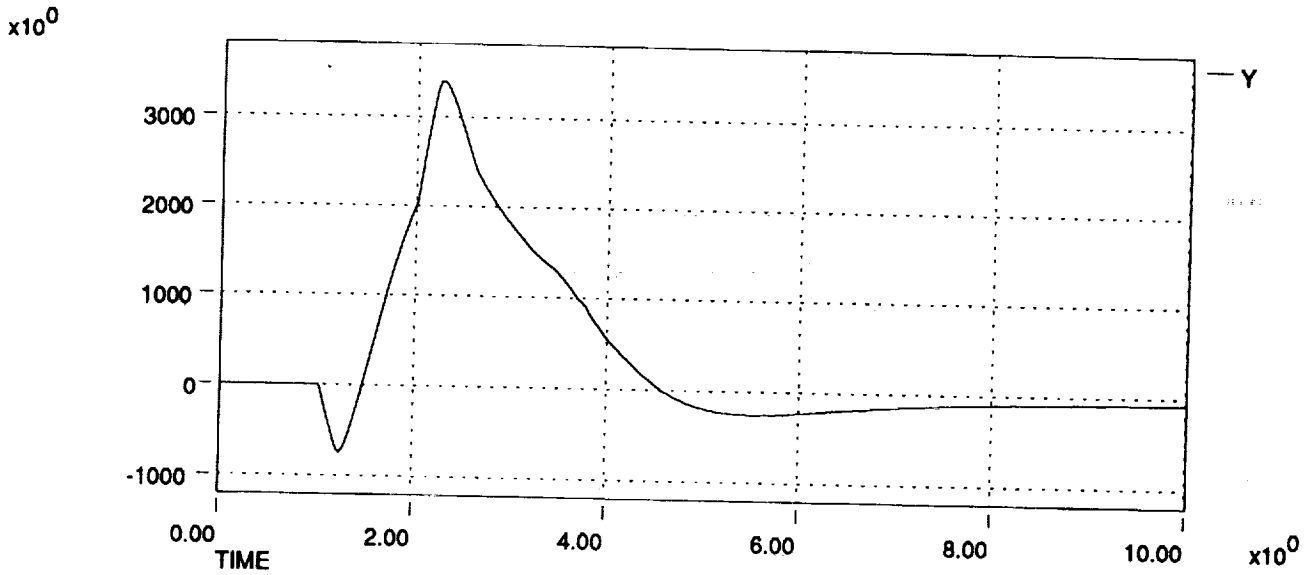
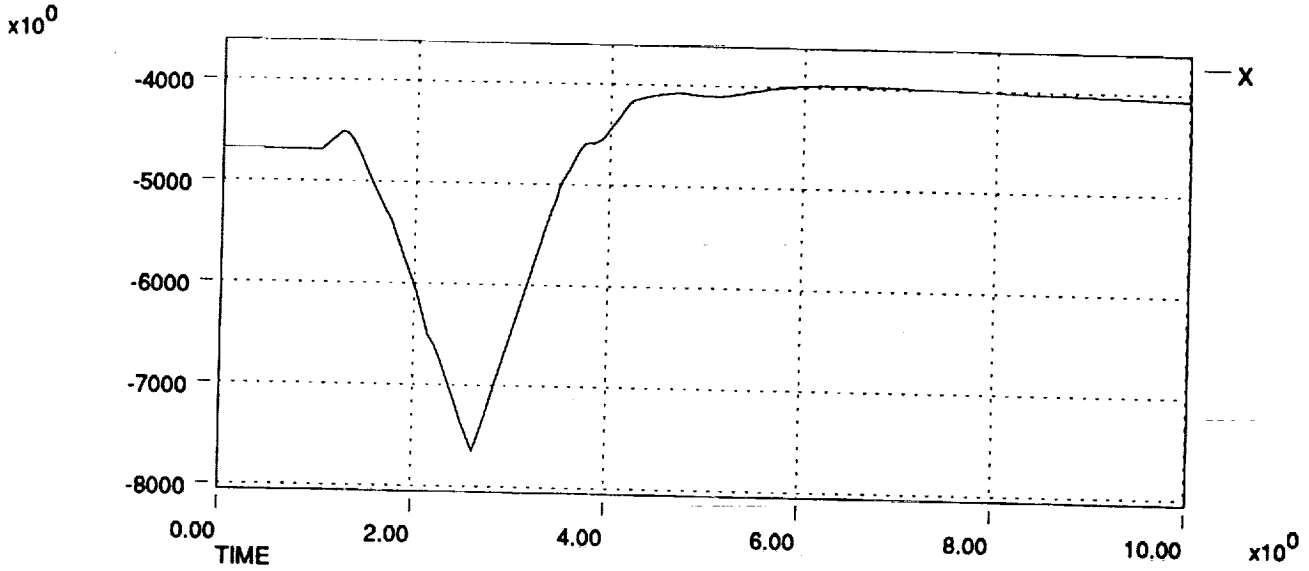

HL-20 Dynamic Check Case Data Plots 911206
Right Rudder Pedal Pulse at 300 KEAS, 10,000 ft

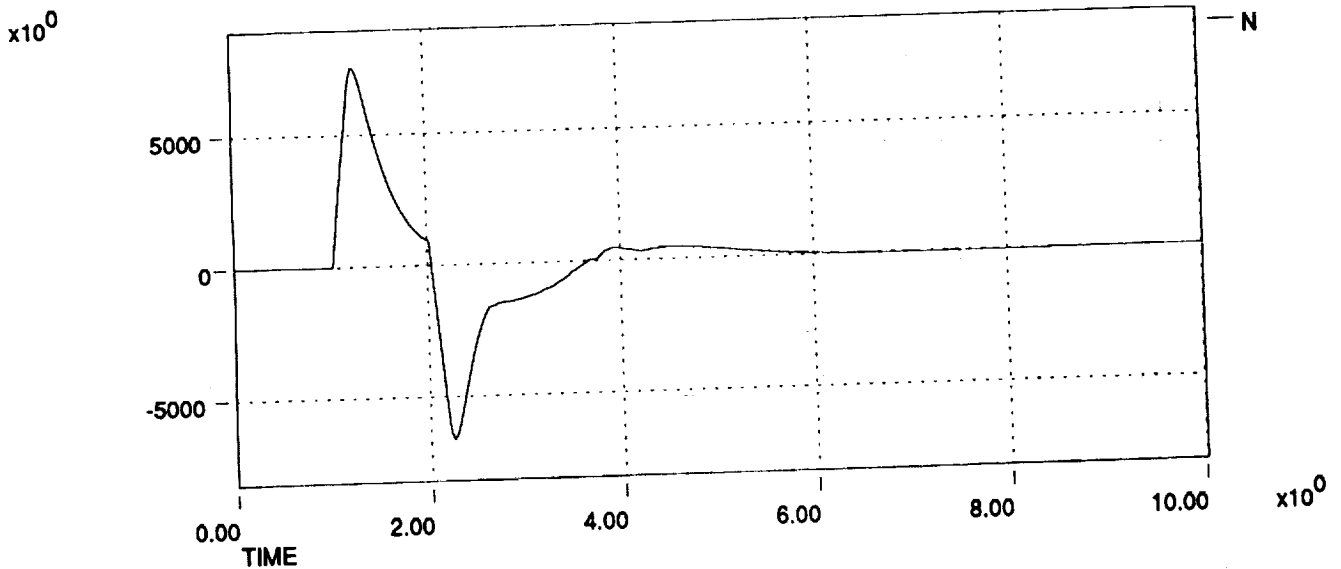
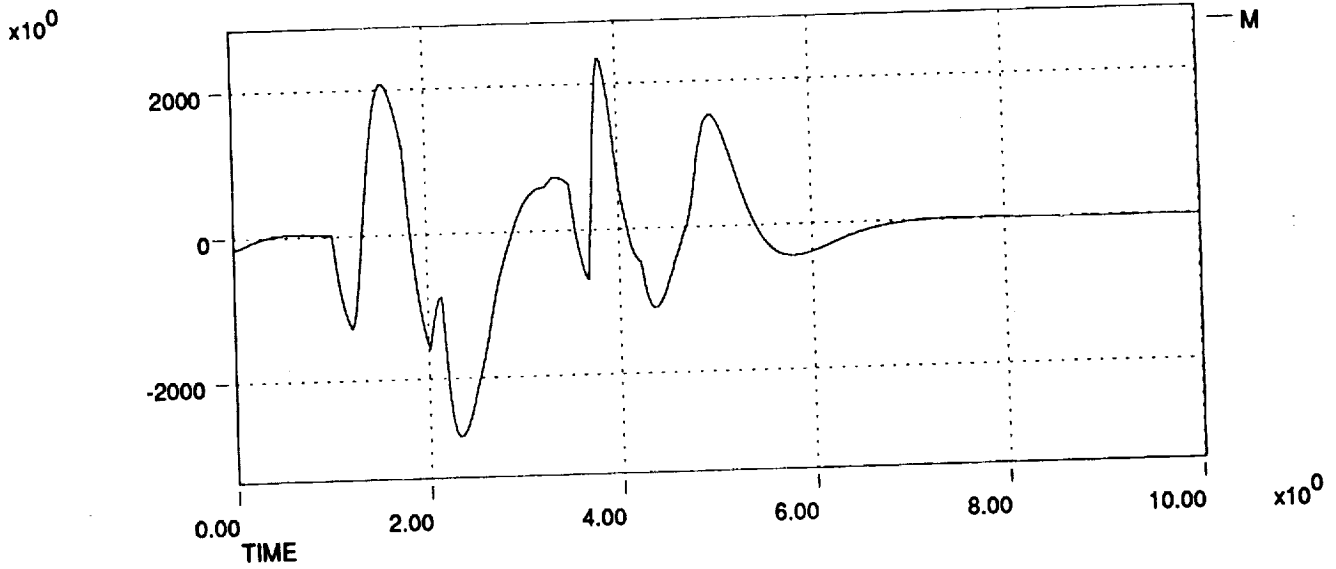
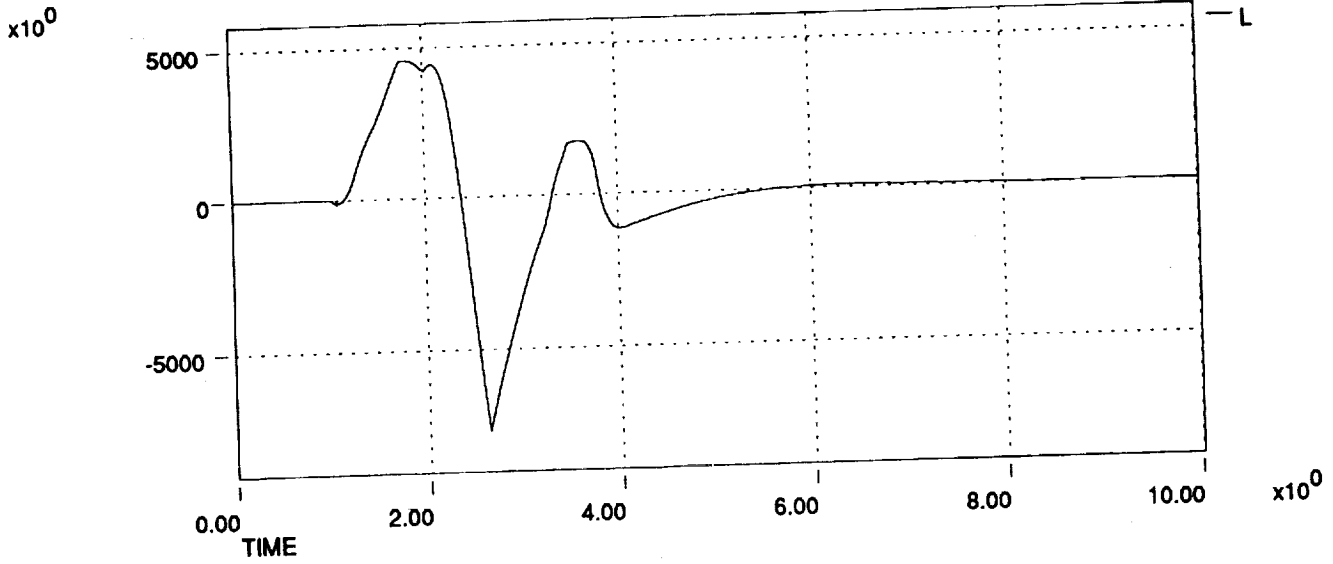

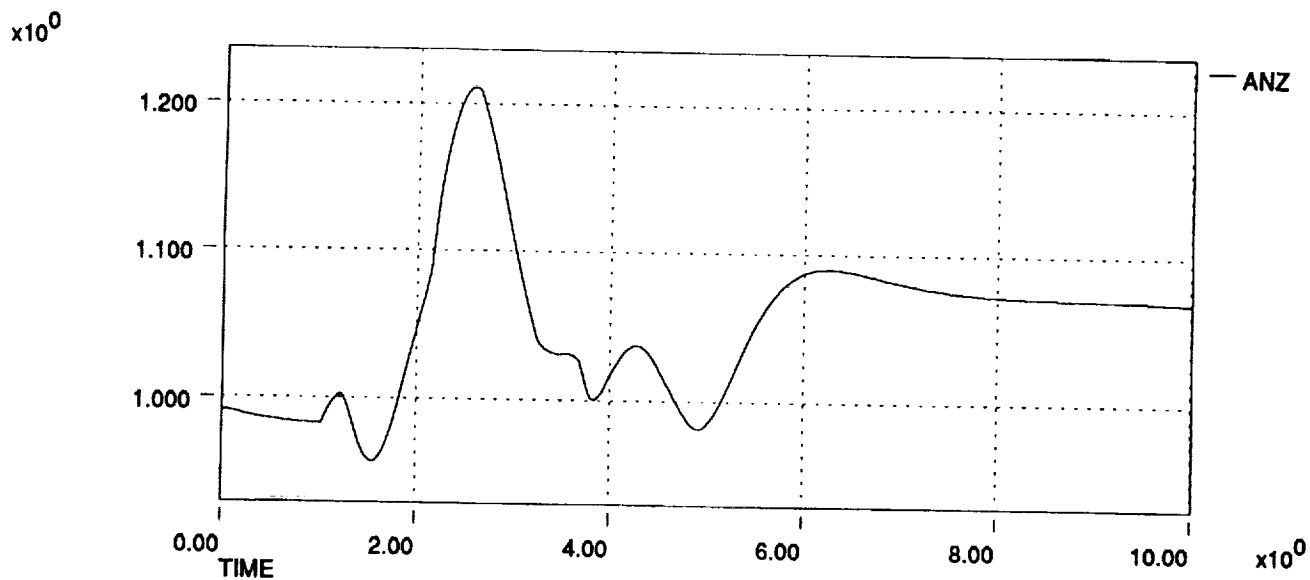
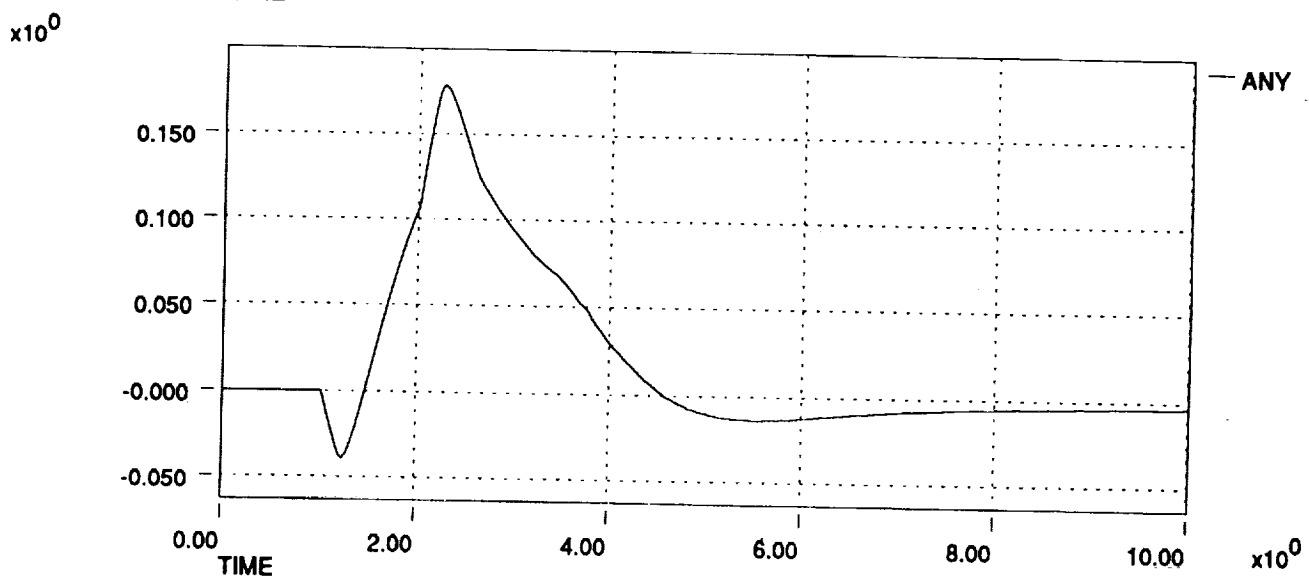
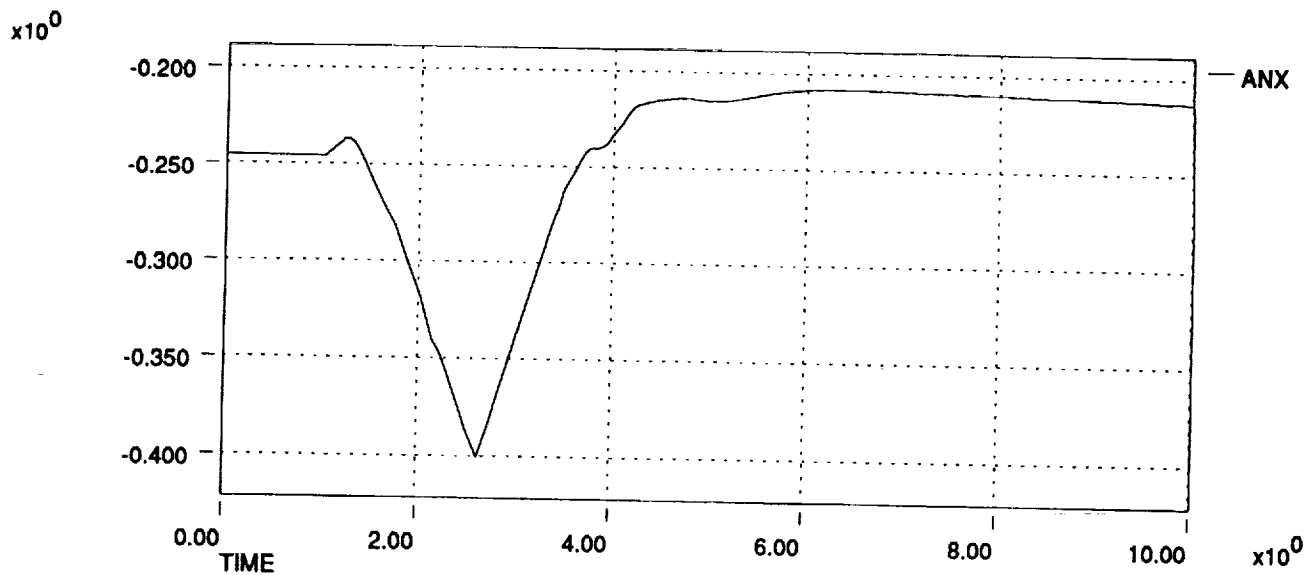

HL-20 Dynamic Check Case Data Plots 911206
Right Rudder Pedal Pulse at 300 KEAS, 10,000 ft

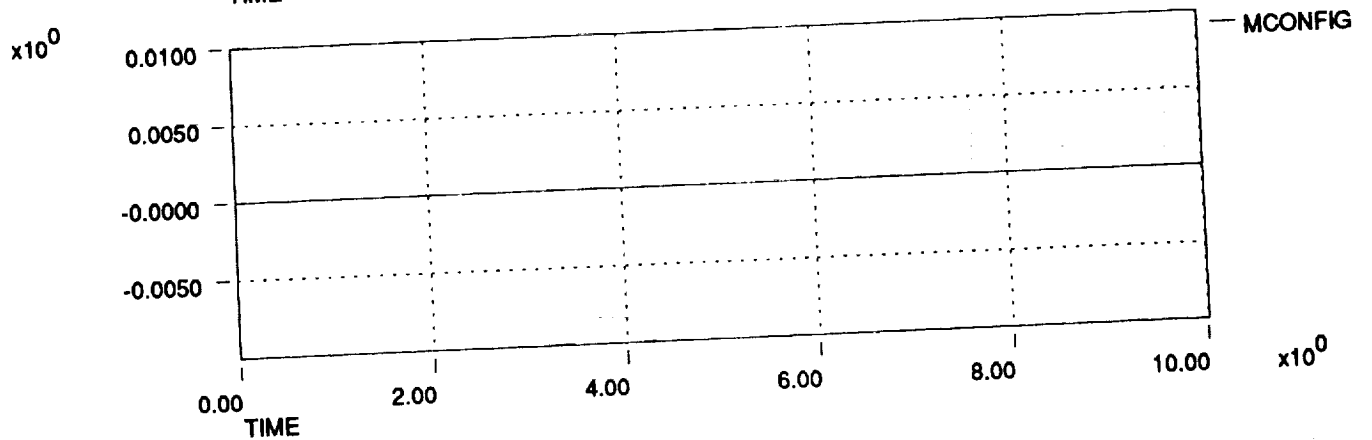
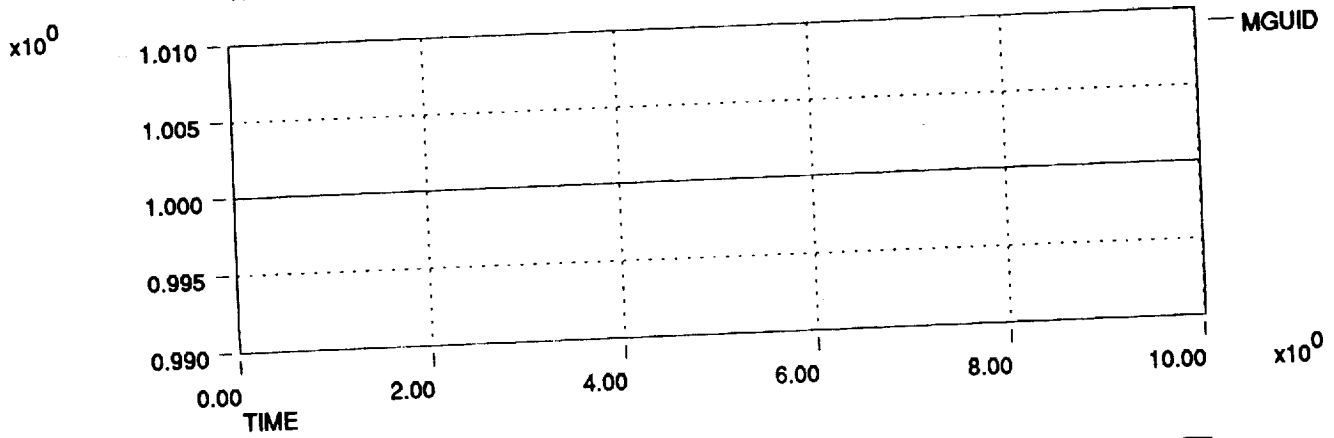
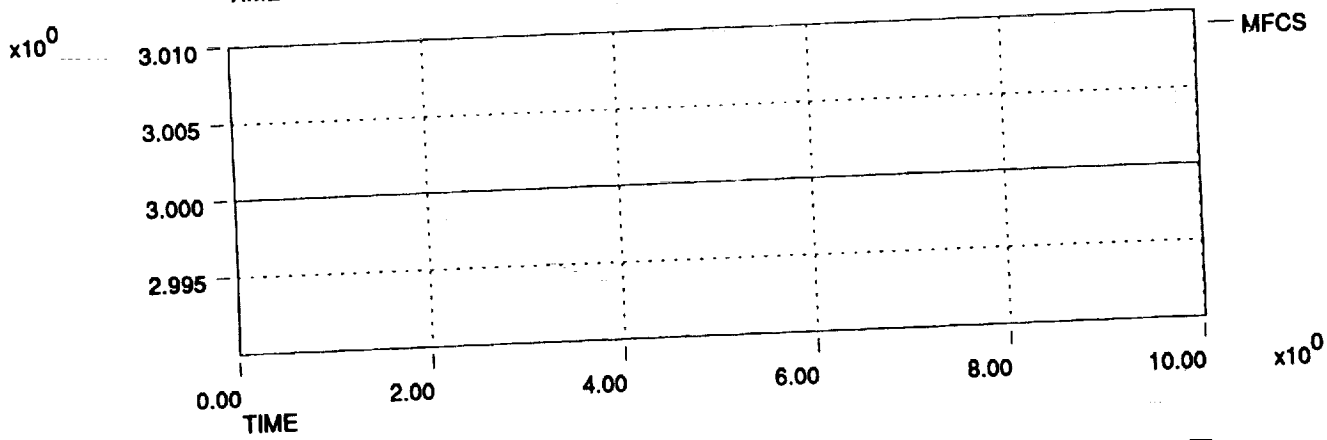
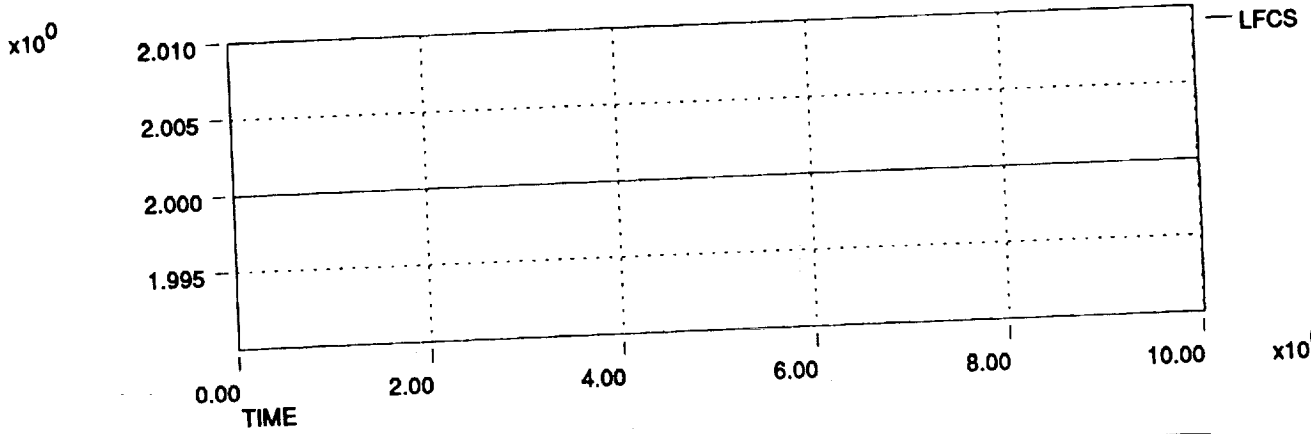

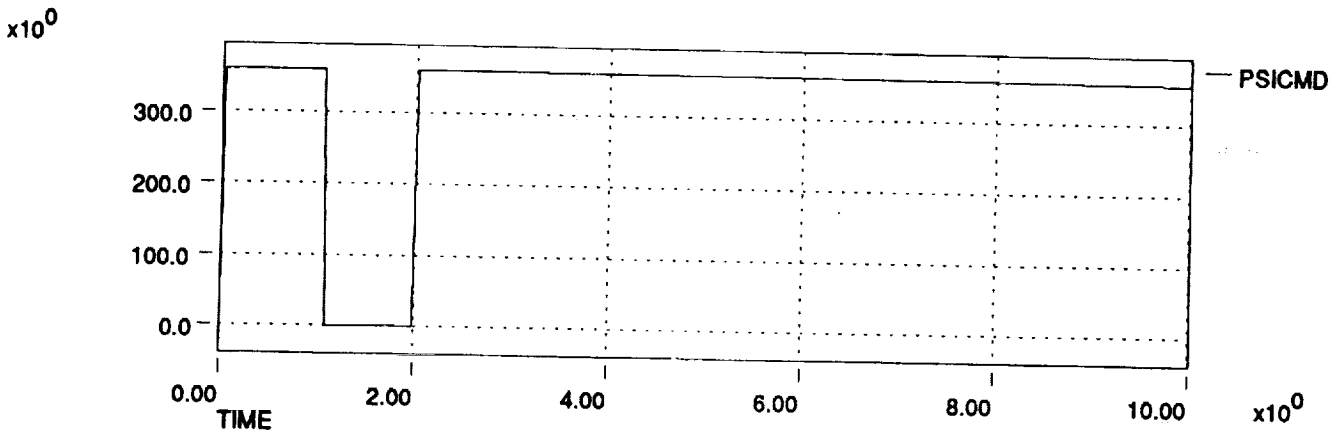
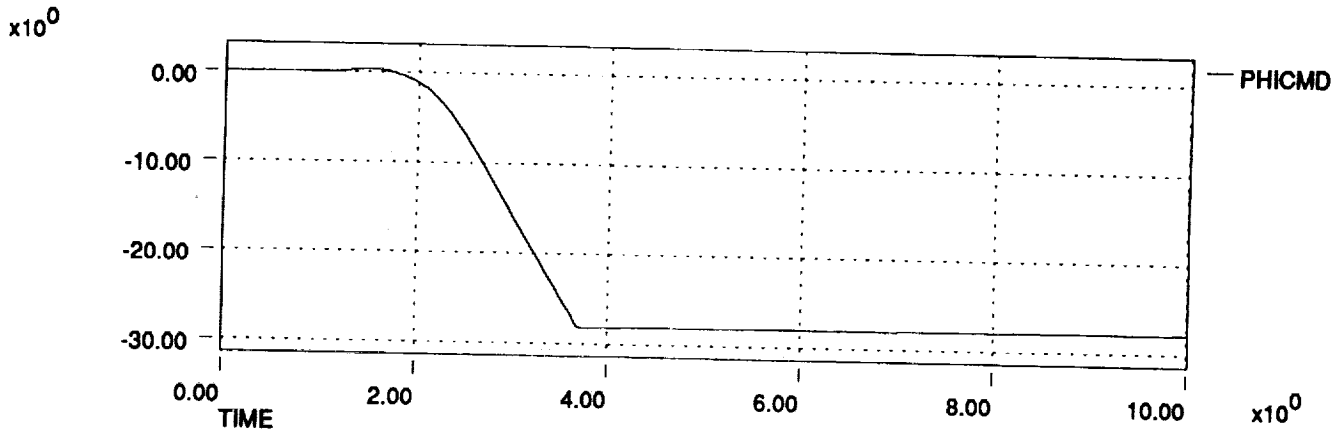
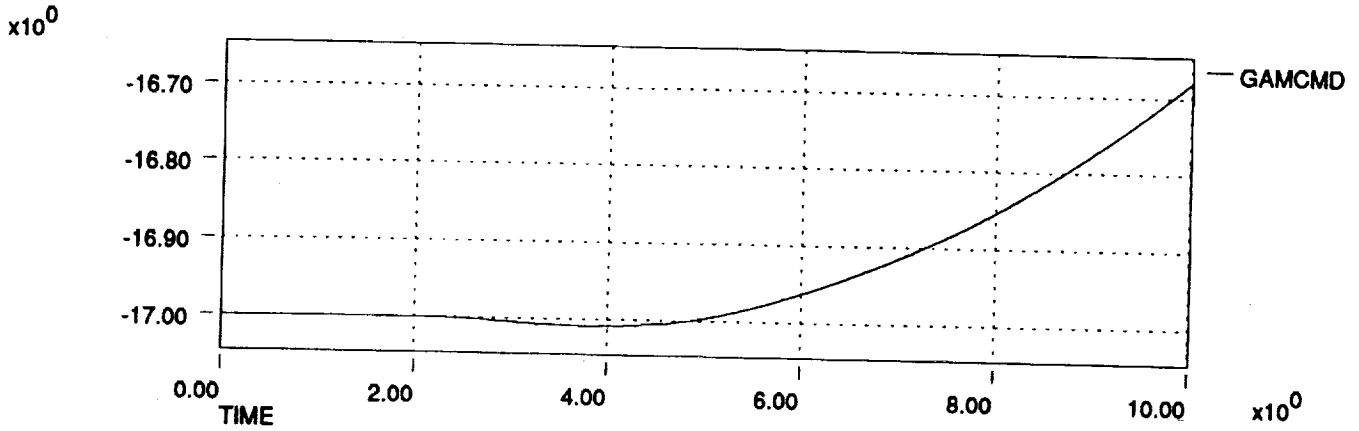
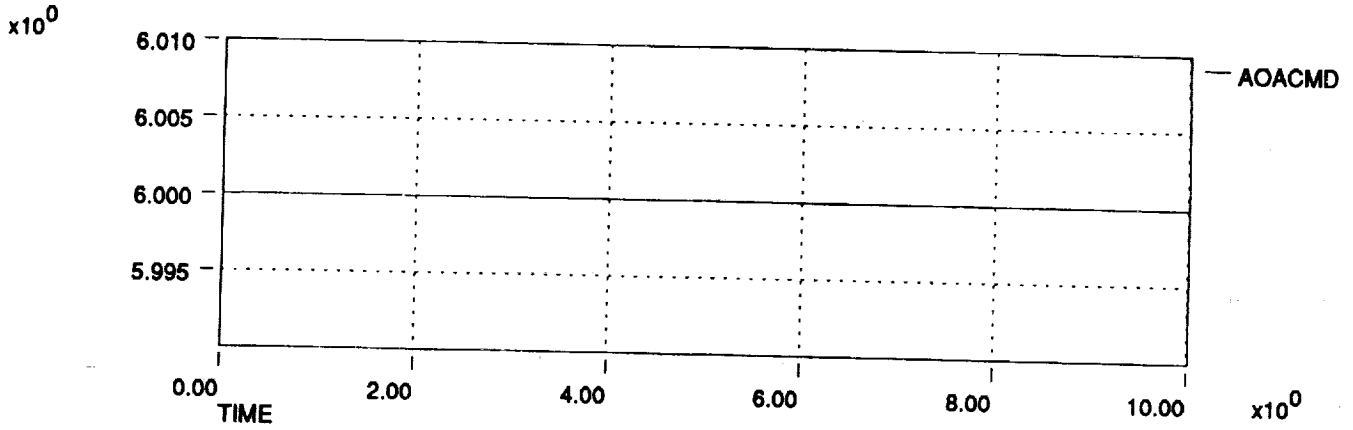

HL-20 Dynamic Check Case Data Plots 911206
Right Rudder Pedal Pulse at 300 KEAS, 10,000 ft

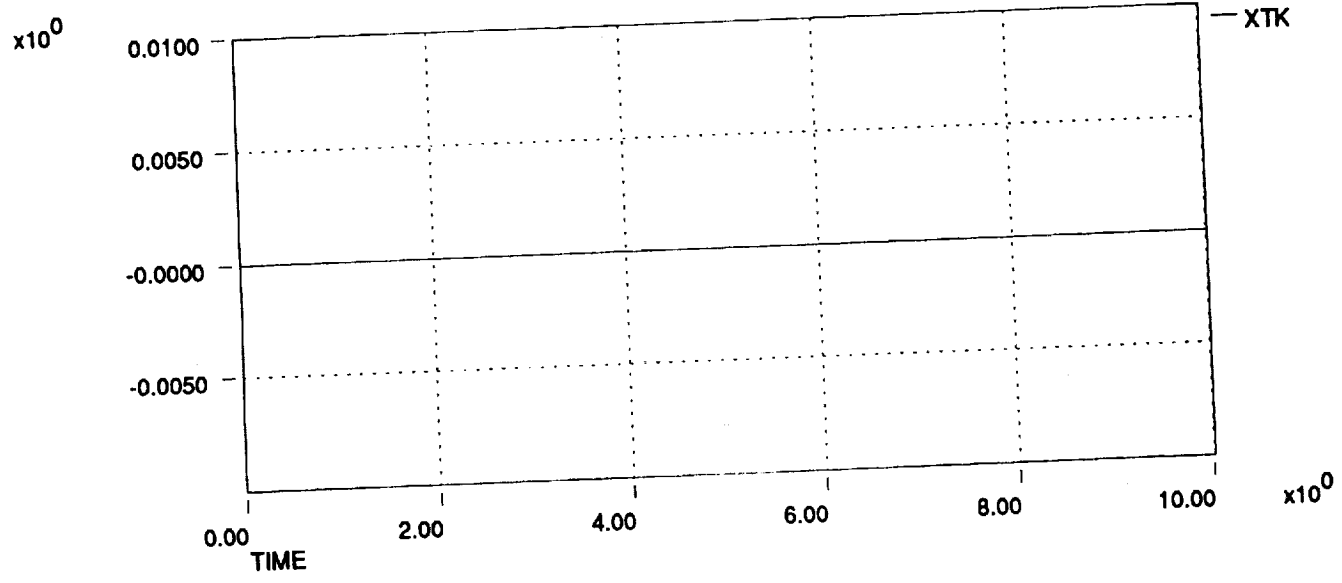
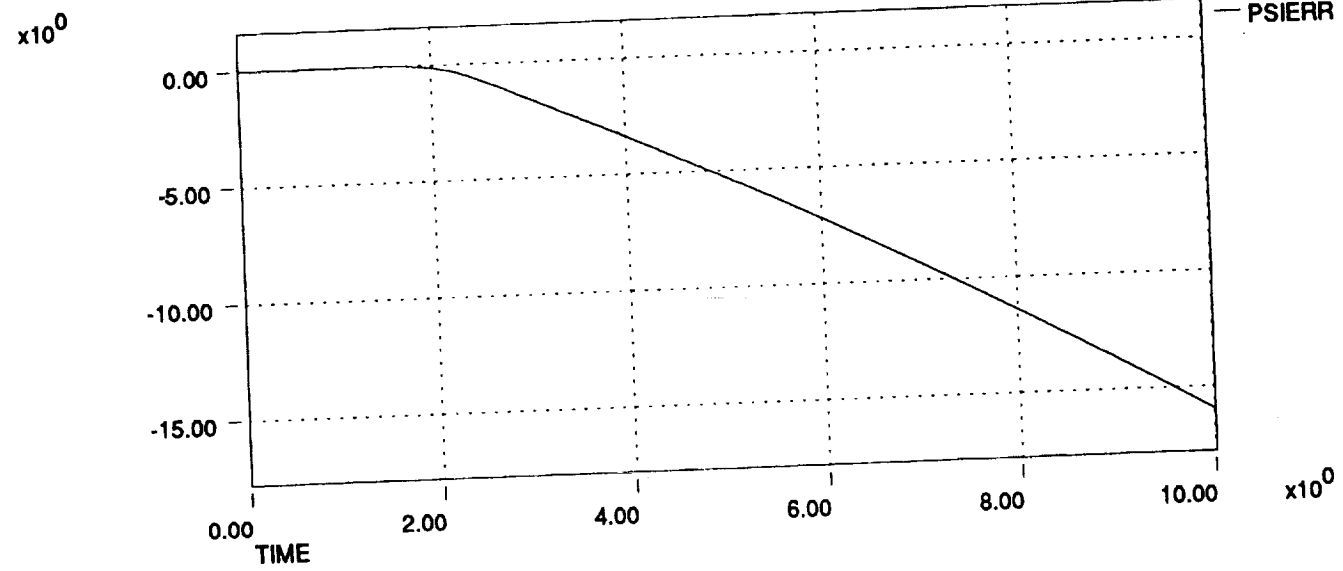
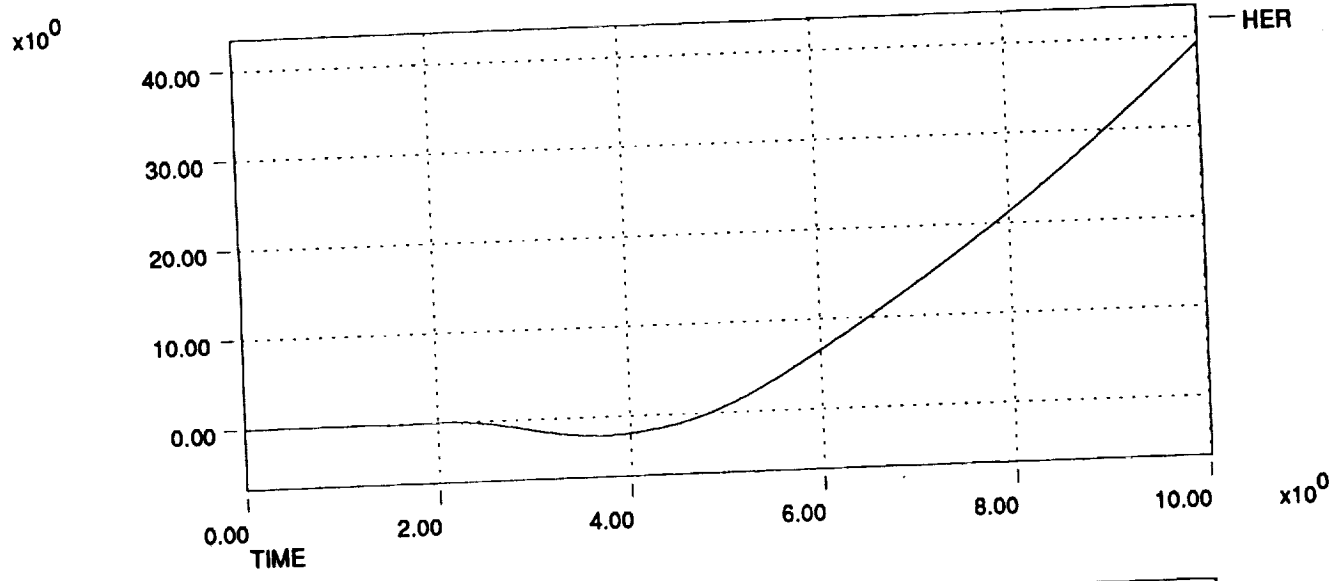

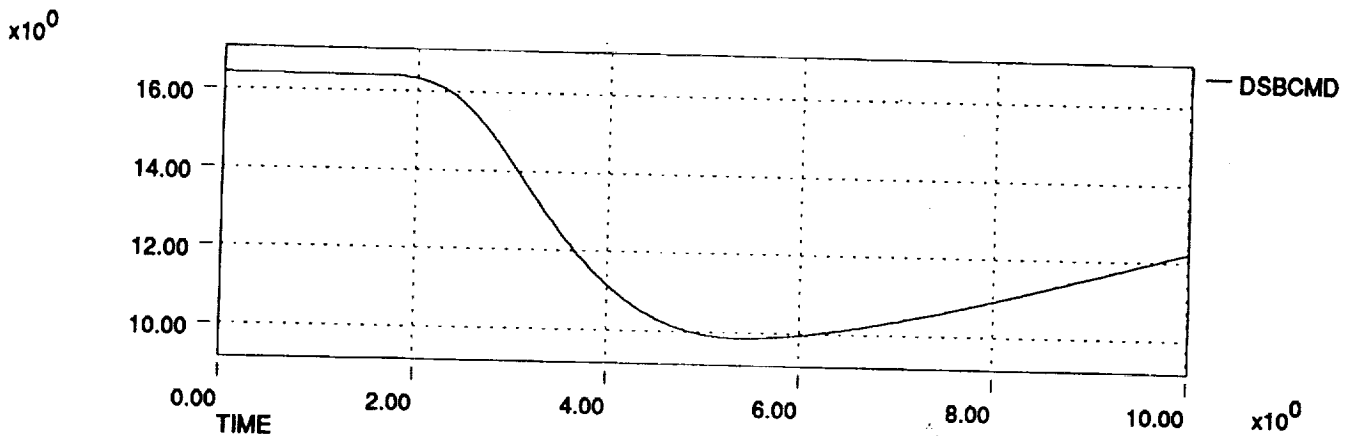
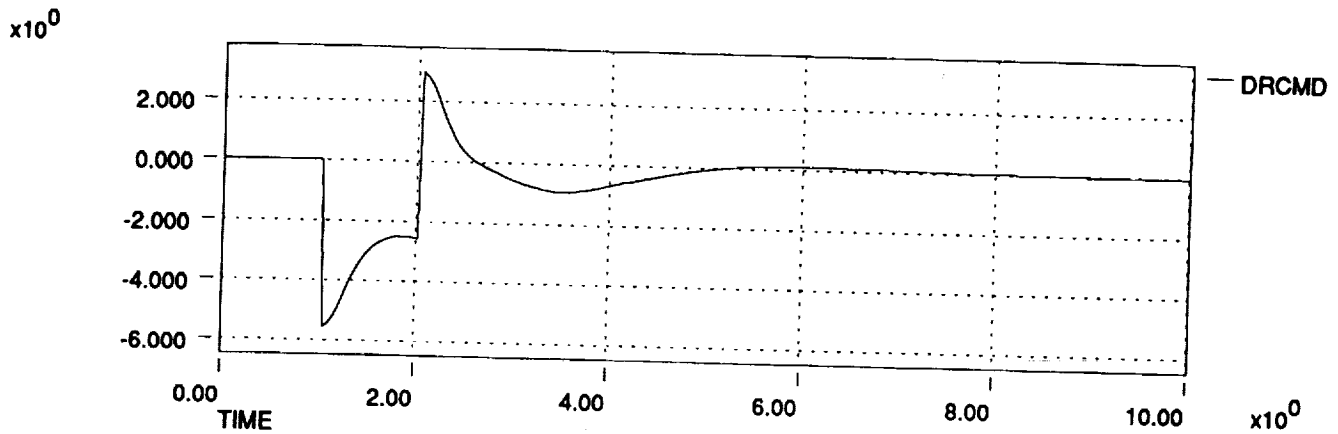
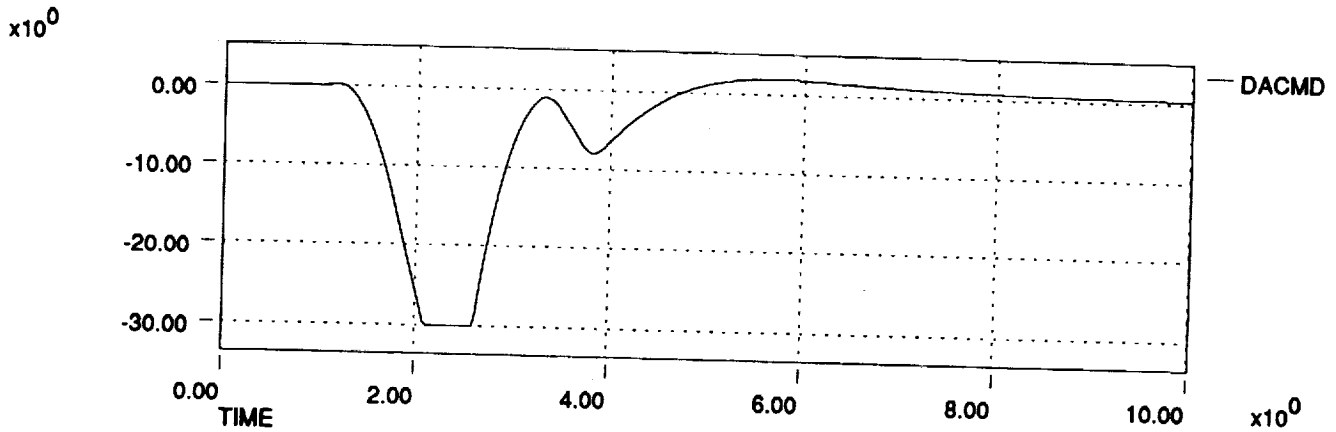
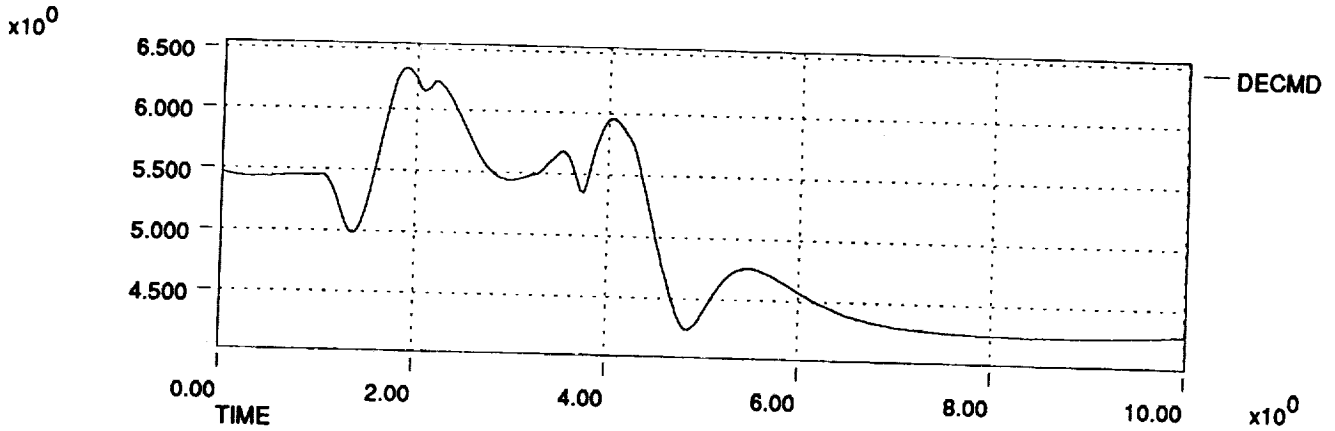

HL-20 Dynamic Check Case Data Plots 911206
Right Rudder Pedal Pulse at 300 KEAS, 10,000 ft

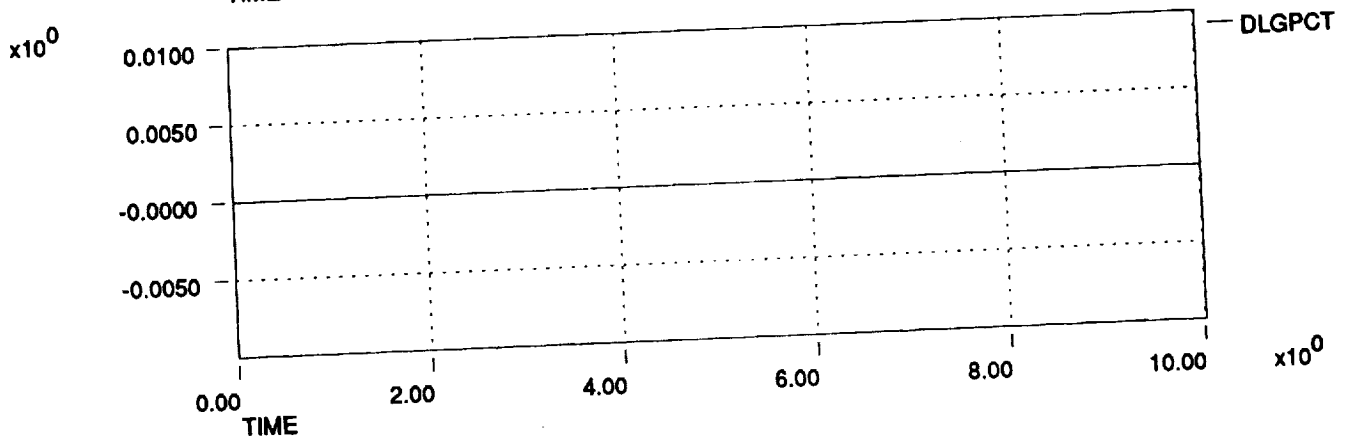
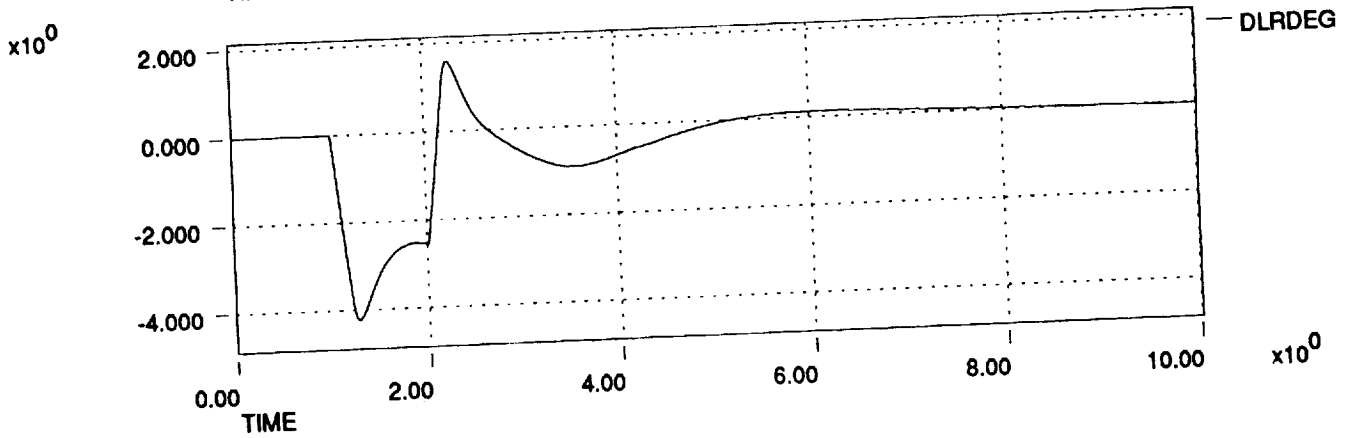
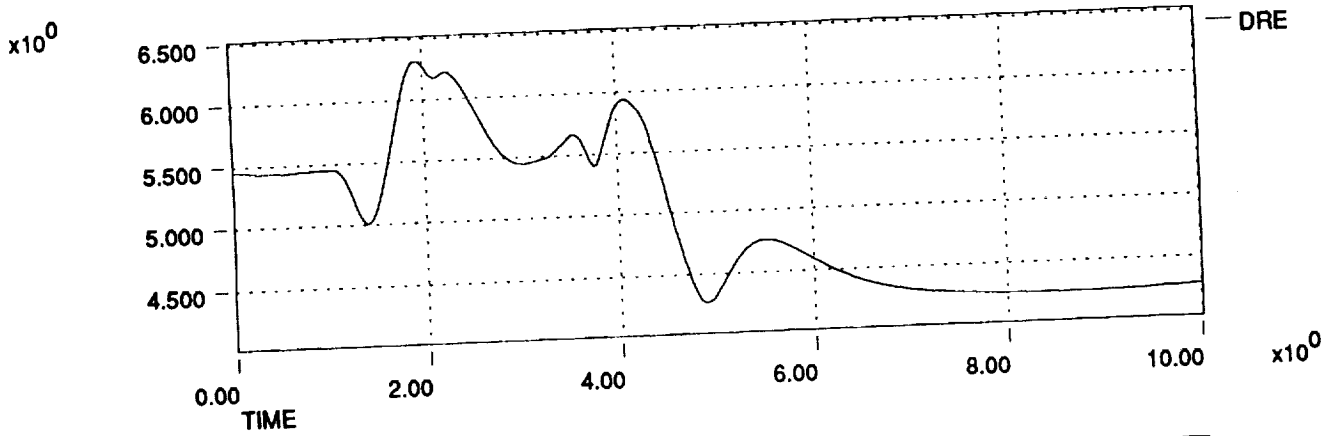
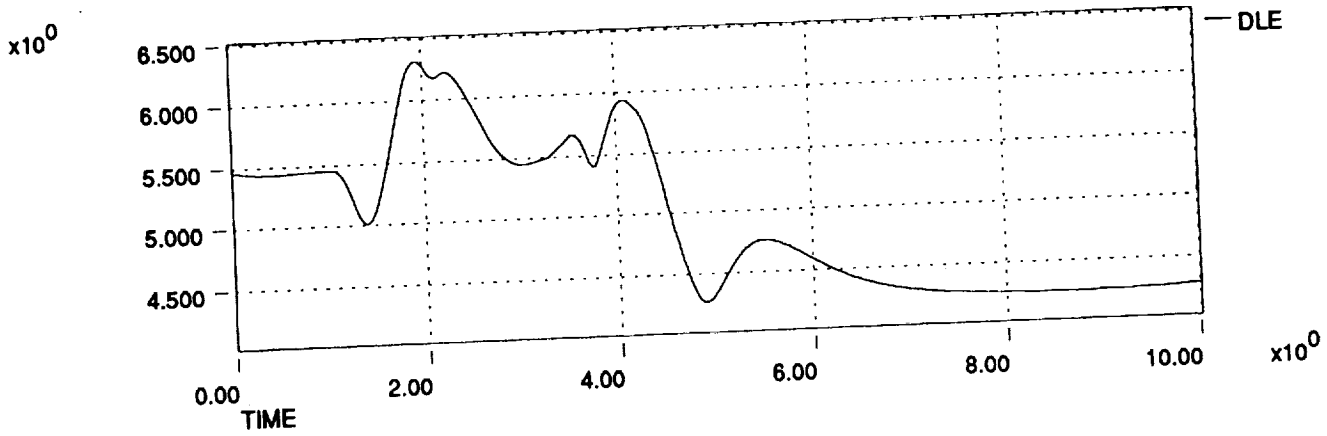

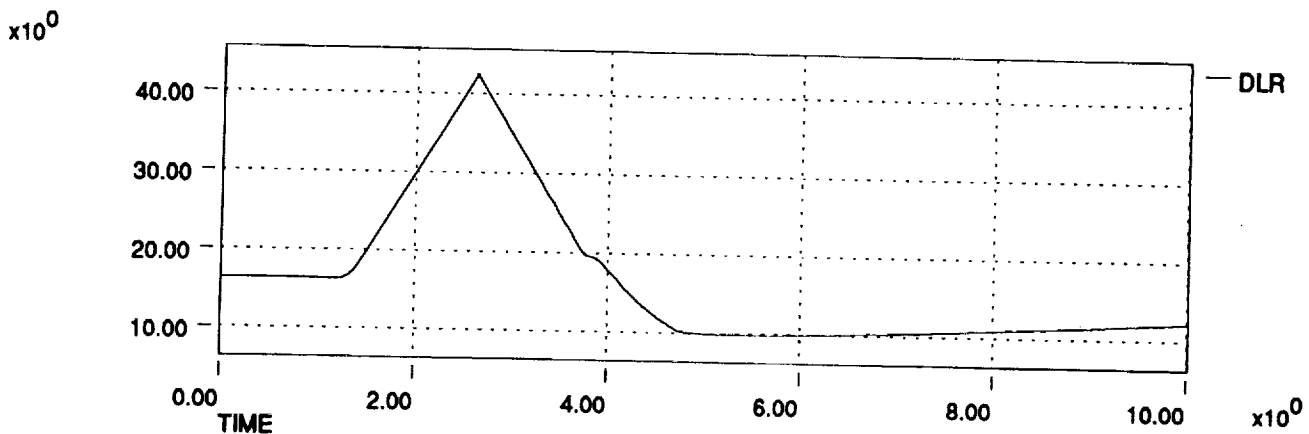
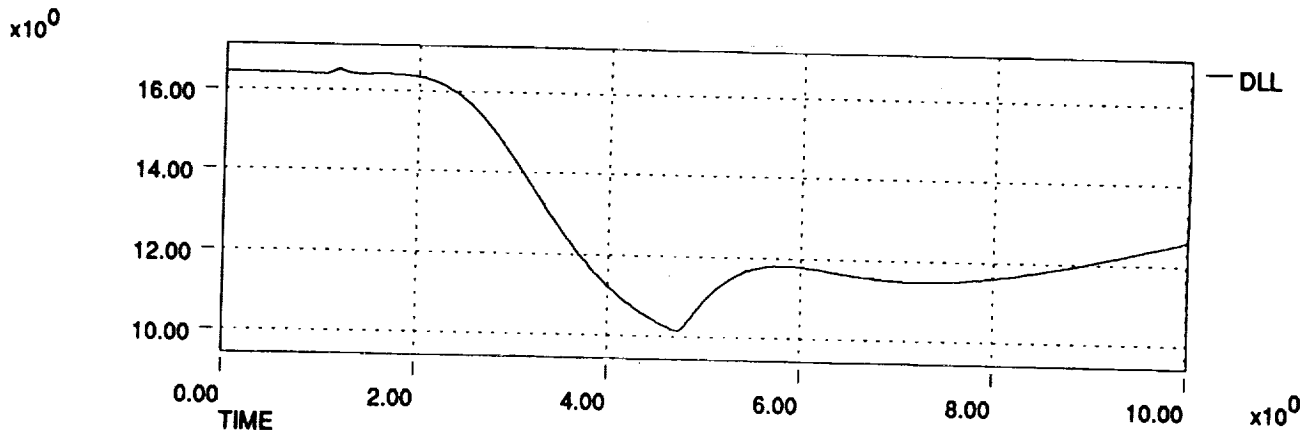
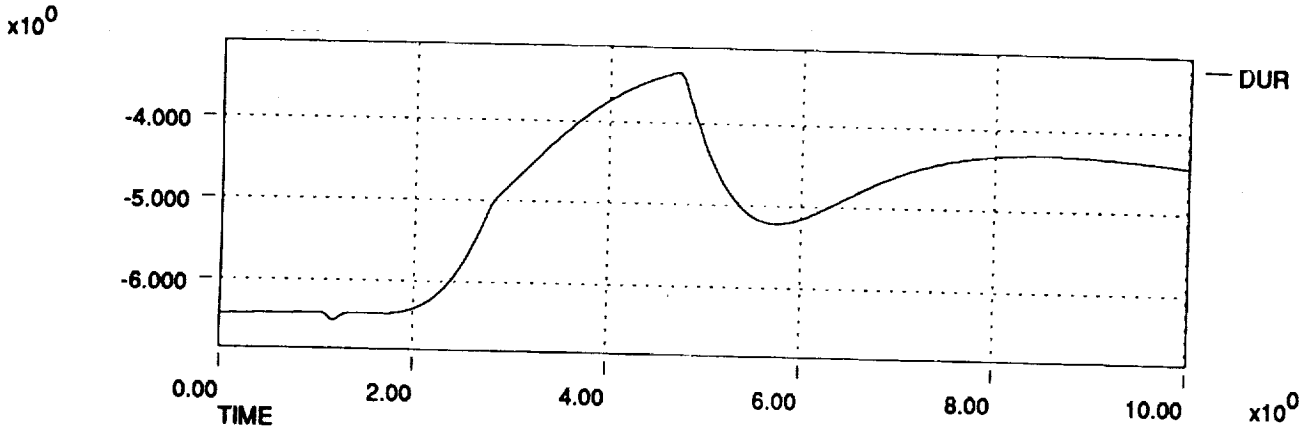
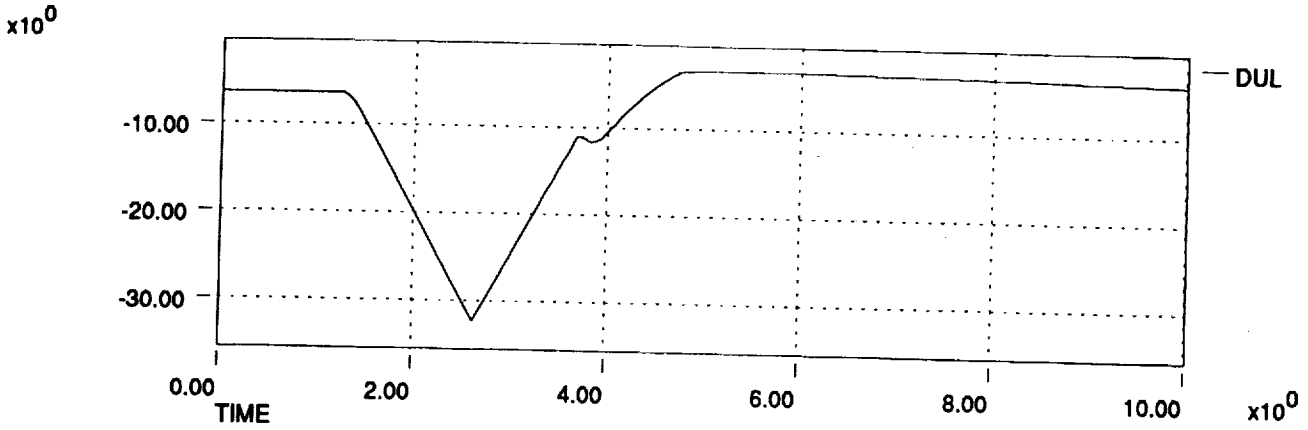

HL-20 Dynamic Check Case Data Plots 911206
Speed Brake Handle Pulse at 300 KEAS, 10,000 ft

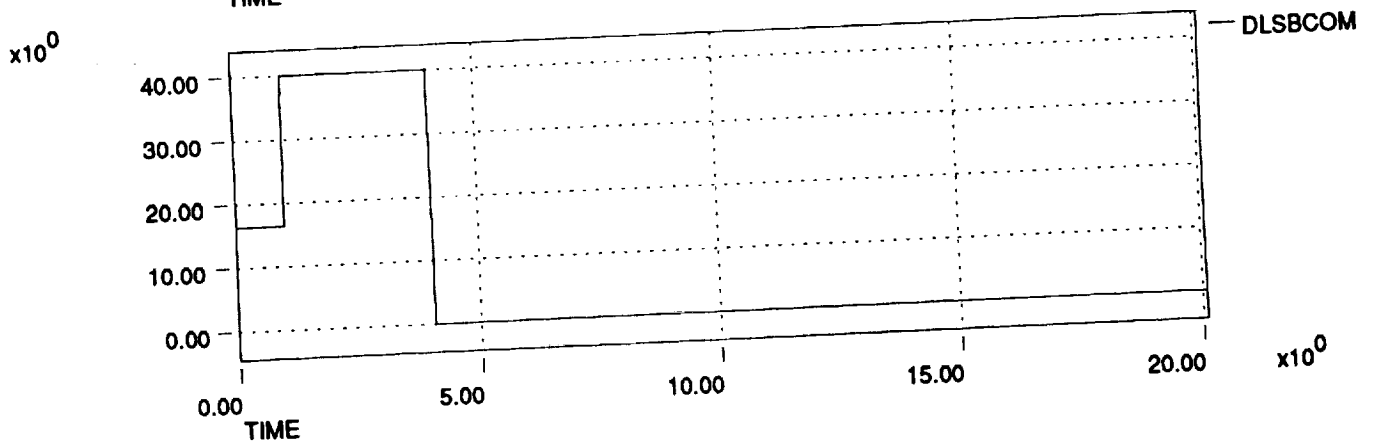
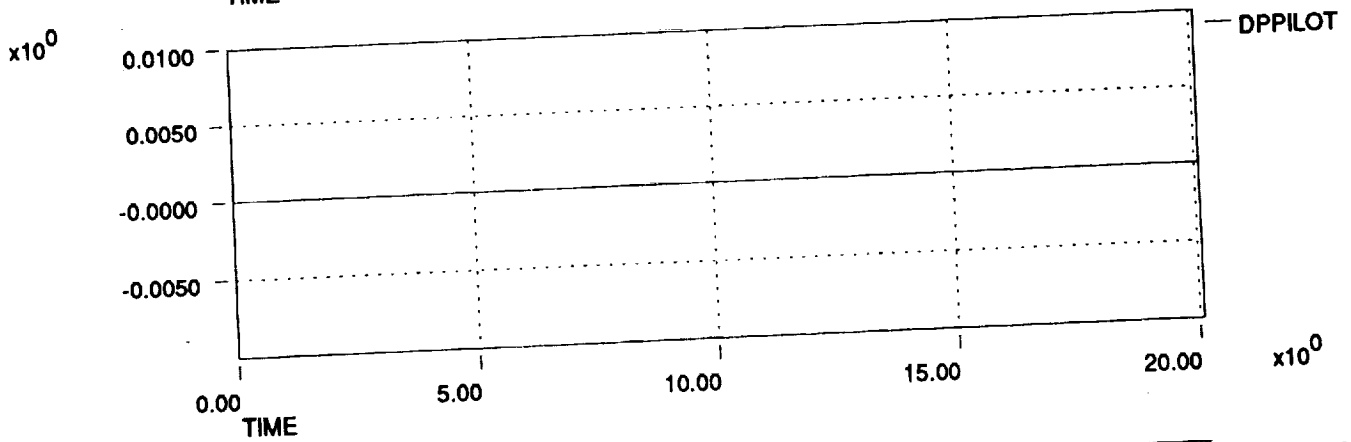
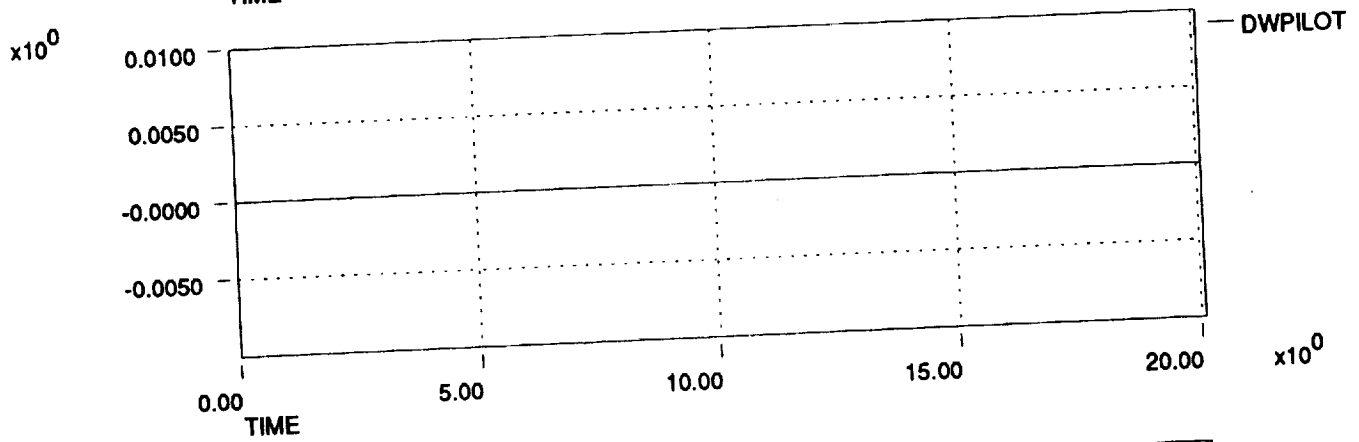
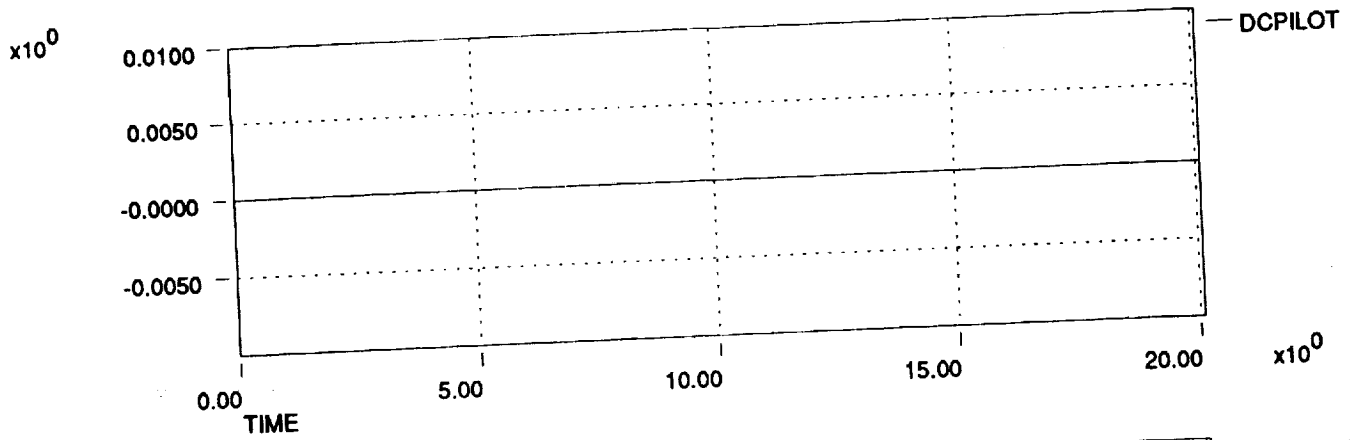

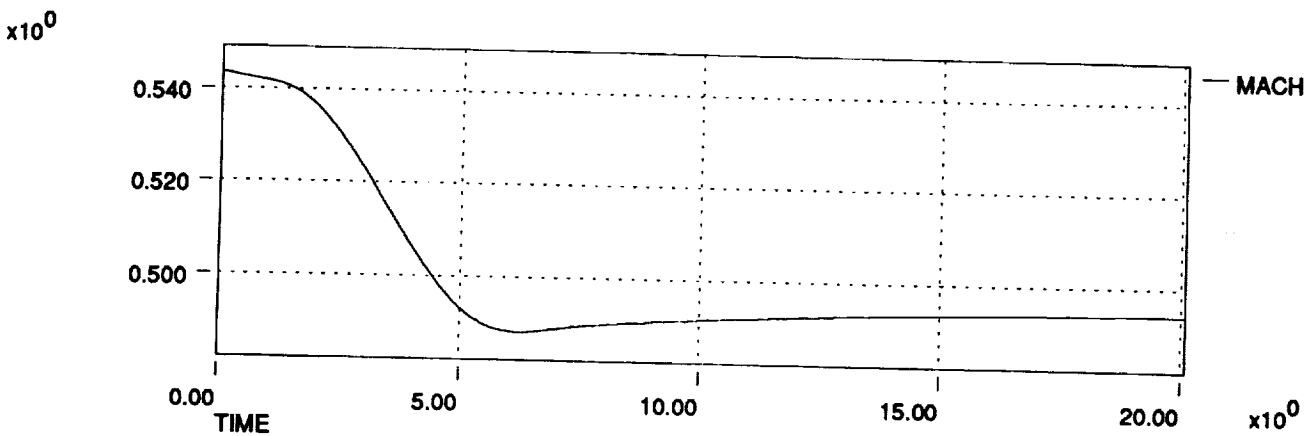
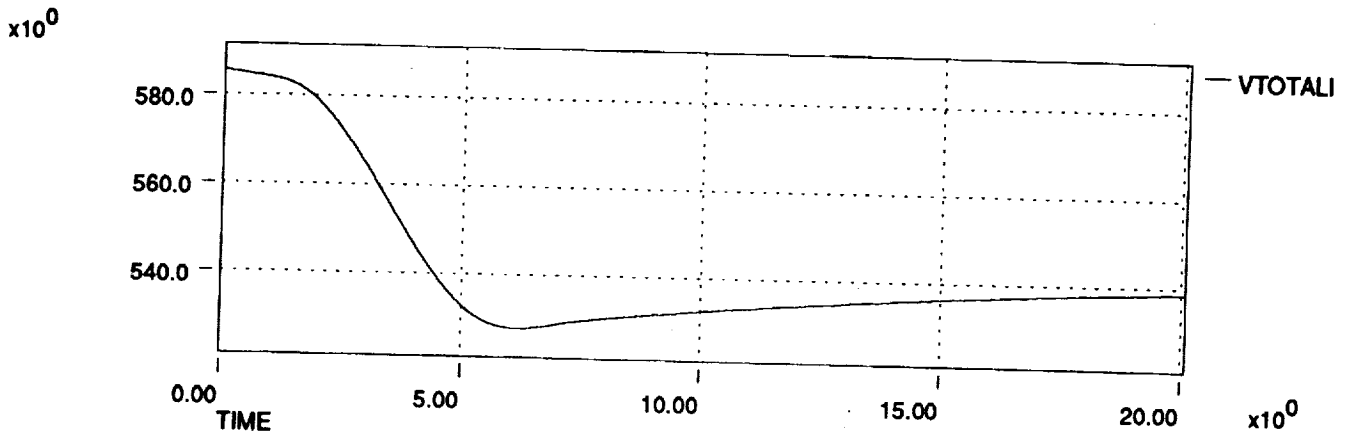
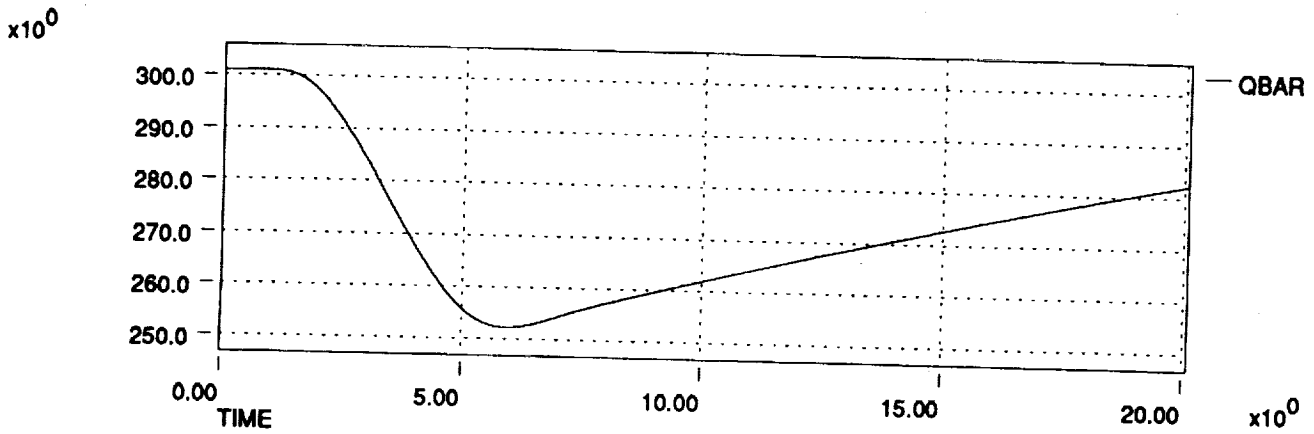
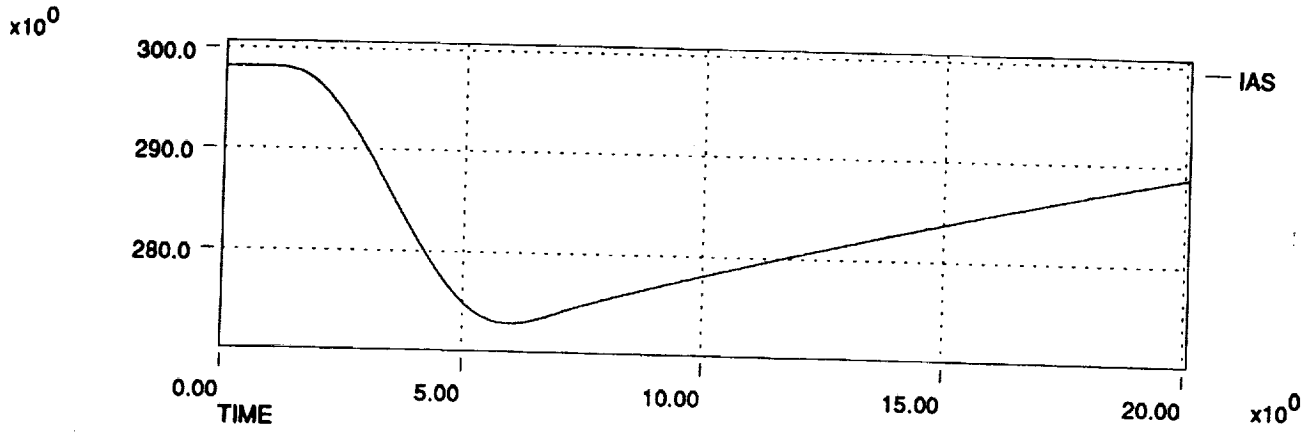

HL-20 Dynamic Check Case Data Plots 911206
Speed Brake Handle Pulse at 300 KEAS, 10,000 ft

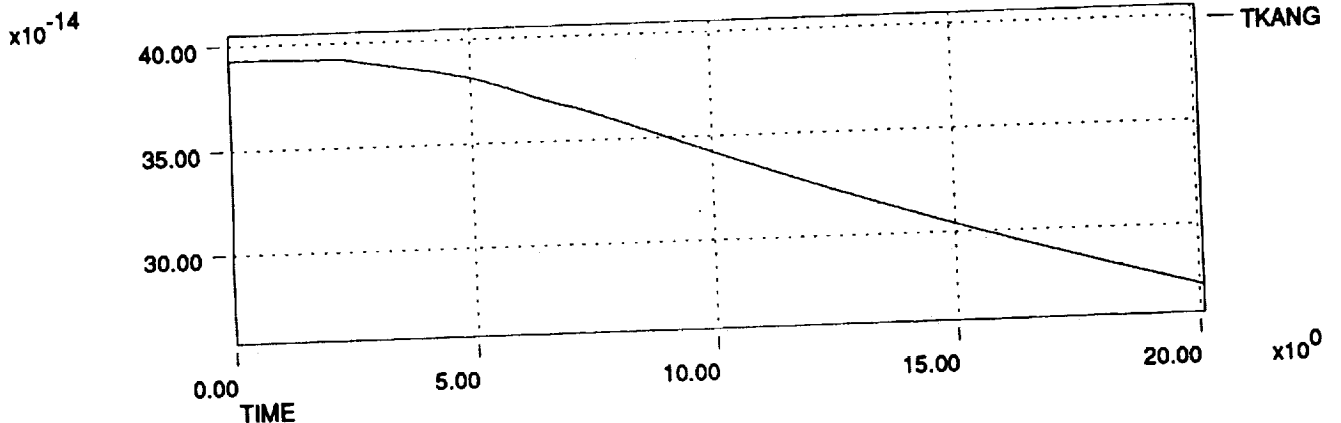
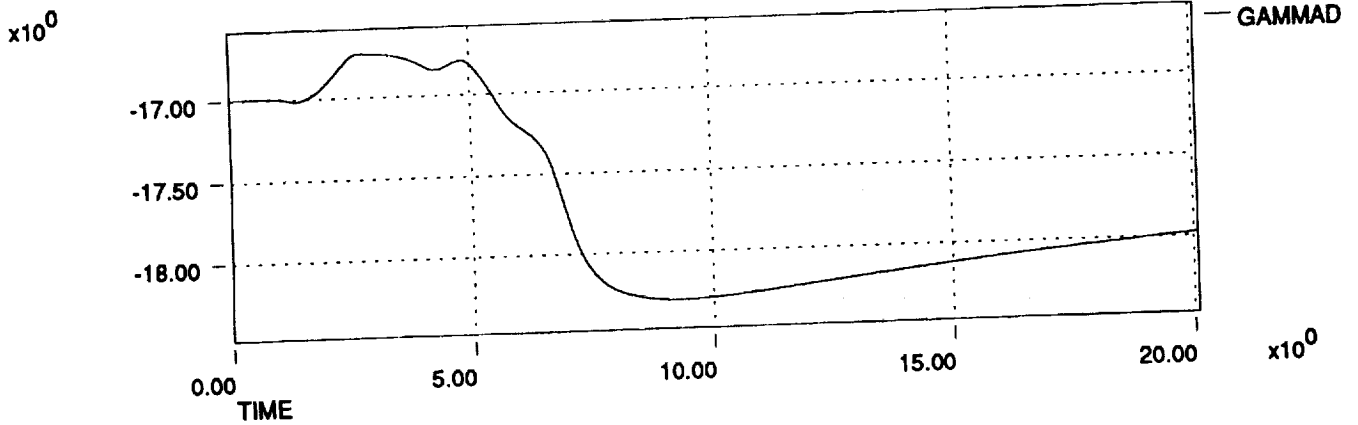
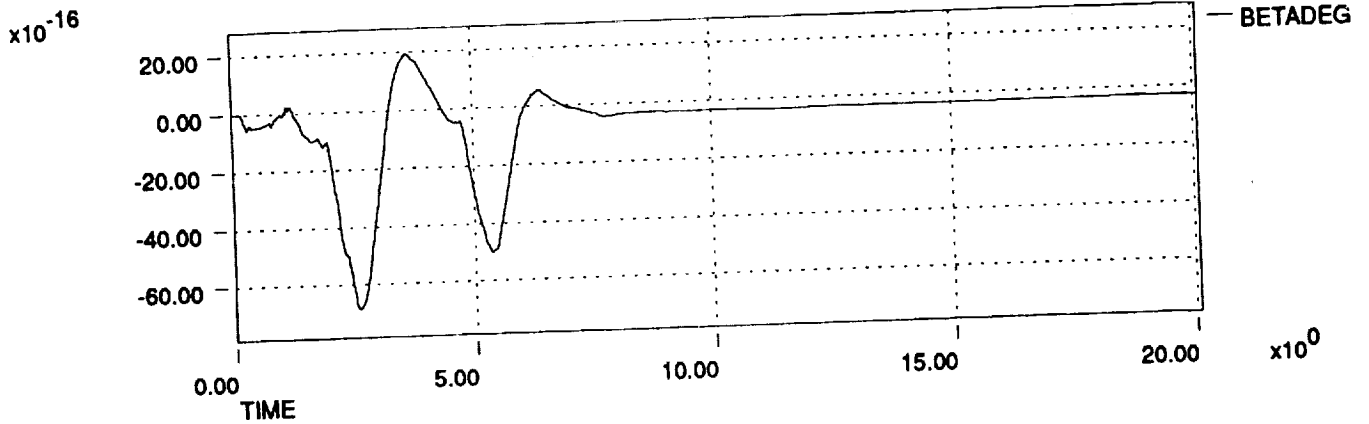
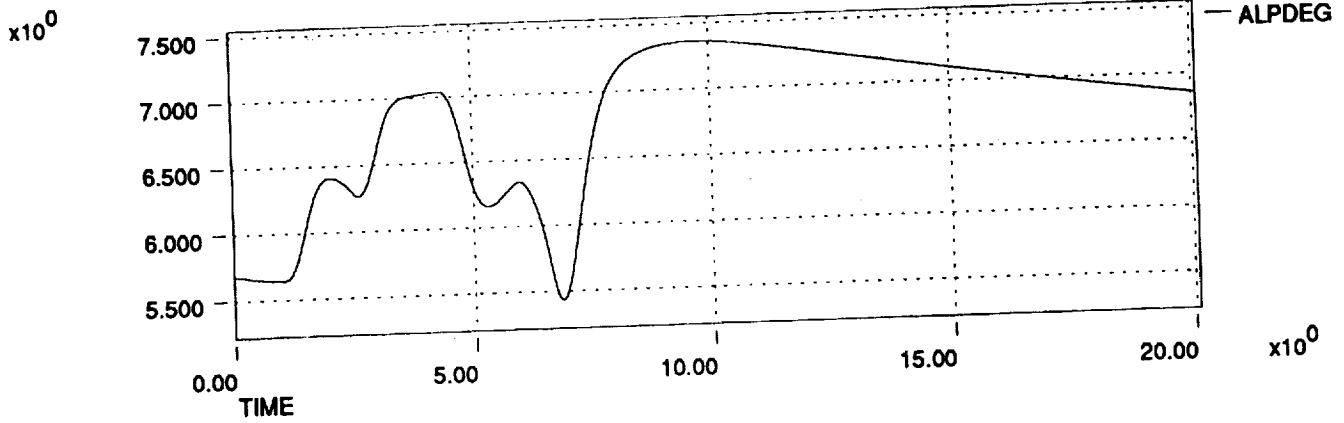

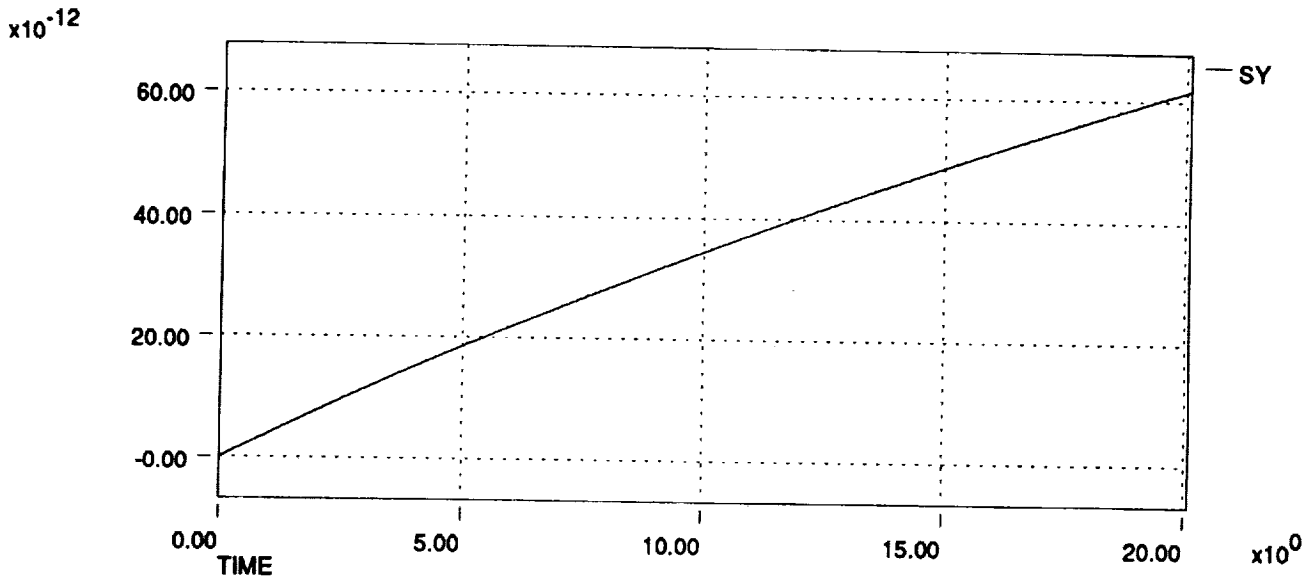
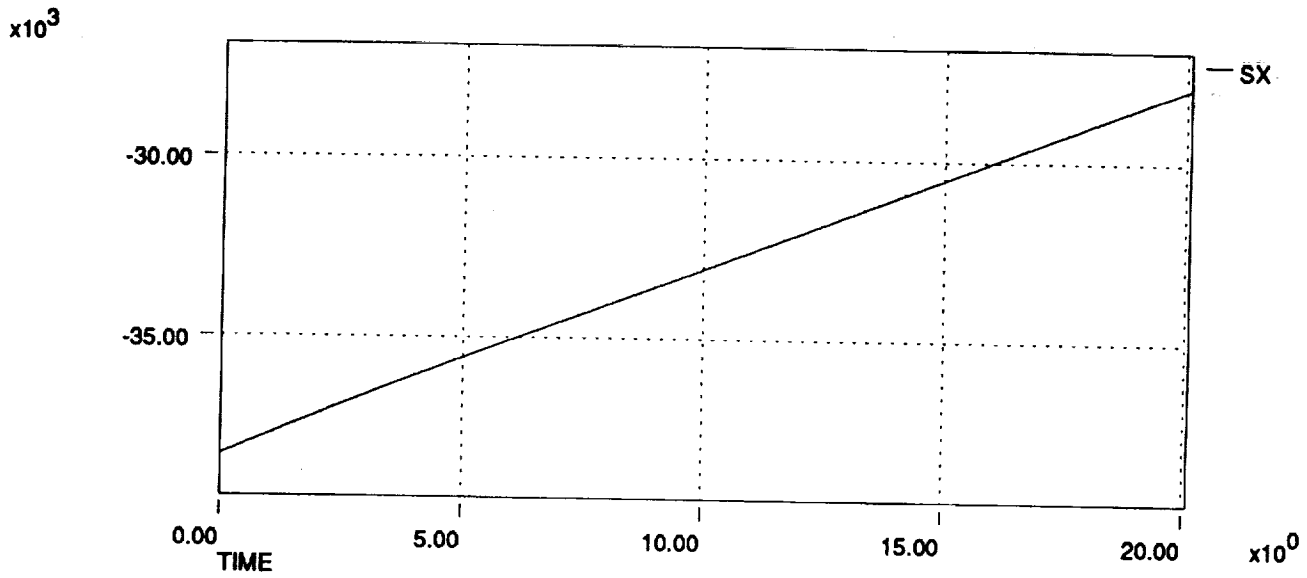
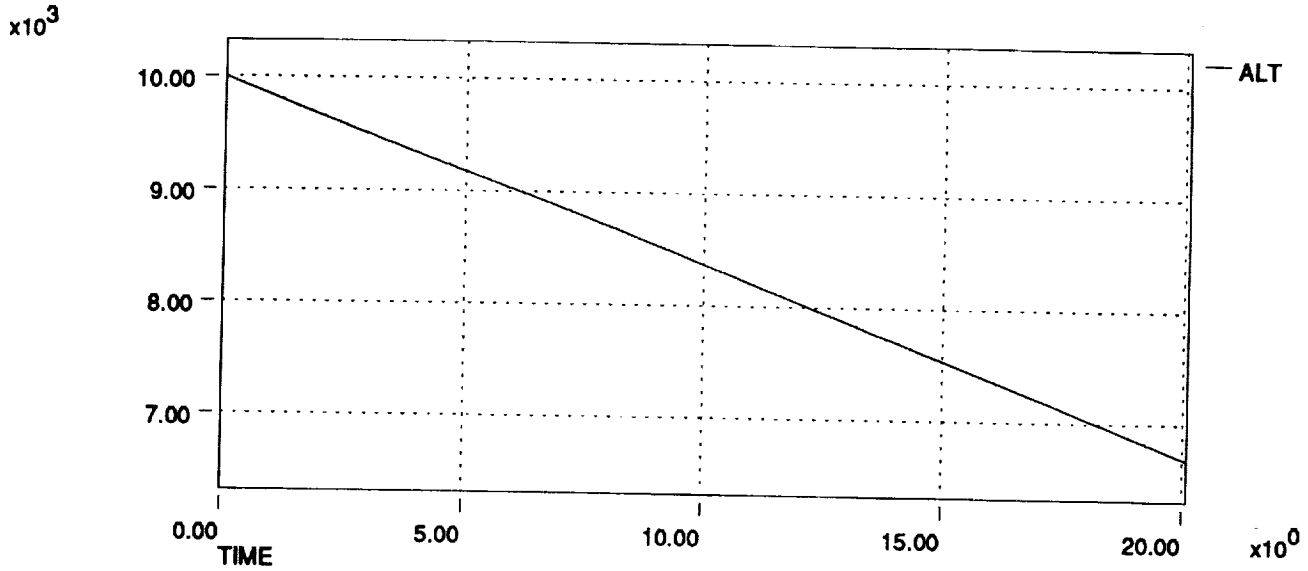

HL-20 Dynamic Check Case Data Plots 911206
Speed Brake Handle Pulse at 300 KEAS, 10,000 ft

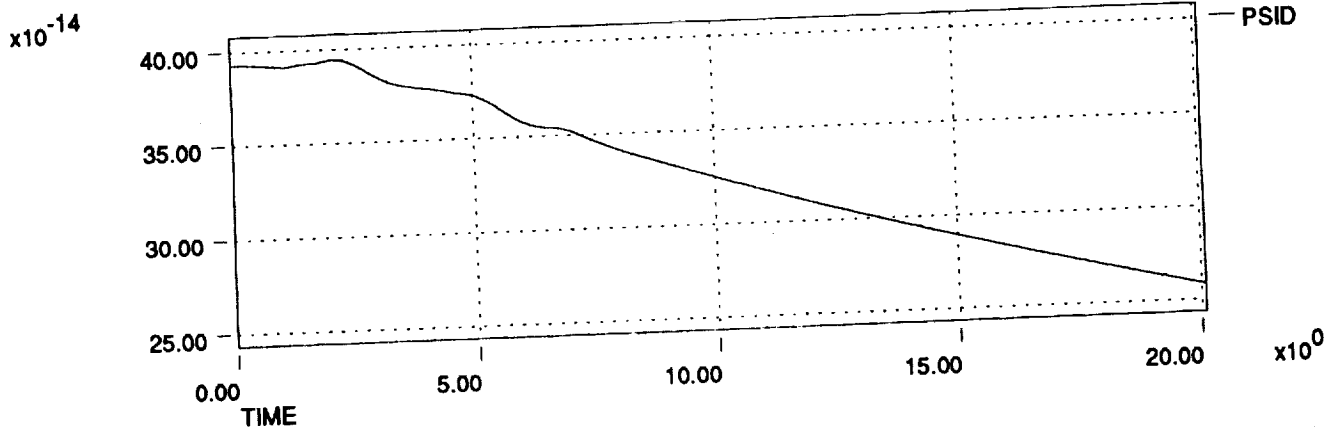
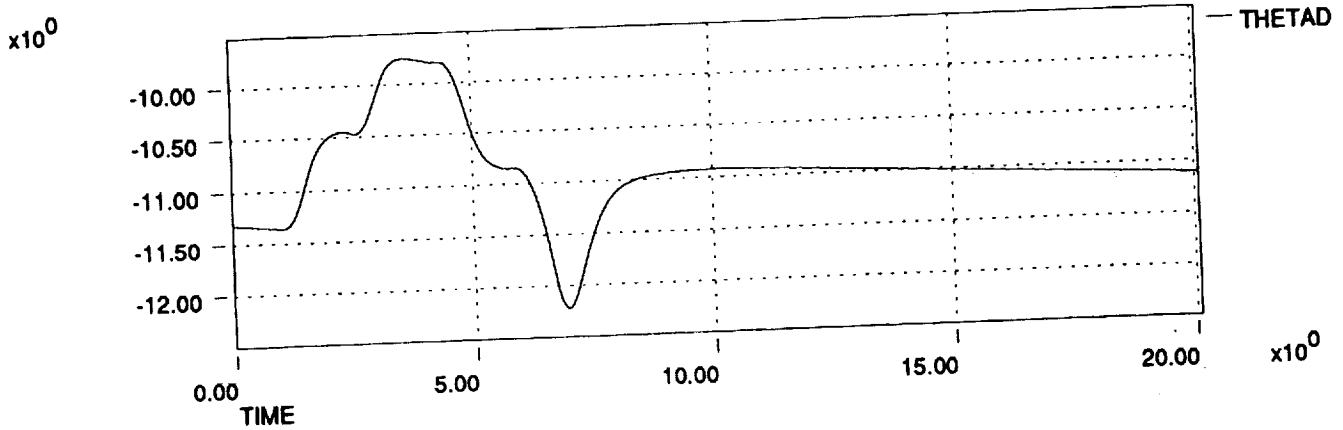
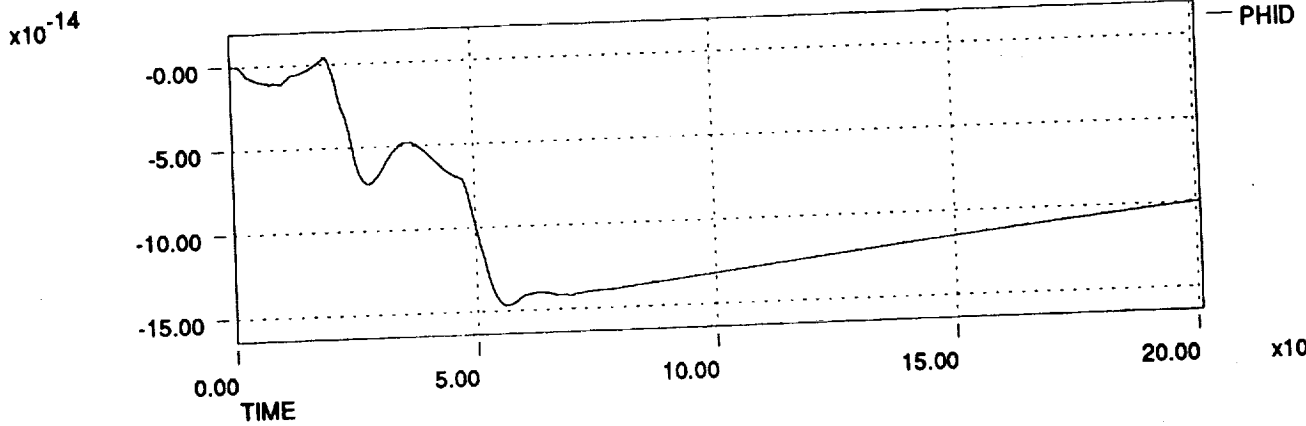
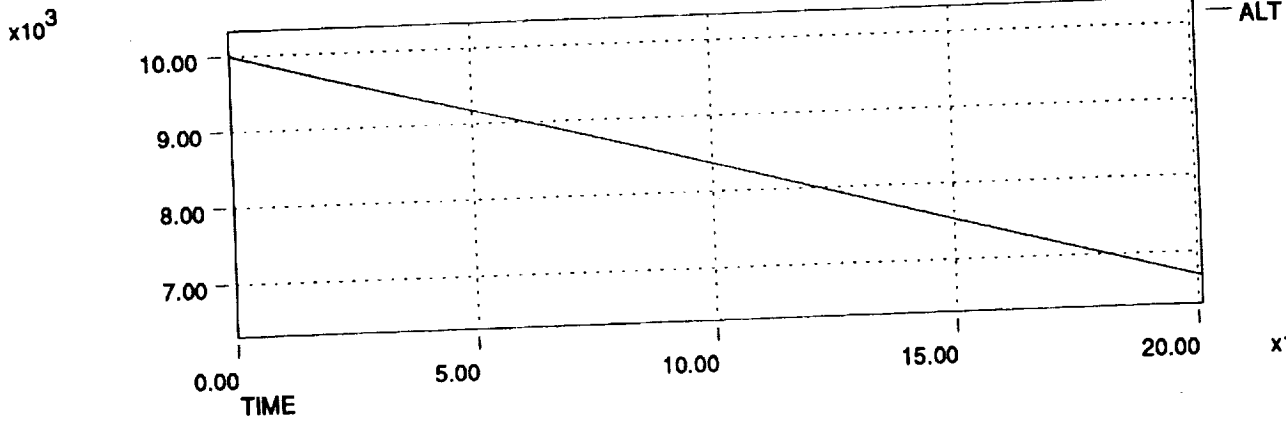

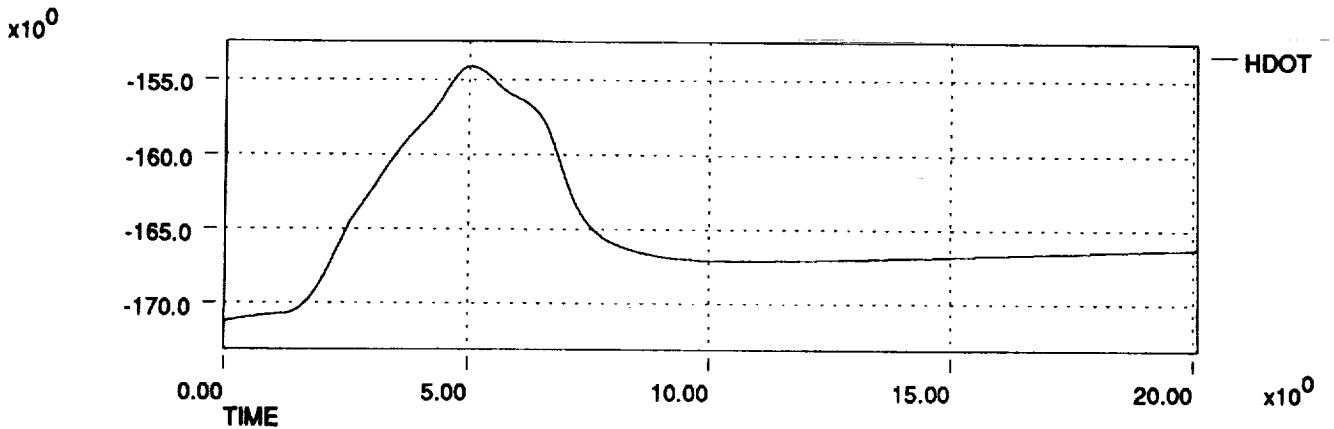
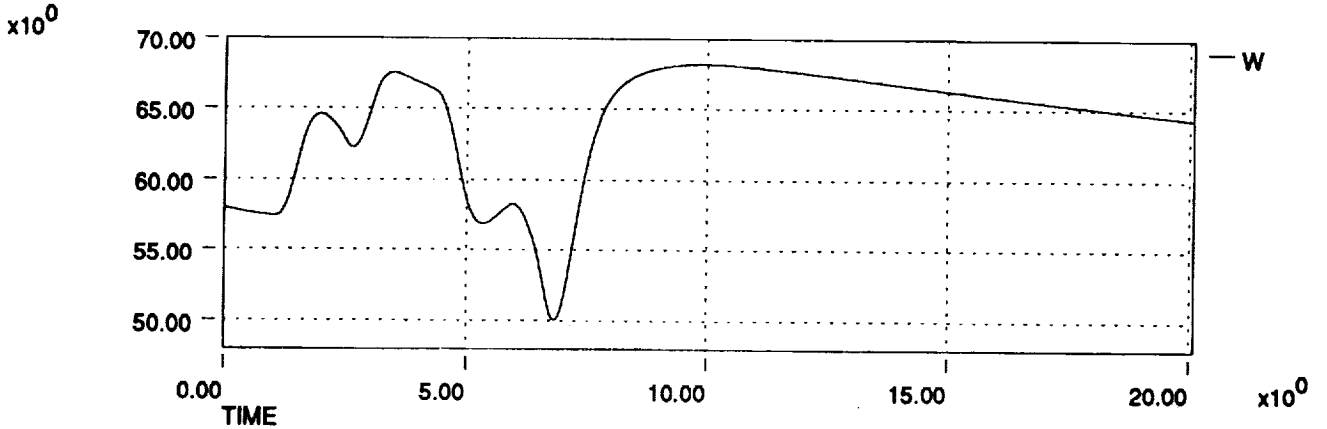
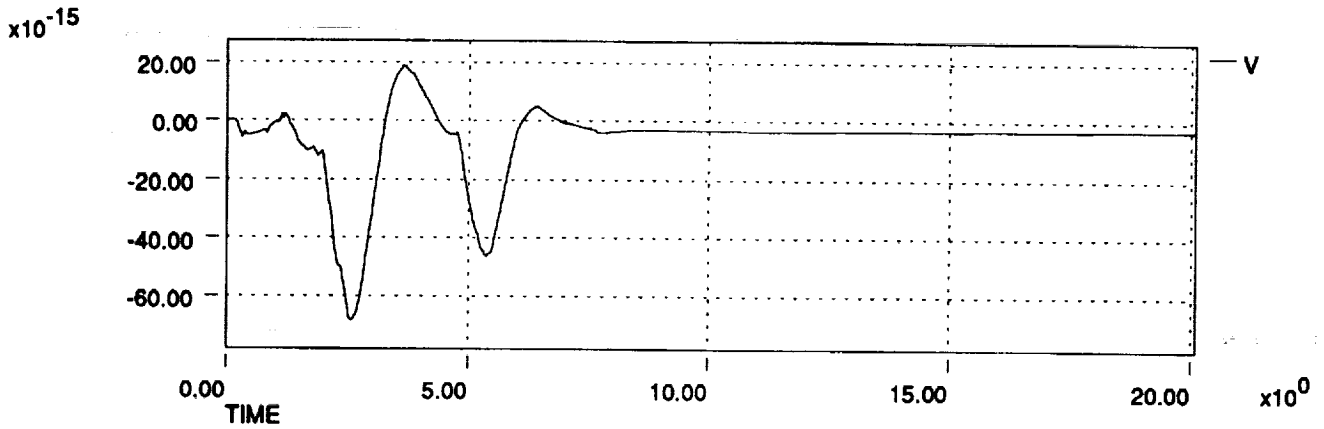
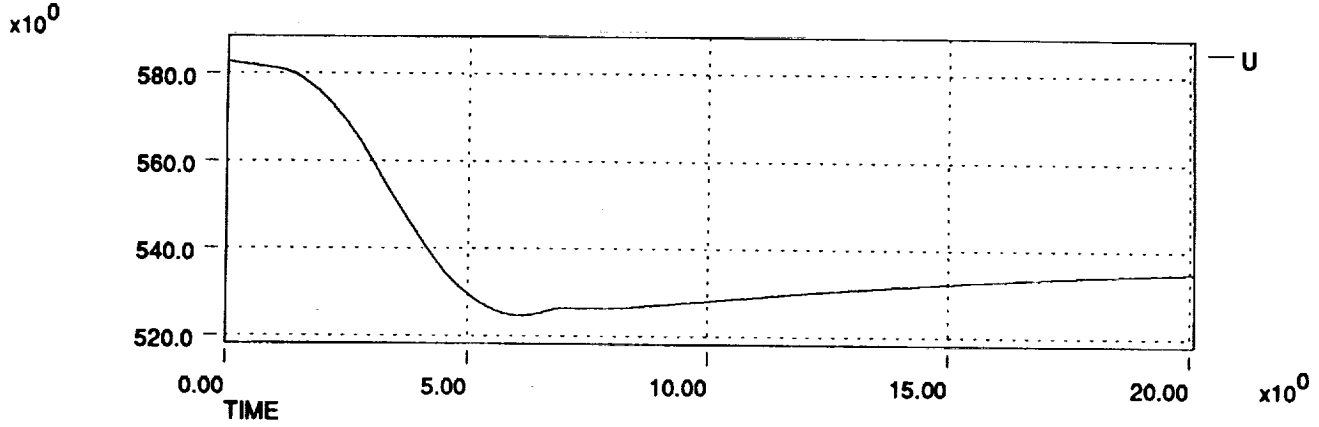

HL-20 Dynamic Check Case Data Plots 911206
Speed Brake Handle Pulse at 300 KEAS, 10,000 ft

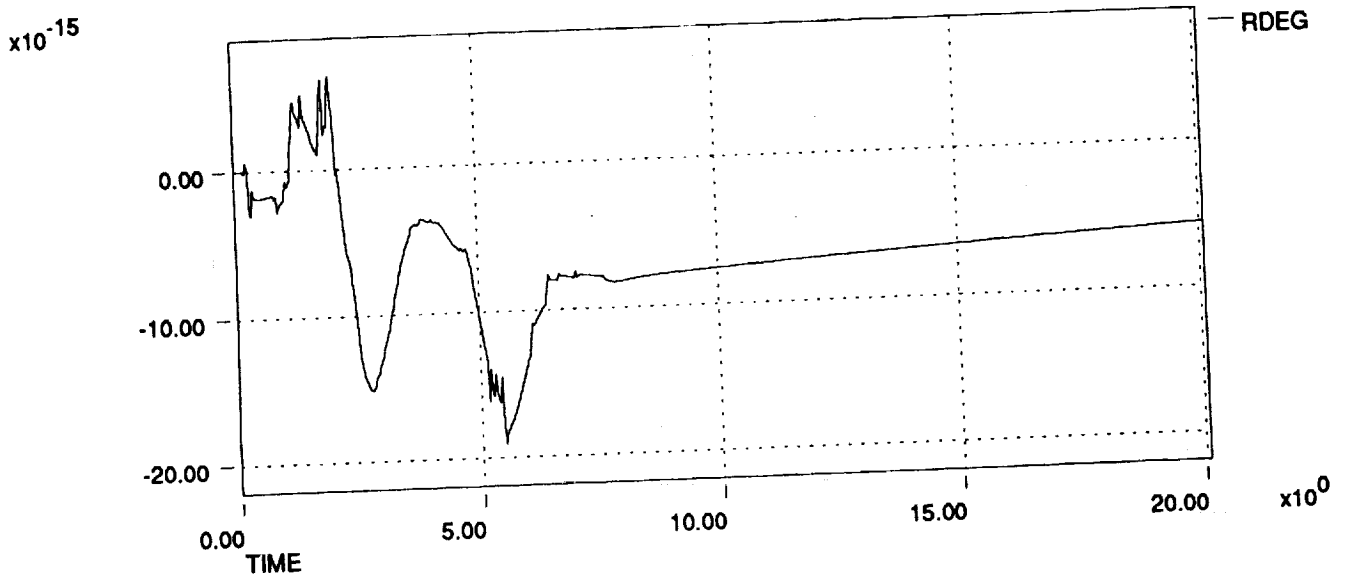
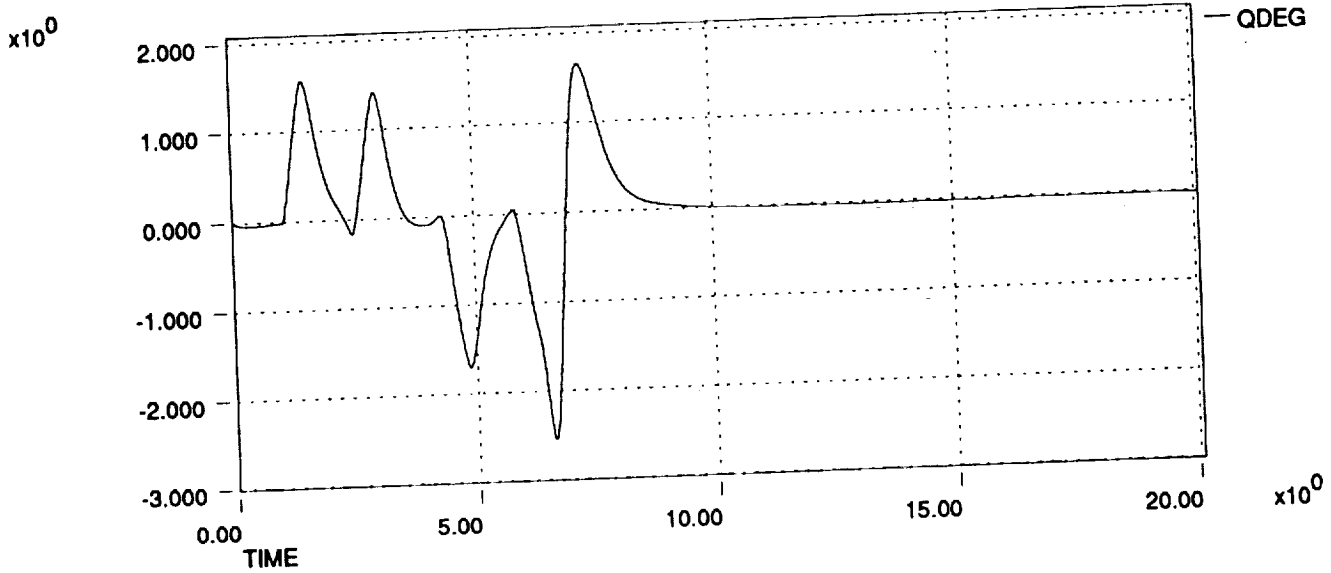
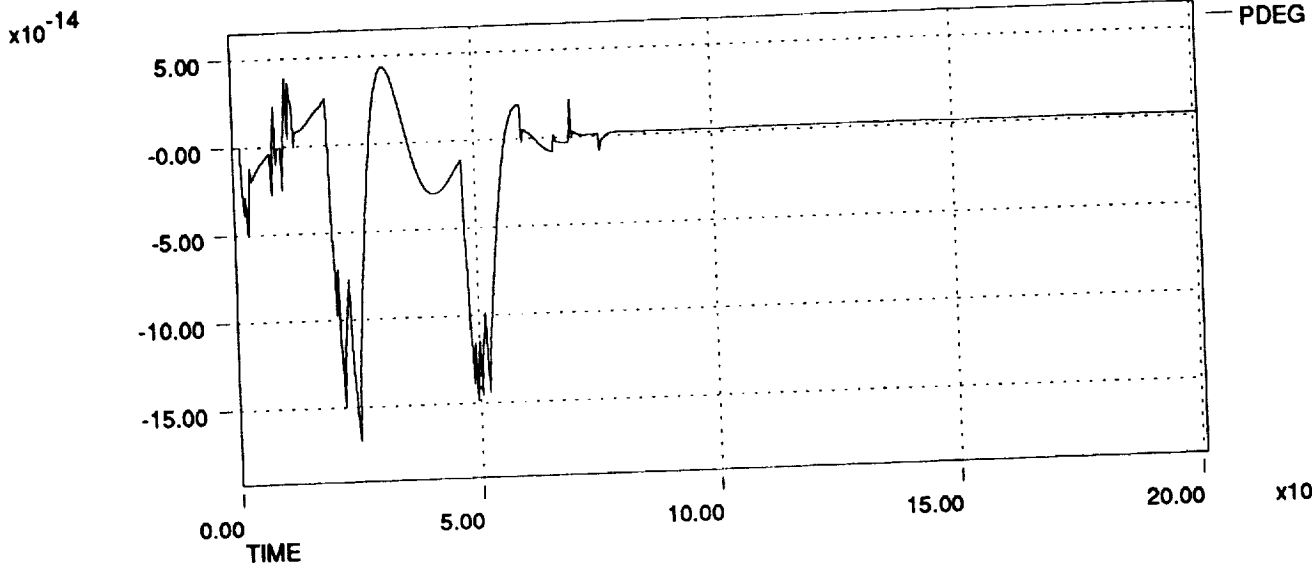

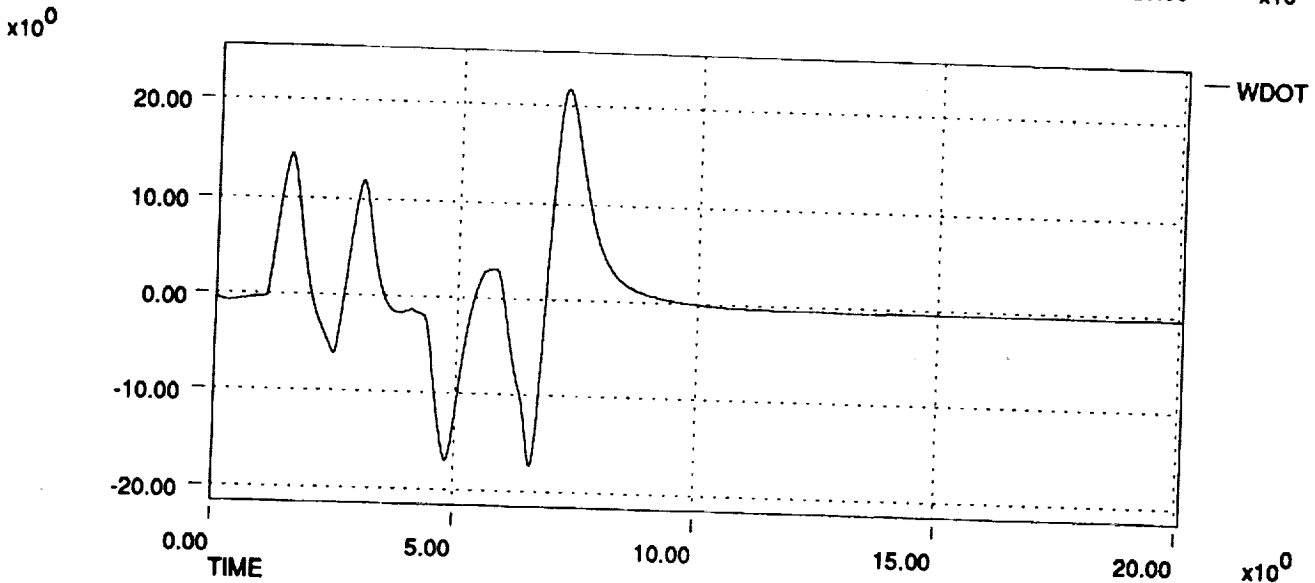
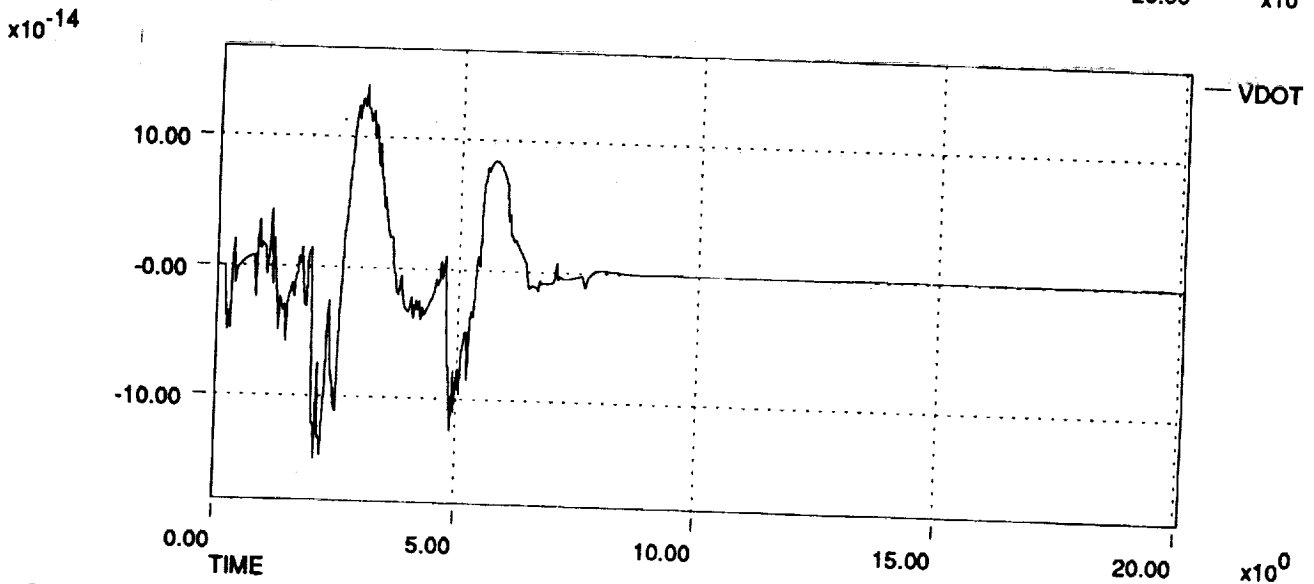
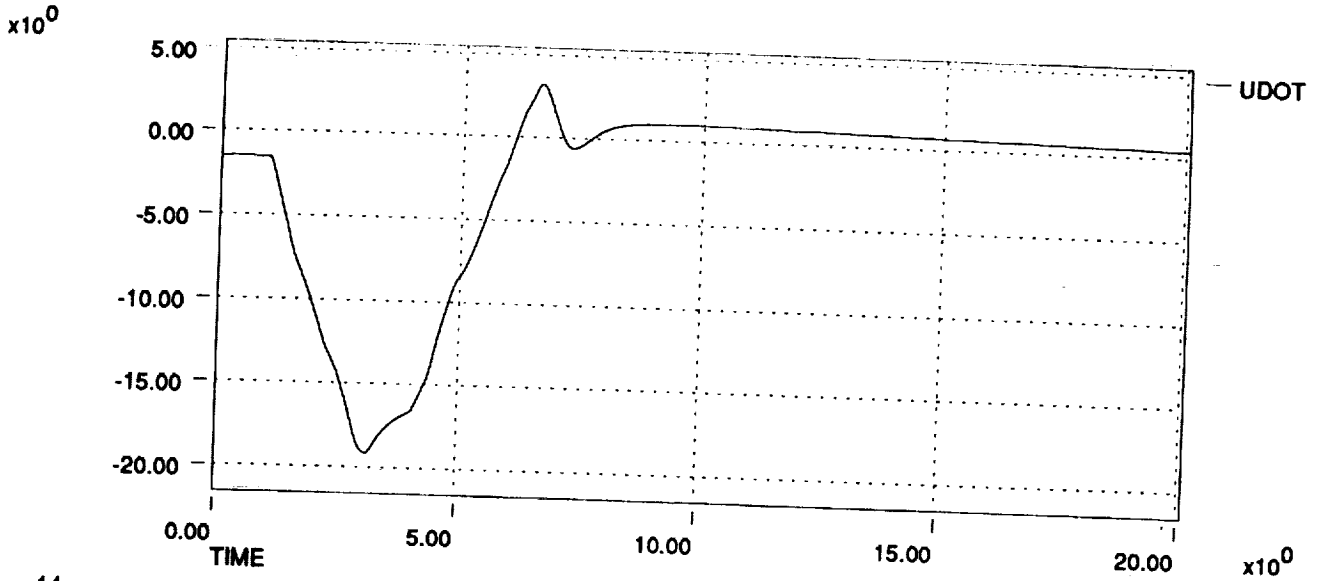

HL-20 Dynamic Check Case Data Plots 911206
Speed Brake Handle Pulse at 300 KEAS, 10,000 ft

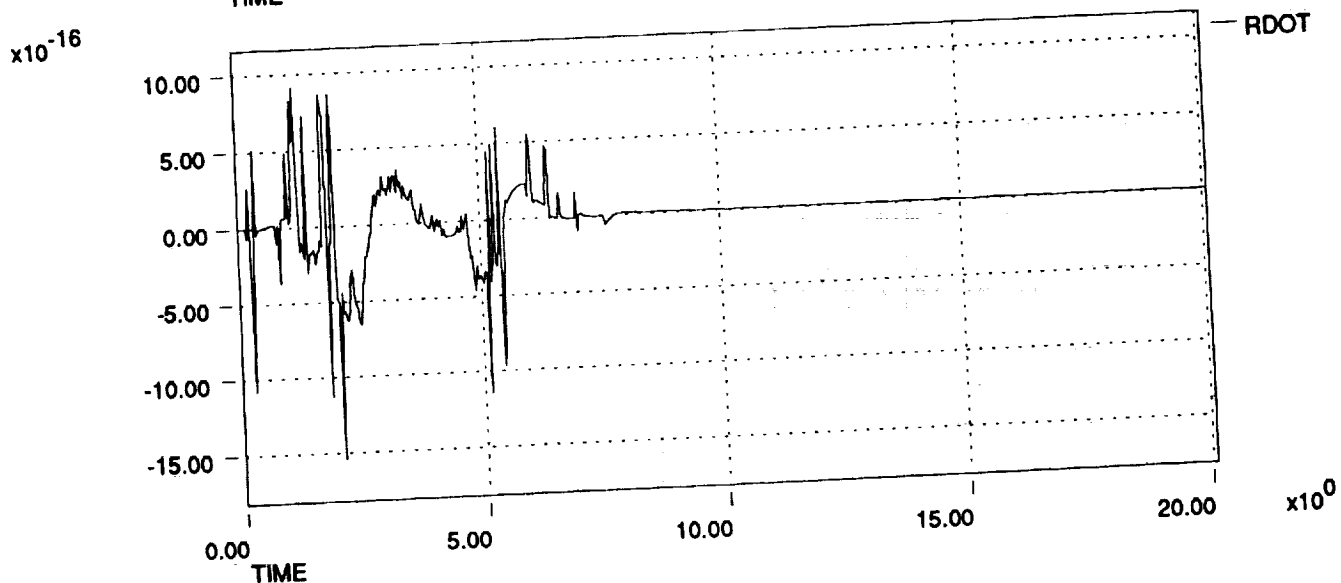
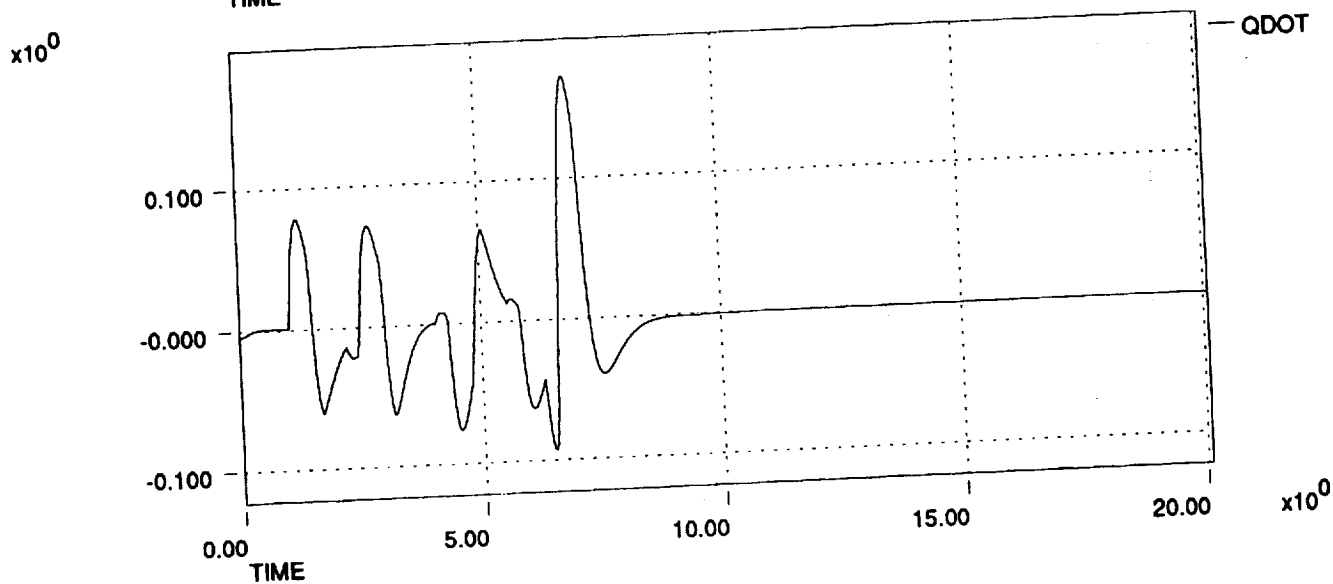
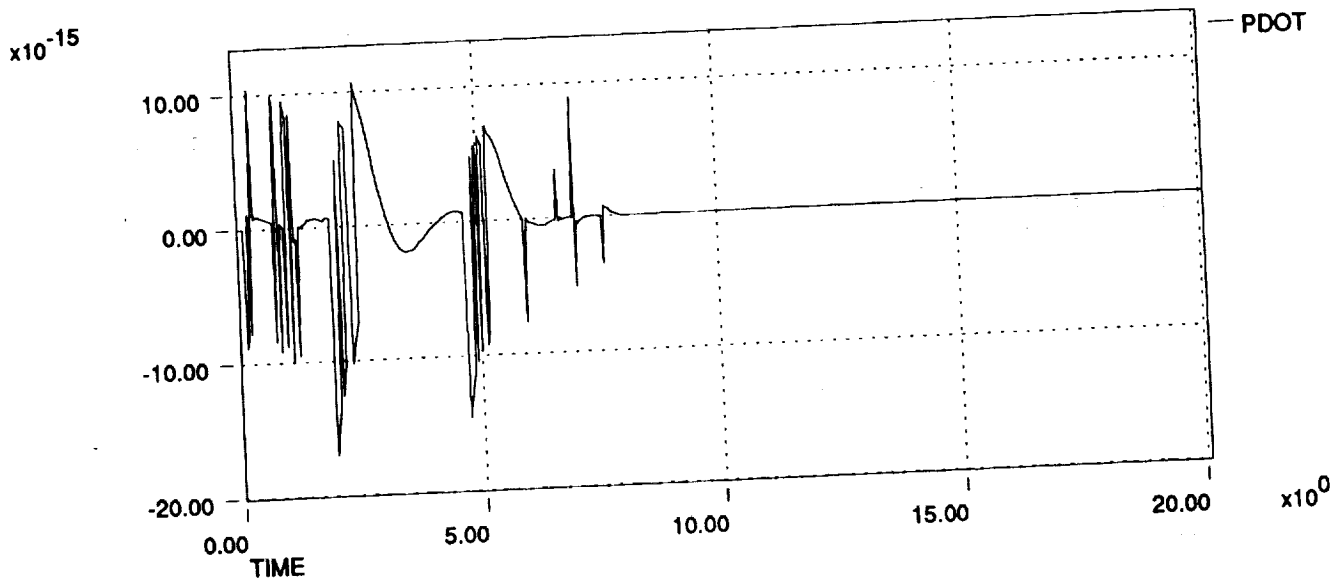

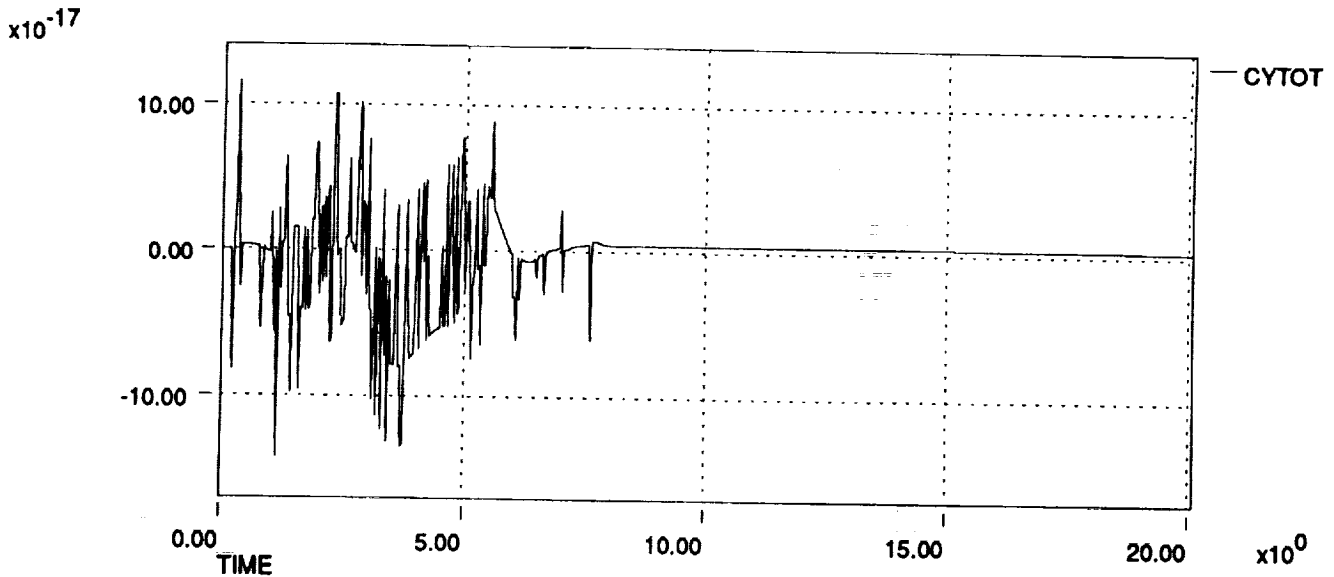
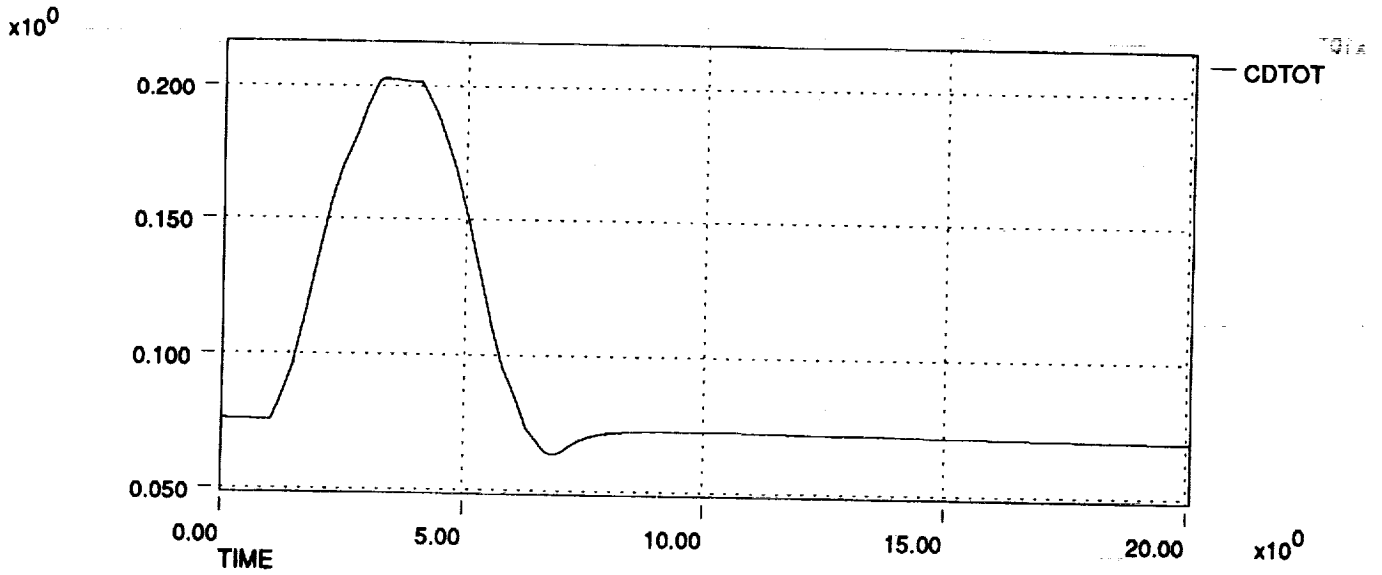
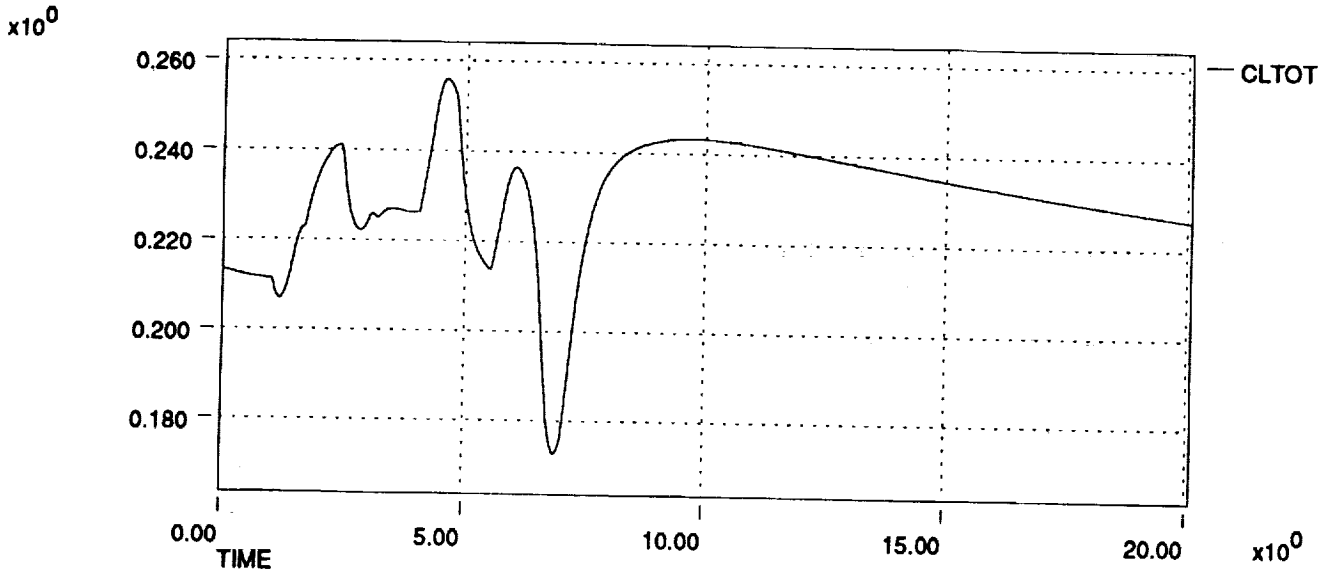

HL-20 Dynamic Check Case Data Plots 911206
Speed Brake Handle Pulse at 300 KEAS, 10,000 ft

$\times 10^{-17}$

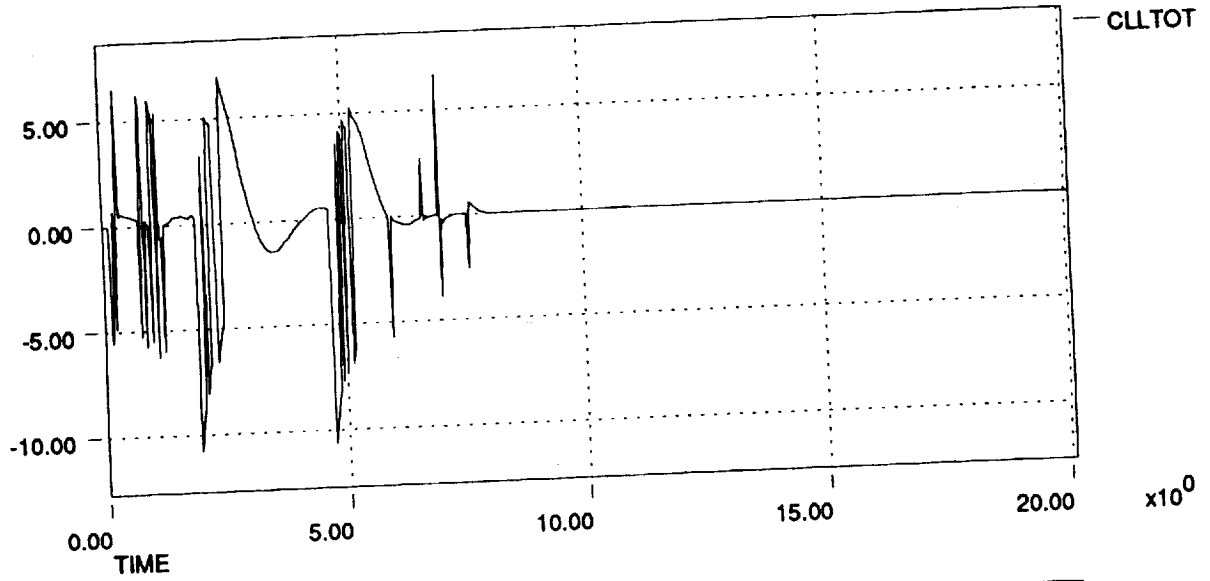

$\times 10^0$

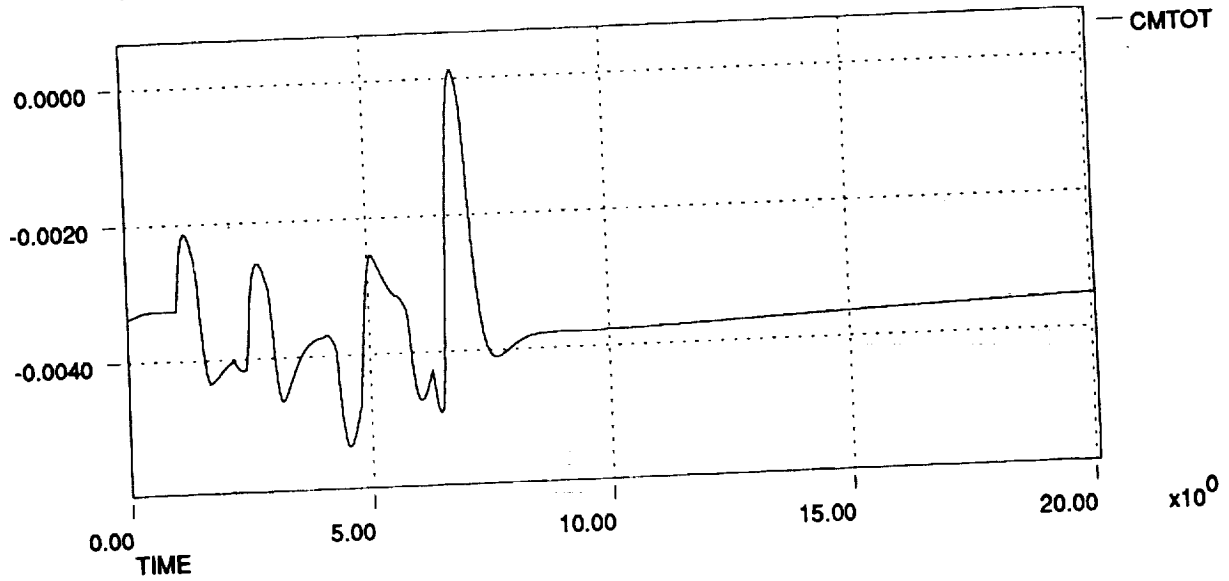

$\times 10^{-18}$

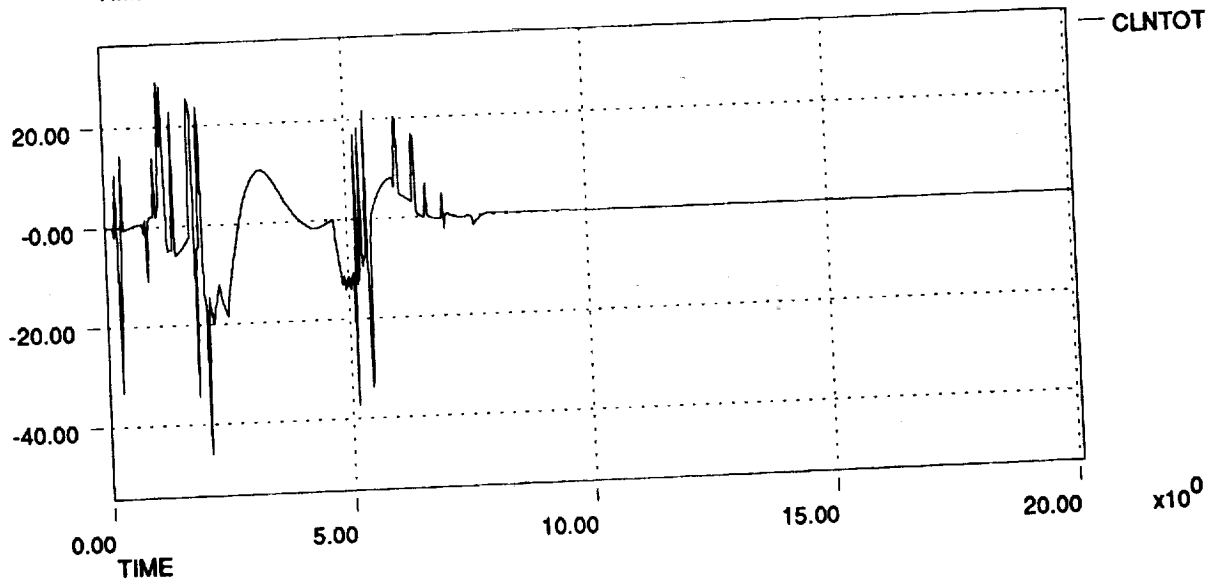

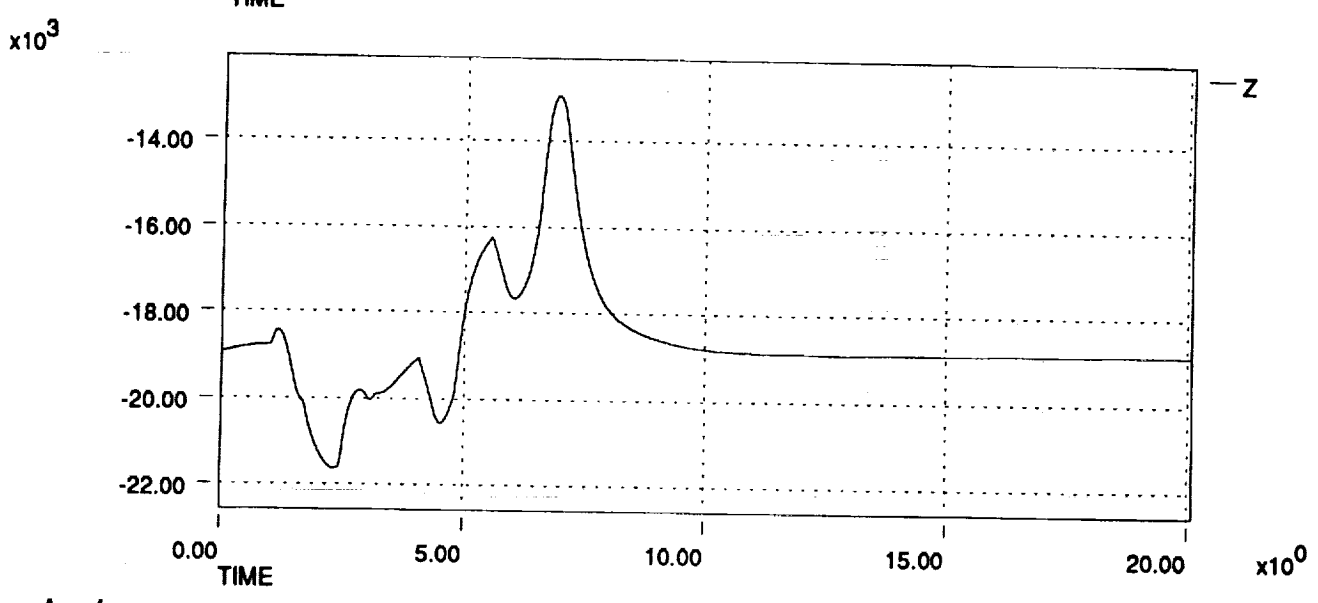
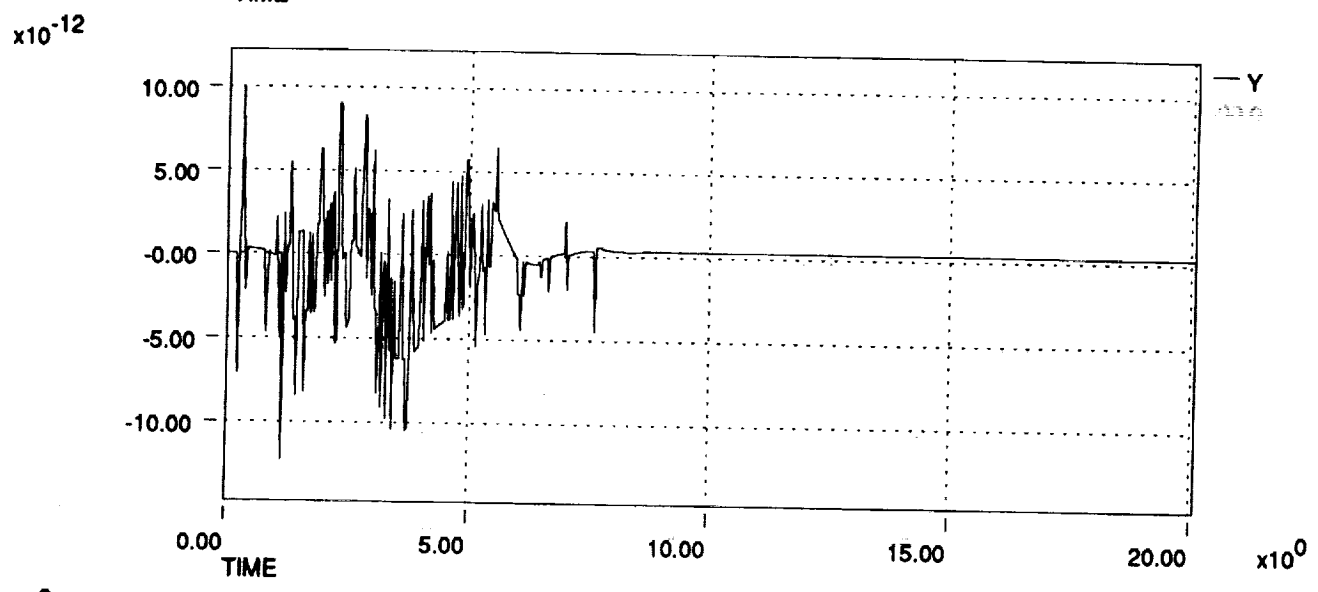
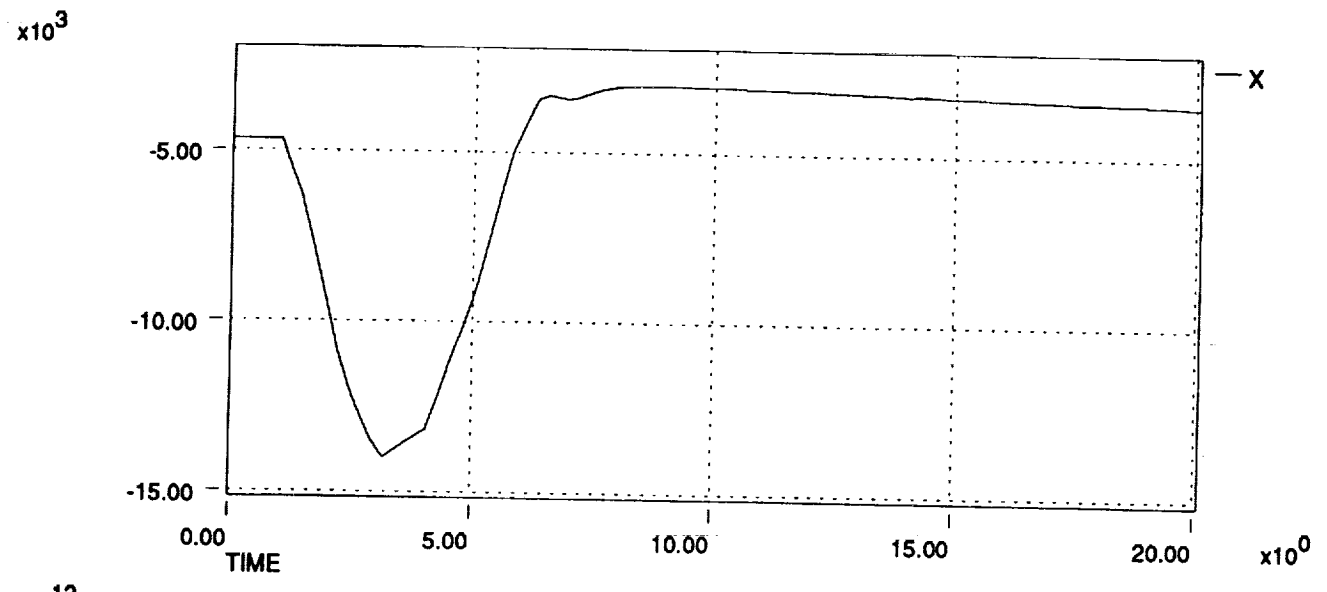

HL-20 Dynamic Check Case Data Plots 911206
Speed Brake Handle Pulse at 300 KEAS, 10,000 ft

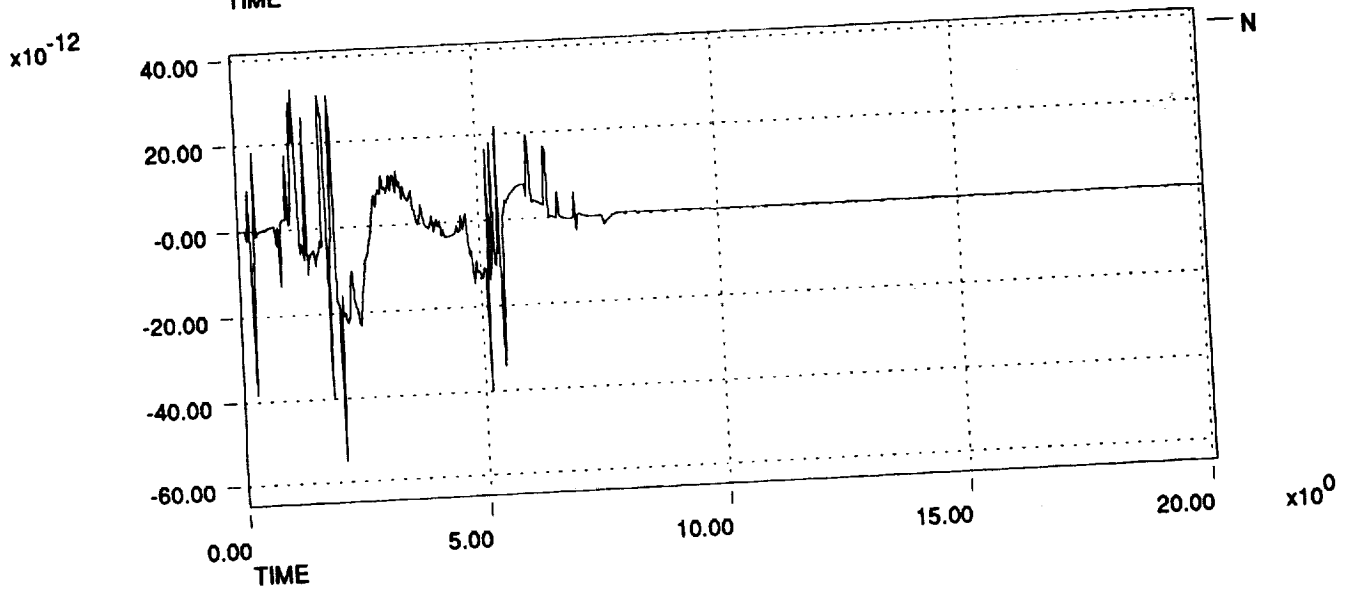
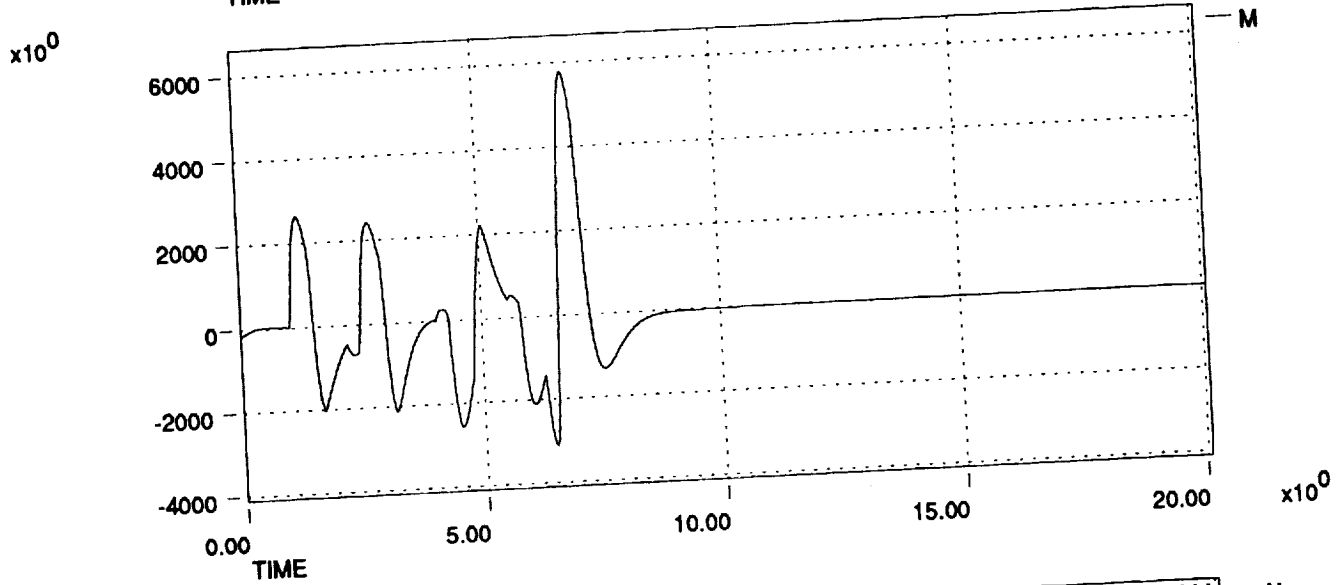
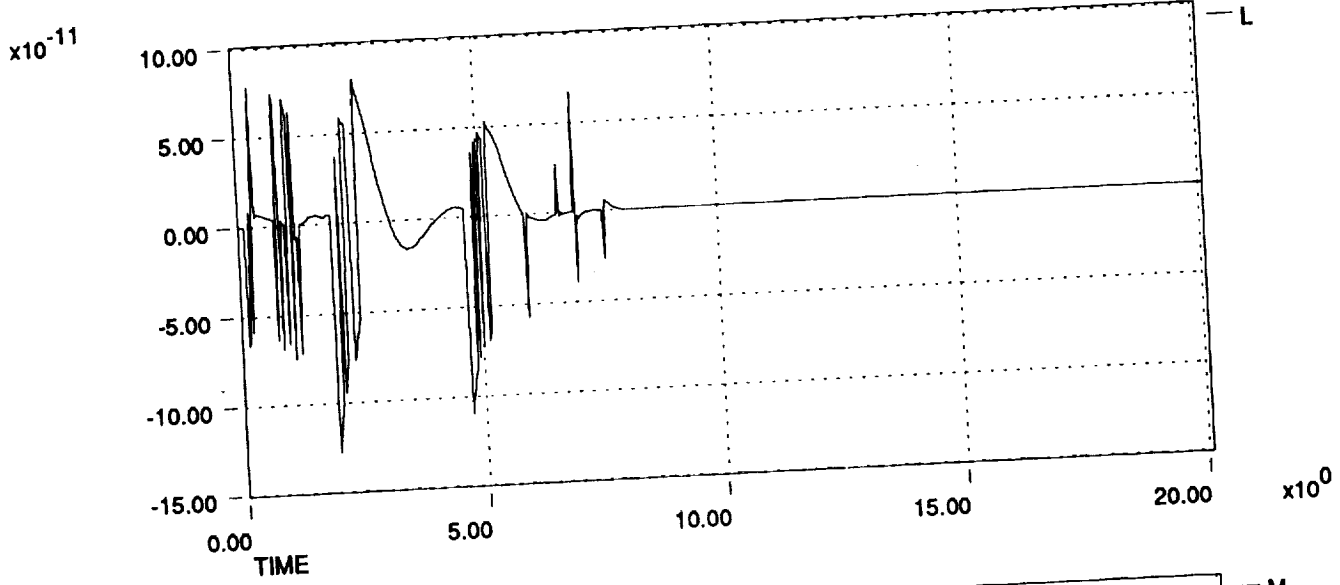

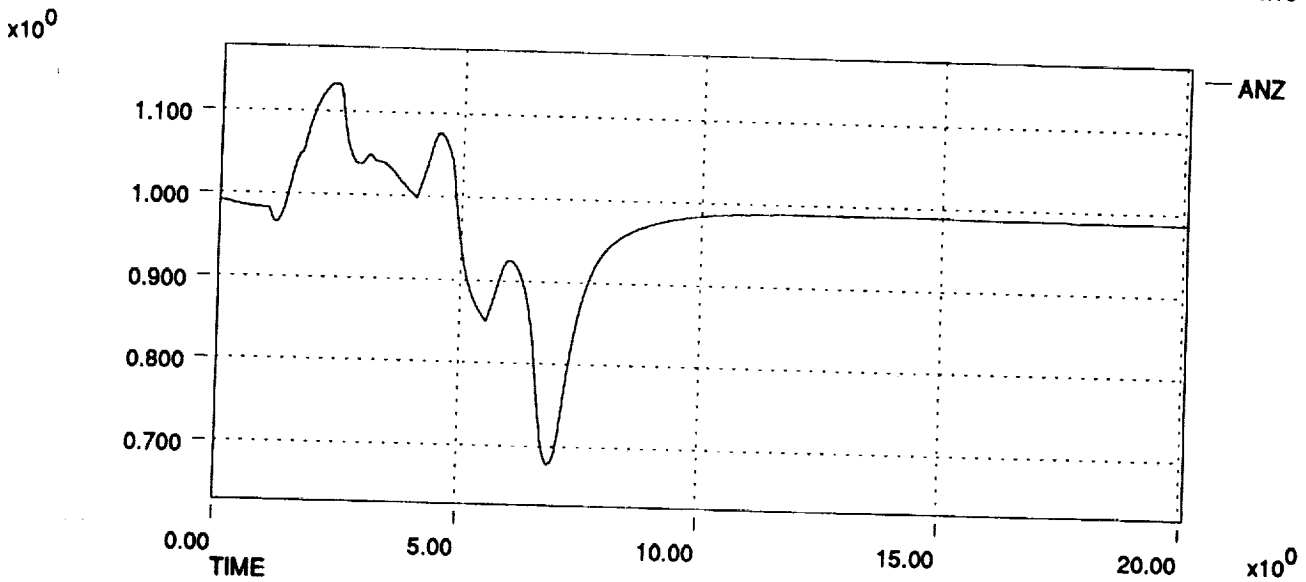
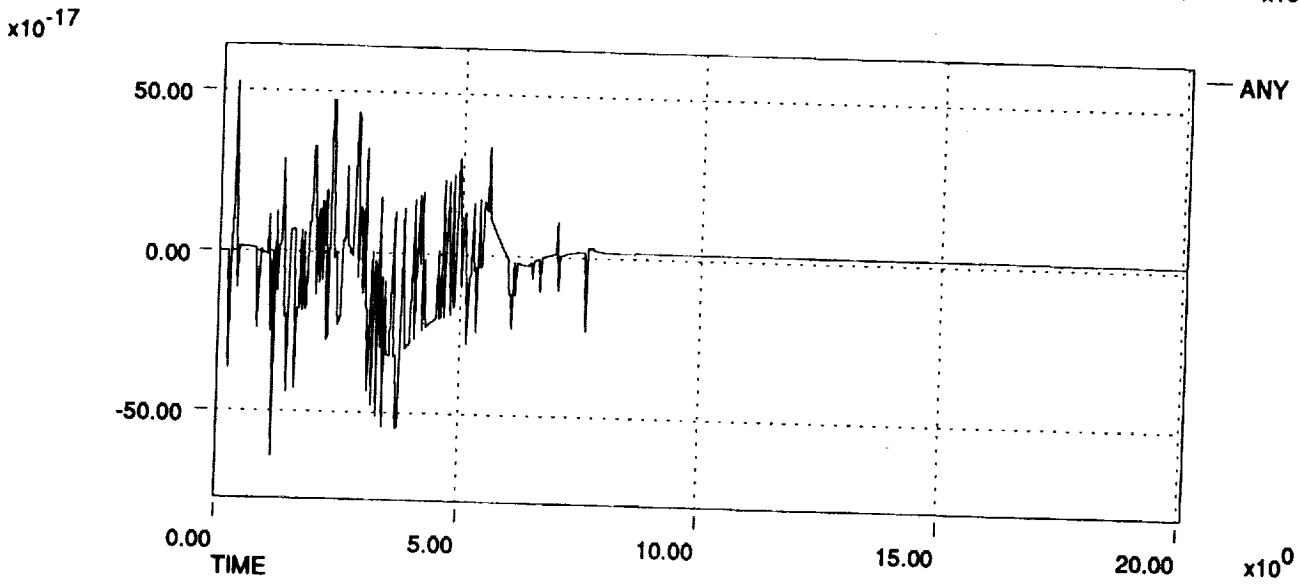
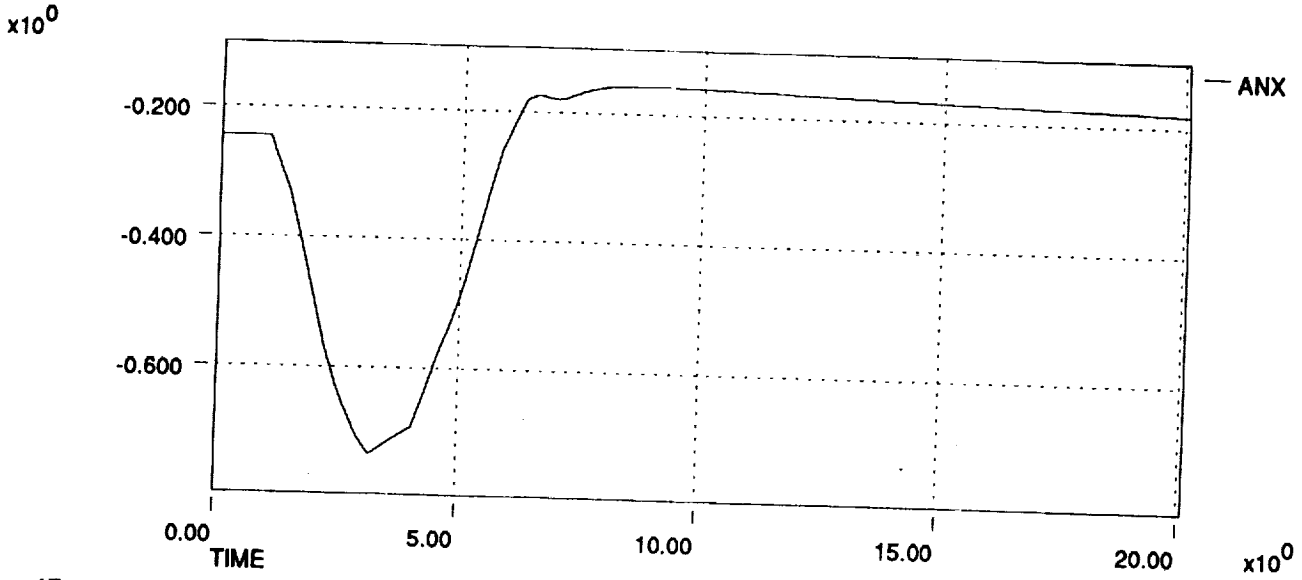

HL-20 Dynamic Check Case Data Plots 911206
Speed Brake Handle Pulse at 300 KEAS, 10,000 ft

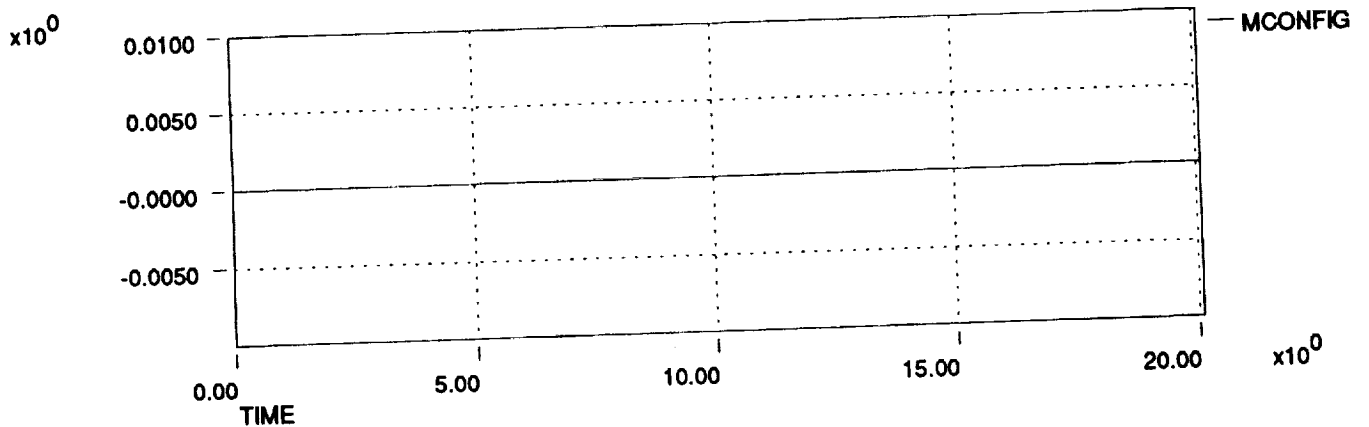
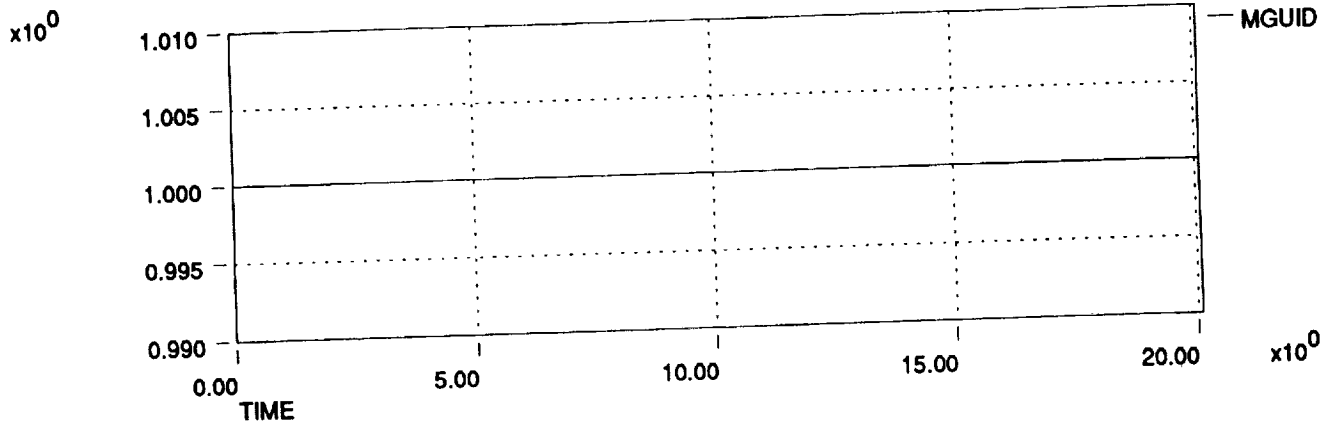
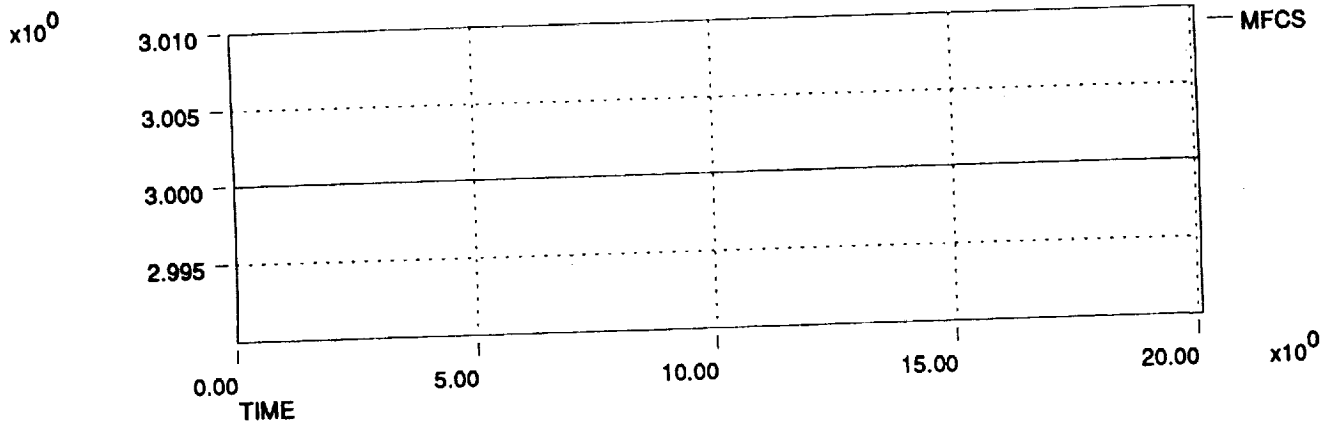
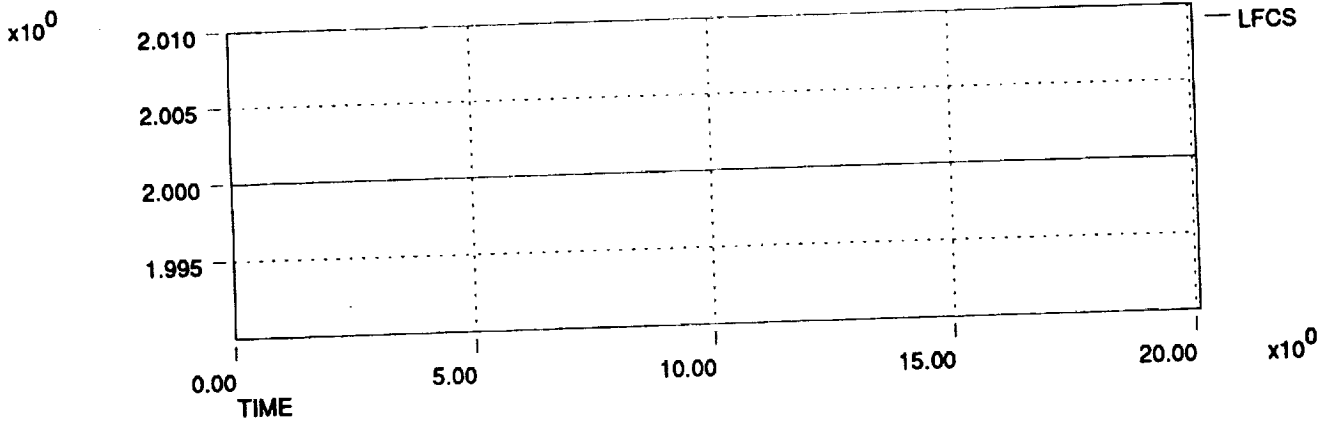

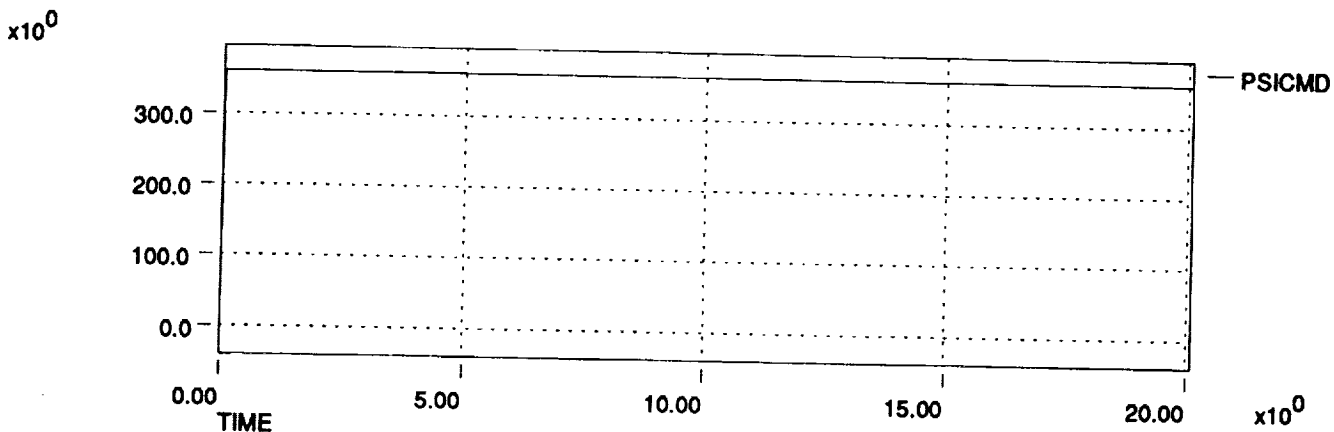
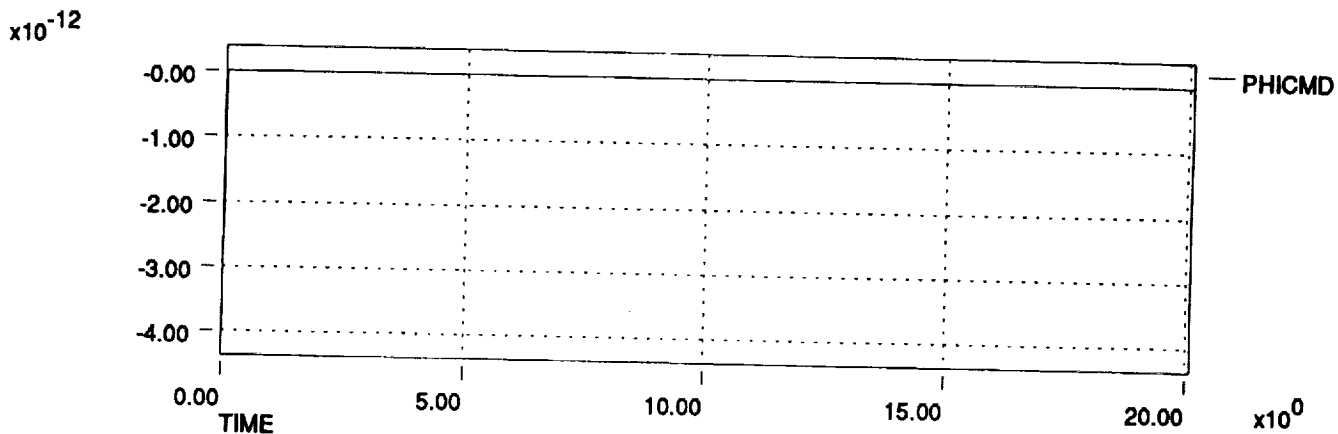
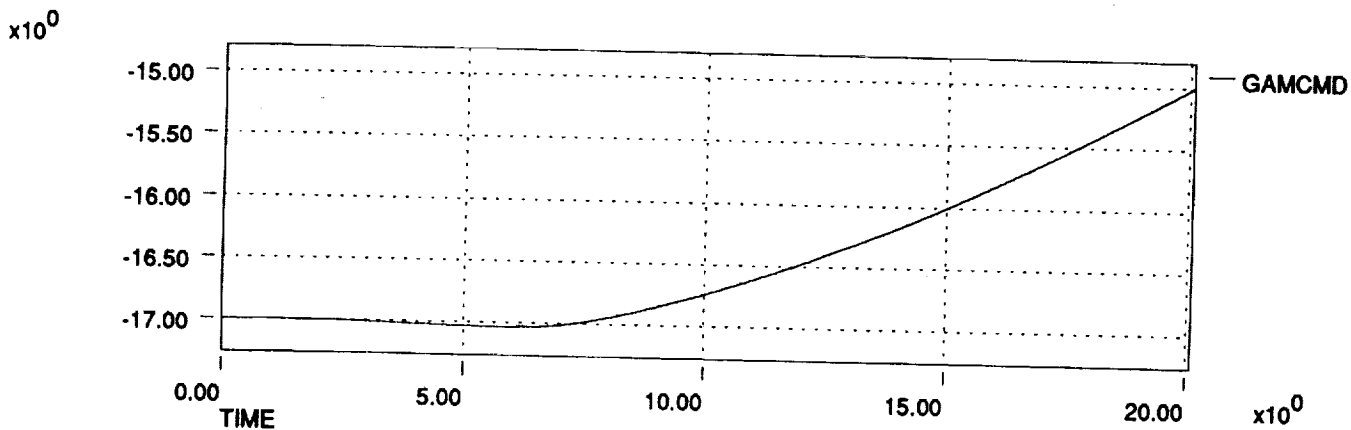
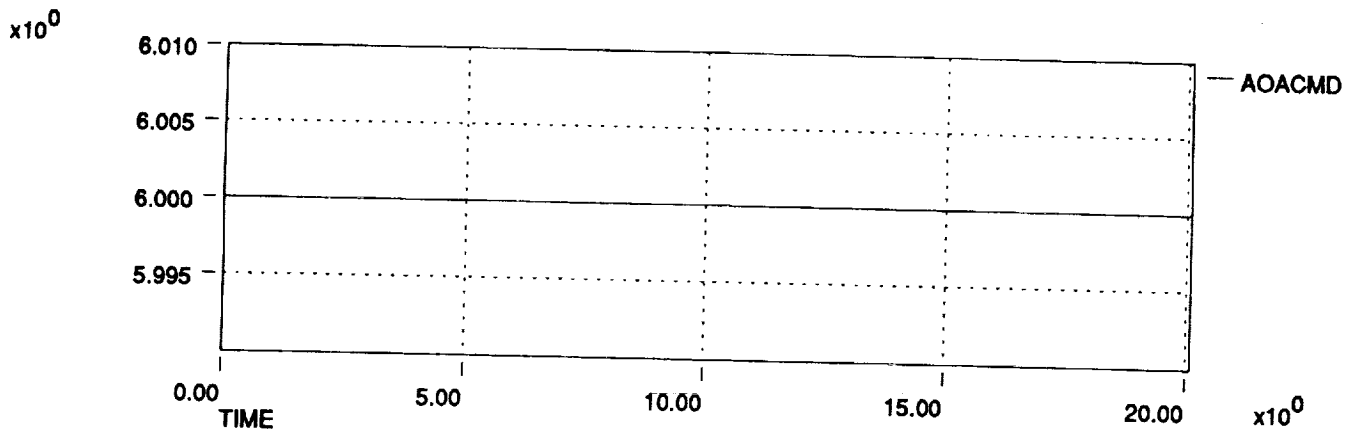

HL-20 Dynamic Check Case Data Plots 911206
Speed Brake Handle Pulse at 300 KEAS, 10,000 ft

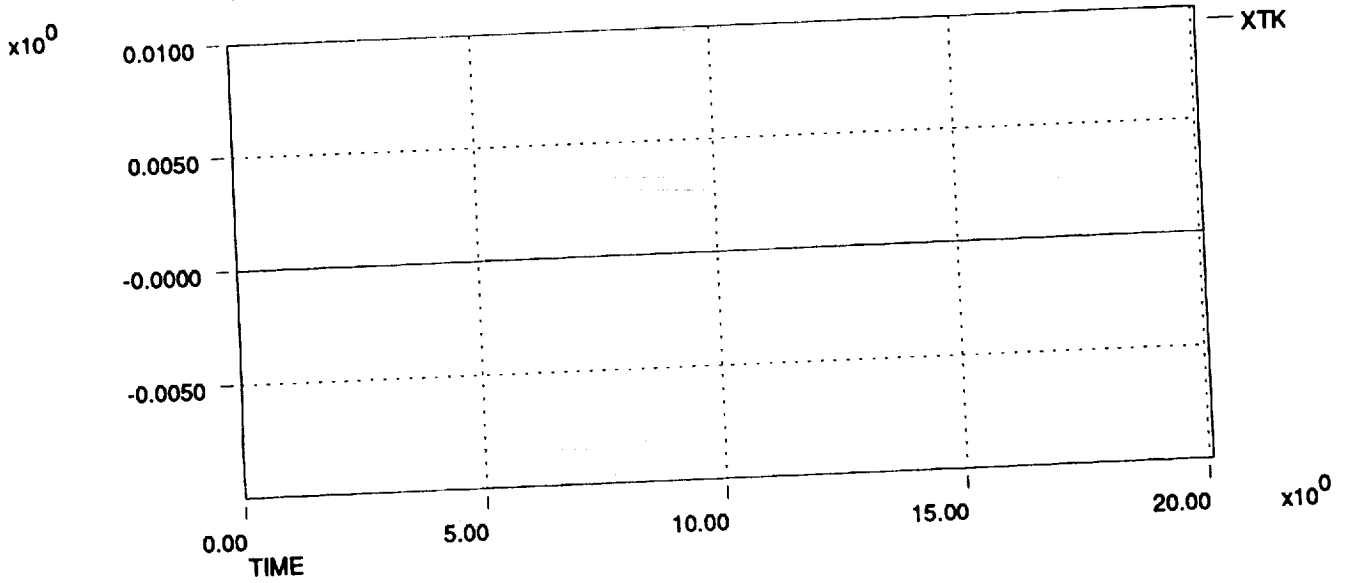
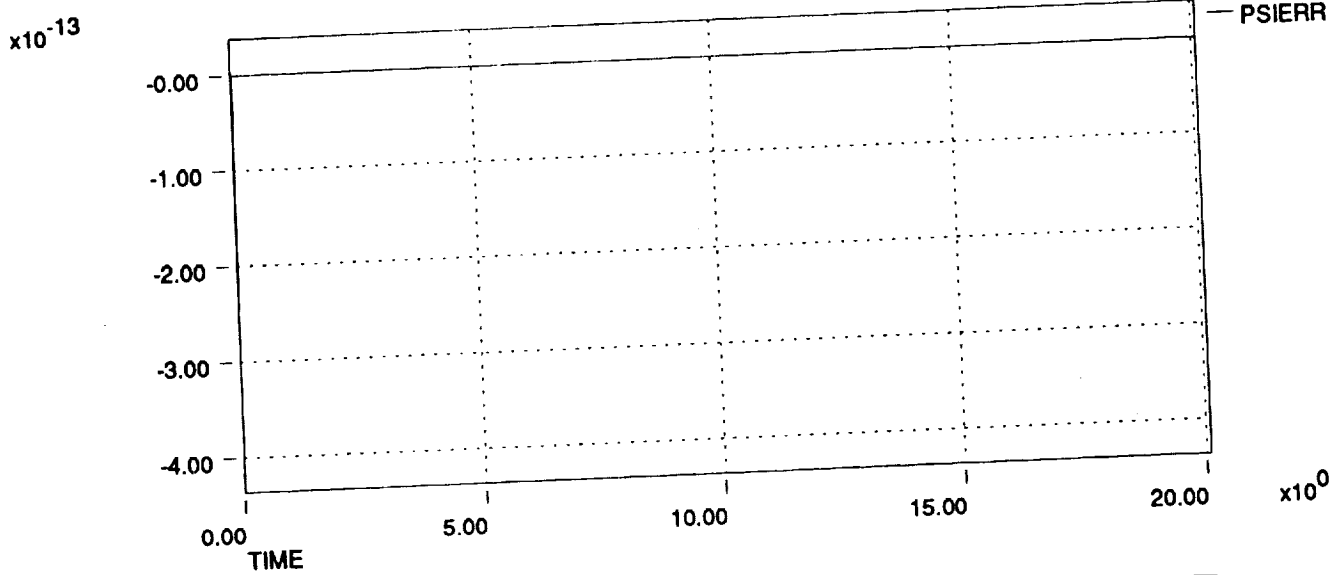
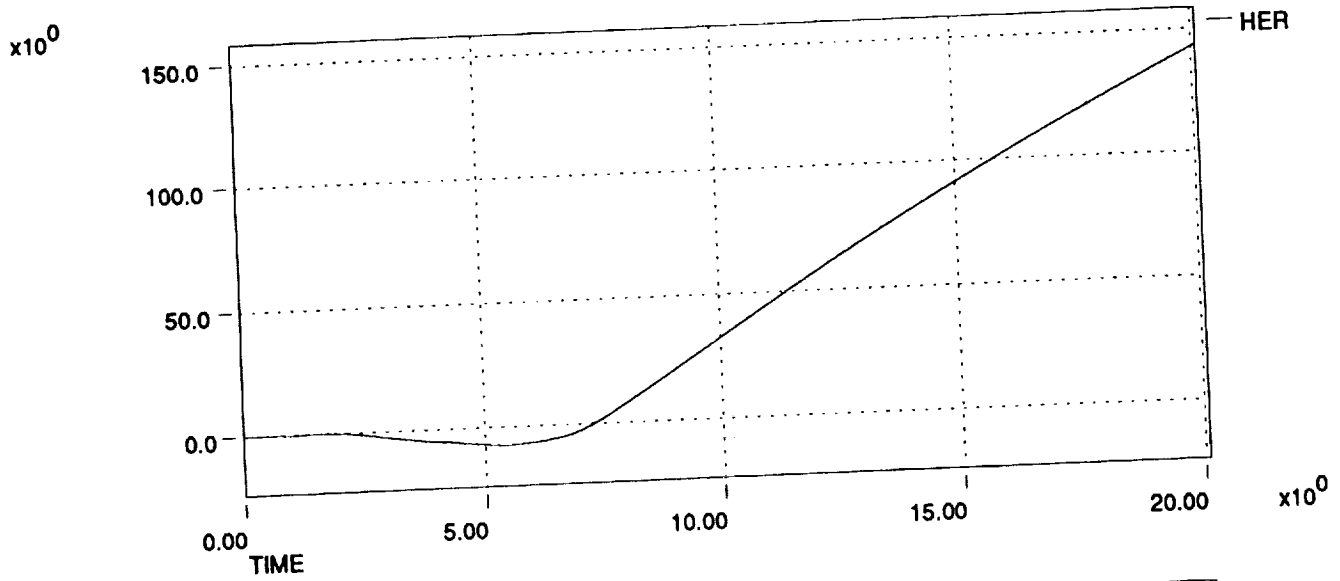

$\times 10^0$

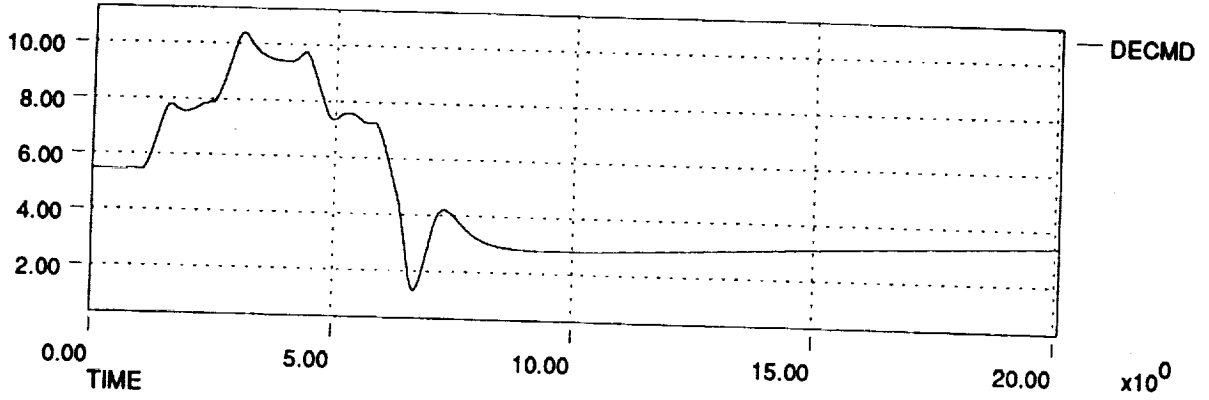

$\times 10^{-14}$

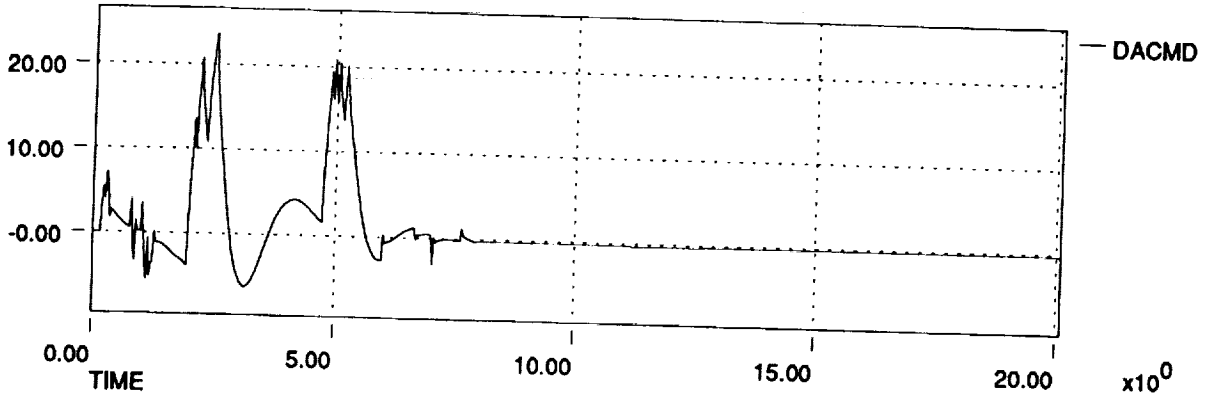

$\times 10^{-15}$

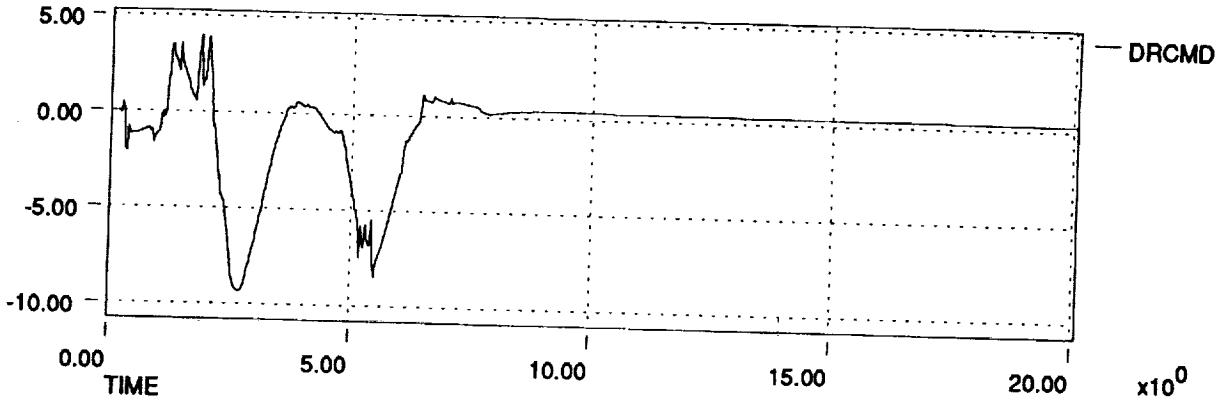

$\times 10^0$

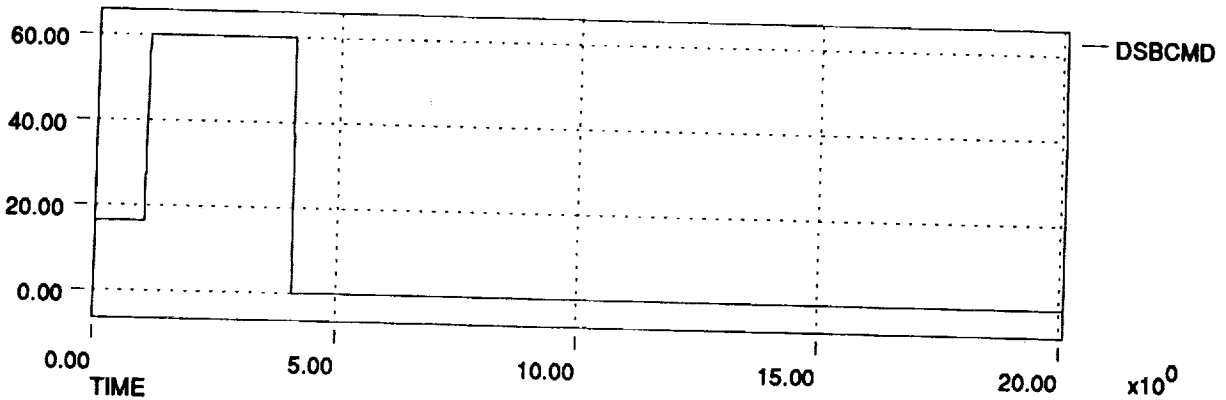

HL-20 Dynamic Check Case Data Plots 911206
Speed Brake Handle Pulse at 300 KEAS, 10,000 ft

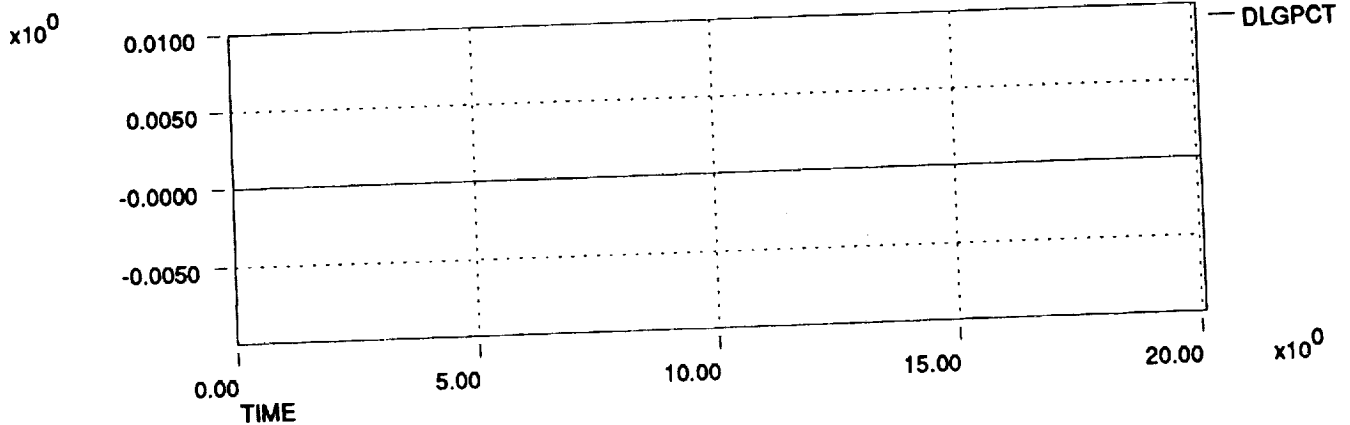
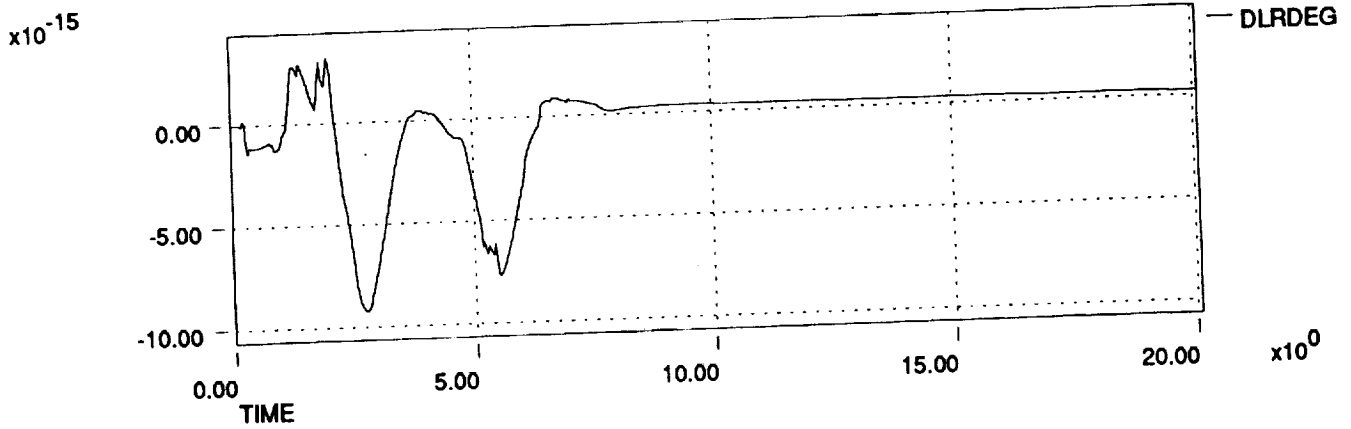
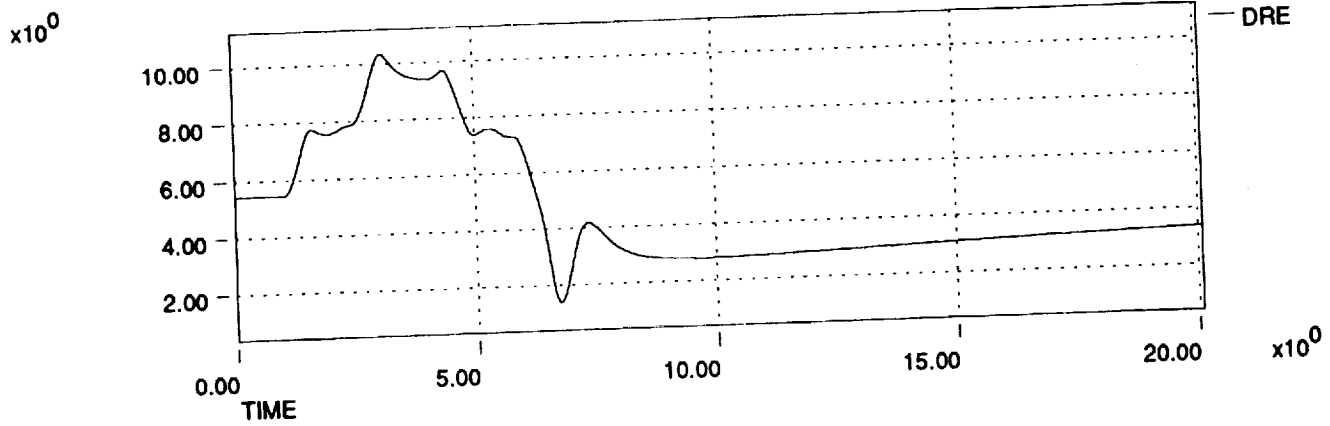
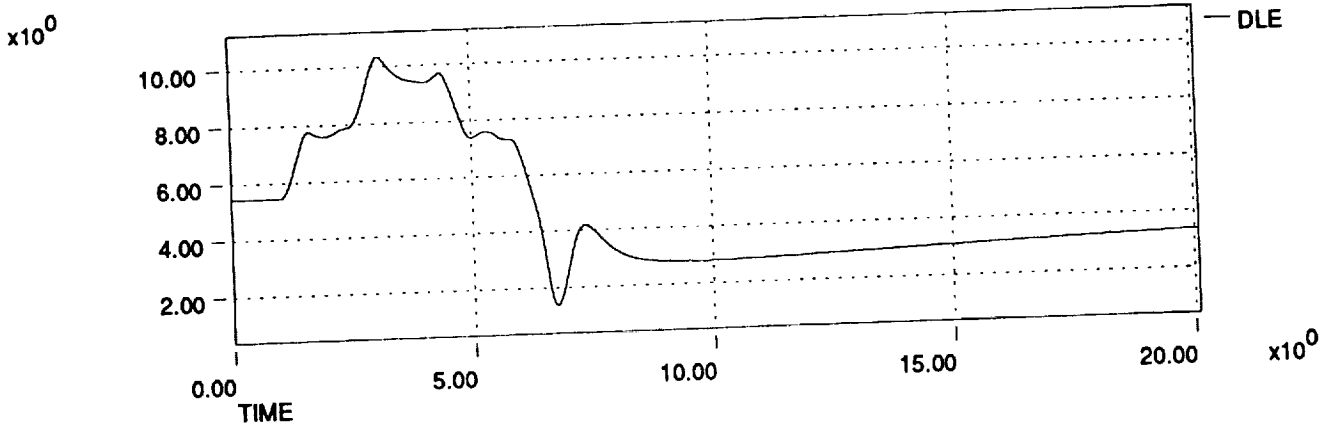

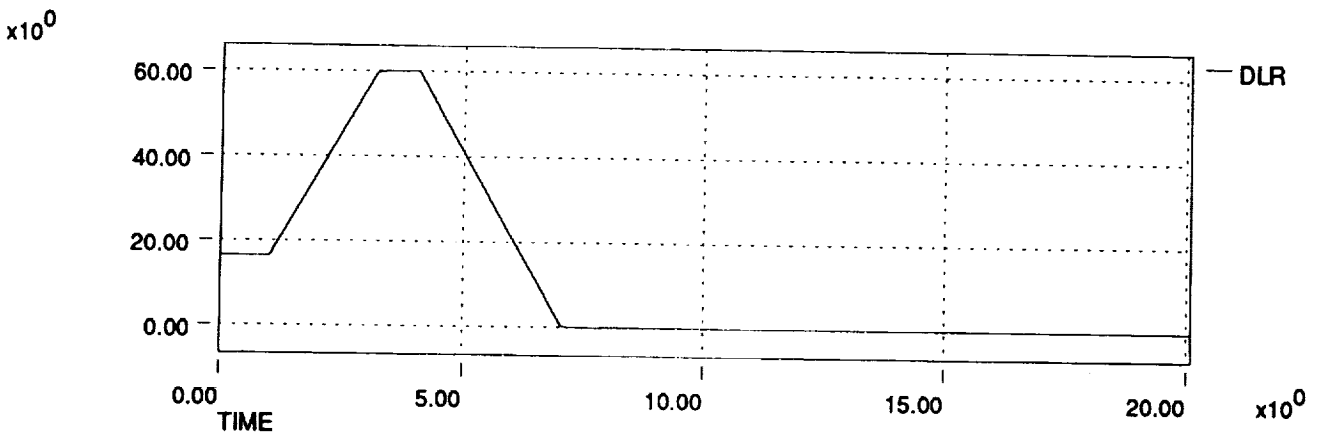
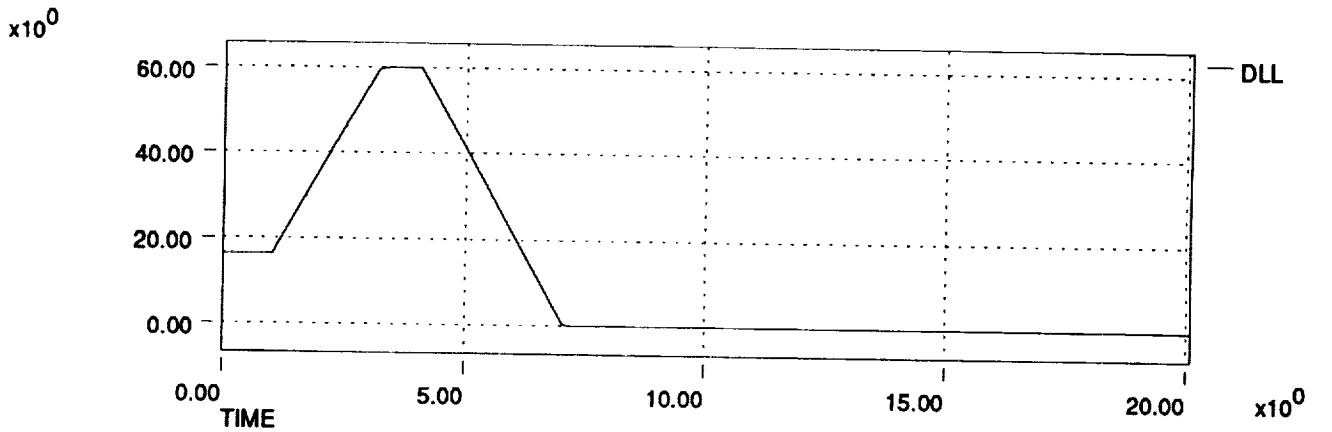
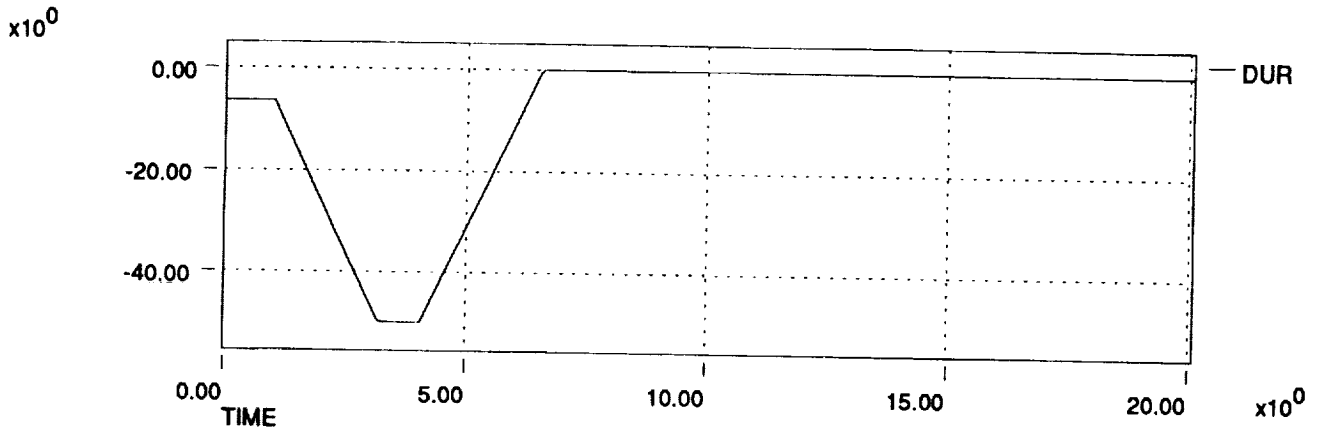
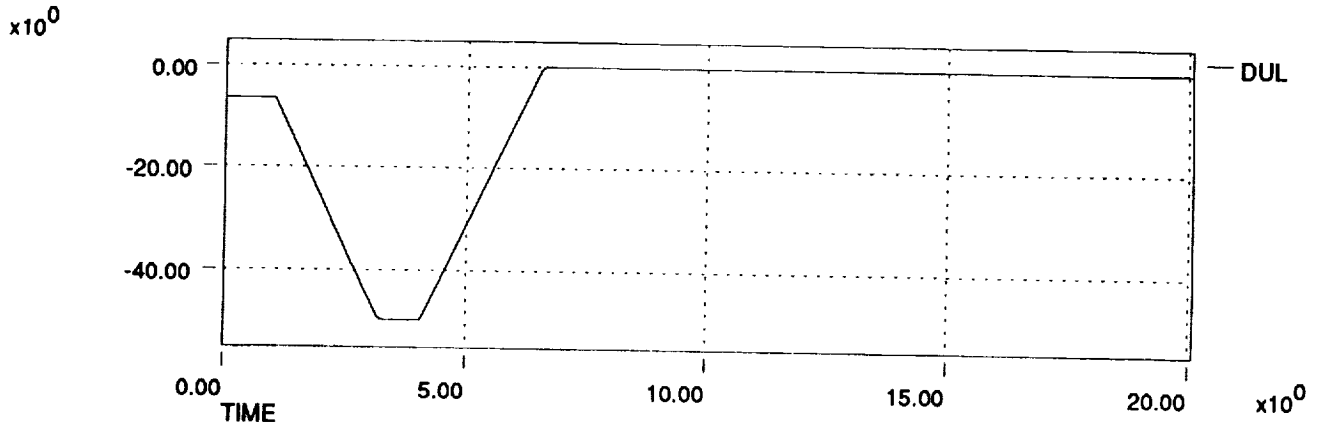

HL-20 Dynamic Check Case Data Plots 911206
Fwd Pitch Stick Pulse at Mach 2 and 58,700 ft

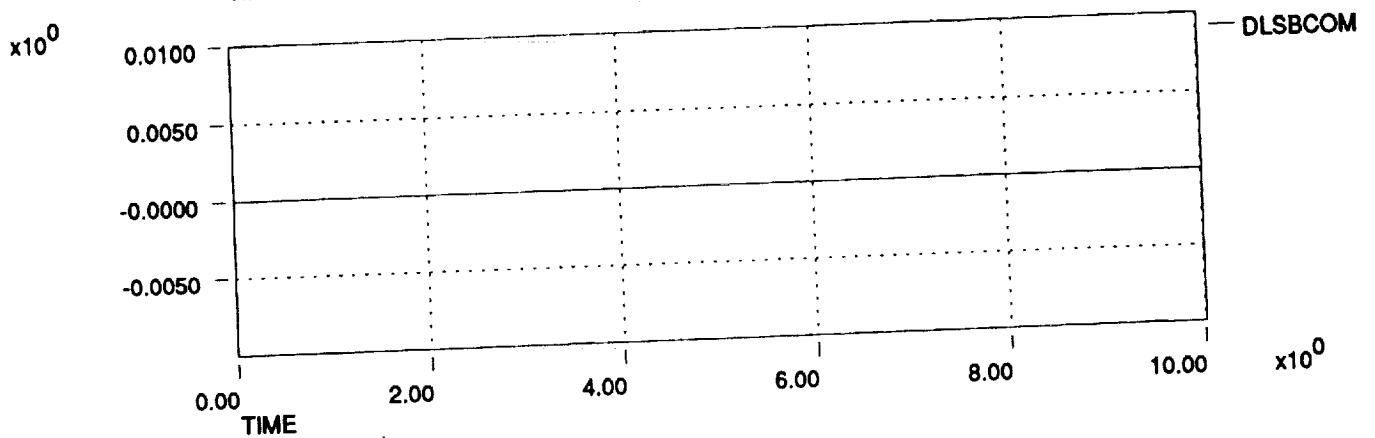
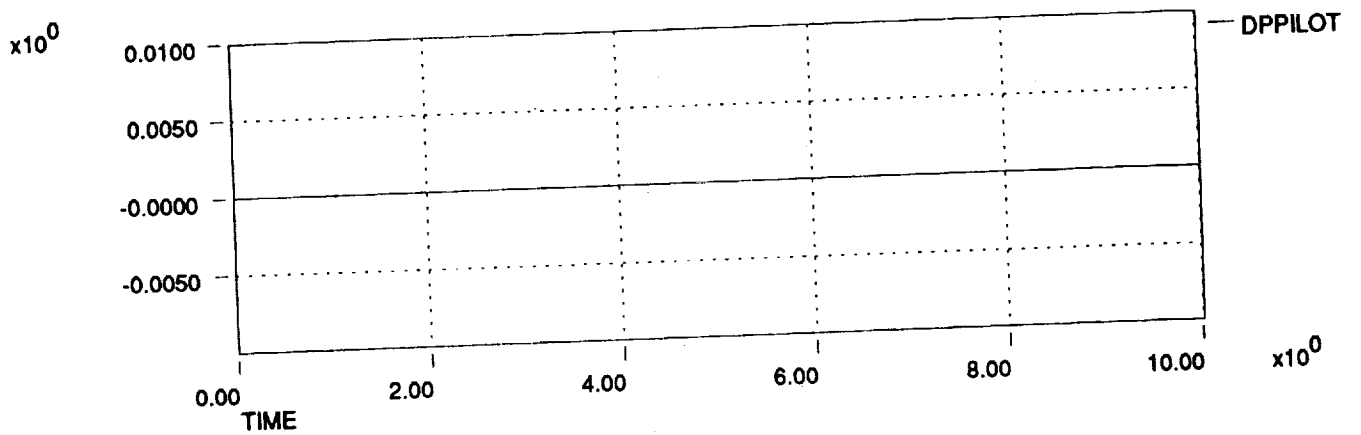
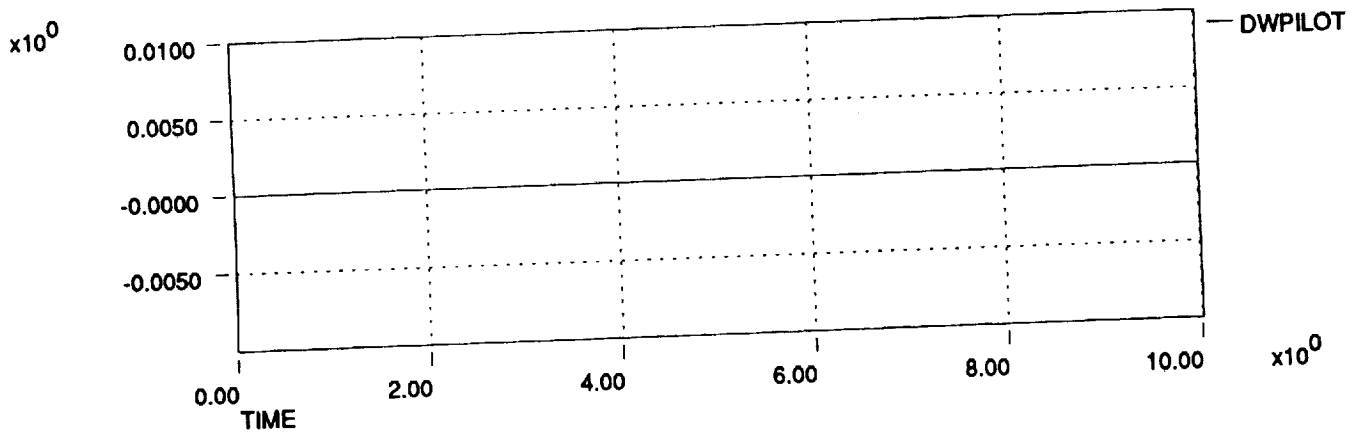
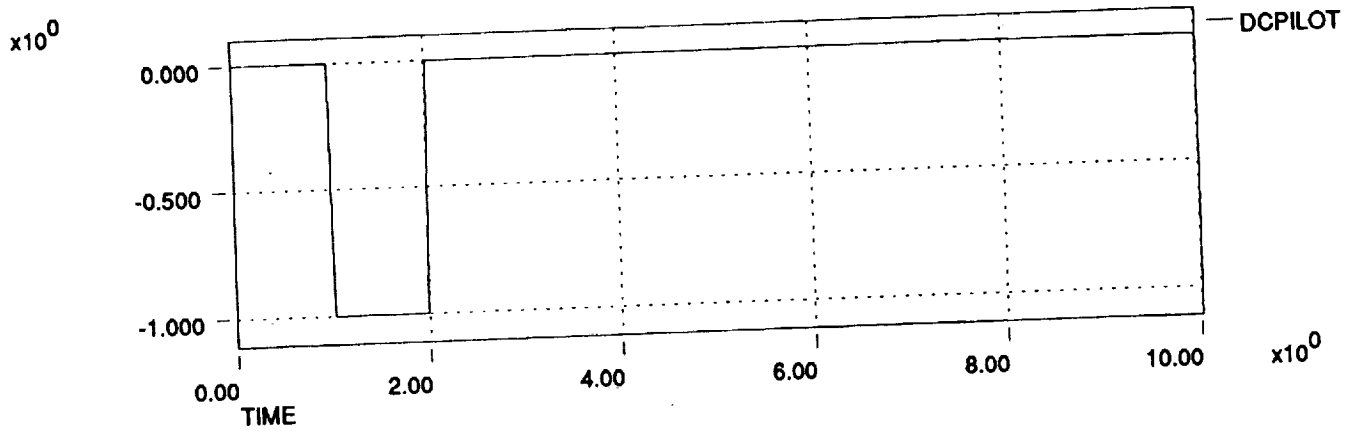

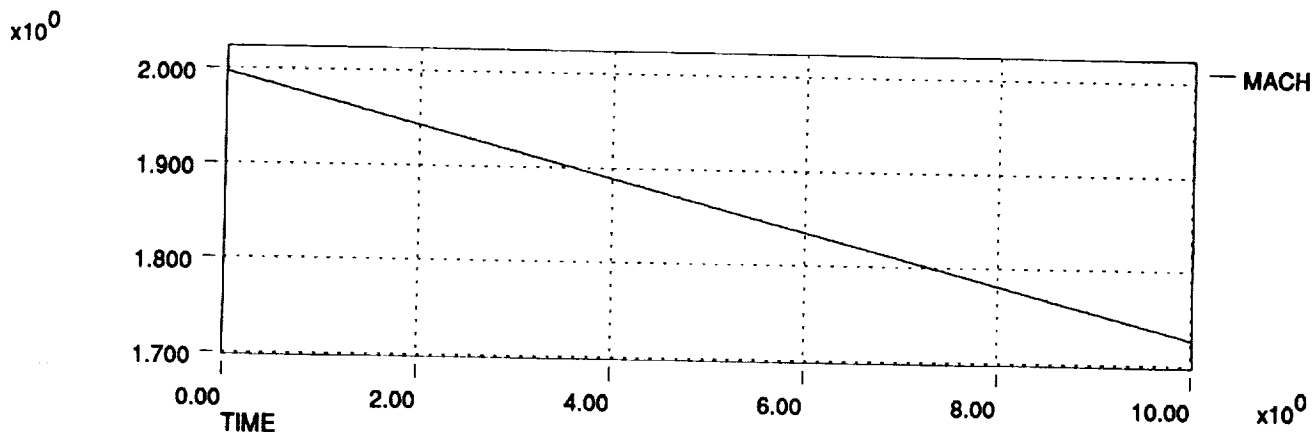
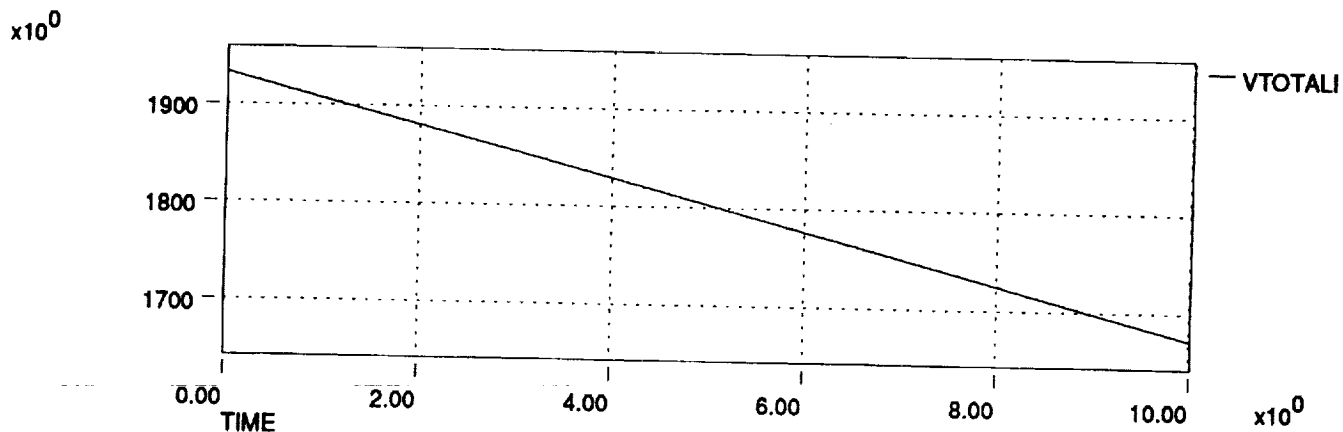
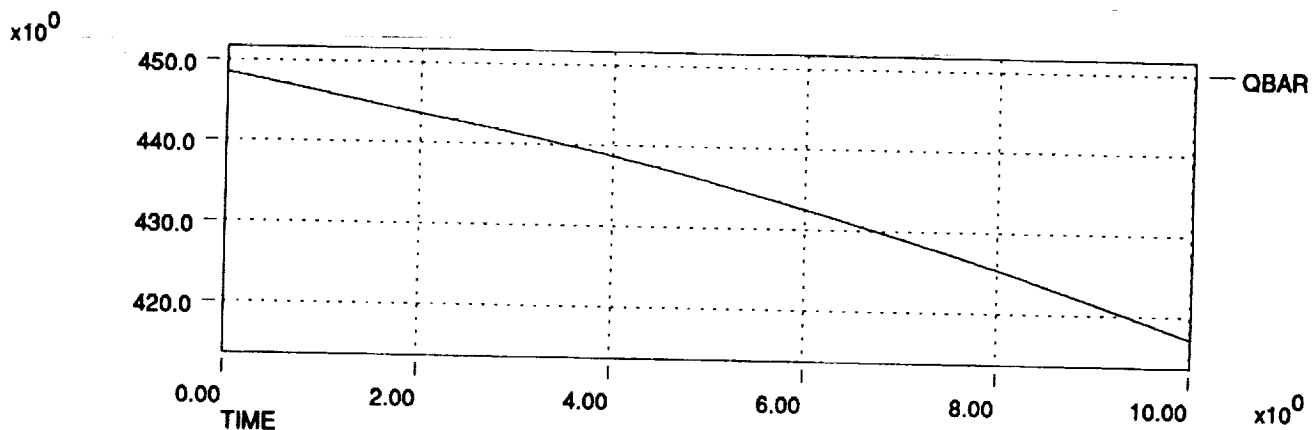
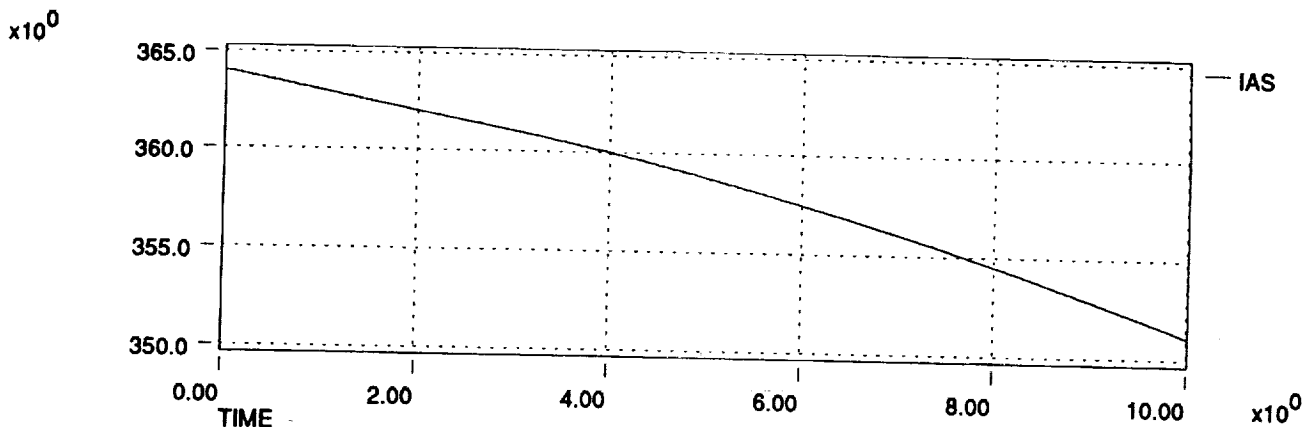

HL-20 Dynamic Check Case Data Plots 911206
Fwd Pitch Stick Pulse at Mach 2 and 58,700 ft

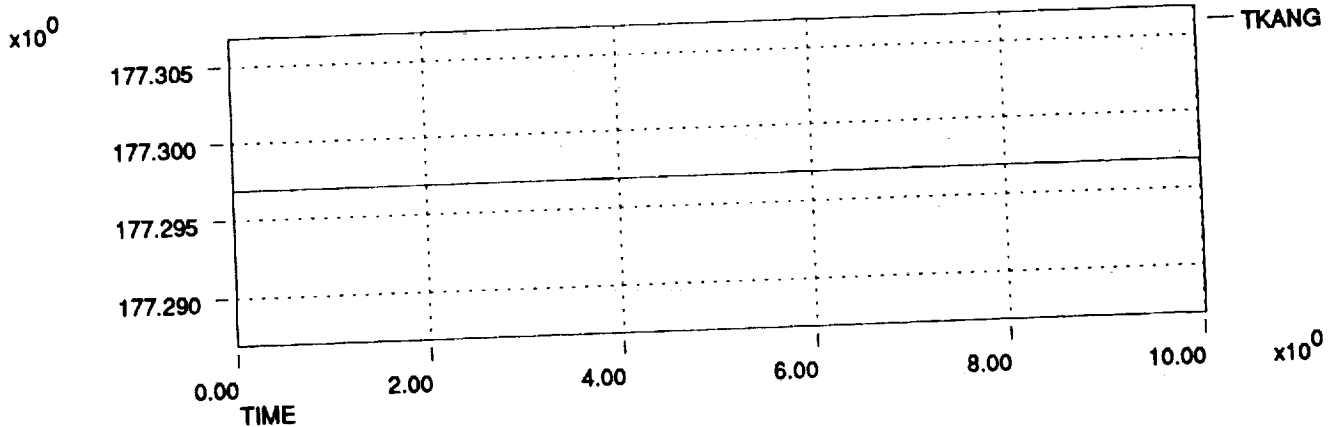
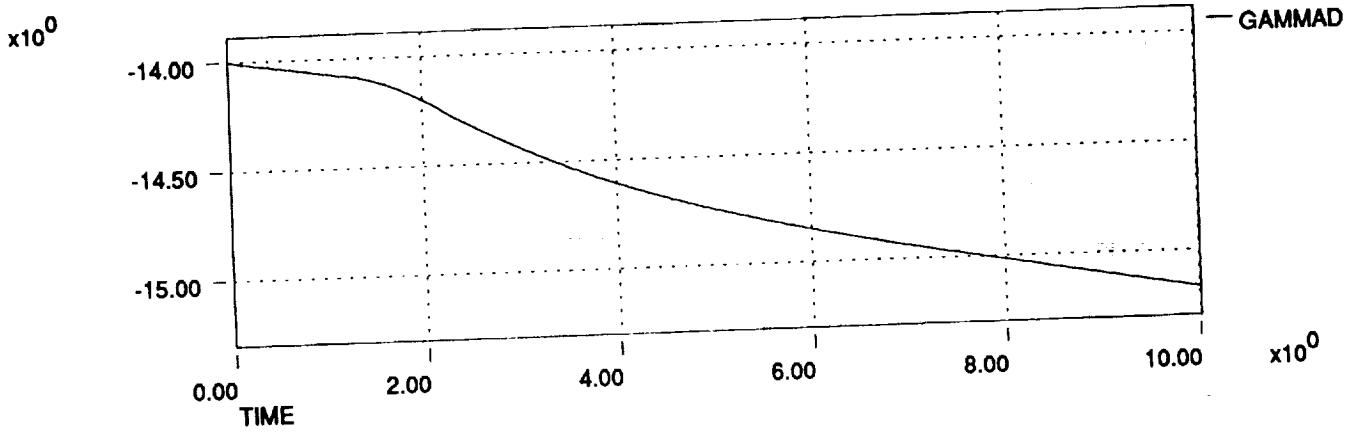
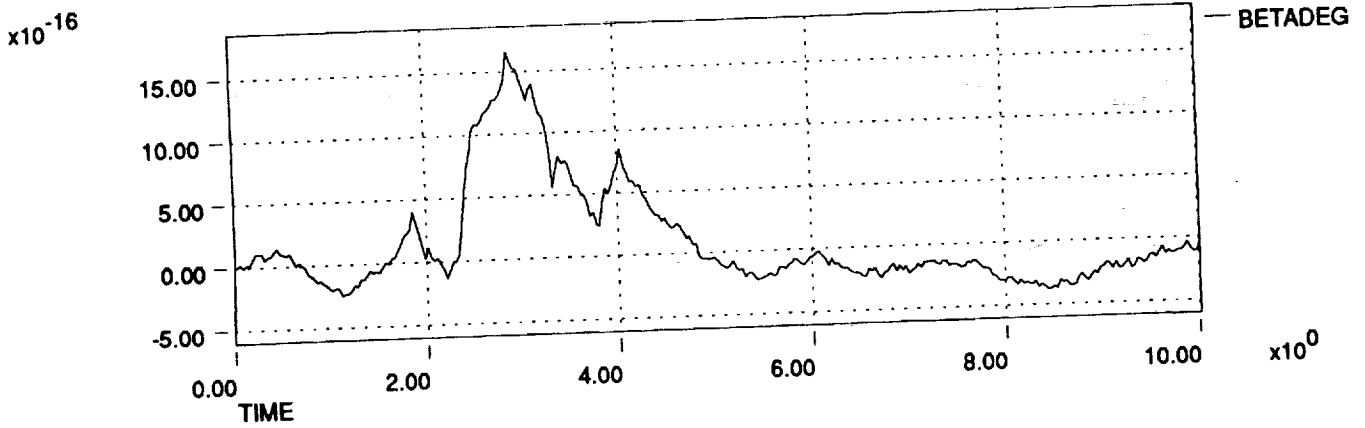
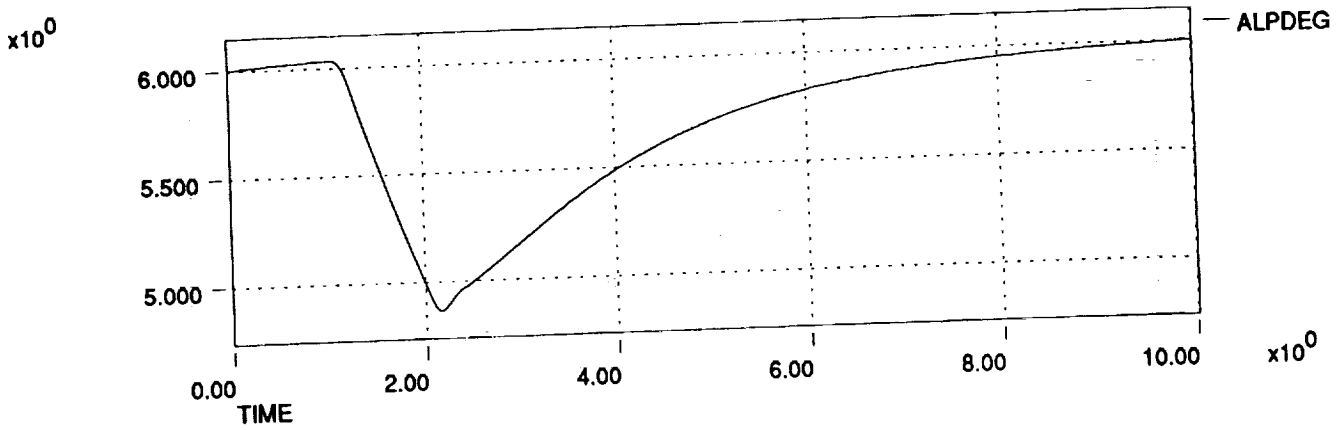

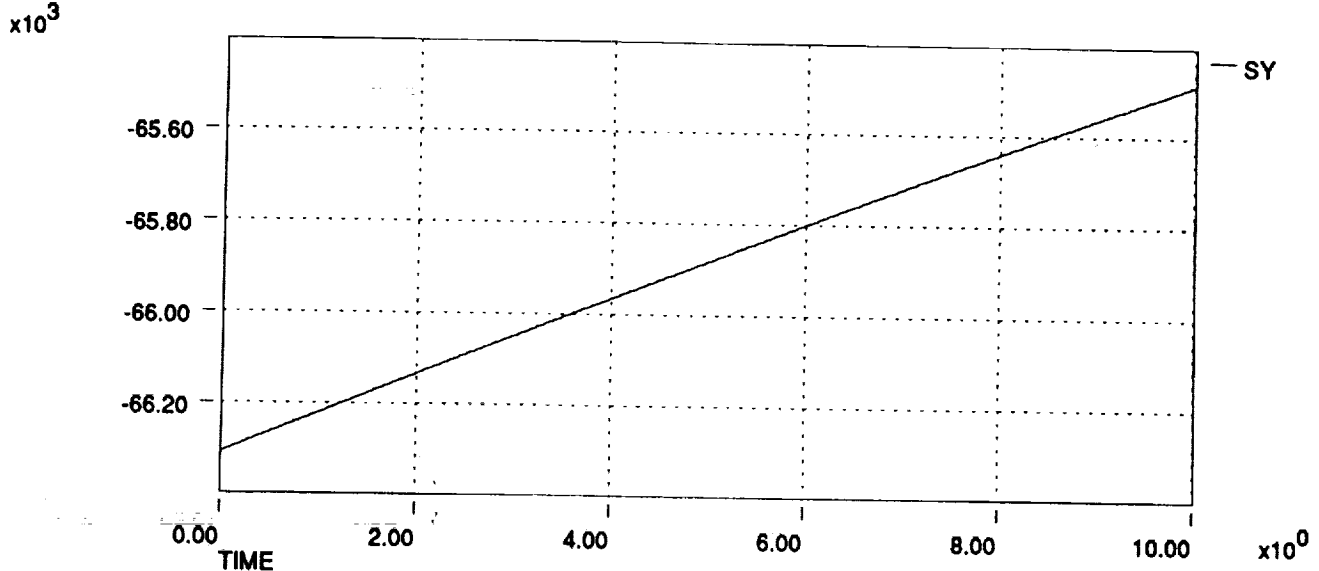
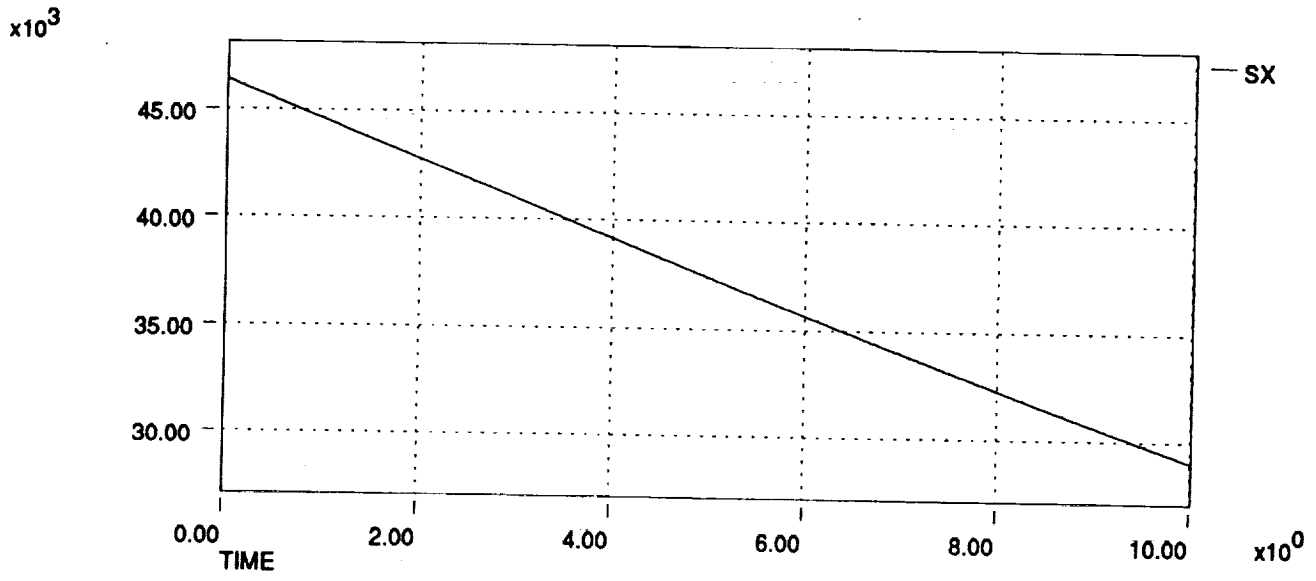
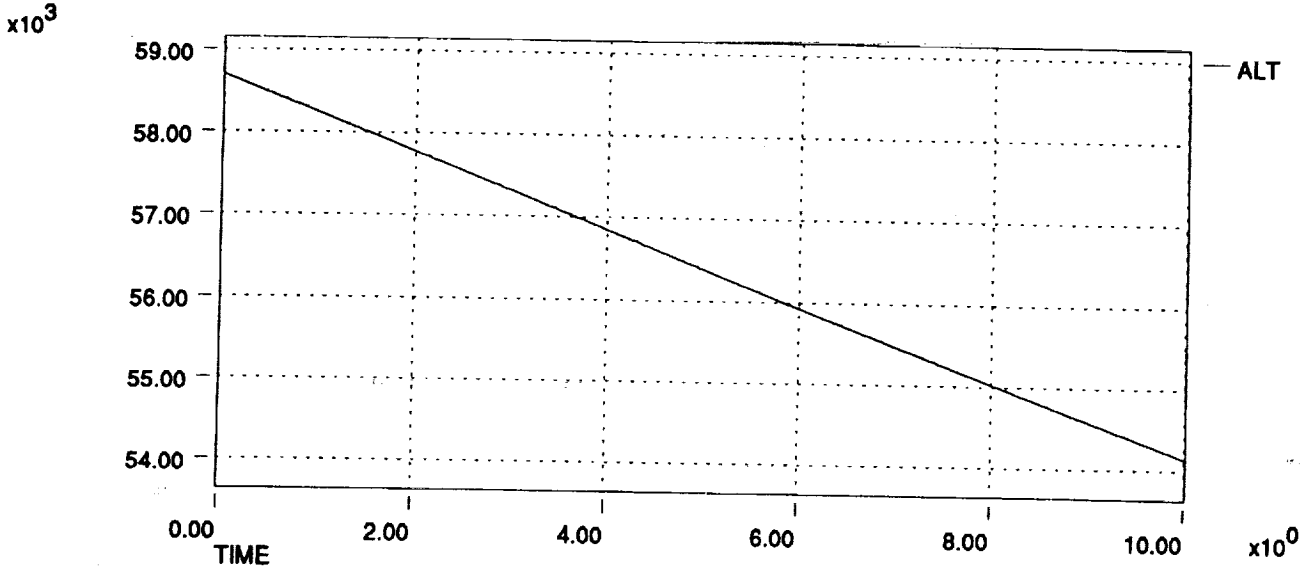

HL-20 Dynamic Check Case Data Plots 911206
Fwd Pitch Stick Pulse at Mach 2 and 58,700 ft

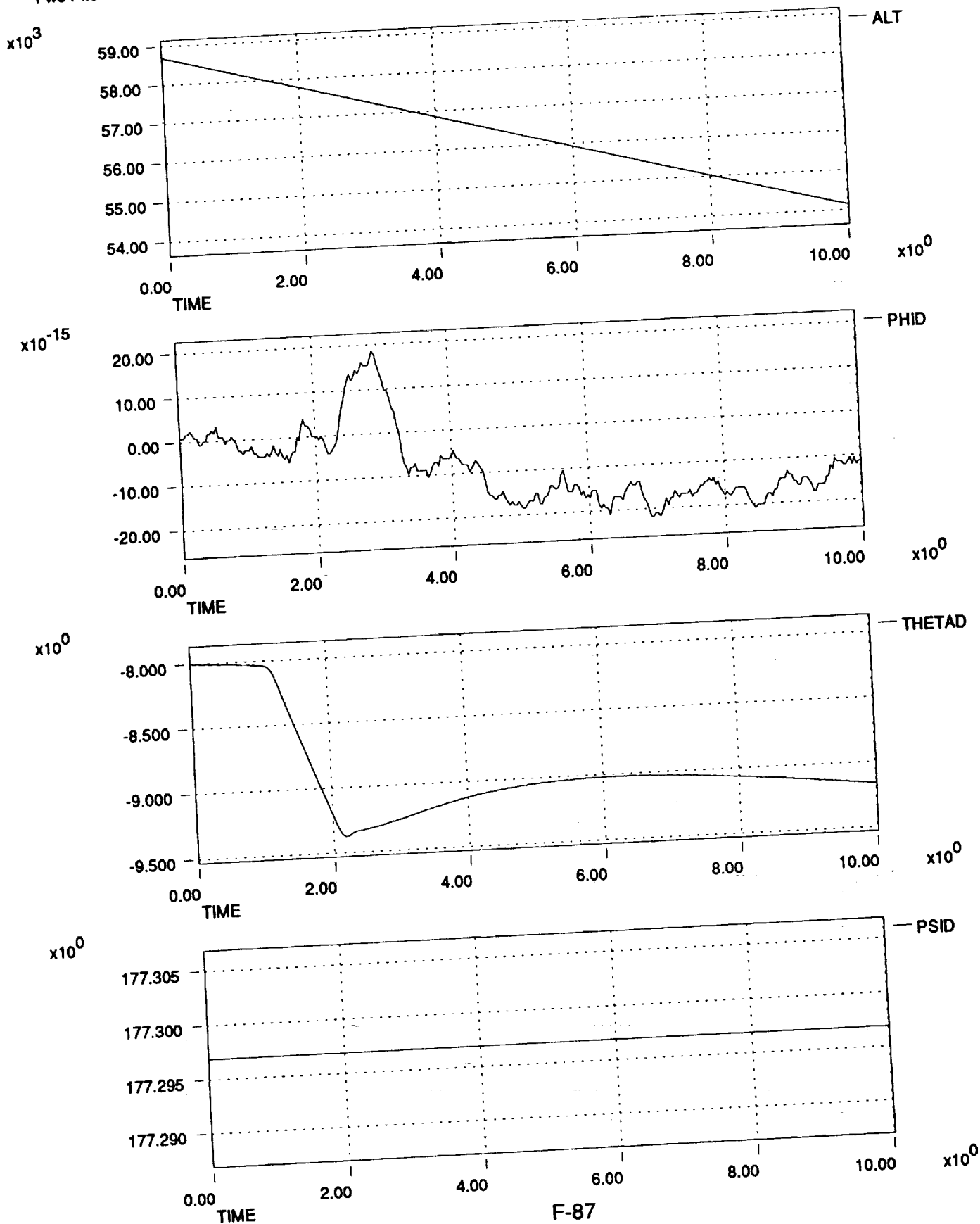

F-87

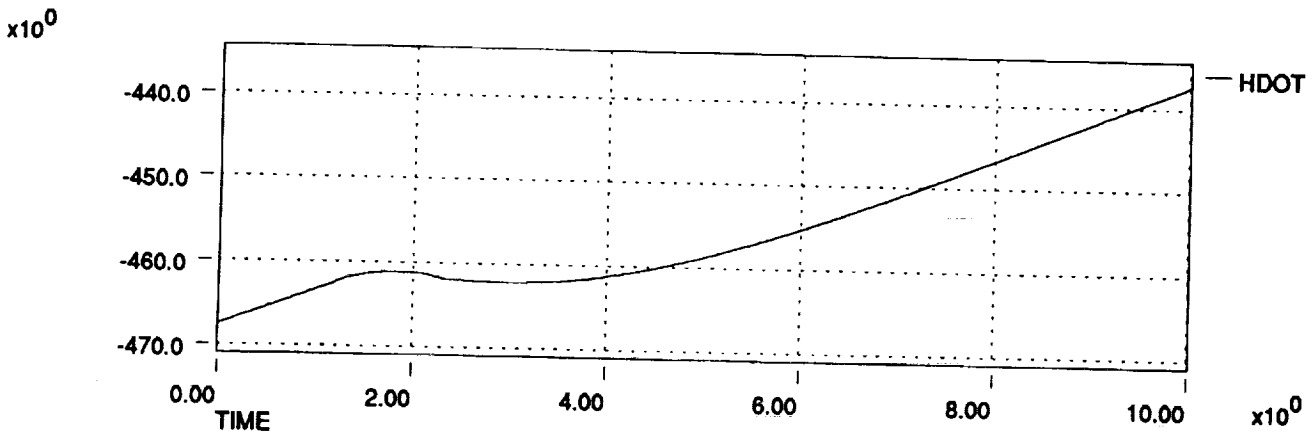
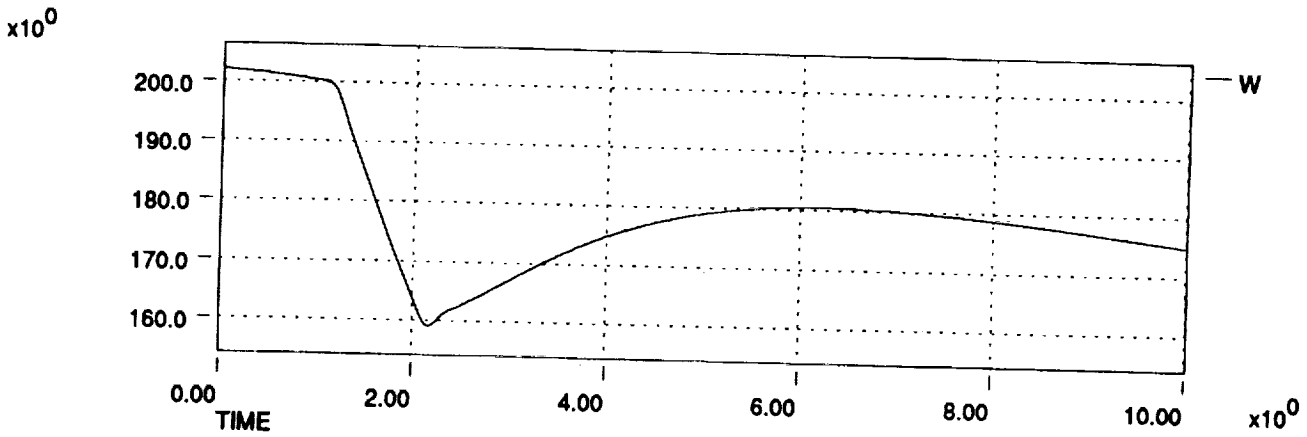
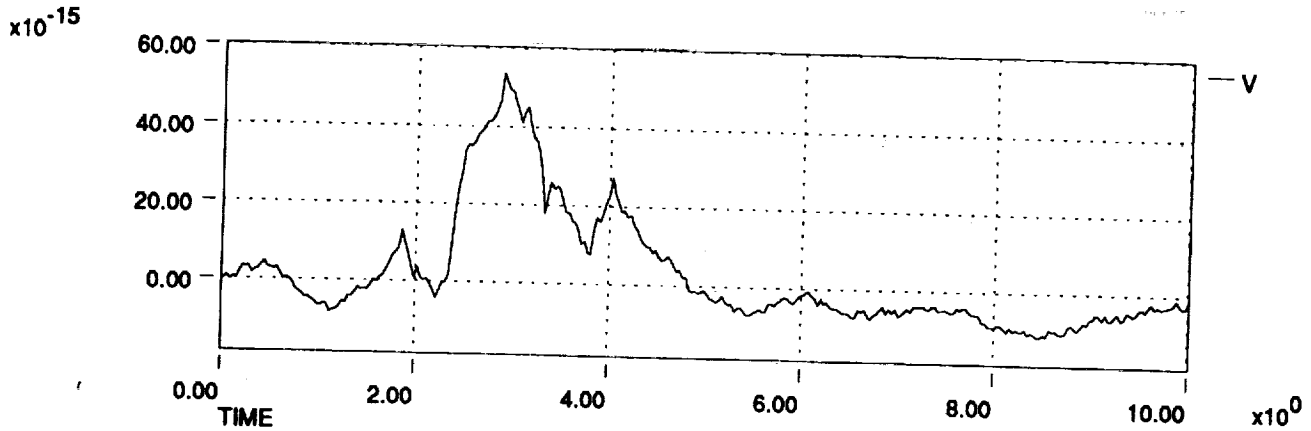
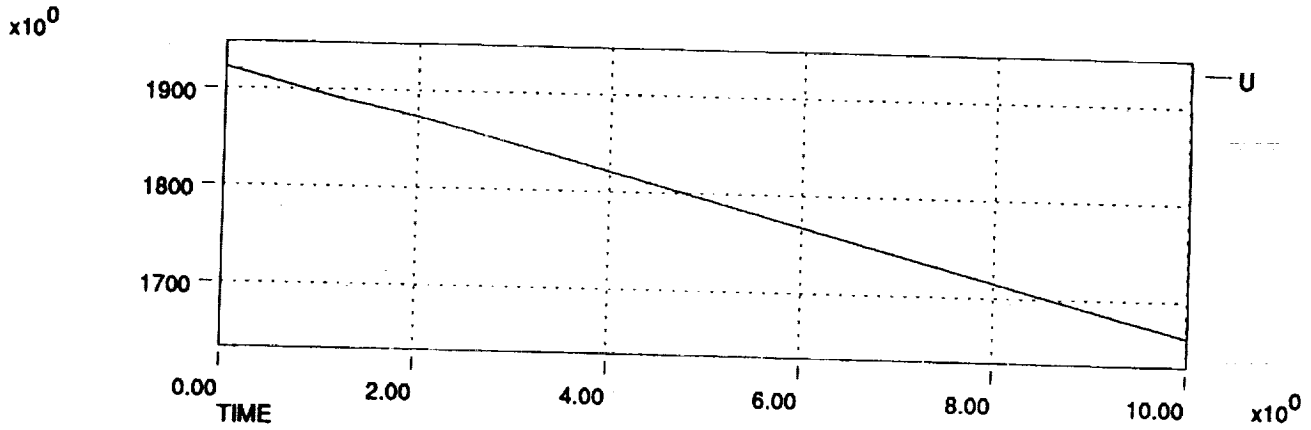

HL-20 Dynamic Check Case Data Plots 911206
Fwd Pitch Stick Pulse at Mach 2 and 58,700 ft

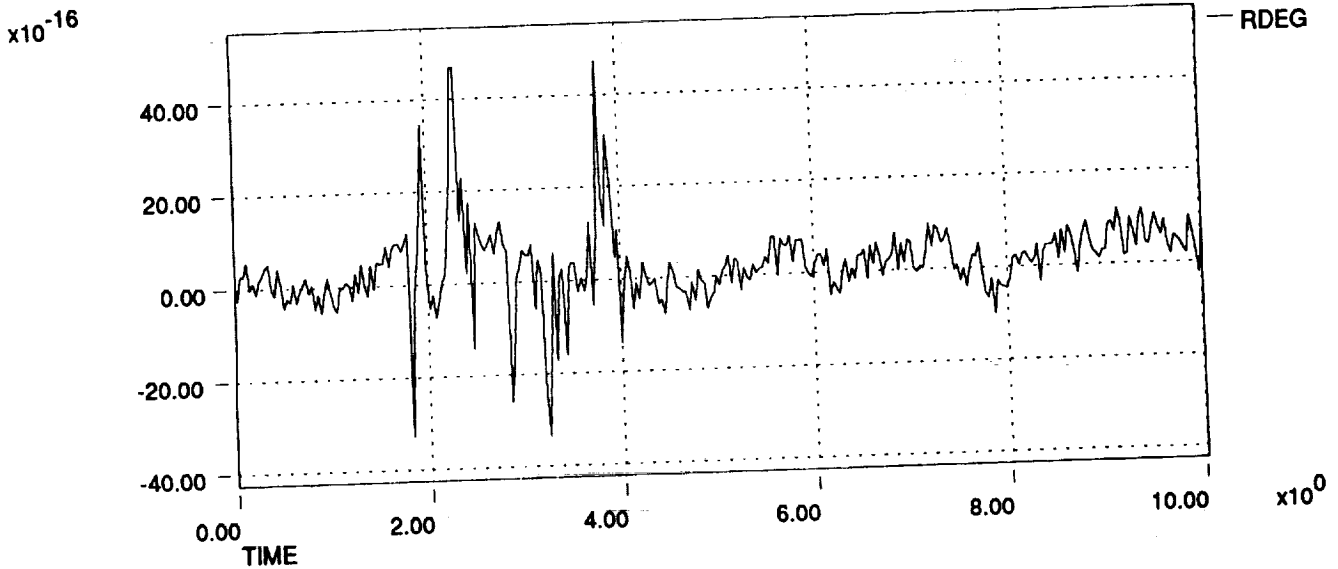
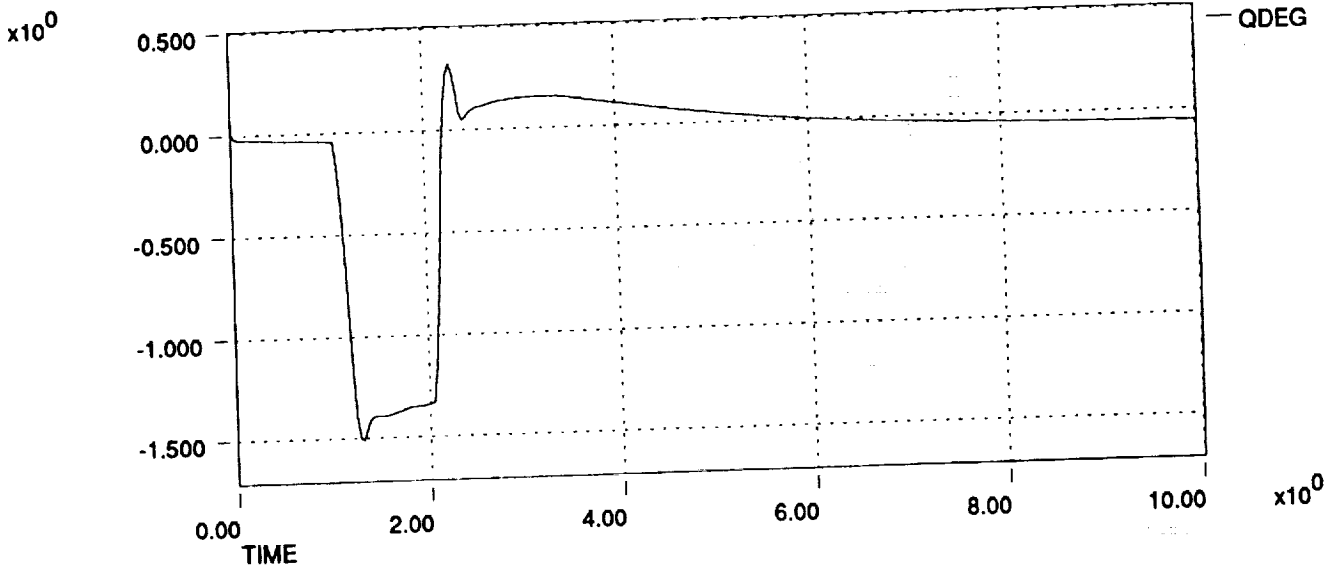
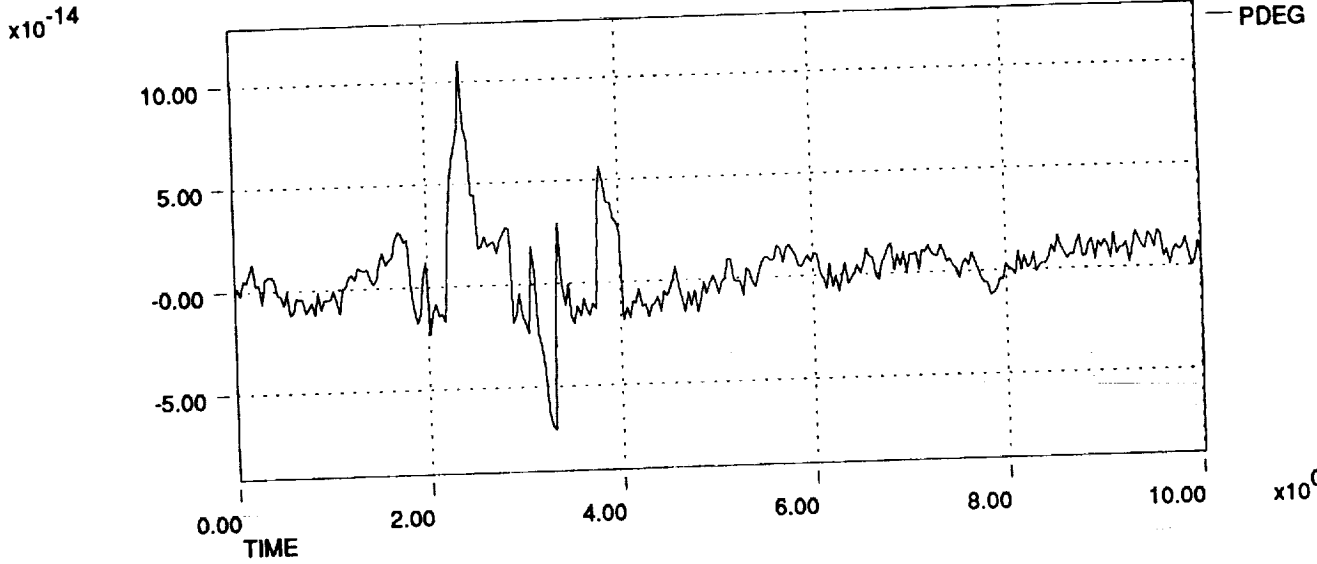

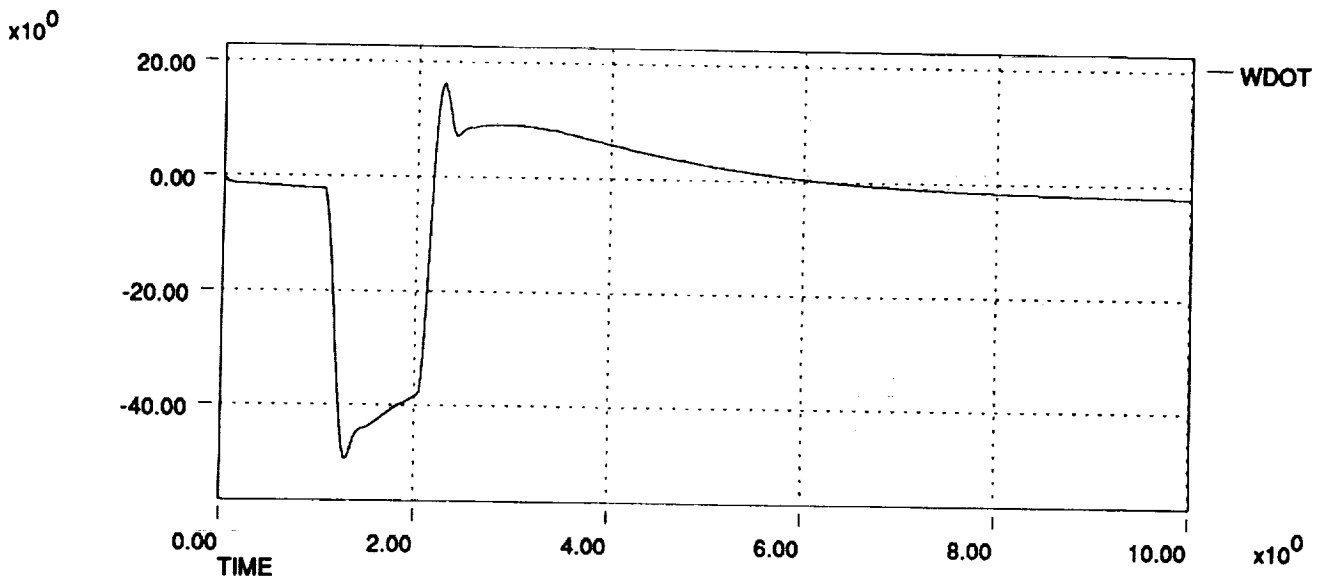
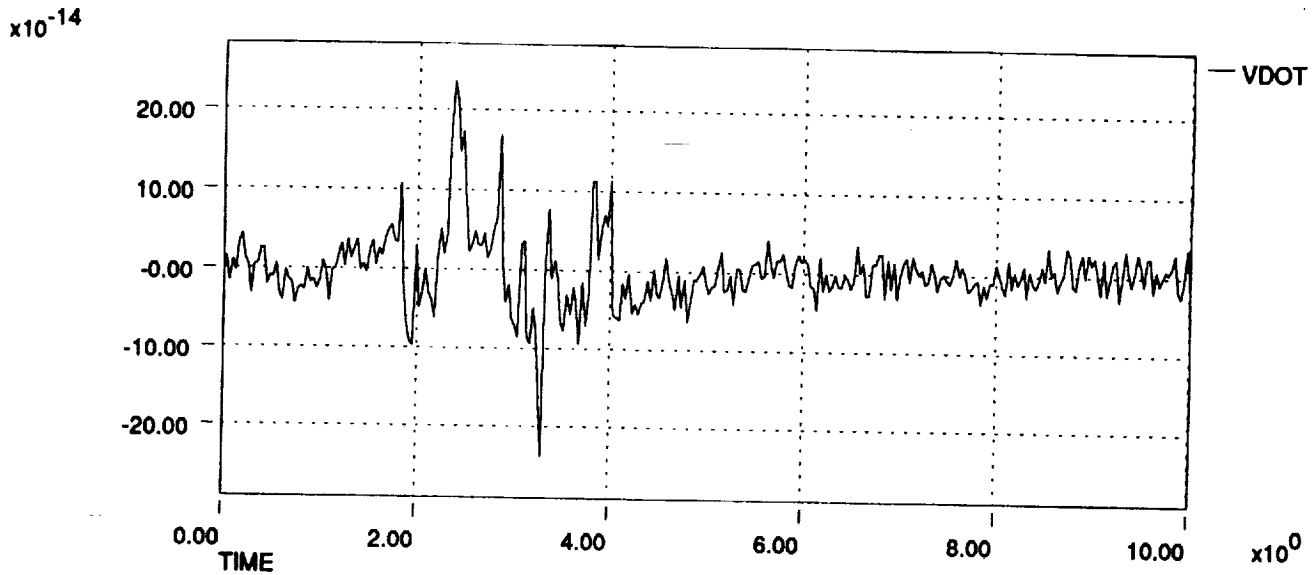
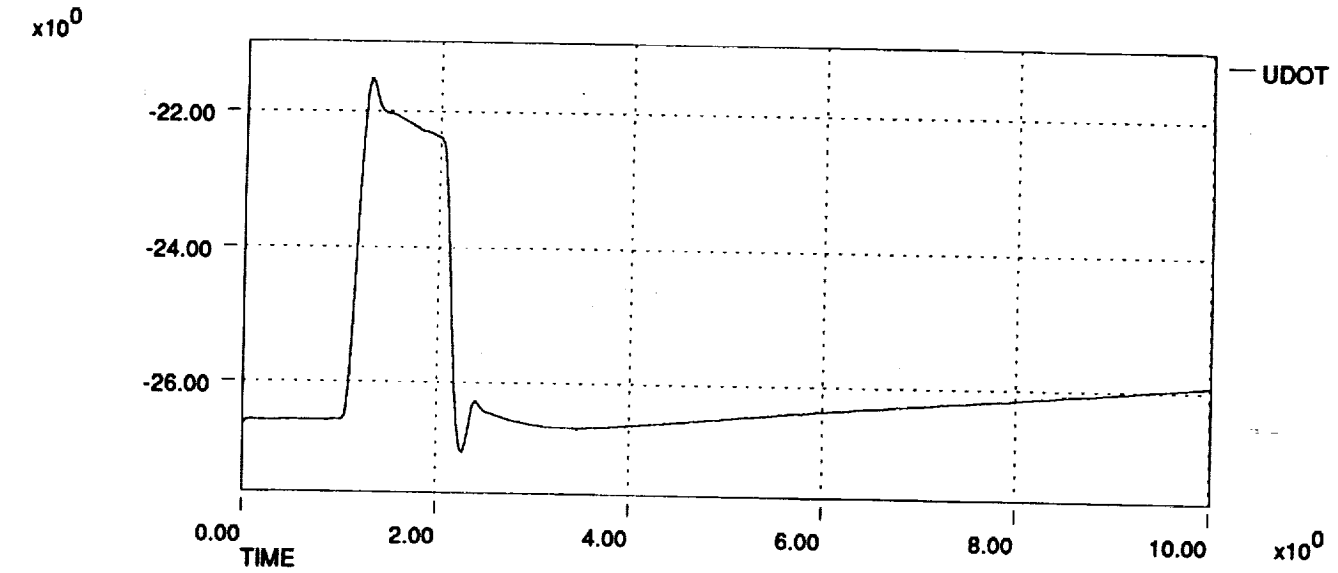

HL-20 Dynamic Check Case Data Plots 911206
Fwd Pitch Stick Pulse at Mach 2 and 58,700 ft

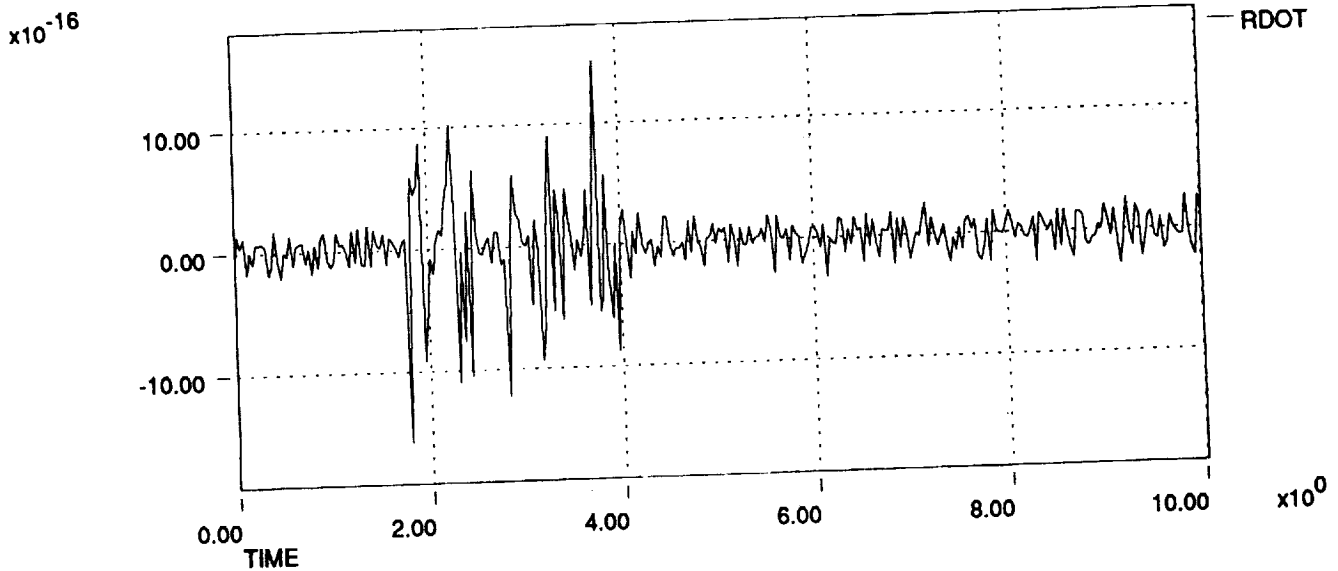
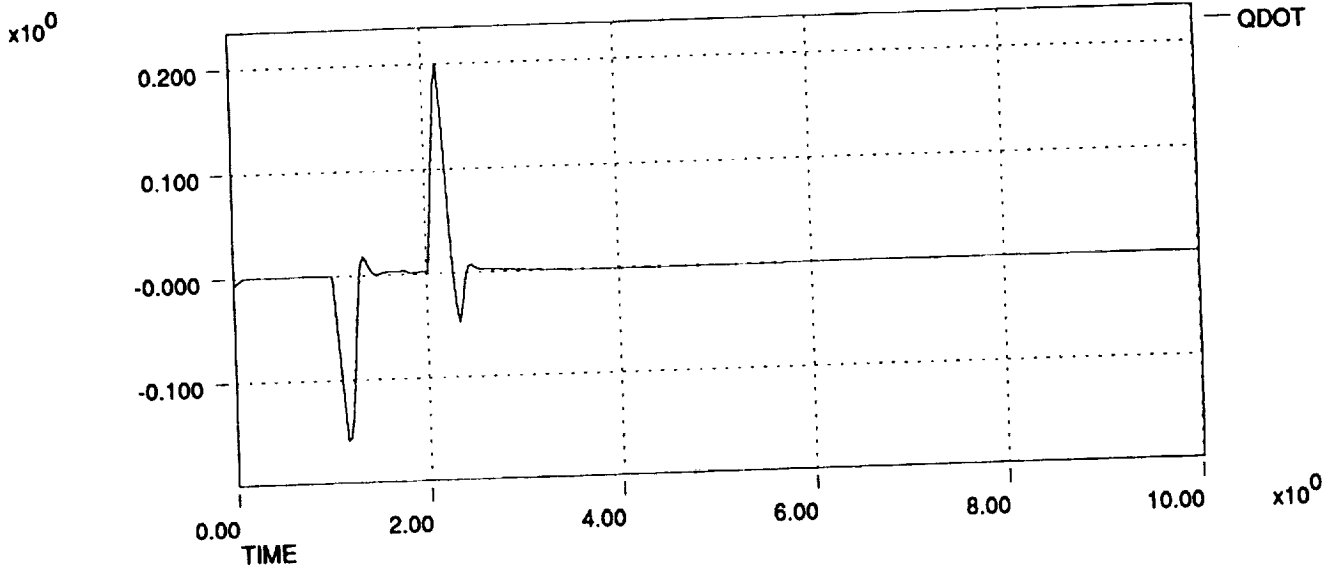
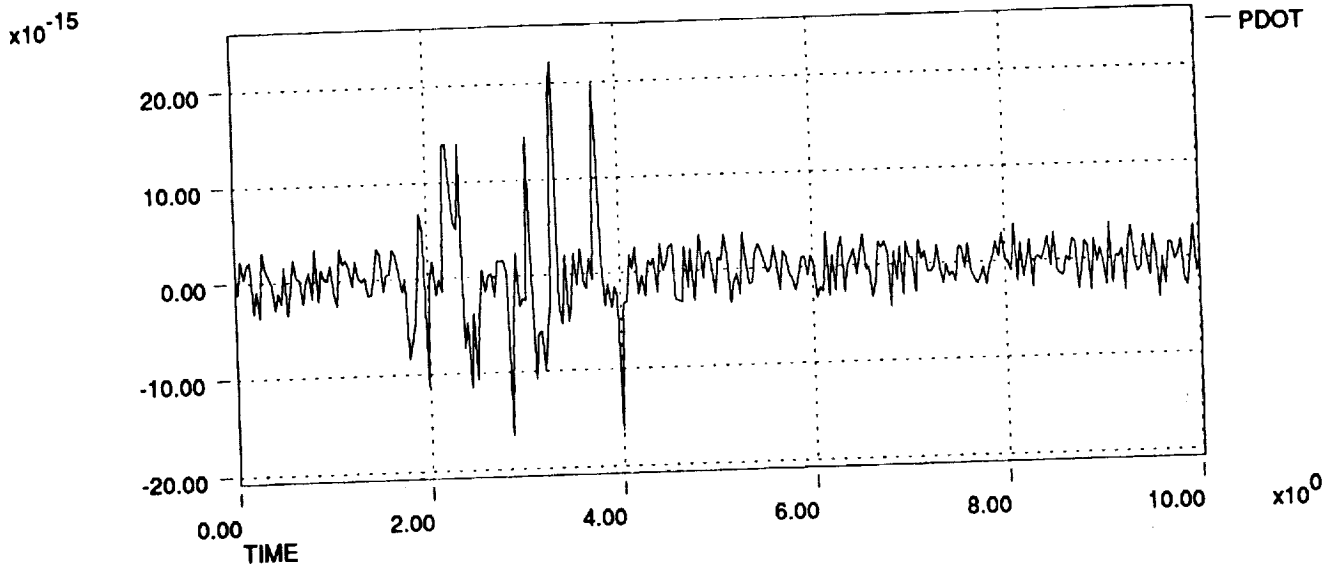

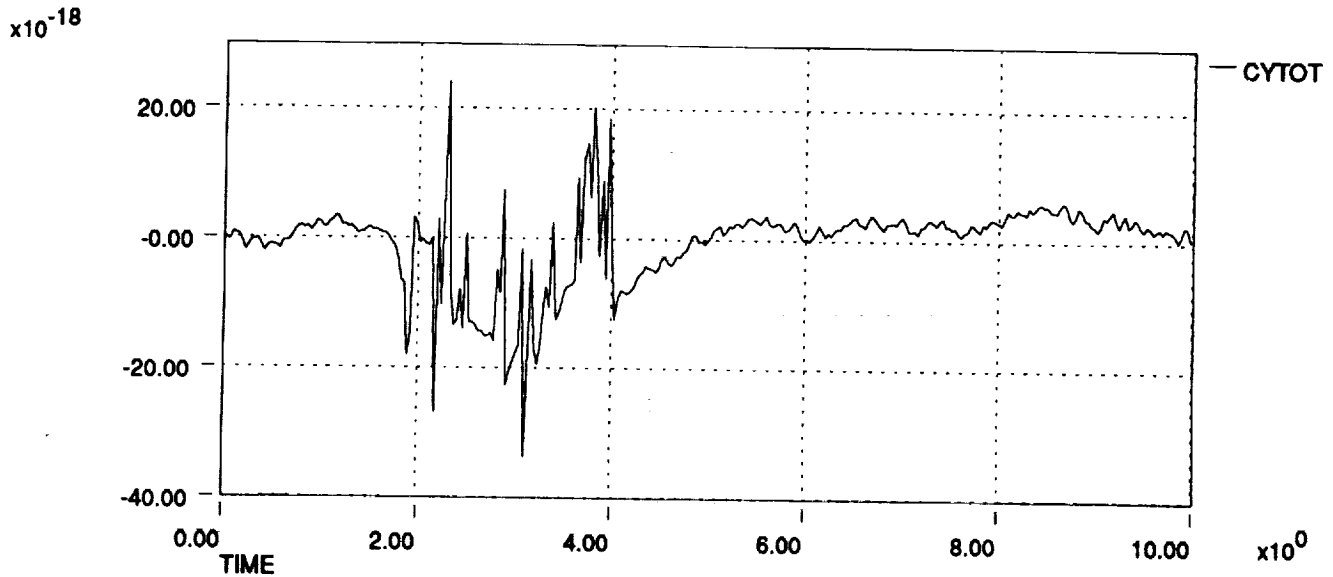
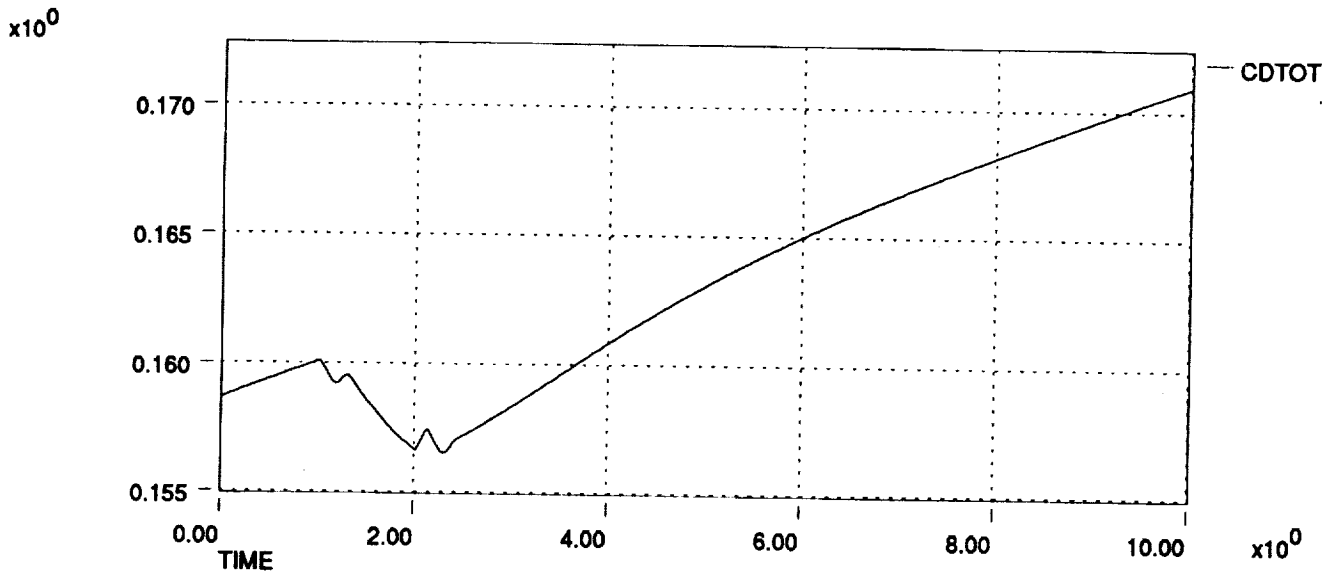
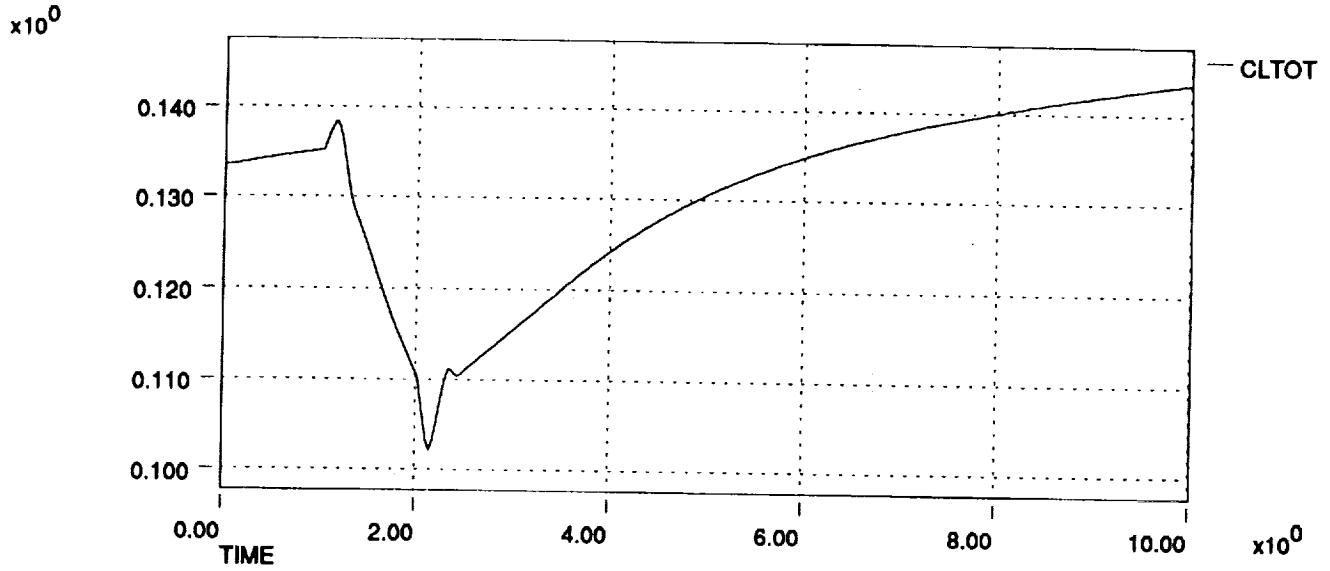

HL-20 Dynamic Check Case Data Plots 911206
Fwd Pitch Stick Pulse at Mach 2 and 58,700 ft

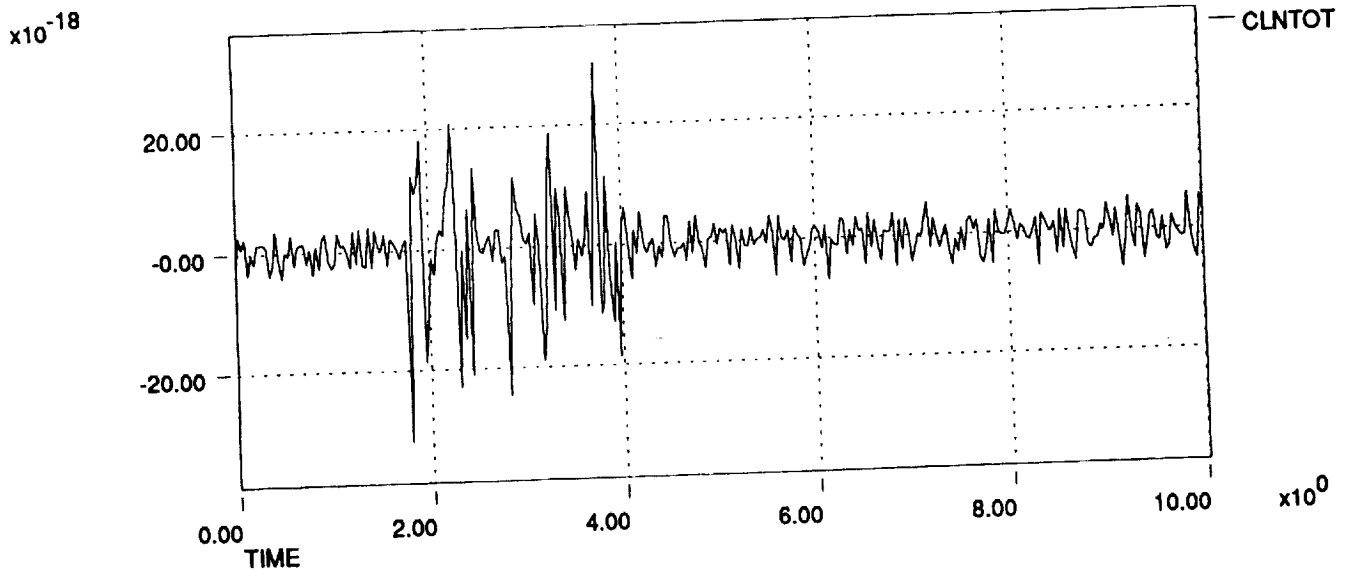
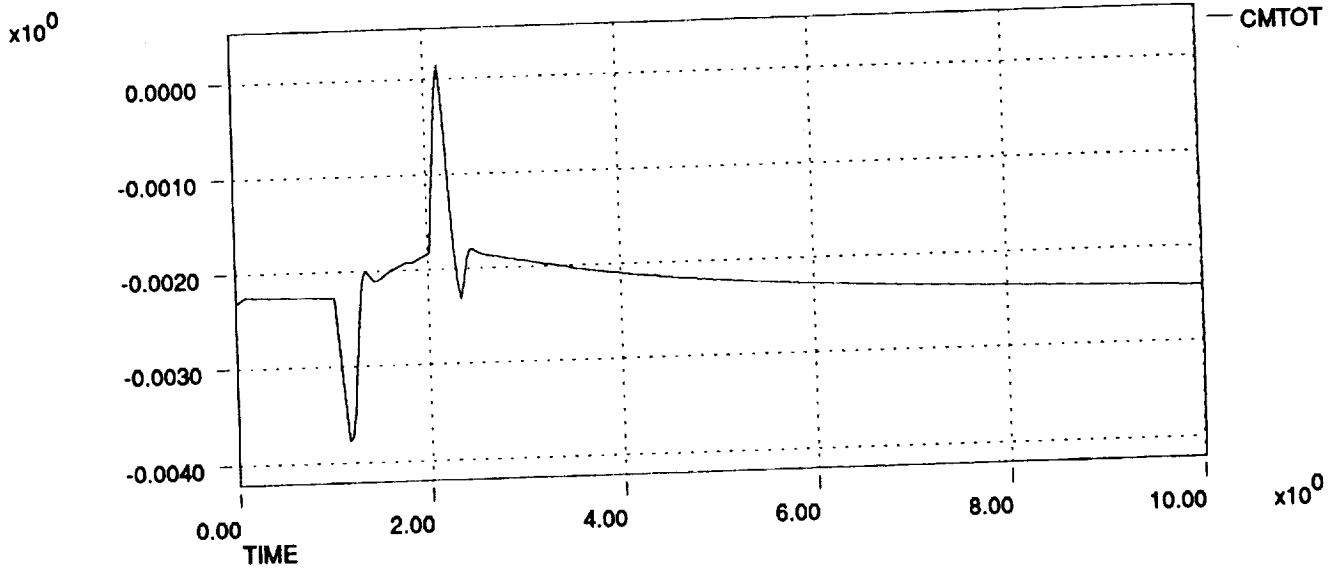
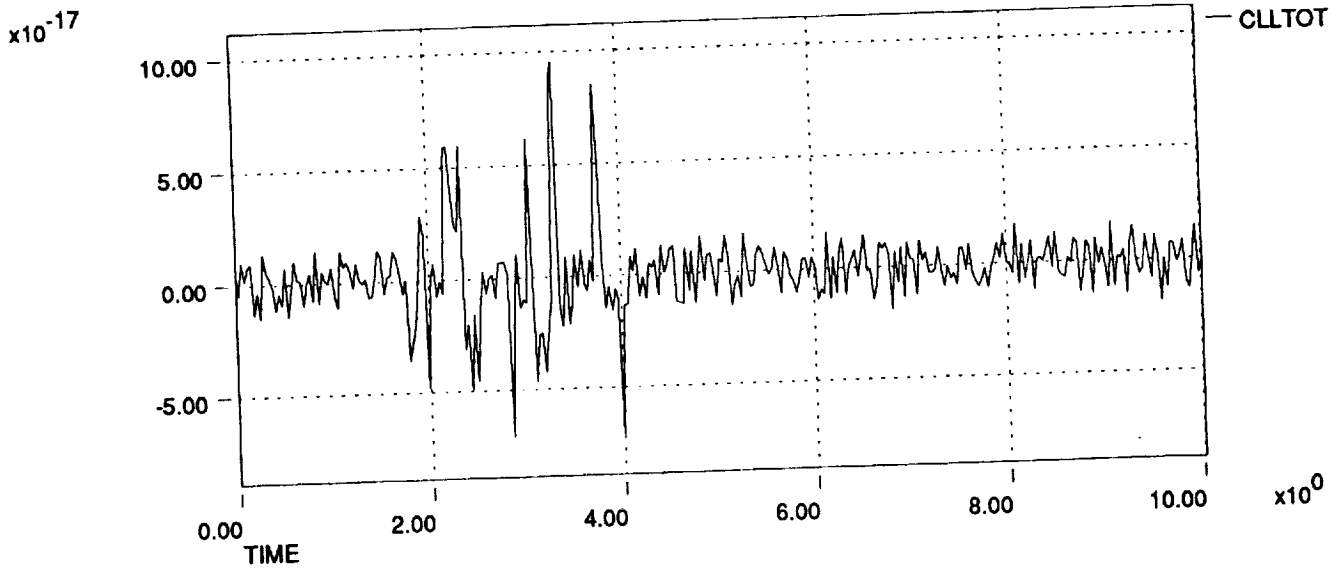

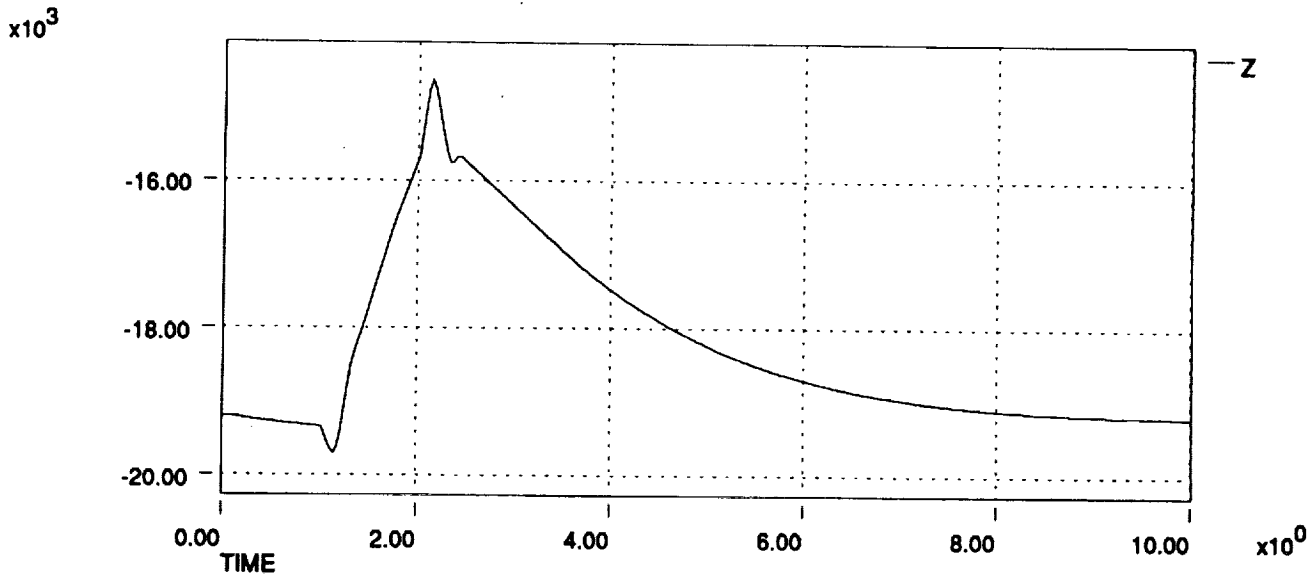
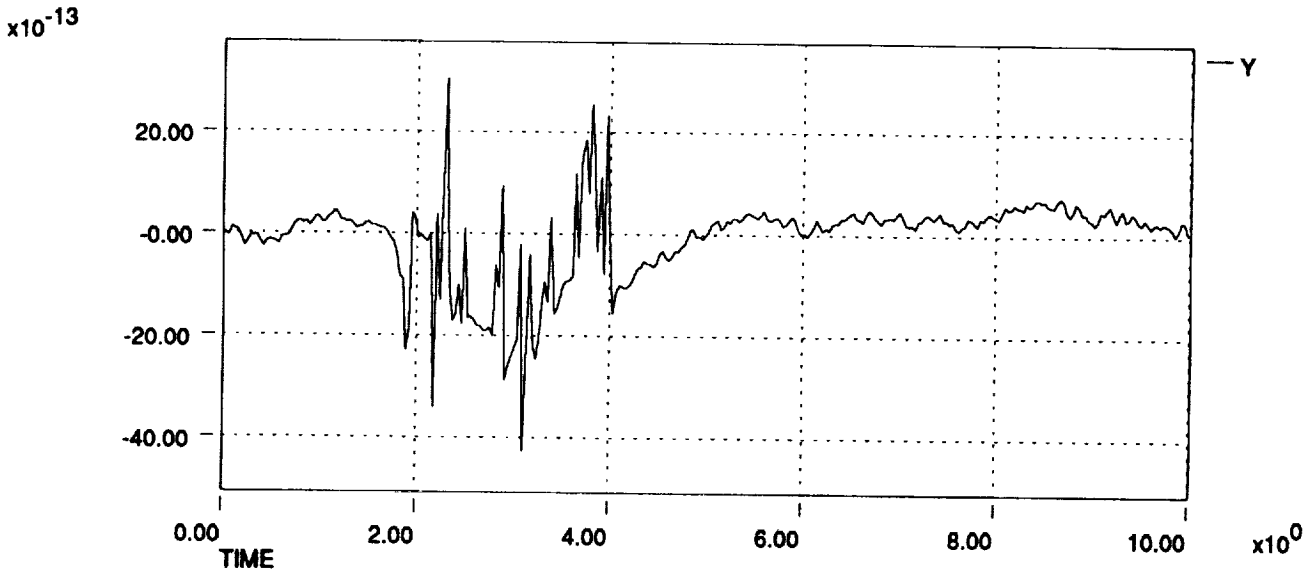
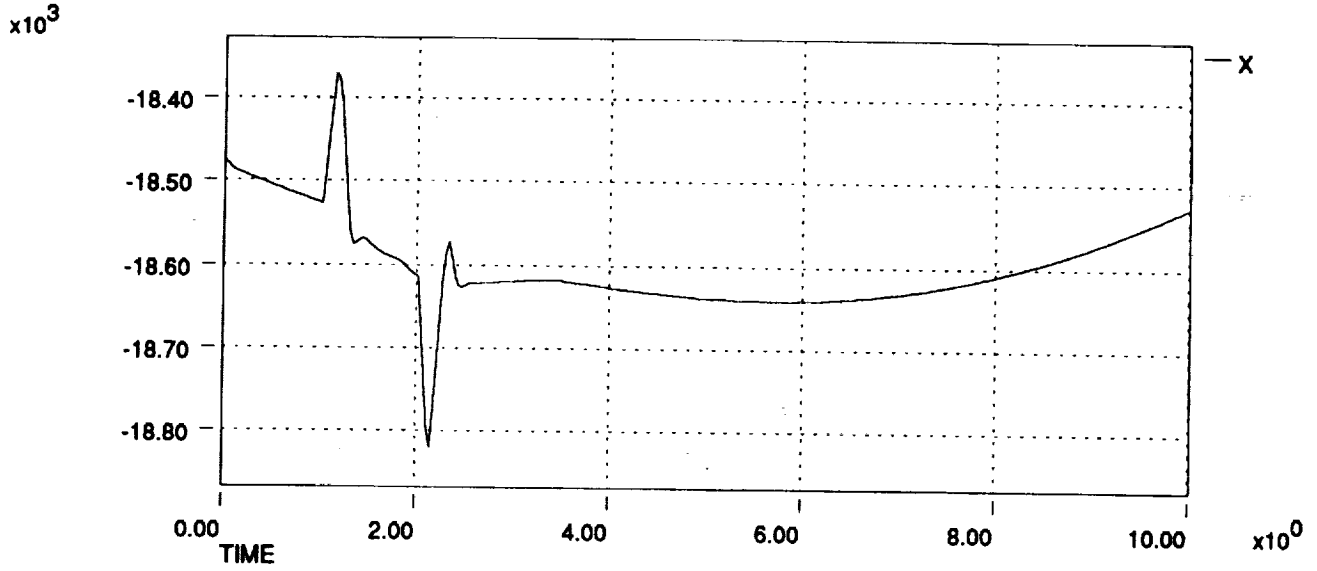

HL-20 Dynamic Check Case Data Plots 911206
Fwd Pitch Stick Pulse at Mach 2 and 58,700 ft

$\times 10^{-11}$

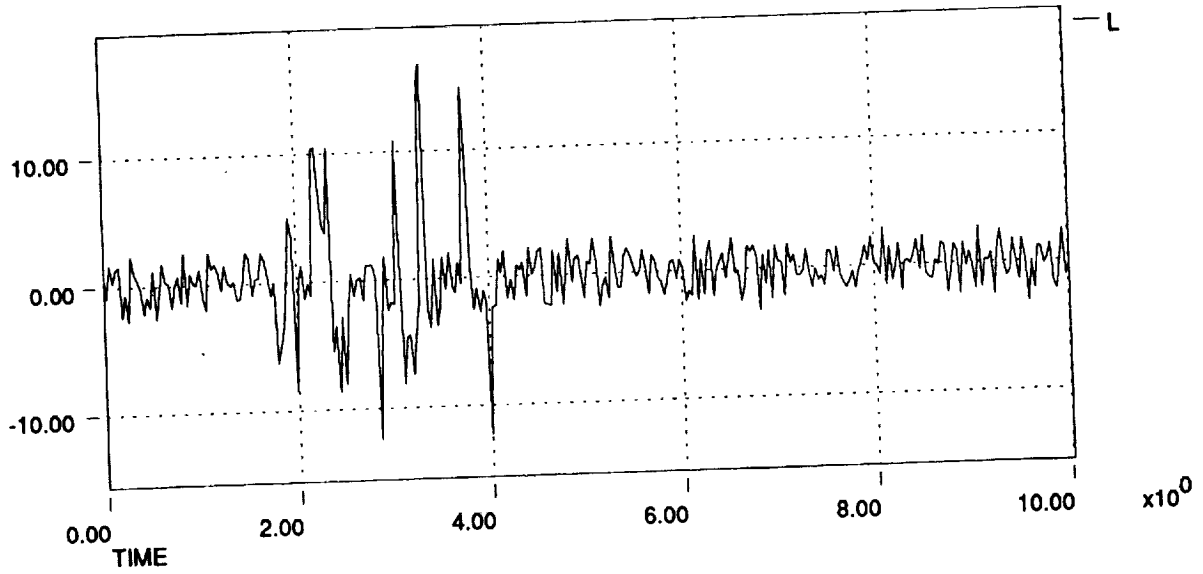

$\times 10^0$

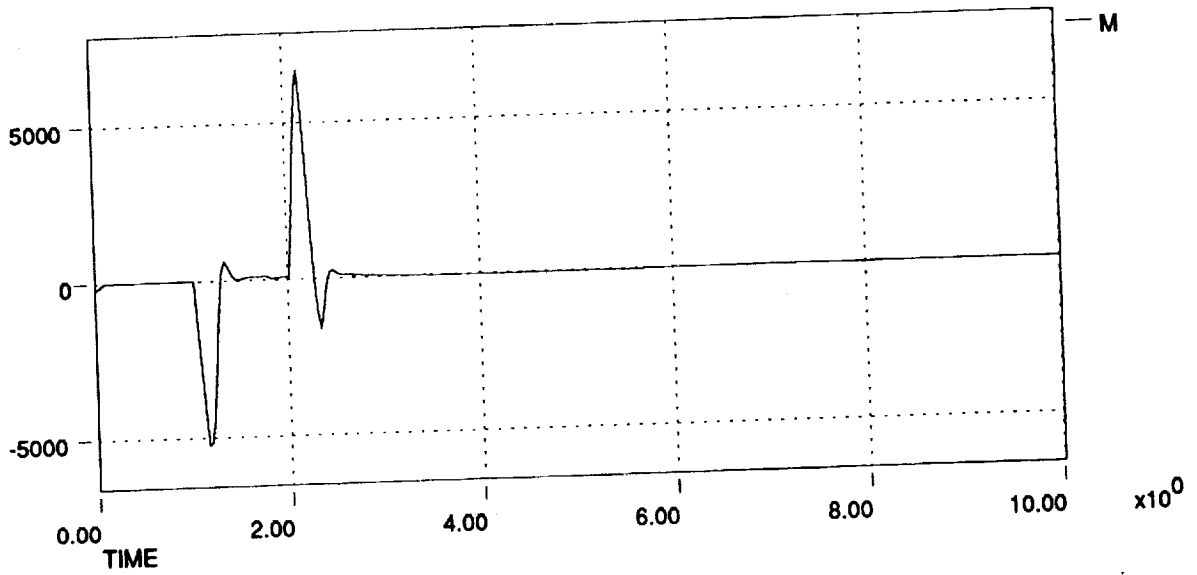

$\times 10^{-12}$

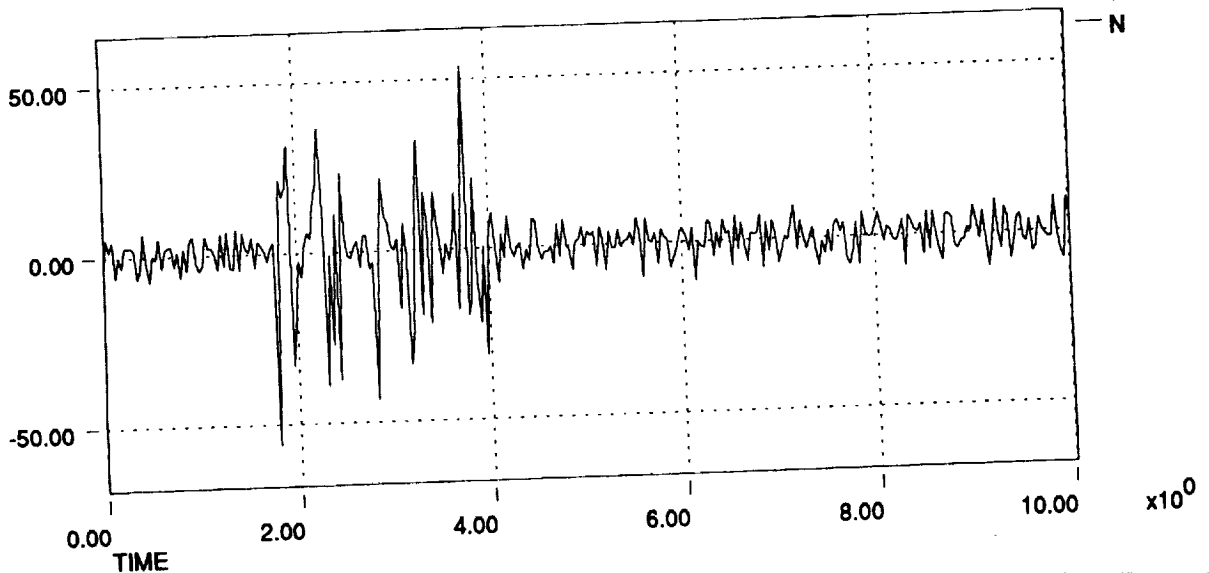

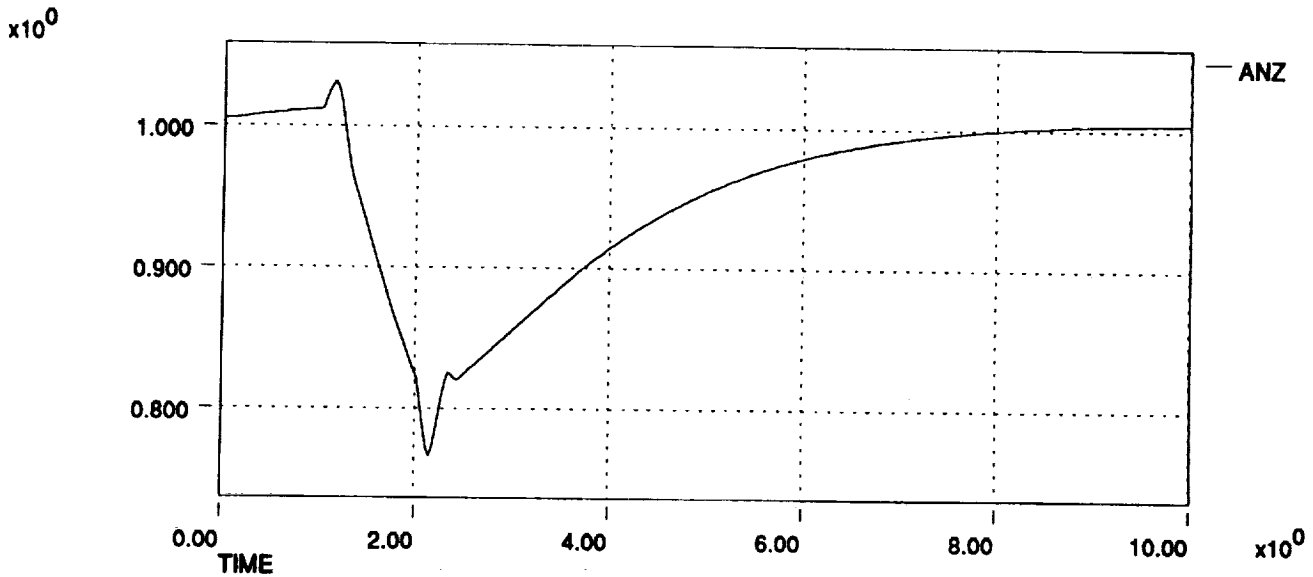
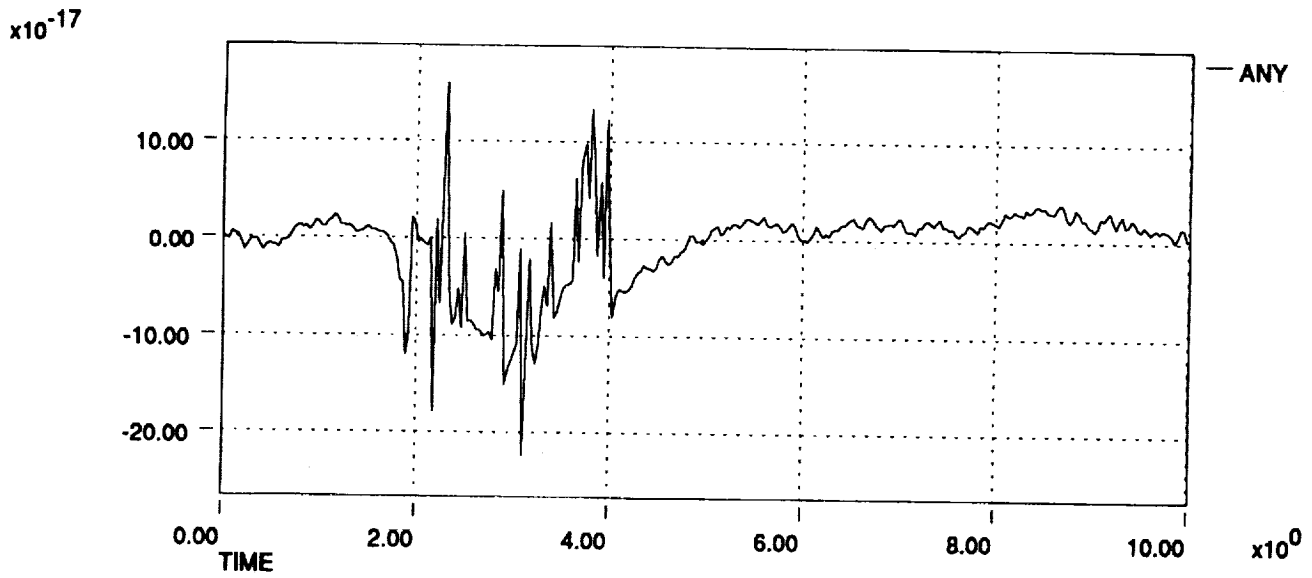
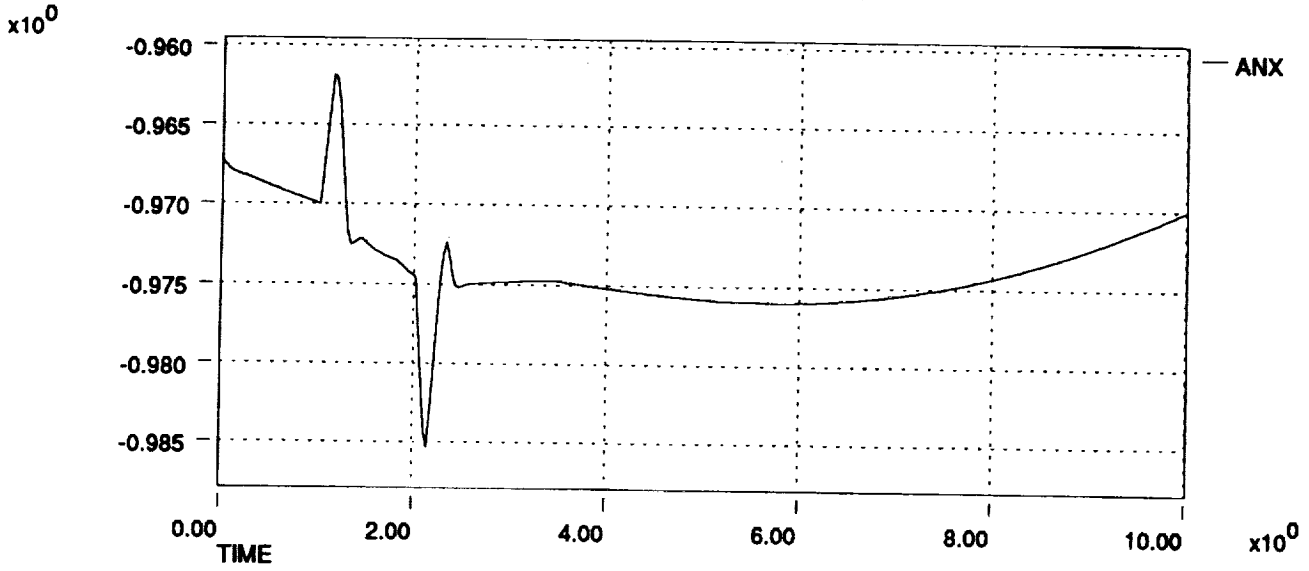

HL-20 Dynamic Check Case Data Plots 911206
Fwd Pitch Stick Pulse at Mach 2 and 58,700 ft

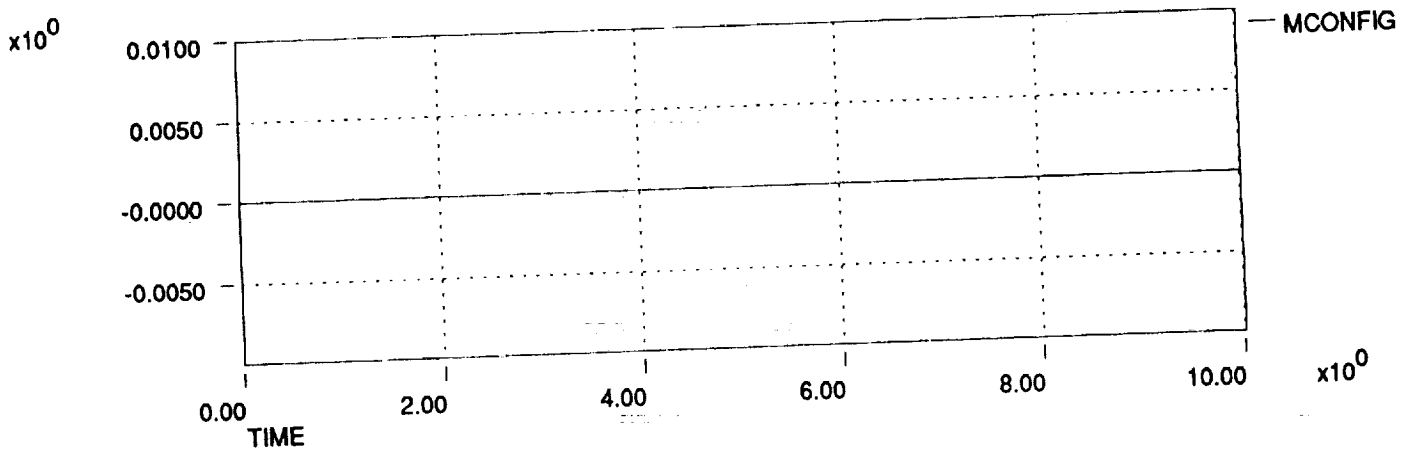
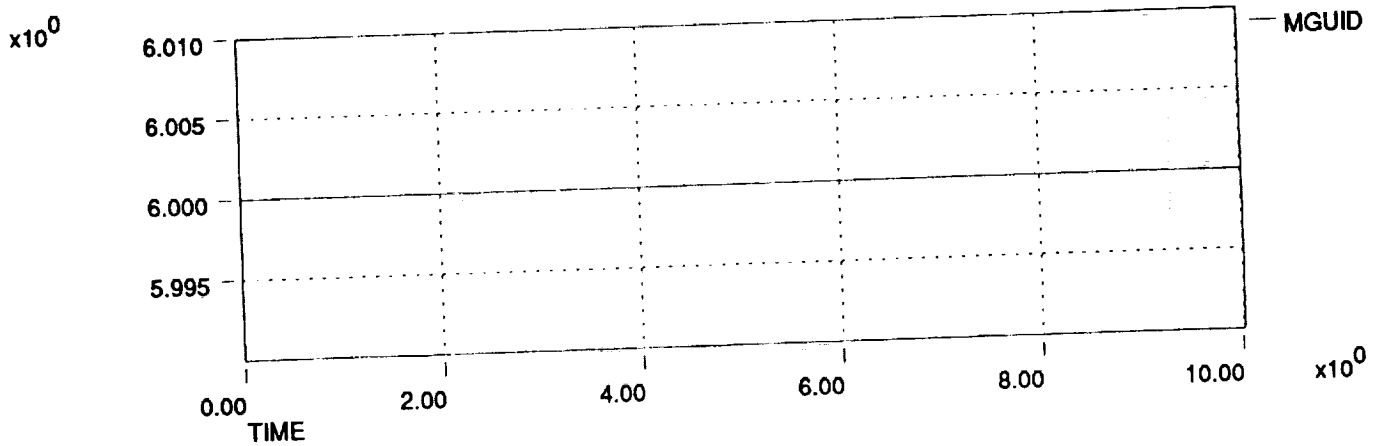
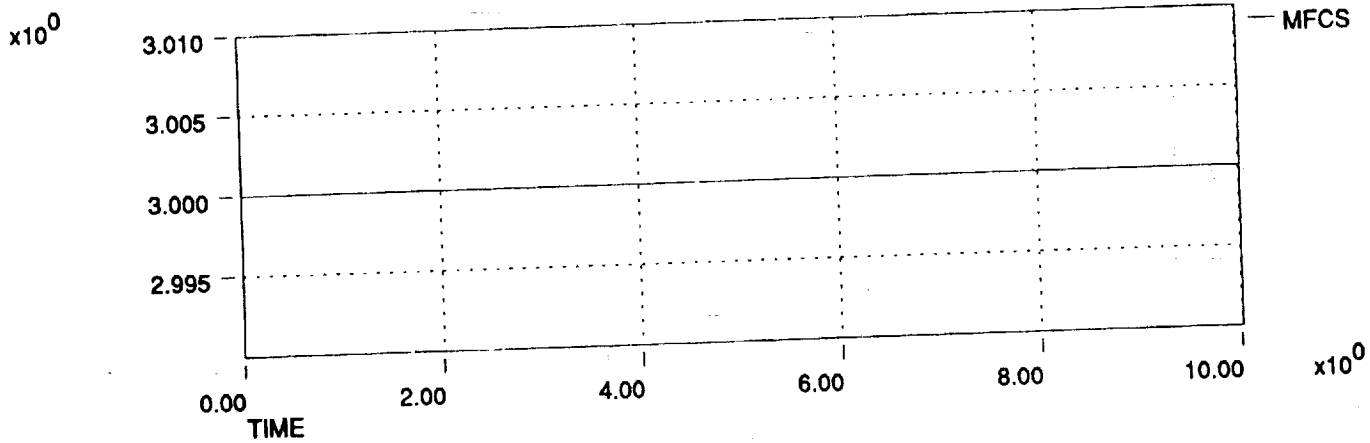
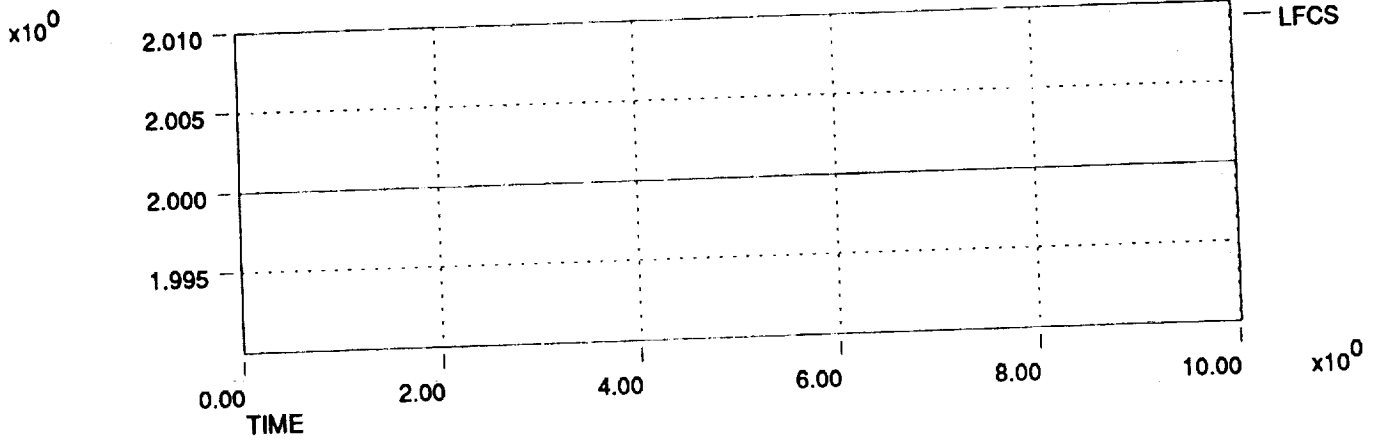

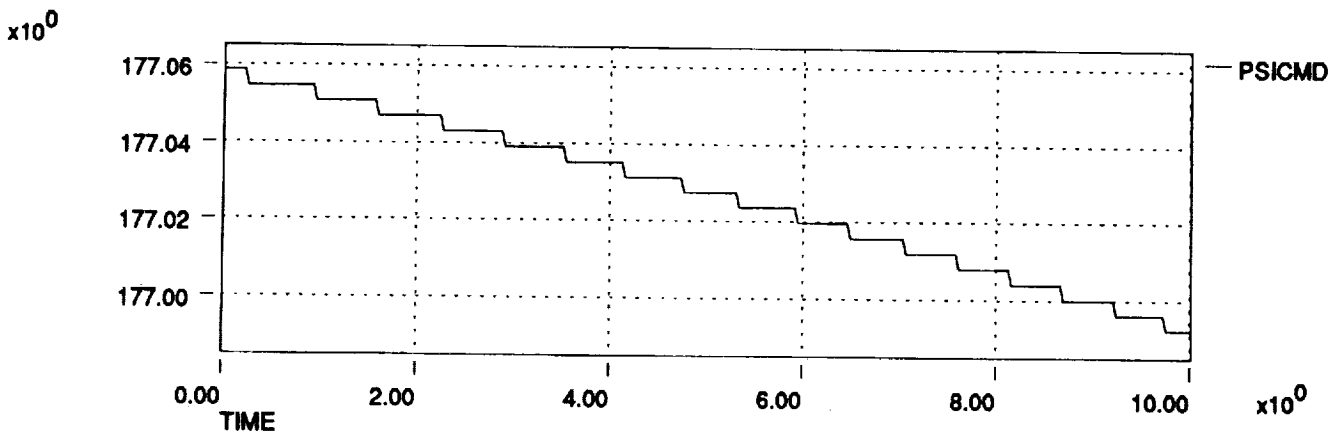
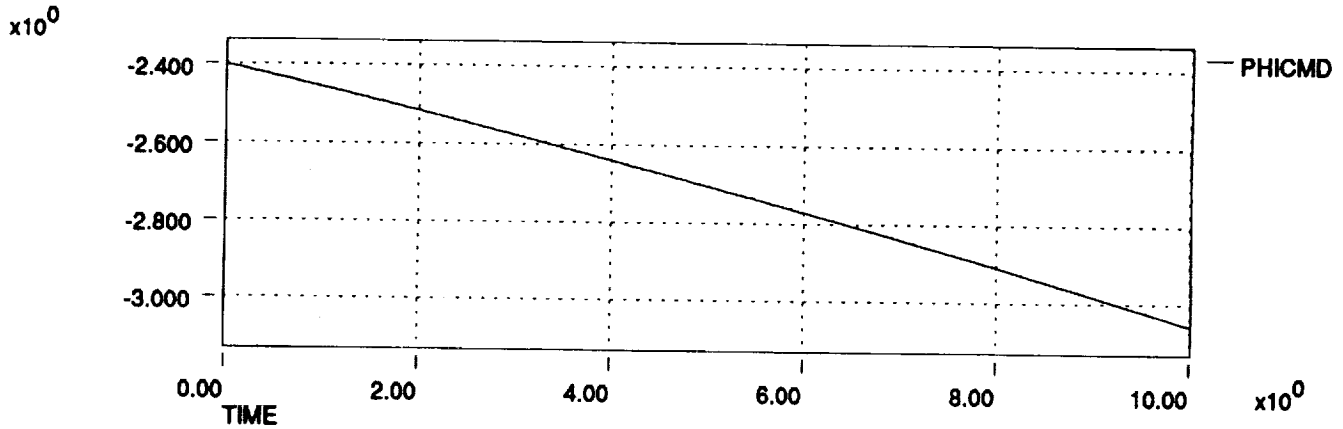
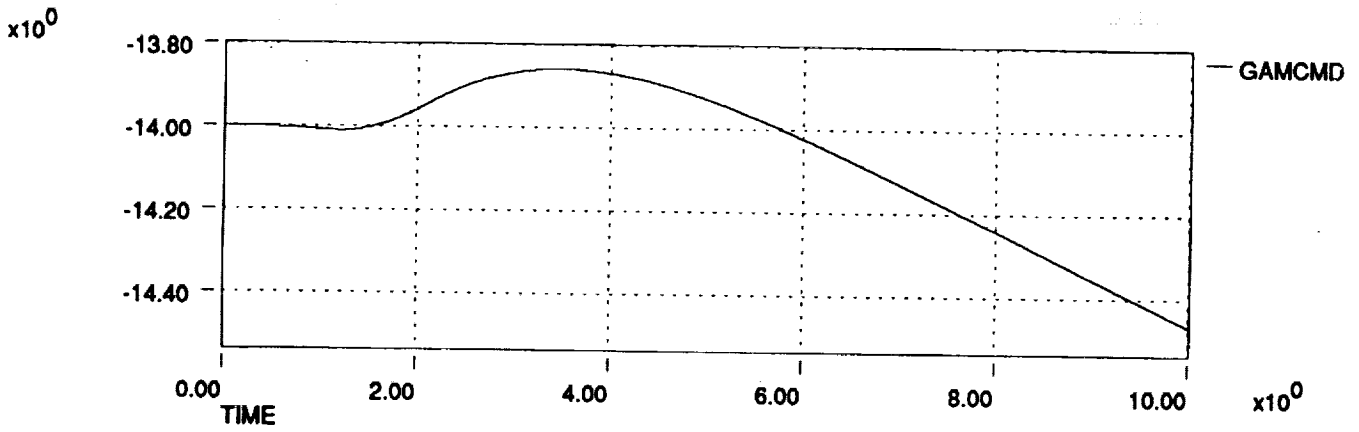
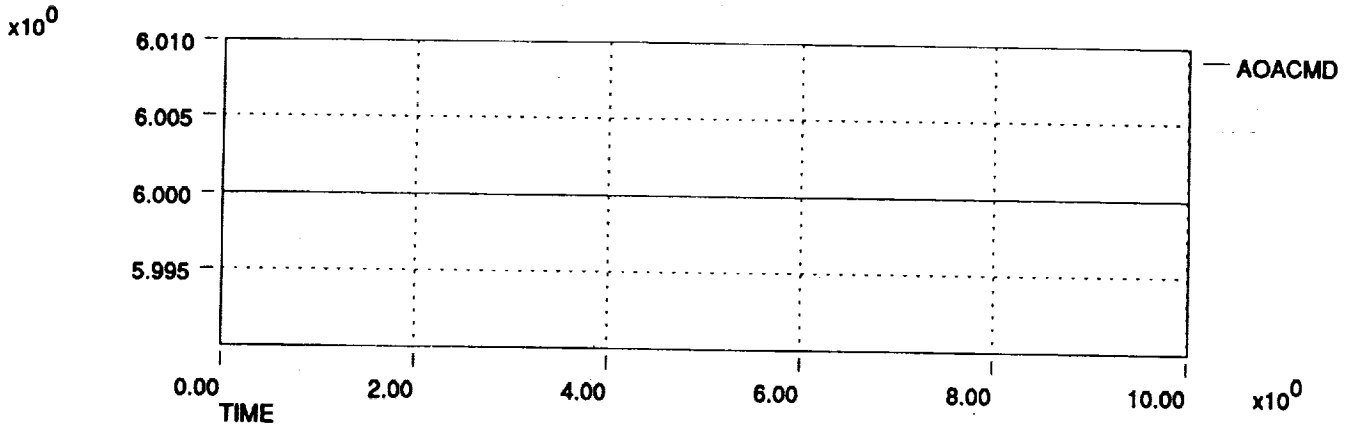

HL-20 Dynamic Check Case Data Plots 911206
Fwd Pitch Stick Pulse at Mach 2 and 58,700 ft

$\times 10^0$

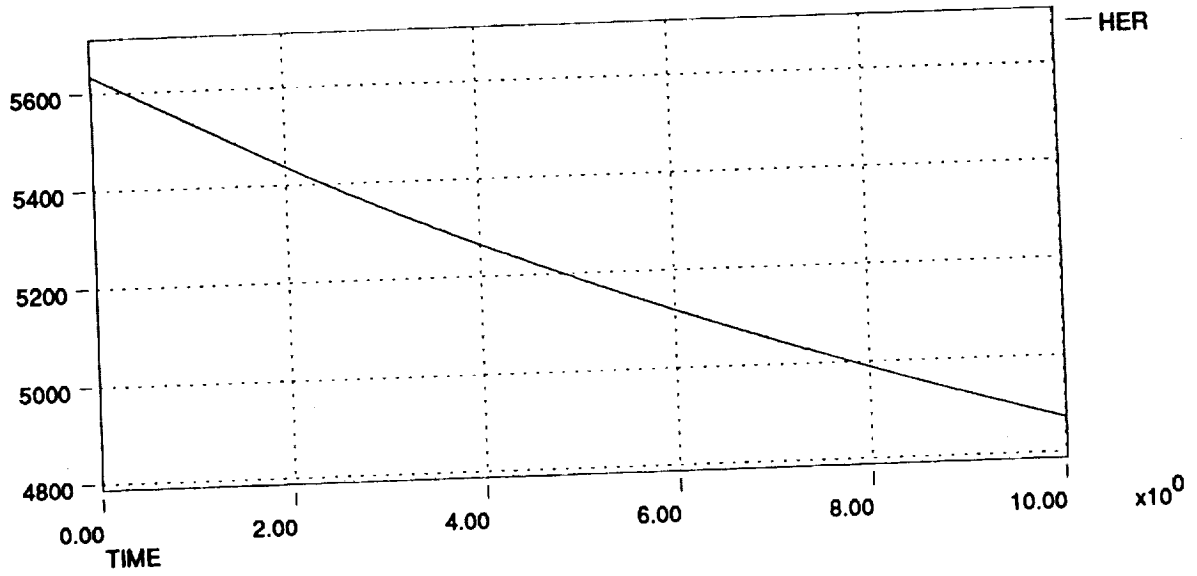

$\times 10^0$

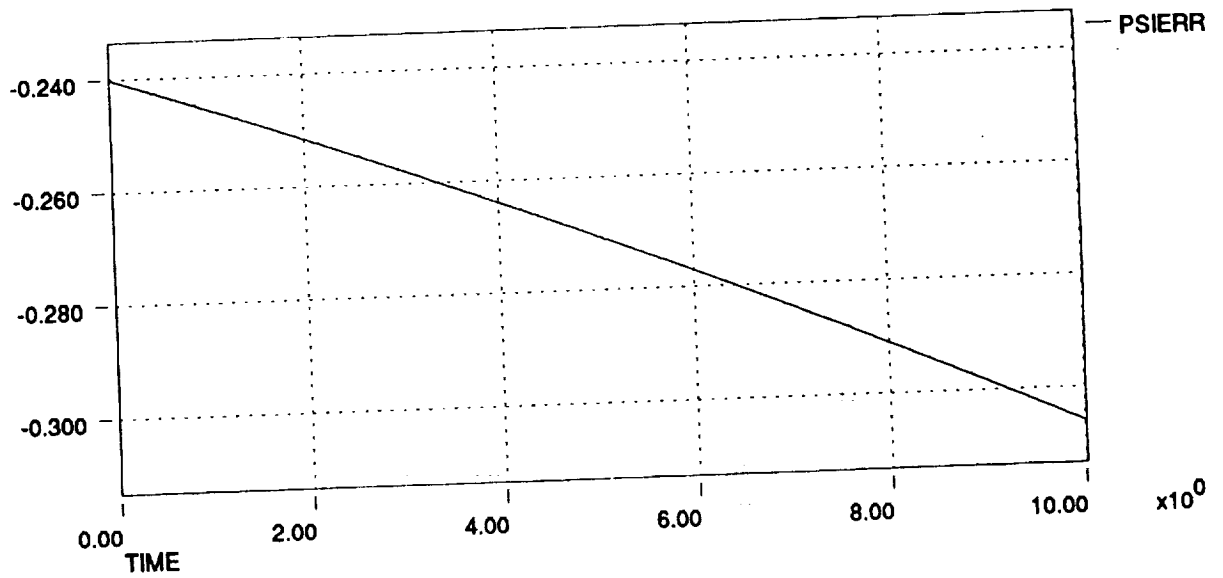

$\times 10^3$

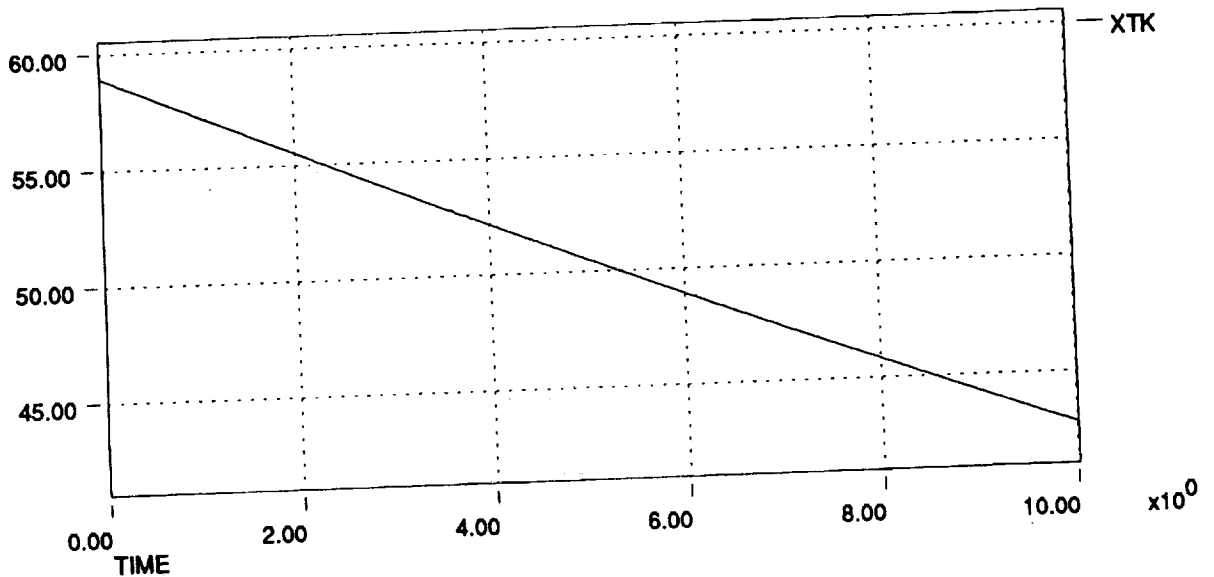

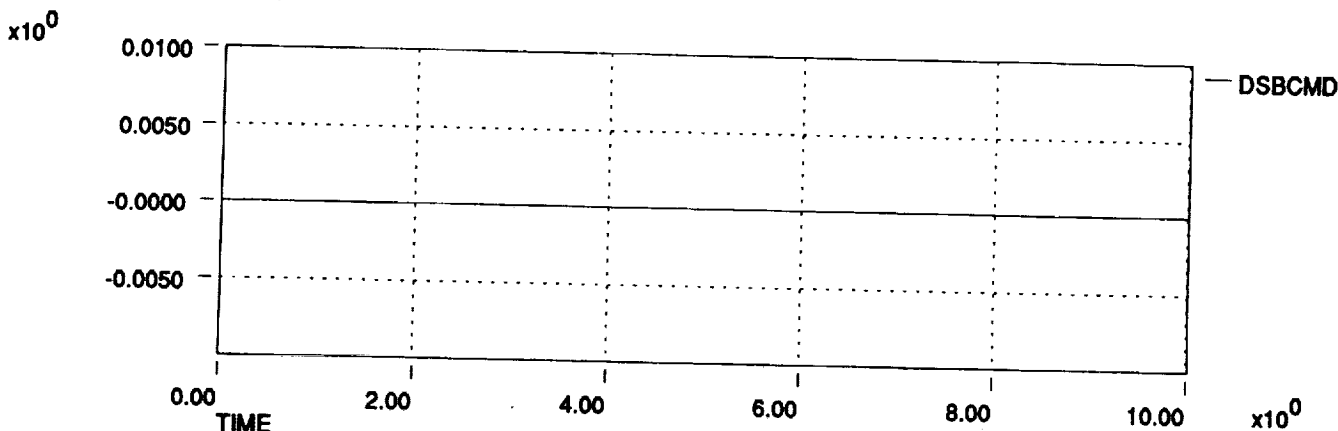
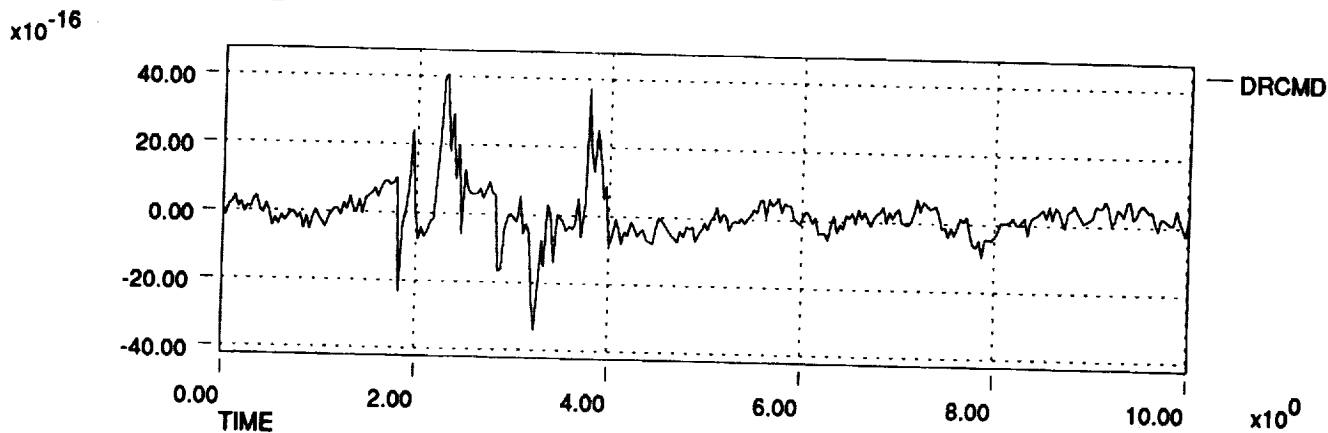
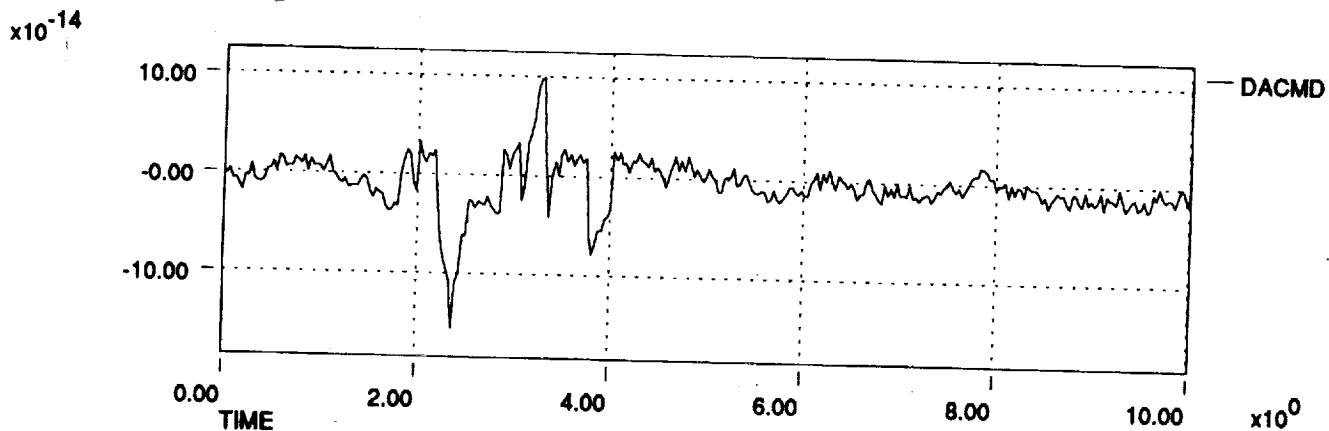
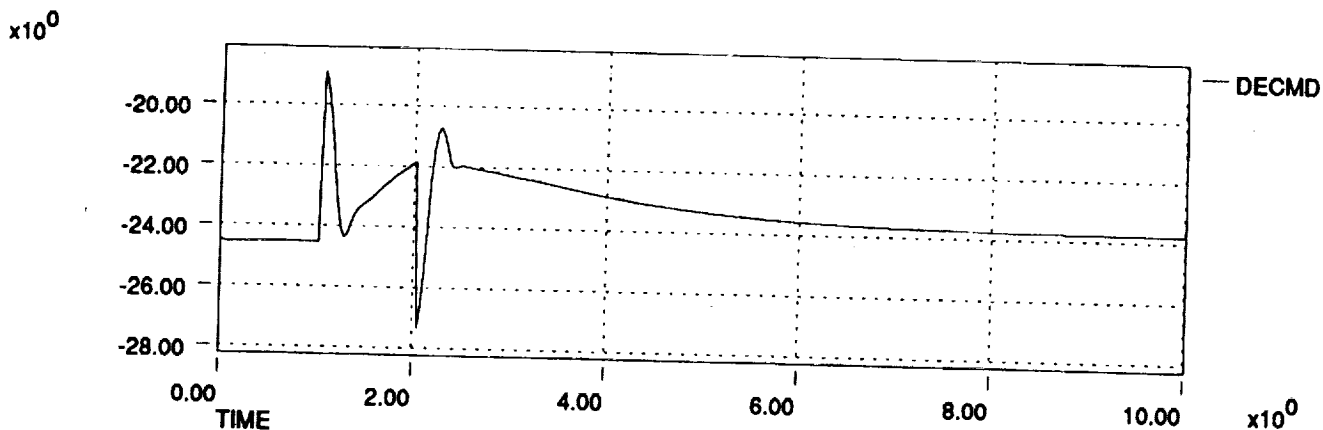

HL-20 Dynamic Check Case Data Plots 911206
Fwd Pitch Stick Pulse at Mach 2 and 58,700 ft

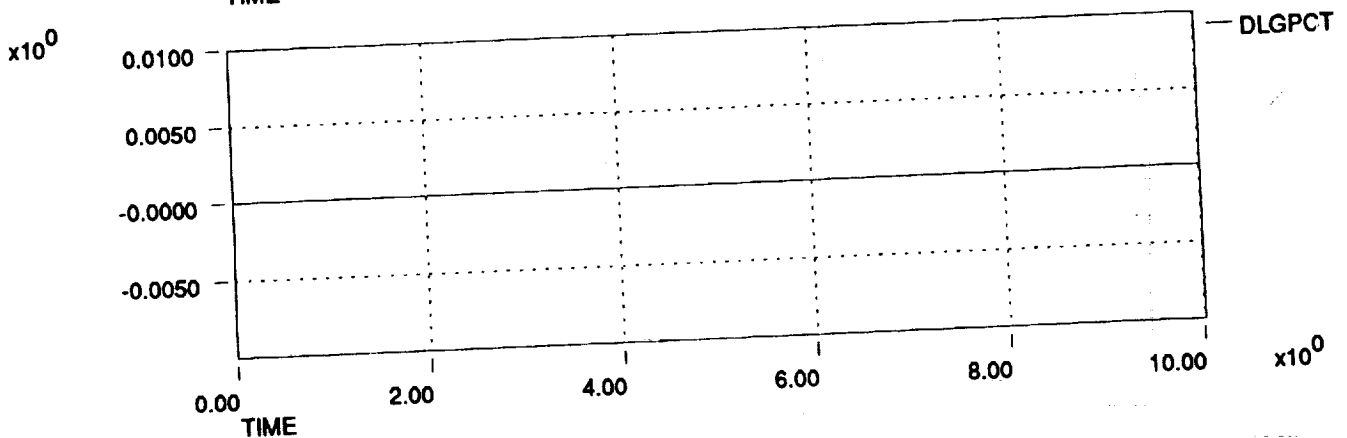
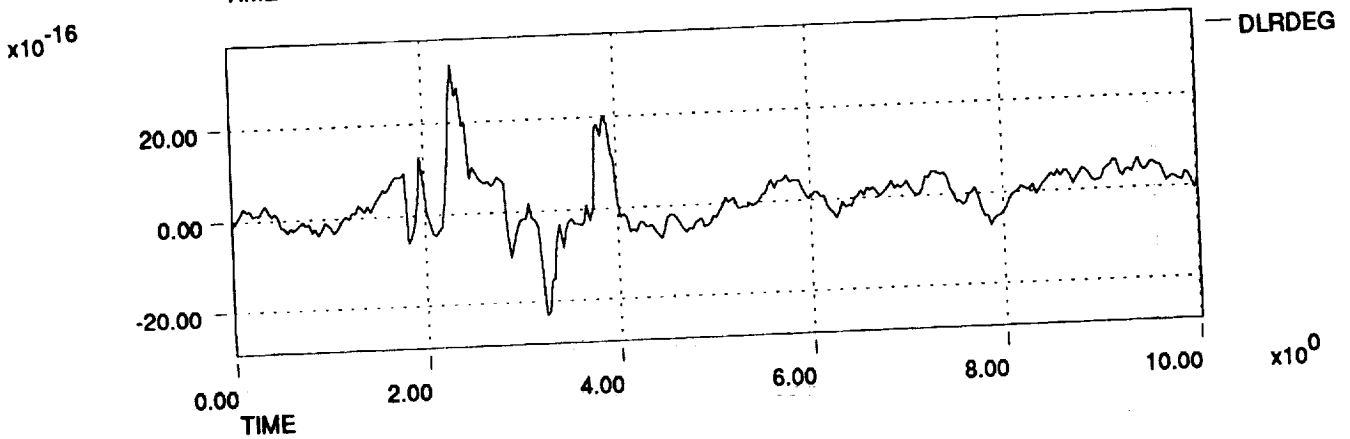
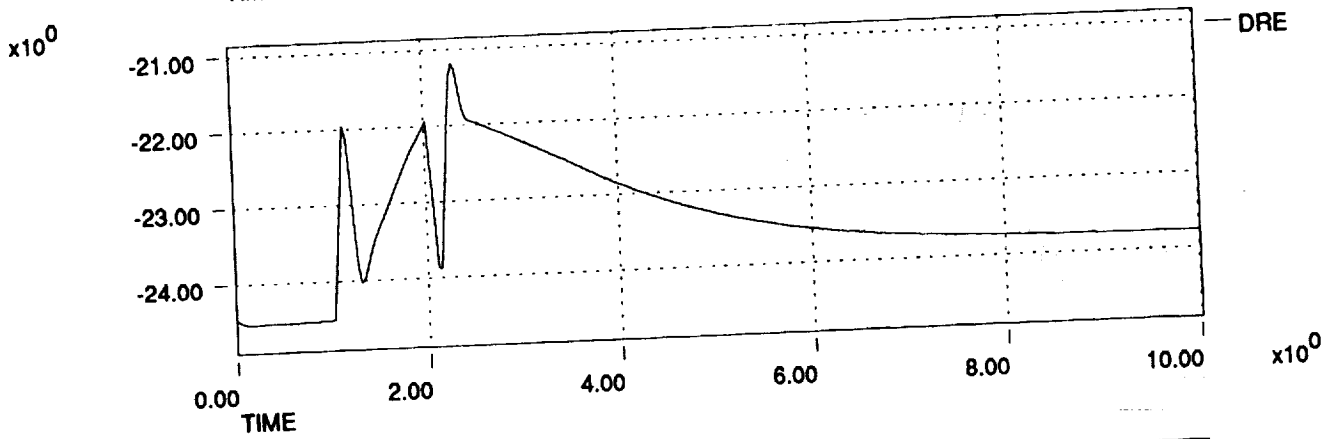
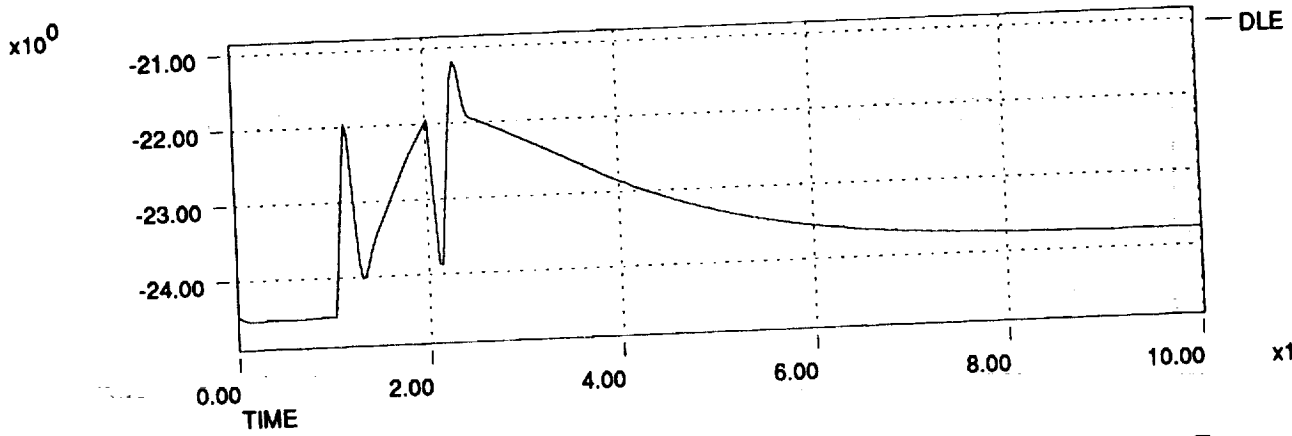

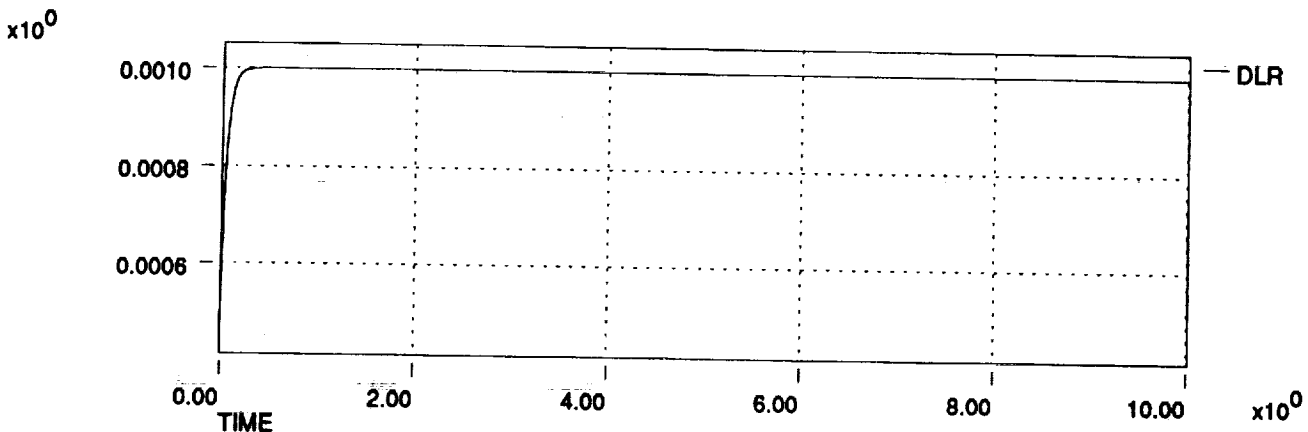
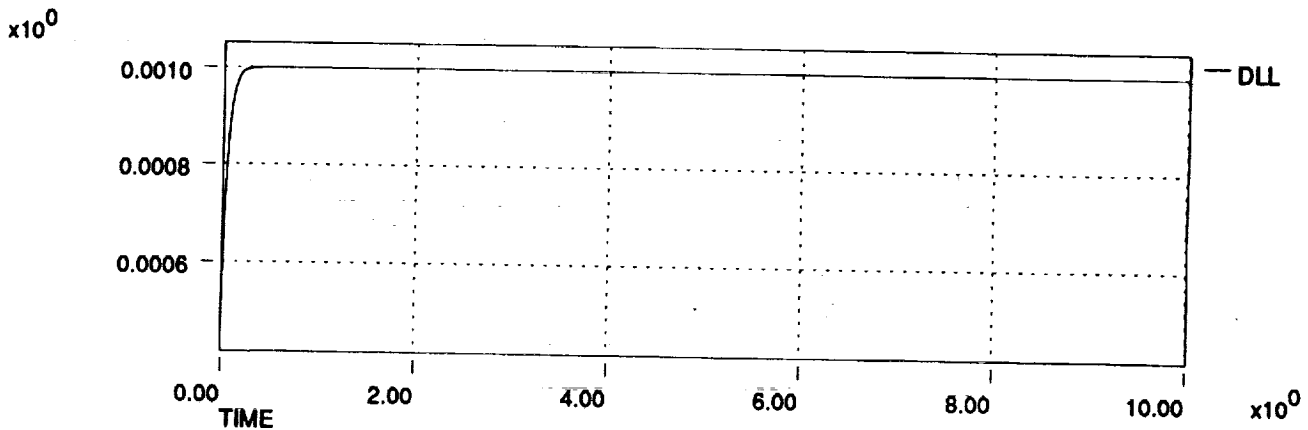
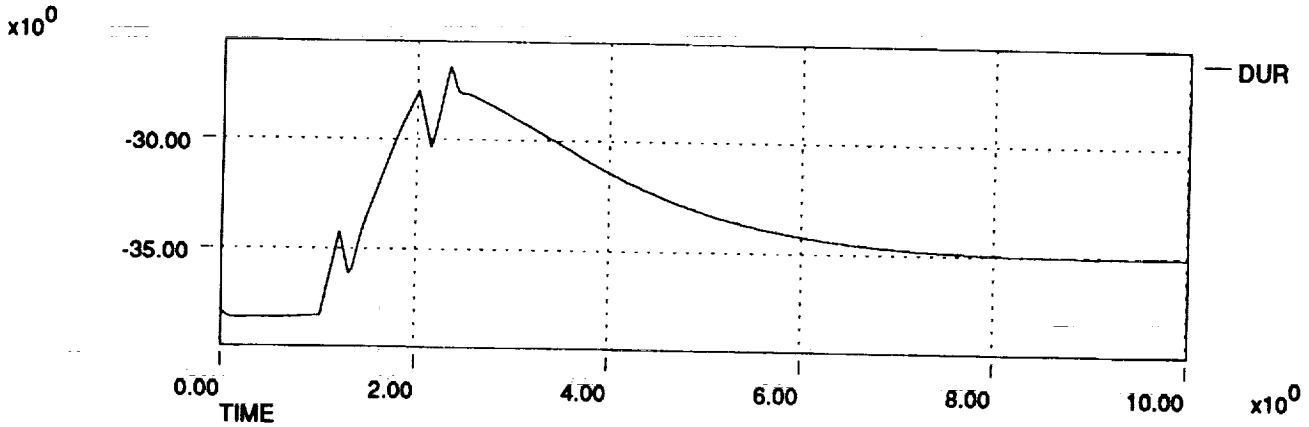
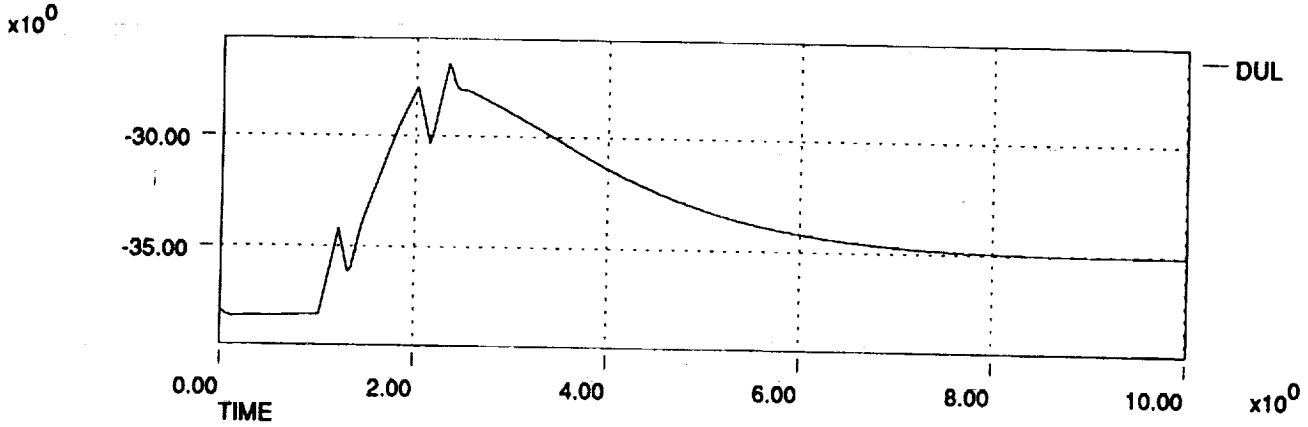

HL-20 Dynamic Check Case Data Plots 911206
Right Roll Stick Pulse at Mach 2 and 58,700 ft

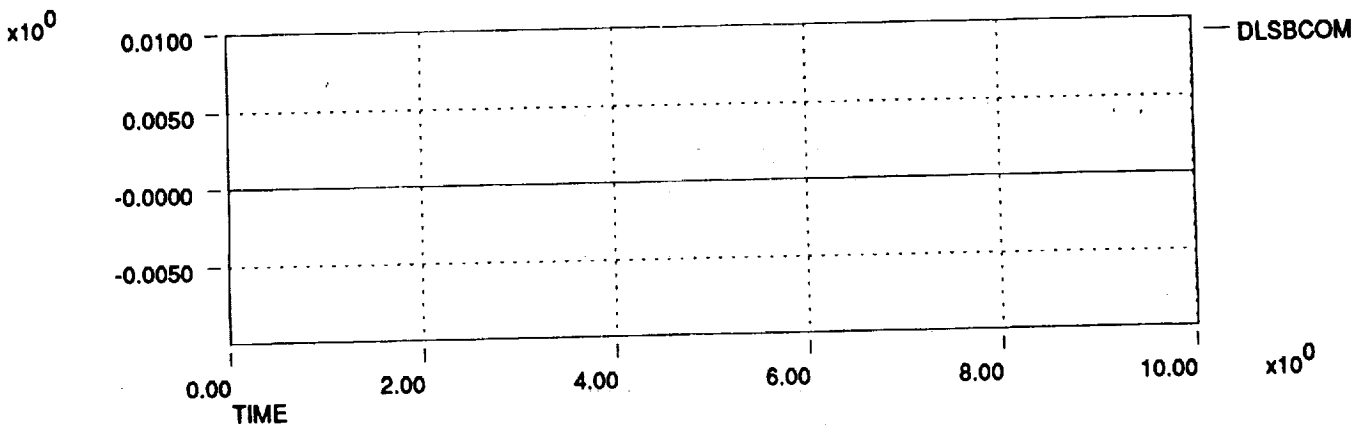
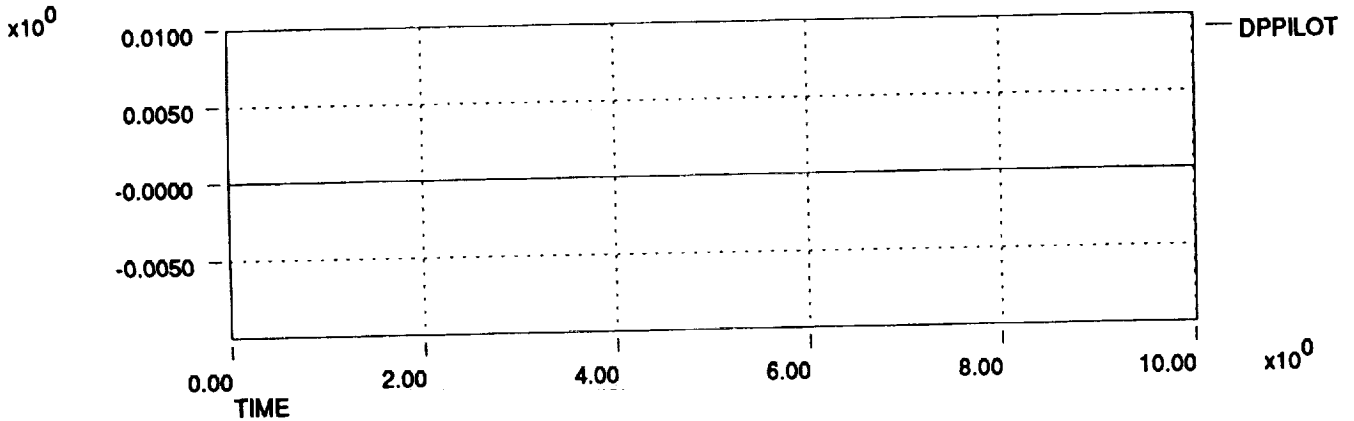
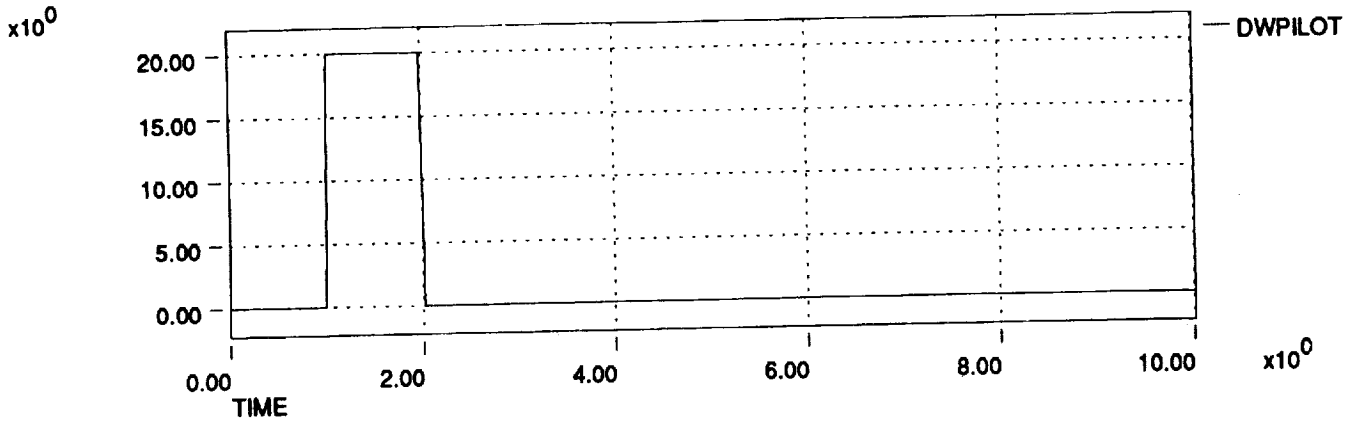
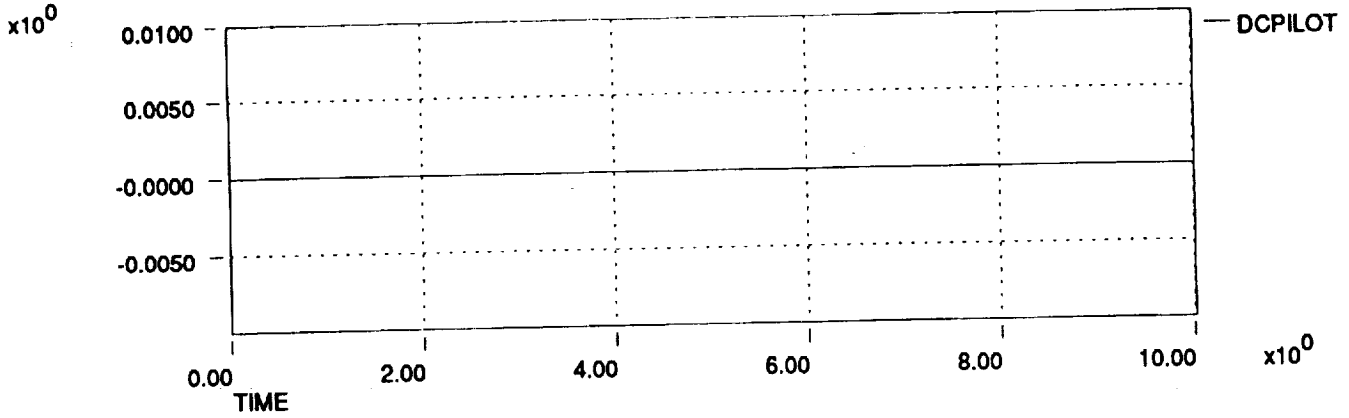

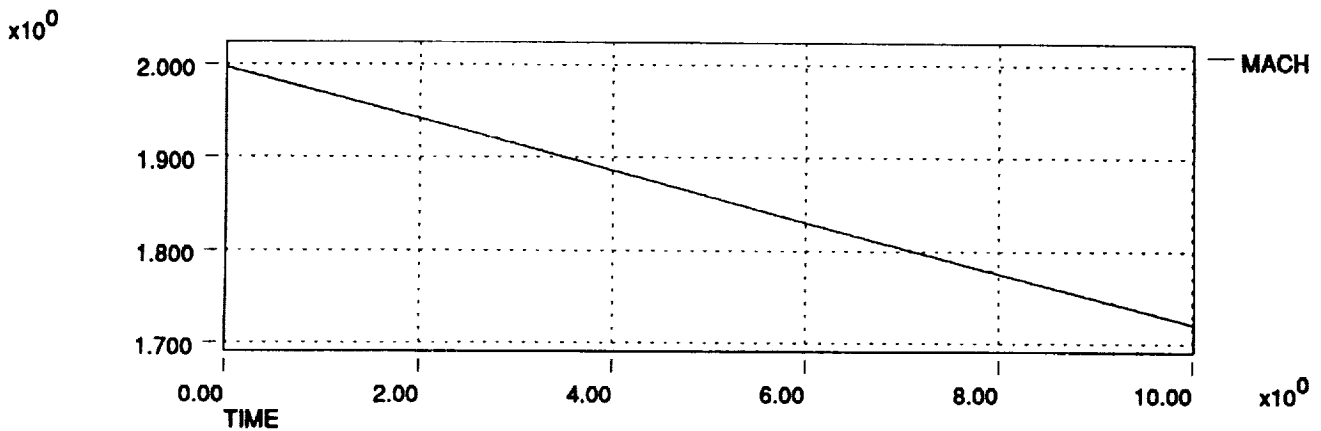
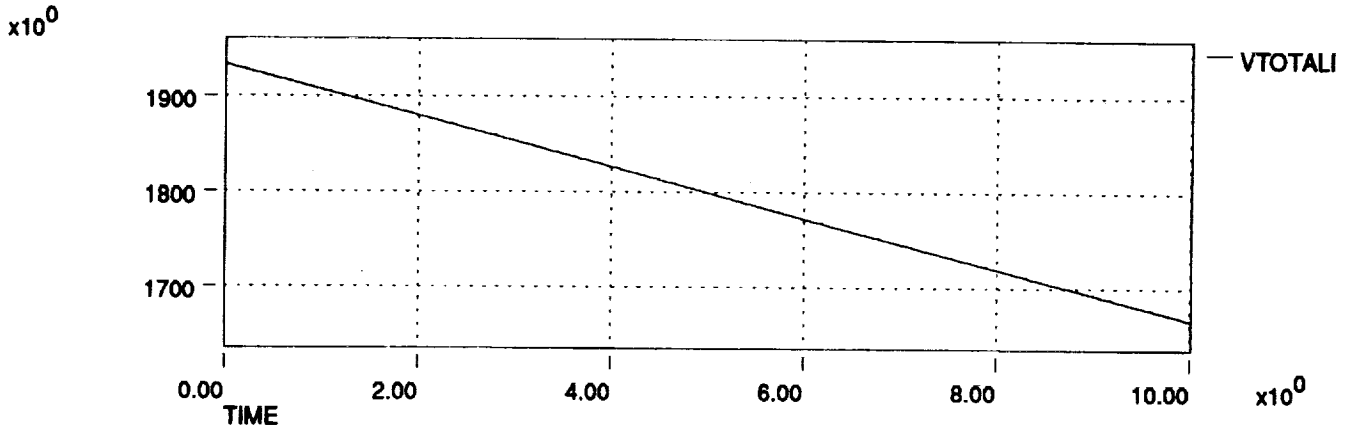
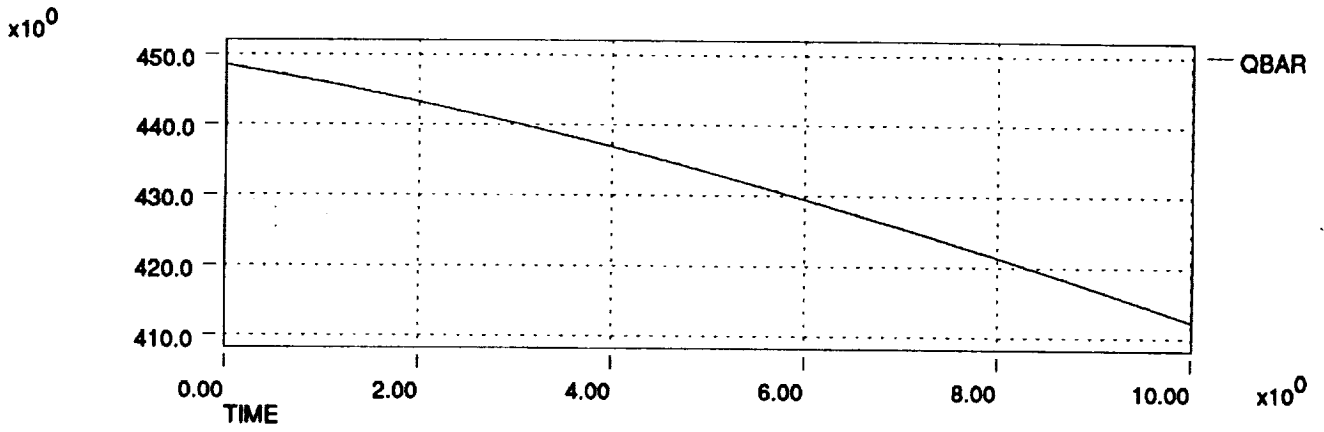
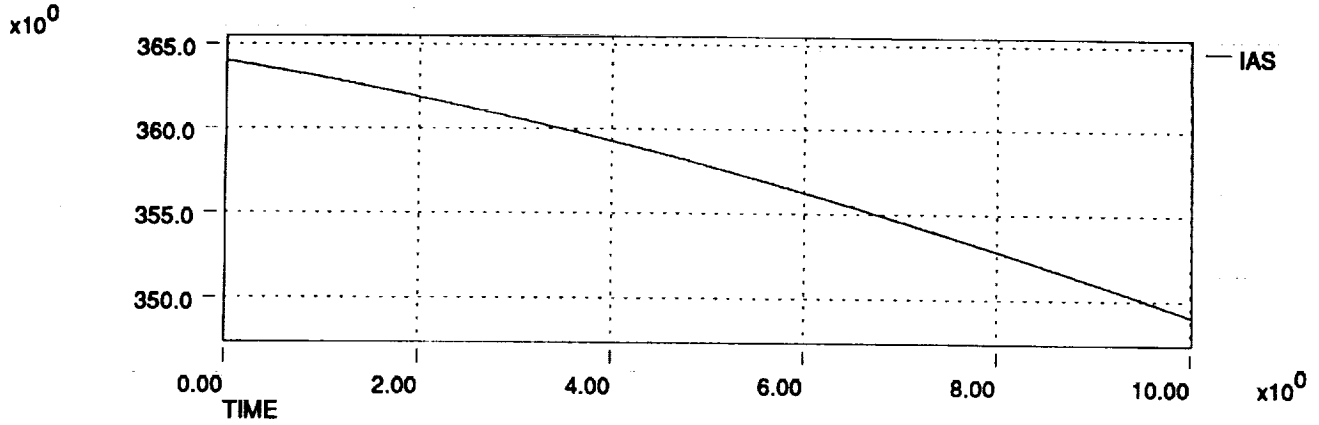

HL-20 Dynamic Check Case Data Plots 911206
Right Roll Stick Pulse at Mach 2 and 58,700 ft

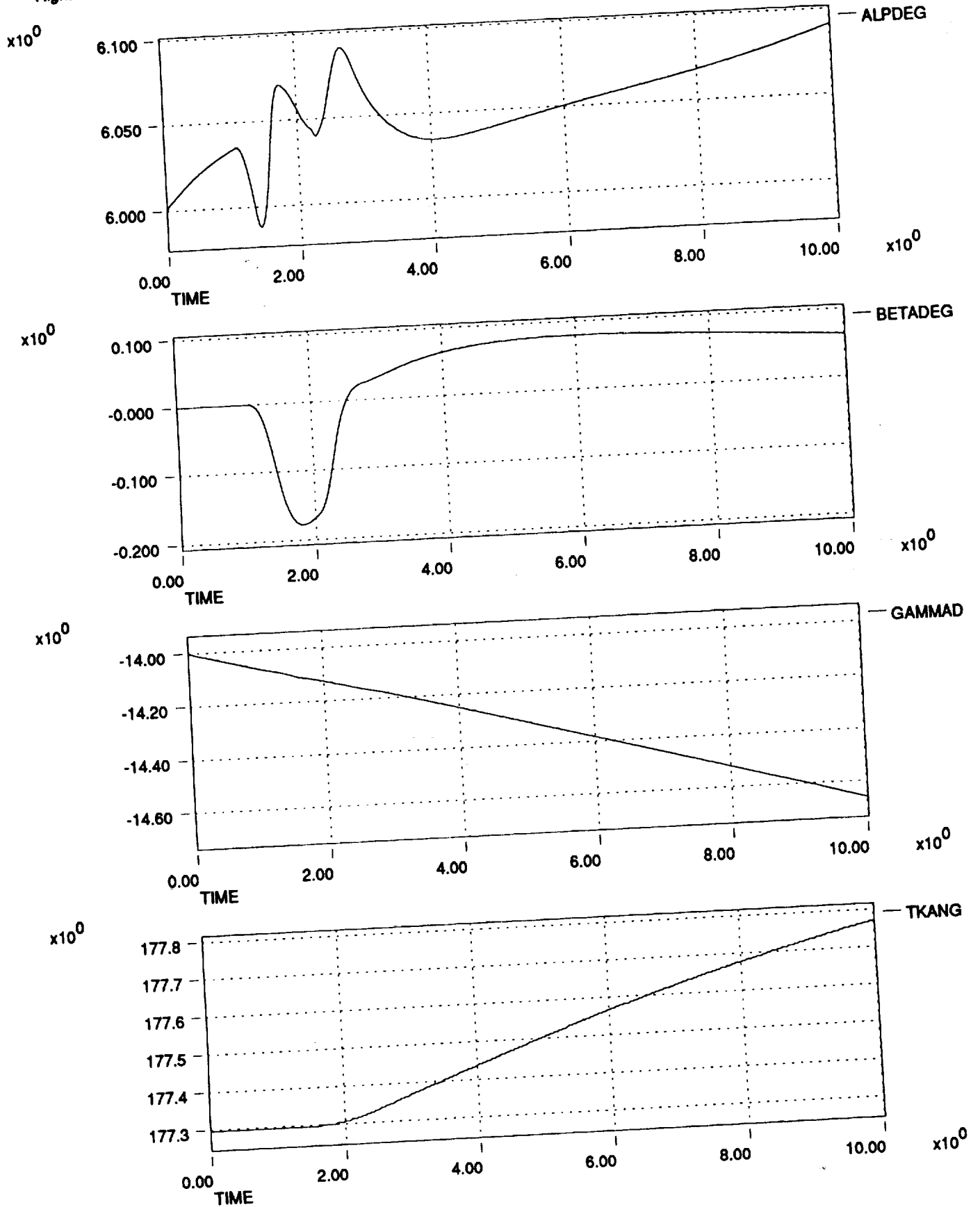

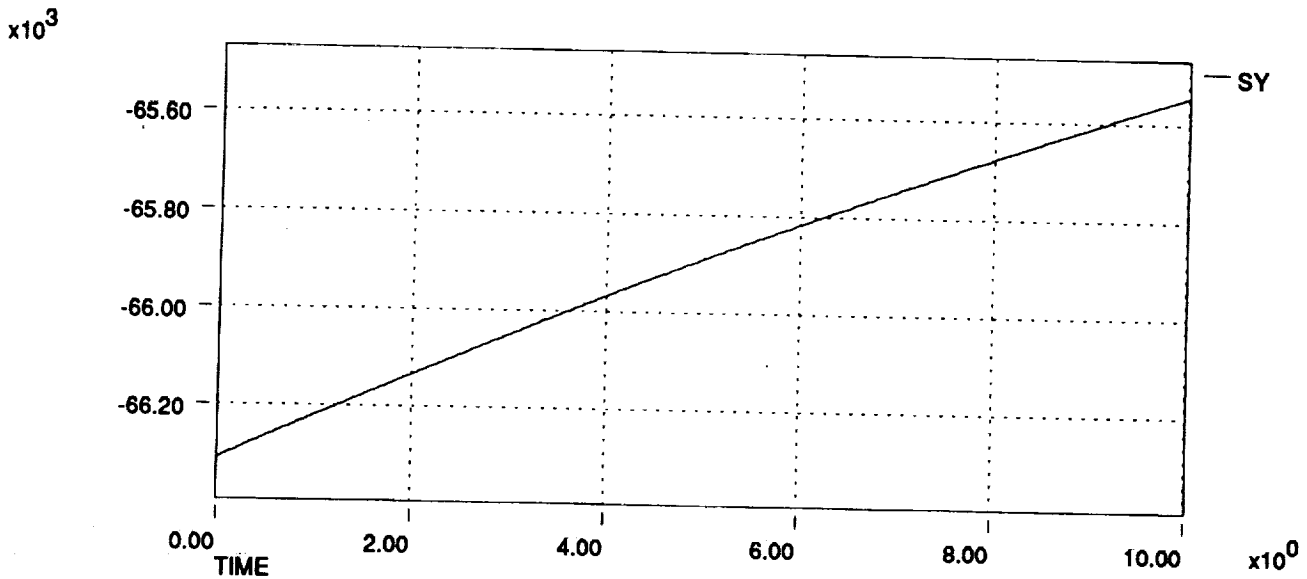
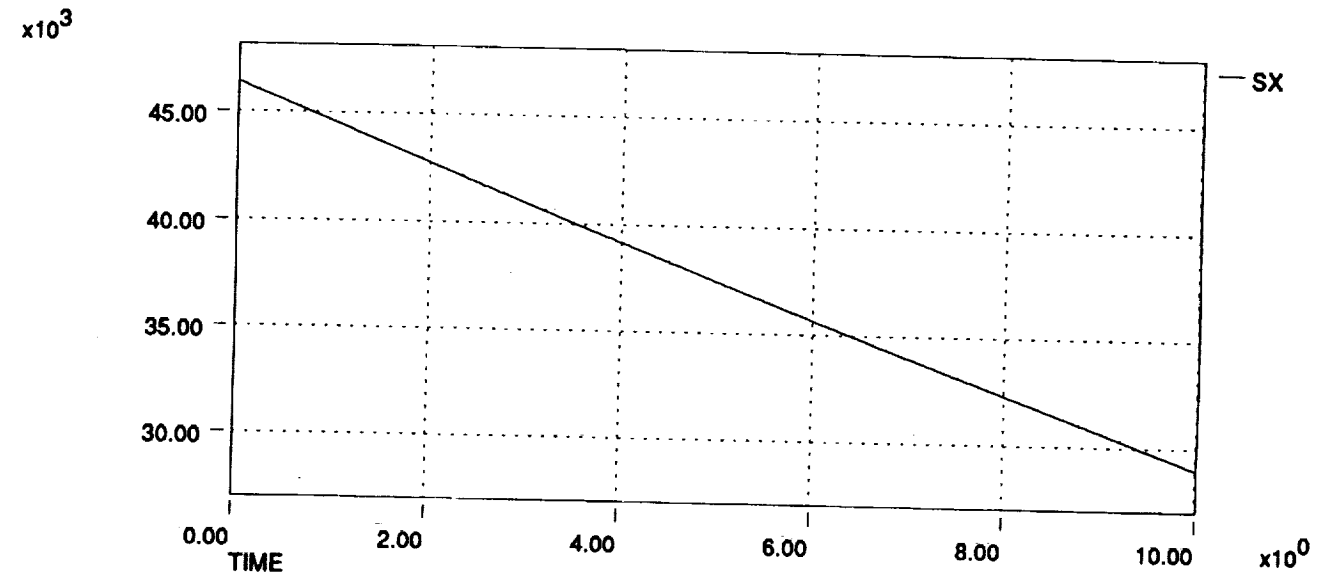
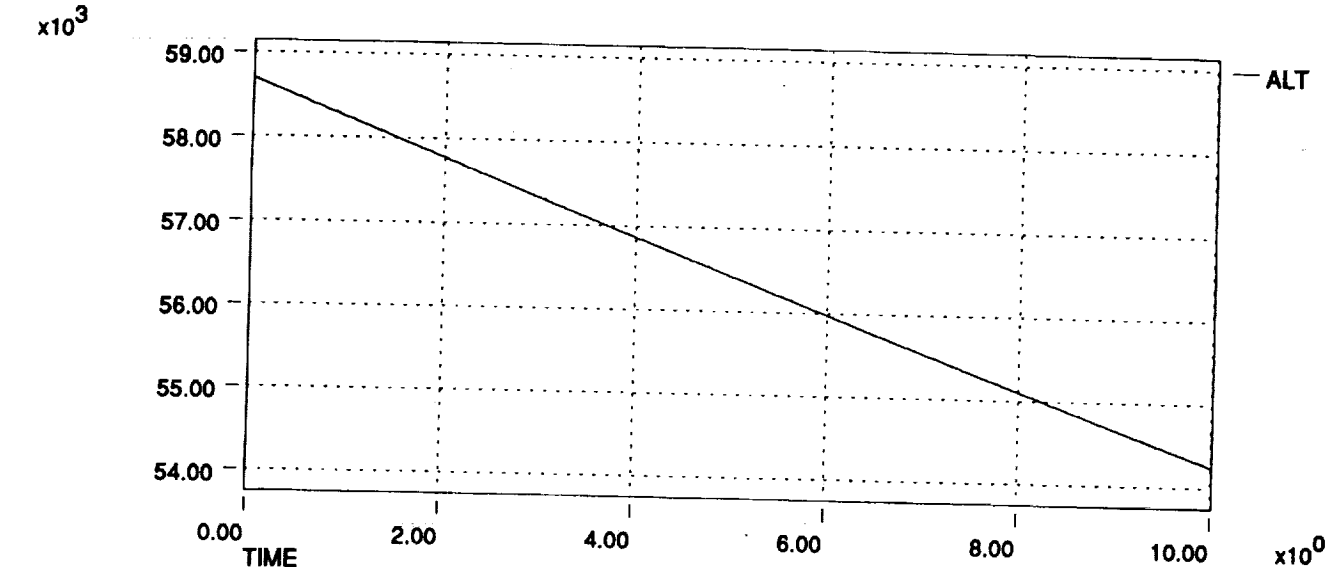

HL-20 Dynamic Check Case Data Plots 911206
Right Roll Stick Pulse at Mach 2 and 58,700 ft

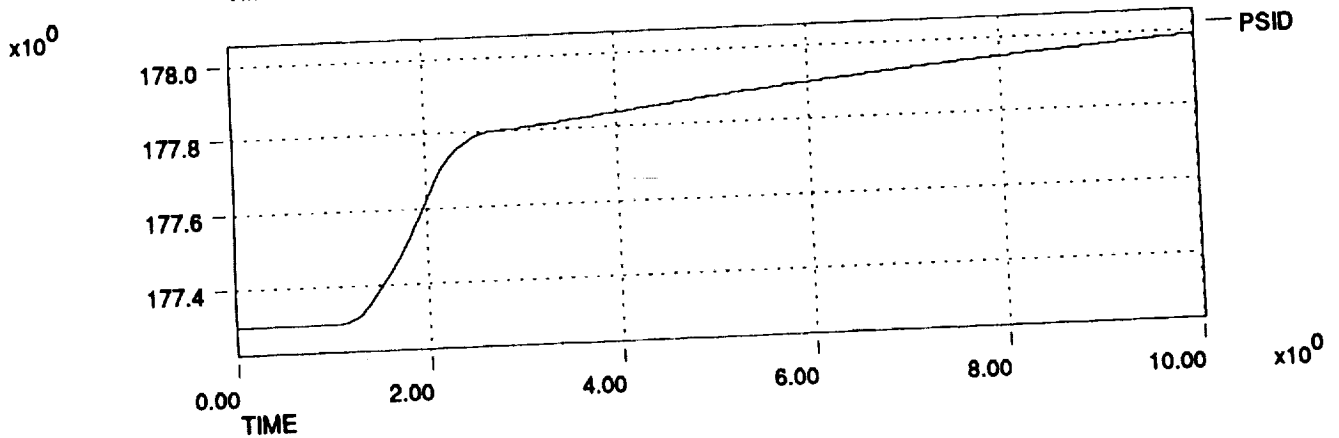
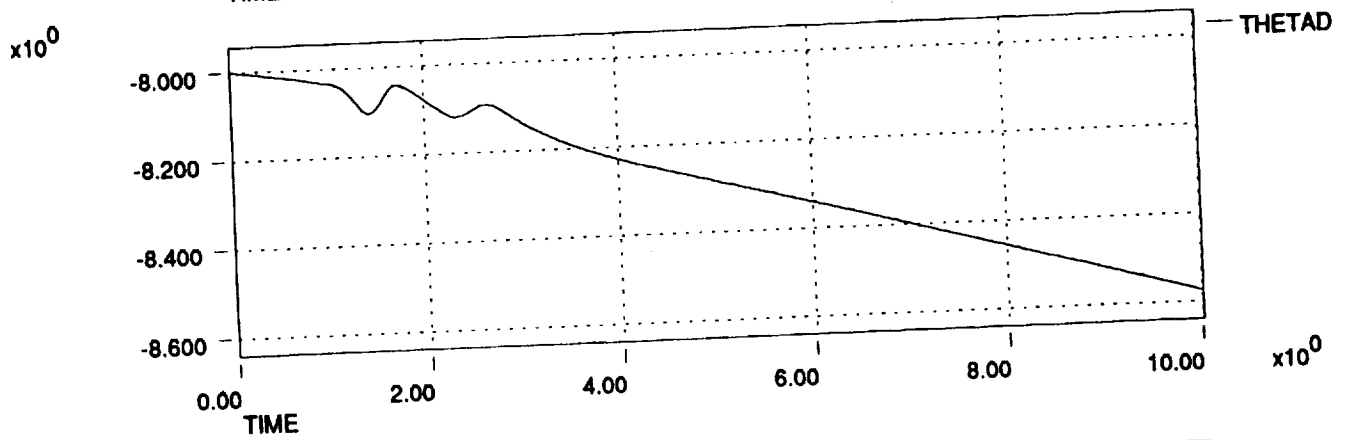
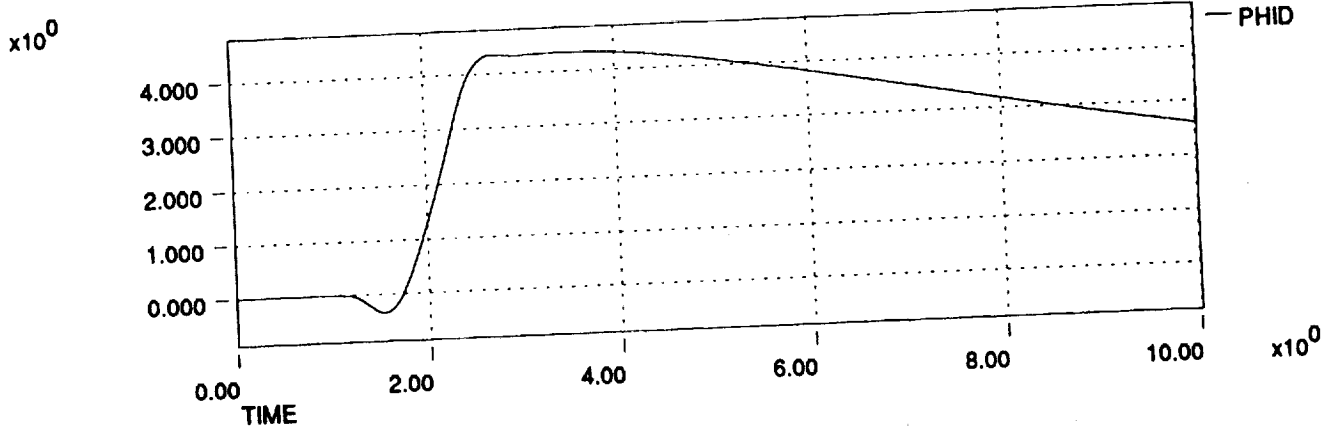
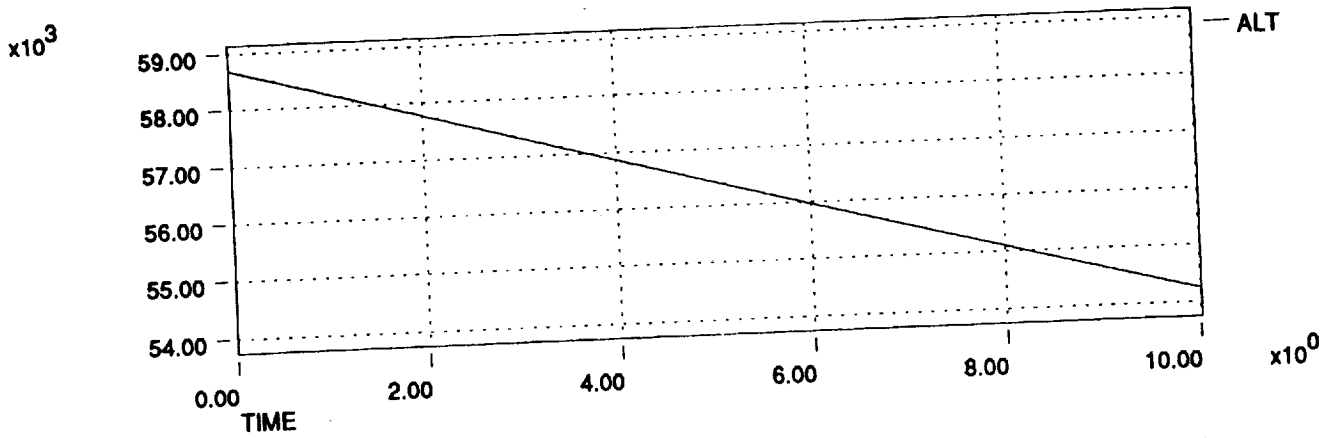

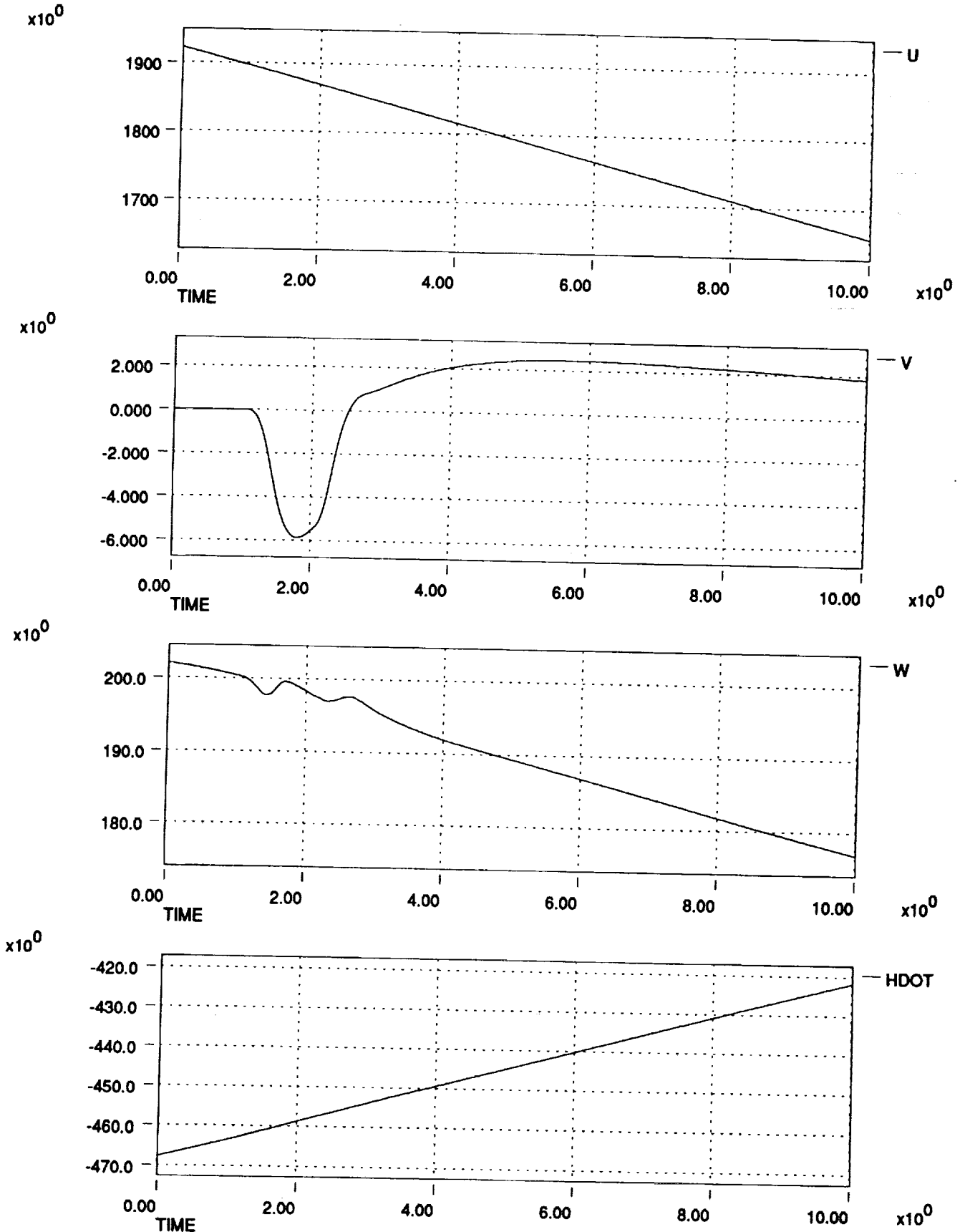

HL-20 Dynamic Check Case Data Plots 911206
Right Roll Stick Pulse at Mach 2 and 58,700 ft

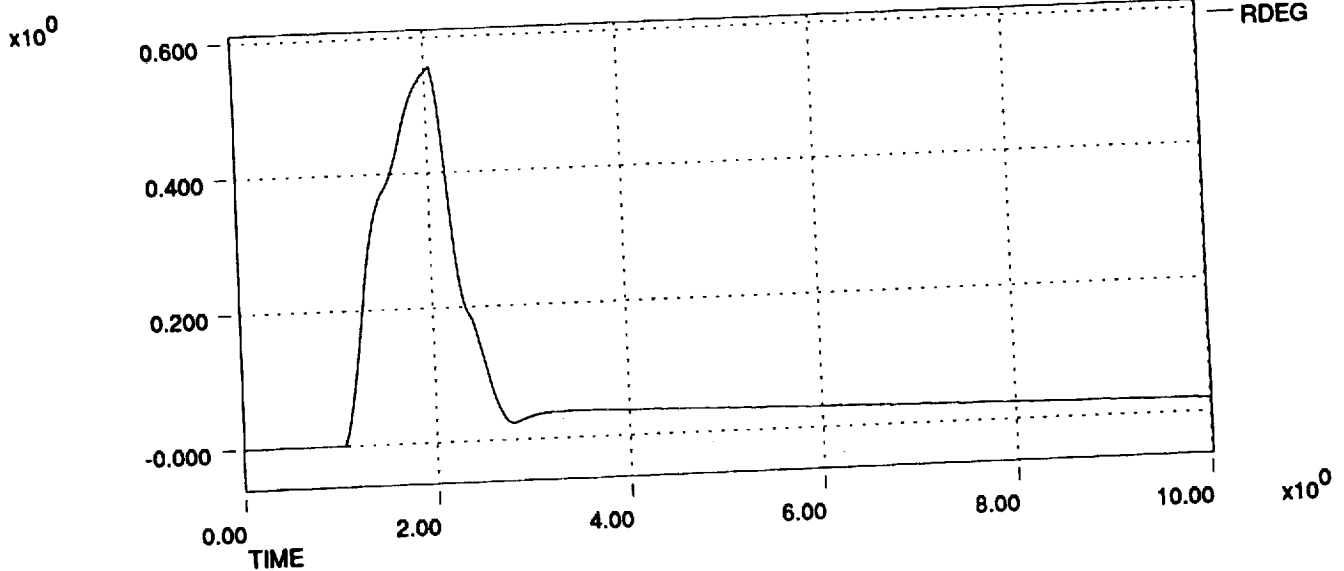
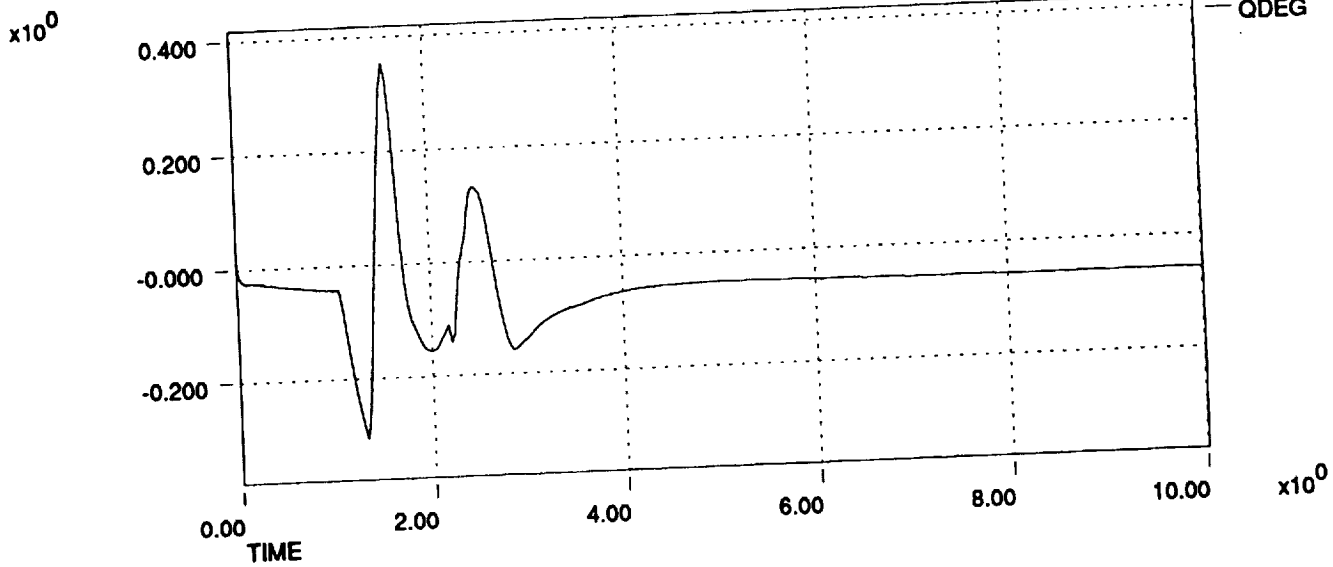
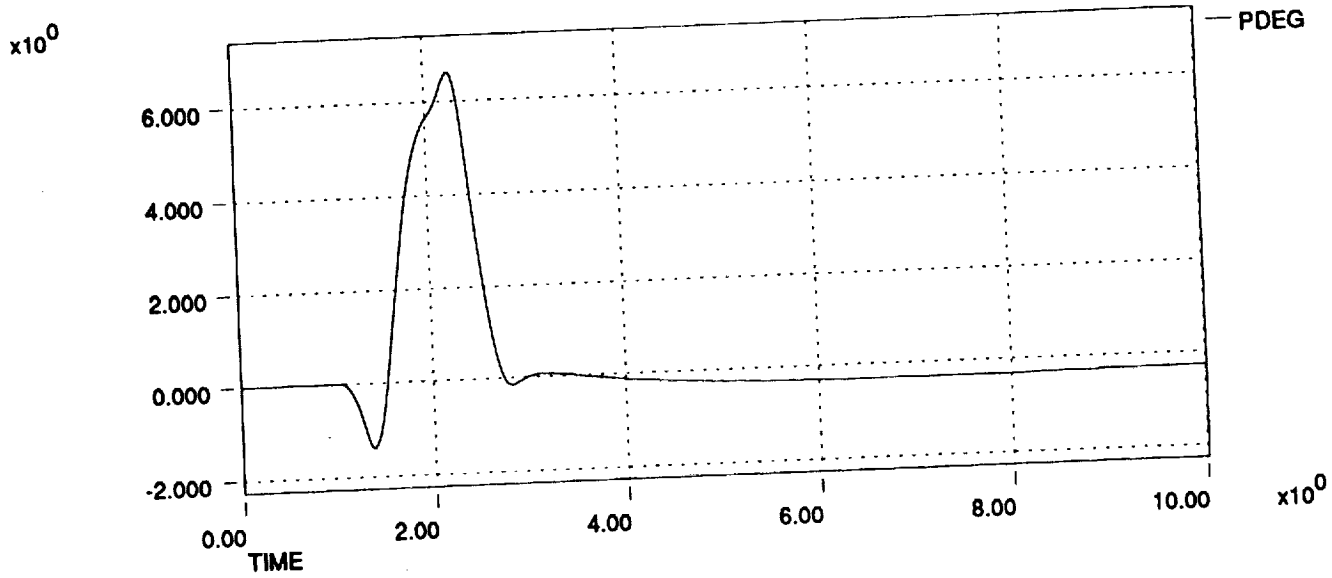

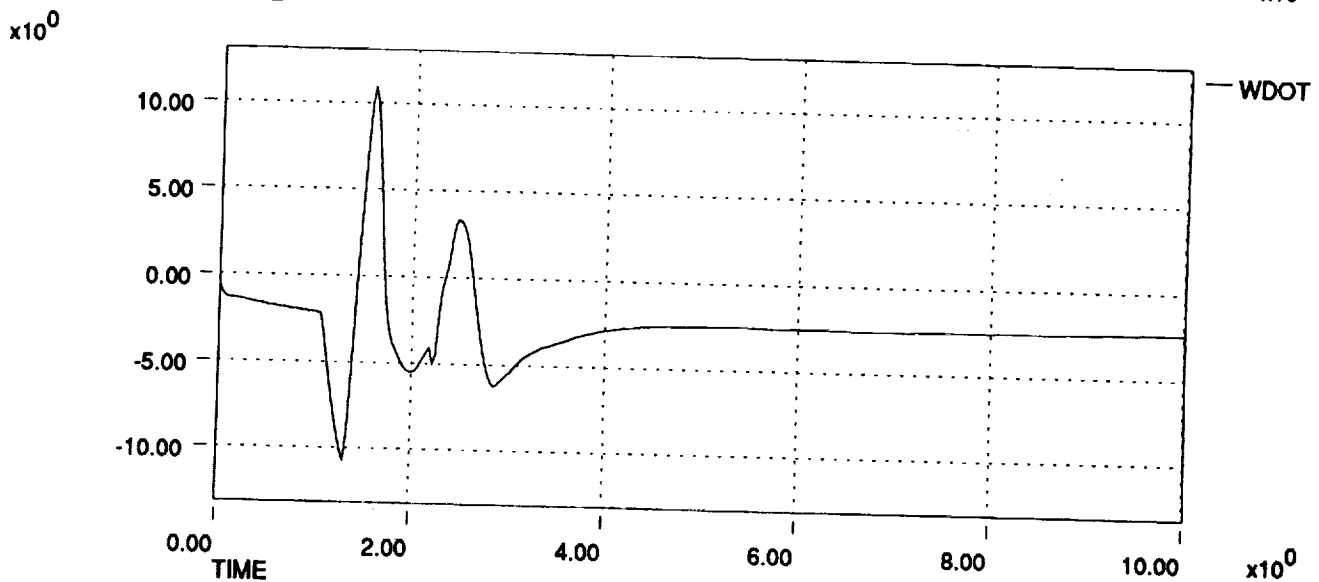
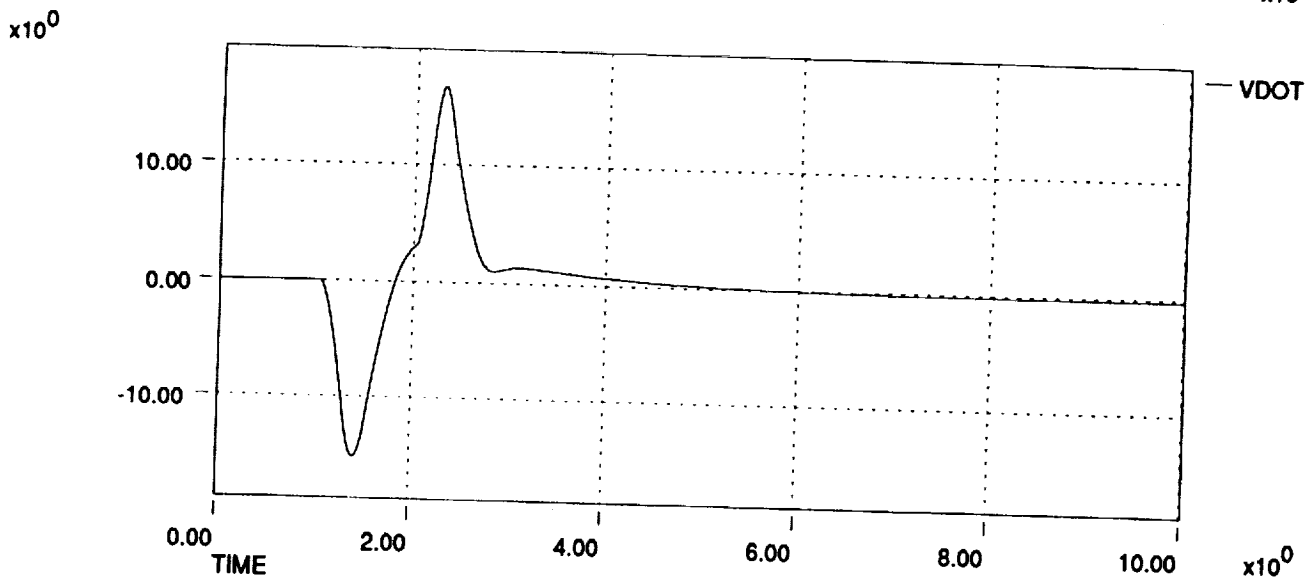
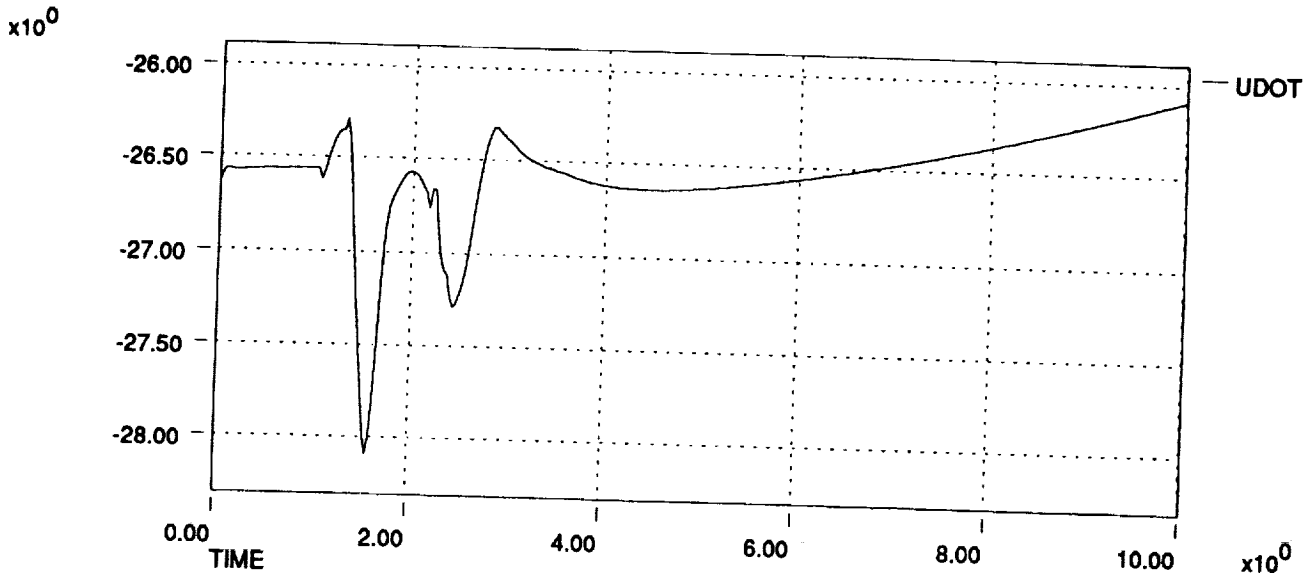

HL-20 Dynamic Check Case Data Plots 911206
Right Roll Stick Pulse at Mach 2 and 58,700 ft

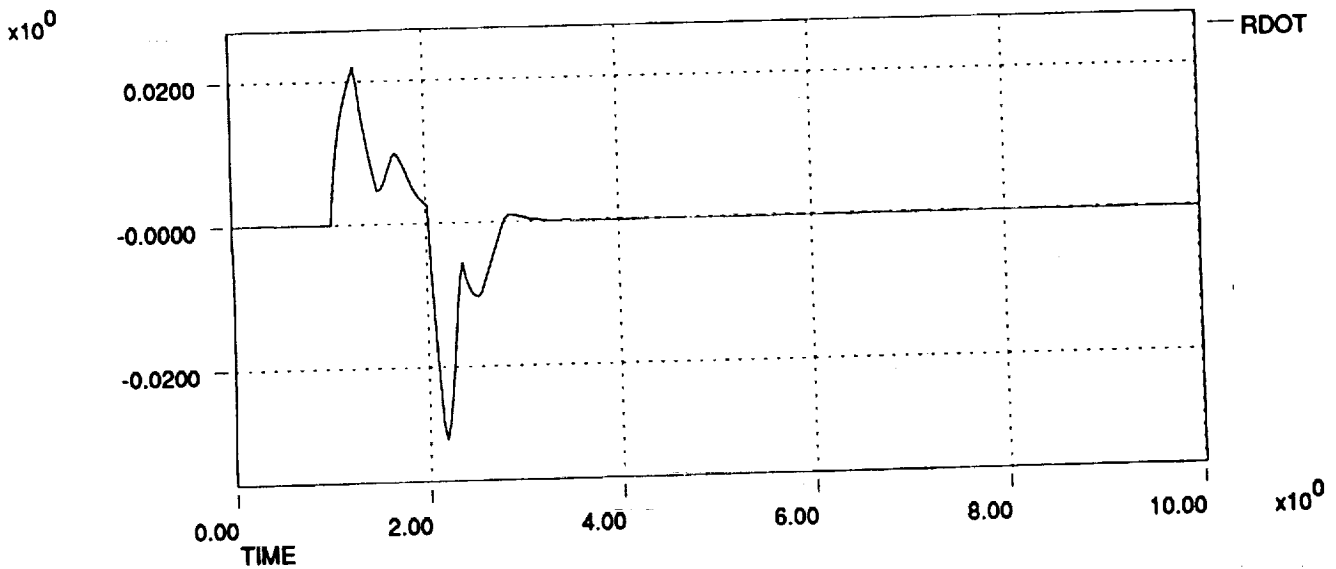
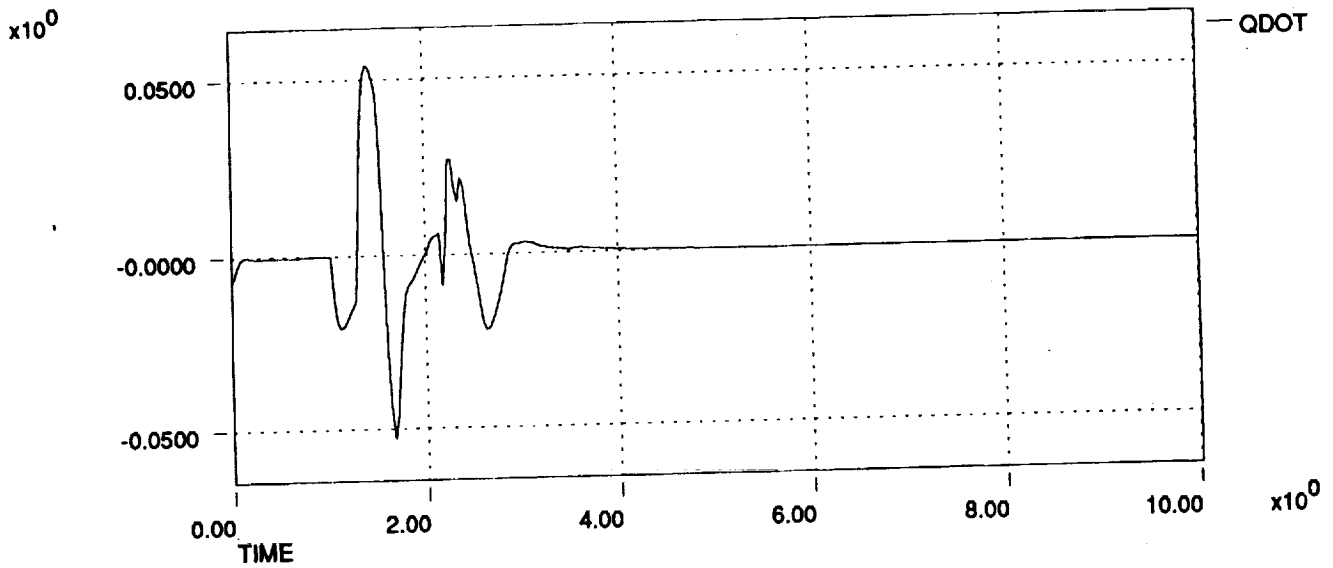
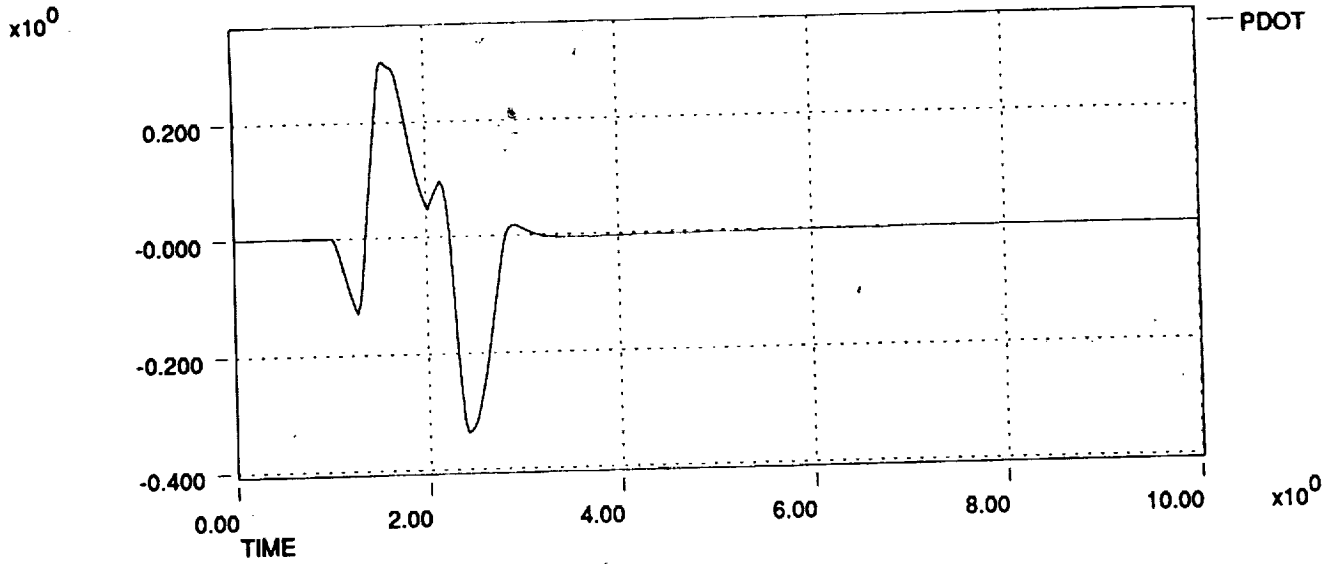

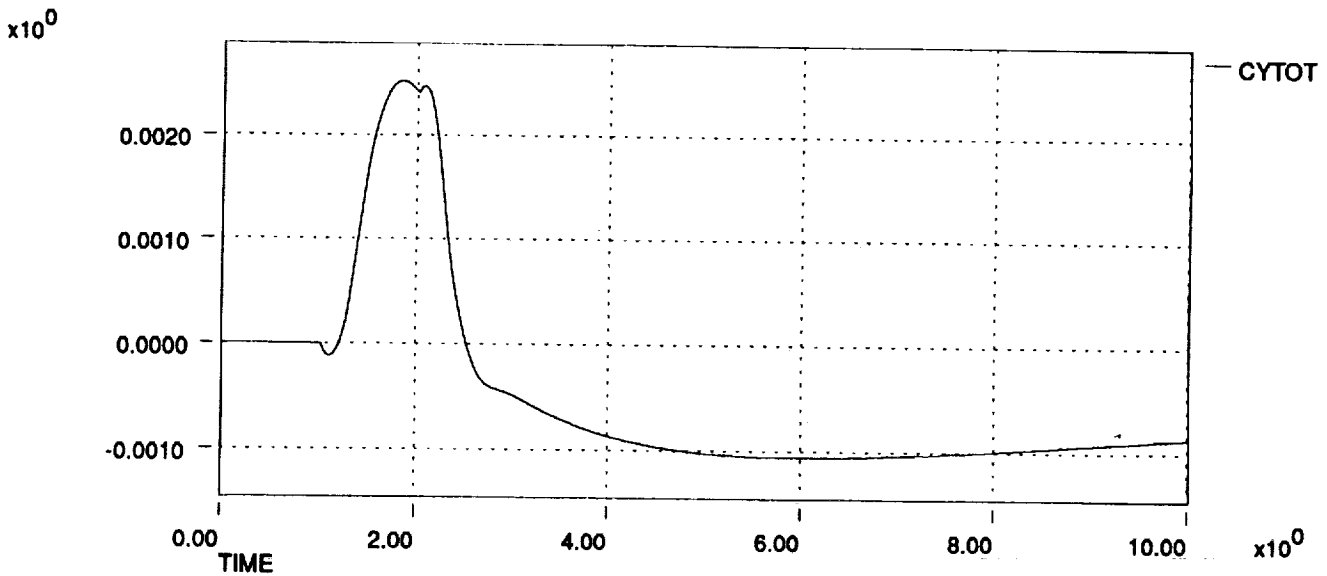
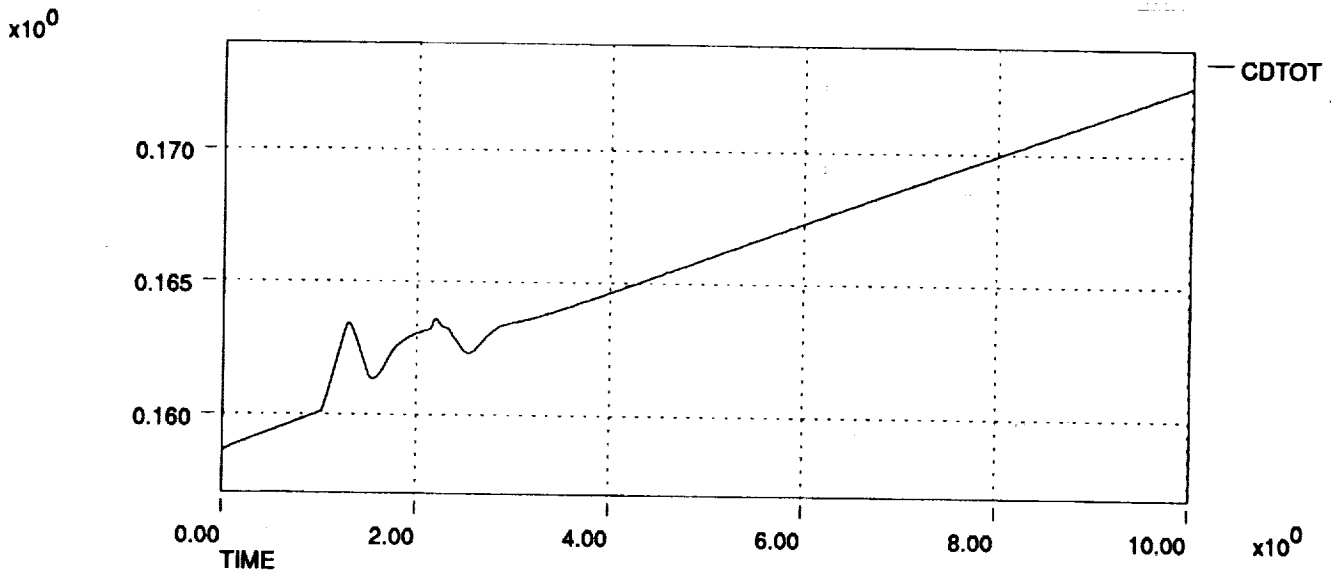
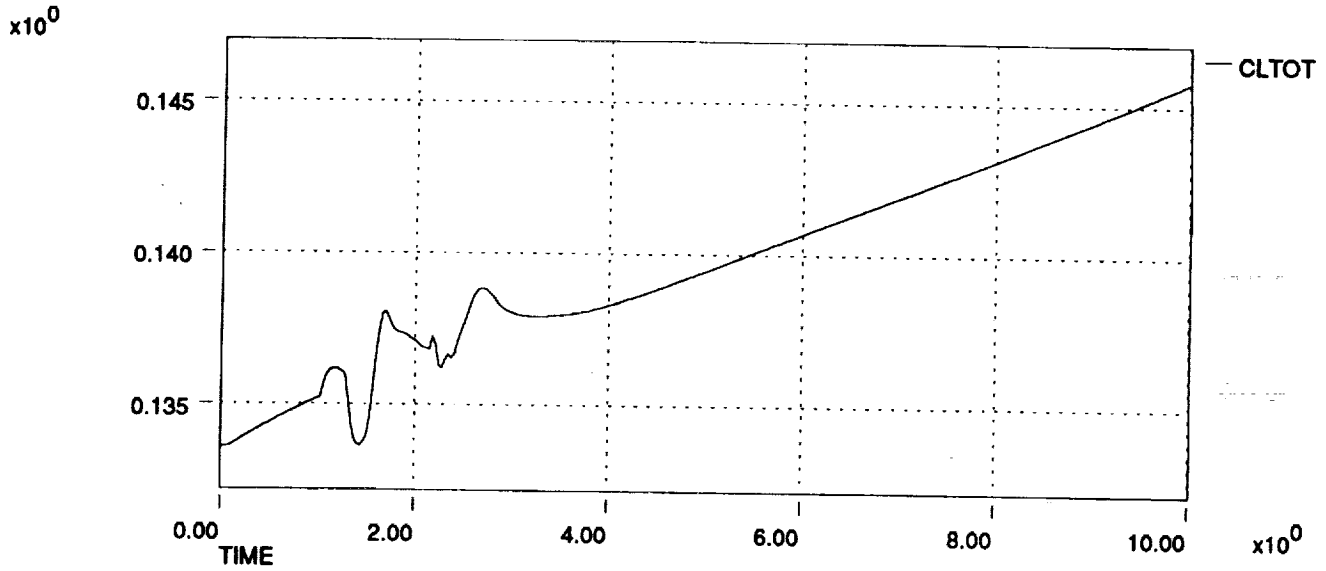

HL-20 Dynamic Check Case Data Plots 911206
Right Roll Stick Pulse at Mach 2 and 58,700 ft

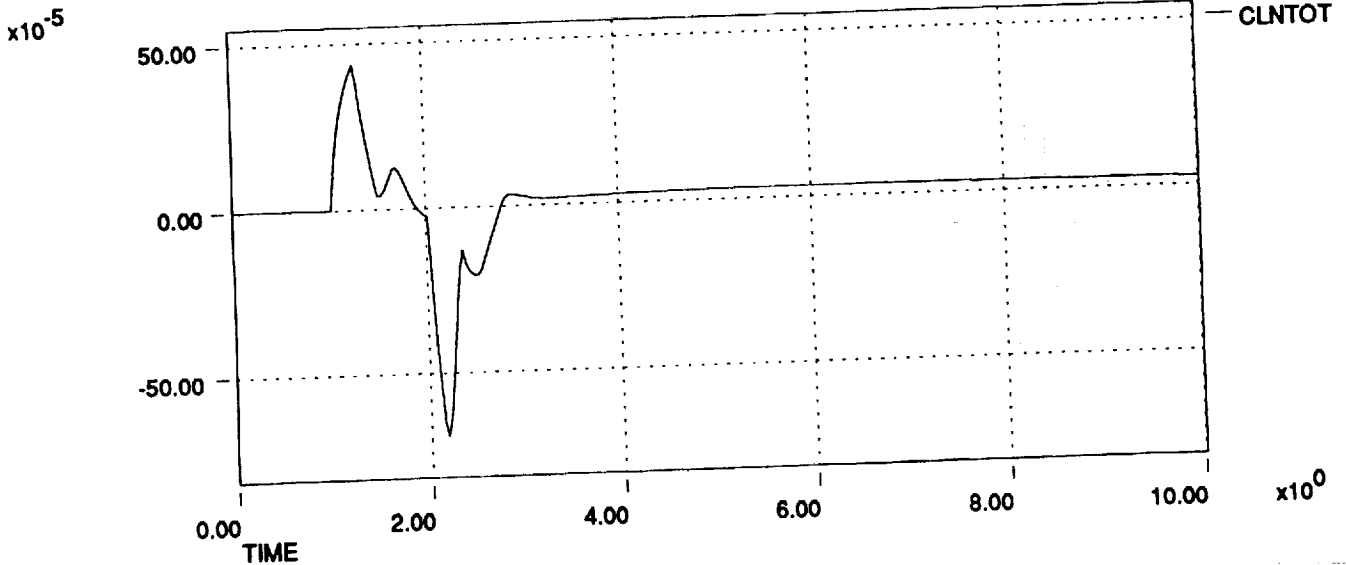
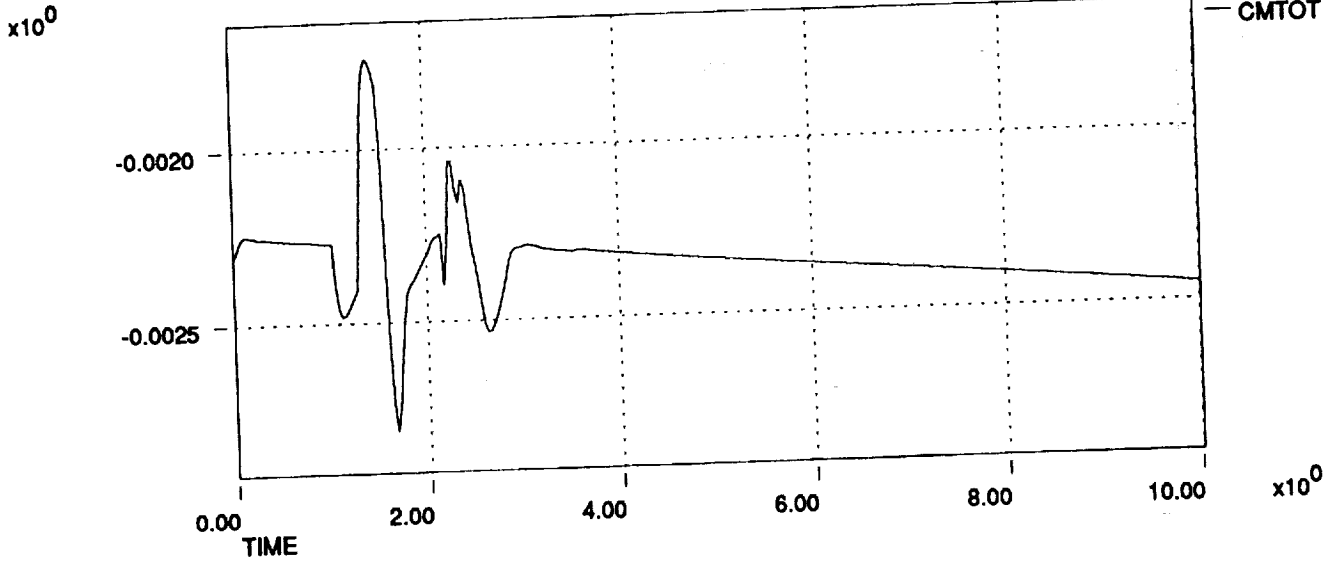
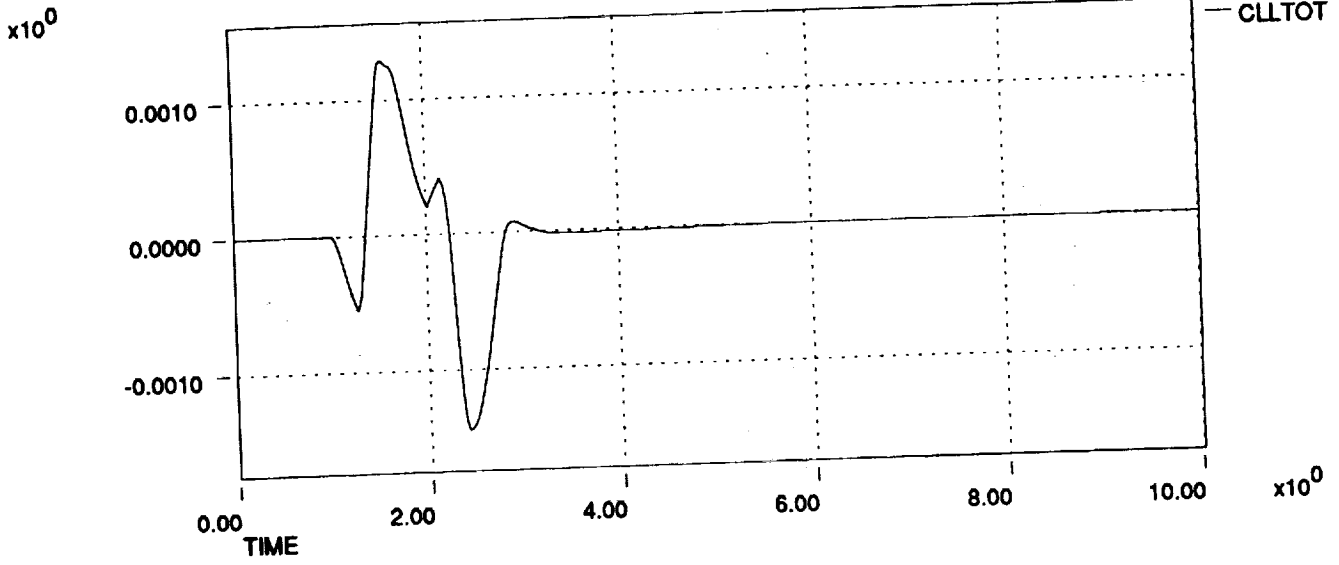

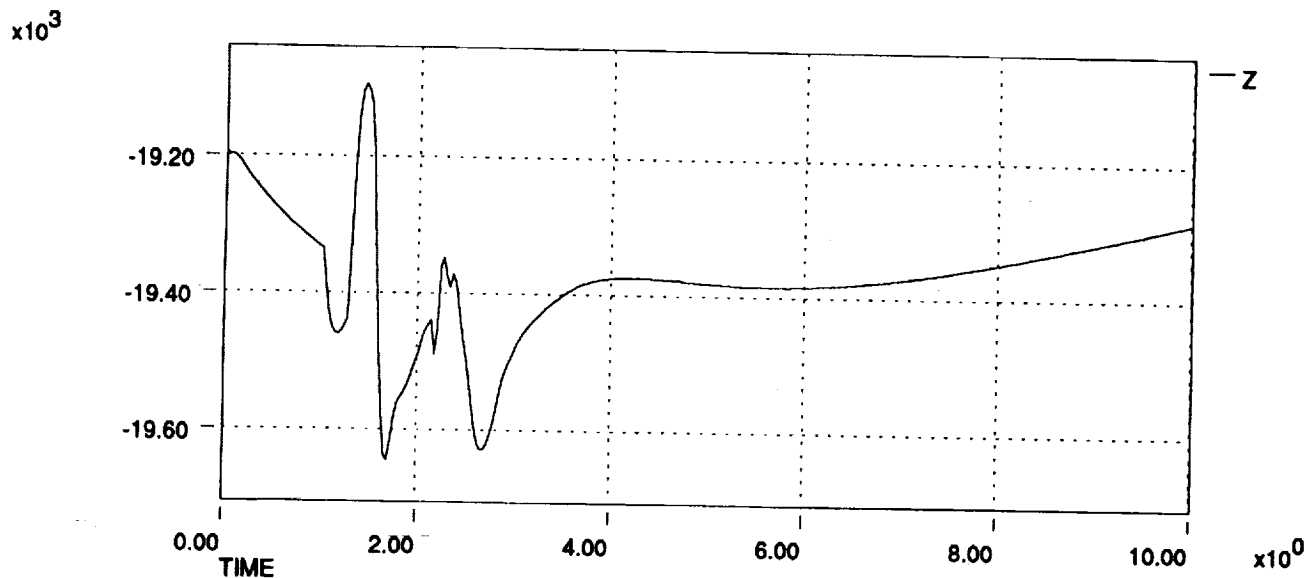
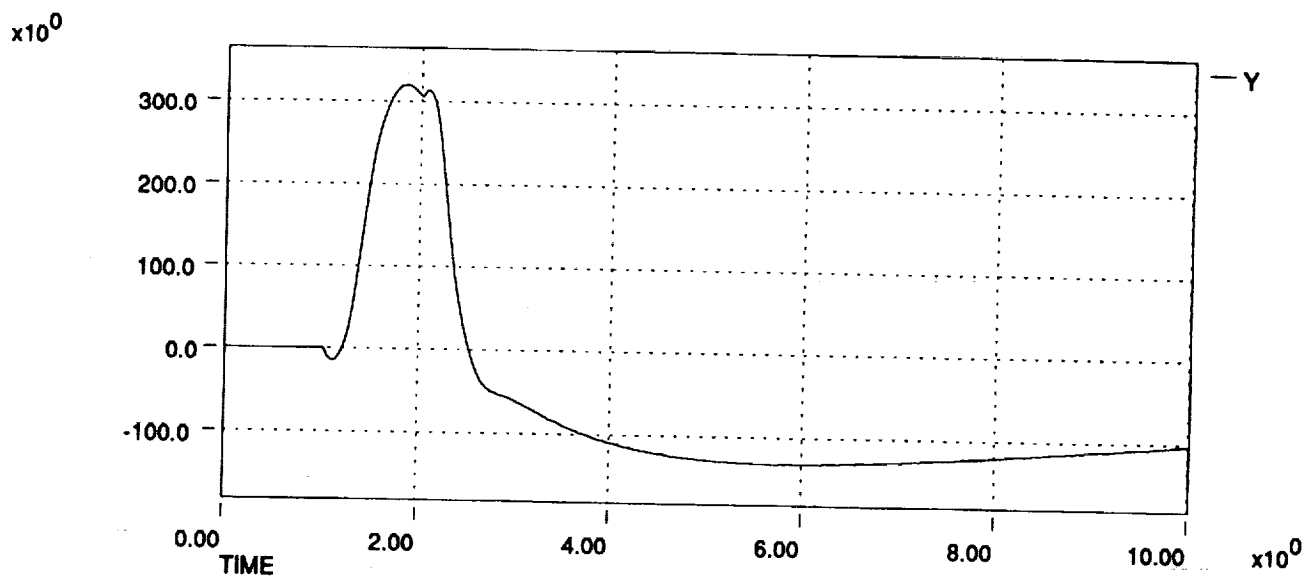
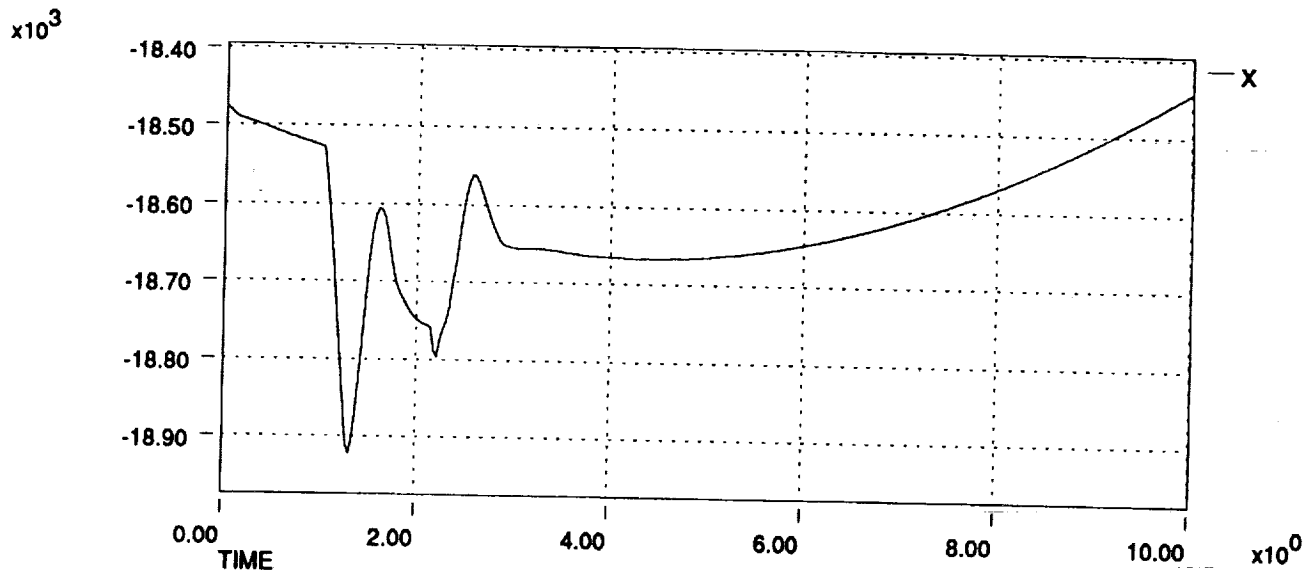

HL-20 Dynamic Check Case Data Plots 911206
Right Roll Stick Pulse at Mach 2 and 58,700 ft

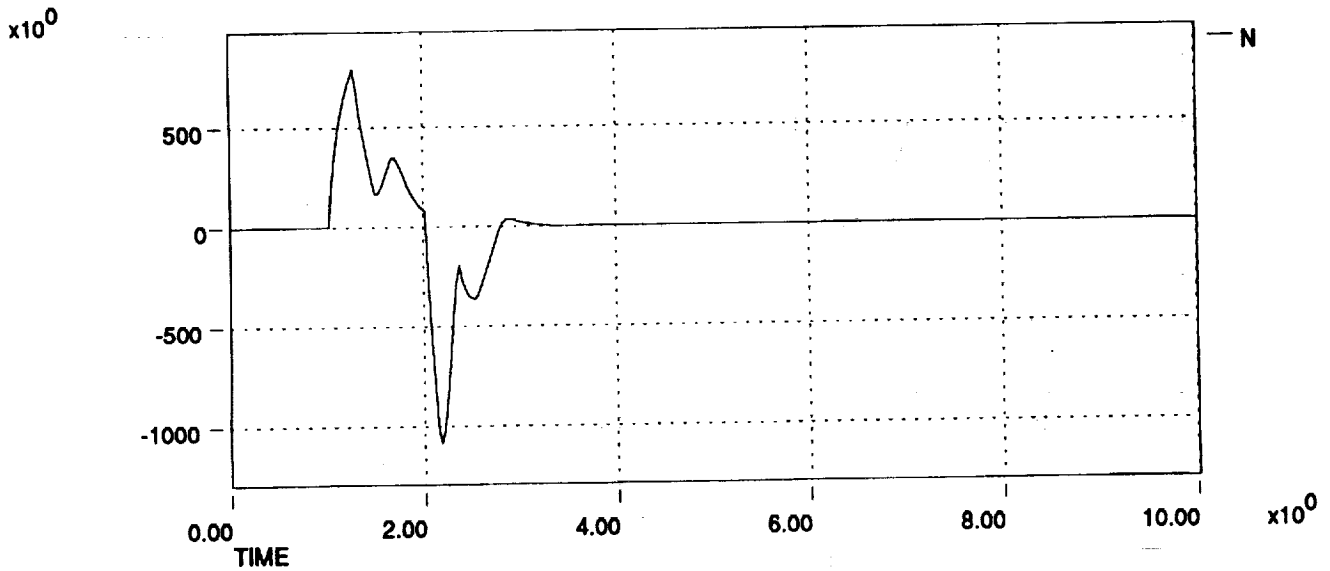
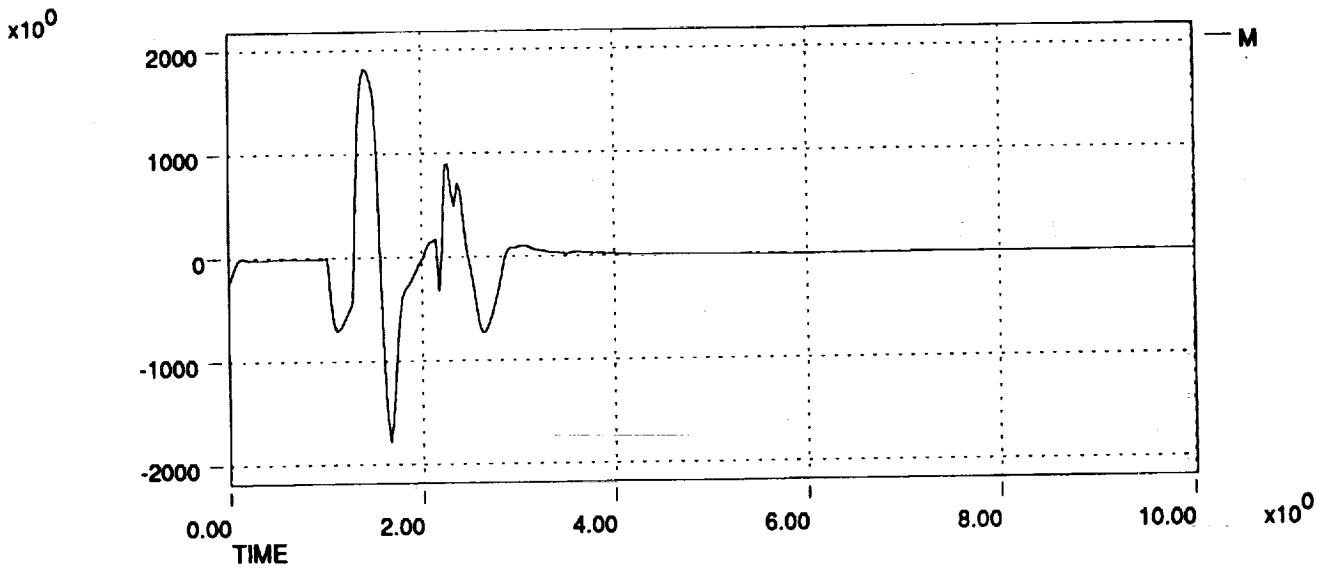
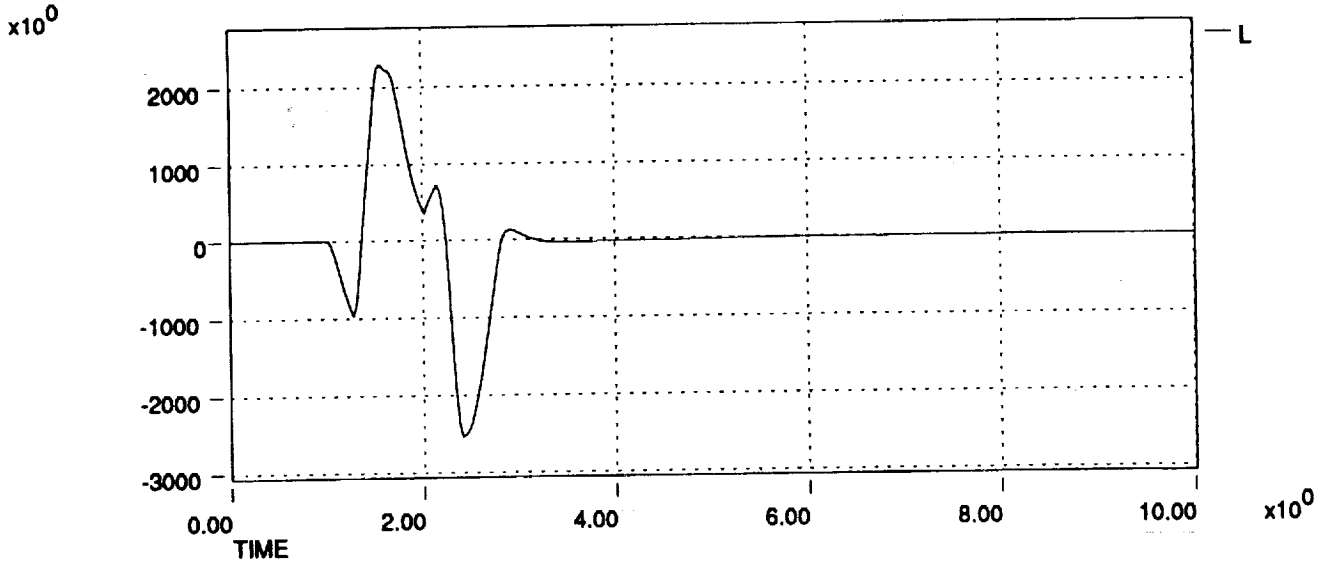

HL-20 Dynamic Check Case Data Plots 911206
Right Roll Stick Pulse at Mach 2 and 58,700 ft

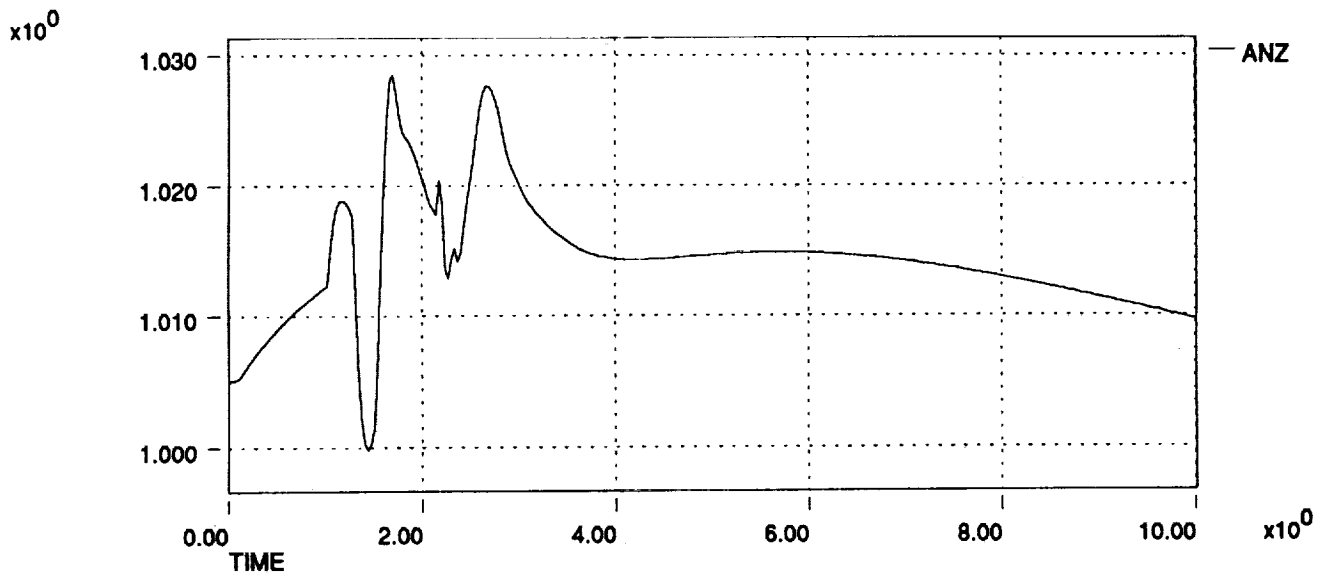
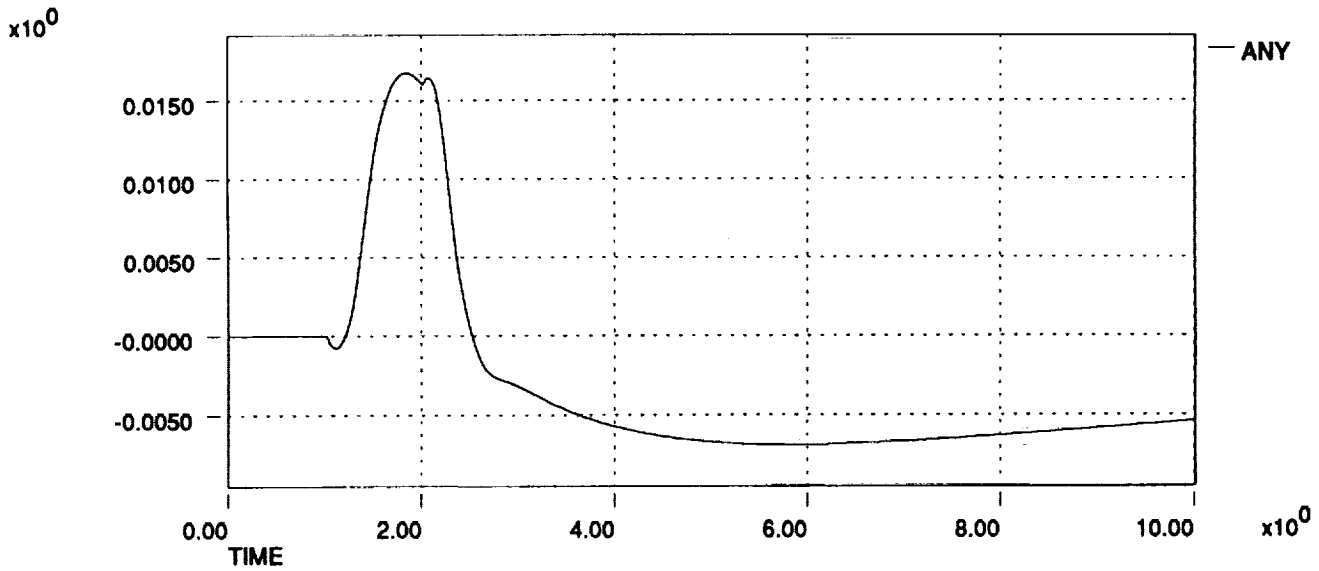
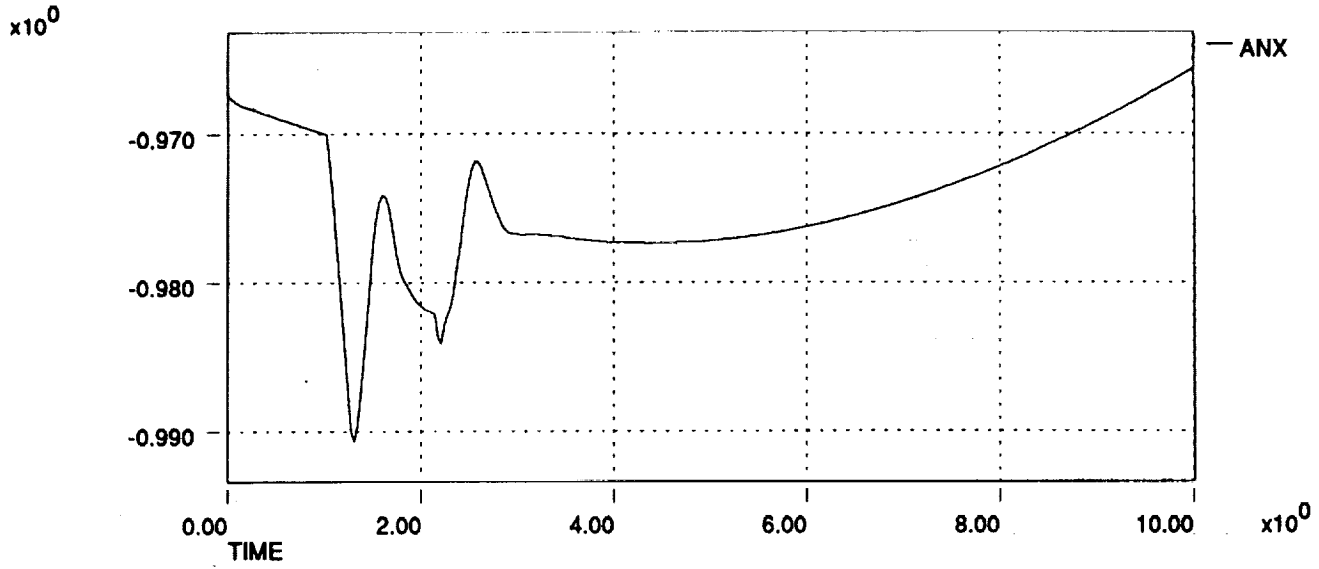

HL-20 Dynamic Check Case Data Plots 911206
Right Roll Stick Pulse at Mach 2 and 58,700 ft

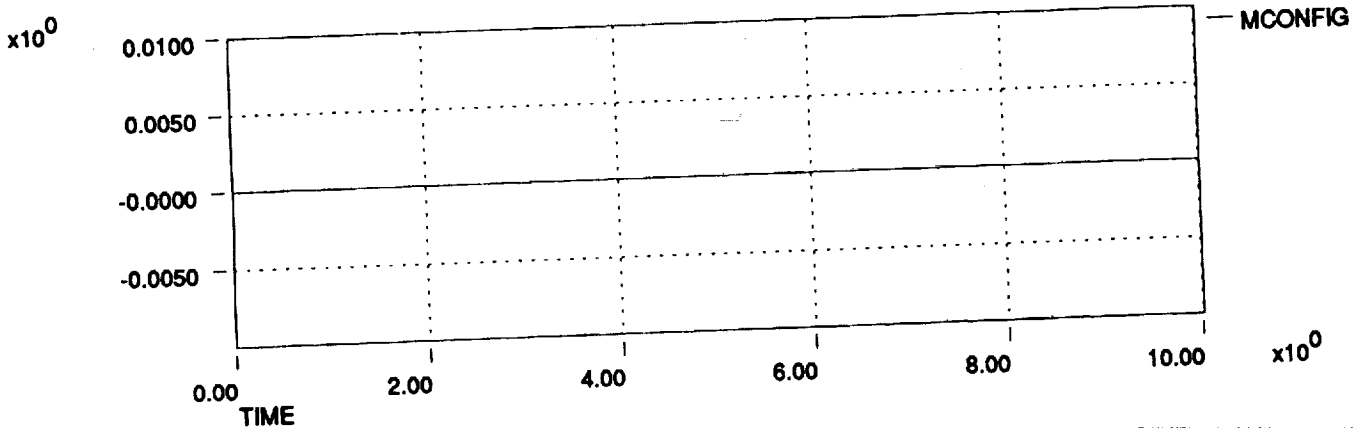
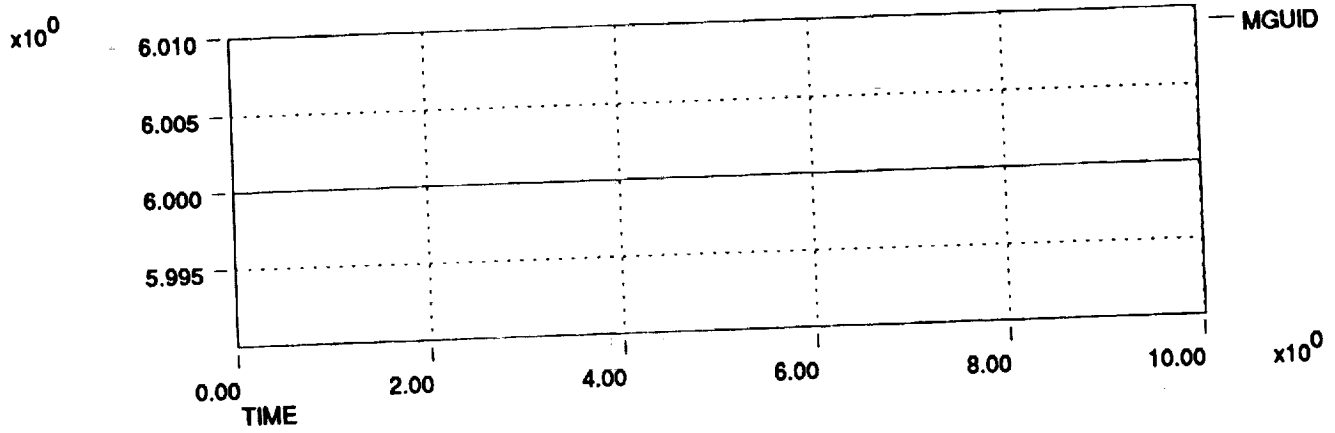
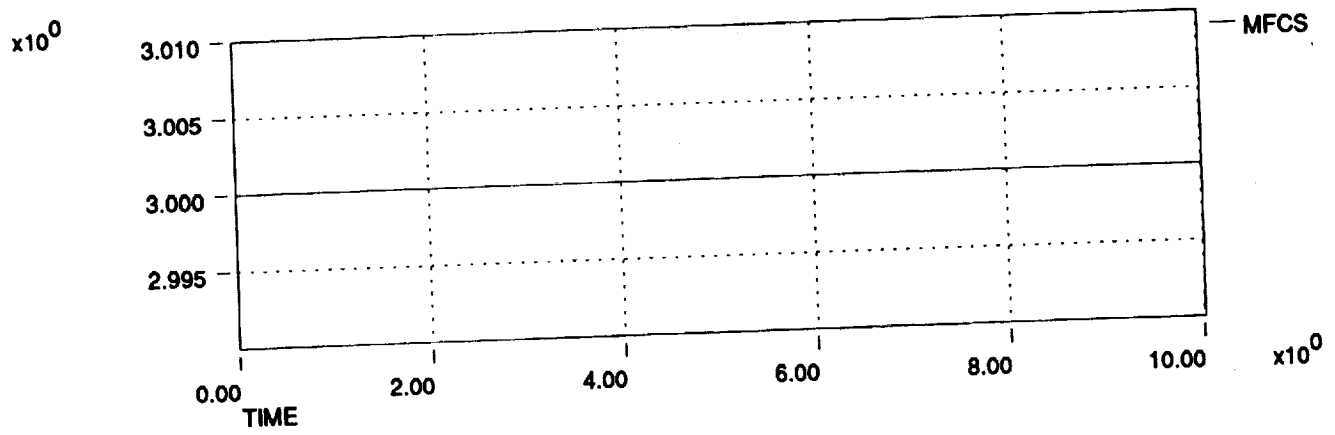
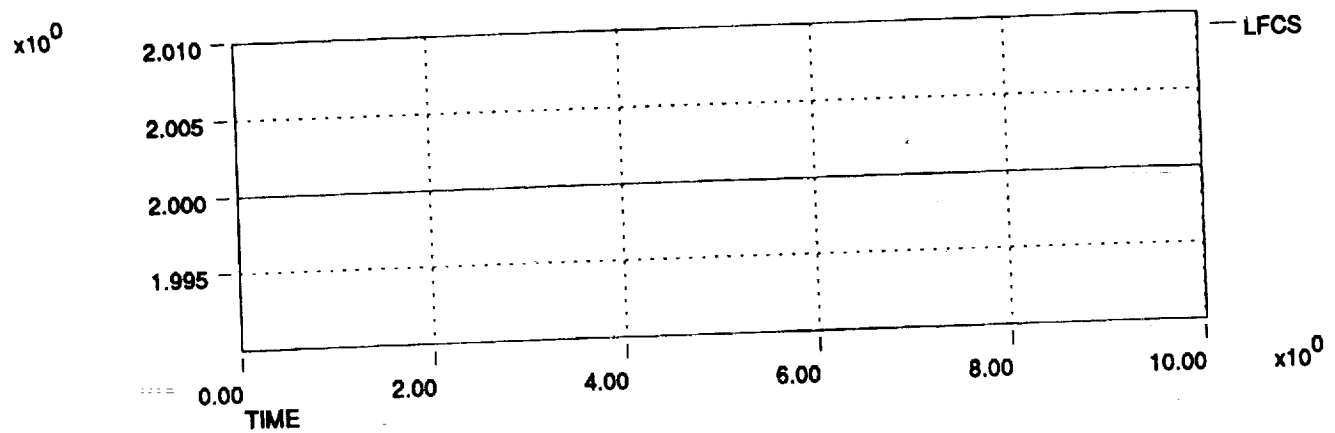

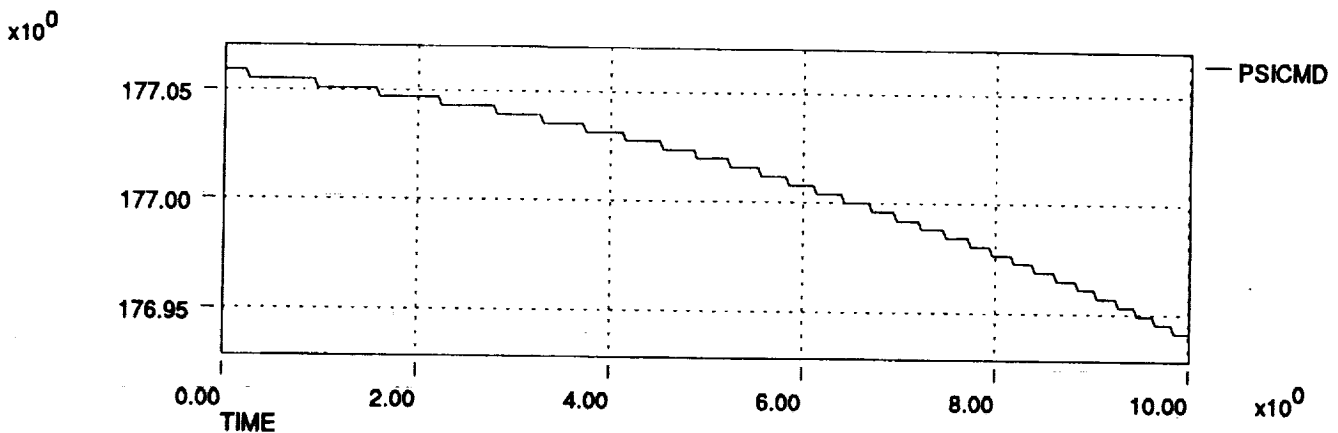
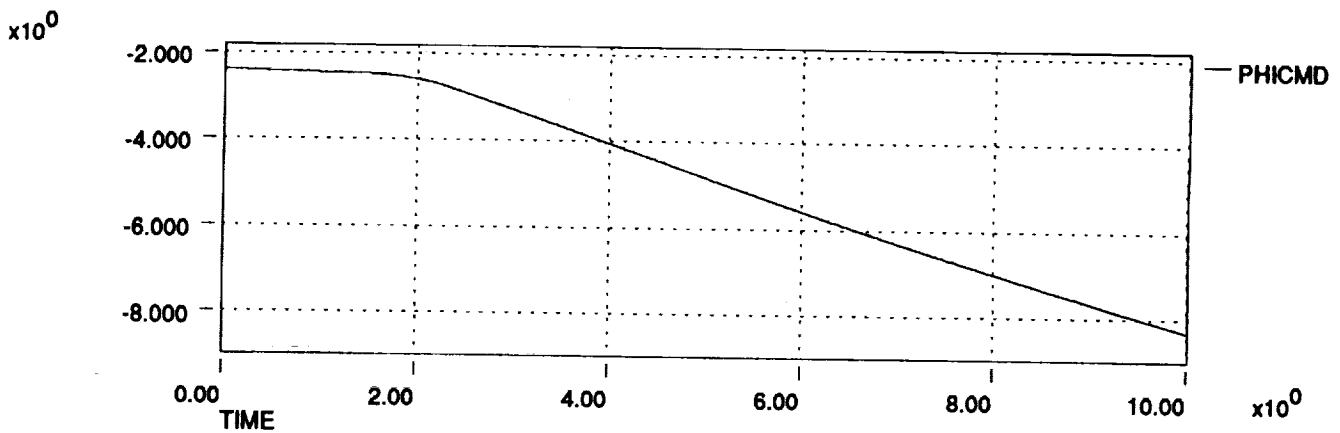
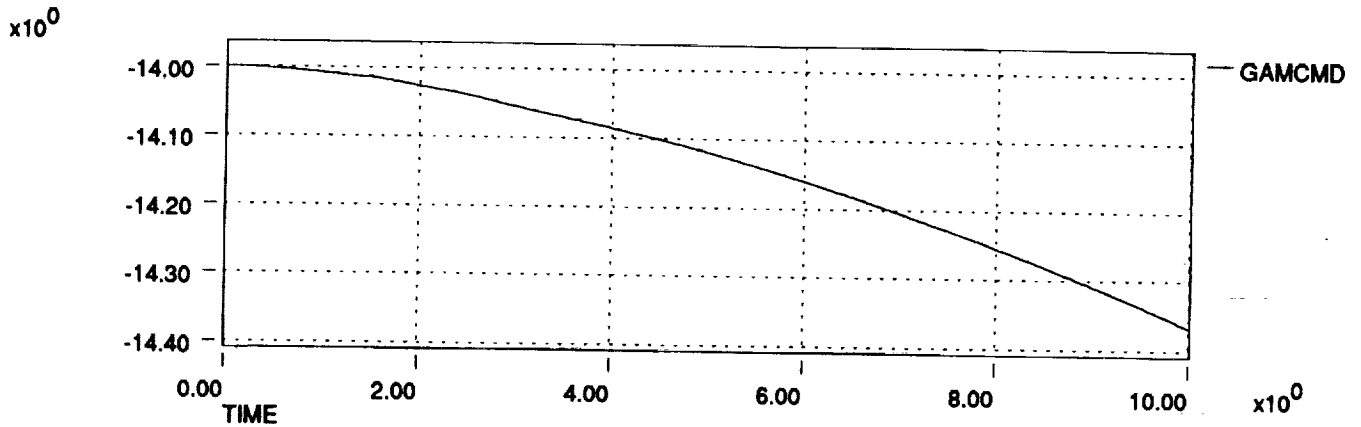
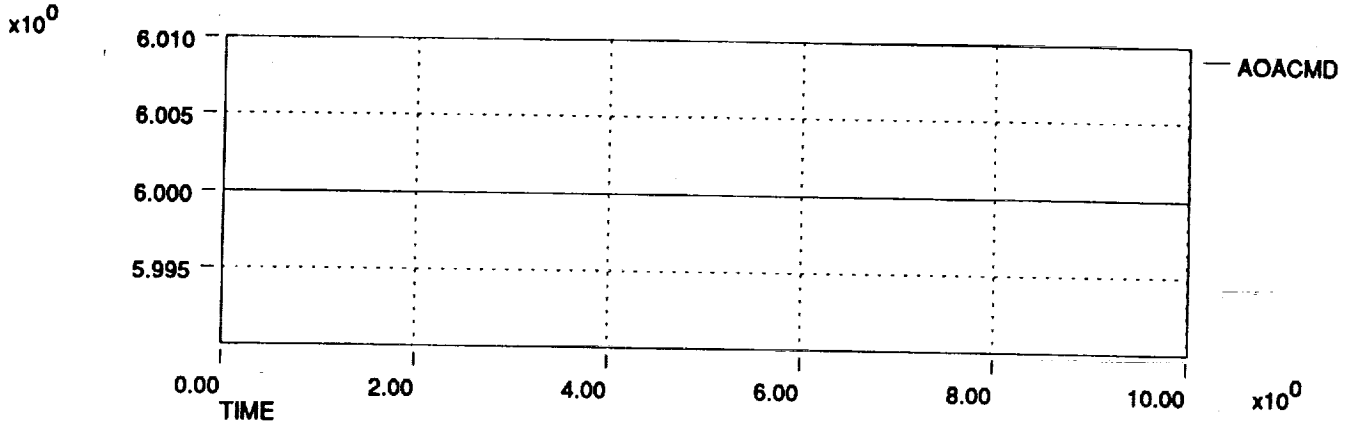

HL-20 Dynamic Check Case Data Plots 911206
Right Roll Stick Pulse at Mach 2 and 58,700 ft

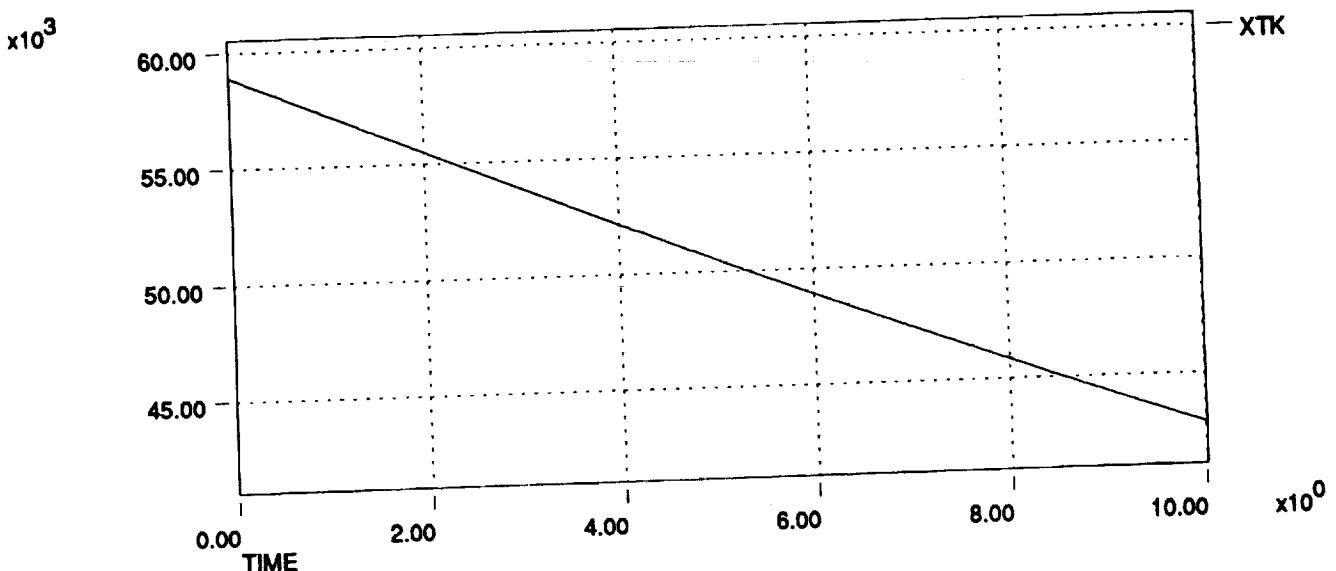
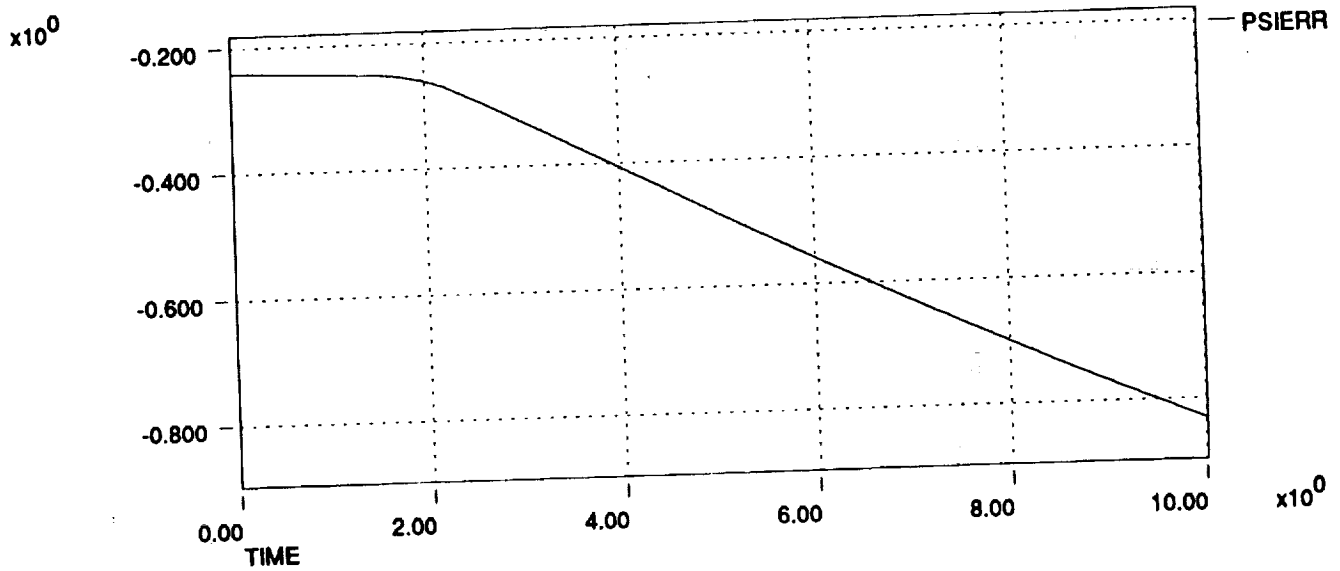
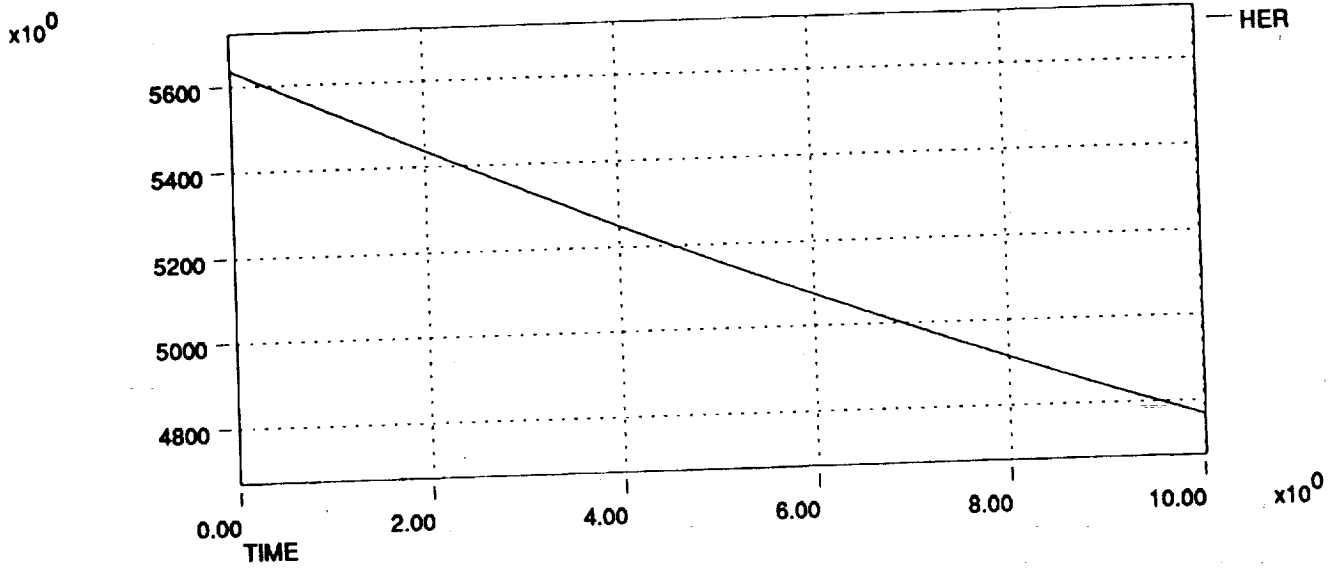

HL-20 Dynamic Check Case Data Plots 911206
Right Roll Stick Pulse at Mach 2 and 58,700 ft

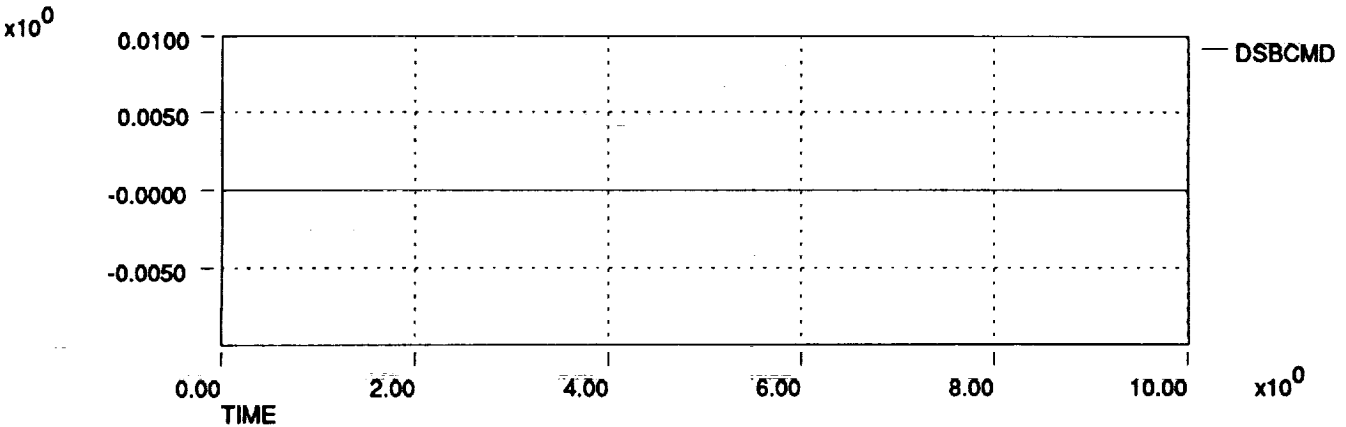
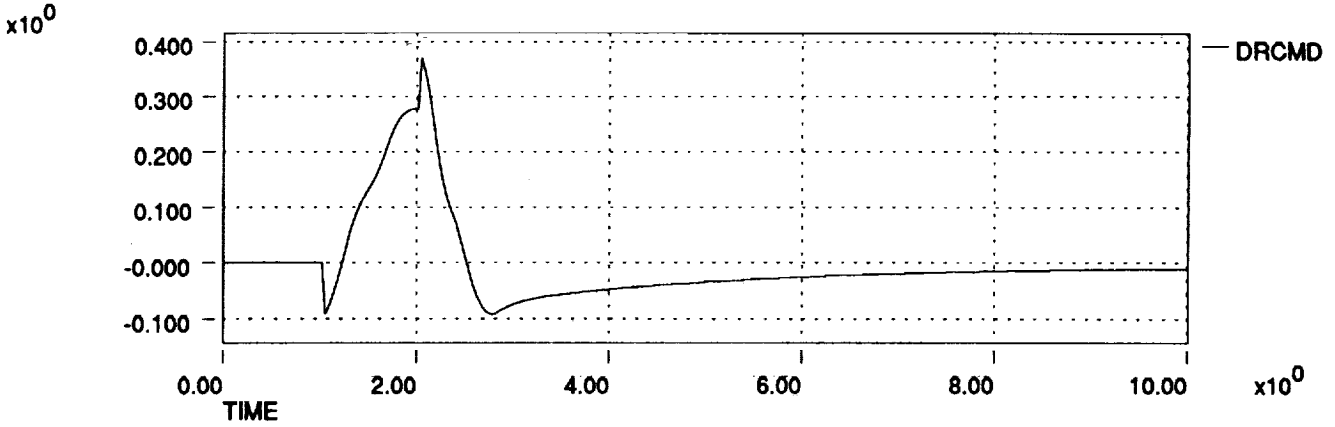
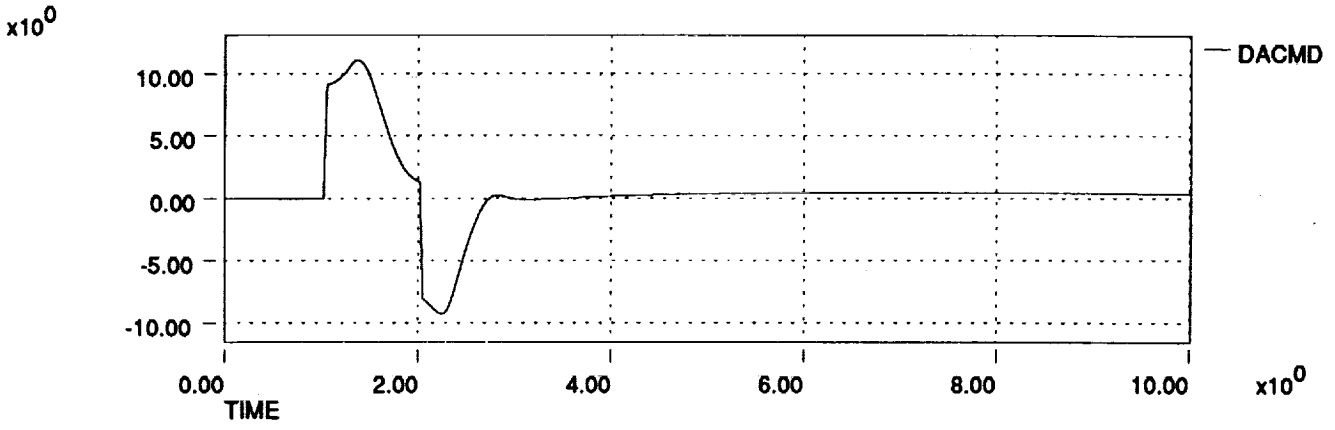
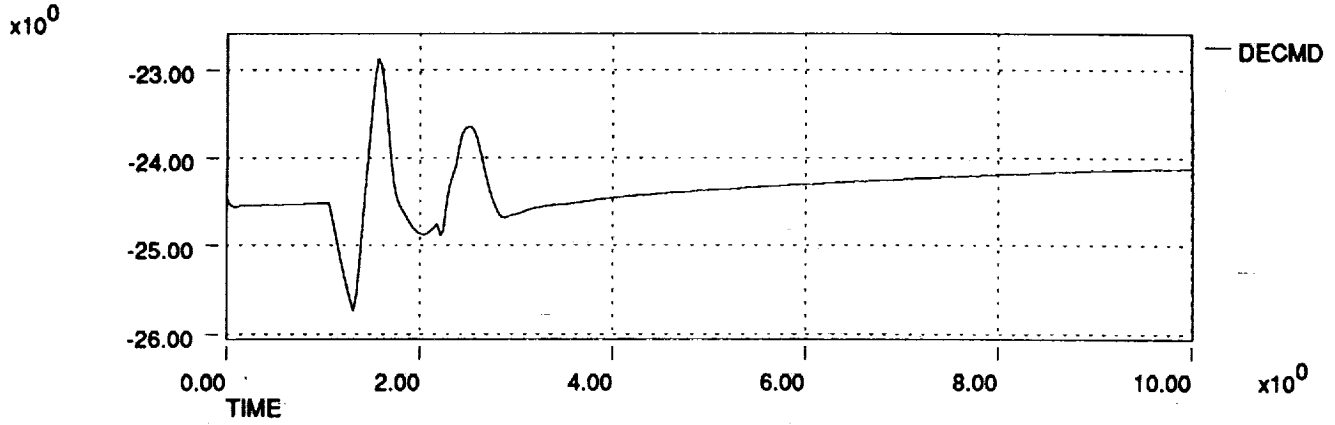

HL-20 Dynamic Check Case Data Plots 911206
Right Roll Stick Pulse at Mach 2 and 58,700 ft

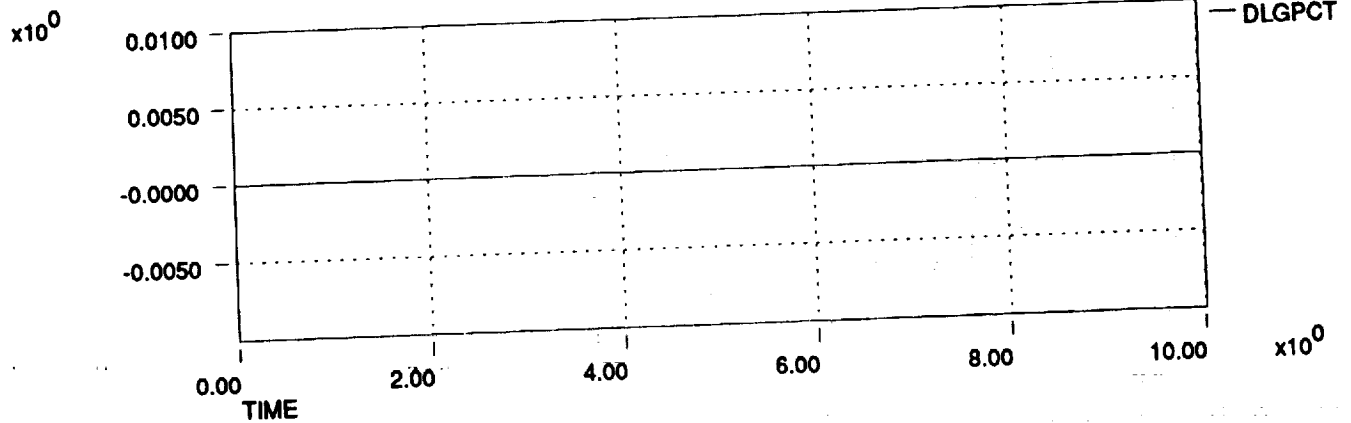
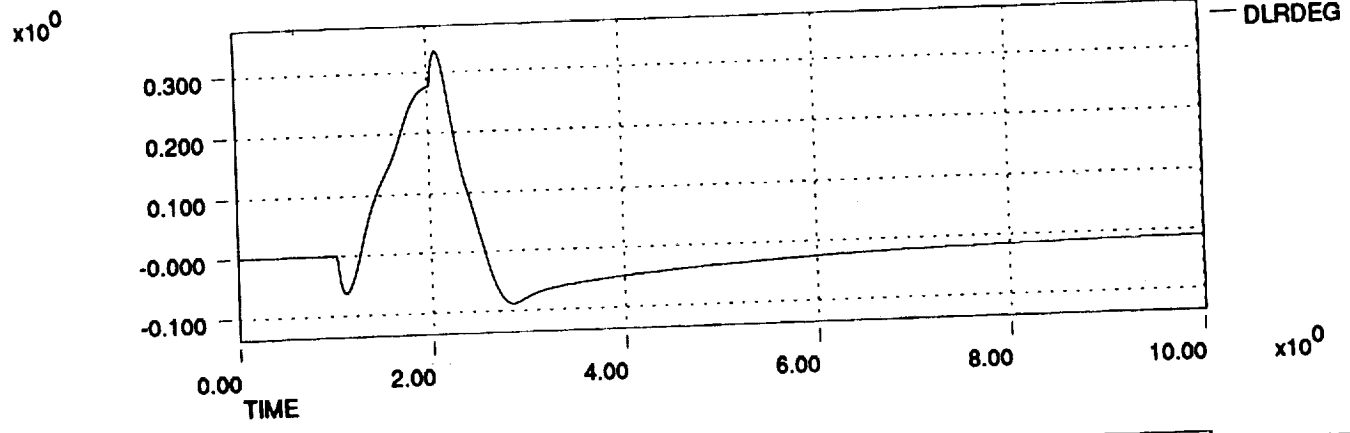
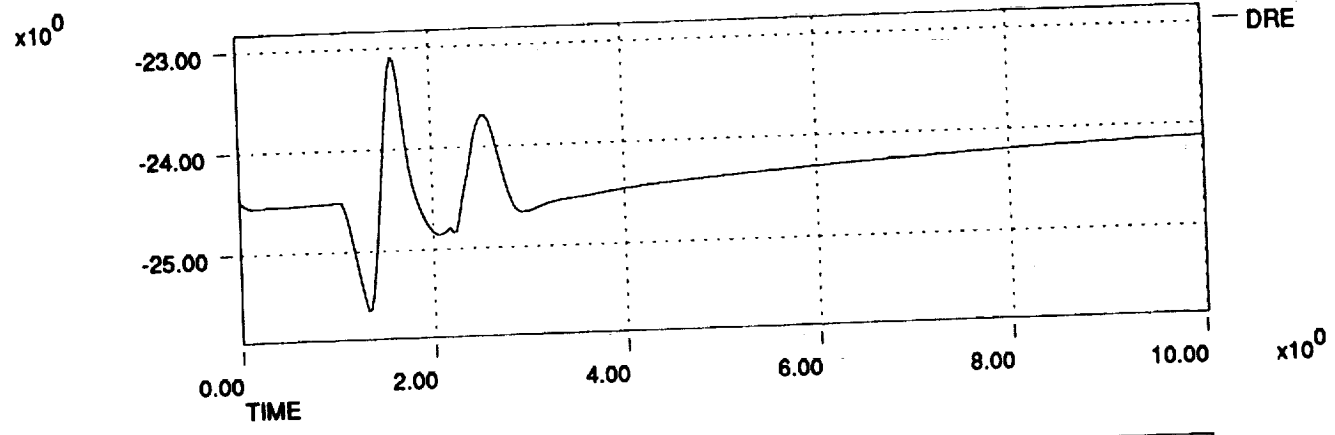
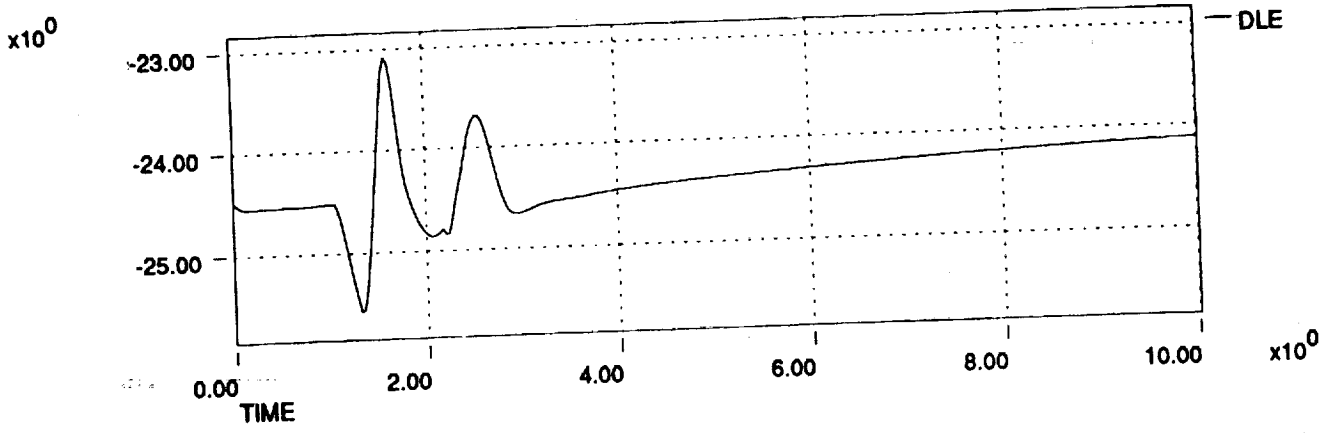

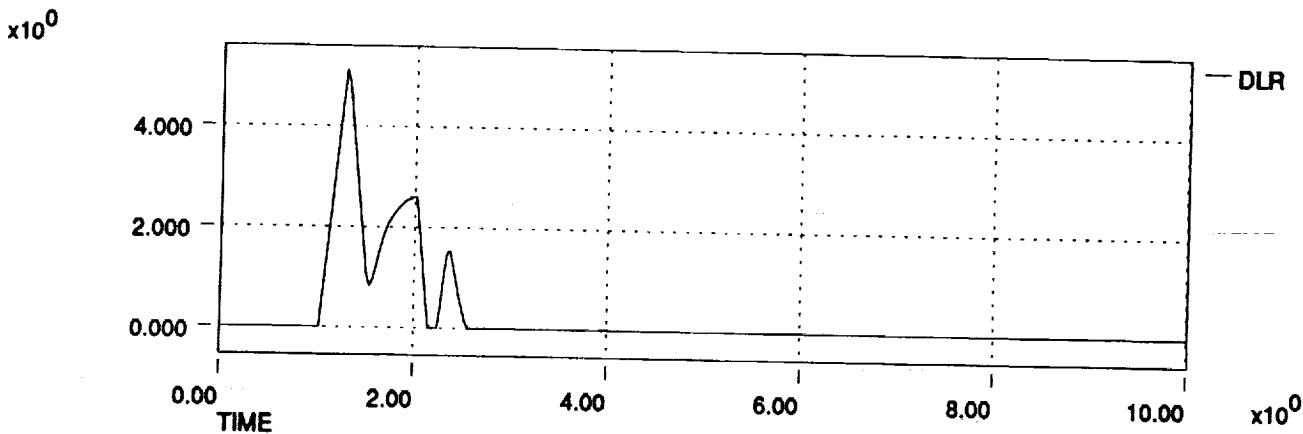
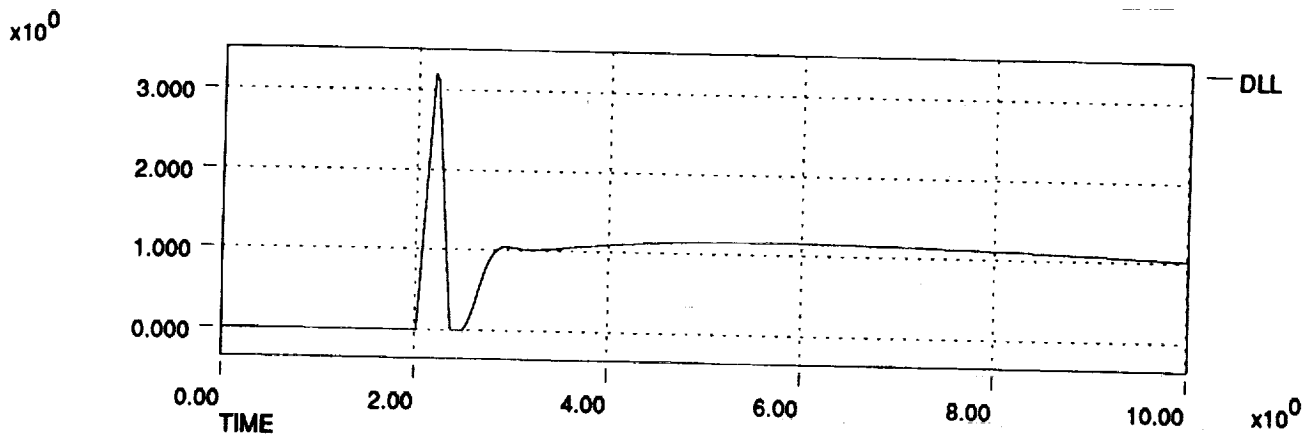
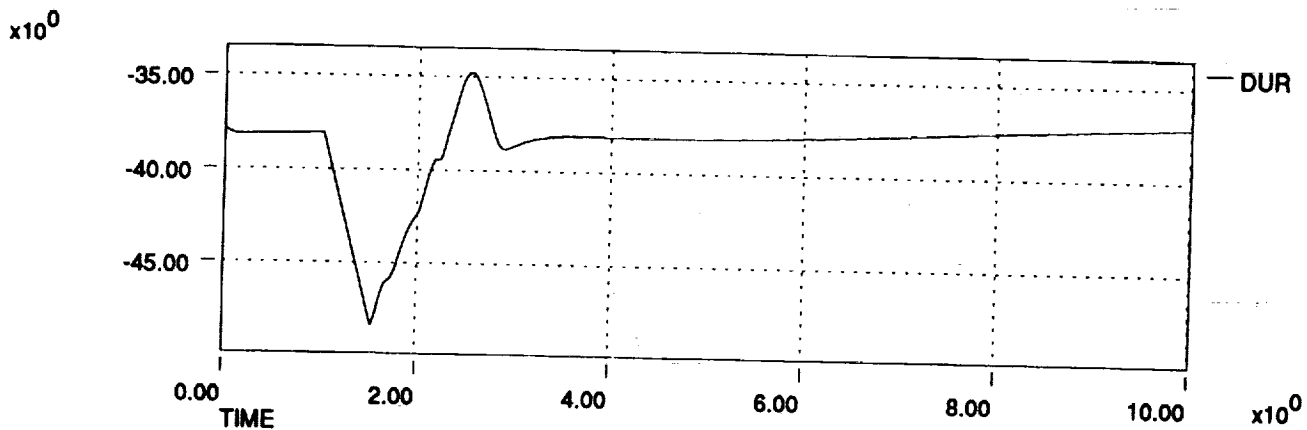
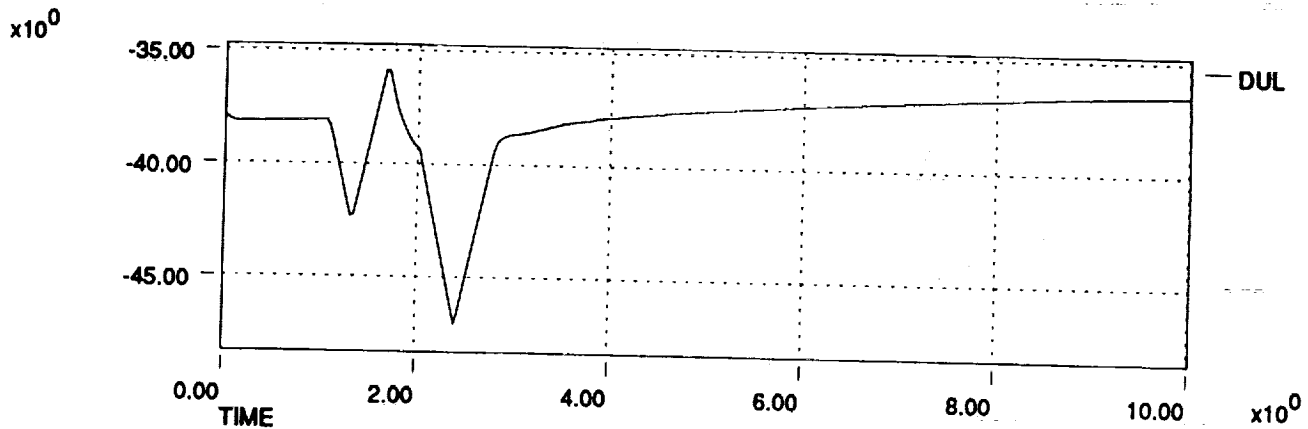

HL-20 Dynamic Check Case Data Plots 911206
Right Rudder Pedal Pulse at Mach 2 and 58,700 ft

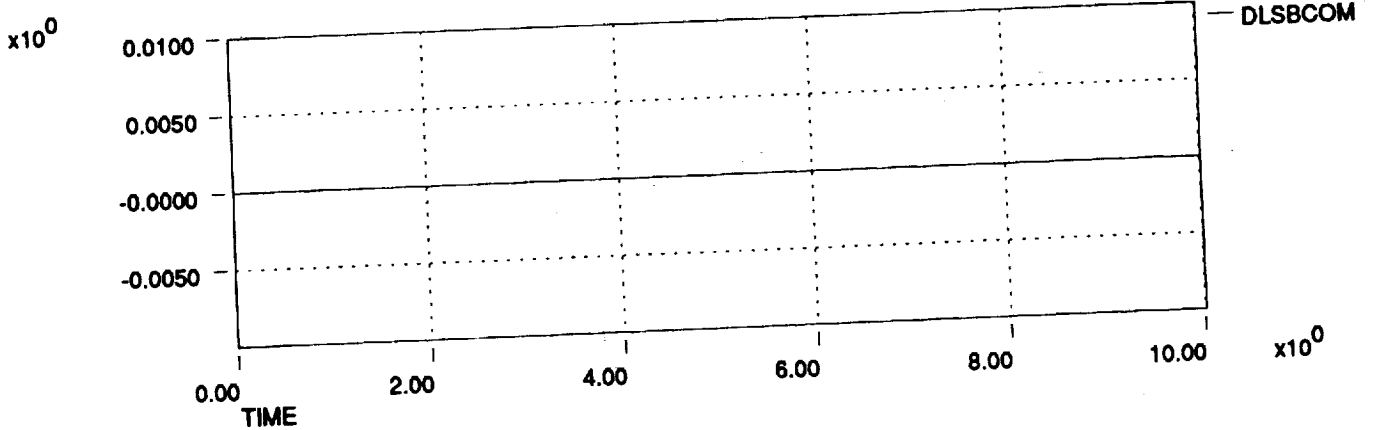
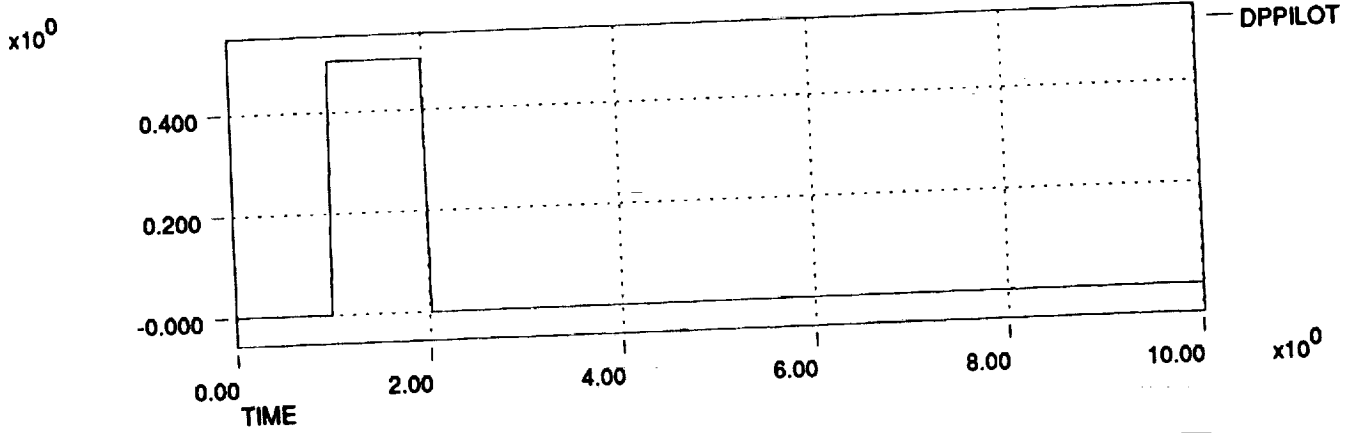
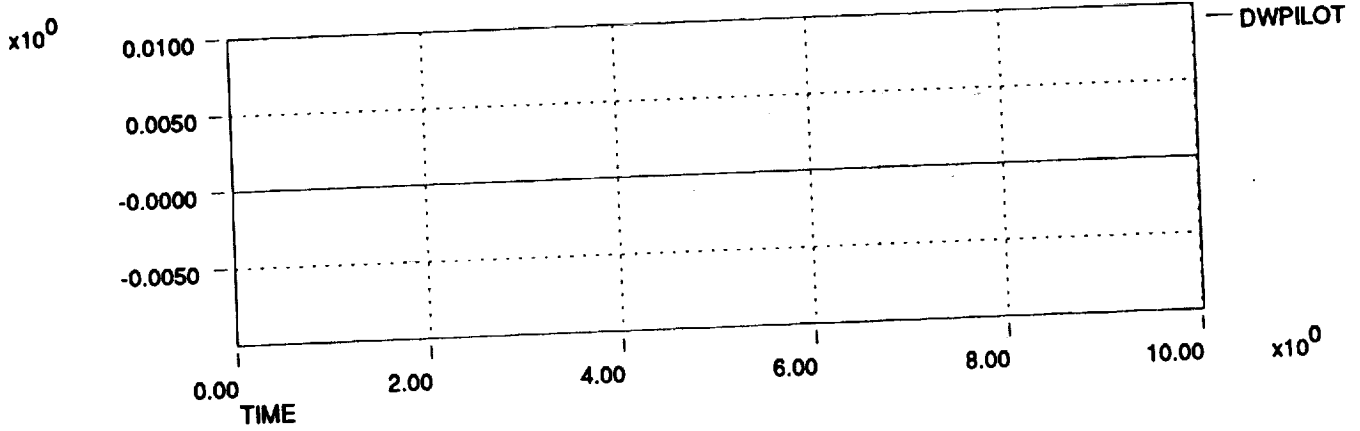
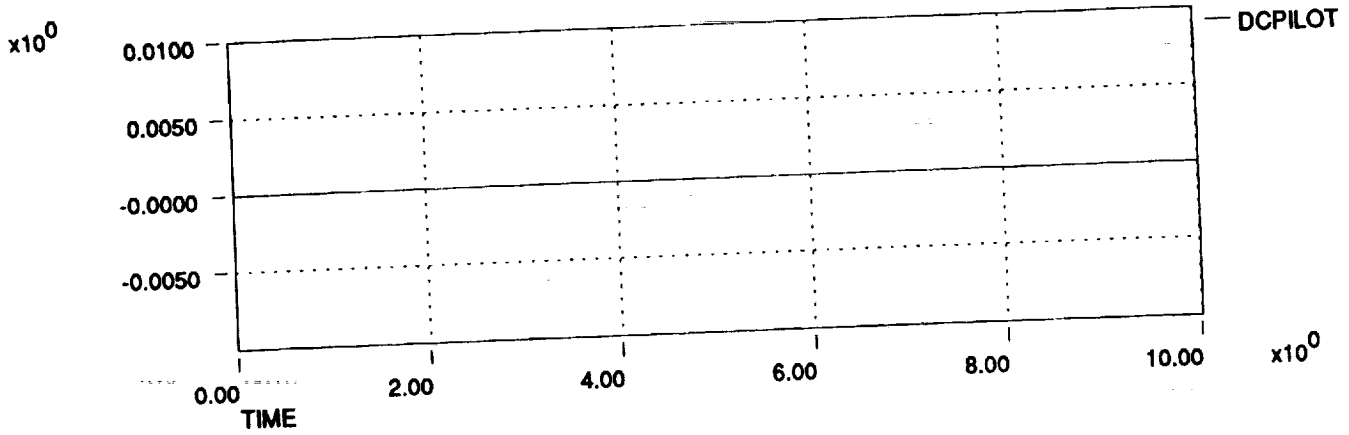

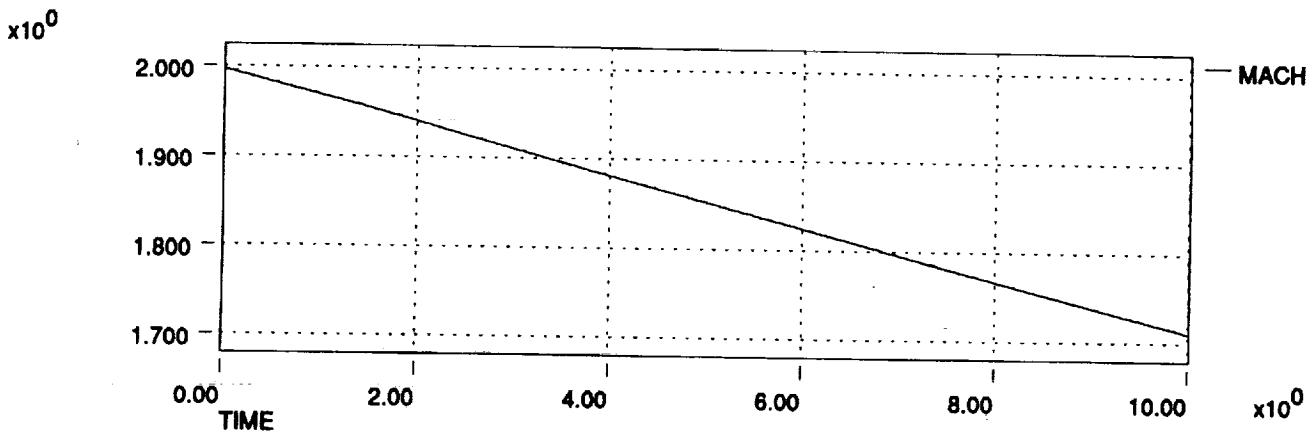
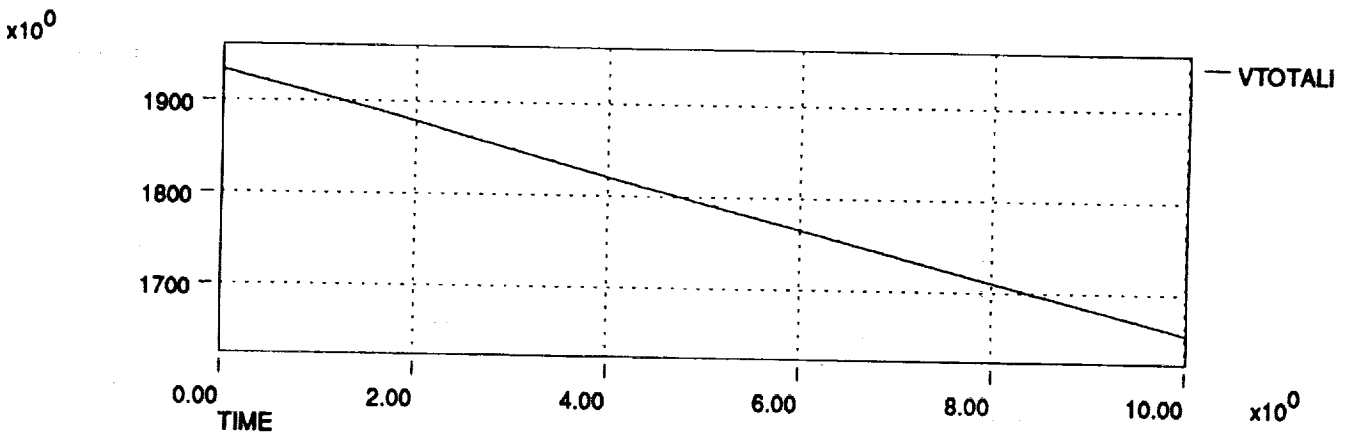
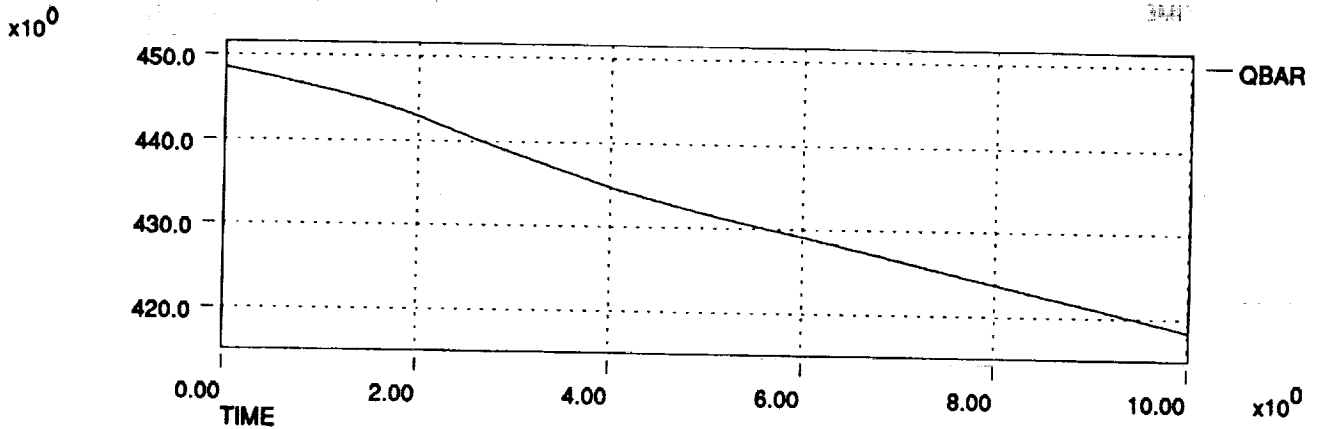
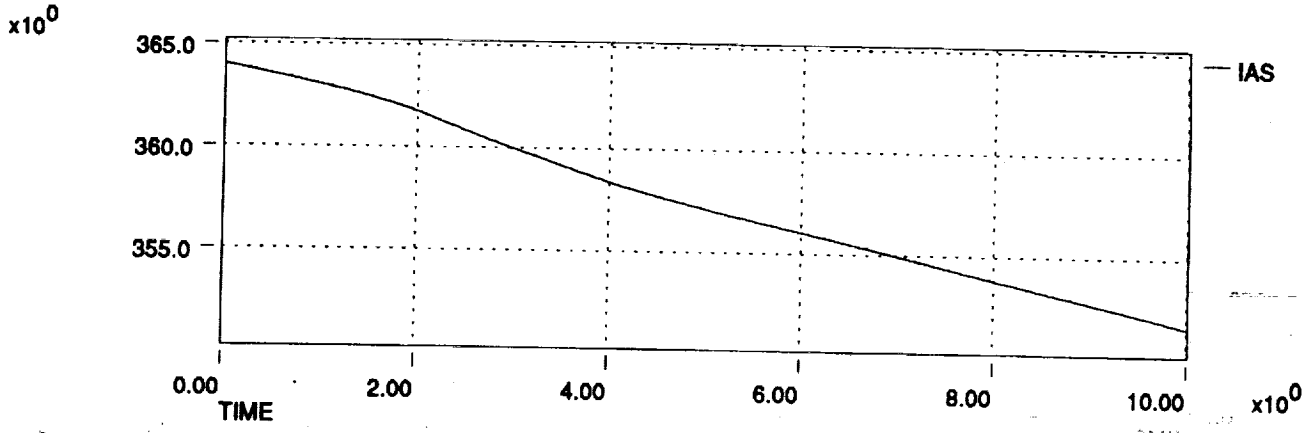

HL-20 Dynamic Check Case Data Plots 911206
Right Rudder Pedal Pulse at Mach 2 and 58,700 ft

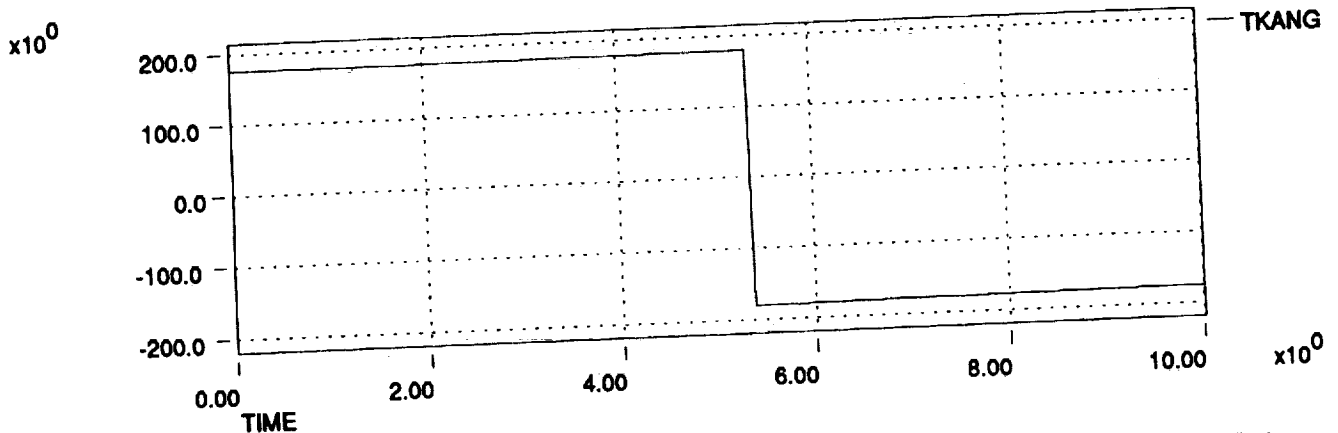
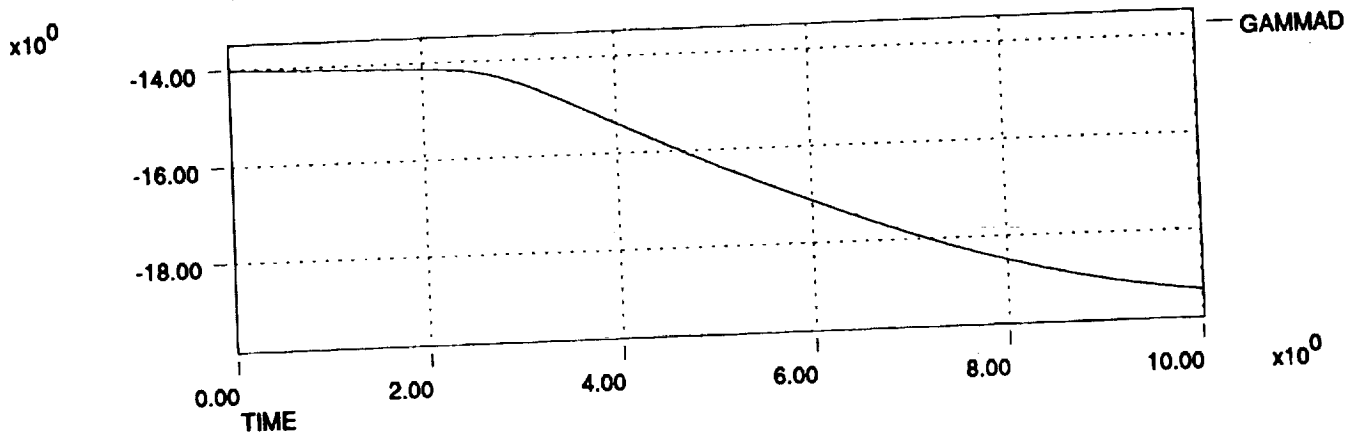
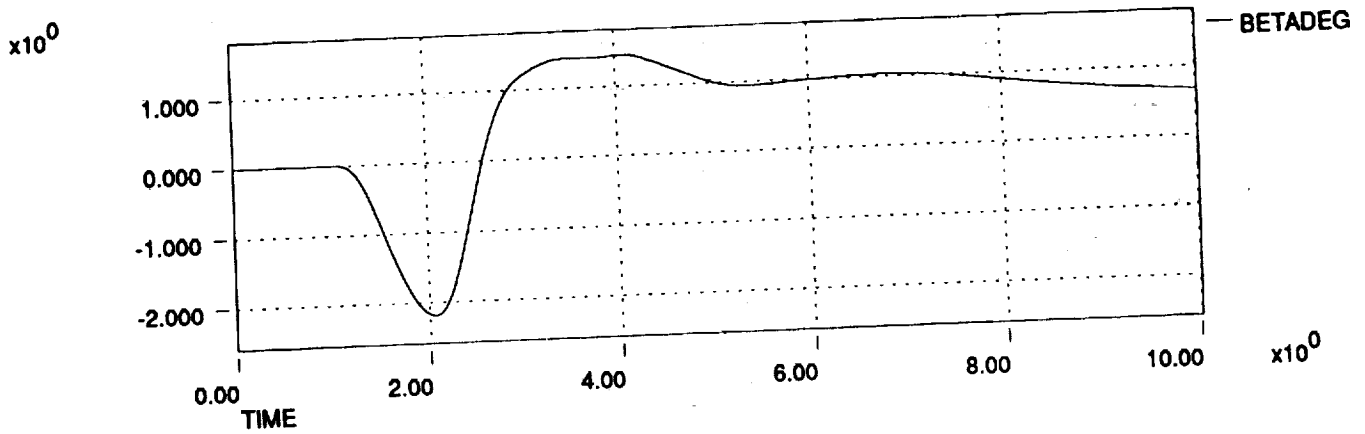
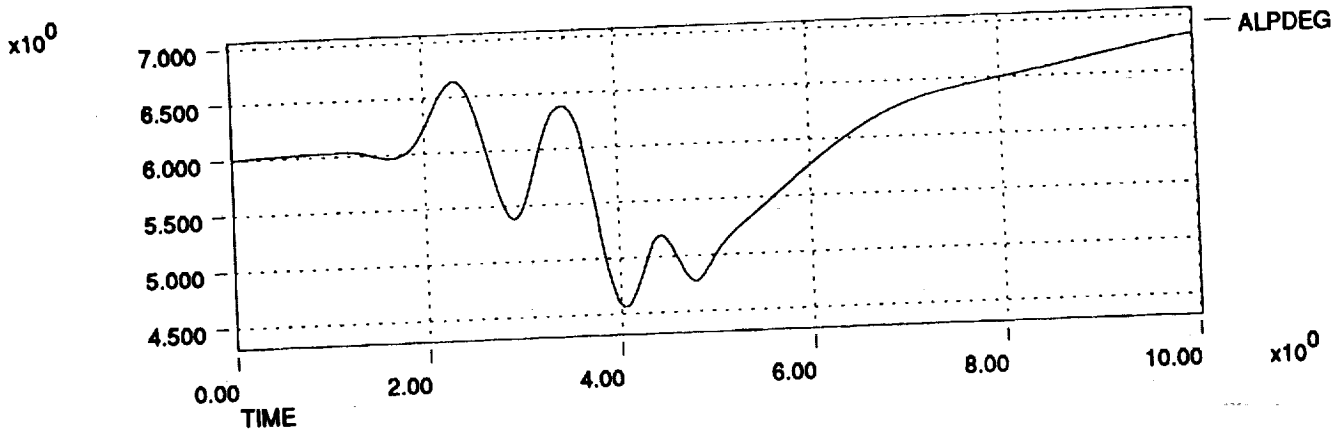

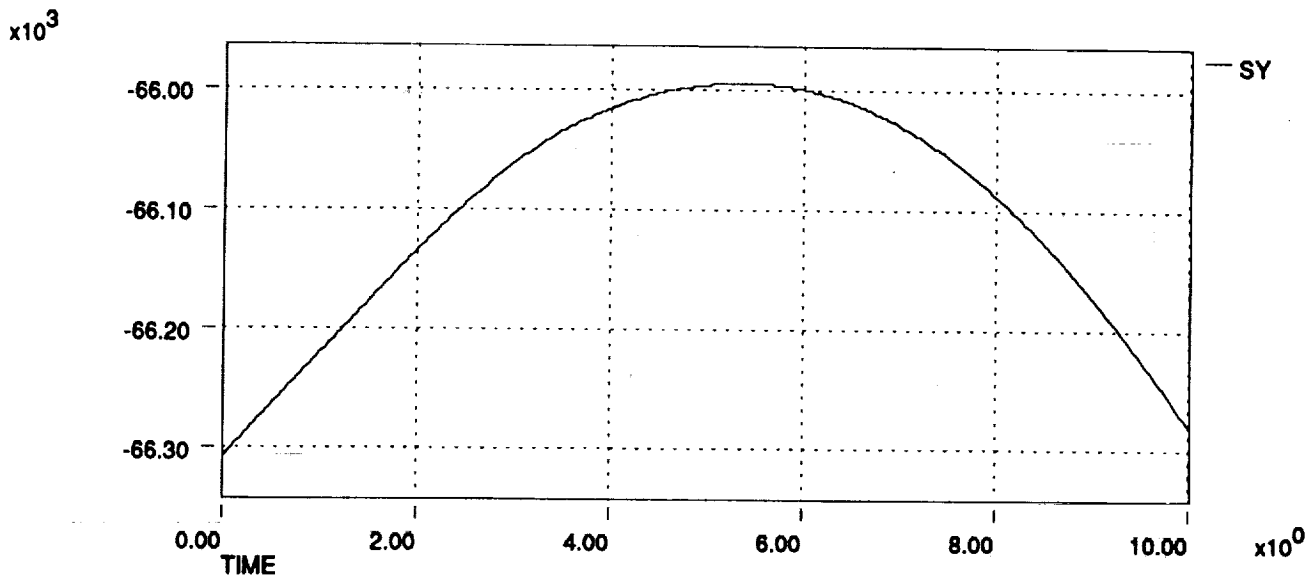
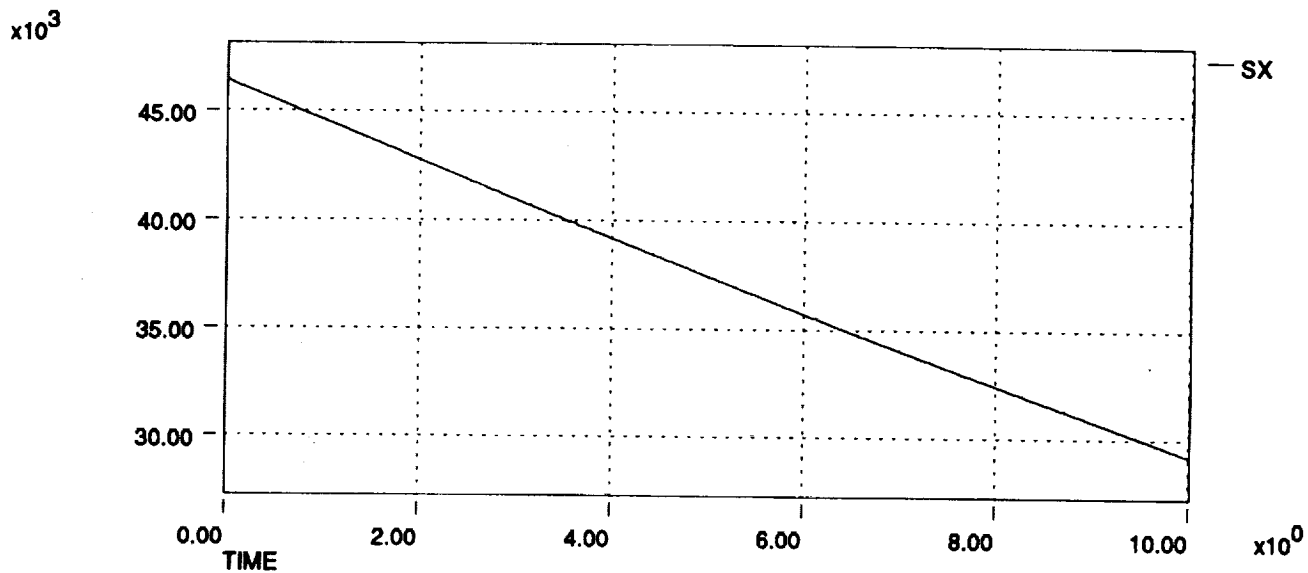
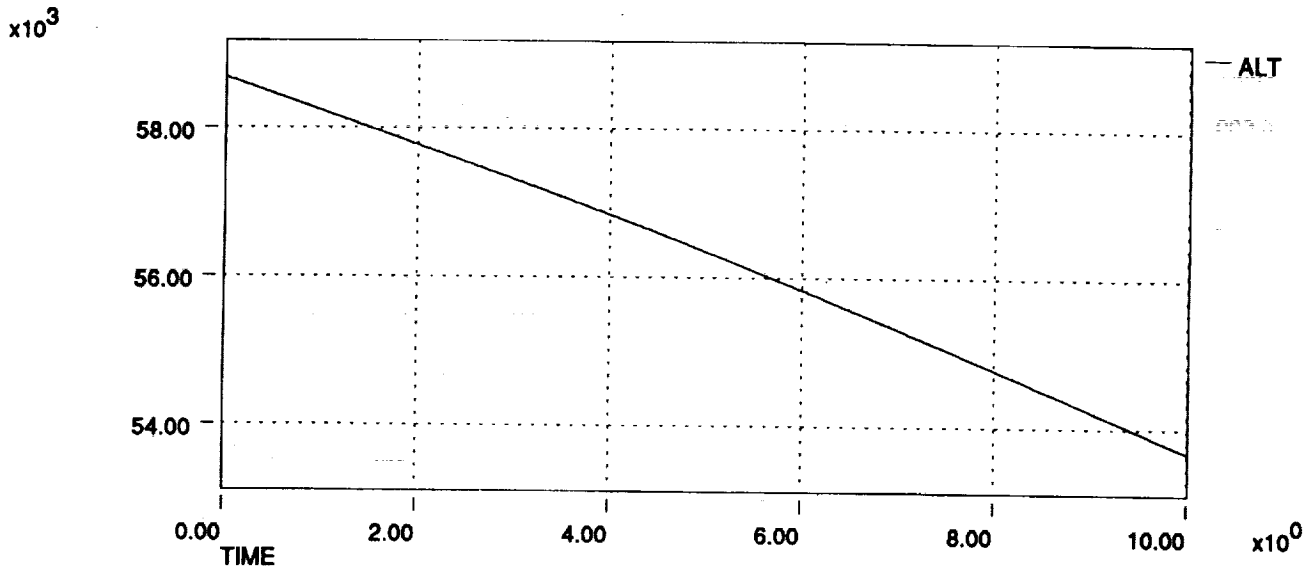

HL-20 Dynamic Check Case Data Plots 911206
Right Rudder Pedal Pulse at Mach 2 and 58,700 ft

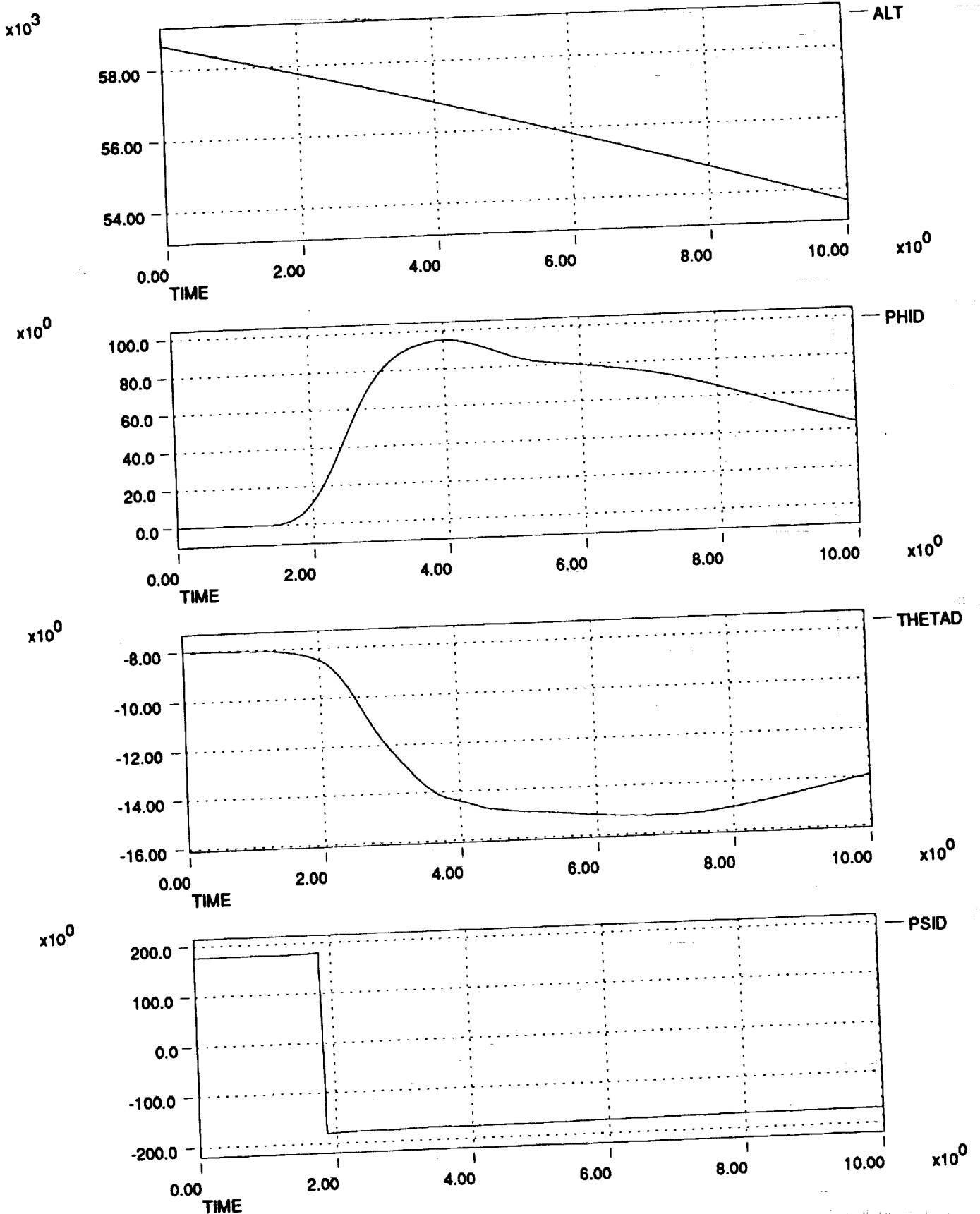

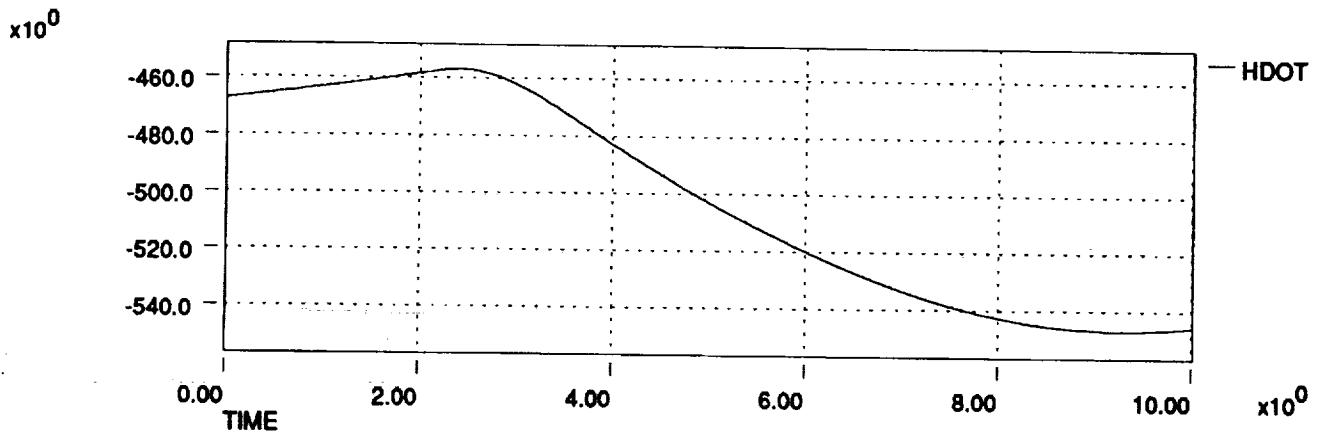
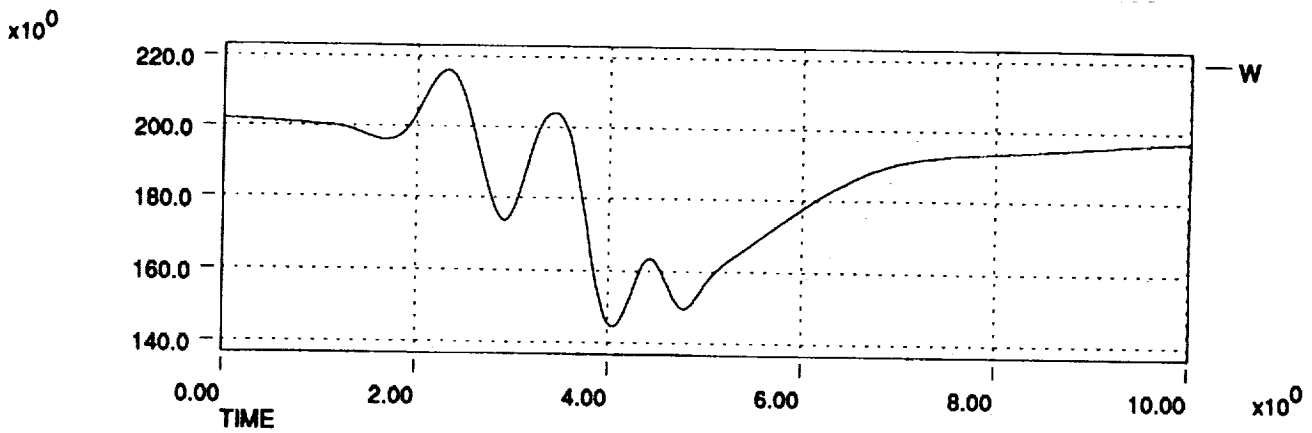
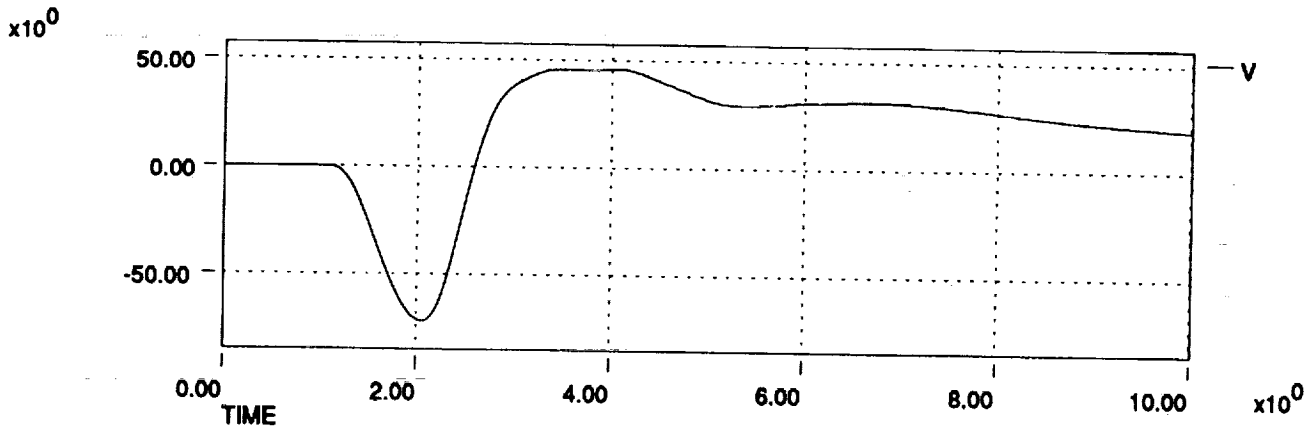
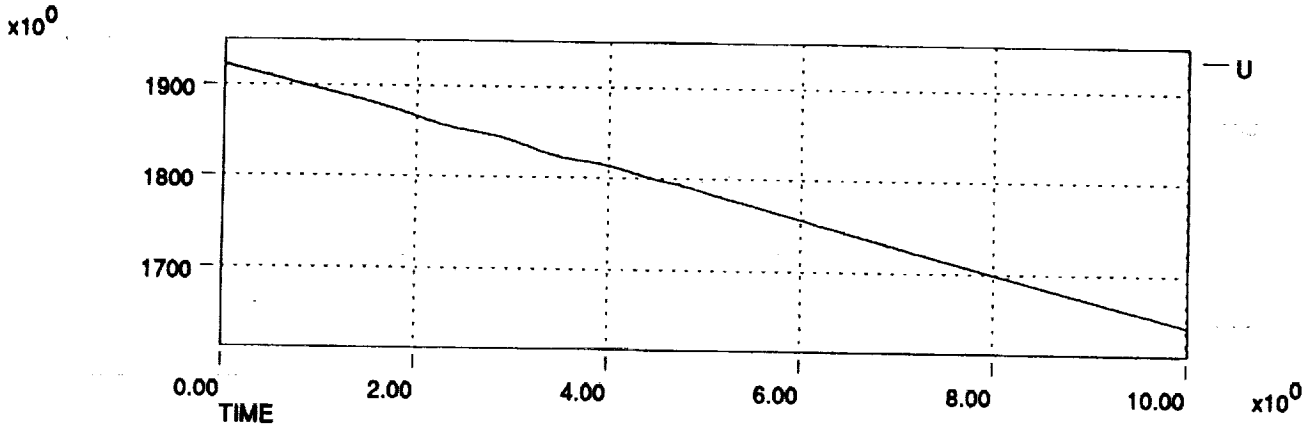

HL-20 Dynamic Check Case Data Plots 911206
Right Rudder Pedal Pulse at Mach 2 and 58,700 ft

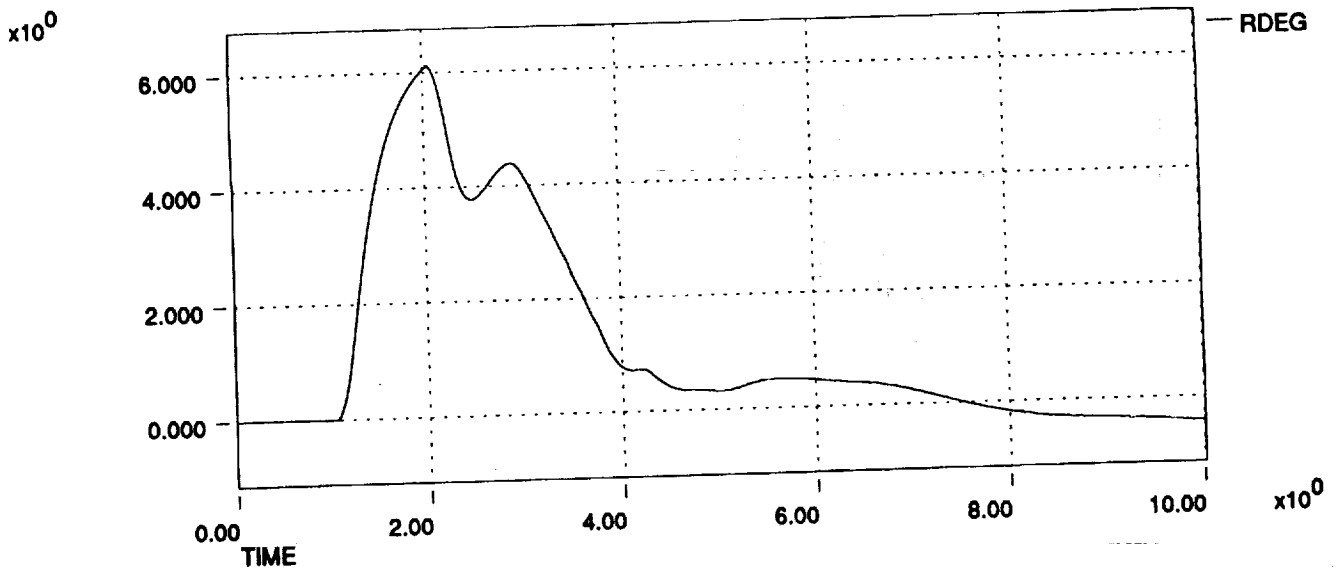
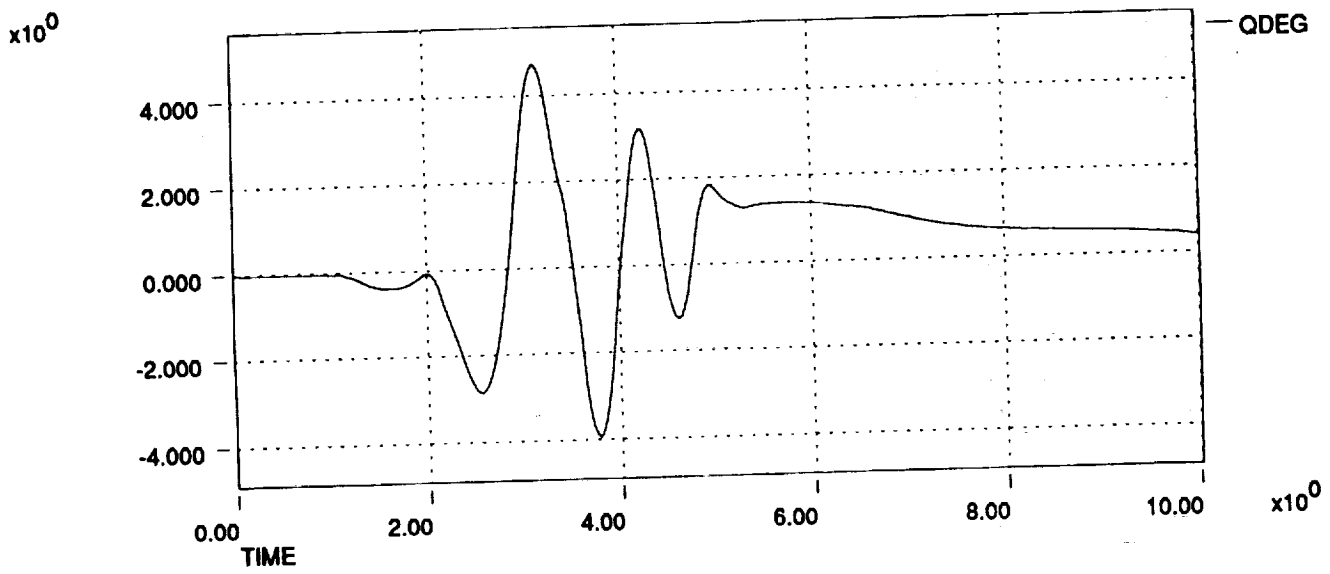
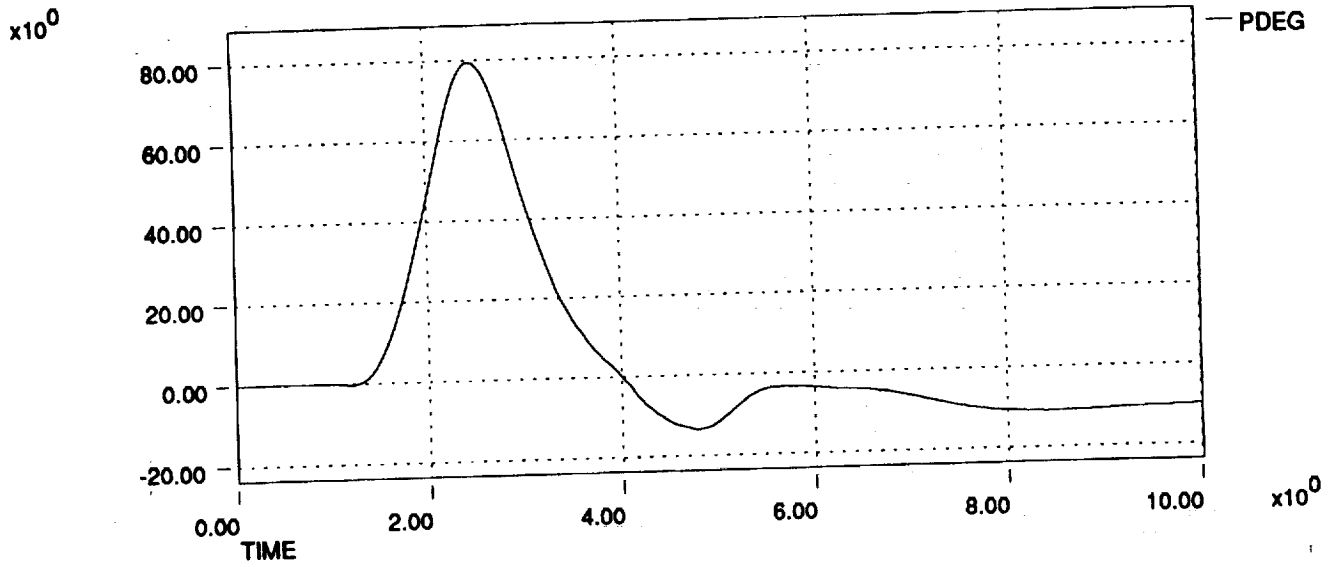

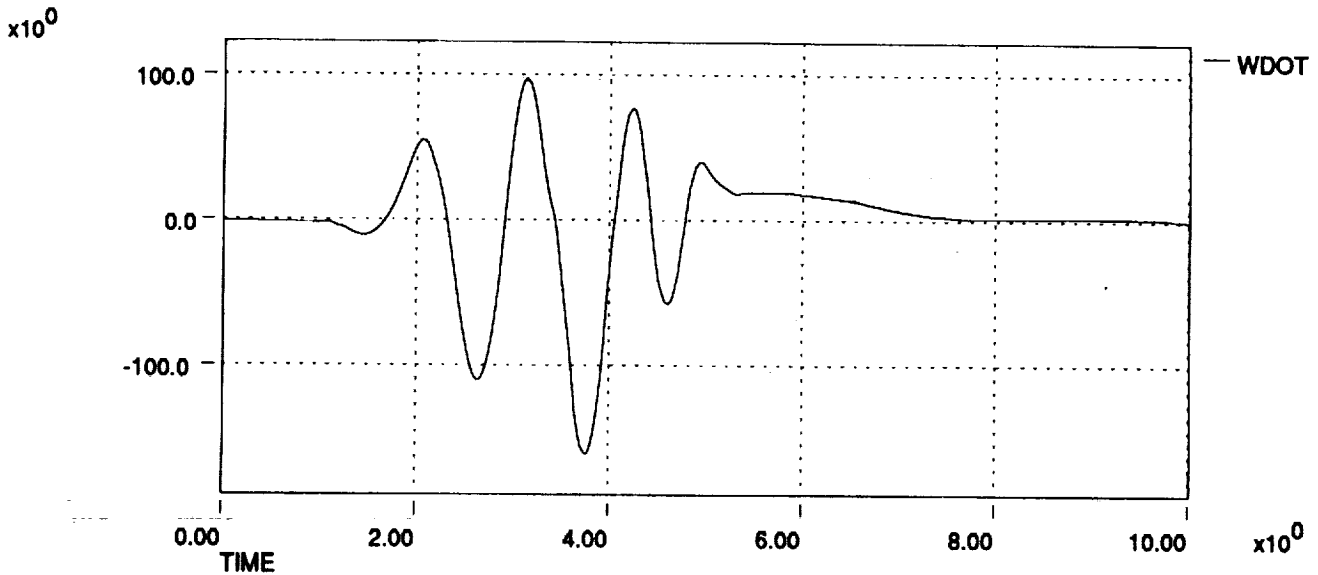
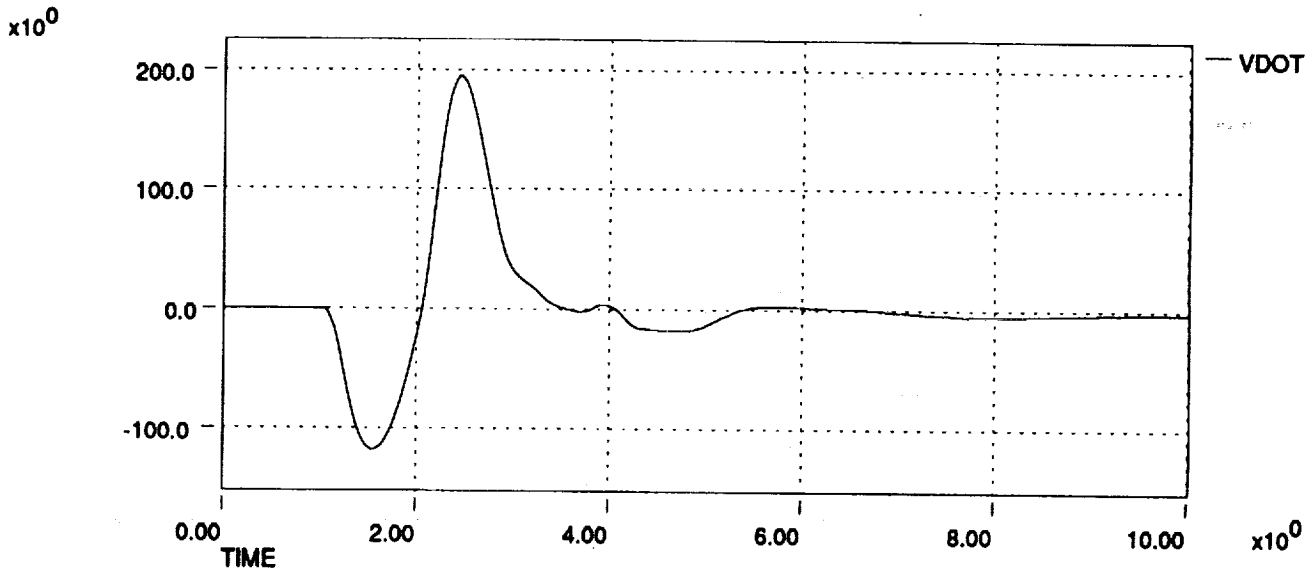
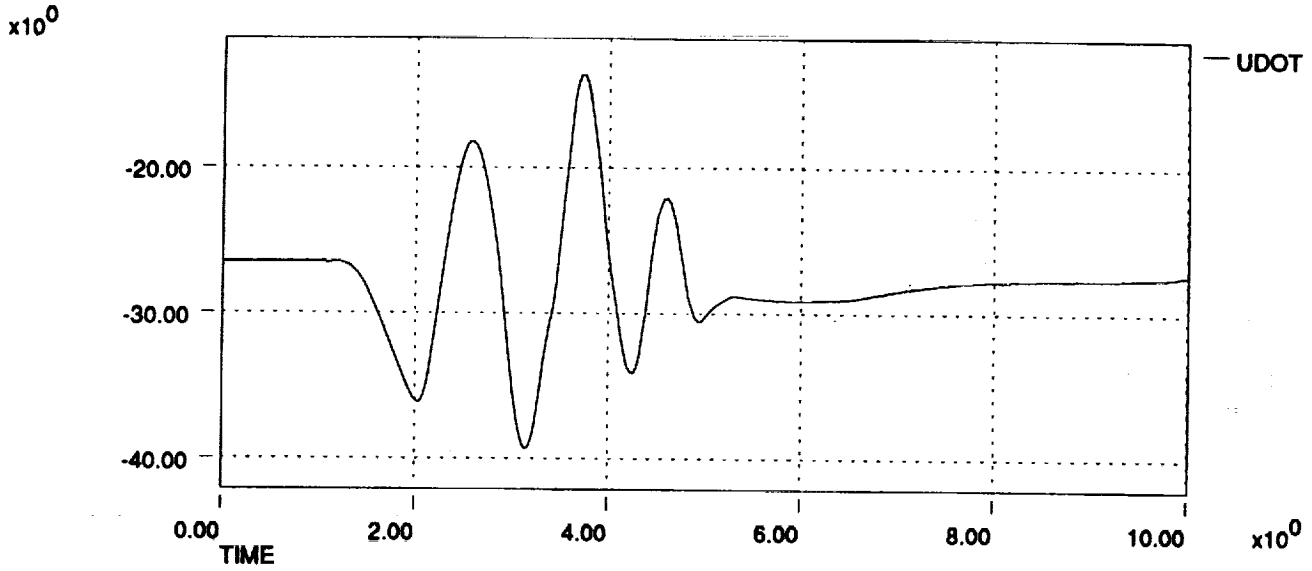

HL-20 Dynamic Check Case Data Plots 911206
Right Rudder Pedal Pulse at Mach 2 and 58,700 ft

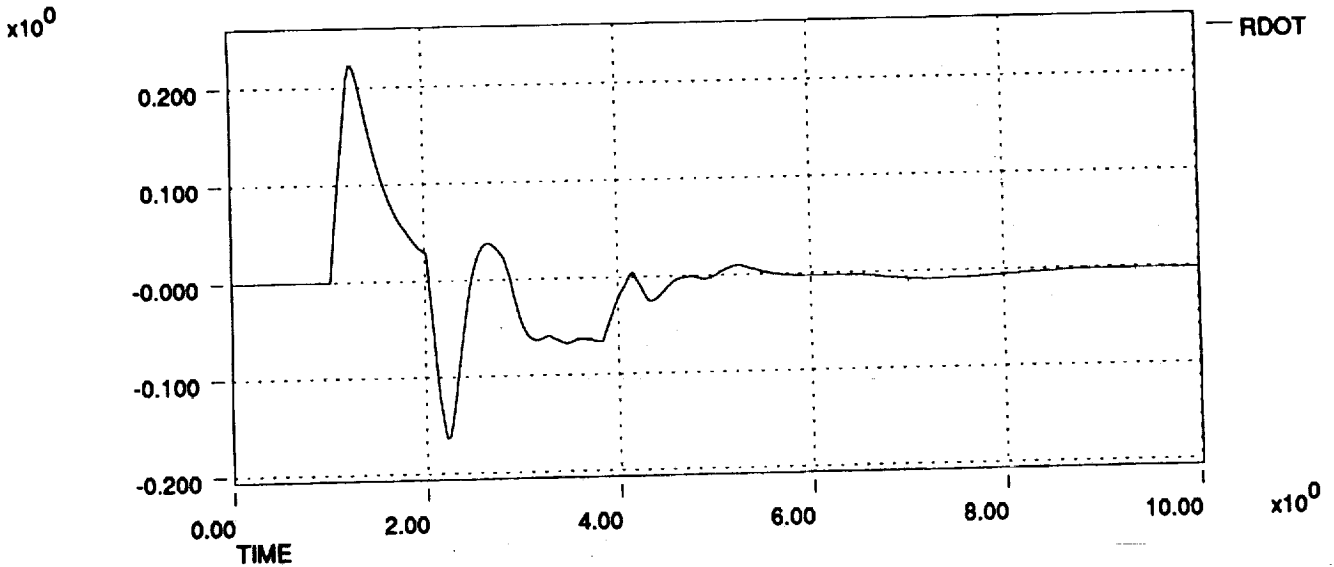
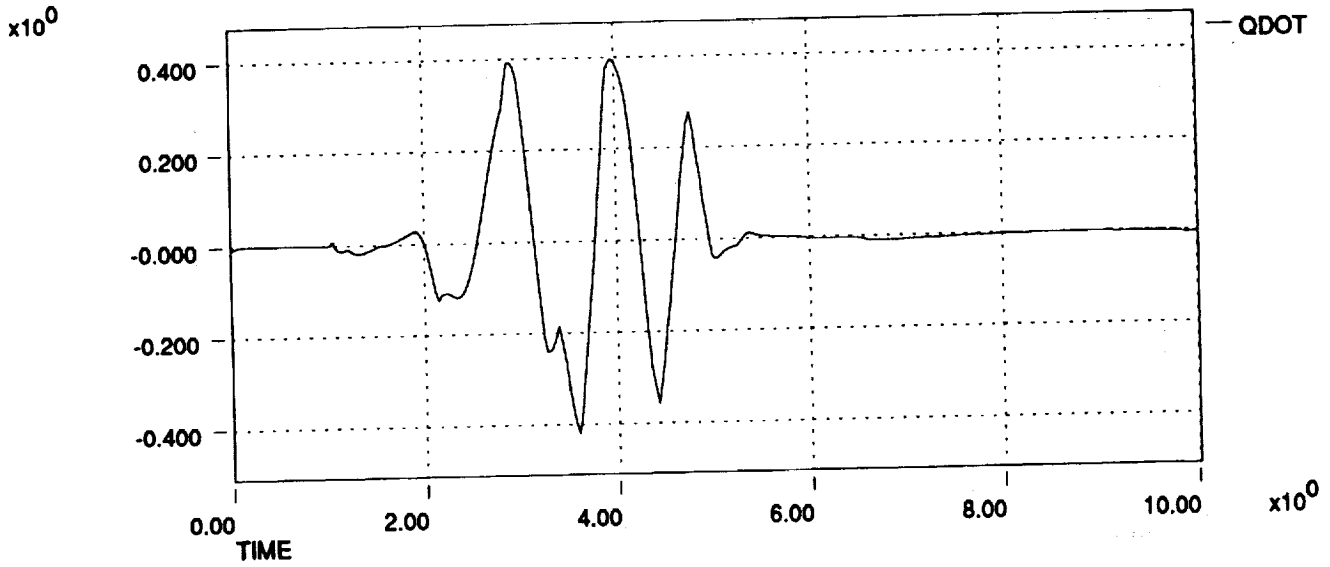
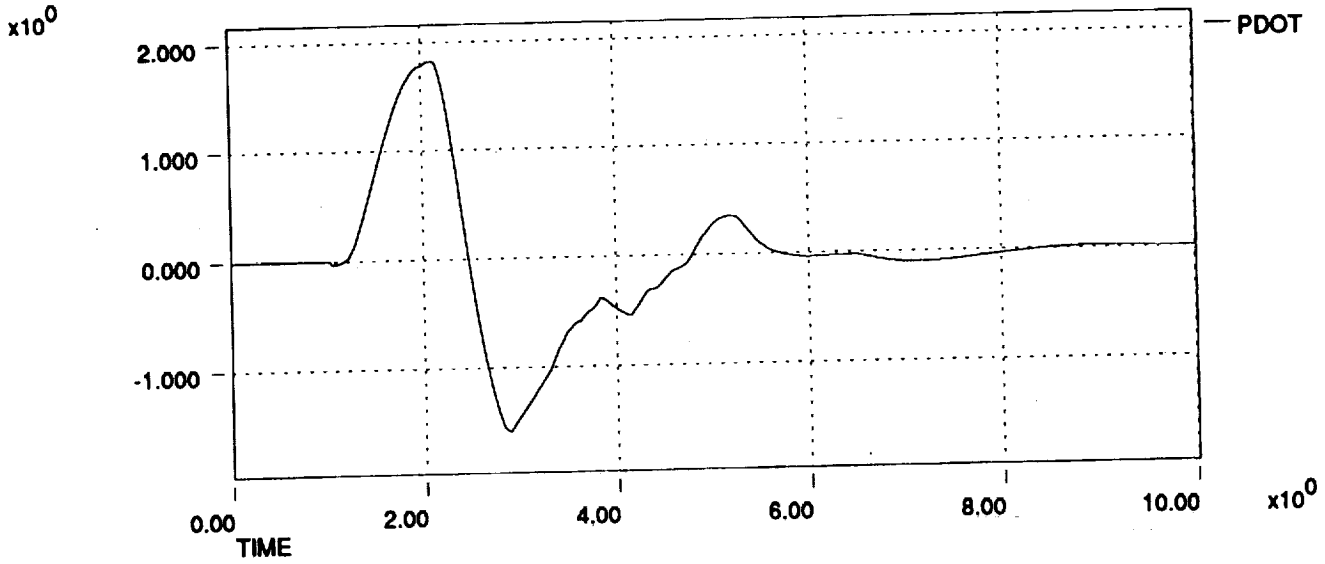

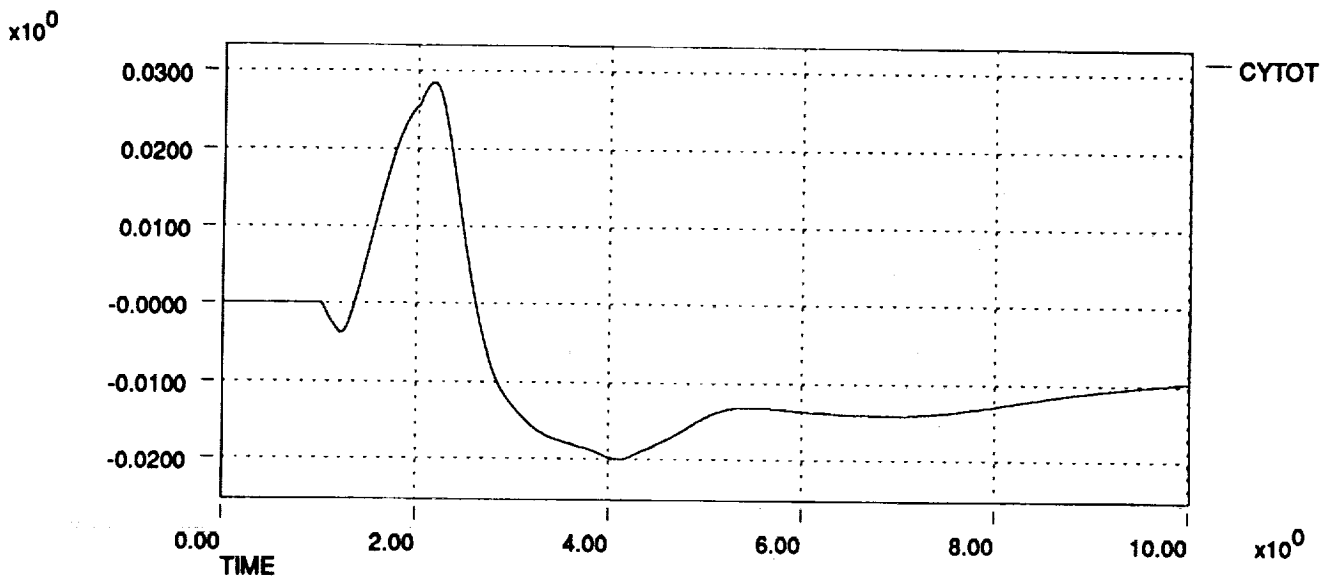
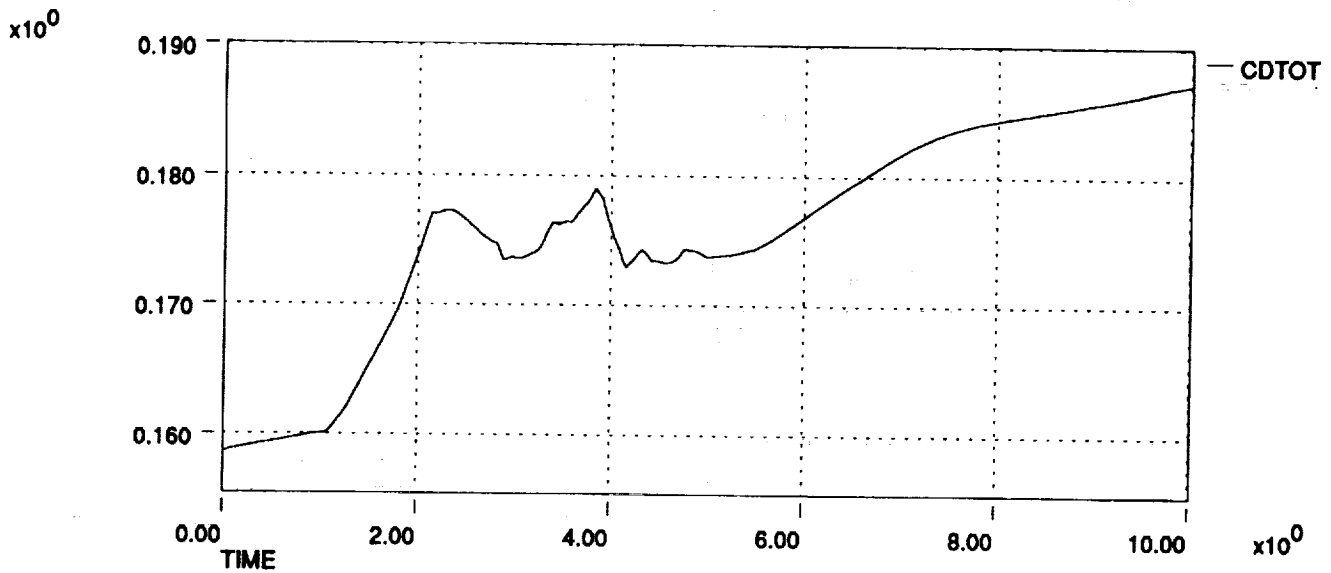
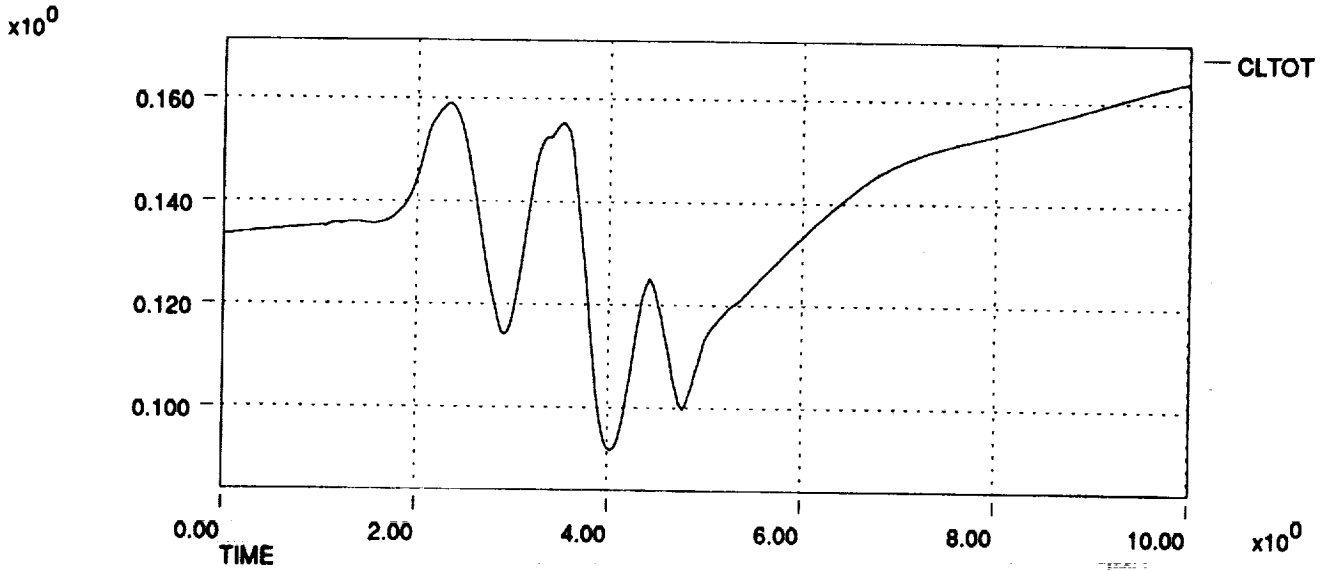

HL-20 Dynamic Check Case Data Plots 911206
Right Rudder Pedal Pulse at Mach 2 and 58,700 ft

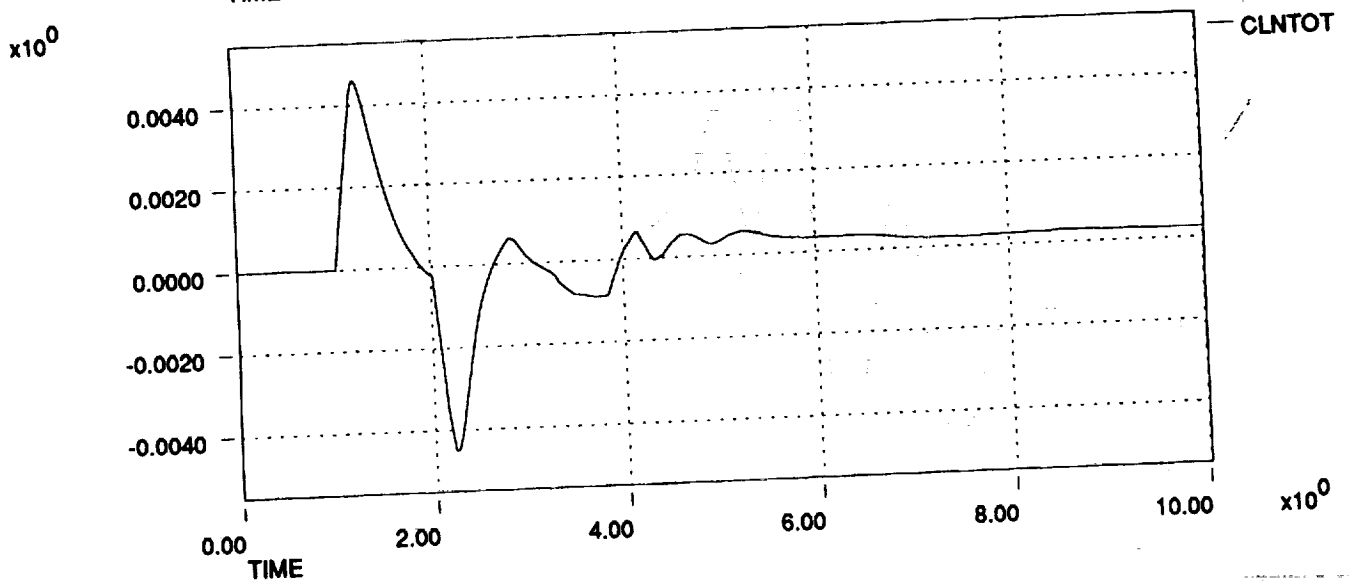
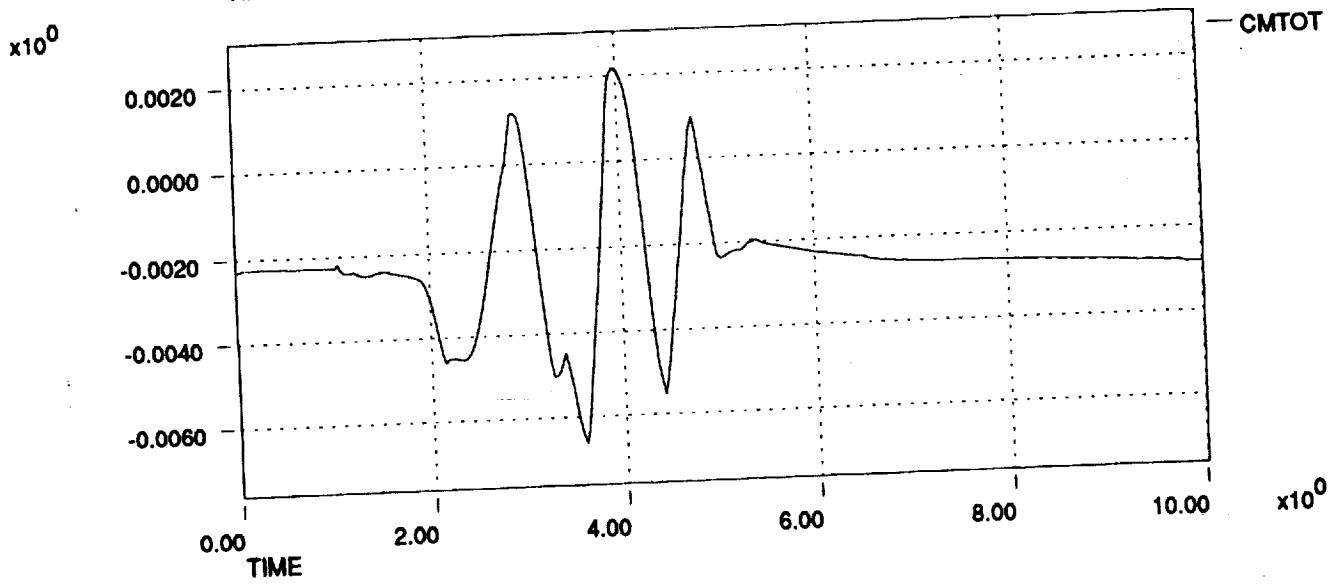
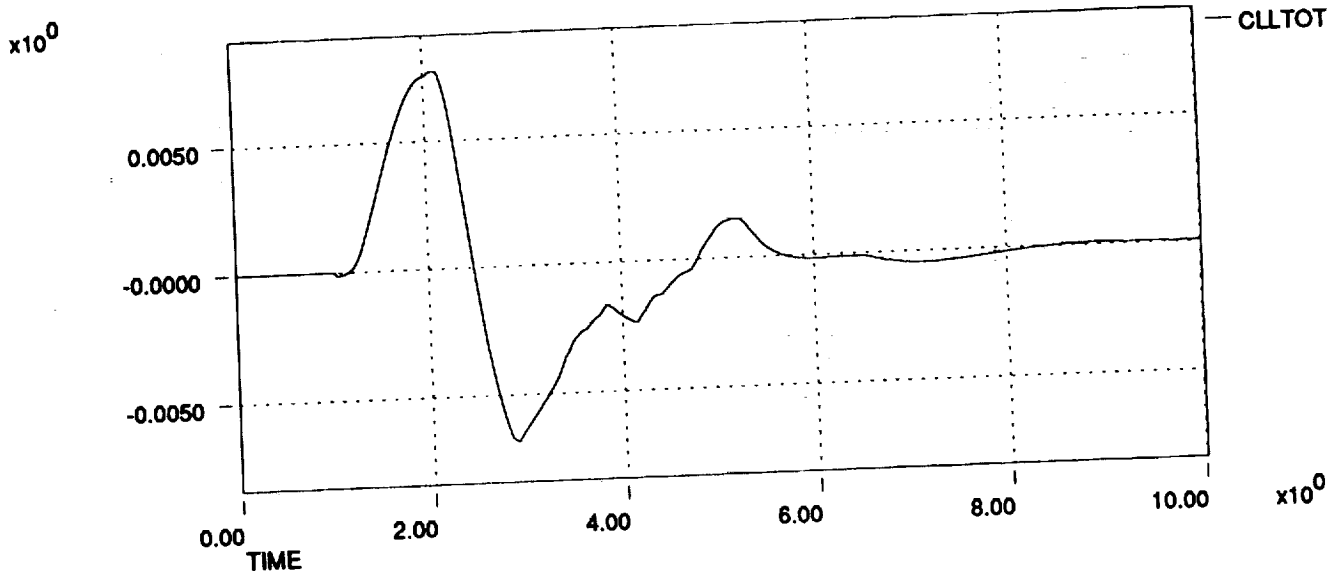

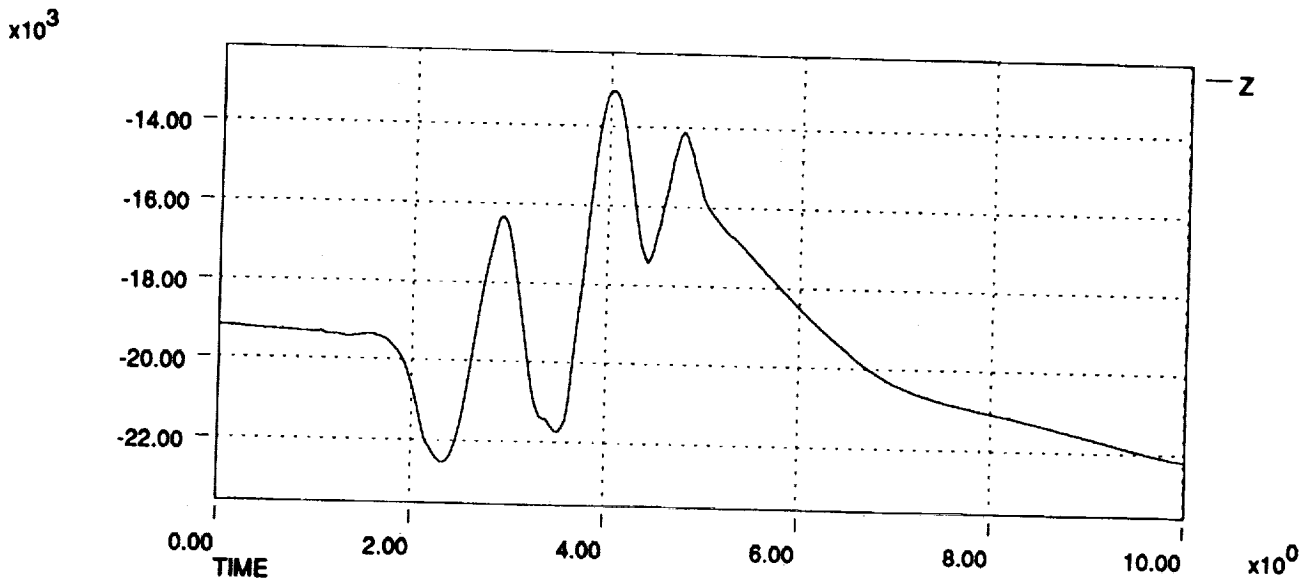
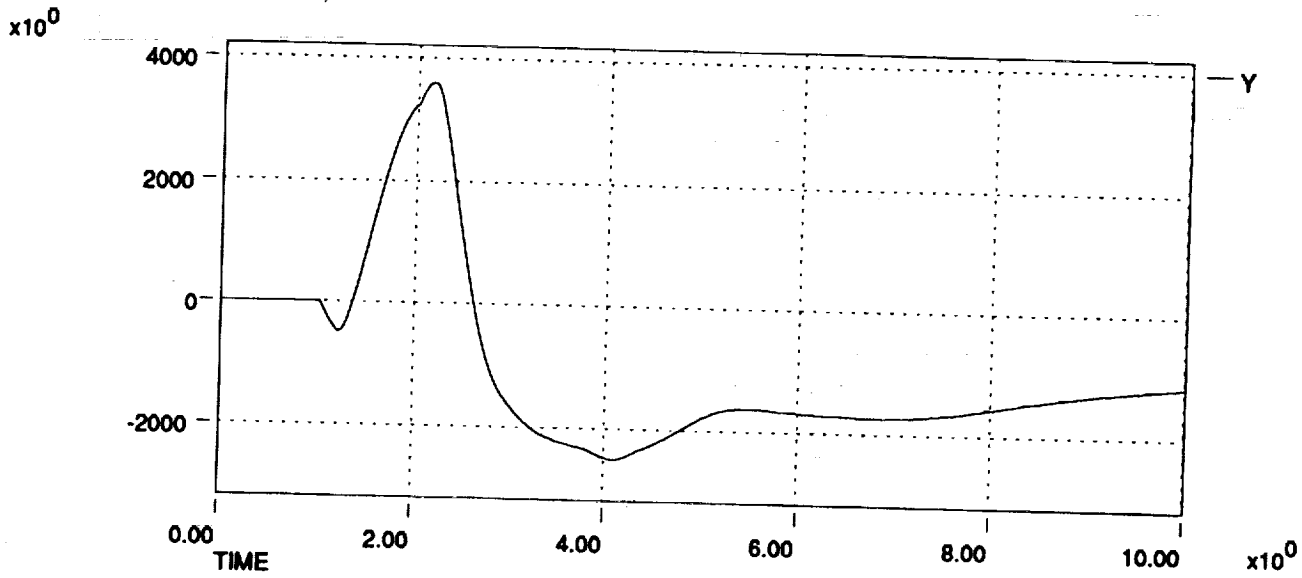
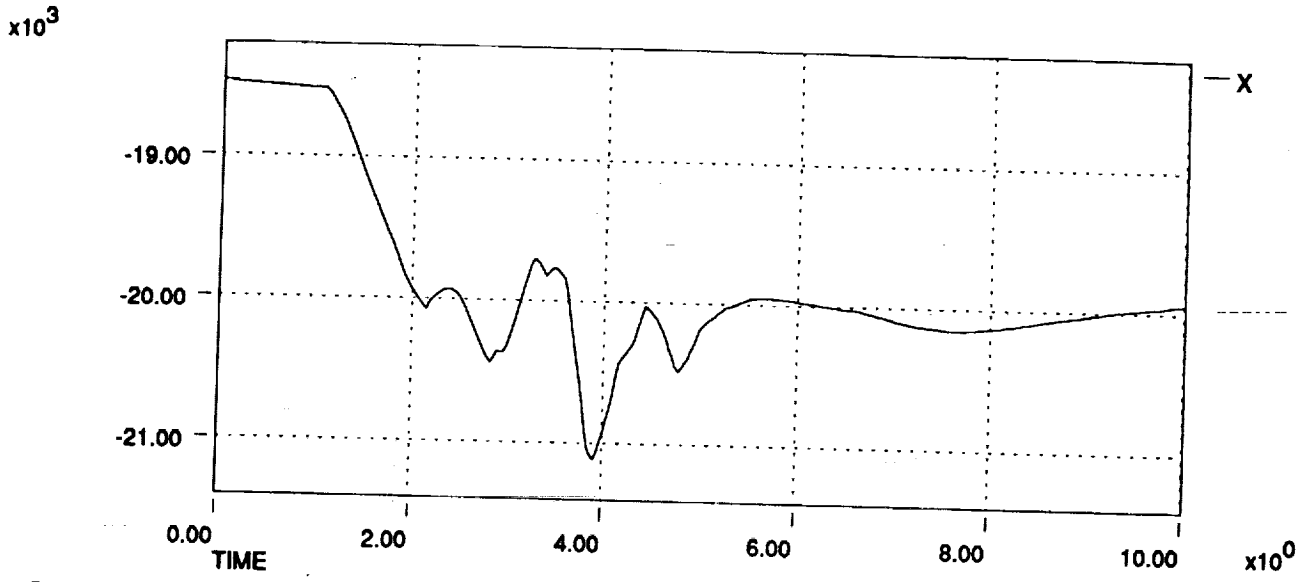

HL-20 Dynamic Check Case Data Plots 911206
Right Rudder Pedal Pulse at Mach 2 and 58,700 ft

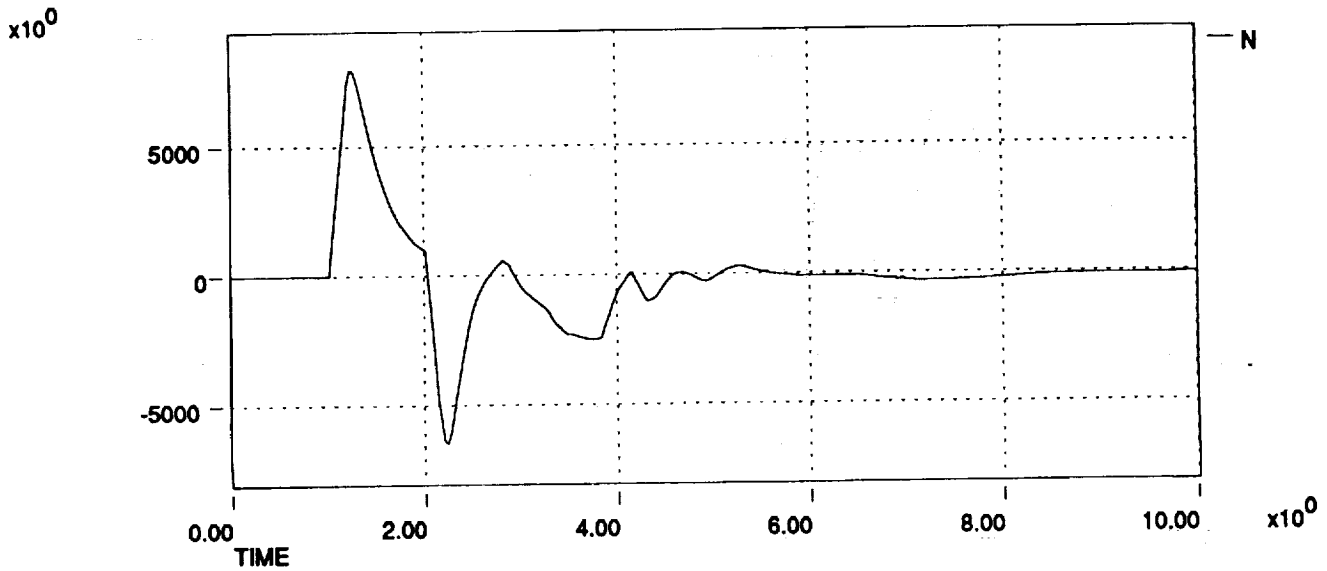
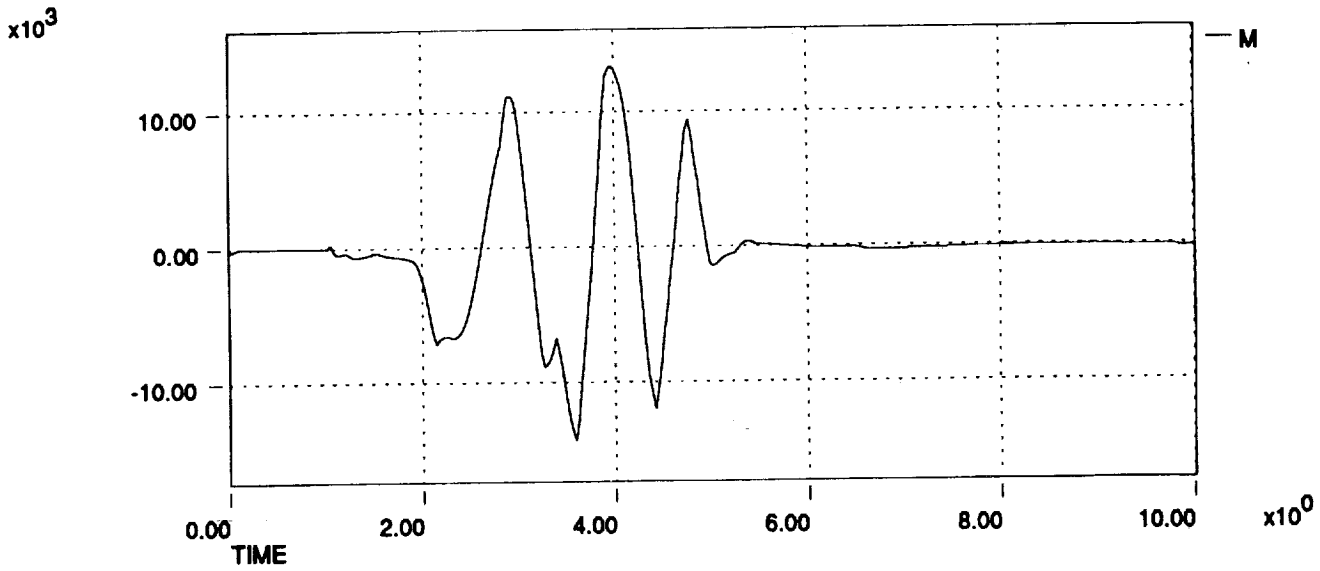
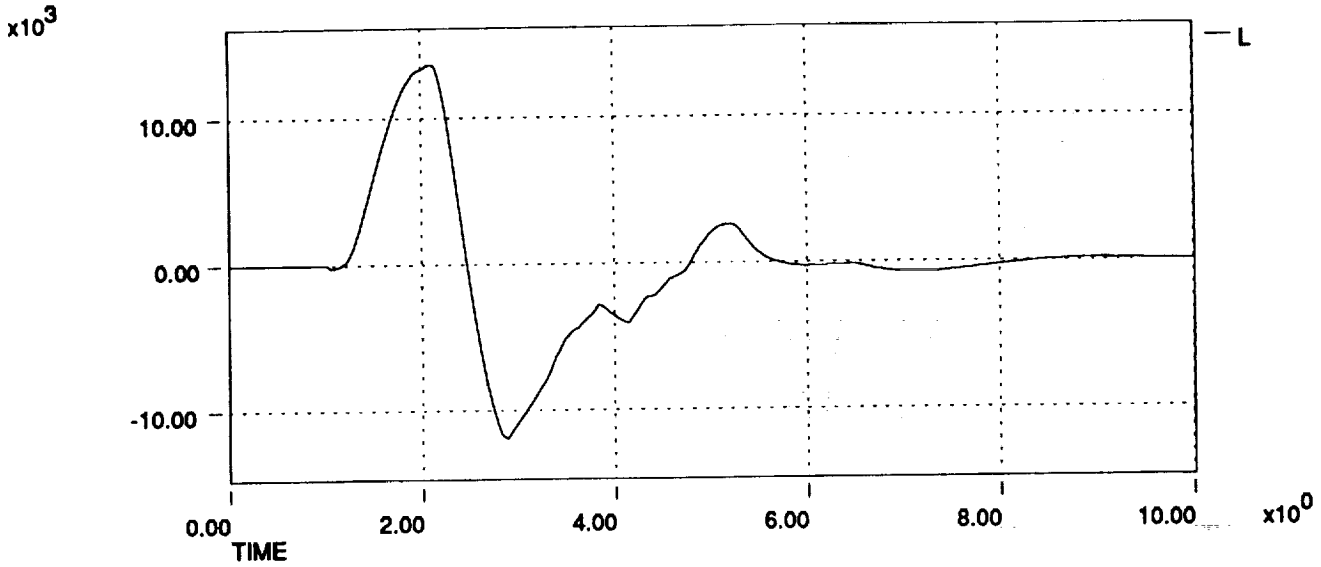

HL-20 Dynamic Check Case Data Plots 911206
Right Rudder Pedal Pulse at Mach 2 and 58,700 ft

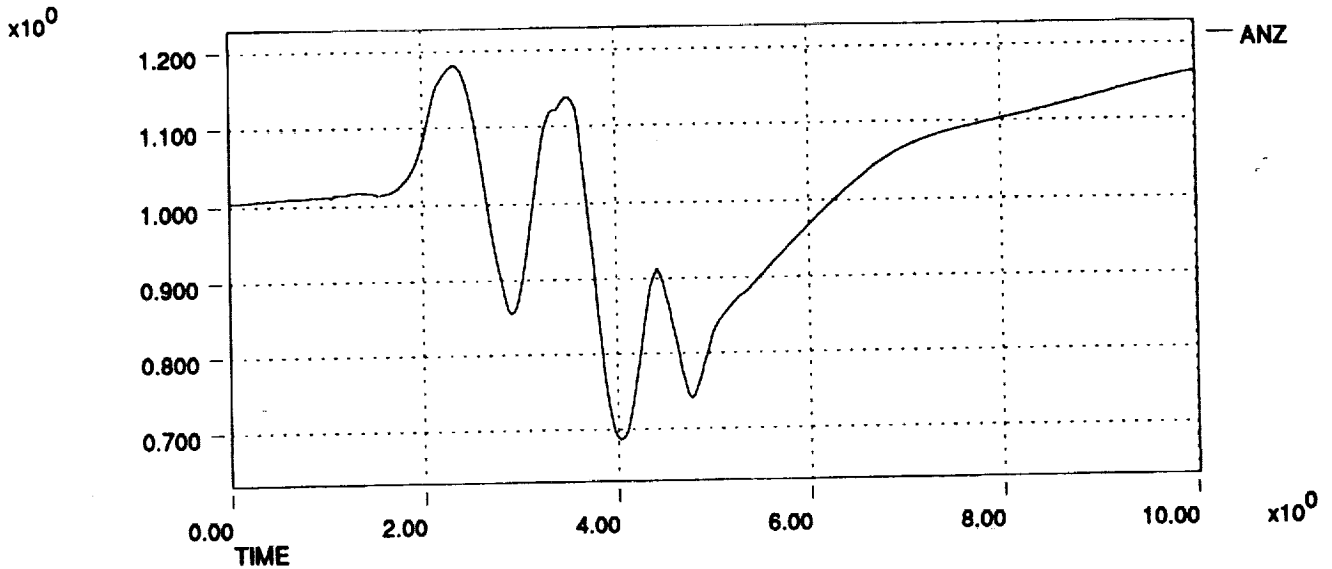
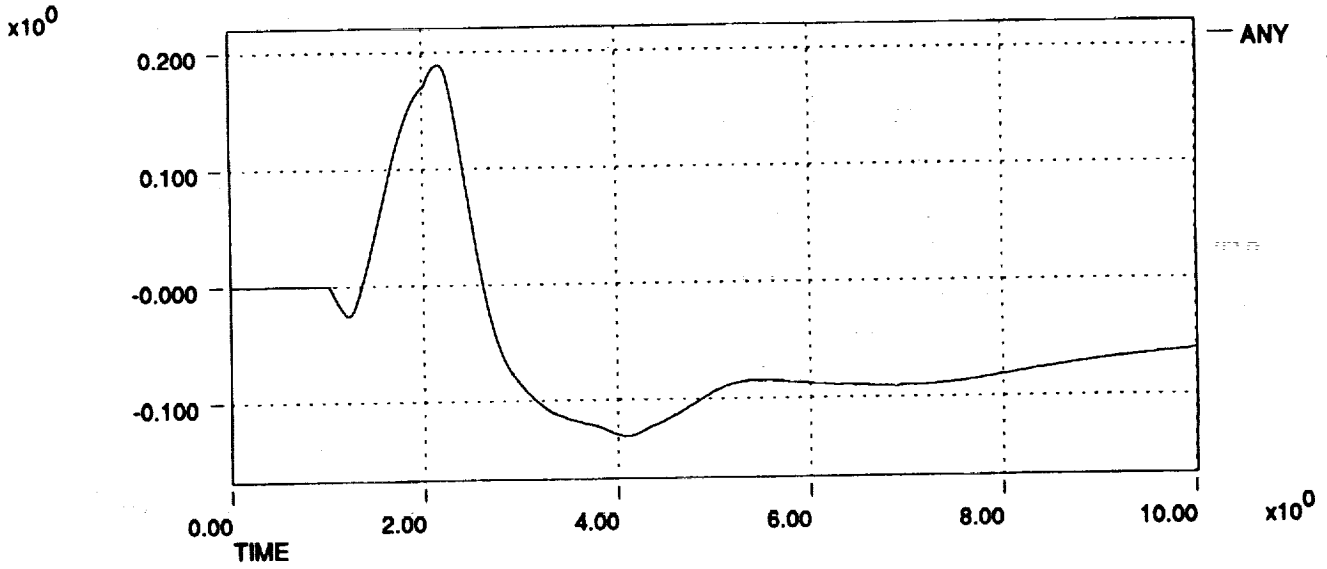
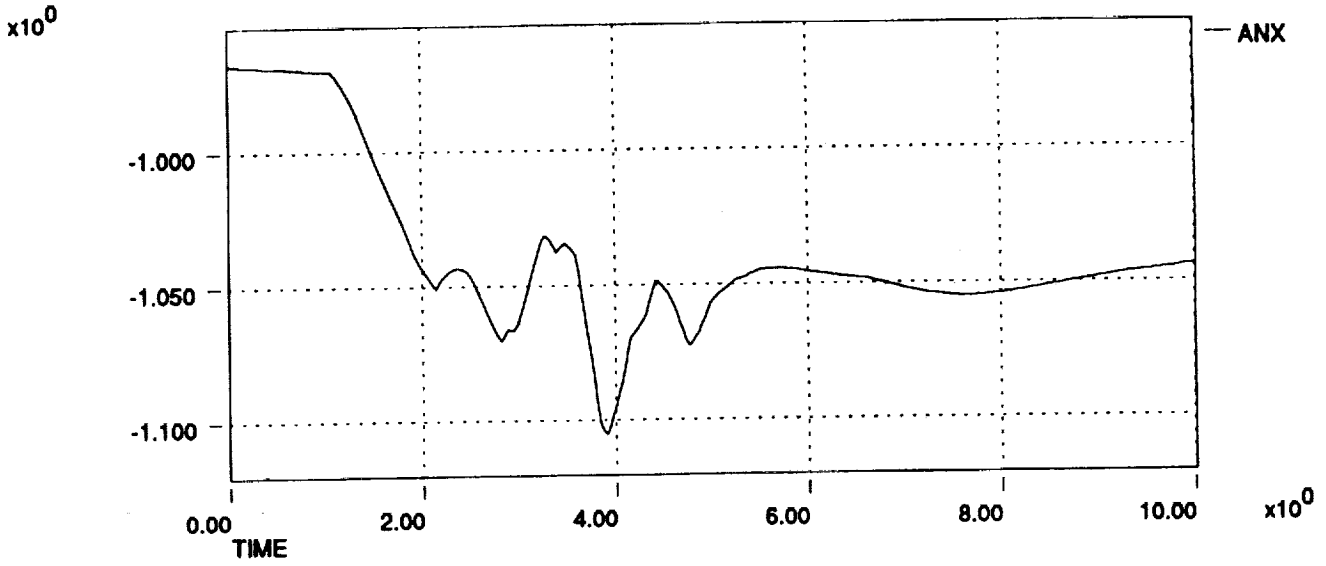

HL-20 Dynamic Check Case Data Plots 911206
Right Rudder Pedal Pulse at Mach 2 and 58,700 ft

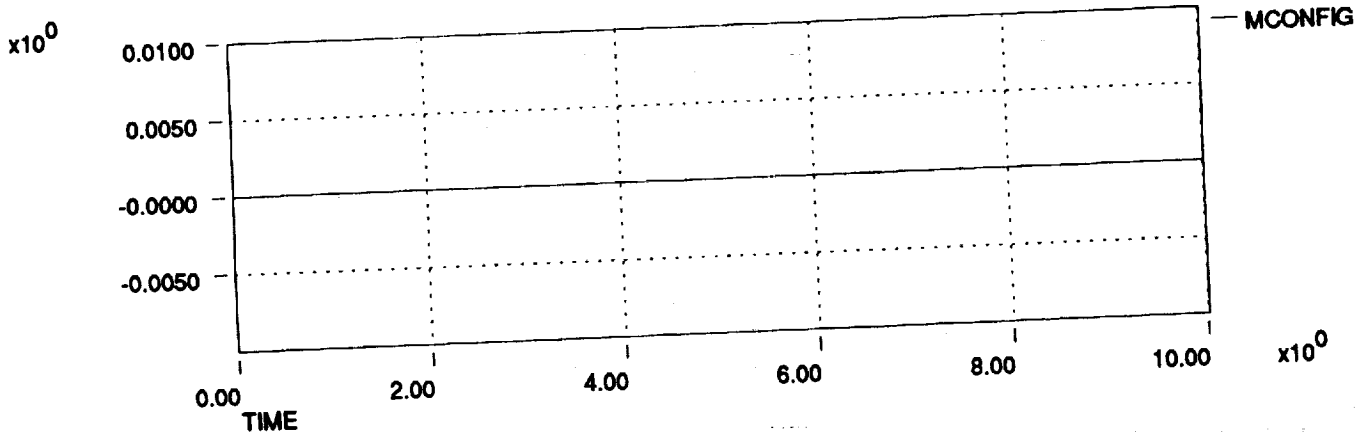
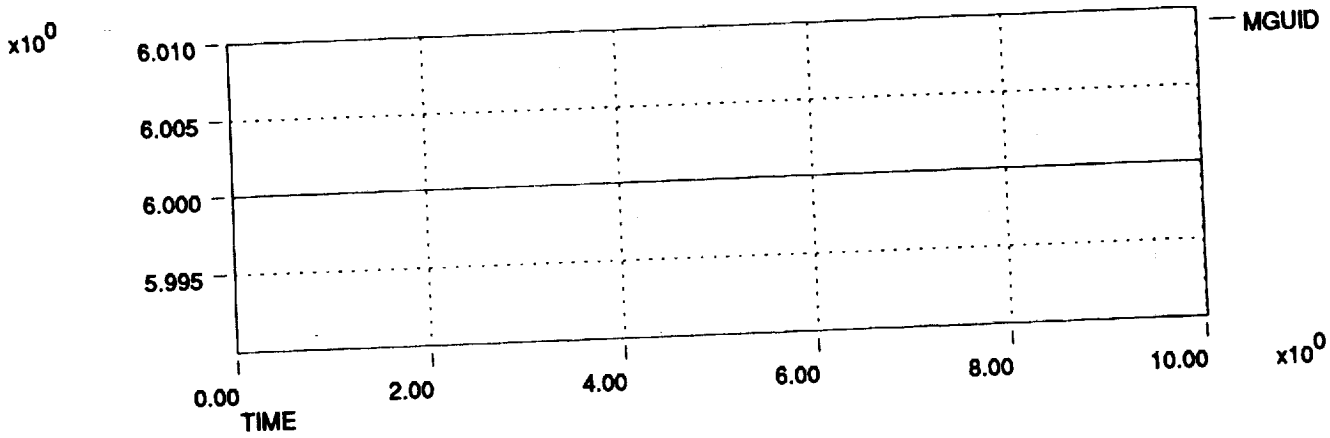
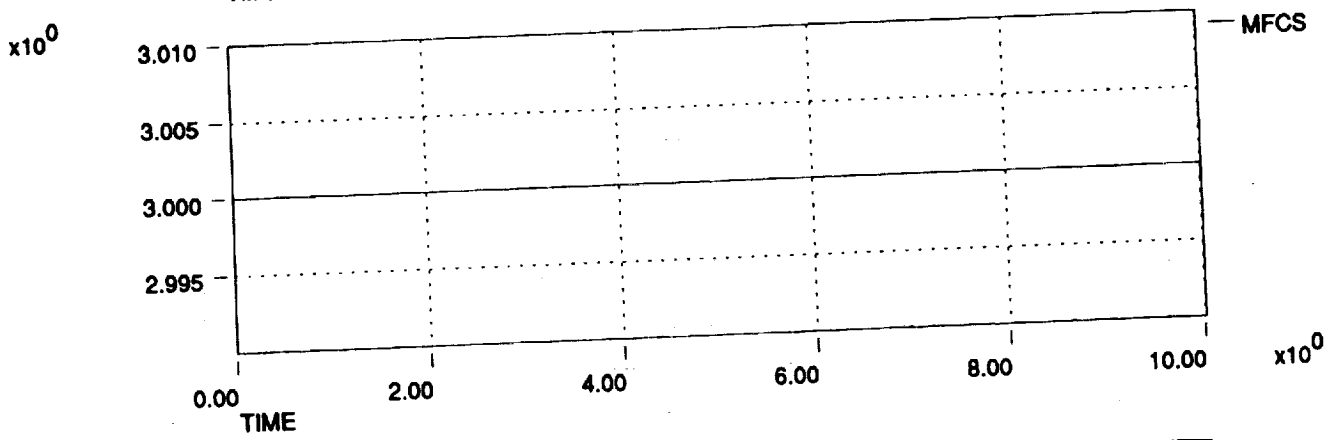
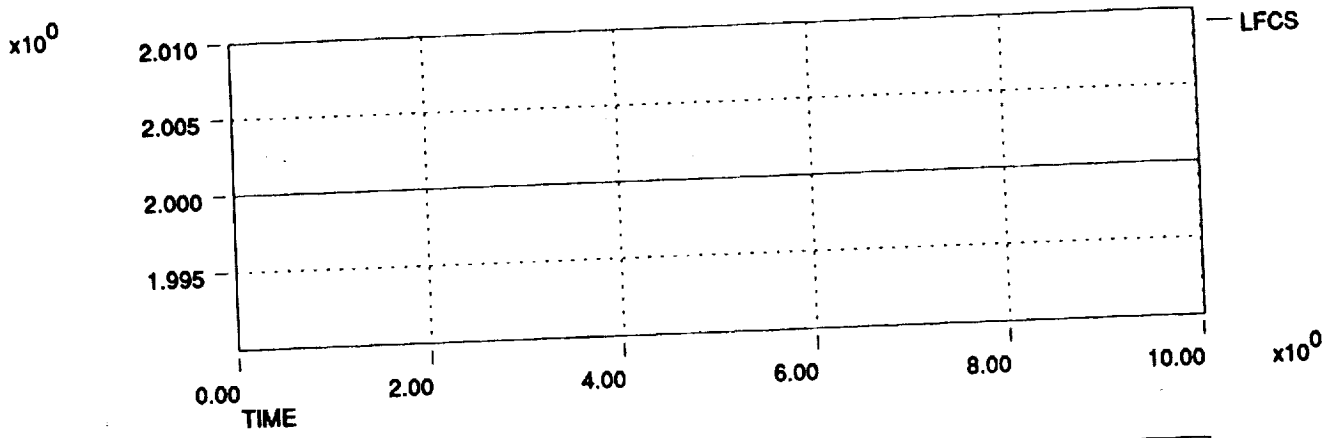

HL-20 Dynamic Check Case Data Plots 911206
Right Rudder Pedal Pulse at Mach 2 and 58,700 ft

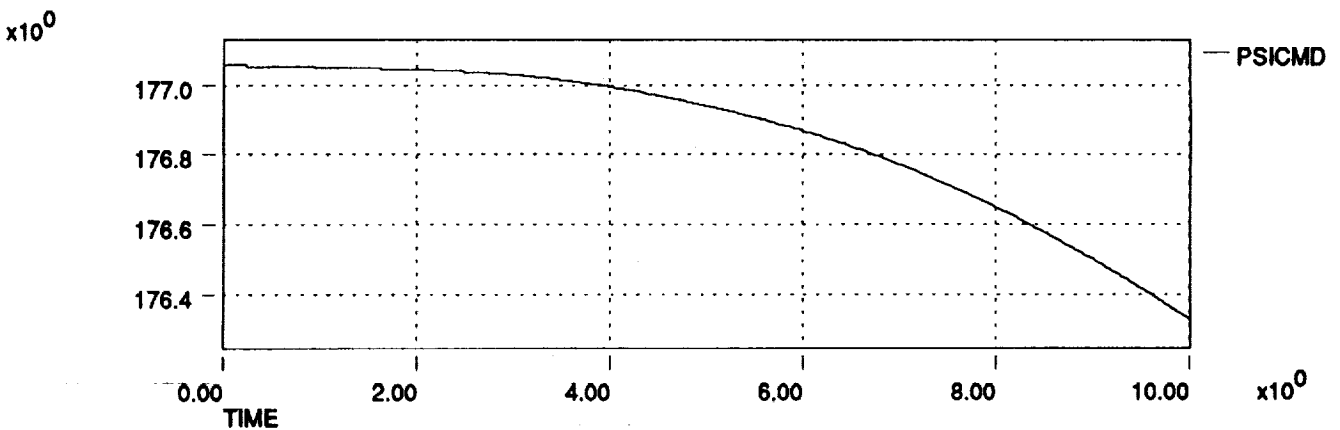
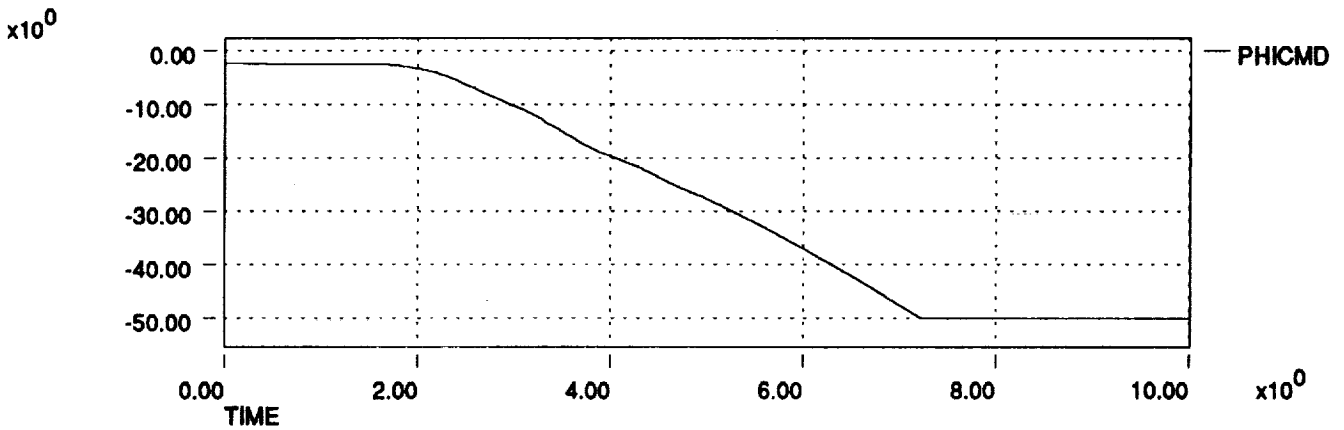
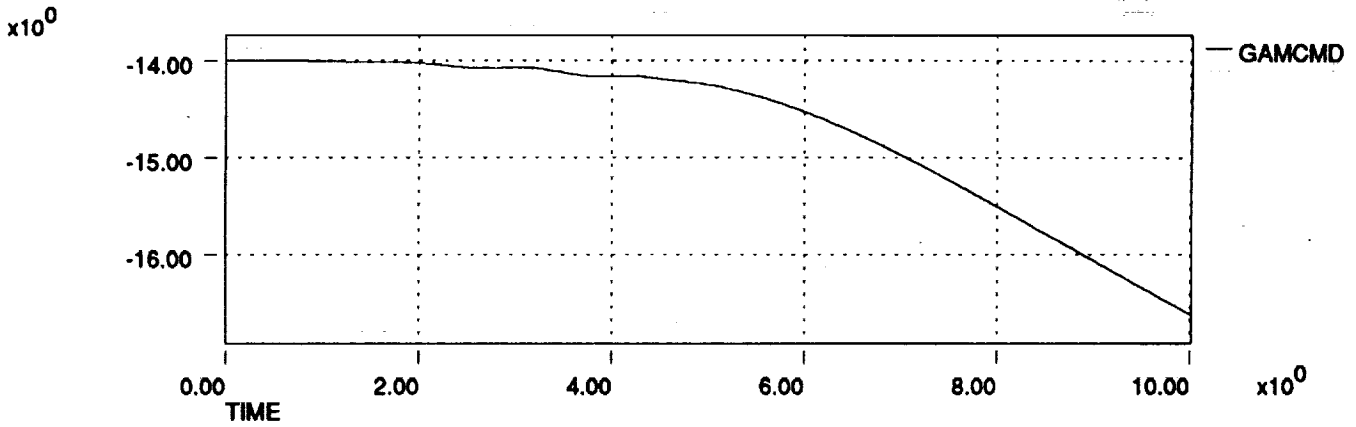
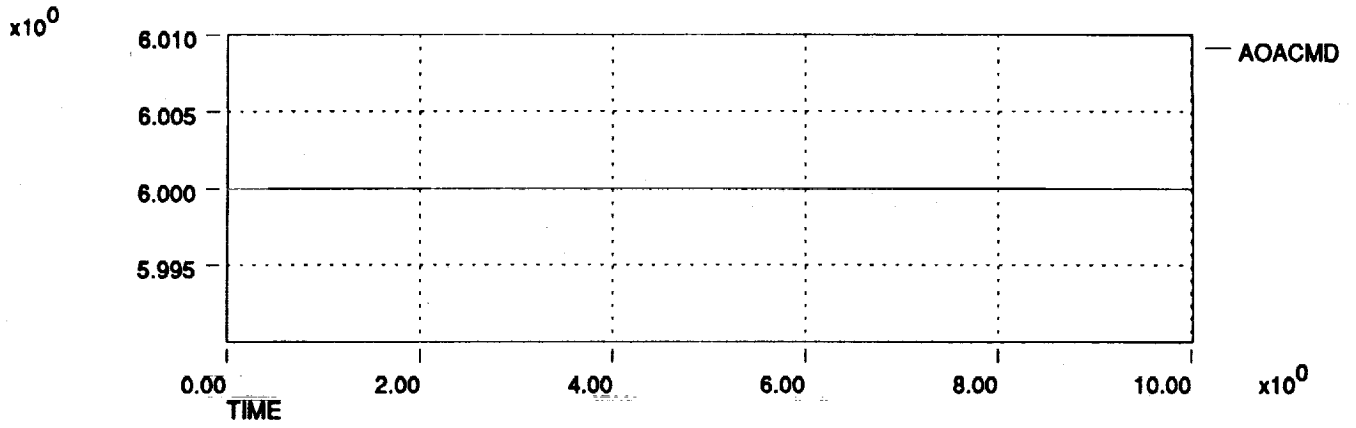

HL-20 Dynamic Check Case Data Plots 911206
Right Rudder Pedal Pulse at Mach 2 and 58,700 ft

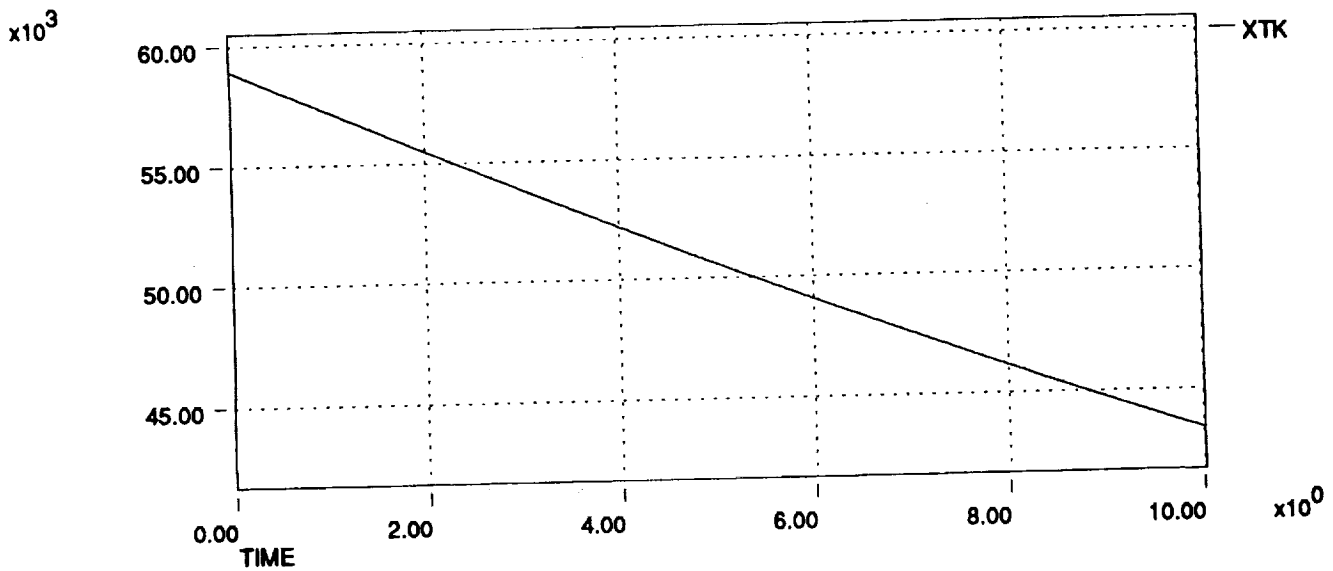
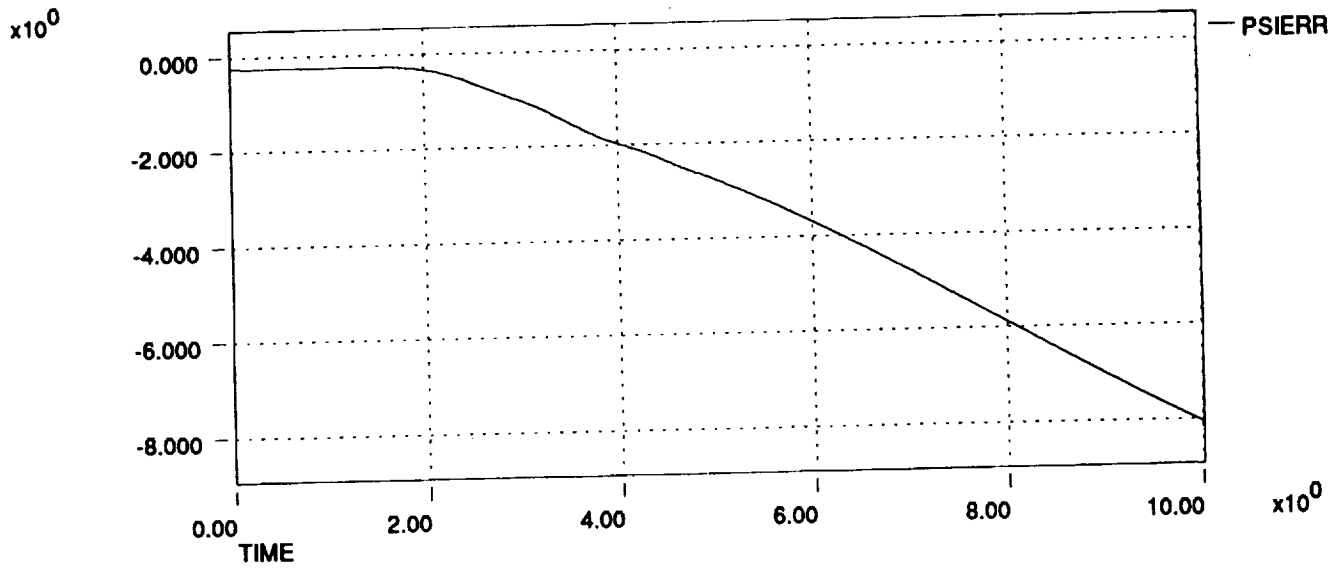
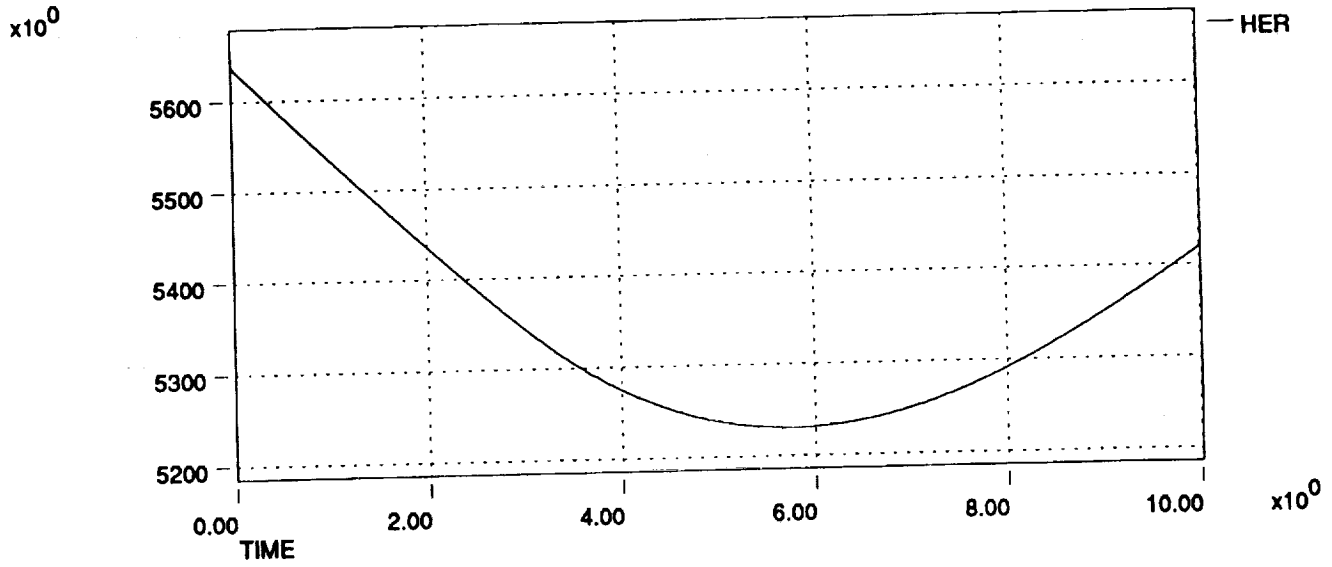

HL-20 Dynamic Check Case Data Plots 911206
Right Rudder Pedal Pulse at Mach 2 and 58,700 ft

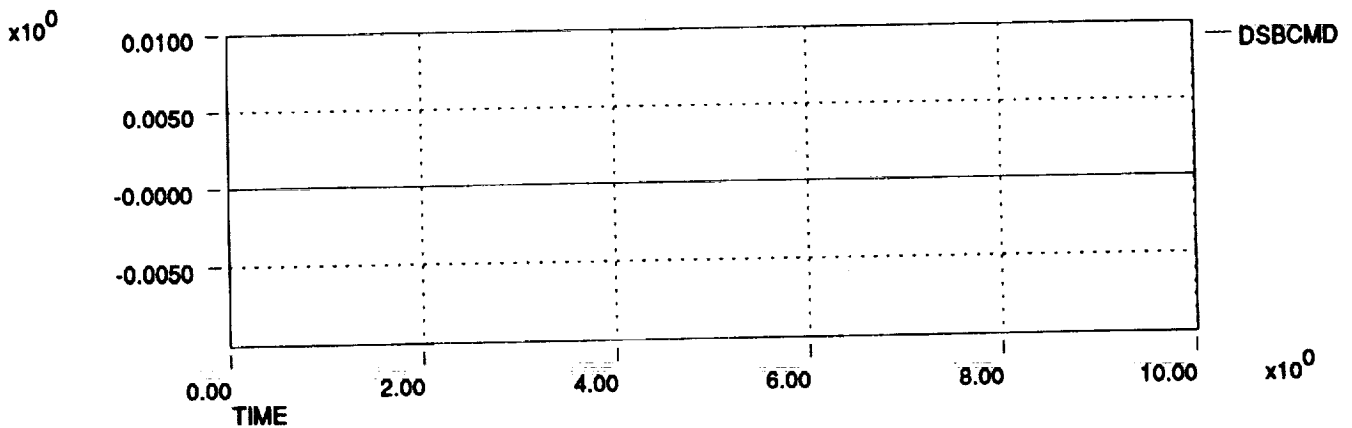
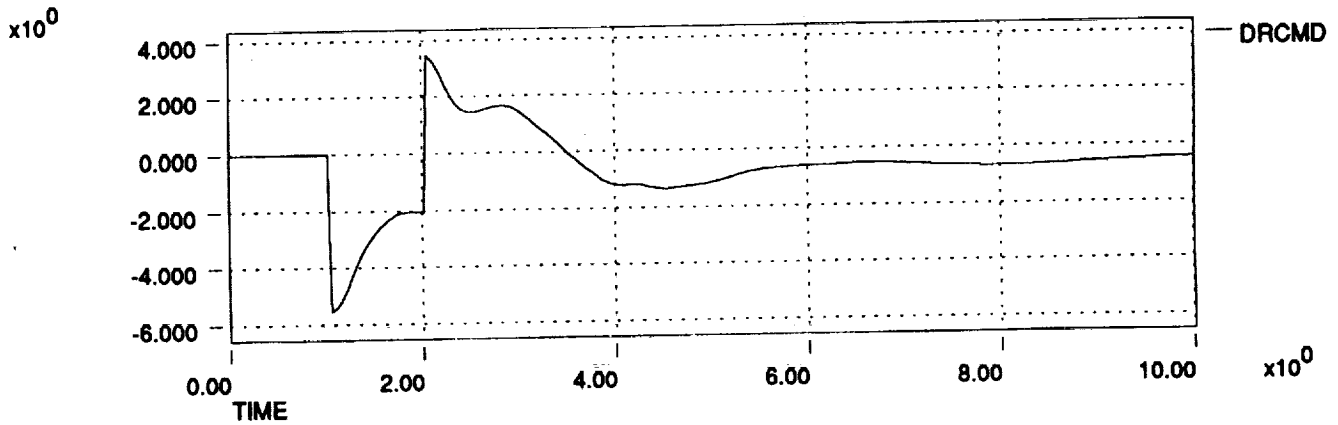
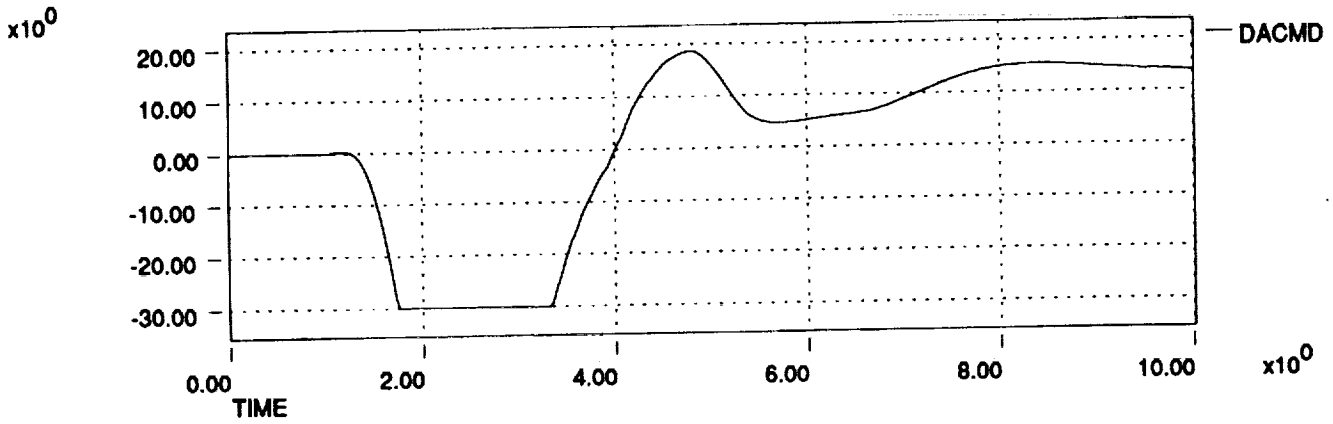
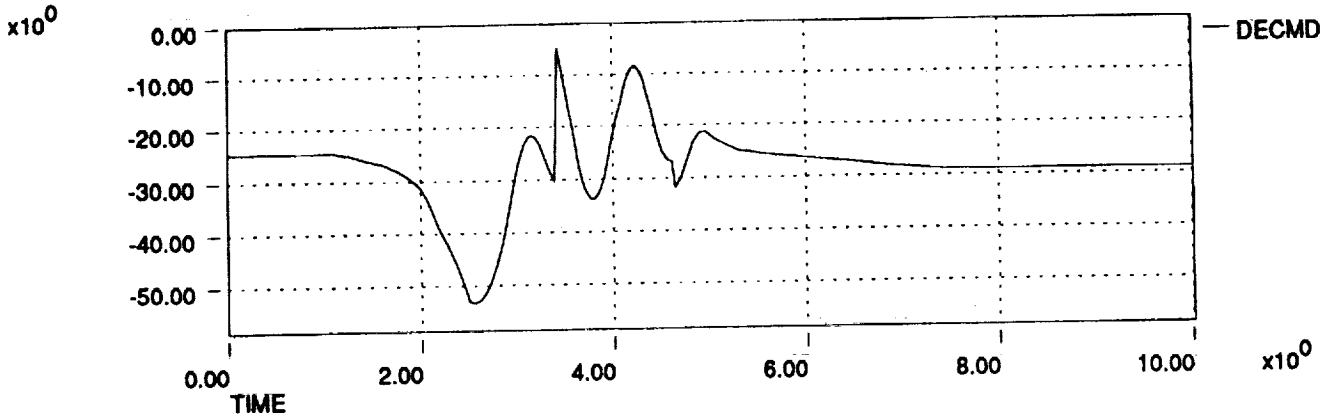

HL-20 Dynamic Check Case Data Plots 911206
Right Rudder Pedal Pulse at Mach 2 and 58,700 ft

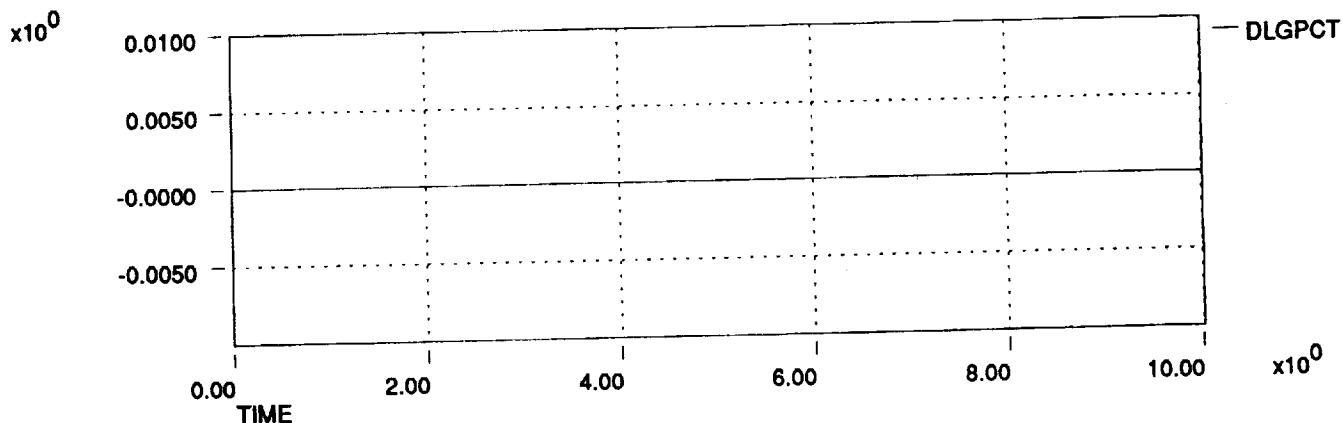
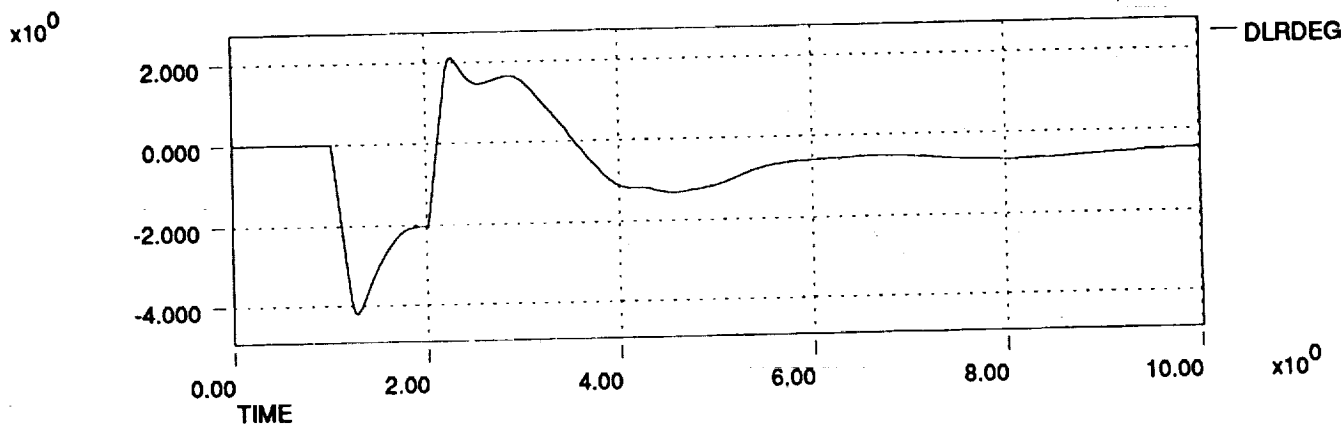
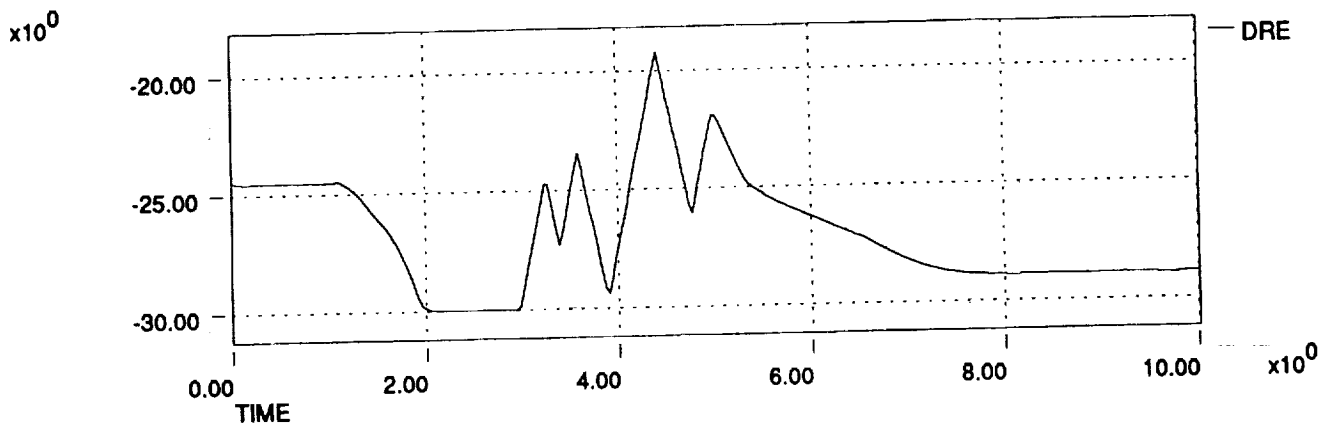
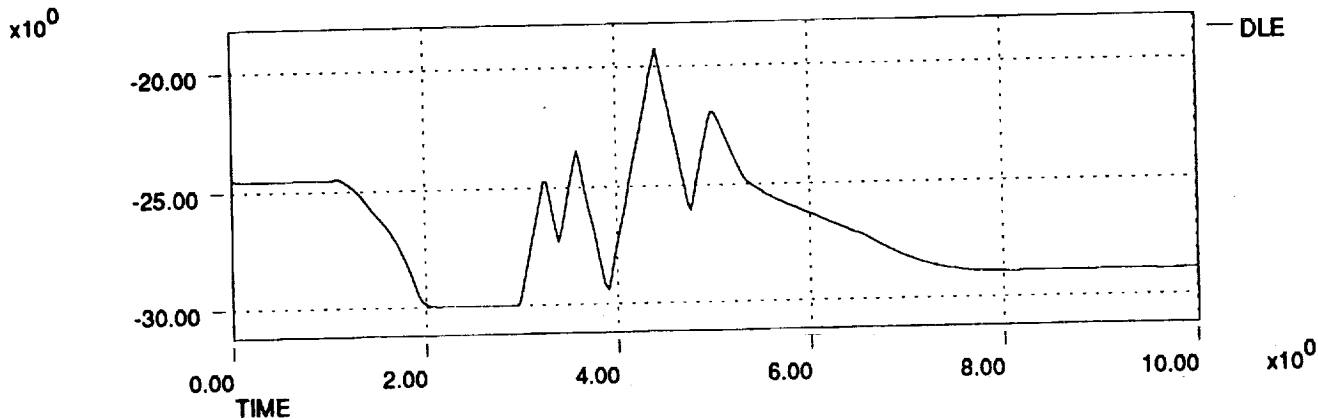

HL-20 Dynamic Check Case Data Plots 911206
Right Rudder Pedal Pulse at Mach 2 and 58,700 ft

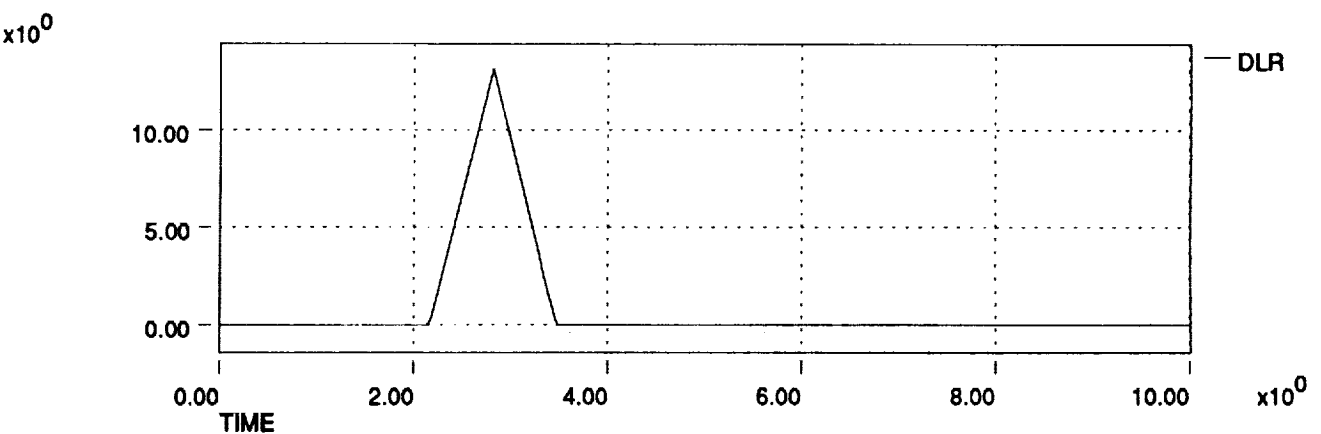
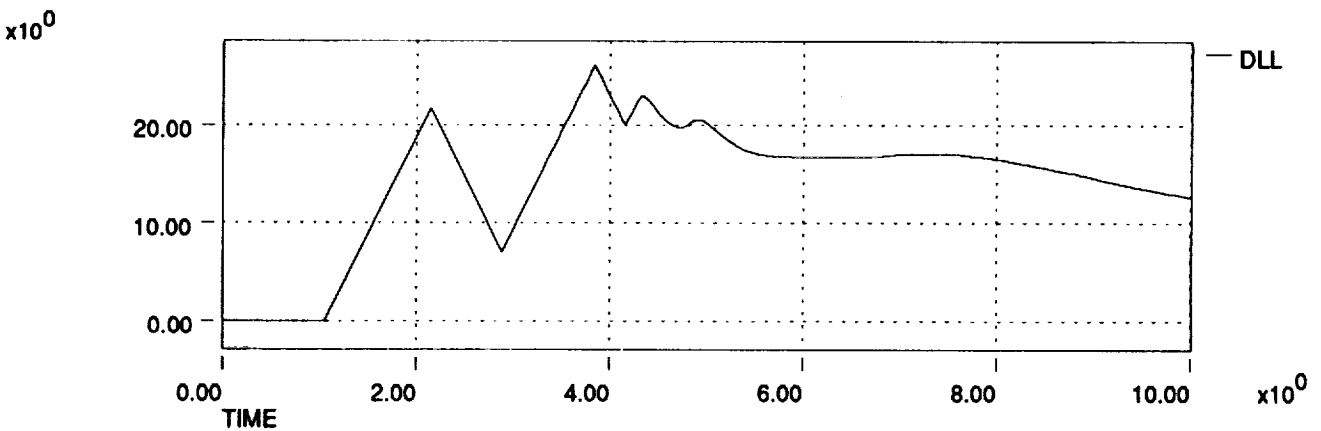
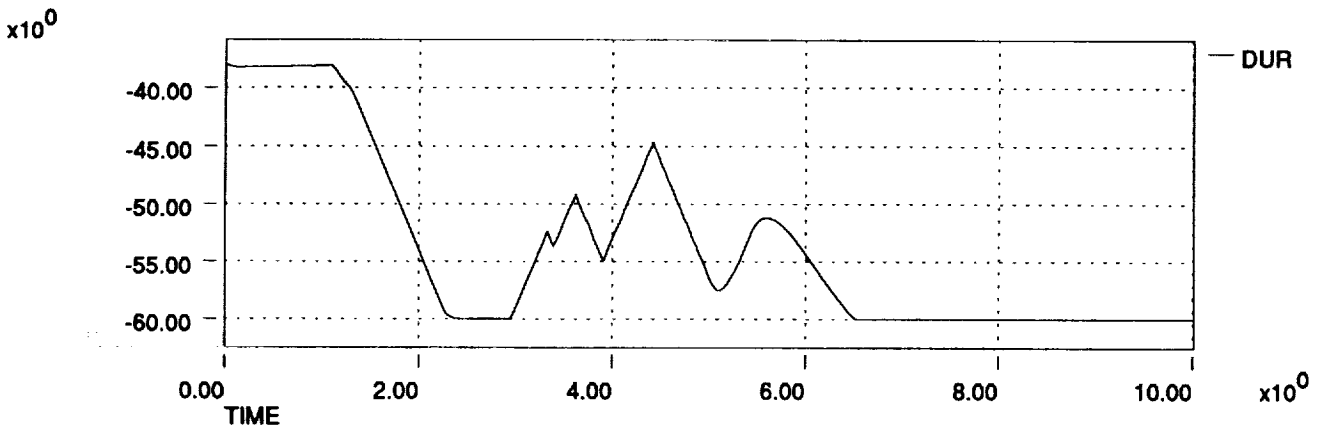
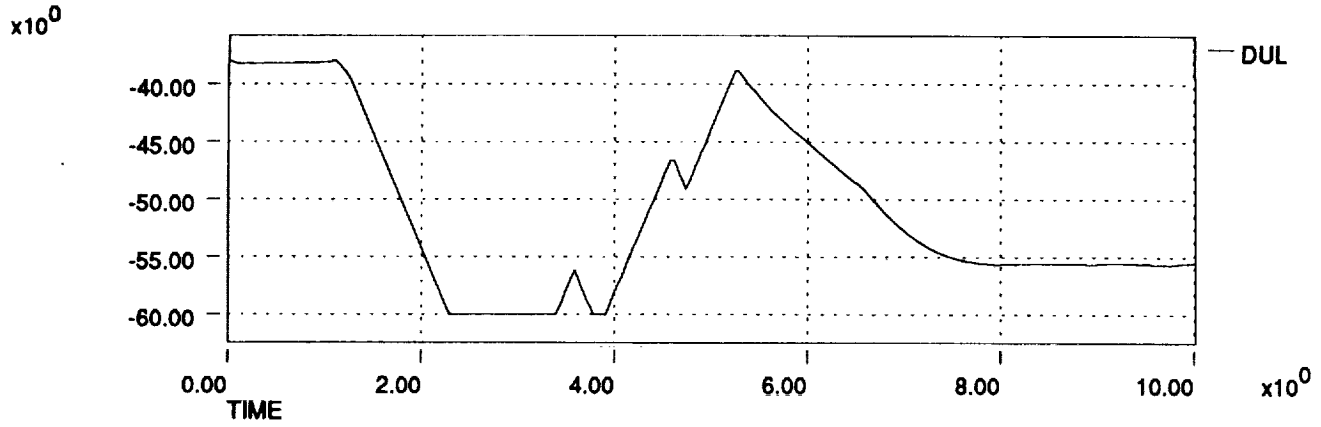

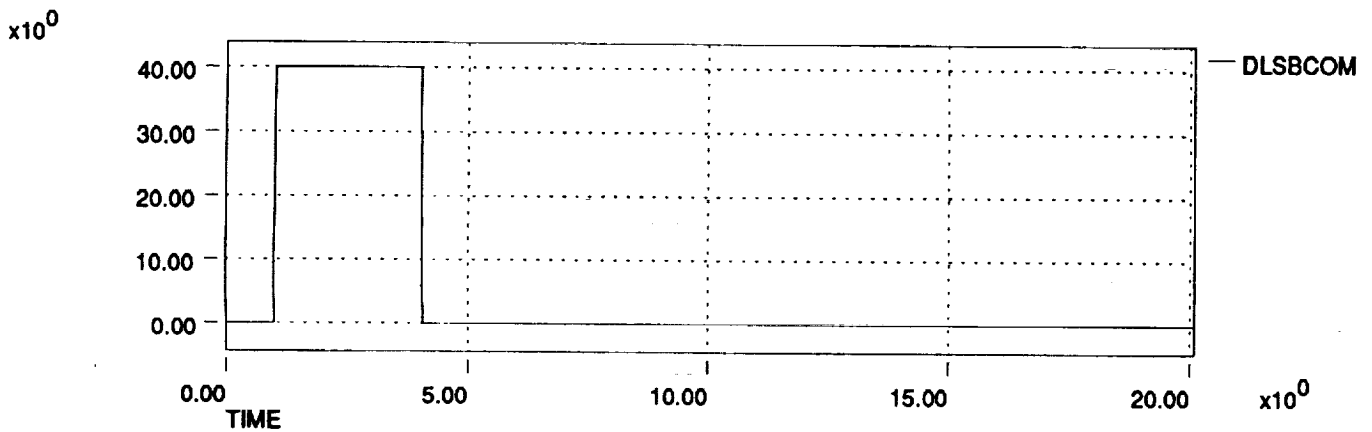
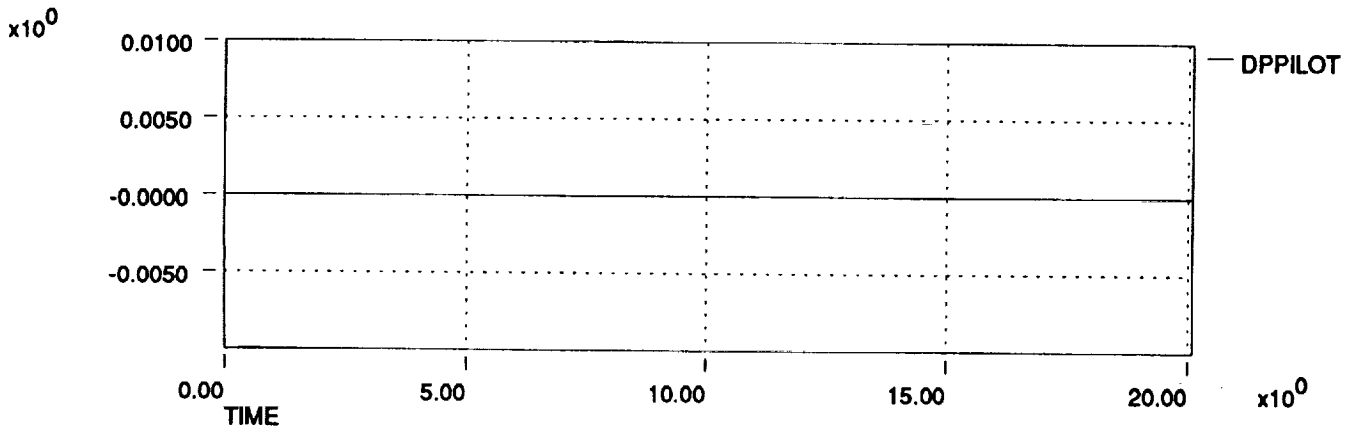
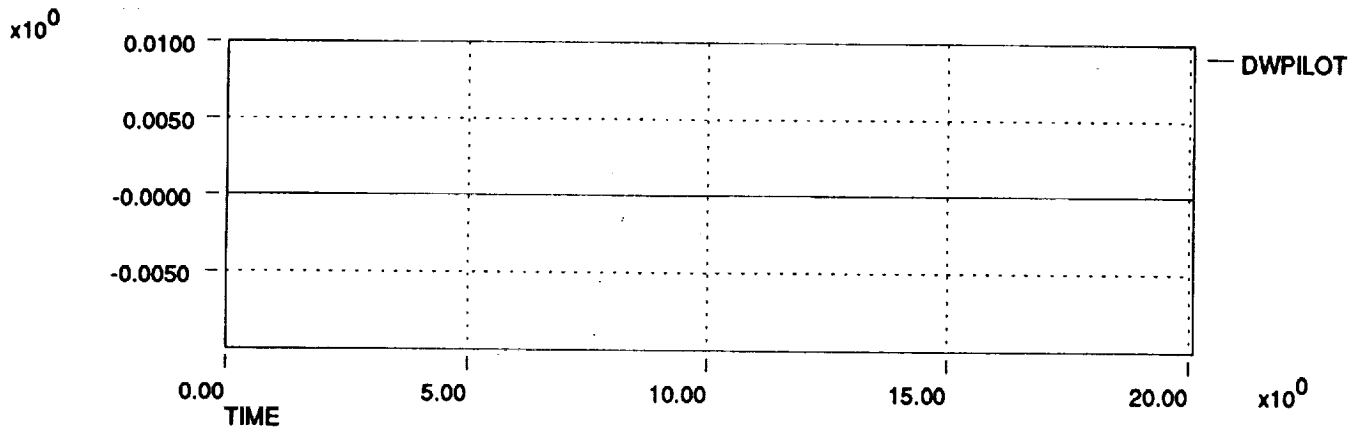
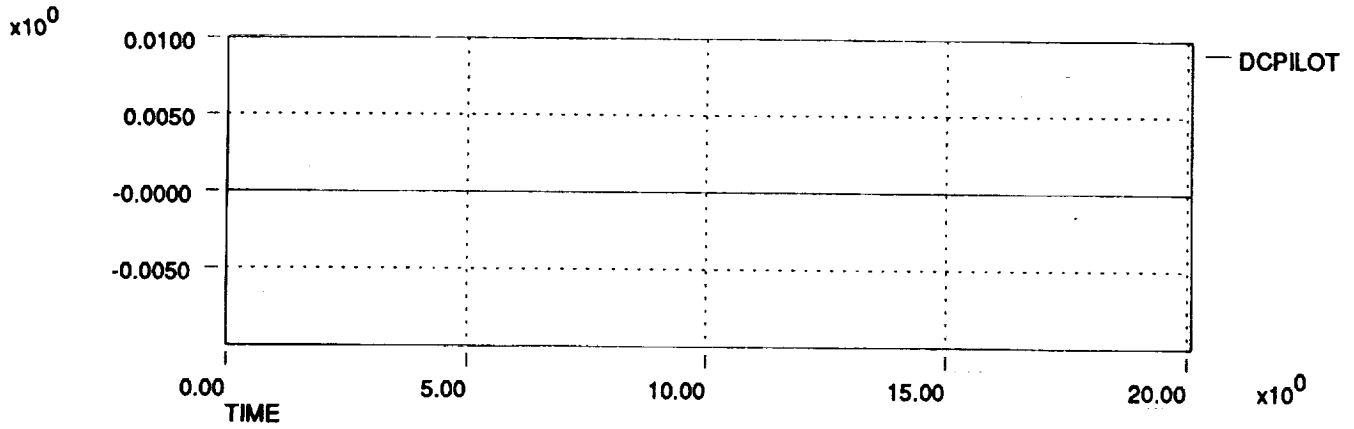

HL-20 Dynamic Check Case Data Plots 911206
Speed Brake Handle Pulse at Mach 2 and 58,700 ft

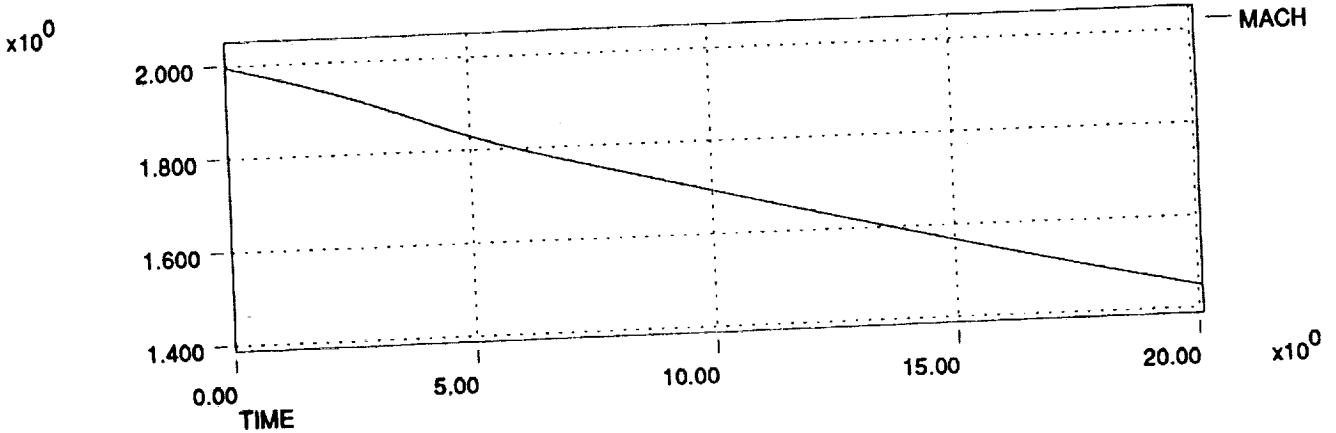
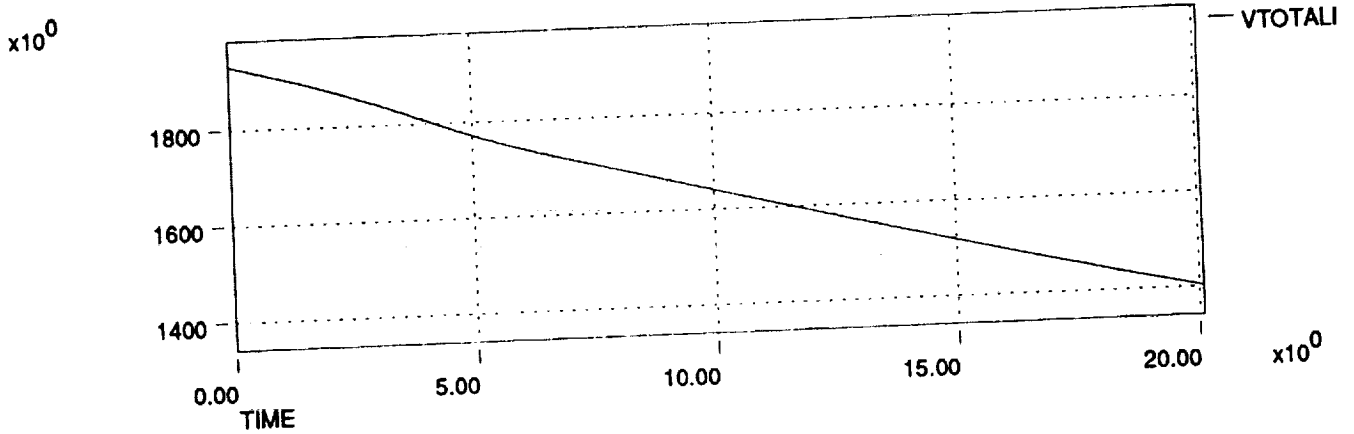
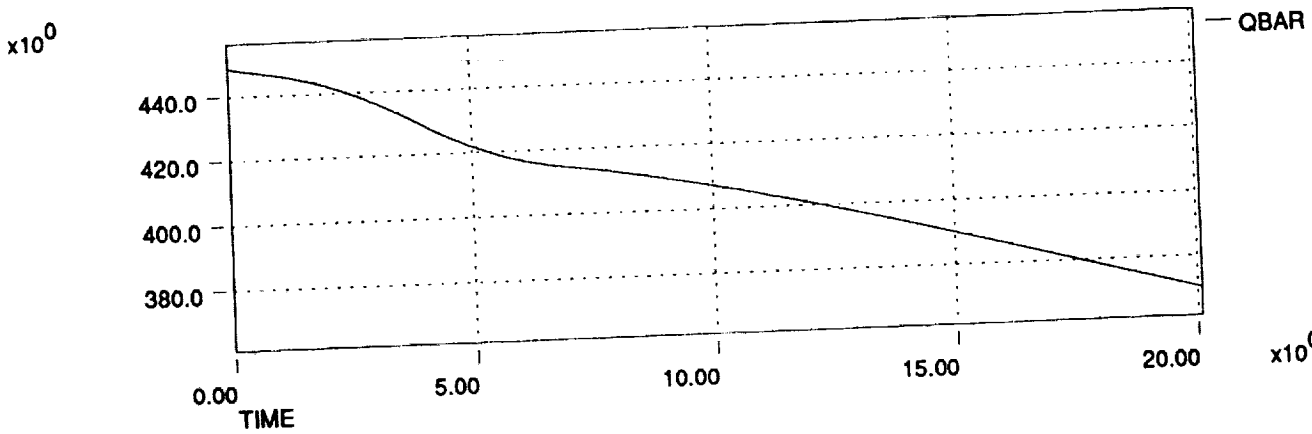
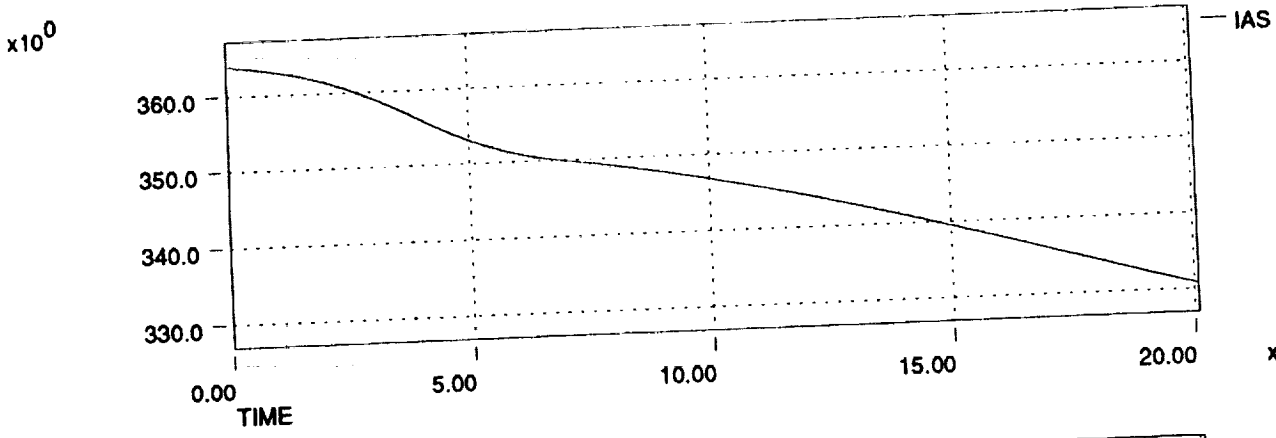

HL-20 Dynamic Check Case Data Plots 911206
Speed Brake Handle Pulse at Mach 2 and 58,700 ft

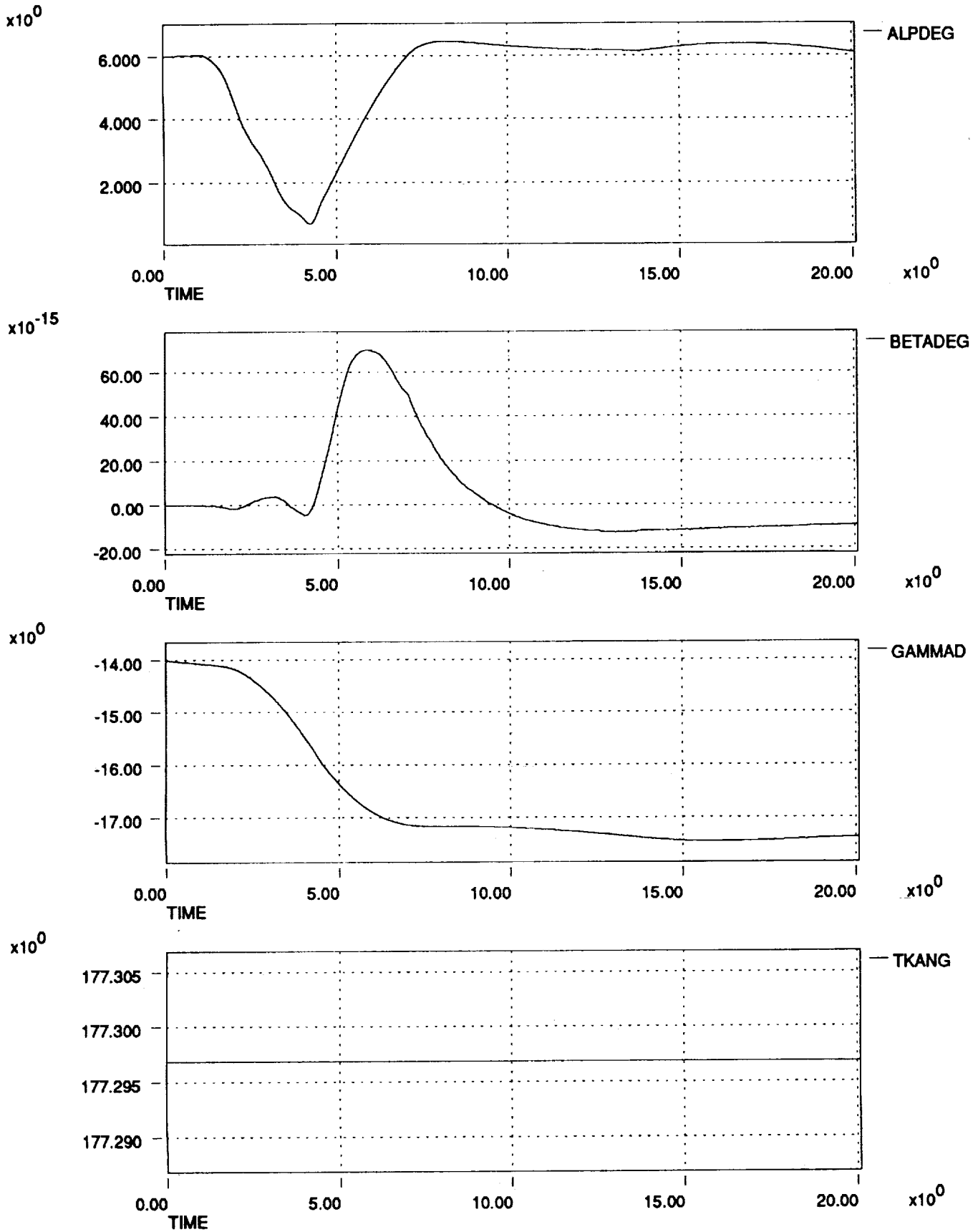

HL-20 Dynamic Check Case Data Plots 911206
Speed Brake Handle Pulse at Mach 2 and 58,700 ft

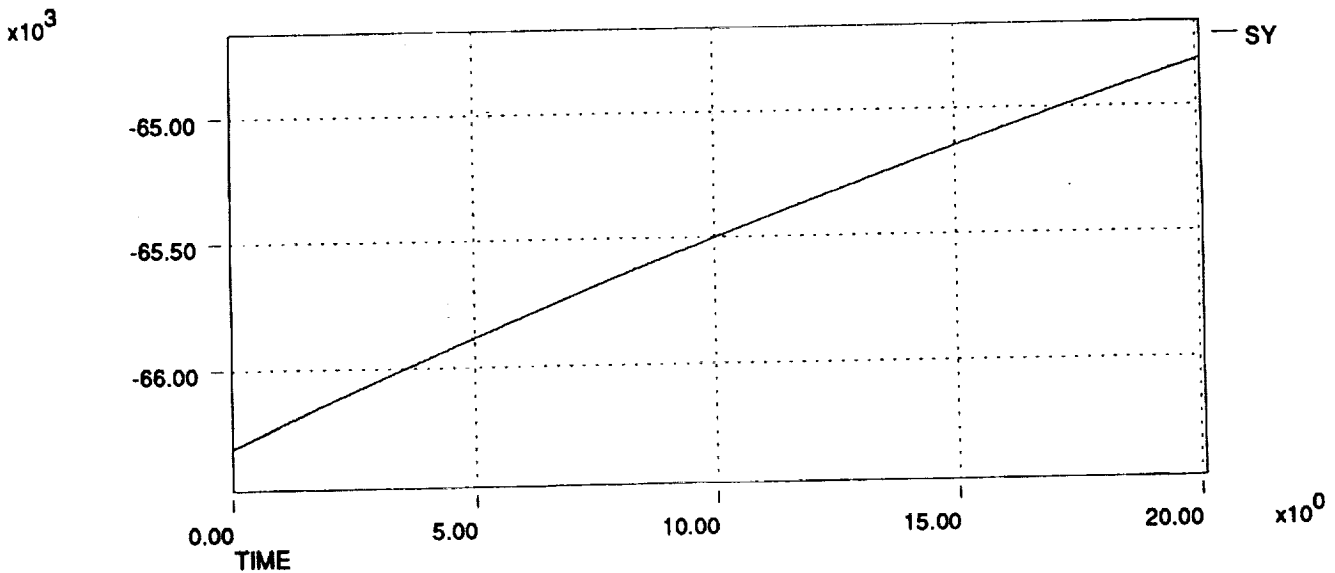
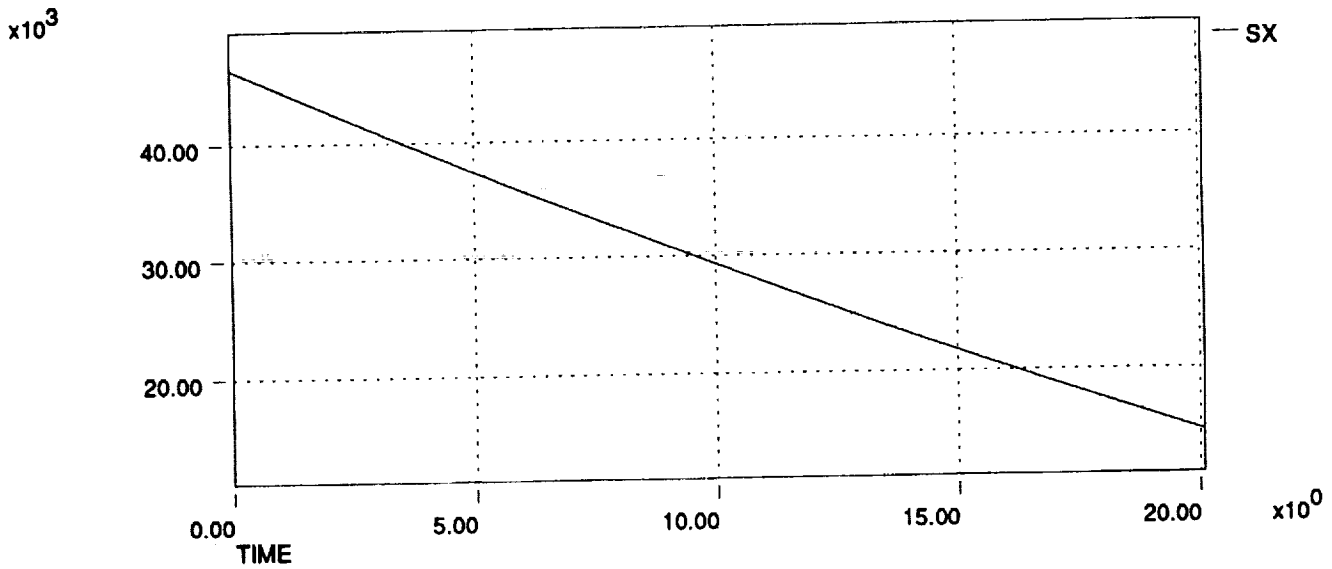
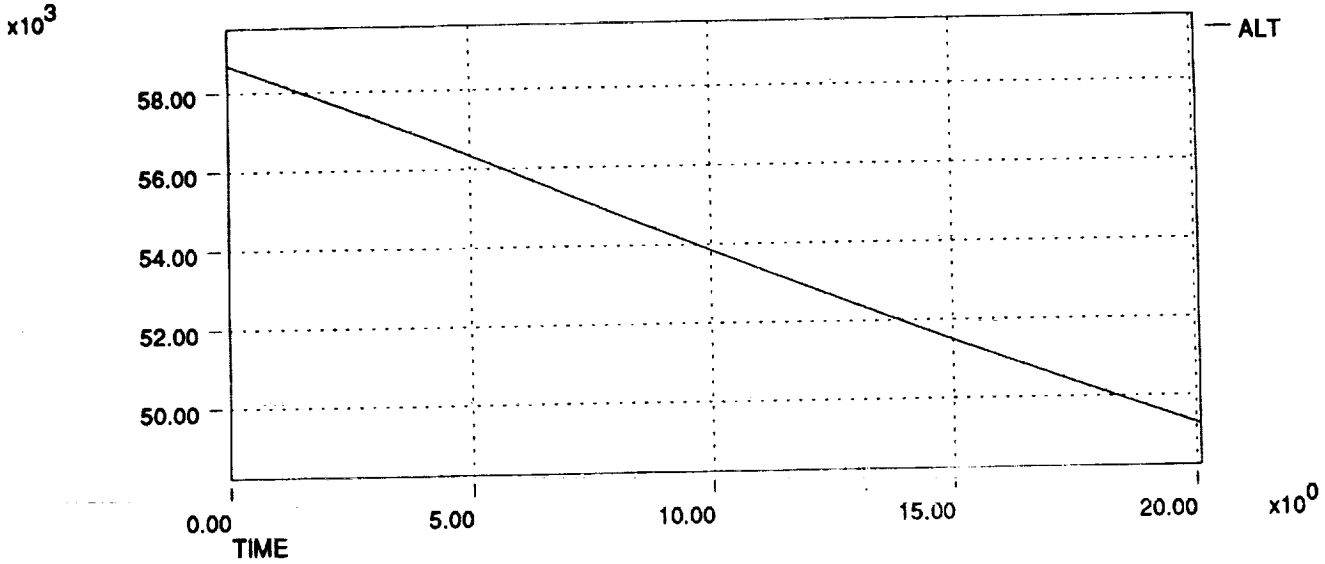

HL-20 Dynamic Check Case Data Plots 911206
Speed Brake Handle Pulse at Mach 2 and 58,700 ft

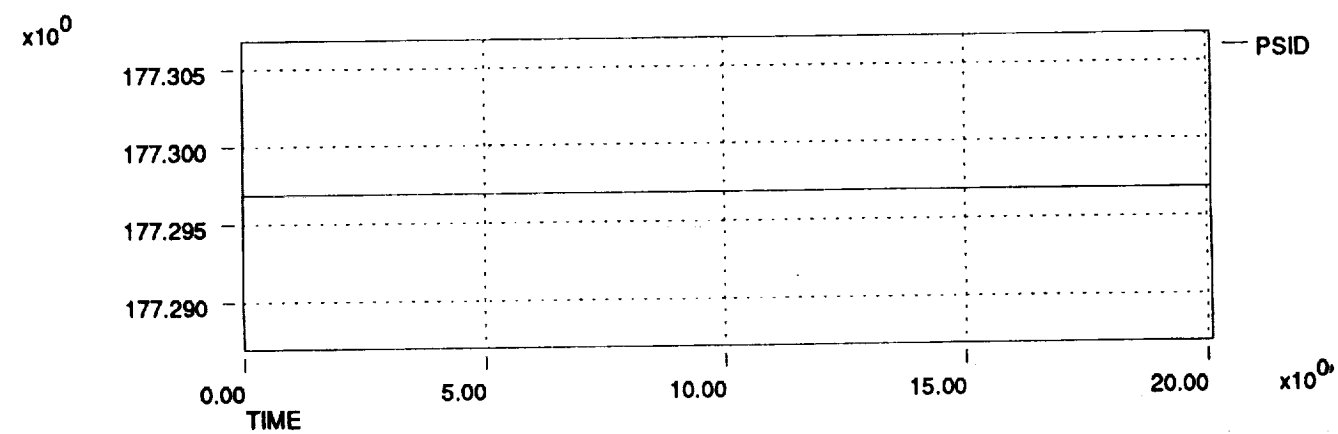
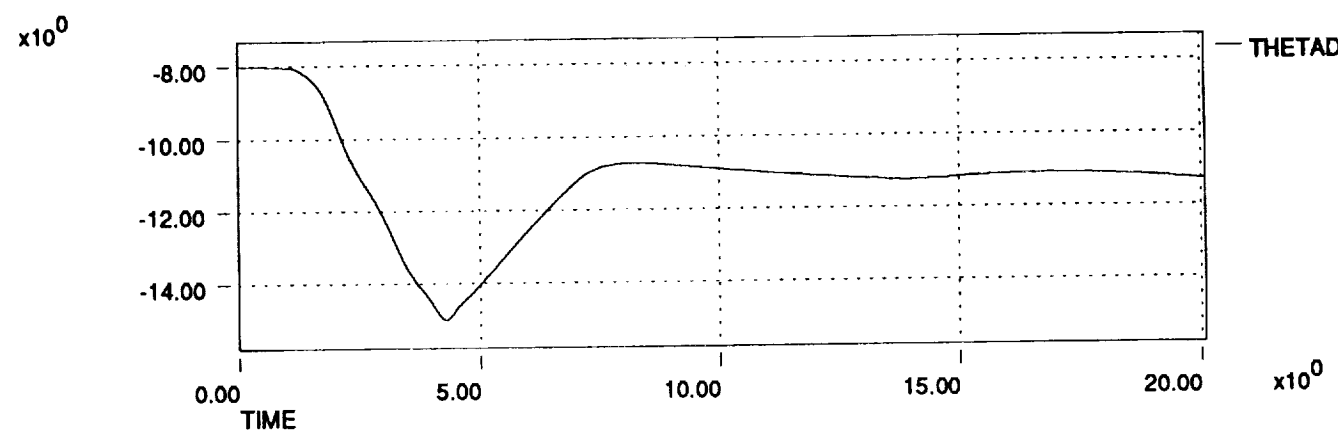
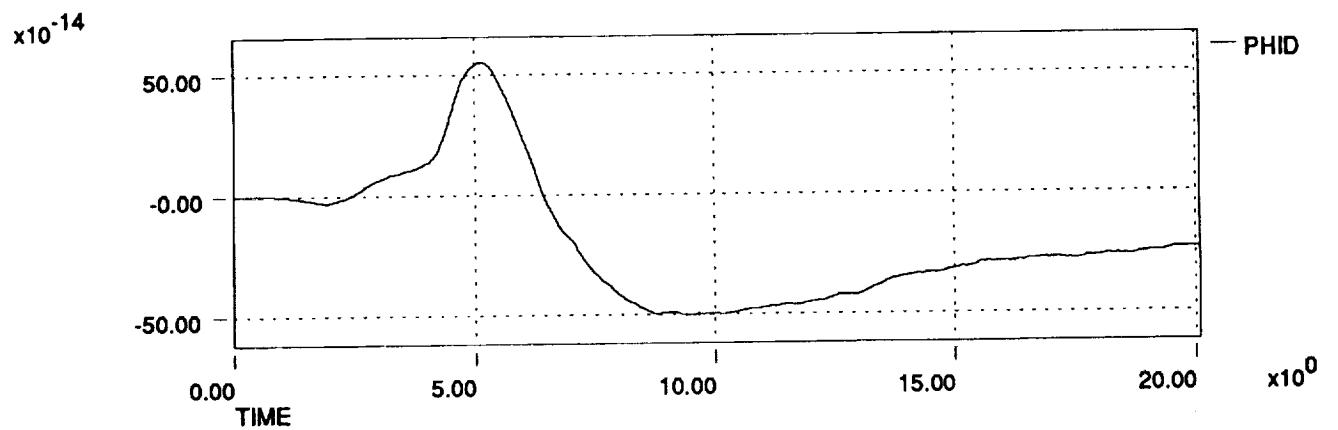
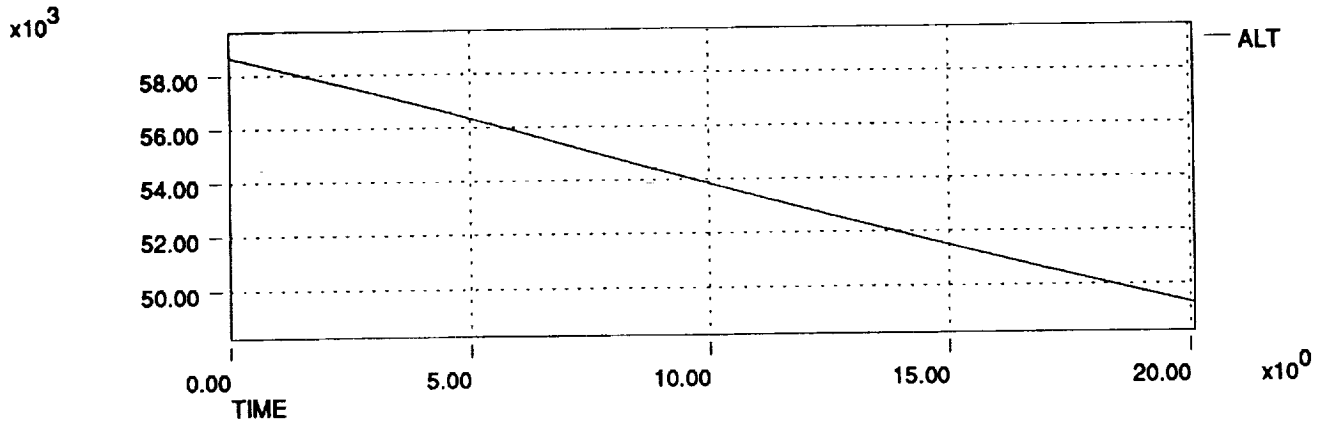

HL-20 Dynamic Check Case Data Plots 911206
Speed Brake Handle Pulse at Mach 2 and 58,700 ft

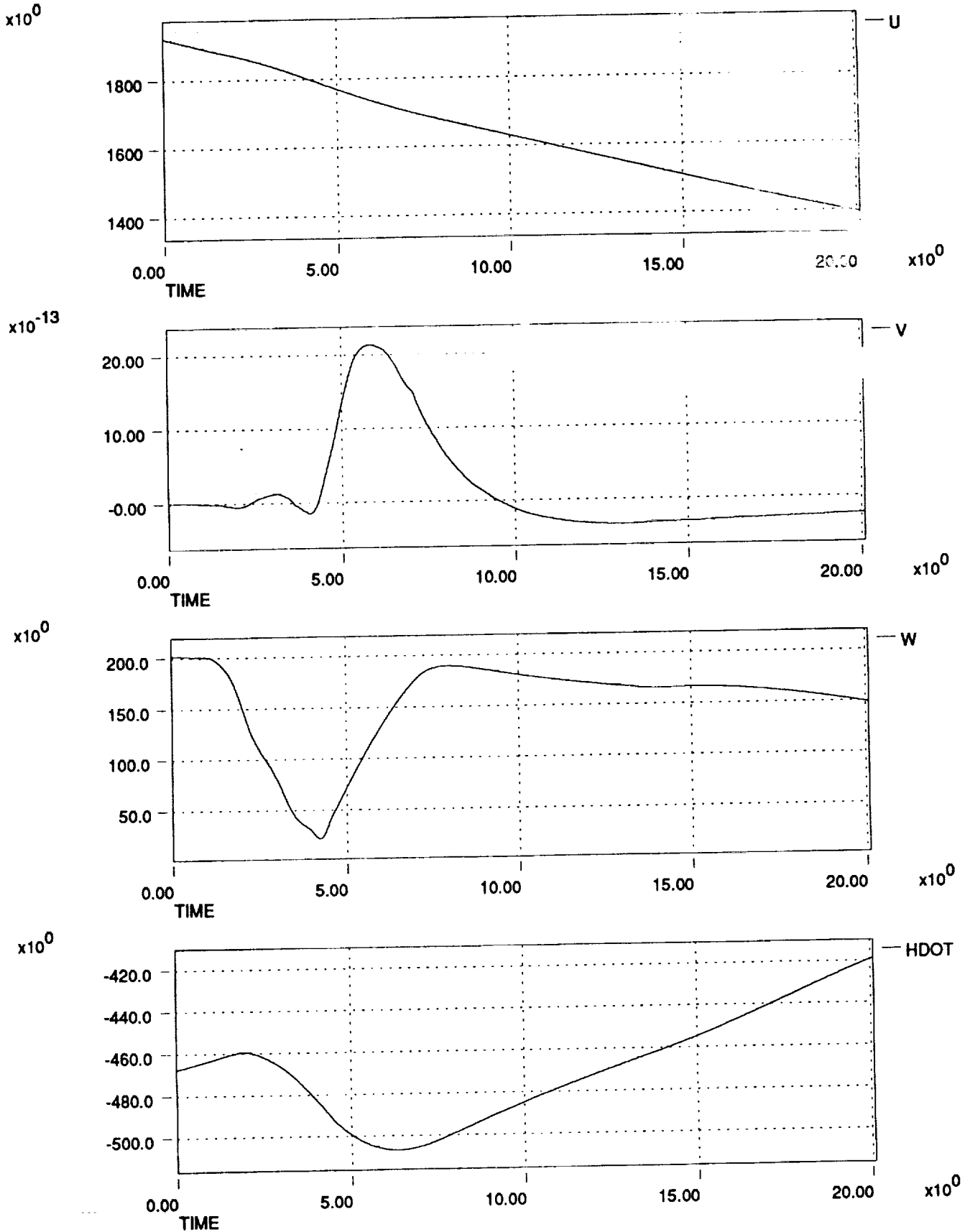

HL-20 Dynamic Check Case Data Plots 911206
Speed Brake Handle Pulse at Mach 2 and 58,700 ft

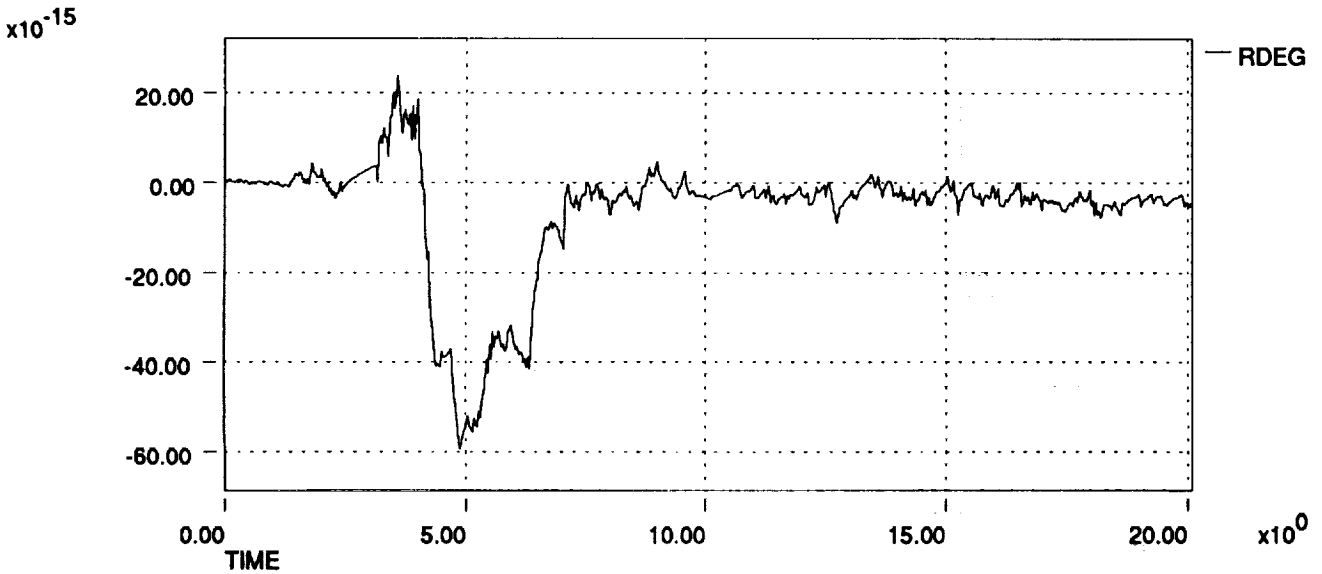
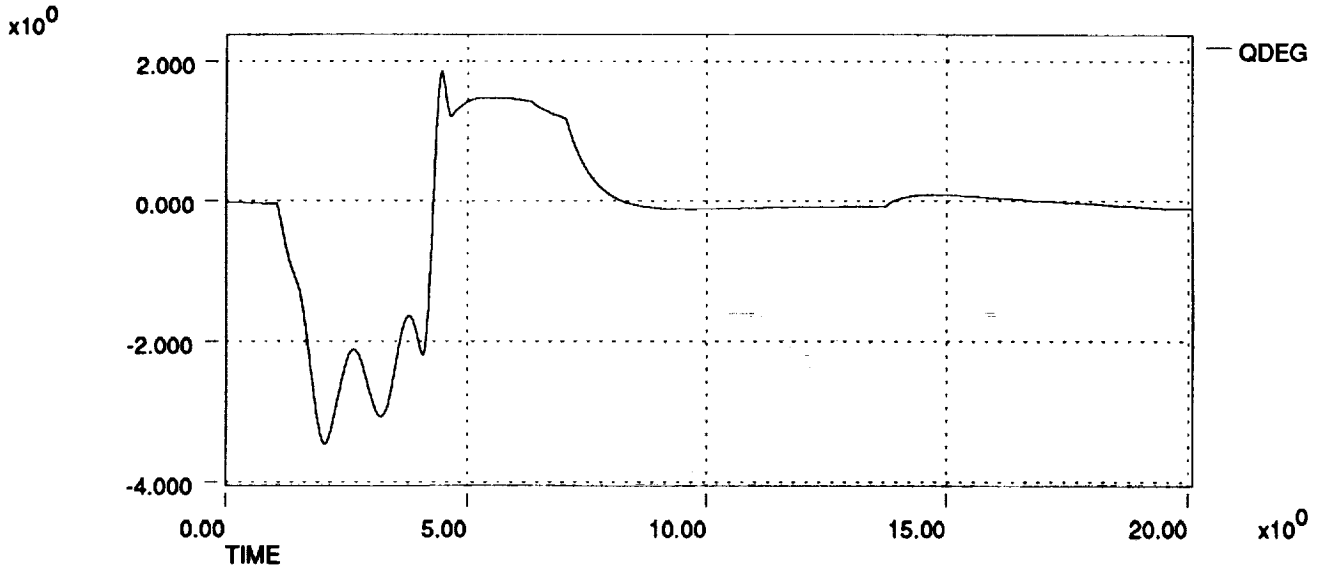
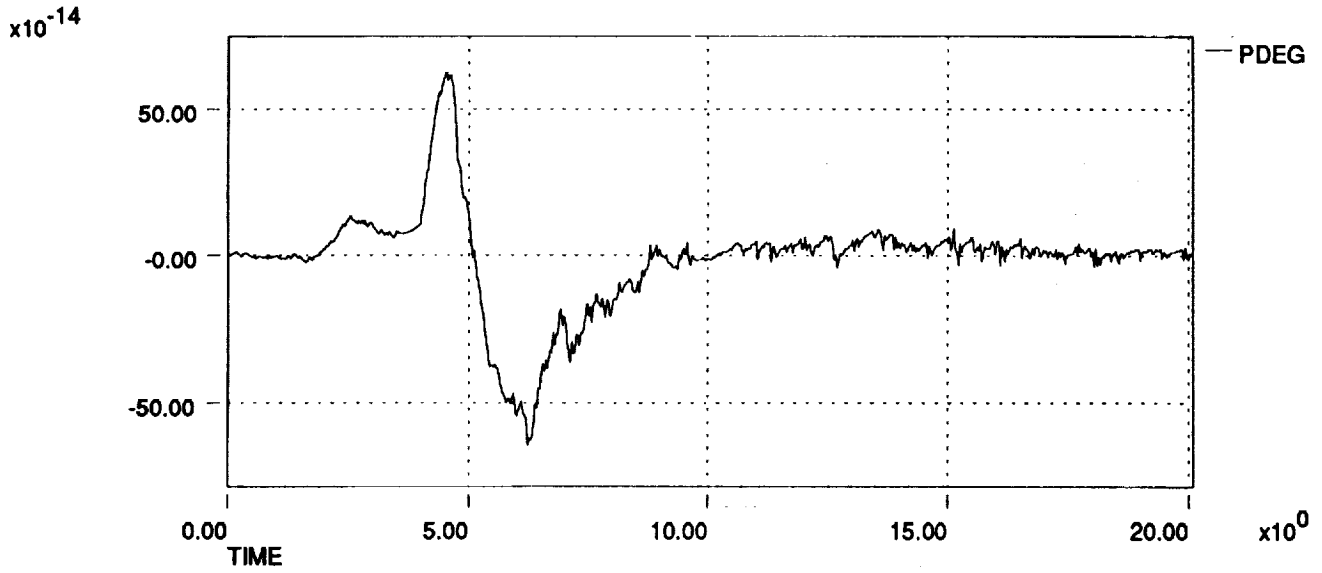

HL-20 Dynamic Check Case Data Plots 911206
Speed Brake Handle Pulse at Mach 2 and 58,700 ft

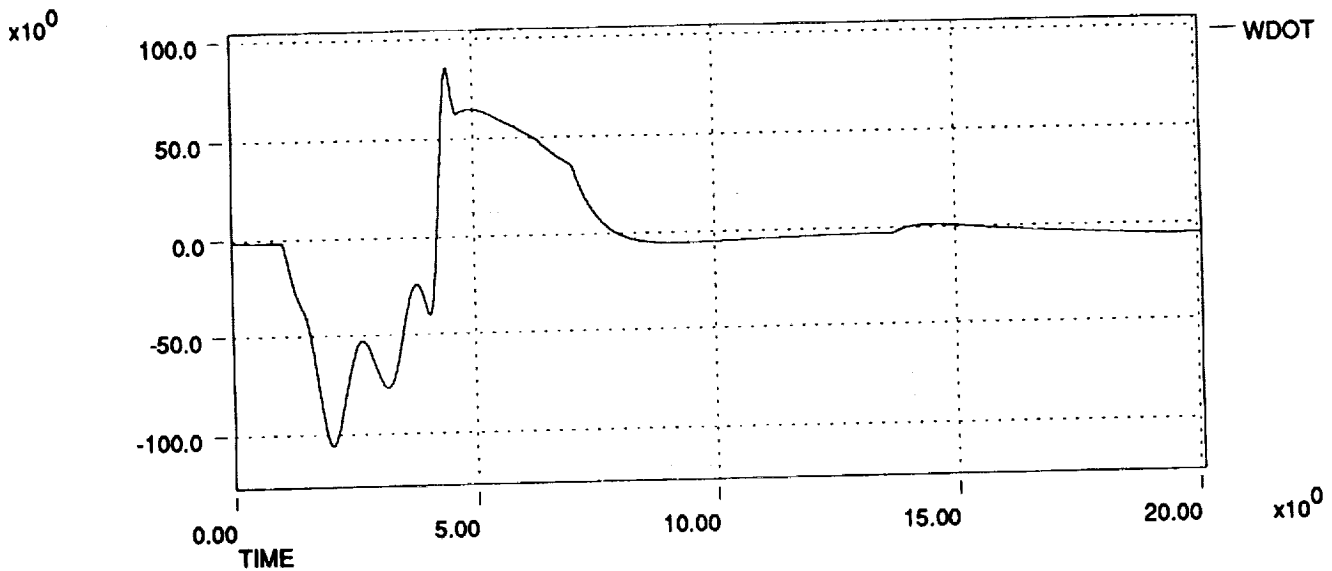
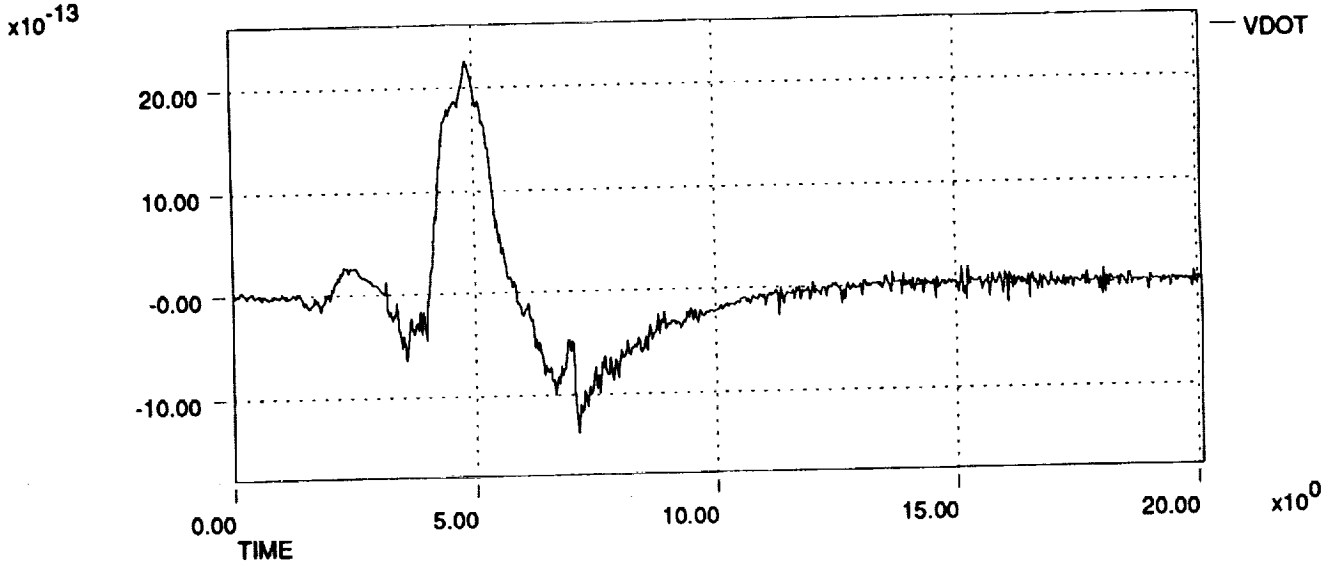
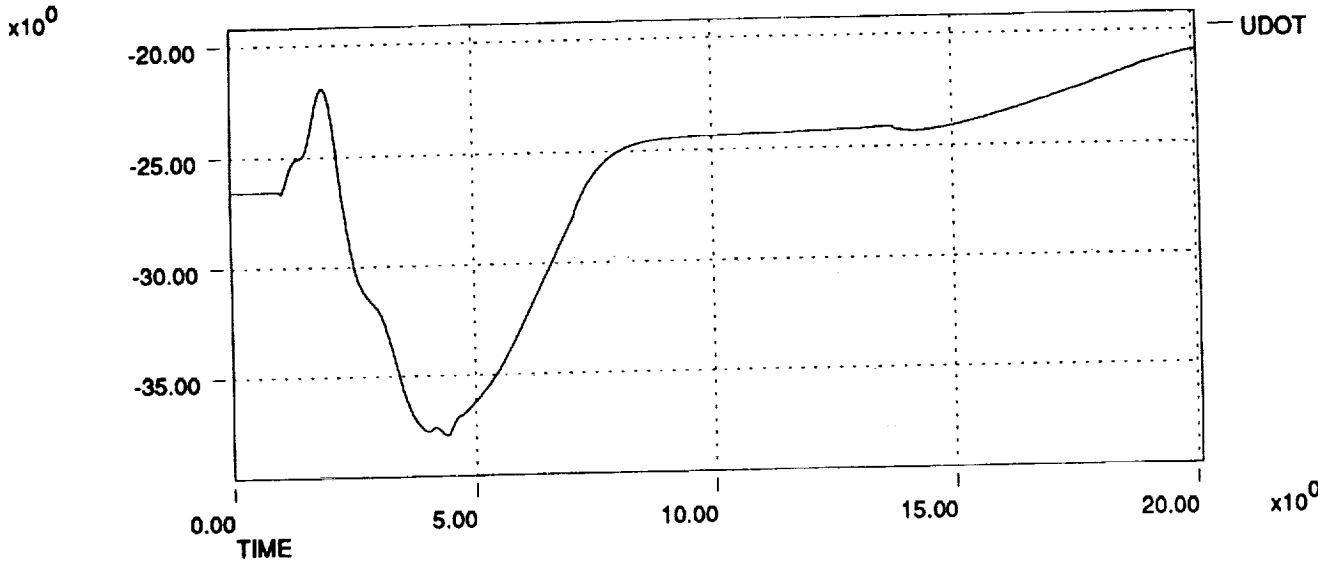

HL-20 Dynamic Check Case Data Plots 911206
Speed Brake Handle Pulse at Mach 2 and 58,700 ft

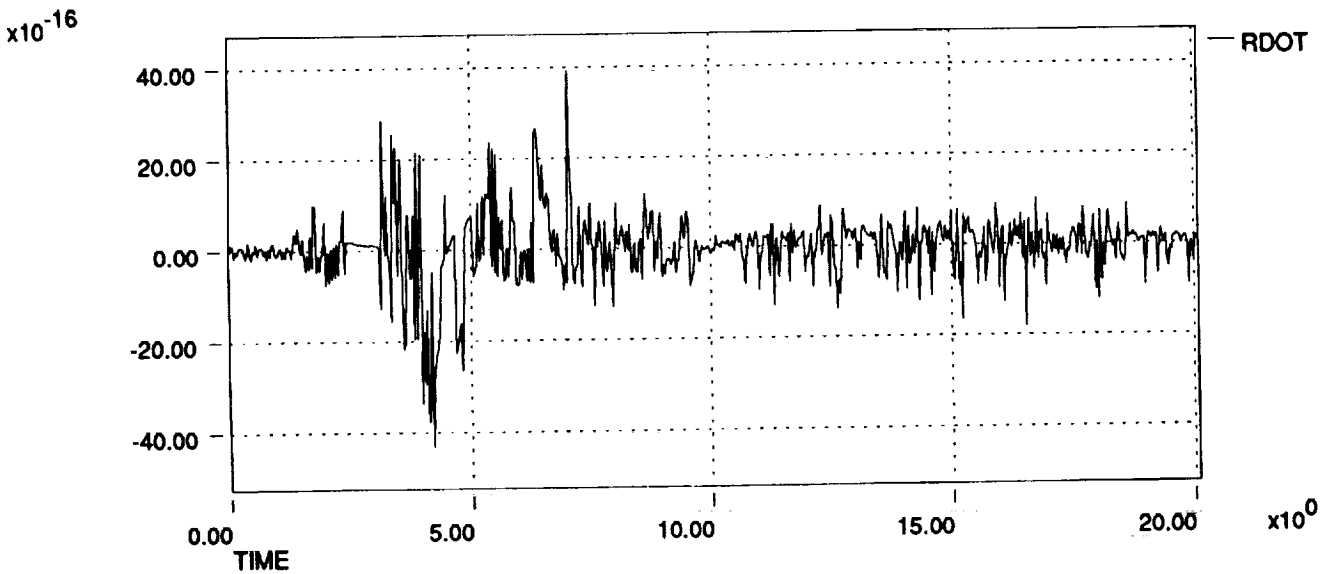
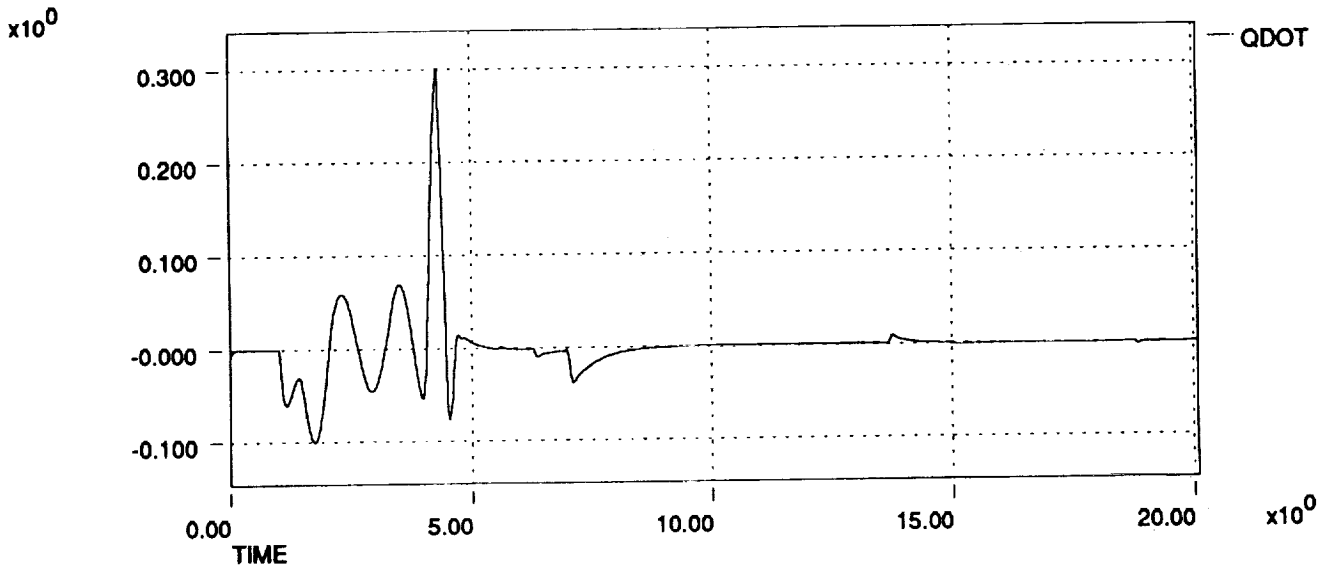
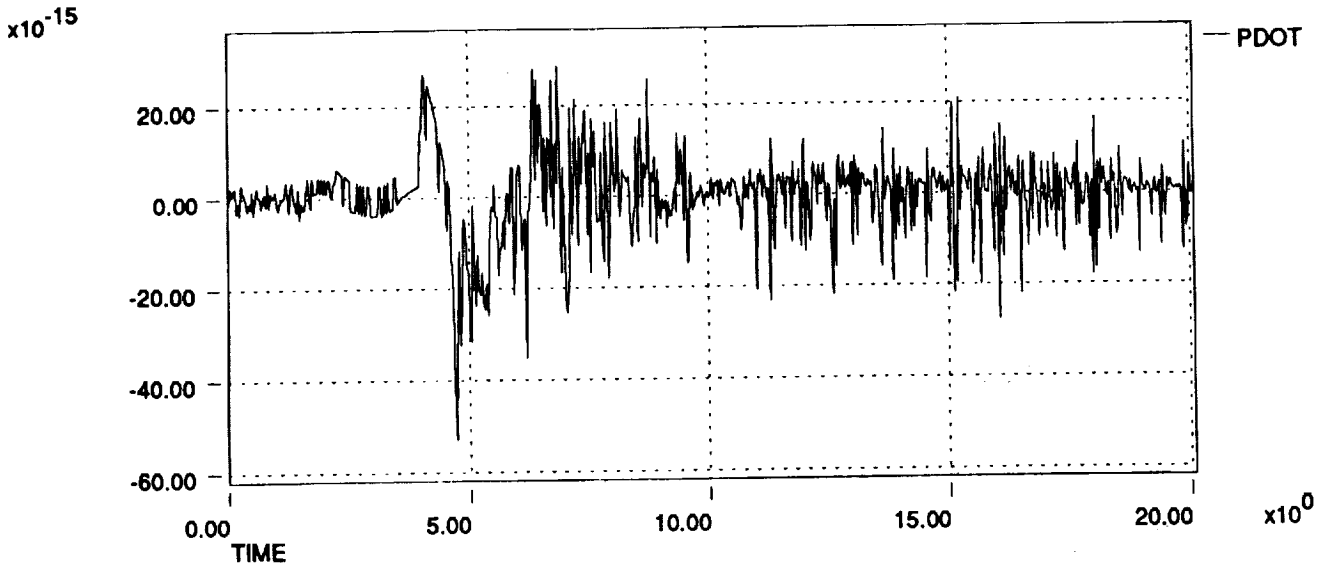

HL-20 Dynamic Check Case Data Plots 911206
Speed Brake Handle Pulse at Mach 2 and 58,700 ft

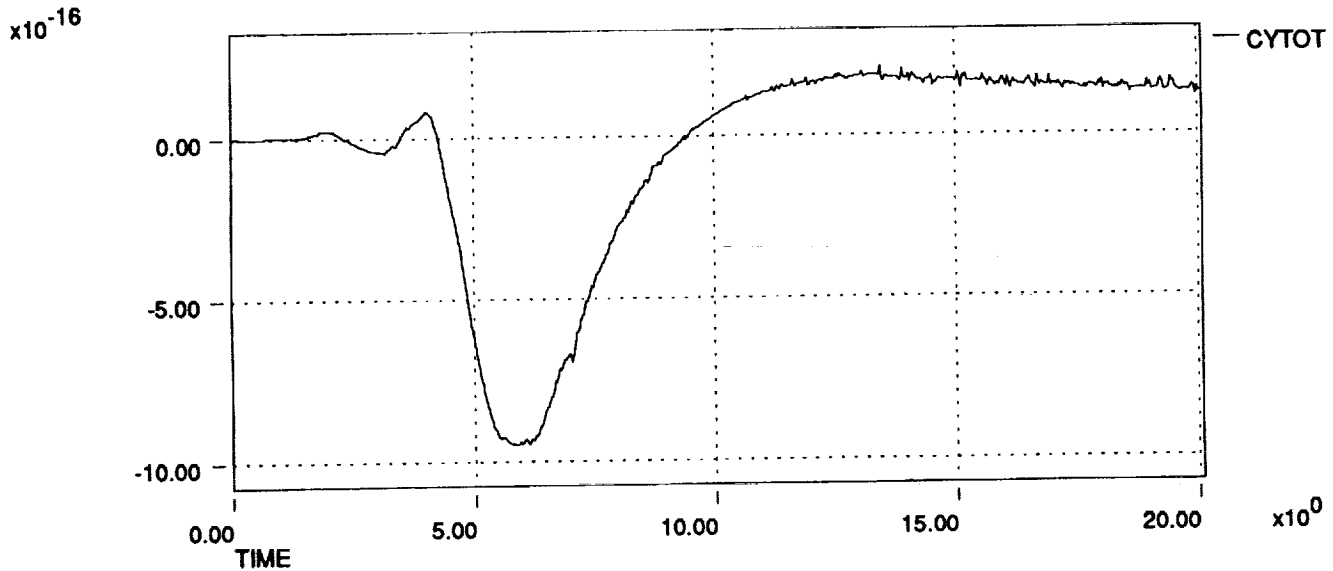
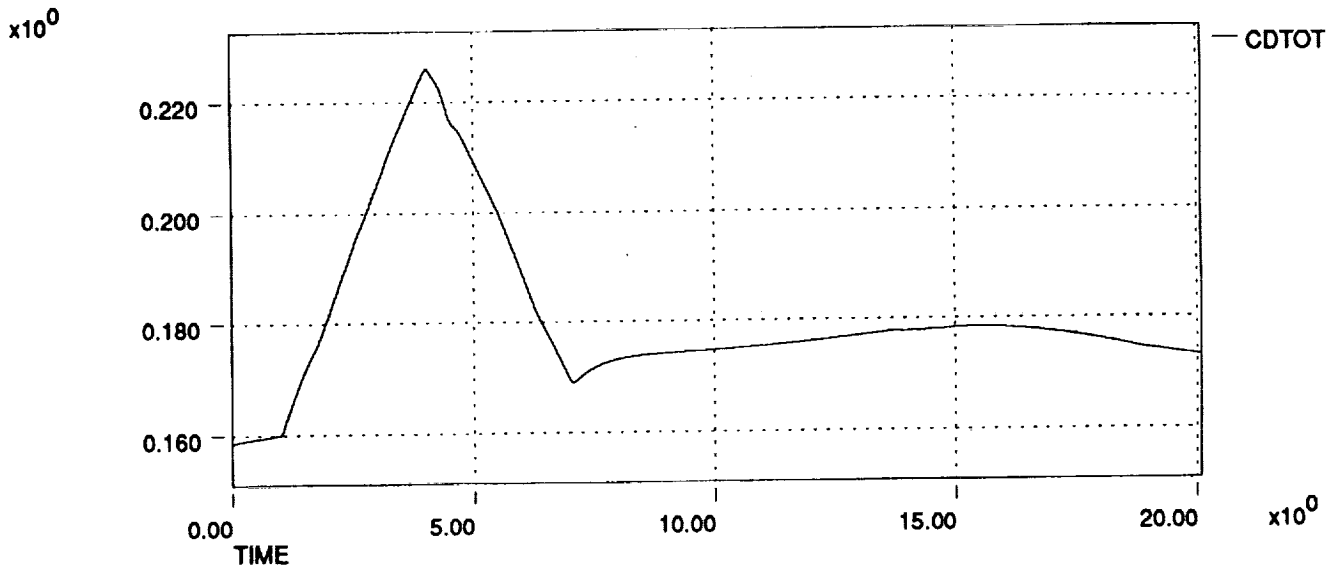
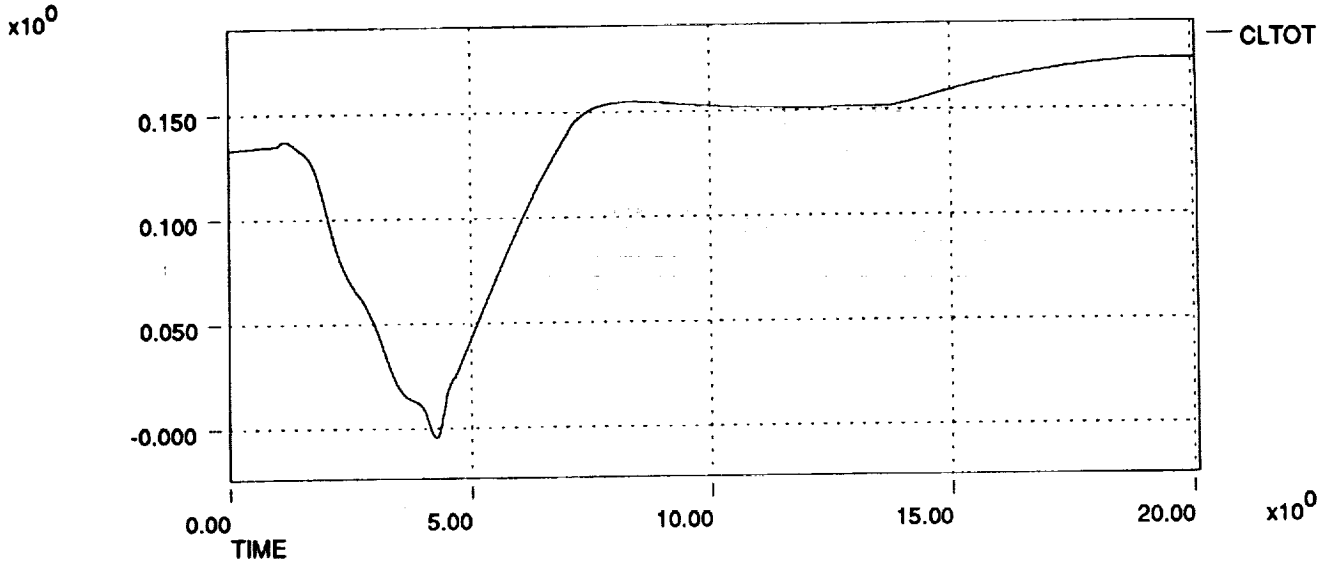

HL-20 Dynamic Check Case Data Plots 911206
Speed Brake Handle Pulse at Mach 2 and 58,700 ft

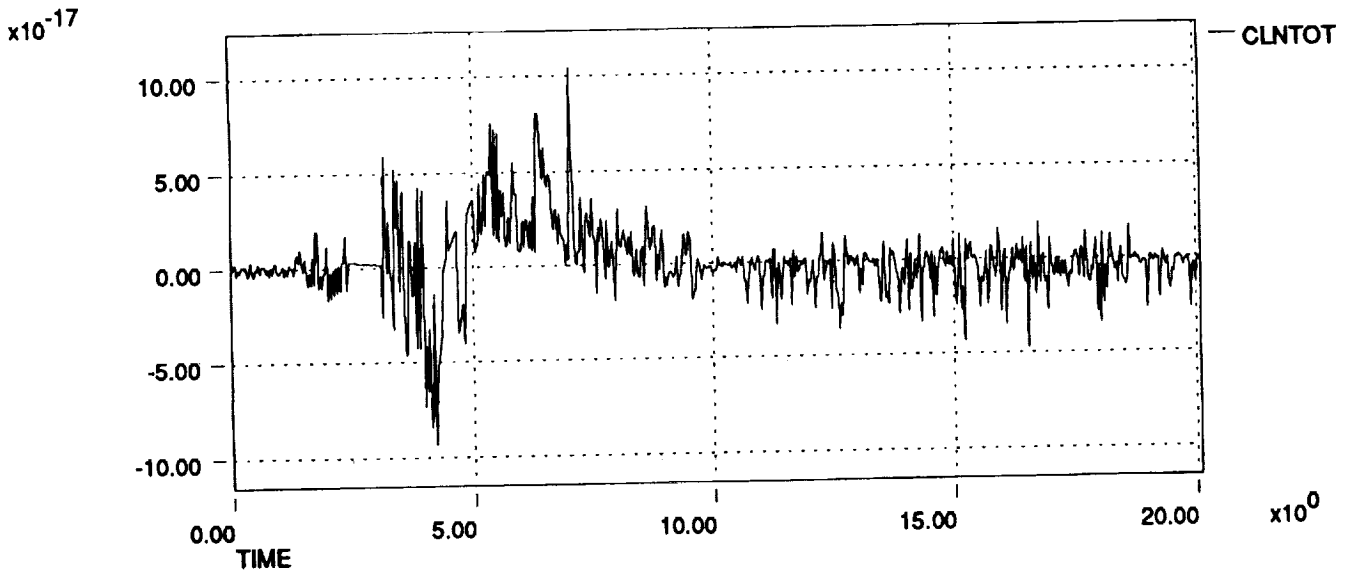
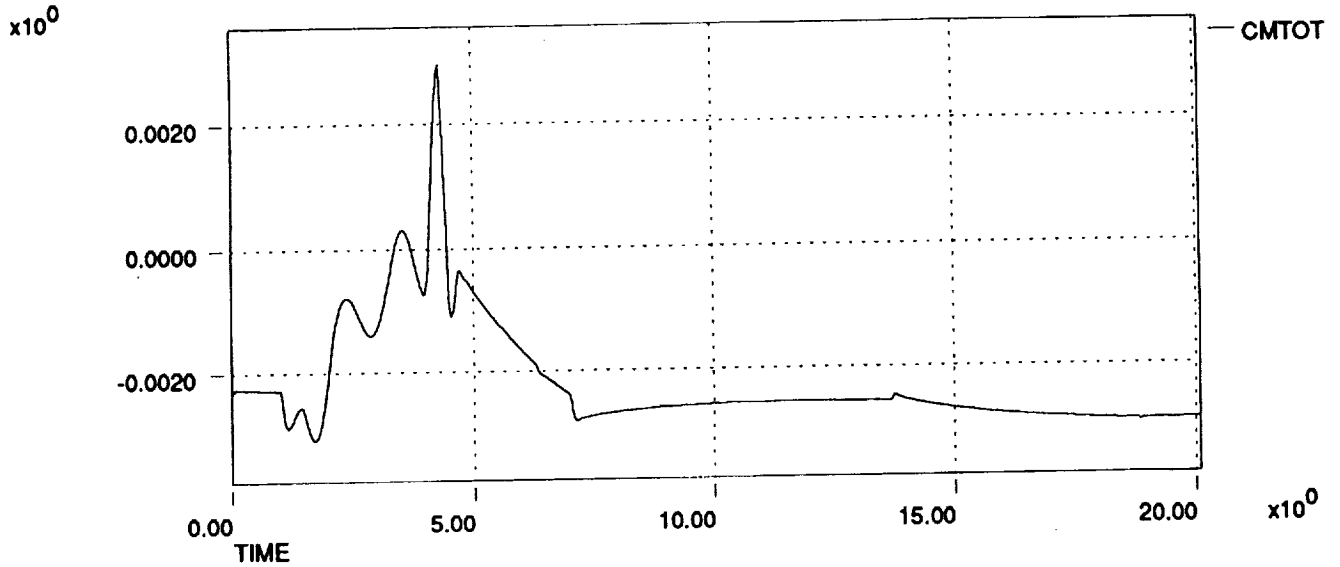
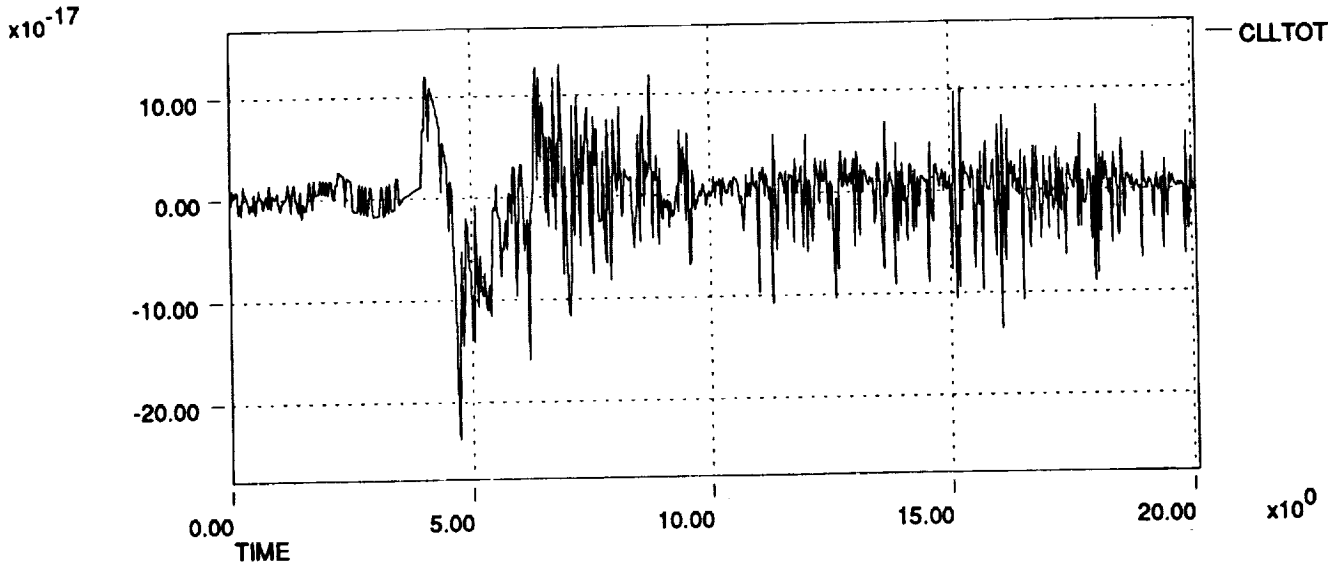

HL-20 Dynamic Check Case Data Plots 911206
Speed Brake Handle Pulse at Mach 2 and 58,700 ft

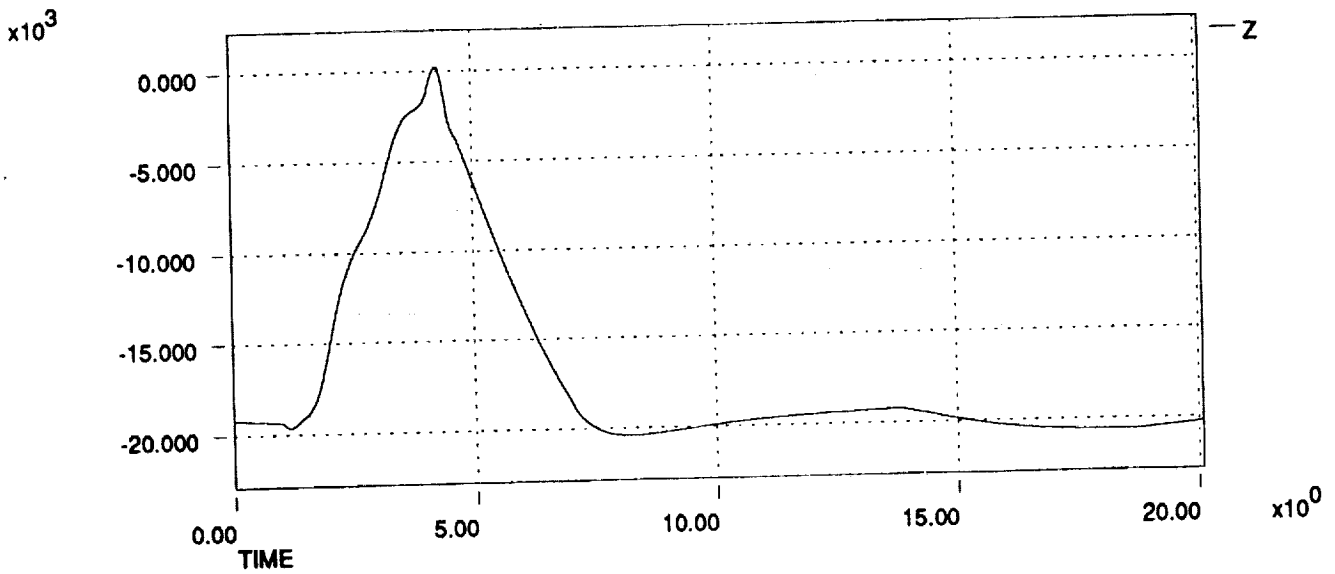
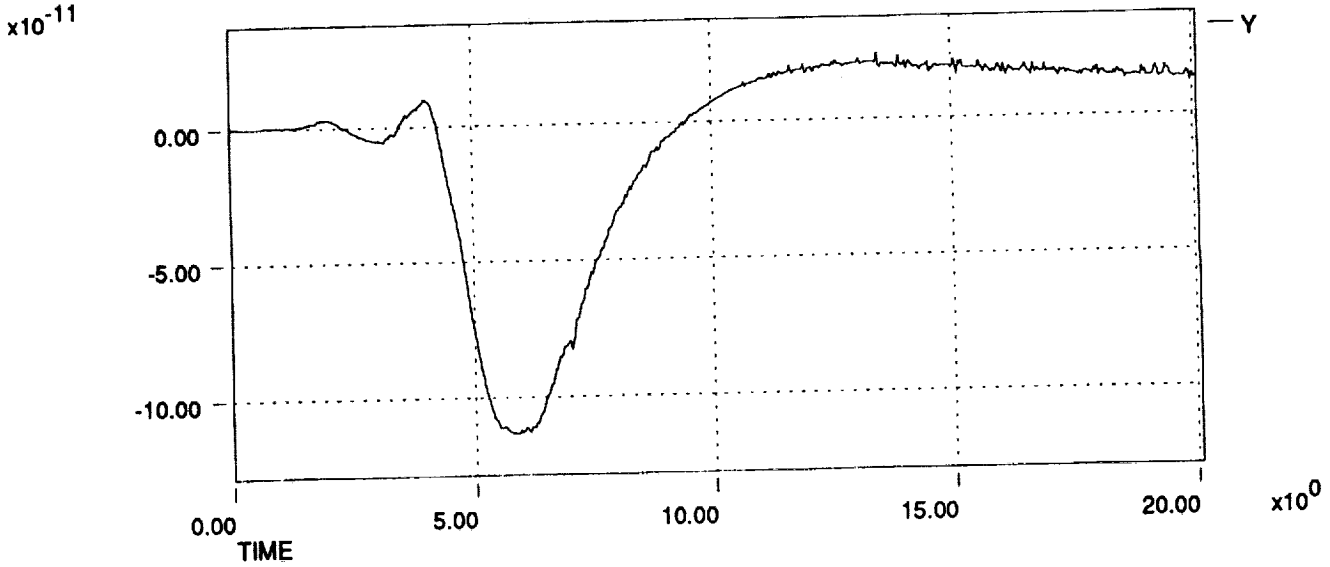
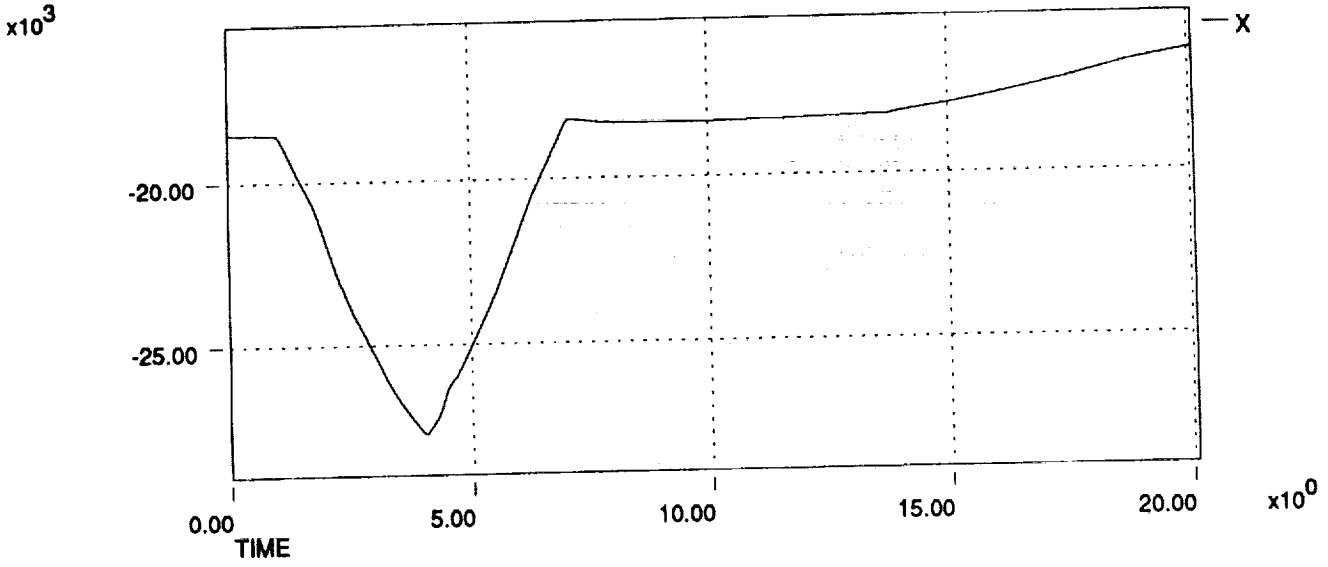

HL-20 Dynamic Check Case Data Plots 911206
Speed Brake Handle Pulse at Mach 2 and 58,700 ft

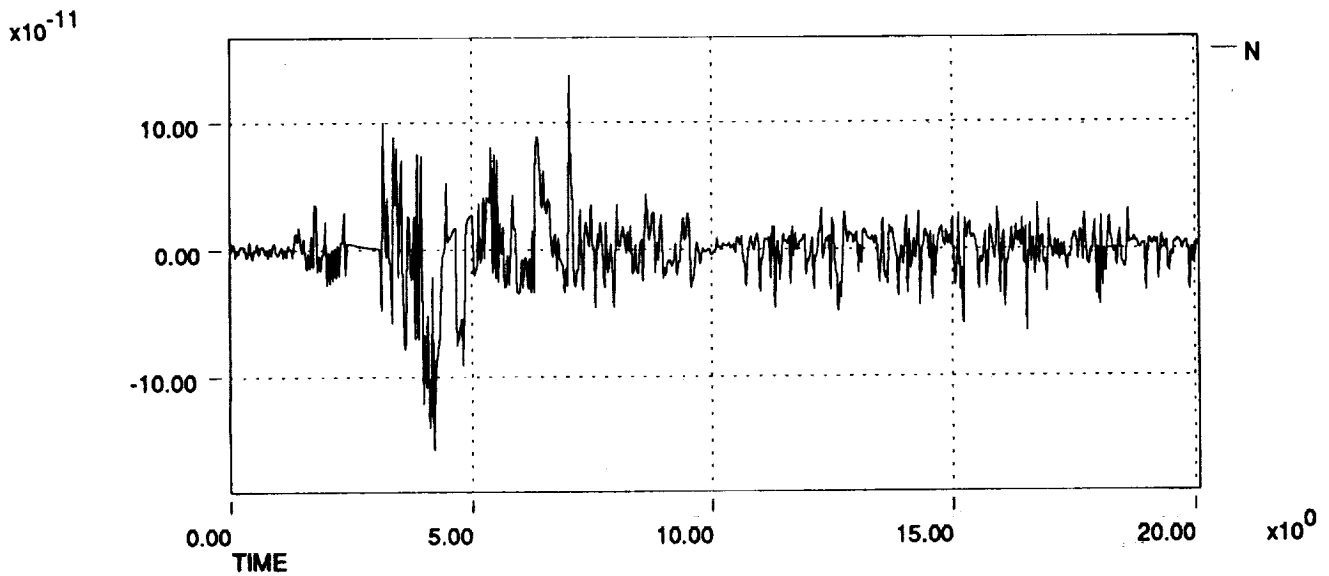
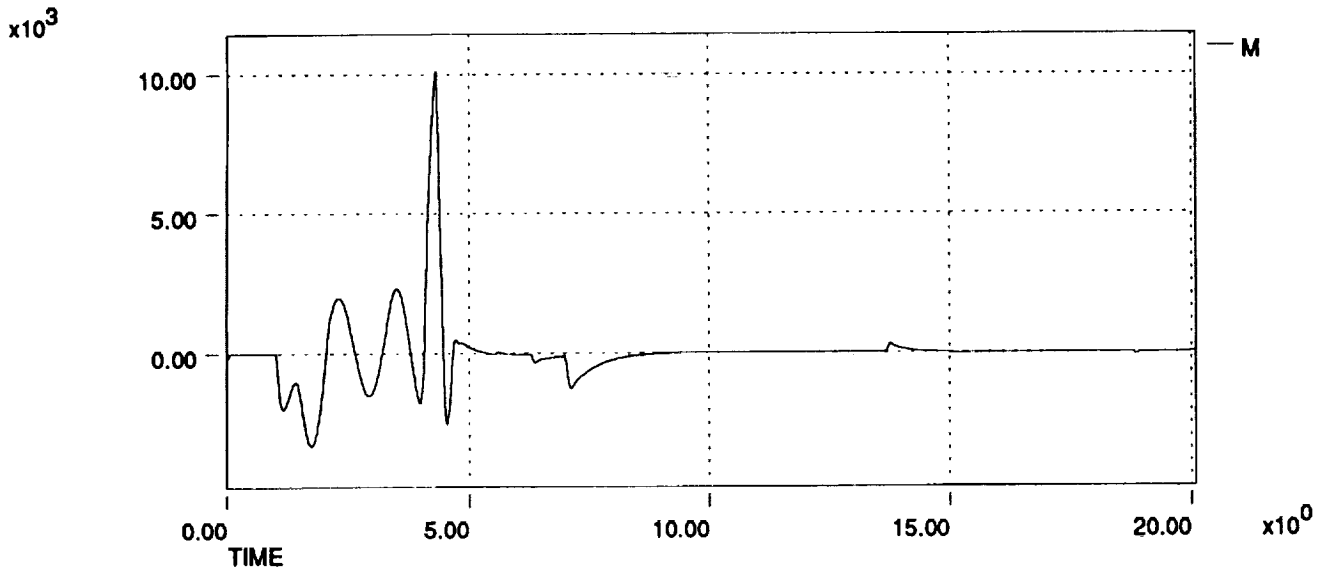
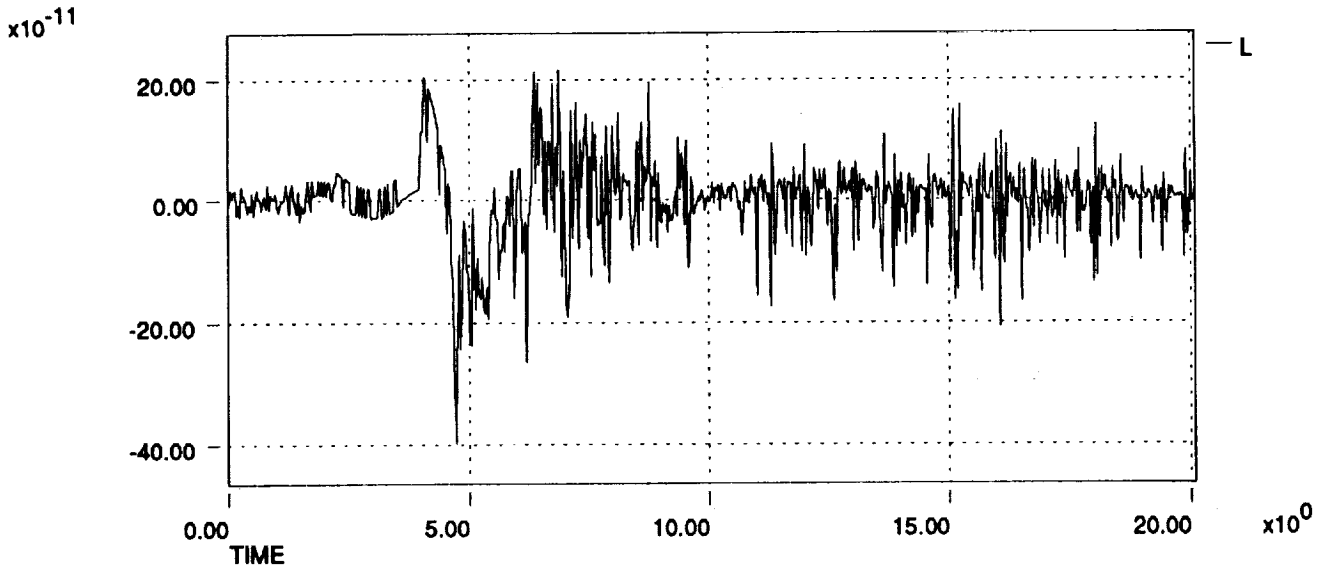

HL-20 Dynamic Check Case Data Plots 911206
Speed Brake Handle Pulse at Mach 2 and 58,700 ft

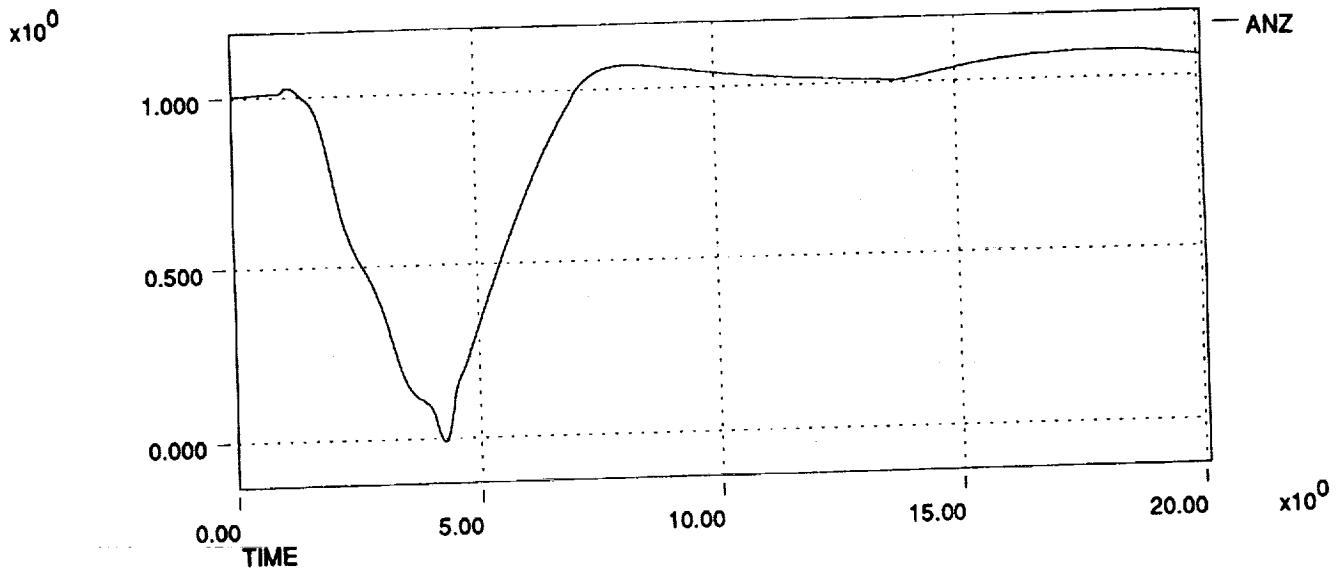
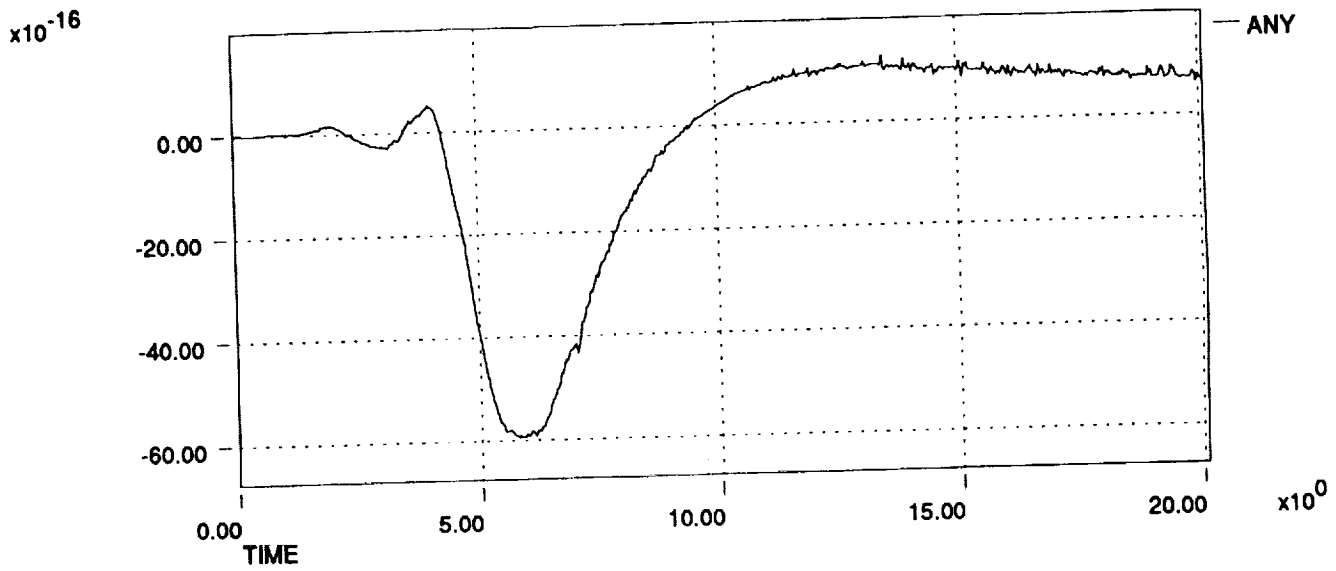
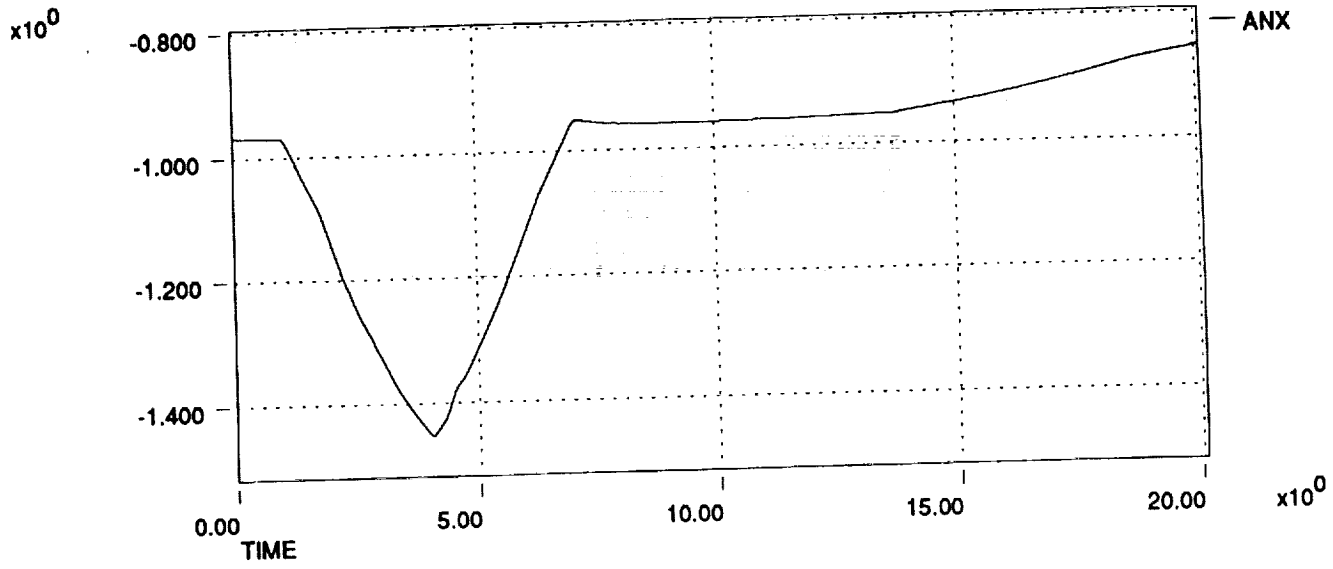

HL-20 Dynamic Check Case Data Plots 911206
Speed Brake Handle Pulse at Mach 2 and 58,700 ft

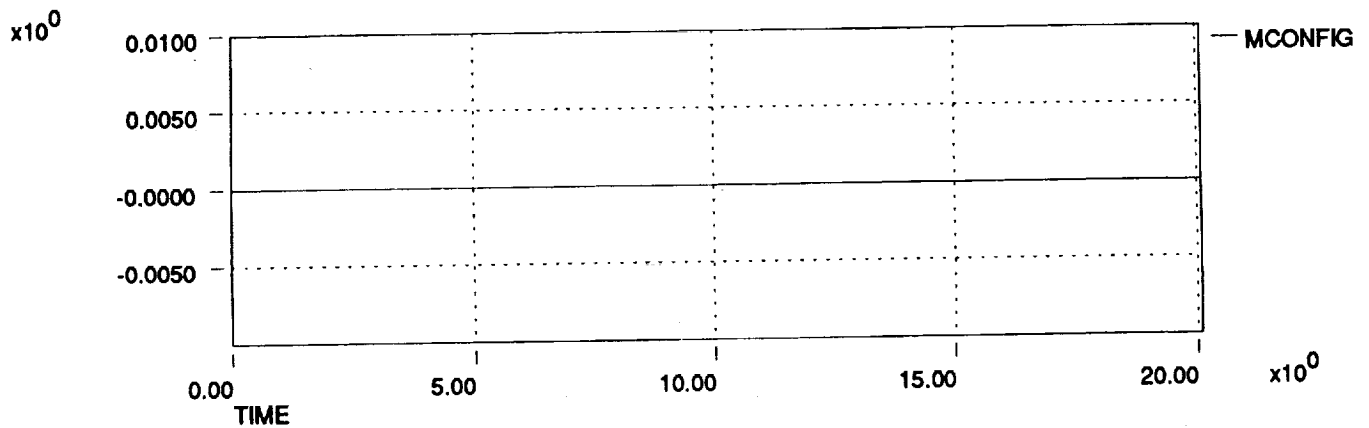
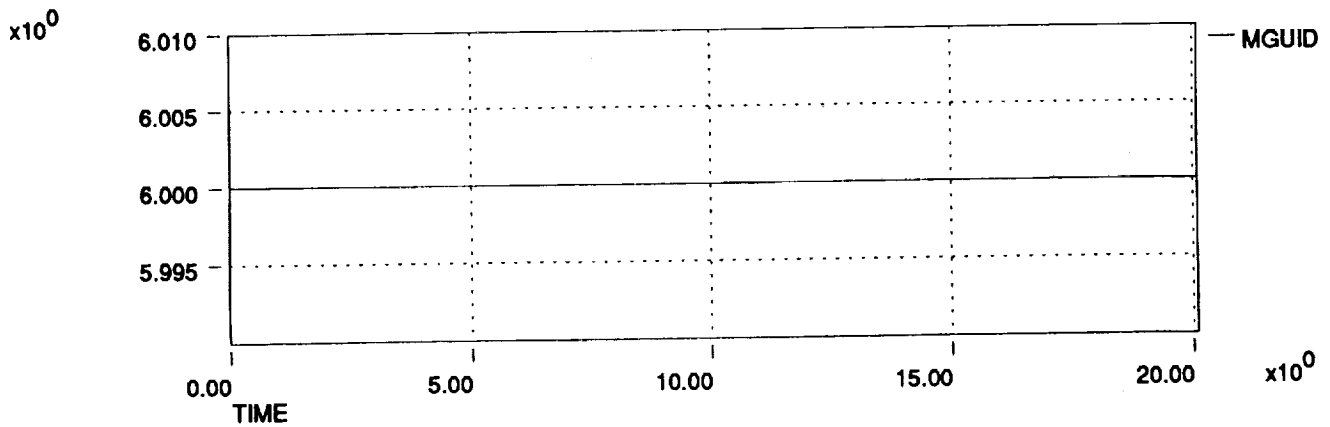
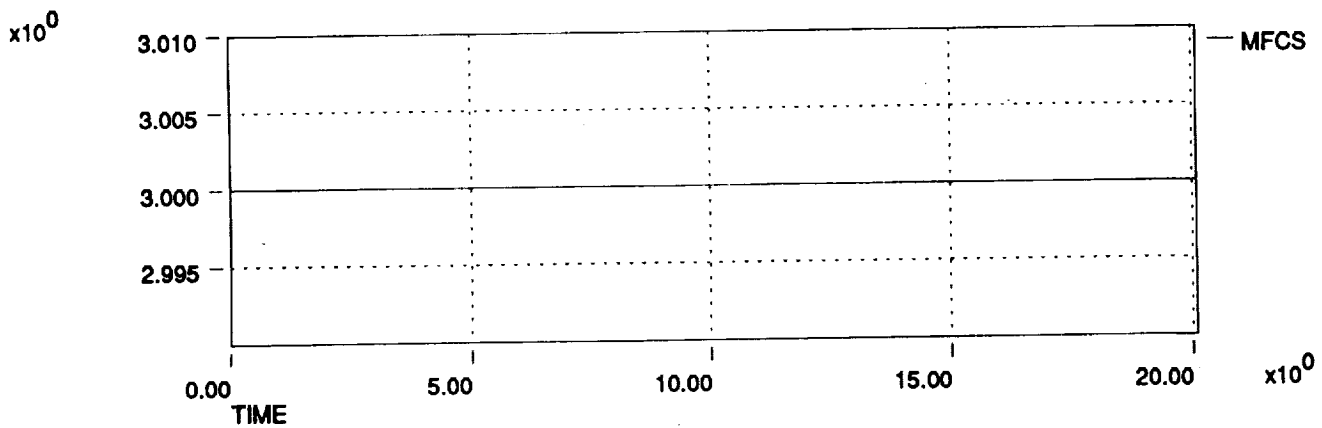
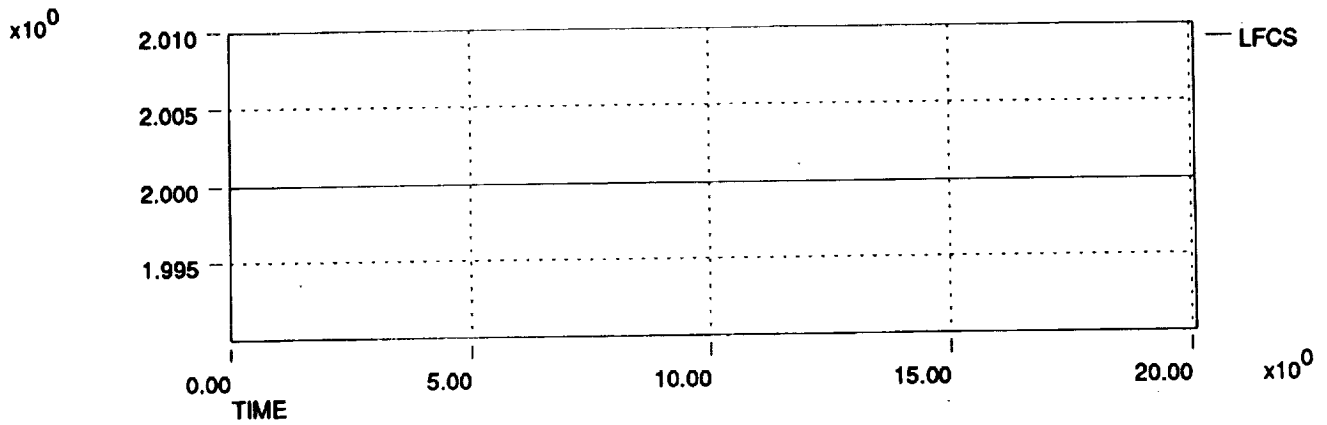

HL-20 Dynamic Check Case Data Plots 911206
Speed Brake Handle Pulse at Mach 2 and 58,700 ft

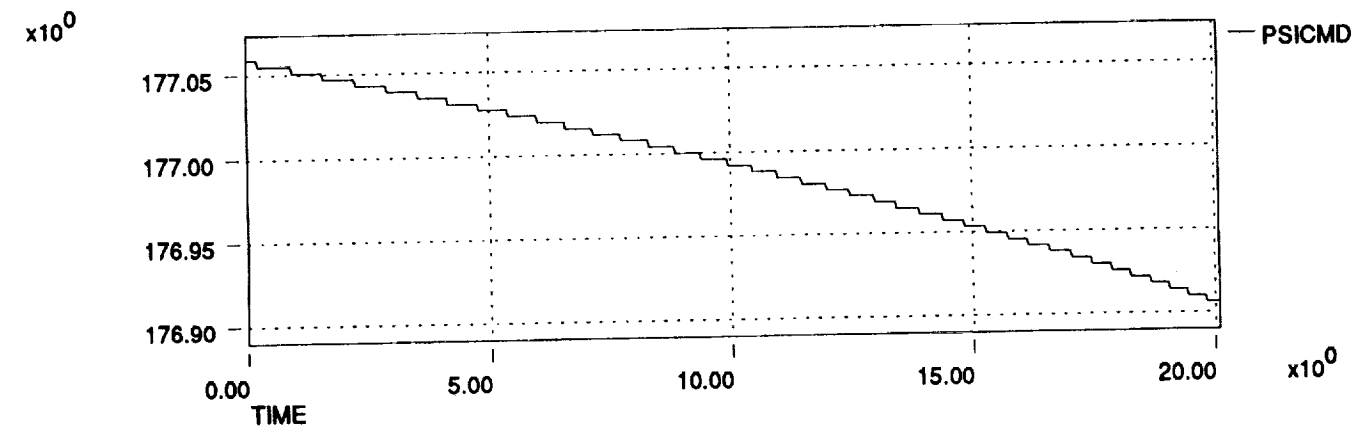
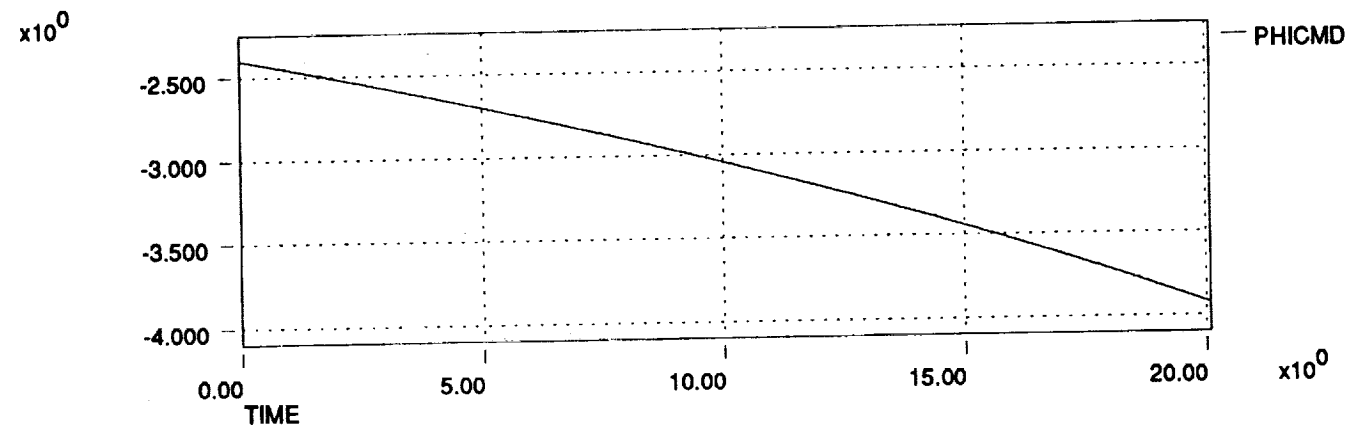
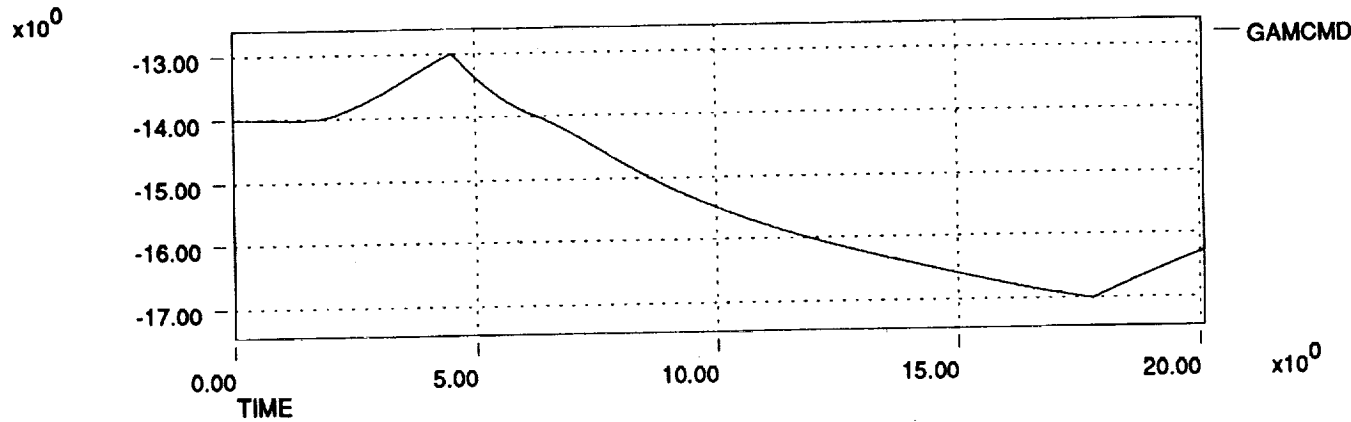
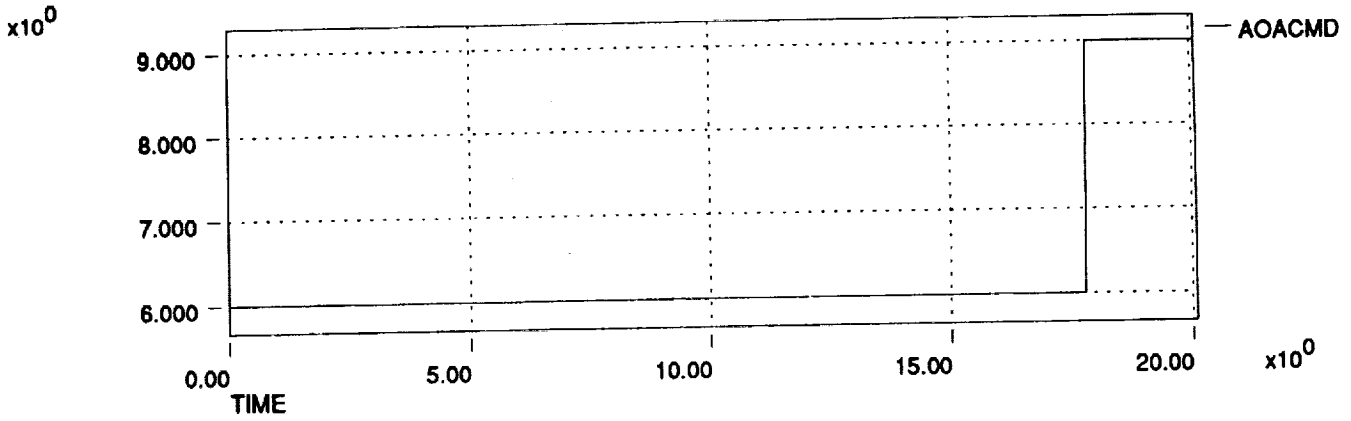

HL-20 Dynamic Check Case Data Plots 911206
Speed Brake Handle Pulse at Mach 2 and 58,700 ft

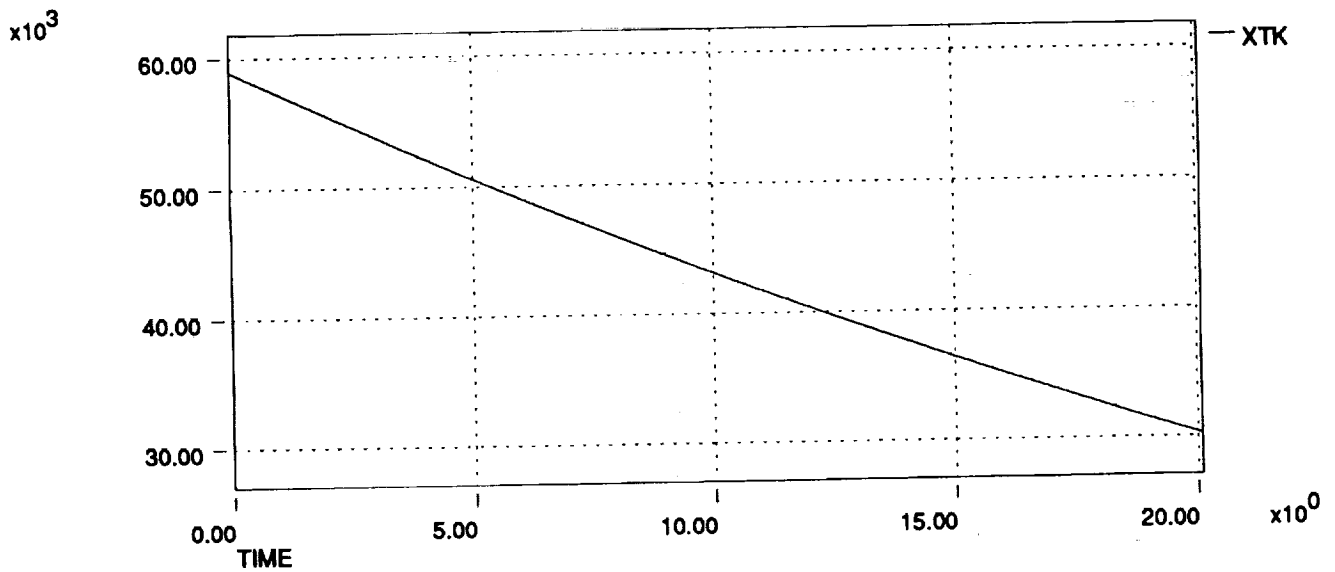
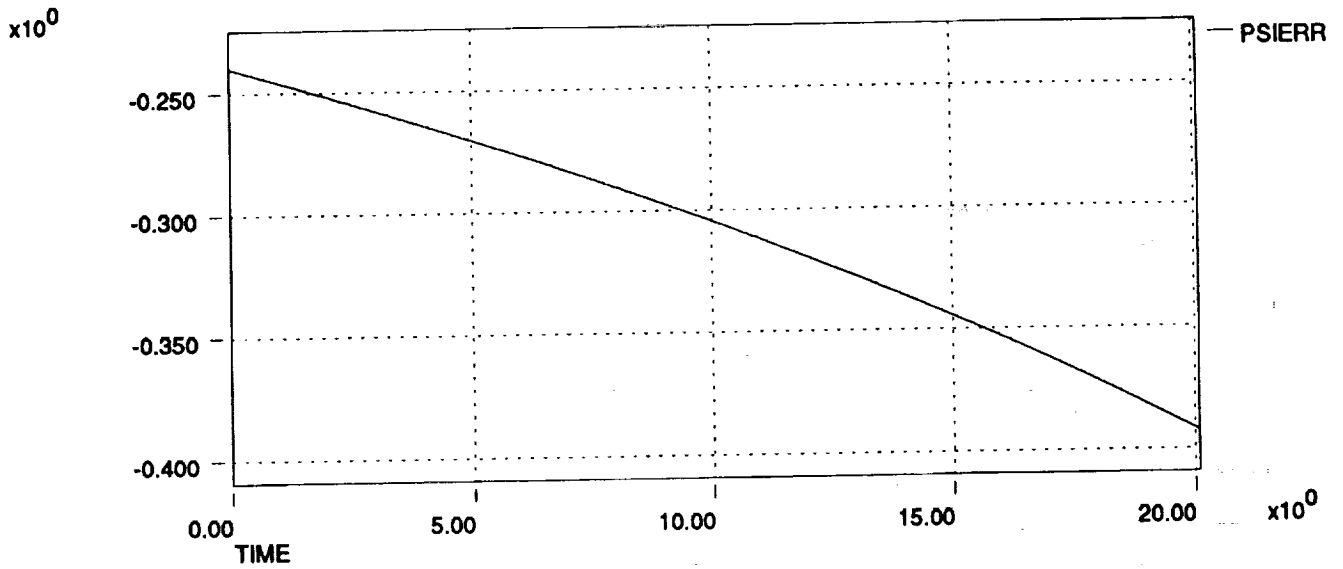
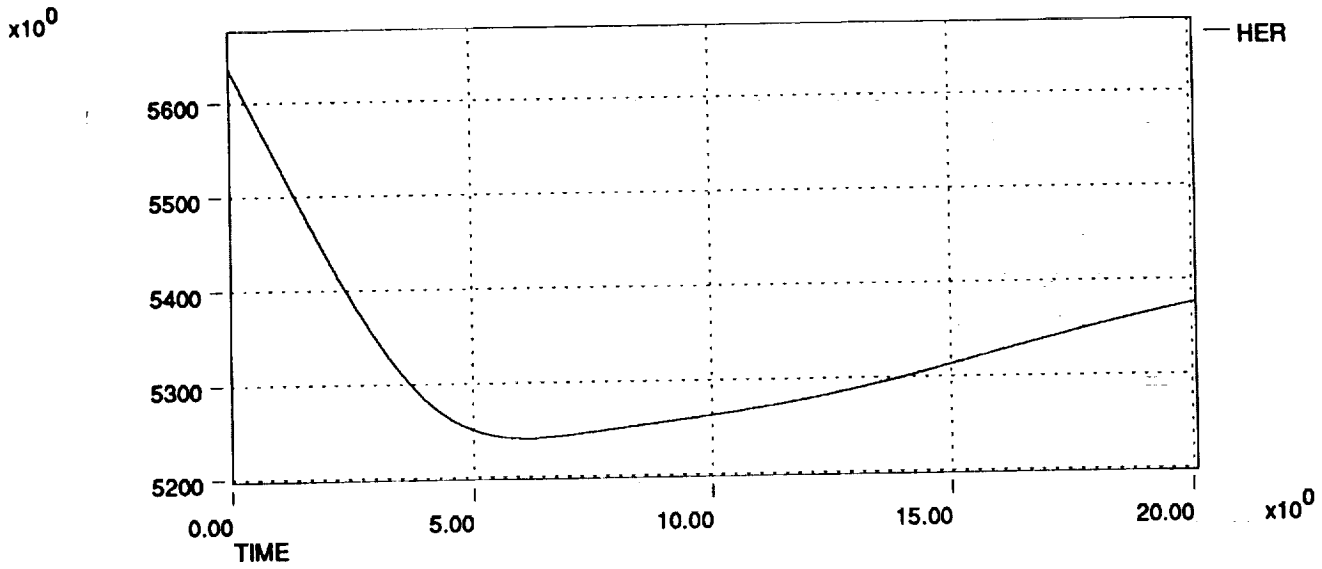

HL-20 Dynamic Check Case Data Plots 911206
Speed Brake Handle Pulse at Mach 2 and 58,700 ft

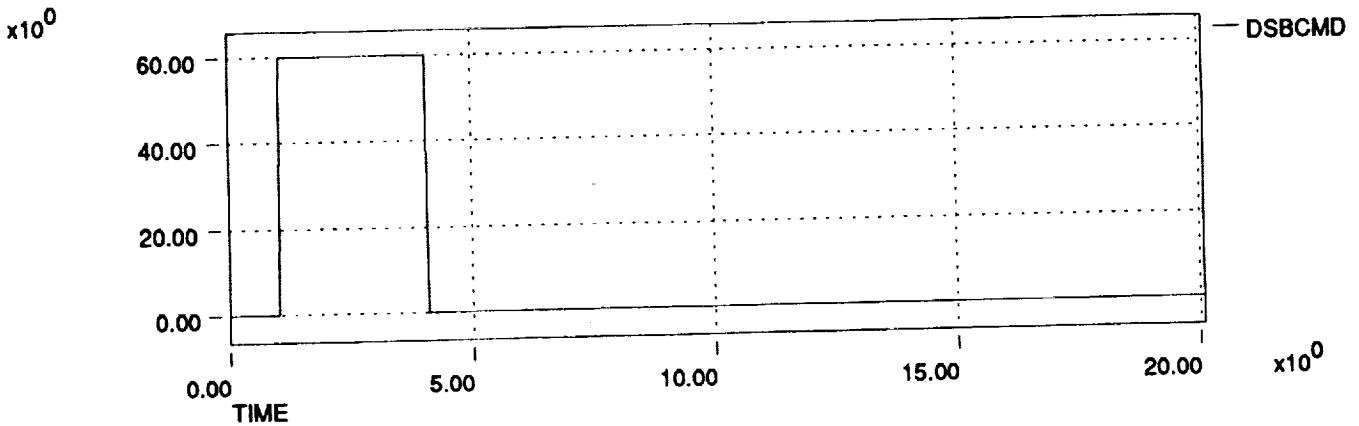
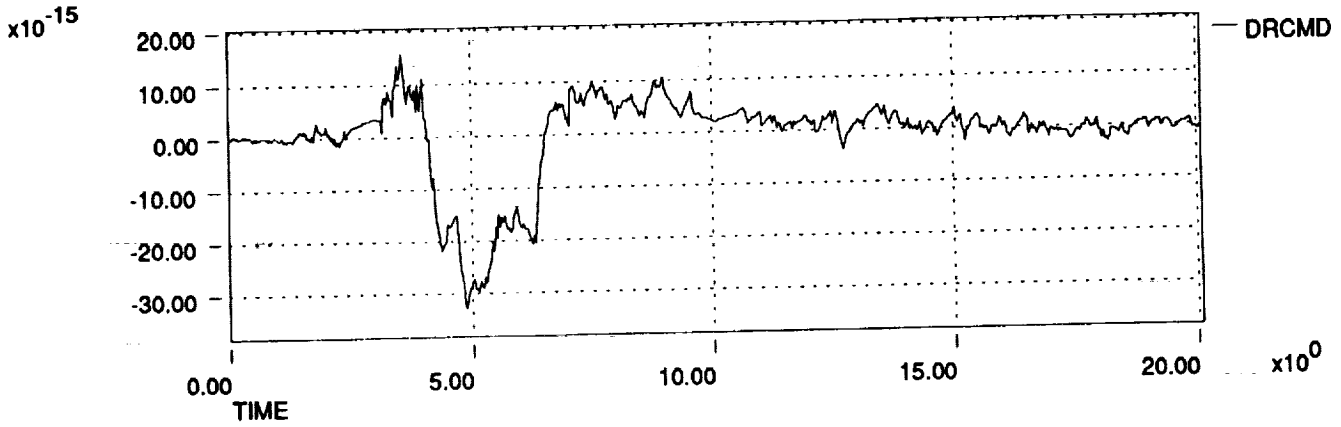
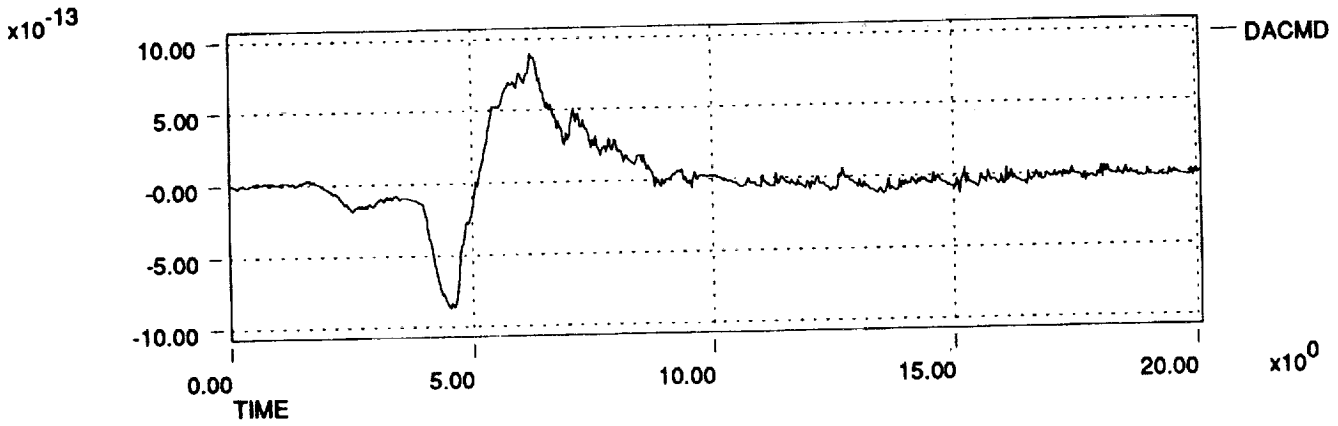
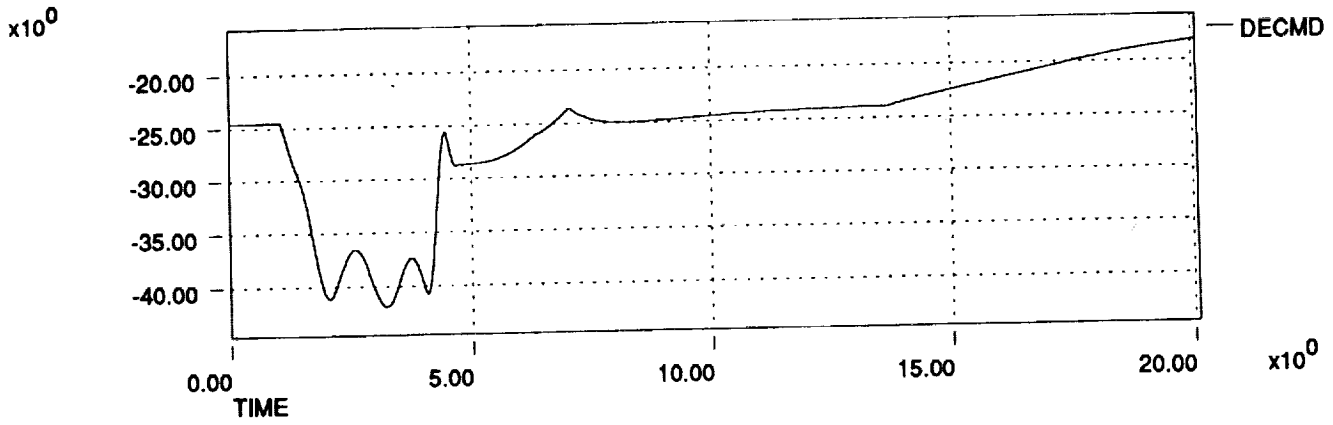

HL-20 Dynamic Check Case Data Plots 911206
Speed Brake Handle Pulse at Mach 2 and 58,700 ft

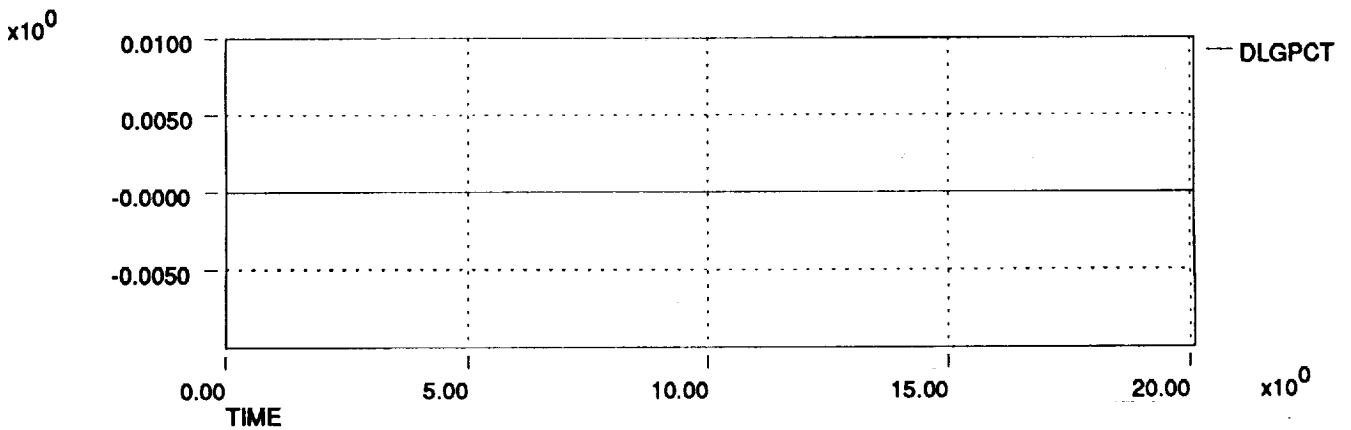
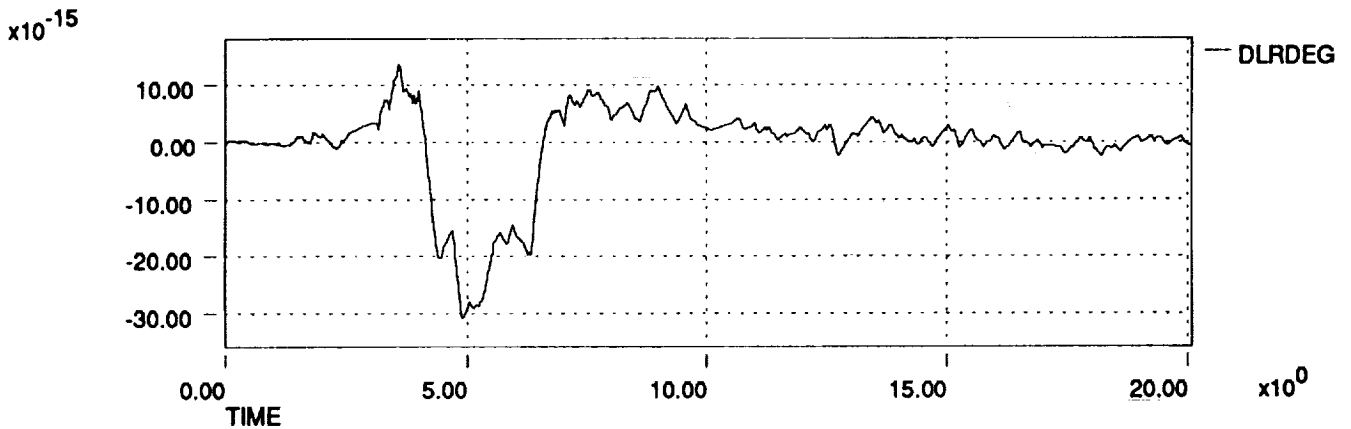
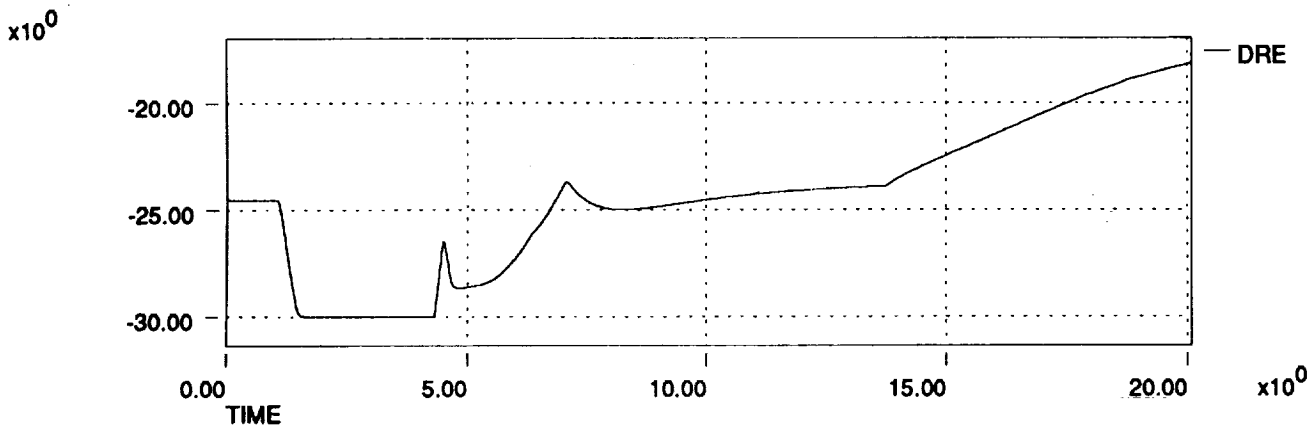
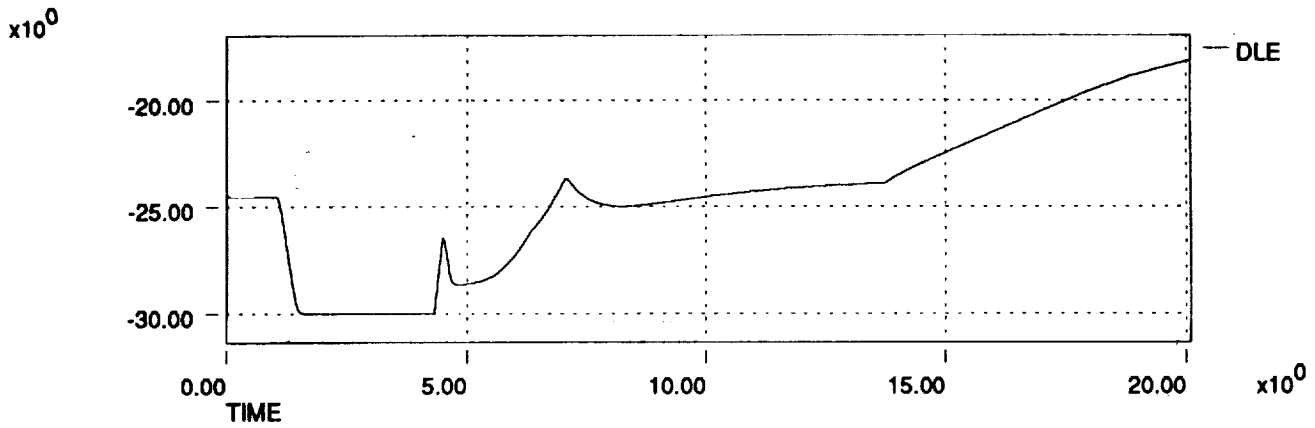

HL-20 Dynamic Check Case Data Plots 911206
Speed Brake Handle Pulse at Mach 2 and 58,700 ft

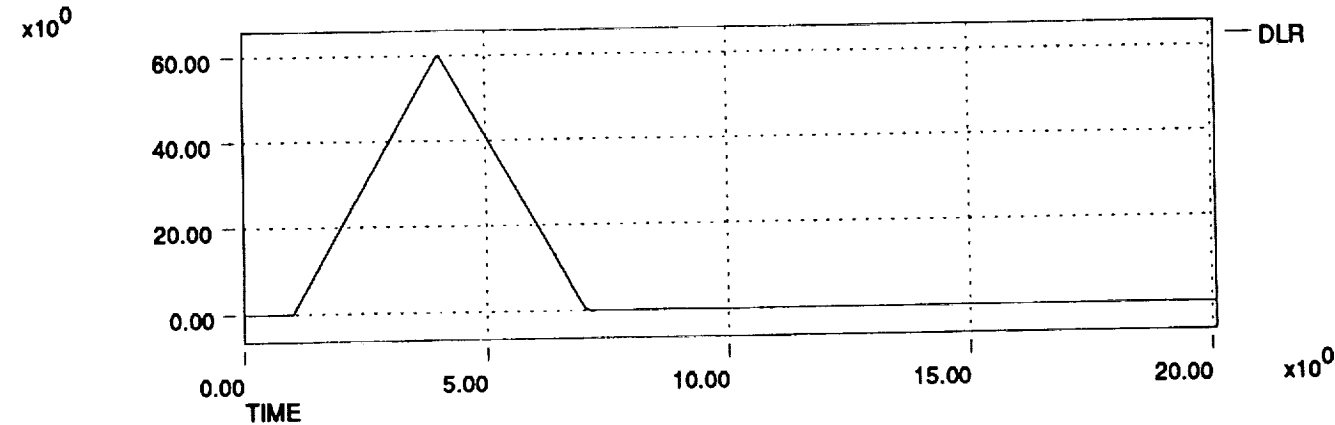
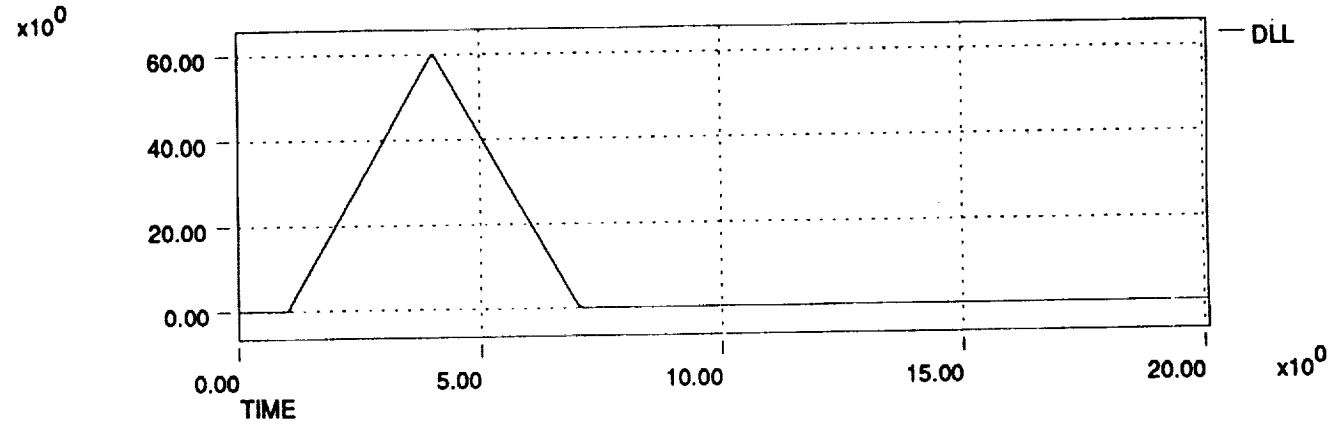
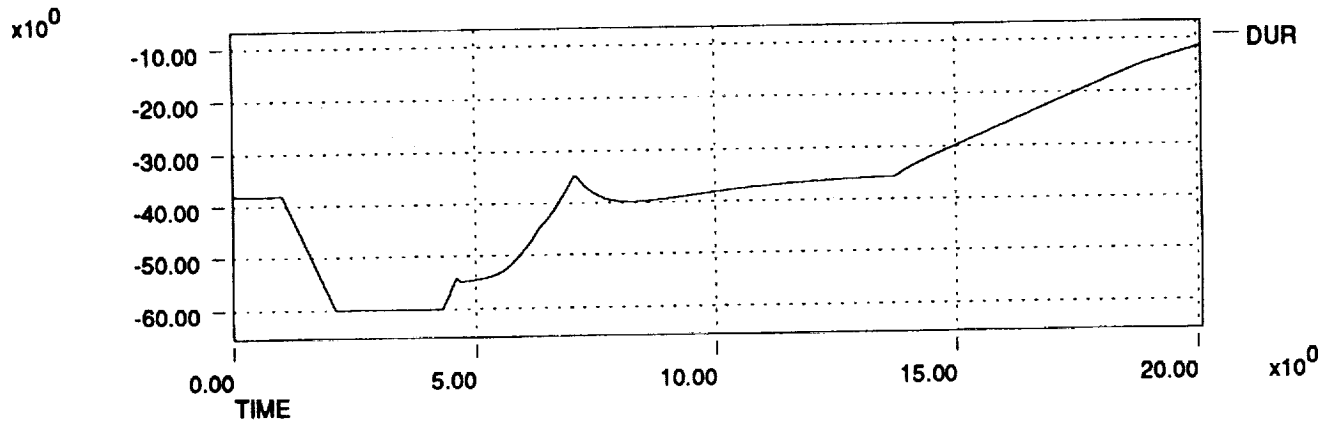
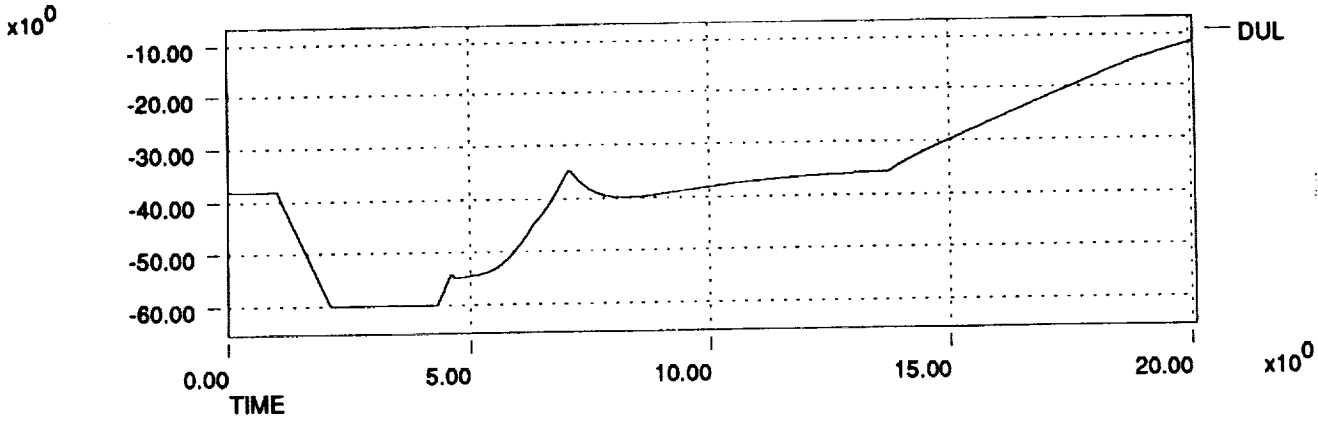

HL-20 Dynamic Check Case Data Plots 911206
Aft Pitch Stick Pulse at Mach 4 and 104,000 ft

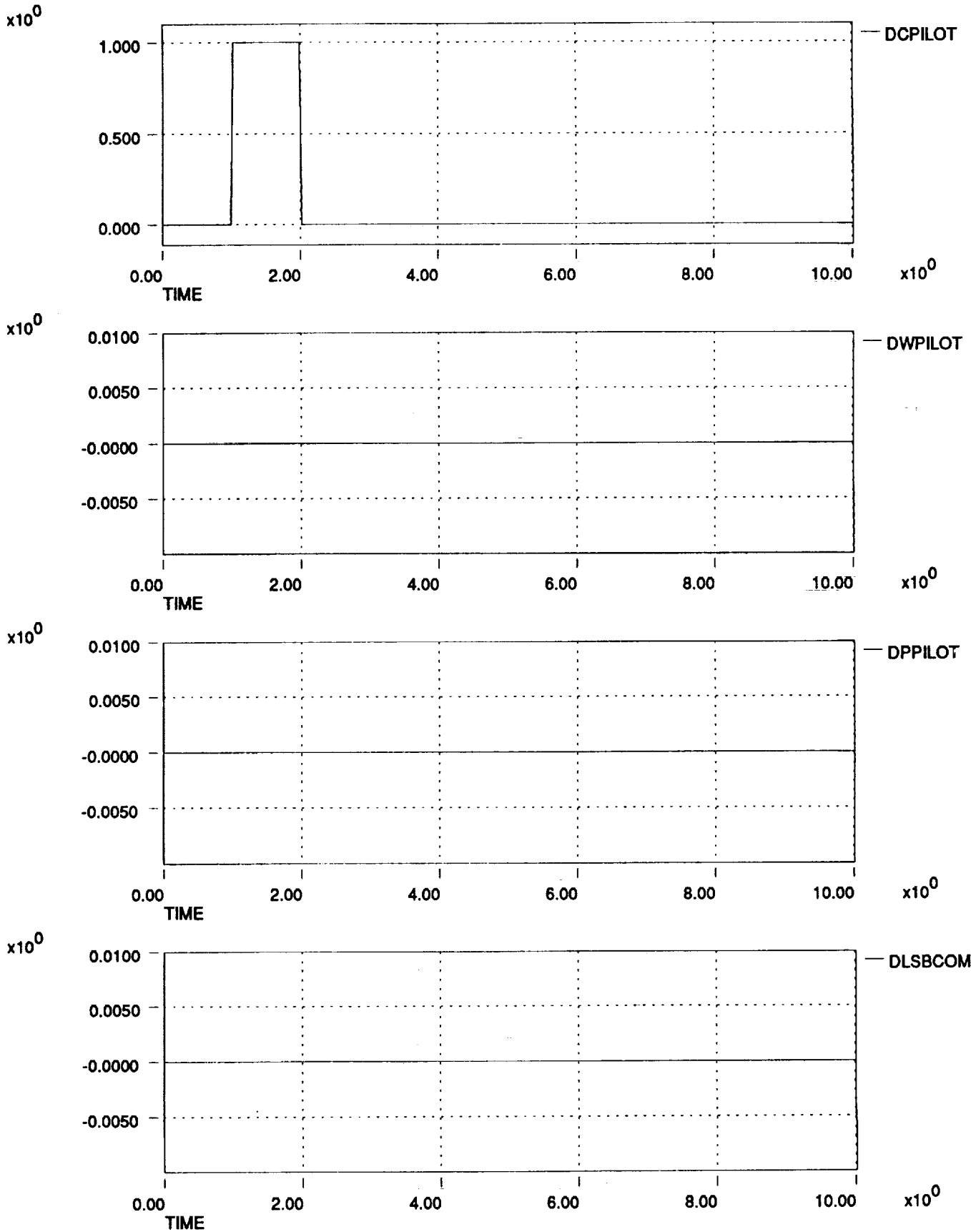

HL-20 Dynamic Check Case Data Plots 911206
Aft Pitch Stick Pulse at Mach 4 and 104,000 ft

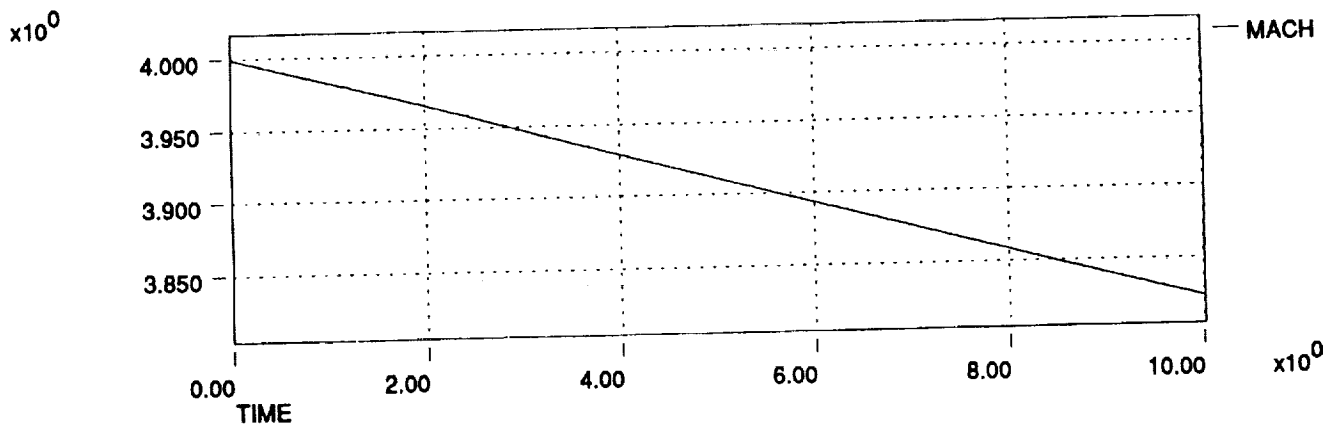
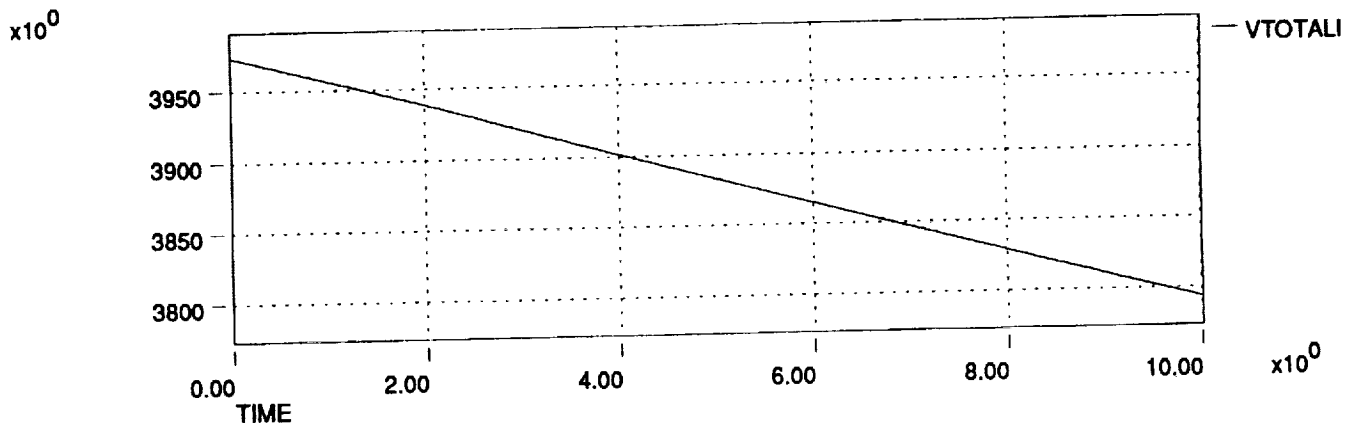
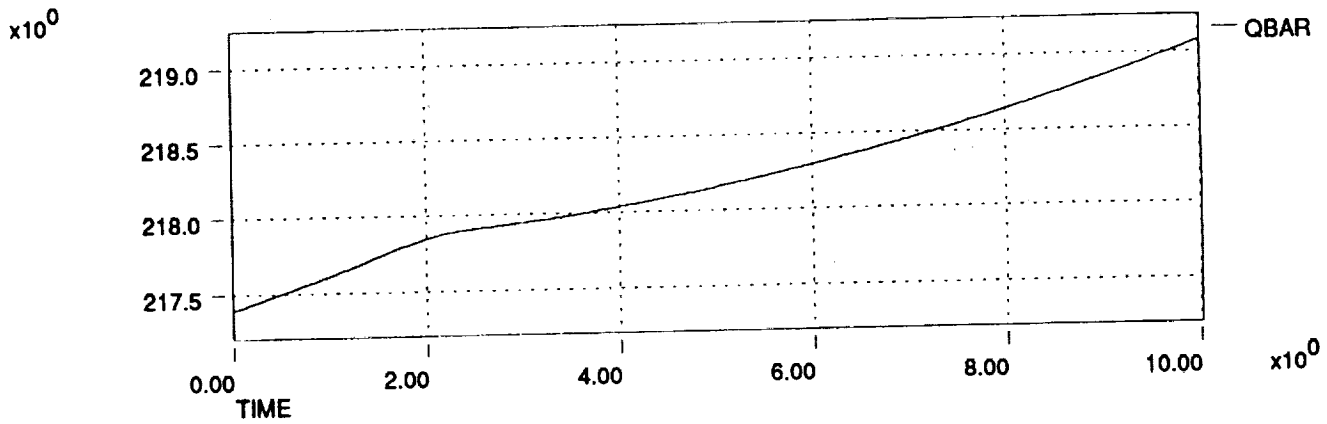
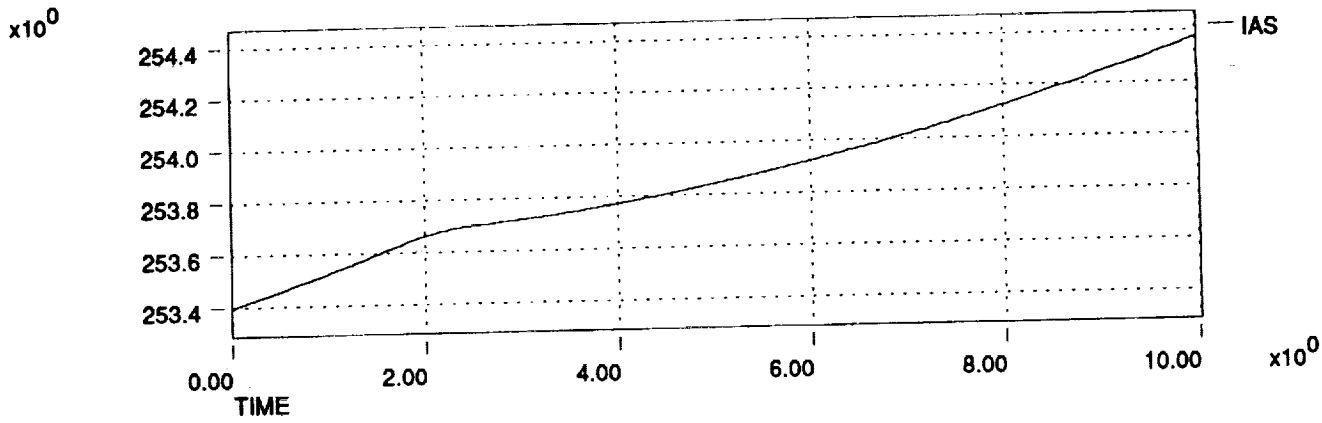

HL-20 Dynamic Check Case Data Plots 911206
Aft Pitch Stick Pulse at Mach 4 and 104,000 ft

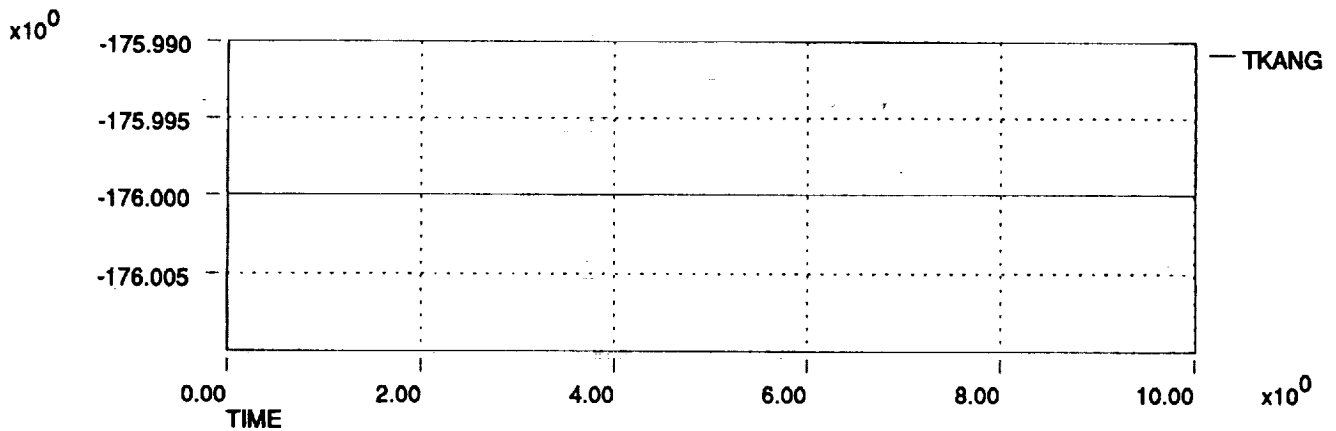
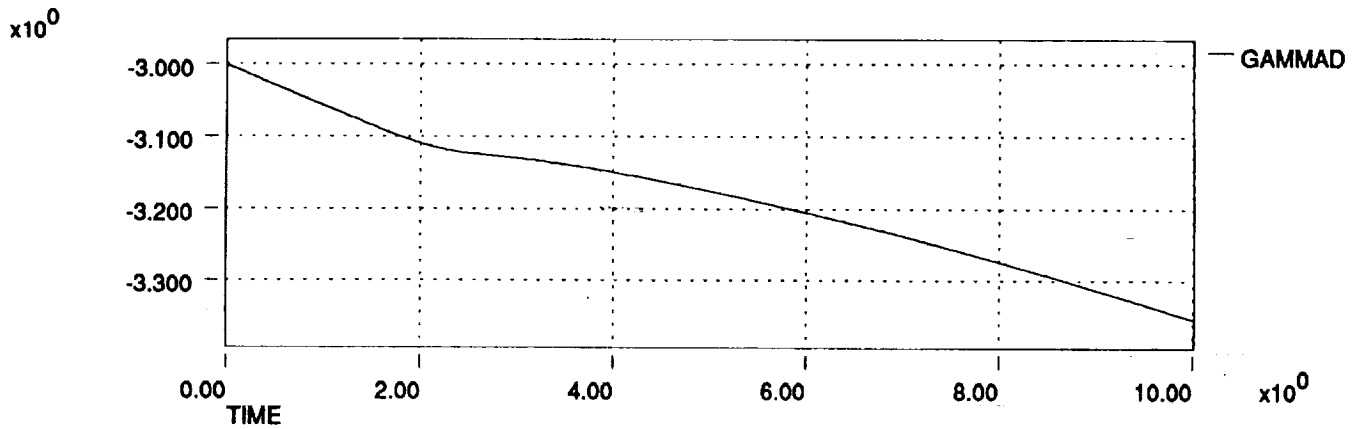
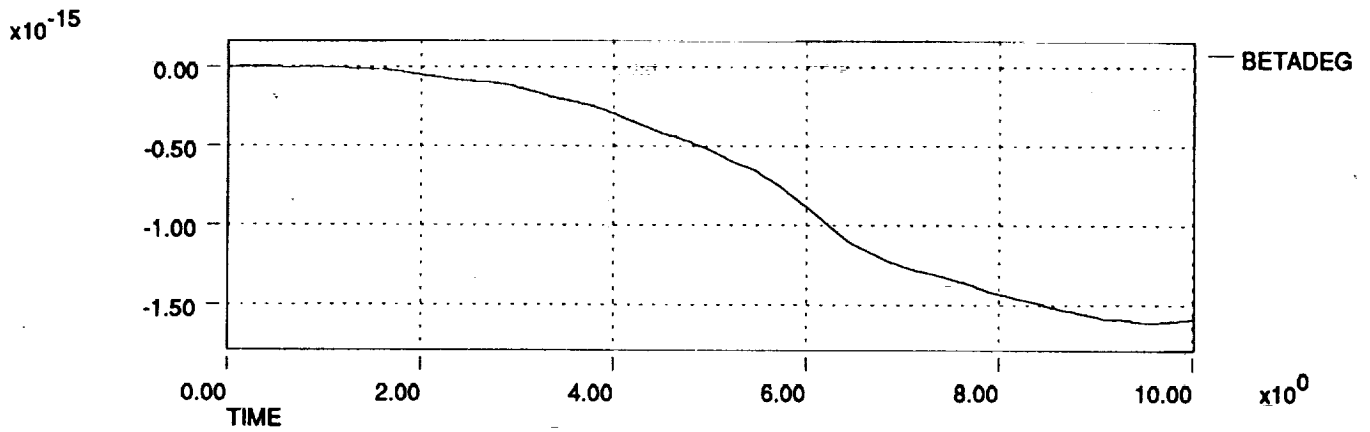
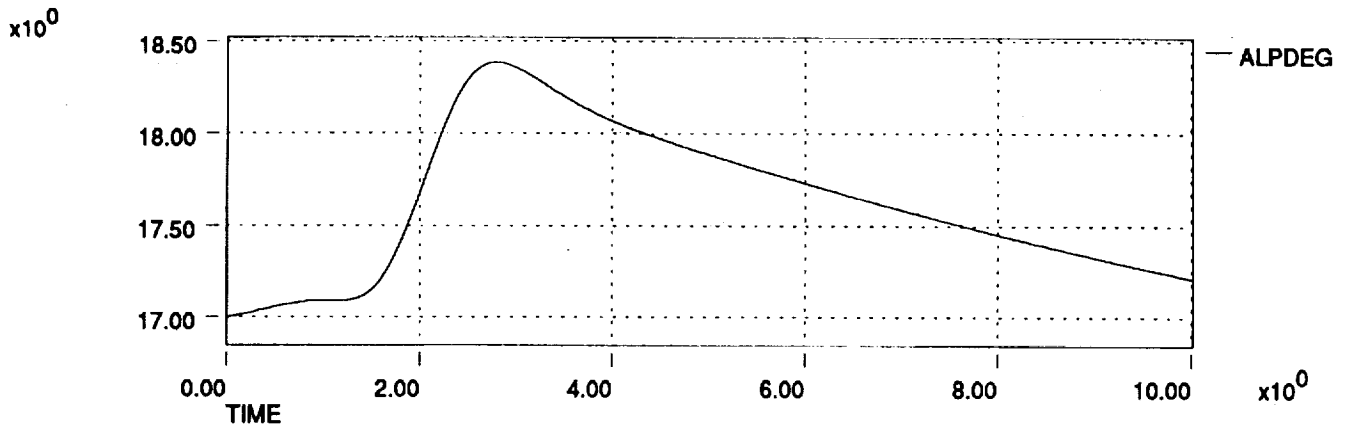

HL-20 Dynamic Check Case Data Plots 911206
Aft Pitch Stick Pulse at Mach 4 and 104,000 ft

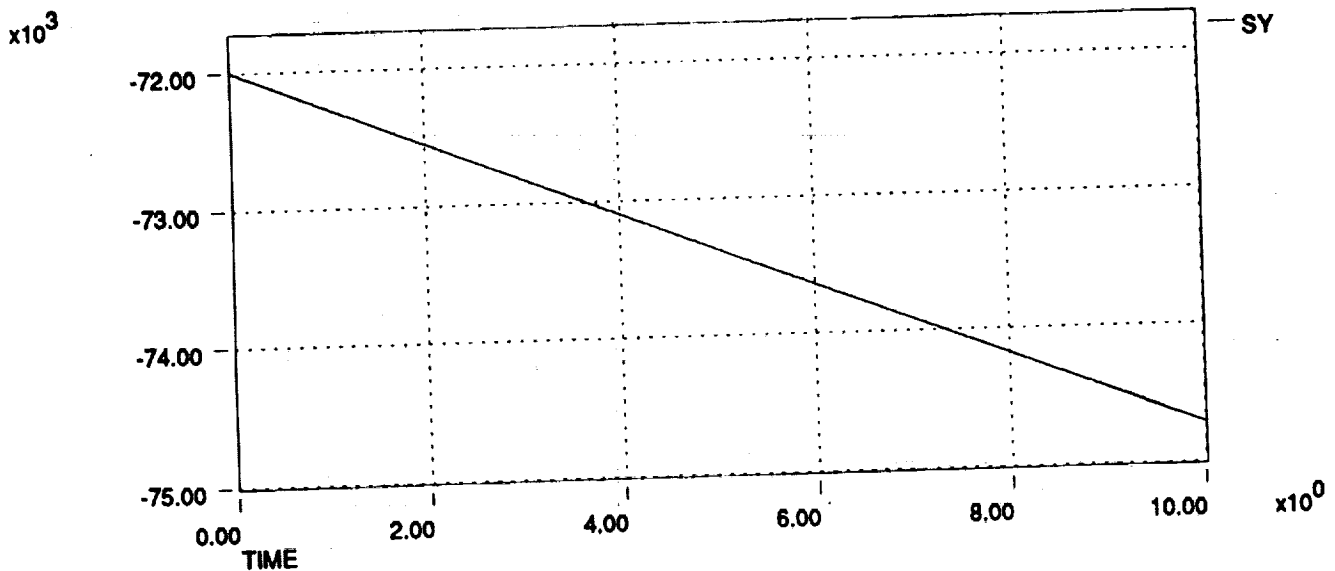
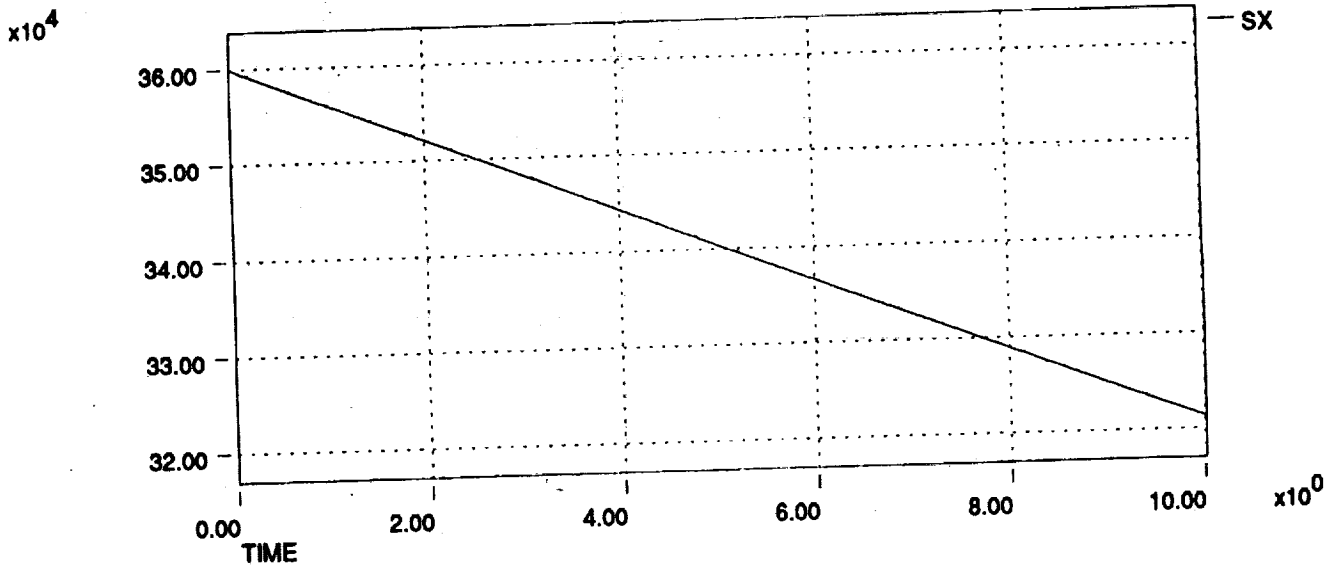
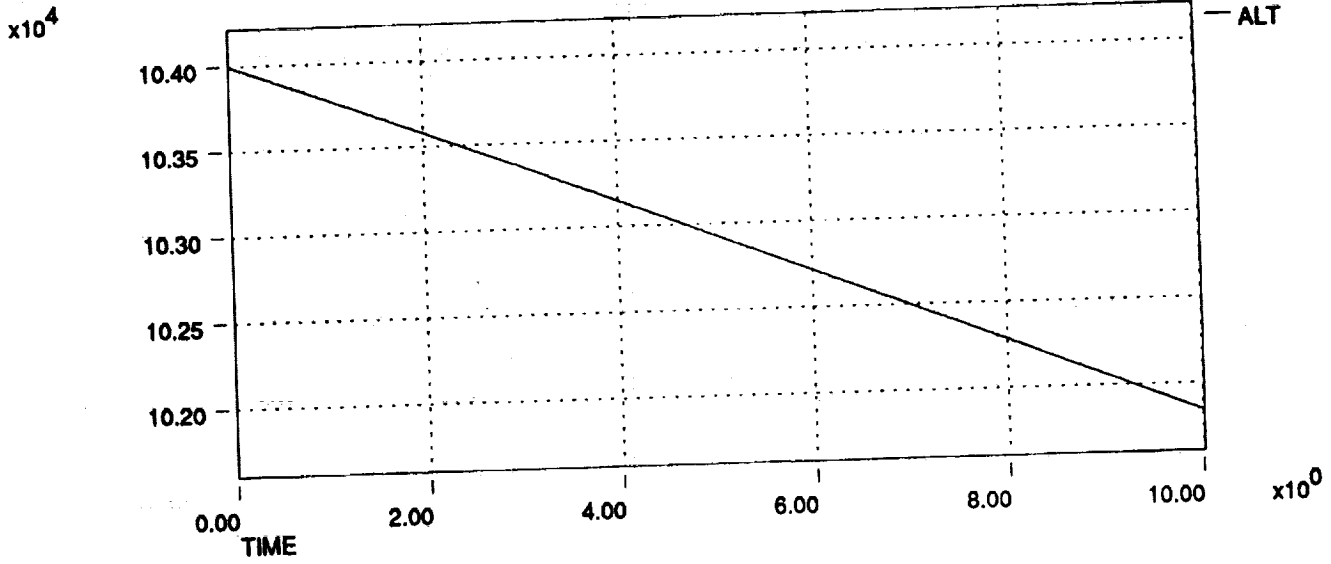

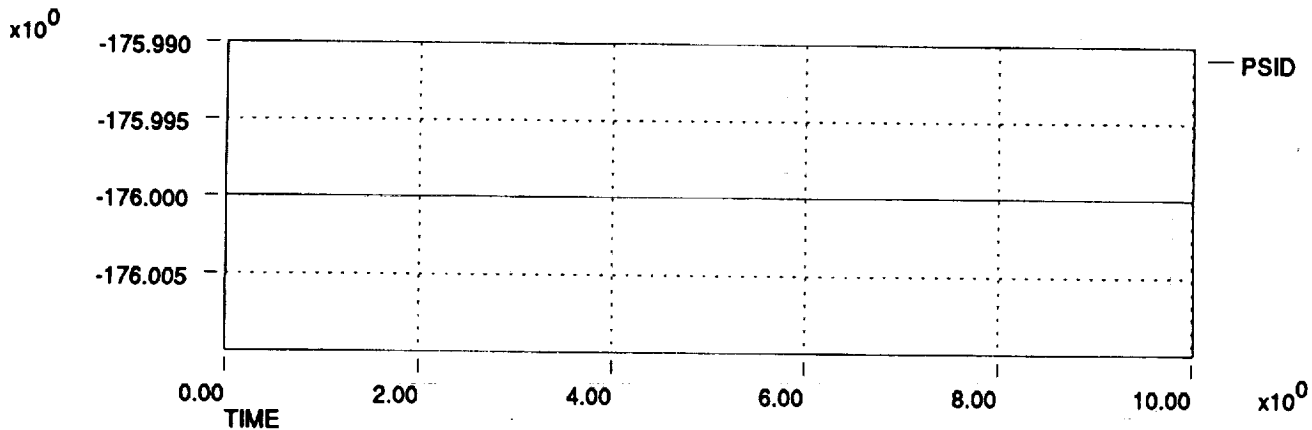
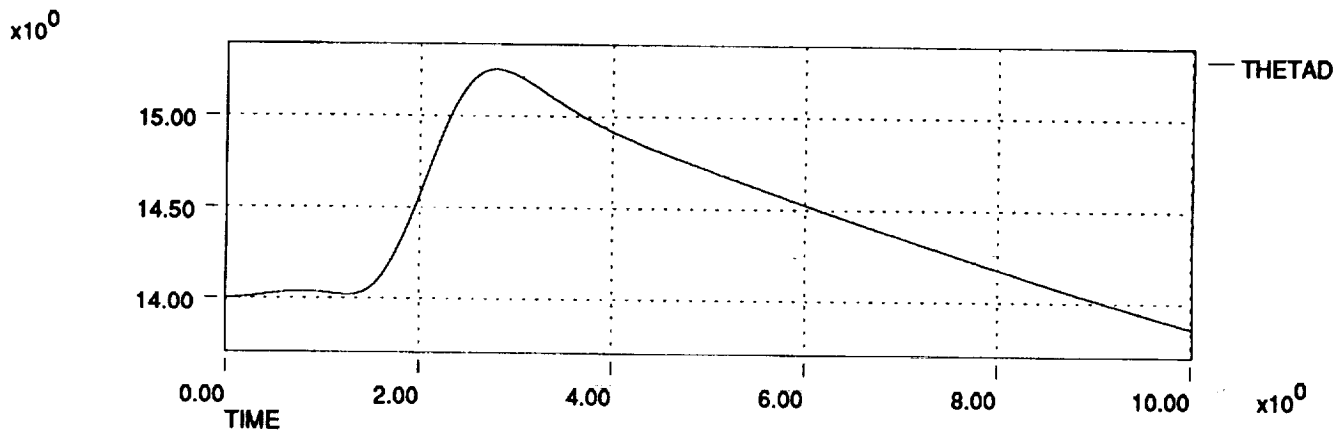
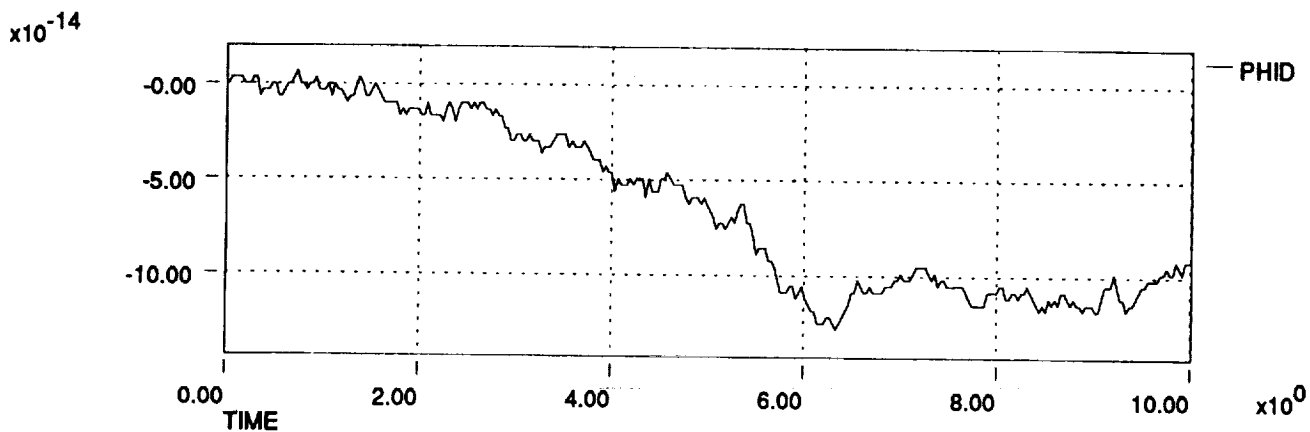
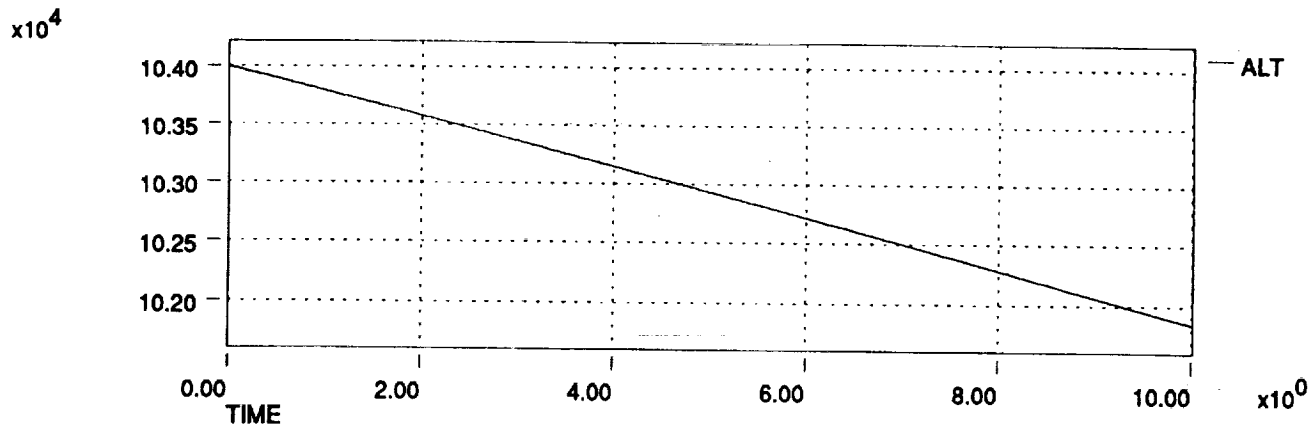

HL-20 Dynamic Check Case Data Plots 911206
Aft Pitch Stick Pulse at Mach 4 and 104,000 ft

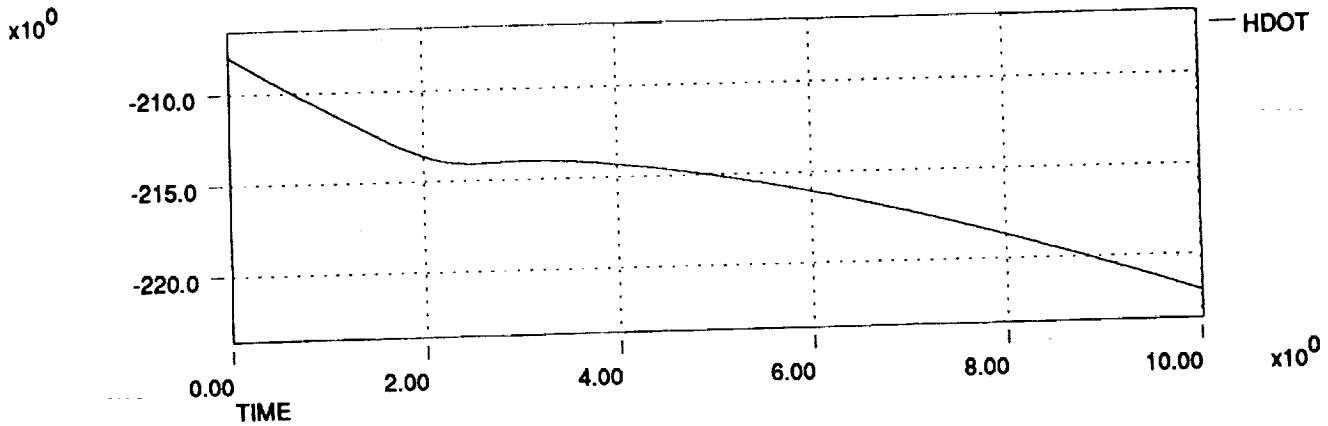
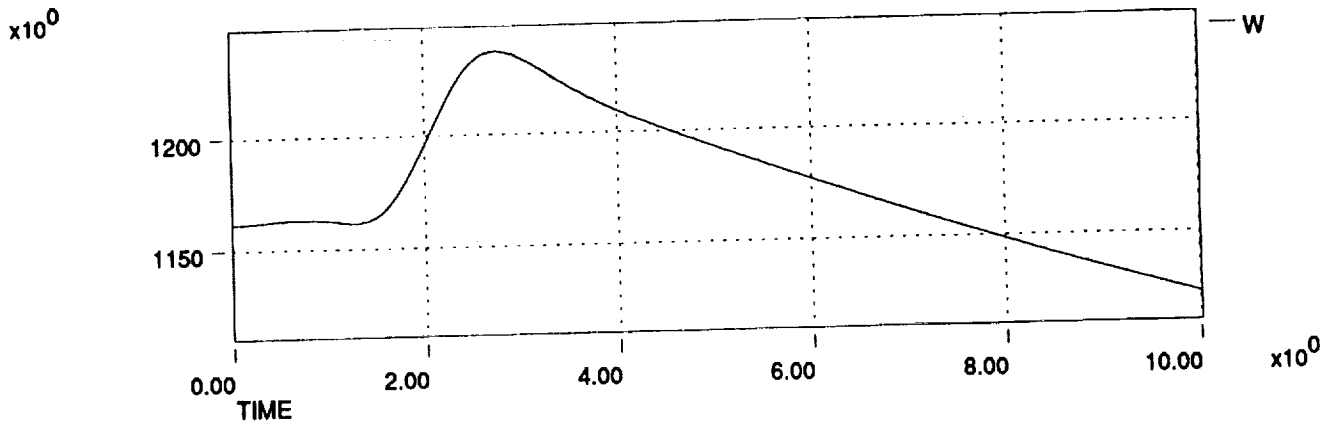
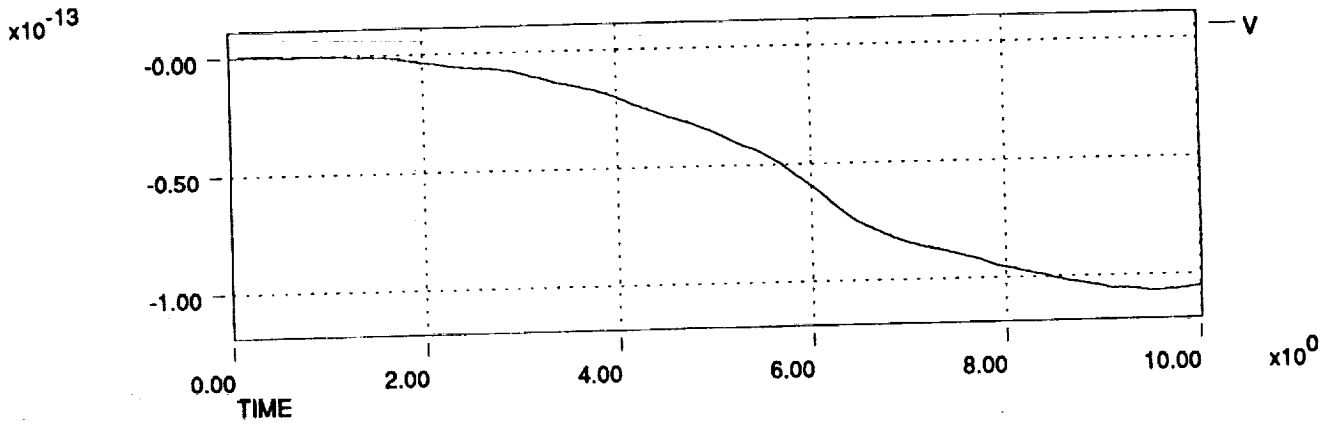
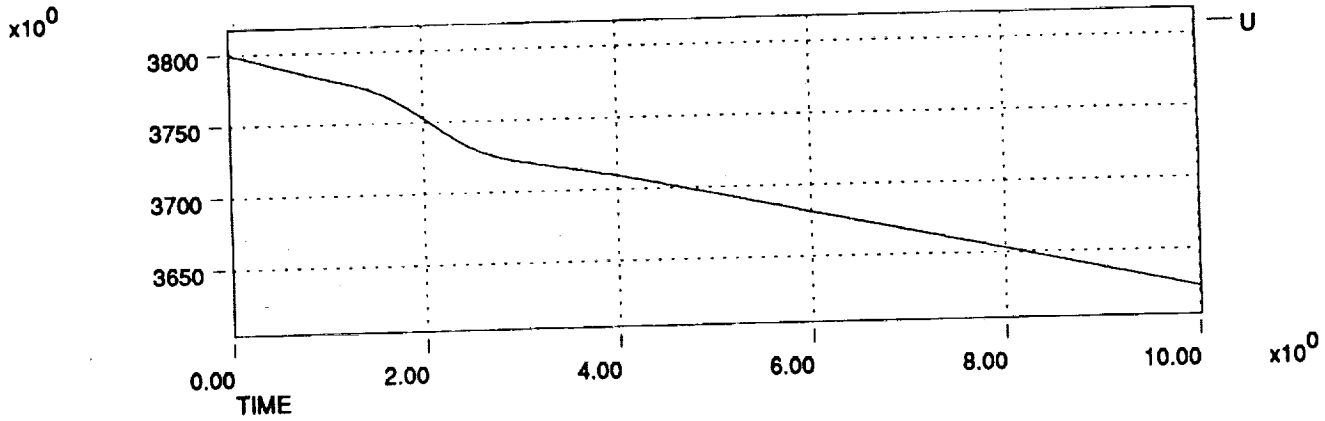

HL-20 Dynamic Check Case Data Plots 911206
Aft Pitch Stick Pulse at Mach 4 and 104,000 ft

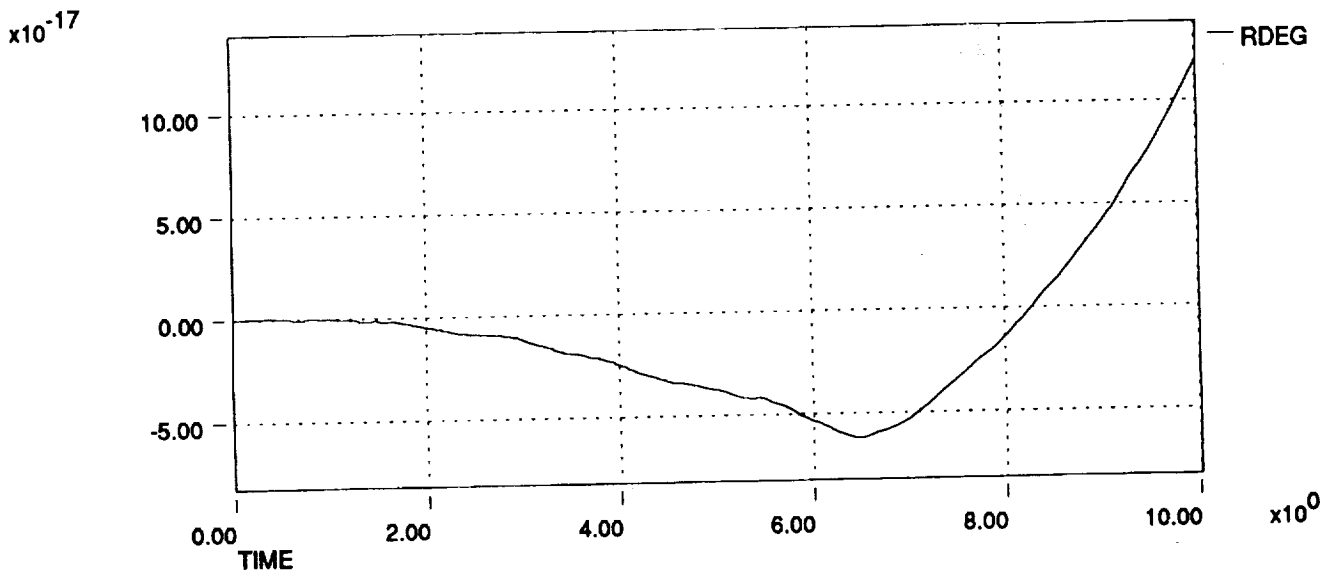
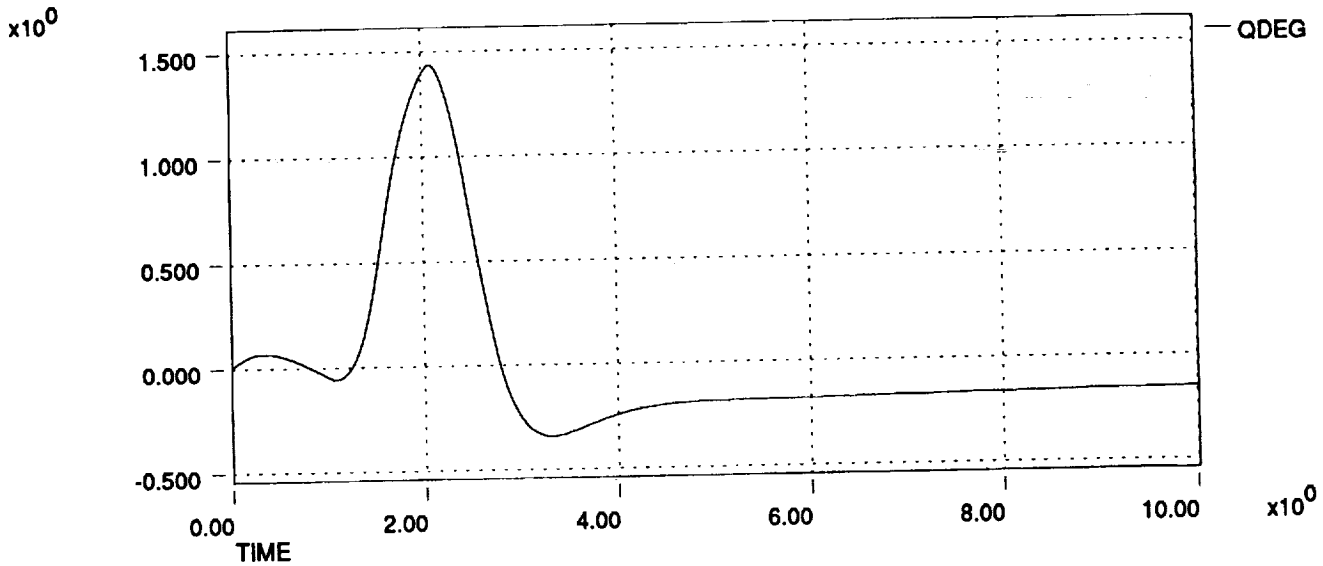
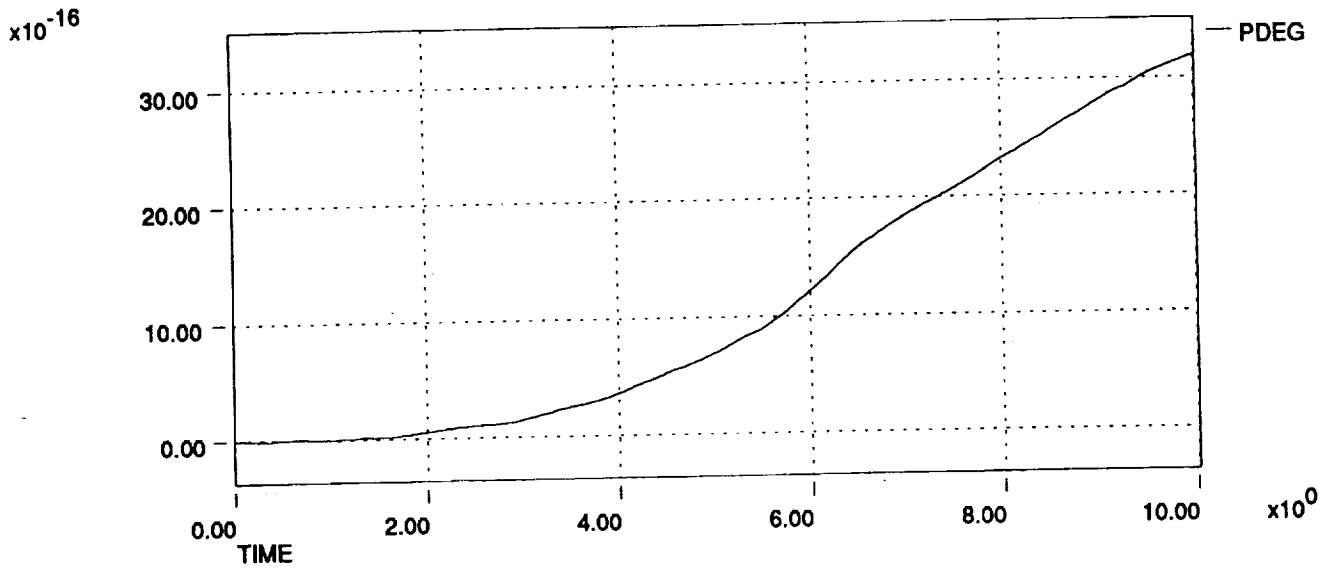

C-5

HL-20 Dynamic Check Case Data Plots 911206
Aft Pitch Stick Pulse at Mach 4 and 104,000 ft

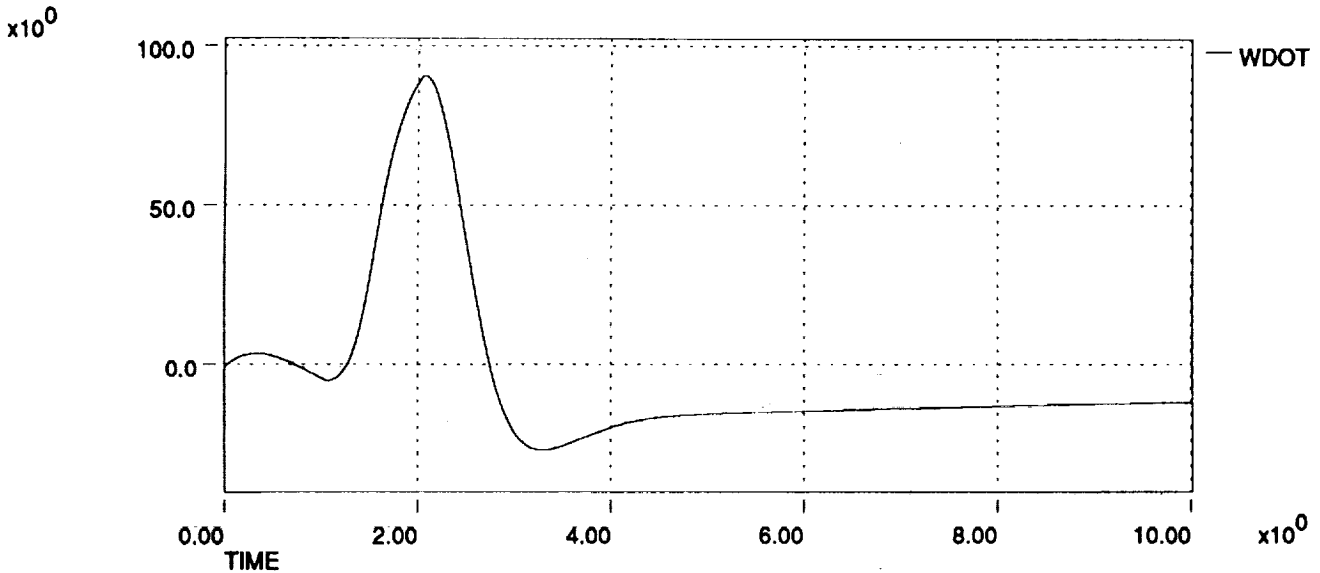
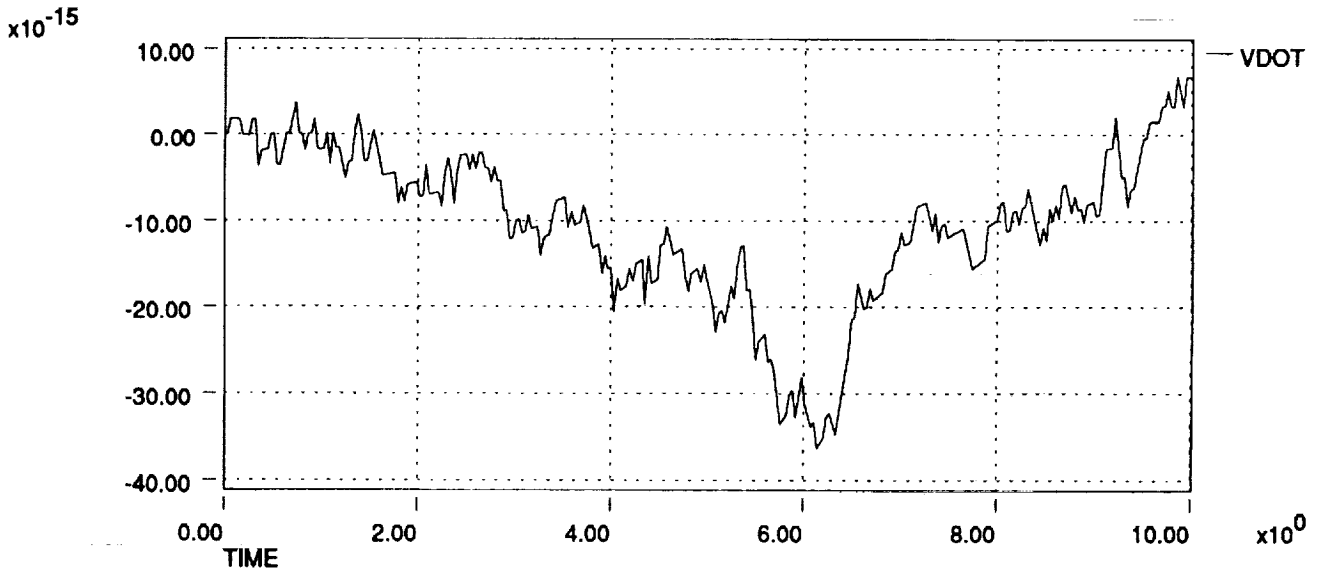
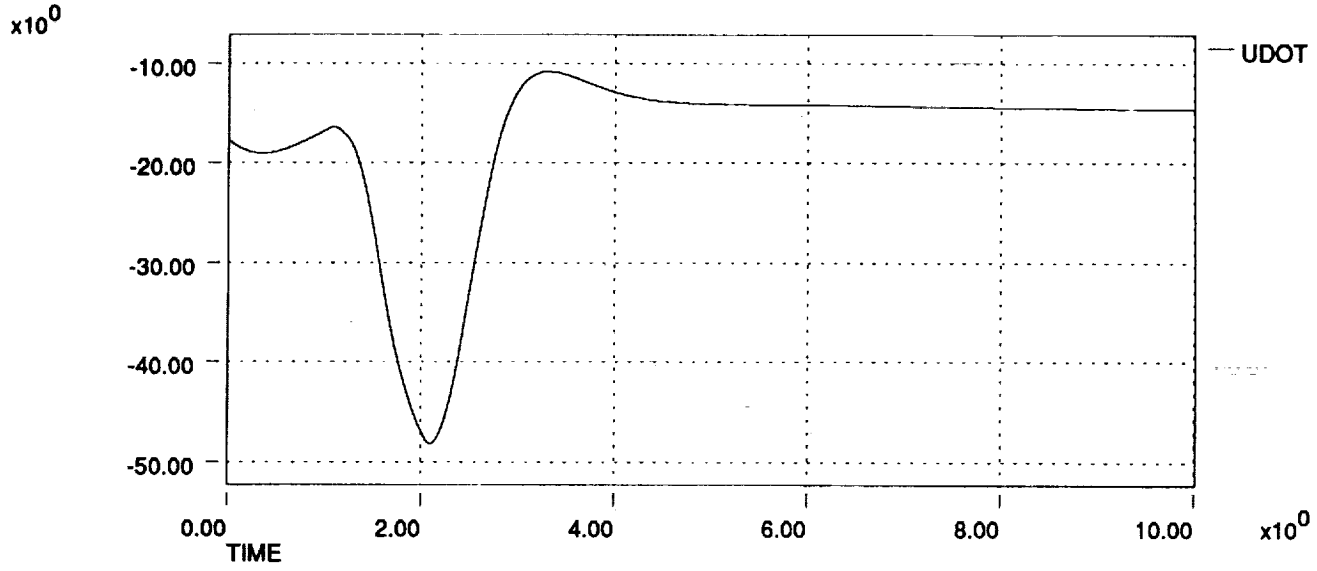

HL-20 Dynamic Check Case Data Plots 911206
Aft Pitch Stick Pulse at Mach 4 and 104,000 ft

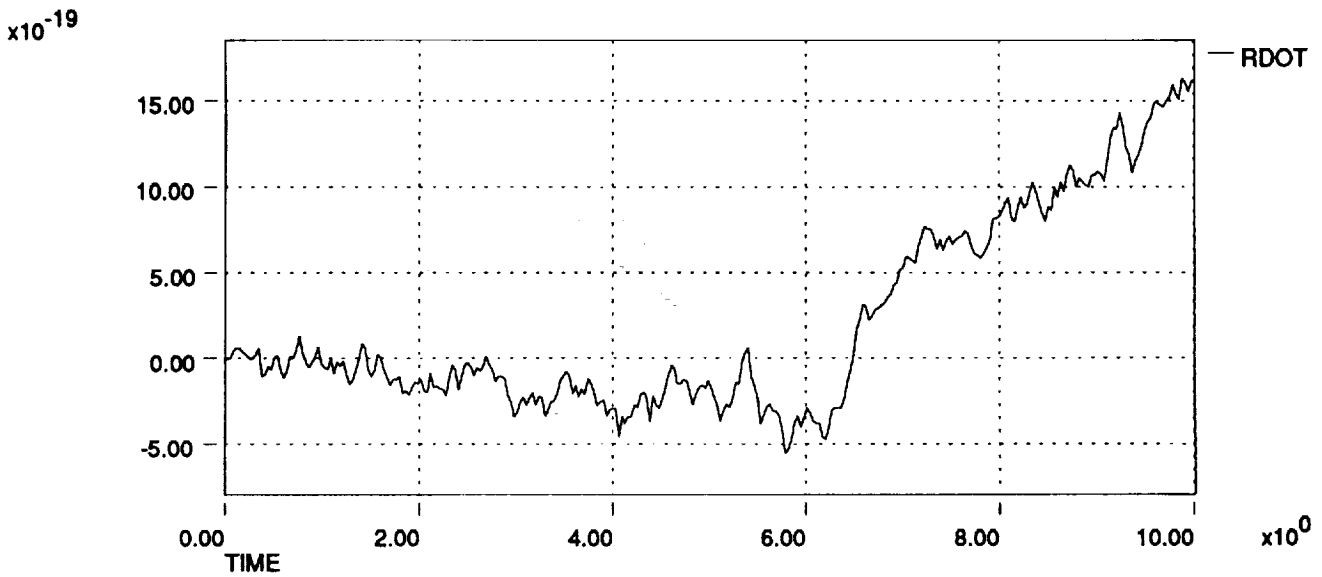
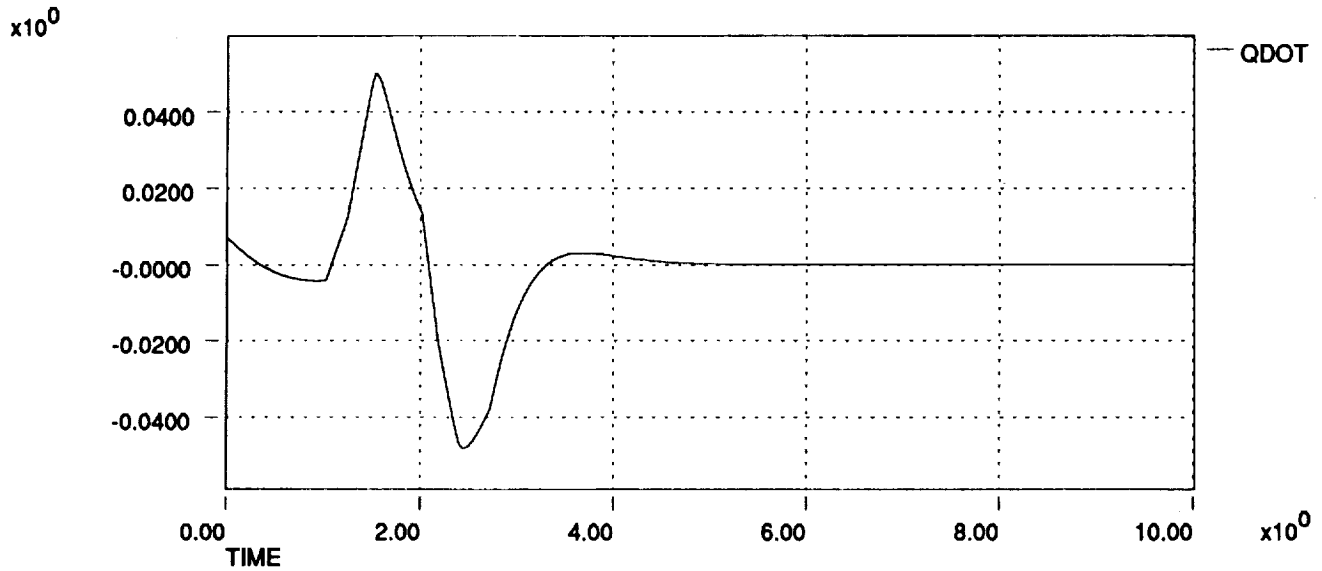
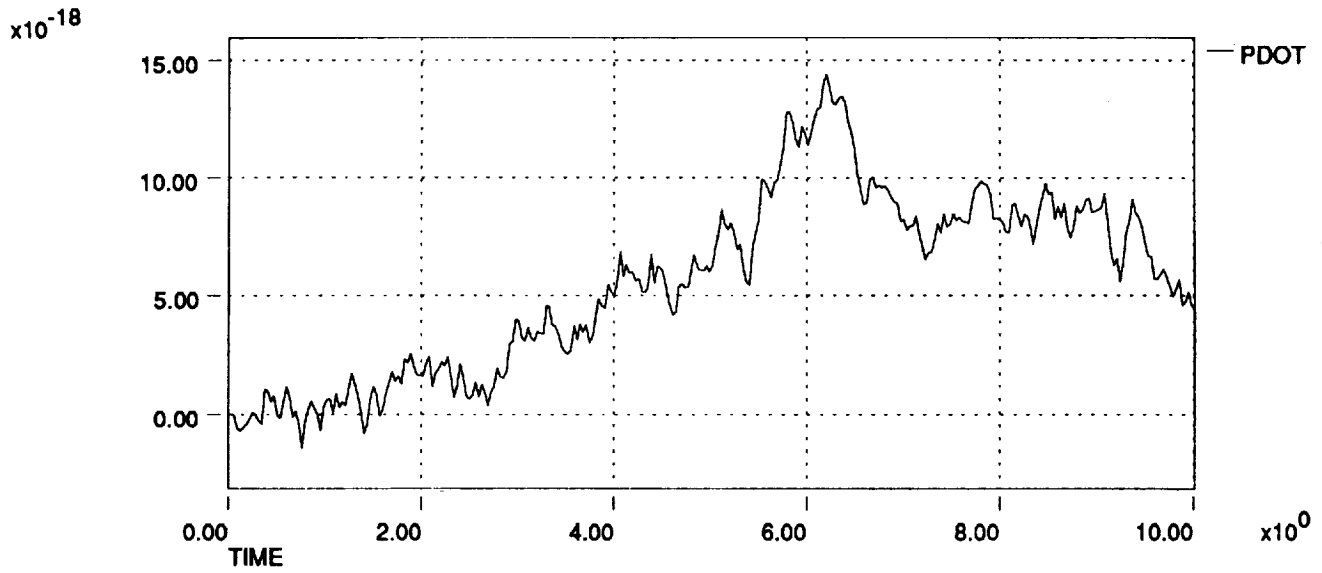

HL-20 Dynamic Check Case Data Plots 911206
Alt Pitch Stick Pulse at Mach 4 and 104,000 ft

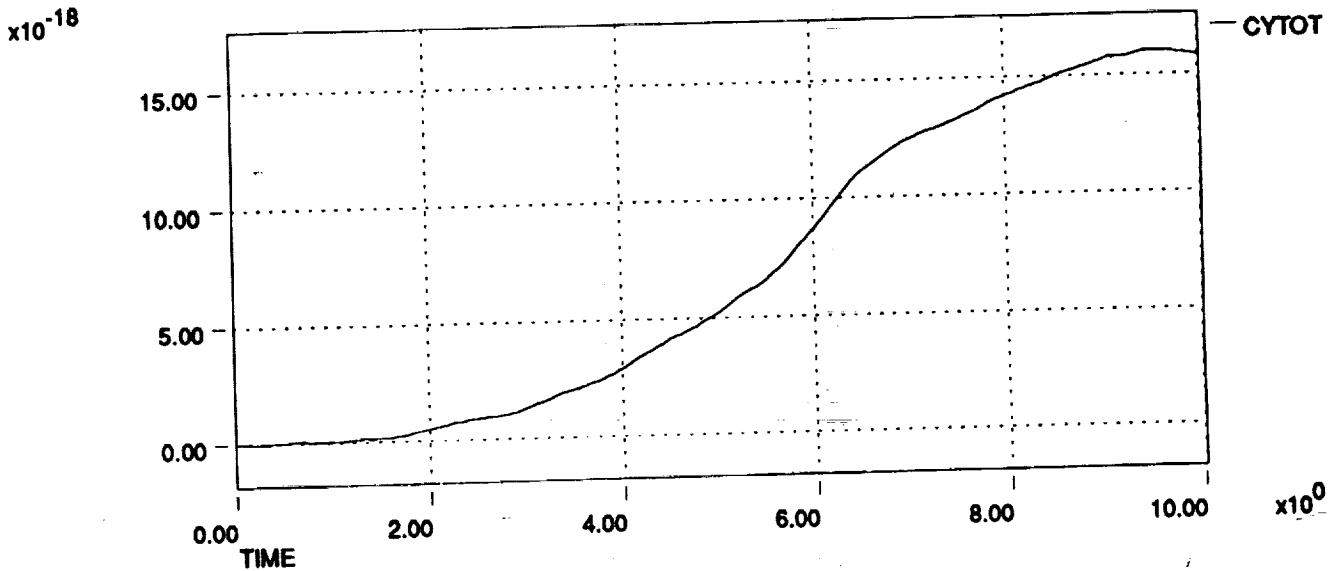
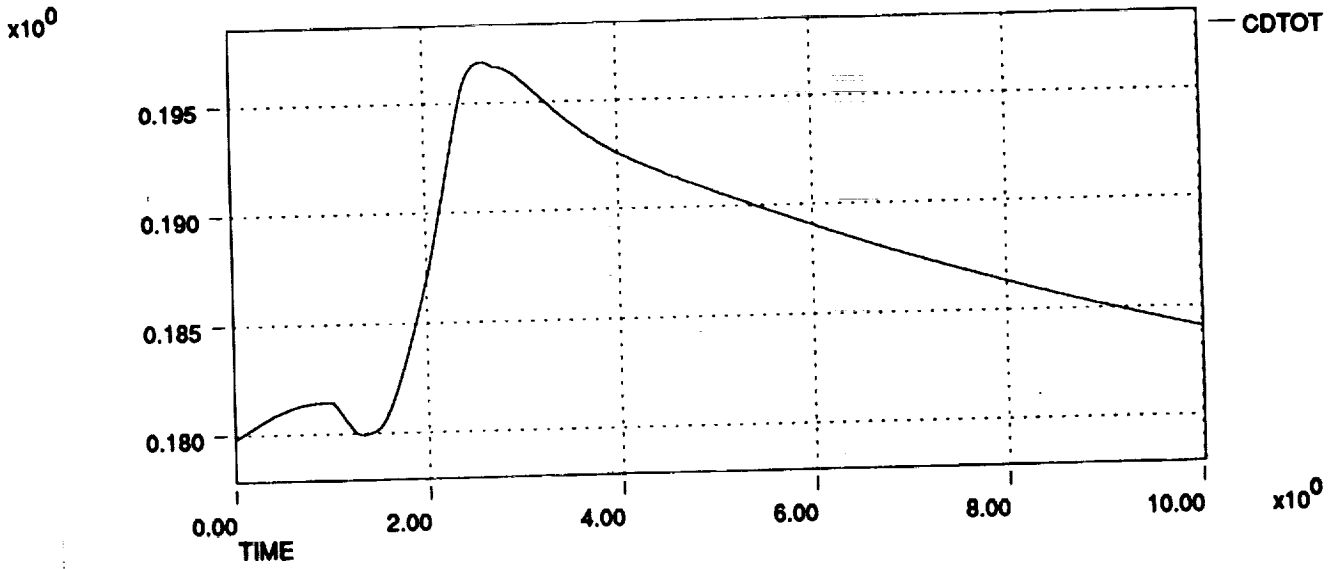
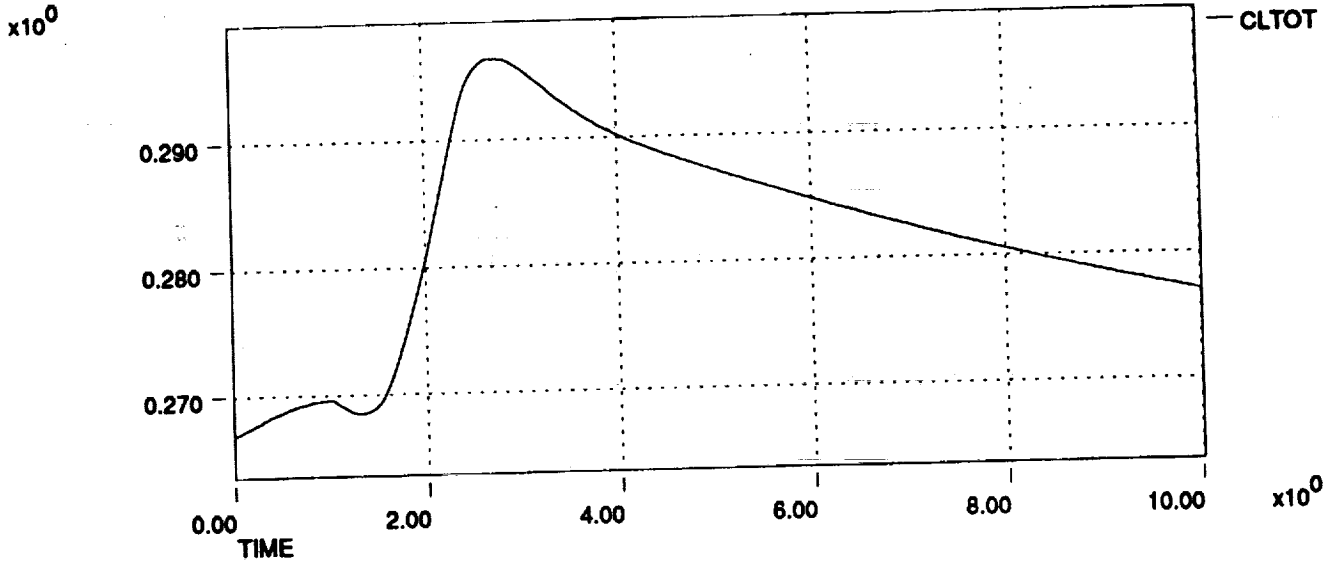

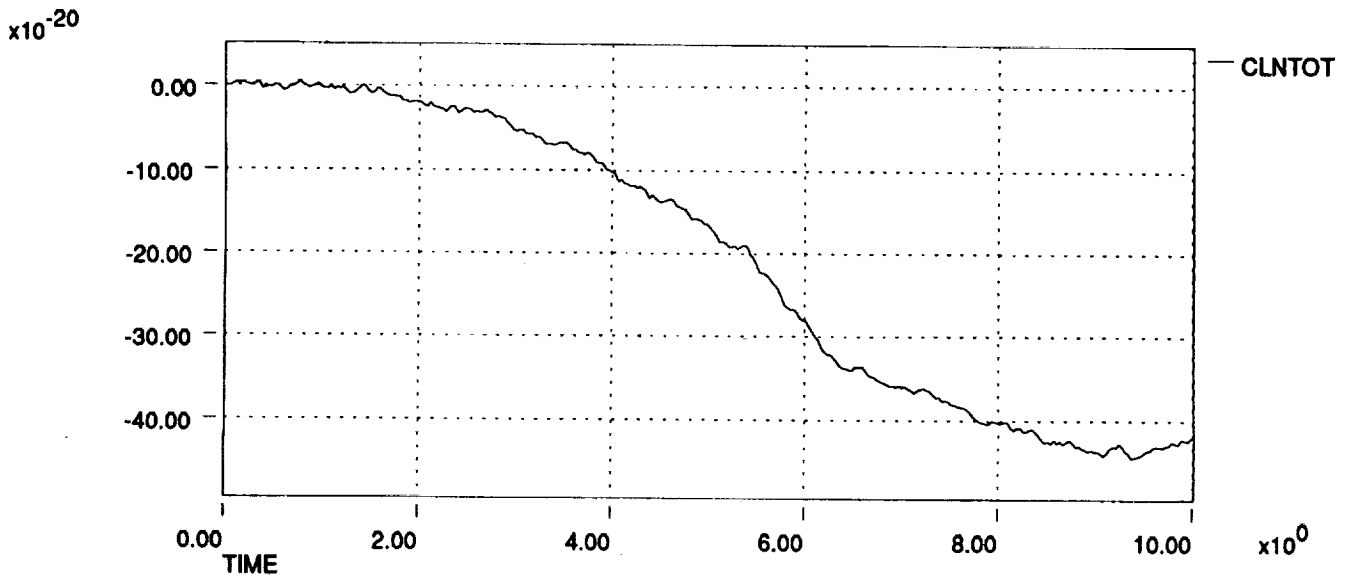
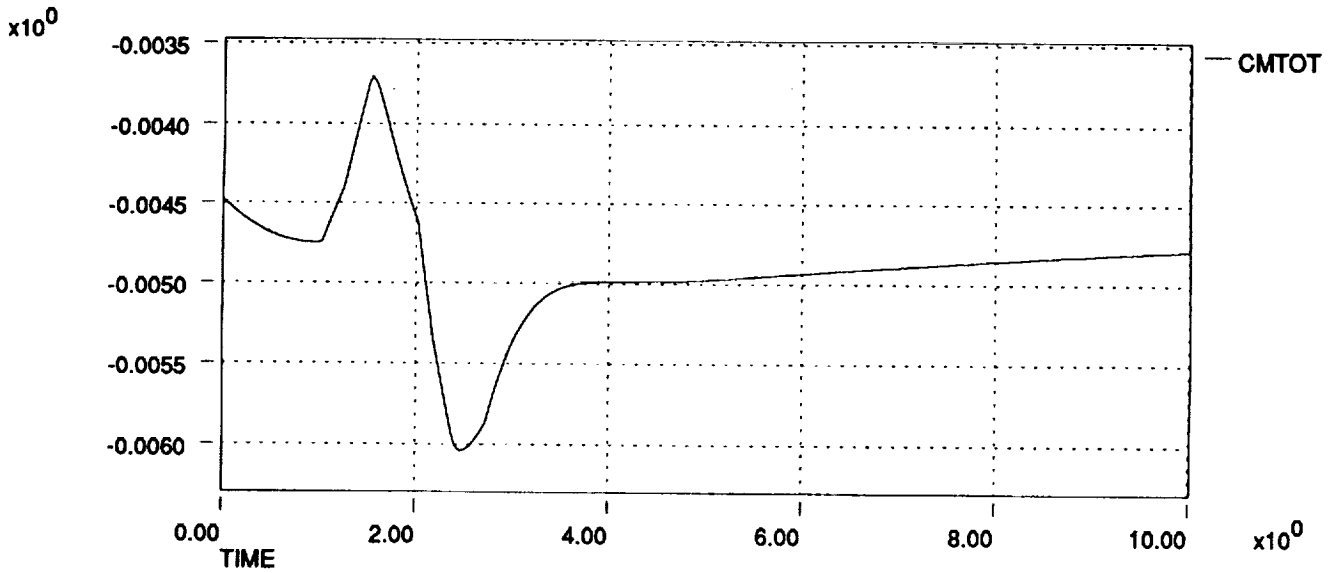
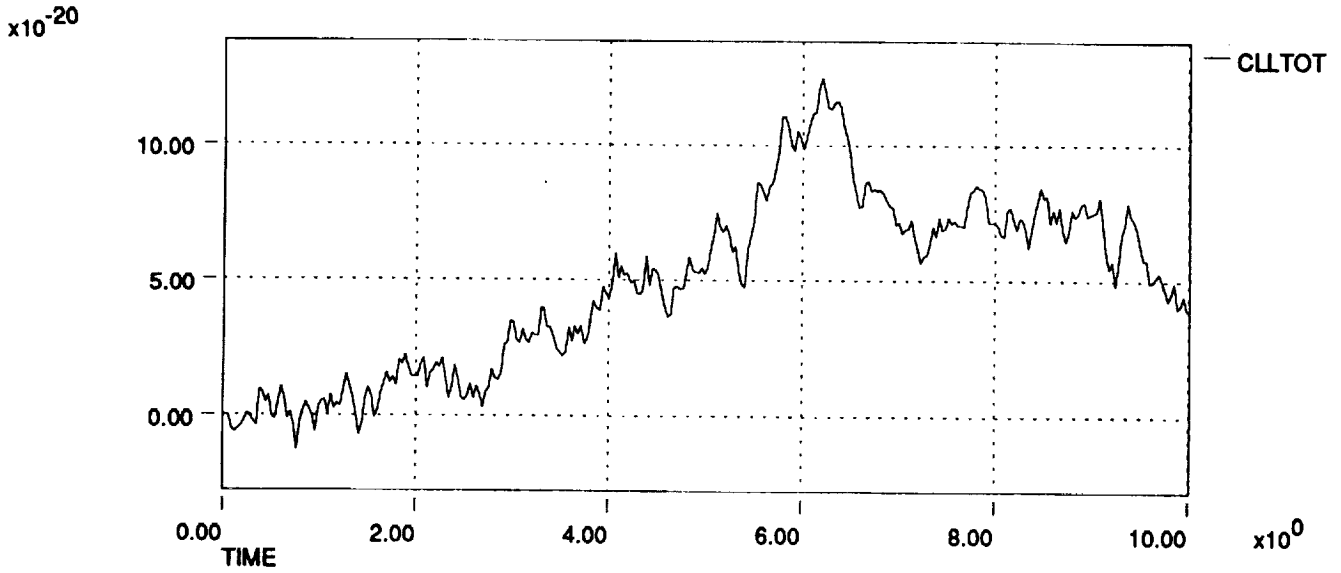

HL-20 Dynamic Check Case Data Plots 911206
Aft Pitch Stick Pulse at Mach 4 and 104,000 ft

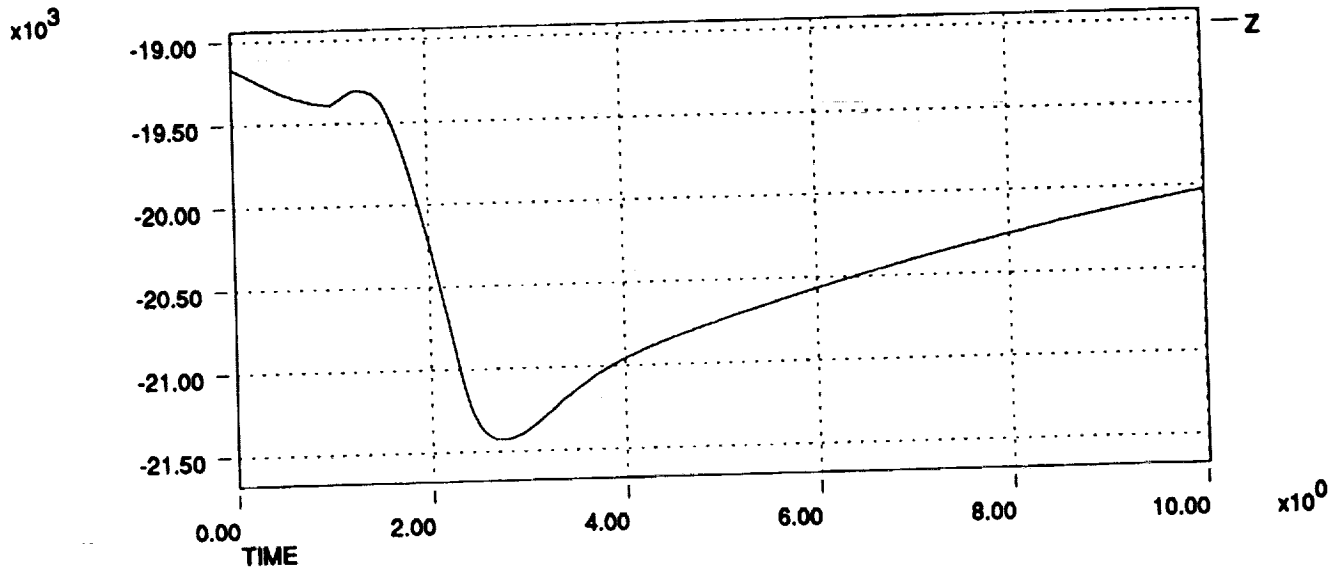
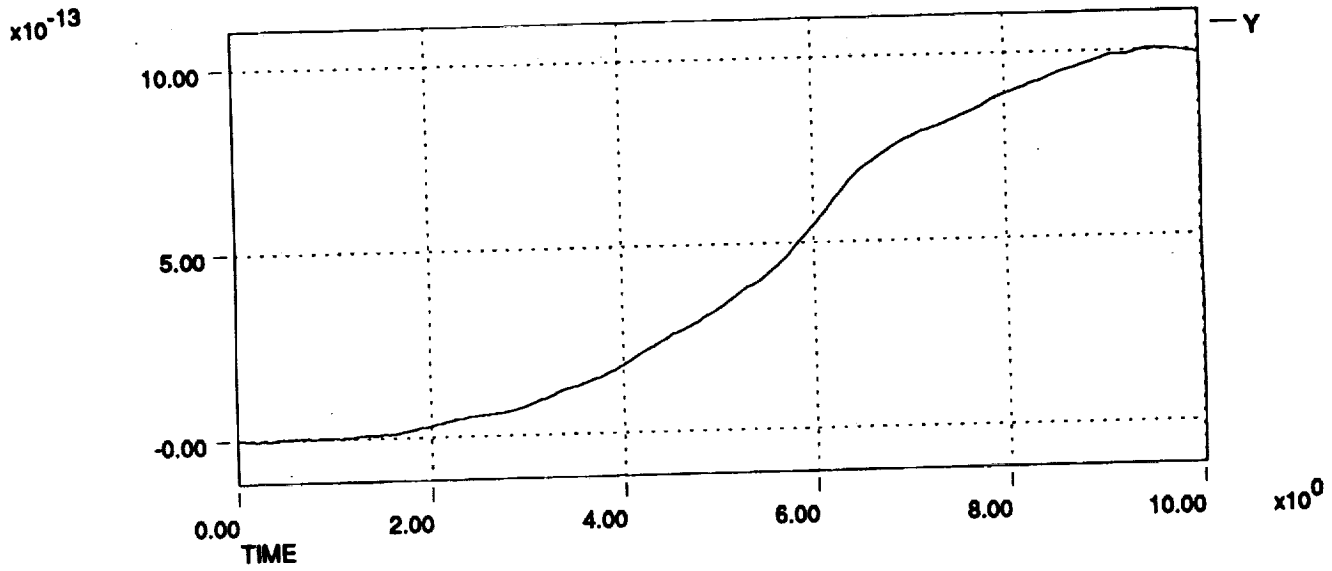
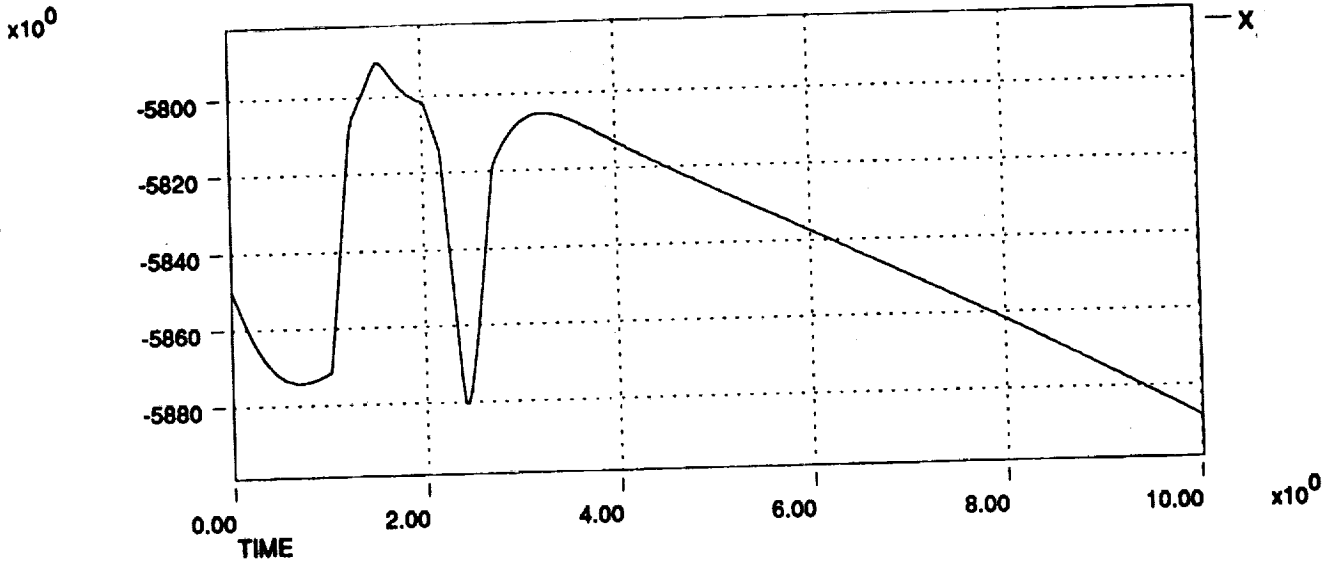

HL-20 Dynamic Check Case Data Plots 911206
Aft Pitch Stick Pulse at Mach 4 and 104,000 ft

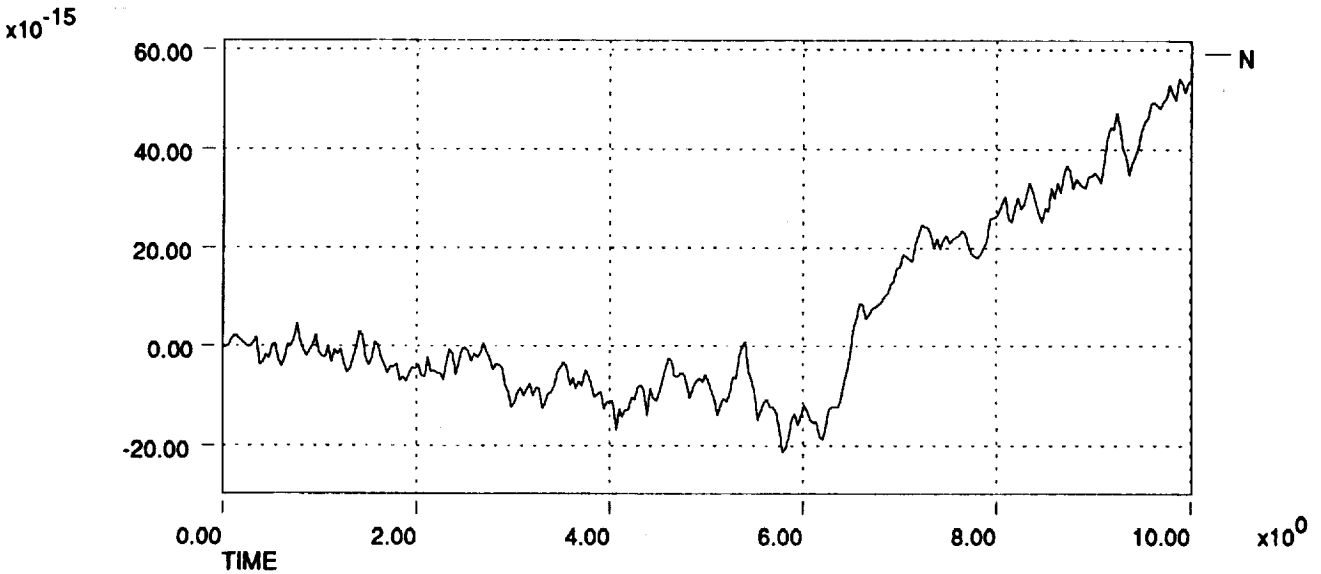
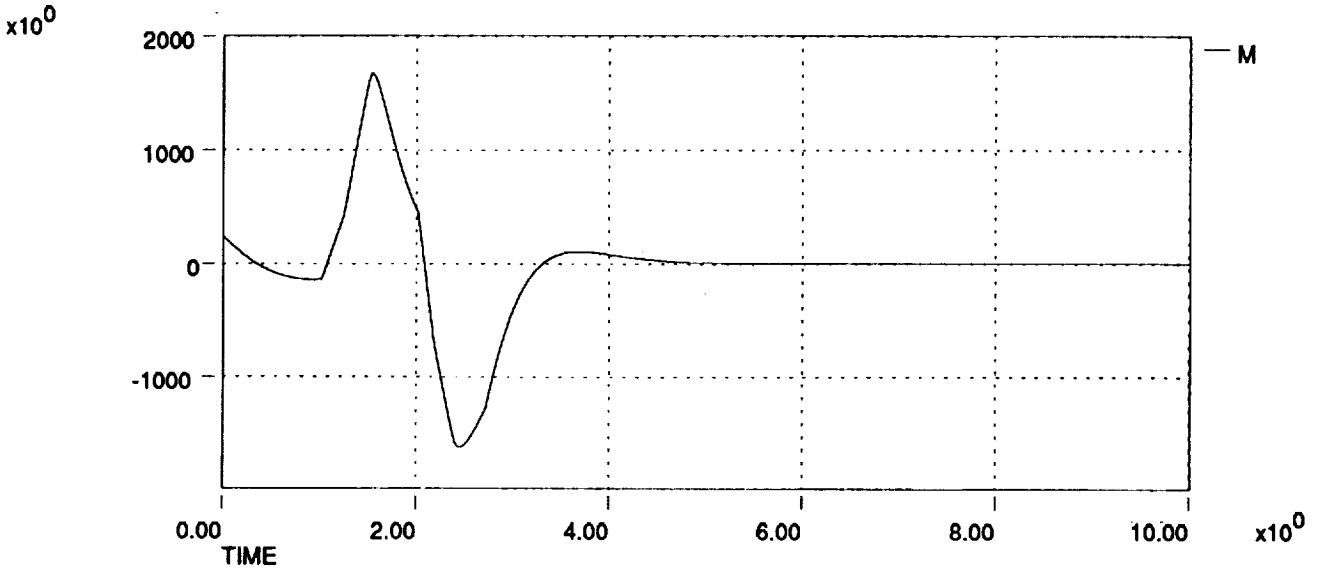
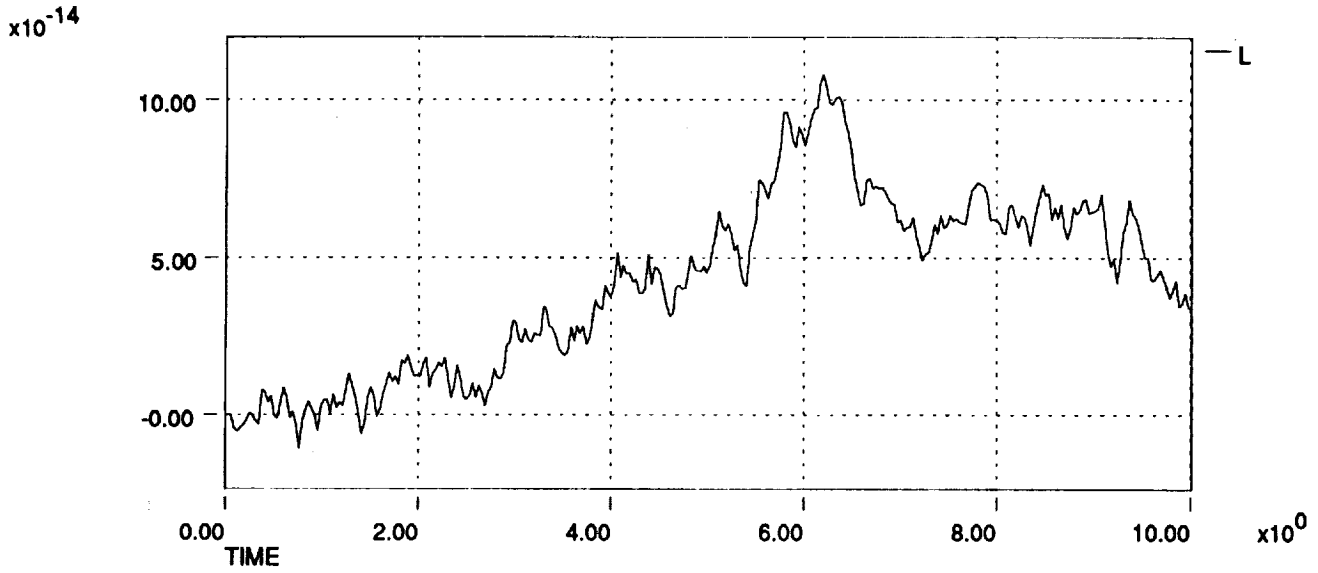

HL-20 Dynamic Check Case Data Plots 911206
Alt Pitch Stick Pulse at Mach 4 and 104,000 ft

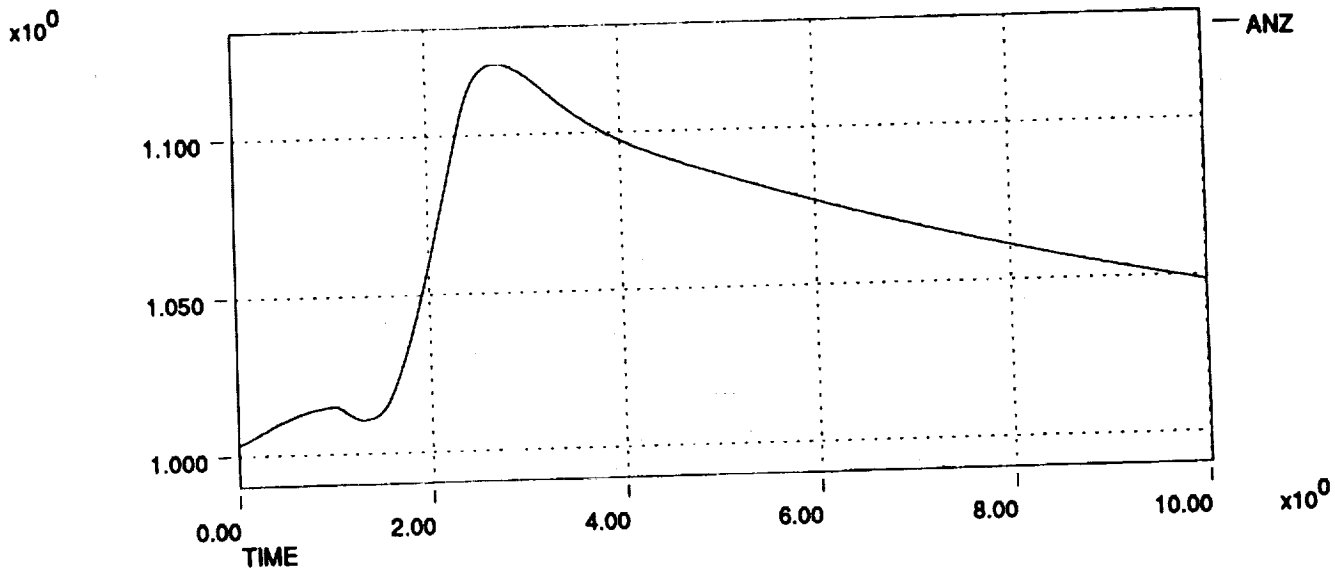
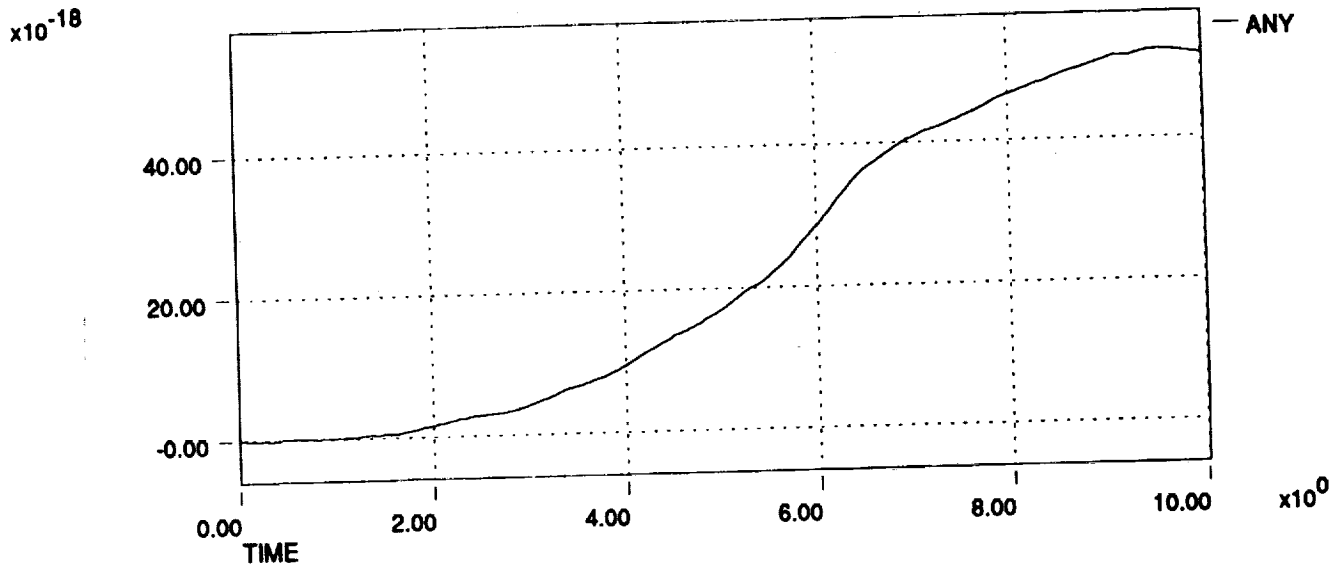
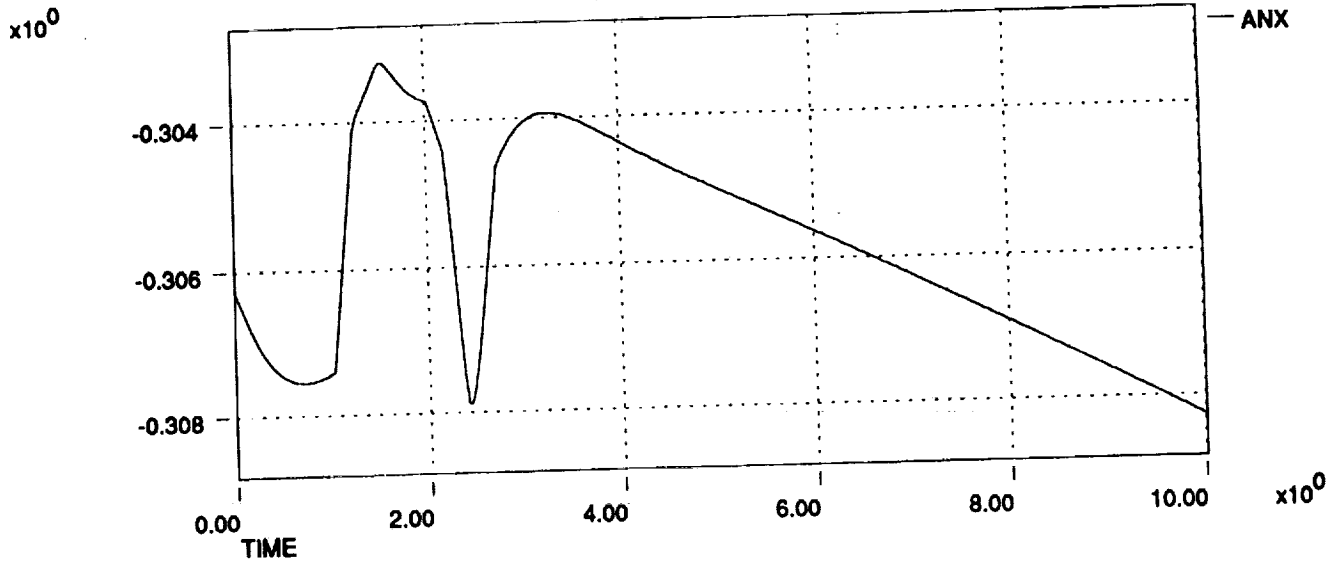

HL-20 Dynamic Check Case Data Plots 911206
Aft Pitch Stick Pulse at Mach 4 and 104,000 ft

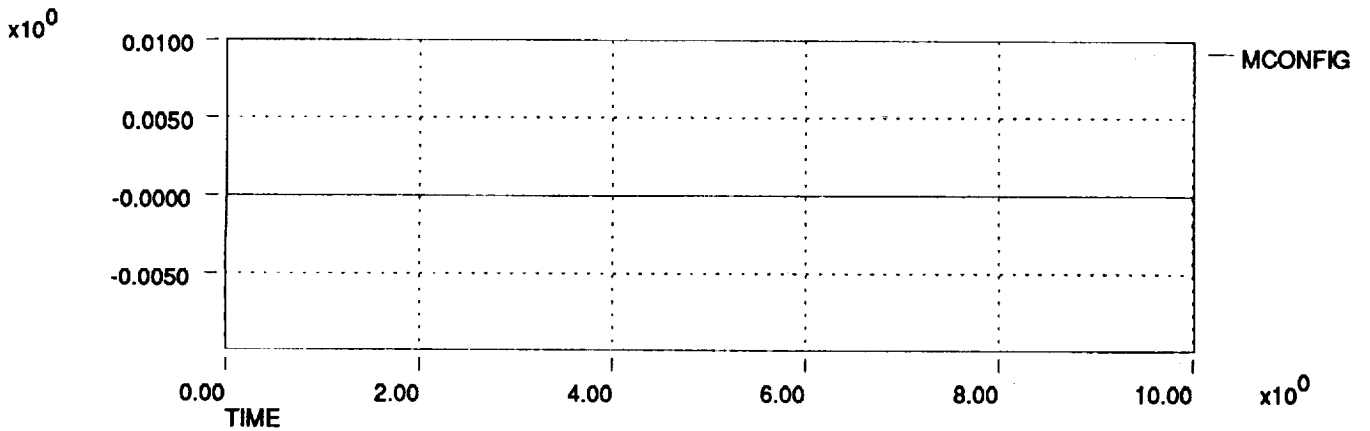
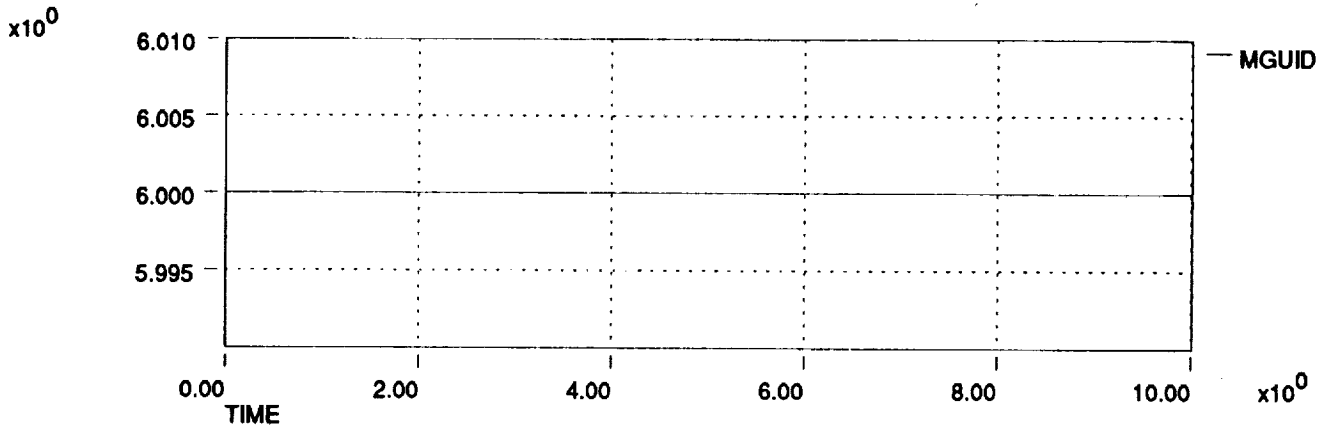
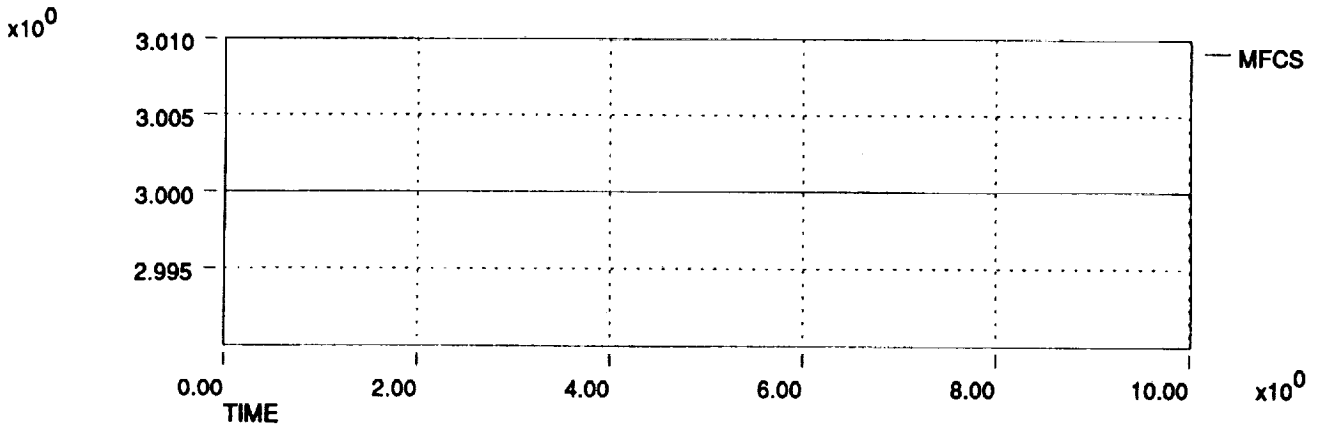
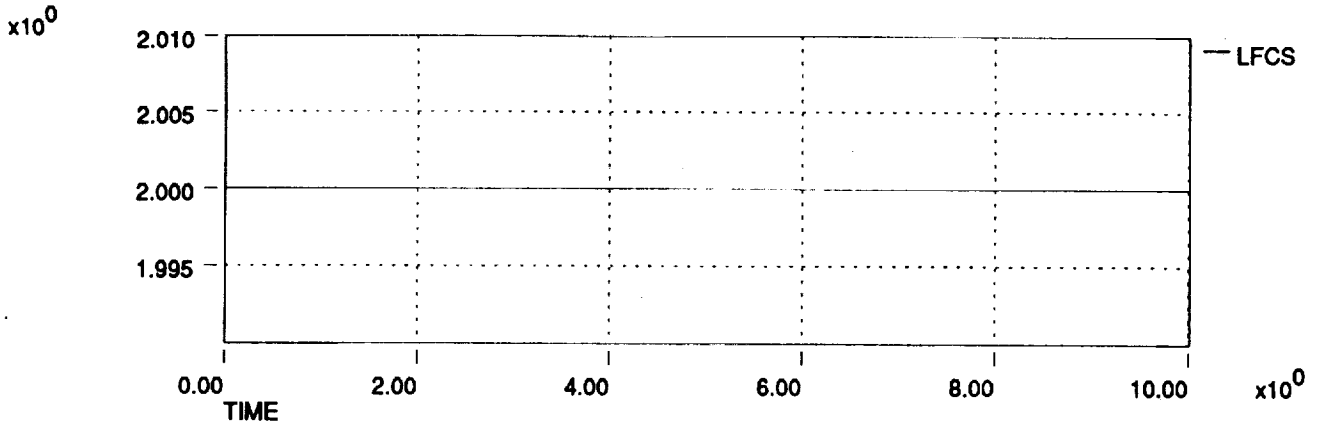

HL-20 Dynamic Check Case Data Plots 911206
Aft Pitch Stick Pulse at Mach 4 and 104,000 ft

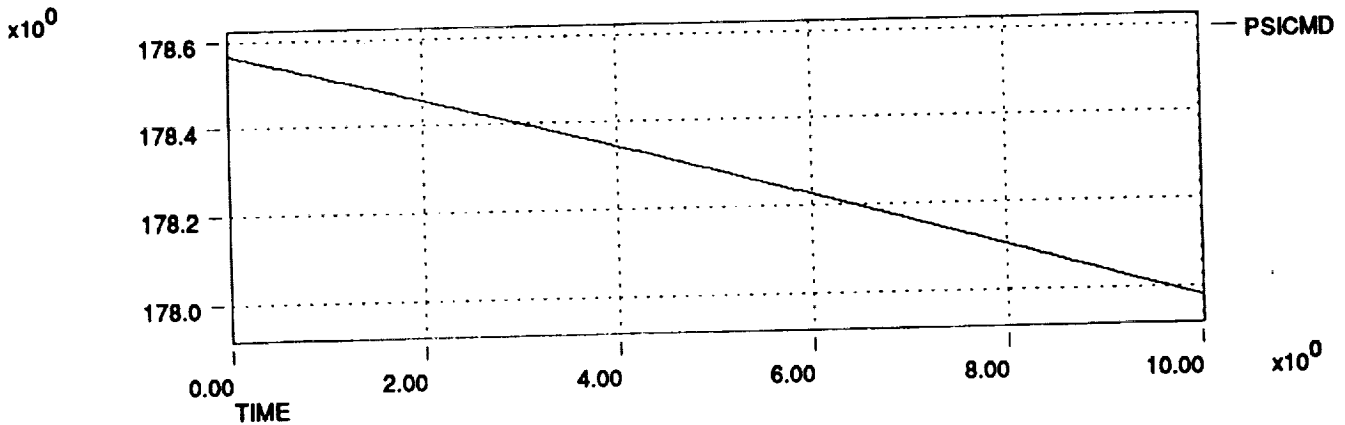
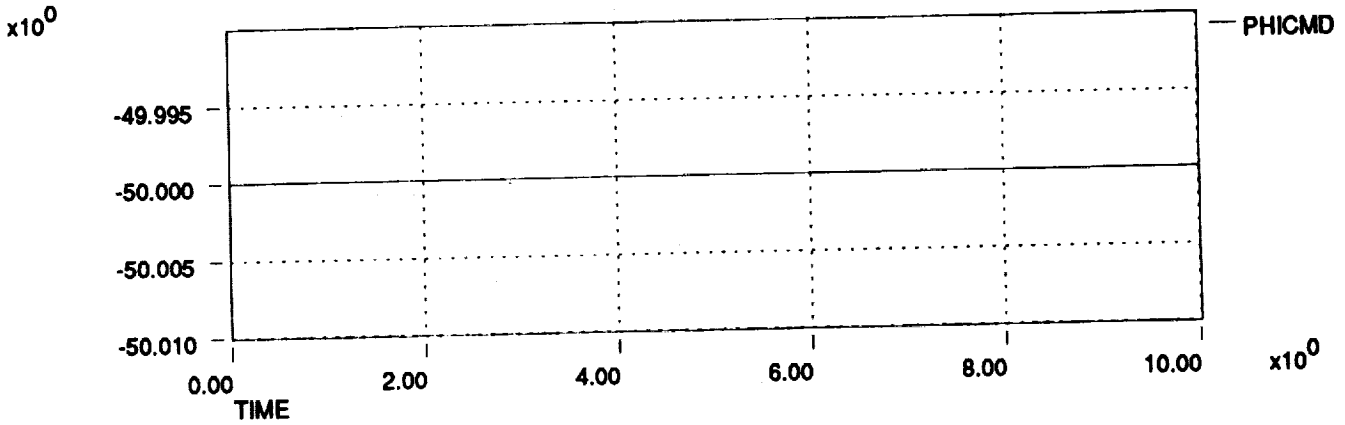
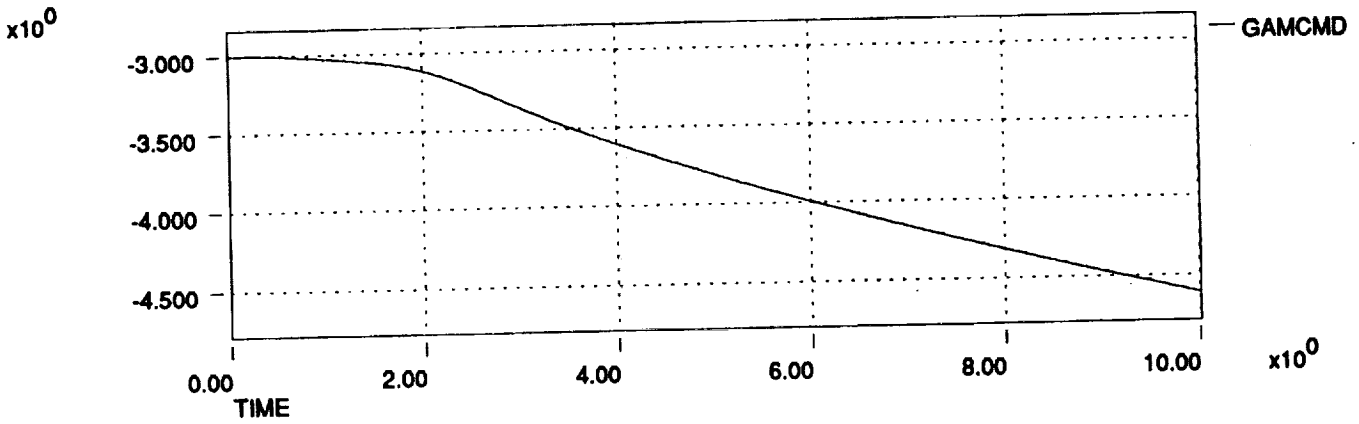
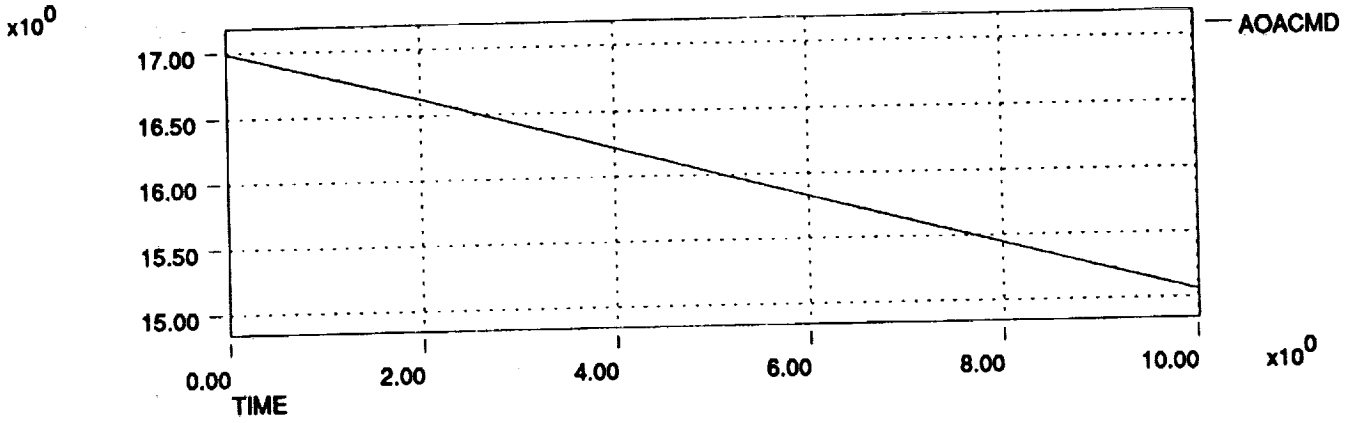

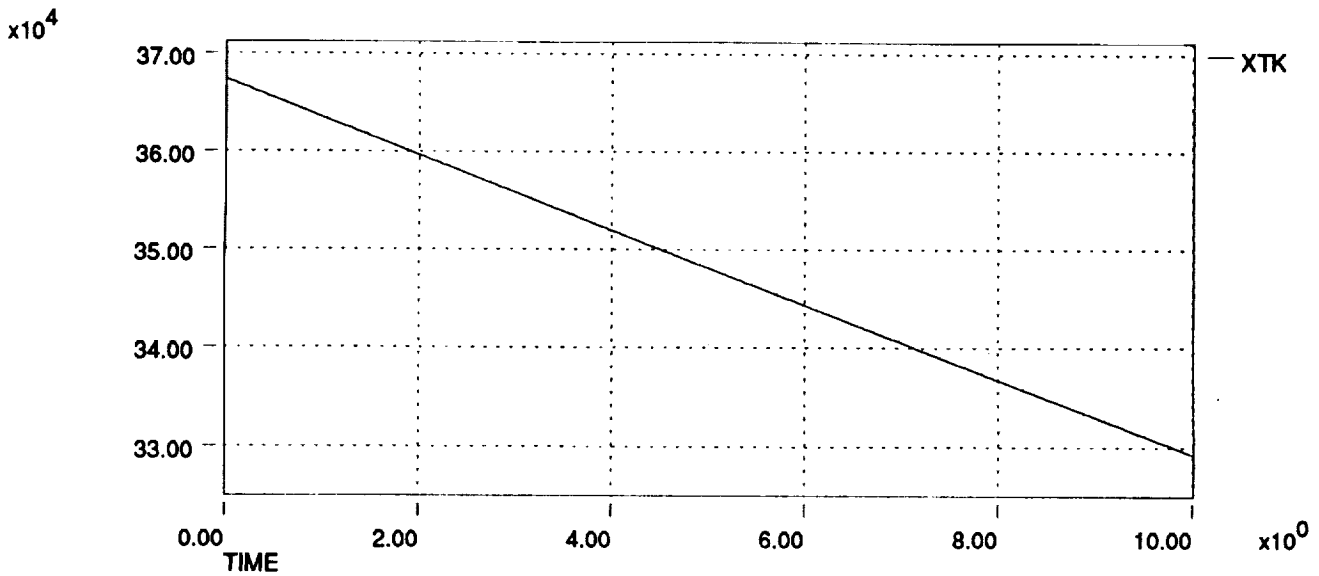
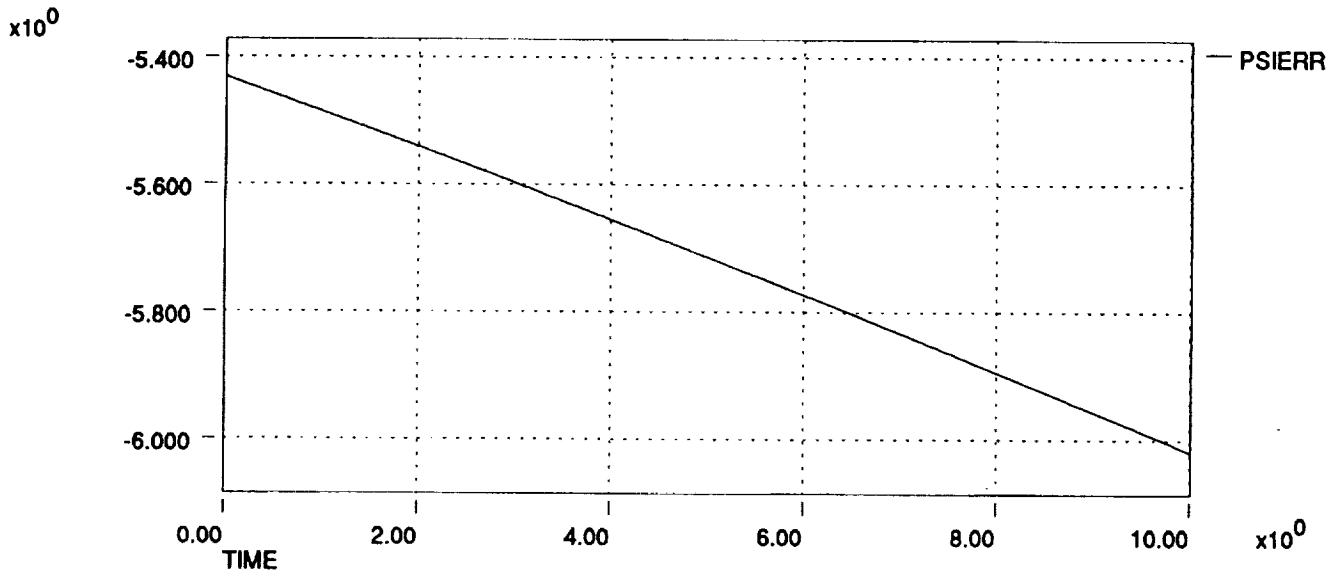
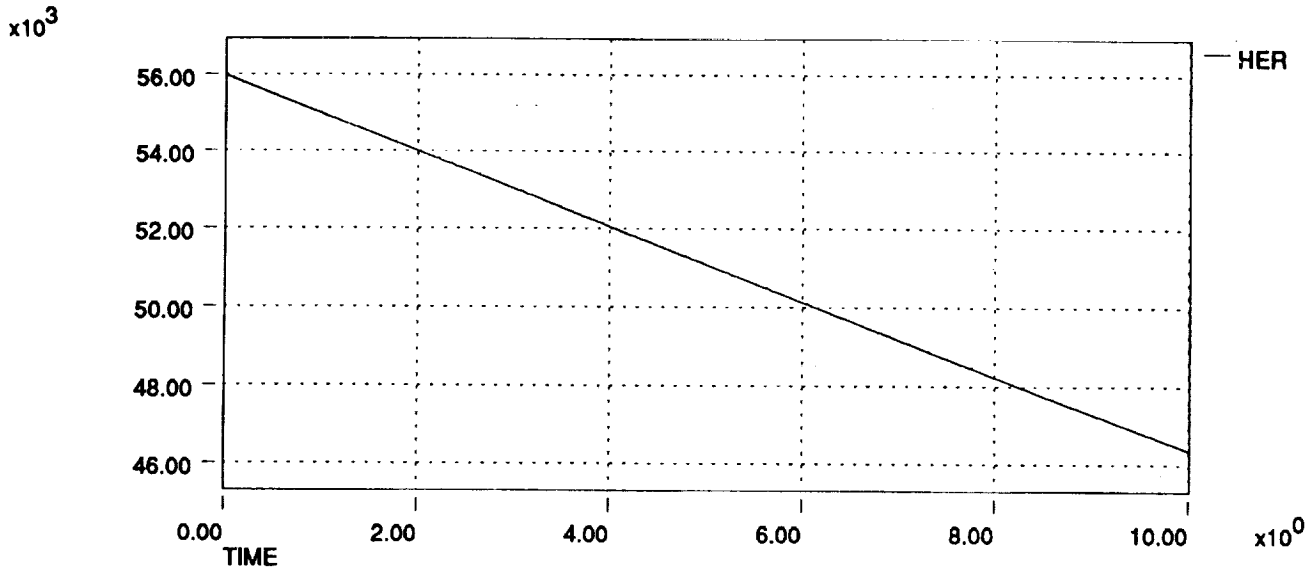

HL-20 Dynamic Check Case Data Plots 911206
Alt Pitch Stick Pulse at Mach 4 and 104,000 ft

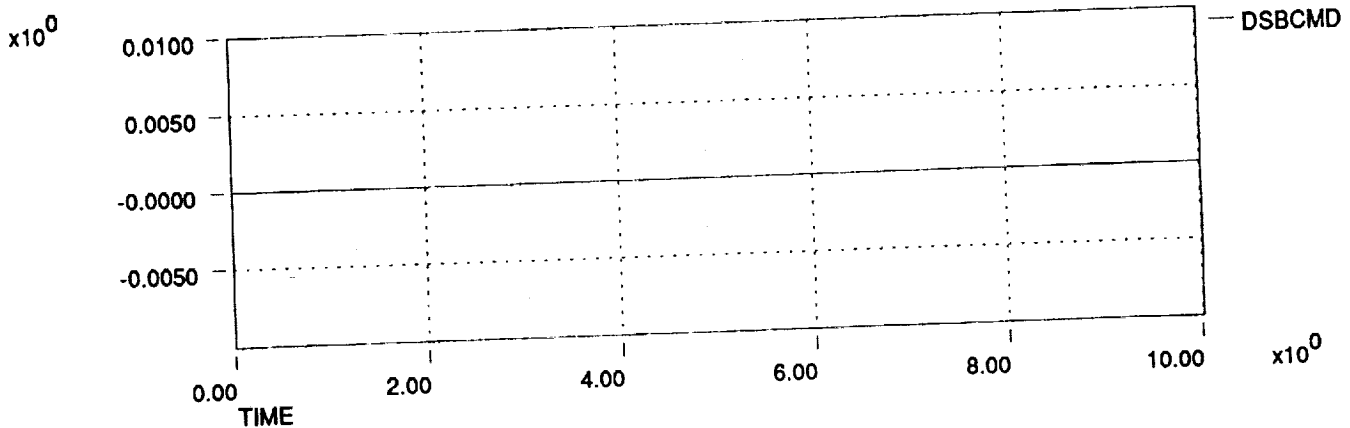
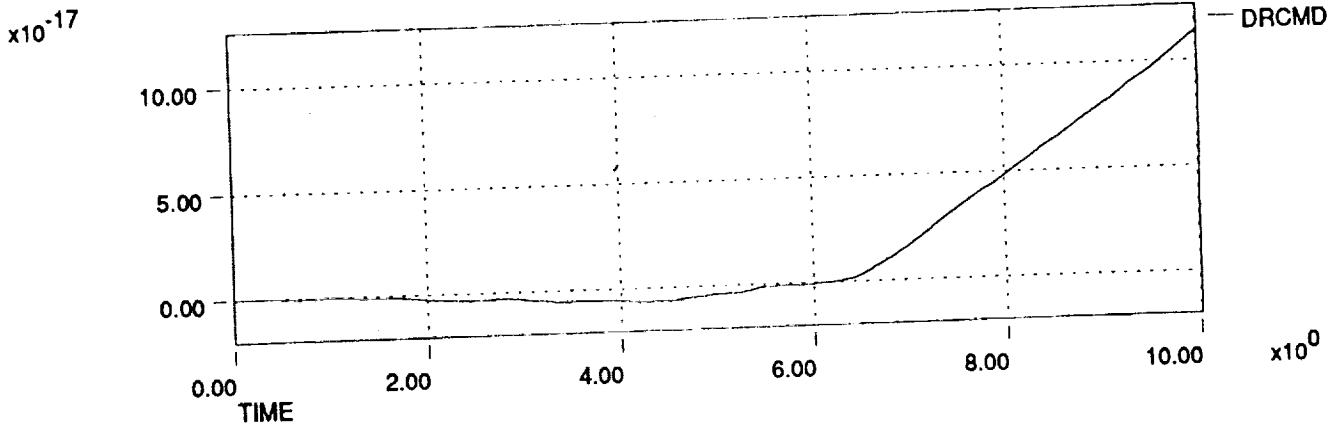
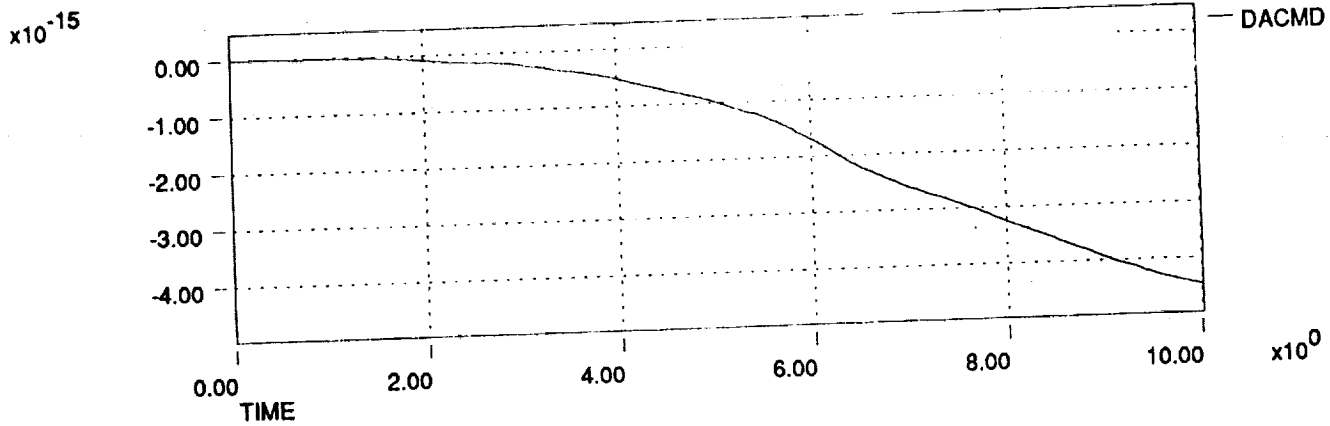
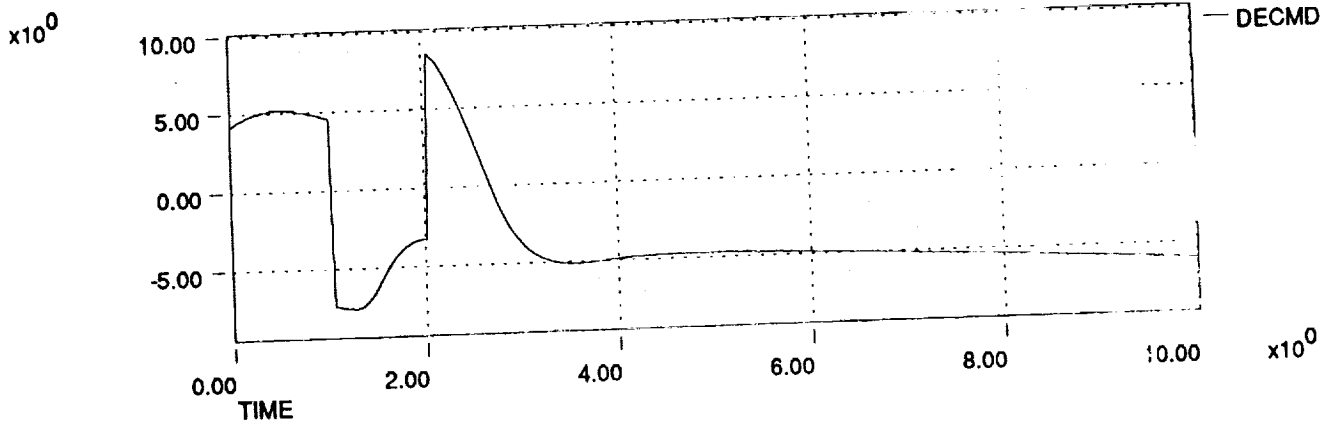

HL-20 Dynamic Check Case Data Plots 911206
Alt Pitch Stick Pulse at Mach 4 and 104,000 ft

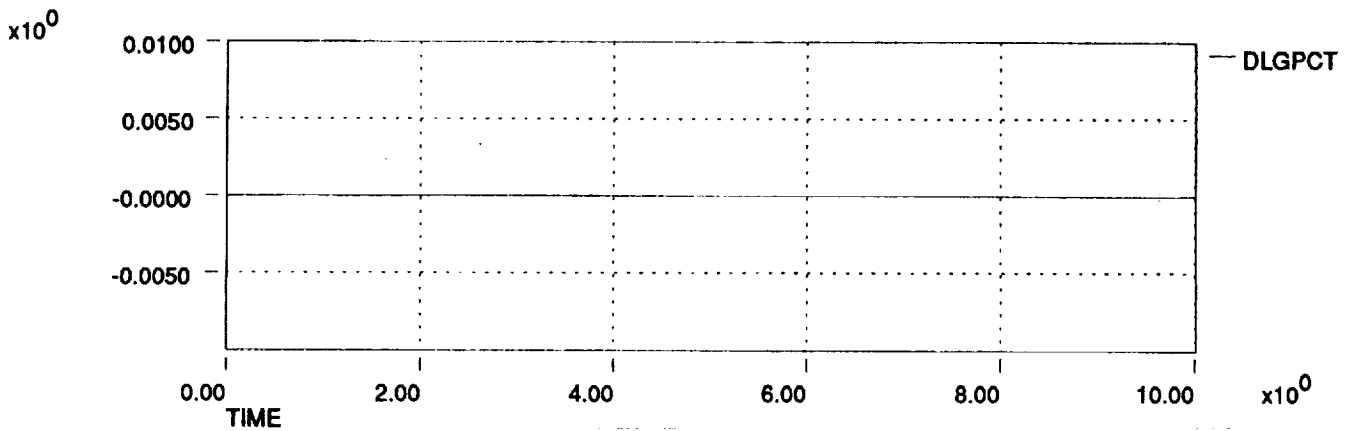
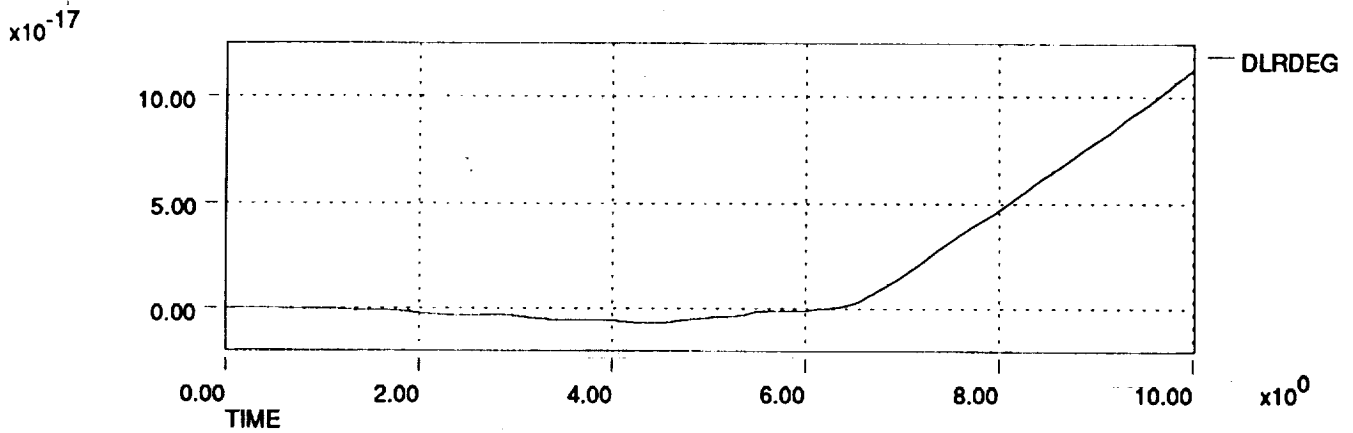
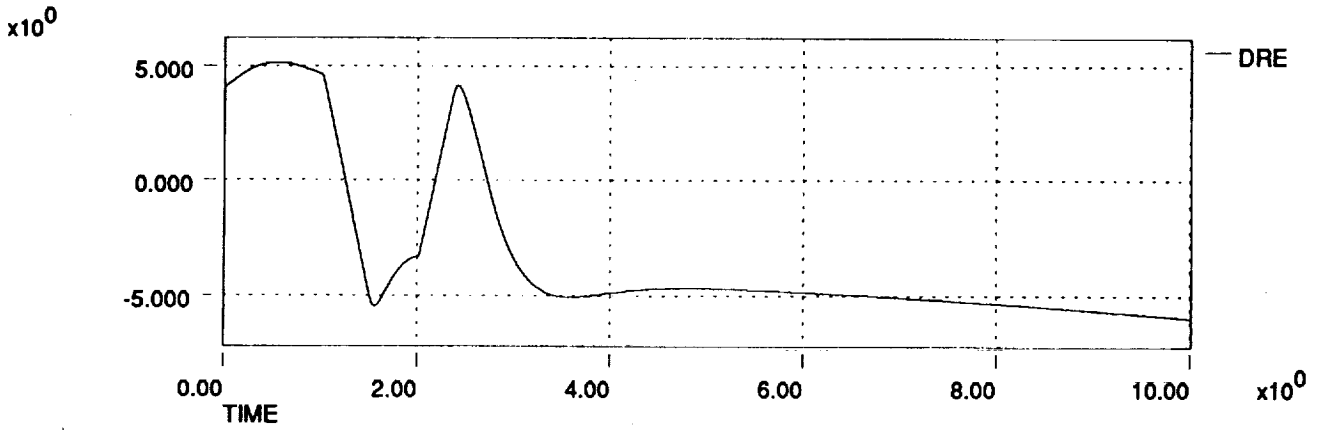
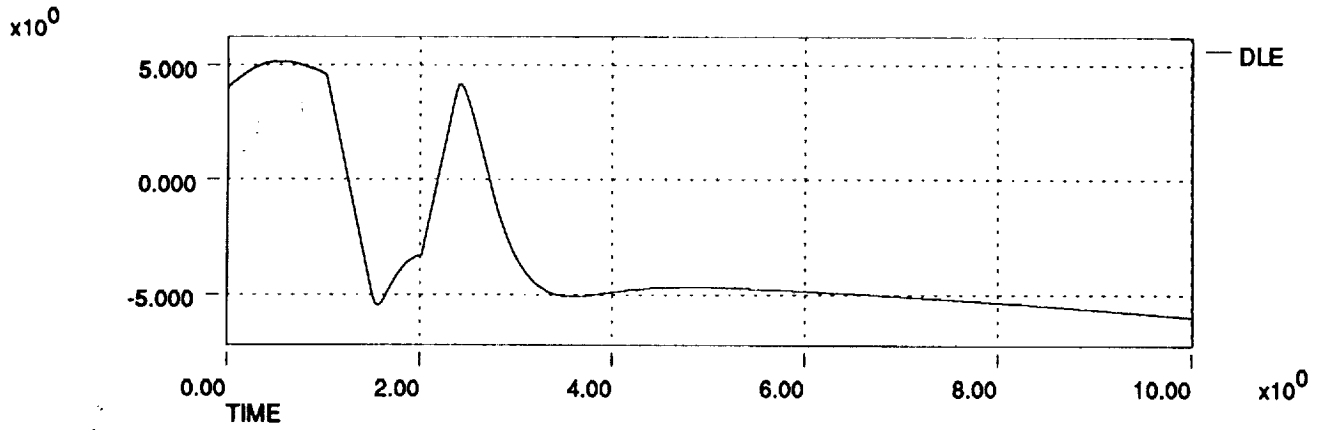

HL-20 Dynamic Check Case Data Plots 911206
Alt Pitch Stick Pulse at Mach 4 and 104,000 ft

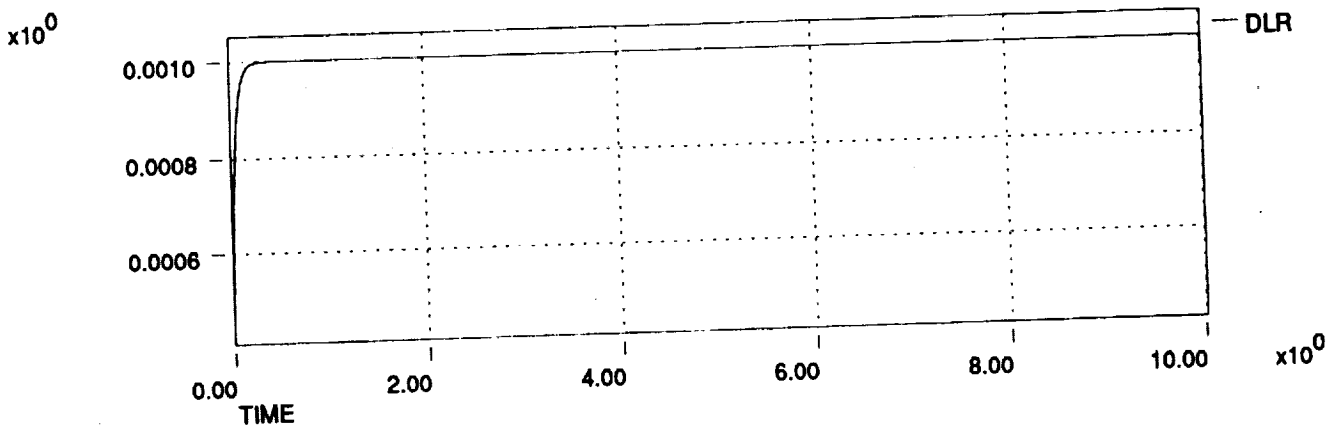
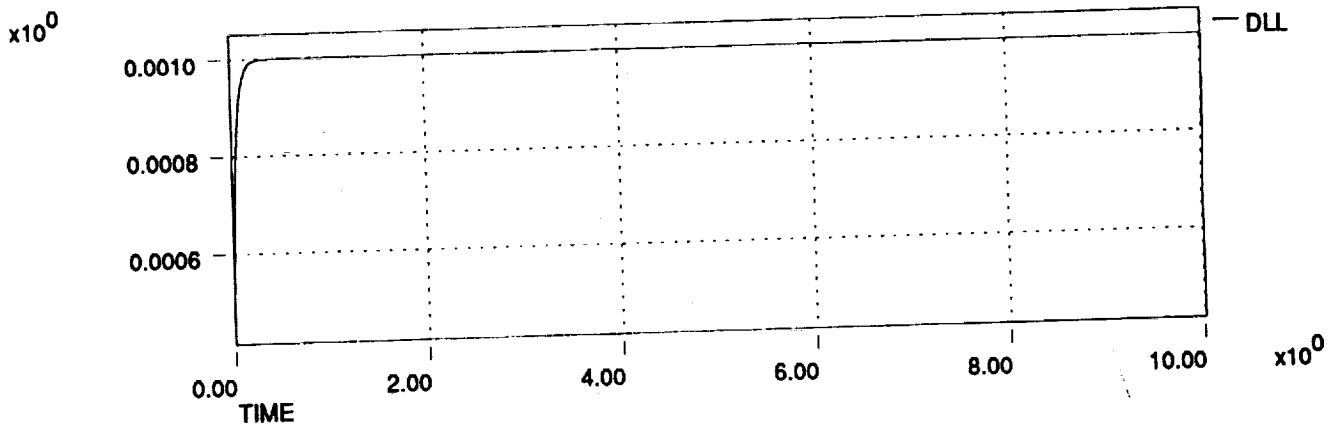
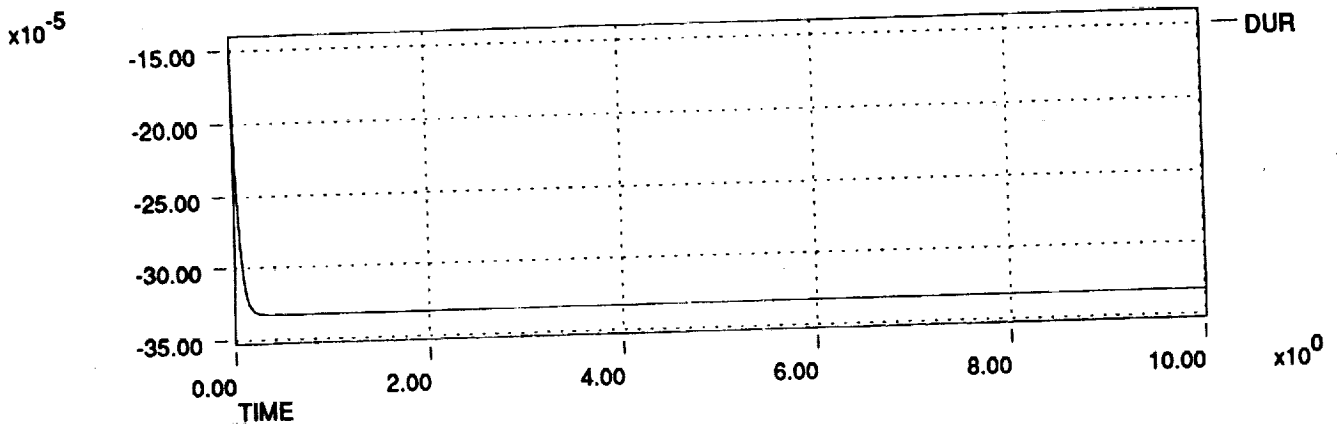
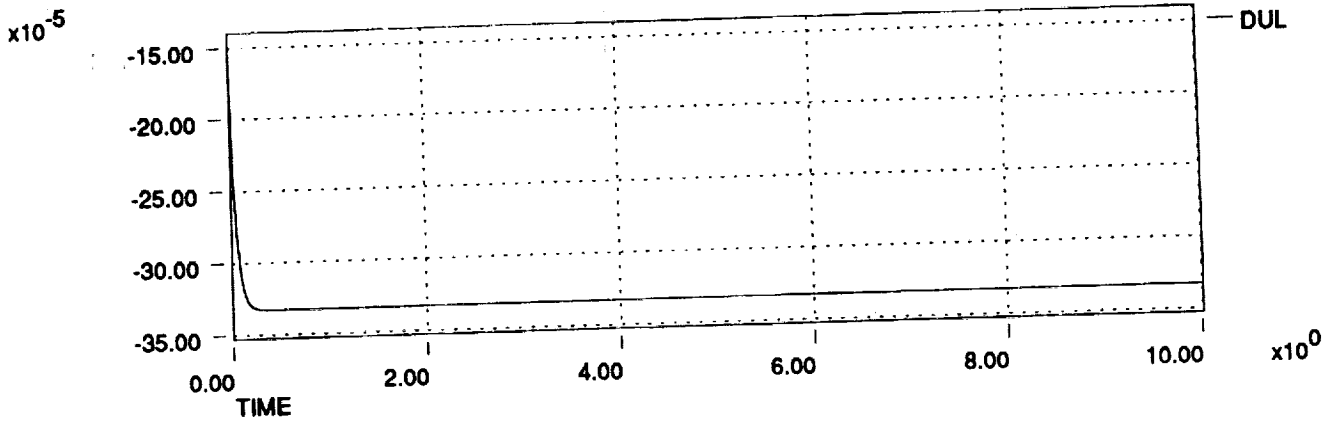

HL-20 Dynamic Check Case Data Plots 911206
Right Roll Stick Pulse at Mach 4 and 104,000 ft

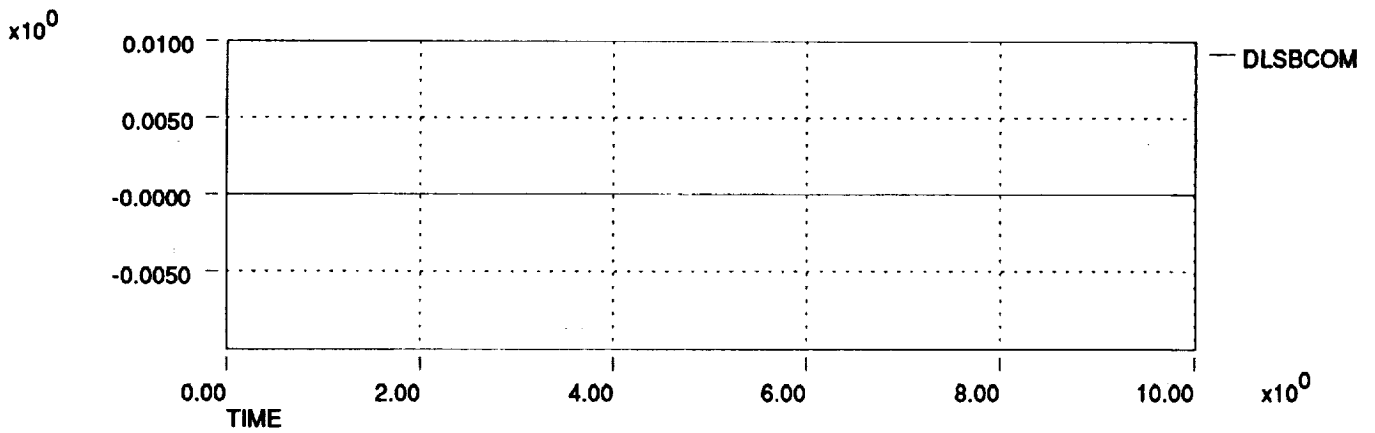
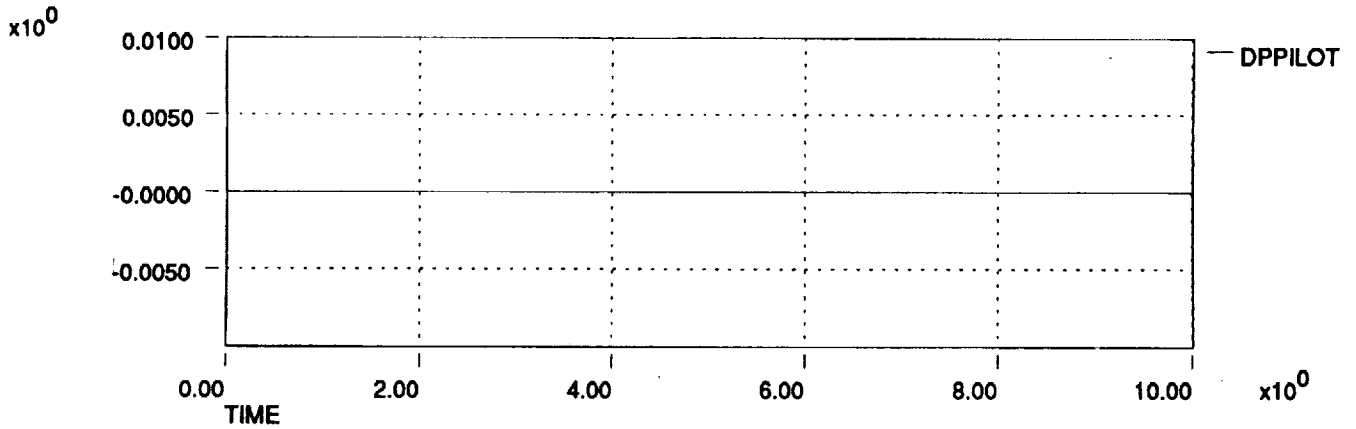
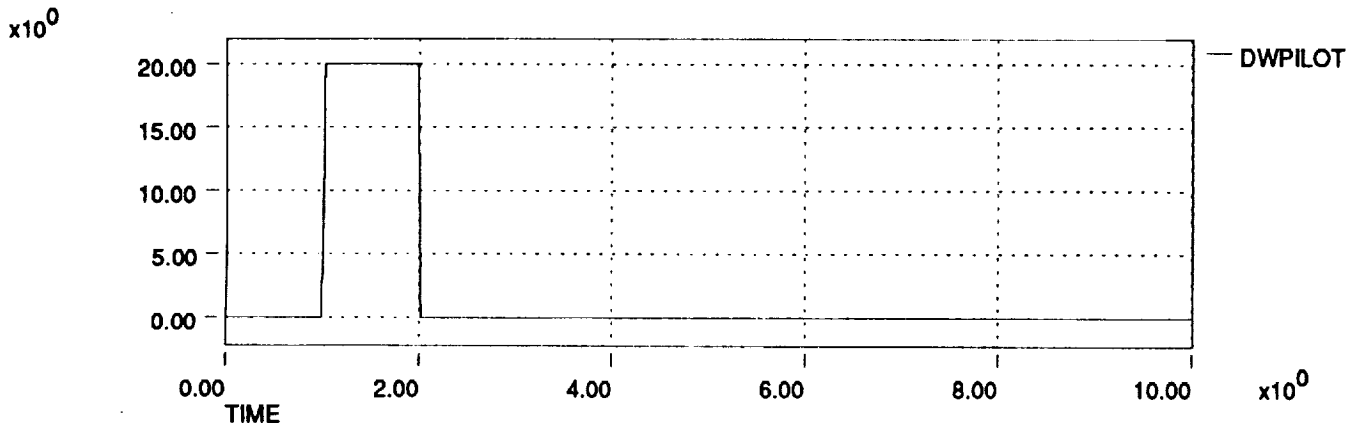
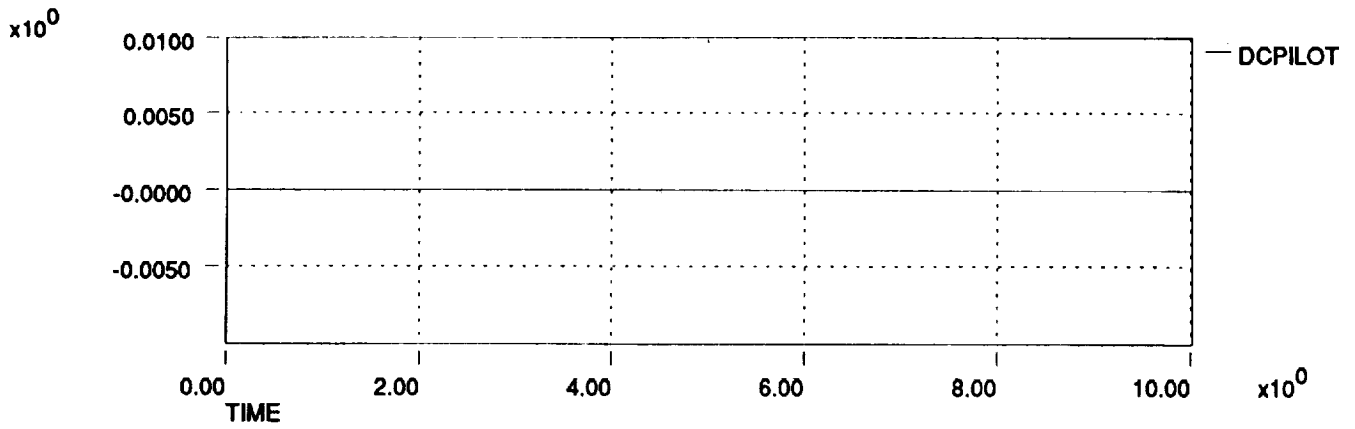

HL-20 Dynamic Check Case Data Plots 911206
Right Roll Stick Pulse at Mach 4 and 104,000 ft

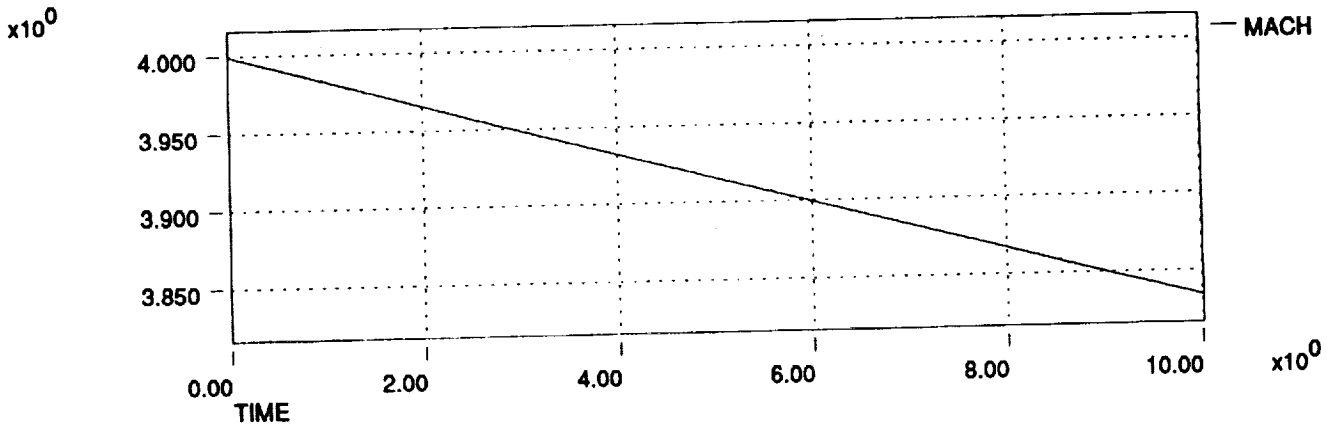
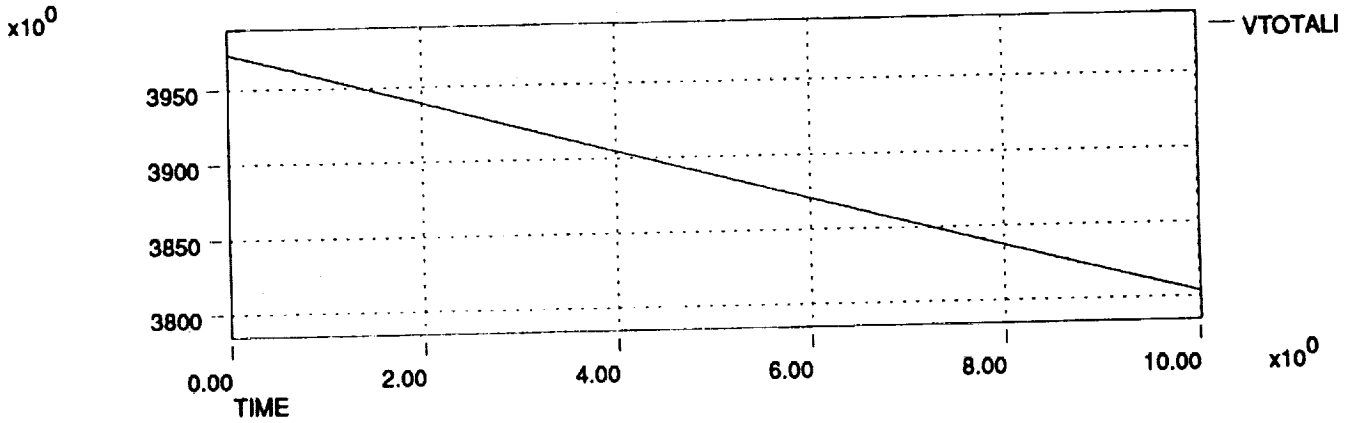
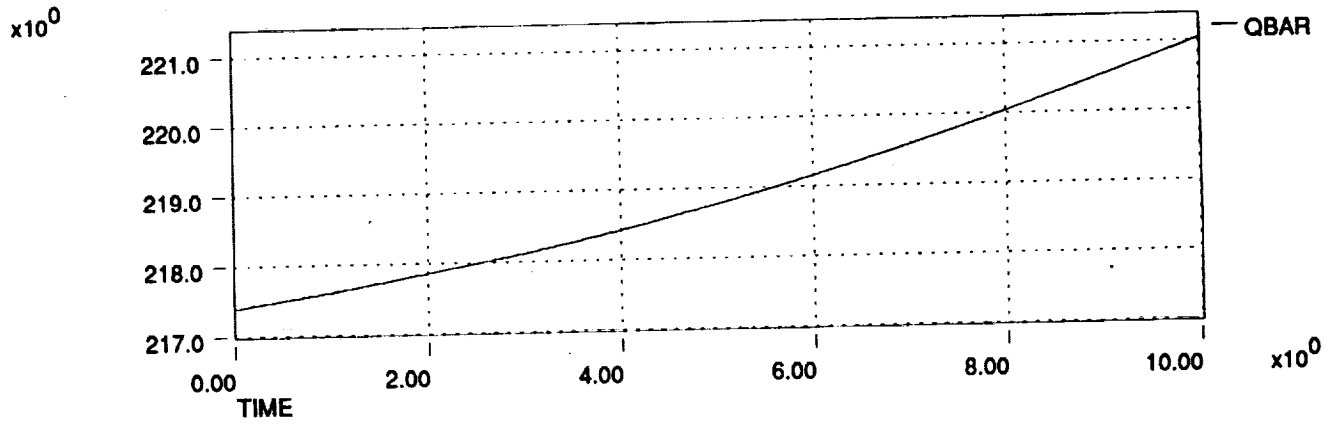
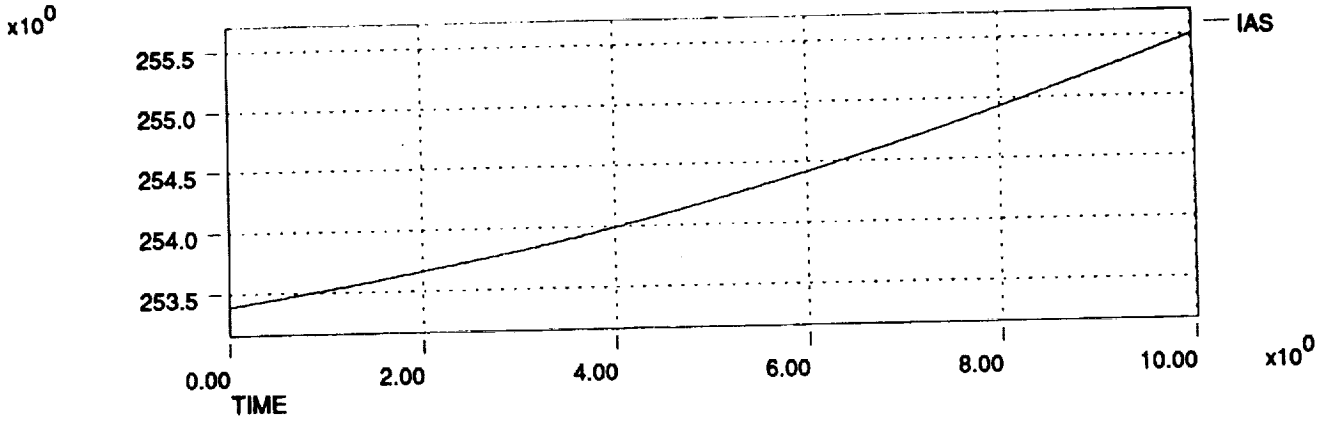

HL-20 Dynamic Check Case Data Plots 911206
Right Roll Stick Pulse at Mach 4 and 104,000 ft

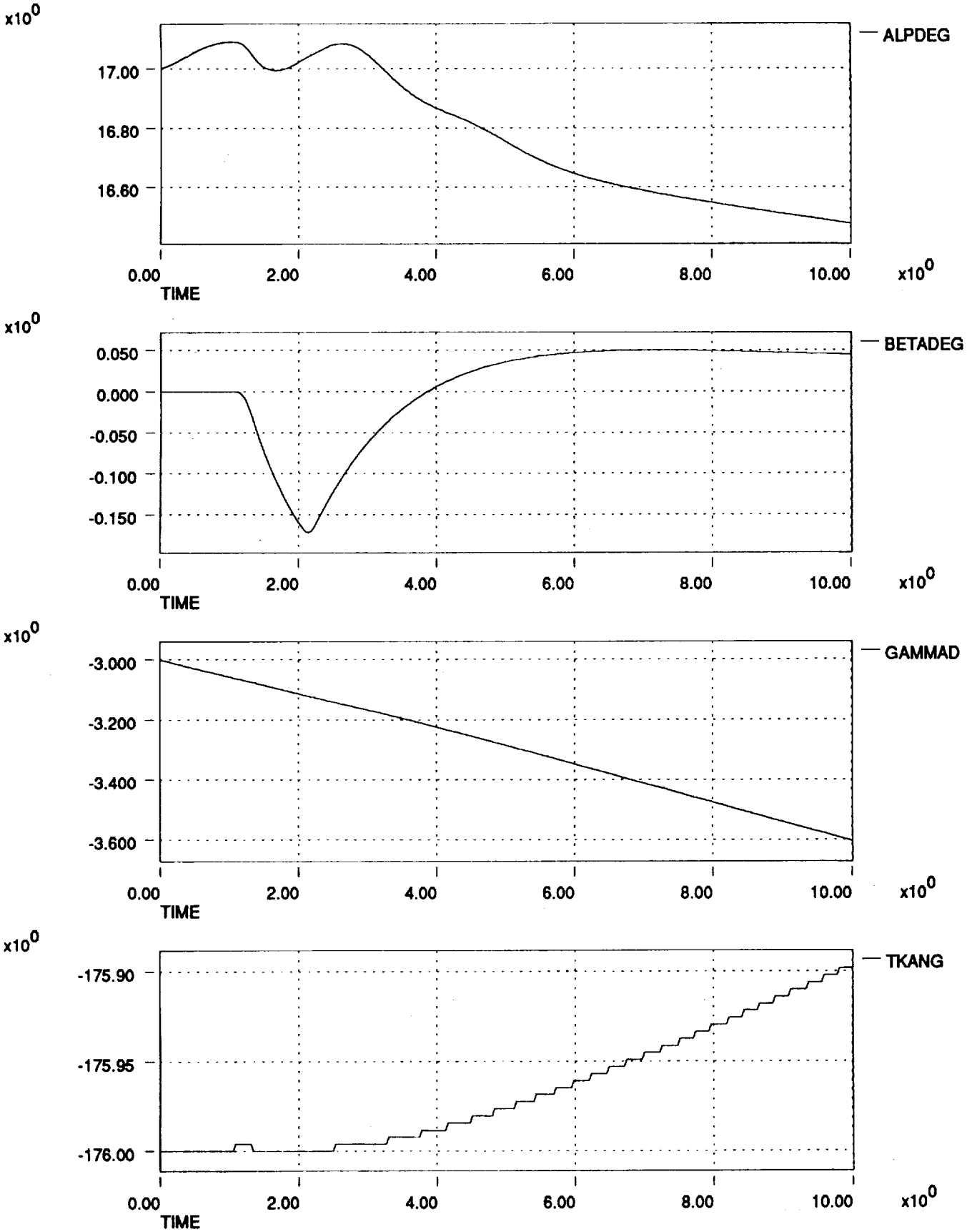

HL-20 Dynamic Check Case Data Plots 911206
Right Roll Stick Pulse at Mach 4 and 104,000 ft

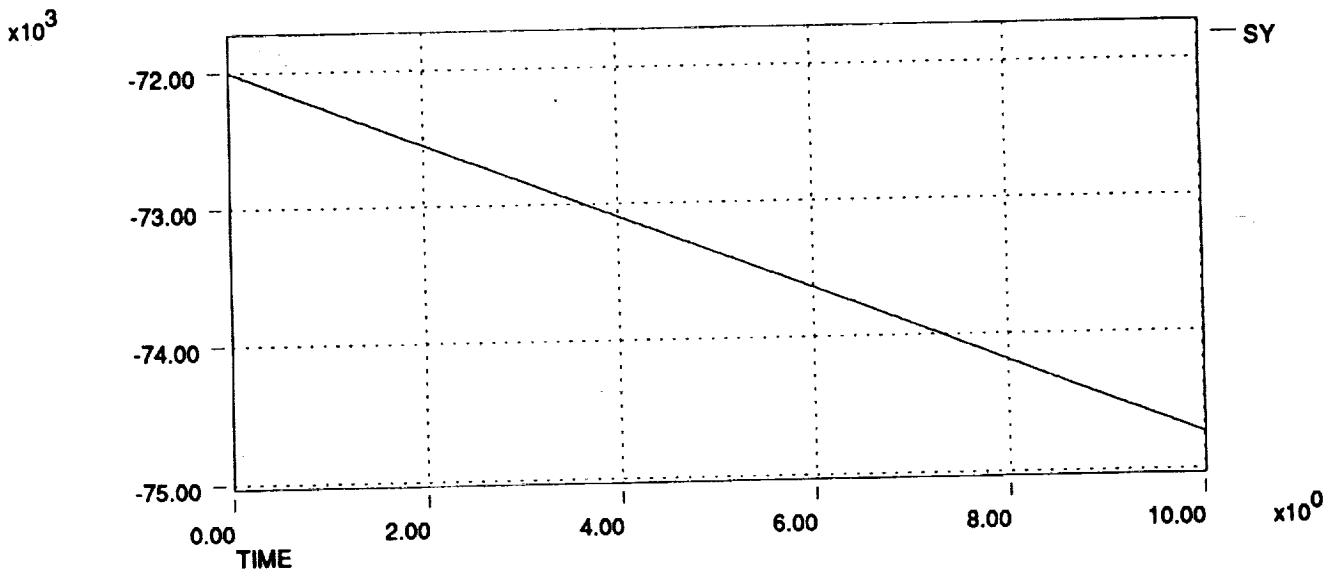
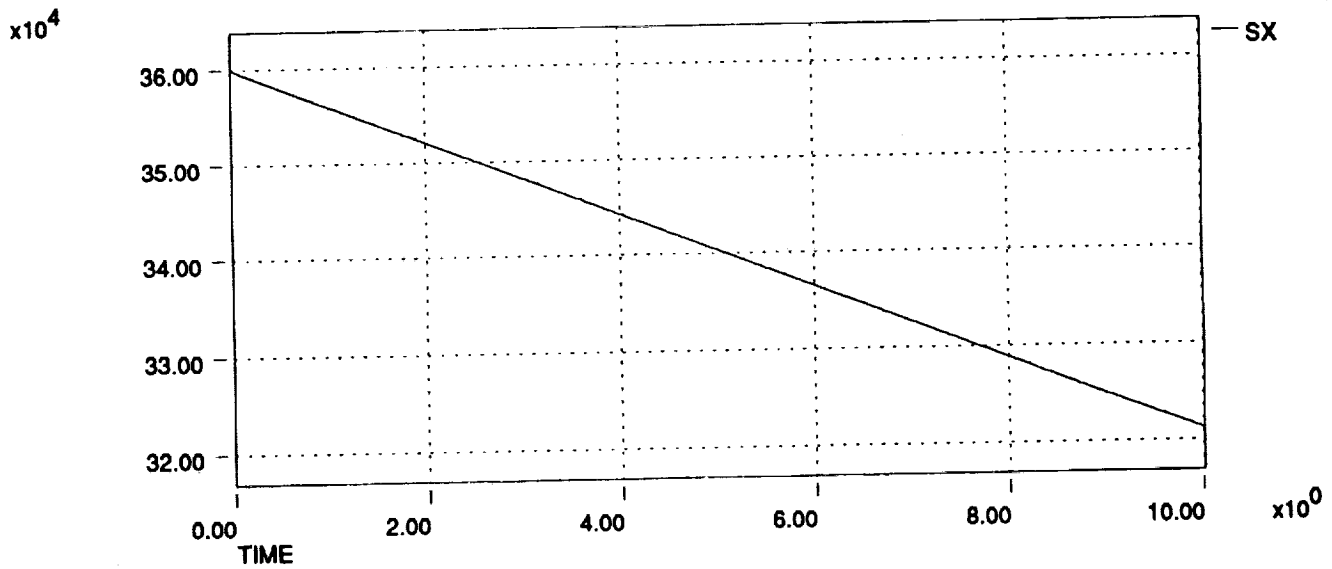
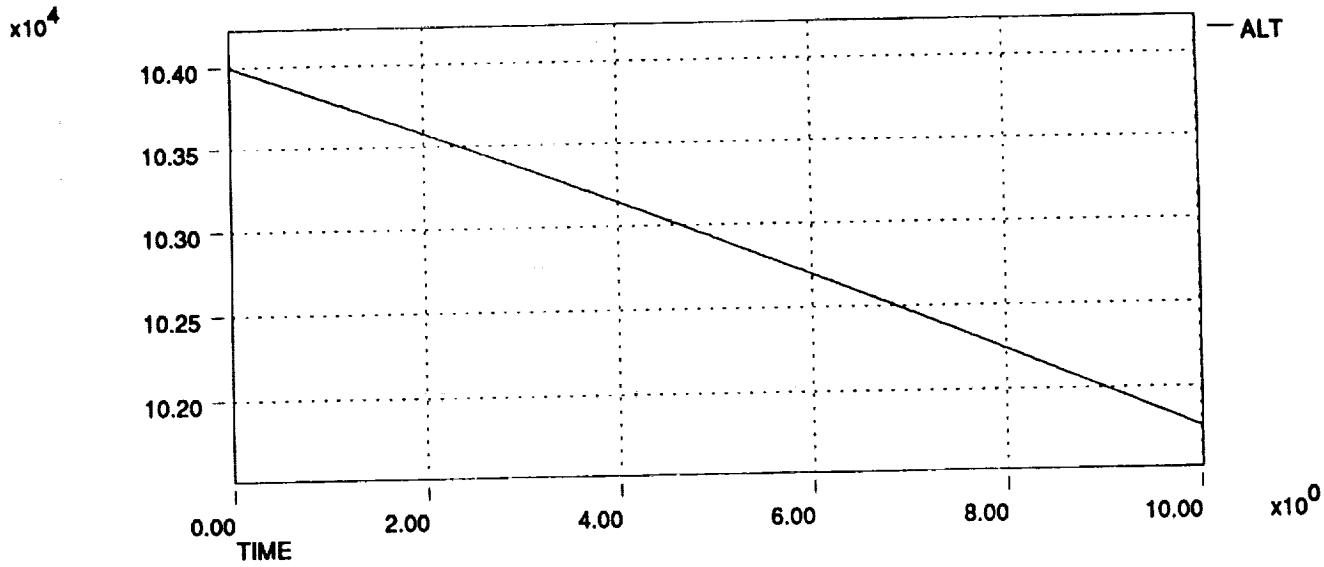

HL-20 Dynamic Check Case Data Plots 911206
Right Roll Stick Pulse at Mach 4 and 104,000 ft

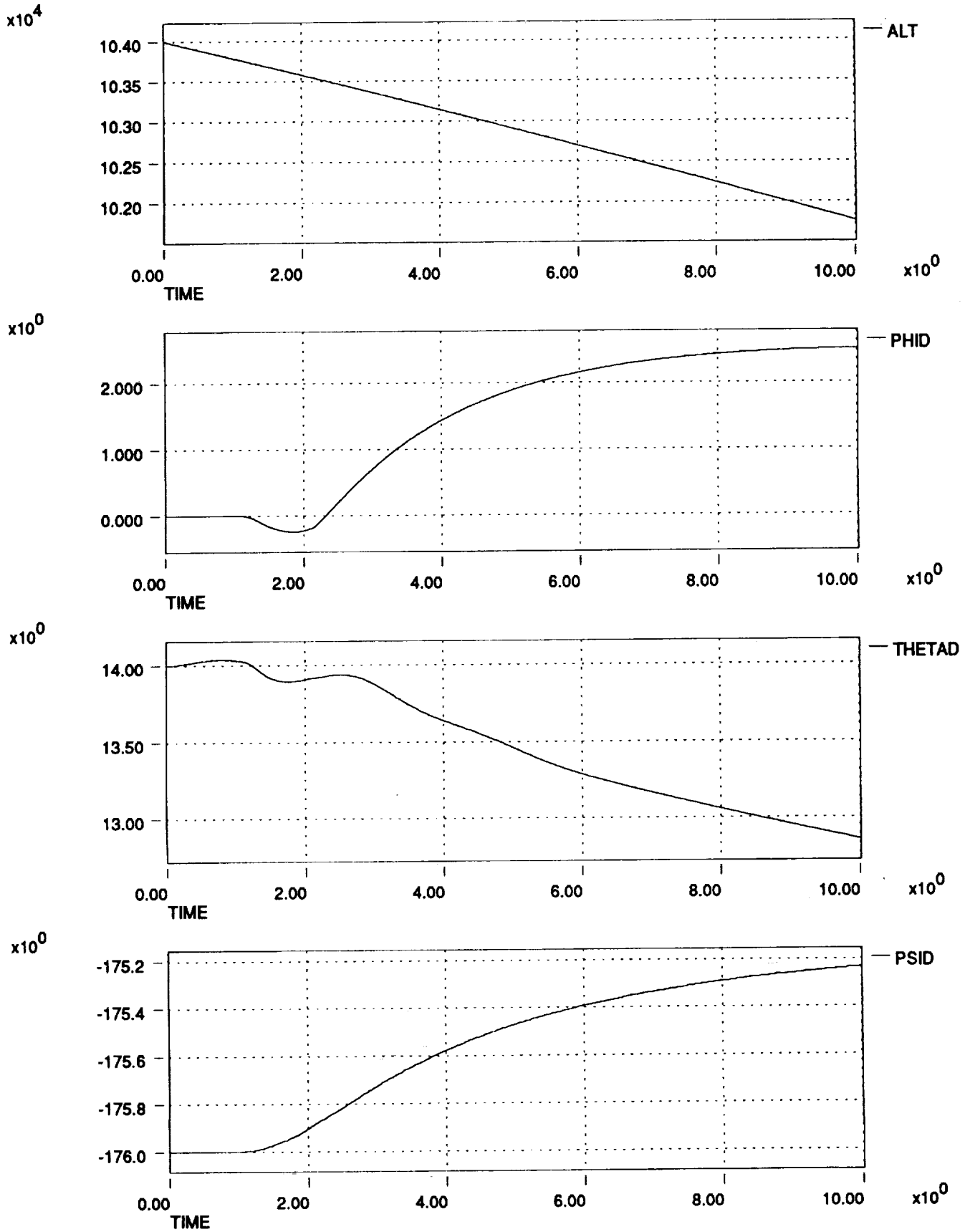

HL-20 Dynamic Check Case Data Plots 911206
Right Roll Stick Pulse at Mach 4 and 104,000 ft

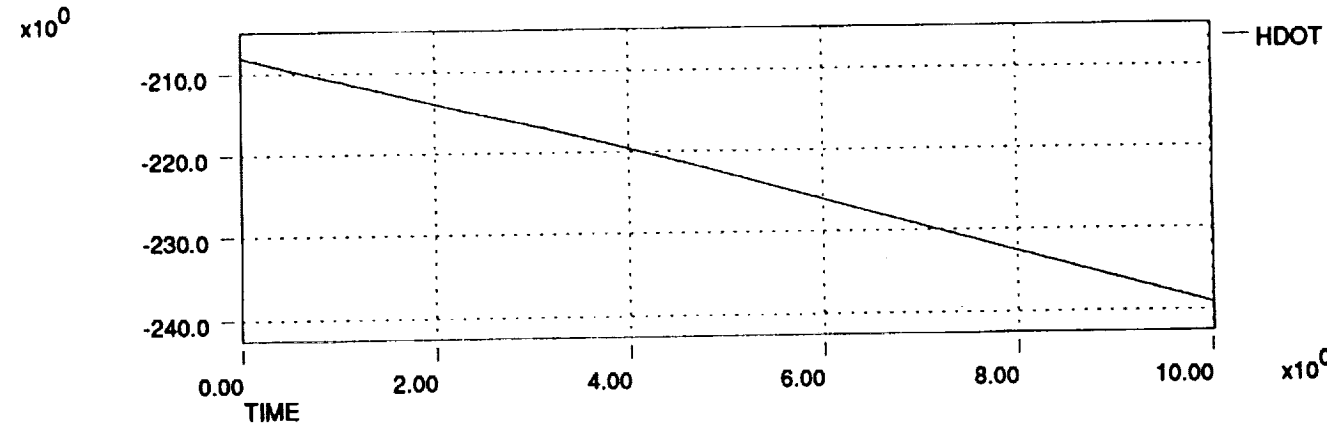
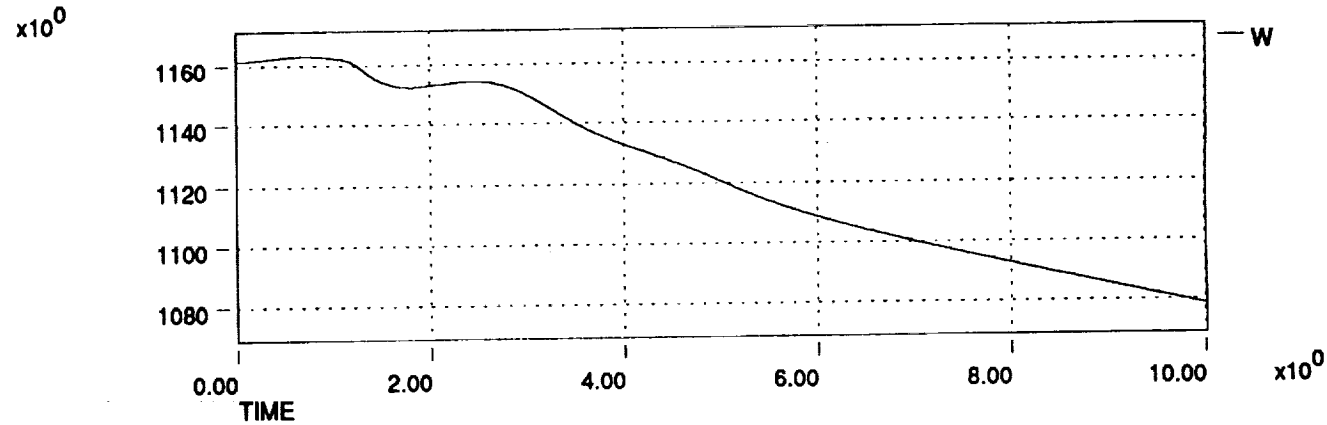
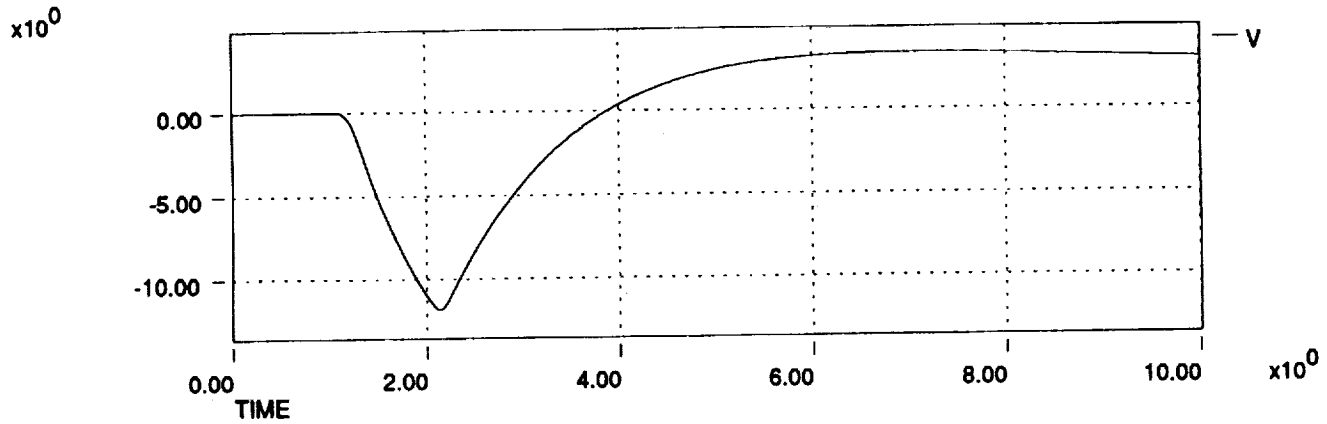
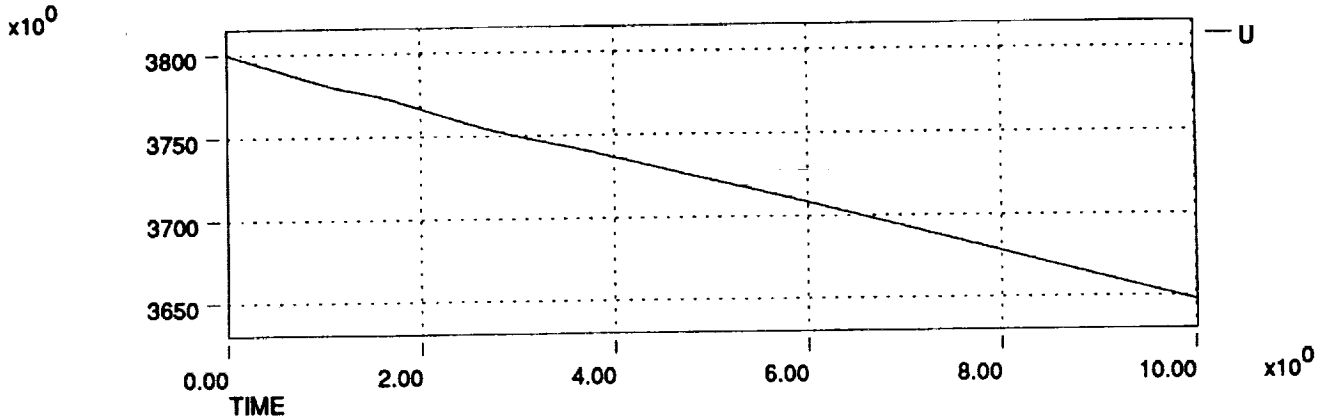

HL-20 Dynamic Check Case Data Plots 911206
Right Roll Stick Pulse at Mach 4 and 104,000 ft

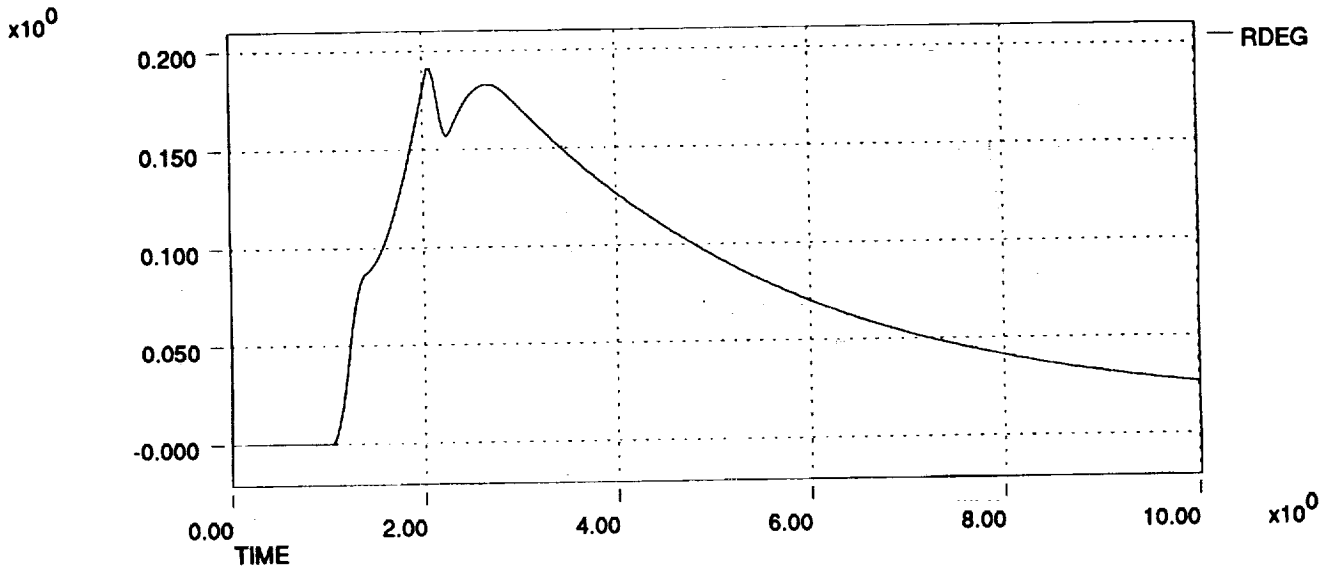
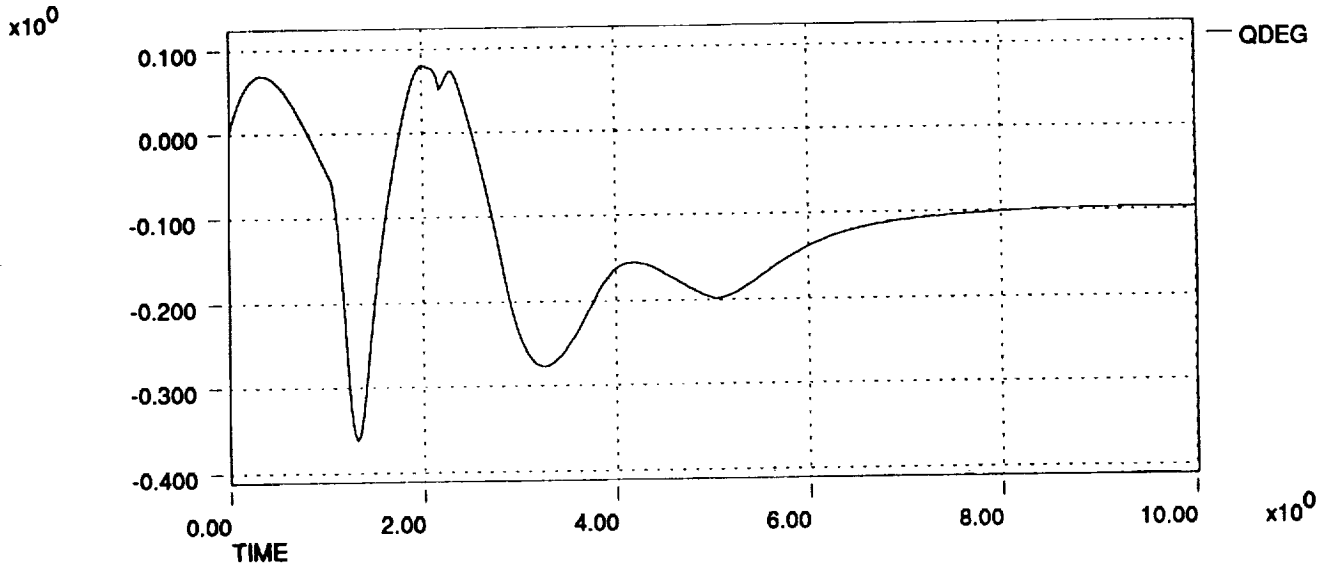
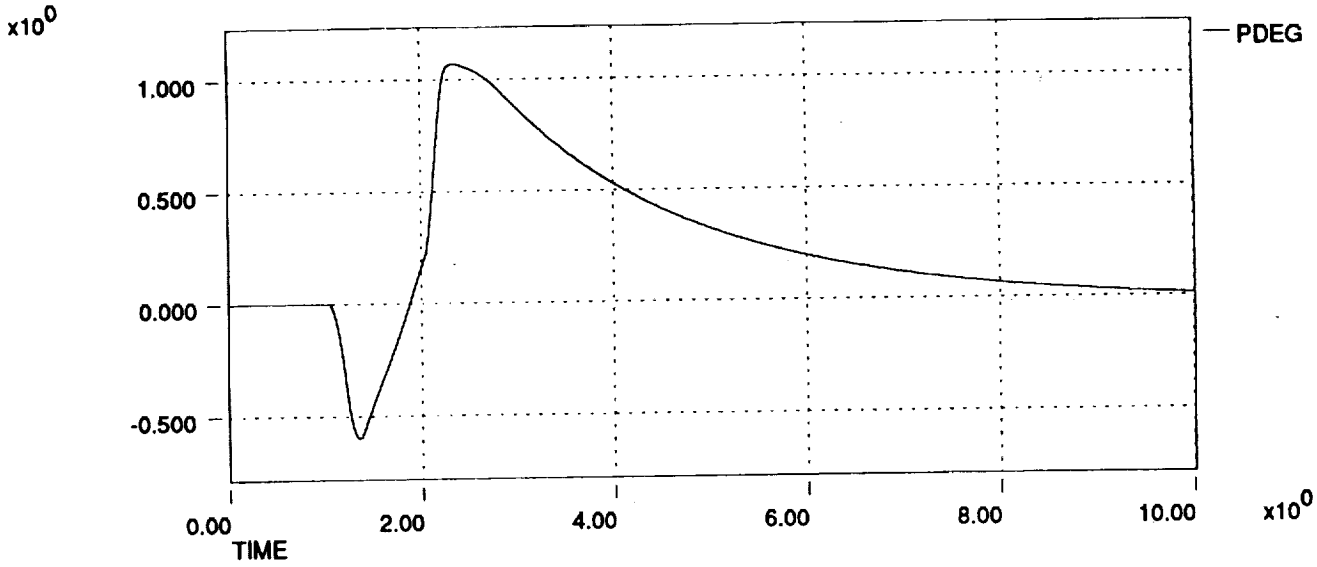

HL-20 Dynamic Check Case Data Plots 911206
Right Roll Stick Pulse at Mach 4 and 104,000 ft

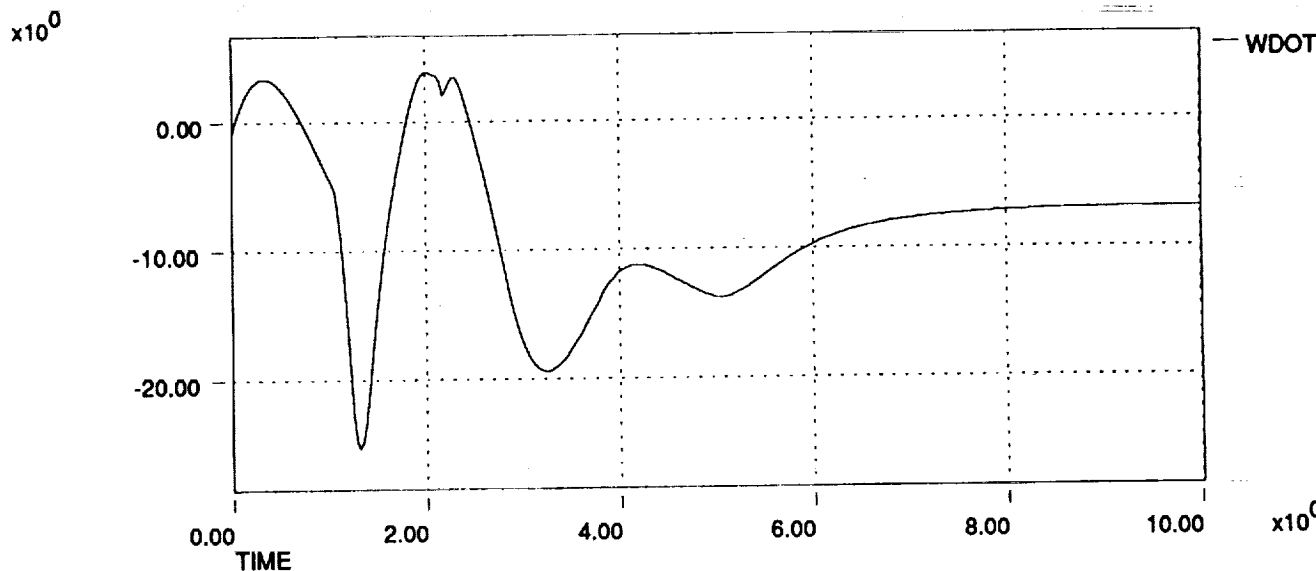
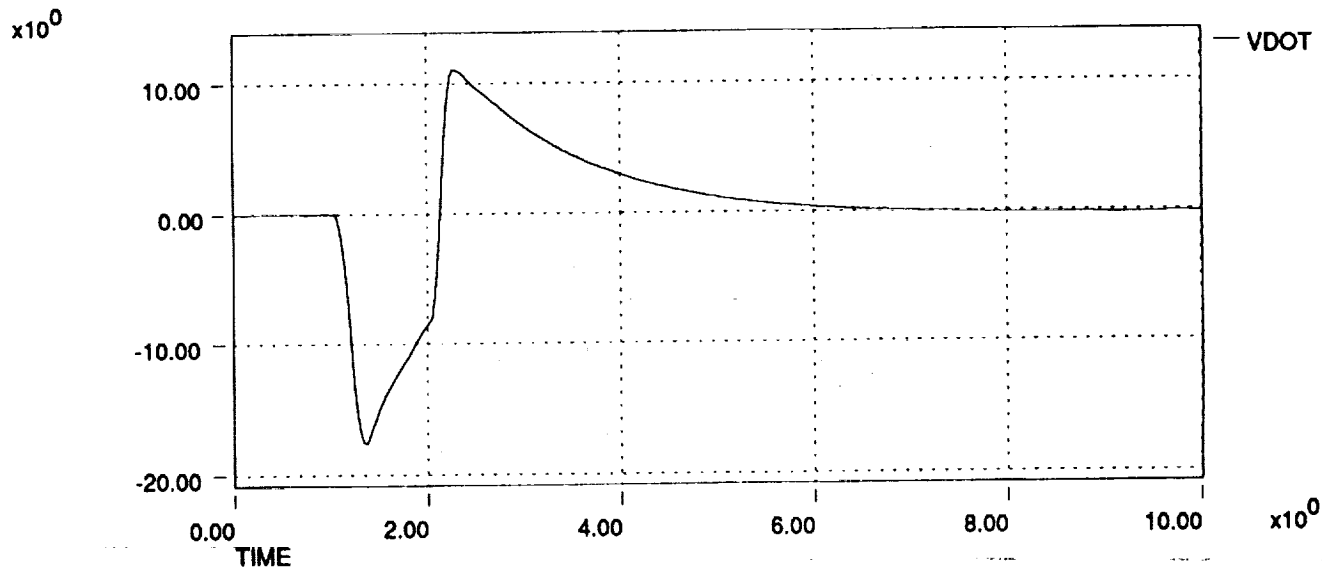
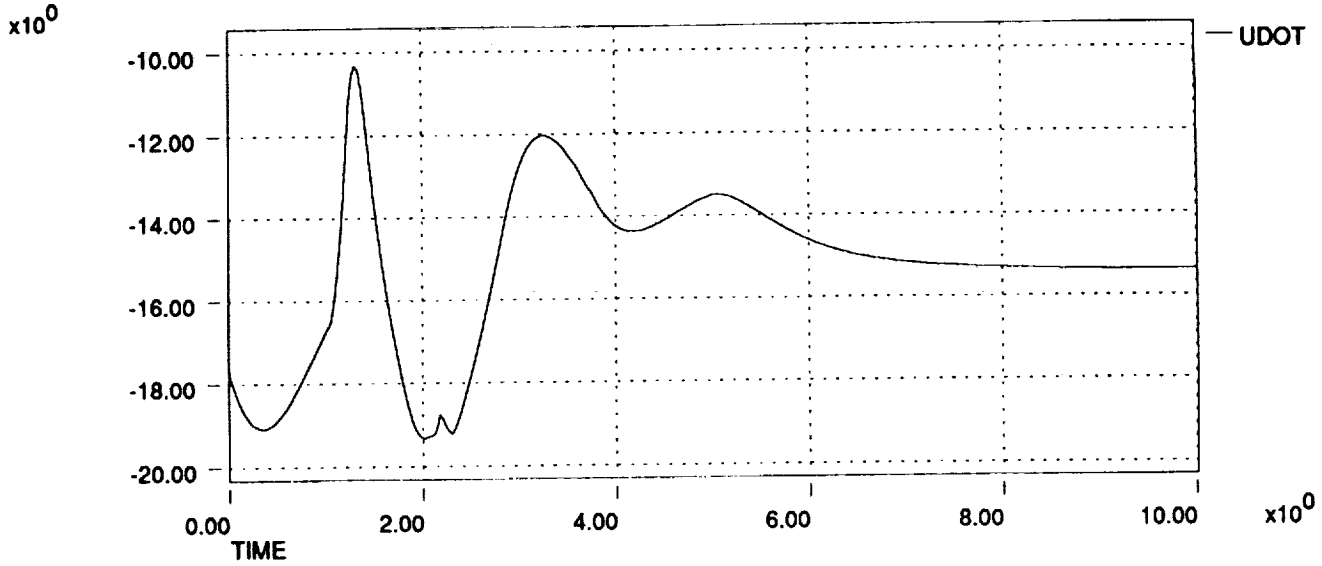

HL-20 Dynamic Check Case Data Plots 911206
Right Roll Stick Pulse at Mach 4 and 104,000 ft

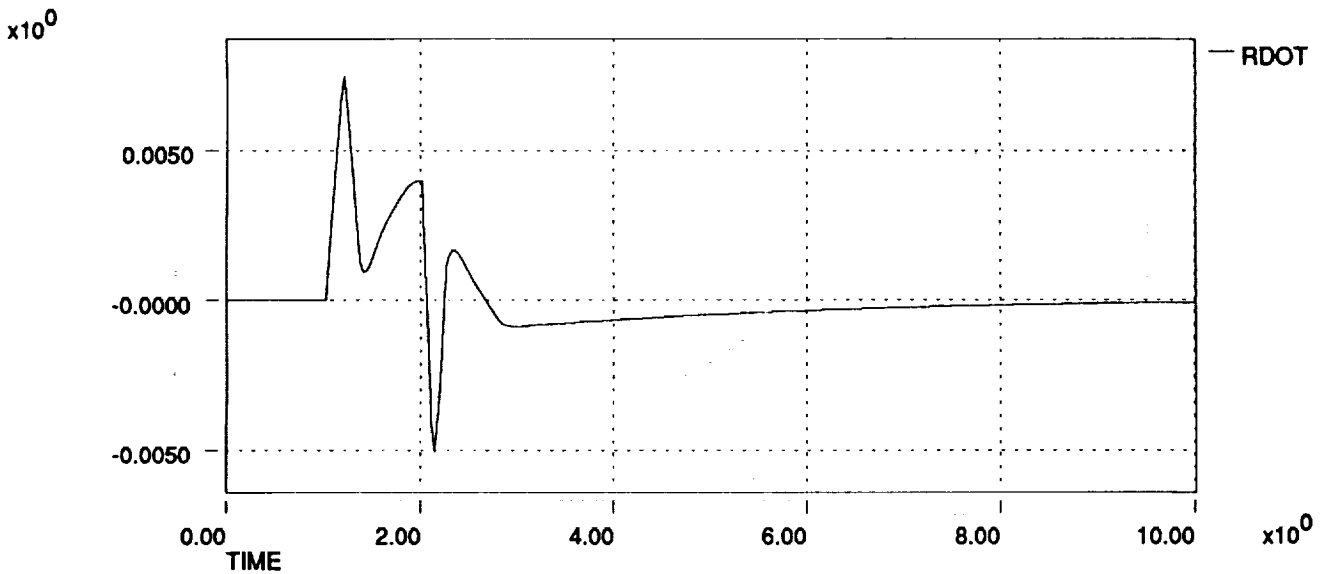
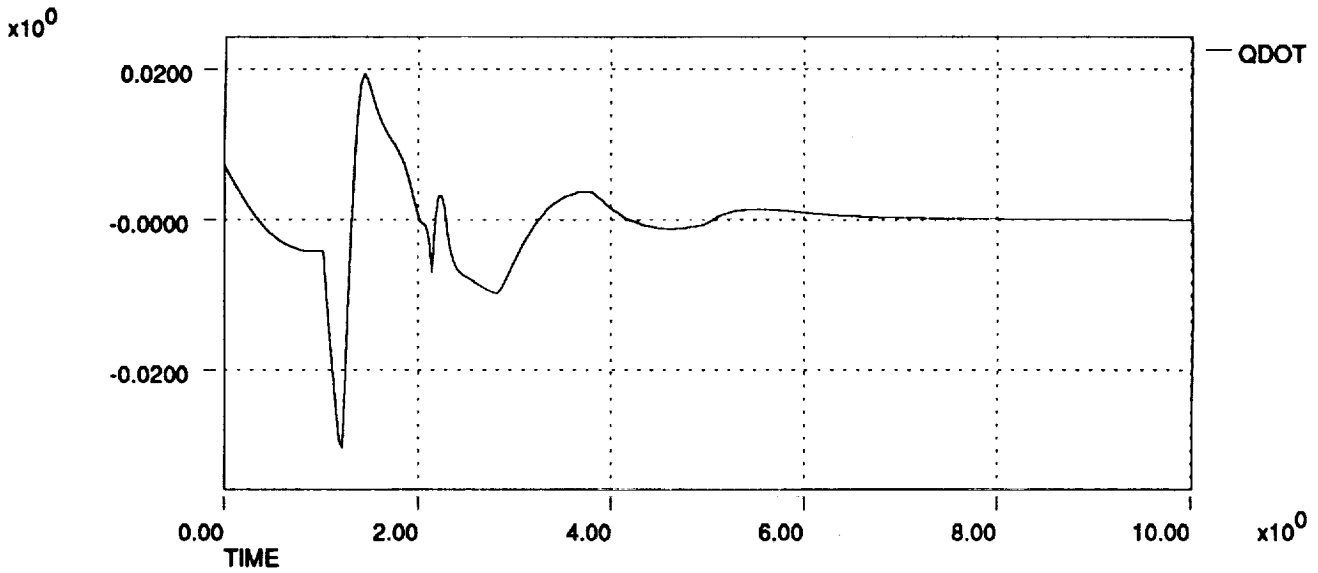
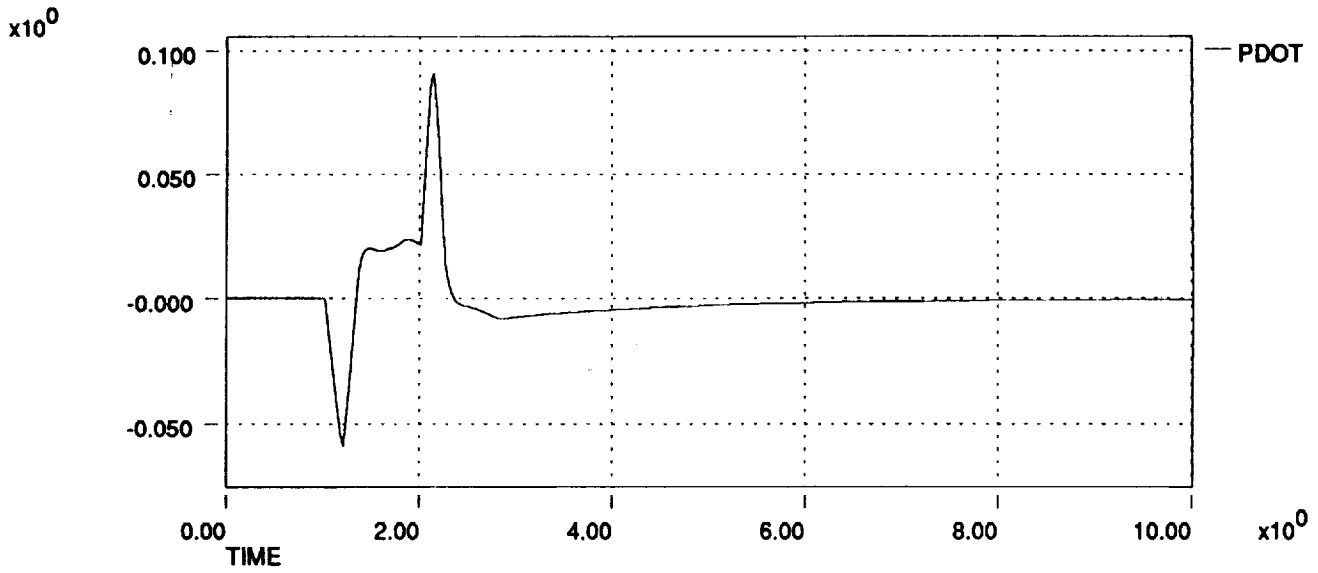

HL-20 Dynamic Check Case Data Plots 911206
Right Roll Stick Pulse at Mach 4 and 104,000 ft

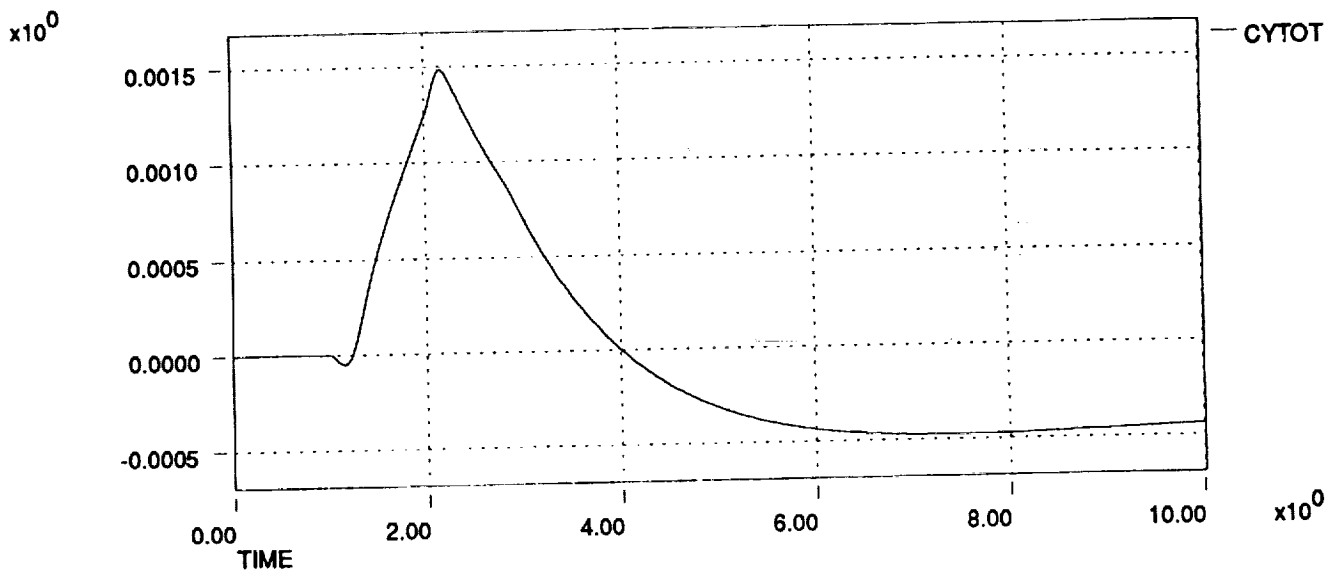
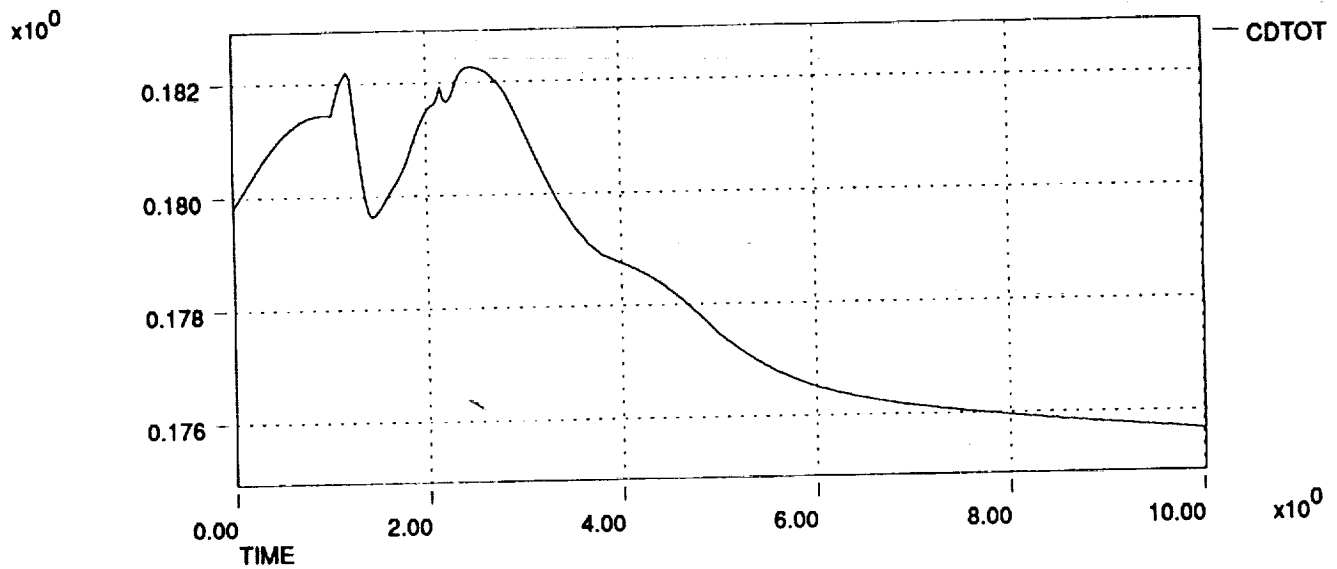
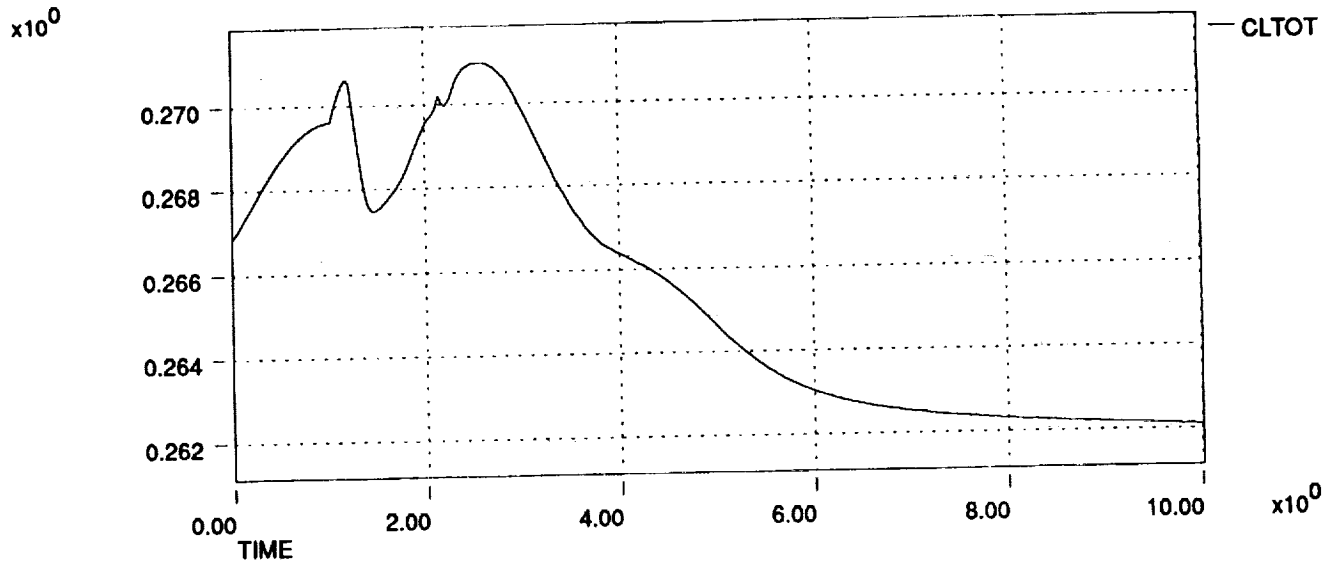

HL-20 Dynamic Check Case Data Plots 911206
Right Roll Stick Pulse at Mach 4 and 104,000 ft

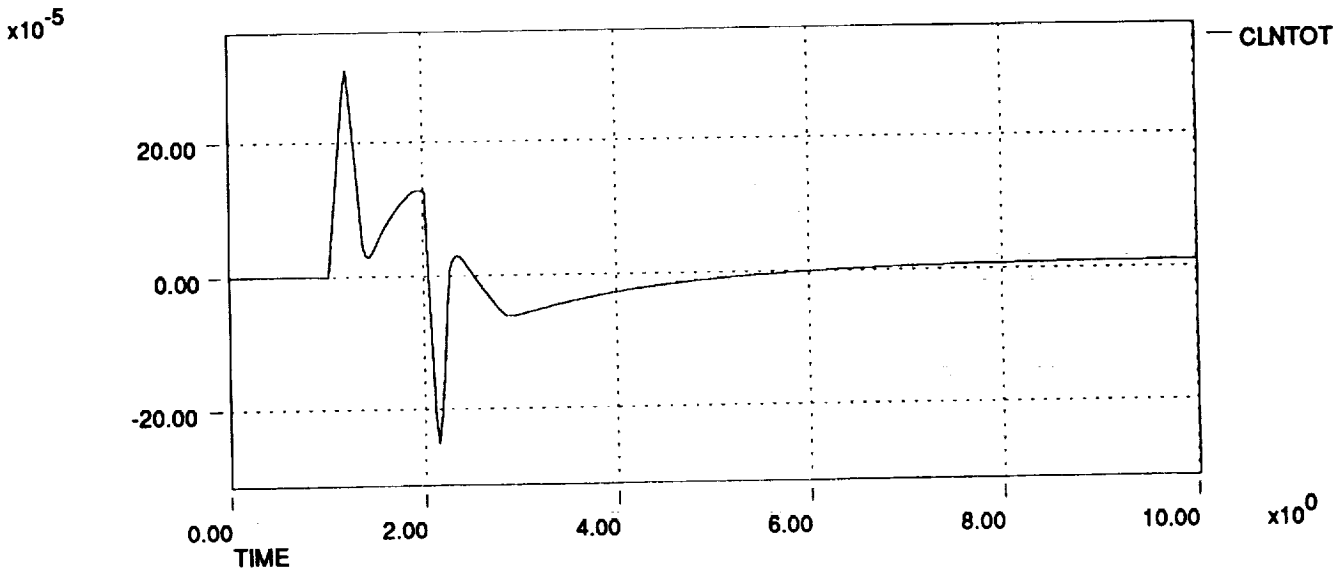
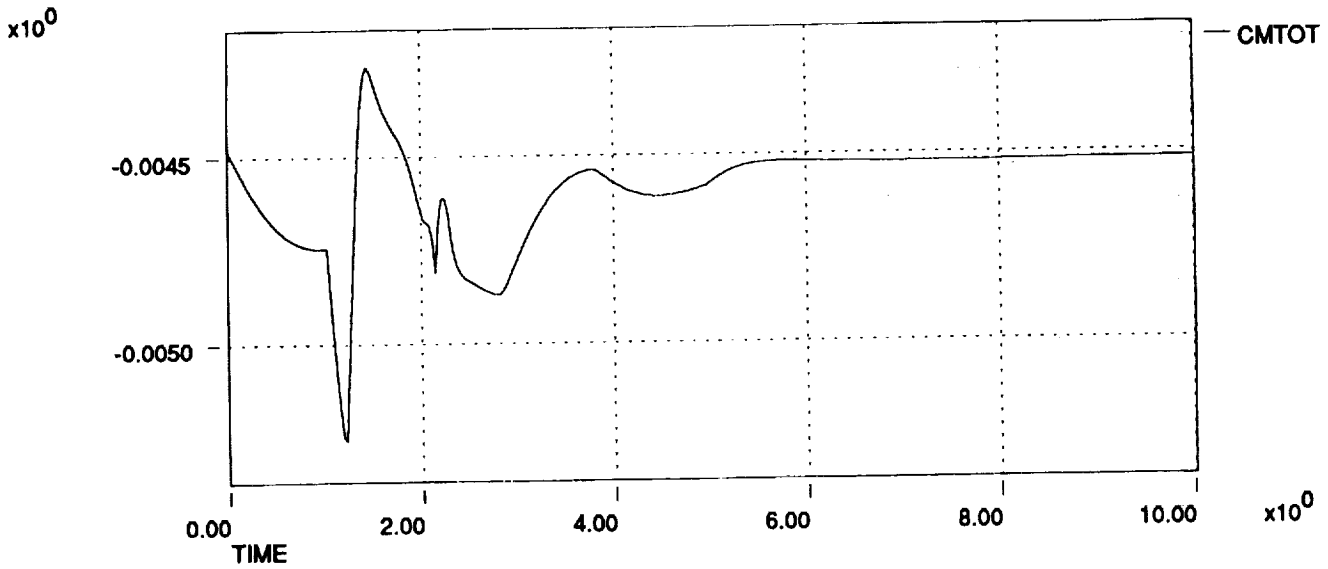
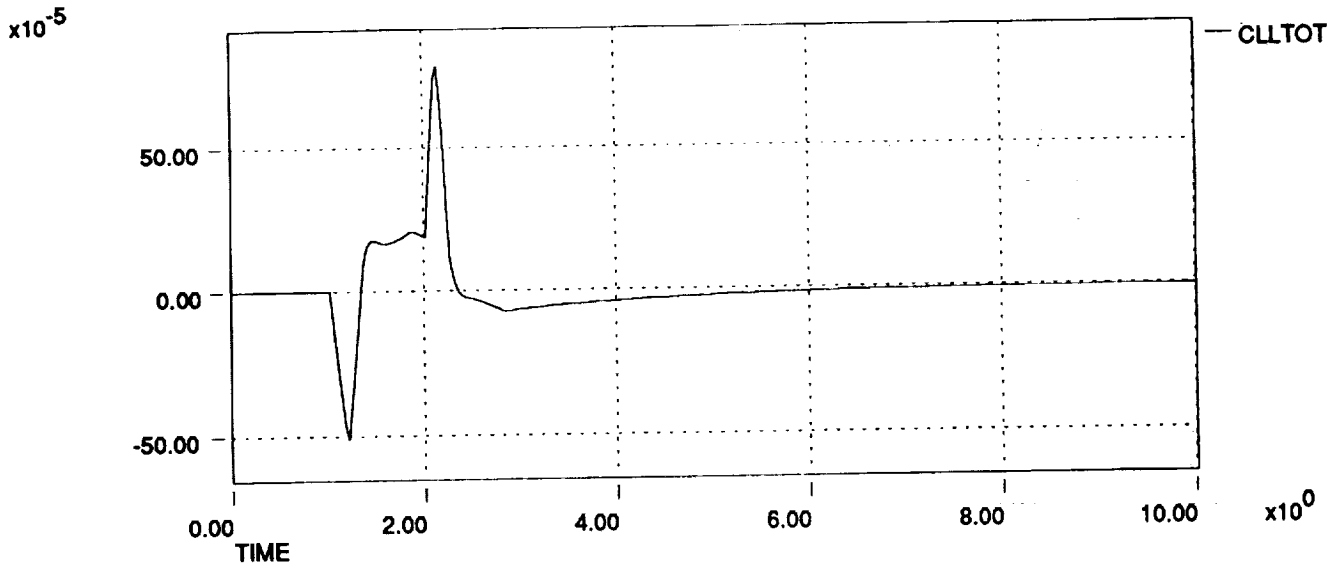

HL-20 Dynamic Check Case Data Plots 911206
Right Roll Stick Pulse at Mach 4 and 104,000 ft

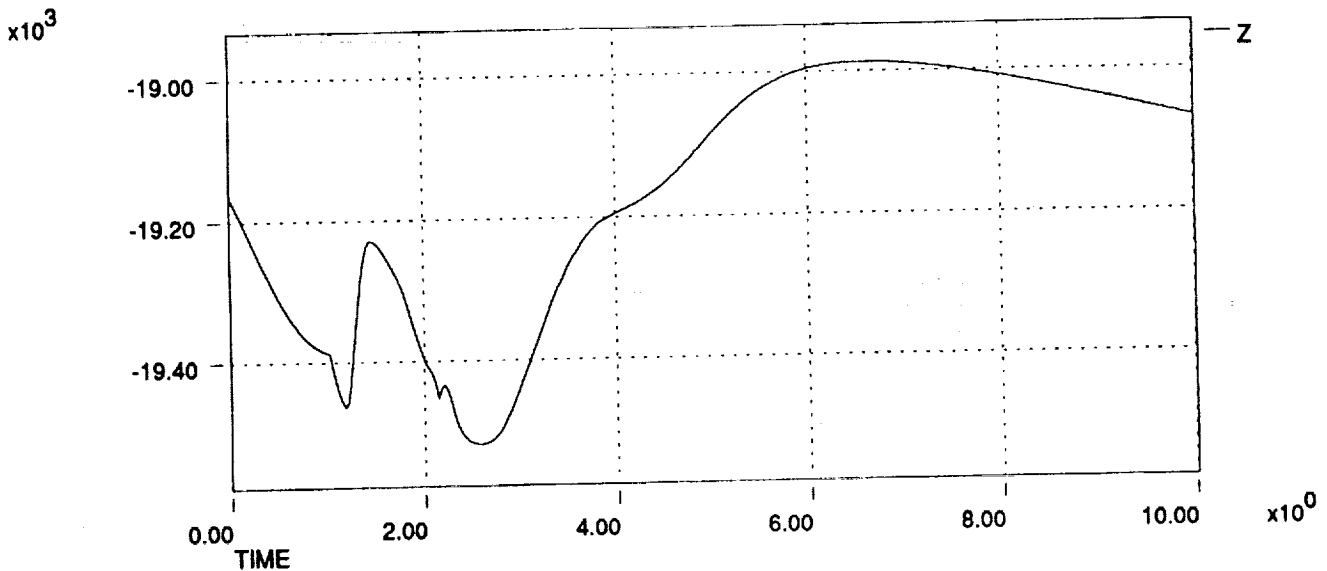
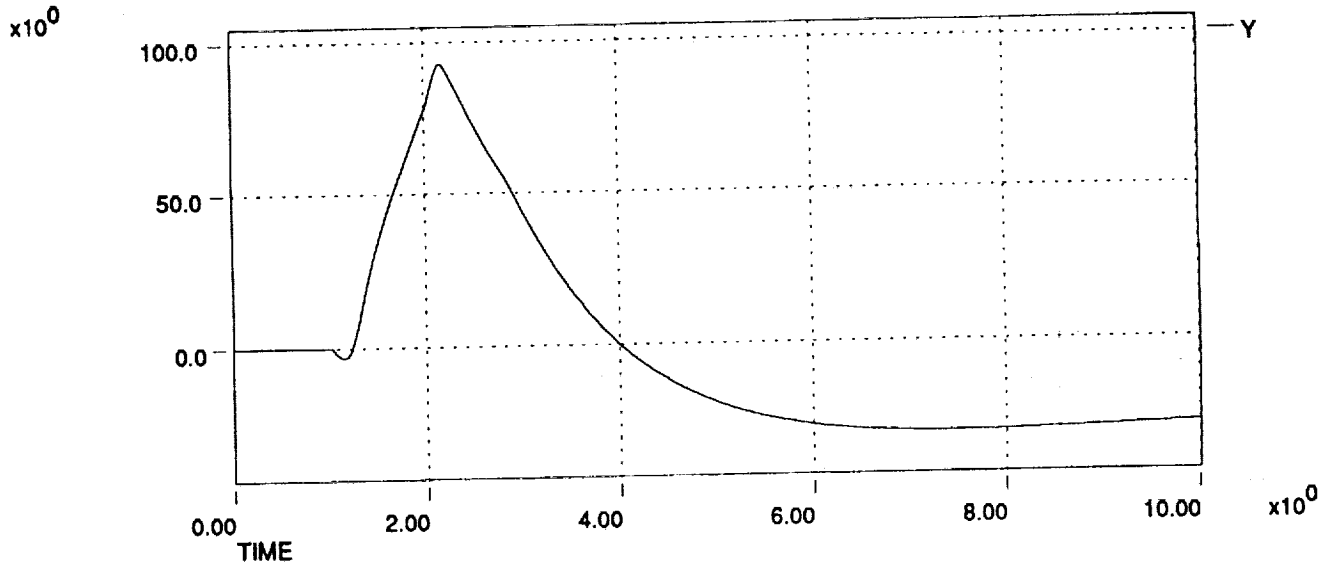
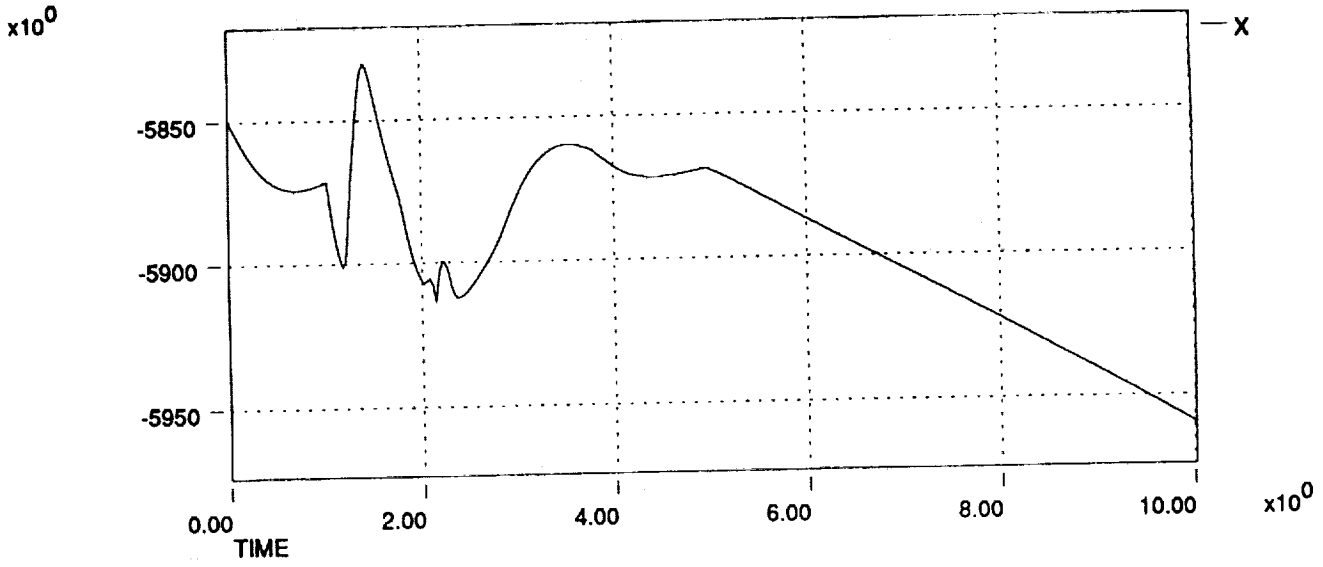

HL-20 Dynamic Check Case Data Plots 911206
Right Roll Stick Pulse at Mach 4 and 104,000 ft

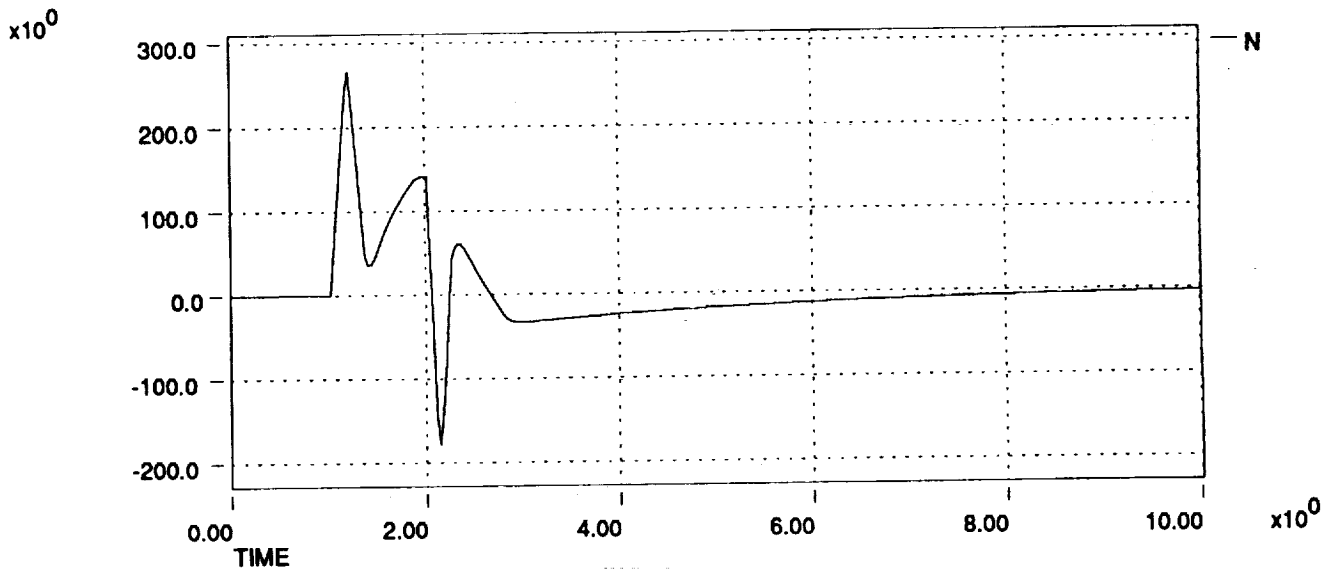
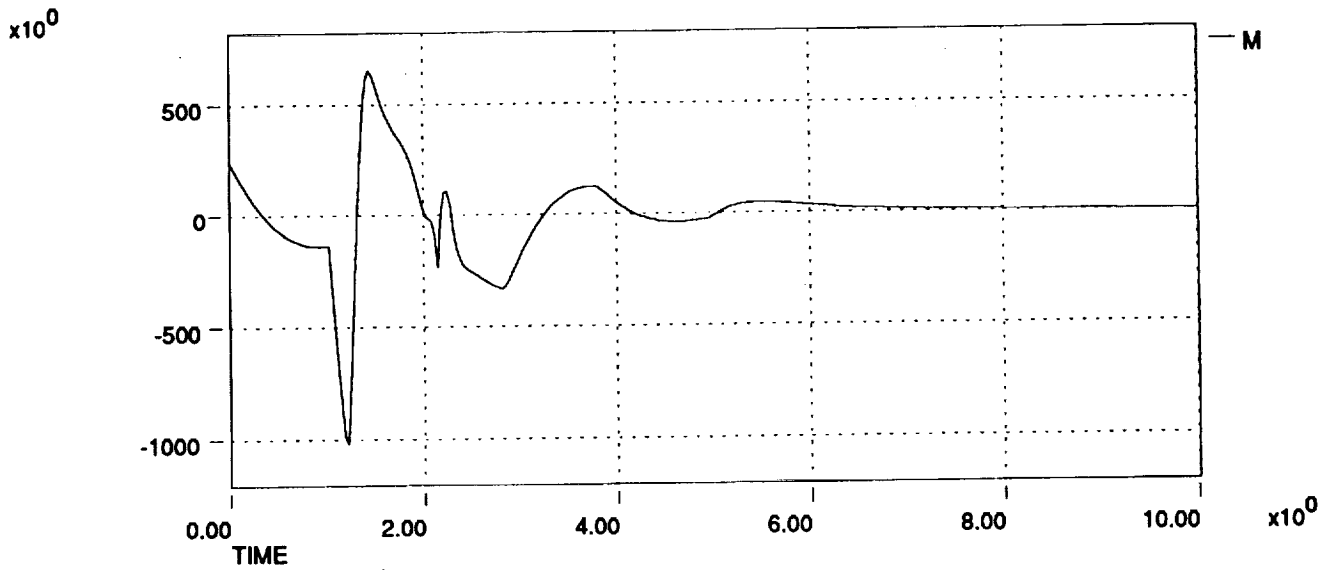
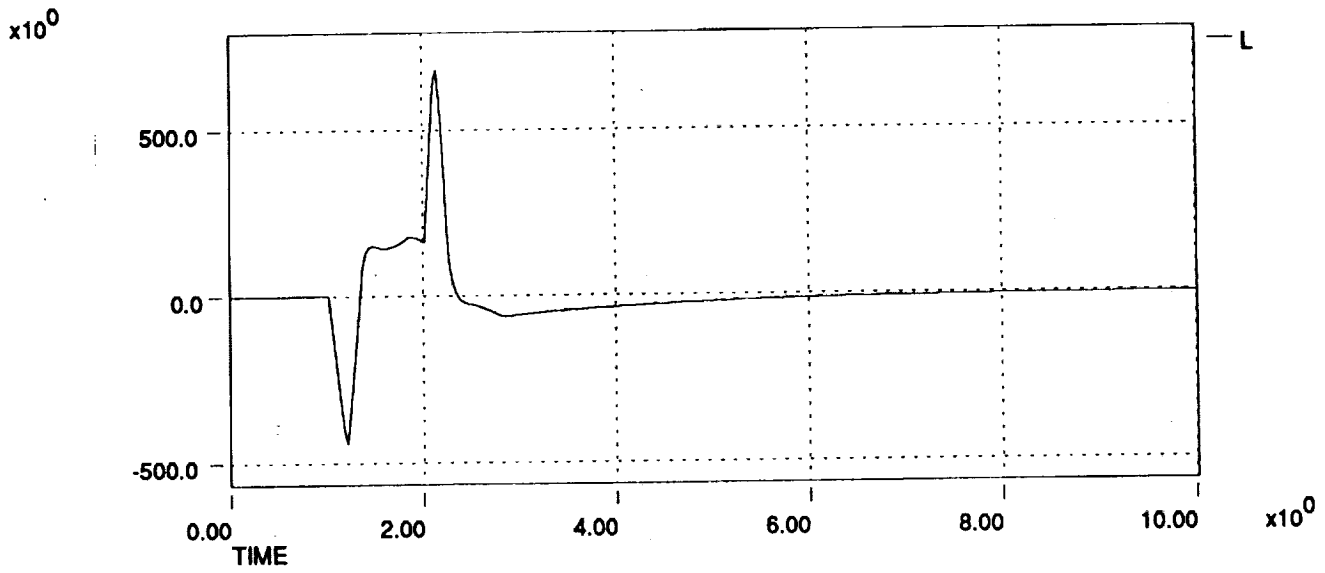

HL-20 Dynamic Check Case Data Plots 911206
Right Roll Stick Pulse at Mach 4 and 104,000 ft

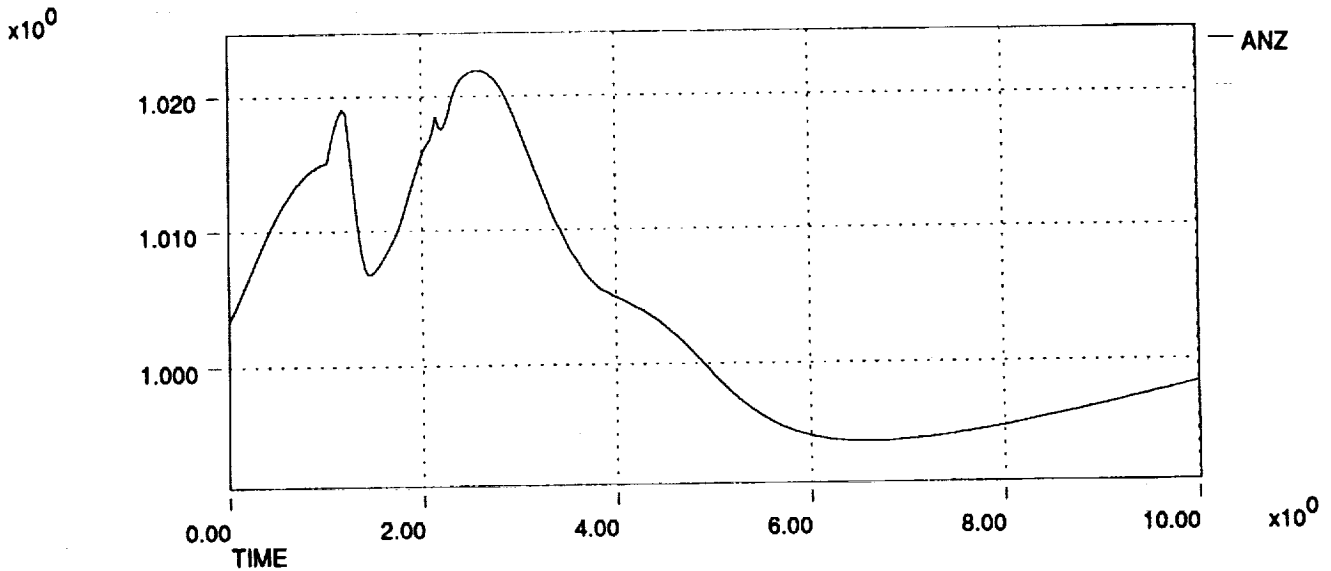
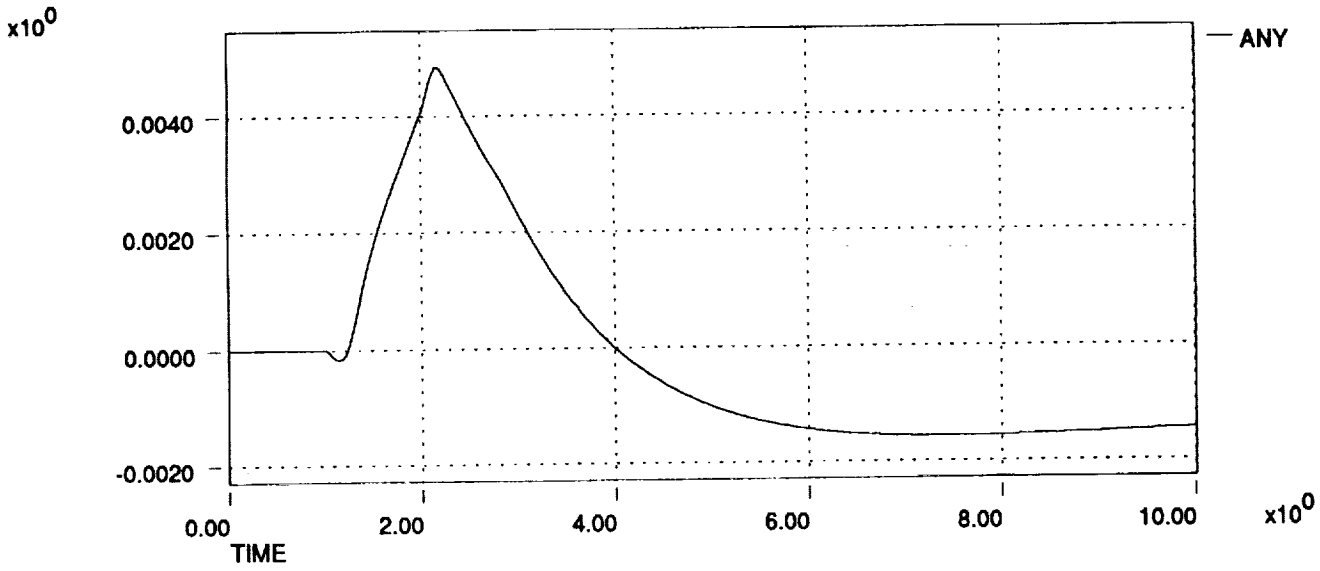
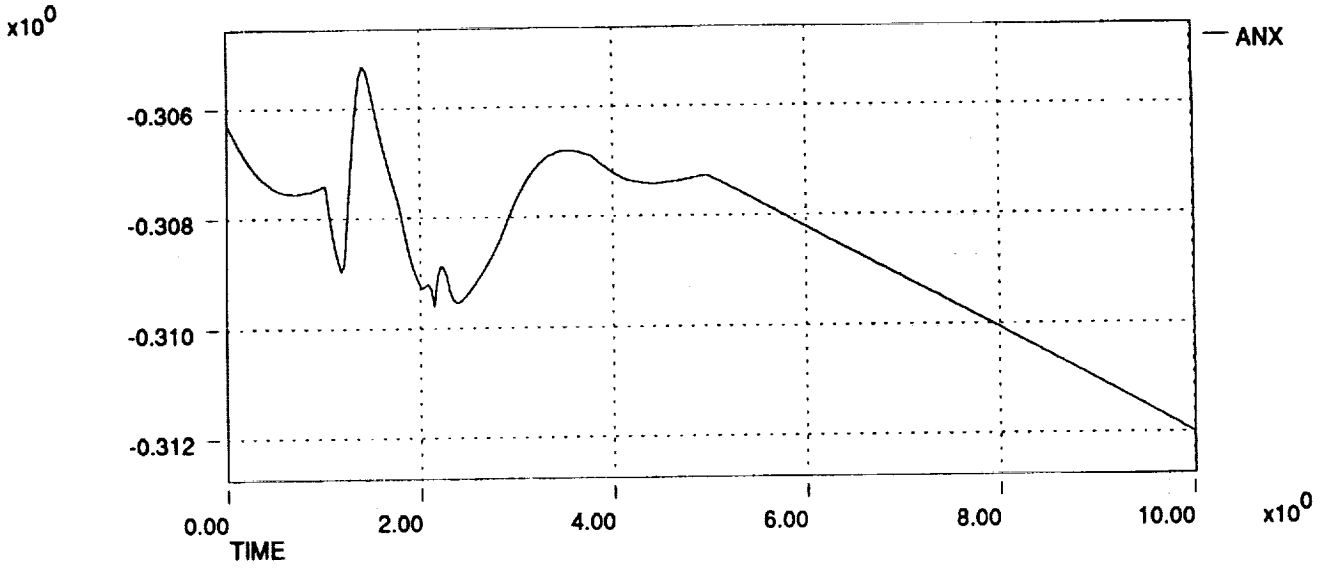

HL-20 Dynamic Check Case Data Plots 911206
Right Roll Stick Pulse at Mach 4 and 104,000 ft

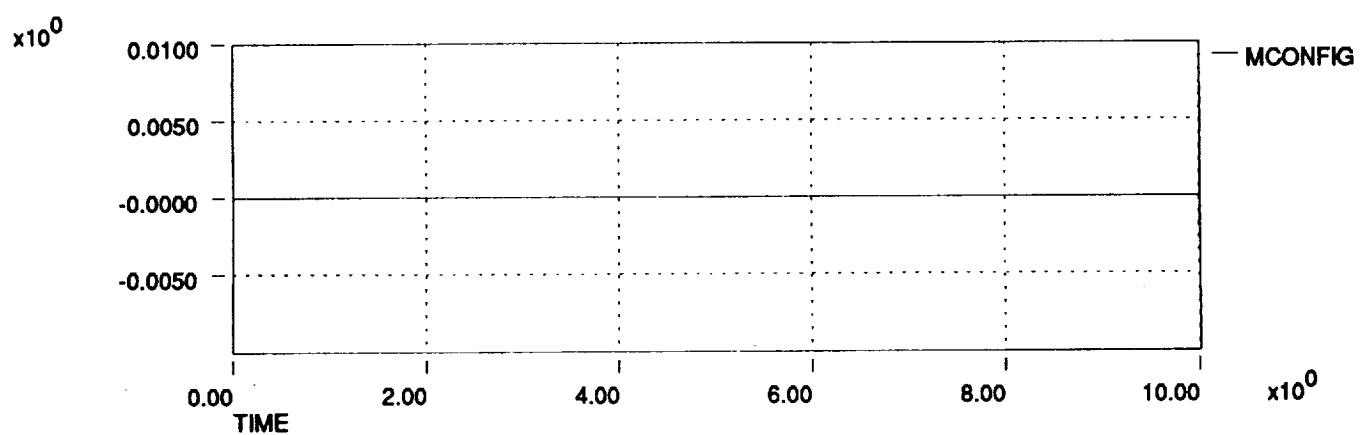
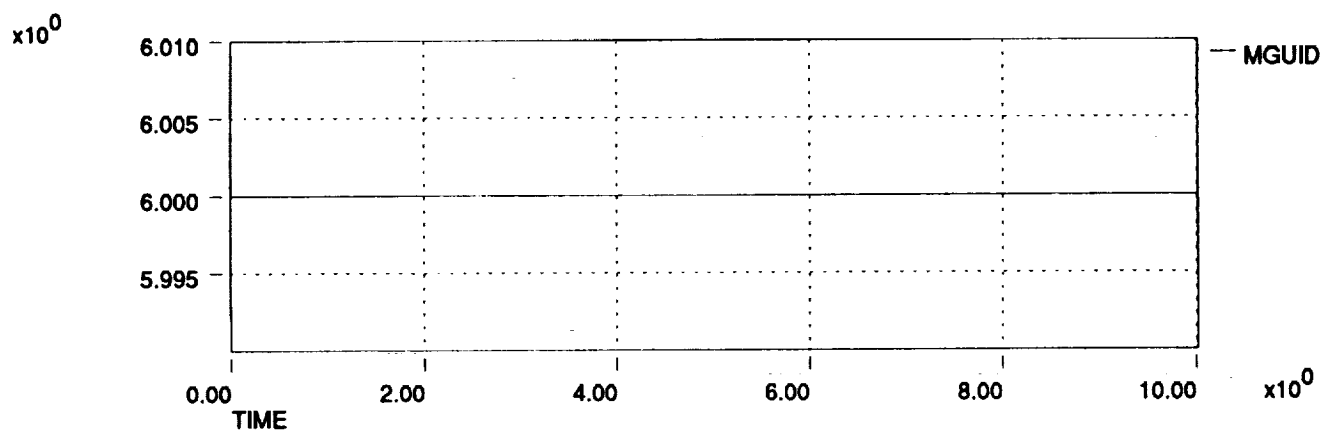
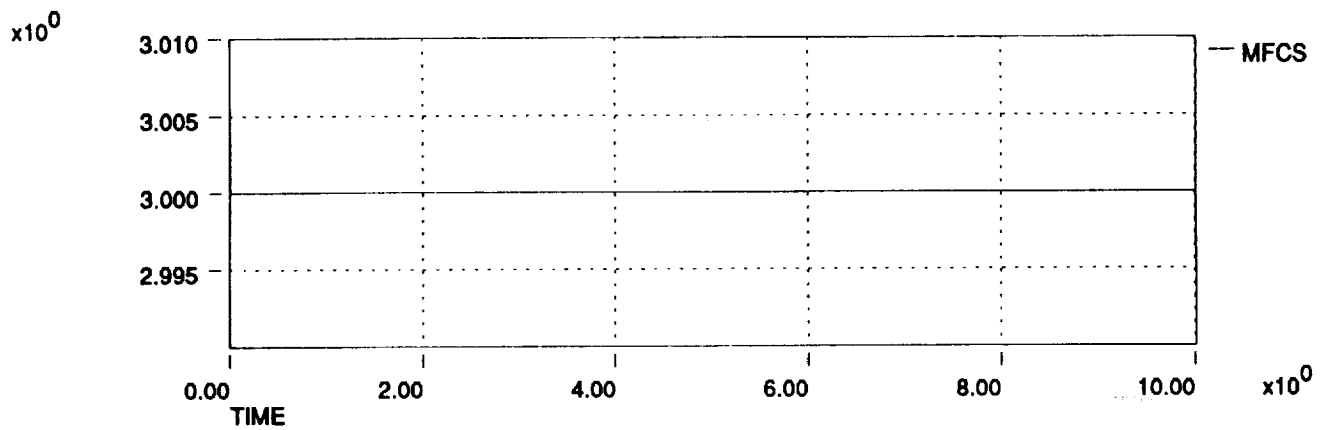
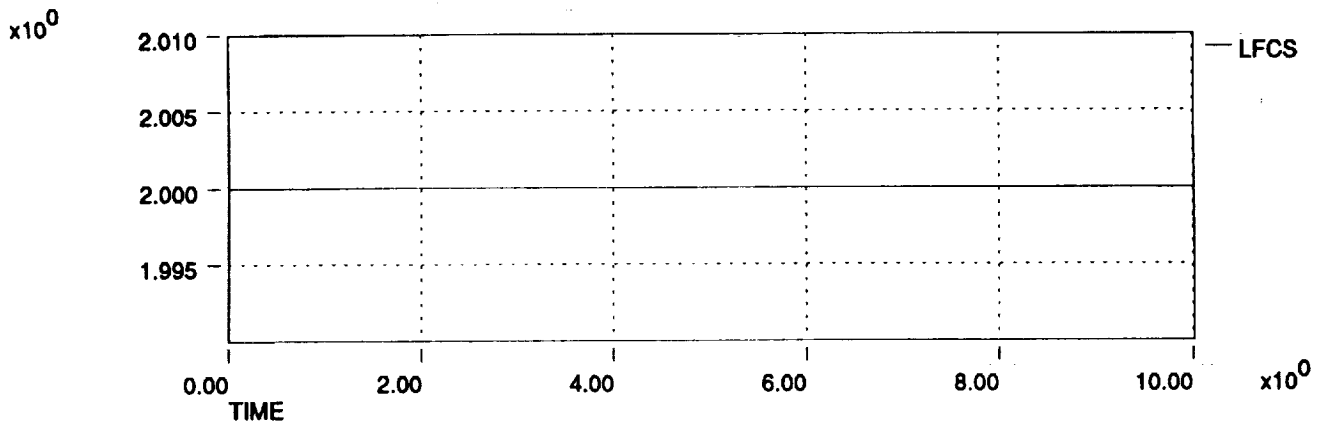

HL-20 Dynamic Check Case Data Plots 911206
Right Roll Stick Pulse at Mach 4 and 104,000 ft

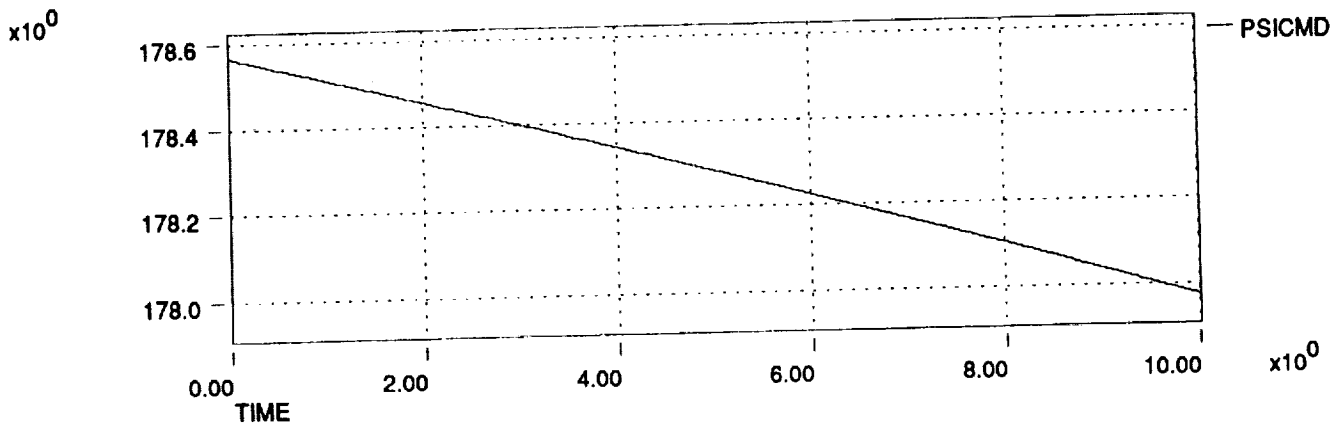
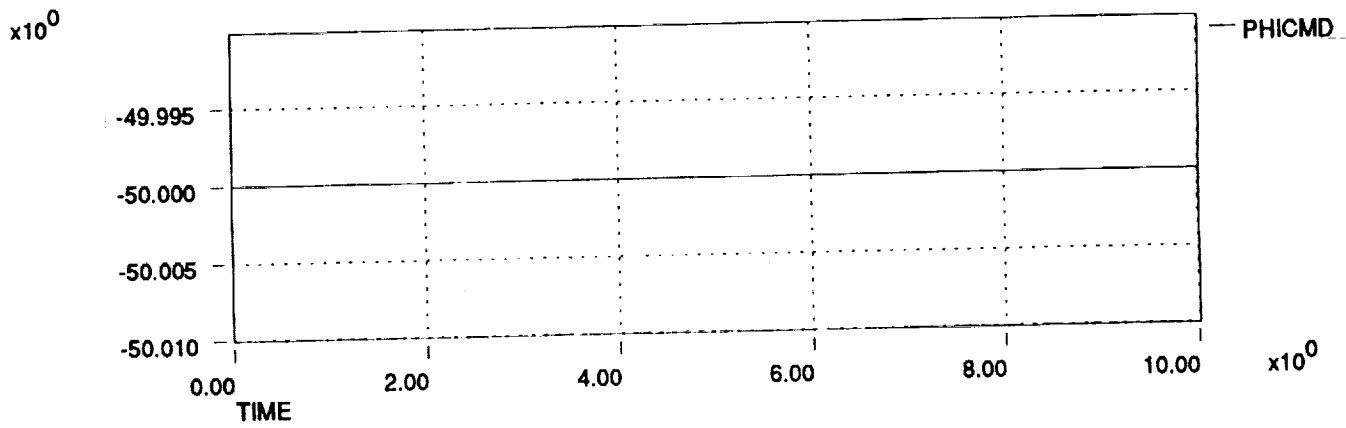
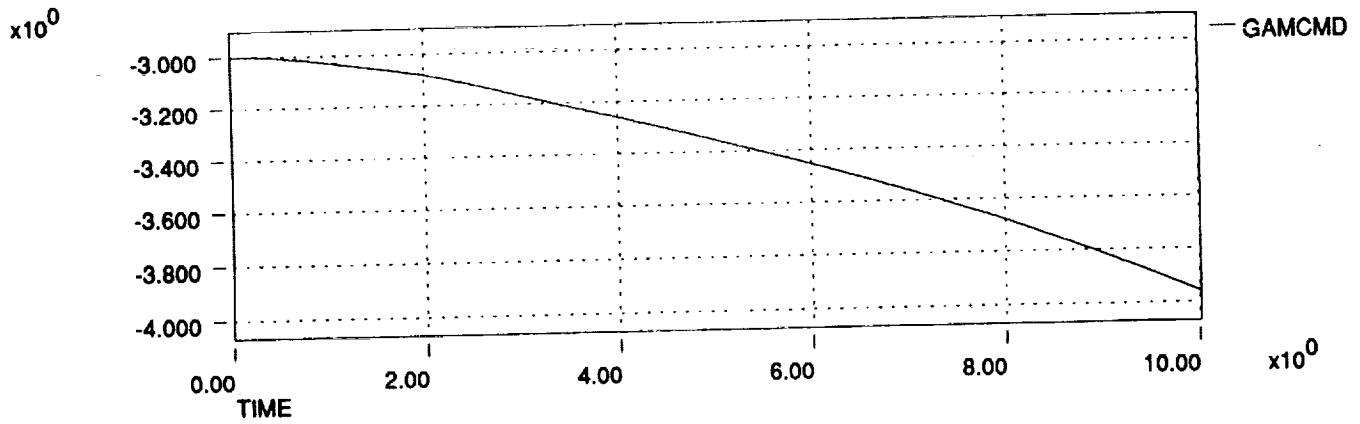
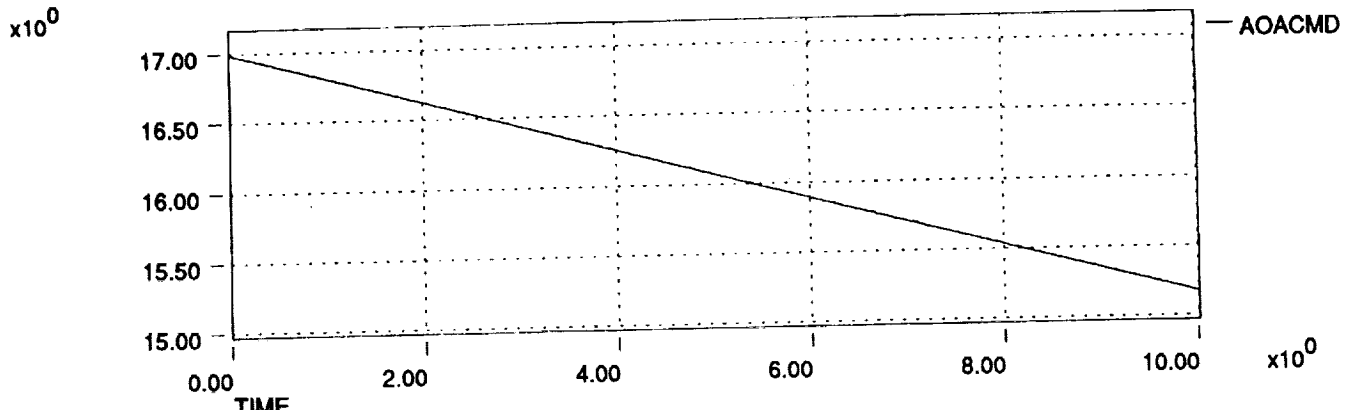

HL-20 Dynamic Check Case Data Plots 911206
Right Roll Stick Pulse at Mach 4 and 104,000 ft

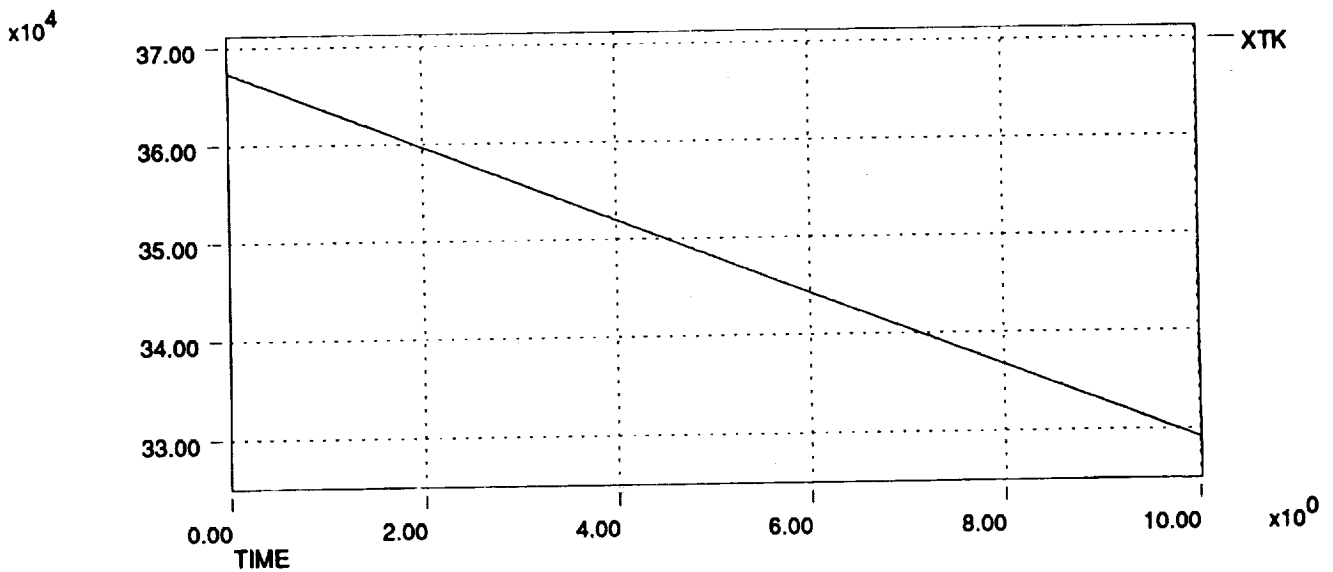
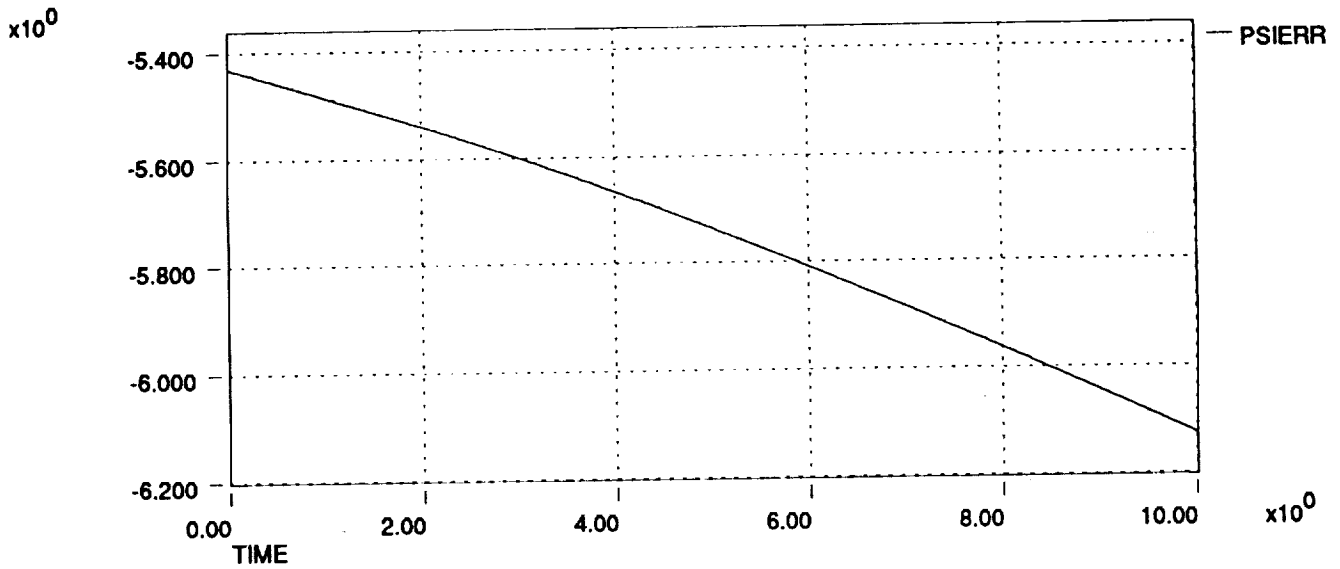
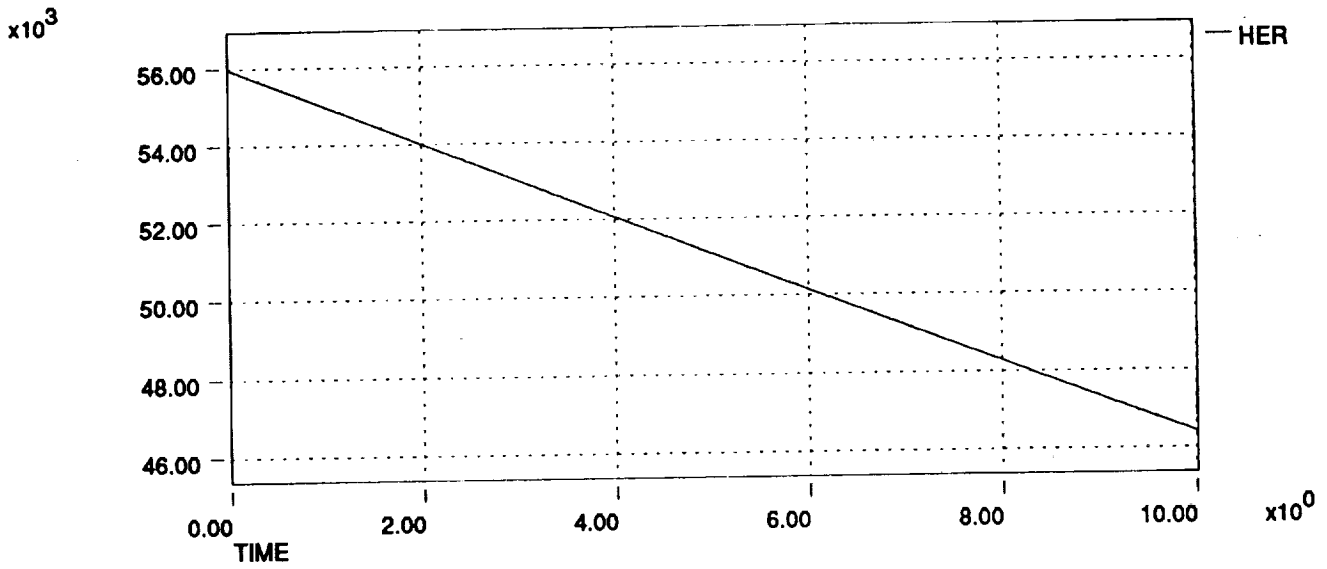

HL-20 Dynamic Check Case Data Plots 911206
Right Roll Stick Pulse at Mach 4 and 104,000 ft

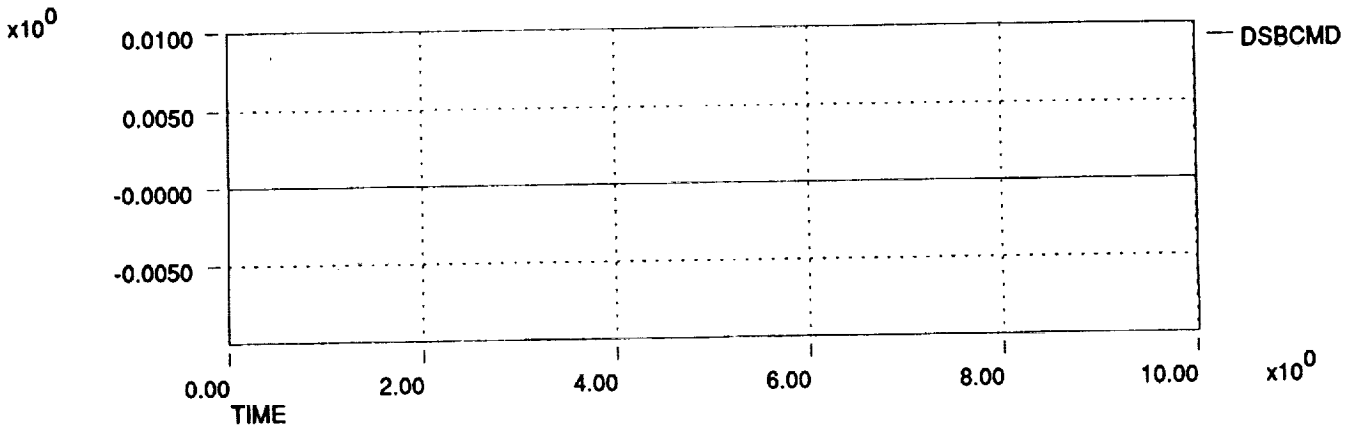
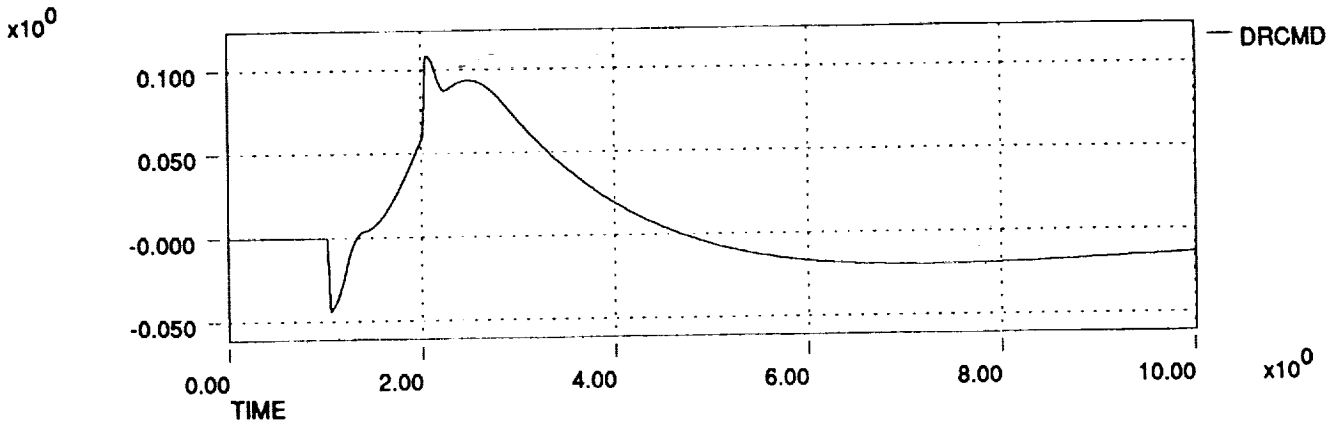
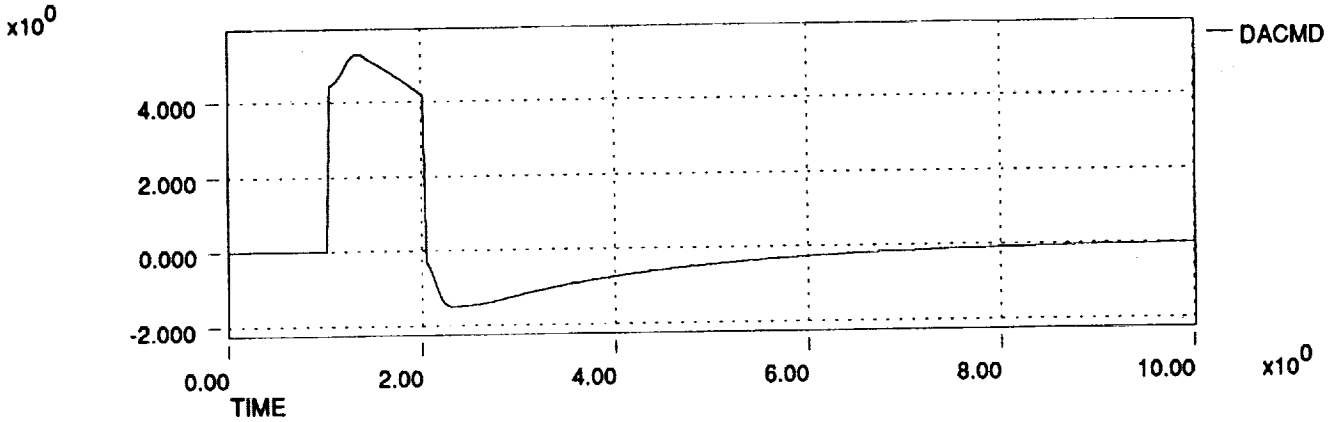
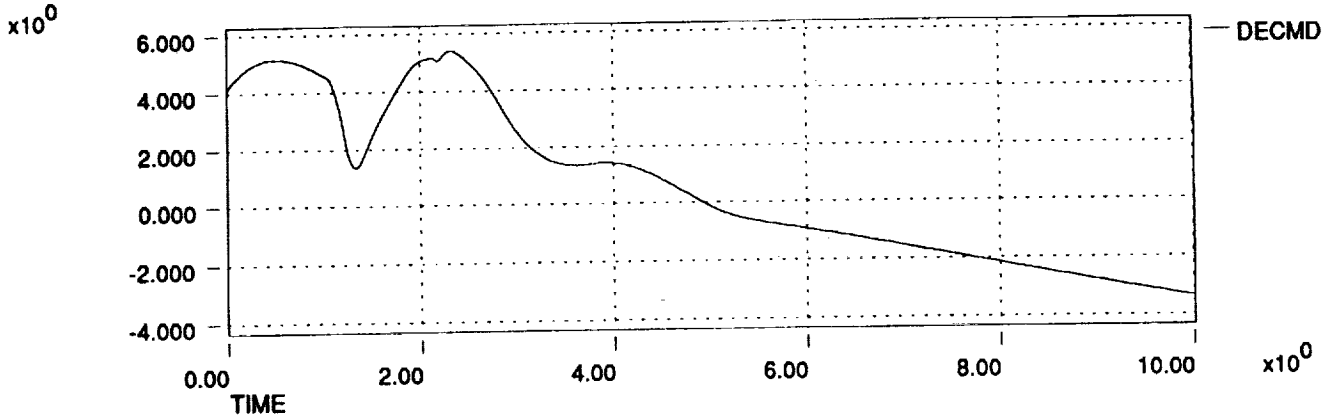

HL-20 Dynamic Check Case Data Plots 911206
Right Roll Stick Pulse at Mach 4 and 104,000 ft

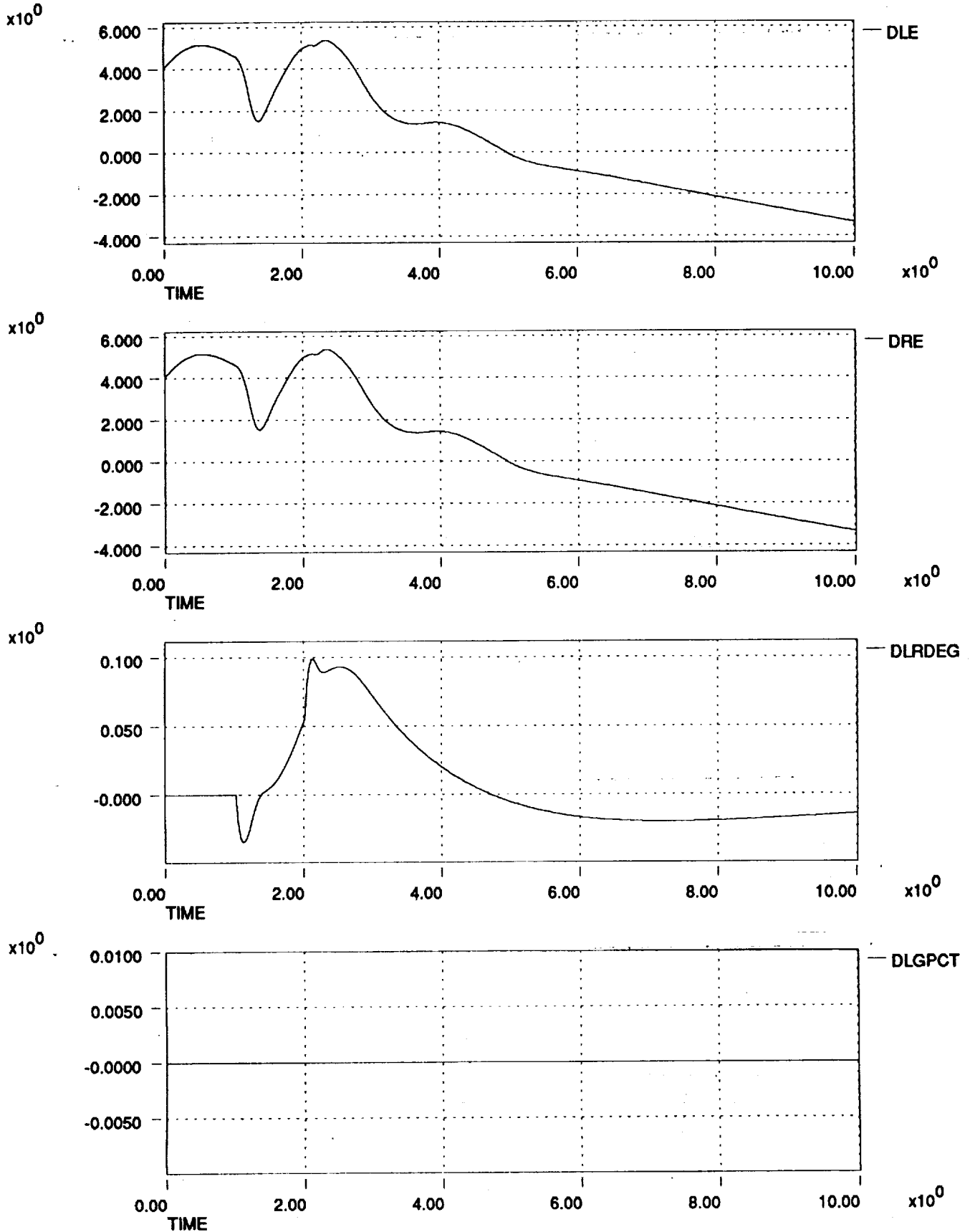

HL-20 Dynamic Check Case Data Plots 911206
Right Roll Stick Pulse at Mach 4 and 104,000 ft

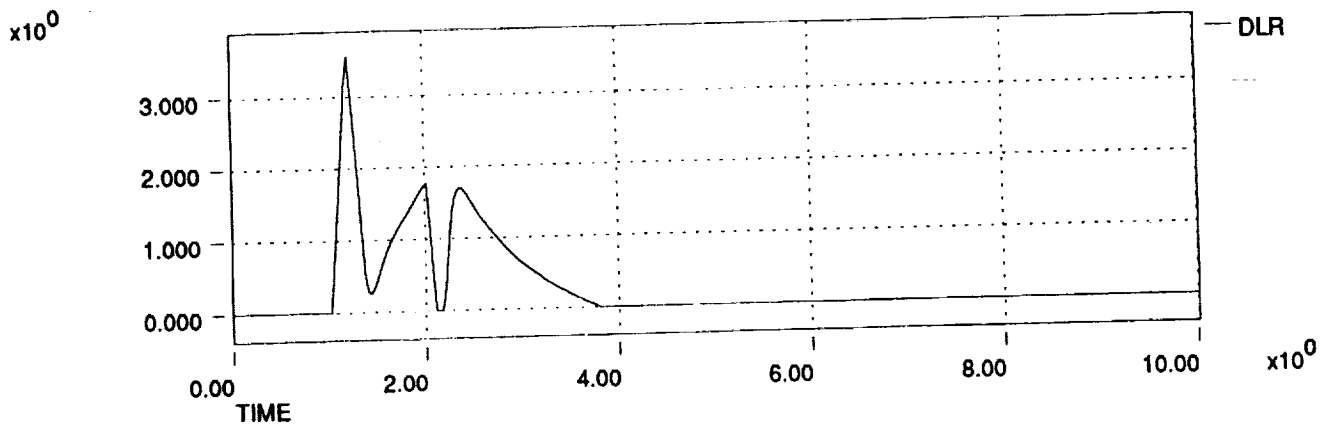
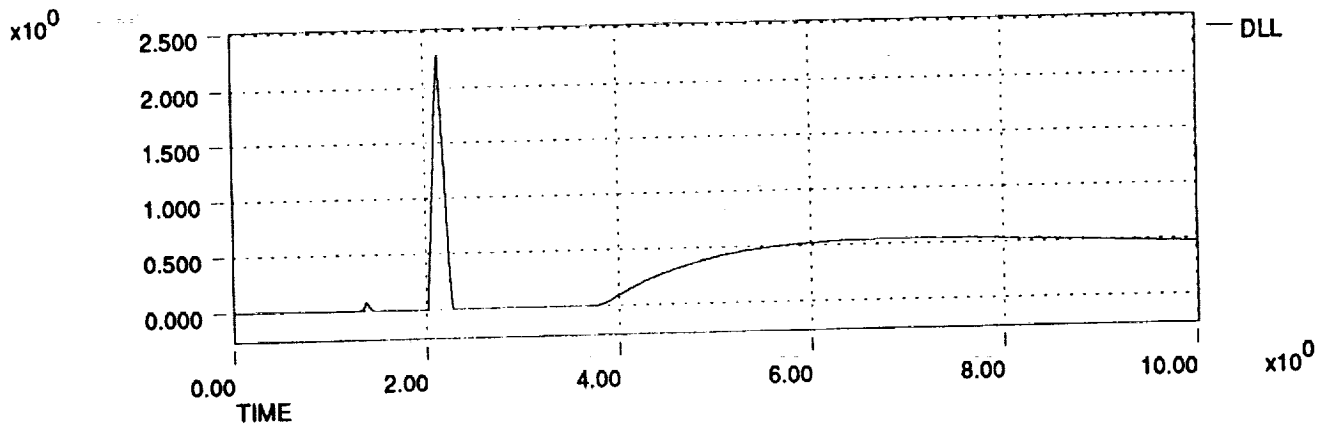
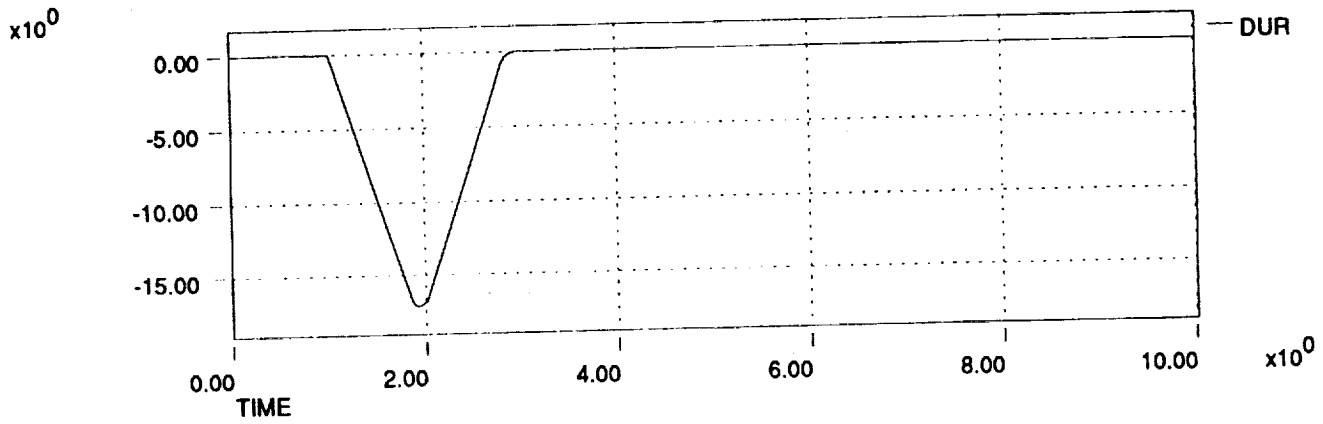
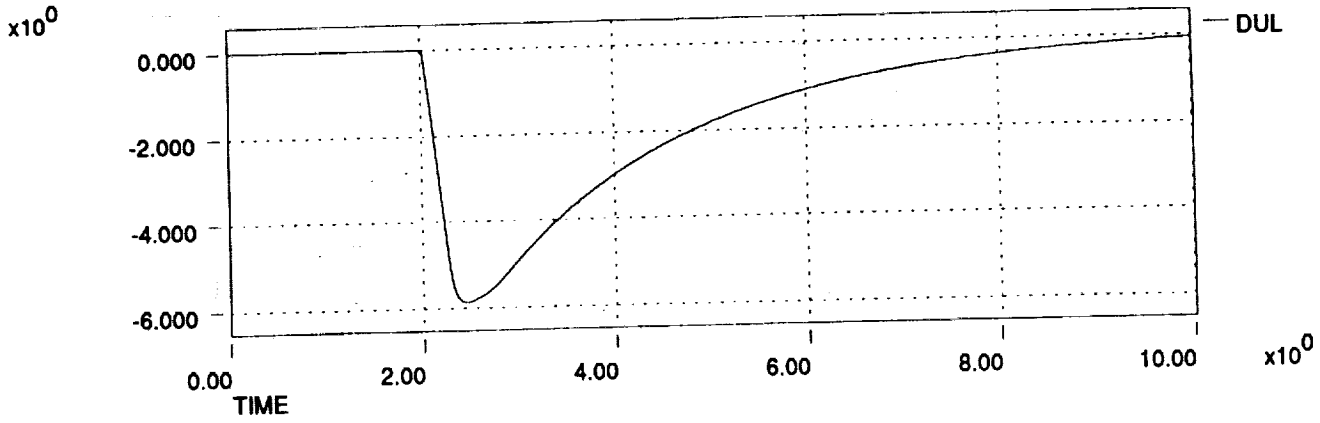

HL-20 Dynamic Check Case Data Plots 911206
Right Rudder Pedal Pulse at Mach 4 and 104,000 ft

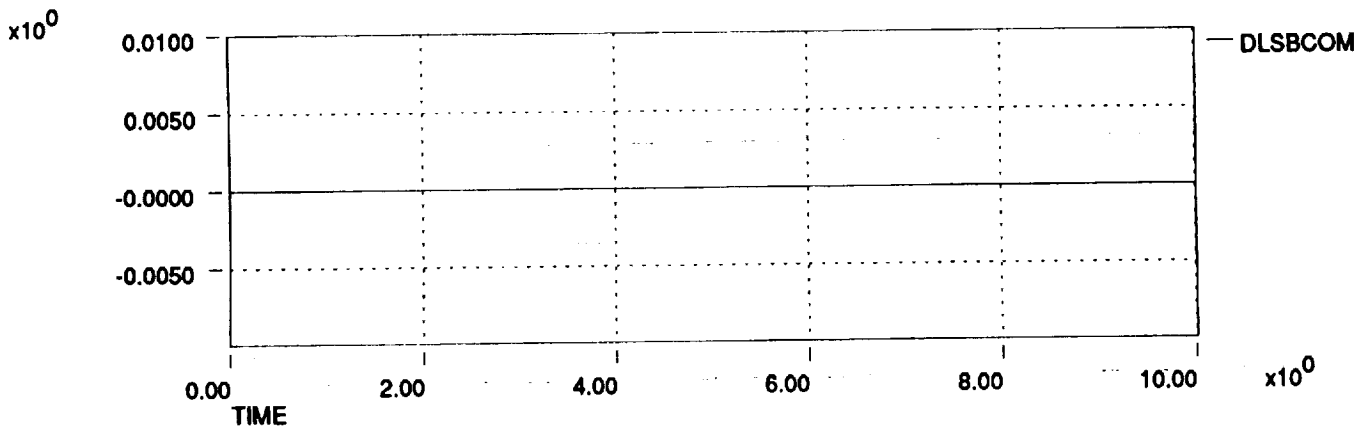
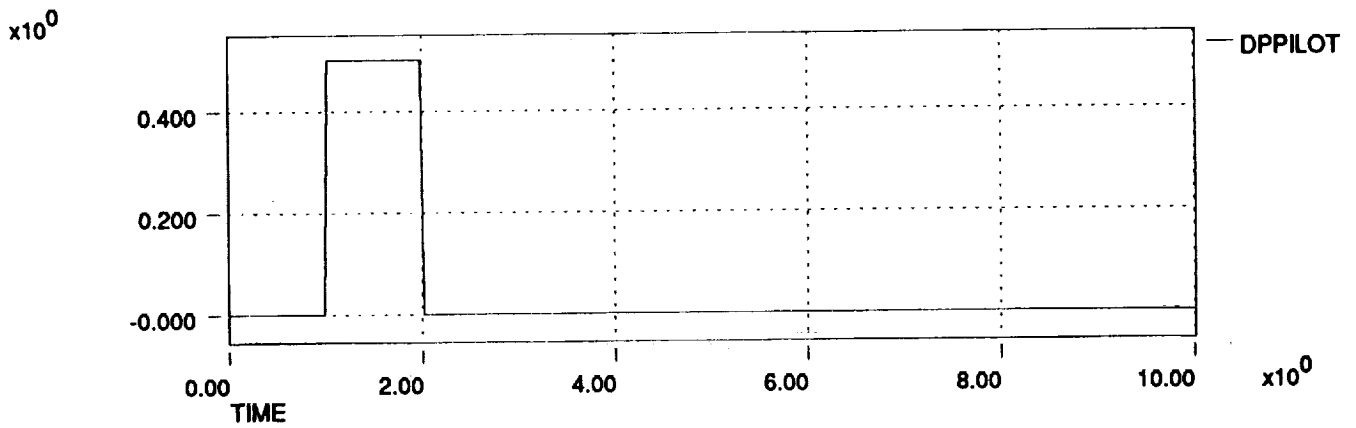
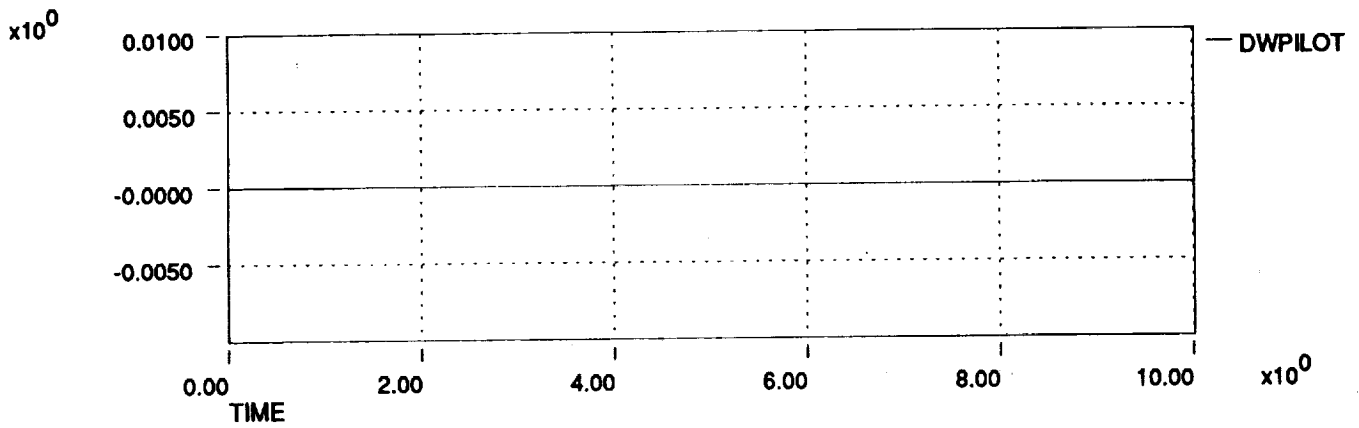
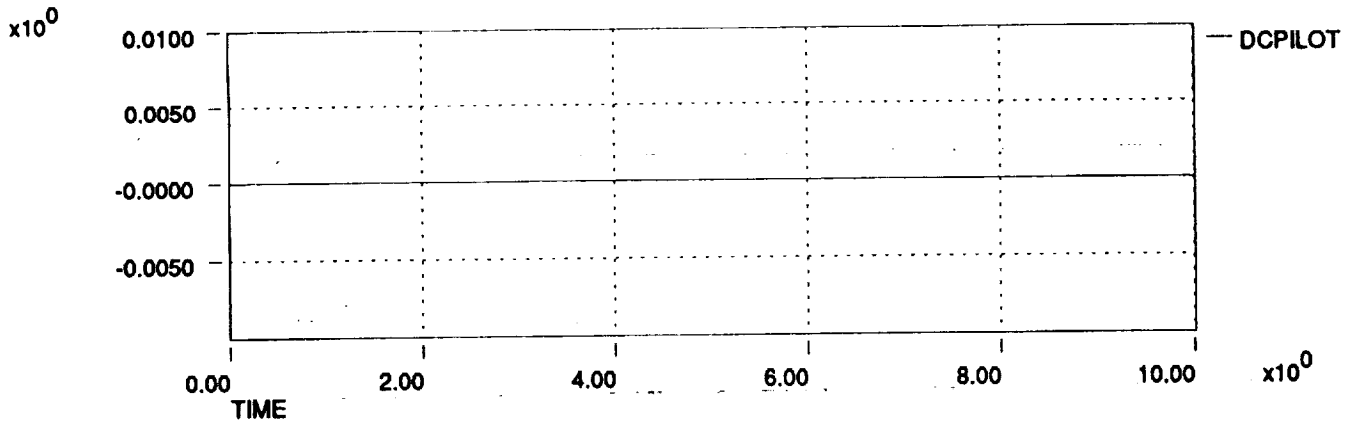

HL-20 Dynamic Check Case Data Plots 911206
Right Rudder Pedal Pulse at Mach 4 and 104,000 ft

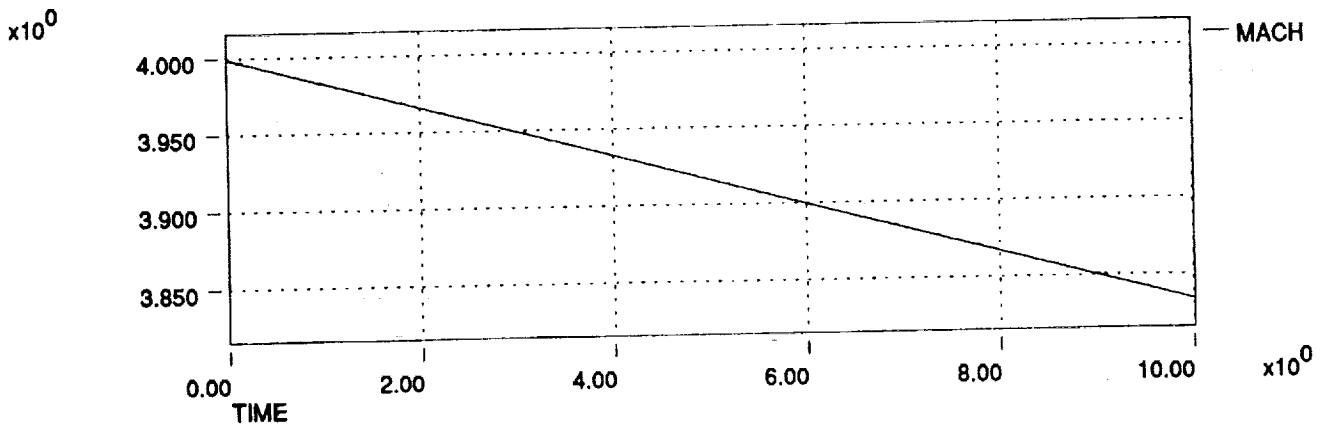
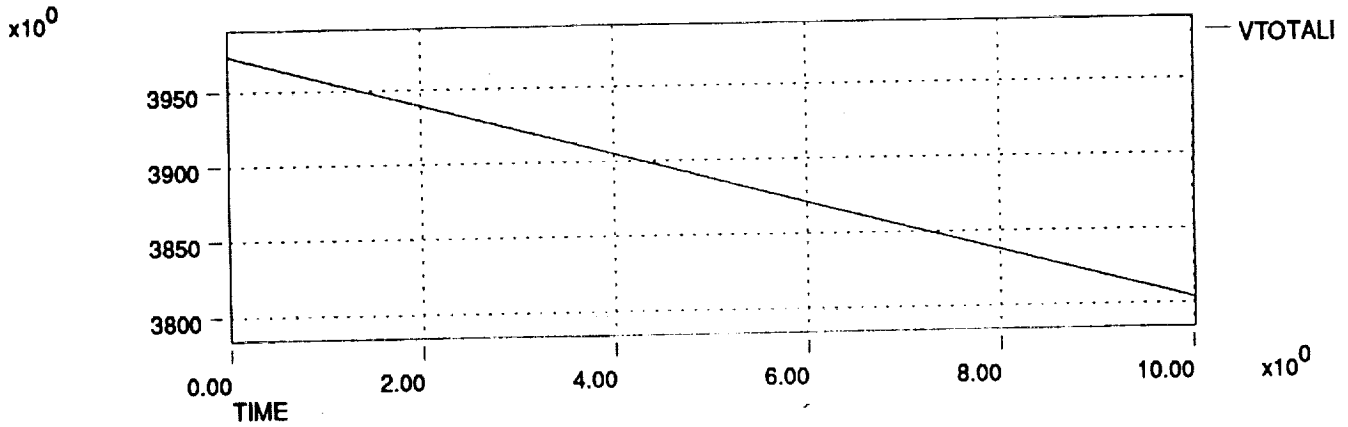
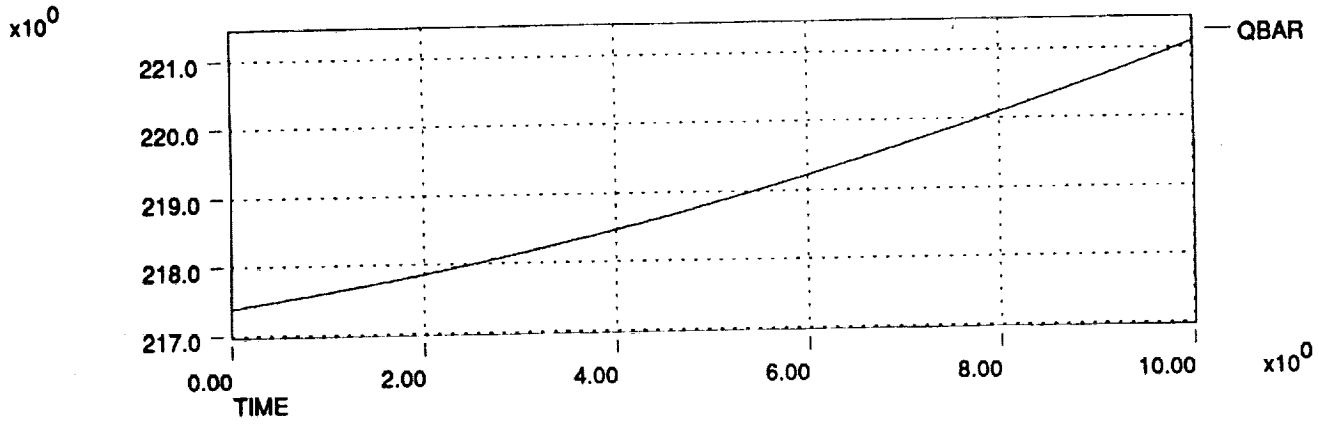
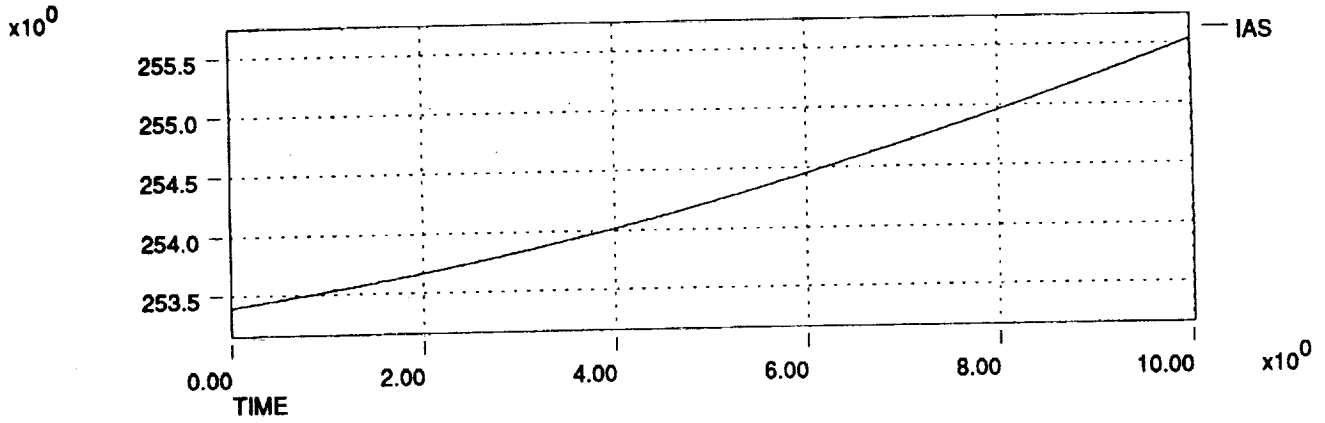

HL-20 Dynamic Check Case Data Plots 911206
Right Rudder Pedal Pulse at Mach 4 and 104,000 ft

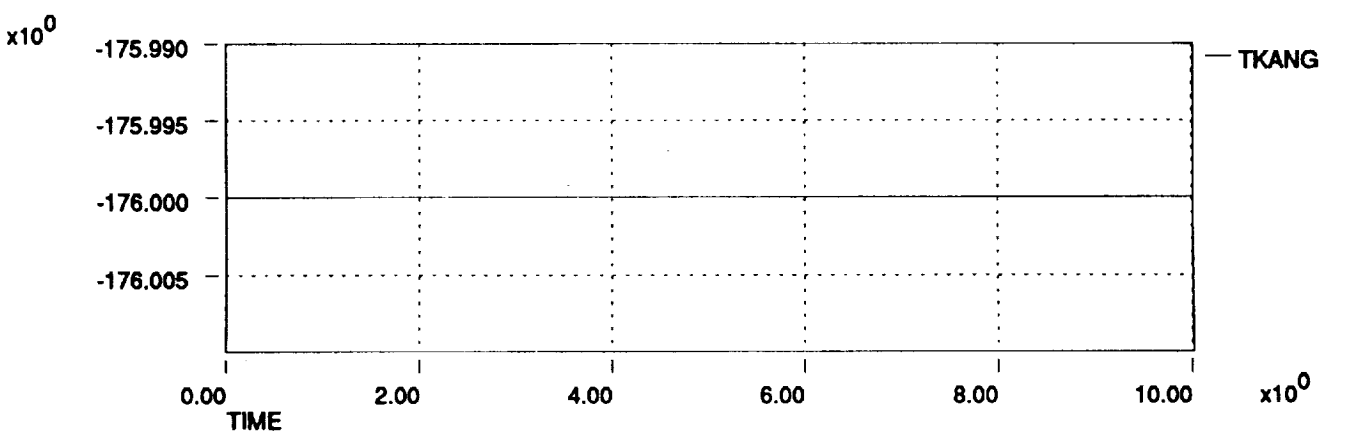
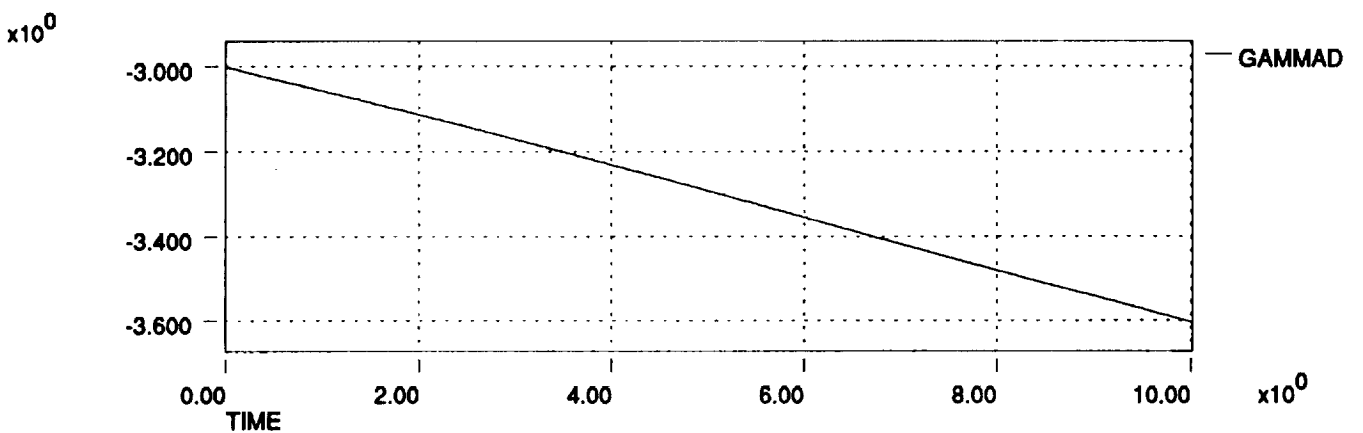
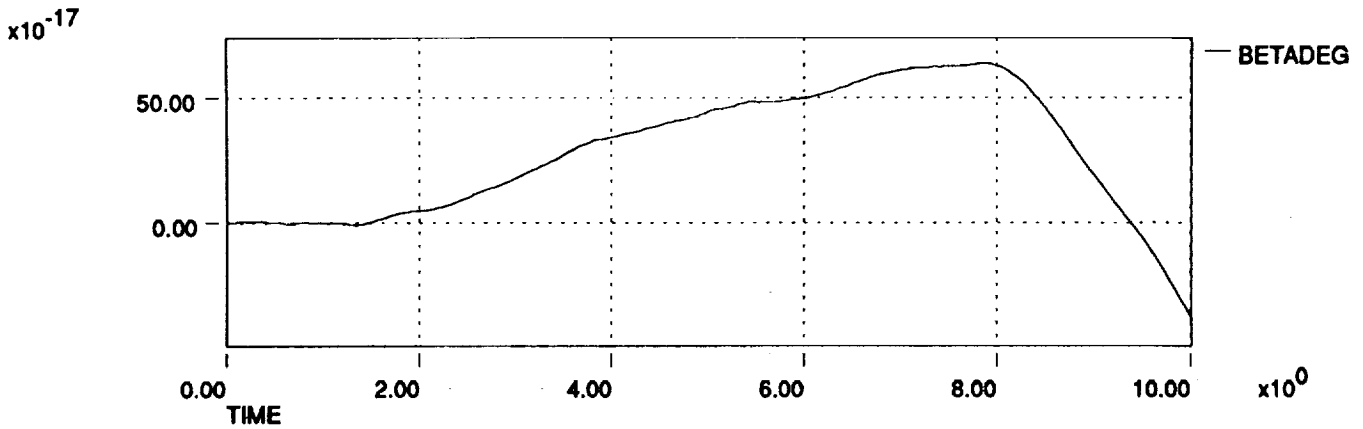
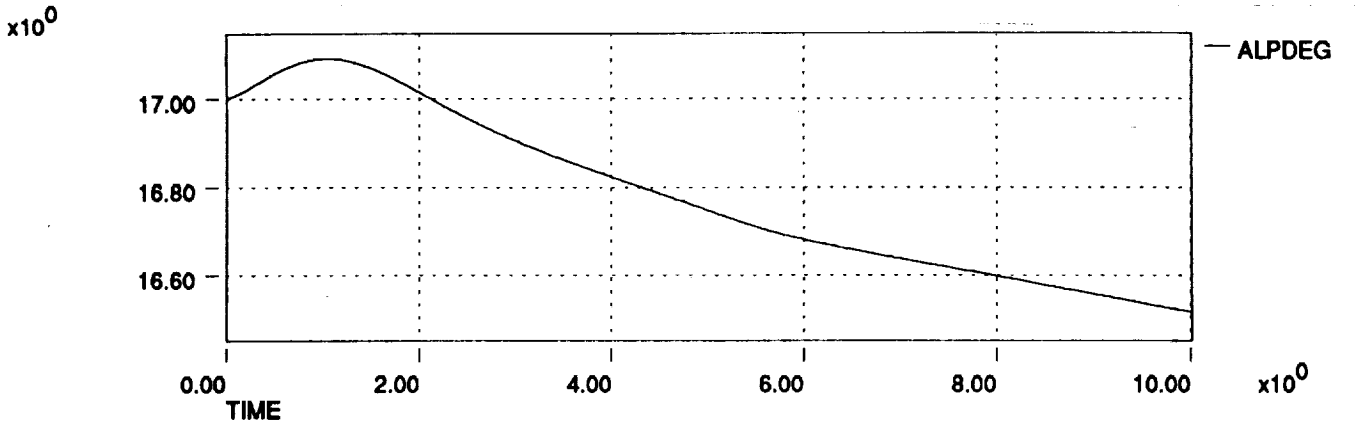

HL-20 Dynamic Check Case Data Plots 911206
Right Rudder Pedal Pulse at Mach 4 and 104,000 ft

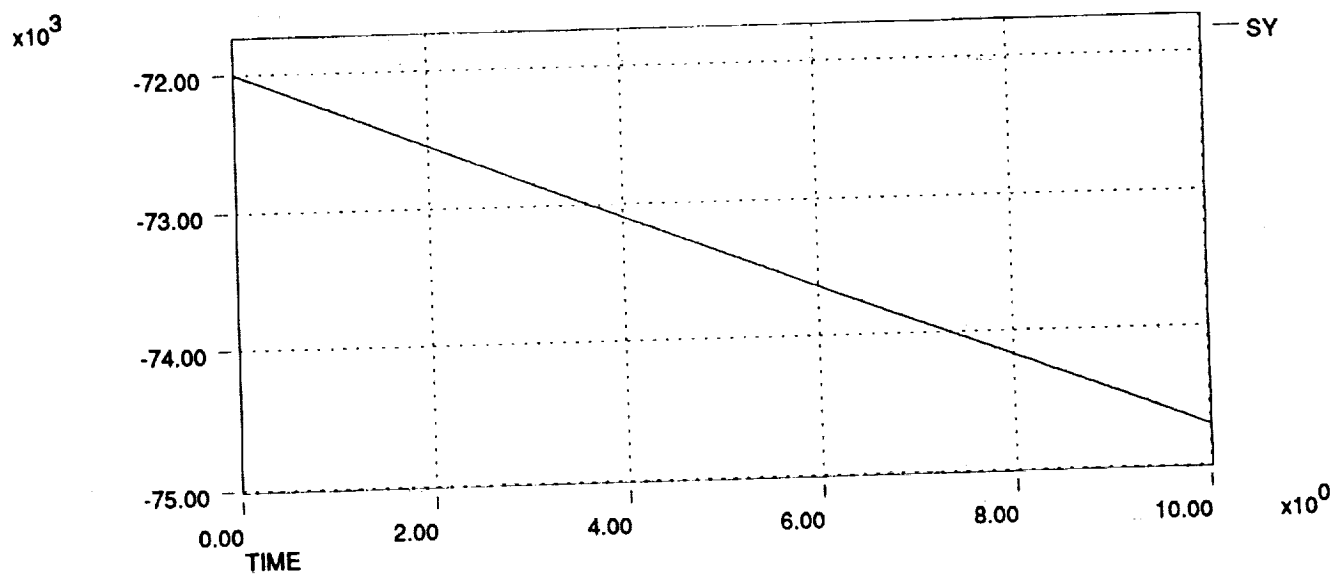
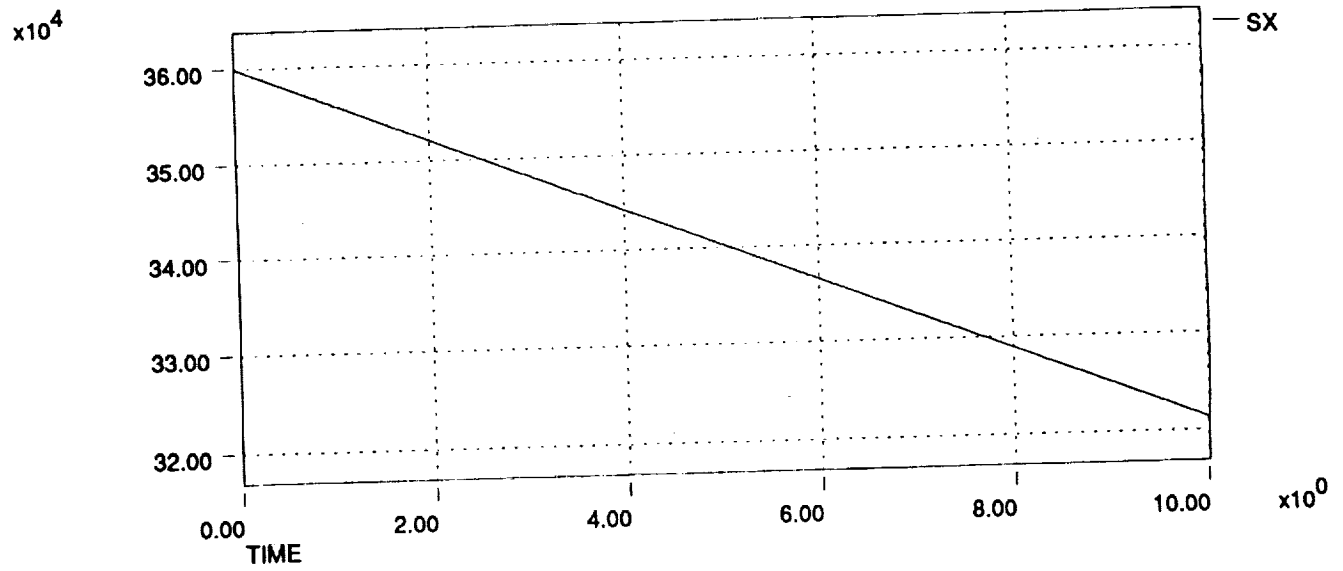
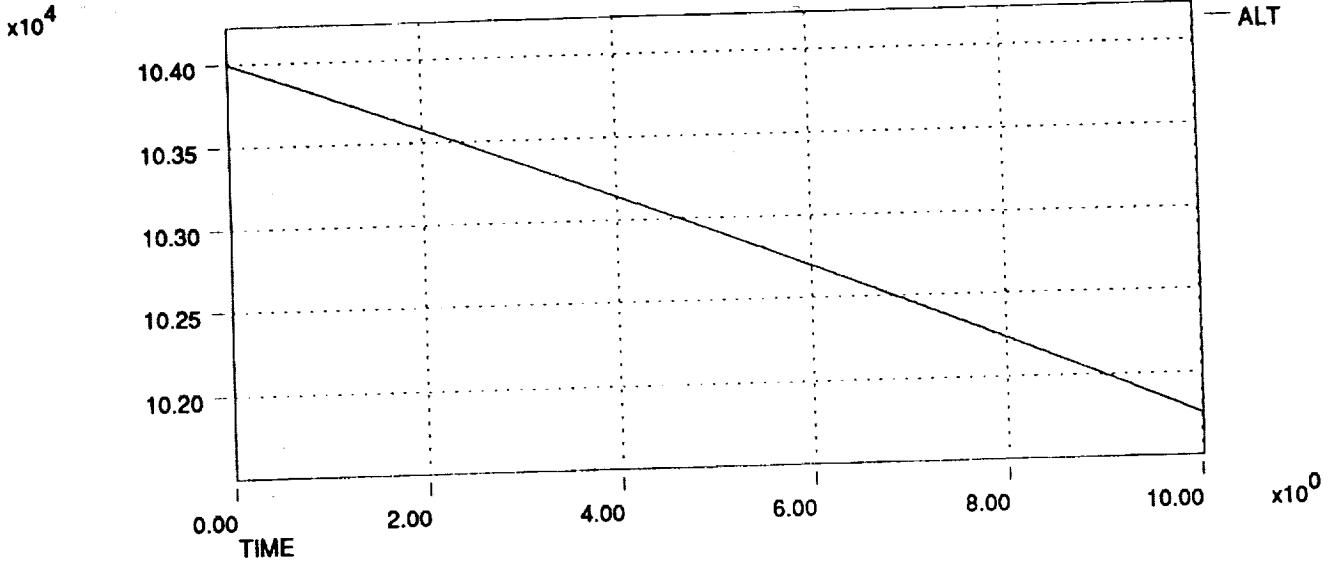

HL-20 Dynamic Check Case Data Plots 911206
Right Rudder Pedal Pulse at Mach 4 and 104,000 ft

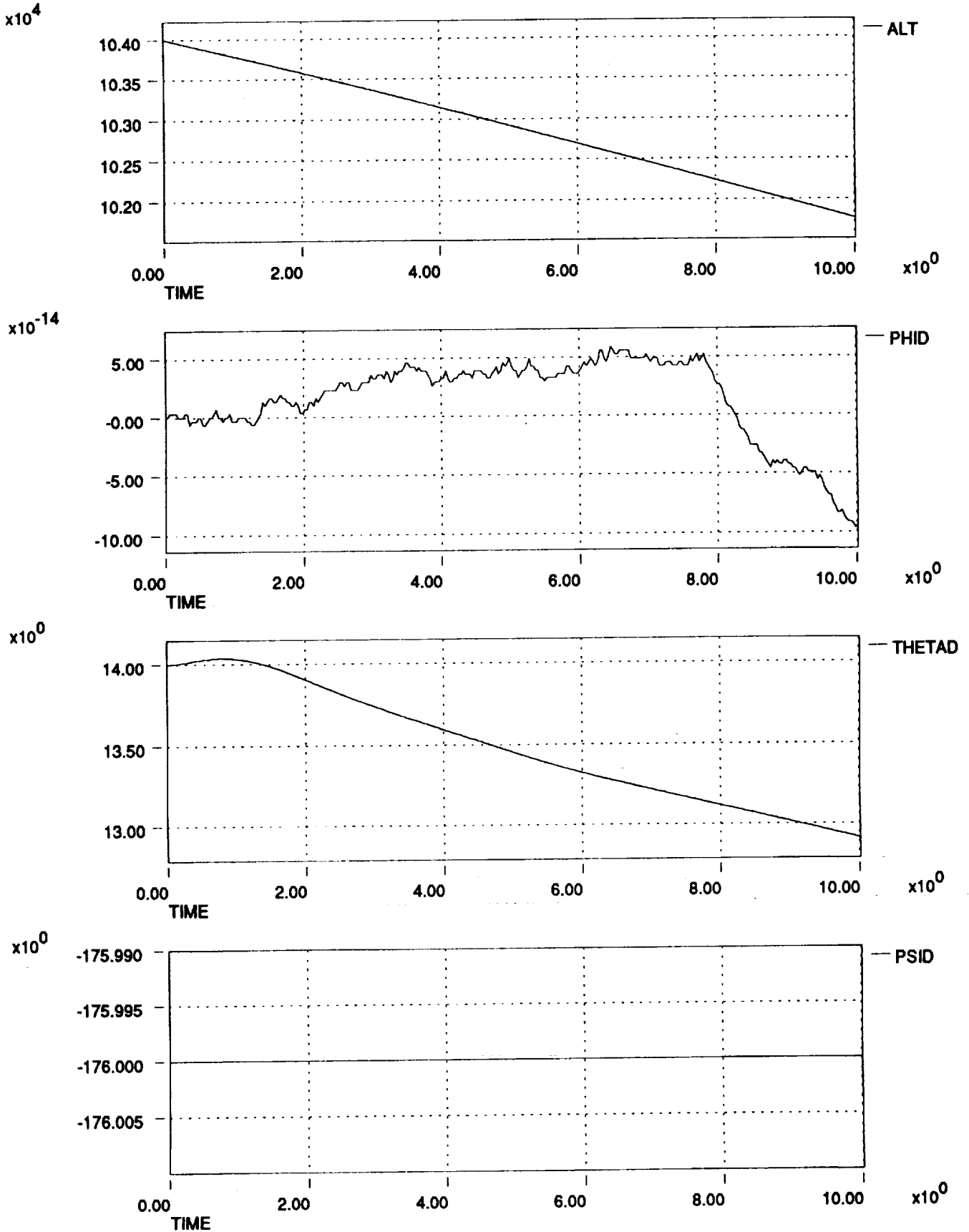

HL-20 Dynamic Check Case Data Plots 911206
Right Rudder Pedal Pulse at Mach 4 and 104,000 ft

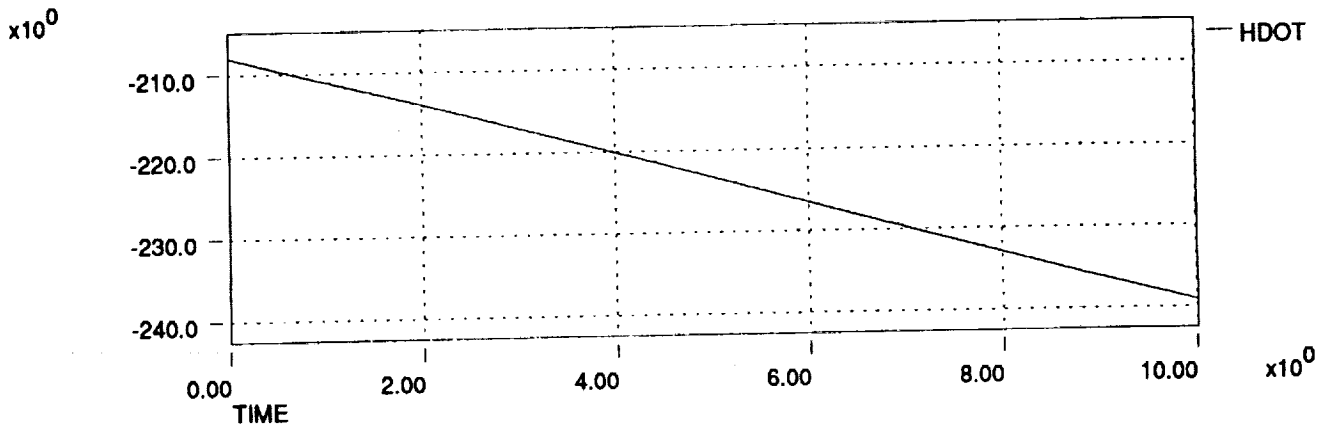
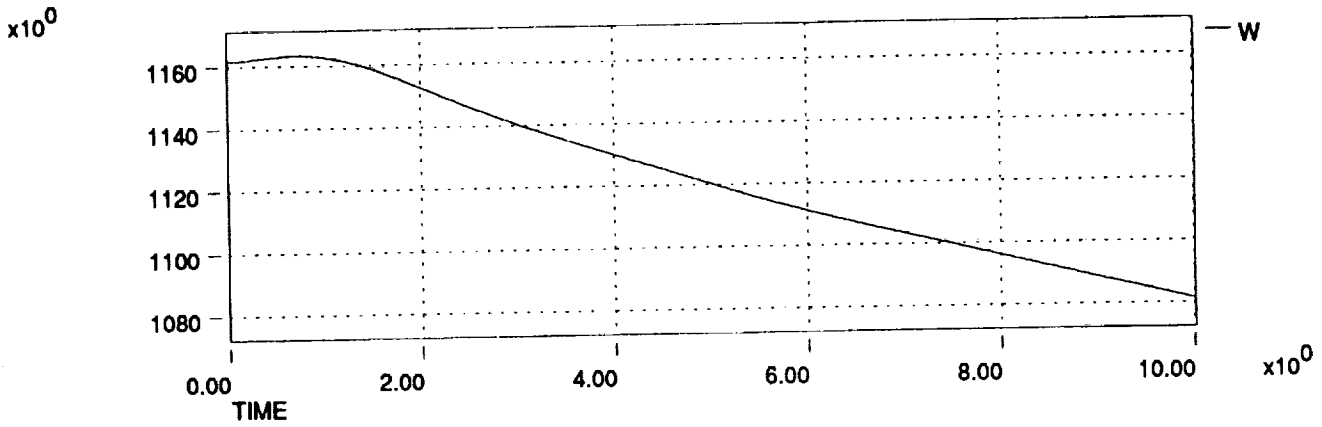
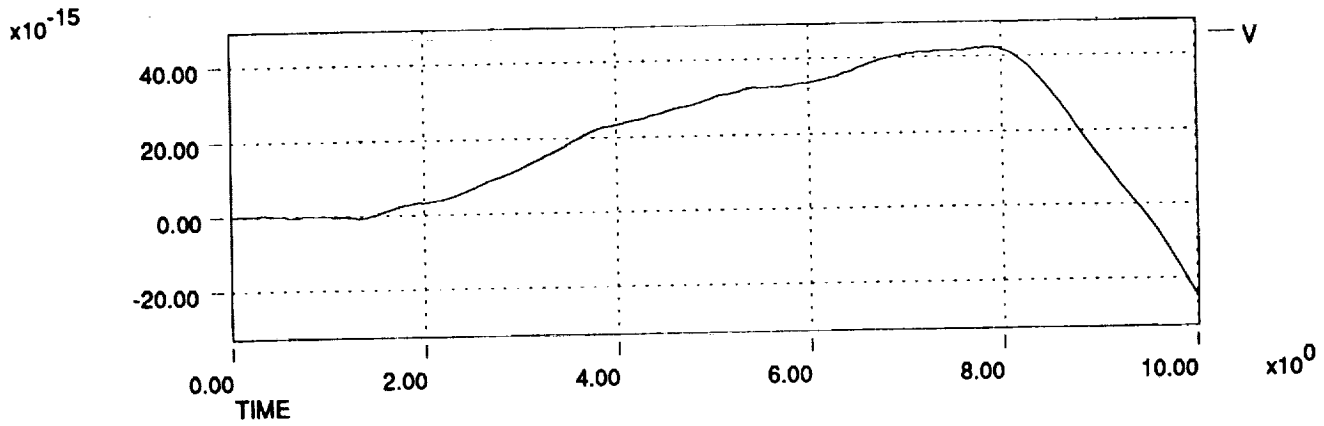
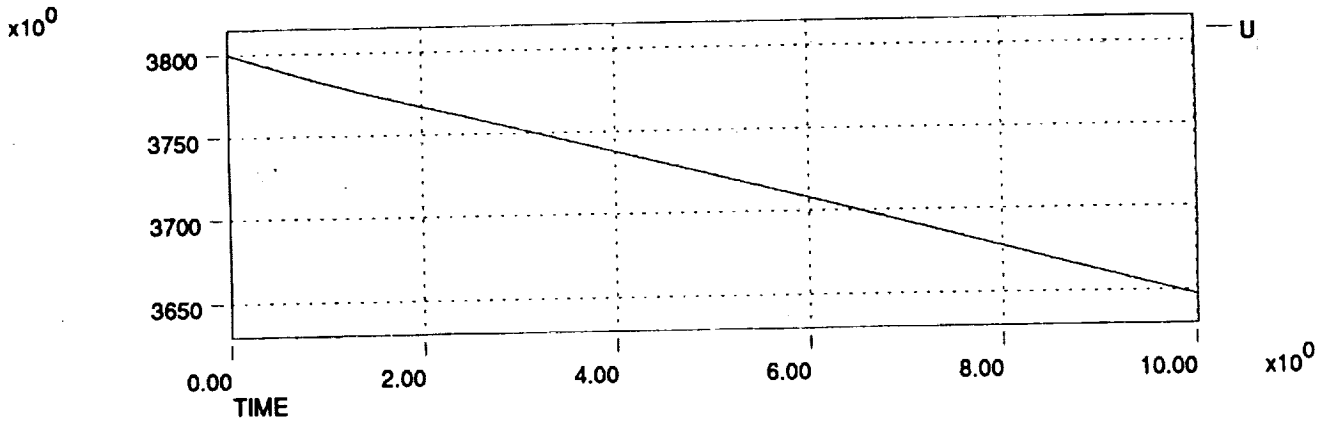

HL-20 Dynamic Check Case Data Plots 911206
Right Rudder Pedal Pulse at Mach 4 and 104,000 ft

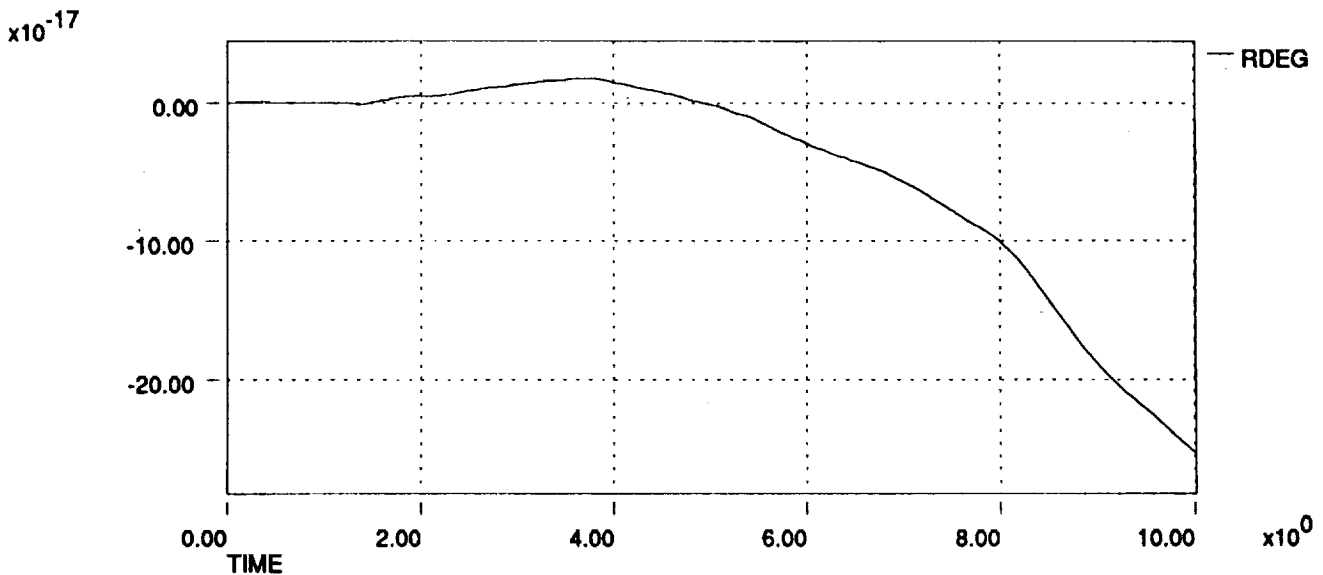
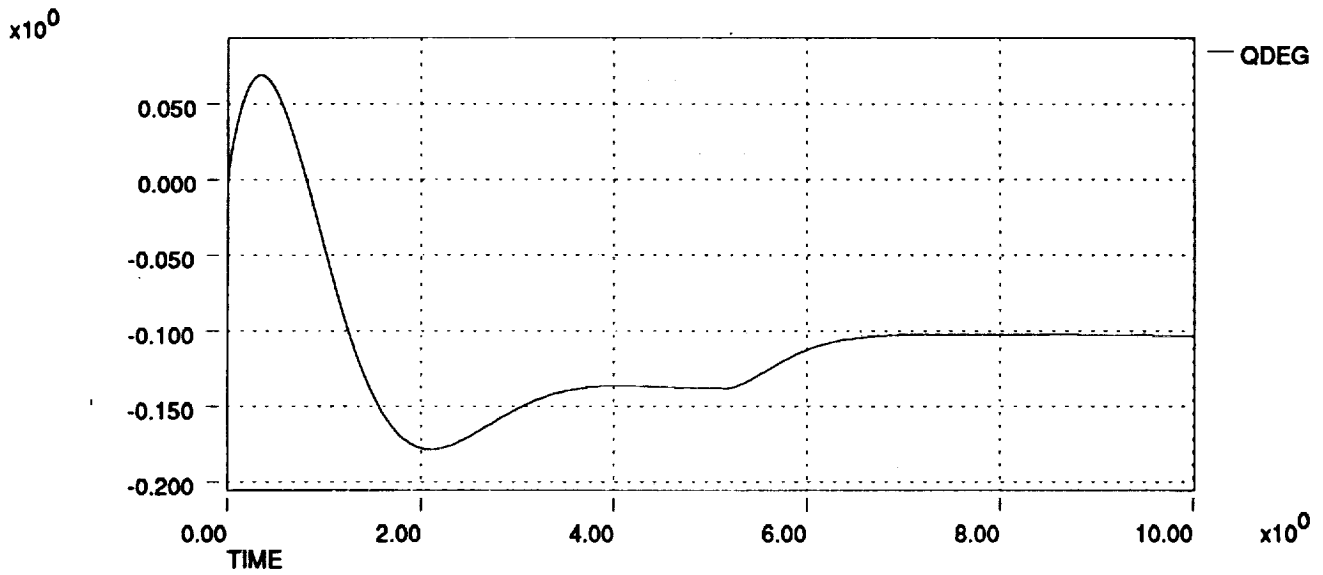
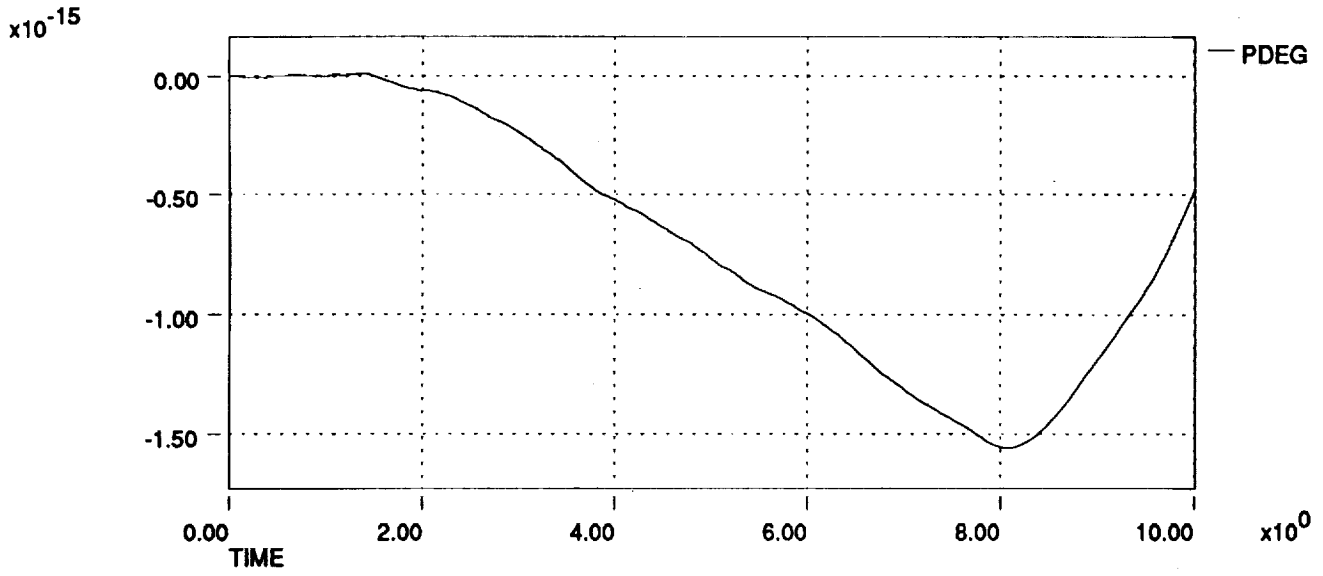

HL-20 Dynamic Check Case Data Plots 911206
Right Rudder Pedal Pulse at Mach 4 and 104,000 ft

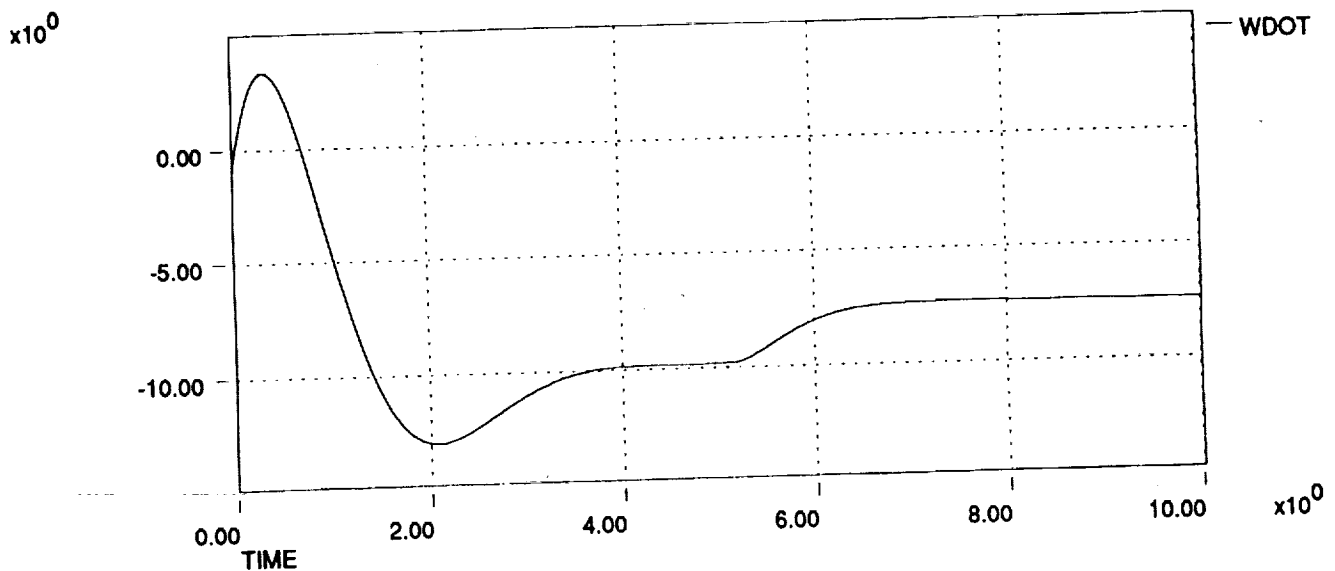
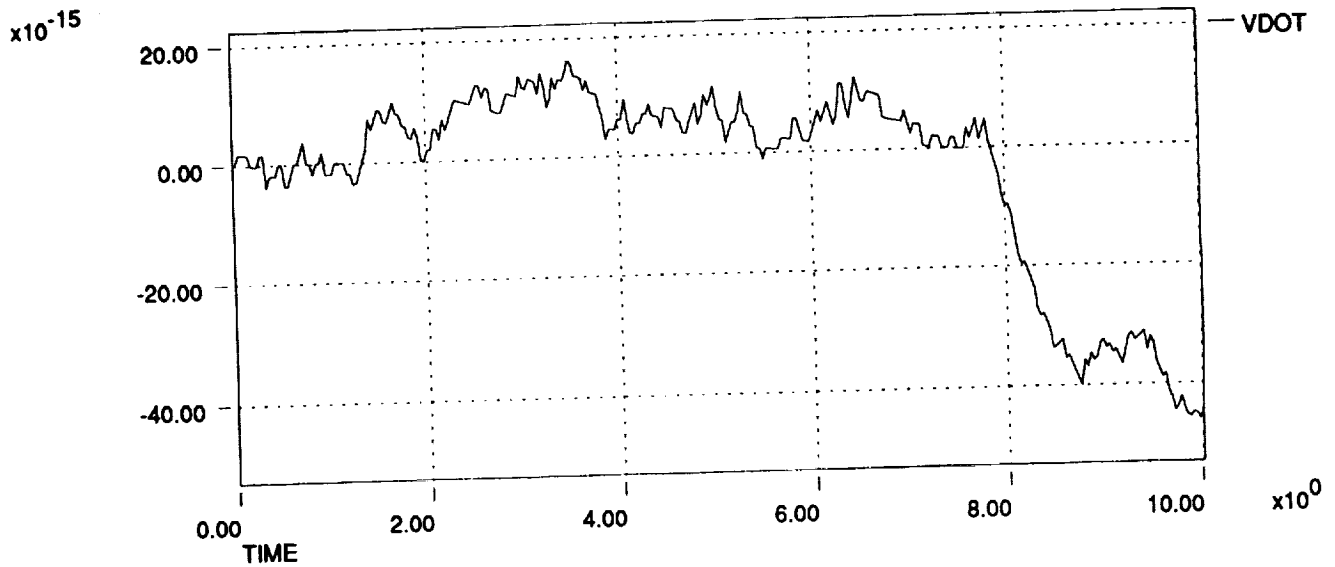
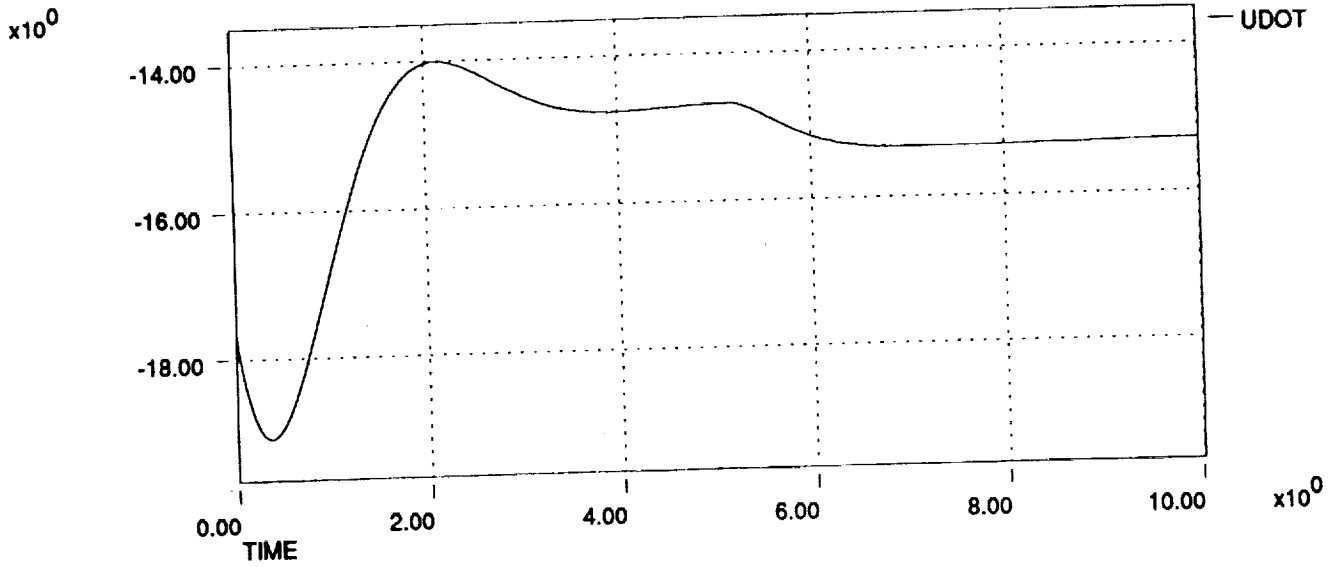

HL-20 Dynamic Check Case Data Plots 911206
Right Rudder Pedal Pulse at Mach 4 and 104,000 ft

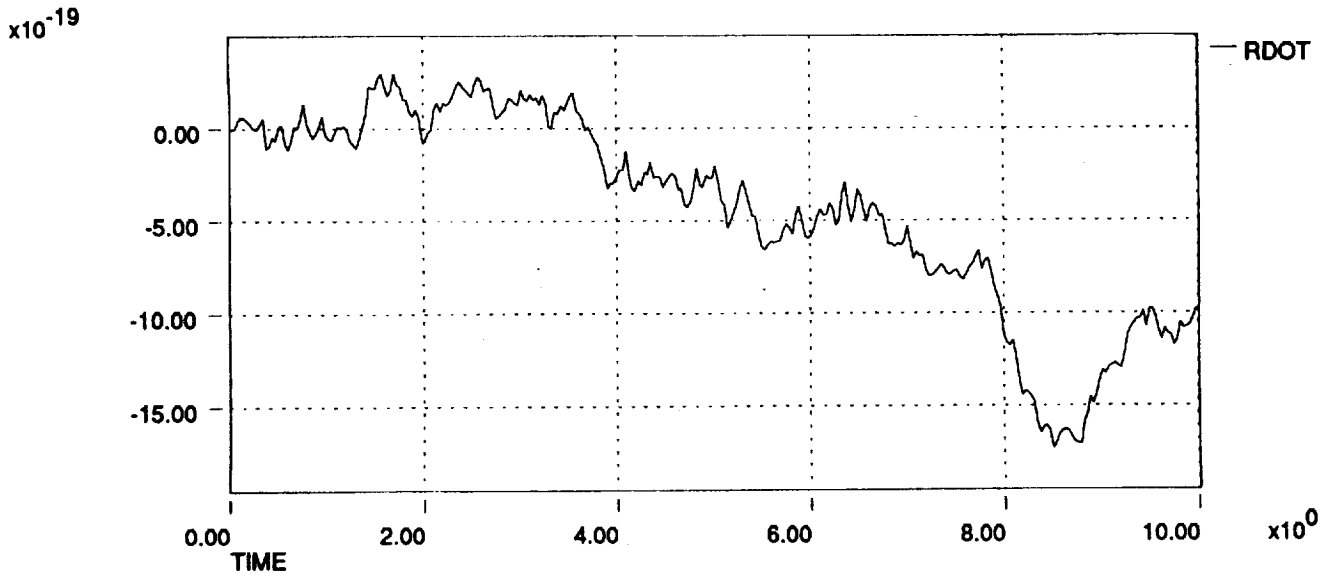
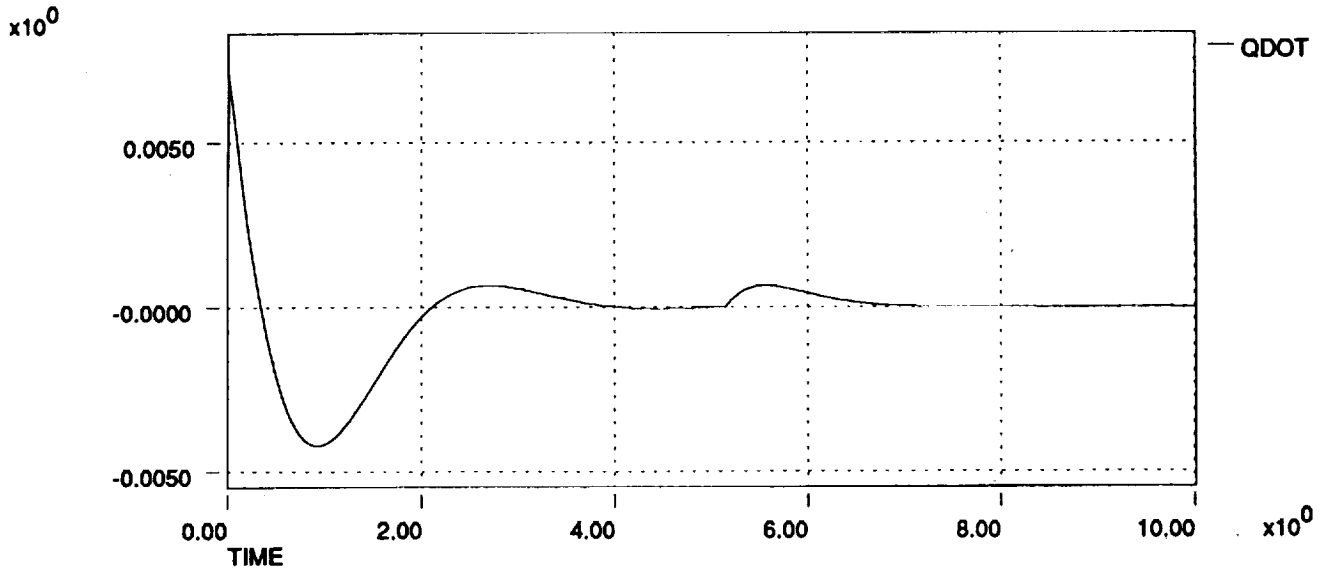
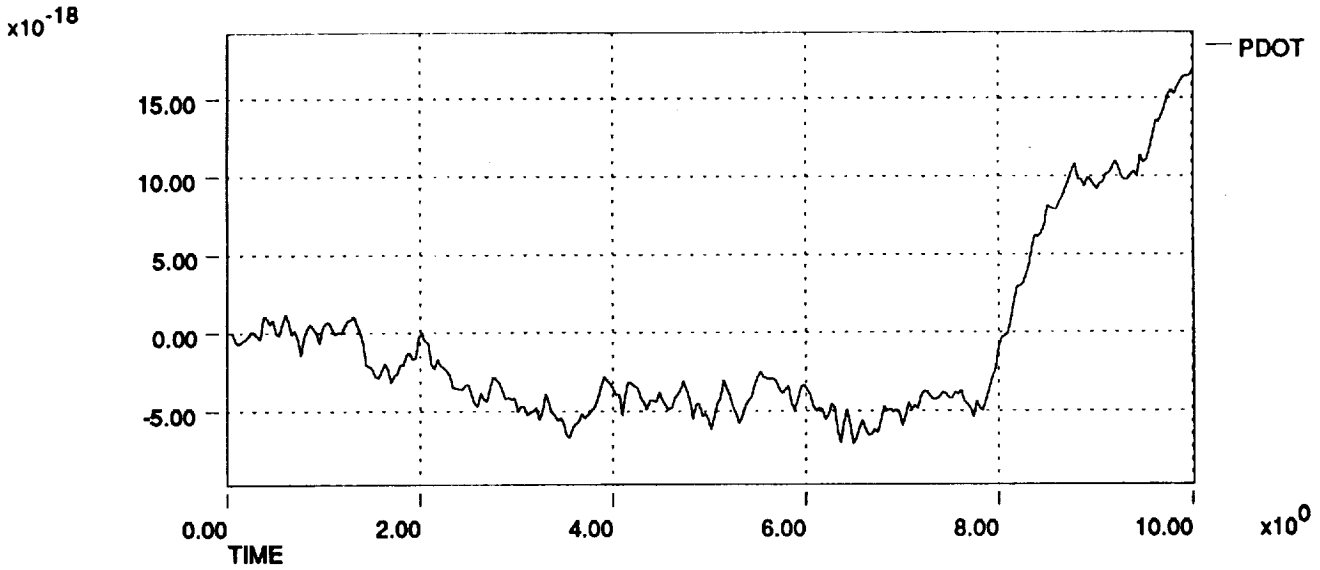

HL-20 Dynamic Check Case Data Plots 911206
Right Rudder Pedal Pulse at Mach 4 and 104,000 ft

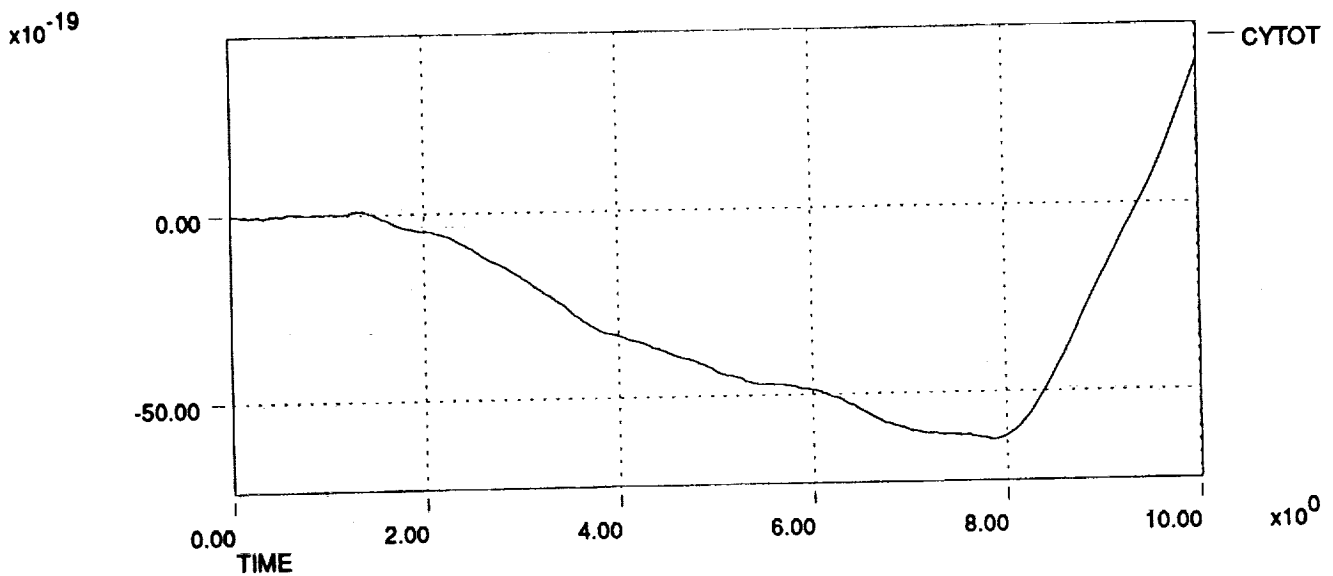
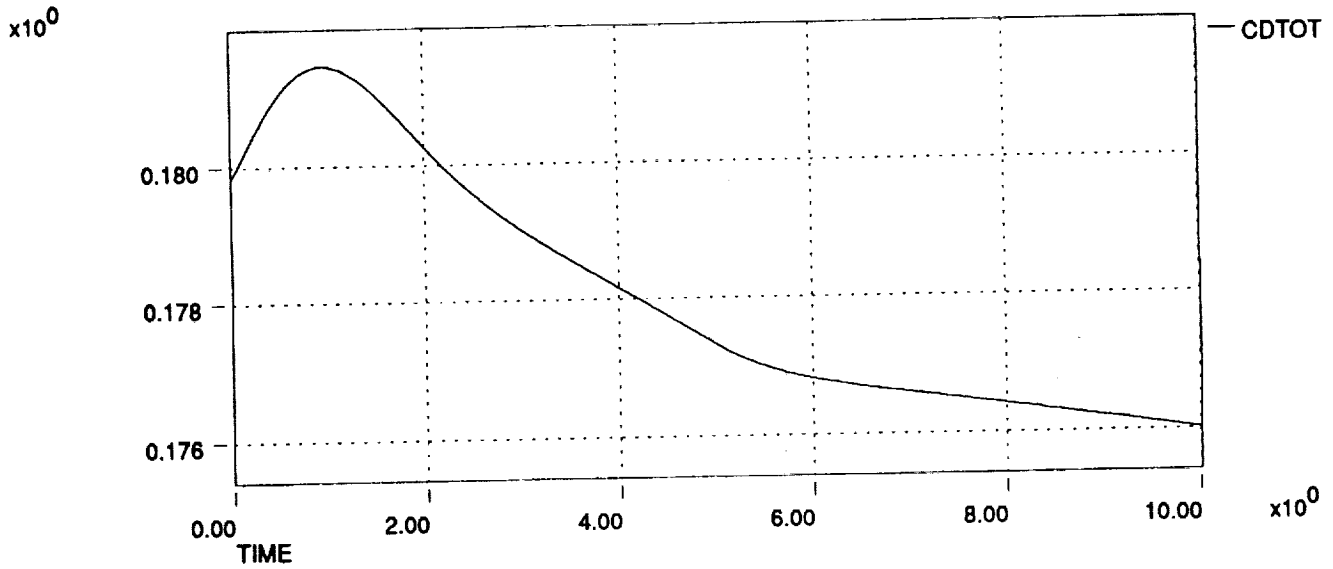
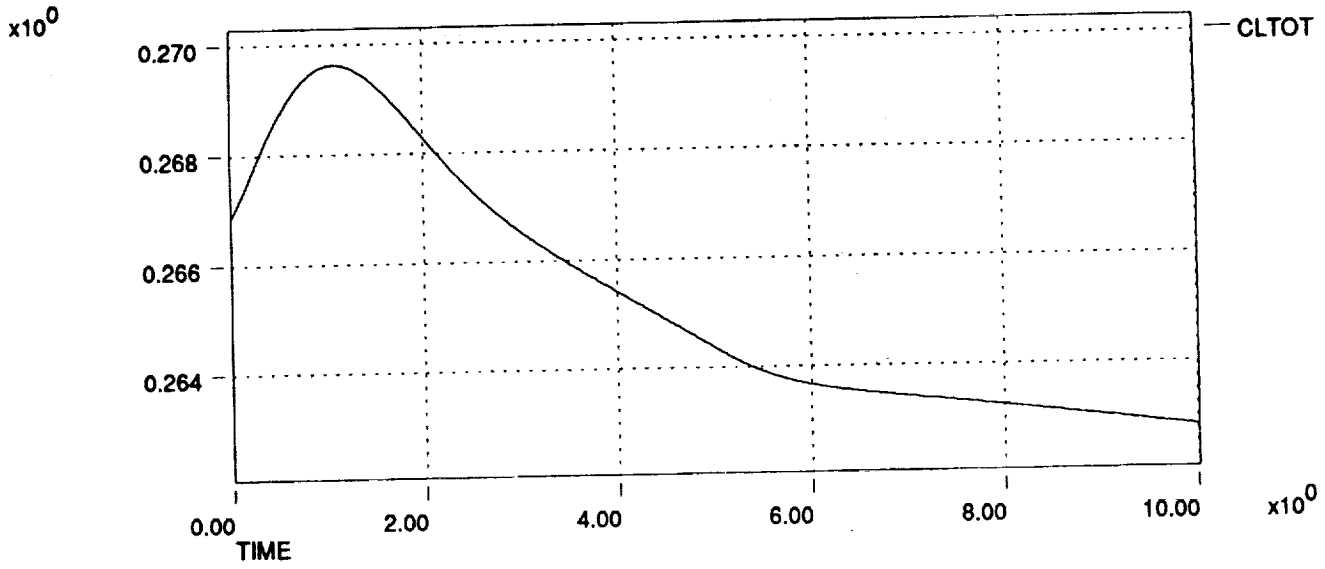

HL-20 Dynamic Check Case Data Plots 911206
Right Rudder Pedal Pulse at Mach 4 and 104,000 ft

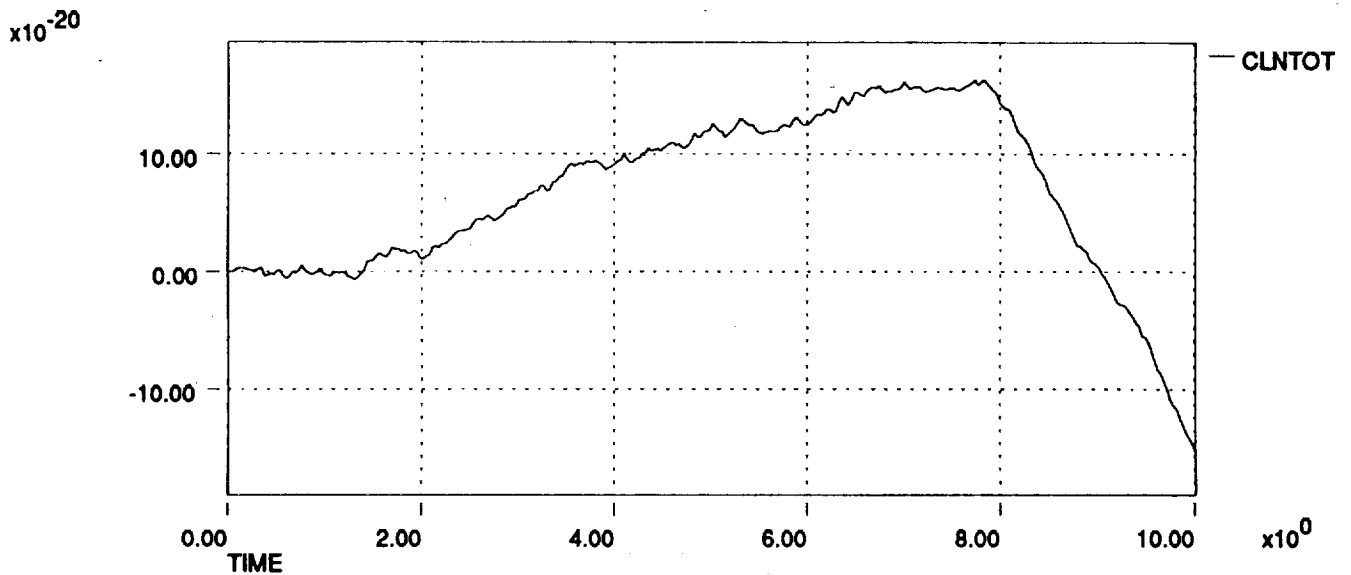
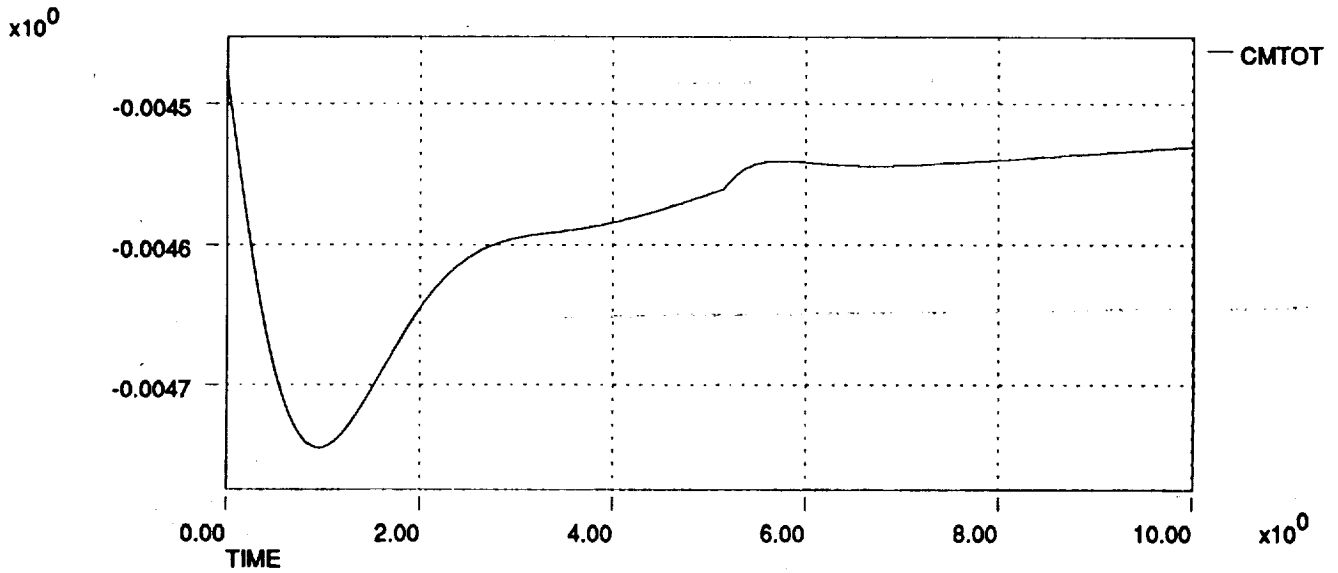
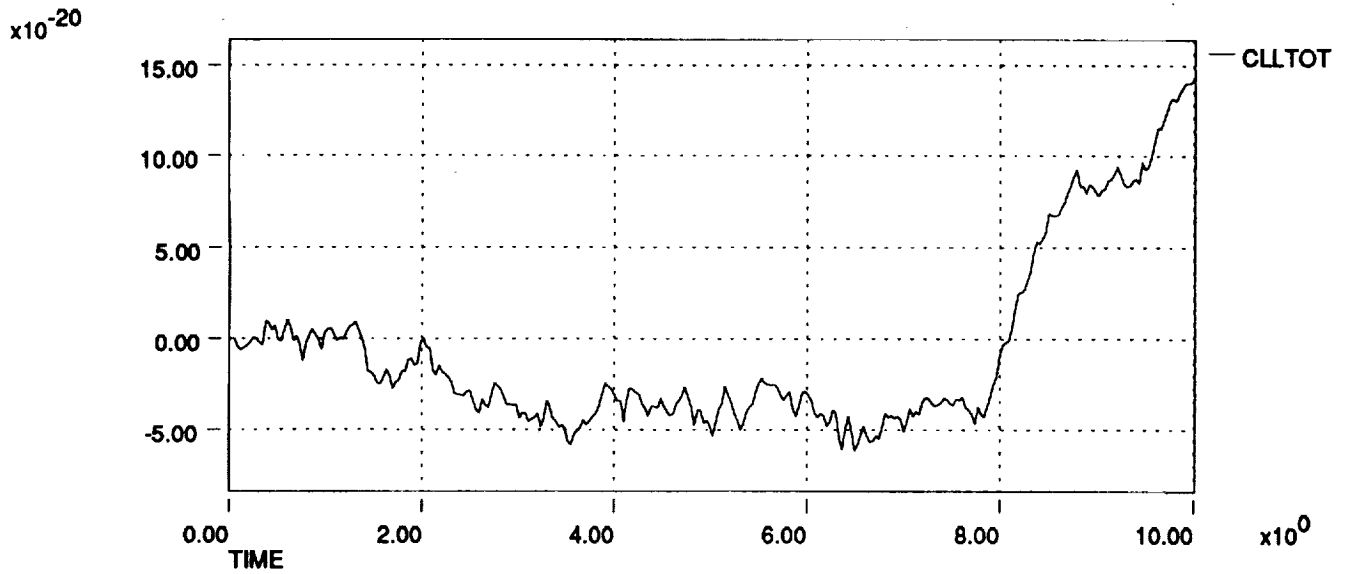

HL-20 Dynamic Check Case Data Plots 911206
Right Rudder Pedal Pulse at Mach 4 and 104,000 ft

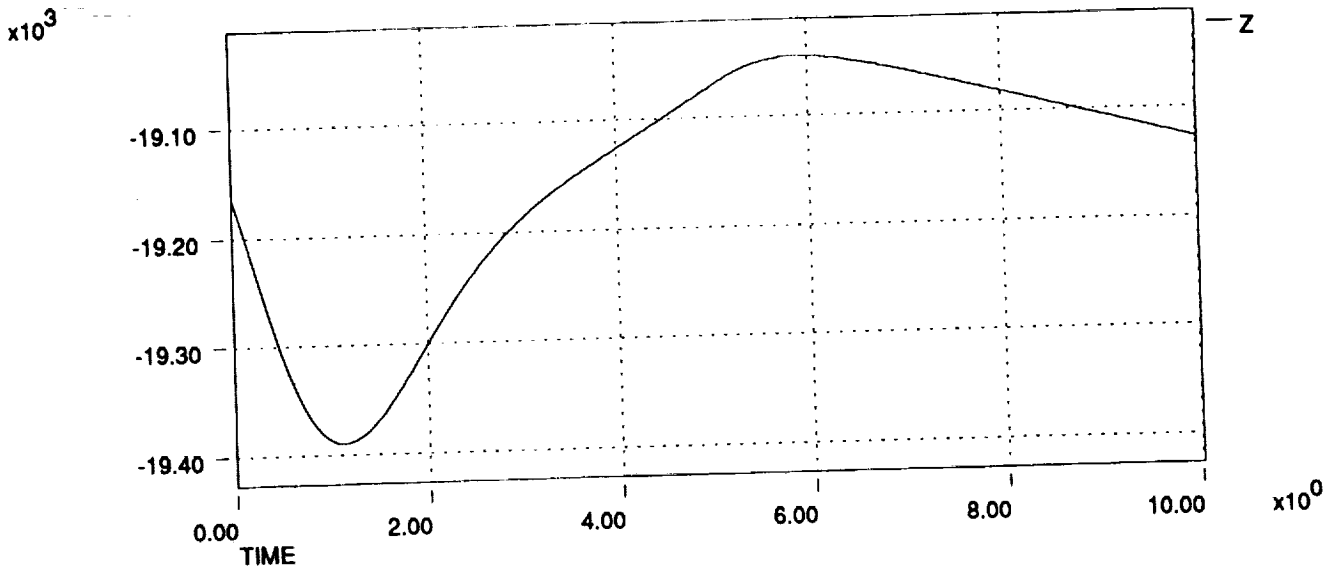
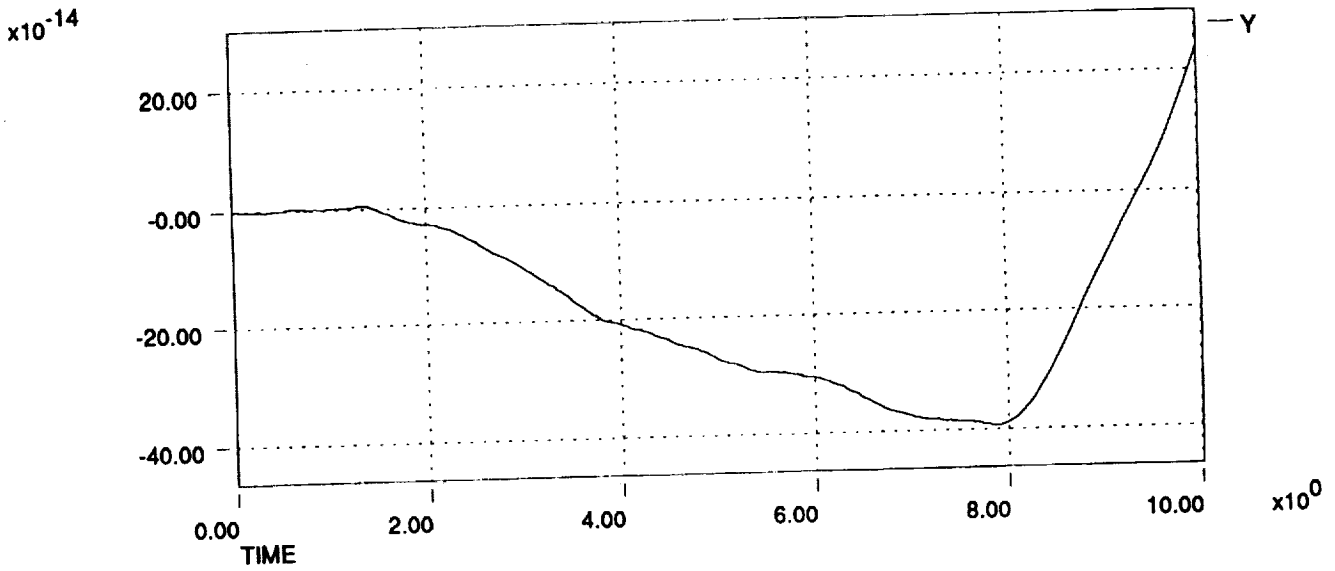
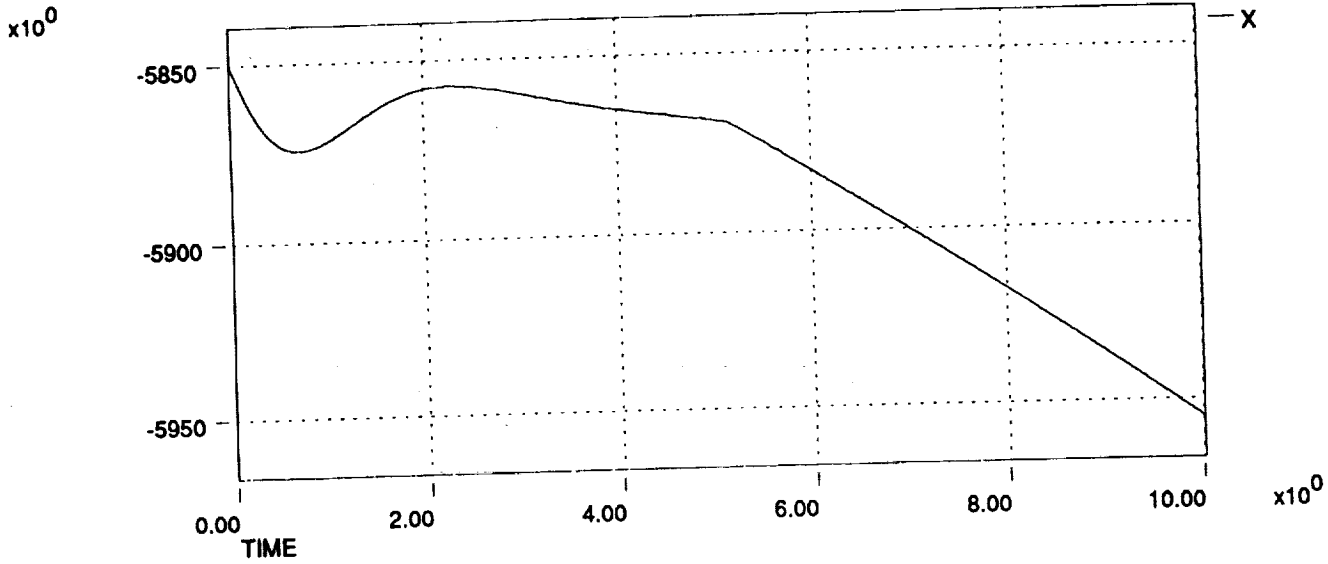

$\times 10^{-14}$

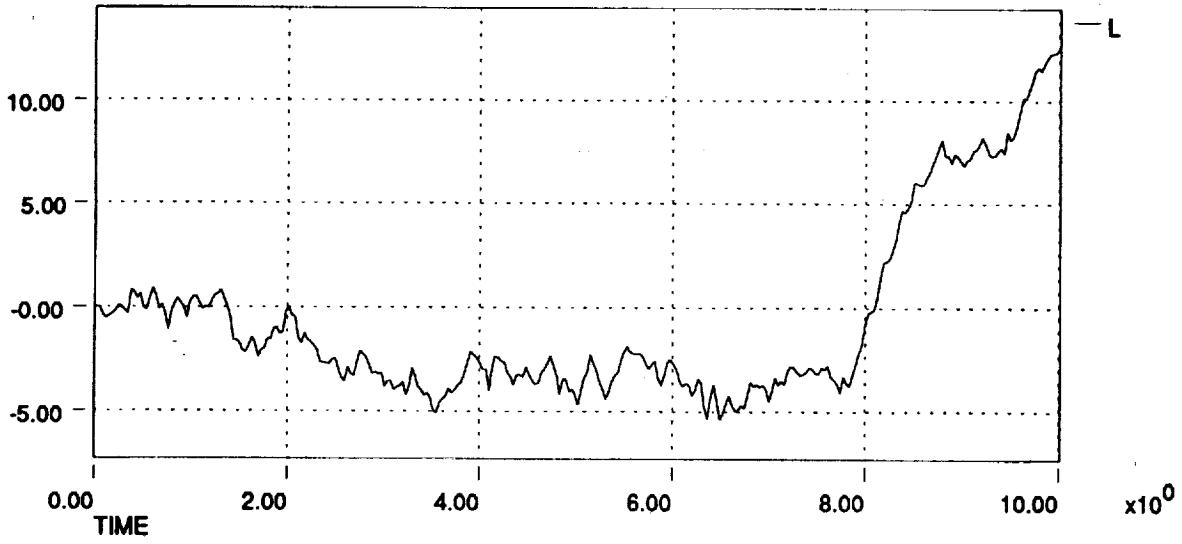

$\times 10^0$

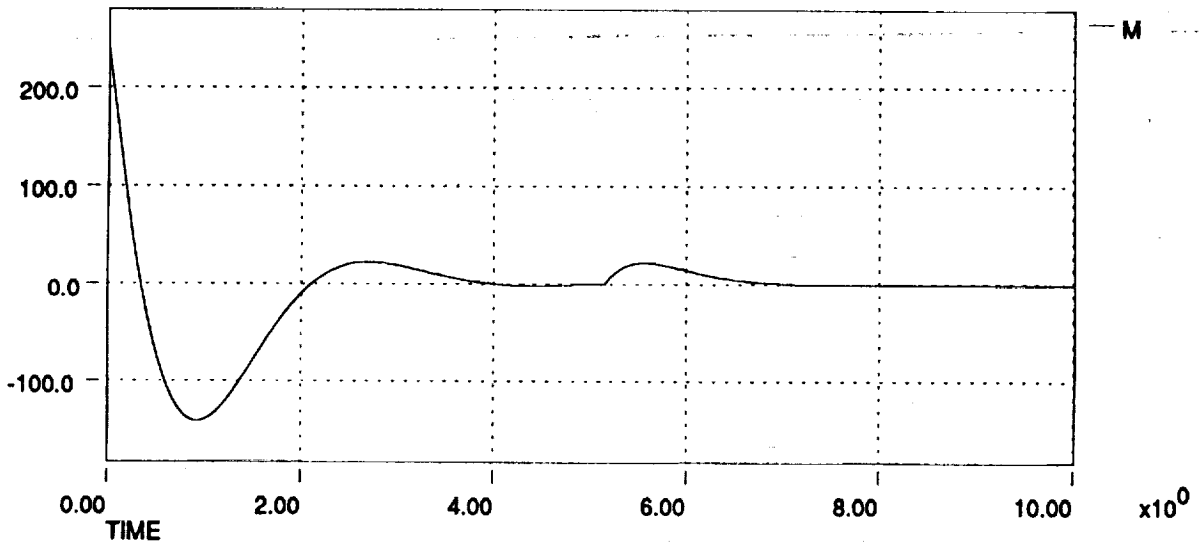

$\times 10^{-15}$

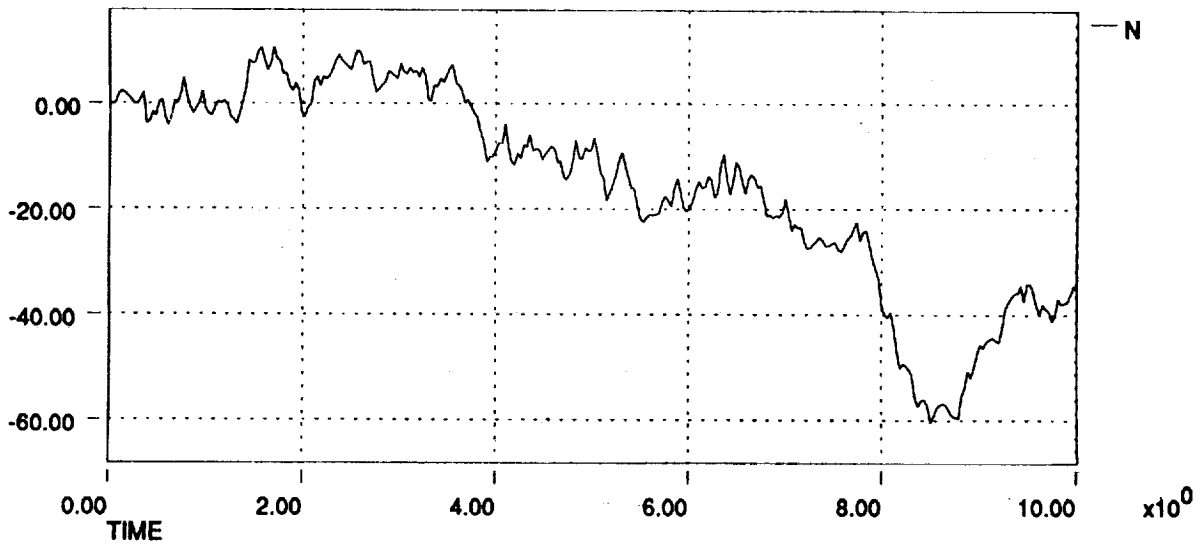

HL-20 Dynamic Check Case Data Plots 911206
Right Rudder Pedal Pulse at Mach 4 and 104,000 ft

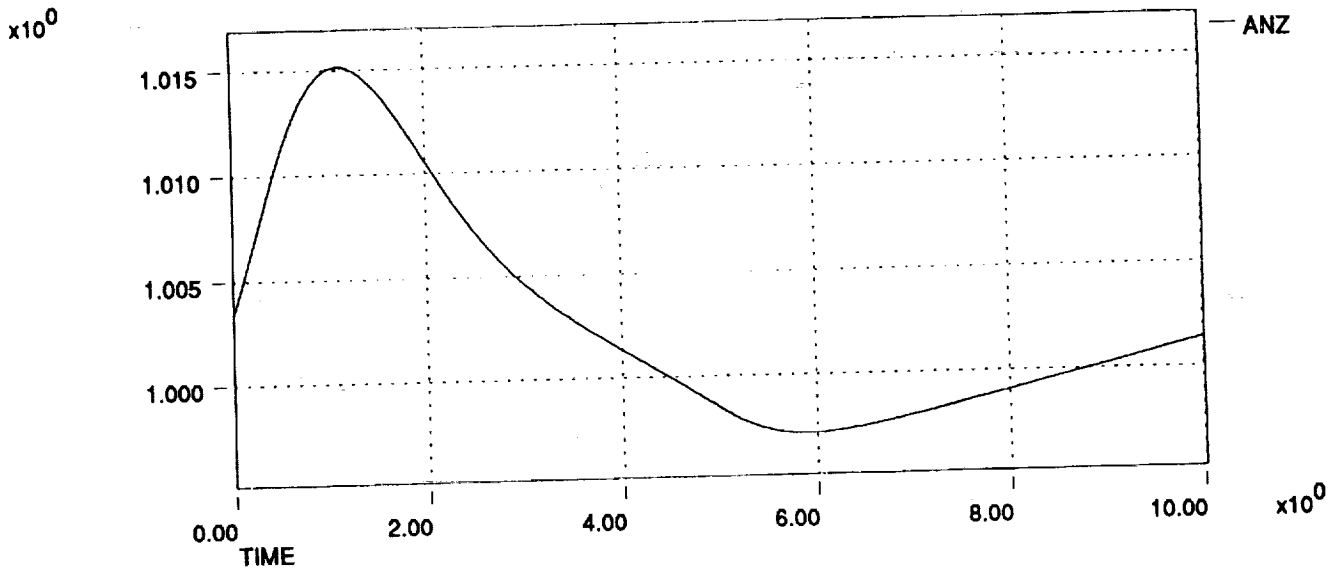
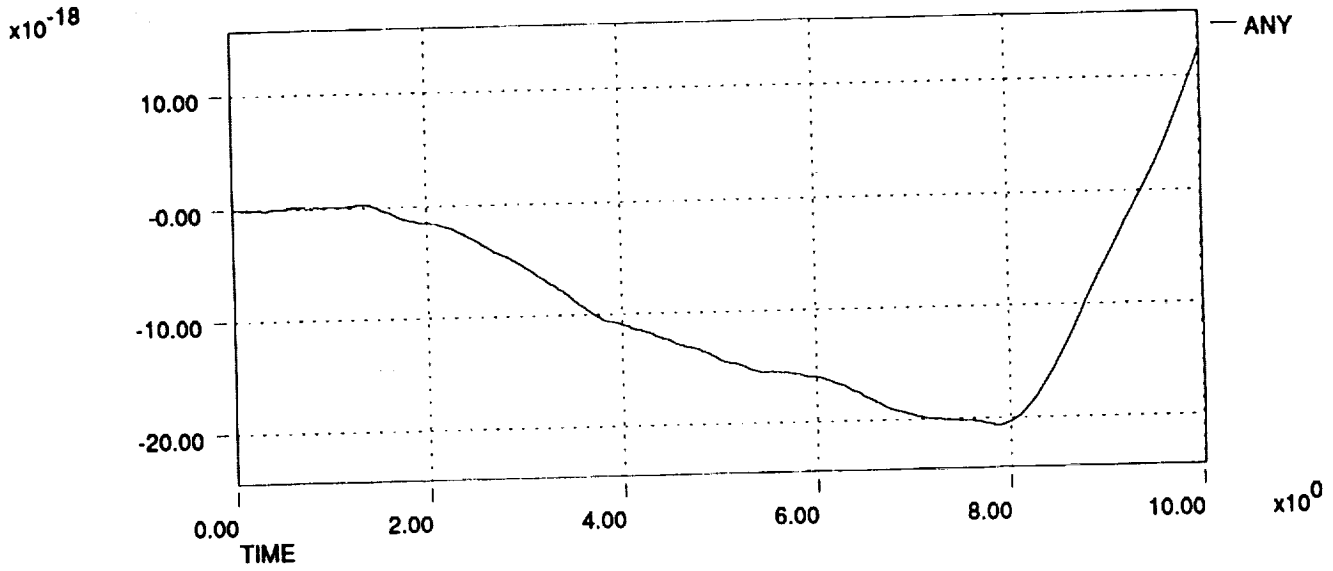
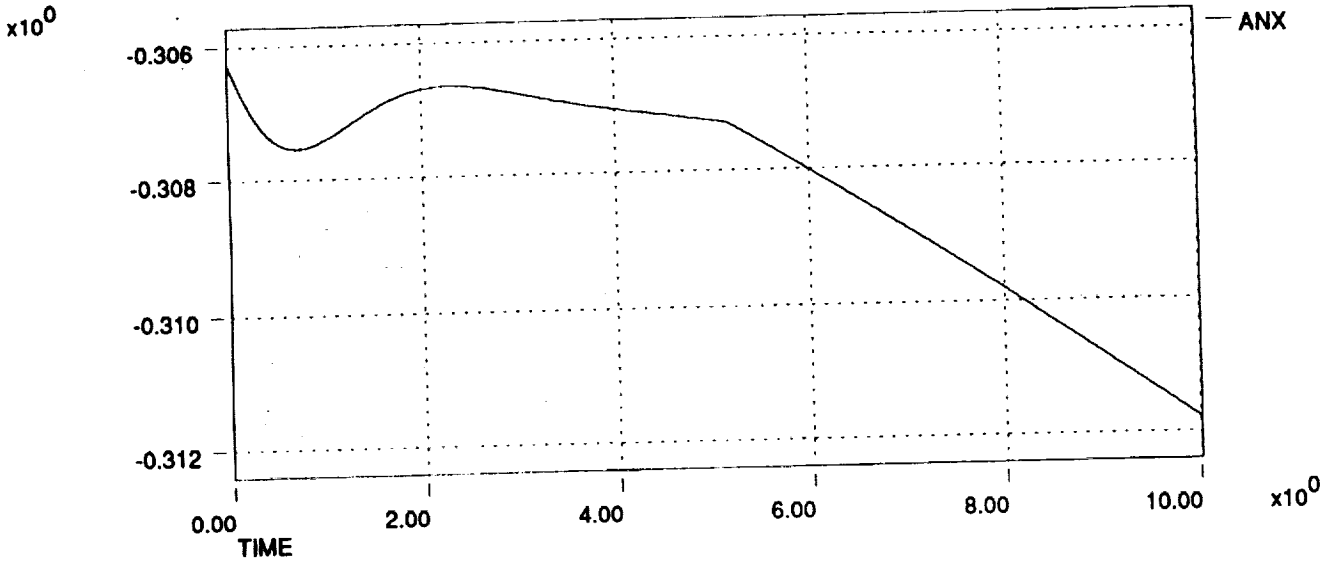

HL-20 Dynamic Check Case Data Plots 911206
Right Rudder Pedal Pulse at Mach 4 and 104,000 ft

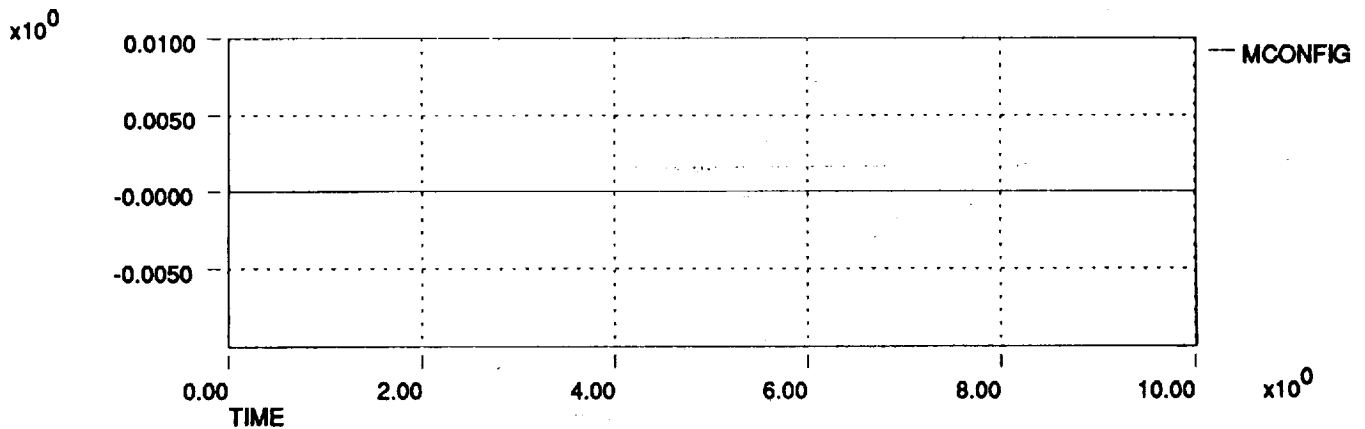
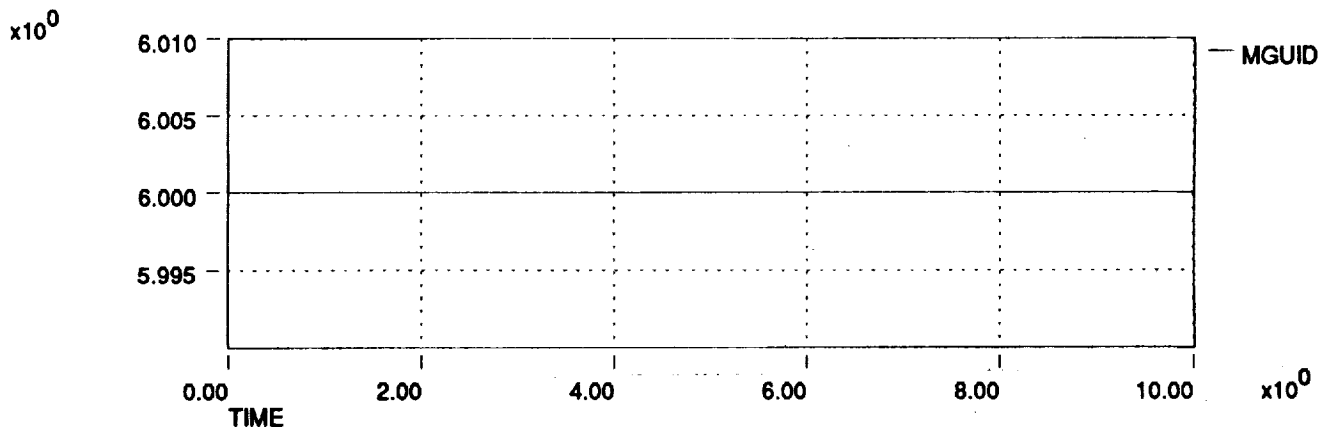
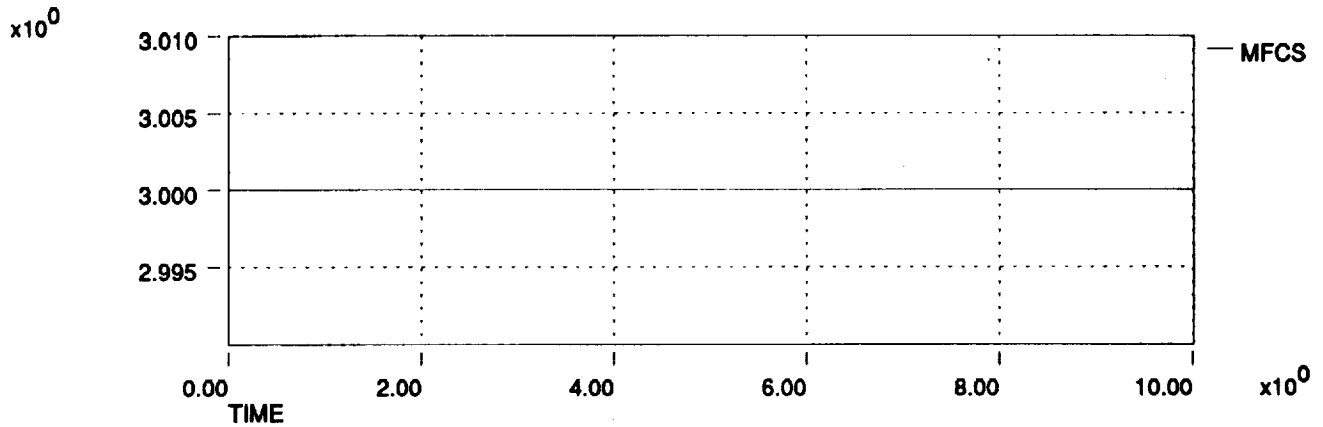
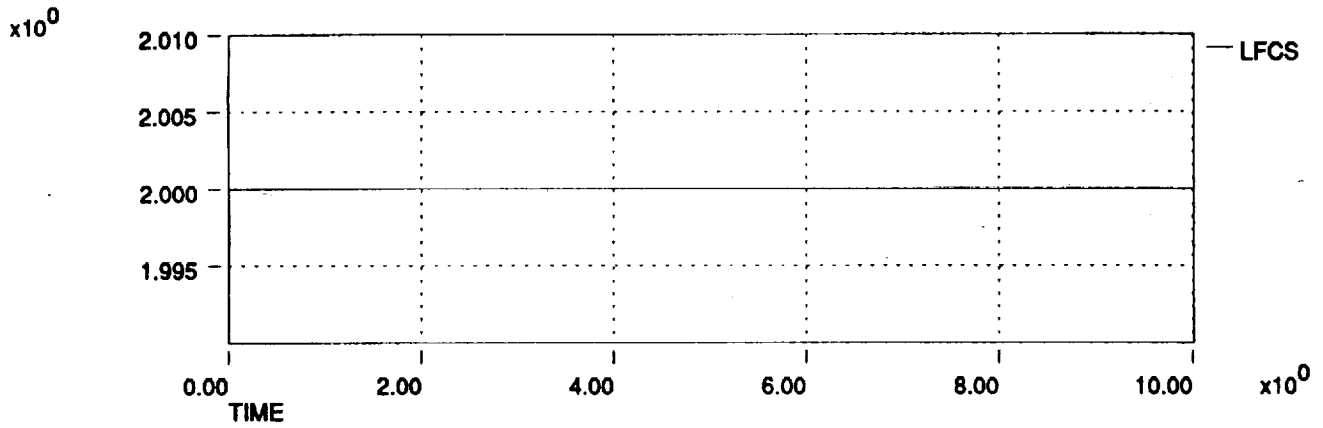

HL-20 Dynamic Check Case Data Plots 911206
Right Rudder Pedal Pulse at Mach 4 and 104,000 ft

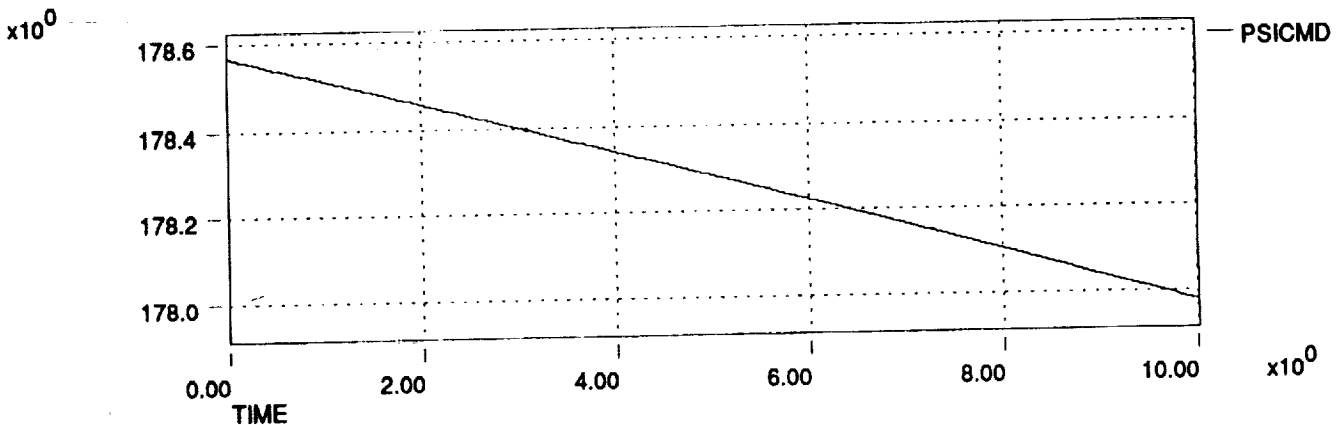
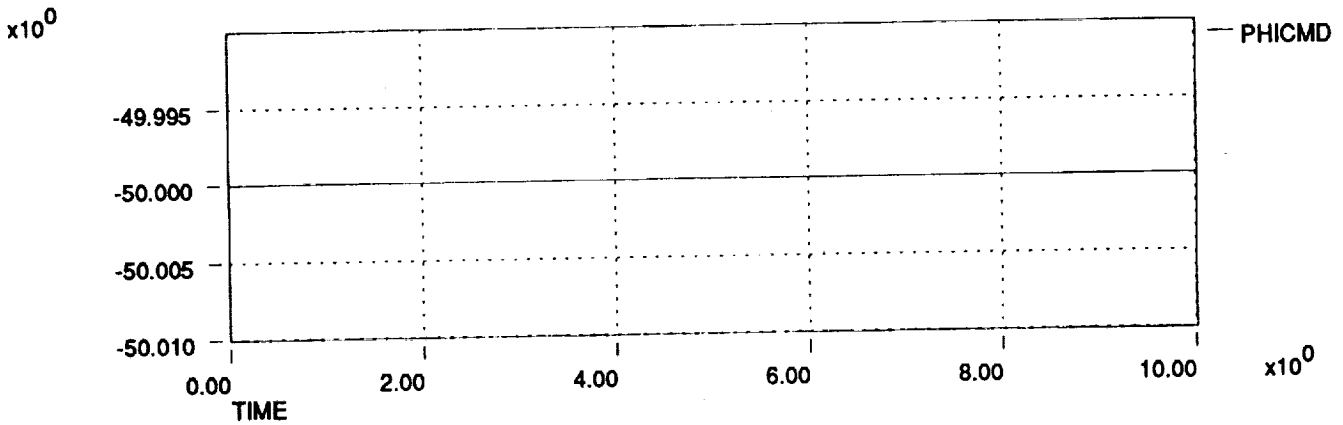
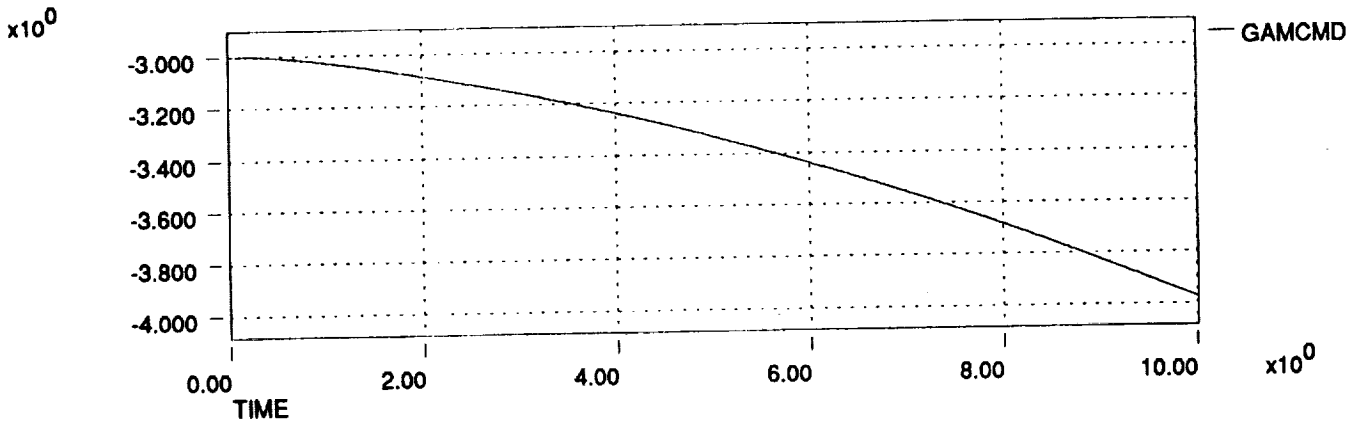
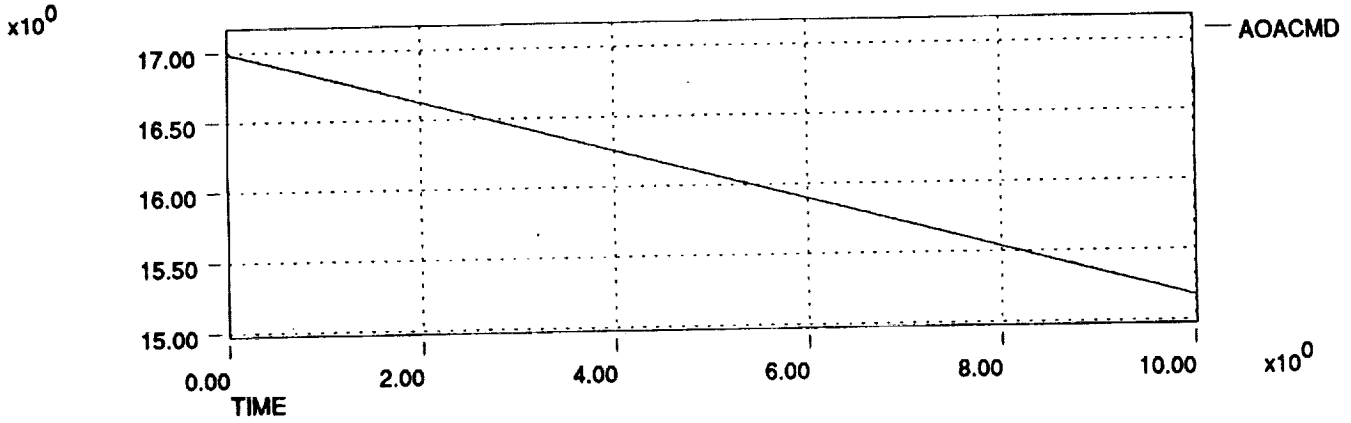

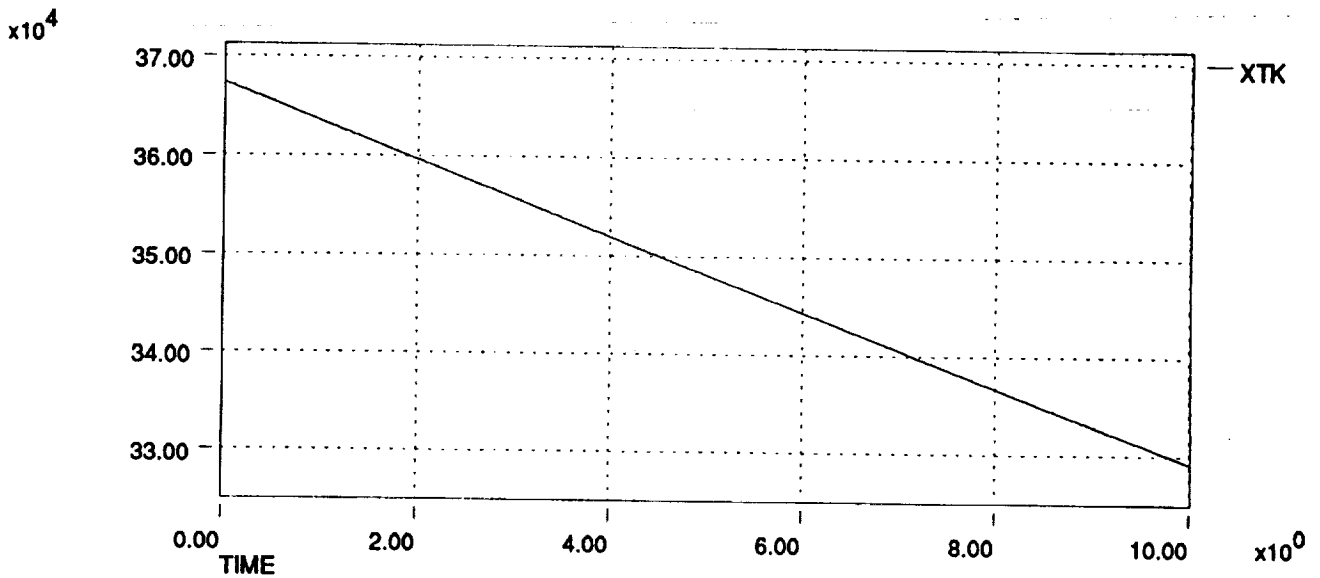
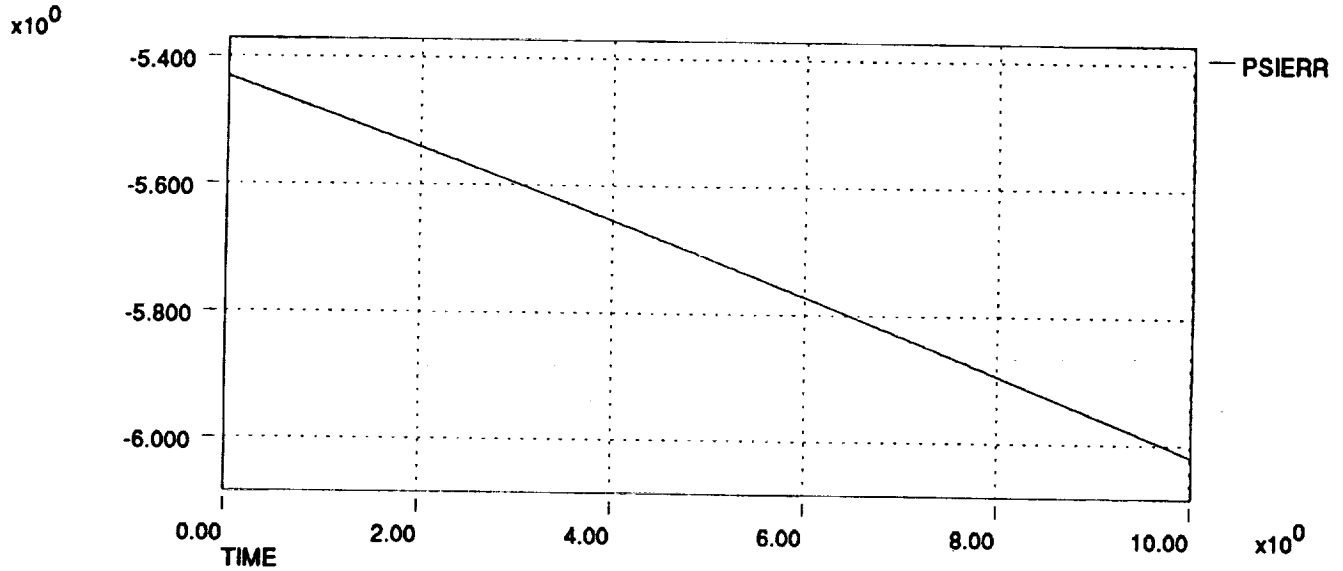
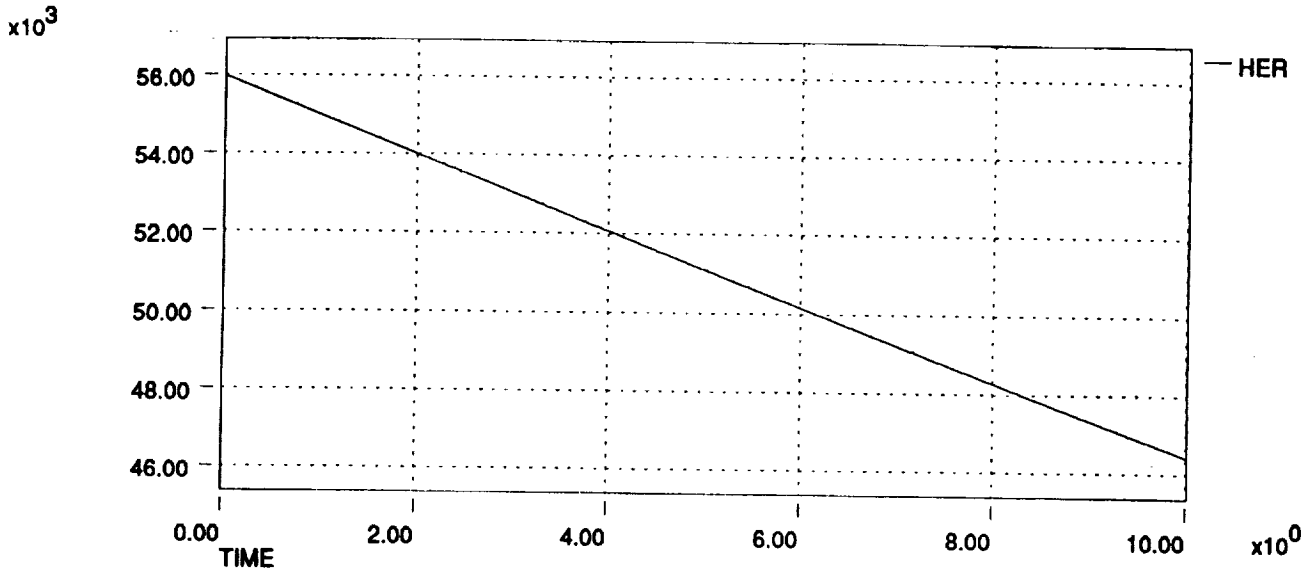

HL-20 Dynamic Check Case Data Plots 911206
Right Rudder Pedal Pulse at Mach 4 and 104,000 ft

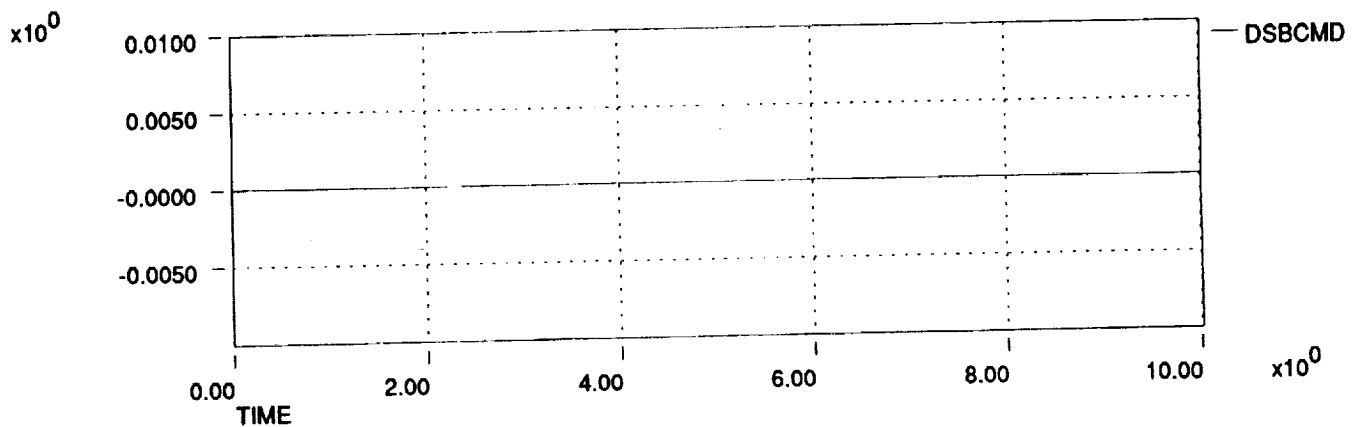
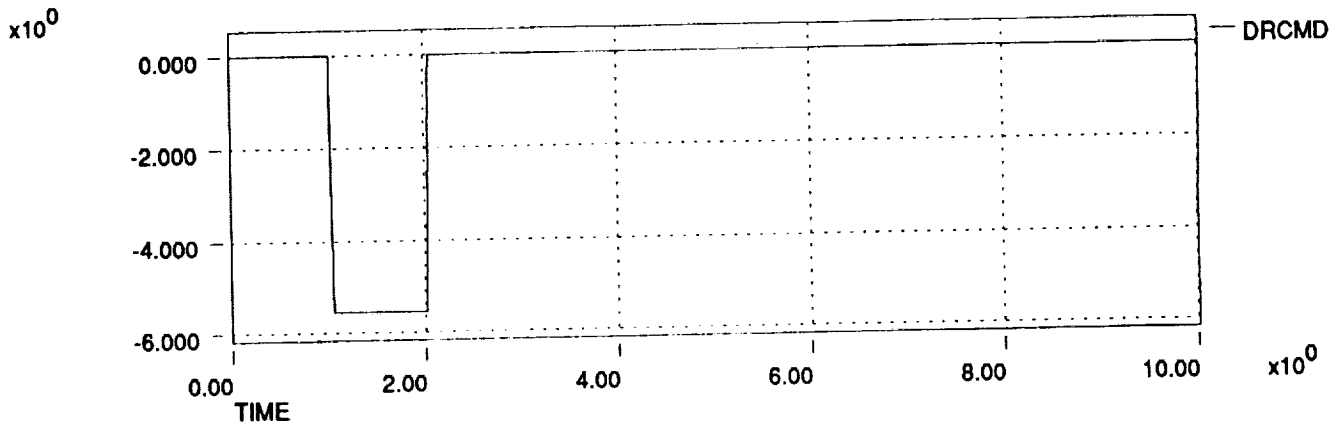
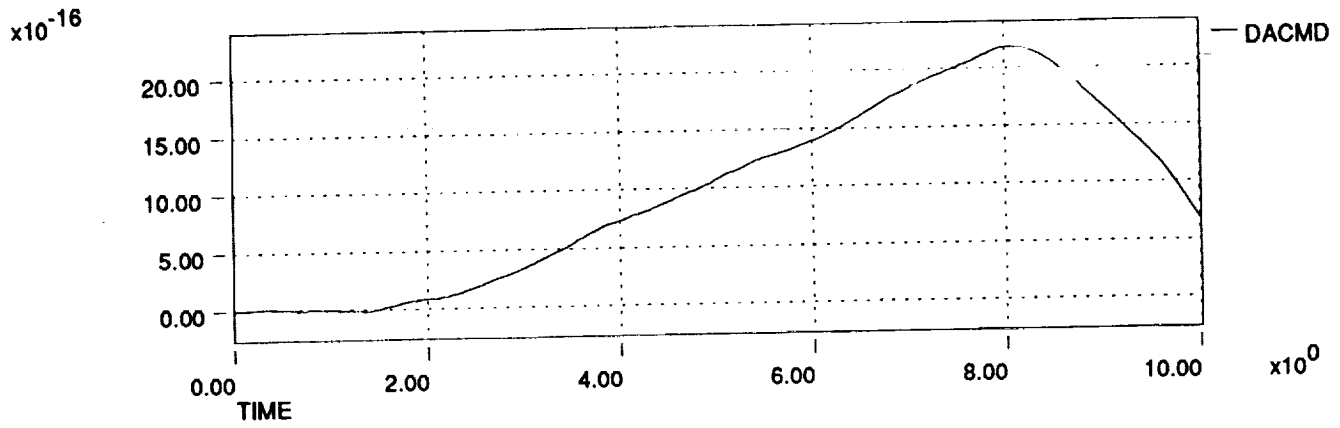
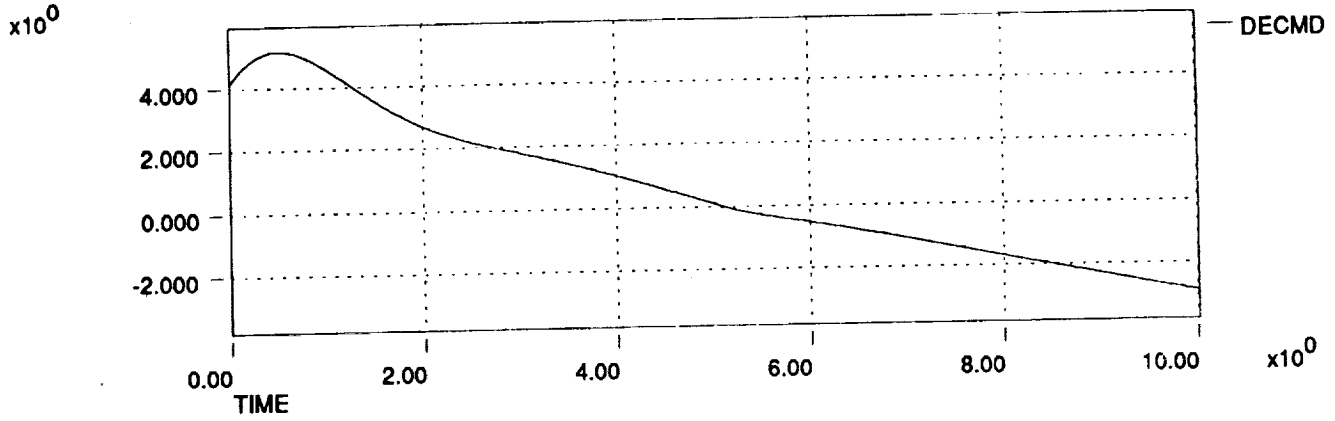

HL-20 Dynamic Check Case Data Plots 911206
Right Rudder Pedal Pulse at Mach 4 and 104,000 ft

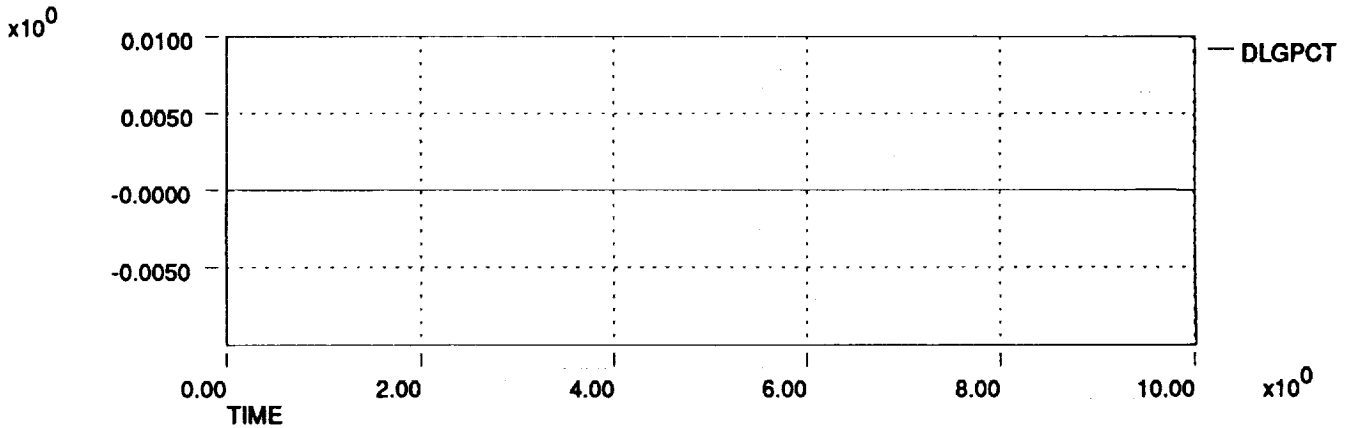
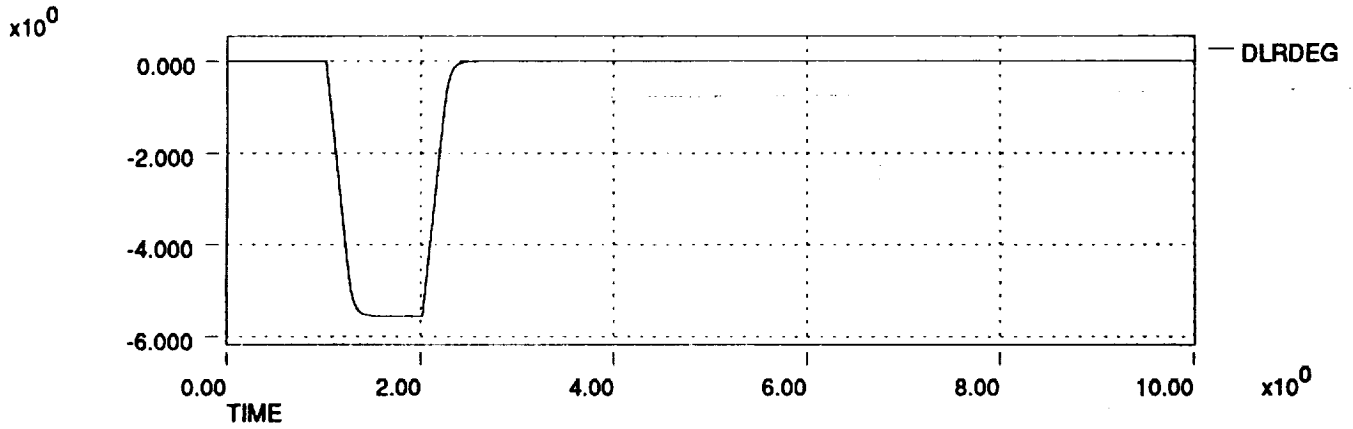
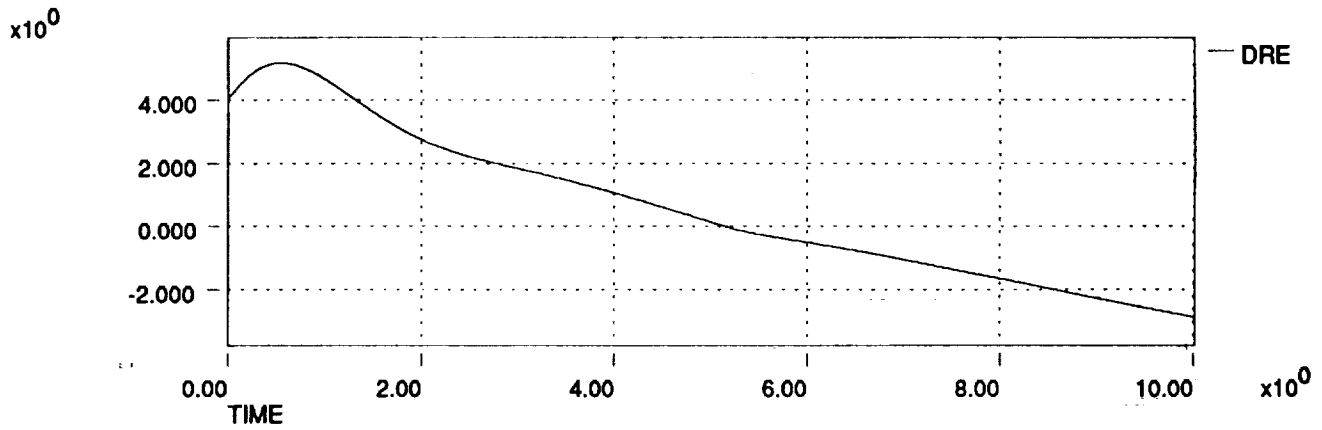
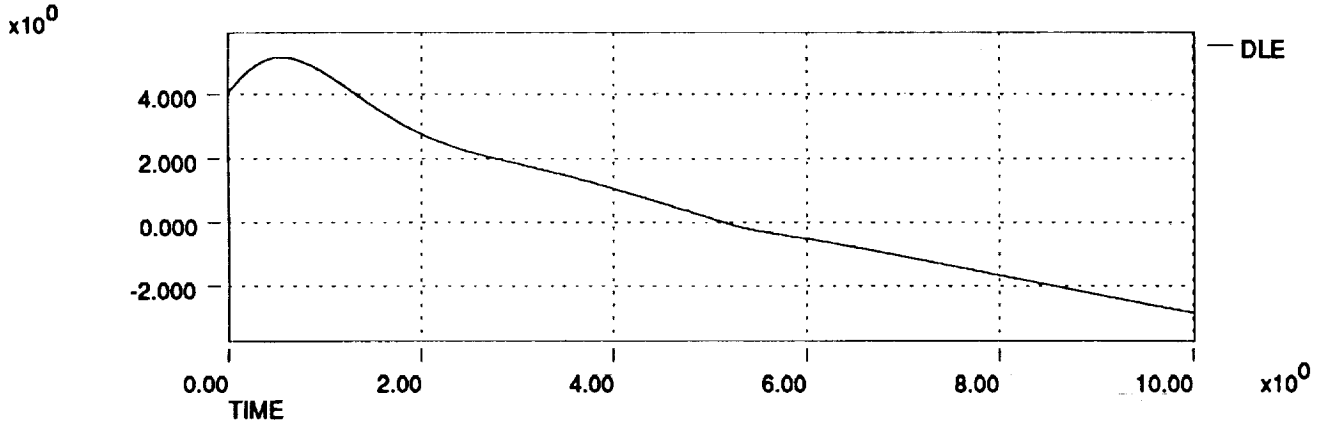

HL-20 Dynamic Check Case Data Plots 911206
Right Rudder Pedal Pulse at Mach 4 and 104,000 ft

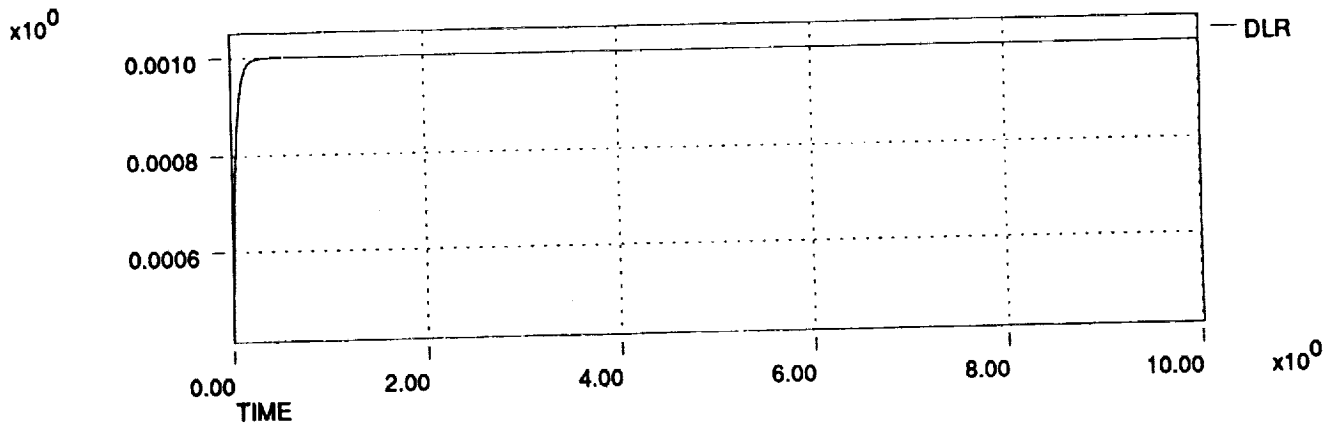
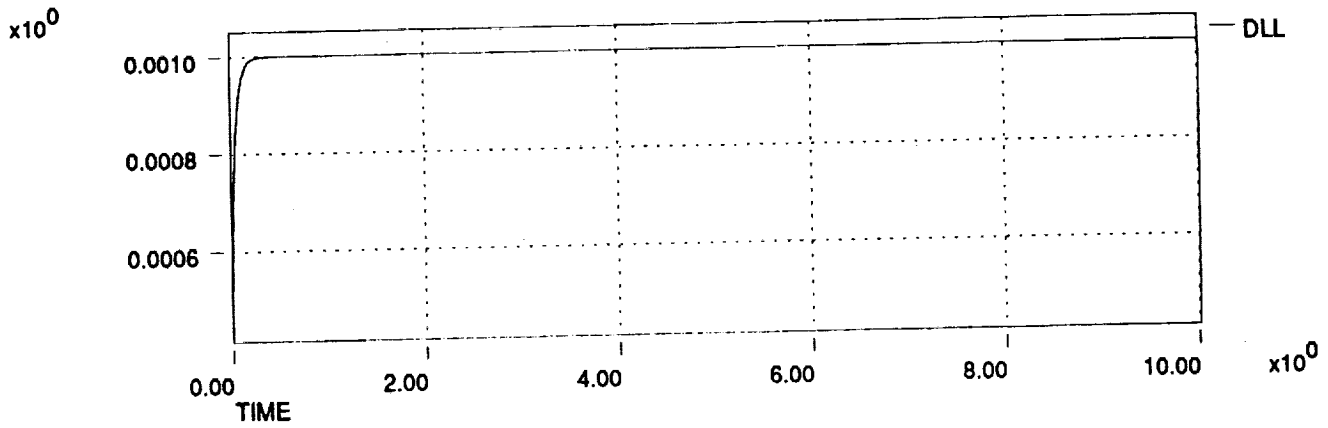
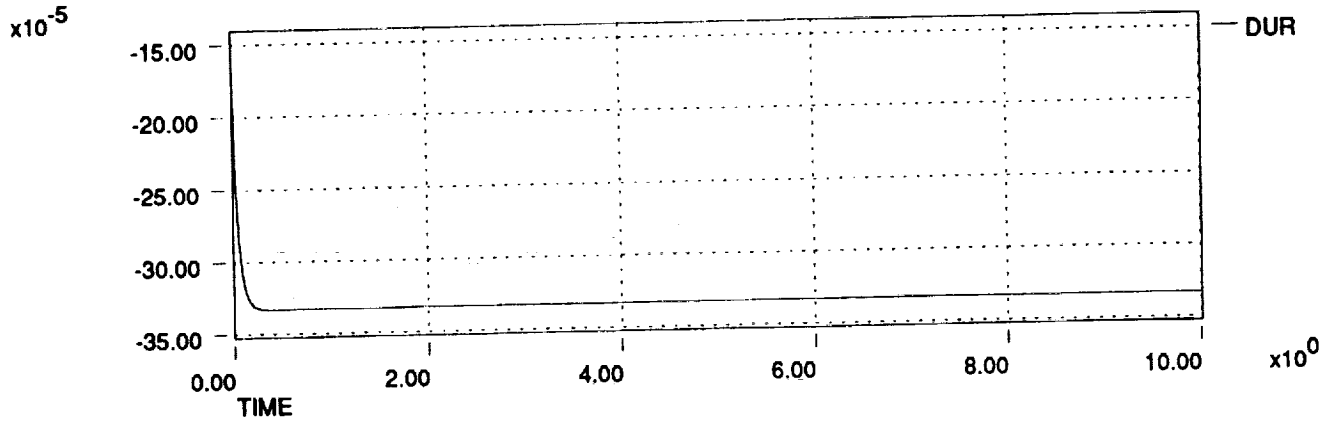
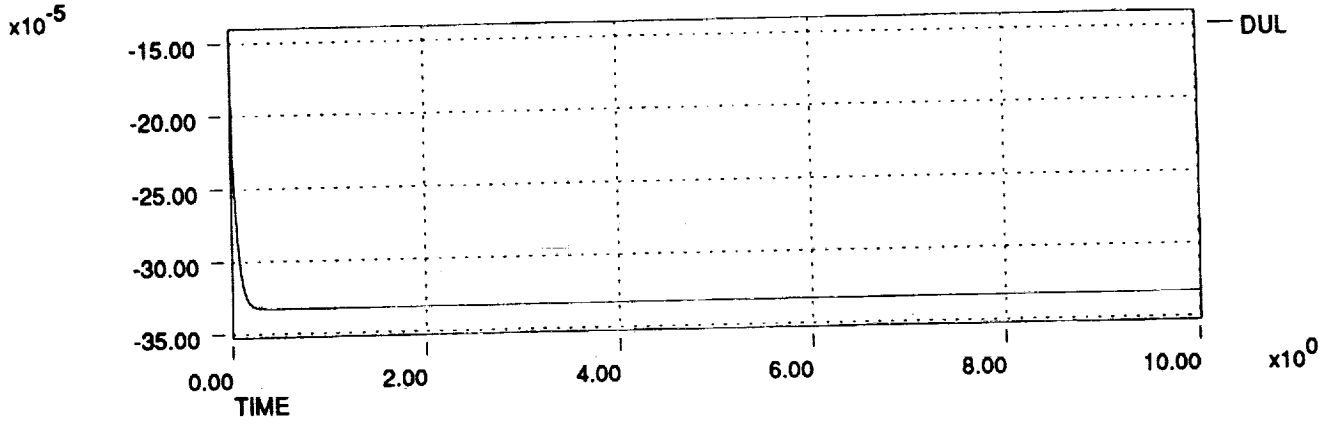

HL-20 Dynamic Check Case Data Plots 911206
Speed Brake Handle Pulse at Mach 4 and 104,000 ft

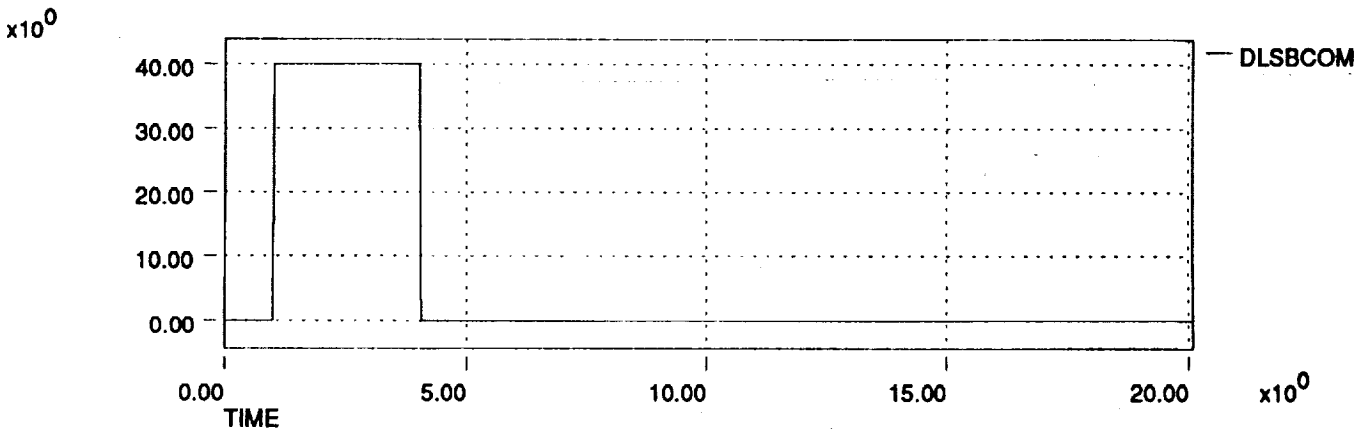
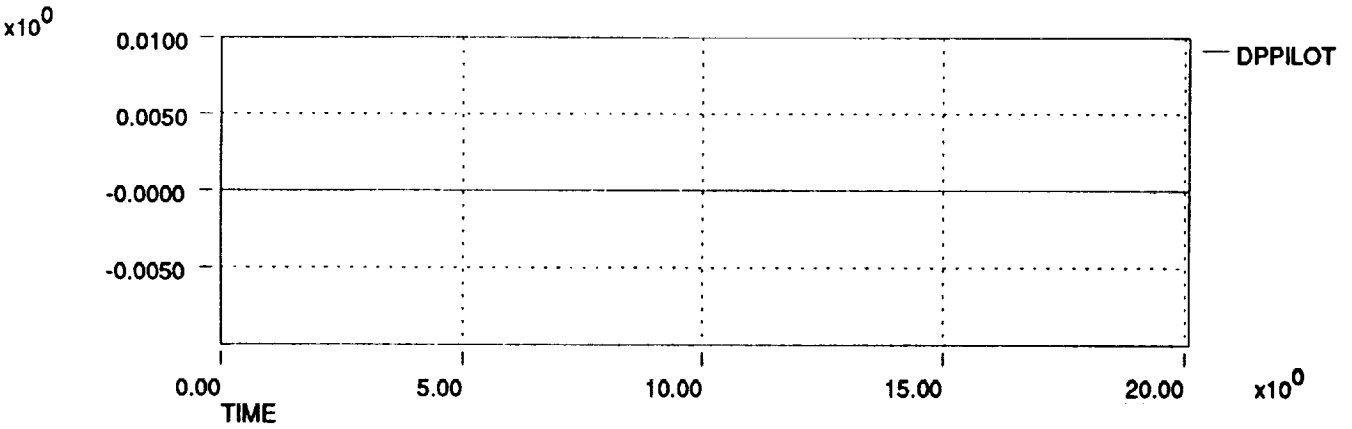
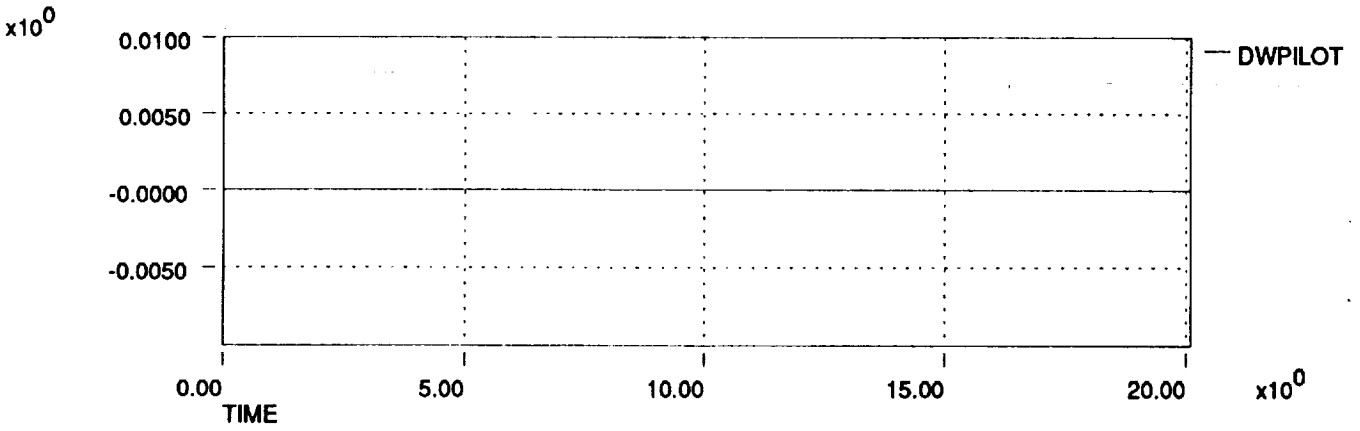
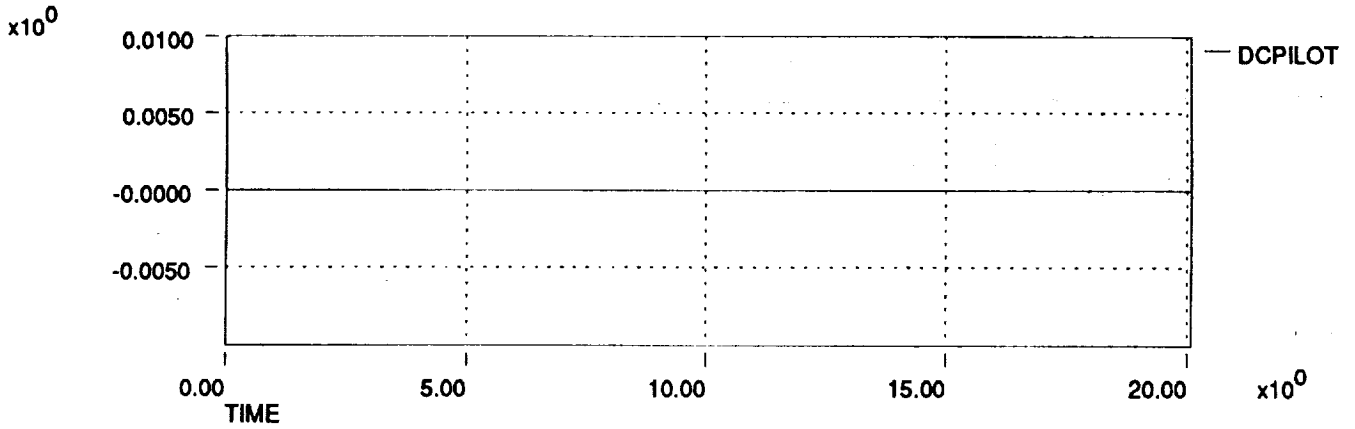

HL-20 Dynamic Check Case Data Plots 911206
Speed Brake Handle Pulse at Mach 4 and 104,000 ft

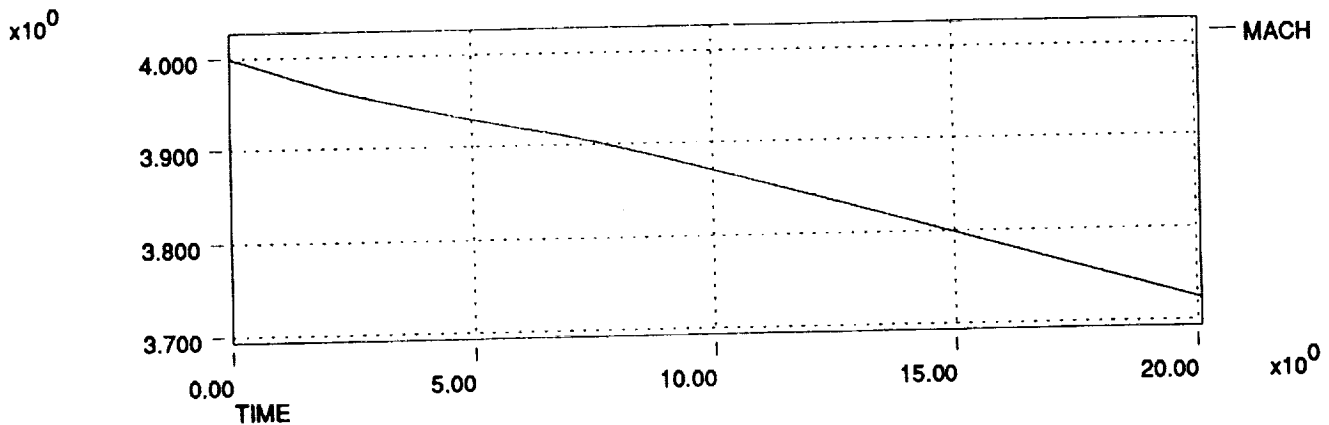
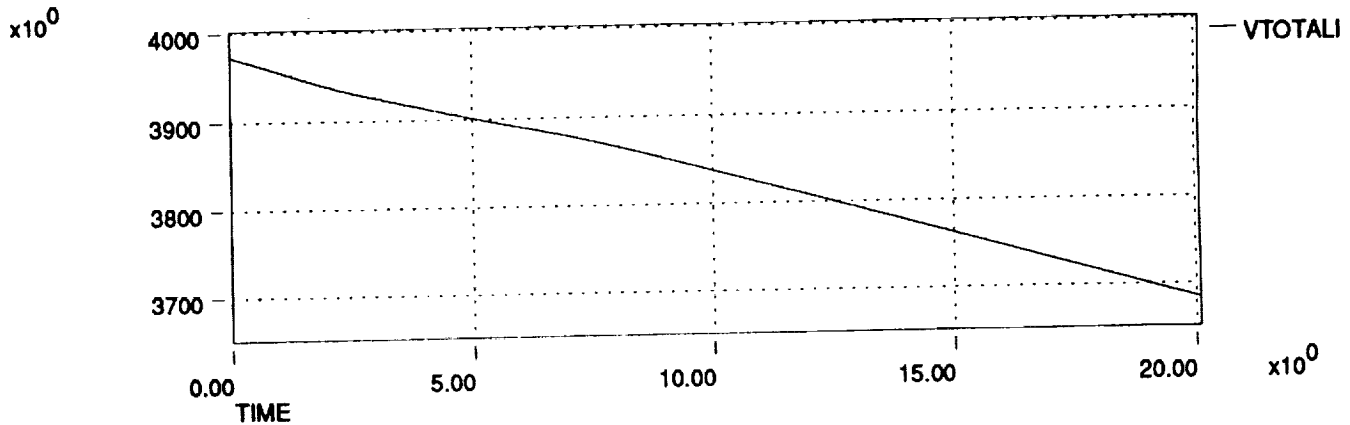
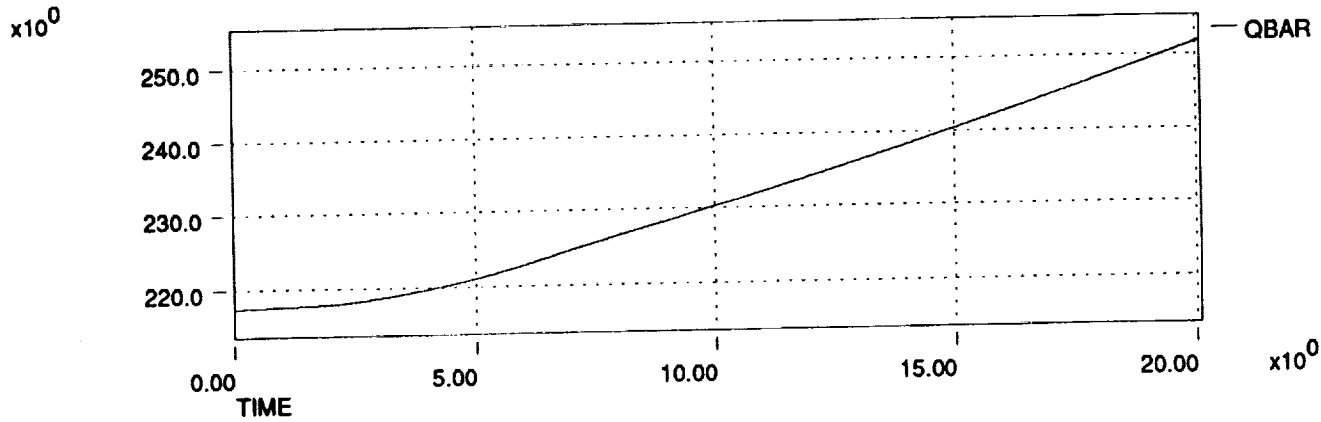
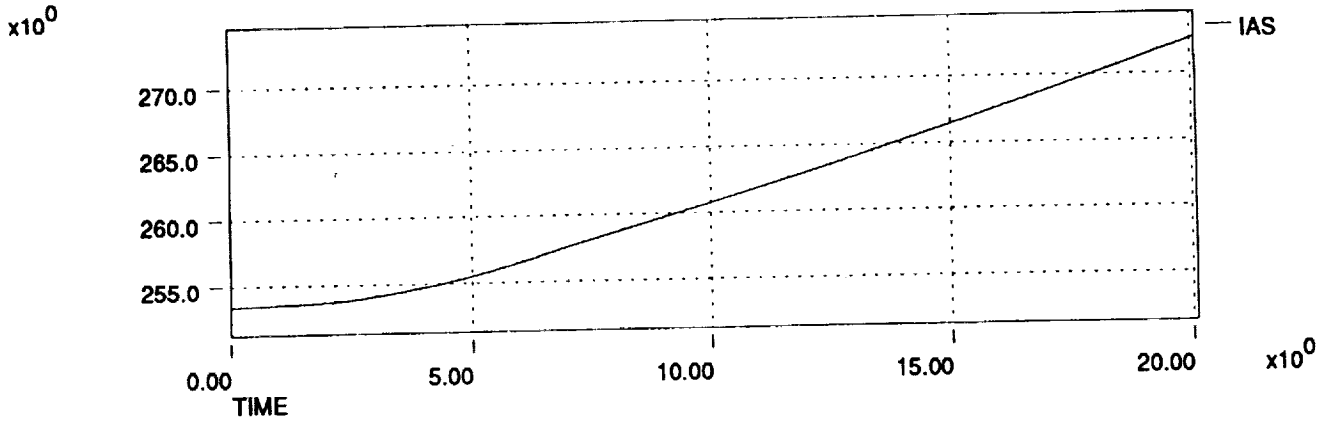

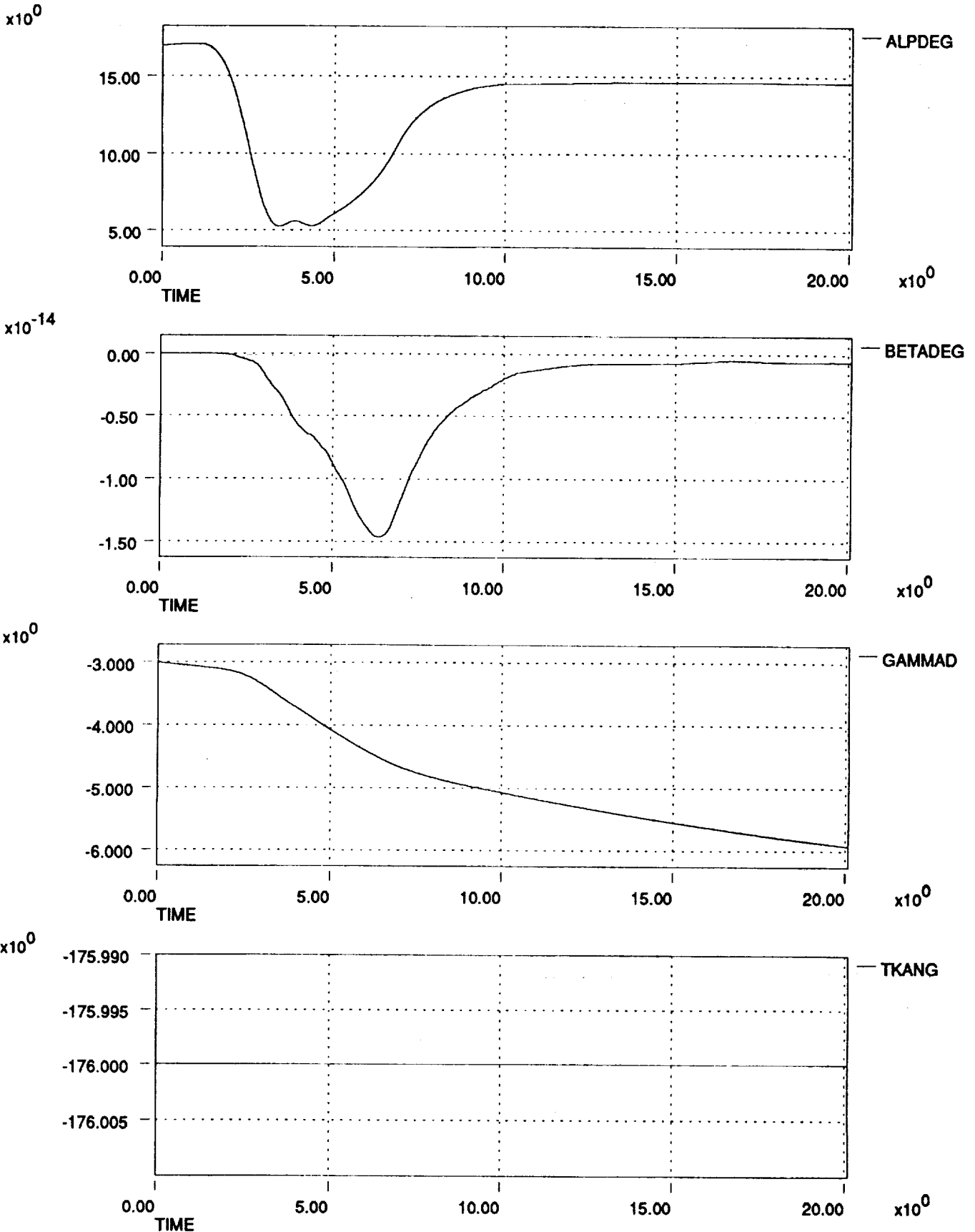

HL-20 Dynamic Check Case Data Plots 911206
Speed Brake Handle Pulse at Mach 4 and 104,000 ft

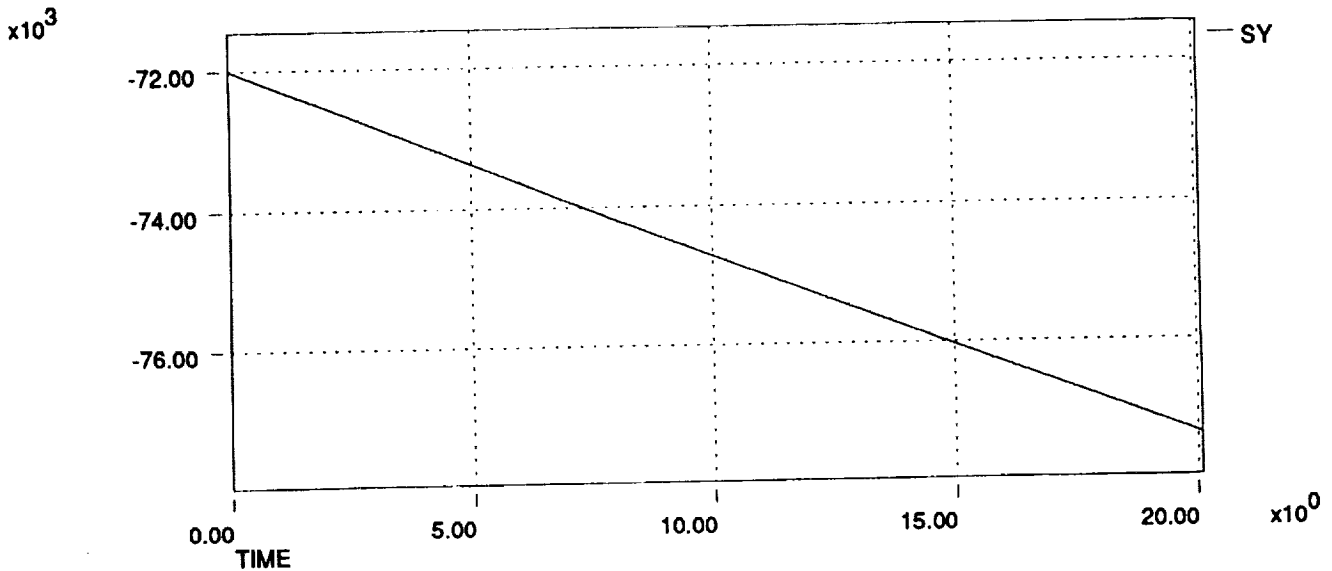
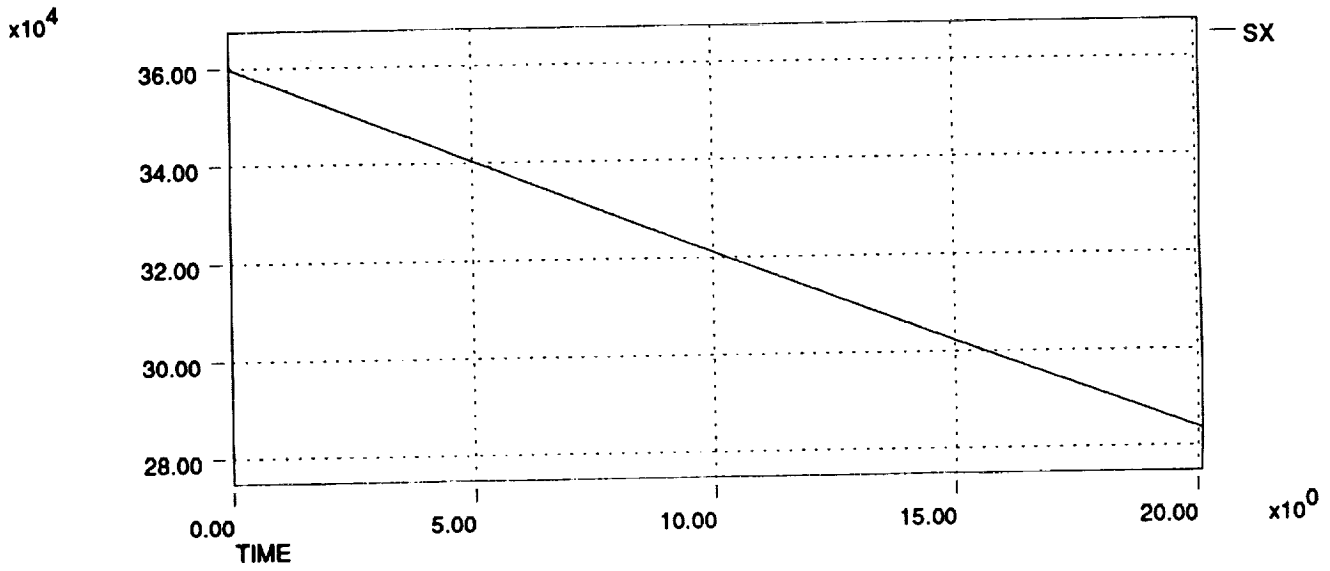
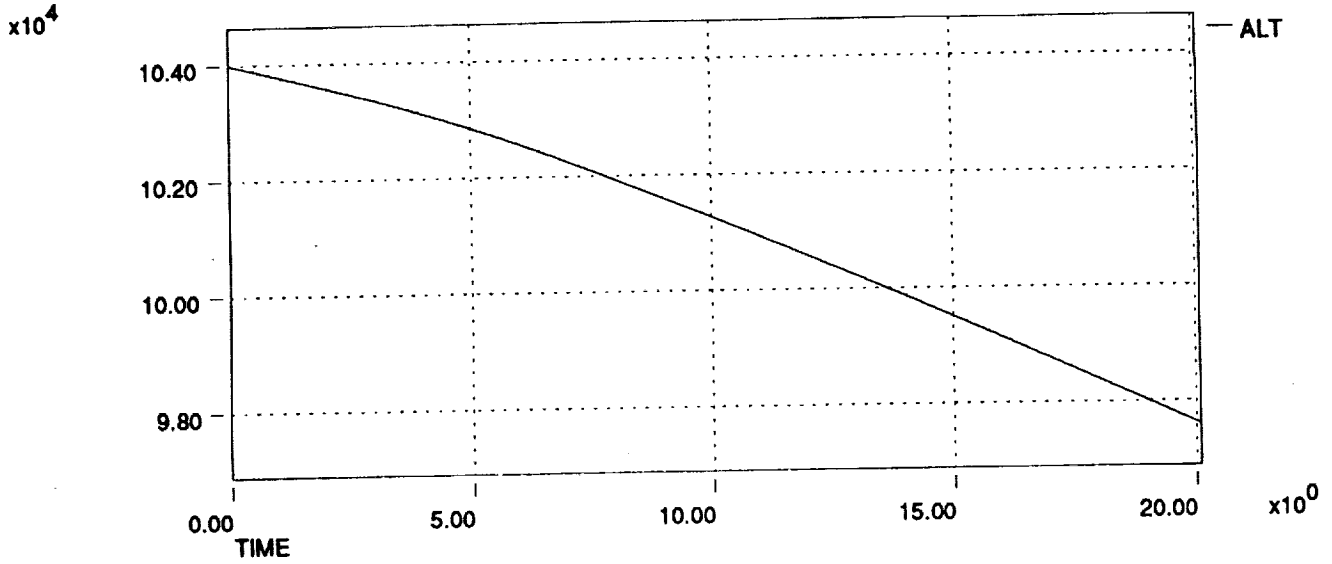

HL-20 Dynamic Check Case Data Plots 911206
Speed Brake Handle Pulse at Mach 4 and 104,000 ft

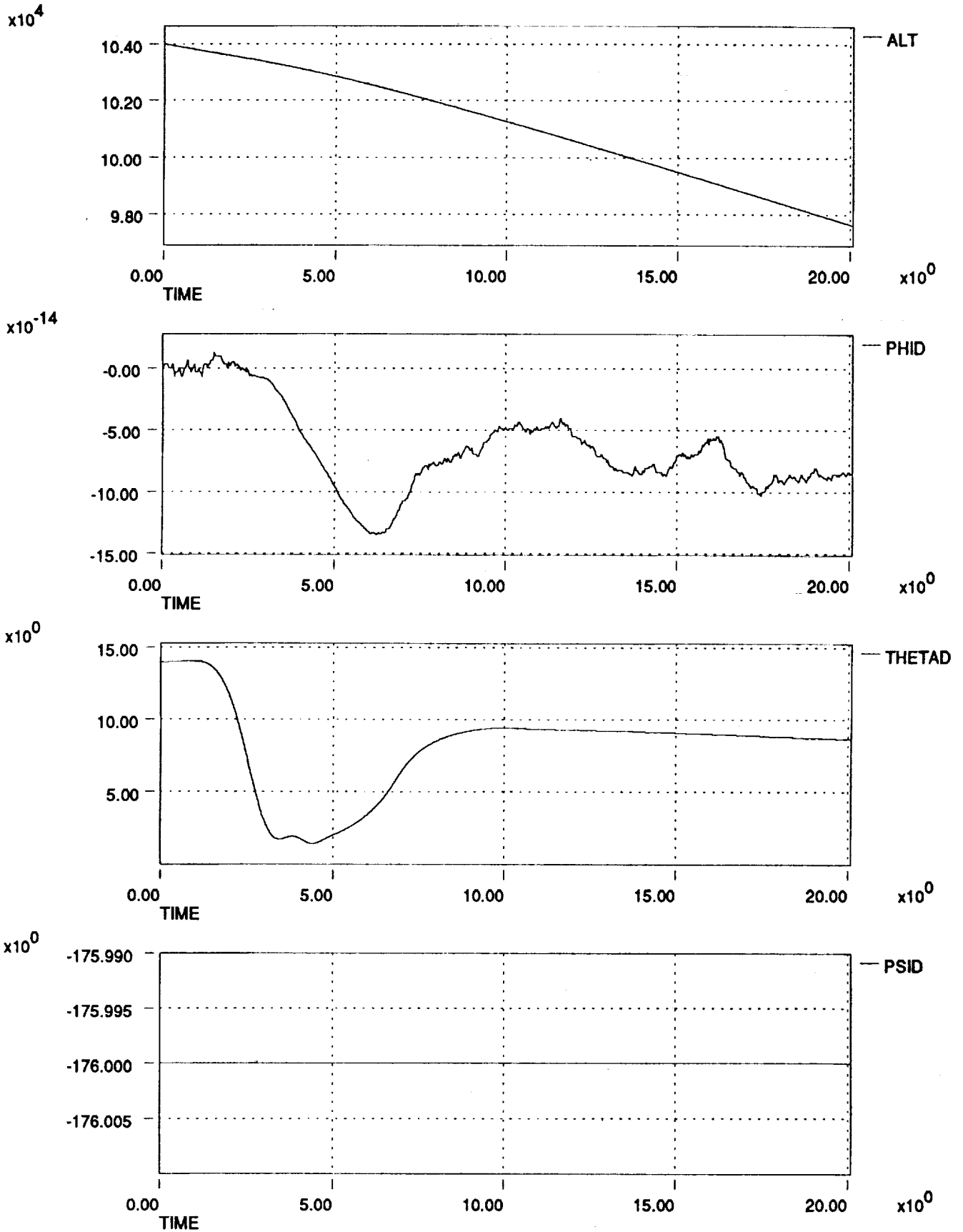

HL-20 Dynamic Check Case Data Plots 911206
Speed Brake Handle Pulse at Mach 4 and 104,000 ft

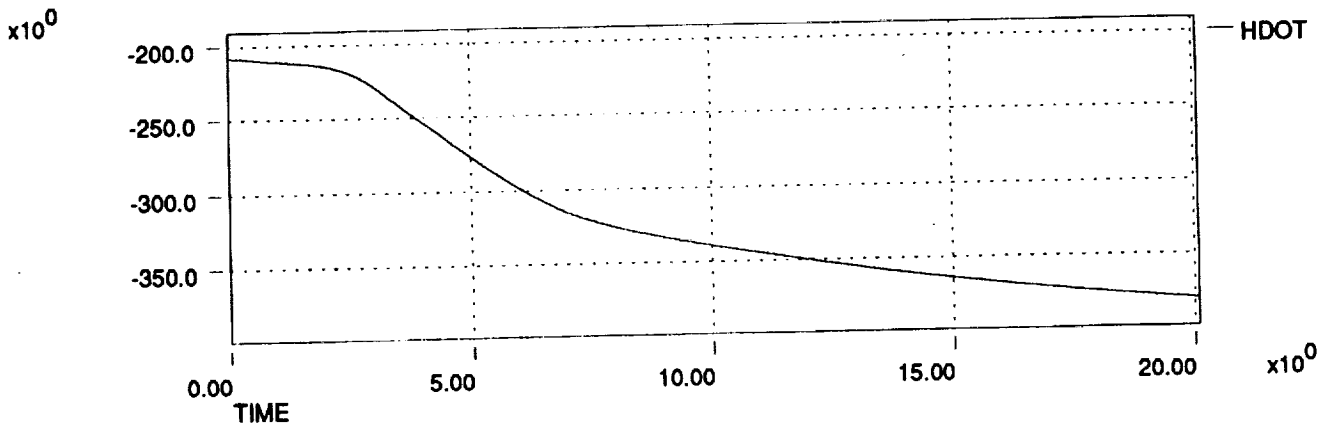
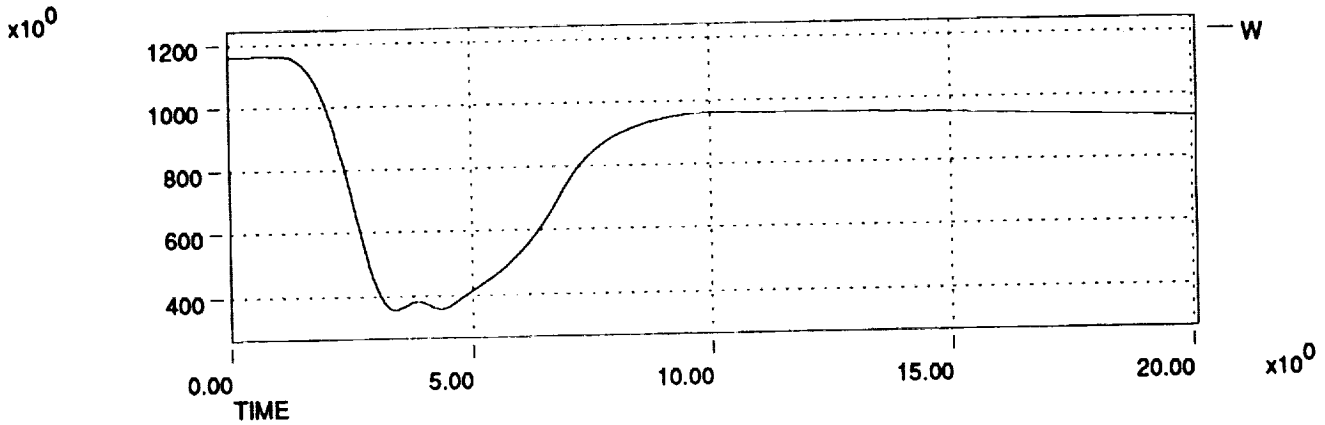
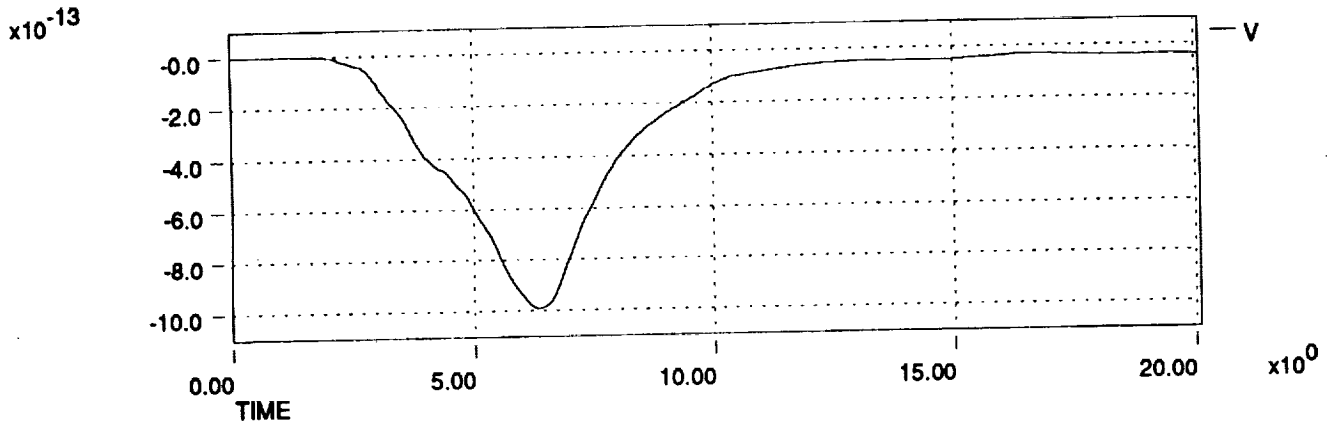
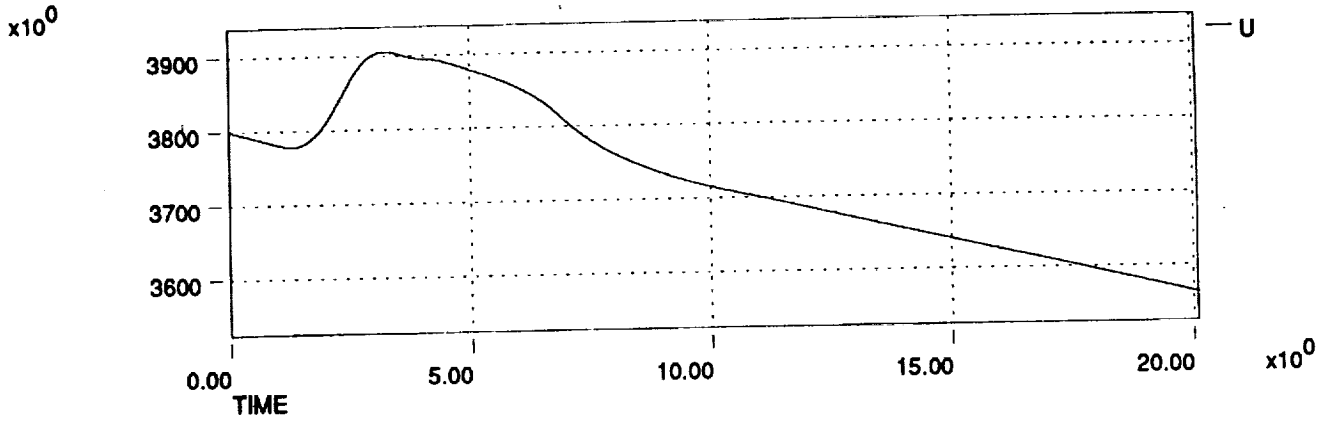

HL-20 Dynamic Check Case Data Plots 911206
Speed Brake Handle Pulse at Mach 4 and 104,000 ft

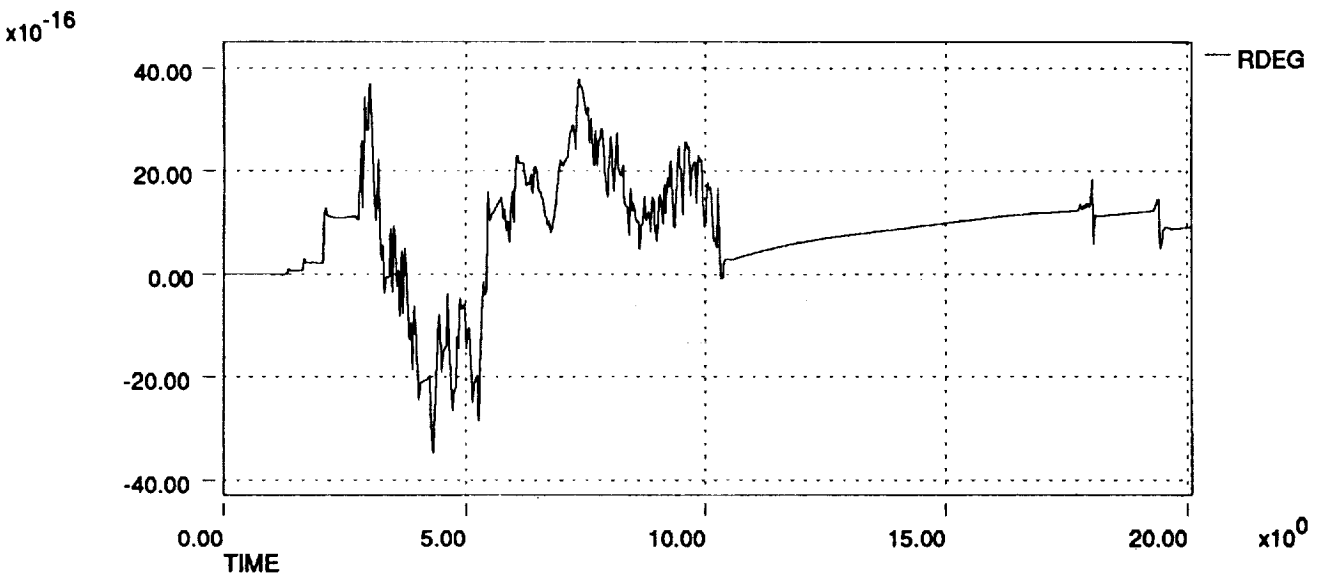
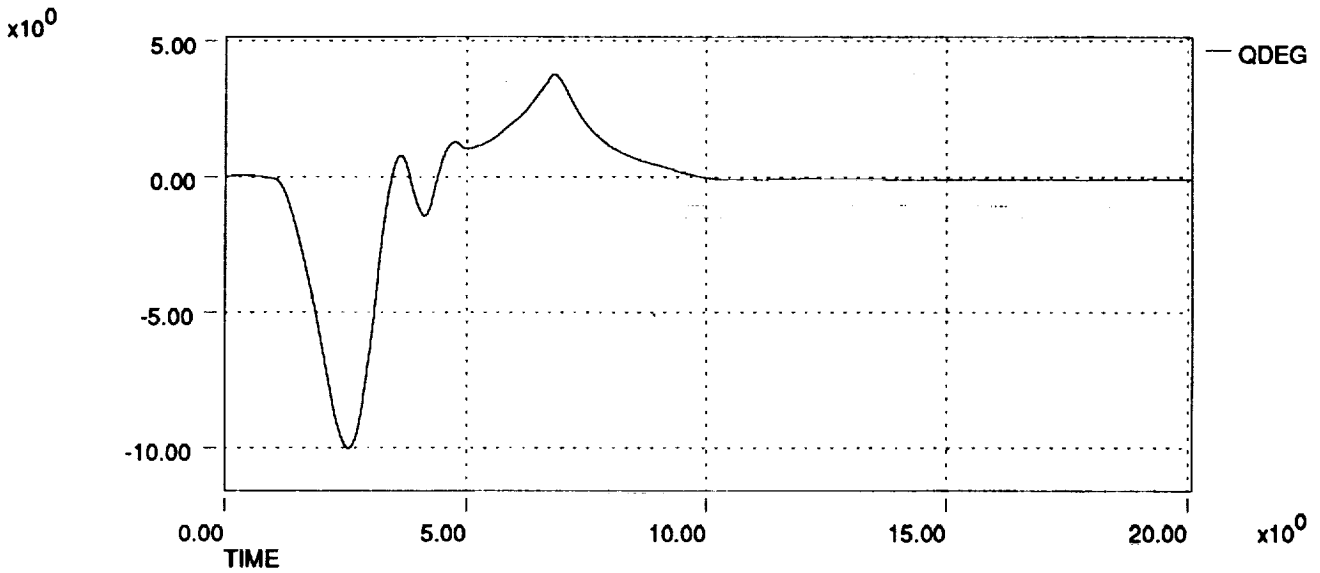
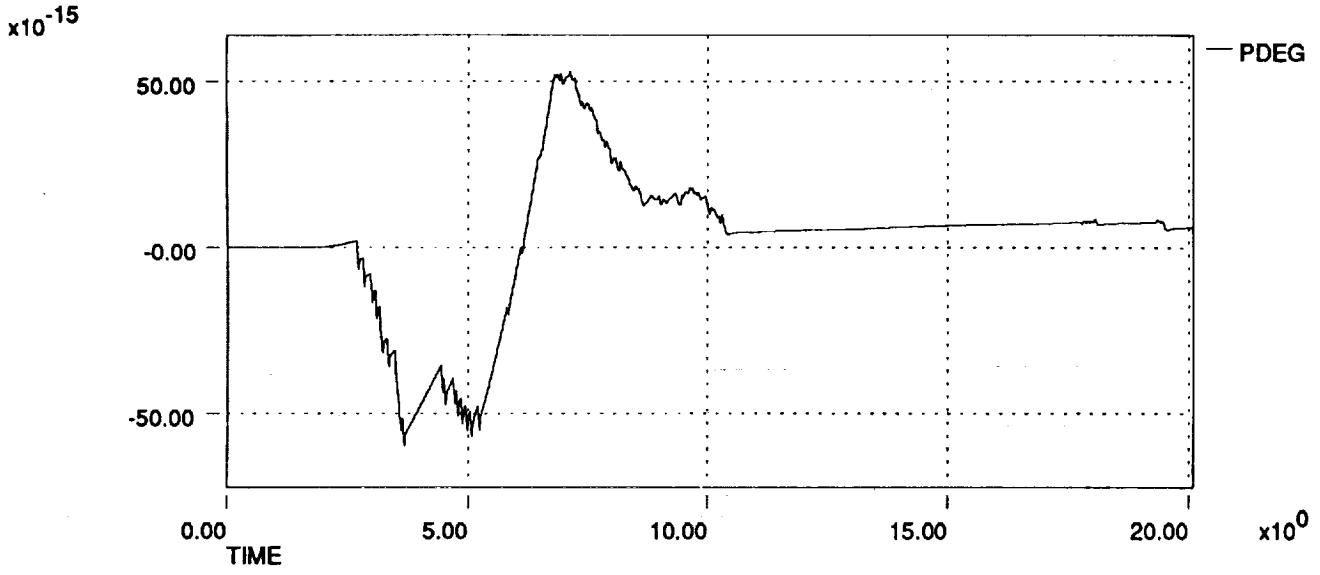

HL-20 Dynamic Check Case Data Plots 911206
Speed Brake Handle Pulse at Mach 4 and 104,000 ft

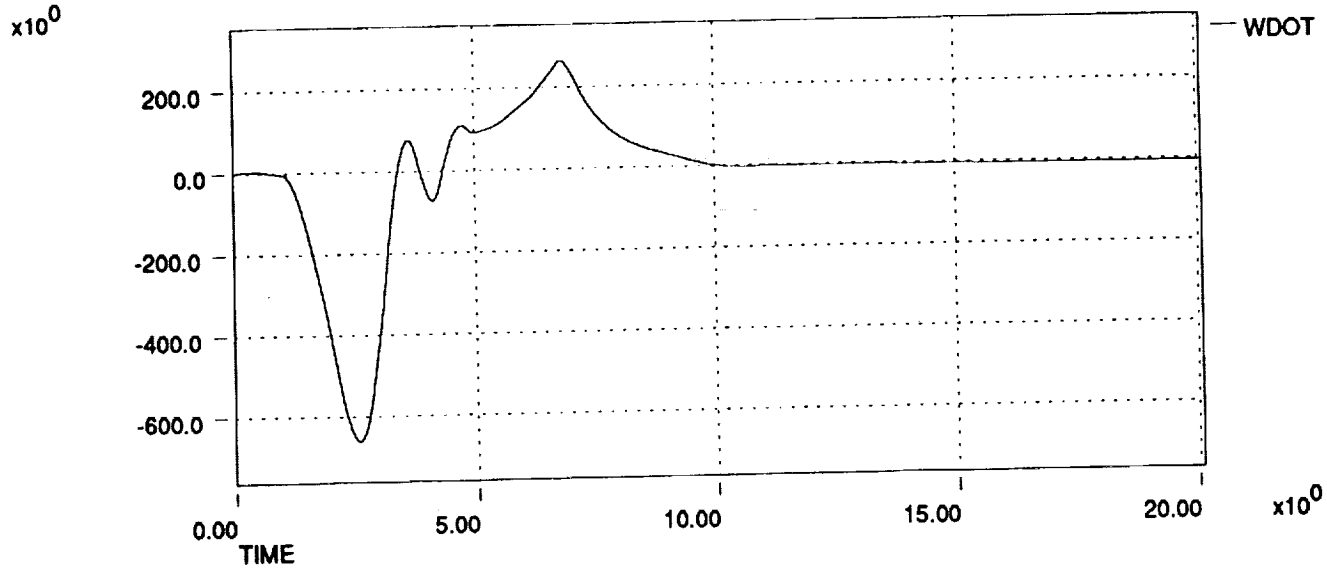
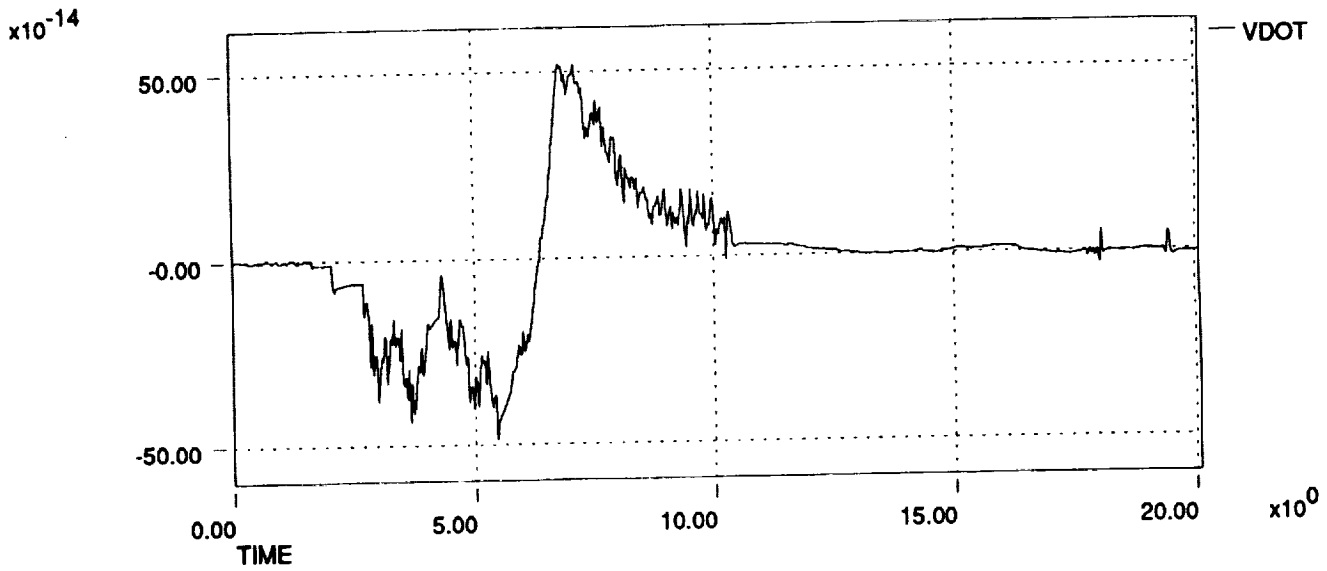
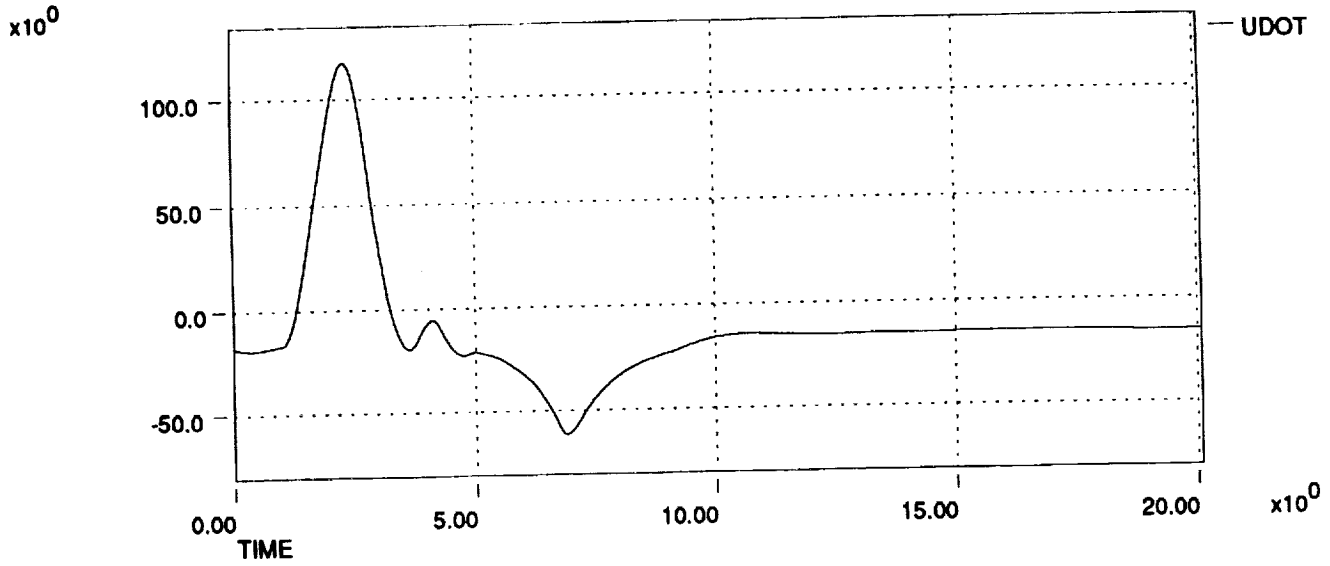

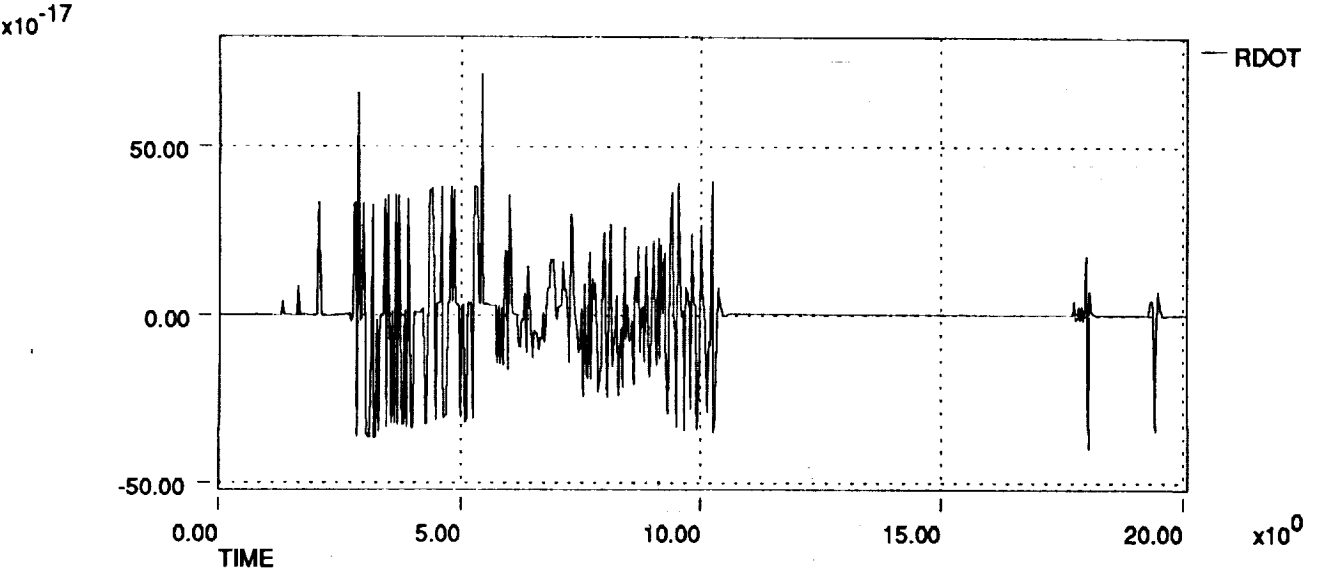
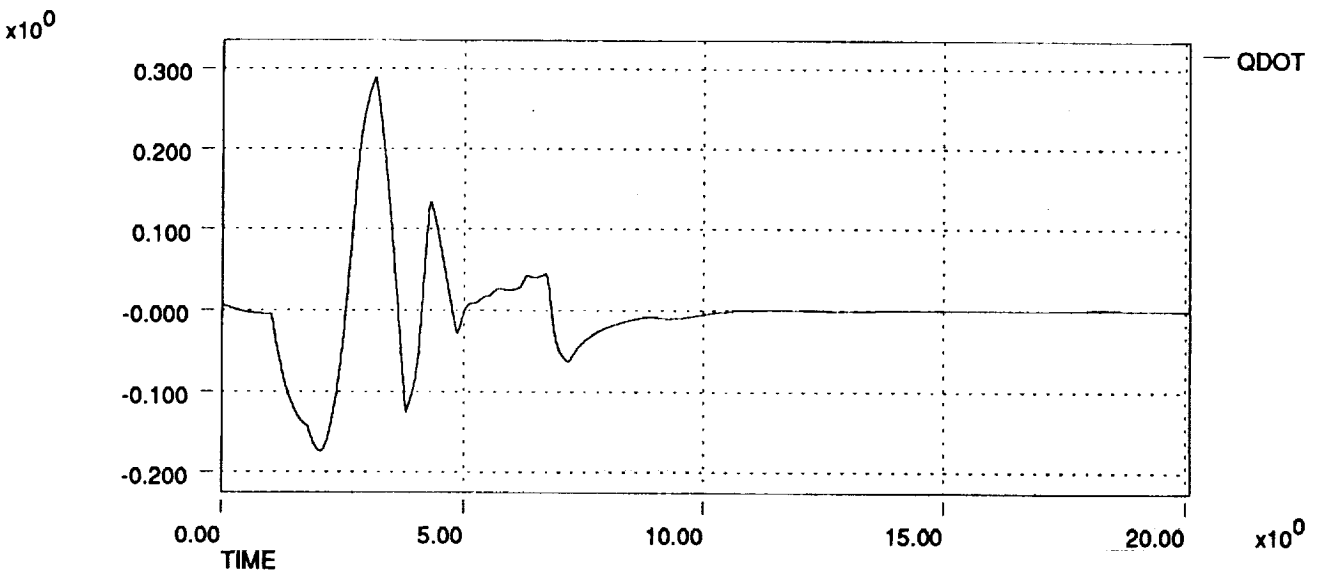
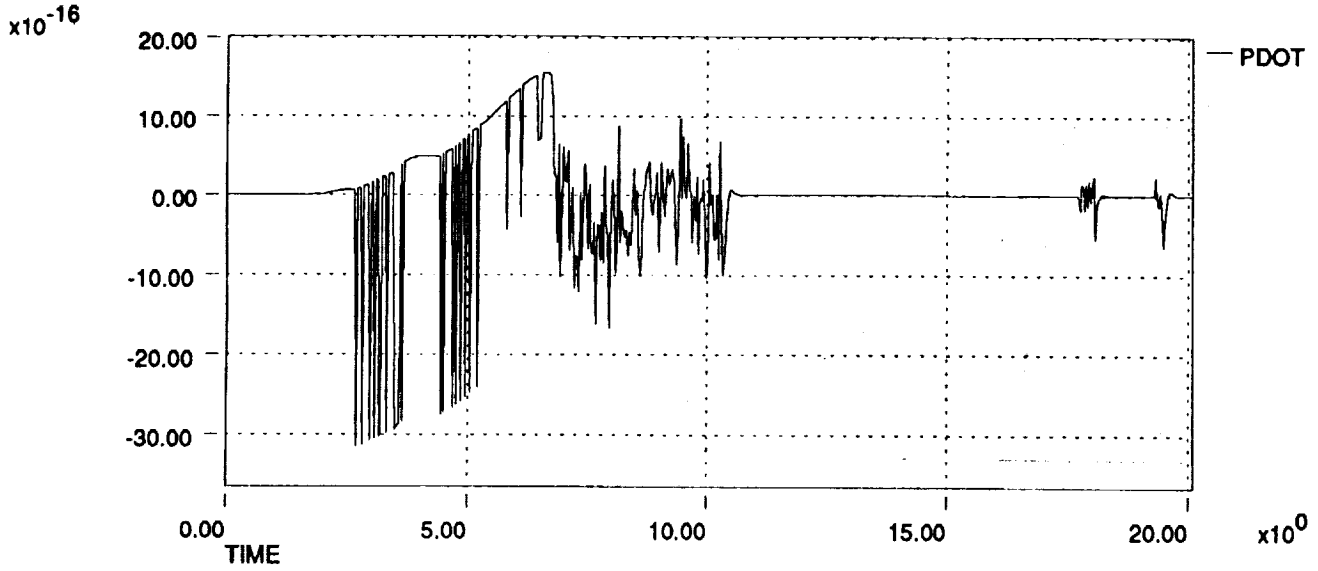

HL-20 Dynamic Check Case Data Plots 911206
Speed Brake Handle Pulse at Mach 4 and 104,000 ft

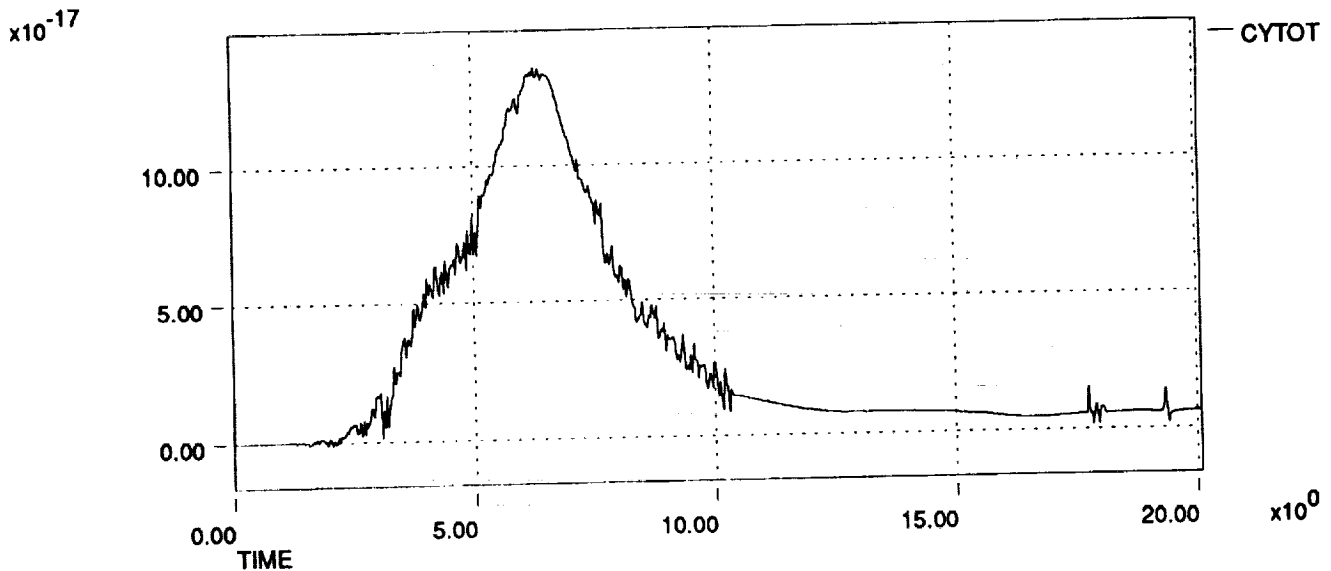
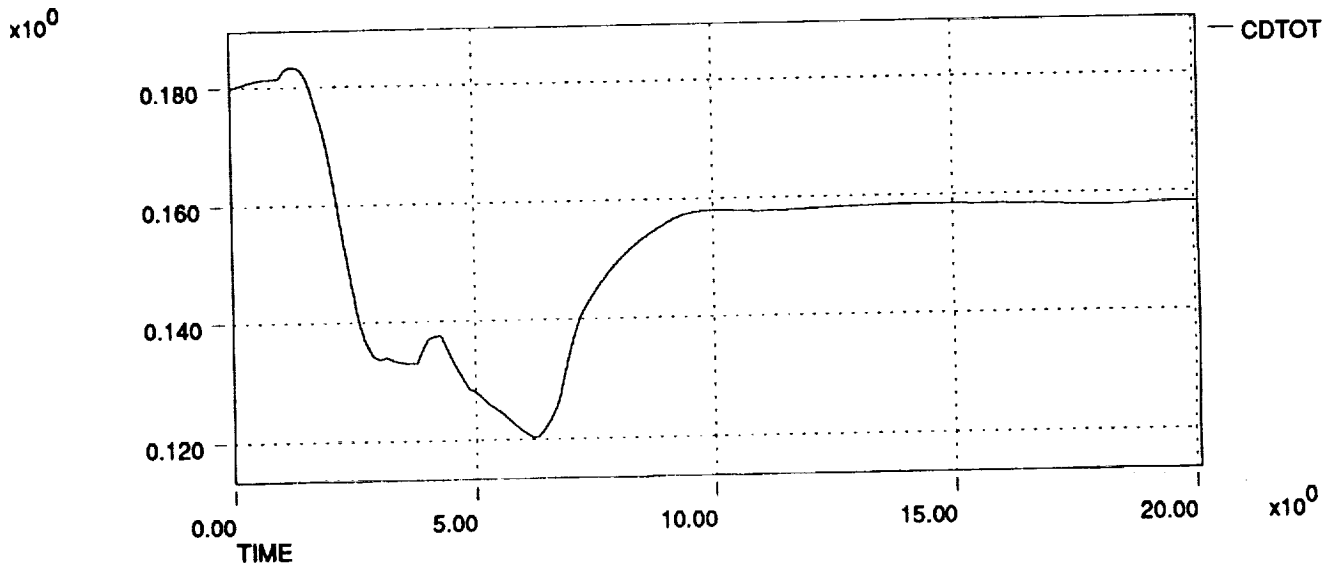
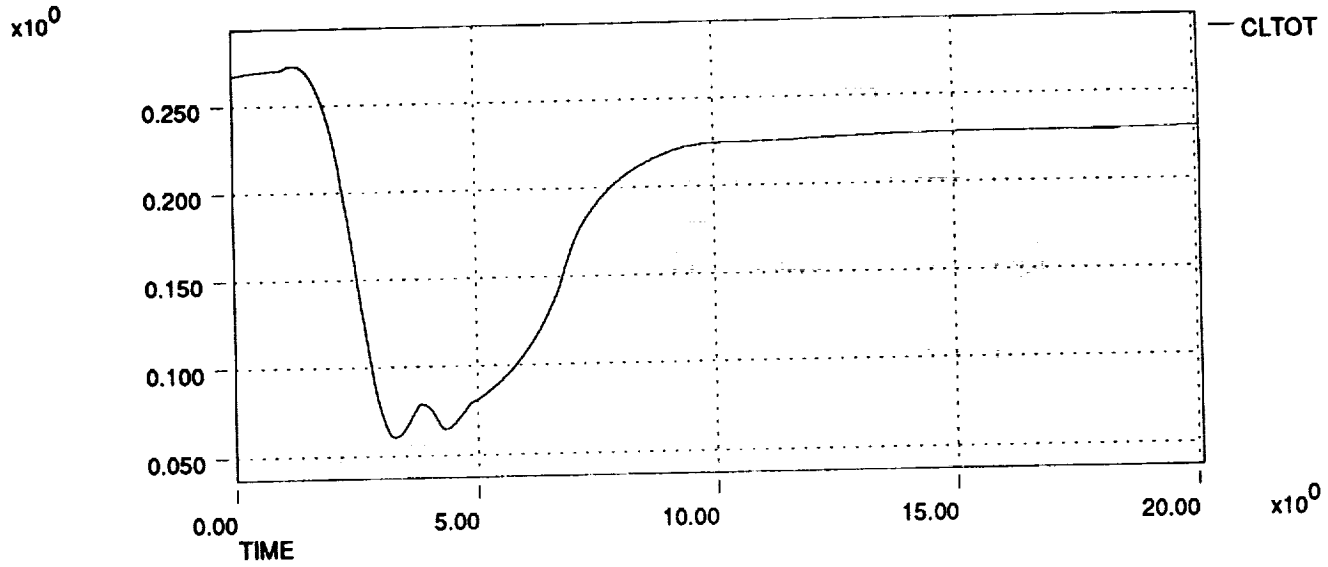

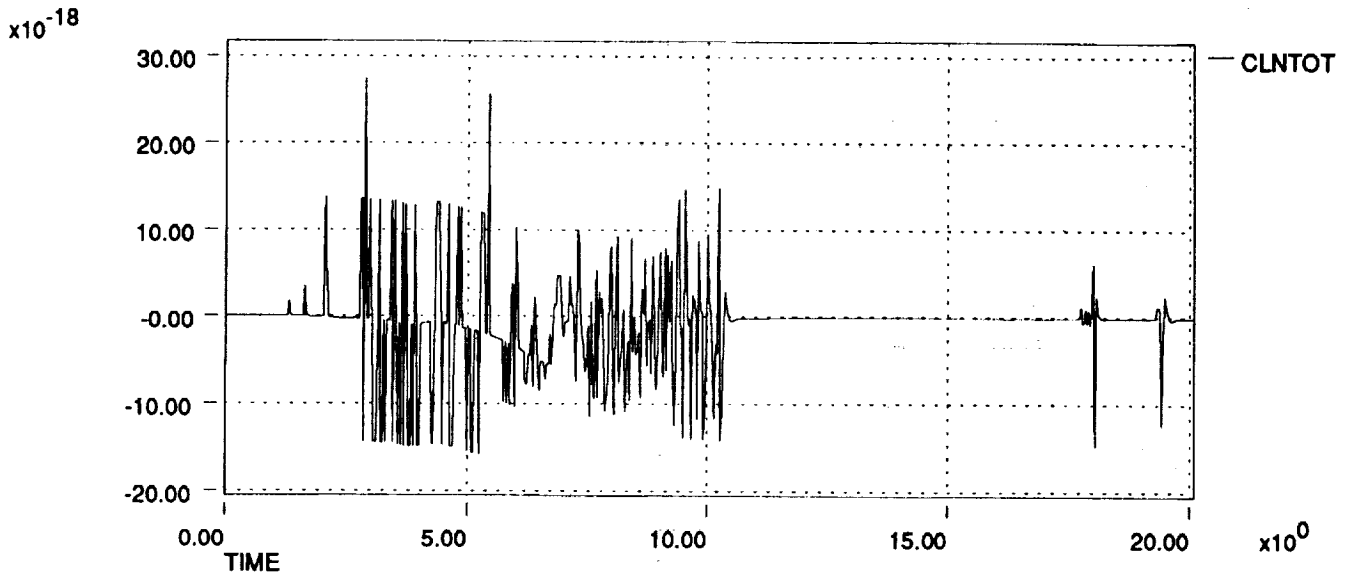
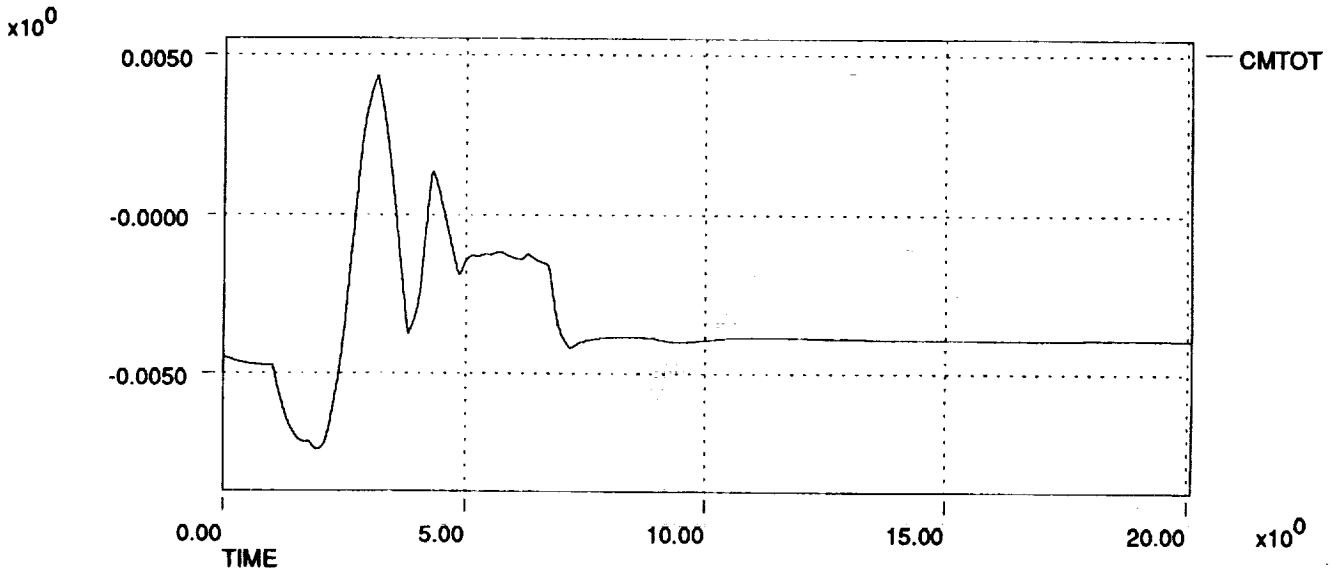
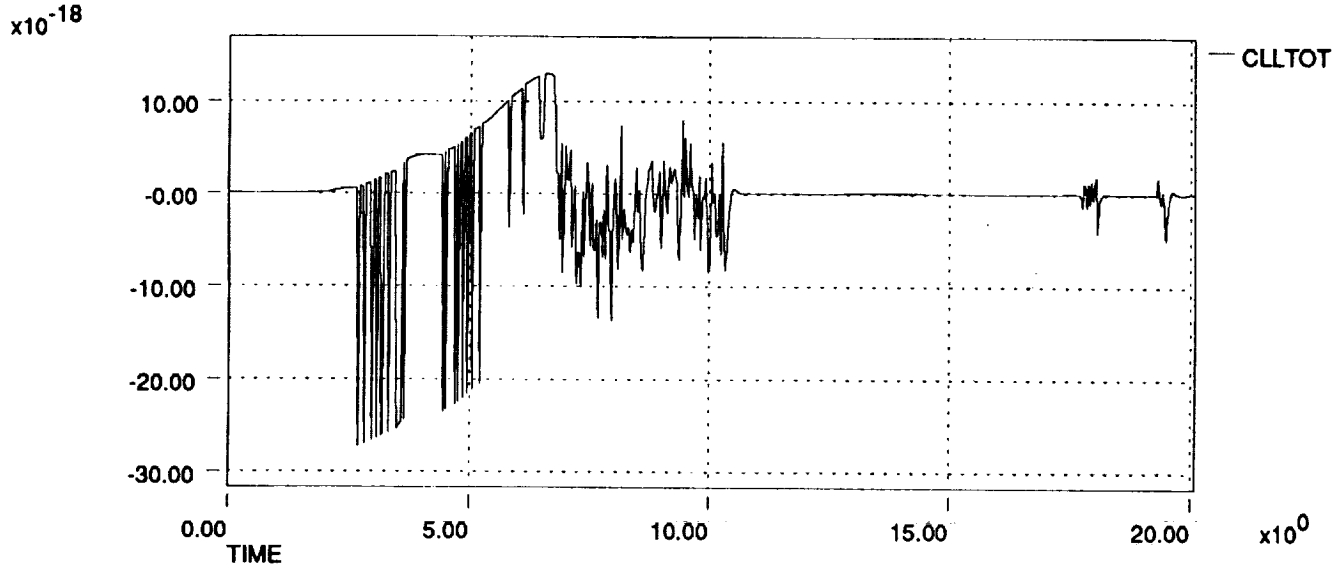

HL-20 Dynamic Check Case Data Plots 911206
Speed Brake Handle Pulse at Mach 4 and 104,000 ft

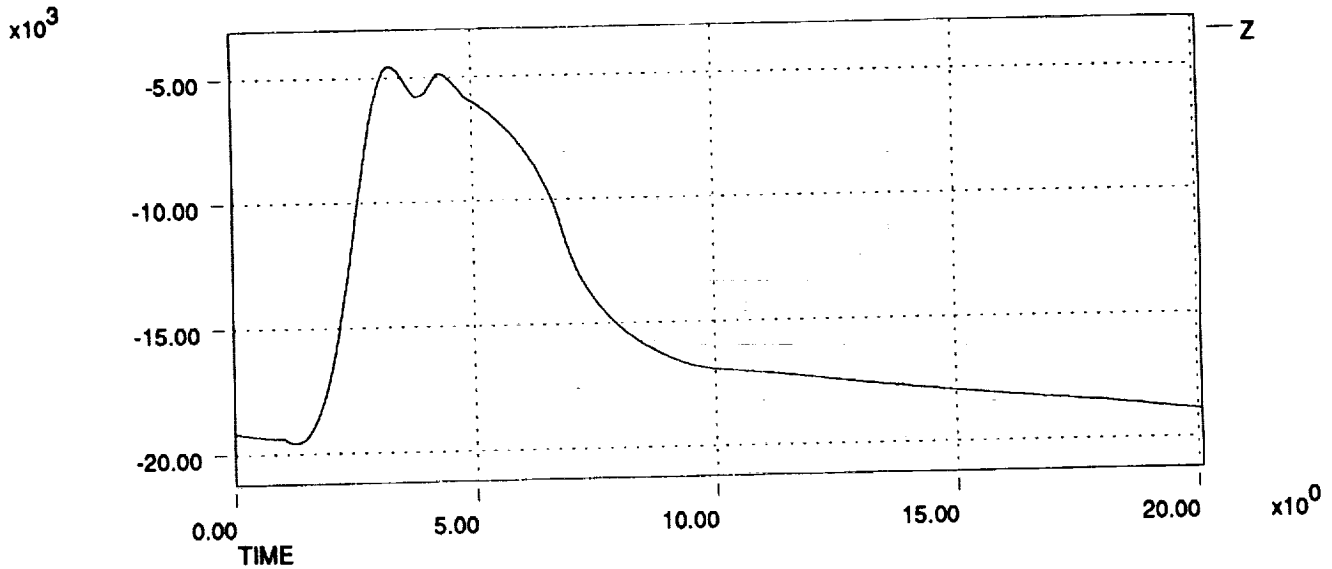
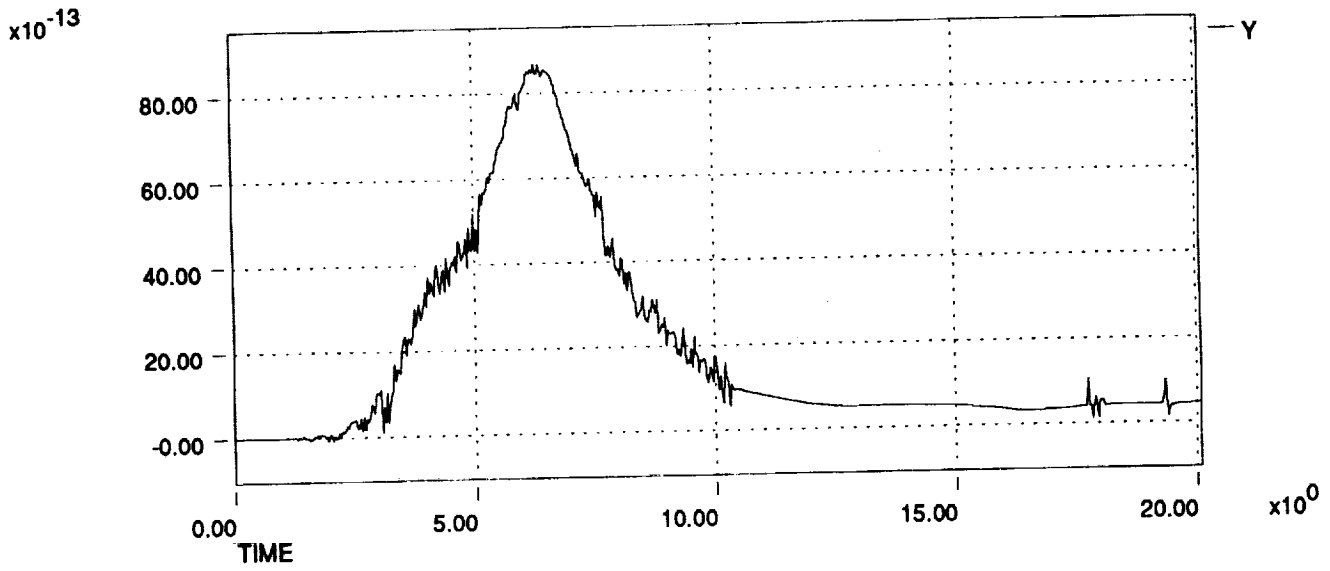
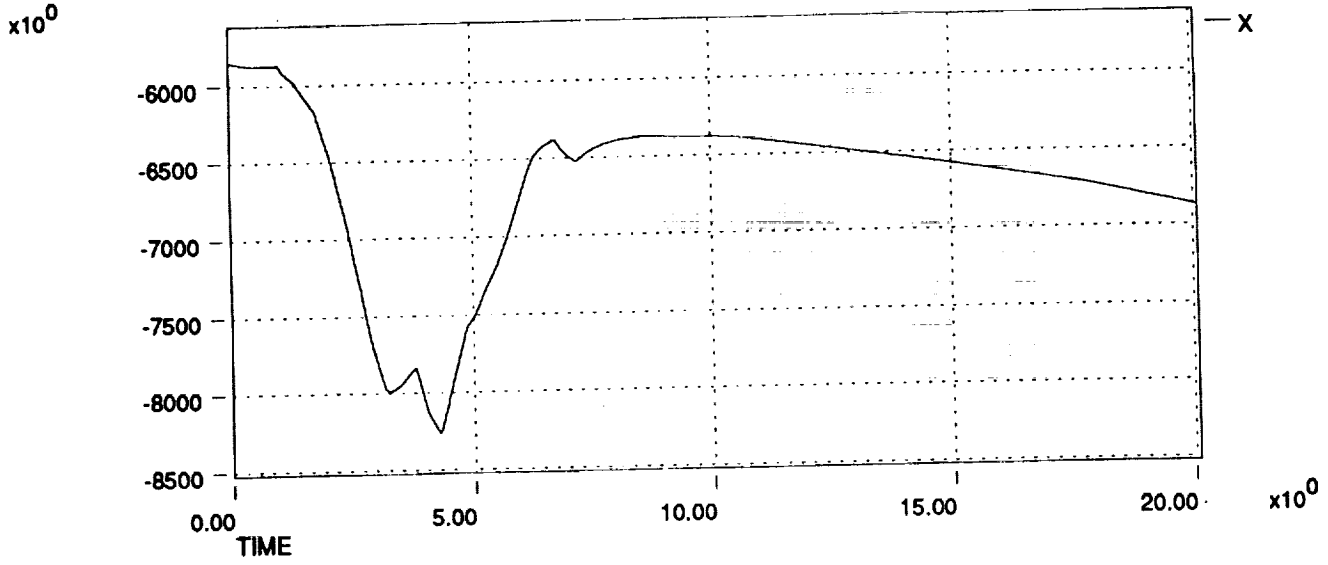

HL-20 Dynamic Check Case Data Plots 911206
Speed Brake Handle Pulse at Mach 4 and 104,000 ft

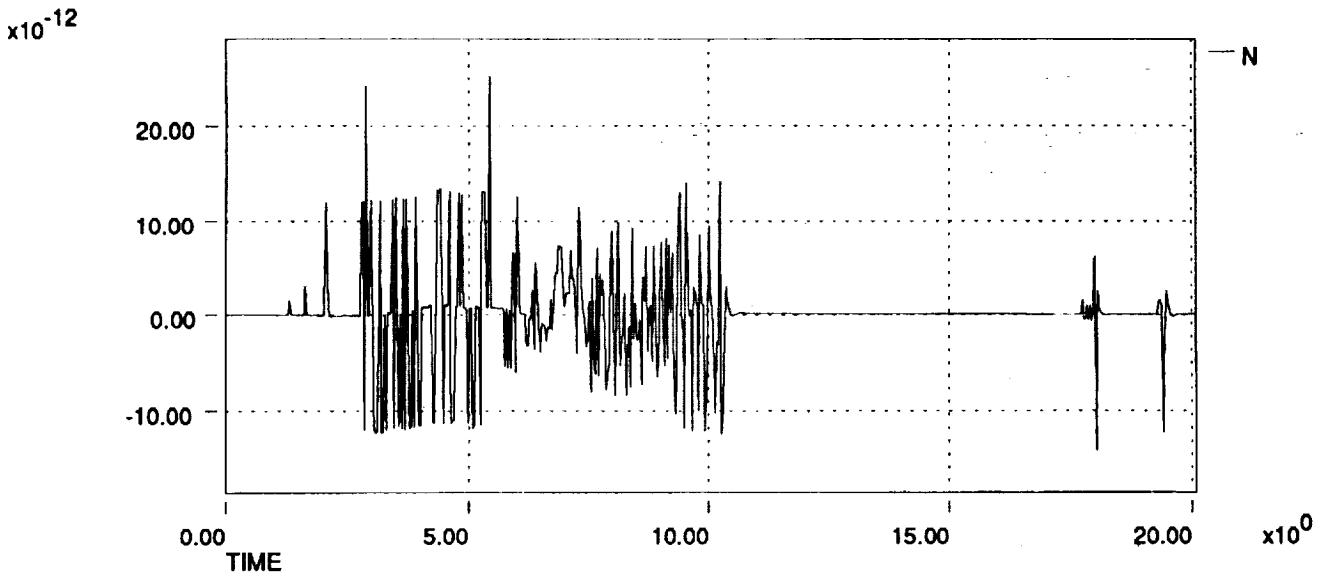
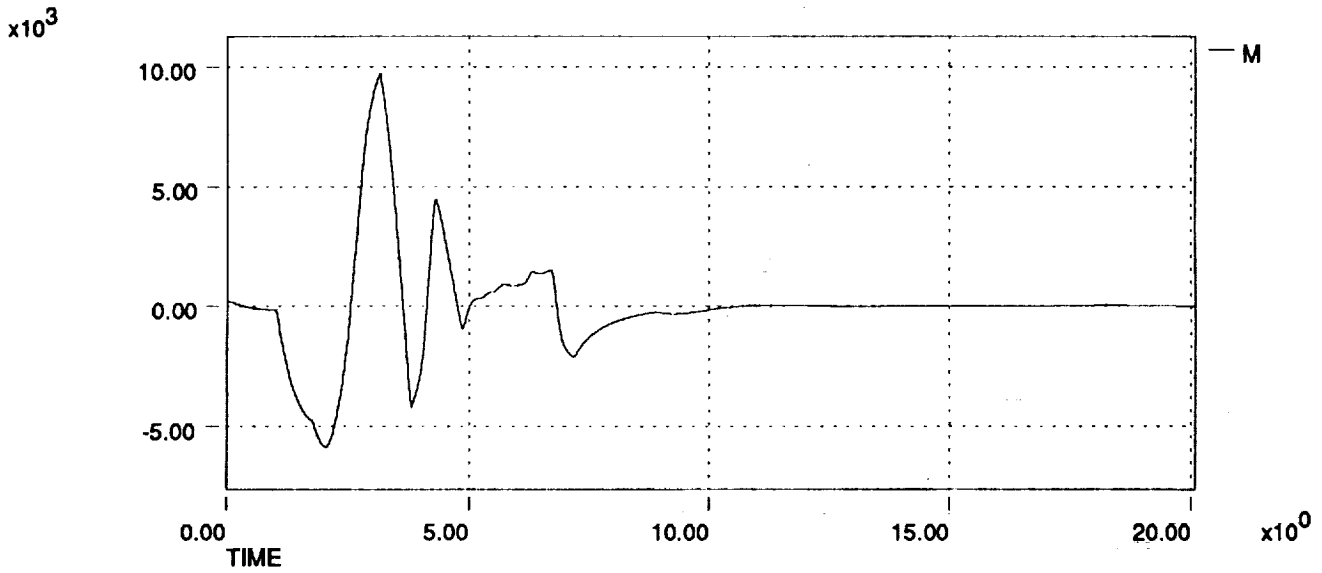
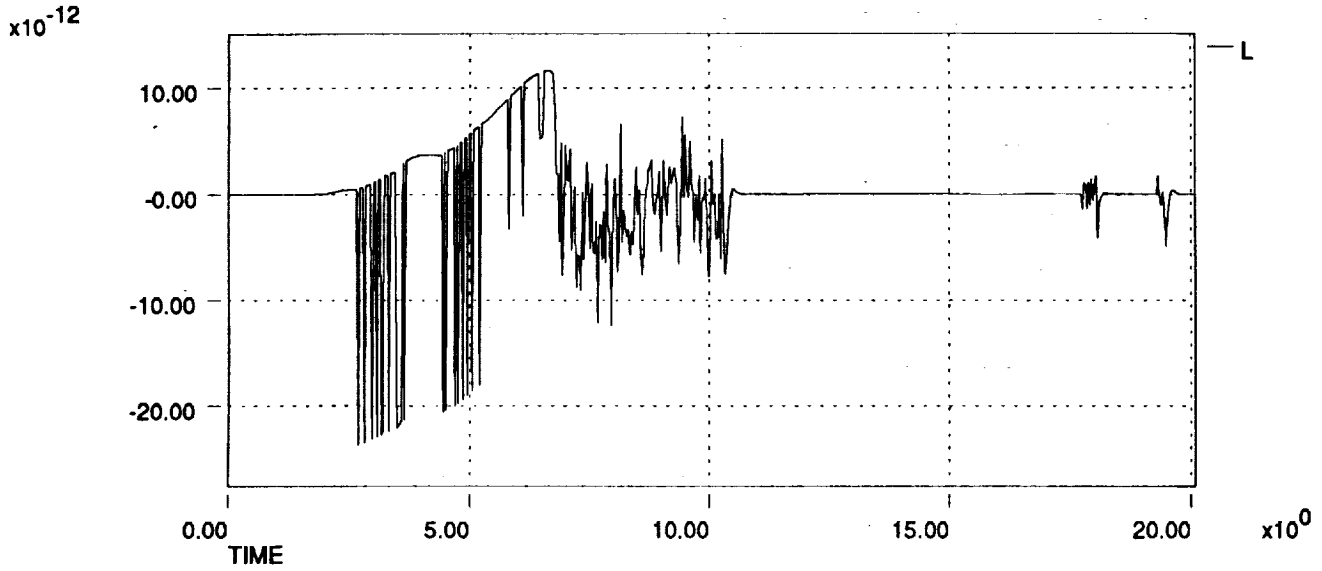

HL-20 Dynamic Check Case Data Plots 911208
Speed Brake Handle Pulse at Mach 4 and 104,000 ft

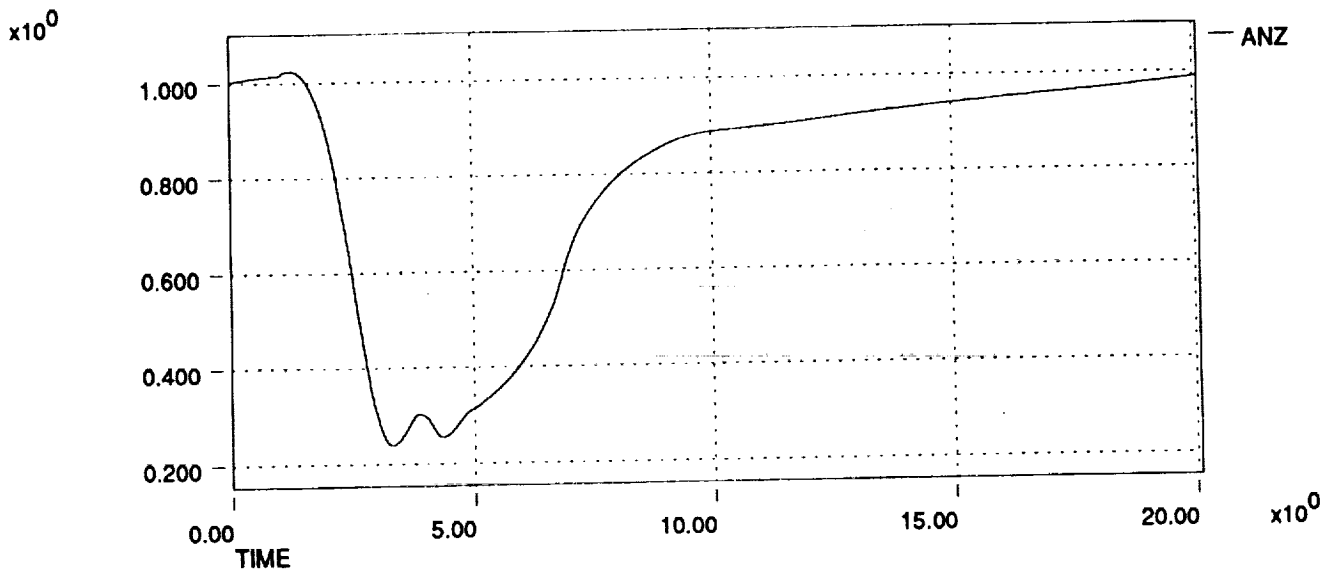
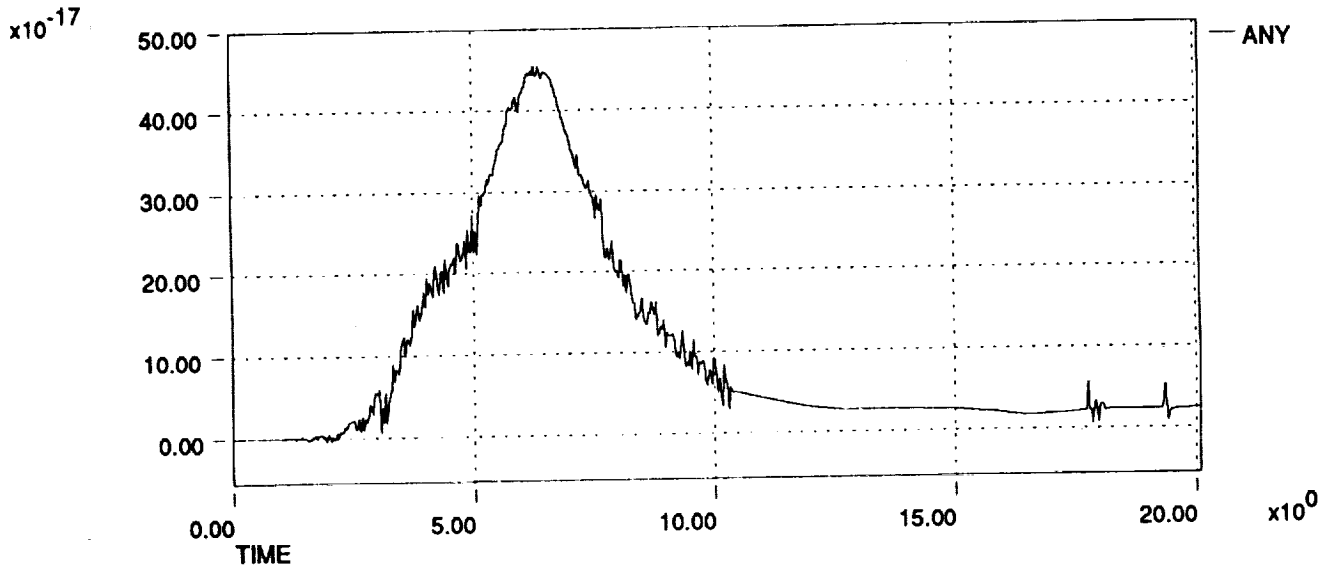
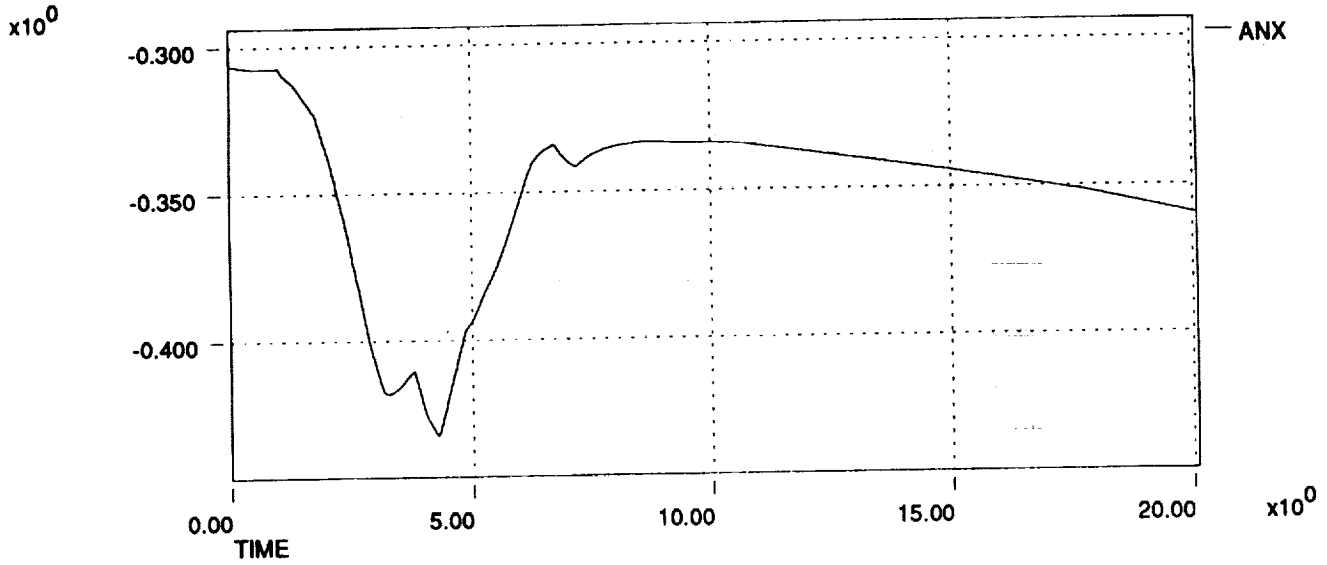

HL-20 Dynamic Check Case Data Plots 911206
Speed Brake Handle Pulse at Mach 4 and 104,000 ft

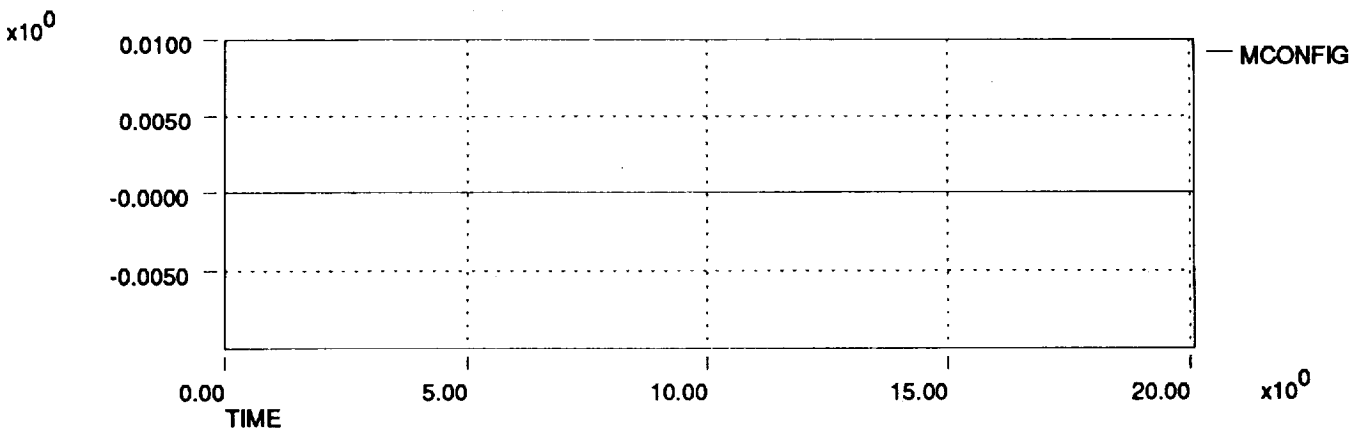
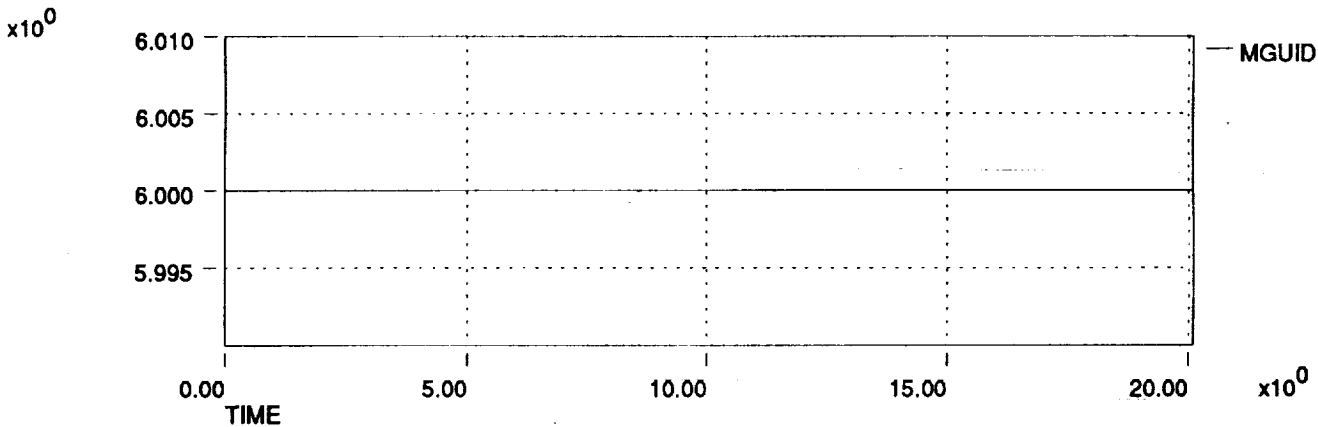
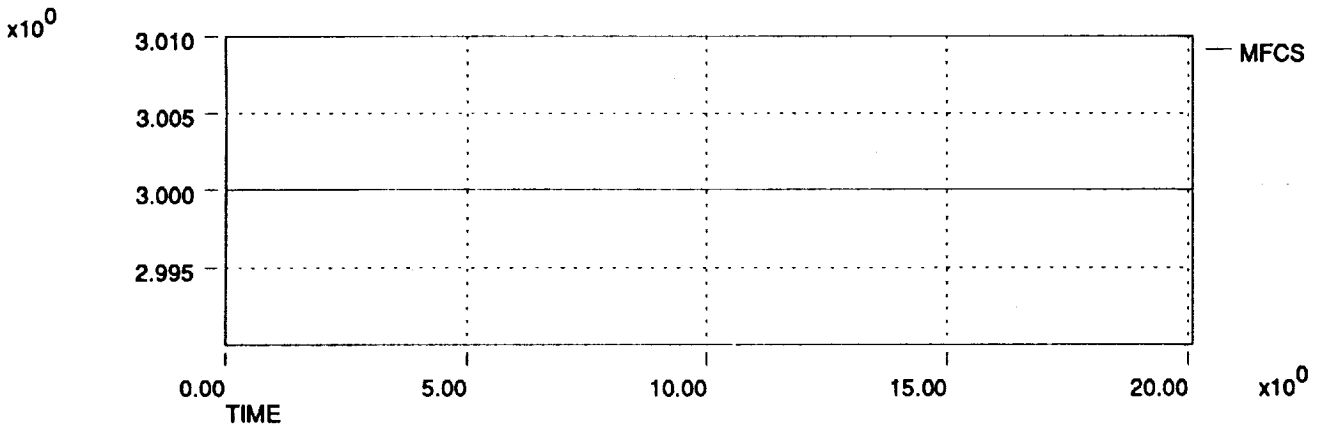
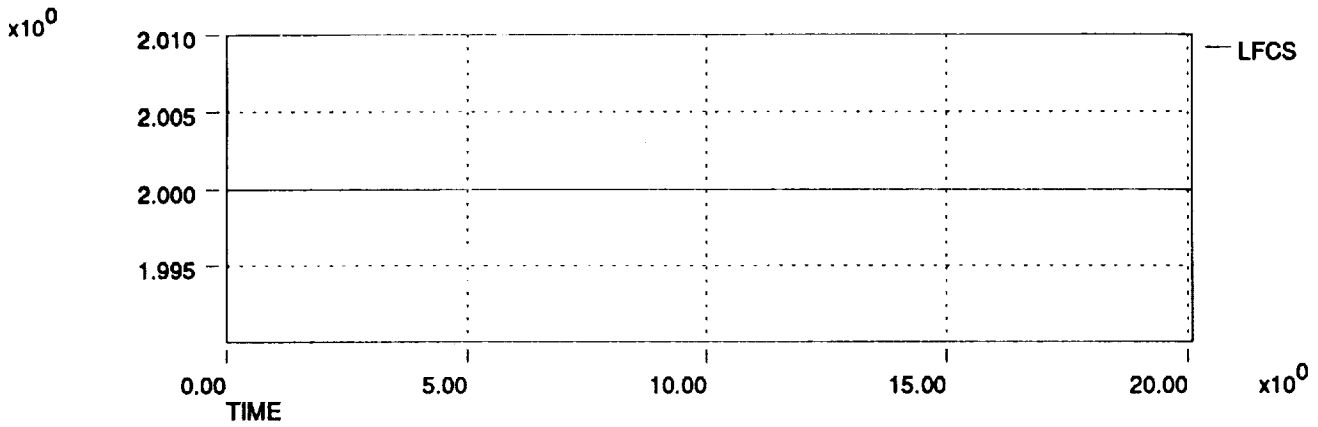

HL-20 Dynamic Check Case Data Plots 911206
Speed Brake Handle Pulse at Mach 4 and 104,000 ft

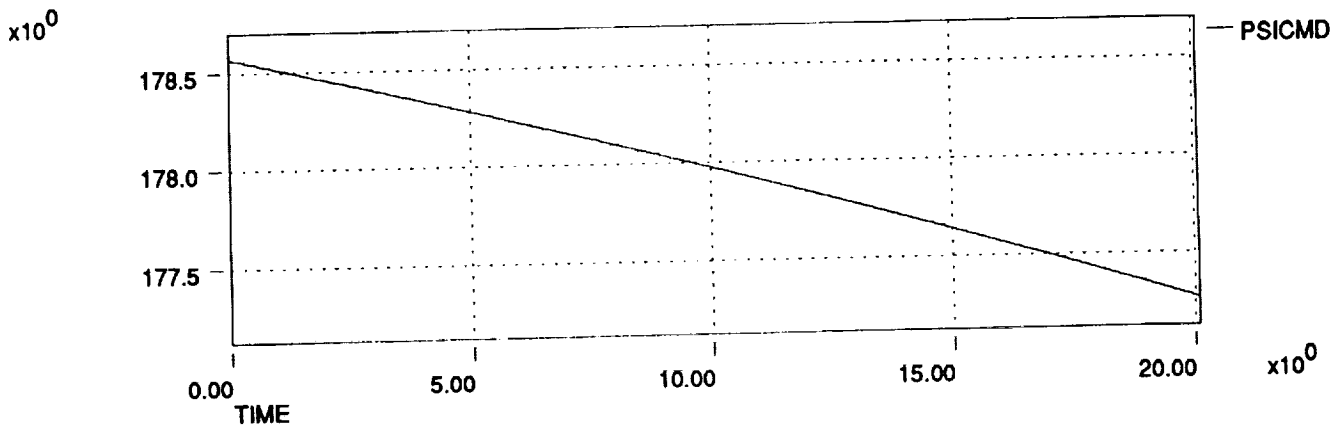
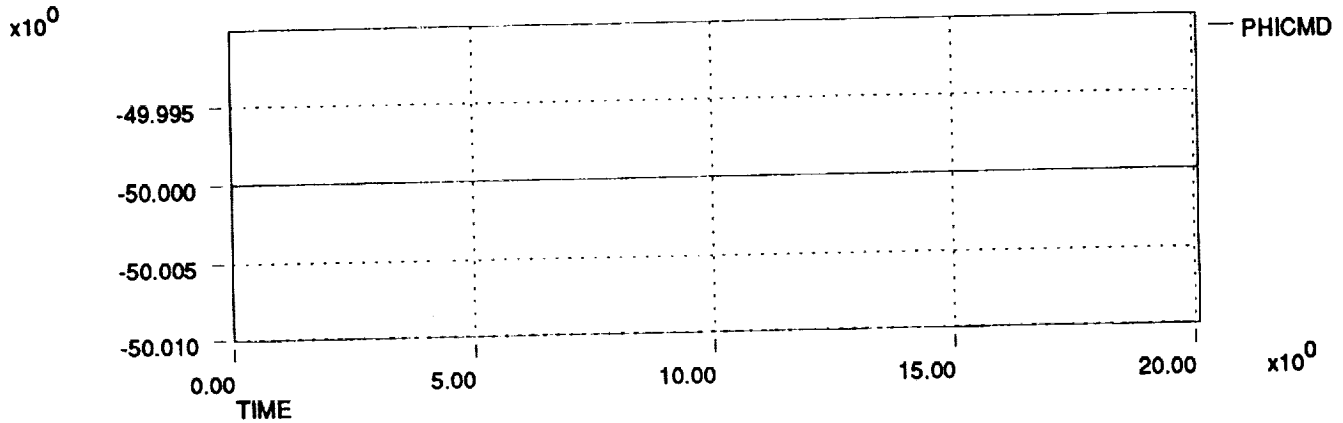
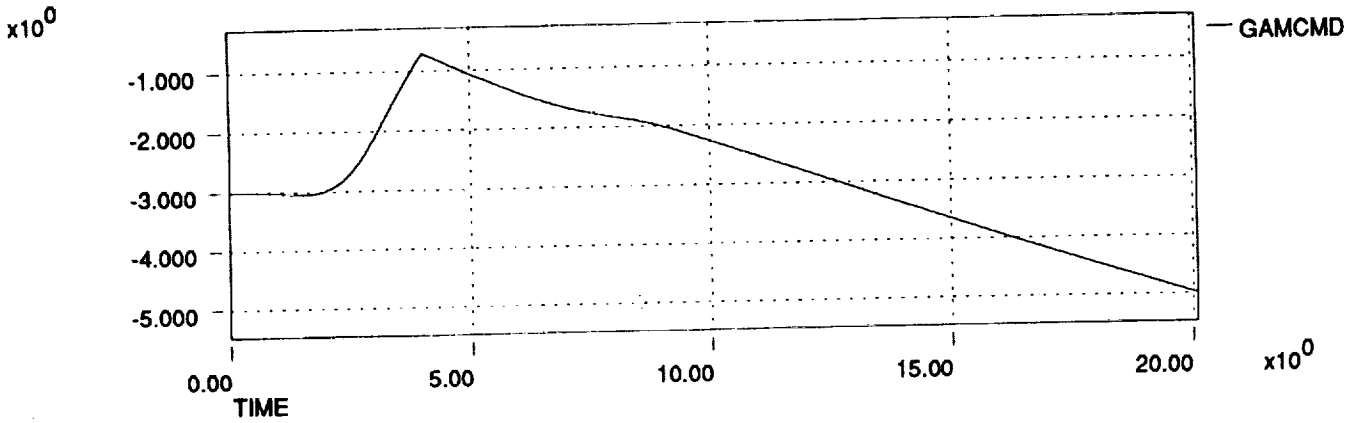
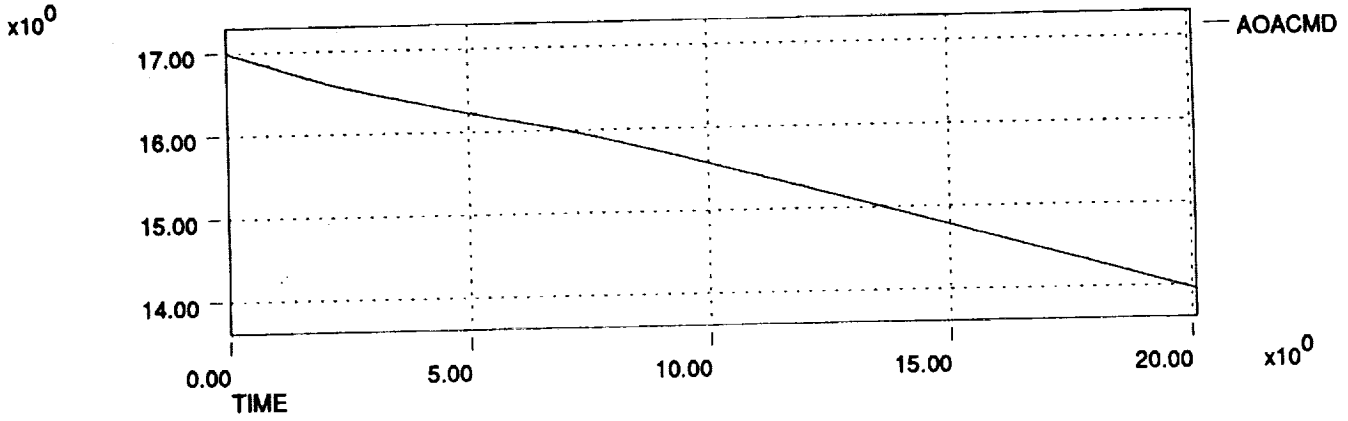

HL-20 Dynamic Check Case Data Plots 911206
Speed Brake Handle Pulse at Mach 4 and 104,000 ft

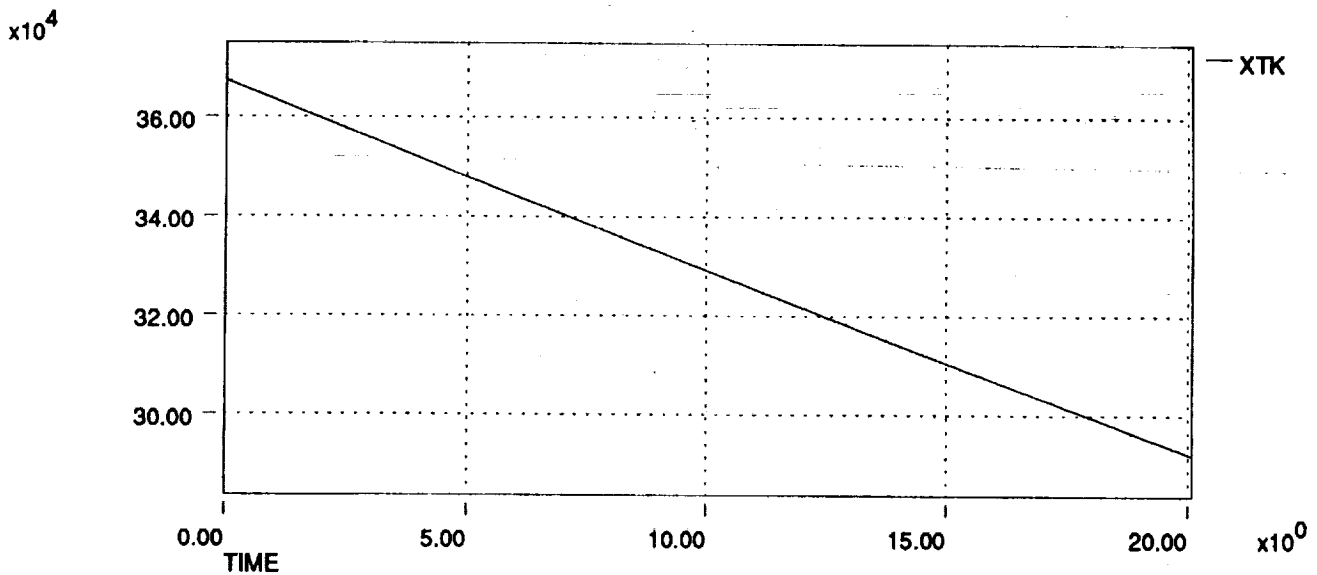
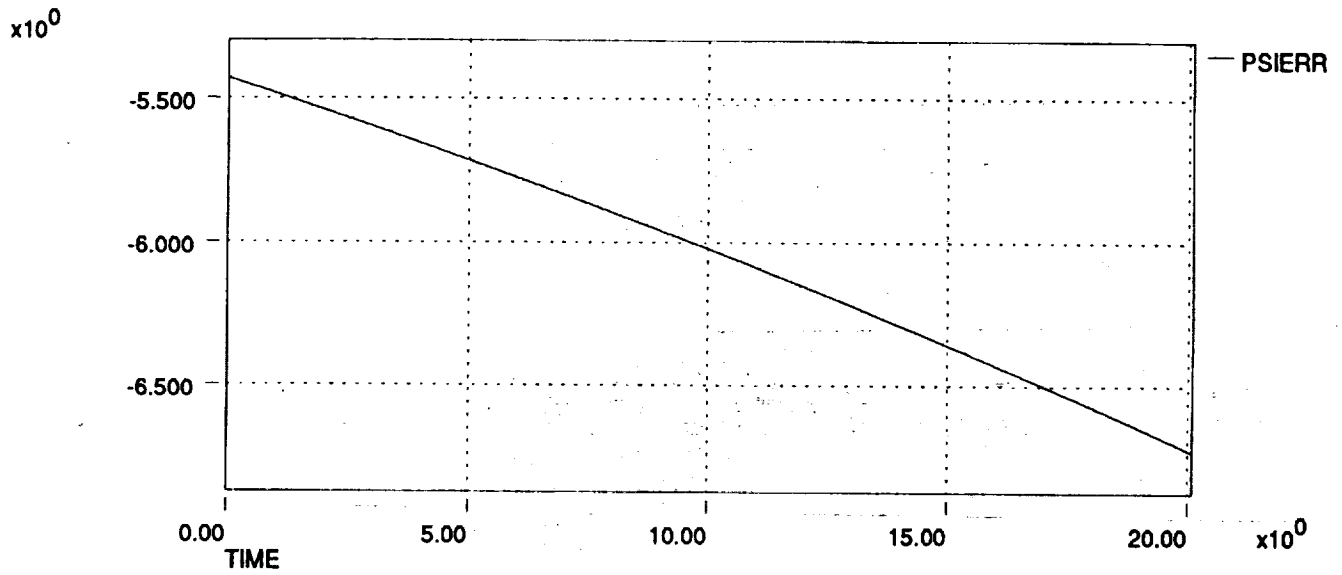
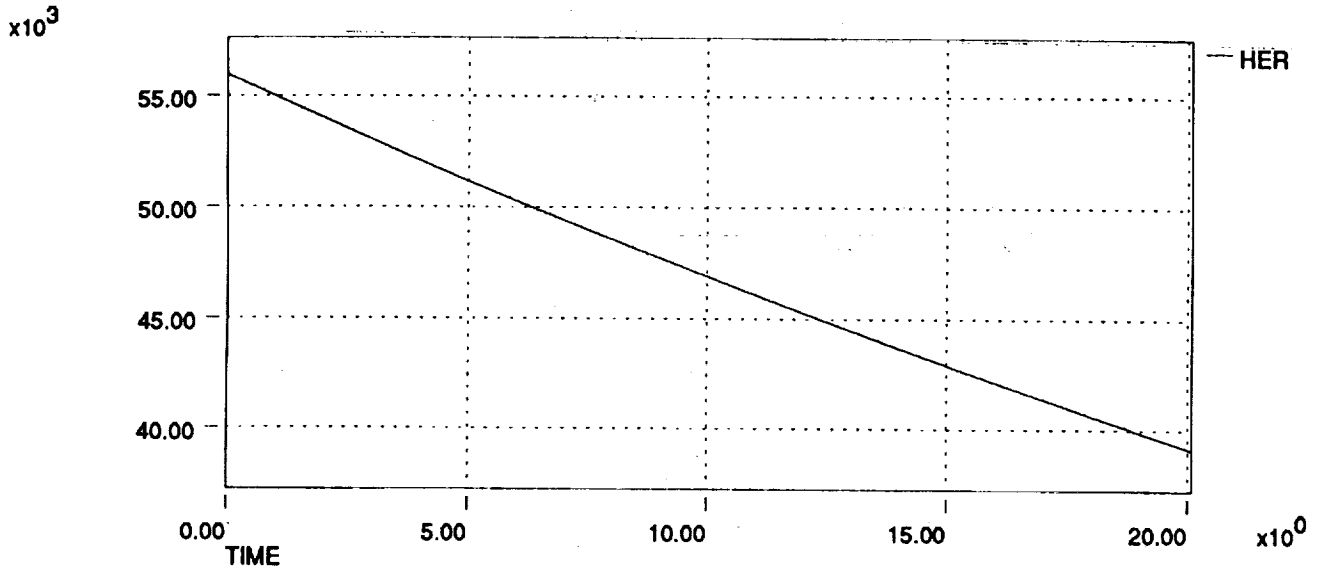

HL-20 Dynamic Check Case Data Plots 911206
Speed Brake Handle Pulse at Mach 4 and 104,000 ft

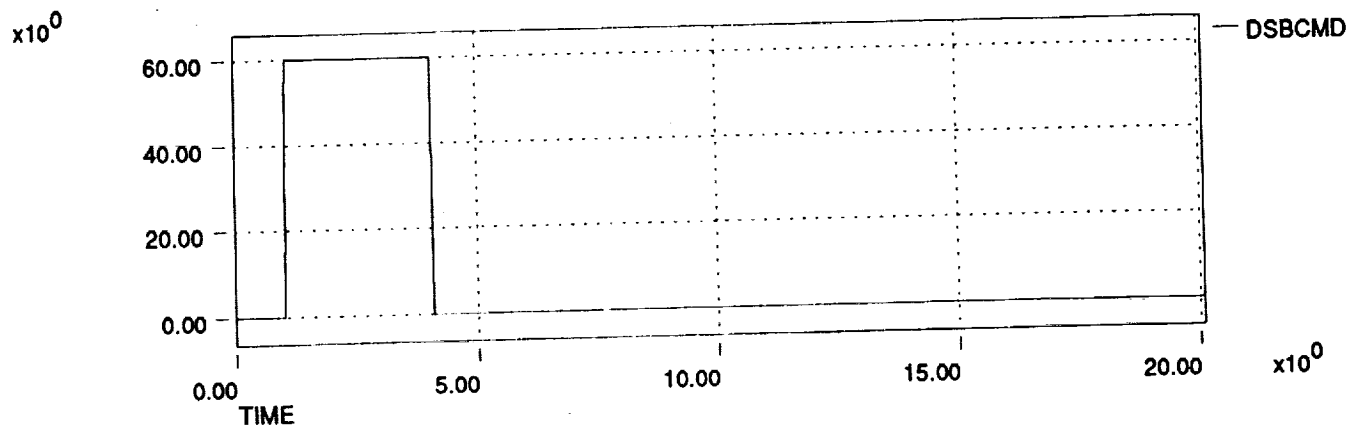
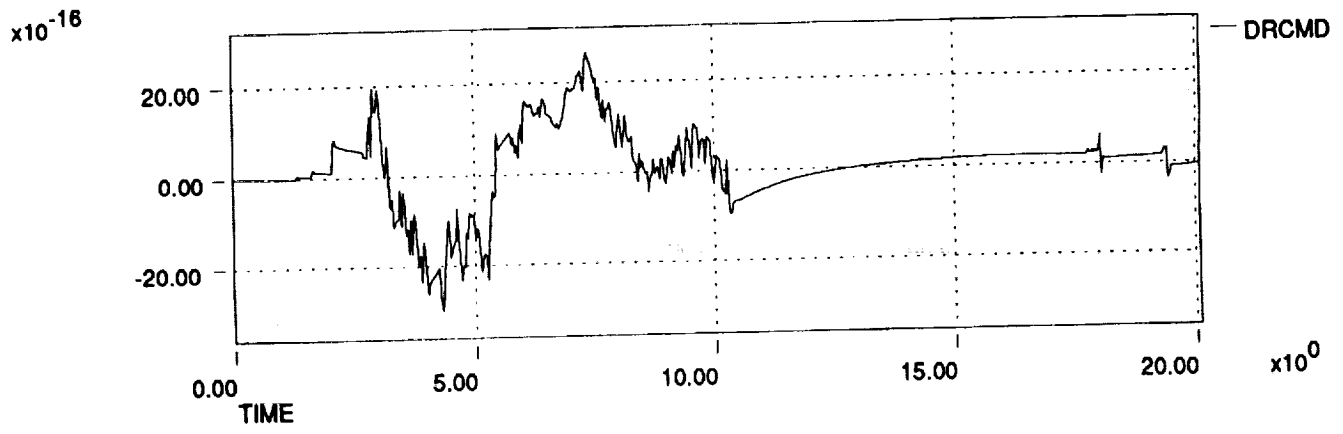
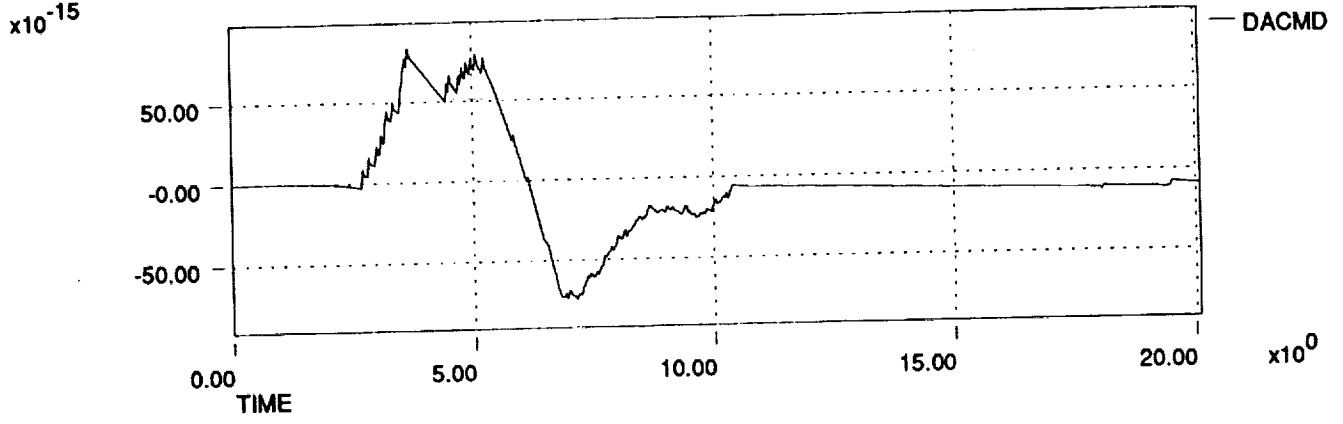
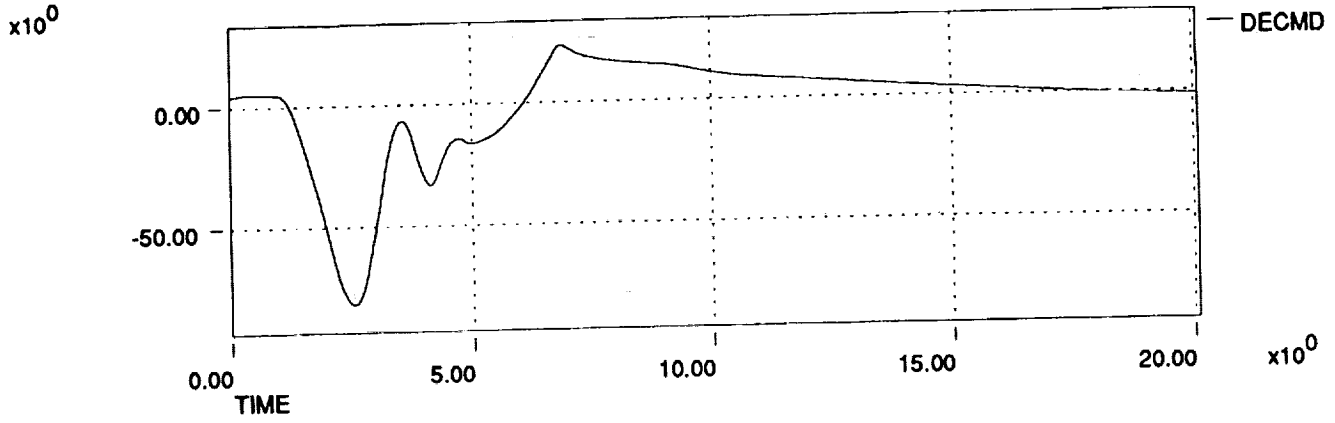

HL-20 Dynamic Check Case Data Plots 911206
Speed Brake Handle Pulse at Mach 4 and 104,000 ft

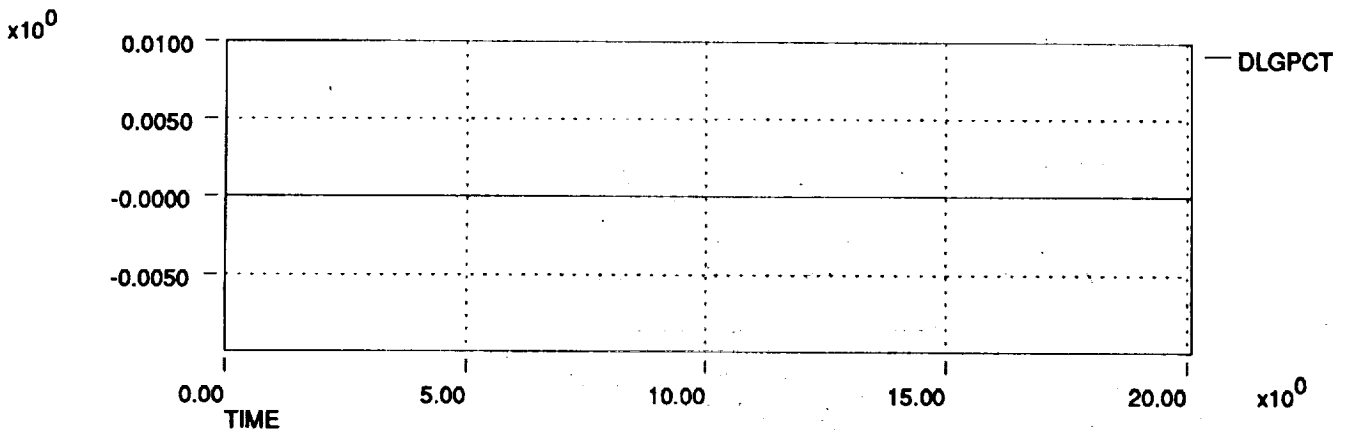
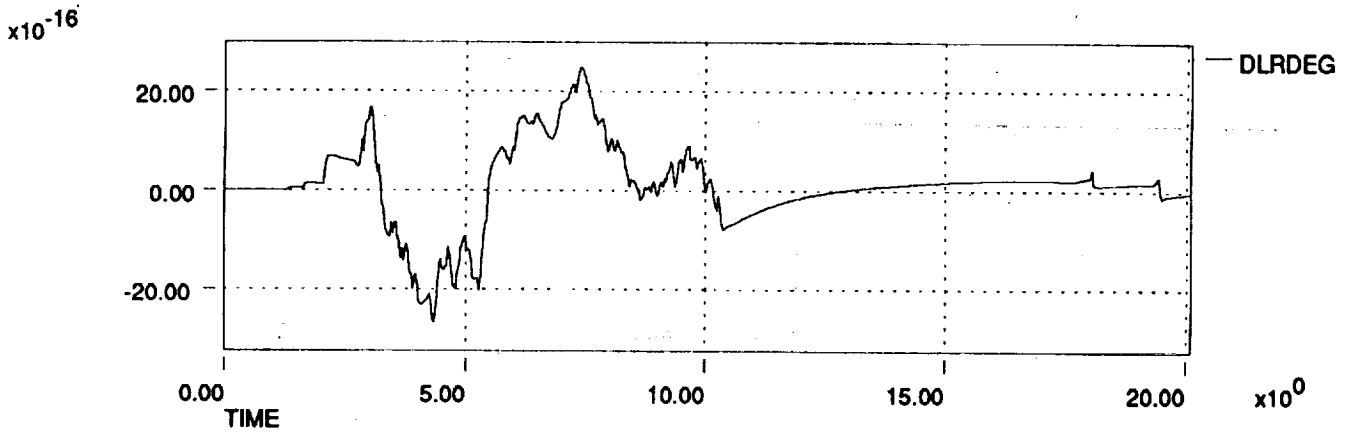
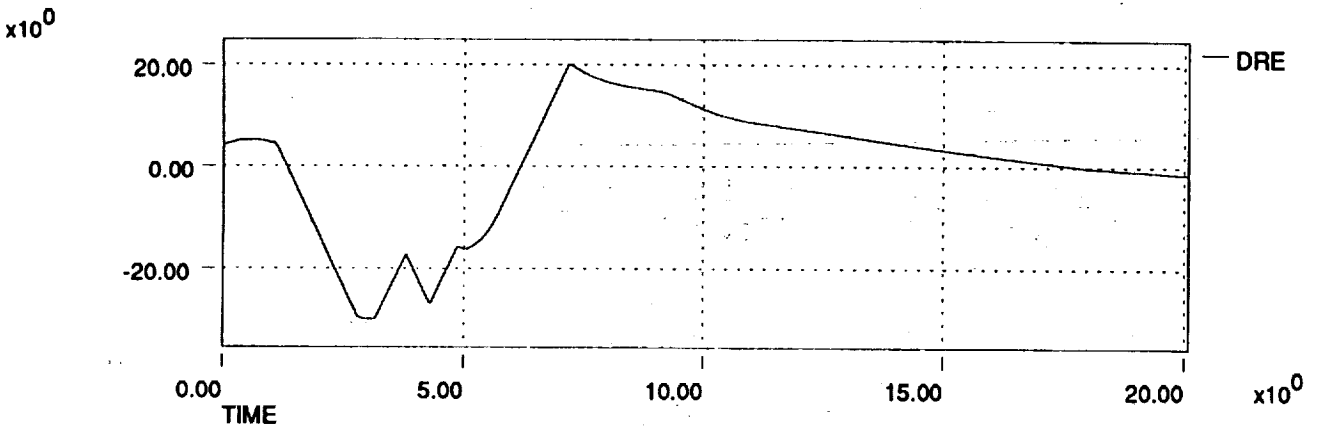
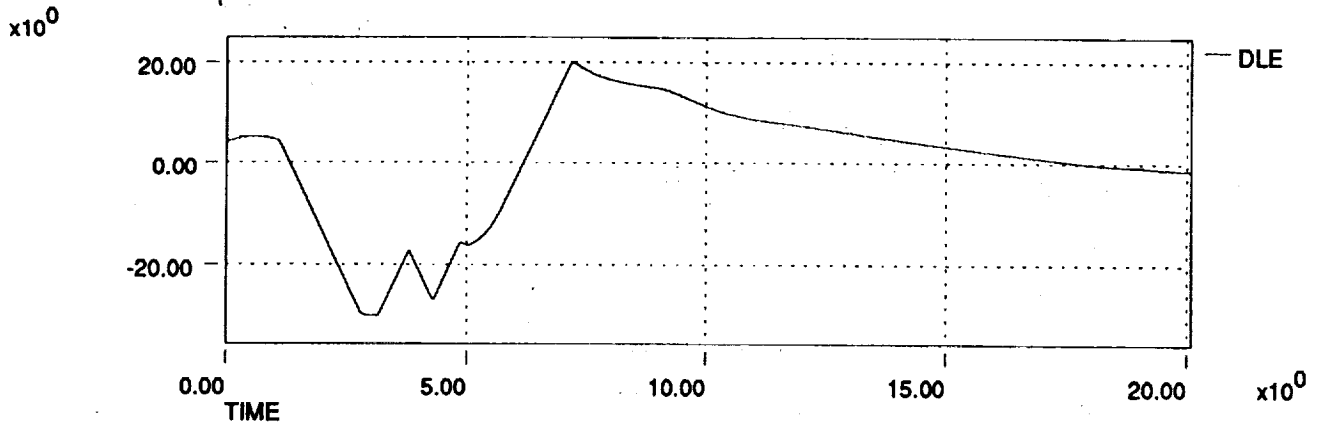

HL-20 Dynamic Check Case Data Plots 911206
Speed Brake Handle Pulse at Mach 4 and 104,000 ft

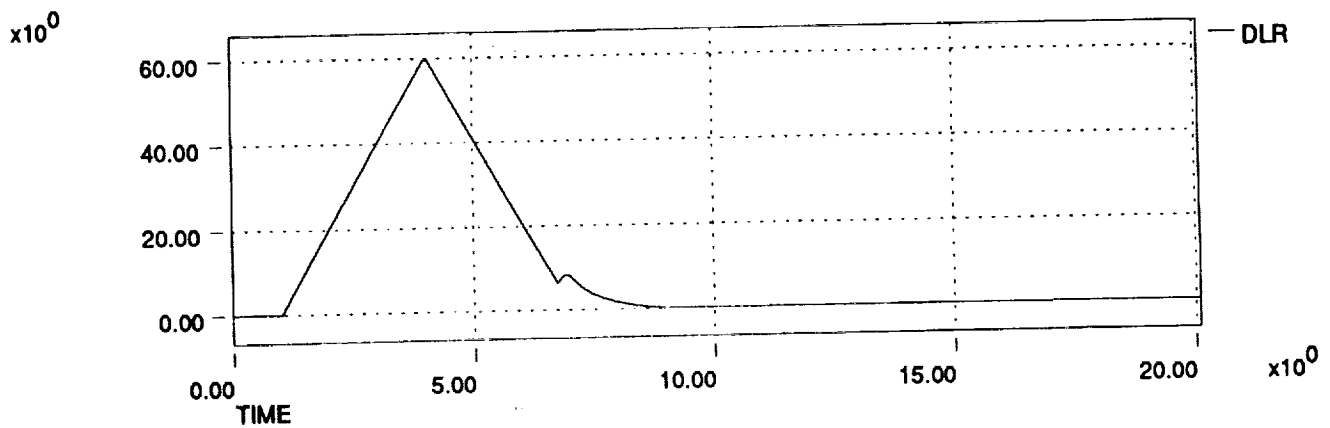
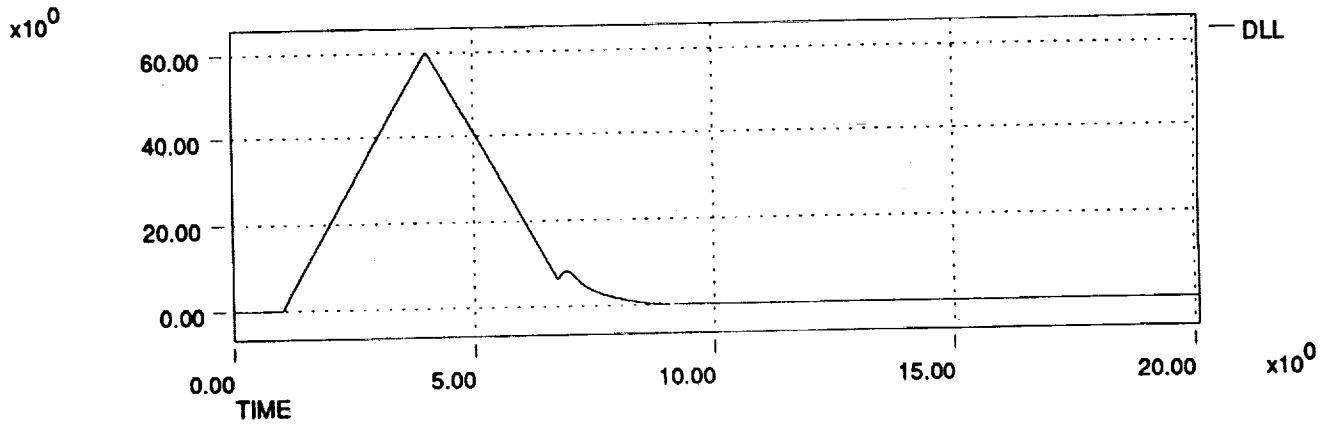
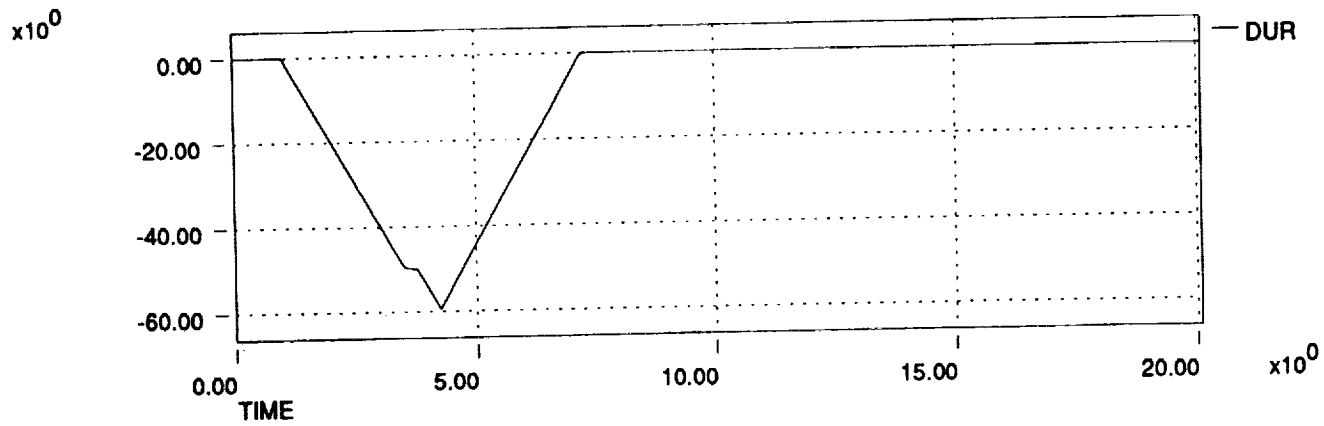
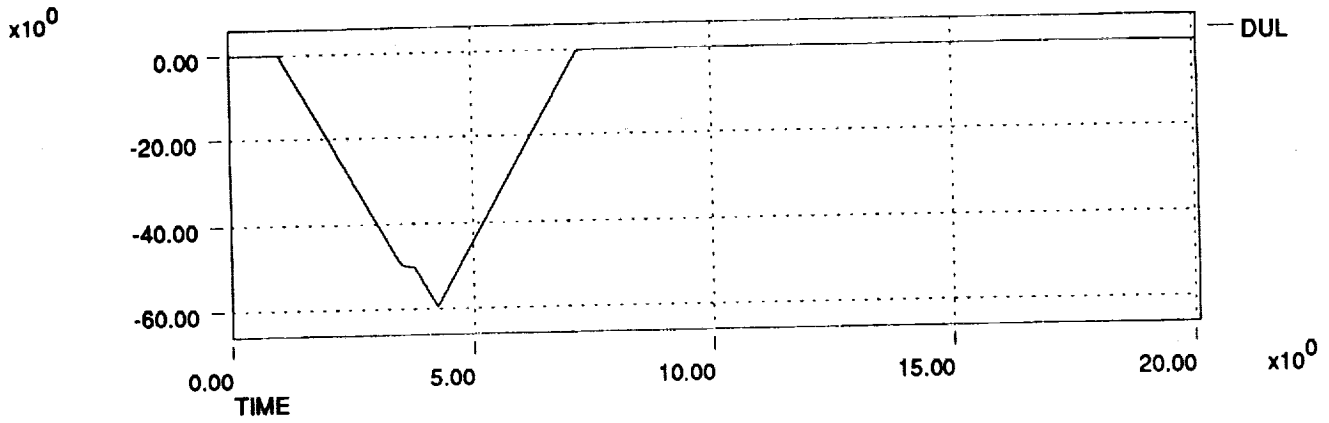

REPORT DOCUMENTATION PAGE

Form Approved
OMB No. 0704-0188

Public reporting burden for this collection of information is estimated to average 1 hour per response, including the time for reviewing instructions, searching existing data sources, gathering and maintaining the data needed, and completing and reviewing the collection of information. Send comments regarding this burden estimate or any other aspect of this collection of information, including suggestions for reducing this burden, to Washington Headquarters Services, Directorate for Information Operations and Reports, 1215 Jefferson Davis Highway, Suite 1204, Arlington, VA 22202-4302, and to the Office of Management and Budget, Paperwork Reduction Project (0704-0188), Washington, DC 20503.

1. AGENCY USE ONLY (Leave blank)	2. REPORT DATE July 1992	3. REPORT TYPE AND DATES COVERED Technical Memorandum
----------------------------------	-----------------------------	--

4. TITLE AND SUBTITLE Real-Time Simulation Model of the HL-20 Lifting Body	5. FUNDING NUMBERS 505-64-52-01
---	------------------------------------

6. AUTHOR(S) E. Bruce Jackson, Christopher I. Cruz, and W. A. Ragsdale	
---	--

7. PERFORMING ORGANIZATION NAME(S) AND ADDRESS(ES) NASA Langley Research Center Hampton, VA 23665-5225	8. PERFORMING ORGANIZATION REPORT NUMBER
--	--

9. SPONSORING/MONITORING AGENCY NAME(S) AND ADDRESS(ES) National Aeronautics and Space Administration Washington, DC 20546-0001	10. SPONSORING/MONITORING AGENCY REPORT NUMBER NASA TM-107580
---	--

11. SUPPLEMENTARY NOTES Jackson and Cruz: Langley Research Center, Hampton, VA; Ragsdale: Unisys Corporation, Hampton, VA.

12a. DISTRIBUTION/AVAILABILITY STATEMENT Unclassified-Unlimited Subject Category 15	12b. DISTRIBUTION CODE
---	------------------------

13. ABSTRACT (Maximum 200 words) A proposed manned spacecraft design, designated the HL-20, has been under investigation at Langley Research Center. Included in that investigation are flight control design and flying qualities studies utilizing a man-in-the-loop real-time simulator. This report documents the current real-time simulation model of the HL-20 lifting body vehicle, known as version 2.0, presently in use at NASA Langley Research Center. Included are data on vehicle aerodynamics, inertias, geometries, guidance and control laws, and cockpit displays and controllers. In addition, trim case and dynamic check case data is provided. The intent of this document is to provide the reader with sufficient information to develop and validate an equivalent simulation of the HL-20 for use in real-time or analytical studies.

14. SUBJECT TERMS LIFTING BODY HL-20 SIMULATOR FLYING QUALITIES AERODYNAMICS CONTROL LAWS	15. NUMBER OF PAGES 473
	16. PRICE CODE A20

17. SECURITY CLASSIFICATION OF REPORT Unclassified	18. SECURITY CLASSIFICATION OF THIS PAGE Unclassified	19. SECURITY CLASSIFICATION OF ABSTRACT Unclassified	20. LIMITATION OF ABSTRACT
---	--	---	----------------------------