

FINAL REPORT

**NAS8-36955
DELIVERY ORDER 30**

HIGH TEMPERATURE AIRCRAFT RESEARCH FURNACE FACILITIES

Submitted to

**Richard M. Poorman
George C. Marshall Space Flight Center
National Aeronautics and Space Administration
Huntsville, Alabama 35812**

Prepared by

**James E. Smith, Jr., Ph.D.
Associate Professor and Chairman**

and

**John L. Cashon
Graduate Research Assistant**

**Department of Chemical and Materials Engineering
College of Engineering
The University of Alabama in Huntsville
Huntsville, Alabama 35899**

August 1992

**(NASA-CR-184384) HIGH TEMPERATURE
AIRCRAFT RESEARCH FURNACE
FACILITIES Final Report (Alabama
Univ.) 109 p**

N92-33826

Unclas

G3/09 0120941

FINAL REPORT

NAS8-36955
DELIVERY ORDER 30

HIGH TEMPERATURE AIRCRAFT RESEARCH FURNACE FACILITIES

Submitted to

Richard M. Poorman
George C. Marshall Space Flight Center
National Aeronautics and Space Administration
Huntsville, Alabama 35812

Prepared by

James E. Smith, Jr., Ph.D.
Associate Professor and Chairman

and

John L. Cashon
Graduate Research Assistant

Department of Chemical and Materials Engineering
College of Engineering
The University of Alabama in Huntsville
Huntsville, Alabama 35899

August 1992

TABLE OF CONTENTS

| | |
|-------------------------------------|----|
| 1.0 Introduction | 1 |
| 1.1 Objective | 2 |
| 1.2 Overview | 2 |
| 2.0 Equipment | 11 |
| 2.1 Operations | 12 |
| 2.2 Cabinets | 21 |
| 2.3 Collet Holders | 30 |
| 2.4 Translation System | 33 |
| 2.5 Orbital Tube Welding System | 40 |
| 2.6 Accelerometers | 43 |
| 2.7 Cooling System | 45 |
| 2.8 Power Distribution | 51 |
| 2.9 Ground Path Module | 52 |
| 2.10 Operations Computer | 53 |
| 2.11 Operations Software | 56 |
| 3.0 Procedures | 56 |
| 3.1 Samples | 56 |
| 3.2 Hardware | 57 |
| 3.3 Powering Up and Loading Samples | 59 |
| 3.4 Operations | 63 |
| 4.0 Results and Discussion | 67 |
| 5.0 Conclusions and Recommendations | 69 |
| 8.0 Future Work | 69 |

| | |
|---|-----|
| APPENDIX A: OPERATIONAL PROCEDURES | 70 |
| APPENDIX B: HTARFF OUTPUT FILE (DSFOUT.DAT) | 86 |
| APPENDIX C: COMPUTER-AIDED-DESIGN DRAWINGS | 89 |
| APPENDIX D: HTARFF PARTS INVENTORY | 100 |

1.0 INTRODUCTION

This is the final report for work focused on the design, fabrication, and development of the High Temperature Aircraft Research Furnace Facilities (HTARFF). This work was conducted in laboratory space provided by the Department of Chemical and Materials Engineering at the University of Alabama in Huntsville, and funded by NASA-MSFC through contract number NAS8-36955, delivery order 30.

The HTARFF has been developed to process electrically conductive materials with high melting points in a low gravity environment. The basic principle of operation is to accurately translate a high temperature arc-plasma gas front as it orbits around a cylindrical sample, thereby making it possible to precisely traverse the entire surface of a sample. The furnace utilizes the Gas-Tungsten-Arc-Welding (GTAW) process, also commonly referred to as Tungsten-Inert-Gas (TIG). The HTARFF has been developed to further research efforts in the areas of directional solidification, float-zone processing, welding in a low-gravity environment, and segregation effects in metals. The furnace is intended for use aboard the NASA-JSC Reduced Gravity Program KC-135A Aircraft.

1.1 OBJECTIVE

The objective of this research was to design, fabricate, and develop an advanced high temperature prototype research furnace using the High Temperature Containerless Aircraft Furnace (HTCAF) as a basis. The HTCAF utilized an orbital tube welding system to statically process electrically conductive materials with very high melting points.

The HTARFF contains a computer controlled mechanism for translation of the rotating arc over the sample. The system is a prototype unit designed for ground operations. When completed, it should operate continuously through a parabolic flight profile, allowing samples to resolidify under desired gravity conditions. The HTARFF has the capacity to process samples as large as 1/2" in diameter.

Design of furnace components was accomplished on a state-of-the-art computer-aided-design system, namely an Intergraph Interpro 220 workstation utilizing Intergraph Engineering Modelling System software version 2 (I/EMS).

1.2 OVERVIEW

All work associated with the construction of the ground based HTARFF has been completed. A schematic illustrating the

HTARFF system network is depicted in Figure 1. The vital components represented in the diagram are the S.T. International Nika-BTW orbital tube welder, which initiates and sustains a melt zone in the sample, the Compumotor C4000 translation system, which moves the weld head along the stationary sample, and the 80386-20Mhz operations computer which functions as the control center for the system. Other subsystems include the data acquisition and control hardware, and the cooling system. The specifics of each component and its interaction with other components are addressed later in this report.

All components and subsystems have been integrated into two industrial cabinets for safety and ease of transport, as shown in Figures 2 and 3. In each figure, the cabinet to the left is referred to as the electrical cabinet, and the one on the right is the furnace cabinet. The cabinets are 56.41" tall and 24.12" wide. The electrical cabinet is 29.12" deep, while the furnace cabinet is 24.12" deep. Both cabinets have doors with full length 1/4" thick acrylic windows, while the electrical cabinet also possesses a flip-down keyboard compartment. Rack mounted panels provide a second barrier to protect the user from the internal cabinet components when the doors are open.

Furnace components contained in the electrical cabinet are the operations computer, its monitor, the cooling system's heat exchanger, pump, and expansion tank, and the S.T. International Nika BTW power supply. The furnace cabinet holds the Compumotor

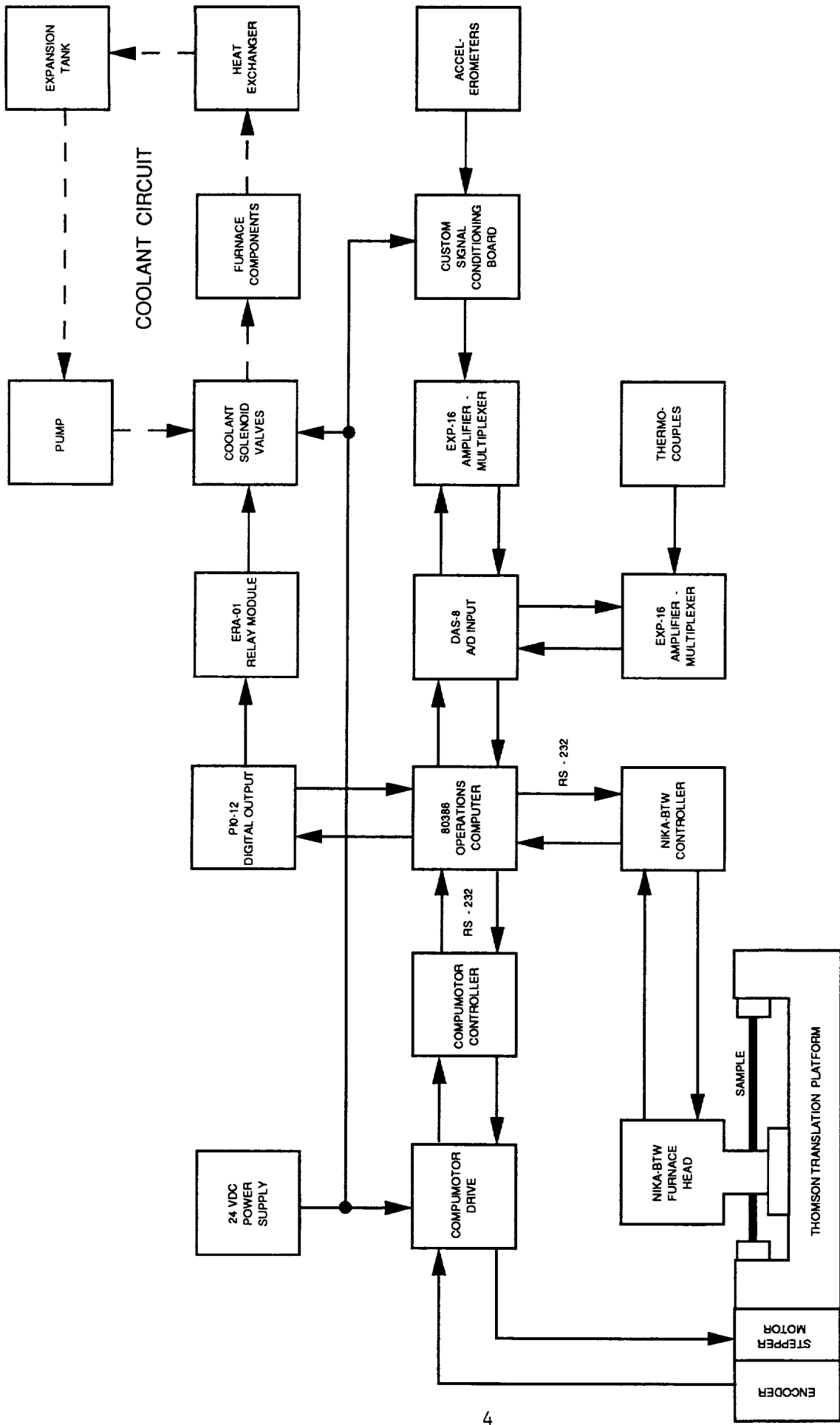

FIGURE 1
HIGH TEMPERATURE AIRCRAFT RESEARCH FURNACE FACILITY
SYSTEM SCHEMATIC

ORIGINAL MADE
BLACK AND WHITE PHOTOGRAPH

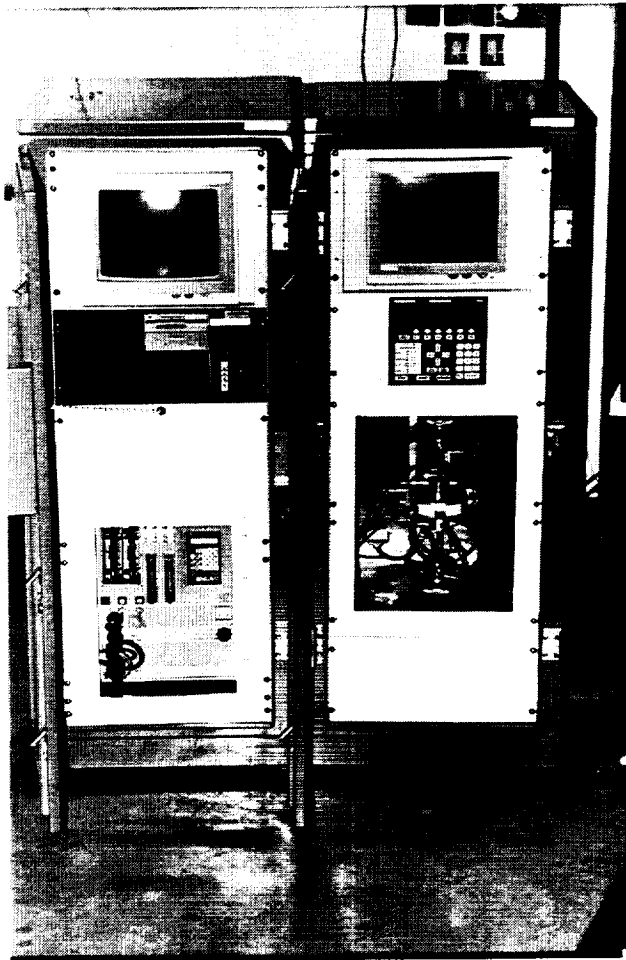

Figure 3
HTARFF Cabinets,
with Cabinet Doors Open

C4000 translation system, Thomson superslide, BTW furnace head, furnace housing, accelerometers, thermocouples, and monitors for the BTW and C4000 power supplies.

As shown in Figure 4, the BTW furnace head is positioned around the stationary 1/4" stainless steel sample, and is mounted to the Thomson Superslide translation platform. The Compumotor computer controlled stepper motor is attached to the Superslide's turn screw and supplies power for precise translation of the BTW furnace head along the length of the sample.

The S.T. International Nika-BTW utilizes the TIG welding process, and is capable of temperatures in excess of 3500 degrees Celsius. Temperatures above and below the melt zone in the sample are governed by two cooling zones which are fixed to the furnace head immediately above and below the melt zone. Coolant temperatures in the cooling zones are measured by type-T thermocouples and regulated by valves in the cooling system which are operated by the operations software based on user defined limits.

Continuous operations through a defined low-gravity range has been made possible by incorporating accelerometers into the system. Measurements from the accelerometers, along the three principal axis, are logically tied to the start and stop signals sent from the operations computer to the BTW and the C4000. This provides a means for selecting a desired gravity level for

ORIGINAL PAGE
BLACK AND WHITE PHOTOGRAPH

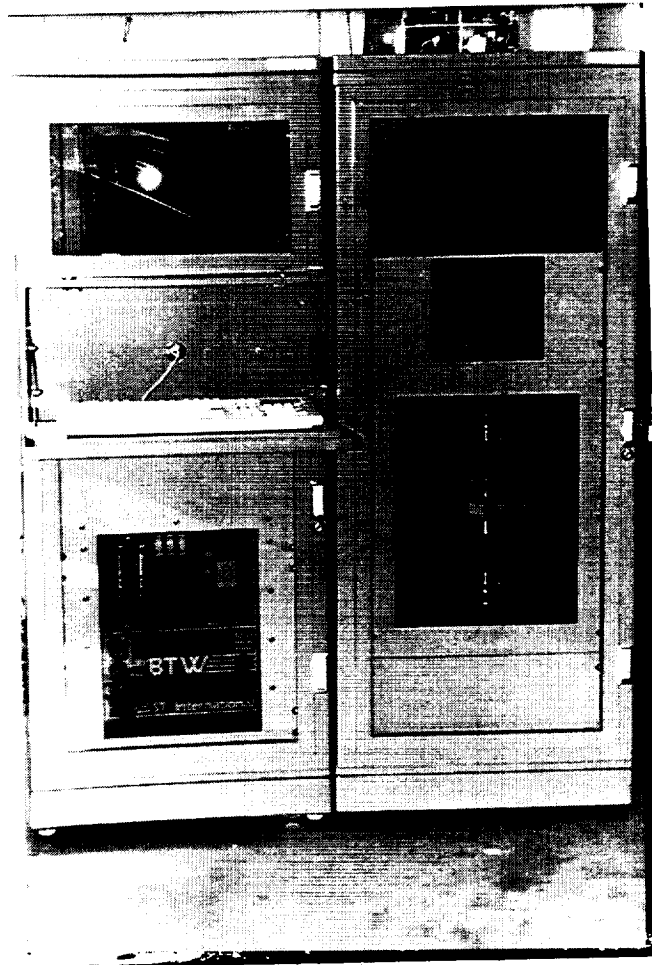

Figure 2

Electrical Cabinet (left), and
Furnace Cabinet (right)

ORIGINAL PAGE
BLACK AND WHITE PHOTOGRAPH

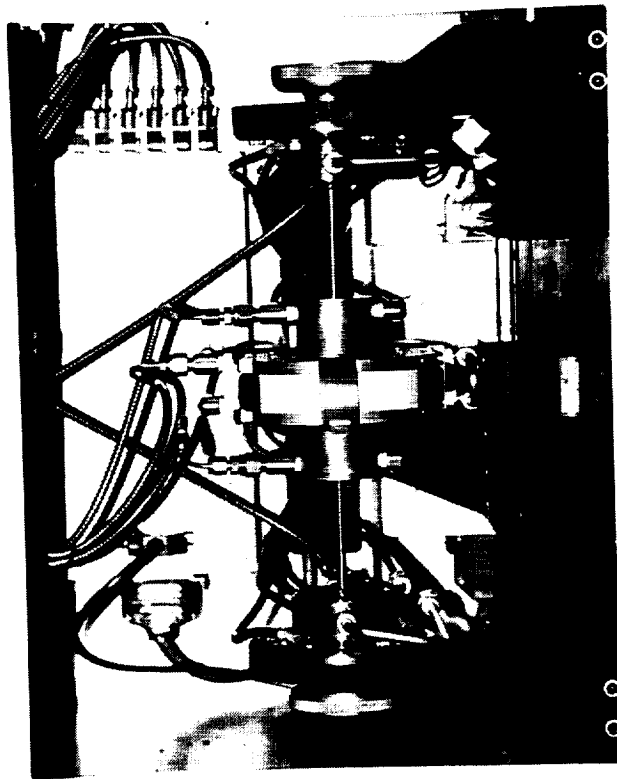

Figure 4

BTW Furnace Head, Thomson Superslide,
and 1/4" Diameter Stainless Steel Sample

eventual processing of materials aboard the KC-135A research aircraft while allowing continuous translation of the arc over the sample through a parabolic flight profile.

The HTARFF is designed to accommodate cylindrical rods as samples in lengths of twelve inches, with a maximum diameter of 1/2 inch, and is only limited by the current available from the S.T. International welding equipment on which the system is based. Hardware is included for processing rods in diameters of 1/2, 1/4, and 1/8 inch.

Design of the furnace components requiring fabrication was accomplished using Intergraph Interpro 220 hardware and I/EMS software version 2. Surface dimensions accurate to 1/1000 inch were dictated where deemed necessary on critical components. Mechanical drawings of these components are included in Appendix C. Fabrication was completed at the University of Alabama in Huntsville Machine Shop, with final inspection and acceptance determined by personnel in the Department of Chemical and Materials Engineering. Stress relief and surface coatings were applied to those parts requiring such preparation.

A ground path module, seen in Figure 5, has been devised, by which the user can manually select a path for the electrical current to flow through the sample during processing. Current enters the sample from the furnace head electrode, and can exit through either end of the sample, or both, depending on how the

ORIGINAL PAGE
BLACK AND WHITE PHOTOGRAPH

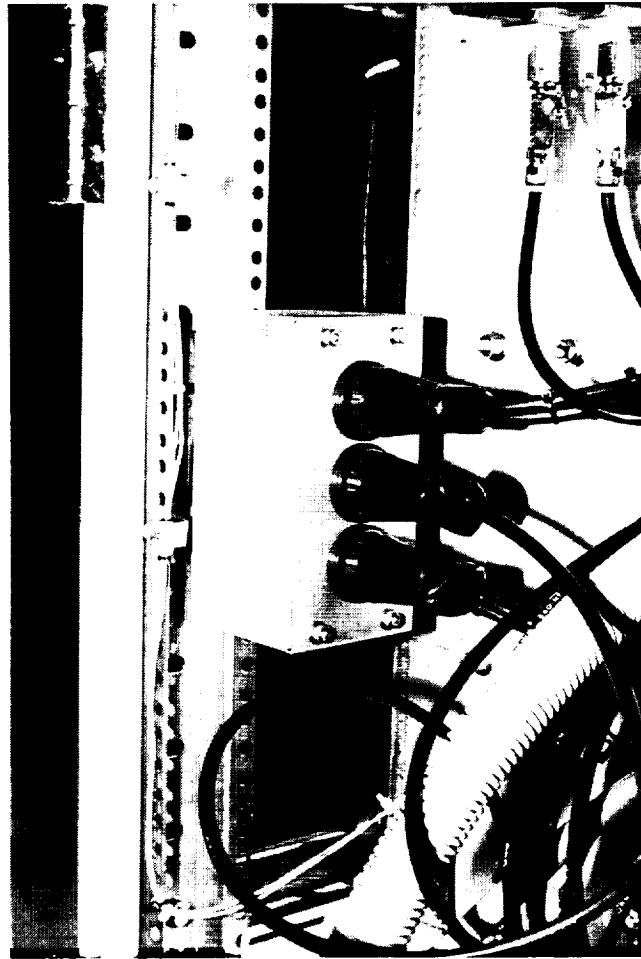

Figure 5
Ground Path Selection Module

ground path module is configured. This feature allows research to be conducted as to how strong electrical currents influence solidification behavior in conductive materials.

The HTARFF features a user-friendly menu driven software package with user definable temperature settings for the liquid cooled furnace components. Multiple runs are possible using the same sample. Upon completion of every run, a summary of measured data is output to a hard disk file for use in analysis at a later date.

2.0 EQUIPMENT

An inventory list of all major parts and subsystems used to complete the HTARFF system has been compiled. A copy of this list is provided in Appendix D of this report.

All essential HTARFF system hardware required for successful operation is contained in two commercially available cabinets. Other hardware is included which allows the system to accommodate different diameter samples. This equipment includes 1/2", 1/4", and 1/8" brass cooling zone inserts and collets, and 1/2" and 1/4" electrodes for the BTW furnace head. Also included are miscellaneous Nika-BTW parts, and keys to the cabinet side panels.

An Operational Procedures manual for the HTARFF is included with the furnace. Other manuals are included pertaining to various furnace subsystems, including the operations computer's monitor, keyboard, CATN386, IOSB, DAS-8, and EXP-16 cards, the Tripp Lite line conditioner, the Compumotor Model 4000 Controller, C-Drive, 24VDC power supply, and X command language, and S.T. International manuals for BTW and ATW systems.

Stainless steel fasteners were utilized wherever possible during integration of furnace components into the cabinets. They were also used, where necessary, in the construction of the furnace subsystems.

High temperature nickel alloy, teflon coated wire, of the appropriate gauge where required, was also used in the construction of the HTARFF system and associated subsystems.

2.1 OPERATIONS

The HTARFF was constructed following the system schematic shown in Figure 1. The major furnace components are the Thomson and Compumotor C4000 translation system, the S.T. International Nika-BTW orbital tube welder, data acquisition and control systems, cooling system, and the operations computer. Furnace operations software has been written to communicate with and control the furnace components through the operations computer.

Samples are held in place by collets at each end of the sample as seen in Figure 6. The collets are held in place by liquid cooled collet holders located at either end of the translation platform. Knurled knobs on back of the collet holders serve as draw spindles for the collets.

The sample passes through, but does not come into contact with, the furnace head, and two liquid cooled cooling zones. See Figures 7 and 8. The cooling zones are attached to the furnace head, above and below the point where the melt pool is established. They provide cooling to the sample via radiative heat transfer. Brass inserts for the cooling zones are included for the promotion of radiative heat exchange. Operating temperatures for the cooling zones can be set by the user through the operations software. Inert gas (helium or argon) is fed to the melt chamber through the BTW umbilical cable.

The furnace head is mounted to the carriage of the Thomson 2DB Superslide by an aluminum bracket of 1/2 inch nominal thickness, as can be seen in Figure 4. The superslide supplies 5.375 inches of travel, of which only 4.5 inches is exercised. The remaining travel, not in active service, is divided equally between the two ends of the translation length and serve as hardware limit safety zones. The superslide is mechanically isolated with high durometry rubber bushings from the furnace housing, which in turn is isolated from the furnace cabinet, in order to reduce effects from high frequency vibrations.

ORIGINAL PAGE
BLACK AND WHITE PHOTOGRAPH

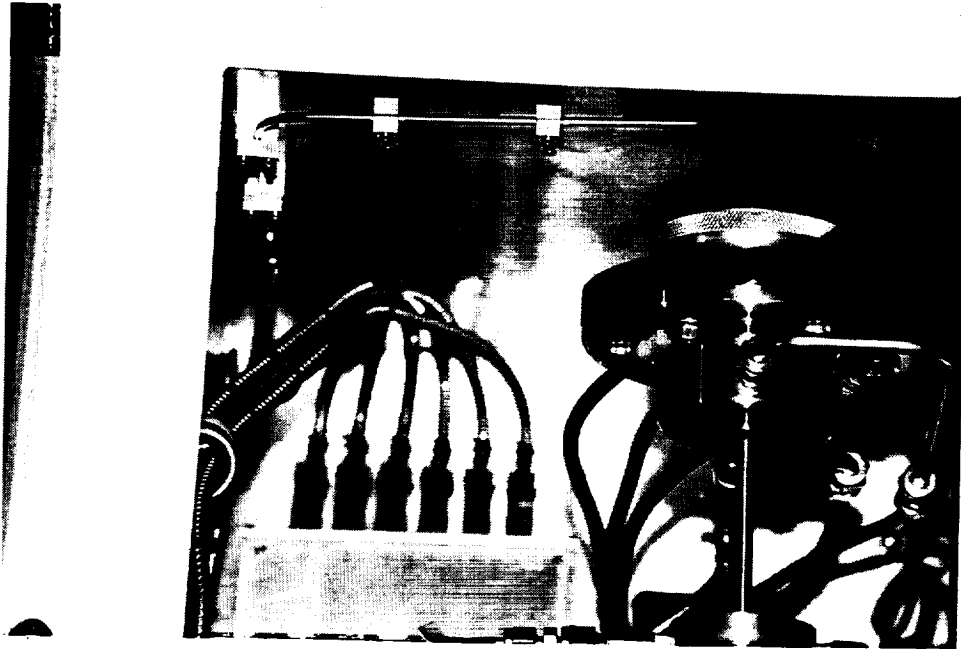

Figure 6
Collet Holder, and
Thermocouple Number 6

ORIGINAL PAGE
BLACK AND WHITE PHOTOGRAPH

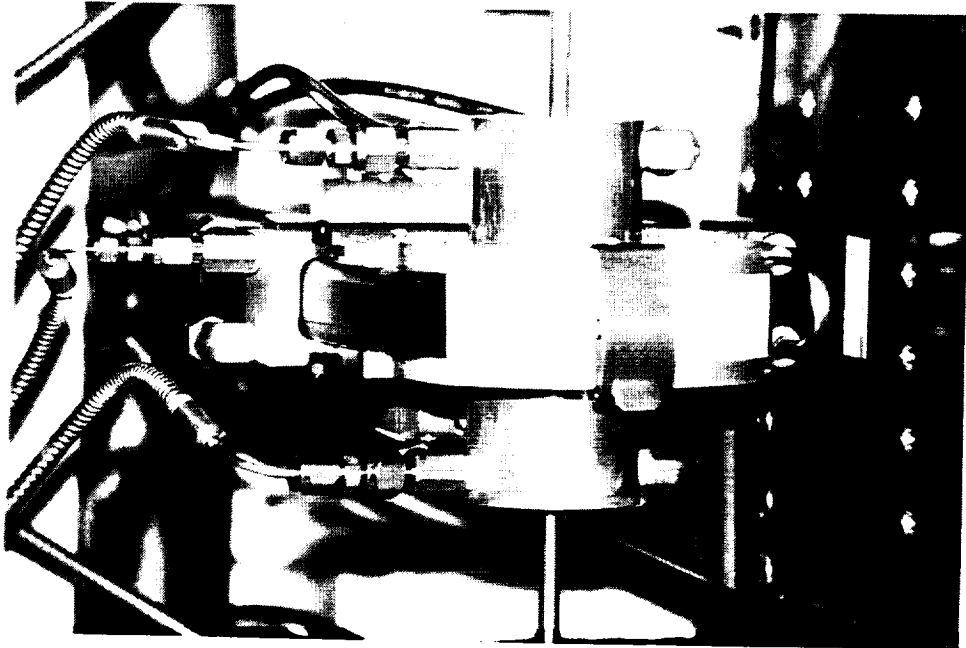

Figure 7
Furnace Head, and Cooling Zones

ORIGINAL PAGE
BLACK AND WHITE PHOTOGRAPH

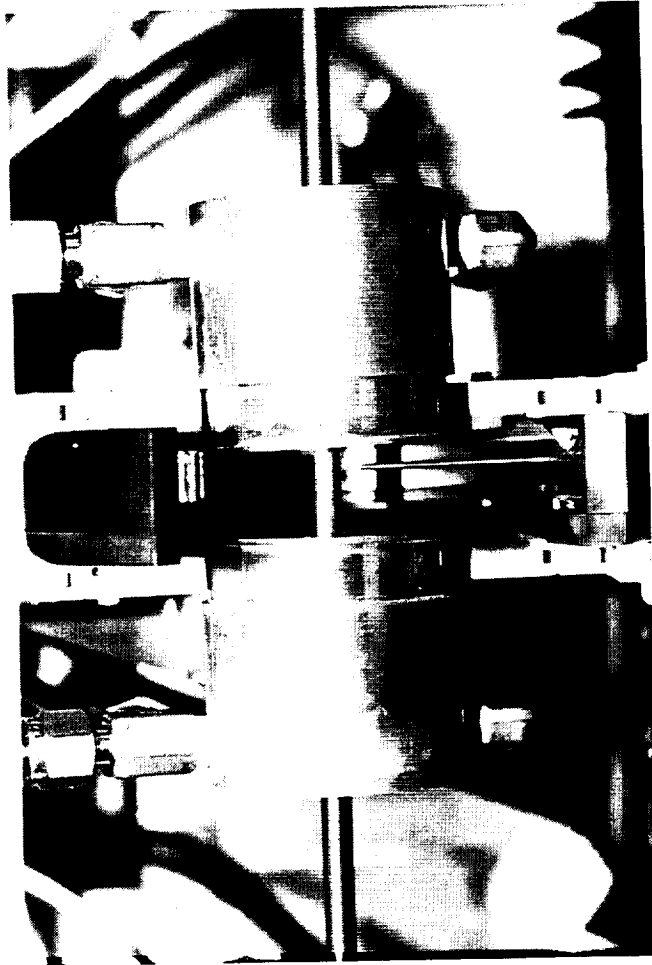

Figure 8
Furnace Head (open), and Cooling Zones

Translation of the superslide carriage is accomplished by a high resolution stepper motor providing power to turn a screw running the length of the superslide. An encoder, piggy-backed to the motor, supplies a reference to indicate motor position and warn of motor stall. Power to the motor is supplied by a 24 VDC power supply through the Compumotor C-series drive. The Compumotor controller acquires encoder readings, and controls motor pulses through the C-drive. Ultimate command of the motor, and therefore translation of the furnace head, originates at the operations computer. Commands are determined by the operations software based on encoder readings. Continuous RS-232 communications between the operations computer and the Compumotor controller provide a path for motor and encoder data retrieval and command execution.

Energy is supplied to the sample, for initiation and maintaining of a melt zone, by the BTW furnace head. Parameters such as electrode RPM, arc amperage, strike amperage, arc duration, and inert gas flow rate are designated by the user during set-up procedures, and controlled by the BTW controller while the furnace is running. Programming of the BTW parameters is accomplished through the HTARFF operations software which provides a menu selection for direct RS-232 communications with the BTW control module. The BTW is a self contained welding system, maintaining complete control of its own functions, however, commands for initiating and terminating arcing operations are controlled by the operations computer through the

operations software.

Three accelerometers are attached to the superslide to provide linearly independent gravity level readings along the x, y, and z axes; the z axis is vertical, positive downward, while the x-y plane is normal to the z-axis. A custom designed and fabricated signal conditioning board amplifies the accelerometer signals, which consumes power from the 24 VDC power supply. Signals are sent to a Keithley / Metrabyte EXP-16 amplification-multiplexer board (gain = 1) which supplies the information to the operations computer through a Keithley / Metrabyte DAS-8 analog-to-digital card when polled by the operations software. Shown in Figure 4, the EXP-16 boards for the Omega type-T thermocouples and the Sundstrand Data Control accelerometers are both contained in the same housing, which is mounted on the back wall of the furnace housing. Accelerometer data ensures the desired gravity environment is reached and maintained during furnace arcing operations.

Type-T thermocouples monitor temperatures inside the five critical components which are exposed to the intense heat generated by the furnace head, namely the BTW furnace head, both collet holders, and both cooling zones. Shown in Figure 6, a sixth thermocouple is located above the superslide for measuring ambient conditions inside the furnace housing. Thermocouple signals are fed to an EXP-16 amplifier-multiplexer board (gain = 200), prior to being polled by the operations computer's DAS-8

analog-to-digital card for use by the operations software.

Before furnace arcing procedures begin, the user, through the menu driven software, selects operating temperatures for each of the five liquid cooled components and the ambient temperature thermocouple. During furnace arcing operations the thermocouples are continuously monitored. When a component exceeds its allotted temperature, the operations software signals the opening of the valve in the coolant circuit to that component. These valves are shown in Figure 9. Digital signals are sent via a Keithley / Metrabyte PIO-12 digital output card directly to a Keithley / Metrabyte ERA-01 relay board, which in turn completes the electrical circuit to the solenoid activated coolant valve for that component. Power is supplied to the solenoid valves by the 24 VDC power supply. Coolant is circulated through the components, extracting heat in the process, then into an air-cooled heat exchanger where heat is expelled, through a pressure adjustable expansion tank, then to a pump which feeds the coolant back to the valves. When the temperature drops below the designated temperature, the operations software signals for the valve to be closed.

The signal from the sixth thermocouple, seen in Figure 6, is also monitored continuously while the furnace is arcing. However, if the temperature limit for this thermocouple is exceeded, the operations software signals for all arcing and translation actions to be terminated immediately. The user is

ORIGINAL PAGE
BLACK AND WHITE PHOTOGRAPH

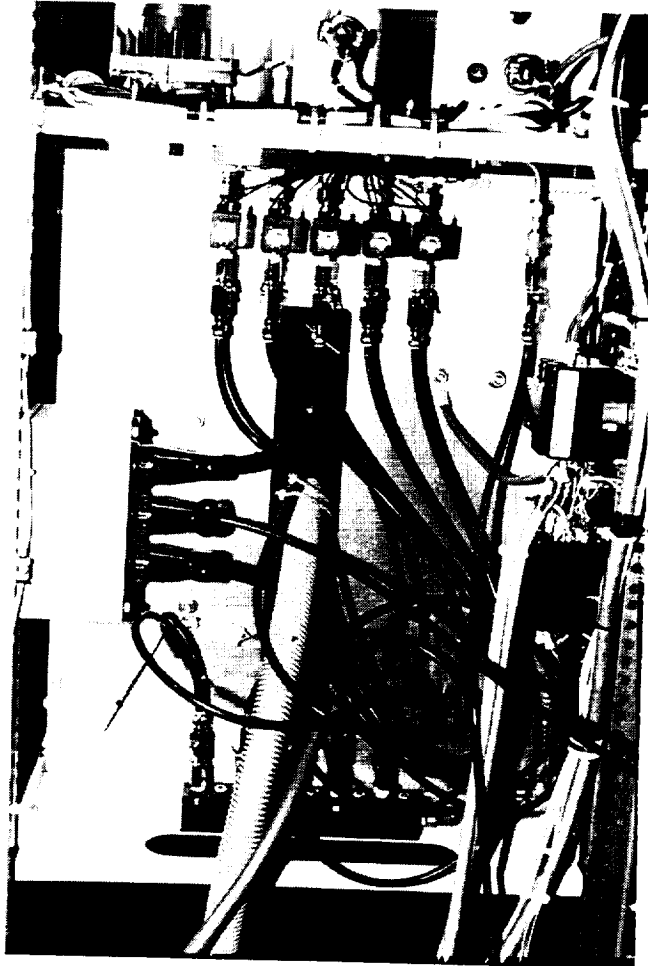

Figure 9

**Furnace Cabinet: Rear View.
Clockwise from Top; Inlet manifold,
Master Power Relays, Return Manifold,
and Ground Path Selection Module**

notified of such actions by an audible tone and written message on the operations computer screen.

After each run of the furnace, the DSFOUT.DAT data file is generated and output to the operations computer's hard disk for permanent storage. The data output to this file summarizes the values selected by the user for that run, highs and lows experienced by each of the accelerometers and thermocouples, and a statement as to whether translation was successful or terminated prematurely and for what reason. Timed data from the encoder, accelerometers, and cooling zone thermocouples is also included. A copy of a typical DSFOUT.DAT file generated during furnace operations is located in Appendix B of this report.

2.2 CABINETS

The HTARFF consists of two cabinets; an electrical cabinet, and a furnace cabinet as shown in Figures 2 and 3. These cabinets were special ordered from the Hoffman Engineering Company. Special features include 1/4" thick smoke tinted acrylic windows installed along the full length of the both front doors, and a flip-down keyboard shelf installed on the front on the electrical cabinet which is visible in Figure 2. This permits control and monitoring of all furnace functions through keyboard input, while ensuring the safety of the operator, by keeping all heating and electrical components behind closed

doors. Cooling, electrical, and communications lines which do not feed between the two cabinets, have been lashed to the internal support structure of each cabinet using stainless steel clamps with teflon cushions, and tie wraps where applicable.

The cabinets are constructed of 14 gauge steel, with the seams continuously welded and ground smooth. Functional openings are located on all four sides, the top, and the bottom. Hinged doors are mounted on the front and back of each cabinet frame. They are easily removable, and sweep 120 degrees when opened. Oil resistant gaskets are in place around the door perimeters, and keyboard compartment. The sides fit flush and are held in place with low profile, quarter turn, oil tight latches operated by a key. Keys to the cabinet side panels are included with the HTARFF. The top is flush, drip-proof, and held in place with internal captive fasteners. The base has reinforced corners for additional strength, and levelers and casters for moving and securing the cabinets in their desired locations. Horizontal struts, rack mounting angles, and fixed shelves provide the necessary hard points for installing furnace components into the cabinets. Modified panels shield the user from system hardware when either front door is open.

The electrical cabinet, as shown in Figure 10, utilizes four horizontal struts, six rack mounting angles, and one Hoffman shelf to secure components. The monitor to the operations computer is in the top of the electrical cabinet, and is mounted

ORIGINAL PAGE
BLACK AND WHITE PHOTOGRAPH



Figure 10

Electrical Cabinet; Side View.
Top to Bottom: Monitor, Operations Computer,
Cooling System Hardware, and BTW Power Supply

to the front angle rack. The operations computer is attached to the front and intermediate racks, beneath the monitor. A shelf is located immediately below the operations computer, from which is hung the coolant system pump and expansion tank.

Figure 11 provides a close up of the cooling system components in this cabinet. The coolant heat exchanger and fan assembly is located just behind the pump and expansion tank and is attached to the rear-most angle rack. The fan's exhaust exits through a filter and stainless steel ventilation grating in the back door. A second ventilation grating is installed in the back door to allow fresh air to circulate into the cabinet.

A 1/4 inch thick aluminum shelf has been fabricated to support the BTW control module. This shelf is located at the lowest point in the electrical cabinet, and is attached to the front and rear angle racks. Angles run length-wise along the bottom of the BTW control module. These angles are fixed to the fabricated shelf using 1/4" screws, and attach to the BTW control module with its own screws to secure the cover. Extra support for the BTW control module is provided by a 1/4 inch aluminum bar placed laterally in the middle over the top of the module. It is held in place by 5/16 inch screw rods running from the aluminum shelf to the bar. Proper location and pressure is maintained by lock-nuts above and below the bar, on both sides. These nuts should not be over tightened, as this will cause the outer cover on the BTW control module to be damaged. A panel is

ORIGINAL PAGE
BLACK AND WHITE PHOTOGRAPH

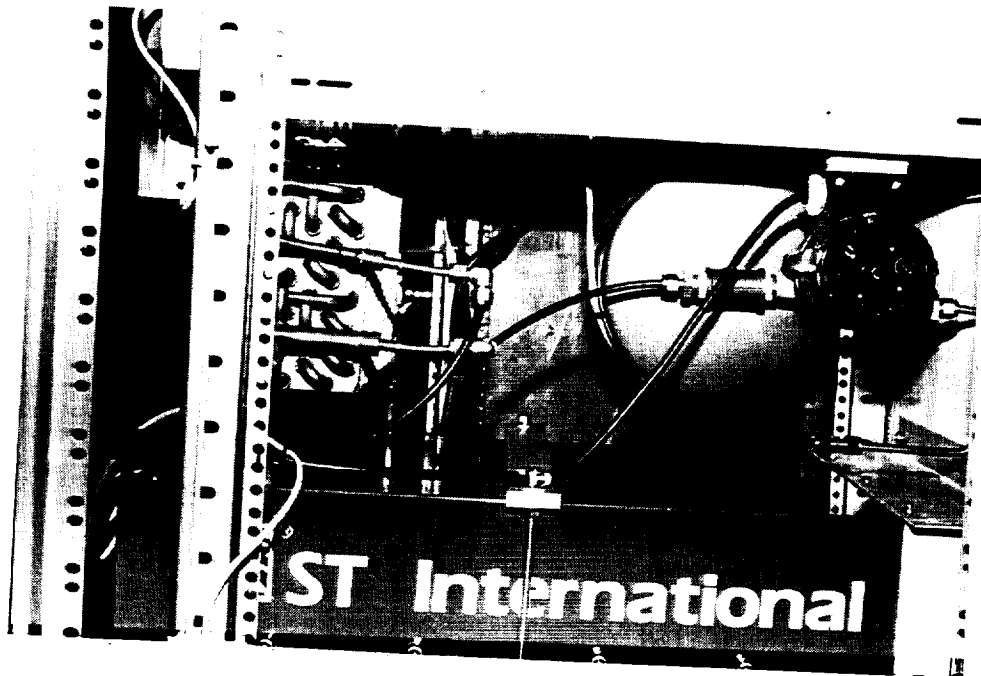

Figure 11
Cooling System Hardware.
Left to Right: Heat Exchanger,
Expansion Tank, and Pump

mounted in the front of the cabinet, extending from the bottom of the operations computer to the bottom of the cabinet. An opening has been machined into the panel allowing full access to the BTW control module panel. Skirts were fabricated to cover the gap between the panel and BTW module on all three sides. The skirts are fastened to the panel, and to the BTW module using its own screws to secure the cover.

The operations keyboard is secured to its compartment flip-down door with velcro strips. This facilitates removal if deemed necessary. The keyboard line passes through a rubber port in the compartment and door. The 120 VAC 5 amp master power switch is located in the keyboard compartment, on the right side of the back surface. Lines from the master power switch and keyboard are intertwined, and pass through a port, cut in the cabinet panel below the computer.

The furnace housing utilizes six horizontal cabinet struts and six angle racks. Two horizontal struts are located at the top on both sides of the furnace cabinet for support. Two pairs are also located on both sides along the top and bottom of the furnace housing and provide a stiffer support structure to eliminate any low frequency vibrations of the housing inside the cabinet. Angle racks are in the front and rear of the cabinet, and along the rear edge of the furnace housing, on both sides, providing additional stiffness.

Three Hoffman shelves are located in the furnace cabinet. The first one is located in the top of the cabinet, from which is hung the controller for the Compumotor translation system. See Figure 12. The remaining two are situated just above and below the furnace housing. The monitor for the BTW is fastened to the front rack, and is just below the upper most panel. The Tripp Lite spike protection and power distribution bus is mounted behind the BTW monitor, and below the Compumotor controller. A cabinet panel has been modified to support the control panel for the Compumotor controller, and allow it to display through the window in the front door. This panel is located just below the BTW monitor, and above the shelf over the furnace housing. Several components have been attached to this shelf, behind the Compumotor panel, and below the Tripp Lite power bus. The Compumotor stepper motor with piggy-backed encoder is located on the front of this shelf on the right hand side. A hole has been machined into the shelf for the drive shaft from the stepper motor to the translation platform to pass. Behind the stepper motor is the Compumotor C-drive. Left of the C-drive are the relay module and 24 VDC power supply, respectively. Hanging from this shelf, behind the furnace housing, is the inlet coolant manifold, attached to which are the solenoid actuated valves.

The furnace housing is mounted in the cabinet below the previously mentioned shelf. The housing is fabricated from 1/4 inch aluminum plates welded together, forming a box, with one open side as shown in Appendix C, Figure 2.8. Openings have been

ORIGINAL PAGE
BLACK AND WHITE PHOTOGRAPH

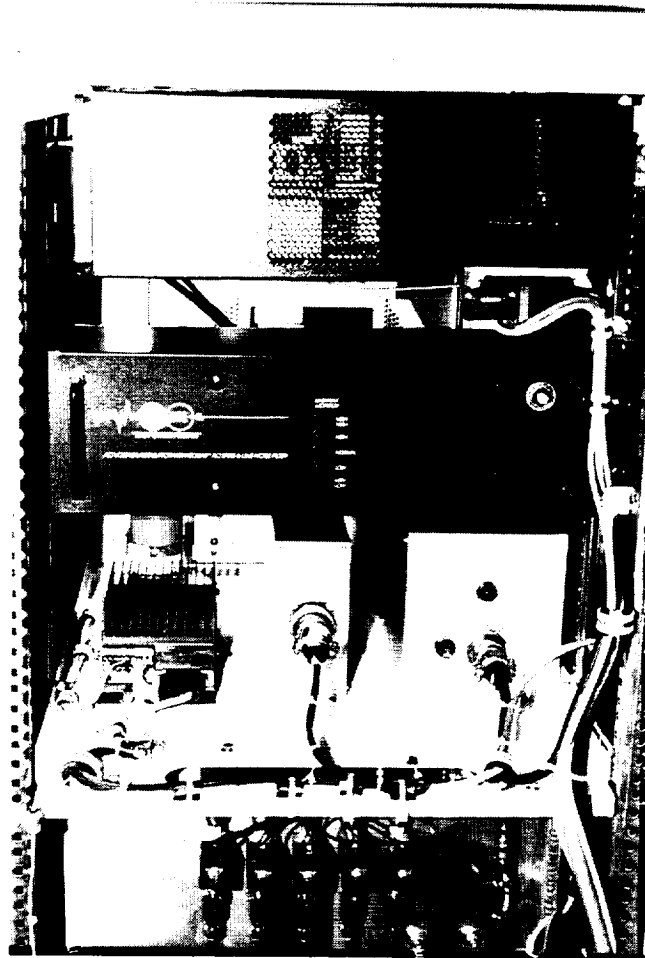

Figure 12

Electrical Cabinet; Rear View.
Top to Bottom; Compumotor controller,
Tripp Lite distribution bus, (left to right)
Compumotor C-drive, ERA-01 Relay Module,
and 24 VDC Power Supply

machined into the housing for mounting to the cabinet racks, mounting of components inside the housing, and to allow passage of the BTW umbilical cable, and stepper motor axle. Rubber vibration and shock grommet isolators, from the Lord Corporation, are used on eight corners to attach the housing to the cabinet racks. These grommets reduce the amount of high frequency vibrations being transferred to the housing from the cabinet. They are rated to 250 pounds each, and feature internal steel shanks to prevent shearing. Custom 1/2 inch steel fasteners were fabricated for use with the isolation grommets. The superslide is mounted inside the housing on the right vertical wall. A 1/2 inch thick layer of 60 durometry rubber is installed between the superslide and the housing wall to further eliminate the effects of high frequency vibrations on sample during processing. Four 3/8 inch bolts attach the superslide to the housing. Nylon inserts isolate the bolts from the housing wall where they pass through it. Rubber and aluminum pads, on the outside of the housing help to distribute the load and further isolate the superslide from the housing.

As is shown in Figure 9, the coolant system return manifold is mounted on the shelf below and behind the furnace housing. A storage area for transfer lines is located below this shelf. The master power relays, which are actuated by the master power switch, and the ground path selection module are located behind the furnace housing and are mounted to the rearmost racks. The relays are on the left side of the furnace, and the ground path

module is on the right side.

External power is supplied by two 120VAC-60Hz electrical power lines. These lines run to the master power relays in the furnace cabinet. When the relays are activated, power is supplied directly to the Tripp Lite power distribution bus, and the BTW control module. External inert gas is supplied to the system, via a quick disconnect fitting on back of the BTW control module.

Cooling system, electrical, communication, and inert gas lines run between the electrical and furnace cabinets.

2.3 COLLET HOLDERS

The samples are held in place by collets commonly used in machining practice with lathes and mills. Two 3AT collets, from Hardinge Brothers, Inc. are incorporated at each end of the length of the superslide to seize the sample and hold it in place. Collets are available to hold different size samples up to 1/2 inch in diameter. Only three sizes have been provided with the HTARFF, 1/8, 1/4, and 1/2 inch diameters. Two adjustable collet holders position the collets at each end of the sample.

The collet holders, seen in Figures 4 and 6, were fabricated

from two separate pieces of stainless steel, which are welded together to form an internal cavity making water cooling possible. Refer to Appendix C, Figure 2.1.1.4 for details. The collet holders locate the collets for proper sample positioning, provide heat transfer away from the collets and sample, and serve as terminals for the electrical current ground path coming out of the sample. The collet holders are mounted to brackets with 5/16 inch bolts, on each end of the superslide. Placement of the collet holders on the brackets is adjustable, allowing for proper alignment along the full length of the sample with respect to the furnace head electrode. Three 1/4 inch set screw and lock nuts provide six degrees of translational and rotational adjustment of the sample ends. These set screws and nuts also serve as terminals for the lines leading to the ground path selection module. The HTARFF has been delivered with the sample and electrode aligned. Set screws and retaining nuts should not be disturbed as the alignment of the sample will be compromised. Misalignment could potentially damage components of the furnace head and translation mechanism.

***** CAUTION *** CAUTION *** CAUTION *** CAUTION *** CAUTION *****
ALTER THE SETTINGS OF THE BOLTS OR SET SCREWS ON THE COLLET
HOLDERS AT YOUR OWN RISK.

The collet holders are held in place by brackets machined from billet 6061-T6 aluminum. Refer to Appendix C, Figures 2.1.1.2 and 2.1.1.3 for details. The brackets have a nominal

thickness of 1/2 inch providing a rigid platform for holding the collet holders in place. All internal corners and edges were cut leaving a 1/4 inch radius to guard against a build up of stress concentrations. The brackets were finished using walnut shell particulate as bead material in a blasting operation to relieve residual stresses brought on by the cutting action of the machine tools. The final parts were anodized black to provide a protective coating from contaminants.

Stainless steel seats have been installed in the brackets to serve as a hard base for the collet holder set screws to press against, thereby preventing any gouging of the aluminum by the set screws. Damage to the brackets, as a result of gouging, could have caused misalignment of the sample or contribute to failure of a bracket when stresses. The ends of the brackets are fixed to the end blocks of the superslide. Six stainless steel bolts per bracket are utilized hold the brackets in place.

The brackets were designed and fabricated with an appendage extending to one side of and normal to the mounting surface of the bracket. These members rest on sides of the end blocks adjacent to the side the brackets are mounted to. Two bolts fix the ends of the members to the end blocks. This configuration provides a moment arm to counteract cantilever actions caused by the collet holders loading the free ends of the brackets. Undue cantilever actions could cause the brackets to rotate on the face of the end blocks. Brass shims were placed between the brackets

and end blocks during the alignment of samples and HTARFF hardware. Bolts securing the brackets to the superslide should not be loosened under any circumstance.

***** CAUTION *** CAUTION *** CAUTION *** CAUTION *** CAUTION *****
BOLTS SECURING THE COLLET HOLDER BRACKETS TO THE SUPERSLIDE SHOULD NOT BE LOOSEMED UNDER ANY CIRCUMSTANCE, AS THIS WILL CAUSE MISALIGNMENT OF THE SAMPLE AND POTENTIAL DAMAGE TO THE FURNACE.

Passages are provided in the center of the brackets for the threaded ends of the collets to extend through. Two 3 inch diameter aluminum knobs with knurled rims, from Balcrank Products, serve as draw spindles for the collets. The knobs are located on the back side of the collet holder brackets and are turned manually.

2.4 TRANSLATION SYSTEM

The translation system consists of a Thomson 2DB superslide, and a Compumotor programmable motion control system. Mechanical linkage between the superslide and motion control system is accomplished by a half inch diameter aluminum shaft acting through a Berg slip coupling.

The Thomson 2DB superslide is made up of two end blocks between which a carriage traverses along a lead screw, while

supported by the superslide body and two precision ground guides. The system is capable of sustaining loadings up to 3120 lbf. The shaft diameter is one inch, with a lead of 0.2 inch per revolution accurate to 0.002 inches per foot, with a backlash of 0.002 inch. Maximum operating temperature for the system is 180 degrees fahrenheit. Bellows, which cover each end of the superslide body, were installed, to protect the guides from dust and contamination. The bellows can withstand temperatures up to 185 degrees fahrenheit. Overall length of the superslide is eighteen inches.

The carriage is 7.6 wide by 7.5 inches high. Four vertical rows of 5/16-18 UNC bolt holes were custom machined into the superslide carriage by Thomson. The holes are, 0.6 inch deep, and were special ordered from Thomson. They were required to mount the furnace head to the carriage, via a fabricated bracket, and allows adaptations for further development of the HTARFF system.

The furnace head is held in place by a bracket machined from billet 6061-T6 aluminum. Refer to Appendix C, Figure 2.1.1.1 for details. The bracket has a nominal thickness of 1/2 inch providing a rigid platform for the furnace head. All internal joints have a 1/4 inch radius to reduce stress concentrations. The bracket was finished using walnut shell particulate as bead material in a blasting operation to relieve residual stresses brought on by the cutting action of the machine tools. The

bracket was anodized black to provide a protective coating from contaminants.

Modifications to the superslide end blocks were required to mount the collet holder brackets and the accelerometer triaxial mount. Care was taken to avoid damage to hardware internal to the superslide end blocks.

The superslide provides 5.375 inches of travel, of which only 4.5 inches are exercised by the HTARFF software. The remaining translation space is divided between both ends of the translation length, and serve as buffer zones in the event hardware limits defined in the software are exceeded.

The Compumotor motion control system includes a model 4000 controller, operators panel, C-series drive, 24 VDC power supply, stepper motor, and a DRC encoder provided by Compumotor, seen in Figures 12 and 13. This system is designed to control one to four axes. All actions of the Compumotor equipment are governed by the C4000 controller, which is slaved to the operations computer. The controller is microprocessor controlled and provides smooth microstepping operation over a wide range of speeds. The operator panel is removable, and is mounted remotely to a panel in the front of the furnace cabinet. As currently configured the panel serves no function in the operational procedures of the HTARFF. The controller requires a 120VAC power source.

ORIGINAL PAGE
BLACK AND WHITE PHOTOGRAPH

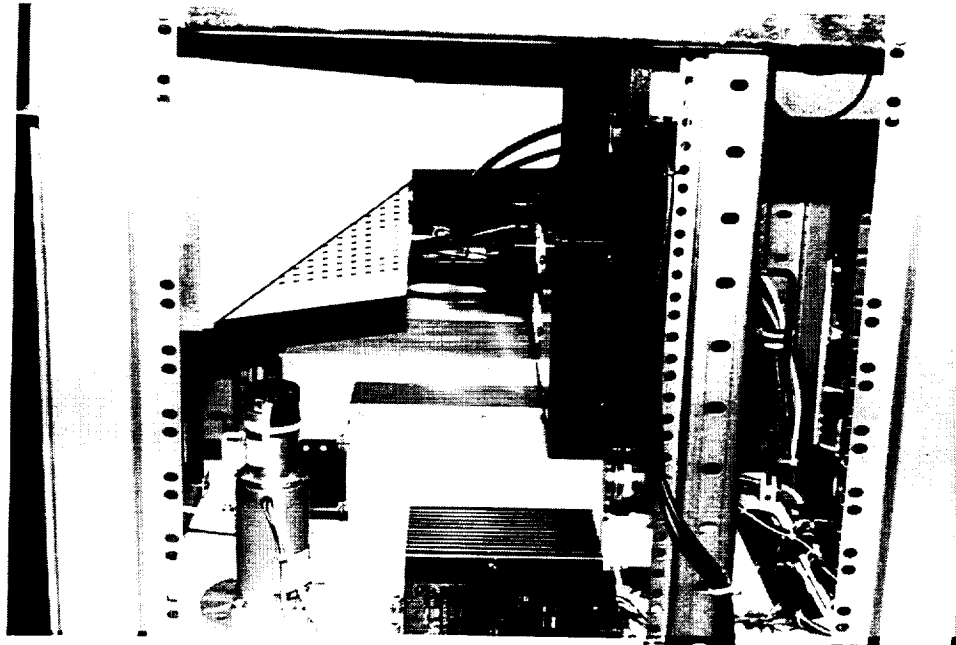

Figure 13

Furnace Cabinet; Side View.
Compumotor Stepper Motor in Foreground

The C-drive is a low cost, compact microstepping drive designed to control standard step motors. The drive provides pulse width modulated power at a switching frequency of 20KHz for inaudible operation. Communications between the C4000 controller and the C-drive are established with a 25 wire cable with DB25 connectors. The C-drive requires two external unregulated DC voltages for logic power, and motor power. Four resolutions are jumper selectable ranging from 2,000 to 25,000 steps per revolution, the later being utilized in the design of the HTARFF. Operations are typically accurate to +/- 4 arc minutes, and repeatable to +/- 1 step, with a hysteresis of less than 4 steps. A red LED located above the wiring bus illuminates when pulsing operations are in progress. Power for C-drive operations is supplied by the 24VDC power supply.

The DC3 power supply obtains its power through the Tripp Lite power distribution bus. Output voltage is jumper selectable from 24 to 90 VDC. The power supply was originally received on an open frame which was structurally unsound. Subsequently, a custom enclosure was fabricated for the power supply. A green indicator light is located on front of the power supply to indicate normal operations. An external 4 amp @ 250 volt fuse is also located on front of the power supply.

The stepper motor shown in Figure 13 provides 25,000 steps/revolution, and receives pulsing commands from the C-drive. The stepper motor provides 120 oz-in of torque when power is

supplied to the system, even when pulsing operations are not in affect. This insures the carriage will remain stationary until translation is commanded, and will not alter from its stationary position during high gravity loadings. With power off, however, the carriage can be positioned easily by hand.

The encoder provides 4,000 lines/revolution. It is mechanically fixed to the back of the stepper motor and is attached to the drive rotor via a flex coupling. Detection of mechanical stalls of the translation system is accomplished by the operations software. The motor and encoder positions are constantly polled during translation operations. If the difference between the two positions exceeds the limit set in the operations software signals, the BTW and the C4000 are commanded to terminate all operations. The C4000 also has its own stall detection enabled, which is set up during the initialization of C4000 communications with the operations computer. The controller will automatically stop the move in progress when a stall is detected. This feature is internal to the C4000 system but does not provide an output signal to indicate this condition. This stall detection feature serves only as a backup to the operations software stall detection feature.

The operations software reads motor and encoder positions in their respective resolutions. The motor resolution is then converted to match that of the encoder to allow differential comparisons to be made. The translation length has been divided

into 90,000 individual steps, made up of 4000 measurable encoder lines per revolution divided by the 0.2 inch per revolution turn screw lead and multiplied by the 4.5 inch translation length. This allows an accuracy of approximately +/- 0.00005 inch for any axial measurement. During a translation process, the operations software polls several different devices for information, processes that information, then issues commands to other devices based on the results. Due to the time required for processing information, translations do not always begin and end exactly on the requested positions. Actual axial locations are typically +/- 0.015 inch from the requested beginning or ending positions, however, all measurements are still accurate to +/- 0.00005 inch.

The Berg JJ-14 slip coupling provides bi-directional torque up to 88+/-9 Oz-in. The slip coupling also allows for axial shaft misalignment, and angular misalignment. The coupling serves as a back up to the software defined hardware limits. The coupling will allow slippage between the stepper motor and superslide turn screw in the event mechanical interference is encountered by the carriage while translating, thus reducing the chance of damage to hardware when proper operational procedures are not followed.

2.5 ORBITAL TUBE WELDING SYSTEM

The S.T. International Nika - Basic Tube Welder (BTW) is an orbital tube welding system utilizing an 8088 microprocessor to control welding operations. The BTW system consists of a control module, furnace-head, umbilical cable, and a monochrome monitor.

The user must interface with the BTW to set up welding parameters. Direct communications are accomplished through the HTARFF operations software. The HTARFF was developed assuming that all users of the HTARFF are familiar with BTW operations, TIG welding procedures, and safety precautions.

The BTW has been upgraded with features available on the Advanced Tube Welder (ATW). These include data monitoring and logging options, installation of a second floppy disk drive for storage of logged run data, and upgrade to revision 3.01 software which allows menu driven operations.

Modifications to the BTW system include disabling of the Hand Held Controller (HHC), a passage cut in the rear panel of the control module for RS-232 and video cable access, mounting holes tapped into the furnace-head removable cartridge, and disabling of the ground socket plug in the umbilical cable.

The HHC port provides RS-232 communications between the BTW system and the operations computer (com 2). Currently, use of

ORIGINAL PAGE
BLACK AND WHITE PHOTOGRAPH

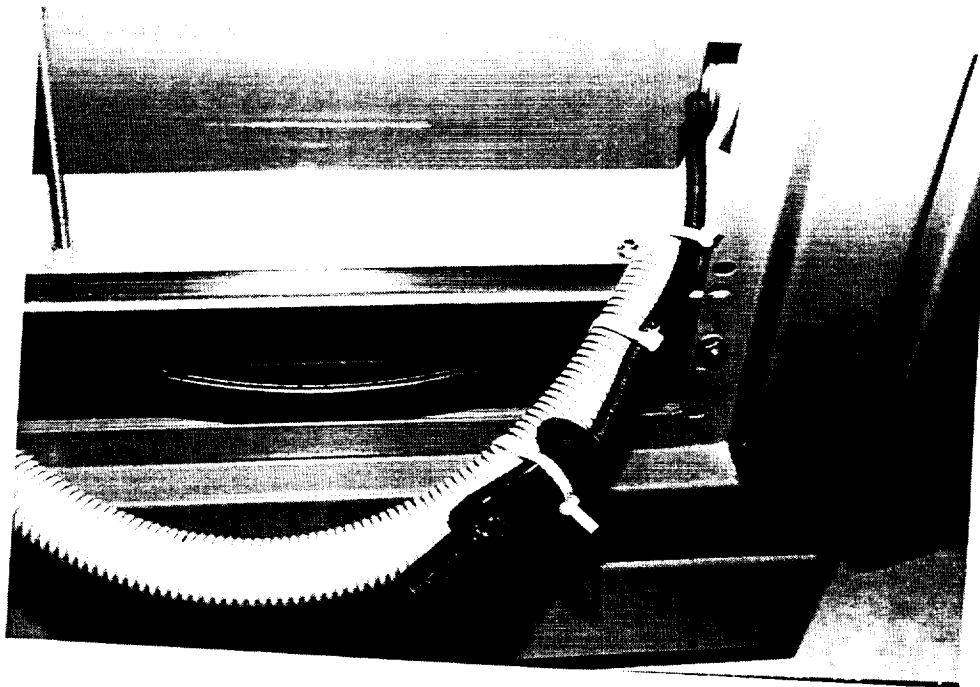

Figure 14
Disabled BTW Ground Socket Plug

The BTW system utilizes 2% thoriated Tungsten electrodes 0.062 inch in diameter. The BTW operating manuals provide information for proper selection and preparation of electrodes, and gap requirements. Electrodes for use with 1/2" and 1/4" samples are included with the HTARFF. S.T. International can supply future need for electrodes.

Separate facilities for storage of the inert gas is required. The BTW control module supports helium and argon with its built in gas flow rate meter.

Power requirements are 120VAC-60Hz for the control module and the monitor. Power is supplied directly to the BTW control module from the master power relays, when activated by the master power switch in the electrical cabinet flip-down shelf. Monitor power is supplied through the Tripp Lite power distribution bus.

2.6 ACCELEROMETERS

Three Sundstrand Data Control QA-700-2 Q-Flex servo accelerometers with temperature modelling are incorporated in the HTARFF system for monitoring gravity levels. These accelerometers are designed for high accuracy, low frequency applications, and develop current outputs which are proportional to the acceleration input. Each accelerometer generates four signals; course, medium, and fine channels, and a temperature

compensation channel. Only the course channel is utilized for ground and eventual KC-135A aircraft operations of the HTARFF. Noise generated in either location will over-ride any compensation of temperature changes, and measurements of high frequency vibrations would be a waste of valuable processing time due to the dominating effect of the low frequency noise.

A triaxial mount is used to locate the accelerometers to the back of the top superslide end block. The mount provides linearly independent gravity level measurements along the x, y, and z axes, where the x-axis is positive measured right to left, the y-axis is positive measured front to back, and the z-axis is positive downward, when viewing the furnace cabinet from the front.

A custom designed and fabricated signal conditioning board was constructed for amplification of the accelerometer signals. The board is housed in its own custom designed enclosure located behind the furnace head assembly. Design, population, and testing of the board was accomplished by staff in the Consortium for Materials Development in Space at the University of Alabama in Huntsville. The UAH designed accelerometer system has flown successfully in sounding rockets and aboard the Space Shuttle. Fabrication of the printed circuit board was performed by a local small business specializing in this field of work.

Output from the accelerometers are passed through an EXP-16

the HTARFF operations software is the only viable means of running the BTW system. The HHC is still in place and can be placed back into service if desired. Operating the HTARFF or BTW with the HHC in service is highly discouraged and performed at the user's own risk of personal injury and damage to equipment.

In its current condition the XT keyboard port is not functioning. S.T. International representatives have stated that noise in keyboard lines is common during BTW welding operations and has a tendency to destroy video cards. Also confirmed by an S.T. International representative is the existence of a software bug in the BTW operating software which hinders retrieval of logged run data. Software to correct this bug has been promised by S.T. International, and will be delivered when received.

As shown in Figure 14, the green ground socket plug leading from the umbilical cable to the BTW control module has been tied back against the umbilical cable casing. This cable is no longer in use, and will pose a safety hazard if used. A separate and individual ground return line is now incorporated. It should be plugged into the ground receptacle on the BTW control module panel instead of the old receptacle plug.

***** CAUTION *** CAUTION *** CAUTION *** CAUTION *** CAUTION *****
THE HTARFF SYSTEM MUST NOT BE OPERATED UNLESS THE BTW GROUND RECEPTACLE IS PROPERLY CONNECTED WITH THE GROUND PATH SELECTION MODULE, SEE FIGURE 5.

amplification-multiplexing board (gain = 1) to the DAS-8 analog-to-digital data acquisition card located in the operations computer. With unity gain, the accelerometer EXP-16 functions only as a multiplexer. The EXP-16 is housed in a custom designed and fabricated aluminum enclosure, along with the EXP-16 used for amplifying and multiplexing the thermocouple signals. Each EXP-16 is repeatedly polled, in turn, by the operations software and the DAS-8 data acquisition board.

2.7 COOLING SYSTEM

The cooling system is a closed loop system, providing cooling to the collet holders, cooling zones, and the furnace head. A simplified model of the cooling system is illustrated in Figure 1. The cooling system contains a 50/50% mixture of water and ethylene glycol as the working fluid. The system consists of a heat exchanger with integrated fan, expansion tank, pump, cabinet transfer lines, inlet and exit manifolds, thermocouples, and solenoid activated valves.

Stainless steel 1/4" O.D. tubing and stainless steel double ferrule tube fittings were utilized where possible in the construction of the cooling system. High temperature Poly-flow 1/4 inch tubing is used in those places requiring flexibility.

Chrome plated brass double-shut-off quick-disconnects from

Poly-Flo are used to provide a means of disconnecting the coolant transfer lines running between the furnace and electrical cabinets, and the individual coolant lines between the inlet and return manifolds and the cooled furnace component.

Two multiple connection manifolds from Pneumadyne, Inc. are used for distributing and collecting the coolant to and from the furnace components. Stainless steel pipe plugs are used to fill passage holes which are not required. Solenoid actuated valves from Asco, working off the 24 VDC power supply, are attached to the top manifold, which serves as the inlet manifold.

The cooled furnace components (i.e. collet holders, cooling zones, and furnace head) are numbered according to their relative position in the furnace housing. Refer to Figure 4. The top collet holder is highest and therefore labelled component one. The top cooling zone is next highest and labelled number two, then the furnace head (3), the lower cooling zone (4), and the lower collet holder labelled number five. This numbering system is utilized in assembling the cooling system hardware, and selecting operating temperatures for each component in the operations software.

The collet holders are discussed in Section 2.3 of this report, and the furnace head is discussed in the BTW manuals provided by S.T. International.

The cooling zones were fabricated by welding together two concentric pieces of aluminum forming an internal cavity for coolant to flow. The welds were turned flush, with subsequent polishing to a high luster. As is visible in Figure 8, seats have been installed in the lower portion of the cooling zones to allow them to be locked into the furnace head when it is closed and locked. These seats were slightly over-sized to allow the cooling zones to be aligned about the sample. Brass inserts fit into the aluminum bodies and are held in place by internal retaining rings. The brass inserts provide better radiative heat transfer away from the sample than does aluminum. They come in sizes to fit samples 1/8", 1/4", and 1/2" in diameter. It was originally planned to also fabricate inserts from lava-stone providing adiabatic capabilities. Extremely high temperatures experienced with the brass inserts during testing, however, proved it was not feasible to operate the furnace head in the adiabatic mode (i.e., some means of cooling the furnace head and sample are deemed necessary).

A single speed 1/100 H.P. pump provides the required head for coolant flow. The brass pump body is rated to 150 psi, and 250 degrees fahrenheit. The pump has a seal-less magnetic drive to provide better sealing action. The pump was originally located in the lower section of the furnace cabinet. However, due to excess vibrations, the shelf containing the pump, expansion tank, and the heat exchanger/fan unit was moved to the electrical cabinet. The pump requires 120 VAC electrical power

which is supplied by the Tripp Lite power bus.

The Extrol expansion tank is a pressurized vessel with an internal flexible diaphragm. Coolant fluid is contained in the side open to the cooling system loop, while the other side is filled with pressurized air. By varying the air pressure in the dry side, it is possible to vary, and control, the pressure of the coolant fluid in the other side. This allows the user to control the vaporization point of the coolant fluid. A valve stem is located on the back side of the expansion tank, and is accessible by removing the right side panel from the electrical cabinet and unscrewing the red protective cap covering the valve stem. Air pressure is varied using a standard air nozzle. The maximum safe operating pressure of the cooling system, which is controlled by the expansion tank, is 12.5 psig.

***** CAUTION *** CAUTION *** CAUTION *** CAUTION *** CAUTION *****
DO NOT EXCEED 12.5 PSIG IN EXPANSION TANK, AS RUPTURE OF COOLING SYSTEM COMPONENTS COULD RESULT.

The heat exchanger/fan assembly was originally located in the lower section of the furnace cabinet. However, due to excess vibrations, the shelf containing this assembly, the coolant pump and the expansion tank was moved to the electrical cabinet. The heat exchanger is a modified condenser from an air-conditioning system used in the automobile industry. It is mounted to the modified blower housing from Hoffman Engineering. Cool air is

drawn over the heat exchanger before passing through the blower housing and exiting through an aluminum filter and stainless steel grill. The aluminum filter is washable and traps airborne dirt with minimal pressure drop. Cool air is drawn into the electrical cabinet through the upper stainless steel grill located in the back door of the cabinet. The blower unit delivers 275 cubic feet per minute of air at zero static pressure, and requires 120 VAC electrical power from the Tripp Lite power bus.

Omega Engineering copper-constantan (type-T) thermocouples with ungrounded sheaths are used to measure the temperatures of furnace components exposed to the high heat loads generated by the arc. The thermocouple signals feed directly into a custom designed and fabricated EXP-16 module. The thermocouple EXP-16 resides alongside the accelerometer EXP-16, which reside in the same housing mounted on the back wall of the furnace housing. Each EXP-16 is repeatedly polled, in turn, by the operations software via the DAS-8. Conditioned signals are multiplexed along a 37 wire cable to the operations computer where a high speed 12 bit Analog-to-Digital converter board (Keithley / Metrabyte DAS-8) converts the signal to a useful format. The ungrounded sheath isolates the thermocouple leads from the erroneous effect of voltage surges. Cables leading from the thermocouples to the EXP-16 module are covered by spiral armor cable to protect against contact with high temperature components in the furnace housing. Heavy duty jacks at the ends of the

armor cables allow each thermocouple to be plugged into the EXP-16 module, which has a jack panel fabricated into one of its end plates. This allows easy removal of the thermocouples for repair or replacement.

Control of the coolant flow to the cooled components is individually controlled by 24 VDC solenoid valves. Signals are sent to the valves by an electro-mechanical single-pole-double-throw relay output board (Keithley / Metrabyte ERA-01). Signals are sent to the relay board from the operations computer, by a parallel digital Input / Output card (Keithley / Metrabyte PIO-12), based on data received from the thermocouples. A custom aluminum enclosure was fabricated to house the ERA-01 relay board. The enclosure features a Cannon pin plug connector for power input and signal output to the solenoid valves, and a bulkhead mounted DB37 plug for the communications link with the PIO-12 I/O card in the operations computer.

A sixth type-T thermocouple, which has exposed leads, shown in Figure 6, is located inside the furnace housing above the furnace. A temperature limit must be set for this thermocouple, which, if exceeded will cause the HTARFF operating software to stop movement of the translation platform, and signal the BTW to cease arcing operations. This thermocouple possesses exposed leads to allow a quick response to steep temperature gradients within the furnace housing.

2.8 POWER DISTRIBUTION

Power is supplied to all components of the HTARFF, except the BTW control module, through a Tripp Lite LCR-2400 rack mount line conditioner shown in Figure 12. The LCR-2400 has two built in line frequency noise filters. There are two banks of different color receptacles, black and white, to distinguish between the two filters. The regular filter operates through the black receptacles, and filters up to 20db at 20 kHz, and 40db at 1 MHz. The white receptacles feed through a precision filter at 40 db at 20kHz, and 75 db at 1MHz. Also, each white receptacles is electrically isolated from all other receptacles. A green indicator light on the front panel indicates normal operating conditions for the distribution bus.

The Compumotor DC3 24 VDC power supply, also shown in Figure 12 is used to provide power to the translation stepper motor, accelerometer signal conditioning board, and the coolant flow control valves. The DC3 power supply obtains its power through the Tripp Lite power distribution bus. Output voltage is jumper selectable from 24 to 90 VDC, however, this jumper must remain in the 24 volt position to prevent damage to the solenoid valves which operate only at 24 VDC. The power supply was originally received on an open frame which was structurally unsound. Subsequently, a custom enclosure was fabricated to house the internal components of the power supply. A green indicator light is located on front of the power supply to indicate normal

operations. An external 4 amp @ 250 volt fuse is also located on front of the power supply.

2.9 BTW GROUND PATH MODULE

The user of the HTARFF has the option of selecting the direction current flows through the sample. The BTW creates a voltage difference between the electrode terminal and ground terminal causing current to flow, once that voltage difference is great enough to cause electrons to jump the gap between the furnace head electrode and the sample. Current exits the sample from either end, or both, depending on how the user has configured the ground path module.

***** CAUTION *** CAUTION *** CAUTION *** CAUTION *** CAUTION *****
THE HTARFF SYSTEM MUST NOT BE OPERATED UNLESS THE BTW GROUND RETURN PATH LINE IS PROPERLY HOOKED-UP.

The ground path module consists of a box located behind the furnace housing which contains three pin receptacles as can be seen in Figure 9. A close up of the module is shown in Figure 5. The independent ground path cable must be plugged into any one of the three module receptacles, and the other end plugged into the pin receptacle on the front of the BTW control module. Cables lead from both collet holders to the ground selection module. The user must plug at-least one of these two cables into the

module. This will determine whether current flows up the sample, down the sample, or in both directions.

Multi-wire cables used in the construction of the ground path module meet or exceed the following ratings: E5 1776a, 6 AWG, type MTW or THHN or THWN or Gasoline & Oil, Resistant II (UL) or AWM styles 1318 & 1410, 600V VW-1.

2.10 OPERATIONS COMPUTER

The rack mounted operations computer is the control center of the HTARFF. It is located in the electrical cabinet, behind the door panel containing the keyboard flip-down compartment. It is the source for user input into the furnace operating system. The computer also acquires and processes thermocouple and accelerometer data, controls coolant system valving, and provides RS-232 communication with the Nika-BTW and Compumotor translation system.

The operations computer is based on an INTEL 32 bit 80386-20 MHz microprocessor, with 640 kb main memory. It features both 5.25" and 3.5" high density / double density floppy drives, and a 21 Mb hard drive with a 72.21 msec self-parking head. The self-parking head insures that the hard drive is not damaged in low gravity situations. Accessing the hard drive, in other than a one-g environment, will damage the hard drive. The HTARFF

operations program is designed in such a way that write operations to the hard disk drive do not occur until the accelerometers sense a safe gravity level.

***** CAUTION *** CAUTION *** CAUTION *** CAUTION *** CAUTION *****
DO NOT ACCESS THE OPERATIONS COMPUTER'S HARD DISK OR FLOPPY DRIVES IN GRAVITY LEVELS OTHER THAN 1-G VERTICALLY DOWNWARD.

The computer is of back-plane construction with a plane mounted mother-board as shown in Figure 15. This allows for easy upgrading to a faster operating system, or modifications to the HTARFF in the future. Installed in the computer are an IOSB dual RS232, printer, and game card, an EGA video card, a MetraByte DAS-8 card for A/D data acquisition of thermocouple and accelerometer data, and a MetraByte PIO-12 card for digital control of the cooling system solenoid valves via relays. An external battery supplies power for the non volatile memory on the mother board.

The operations computer also consists of a rack-mounted EGA color monitor, and a 101 (AT) shelf mounted keyboard.

Power requirements are 120VAC-60Hz for the computer and monitor.

ORIGINAL PAGE
BLACK AND WHITE PHOTOGRAPH

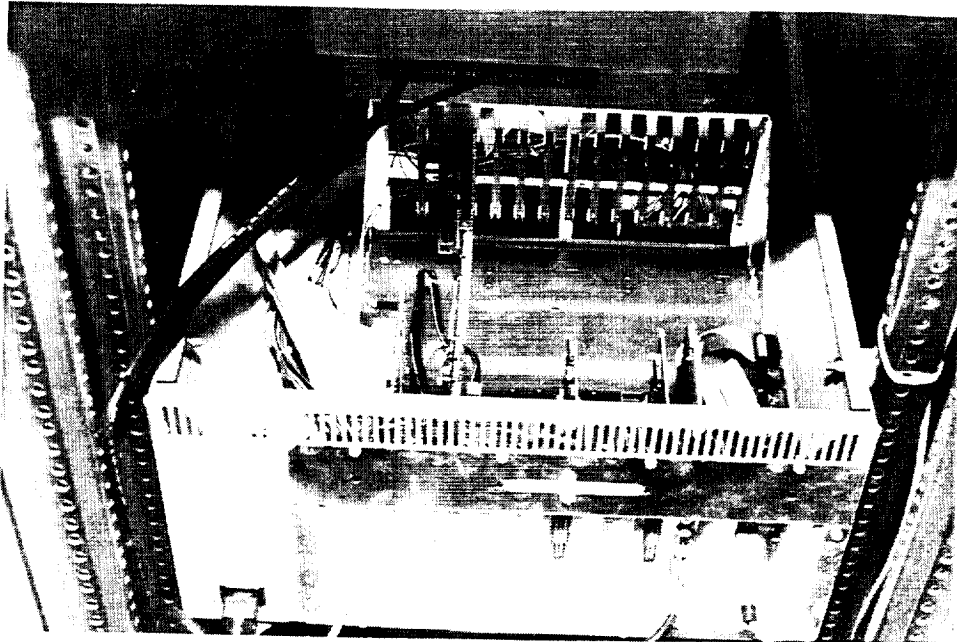

Figure 15
Operations Computer;
Back-Plane Construction

2.11 OPERATIONS SOFTWARE

The furnace operating software is written in BASIC computer language utilizing the GW-BASIC software supplied with the Microsoft MS-DOS version 4.01 disk operating system. Care must be taken to insure the program code is not altered in any way.

***** CAUTION *** CAUTION *** CAUTION *** CAUTION *** CAUTION *****
ALTER THE OPERATIONS SOFTWARE (DSF.BAS) FROM ITS STATE AS
DELIVERED AT YOUR OWN RISK.

The operating code, DSF.BAS, is a user-friendly menu driven program. A description of its use is outlined in the following section.

3.0 PROCEDURES

3.1 SAMPLES

The HTARFF is designed to accommodate cylindrical rods as samples in lengths of twelve inches, with a maximum diameter of 1/2 inch. Hardware is included for processing rods in diameters of 1/2, 1/4, and 1/8 inch. Other diameters can be accommodated, however, cooling zone inserts, and collets for the desired diameter must be obtained. Sample material is restricted to those types possessing high electrical conductivity (e.g.,

aluminum and steel). The surface of the sample must be clean, dry, and smooth. A smooth surface is critical in assuring a constant electrode gap exists at all points along the samples surface. Bevelled ends on the samples will ease the task of inserting and removing samples from the collets.

3.2 HARDWARE

The cabinets may be rolled to a desired location by means of built in casters. Upon arrival, leveling pads located at all four corners of each cabinet must be lowered to level the cabinets and secure their location.

Connect all the coolant, electrical, and communications lines running between the cabinets, and the 120VAC-60Hz power cords to the external electrical power supply. The ground path lines must also be connected. The ground line from the module to the BTW ground receptacle, and at least one line from either of the collet holders must be connected.

***** CAUTION *** CAUTION *** CAUTION *** CAUTION *** CAUTION *****
THE HTARFF SYSTEM MUST NOT BE OPERATED UNLESS THE BTW GROUND RETURN PATH LINE IS PROPERLY HOOKED-UP.

Lines located in the electrical cabinet are, the exit and return coolant transfer lines, BTW video cable, and electrical

power lines for the operations computer, its monitor, the coolant pump, and heat exchanger fan.

Lines located in the furnace cabinet are, the master power switch lines, the BTW power cord and video cable, the BTW umbilical cable (gas, electrode, power lines), the ground return line, the Compumotor controller RS-232 communications line to the operations computer, 37-wire cables for the ERA-01 and EXP-16 modules, and two 120VAC-60HZ power cords for external power supply.

Connect the inert gas supply line to the gas-in connection on back of BTW control module. Gas supply must be regulated between 25 and 30 psig prior to BTW connection. Open the gas supply lines for use. The gas supply must be large enough and have the flow rate capacity to sustain furnace operations for the designated run time and flow rate.

Prior to switching on power to the HTARFF, the furnace head and translation platform must be moved manually to its lowest position by applying pressure on the furnace head bracket. Pressure should not be applied to the furnace head, as this could result in structural damage. The furnace head must be lowered with all power off for two reasons. First, it is a safety hazard to be in close proximity to the weld head when it is powered and capable of striking an arc. Second, when power is first turned on, the Compumotor stepper motor locks itself into place until it

receives signals from the HTARFF software to unlock itself. With the power off, however, the stepper motor is free to rotate.

Ensuring that the furnace head and translation platform are in their lowest positions before power is applied, is a critical instruction that must be followed. All positions for translations of the furnace head are measured from the powered up position. Failure to move the head to this lower position could result in erroneous translation of the weld head, premature translation termination, or physical damage to HTARFF hardware.

***** CAUTION *** CAUTION *** CAUTION *** CAUTION *** CAUTION *****
THE FURNACE HEAD MUST PHYSICALLY BE MOVED TO THE LOWEST POINT ON THE SUPERSLIDE BEFORE POWER IS SUPPLIED TO THE HTARFF.

3.3 POWERING UP AND LOADING SAMPLES

All power switches to HTARFF subsystems should remain in the on position at all times. This includes the operations computer, both monitors, the Compumotor controller, Tripp Lite power distribution bus, and the BTW controller. On the BTW controller, the weld button should remain on, except when loading a sample. The weld switch illuminates red when it is activated. Both keyed switches should remain in the Automatic, and Teach modes at all times.

Close and latch both cabinet doors. Open the flip-down shelf on front of the electrical cabinet. Turn power on to the HTARFF by flipping the master switch, located in the flip-down shelf, into the up position. Power is subsequently turned off by flipping the switch down.

Sample installation is made easier by physically moving the furnace head to the middle of the translation length of the superslide.

To load a sample for processing, the weld button on the BTW controller must be turned off. A severe electrical shock could result if this action is not performed.

***** CAUTION *** CAUTION *** CAUTION *** CAUTION *** CAUTION *****
THE WELD BUTTON ON FRONT OF THE BTW CONTROL MODULE MUST BE IN THE OFF POSITION BEFORE SAMPLES CAN BE LOADED !!

Samples should not be any longer than twelve inches. The collets should be removed and set aside within arms reach. Undo the large buckle on front of the BTW furnace head and the two clasps on the side, and open the furnace head removable cartridge exposing the electrode.

There are four buttons located in a recess in the black handle of the furnace head on the side closest to the EXP-16 module. The "jog" button, the third button back, should be

pressed until the electrode rotates around the circular track and exposes the allen head set screw which holds the electrode in place. A loud tone is generated by the BTW control module when the job button is depressed, and is normal. The set screw should only be slightly loosened, allowing the electrode to be removed. Always remove the allen wrench from the set screw in the circular track before proceeding. The electrodes are extremely fragile, and may broken during sample installation if they are not removed. The first button, "Final Slope" should then be pressed which will position the circular track out of the way.

While holding both cooling zones in their proper orientation, pass the sample through them from the top, first through the top cooling zone, then the bottom cooling zone. Continue inserting the sample passing the bottom end of the sample through the hole in the bottom collet holder and its bracket until the sample comes to rest on the furnace housing. The bottom collet and draw spindle should not be in place at this time.

Position the cooling zones onto the furnace head as seen in Figure 8. Place the collet in the top collet holder. Slide the sample up, through the cooling zones and the top collet until the sample comes to rest on the top of the furnace housing. Place a collet in the bottom collet holder and place a draw spindle knob on back of it, but do not tighten down. Let the sample come down far enough such that the ends of the sample are in both collets.

Install the top draw spindle knob, and tighten both knobs until the sample does not move.

Push the "jog" button on the weld head until the electrode set screw is exposed once again. Insert the electrode until it almost touches the sample and tighten the set screw enough to stabilize the electrode in a horizontal position with no wobble, yet loose enough for the electrode to move freely. Do not let the end of the sample stick out the back end of the circular track. Make sure the allen wrench is removed, and depress the "Final Slope" button to position the electrode for gap setting.

Place a feeler gage of the desired gap thickness between the electrode tip and the sample. Adjust the gap by pulling or pushing the electrode in or out of the circular track. When the proper gap is set, "jog" the electrode set screw back into sight and tighten. Depress the "Final Slope" button again and check the gap for desired width. If it is not correct, loosen the electrode set screw and redo the gap setting procedures mentioned above until the desired width is obtained.

Close the bottom hinge on the furnace head removable cartridge. Align the bottom cooling zone such that it is symmetric about the sample, while closing the clasp to the bottom hinge. Close and clasp the top hinge, and align the top cooling zone with the sample. While aligning the top cooling zone, hold the zone so it extends out of the furnace head as far as

possible. Close the buckle on the front of the furnace head.

3.4 OPERATIONS

Ensure that the furnace head and translation platform are in their lowest positions before power is applied. This is a critical instruction that must be followed. All positions for translations of the furnace head are measured from the powered up position. Failure to move the head to this lower position could result in erroneous translation of the weld head, premature translation termination, or physical damage to HTARFF hardware.

***** CAUTION *** CAUTION *** CAUTION *** CAUTION *** CAUTION *****
THE FURNACE HEAD MUST PHYSICALLY BE MOVED TO THE LOWEST POINT ON
THE SUPERSLIDE BEFORE POWER IS SUPPLIED TO THE HTARFF.

After power has successfully been switched on, activate the "CapsLock" on the keyboard. BTW commands and translation speed commands require capital letters to operate correctly.

***** CAUTION *** CAUTION *** CAUTION *** CAUTION *** CAUTION *****
CAPSLOCK MUST BE ENGAGED FOR PROPER OPERATIONS TO PROGRESS.

Figures displaying commands and responses on the operations computer monitor are shown in Appendix B.

Appendix B, Figure B.1 shows the display to the operations computer's monitor when it is first turned on. The working directory must be changed to the directory where HTARFF operations software resides, using the "cd" command. Execution of the .bat file DSF is required for proper configuration of the operations computer communications ports, and configuring the BTW control module to receive RS-232 communications through the hand held controller port. At this time the GWBASIC software package provided with the DOS-4.01 operating system is initiated.

Figure B.2 shows the loading of the HTARFF operations software program, DSF.BAS, and run initialization of that program.

The first operation performed by the HTARFF software is prompting of the user to see if the furnace head has been moved to its lowest position. See Figure B.3. If the furnace head is positioned correctly, the user hits any keyboard key to move onto the main HTARFF menu. At the same time, the translation mechanism moves the head to the bottom of the defined translation length. If the furnace head has not been positioned to the bottom of the superslide, the user is asked to turn off power, move the furnace head to its proper location, then attempt powered operations again.

Figure B.4 shows the main menu for the HTARFF operating system. At this time, users are able to set the parameters of

the HTARFF as they desire. All menu selection are set to default values during program initialization, except parameters associated with selections number six, which allows RS-232 communications with the BTW controller, number seven, which starts automated operations of the HTARFF system, and number eight, which exits the user from the HTARFF software when desired operations are completed.

Figures B.5, B.6, B.7, B.8, B.9, and B.10 show proper procedures for setting HTARFF parameters, and communicating with the BTW controller. Once entering a menu selection, a value must be entered even if it is the same value already listed for that parameter. Hitting return without entering a new value for a parameter, will cause that parameter's value to be set at zero. The user is automatically returned to the main menu after values are set in each selection. In Figure B.5 all temperatures are measured in degrees celsius. The "Repeat weld?" option offered during the creation of BTW weld profiles and during set-up procedures should not be selected for weld profiles to be run on the HTARFF.

When the user selects menu number seven, in Figure B.4, the HTARFF software begins functioning automatically. The first task fulfilled is moving the furnace head to the desired beginning location. The software indicates this operation by displaying output similar to Figure B.11 onto the operations computer's screen. The operations software then begins monitoring of

accelerometer data, see Figure B.12, until gravity levels are within the users designated value range.

At this time start signals are sent to the BTW to begin arcing functions, and to the Compumotor controller to begin translation of the furnace head. The user is able to stop procedures at any time during this operation by hitting the "Esc" key on the operations keyboard, see Figure B.13. Component temperatures are measured in degrees celsius, and valves are open when = 1, and closed when = 0.

Figure B.14 shows a typical screen upon successful completion of a translation operation. If other than a successful operation, the reason for premature termination is displayed.

The software waits at this point until the user acknowledges that operations have ceased. Monitoring of accelerometer data begins until measurements indicate a near one gravity condition exists, see Figure B.15, at which point recorded run data is output to DSFOUT.DAT, and operations are returned to the HTARFF main menu, Figure B.4. Subsequent output data, from additional runs, is automatically appended to the end of the DSFOUT.DAT file. Runs are distinguishable by data and time.

At this time the user can redefine the operating parameters and proceed with another run, or exit the operating system by

selecting menu number eight (GWBASIC is terminated by typing "system" and hitting return). To proceed with another run, the user must reselect menu number six and place the BTW back into start mode. After redefining any translation or temperature parameters, if desired, the furnace is ready to run again by selecting menu number seven.

Subsequent sample removal is accomplished by reversing the procedures discussed in Section 3.3.

***** CAUTION *** CAUTION *** CAUTION *** CAUTION *** CAUTION *****
THE WELD BUTTON ON FRONT OF THE BTW CONTROL MODULE MUST BE IN THE OFF POSITION BEFORE SAMPLES CAN BE UNLOADED !!

4.0 RESULTS AND DISCUSSION

The HTARFF provides precise computer controlled translation of the rotating arc over the sample. The furnace is capable of eventual continuous operation through a parabolic flight profile, allowing samples to resolidify under desired gravity conditions. The HTARFF has the capacity to process samples as large as 1/2" in diameter, and is only limited by the current available from the S.T. International welding equipment on which the system is based.

Design of furnace components was accomplished on an

Intergraph Interpro 220 workstation utilizing Intergraph Engineering Modelling System software (I/EMS) version 2.

The HTARFF features other attributes which generate interest as a tool for future research. The furnace relies completely on electrical power for system operations and generation of its very high temperatures. This characteristic is important when considering future high temperature materials processing facilities for use aboard the National Space Transportation System (i.e., the Space Shuttle), and Space Station Freedom.

Containerless processing is achieved by the HTARFF. This allows processing of materials with very high melting points which otherwise could not be contained. It also allows operations as a float-zone research furnace. These characteristics could be brought to their highest potential in a low-gravity environment.

Samples have been processed during testing operations of the HTARFF to verify its performance and operation. Stainless steel rods of 1/2 inch diameter have been processed at 100 amp levels. Metallurgical analysis reveals penetration of the melt zone to be less than half of the rods' diameters.

At the same amperage level, stainless steel 1/4 inch rods generate melt pools too large to be constrained by surface forces due to the influence of gravity. Melt zone penetration across

the diameter of 1/4 inch stainless steel samples can be achieved at operations above 50 amperes.

5.0 CONCLUSIONS AND RECOMMENDATIONS

All objectives of this research have been met. The HTARFF is a state-of-the-art materials processing furnace, with capabilities and performance exceeding the objectives set forth at the beginning of this research.

It is recommended that support of further research, including modification of the ground based prototype to full flight status be considered. This research could be used to demonstrate the unique capabilities of the HTARFF.

6.0 FUTURE WORK

It is recommended that support be provided to eliminate problems arising from strong electro-magnetic fields emanating from the furnace head during its operation. These fields disrupt signals sent to the operations and BTW monitors, and pose a threat to materials stored on magnetic media within the system.

APPENDIX A: OPERATIONAL PROCEDURES

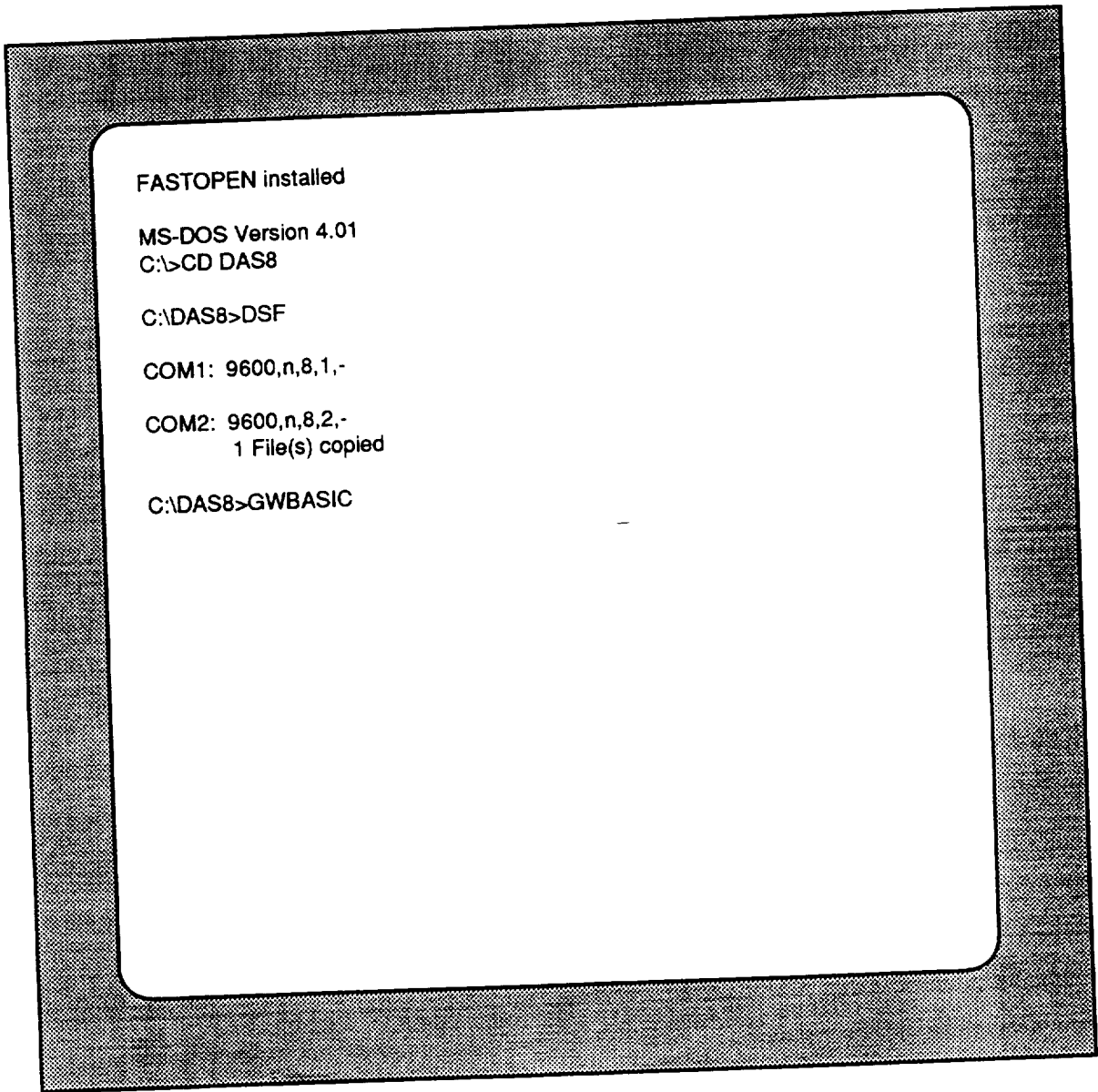



Figure B.1
Initialization Procedures



```
GW-BASIC 3.20
(C) Copyright Microsoft 1983, 1984, 1985, 1986
(C) Copyright Seiko Epson Corp. 1986
Release Version 1.04
61519 Bytes free
Ok
LOAD'DSF.BAS'
Ok
RUN
```

```
1LIST 2RUN 3LOAD' 4SAVE' 5CONT 6, 7TRON 8TROFF 9KEY 10SCREE
```

Figure B.2

Loading and Running HTARFF Software

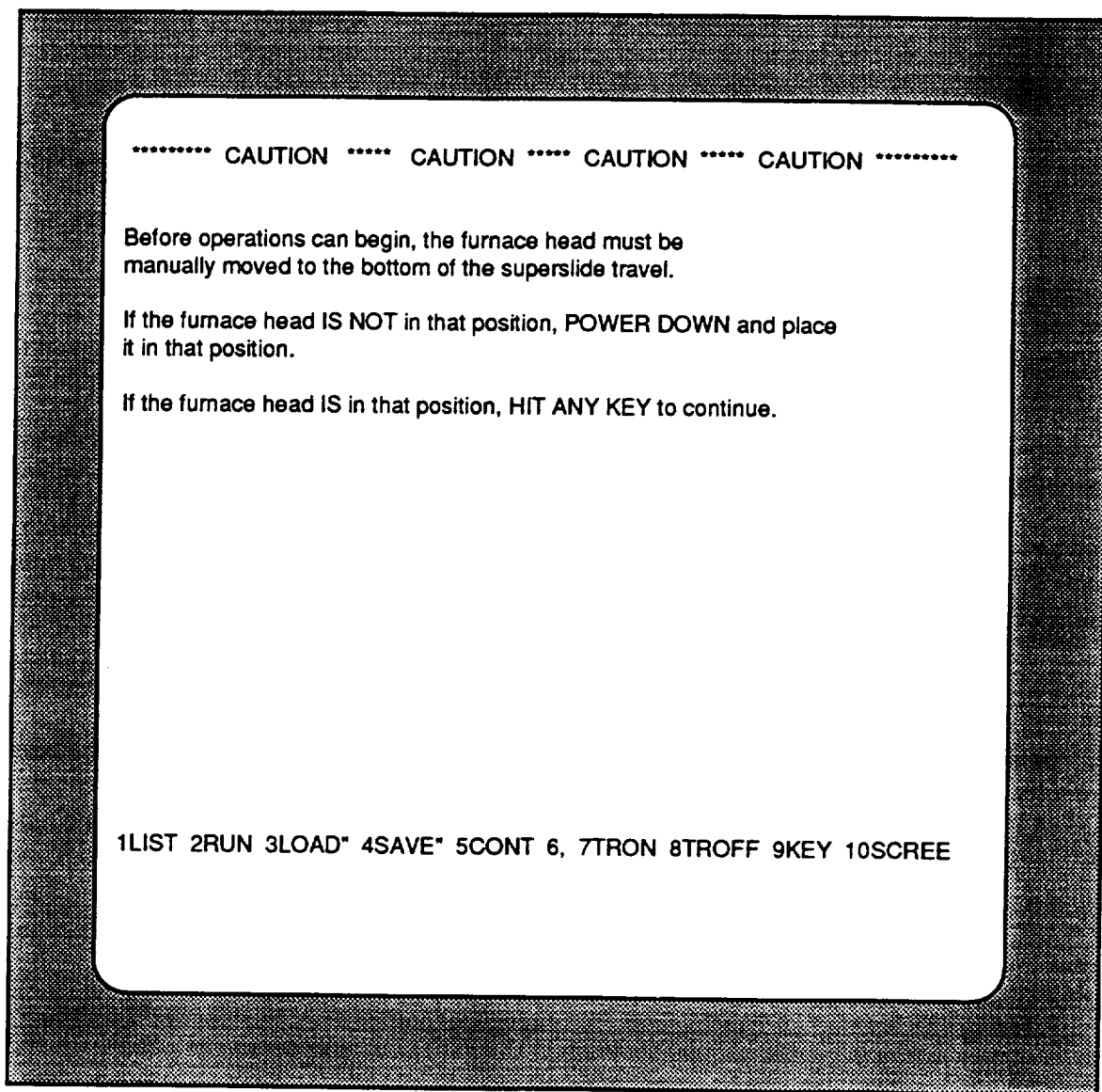

Figure B.3

Furnace Head Position Caution Prompt

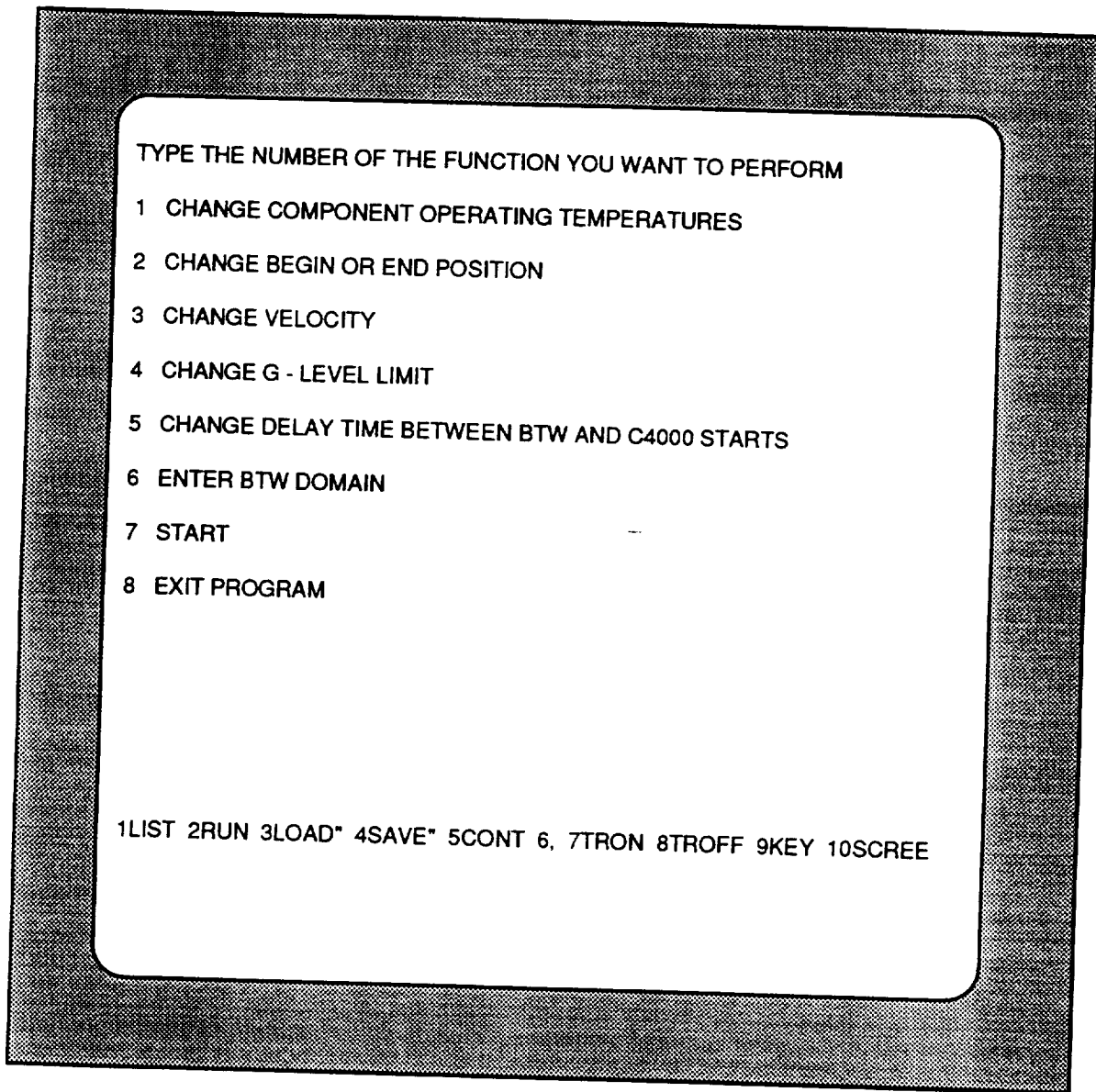

Figure B.4

HTARFF Main Menu

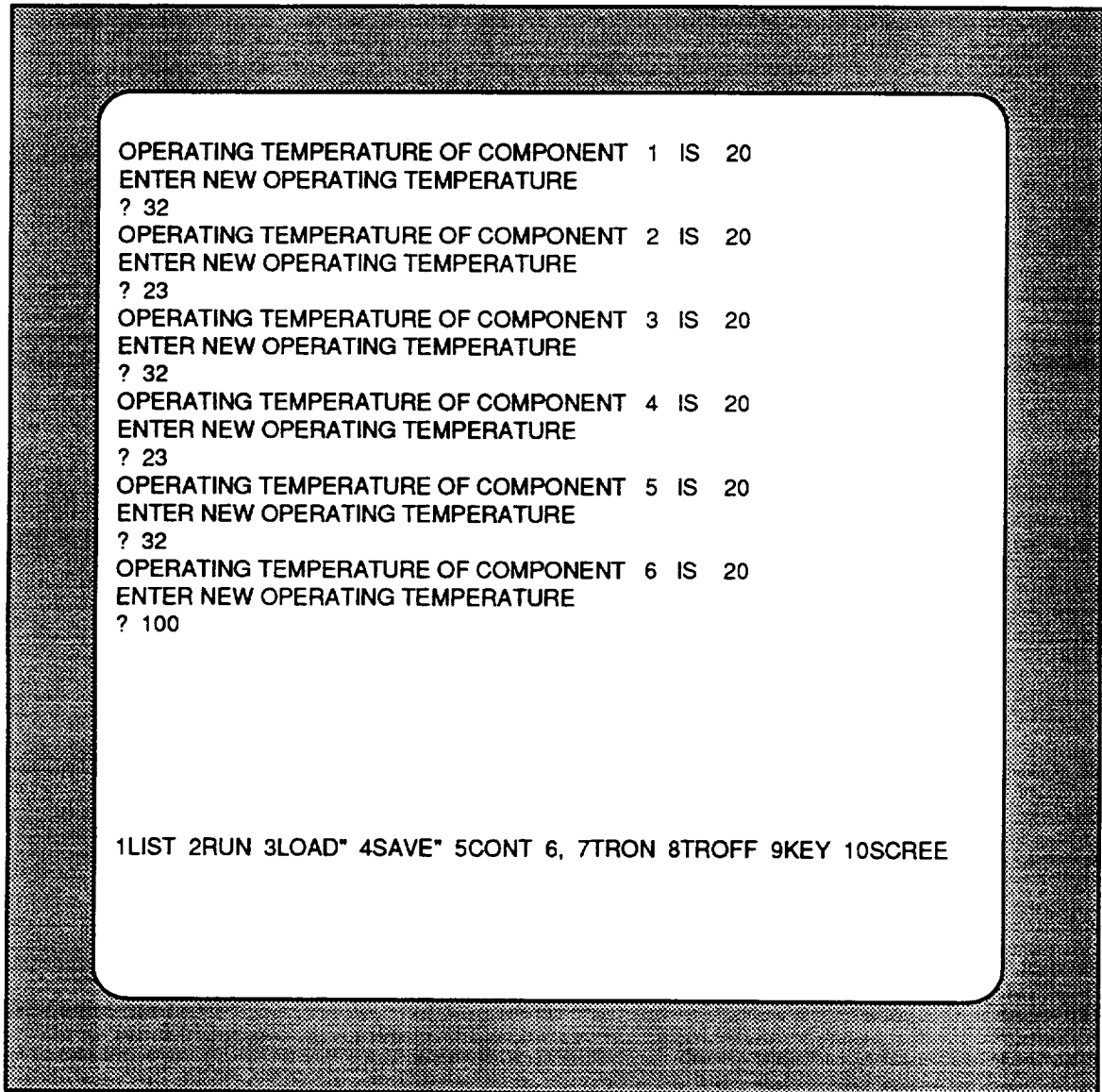

Figure B.5

Setting Component Temperatures



Figure B.6

**Setting Translation Begin
and Ending Positions**

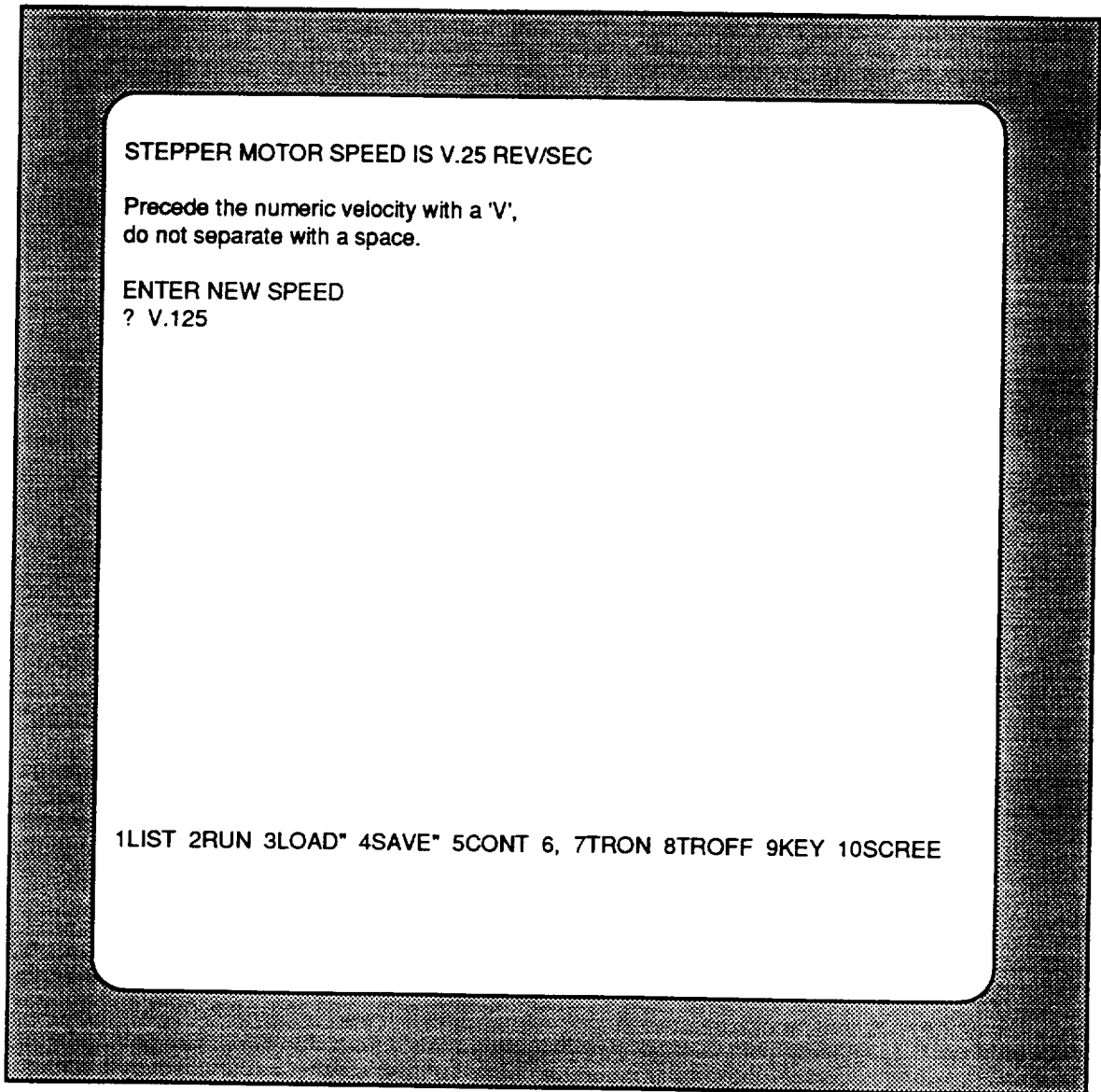

Figure B.7

Setting Stepper Motor Speed

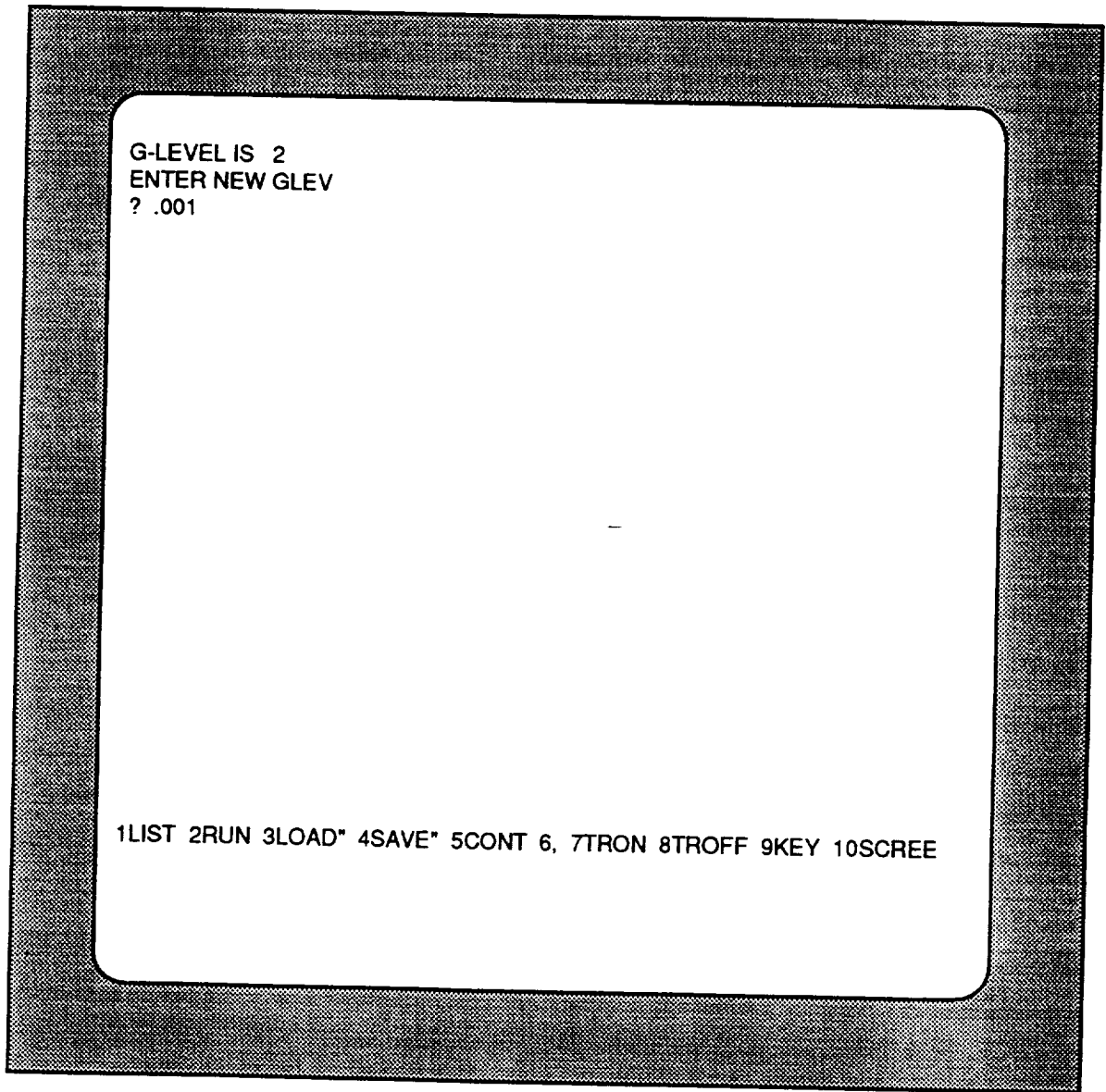

Figure B.8
Setting Gravity Level

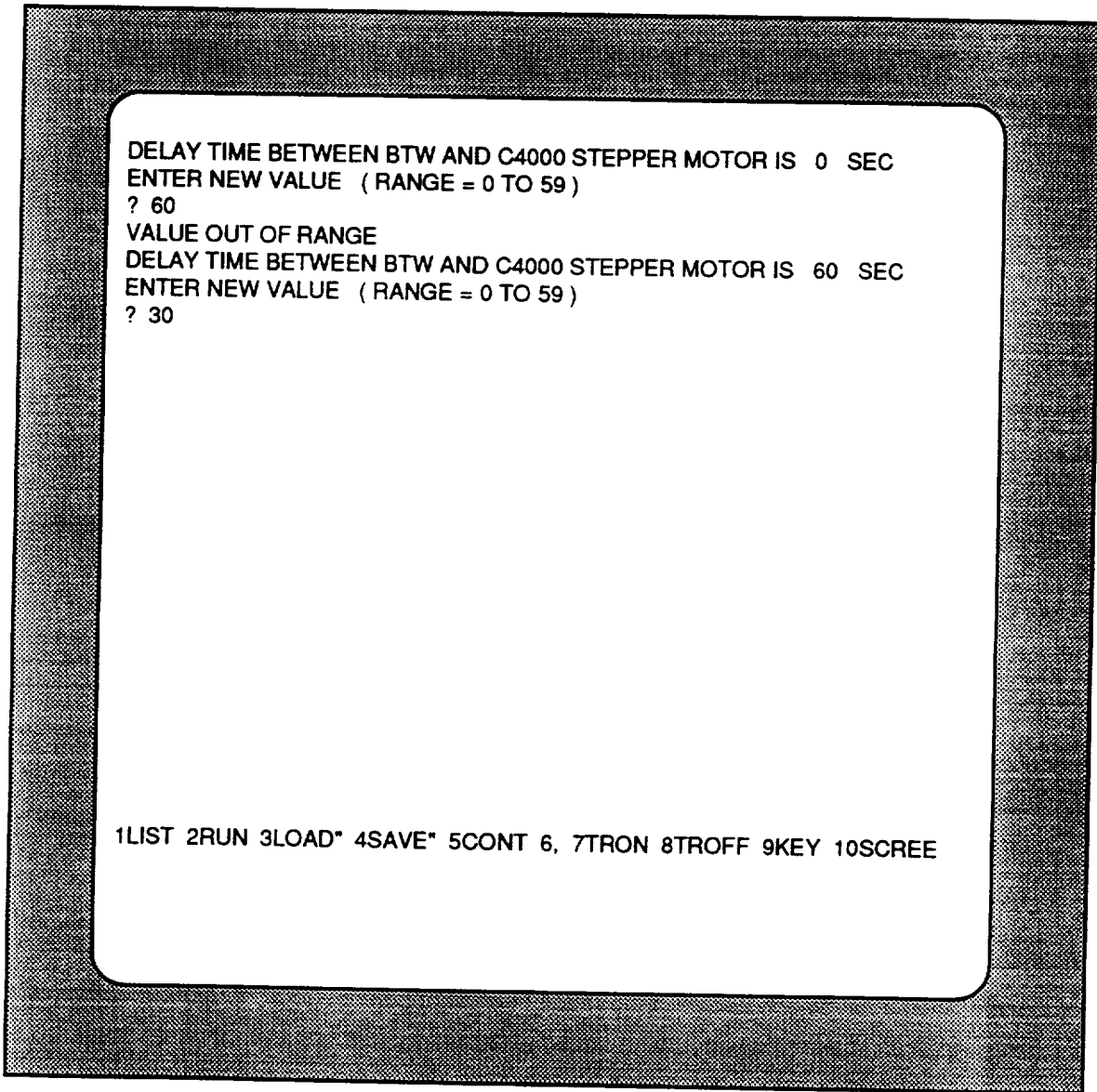

Figure B.9
Setting Delay Time

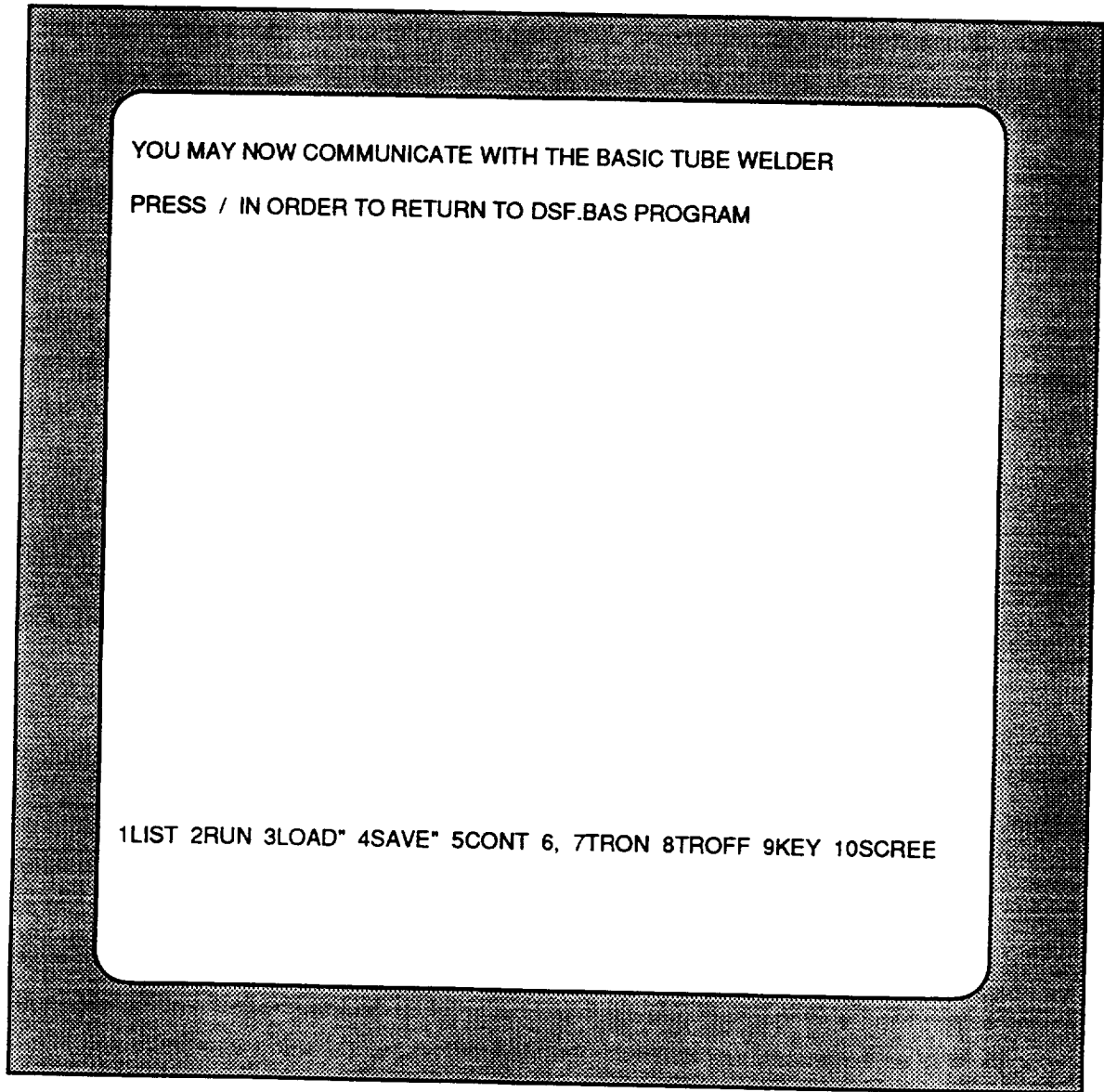

Figure B.10

**S.T. International Nika-BTW
Communications Prompt**

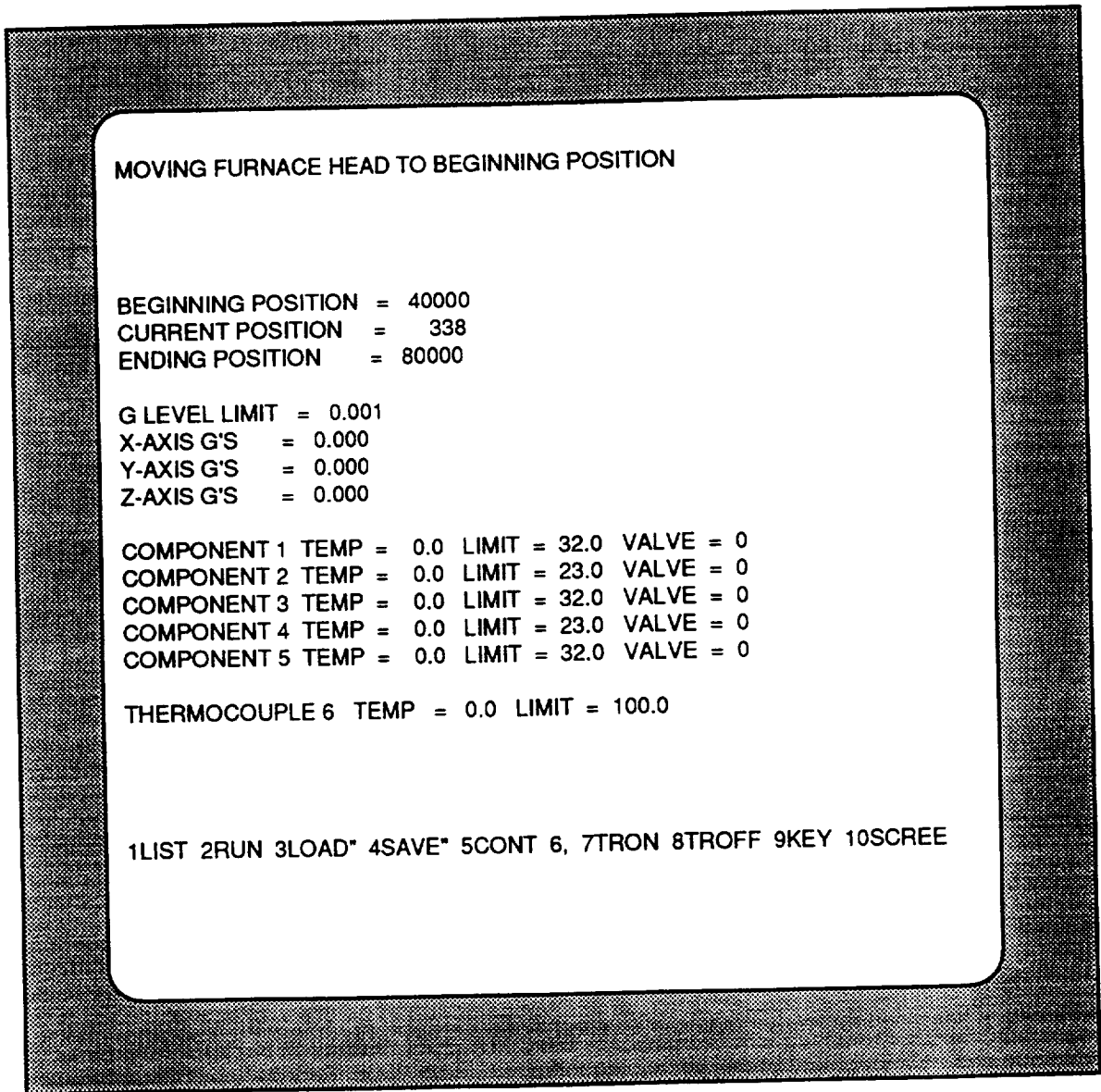

Figure B.11
Furnace Head Translation
to Beginning Position

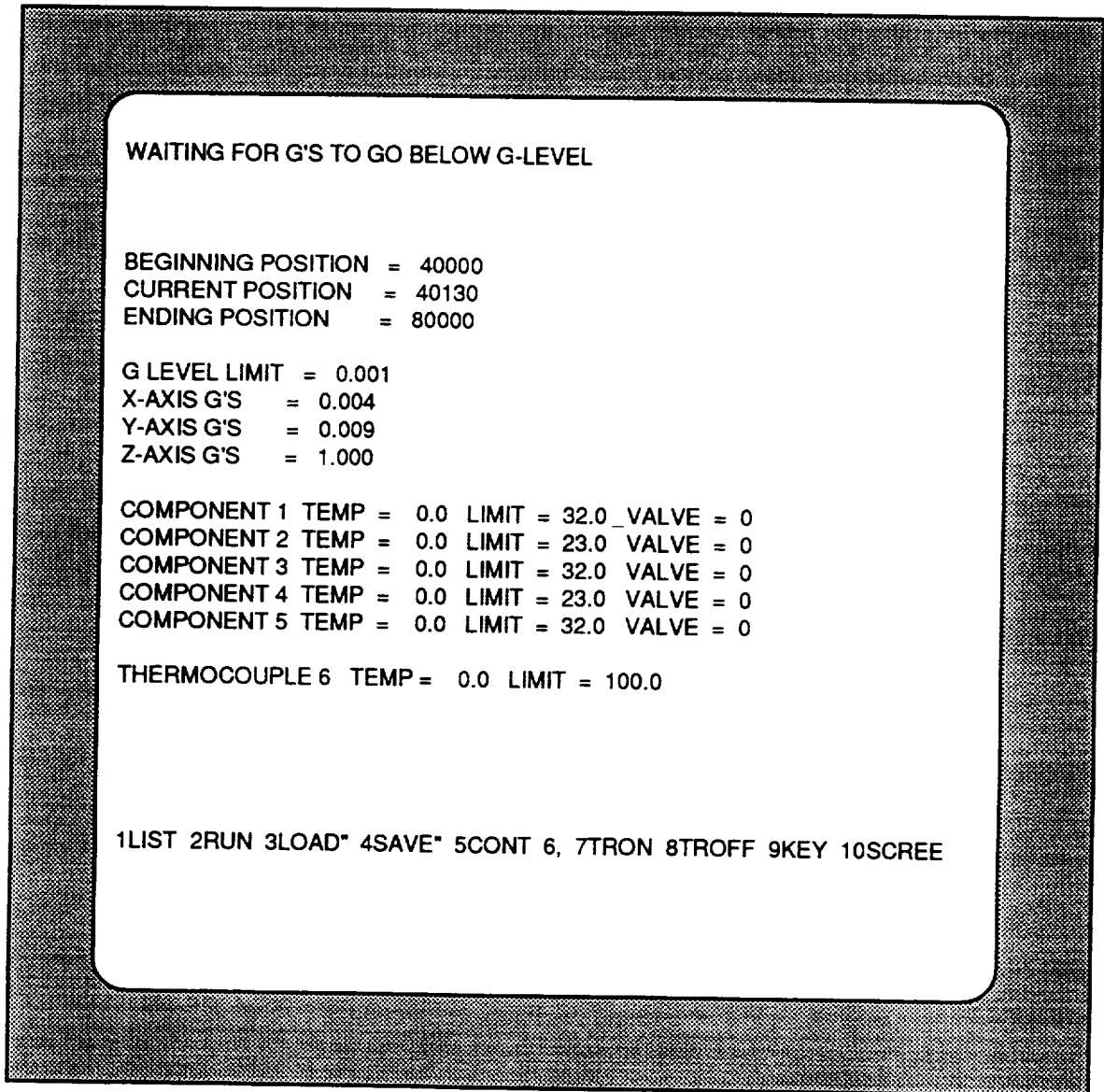

Figure B.12

Waiting for Desired Gravity Level

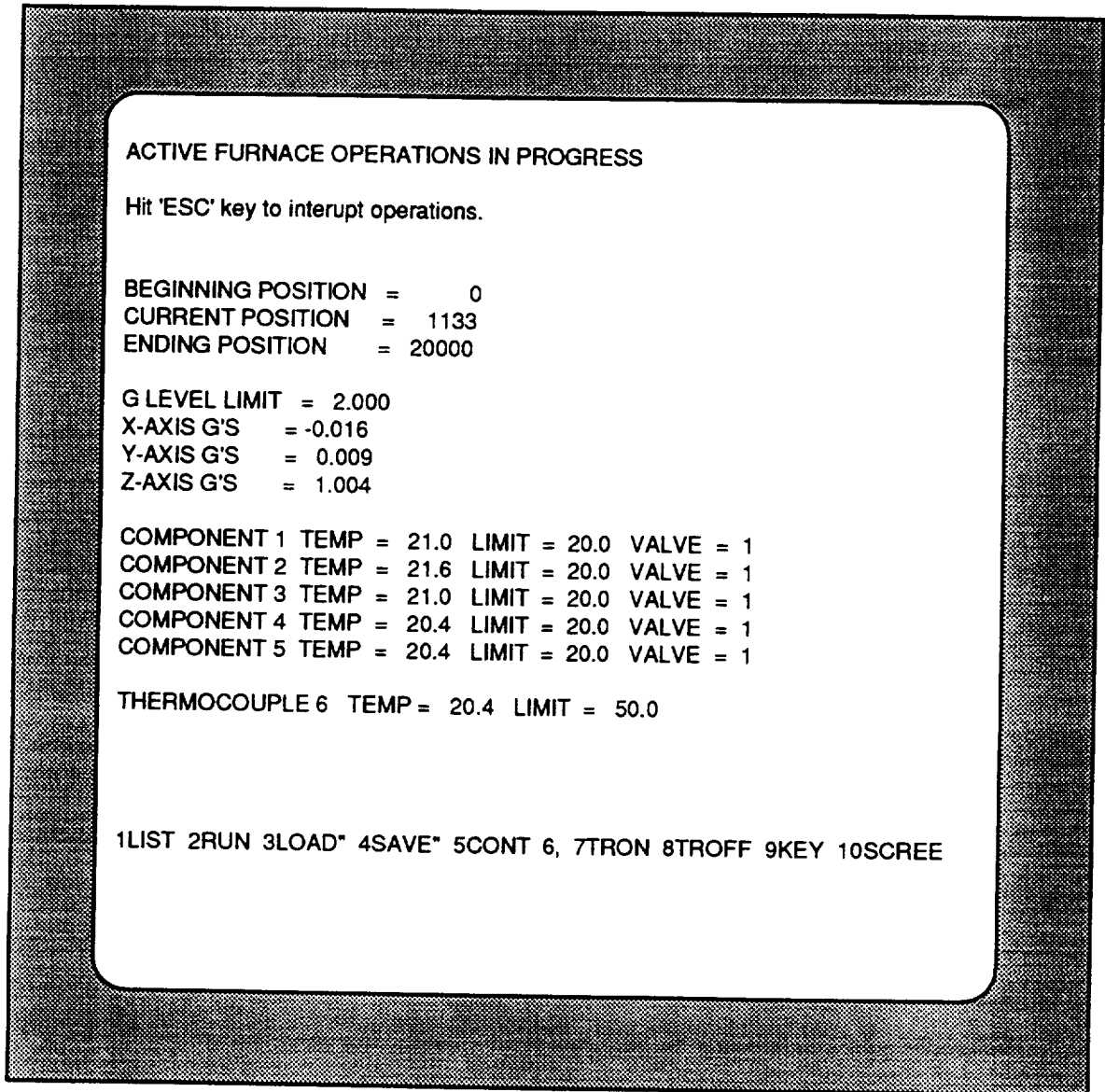

Figure B.13

Active Furnace Operations

FURNACE OPERATIONS HAVE HALTED
SUCCESSFUL COMPLETION

Hit any key to return to main menu, and print data to output file.

BEGINNING POSITION = 0
CURRENT POSITION = 20255
ENDING POSITION = 20000

G LEVEL LIMIT = 2.000
X-AXIS G'S = -0.033
Y-AXIS G'S = -0.008
Z-AXIS G'S = 0.990

COMPONENT 1 TEMP = 21.6 LIMIT = 20.0 VALVE = 1
COMPONENT 2 TEMP = 21.6 LIMIT = 20.0 VALVE = 1
COMPONENT 3 TEMP = 20.7 LIMIT = 20.0 VALVE = 1
COMPONENT 4 TEMP = 20.1 LIMIT = 20.0 VALVE = 1
COMPONENT 5 TEMP = 20.1 LIMIT = 20.0 VALVE = 1

THERMOCOUPLE 6 TEMP = 19.8 LIMIT = 50.0

1LIST 2RUN 3LOAD* 4SAVE* 5CONT 6, 7TRON 8TROFF 9KEY 10SCREE

Figure B.14

Completed Operations

WAITING FOR G'S TO APPROACH 1g

BEGINNING POSITION = 0
CURRENT POSITION = 20255
ENDING POSITION = 20000

G LEVEL LIMIT = 2.000
X-AXIS G'S = -0.010
Y-AXIS G'S = -0.011
Z-AXIS G'S = 1.002

COMPONENT 1 TEMP = 21.6 LIMIT = 20.0 VALVE = 1
COMPONENT 2 TEMP = 21.6 LIMIT = 20.0 VALVE = 1
COMPONENT 3 TEMP = 20.7 LIMIT = 20.0 VALVE = 1
COMPONENT 4 TEMP = 20.1 LIMIT = 20.0 VALVE = 1
COMPONENT 5 TEMP = 20.1 LIMIT = 20.0 VALVE = 1

THERMOCOUPLE 6 TEMP = 19.8 LIMIT = 50.0

1LIST 2RUN 3LOAD* 4SAVE* 5CONT 6, 7TRON 8TROFF 9KEY 10SCREE

Figure B.15

Waiting for Unit Gravity Level

APPENDIX B: HTARFF OUTPUT FILE (DSFOUT.DAT)

RUN SUMMARY

02-10-1992 16:43:58

STEPPER MOTOR SPEED: V.125 RPM

G-LEVEL LIMIT: 2.000 G'S

G(1): HIGH = 0.003, LOW = -0.221

G(2): HIGH = 0.002, LOW = -0.262

G(3): HIGH = 1.005, LOW = 0.841

TEMPERATURE 1: LIMIT = 20.0, HIGH = 34.0, LOW = 2.1

TEMPERATURE 2: LIMIT = 20.0, HIGH = 34.7, LOW = 1.8

TEMPERATURE 3: LIMIT = 20.0, HIGH = 36.9, LOW = 2.1

TEMPERATURE 4: LIMIT = 20.0, HIGH = 35.7, LOW = 2.6

TEMPERATURE 5: LIMIT = 20.0, HIGH = 32.9, LOW = 0.1

TEMPERATURE 6: LIMIT = 50.0, HIGH = 32.6, LOW = -8.1

BTW TIME: STARTED 16:44:00, STOPPED 16:44:51

C4000 TIME: STARTED 16:44:00, STOPPED 16:44:51

C4000 START DELAY: 0 SEC

C4000 START POSITION: SPECIFIED 0 ACTUAL 0

C4000 END POSITION: SPECIFIED 25,000 ACTUAL 25112

FSTOP1 = 1 MOVE TO BEGINNING POSITION SUCCESSFUL

FSTOP2 = 1 RUN EXECUTION WAS SUCCESSFUL

TIMED DATA

| NO. | TIME | POS. | Gx | Gy | Gz | T2 | T4 |
|-----|----------|-------|--------|--------|-------|------|------|
| 1 | 16:44:01 | 17 | -0.004 | -0.000 | 0.999 | 19.9 | 20.2 |
| 2 | 16:44:01 | 534 | 0.003 | -0.001 | 1.004 | 20.1 | 20.1 |
| 3 | 16:44:02 | 977 | -0.007 | 0.002 | 0.999 | 20.0 | 20.0 |
| 4 | 16:44:03 | 1419 | -0.005 | -0.002 | 0.996 | 19.8 | 19.8 |
| 5 | 16:44:04 | 1860 | 0.001 | -0.001 | 0.998 | 19.9 | 19.9 |
| 6 | 16:44:05 | 2300 | -0.001 | -0.001 | 0.999 | 20.4 | 19.5 |
| 7 | 16:44:06 | 2740 | -0.003 | -0.010 | 1.005 | 20.4 | 19.8 |
| 8 | 16:44:07 | 3180 | -0.009 | -0.000 | 1.002 | 20.7 | 19.8 |
| 9 | 16:44:08 | 3622 | -0.002 | -0.000 | 0.996 | 20.2 | 19.9 |
| 10 | 16:44:08 | 4063 | -0.004 | -0.010 | 0.999 | 17.8 | 20.2 |
| 11 | 16:44:09 | 4506 | -0.113 | -0.209 | 0.940 | 21.2 | 14.5 |
| 12 | 16:44:10 | 4951 | -0.120 | -0.137 | 0.902 | 21.2 | 26.0 |
| 13 | 16:44:11 | 5395 | -0.099 | -0.182 | 0.937 | 22.6 | 35.7 |
| 14 | 16:44:12 | 5839 | -0.081 | -0.137 | 0.941 | 10.1 | 21.2 |
| 15 | 16:44:13 | 6281 | -0.107 | -0.219 | 0.907 | 24.6 | 19.5 |
| 16 | 16:44:14 | 6723 | -0.203 | -0.234 | 0.888 | 11.8 | 24.0 |
| 17 | 16:44:15 | 7165 | -0.212 | -0.216 | 0.948 | 23.0 | 9.5 |
| 18 | 16:44:16 | 7607 | -0.150 | -0.251 | 0.908 | 23.8 | 4.8 |
| 19 | 16:44:17 | 8050 | -0.138 | -0.197 | 0.987 | 11.7 | 22.4 |
| 20 | 16:44:17 | 8493 | -0.207 | -0.238 | 0.898 | 22.9 | 2.9 |
| 21 | 16:44:18 | 8935 | -0.138 | -0.184 | 0.991 | 21.4 | 32.1 |
| 22 | 16:44:19 | 9379 | -0.189 | -0.192 | 0.972 | 20.6 | 32.2 |
| 23 | 16:44:20 | 9821 | -0.141 | -0.174 | 0.988 | 32.3 | 17.7 |
| 24 | 16:44:21 | 10263 | -0.149 | -0.184 | 0.966 | 5.4 | 26.2 |
| 25 | 16:44:22 | 10705 | -0.203 | -0.247 | 0.905 | 23.0 | 17.3 |
| 26 | 16:44:23 | 11145 | -0.206 | -0.262 | 0.887 | 32.9 | 6.5 |
| 27 | 16:44:24 | 11588 | -0.175 | -0.238 | 0.935 | 20.9 | 26.9 |
| 28 | 16:44:25 | 12031 | -0.200 | -0.250 | 0.926 | 4.5 | 21.5 |
| 29 | 16:44:25 | 12473 | -0.143 | -0.240 | 0.978 | 22.0 | 23.2 |
| 30 | 16:44:26 | 12916 | -0.181 | -0.241 | 0.981 | 11.1 | 22.7 |

| | | | | | | | |
|----|----------|-------|--------|--------|-------|------|------|
| 31 | 16:44:27 | 13359 | -0.199 | -0.259 | 0.893 | 21.8 | 21.8 |
| 32 | 16:44:28 | 13801 | -0.146 | -0.185 | 0.963 | 32.7 | 3.8 |
| 33 | 16:44:29 | 14242 | -0.173 | -0.261 | 0.875 | 1.8 | 20.1 |
| 34 | 16:44:30 | 14684 | -0.144 | -0.159 | 0.959 | 22.4 | 21.2 |
| 35 | 16:44:31 | 15125 | -0.214 | -0.245 | 0.956 | 20.5 | 21.1 |
| 36 | 16:44:32 | 15569 | -0.142 | -0.176 | 0.961 | 13.8 | 18.7 |
| 37 | 16:44:32 | 16011 | -0.149 | -0.239 | 0.912 | 3.6 | 20.6 |
| 38 | 16:44:33 | 16452 | -0.138 | -0.255 | 0.895 | 29.6 | 6.4 |
| 39 | 16:44:34 | 16894 | -0.166 | -0.192 | 0.927 | 23.7 | 33.8 |
| 40 | 16:44:35 | 17337 | -0.215 | -0.245 | 0.962 | 23.4 | 23.1 |
| 41 | 16:44:36 | 17780 | -0.195 | -0.252 | 0.867 | 6.9 | 18.4 |
| 42 | 16:44:37 | 18221 | -0.167 | -0.254 | 0.879 | 23.5 | 18.7 |
| 43 | 16:44:38 | 18808 | -0.147 | -0.186 | 0.957 | 21.8 | 33.1 |
| 44 | 16:44:39 | 19250 | -0.190 | -0.252 | 0.888 | 20.9 | 23.3 |
| 45 | 16:44:40 | 19694 | -0.140 | -0.178 | 0.955 | 23.1 | 22.5 |
| 46 | 16:44:41 | 20135 | -0.180 | -0.249 | 0.868 | 23.8 | 18.1 |
| 47 | 16:44:42 | 20578 | -0.207 | -0.249 | 0.954 | 30.4 | 2.6 |
| 48 | 16:44:43 | 21019 | -0.158 | -0.176 | 0.883 | 24.5 | 32.5 |
| 49 | 16:44:43 | 21462 | -0.189 | -0.190 | 0.961 | 23.1 | 31.5 |
| 50 | 16:44:44 | 21904 | -0.175 | -0.234 | 0.923 | 23.1 | 24.9 |
| 51 | 16:44:45 | 22347 | -0.221 | -0.262 | 0.841 | 23.7 | 22.8 |
| 52 | 16:44:46 | 22790 | -0.173 | -0.259 | 0.934 | 12.5 | 34.5 |
| 53 | 16:44:47 | 23234 | -0.201 | -0.243 | 0.938 | 34.7 | 9.3 |
| 54 | 16:44:48 | 23674 | -0.182 | -0.249 | 0.863 | 22.1 | 23.3 |
| 55 | 16:44:49 | 24116 | -0.175 | -0.252 | 0.883 | 25.1 | 21.8 |
| 56 | 16:44:50 | 24558 | -0.196 | -0.187 | 0.966 | 25.7 | 21.5 |
| 57 | 16:44:51 | 25000 | -0.214 | -0.258 | 0.861 | 26.7 | 10.9 |

APPENDIX C: COMPUTER-AIDED-DESIGN DRAWINGS

| NO. | QTY | DESCRIPTION | MATERIAL / REFERENCE |
|-----|-----|------------------|----------------------|
| 1 | 1 | WELDHEAD BRACKET | A LUMINUM |

- NOTES:
 1. PART TO BE MACHINED FROM SINGLE PIECE OF STOCK
 2. FINISHED PART TO BE ANNOTATED BLACK
 3. BREAK ALL EDGES
 4. OLD PIECE CAN BE USED AS A TEMPLATE TO LOCATE HOLE CENTERS
 5. ACTUALLY 1.1318 INCH
 6. SEE DRG 2.1.1.1 PAGE 2 FOR ELECTRICAL CONNECTION CONFIGURATION

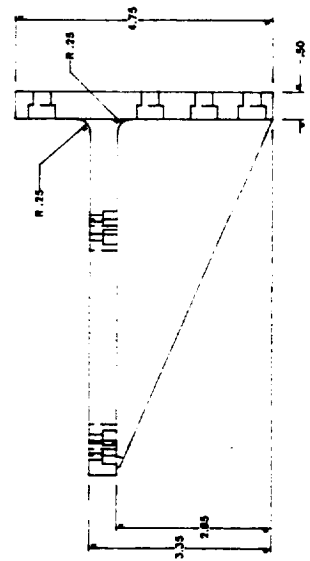
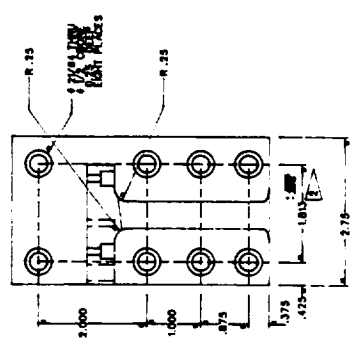
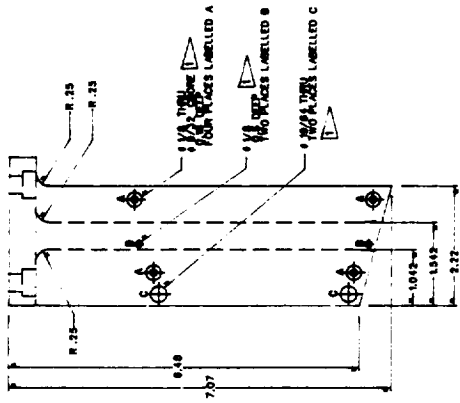

| | | | | | | | | | |
|--|---|---------------------------|---------------------------|-----------------------------|-----------------|--------------------------|----------|---|---|
| UNLESS OTHERWISE SPECIFIED DIMENSIONS ARE IN INCHES TOLERANCES ON FRACTIONS | UNLESS OTHERWISE SPECIFIED DIMENSIONS ARE IN INCHES TOLERANCES ON DECIMALS | APPROVED DATE 11/27/03 | APPROVED DATE 11/27/03 | DESIGNED BY JOHN CASHION | DATE 12-8-03 | ORIGINAL DATE 12-8-03 | BY JH | DESCRIPTION WELDHEAD BRACKET FOR MOUNTING HOLES | UJAH THE UNIVERSITY OF ALABAMA IN HUNTSVILLE HUNTSVILLE, ALABAMA 35894 DRG NO. 2.1.1.1 SCALE FULL SIZE 1:1 |
|--|---|---------------------------|---------------------------|-----------------------------|-----------------|--------------------------|----------|---|---|

| NO. | QTY | DESCRIPTION | MATERIAL / REFERENCE |
|-----|-----|----------------|----------------------|
| 1 | 1 | WELDED BRACKET | ALUMINUM |

NOTES:
 1. PART TO BE MACHINED FROM SINGLE PIECE OF STOCK
 2. FINISHED PART TO BE ANODIZED BLACK
 3. BREAK ALL EDGES

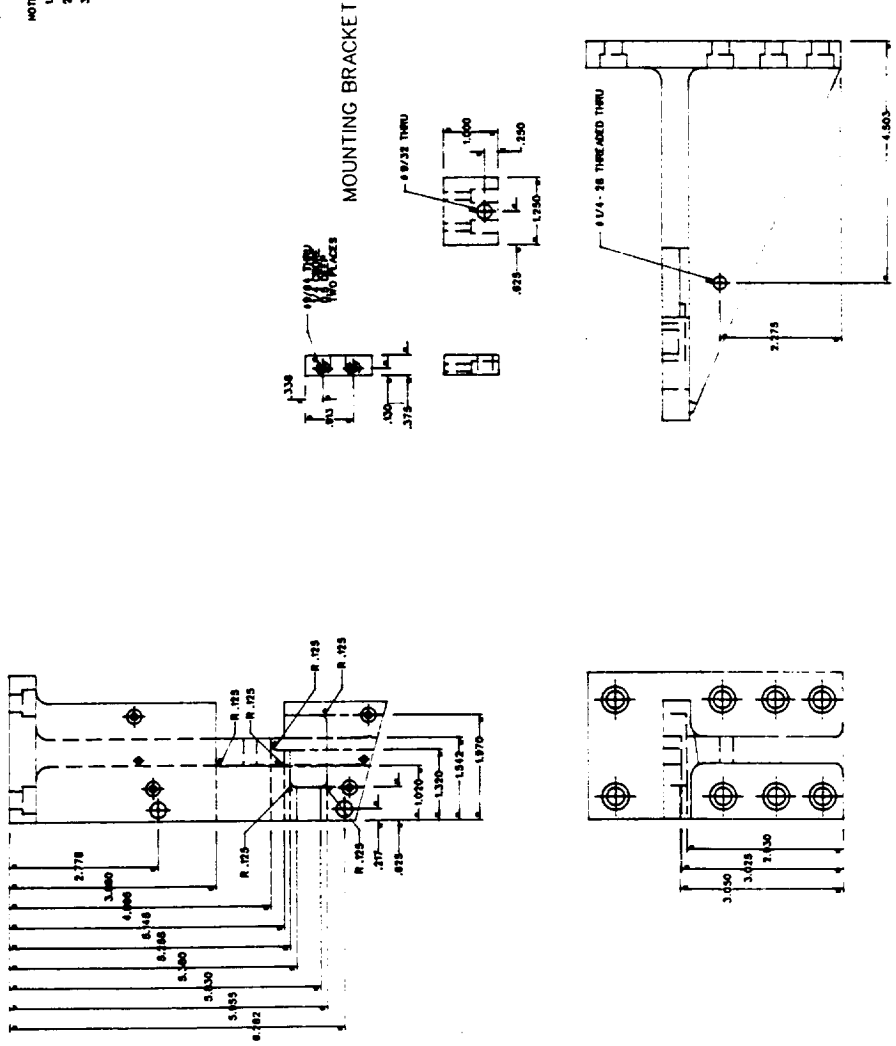

| GENERAL DATE | 12-8-98 | 11/19/97 | UAH |
|--------------|-------------|----------|------------------------------|
| DESIGNER | JOHN CASHIN | | THE UNIVERSITY OF ALABAMA |
| APPROVED | | | IN HUNTSVILLE, ALABAMA 35894 |
| DATE | 12-8-98 | | DATE IN FULL |
| SCALE | 1:1 | | SHEET 2 OF 3 |

| NO. | QTY | DESCRIPTION | MATERIAL / REFERENCE |
|-----|-----|-----------------------------|----------------------|
| 1 | | COLLET HOLDER BRACKET (TOP) | ALUMINUM |

NOTES:
 1. PART TO BE MACHINED FROM SINGLE PIECE OF STOCK
 2. FINISHED PART TO BE ANODIZED BLACK
 3. BREAK-ALL EDGES

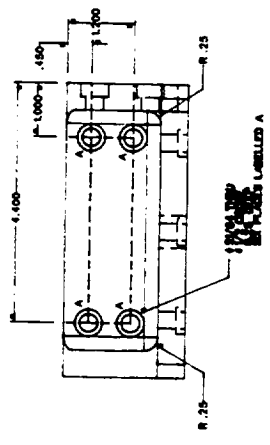
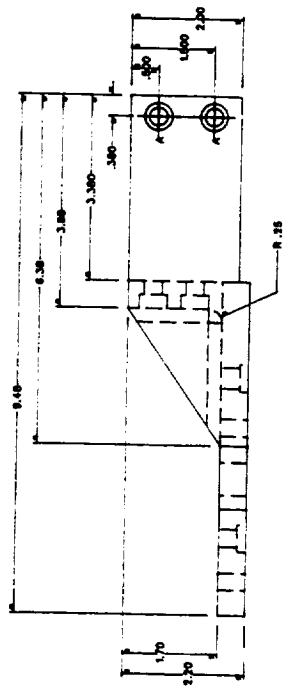
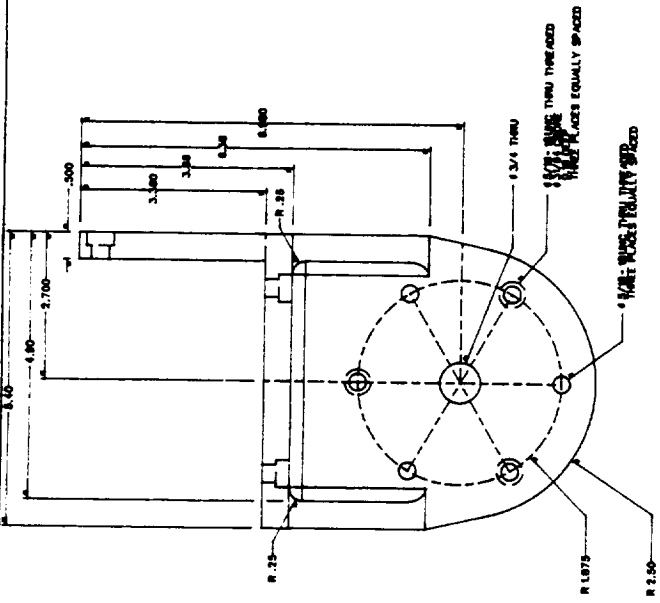

| | | | |
|----------------------------|---------------|------|----|
| UNLESS OTHERWISE SPECIFIED | UNLESS DATE | DATE | BY |
| TOLERANCES ARE IN INCHES | APPROVAL DATE | DATE | BY |
| TOLERANCES ON | APPROVAL | DATE | BY |
| FRACTIONS | DESIGNED | DATE | BY |
| | DRAWN | DATE | BY |
| | CHECKED | DATE | BY |
| | APPROVED | DATE | BY |

UAH
 THE UNIVERSITY OF ALABAMA
 HUNTSVILLE, ALABAMA 35890
 SCALE FULL SIZE
 SHEET 1 OF 1

| QTY | DESCRIPTION | MATERIAL / REFERENCE |
|-----|------------------------|----------------------|
| 1 | FINISHED COLLET HOLDER | 8.1.1.1.4 SHEET 2 |
| 3 | BASE | 2.1.1.1.6 SHEET 2 |
| 3 | OUTER CASE | 2.1.1.1.6 SHEET 2 |

NOTES:
 FINISHED ASSEMBLY:
 1. BREAK ALL EDGES ON FINISHED PIECE
 2. TURN DOWN OUTER SURFACE TO NEW METAL AND RADIUS WELDS
 BEFORE PUTTING IN MOUNTING HOLES

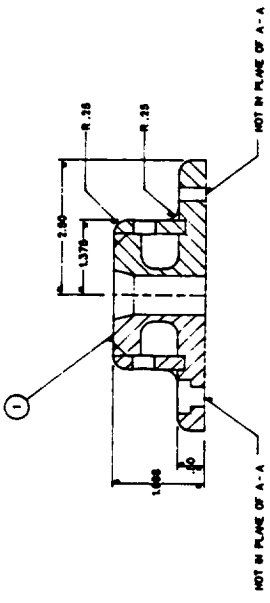
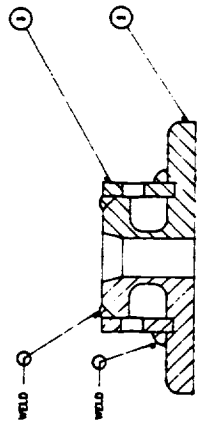
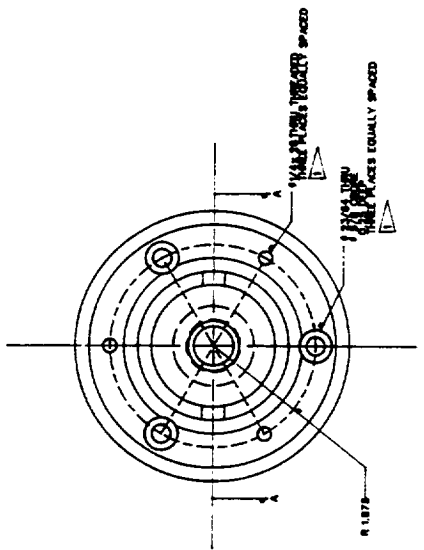
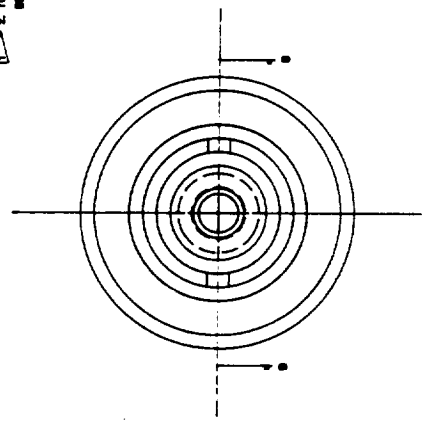

VIEW B-B

PRIMARY ASSEMBLY

VIEW A-A

FINAL ASSEMBLY

| DATE | BY | CHKD | APP'D | REV |
|----------|-----|------|-------|-----|
| 10/10/00 | ... | ... | ... | 1 |
| 11/10/00 | ... | ... | ... | 2 |
| 12/10/00 | ... | ... | ... | 3 |
| 01/11/01 | ... | ... | ... | 4 |
| 02/11/01 | ... | ... | ... | 5 |
| 03/11/01 | ... | ... | ... | 6 |
| 04/11/01 | ... | ... | ... | 7 |
| 05/11/01 | ... | ... | ... | 8 |
| 06/11/01 | ... | ... | ... | 9 |
| 07/11/01 | ... | ... | ... | 10 |
| 08/11/01 | ... | ... | ... | 11 |
| 09/11/01 | ... | ... | ... | 12 |
| 10/11/01 | ... | ... | ... | 13 |
| 11/11/01 | ... | ... | ... | 14 |
| 12/11/01 | ... | ... | ... | 15 |

| DATE | BY | CHKD | APP'D | REV |
|----------|-----|------|-------|-----|
| 10/10/00 | ... | ... | ... | 1 |
| 11/10/00 | ... | ... | ... | 2 |
| 12/10/00 | ... | ... | ... | 3 |
| 01/11/01 | ... | ... | ... | 4 |
| 02/11/01 | ... | ... | ... | 5 |
| 03/11/01 | ... | ... | ... | 6 |
| 04/11/01 | ... | ... | ... | 7 |
| 05/11/01 | ... | ... | ... | 8 |
| 06/11/01 | ... | ... | ... | 9 |
| 07/11/01 | ... | ... | ... | 10 |
| 08/11/01 | ... | ... | ... | 11 |
| 09/11/01 | ... | ... | ... | 12 |
| 10/11/01 | ... | ... | ... | 13 |
| 11/11/01 | ... | ... | ... | 14 |
| 12/11/01 | ... | ... | ... | 15 |

UAH
 THE UNIVERSITY OF ALABAMA
 MATERIALS MANUFACTURING
 CENTER
 885 SOUTH GATEWAY BLVD
 TUSCALOOSA, AL 35709
 TEL: 205/885-5800
 FAX: 205/885-5801

| NO. | QTY | DESCRIPTION | MATERIAL / REFERENCE |
|-----|-----|-----------------|------------------------------------|
| 1 | 6 | BASE | STAINLESS STEEL |
| 2 | 6 | OUTER CASE | STAINLESS STEEL, 2.00 PIPE 0.50 WT |
| 3 | 12 | ALIGNMENT SCREW | |

NOTES:
 1 ALIGNMENT SCREWS MADE BY ROUNDING THE END OF A STAINLESS STEEL
 1/16" SOCKET SET SCREW WITH AN OVAL POINT 3/16" IN. TOTAL LENGTH

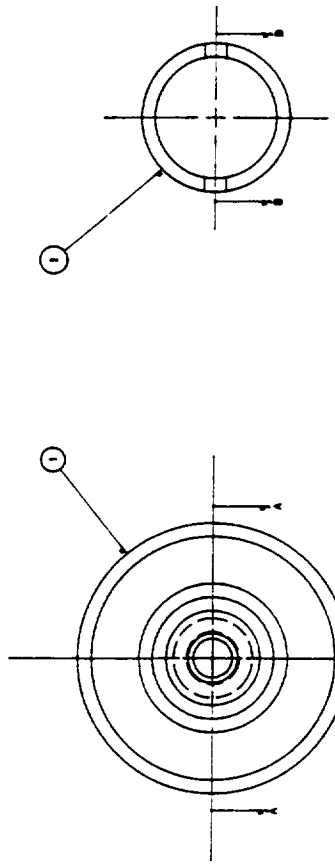

ALIGNMENT SCREW

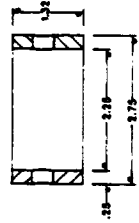
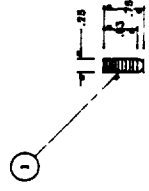

VIEW B-B

OUTER CASE

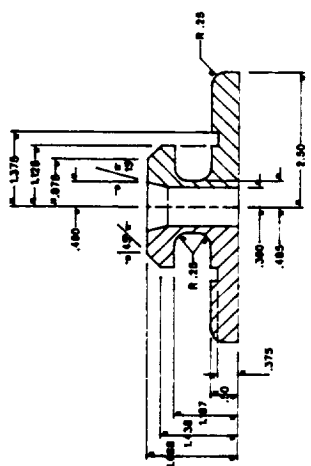

VIEW A-A

BASE

| | | | | | | | | | | | | | |
|--|--|----------------------|----------------------|----------------------|----------------------|----------------------|----------------------|----------------------|----------------------|----------------------|-----------------------|-----------------------|-----------------------|
| UNLESS OTHERWISE SPECIFIED DIMENSIONS ARE IN INCHES TOLERANCES ON FRACTIONS | UNLESS DATE IS GIVEN DATE OF THIS REVISION APPLIES TO ALL REVISED DRAWINGS | REV. 1 DATE BY | REV. 2 DATE BY | REV. 3 DATE BY | REV. 4 DATE BY | REV. 5 DATE BY | REV. 6 DATE BY | REV. 7 DATE BY | REV. 8 DATE BY | REV. 9 DATE BY | REV. 10 DATE BY | REV. 11 DATE BY | REV. 12 DATE BY |
| | | | | | | | | | | | | | |

UJAH
 THE UNIVERSITY OF ALABAMA
 IN MONTGOMERY
 MONTGOMERY, ALABAMA 36109
 SCALE: FULL SIZE
 SHEET 1 OF 1

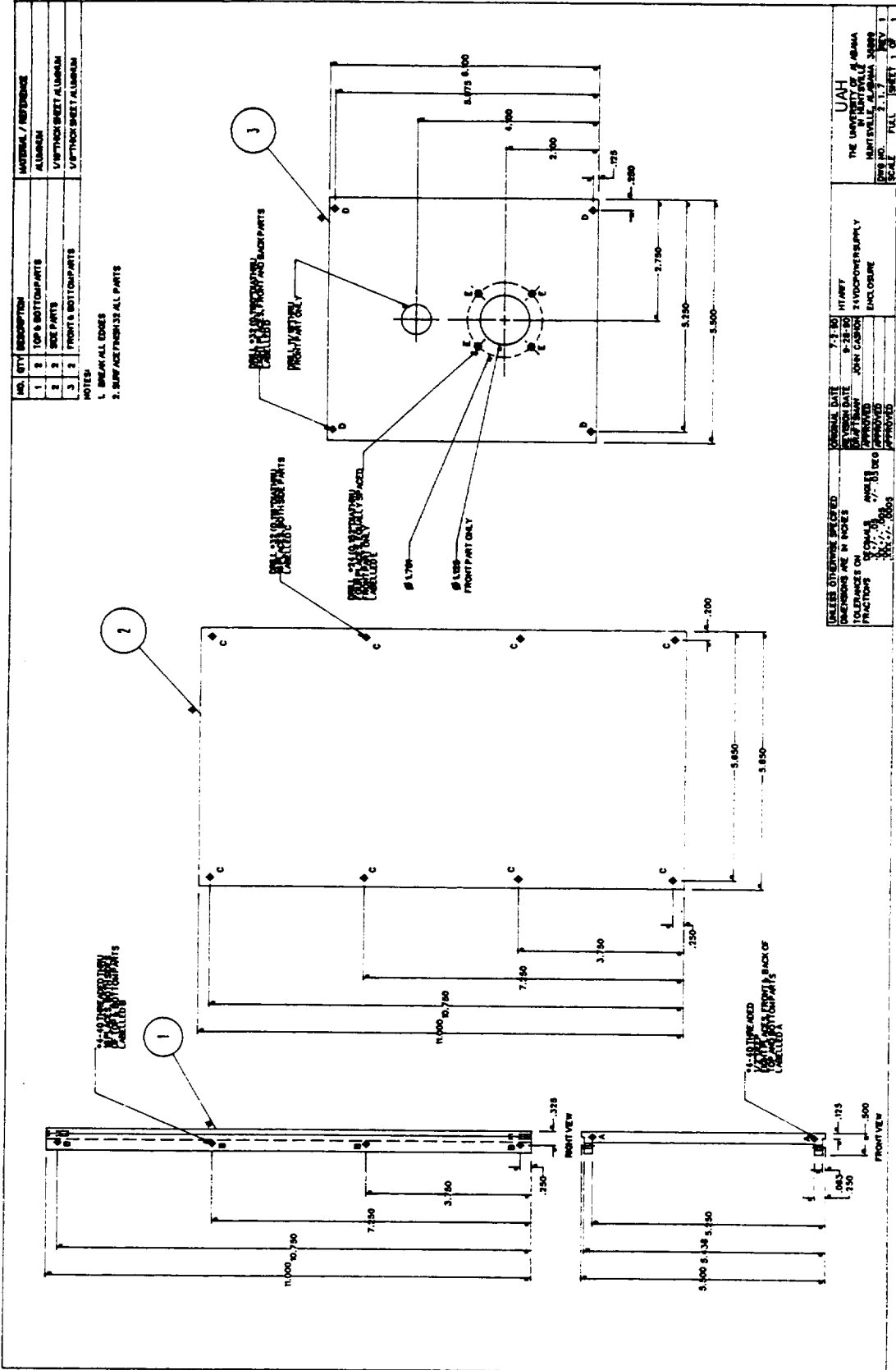

| NO. | QTY | DESCRIPTION | MATERIAL / REFERENCE |
|-----|-----|----------------------|---------------------------|
| 1 | 2 | TOP & BOTTOM PARTS | ALUMINUM |
| 2 | 2 | SIDE PARTS | 1/8" THICK SHEET ALUMINUM |
| 3 | 2 | FRONT & BOTTOM PARTS | 1/8" THICK SHEET ALUMINUM |

NOTES:
 1. BREAK ALL EDGES
 2. SURFACE FINISH IS ALL PARTS

UNLESS OTHERWISE SPECIFIED DIMENSIONS ARE IN INCHES

DATE: 7-1-80
 DRAWN BY: J. H. HART
 CHECKED BY: J. H. HART
 APPROVED BY: J. H. HART

UJAH
 THE UNIVERSITY OF ALABAMA
 JAMES H. HARRIS CENTER FOR SPACE RESEARCH
 UNIVERSITY OF ALABAMA
 TUSCALOOSA, ALABAMA 35889

ENCLOSURE

SCALE: FULL SIZE

SHEET: 1 OF 1

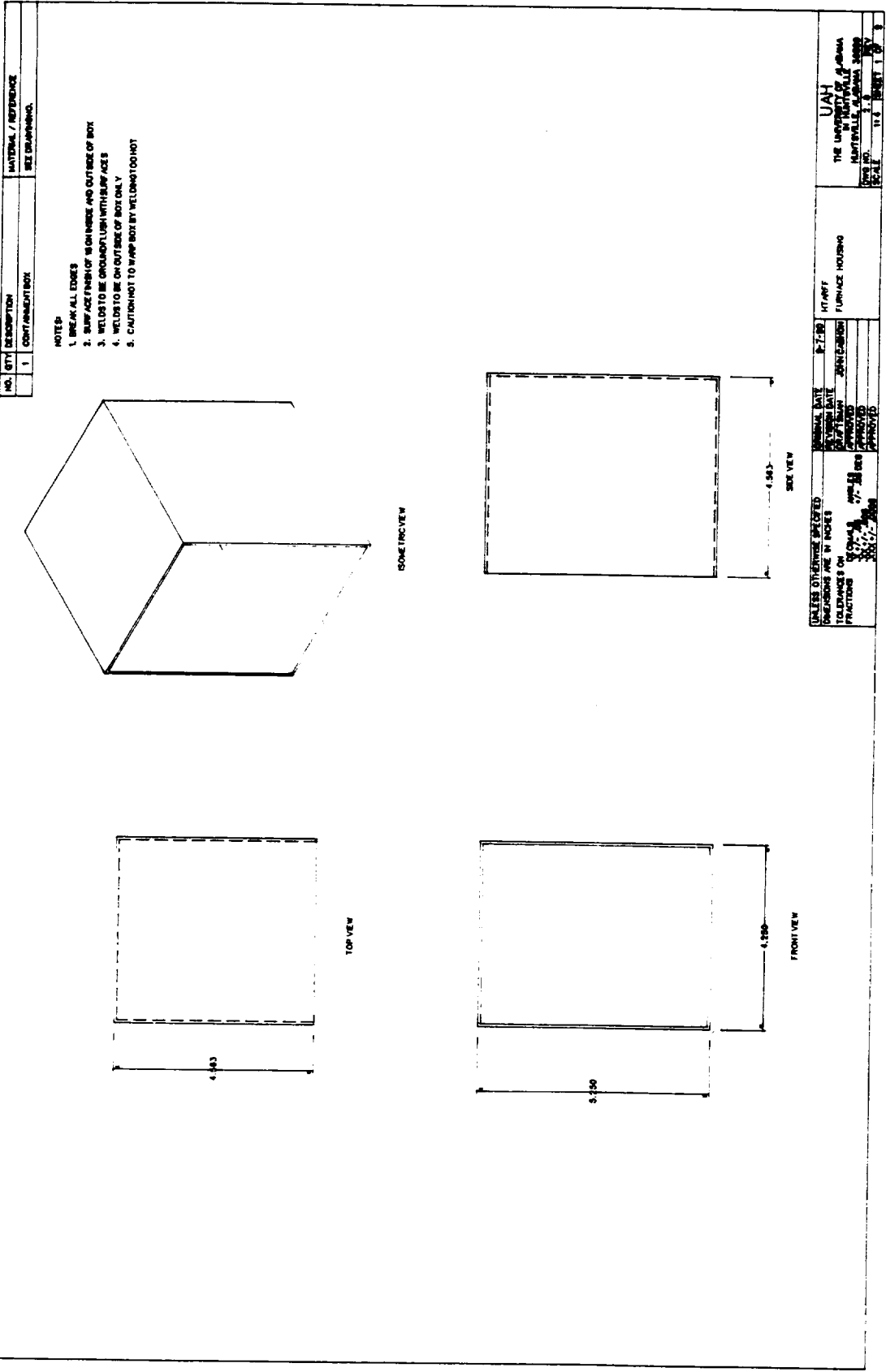

UNLESS OTHERWISE SPECIFIED
DIMENSIONS ARE IN INCHES
TOLERANCES ON
FRACTIONS

| | |
|-------------|-------------|
| DESIGNED BY | APPROVED BY |
| DRAWN BY | CHECKED BY |
| DATE | DATE |

SCALE: 1" = 1" - 1/2"

U.A.H.
THE UNIVERSITY OF ALABAMA
NATIONAL GUARDIAN
SCALE: 1" = 1" - 1/2"

| NO. | QTY | DESCRIPTION | MATERIAL / REFERENCE |
|-----|-----|---------------------|----------------------|
| 1 | 2 | TOP & BOTTOM PANELS | A. ALUMINUM |
| 2 | 1 | BACK PANEL | A. ALUMINUM |
| 3 | 2 | SIDE PANELS | A. ALUMINUM |

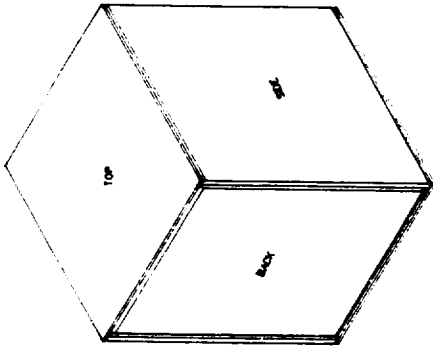

ALL DIMENSIONS SHOWN ON THIS DRAWING ARE IN INCHES

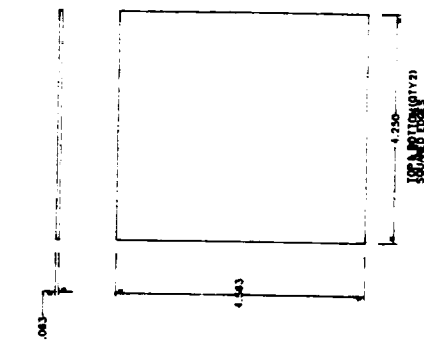
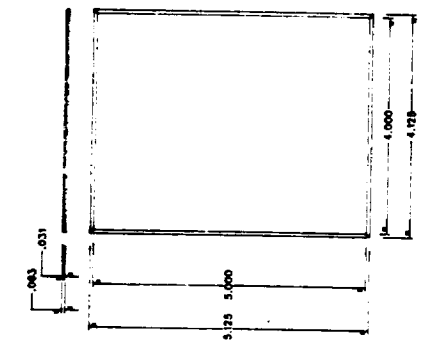
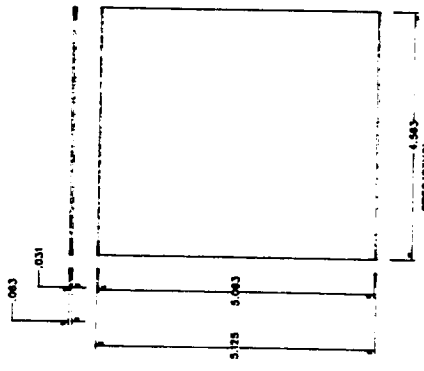

UNLESS OTHERWISE SPECIFIED, DIMENSIONS ARE IN INCHES. DECIMALS TO BE ROUNDED UP TO THE NEXT HIGHER FRACTION.

DATE: 11/11/80
 DRAWN BY: JERRY CARSON
 CHECKED BY: JERRY CARSON
 APPROVED BY: JERRY CARSON

ORIGINAL DATE: 8-7-80
 REVISION DATE: NONE

UJAH
 THE UNIVERSITY OF ALABAMA
 HAYESVILLE, ALABAMA 36889
 Dwg. No. 7-8
 SCALE: 1:1 SHEET 1 OF 2

APPENDIX D: HTARFF PARTS INVENTORY

HTARFF PARTS INVENTORY

MAKE: Hoffman Engineering Company
MODEL NO: D-LEE612424
SERIAL NO: 204600
DESCRIPTION: Furnace Cabinet; 56"x24"x24"; 6 angle racks; 6 horizontal struts; 3 shelves; front & back doors - front contains full length 1/4" acrylic window; 2 sides; casters; levelers

MAKE: Hoffman Engineering Company
MODEL NO: D-LEE612429
SERIAL NO: 204500
DESCRIPTION: Electrical Cabinet; 56"x24"x29"; 6 angle racks; 4 horizontal struts; 1 shelf; front & back doors - front contains full length 1/4" acrylic window and keyboard compartment; 2 sides; casters; levelers

MAKE: Thomson
MODEL NO: 2DB-16-OUB-G L18-B
SERIAL NO: 204613
DESCRIPTION: Translation table; 5.75" travel; custom mounting holes in carriage; bellows; 1" diameter shaft; 0.2"/revolution lead

MAKE: S.T. International, Inc.
MODEL NO: 9121
SERIAL NO: 5066
DESCRIPTION: Nika-Basic Tube Welder (BTW) control module; dated 6-88; rated at 110-220 Volts, 20 Amps, 50-60 Hz

MAKE: S.T. International, Inc.
MODEL NO: 6003-C
SERIAL NO: 1347
DESCRIPTION: Nika-Basic Tube Welder (BTW) weld head and umbilical cable

MAKE: Mitsuba
MODEL NO: Recortec 710A
SERIAL NO: MIA 433
DESCRIPTION: Monitor for Nika-BTW; amber monochrome

MAKE: Compumotor Division / Parker Hannifin Corporation
MODEL NO: 4000
SERIAL NO: 361
DESCRIPTION: Programmable Motion Controller and Programmer/Operator Panel

MAKE: Compumotor Division / Parker Hannifin Corporation
MODEL NO: C-Drive
SERIAL NO: 8264
DESCRIPTION: Rev 1D Code 9005

MAKE: Compumotor Division / Parker Hannifin Corporation
MODEL NO: DC3
SERIAL NO: 204603
DESCRIPTION: 24 VDC power supply with custom designed and
fabricated aluminum enclosure

MAKE: Compumotor Division / Parker Hannifin Corporation
MODEL NO: C57102-3-6-017-010
SERIAL NO: 204604
DESCRIPTION: Stepper Motor; 25,000 steps / revolution;
120 Oz-in torque

MAKE: Compumotor Division / Parker Hannifin Corporation
MODEL NO: C152-421-1000-120CLL
SERIAL NO: 4102585
DESCRIPTION: Encoder; 4,000 lines / revolution

MAKE: Interface Electronics, Inc.
MODEL NO: 2004
SERIAL NO: 18
DESCRIPTION: Intel 80386-20Mhz Operations Computer; back plane
construction by Netway Technology ASSY 98209140 Rev 01; rack
mounted; 640 kb RAM; 32 kb display memory; 21 Mb hard drive with
self parking head and average 72.21 ms seek time; 5-1/4" HD & 3-
1/2" HD; floppy drives; 2 serial ports; 1 parallel port; 101
keyboard; EGA video card; IOSB-1.0 card S/N 8912 01 8473; PIO-12
card; DAS-8 card; Motherboard, S/N 8911 034667, intel i386
microprocessor chip A80386DX-20 SX217 L9410382, with external
battery for nonvolatile memory; hard & floppy drives card
C90708585

MAKE: Paradise
ASSY: 28700 Rev 7
SERIAL NO: 529758
DESCRIPTION: EGA video card

MAKE: Keithley / Metrabyte
MODEL NO: PIO-12
SERIAL NO: 068938
DESCRIPTION: 24 bit parallel digital I/O Interface

MAKE: Keithley / Metrabyte
MODEL NO: DAS-08
SERIAL NO: 006619
DESCRIPTION: 8 Channel High Speed A/D Converter and Timer Interface

MAKE: UNK
MODEL NO: ST-225
SERIAL NO: 64122544
DESCRIPTION: 21 Mb hard disc drive; average 72.21 ms seek time; self parking head

MAKE: Chinon Industries, Inc.
MODEL NO: FZ-506
SERIAL NO: 10627294
DESCRIPTION: 5-1/4" HD/DD floppy drive

MAKE: TEAC
MODEL NO: FD235HF 217-U
SERIAL NO: 2461004
DESCRIPTION: 3-1/2" HD/DD floppy drive

MAKE: Mitsuba
MODEL NO: Recortec 710E
SERIAL NO: 7D 002645
DESCRIPTION: Monitor for Operations Computer; Rack mounted; EGA-color

MAKE: UNK
MODEL NO: 1KB101
SERIAL NO: F01-022138
DESCRIPTION: 101 Keyboard for Operations Computer

MAKE: Teel Water Systems
MODEL NO: 1P760A
SERIAL NO: 809-064-11
DESCRIPTION: Coolant pump; 1/100 HP; 1300 RPM

MAKE: Hoffman Engineering Company (customized)
MODEL NO: A-DB275
SERIAL NO: 783510-22270
DESCRIPTION: Heat exchanger/ fan assembly; rack mounted

MAKE: Extrol, Inc.
MODEL NO: 15
SERIAL NO: 11103188
DESCRIPTION: Pressurized expansion tank with a diaphragm

MAKE: Pneumadyne, Inc.
MODEL NO: M20-125-10
SERIAL NO: 204607
DESCRIPTION: Manifold - coolant inlet

MAKE: Pneumadyne, Inc.
MODEL NO: M20-125-10
SERIAL NO: 204608
DESCRIPTION: Manifold - coolant return

MAKE: ASCO
MODEL NO: Red Hat Series 39806RS
SERIAL NO: U8225-6
DESCRIPTION: QTY: 5; 24 VDC solenoid actuated valves

MAKE: Paragon Electric Company, Inc.
MODEL NO: 303 DOA-58
SERIAL NO: 204609
DESCRIPTION: 120VAC master relay - top

MAKE: Paragon Electric Company, Inc.
MODEL NO: 303 DOA-58
SERIAL NO: 204610
DESCRIPTION: 120VAC master relay - bottom

MAKE: Berg, Inc.
MODEL NO: JJ-14
SERIAL NO: 108 R 0232
DESCRIPTION: Slip Coupling; Stainless Steel; 88+/-9 Oz-in

MAKE: Tripp Lite, Inc.
MODEL NO: LCR-2400
SERIAL NO: 204601
DESCRIPTION: Electrical power line conditioner and spike protection unit