

**NASA  
Technical  
Paper  
3245**

October 1992

Tests of an Alternate  
Mobile Transporter and  
Extravehicular Activity  
Assembly Procedure  
for the Space Station  
*Freedom* Truss

Walter L. Heard, Jr.,  
Judith J. Watson,  
Mark S. Lake,  
Harold G. Bush,  
J. Kermit Jensen,  
Richard E. Wallsom,  
and James E. Phelps

(NASA-TP-3245) TESTS OF AN  
ALTERNATE MOBILE TRANSPORTER AND  
EXTRAVEHICULAR ACTIVITY ASSEMBLY  
PROCEDURE FOR THE SPACE STATION  
FREEDOM TRUSS (NASA) 34 p

N93-10970

Unclas

H1/18 0123614

**NASA**

480588

M 2  
10/14  
P34

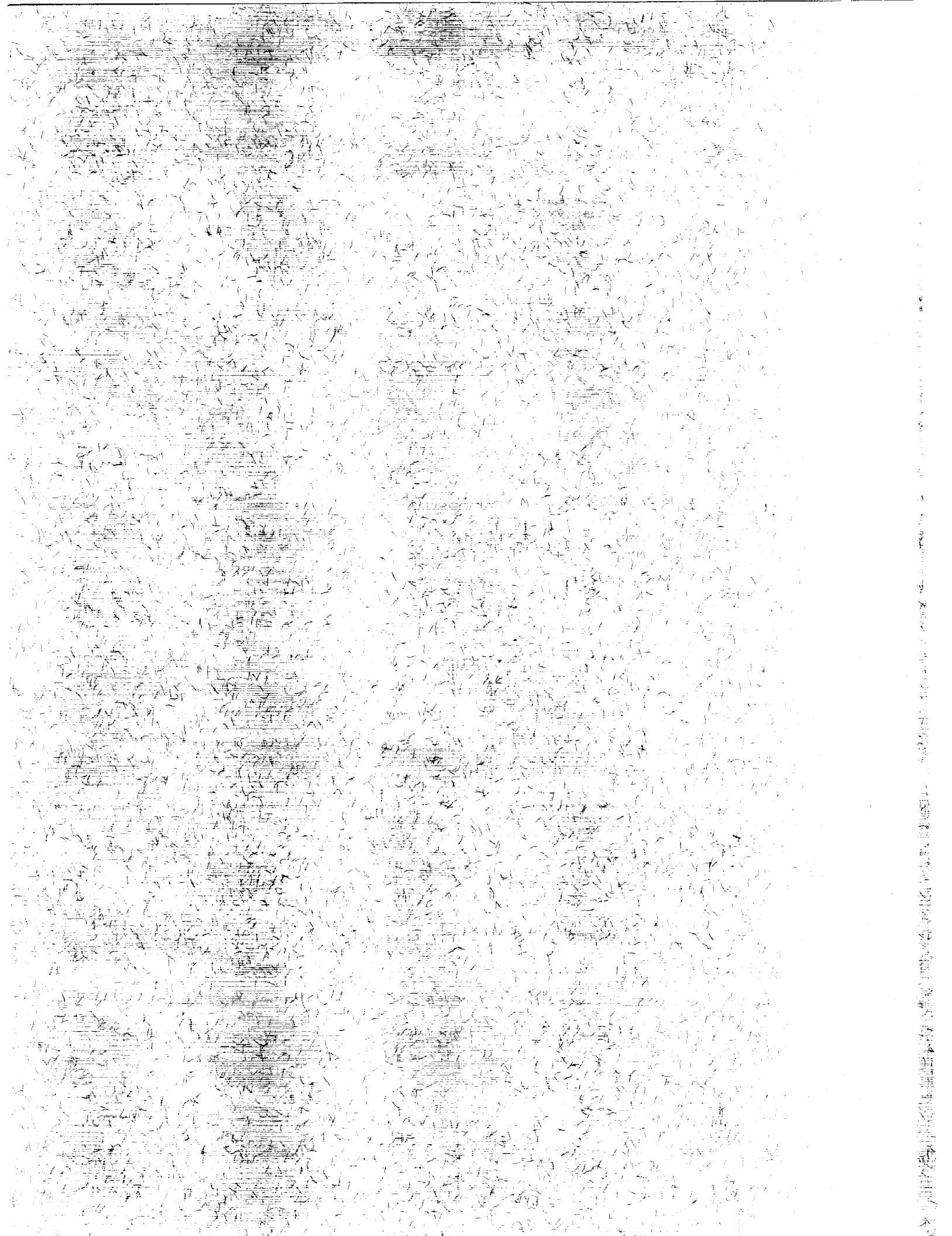

**NASA  
Technical  
Paper  
3245**

1992

Tests of an Alternate  
Mobile Transporter and  
Extravehicular Activity  
Assembly Procedure  
for the Space Station  
*Freedom Truss*

Walter L. Heard, Jr.,  
Judith J. Watson,  
Mark S. Lake,  
and Harold G. Bush  
*Langley Research Center  
Hampton, Virginia*

J. Kermit Jensen,  
Richard E. Wallsom,  
and James E. Phelps  
*Lockheed Engineering & Sciences Company  
Hampton, Virginia*



National Aeronautics and  
Space Administration  
Office of Management  
Scientific and Technical  
Information Program



## Abstract

Results are presented from a ground test program of an alternate mobile transporter (MT) concept and extravehicular activity (EVA) assembly procedure for the Space Station *Freedom* (SSF) truss keel. A three-bay orthogonal tetrahedral truss beam consisting of 44 2-in-diameter struts and 16 nodes was assembled repeatedly in neutral buoyancy by pairs of pressure-suited test subjects working from astronaut positioning devices (APD's) on the MT. The truss bays were cubic with edges 15 ft long. All the truss joint hardware was found to be EVA compatible. The average unit assembly time for a single pair of experienced test subjects was 27.6 sec/strut, which is about half the time derived from other SSF truss assembly tests. A concept for integration of utility trays during truss assembly is introduced and demonstrated in the assembly tests. The concept, which requires minimal EVA handling of the trays, is shown to have little impact on overall assembly time. The results of these tests indicate that by using an MT equipped with APD's, rapid EVA assembly of space station-size truss structure can be expected.

## Introduction

The Space Station *Freedom* (SSF) baseline configuration as proposed in 1987 is shown in figure 1. The primary keel structure is an erectable truss beam, 110 m long, with a 5-m-square cross section. The 1987 baseline proposal for on-orbit construction made use of a mobile transporter (MT) attached to the top of an assembly work platform (AWP) and two astronauts in extravehicular activity (EVA) as discussed in reference 1. The EVA astronauts were to assemble the Station from astronaut positioning devices (APD's) on the AWP. The AWP, which is a partially deployable, partially erectable truss structure nearly 10 m in length, would remain attached directly to the Space Shuttle orbiter sills for all construction activities associated with the first two proposed SSF buildup flights. The proposed construction tasks would include integrated installation of SSF system components as well as assembly of the keel. Half of the keel with associated essential subsystems would be completed during flight 1 and the other half during flight 2.

As the SSF design evolved, considerations for stowage of Station hardware in the Shuttle cargo bay made it increasingly difficult to launch and assemble SSF with a limited number of Shuttle flights (ref. 2). In addition, there was a growing concern regarding the number of EVA hours estimated for SSF assembly and maintenance. Thus, the erectable truss concept was put aside and the SSF was redesigned to

include preintegrated frame-structure sections compatible with the size of the Shuttle cargo bay. These sections would be joined end-to-end by astronauts in EVA to form the final Station configuration. The preintegrated keel would have the same length as in the original concept but have a smaller cross section. A further reduction in cross section at the center of the keel was planned to accommodate habitation and laboratory modules.

Although EVA hours required for maintenance would probably be about the same for both space station concepts, the present paper indicates that assembly of an erectable truss similar to the original SSF proposal can be accomplished rapidly by a pair of astronauts in EVA. The Langley Research Center (LaRC) has conducted an in-house research program to study an alternative to the MT concept and assembly procedure reported in reference 1. The alternate MT concept (ref. 3) would be used for maintenance, repair, and growth activities after SSF is operational, as proposed in reference 1, and also for construction during the first two SSF buildup flights. This concept eliminates the AWP and the structural complexity and risk of moving the SSF truss system after each bay is completed. The alternate EVA assembly procedure developed for the alternate MT requires that the SSF truss be attached to the Shuttle sills through a transition truss while the MT, equipped with APD's (as originally conceived in refs. 4 and 5), "walks" along the completed truss segment carrying the building material and astronauts as they assemble additional sections of the keel structure.

This paper presents the results of a ground test program designed to study EVA assembly, using the LaRC alternate MT and assembly procedure, of a nearly full-scale erectable truss structure proposed for SSF. A method for integrating utility tray installation with truss assembly is also addressed. The test hardware is described, and assembly procedures and assembly times are presented for 1g and neutral buoyancy tests. Whereas preliminary results from this test program were presented in reference 6, the present paper presents the final results. (All references to SSF and the MT in the remainder of this paper apply to the LaRC orthogonal tetrahedral truss configuration and the MT as described in refs. 3, 4, and 5.)

## Abbreviations

APD	astronaut positioning device
AWP	assembly work platform
EMU	extravehicular mobility unit
EVA	extravehicular activity

LaRC	Langley Research Center
MT	mobile transporter
NBS	neutral buoyancy simulator
OTT	orthogonal tetrahedral truss
SSF	Space Station <i>Freedom</i>

### Alternate MT Assembly Procedure for SSF Truss

A schematic of the MT as originally proposed by LaRC is shown in figure 2. The MT would be folded in the Shuttle cargo bay for launch and remotely deployed to an upright position as described in reference 3. The SSF truss consists of a series of 5-m cubic segments called *bays*. The initial bay of the SSF truss would be assembled on a short transition truss manually assembled by the EVA crew and attached to the sills of the Shuttle cargo bay. Guide pins, attached to the truss nodes, form the interface between the MT guide rails and the truss structure. The SSF truss is assembled one bay at a time by two EVA astronauts. The astronauts are secured in foot restraints attached to APD's. The APD's are not complex robotic arms, but relatively simple devices used to move the astronauts to various positions on their respective sides of the MT so that the required truss assembly tasks can be accomplished.

After the crew has assembled the first bay of the truss, the MT is released from its attachments to the Shuttle. The drawbar is then extended (as shown in fig. 2), pushing the MT 1 baylength along the longitudinal axis of the truss and away from the completed bay. The next contiguous bay is then assembled, after which the drawbar is retracted to grasp new guide pins, and extended to move the MT into position for assembly of the next bay. In this manner the MT steps along the truss as the truss is being assembled. When a predetermined number of bays have been assembled and a reaction control system installed, the SSF truss and attached MT are separated from the transition truss (and Space Shuttle) and assembly is continued. The platform of the MT is used to transport SSF operational equipment which requires integrated installation during the primary truss assembly. A remote manipulator arm, shown attached to the MT in figure 2, is envisioned to support these tasks.

### Method for Integrated Installation of Utility Trays

A major concern associated with SSF construction is installation of the utility system that is vital to SSF operation. It is generally accepted that

electrical and fluid utility lines will be housed in protective trays that will be attached to the inside of the primary truss structure. Although electrical and fluid line connections were beyond the scope of this investigation, a method for integrated installation of the utility trays during truss assembly was addressed. This method incorporates folded baylength packages of tray segments that automatically deploy to their proper positions prior to assembly of the supporting bay of the truss. The deployed tray segments can then be attached directly to the truss nodes during truss assembly. Nodes are available for tray attachment because of the use of an orthogonal tetrahedral truss configuration in which all batten-plane diagonal struts are parallel (ref. 7). This procedure, by minimizing handling of the utility trays by the astronauts, is designed to have a minimal impact on truss assembly.

A series of sketches depicting the general procedure for utility tray deployment is shown in figure 3. Sketch 1 represents a cross section of the Shuttle cargo bay with the MT deployed and ready for assembly to begin. Temporary utility tray supports are shown deployed on either side of the cargo bay. The utility trays are fanfolded into 5-m-long packages. Critically damped springs are used at the hinge lines. The Shuttle remote manipulator system is used to remove the packages from stowage and attach them to the supports before truss assembly is begun (sketch 2). The EVA astronauts release latches that allow the packages to unfold 2 baylengths (sketches 3 and 4). The EVA crew then assembles the first bay of truss and attaches the utility trays (sketch 5). The MT then translates 1 baylength, after which the EVA crew unlatches the utility tray package (allowing it to unfold another baylength) and assembles the next truss bay. The procedure is repeated until the desired truss configuration is achieved.

### Test Hardware

#### Mock-Up and Operation of MT

Figure 4(a) is a schematic of the MT which shows how it would be used to assemble the SSF truss on orbit. The preferred orientation for the EVA astronauts is with their heads pointing, generally, in the direction shown (downward in fig. 4(a)). This orientation provides the best visibility and least obstructed work area when the astronauts are working at the nodes in the vicinity of the MT guide rails. (See fig. 2.) With this orientation, the lower arms of the APD's are not directly behind the astronauts and, thus, cannot interfere with the astronauts' back packs and restrict their movements.

Figure 4(b) is a schematic of the MT mock-up used for the 1g, shirtsleeve assemblies, and for the EVA assemblies simulated in neutral buoyancy. The MT mock-up was supported on a tower and remained stationary during the tests. The truss structure was assembled one bay at a time under the MT. When a bay was completed, it was moved out of the work area by the drawbar; thus relative motion was produced between the truss and MT to simulate the MT stepping along the completed portion of the truss structure. For comfort and safety reasons, the test subjects remained upright during the 1g and neutral buoyancy tests. To maintain this orientation the lower arm of each APD was slaved to the motion of the rotating upper arm such that the lower arm remained vertical at all times. For a flight article the lower arm of the APD is envisioned to be independently rotated about the elbow joint. The APD's could also be moved 1 baylength forward or aft as indicated by the arrows in figure 4(b).

### Strut and Node Stowage

All struts and nodes were stowed in two canisters located on the MT as shown in figure 4(b). The canisters were sized to hold enough struts and nodes for assembly of 10 bays of truss. Photographs of the stowage arrangement are shown in figure 5. The longer (diagonal) struts were located in the top of the canister above the node stowage compartments and the shorter (longeron and batten) struts were located below the diagonals and adjacent to the node stowage compartments. Each end of a strut was supported and retained in the canister by a cup with an internal spring-loaded piston. A strut could be removed by a test subject located at any point along its length by pushing or pulling the strut axially to depress the piston in one of the retainer cups; thereby the opposite end of the strut was freed (fig. 5(a)).

The nodes were stowed in compartments. Each compartment was sized to hold two nodes, although only one node was stowed in each compartment for the present tests. Twelve node compartments, for a total 24-node capacity, were located at one end of each canister. Each node was held in the compartment by two flanged guide rails that fit over the flange on the node guide pin (fig. 5(b)).

### Strut and Node Carriers

To minimize the number of trips to the stowage canisters for resupply of truss components during truss assembly, provisions were made for temporary stowage of two struts and two nodes at each of the APD foot restraints. Figure 6(a) is a photograph of the foot restraint and truss component carriers. The

handrails, used by the test subjects to get in and out of the foot restraints (normally only at the beginning and end of each test), provided the structural support for the strut and node temporary stowage carriers. The test subjects manually locked the struts in the carrier brackets by 90° rotations of two latch handles (fig. 6(b)). The nodes were stowed, one each, on either side of the foot restraints on tapered rods with spring retainer clips (fig. 6(c)).

### Control of MT Operations

The APD's, drawbar, and node latches on the drawbar (fig. 7) were hydraulically operated. The controls were located at two remote consoles positioned on either side of the MT (at portholes outside the water tank for the neutral buoyancy tests). Each console was operated by a test engineer who could view the activity as shown in figure 7 for the 1g tests or through a porthole for the neutral buoyancy tests. The inset in figure 7 is an enlarged photograph of the console and console operator on the far side of the MT. Two control consoles were used, one for each APD, because the test subjects worked independently most of the time. Thus, two control stations simplified the responsibility of each console operator. Controls for the drawbar and its node latches were located at only one of the consoles.

Photographs of one of the node latches on the drawbar are shown in figure 8. The latch is shown in the open position in figure 8(a) and in the engaged and locked position in figure 8(b). The proper limits of motion for the drawbar and node latches were set prior to testing and required no vernier adjustments. The coarse movements of the test subjects to the strut and node stowage canisters and then to the vicinity of work sites were controlled by the console operators who followed voice commands from the test subjects. The maximum rate of motion for the test subjects and drawbar was approximately 1 ft/sec. If desired, vernier adjustments could be requested by a test subject through additional voice commands until the test subject was satisfied with the working position. For the flight version of the MT, the APD's would probably be preprogrammed to move to the appropriate work sites. Vernier adjustments, if required, could be controlled by the EVA astronauts

### Truss Configuration and Hardware

Underwater tests upon truss configuration and hardware were performed in the Marshall Neutral Buoyancy Simulator (NBS). The size of the NBS (75 ft in diameter and 40 ft deep) limited to 3 bays the size of truss that could be continuously assembled. An orthogonal tetrahedral truss (OTT)

configuration (fig. 9) was used for the test article because of its operational advantages over the SSF baseline Warren-type truss. Although these advantages are discussed in detail in reference 7, some of the more pertinent ones are summarized herein. All bays of the OTT configuration are identical, whereas the Warren-type truss has two different bay configurations which alternate. Thus, the logistics of component stowage and the assembly procedures are simpler for the OTT configuration because the same routine is used for every bay. Also, the OTT configuration, with all interior diagonal struts aligned in the same direction, has two clear passageways inside the truss with nodal attachment locations available in every bay to accommodate utility trays. (See fig. 9(b).) In the Warren-type truss the interior diagonals alternate in direction, thus interrupting the passageway for utility trays.

The OTT truss assembled in the present study had a 15-ft-square cross section. In order to meet MT design and fabrication scheduling requirements, the cross-sectional dimensions had been selected early, before NASA selected the 5-m (16.4 ft) truss for the SSF configuration. The truss hardware was composed of struts (termed *longerons*, *battens*, and *diagonals* as indicated in fig. 9) and nodes. The struts were aluminum tubes 2 in. in diameter with a fitting at each end to permit side insertion into the mating node fitting during truss assembly. These fittings also were used to set all the strut lengths to within tolerance values prior to the tests. Struts for the 1g tests were fabricated from thin-wall 7075 aluminum tubing to minimize their weight (approximately 8.8 lb for each longeron and batten strut and 11.9 lb for each diagonal strut). The struts for the neutral buoyancy tests consisted of welded sections of 6061 aluminum tubing with a wall thickness of  $\frac{1}{8}$  in. Each neutral buoyancy strut consisted of a center airtight chamber that provided positive buoyancy and two flooded chambers at the ends to which lead shot ballast could be added or removed until neutral buoyancy was achieved. The ballast was adjusted so that the strut was also trimmed (remained in any given orientation in the water tank). Care was taken to set all strut lengths accurately. During the length-setting activities it was noticed that a few of the struts were excessively crooked; thus, the joint end fittings were misaligned. To meet NBS scheduling, the crooked struts, although more difficult to install, were used until replacement struts could be fabricated and delivered to the test site.

A typical truss node with attached struts is shown in the top photograph in figure 10. The nodes were modified spheres to which up to 26 fittings could be

attached for accommodating strut and utility tray (or other equipment) connections. (With this arrangement various truss configurations are possible and potential for truss growth is provided.) On the node shown in the figure, only seven attachment ports are used. The erectable strut-to-node joint was designed at LaRC to facilitate EVA assembly while retaining structural efficiency. An early version of the joint is presented in reference 8. A pattern was painted on the strut end fitting and on the node port fitting to provide a highly visible lock position indicator. The photograph labeled "strut being inserted" in figure 10 shows the pattern when the locking collar is positioned for insertion of the strut end fitting into the mating node fitting. The photograph labeled "strut captured" shows the pattern when the strut is captured in the node fitting. With the locking collar in this position the strut-to-node joint is secure but does not provide the design structural stiffness. With a 45° manual rotation of the locking collar, the locking pattern becomes a wide bar (photograph labeled "joint locked"), and the joint is locked into its design preloaded condition. Making the nodes neutrally buoyant required the use of external flotation devices. Thus, following assembly of a given bay and before the truss was moved by the drawbar, scuba divers attached a device to each of the lower nodes to neutrally buoy it and the node directly above it. In this way the neutral buoyancy of the entire test article was maintained.

### Utility Trays

The integrated utility tray installations were done only in the neutral buoyancy tests. As shown in figure 11, two neutrally buoyed tray systems were provided, one for each side of the three-bay truss. In these tests, each tray was nominally a 3- by 15- by 0.5-ft aluminum box with a dry weight of approximately 150 lb, but the trays could be made larger for flight, if required. Three trays were linked together with simple hinges to form the utility tray system for one side of the truss. Four tubular members were attached to an edge of the unfolded tray system at intervals corresponding to truss node locations. These tubular members had end fittings identical to the strut end fittings and were used to attach the trays to the truss nodes during assembly.

Figure 12 is a schematic showing how the attachment of utility trays was integrated with the assembly of the truss. The view is looking downward on the MT (represented by the dashed lines). Because the MT support tower (also represented by dashed lines) would interfere with the initial, inward unfolding of the utility tray packages, the packages were



predeployed 1 baylength. The two partially unfolded tray packages were then supported on the support tower. (This method simulates the temporary support system that is envisioned for on-orbit operations and is depicted in the computer drawing in figure 13. The temporary support system envisioned for the Shuttle cargo bay holds the packages in place during assembly of the transition truss and first bay of the SSF truss.) The neutral buoyancy tests began at step 2 in figure 12 with assembly of the initial truss bay and attachment of the first tray to a node (both sides of truss). The pins used to secure the second and third trays in the folded configuration were then pulled and the trays unfolded with the aid of water pressure and scuba divers (simulating deployment by damped springs) as the drawbar was extended to move the completed bay out of the work area (steps 3 and 4). The second tray was attached to the second bay of truss as it was assembled (step 5). The drawbar retracted to grasp the nodes of the second bay (step 6) and then extended to move the completed bay out of the work area. The third truss bay was then assembled and the final tray attachments were made.

## Assembly Test Program

Assembly tests were conducted both in  $1g$  and in neutral buoyancy. The  $1g$  tests were performed with the test subjects in street clothes. The neutral buoyancy tests were performed with the test subjects in scuba and also with the test subjects in extravehicular mobility unit (EMU) pressure suits. The  $1g$ , scuba, and pressure-suit assembly tests were conducted in an attempt to isolate the effects of water drag and pressure-suit encumbrance so that EVA assembly times might be more accurately predicted. The difference between pressure-suit assembly times and scuba assembly times is attributed to pressure-suit encumbrance. The difference between  $1g$  assembly times and scuba assembly times is attributed to water drag, provided gravity does not have a significant effect on the  $1g$  assembly times. Although it is intuitive that assembly in  $1g$  would be slower than in  $0g$  (all other factors being equal), the procedures used in the  $1g$  assembly tests were designed to minimize the impediment of gravity. Thus gravity effects, although unknown, are assumed to be negligible. Tethering of the hardware was not addressed in these tests.

### $1g$ Tests

Figure 14 shows a  $1g$  test in progress. In figure 14(a), the first truss bay is being assembled. Figure 14(b) shows the completed three-bay truss

test article. The structural frame shown in the photographs was used to support the weight of the truss. Utility tray installation was not addressed in the  $1g$  tests. The truss assembly procedures varied slightly from the more efficient procedures devised for the neutral buoyancy tests. In neutral buoyancy, struts can be attached to a node at only one end; thus, all struts that need to be attached to a given node can be attached during one visit to that node. However, in  $1g$ , horizontal struts had to be supported at both ends. Thus, the  $1g$  procedures incorporated extra translations of the APD's to allow the test subjects to install some nodes and struts out of sequence with the neutral buoyancy procedure. A short bracket was attached to the MT support tower and used as a prop to help support the upper truss struts as they were being passed across the truss from one test subject to the other. When a lower truss member was being passed across the truss, an engineer on the floor assisted by manually supporting the free end of the strut.

Numerous truss assemblies were performed in  $1g$  by a number of different test subjects (including two NASA astronauts) in order to check out the hardware, develop assembly procedures, and train test subjects and console operators. These activities were followed by four timed tests in which only well-trained test subjects and expert console operators were used. A three-bay truss was assembled in each of these tests.

### Neutral Buoyancy Tests

Figure 15 is a schematic showing the truss assembly sequence used in the neutral buoyancy tests. Test subject 1, stationed on the far side of the truss in figure 15, always moved in a clockwise direction (facing his side of the truss). Test subject 2, stationed on the near side of the truss, always moved in a counterclockwise direction (facing his side of the truss). The batten frame consisting of five struts (step 1) was assembled first, then typical bays, consisting of 13 struts each, were assembled by using the same routine for each bay. In general, two struts and two nodes were removed from their stowage canisters and temporarily stowed on the APD strut and node carriers when the test subjects were in the vicinity of the canisters; thus, no long-distance translations were required for material resupply. During assembly of the first batten frame (step 1), three struts must be attached by test subject 1 at workstation 1; thus, two struts would be stowed in the temporary strut carriers and one would be carried in the test subject's hands. Struts were handled similarly by test subject 2 when he had to install three struts at

workstation 1 during the assembly of each general bay.

The following three types of assembly tests were performed in neutral buoyancy: (1) *without utility trays*—consecutive three-bay truss assemblies (with associated complete disassemblies by utility divers), (2) *with utility trays*—consecutive three-bay truss assemblies (with associated complete disassemblies by utility divers), and (3) *with utility trays*—an initial three-bay truss assembly followed by a two-bay disassembly by utility divers and thereafter consecutive two-bay assemblies (with associated two-bay disassemblies by utility divers). The type (3) tests are representative of assembly of a truss consisting of more than three bays by eliminating multiple assemblies of the first batten frame. The test subjects were idle during the disassemblies by utility divers. The working depth of 40 ft along with allowance of a single decompression stop limited the duration of a test to approximately 2 hr.

Figures 16, 17, and 18 show neutral buoyancy tests in progress. Figure 16 shows a scuba assembly. The assembly procedures used in the pressure-suited neutral buoyancy tests were duplicated in three of the scuba assembly tests. The 1g assembly procedure was duplicated in one of the scuba tests for comparison with the 1g assembly times. Figures 17 and 18 show pressure-suit assemblies both with and without integrated installation of utility trays. As with the 1g tests, numerous assemblies for hardware checkout, procedural development, and personnel training were performed in scuba. Several additional pressure-suit tests were also performed to verify the test setup. Two pairs of test subjects took part in these tests as well as two pairs of console operators. Eight timed assembly tests were performed during which 48 bays of truss were assembled by a single pair of well-trained test subjects and expert console operators. In the last five tests, 34 bays of truss were assembled with integrated installation of utility trays. Two additional tests were performed by a pair of NASA astronauts to provide them with some hands-on experience with the assembly procedures and hardware and to obtain their comments for consideration.

## Test Results

### Qualitative Evaluation of Hardware and Procedures

Most of the present tests were performed by two well-trained test subjects and two well-trained console operators. It is firmly believed that accurate qualitative evaluations and assembly time data are achievable only through the use of well-trained test

personnel. Two astronauts also performed as test subjects in a few tests to gain experience with the MT hardware and procedures and to lend their previous experiences to the qualitative evaluation. One astronaut encountered some difficulties in operating the hardware and executing the assembly procedures, but most of these problems can be attributed to lack of familiarity with the present hardware and little neutral buoyancy pressure-suit experience. The other astronaut had previous experience with the truss joint hardware and had performed as a test subject in some of the 1g assembly tests. This astronaut also had many hours of neutral buoyancy pressure-suit experience plus approximately 12 hr of on-orbit EVA structural assembly experience with the ACCESS (Assembly Concept for Construction of Erectable Space Structure) Shuttle flight experiment (ref. 5).

The MT mock-up closely simulated the external appearance and featured the major operational capabilities required of an on-orbit version. However, due to cost and safety considerations, some envisioned on-orbit capabilities were compromised. The effects of these compromises were evaluated during pressure-suited tests. The most significant compromise in the MT mock-up was that the test subjects were oriented with their heads up because of previously described safety and comfort considerations. This orientation placed the MT guide rails in the test subjects' lines of sight when working at upper nodes (see figs. 17(b) and 18(b)), with interference to both visibility of and reach to these work sites. To reduce the effects of this interference, it was necessary to position the test subjects more precisely at the upper nodes than at the lower nodes; thus, additional vernier motions of the APD's were required. However, after several tests, the test subjects and console operators learned optimum assembly techniques and positions for upper node tasks, and fast assembly times were realized. Poor visibility and reach would be minimized on orbit by orienting the astronauts as shown in figures 2 and 4(a).

Because the test procedures employ a small number of work sites, it is envisioned that many of the APD coarse positioning commands might be automated on orbit. This automation could improve astronaut positioning efficiency and reduce assembly times. Furthermore, APD motion could possibly be controlled locally by the EVA crew members from their foot restraints. However, in the present tests, all APD positioning was done remotely by the console operators in response to verbal commands from the test subjects. Although positioning errors and miscommunications caused occasional delays, the dura-

tion and number of these delays were minimized by the use of console operators who were well-trained in the assembly procedures and thus effective at anticipating APD positioning commands. In general, command and control of APD positioning was efficient and had little effect on the assembly times. The astronauts involved in these tests also felt that, on orbit, the use of voice commands would probably be preferred to a manual controller operated by the EVA crew, because of the desire to minimize extraneous manual operations.

The APD's were designed for a maximum translational rate of 1 ft/sec. This rate is believed to be a reasonable upper limit for on-orbit activities. In general, all pressure-suited test subjects felt comfortable at this maximum translational rate. However, slower rates were used when test subjects occasionally experienced minor difficulties equalizing inner ear pressure during vertical translations (inner ear pressure must be adjusted as the depth changes). These rare occurrences were strictly consequences of the underwater simulation environment and present no concerns for on-orbit operations.

The use of temporary strut and node carriers on the APD foot restraint handrails significantly improved the efficiency of the assembly procedure by minimizing the number of times the test subjects had to be translated to the strut and node stowage canisters for hardware resupply. The temporary hardware carriers were located below the test subjects' waist level to avoid obstructing the work site while allowing easily accessible temporary hardware stowage. The location of the temporary hardware carriers could be adjusted, within limits, to accommodate a range of test subject reach limits. All test subjects worked effectively with these carriers and were generally pleased with their accessibility and utility.

After removal from the temporary hardware carrier, a strut was coarsely aligned by slewing it to the approximate orientation and thrusting it longitudinally into approximate position. Longitudinal thrusts of a strut induced negligible water resistance and could be easily accomplished with one hand. However, significant water drag was induced when a strut was slewed at reasonable speed; thus, two hands were nearly always used. Despite the water resistance, the test subjects could align most of the struts for installation with little difficulty and modest effort. However, considerable effort was required with a few of the struts that span the bay, that is, the batten struts that are installed at the tower end and at the top of each bay, the diagonal strut in the batten frame nearest the tower, and the diagonal strut in the top face of a bay. Alignment of these struts

required the test subjects to reach relatively far from their foot restraints and around the guide rails to perform the final alignment of the struts. Interference of the test subjects' lines of sight by the guide rails aggravated the situation. These awkward positions forced the test subjects to rely on forearm strength rather than upper arm or torso strength. Although the joint capture mechanism was designed to permit one-handed attachment, in most cases the test subjects used both hands to effect final alignment and capture; thus, forearm fatigue was minimized and assembly times were improved. In addition, the test subjects learned from the early tests to perform two-handed, preliminary alignment of the strut as accurately as possible and then work together to align the struts spanning the bay. Manipulating and positioning the struts on orbit should be significantly easier in the absence of water drag. However inertial forces required to start and stop strut motion would still have to be dealt with, and two-handed manipulation of large struts would probably be preferred.

As mentioned previously, the erectable truss structure assembled during these tests incorporated an advanced prototype joint under development at LaRC for several years. Although different versions of this erectable truss joint had been tested in previous neutral buoyancy simulations, the present tests were the first to evaluate the operation and EVA compatibility of this advanced version in a full-scale structural assembly. After effecting final alignment of a strut, the test subjects determined that capturing and locking the strut end joint to its mating node were easy when done within the subjects' optimum reach and visibility envelopes. With one end of the strut locked in place, the free end was essentially aligned for capture. For all but the most excessively crooked struts, this free end was easily captured and locked in a matter of seconds. Thus, the erectable truss joint, as tested, was judged to be EVA compatible, although refinements such as a better grip on the locking collar have already been incorporated in revised designs. Finally, the lock-up indicator painted on each joint was highly visible from long distances and easily interpreted by the test subjects and console operators. This indicator is important for verifying the integrity of the completed structure, and its visibility from long distances simplifies the verification operation.

The concept demonstrated in these tests for integrated installation of utility trays incorporates two important features: (1) the attempt to minimize EVA handling of the trays and (2) the use of the erectable truss joint hardware for connecting the trays directly to truss nodes. EVA handling was min-

imized by stepwise predeployment of the trays (a bay at a time) and assembling the truss bay around the trays. A tray was deployed to its proper position with the nodal attachment fittings on the tray in the vicinity of the truss nodes. Thus, the test subjects could make the tray-to-node connections while they were at that workstation to attach struts to the same node. The only negative aspect of this tray integration process was the obstruction of vision. The test subject's view of the opposite side of the truss was significantly reduced when the trays were present; thus, spanwise struts were more difficult to align. This problem was more significant for the test subject on the left in figures 18(a) and (b) because the utility tray on this side was attached to the upper truss nodes where vision was already compromised by the MT guide rails, as discussed previously. Overall, this tray integration concept was judged to be EVA compatible and, as the assembly times presented in the next section indicate, could be very efficient.

### Assembly Times

**Pressure-suited neutral buoyancy tests.** The assembly times for engineers who served as pressure-suited test subjects and who were experienced in the operation of the hardware and test procedures are presented in figure 19 as a function of build number. The build number applies to a three-bay assembly, with the exception of builds 3, 16, and 17, which were two-bay assemblies. In addition to the total time for the three-bay assembly, times are presented for completion of the first batten frame and each succeeding bay of the truss. The total assembly times generally decreased as the test subjects and the console operators gained experience. However, this trend was reversed during build 6 because of the introduction of utility tray integration into the assembly procedure (note that the time for completion of bay 2 is significantly longer during this test because the procedure for utility tray deployment was not yet refined). Also, minor changes in both the MT and truss hardware as well as the assembly procedure were introduced in build 12 to correct problems that had occurred in previous tests. These improvements caused a 4- to 5-min reduction in the total three-bay assembly time; subsequent tests showed no further gains. The total assembly times for these last four complete builds (builds 12-15), which included integration of utility trays, were shorter than the shortest time achieved without integration of utility trays. Although it is difficult to estimate how much the assembly times without trays could have been shortened through additional training, it is doubtful that these times would be much better than the best times with utility trays.

The time to assemble the first batten frame decreased from about 4 min in the first few builds to approximately 2½ min during builds 12-15. Despite some scatter in the data, the times for completion of each bay also decreased with build number, and these times are generally very close to one another within a given build. The average time for completion of one bay appears to stabilize to about 6 min during the last six builds. This assembly time for each bay is considerably shorter than the 9-13 min per bay reported in references 9-11 for neutral buoyancy assembly tests of competing SSF truss concepts (with no utility trays). However, the tests reported in references 9-11 were intended to compare several different AWP hardware configurations, as well as different assembly procedures, by using many different pairs of astronaut test subjects. No attempt to refine any single assembly concept was made. Consequently, the fidelity of the test fixtures was limited and the astronaut test subjects did not become thoroughly trained in any of the various assembly procedures. The resulting long assembly times demonstrate that such *quick-look tests should not be considered verifications of a concept.*

Assembly times from the present tests with two astronauts as test subjects are presented in figure 20 as a function of build number. A comparison of figures 19 and 20 shows that the astronaut assembly times were slightly greater than those from the first few tests by the engineer test subjects and significantly greater than the final few tests by the engineer test subjects. Because expert console operators were used in the astronaut assembly tests, the difference in assembly times is attributed to the fact that the engineer test subjects had significantly more training in the operation of the hardware and execution of the assembly procedures. Except for the two spikes (bay 1 of build 2 and bay 2 of build 6) that are indicative of additional time taken to install crooked struts, the astronaut assembly times also show a generally downward trend as experience is gained.

**Rationale for scuba and 1g tests.** In order to isolate the effects of pressure-suit encumbrance and water drag on the assembly times, data from 1g, scuba, and pressure-suited assemblies are compared. Comparison of 1g and scuba assembly times gives a good indication of the time penalty associated with water drag (provided gravity does not have a significant effect on the handling of hardware in 1g). Similarly, comparison of scuba and pressure-suited assembly times gives a good indication of the time penalty associated with pressure-suit encumbrance. From this information, it is possible to make better predictions of on-orbit assembly times by subtract-

ing time penalties resulting from water drag (if significant) from neutral buoyancy times. As explained previously, it was necessary to employ a different procedure for 1g testing to minimize hardware handling problems. Consequently, scuba tests were performed with both the 1g procedure and the on-orbit (neutral buoyancy) procedure.

**Comparison of 1g, scuba, and pressure-suited three-bay assembly times.** Figure 21 shows three-bay assembly times performed in 1g with the test subjects in street clothes, in neutral buoyancy with the test subjects in scuba, and in neutral buoyancy with the test subjects in pressure suits. All these results were obtained with the same pair of test subjects and the same pair of console operators. Figure 21(a) presents four 1g assemblies and a single scuba assembly using the same procedure. The times for completion of the three-bay builds in 1g are very consistent because these builds were performed after test subjects and console operators were well-trained in the 1g procedures. Similarly, the scuba test was performed with well-trained personnel. Time was not available for additional scuba assemblies using the 1g assembly procedure; however, additional assemblies should be of similar duration. The average unit assembly time for 1g, three-bay (44 struts) assemblies is about 11 percent (2.5 sec/strut) shorter than that for the single neutral buoyancy assembly performed in scuba using the same procedure. As stated previously, assembly in 1g should be slower than in 0g (all other factors being equal). Neutral buoyancy assembly should also be slower than 0g assembly because of water drag. However, because the scuba assembly (with gravity neutralized) was slower than the 1g assemblies, water drag must have been more significant than gravity. The separate effects of gravity and water drag could not be quantified by comparing the 1g and scuba assembly times. However, the time penalty for gravity effects is believed to be small. Thus, it is assumed that 2.5 sec/strut is the time penalty for water drag. Using this time penalty to adjust neutral buoyancy assembly time for prediction of on-orbit assembly time should result in a conservative prediction.

Figure 21(b) presents four of the last pressure-suited assemblies (builds 12–15 in fig. 19) and a single scuba assembly using the same procedure (again, time was not available for additional scuba assemblies). The average assembly time for a three-bay build was nearly 5 min (6 sec/strut) longer in pressure suits than in scuba. This result suggests that in the simulated EVA assembly procedure, a penalty of approximately 6 sec/strut is directly attributable to the physical encumbrance of the pressure suit. All

test subjects agreed that the most critical aspect of this encumbrance (i.e., loss of dexterity and strength in the hands and forearms) was due to the glove design. In these tests, EMU series 1000 gloves were used. The astronauts commented that the use of EMU series 3000 gloves with low-torque wrist bearings and rubberized palm grips might reduce lower arm fatigue and improve performance.

## Predicted Assembly Time for SSF Truss

The average unit assembly time for a three-bay, 44-strut OTT truss including utility tray installation by pressure-suited test subjects in neutral buoyancy was found to be 27.6 sec/strut, as shown in figure 21(b). The time penalty for water drag was taken to be 2.5 sec/strut. Thus, the unit assembly time on orbit should be about 25 sec/strut if similar hardware and assembly procedures are used. This unit assembly time can be used to estimate the EVA time required to build the SSF truss structure, including attachment of utility trays as proposed herein. The 1987 SSF truss consists of 22 bays. The two end bays contain the rotary joints and would have special geometry. If an OTT truss configuration were used for the other 20 bays (265 struts), they could be assembled in approximately 1.85 hr less than one third the time allowed for a standard EVA (6 hr). Although it may be argued that astronaut fatigue would increase the assembly time, the pressure-suited test subjects were able to assemble nine bays of truss during one neutral buoyancy test (see fig. 19, builds 12, 13, and 14) in 1.6 hr. The actual assembly time was about 1 hr; however, two 17-min idle periods between builds were necessary to allow utility divers time to disassemble the test article.

## Concluding Remarks

Neutral buoyancy tests were conducted to evaluate an alternate truss assembly and utility tray integration procedure for Space Station *Freedom* (SSF). This procedure uses a mobile transporter (MT) functioning as a construction base, and two extravehicular activity (EVA) astronauts performing all construction tasks. The utility tray integration procedure minimizes EVA handling of the trays by using self-deploying, fanfolded stacks of trays. These stacks are deployed, one bay at a time, and the truss bays are assembled around the deployed trays. This procedure minimizes tray integration time by allowing the astronauts to connect the trays directly to truss nodes (with the same joint hardware used for truss assembly) while they are attaching struts at the same node. A three-bay orthogonal tetrahedral truss including utility trays was repeatedly assembled by

pressure-suited engineer and astronaut test subjects on astronaut positioning devices (APD's). None of the hardware was tethered in these tests. The test subjects were translated to various work sites at a nominal rate of 1 ft/sec. Forty-eight bays of truss (34 of which included integrated installation of utility trays) were assembled by a single pair of pressure-suited test subjects. This experience provided significant training for the subjects and allowed them to identify, develop, and implement refinements in both procedures and hardware, which led to very efficient assembly times. Thus, final qualitative assessments of hardware and procedures should be valid, and assembly times are probably representative of on-orbit operations, provided the MT translation rates used are realistic.

The MT mock-up closely simulated the external appearance and featured the major operational capabilities required of an on-orbit version. However, because of cost and safety considerations, some envisioned on-orbit capabilities were compromised. For comfort and safety, the test subjects were oriented in an upright position for all tests, despite the fact that the MT guide rails interfered with the test subjects' vision and reach when working at the upper truss nodes. To circumvent this problem, additional APD vernier motions were used to position test subjects more precisely at these nodes than at the other nodes. On orbit, interference from the MT guide rails would be minimized by orienting the astronauts with their heads pointed in the opposite direction. All APD positioning was done remotely by the console operators in response to verbal commands from the test subjects. Although occasional time lags occurred on account of positioning errors and miscommunications, the duration and number of these delays were minimized by the use of console operators who were well-trained in the assembly procedures and thus effective at anticipating APD positioning commands. The astronauts commented that they would probably prefer voice commands for vernier adjustment over manual controllers operated by themselves because they may be holding struts or nodes when the adjustments need to be made.

In general, all pressure-suited test subjects felt comfortable with the nominal APD translational rate of 1 ft/sec. However, slower rates were used when test subjects occasionally experienced minor difficulties in equalizing inner ear pressure during vertical translations. These rare occurrences were consequences of the underwater simulation environment and present no concerns for on-orbit operations. The use of temporary strut and node carriers on the APD foot restraint handrails significantly improved the ef-

iciency of the assembly procedure by minimizing the number of times the test subjects had to be translated to the strut and node stowage canisters for hardware resupply.

The truss structure assembled during these tests incorporated an advanced prototype erectable truss joint under development at the Langley Research Center for several years. Although the joint capture mechanism was designed to permit one-handed attachment, in most cases the test subjects used two hands during final strut alignment to overcome the effects of water drag; thus, forearm fatigue was reduced and assembly times were improved. The test subjects determined that capturing and locking the strut end joint to its mating node was easy when done within the subjects' optimum reach and vision envelopes. With one end of the strut locked in place, the free end was essentially aligned for capture, which could usually be performed in a matter of seconds. Thus, the erectable truss joint was judged to be EVA compatible. Also, the joint lock-up indicator was determined to be highly visible from long distances and easily interpreted by the test subjects and console operators.

The assembly times generally decreased as the test subjects and console operators became more experienced and procedures were refined, and integration of utility trays added a negligible amount of time to the truss assembly procedure. During the last few builds the average time for completion of one bay with integration of utility trays was nearly constant at approximately 6 min/bay. At this assembly rate, the entire SSF (1987 baseline) truss structure could be assembled on orbit in slightly less than 2 hr. Although many additional EVA activities such as payload attachments and rotary joint and subsystem integration have been neglected, this estimate demonstrates that on-orbit truss assembly by EVA astronauts can be very efficient. The supporting equipment (i.e., the MT) must be designed to position the astronauts so that they can perform their assembly tasks within their optimum reach and vision envelopes, and the building material must be convenient to the workstations to avoid time-consuming translations for resupply. In addition, the assembly procedure should be simple and well rehearsed by the astronauts. Unfortunately, neutral buoyancy tests are both time-consuming and expensive; hence, researchers studying the assembly of large space structures have rarely had the luxury of adequate preliminary testing for proper development of hardware and procedures or the training of test subjects. The resulting scarcity of reliable data has given rise to some grossly conservative projections of

achievable EVA assembly rates which, in turn, have prompted unwarranted pessimism as to the efficiency and effectiveness of EVA operations.

NASA Langley Research Center  
Hampton, VA 23681-0001  
August 26, 1992

## References

1. Adkisson, R. W.: The Role of a Mobile Transporter in Large Space Structures Assembly and Maintenance. *Engineering, Construction, and Operations in Space—Proceedings of Space 88*, Stewart W. Johnson and John P. Wetzell, eds., American Soc. of Civil Engineers, 1988, pp. 787-796.
2. Cruz, Jonathan N.; Monell, Donald W.; Mutton, Philip; and Troutman, Patrick A.: *Pre-Integrated Structures for Space Station Freedom*. NASA TM-102780, 1991.
3. Heard, Walter L., Jr.; Watson, Judith J.; Ross, Jerry L.; Spring, Sherwood C.; and Havens, Kathryn A.: EVA Space Construction: Experience and Fundamental Issues. *Space—A New Community of Opportunity*, Volume 67 of *Advances in the Astronautical Sciences*, William G. Straight and Henry N. Bowes, eds., American Astronautical Soc., 1989, pp. 395-417. (Available as AAS 87-681 to -684.)
4. Mikulas, Martin M., Jr.; Bush, Harold G.; Wallsom, Richard E.; Dorsey, John T.; and Rhodes, Marvin D.: *A Manned-Machine Space Station Construction Concept*. NASA TM-85762, 1984.
5. Bush, Harold G.; Mikulas, Martin M., Jr.; Wallsom, Richard E.; and Jensen, J. Kermit: *Conceptual Design of a Mobile Remote Manipulator System*. NASA TM-86262, 1984.
6. Watson, J. J.; Heard, W. L., Jr.; Bush, H. G.; Lake, M. S.; Jensen, J. K.; Wallsom, R. E.; and Phelps, J. E.: *Results of EVA/Mobile Transporter Space Station Truss Assembly Tests*. NASA TM-100661, 1988.
7. Sutter, Thomas R.; and Bush, Harold G.: *A Comparison of Two Trusses for the Space Station Structure*. NASA TM-4093, 1989.
8. Heard, Walter L., Jr.; Bush, Harold G.; Watson, Judith J.; Spring, Sherwood C.; and Ross, Jerry L.: Astronaut/EVA Construction of Space Station. *A Collection of Technical Papers—AIAA SDM Issues of the International Space Station*, Apr. 1988, pp. 39-46. (Available as AIAA-88-2459.)
9. Stinson, R. G.; and Thomas, L. C.: *Space Station Truss Assembly Fixture Simulation—Final Test Report*. SSS87-208, NASA Johnson Space Center, Mar. 13, 1987.
10. Thomas, L. C.: *Space Station Truss Assembly Simulation and Fixture Evaluation, Second Series—Final Test Report*. JSC 32057, NASA Johnson Space Center, Feb. 9, 1988.
11. Thomas, L. C.; and Matranga, L. P.: *Space Station LaRC Fixture Truss Assembly Simulation (Third Series) Final Test Report, Phase 1—Fixture Evaluation*. JSC 32070, NASA Johnson Space Center, May 17, 1988.

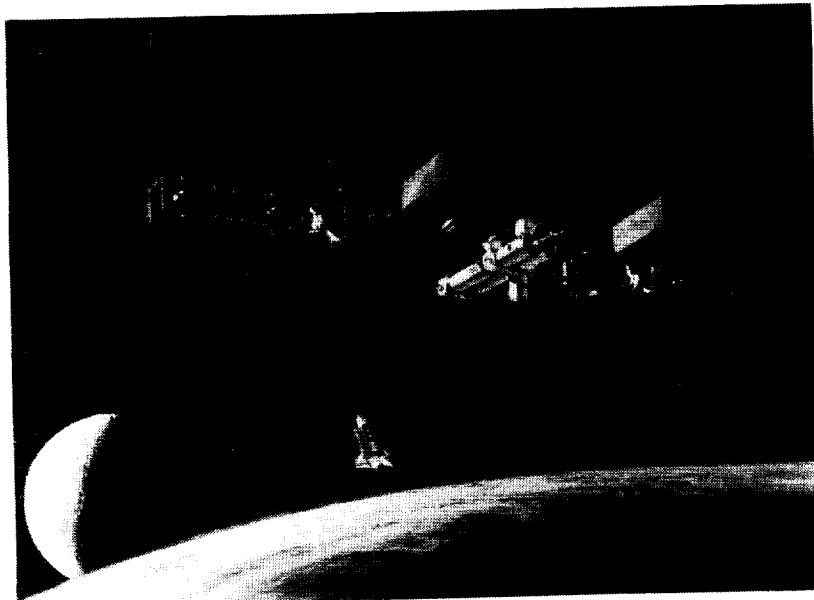

Figure 1. Space Station *Freedom* 1987 baseline configuration.

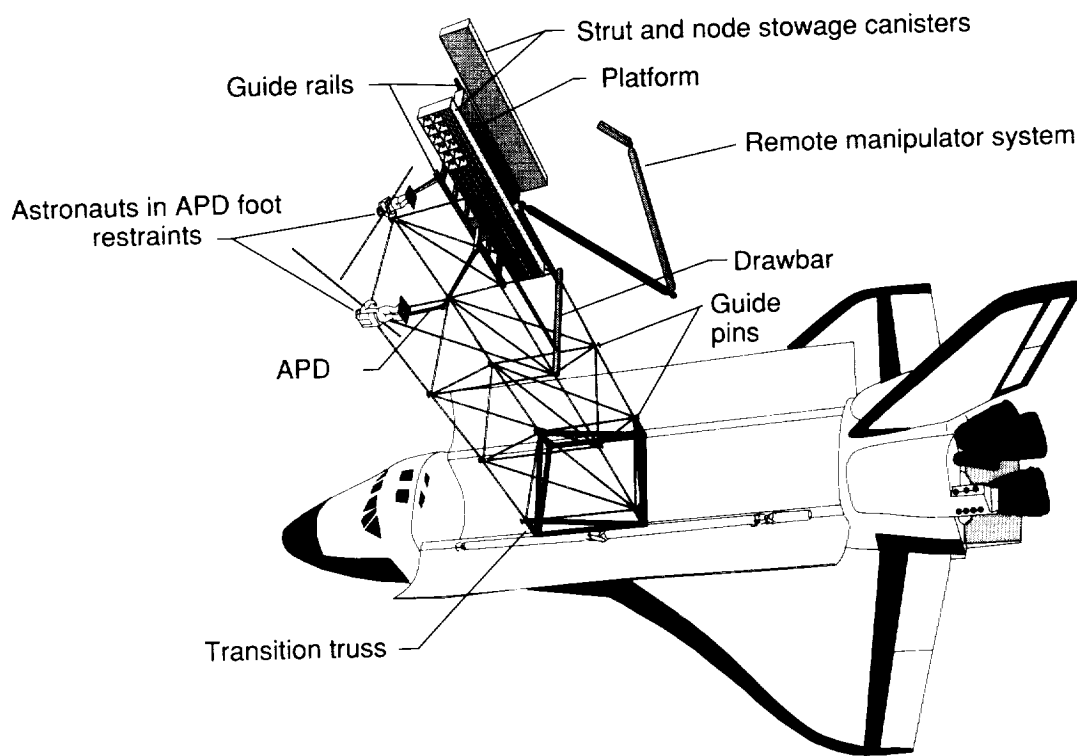

Figure 2. EVA/MT concept for assembly of Space Station.



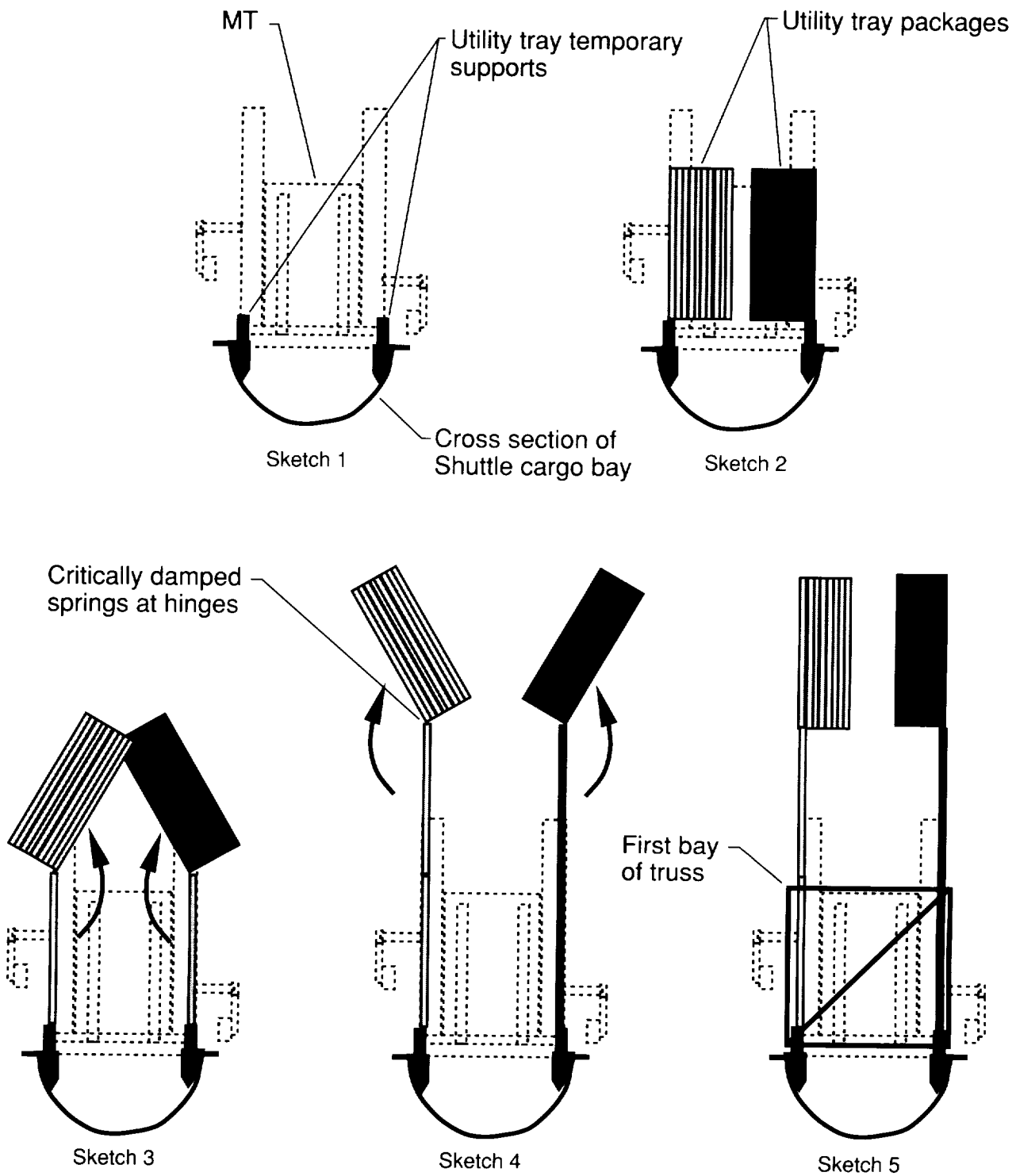
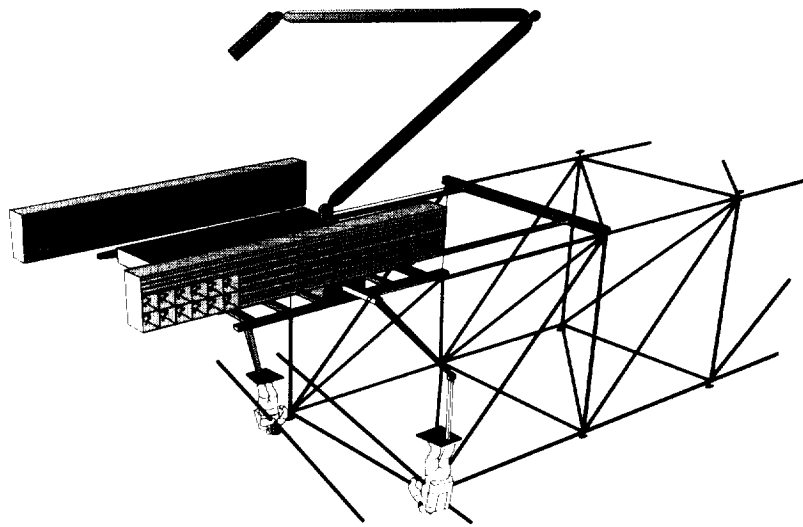
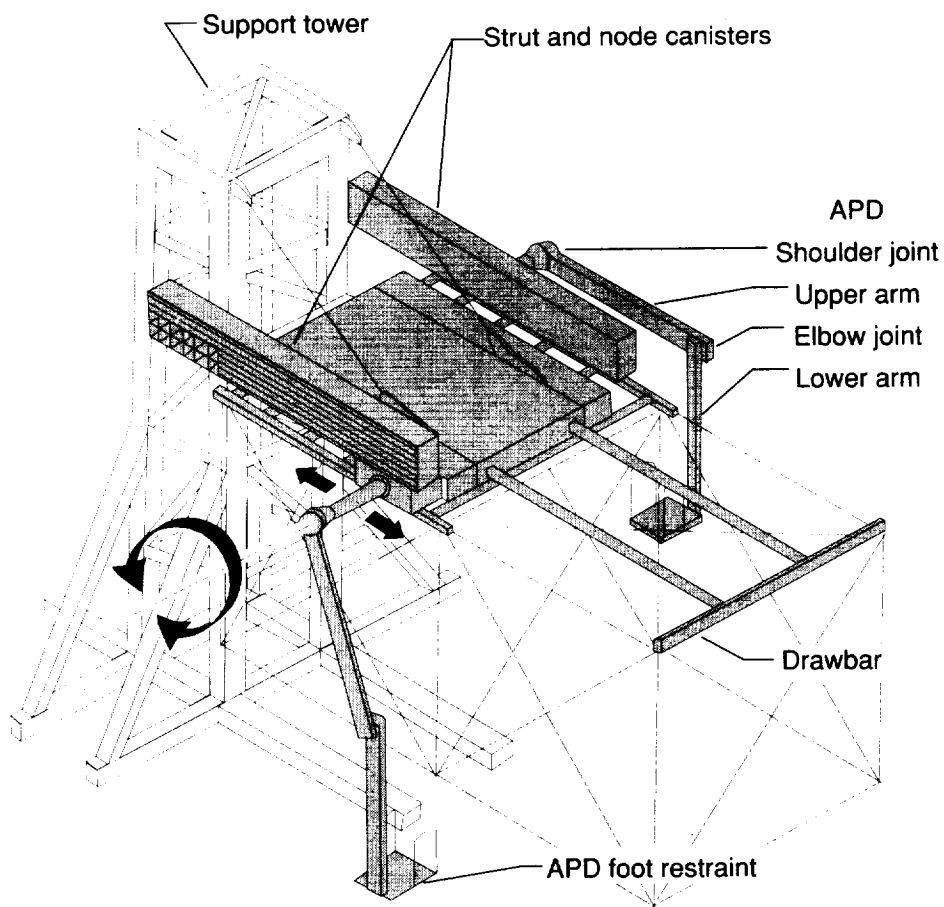

Figure 3. Concept for utility tray deployment.



(a) Flight article.



(b) Mock-up.

Figure 4. Schematic of MT.

ORIGINAL PAGE  
BLACK AND WHITE PHOTOGRAPH

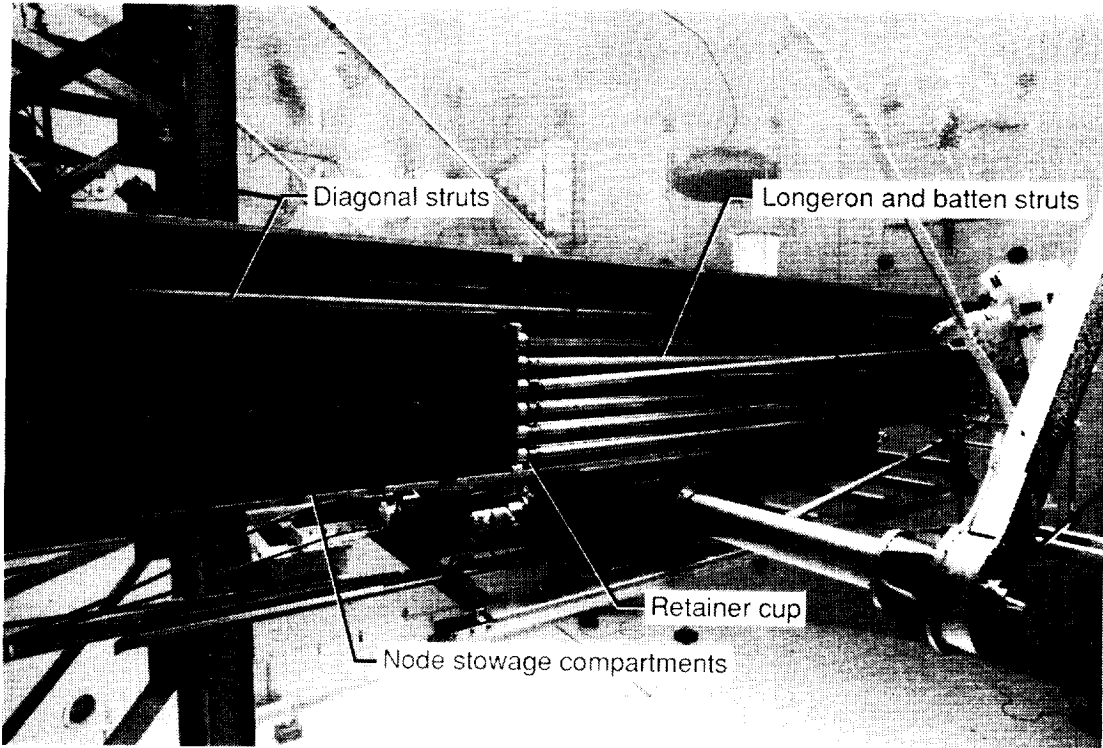

(a) Strut stowage.

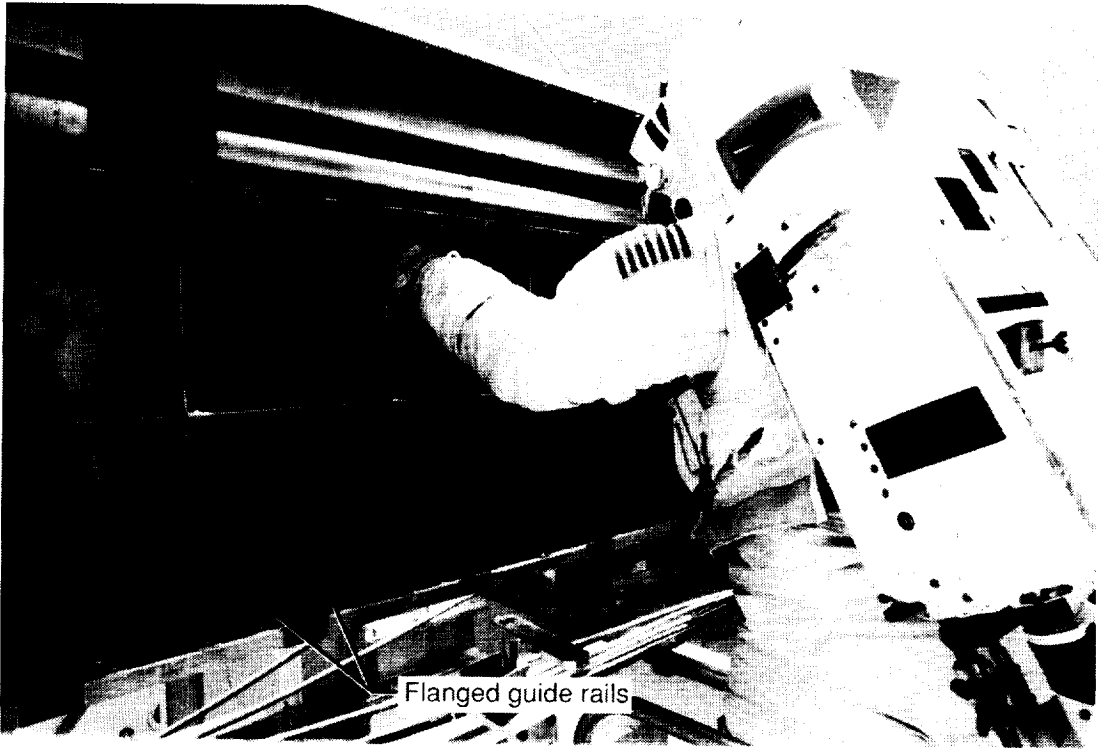

(b) Node stowage.

Figure 5. Strut and node stowage canister.

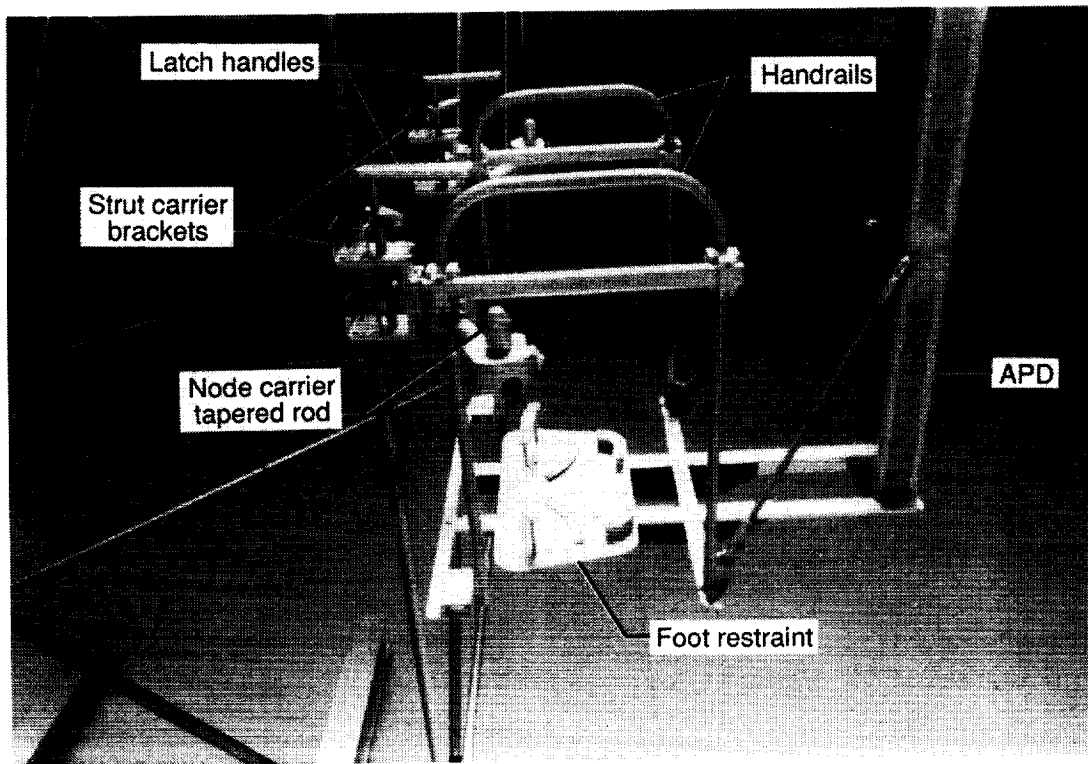

(a) Foot restraint and truss component carriers.

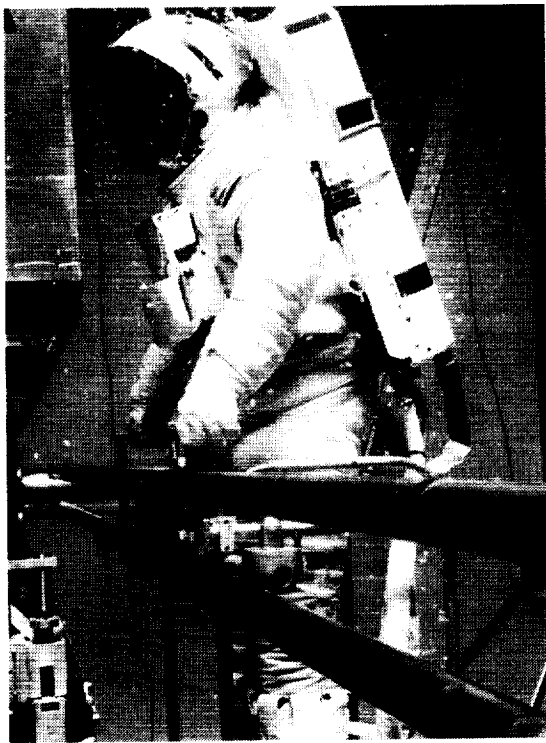

(b) Locking struts in carriers.



(c) Placing node on carrier.

Figure 6. Foot restraint with strut and node carriers.

ORIGINAL PAGE  
BLACK AND WHITE PHOTOGRAPH

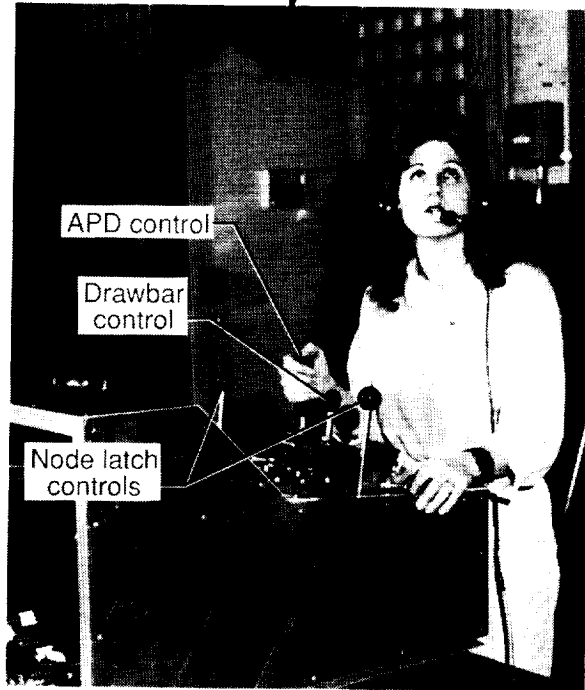
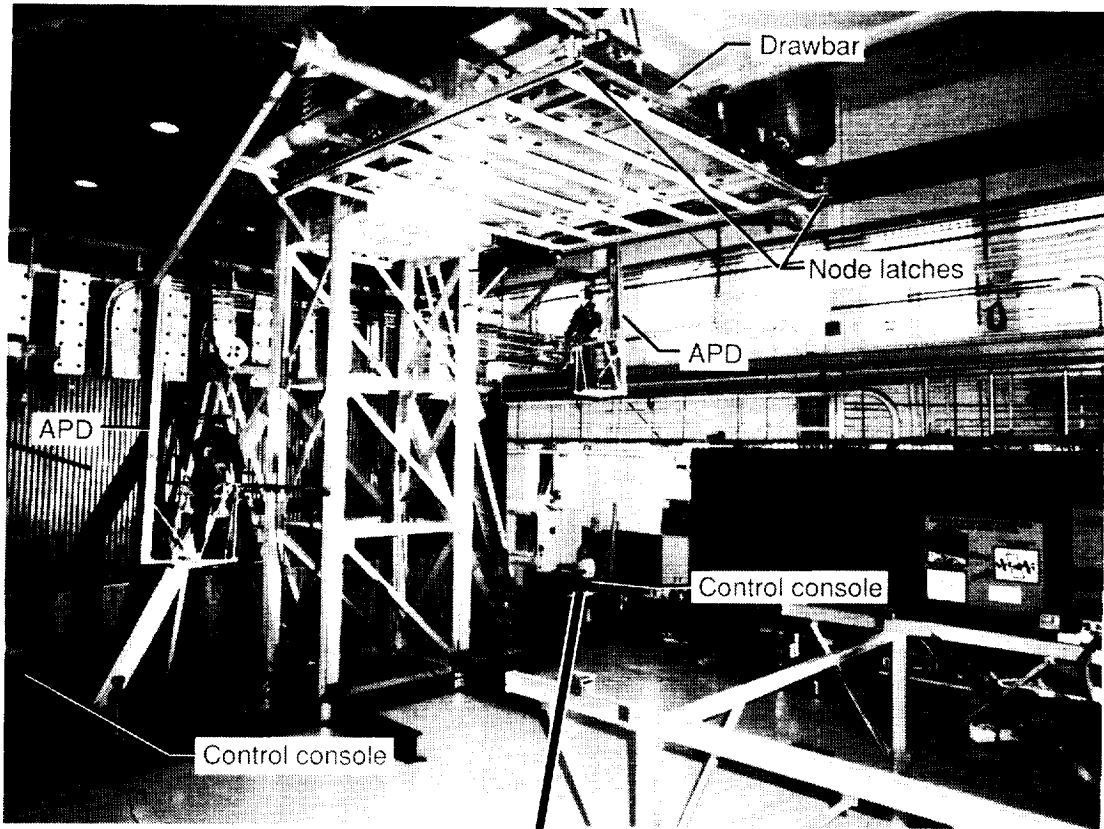
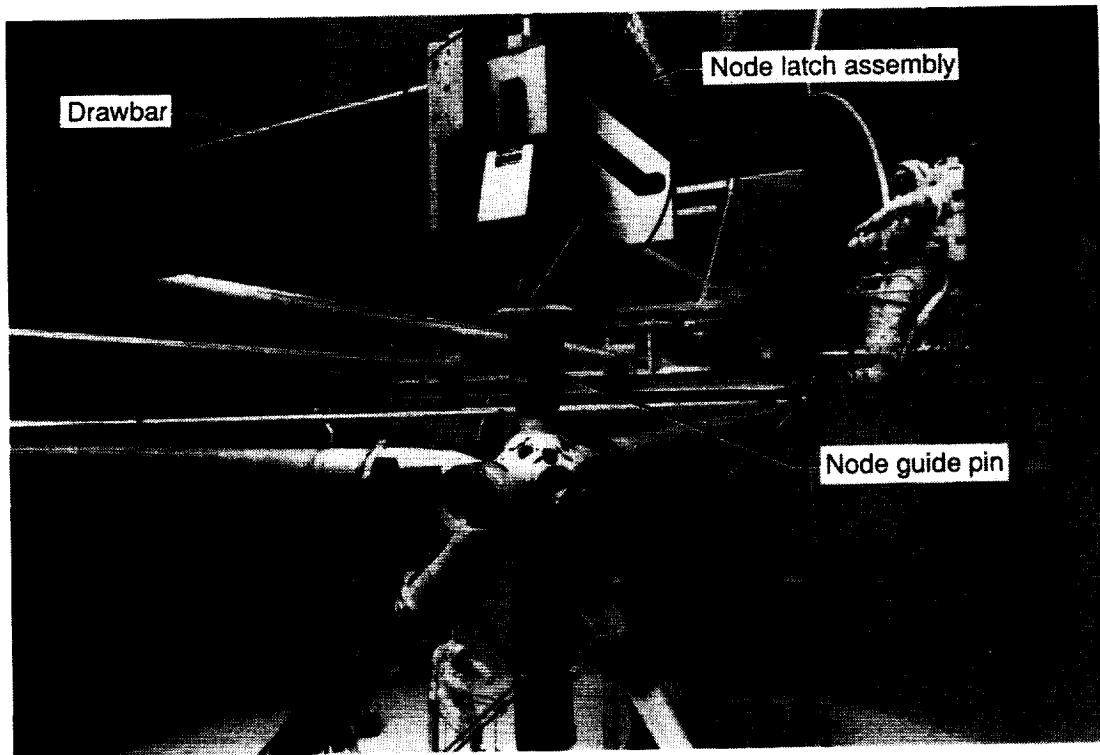
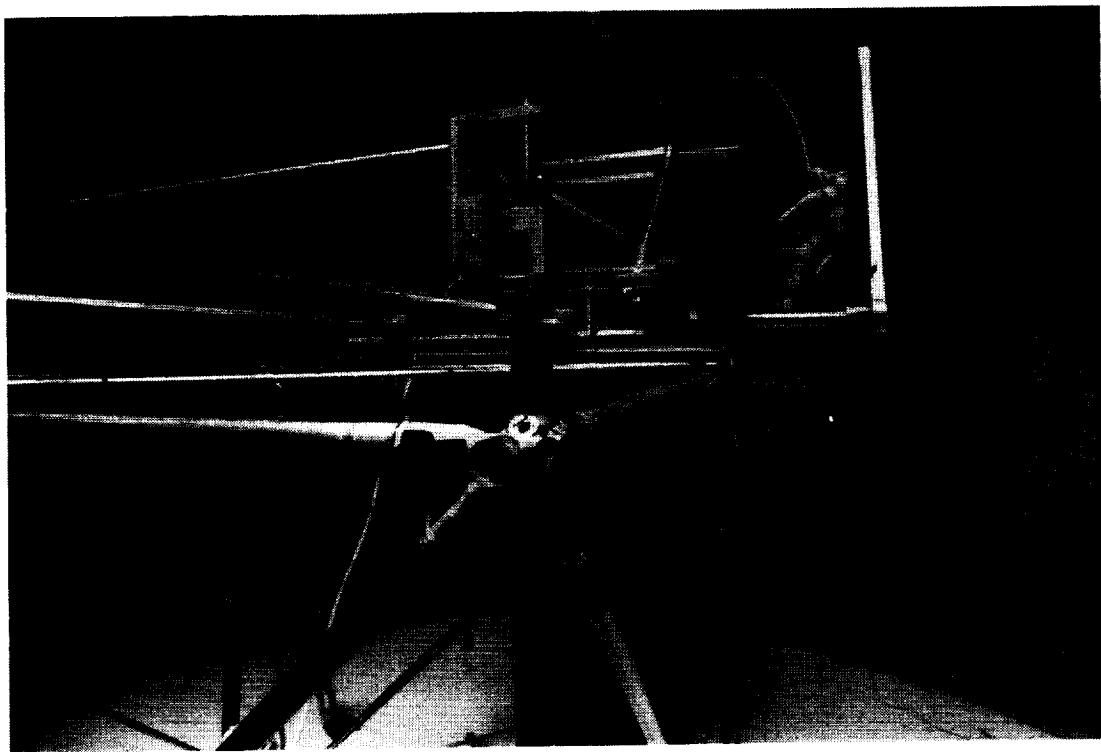

Figure 7. MT controls.



(a) Drawbar node latch not engaged.



(b) Drawbar node latch engaged and locked.

Figure 8. Drawbar node latch.

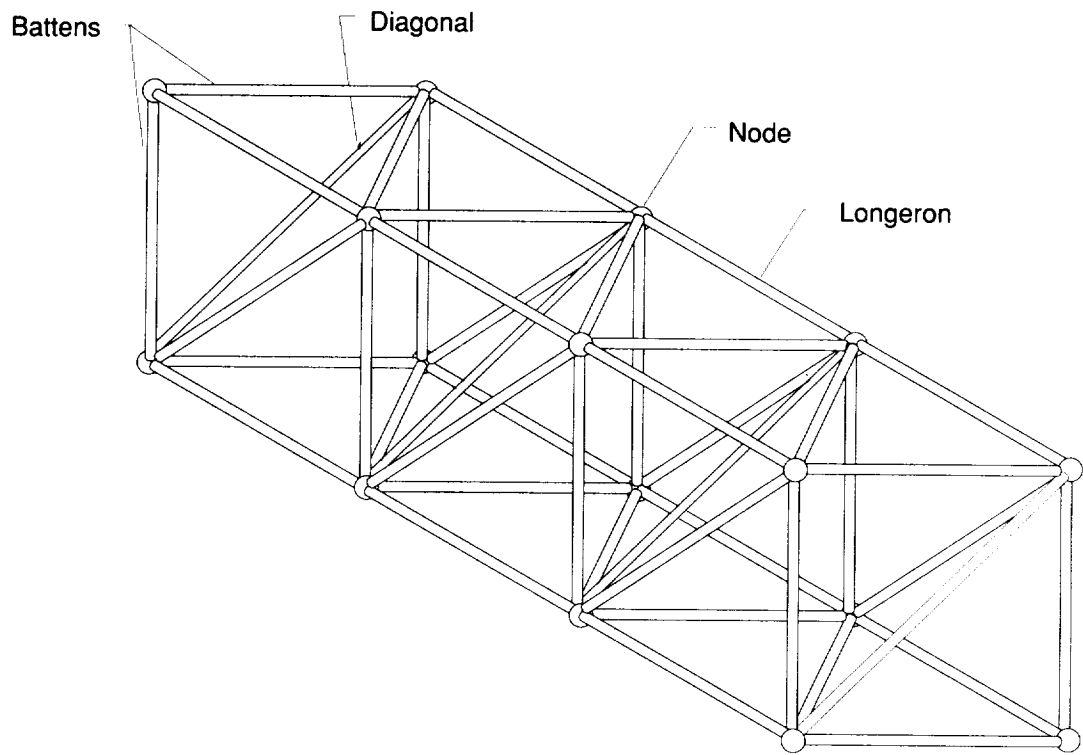

(a) Truss.

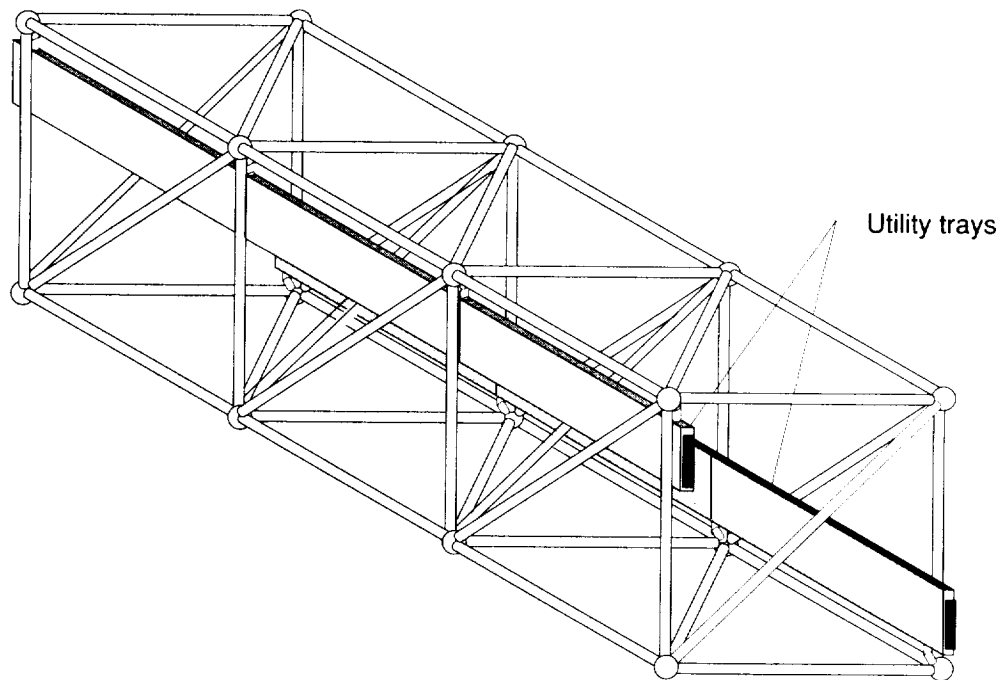

(b) Truss with utility trays.

Figure 9. OTT configuration.

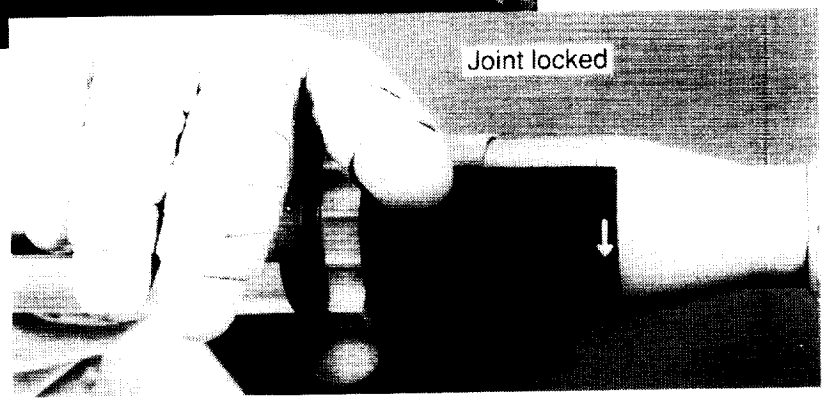
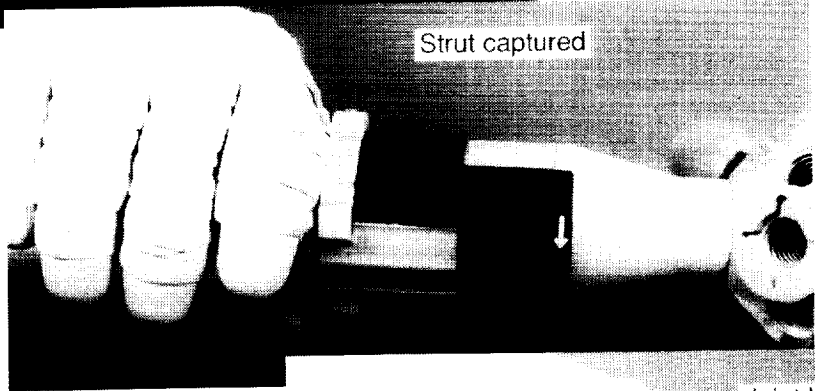
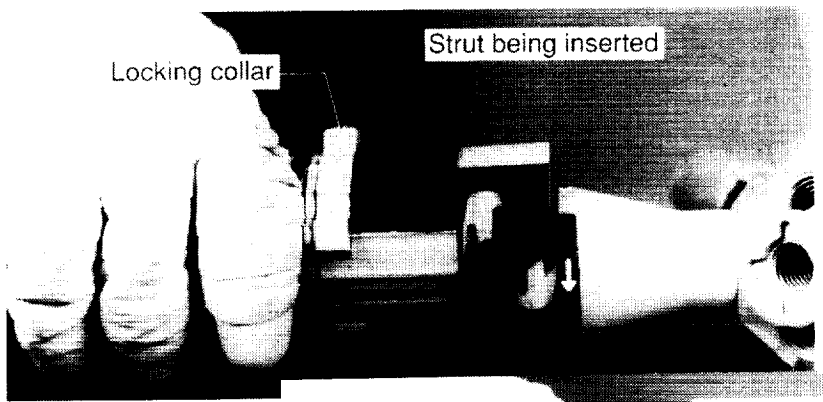
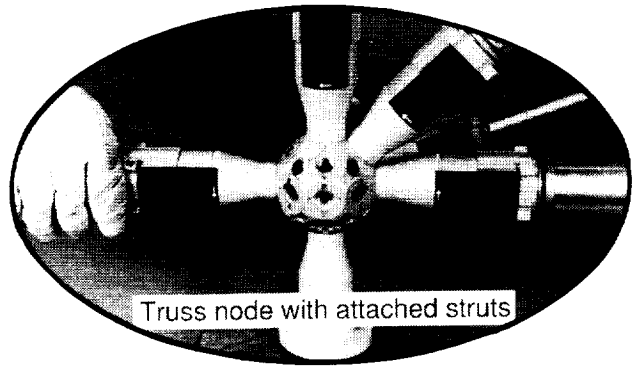

Figure 10. Attachment of strut to node.

ORIGINAL PAGE  
BLACK AND WHITE PHOTOGRAPH



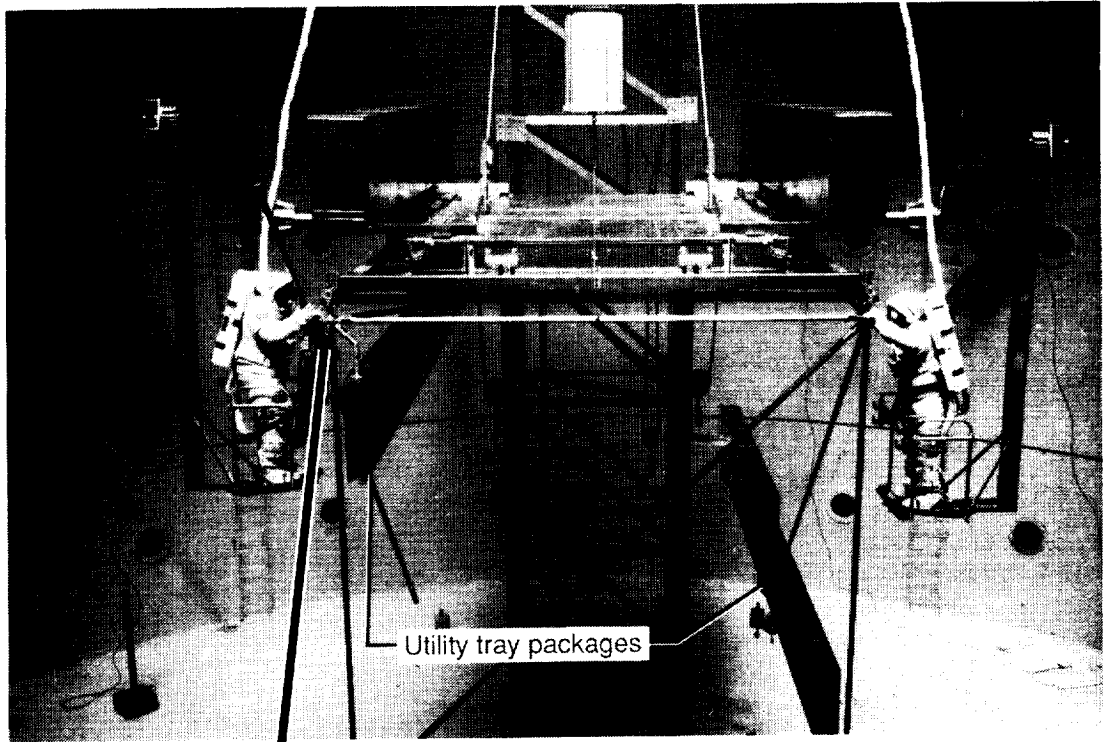

Figure 11. Utility tray packages used in neutral buoyancy assembly tests.

ORIGINAL PAGE  
BLACK AND WHITE PHOTOGRAPH

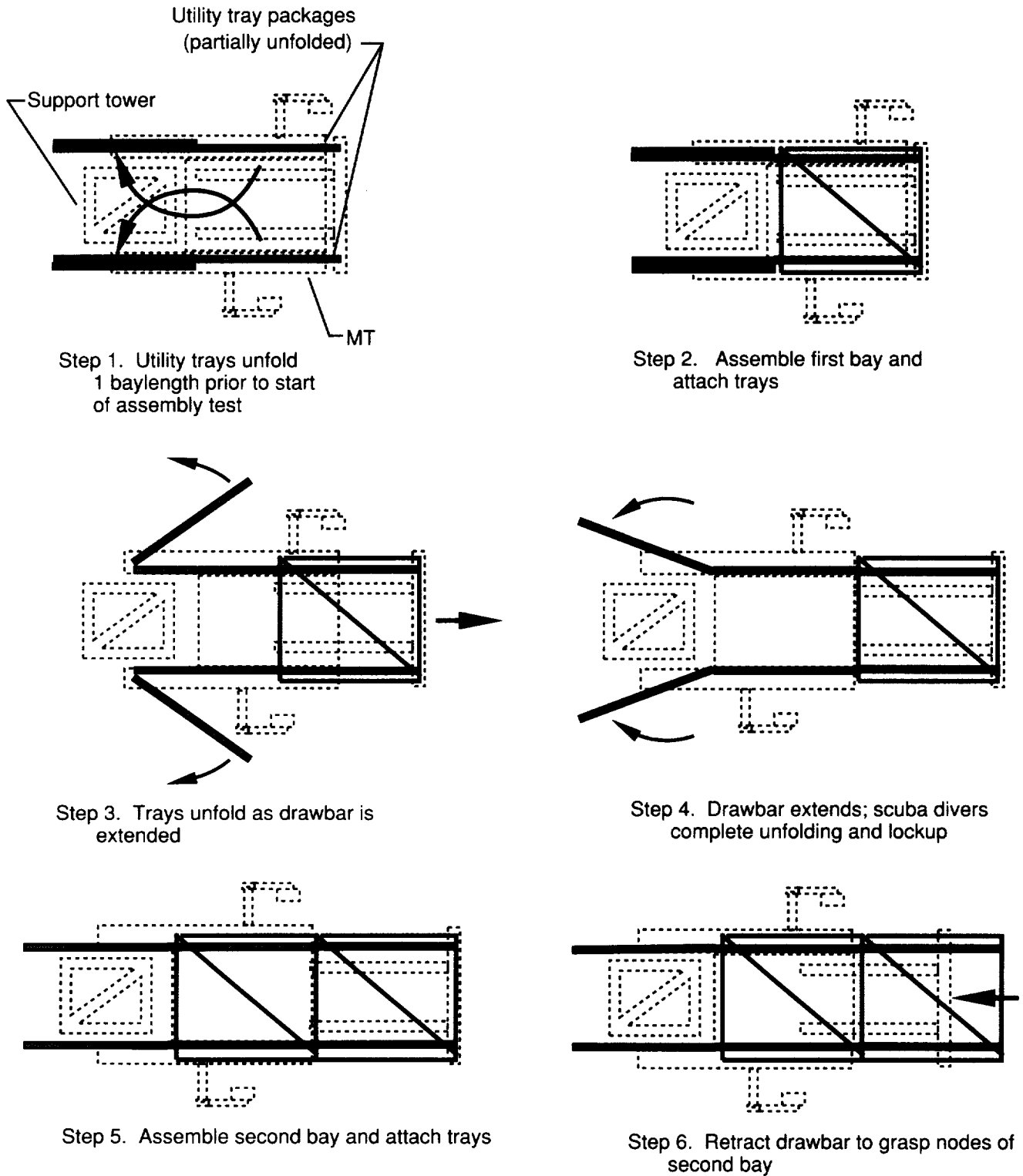

Figure 12. Schematic of utility tray deployment for neutral buoyancy tests.

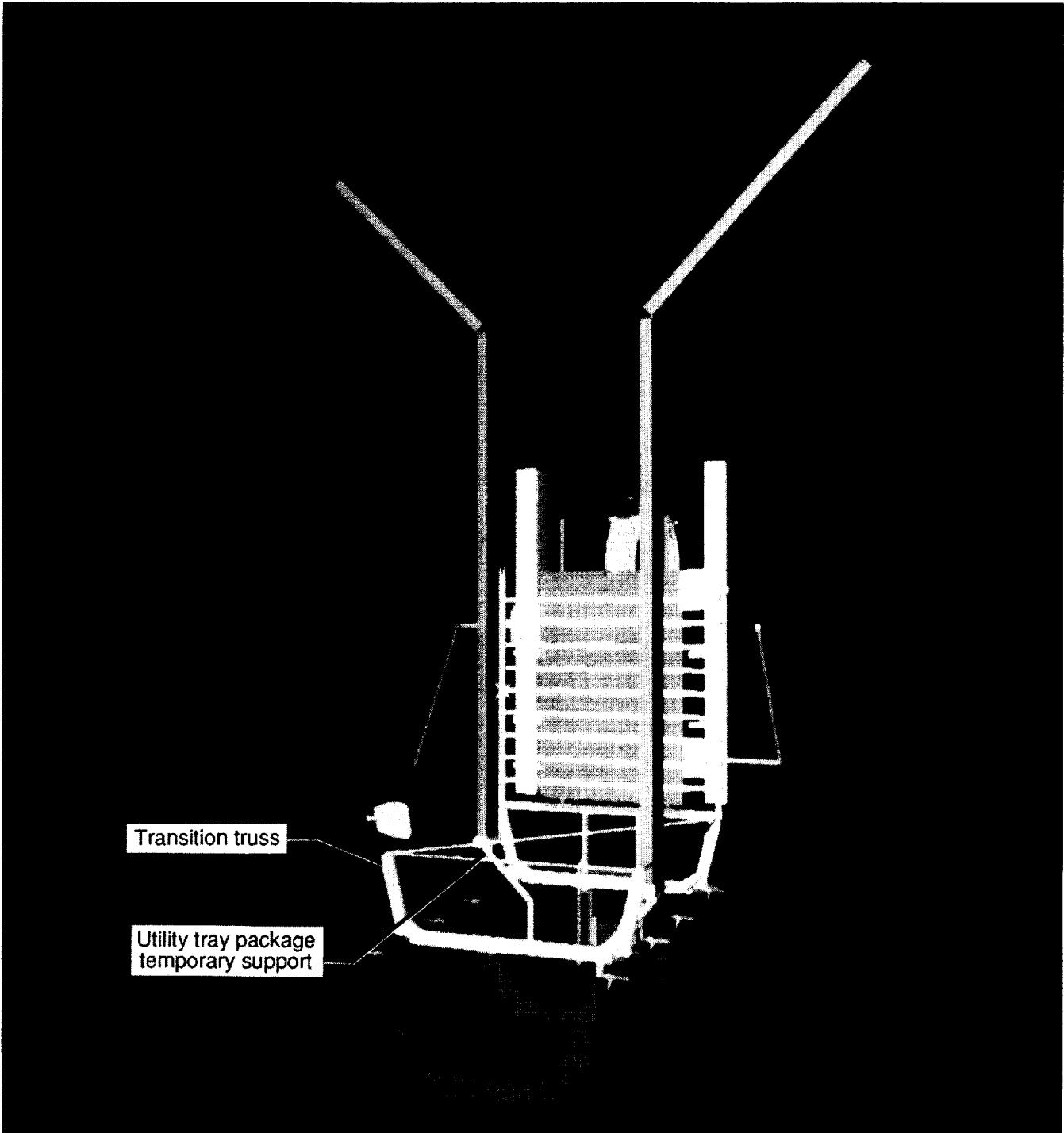
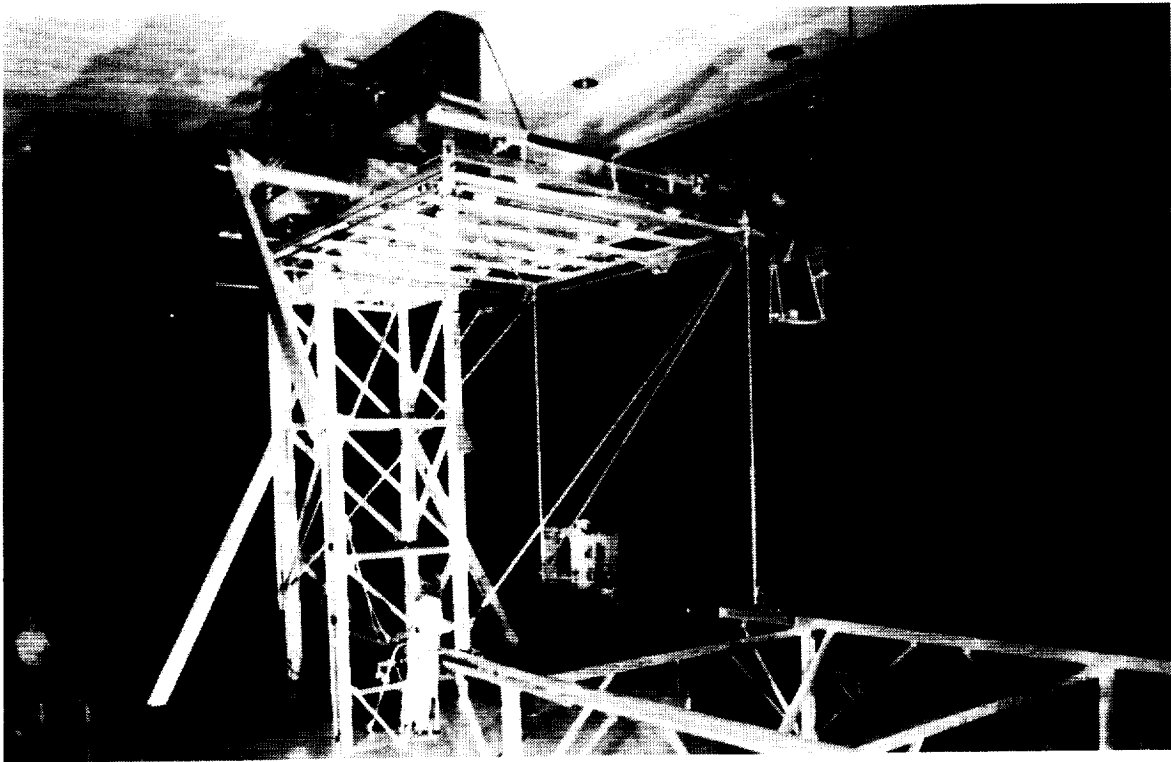
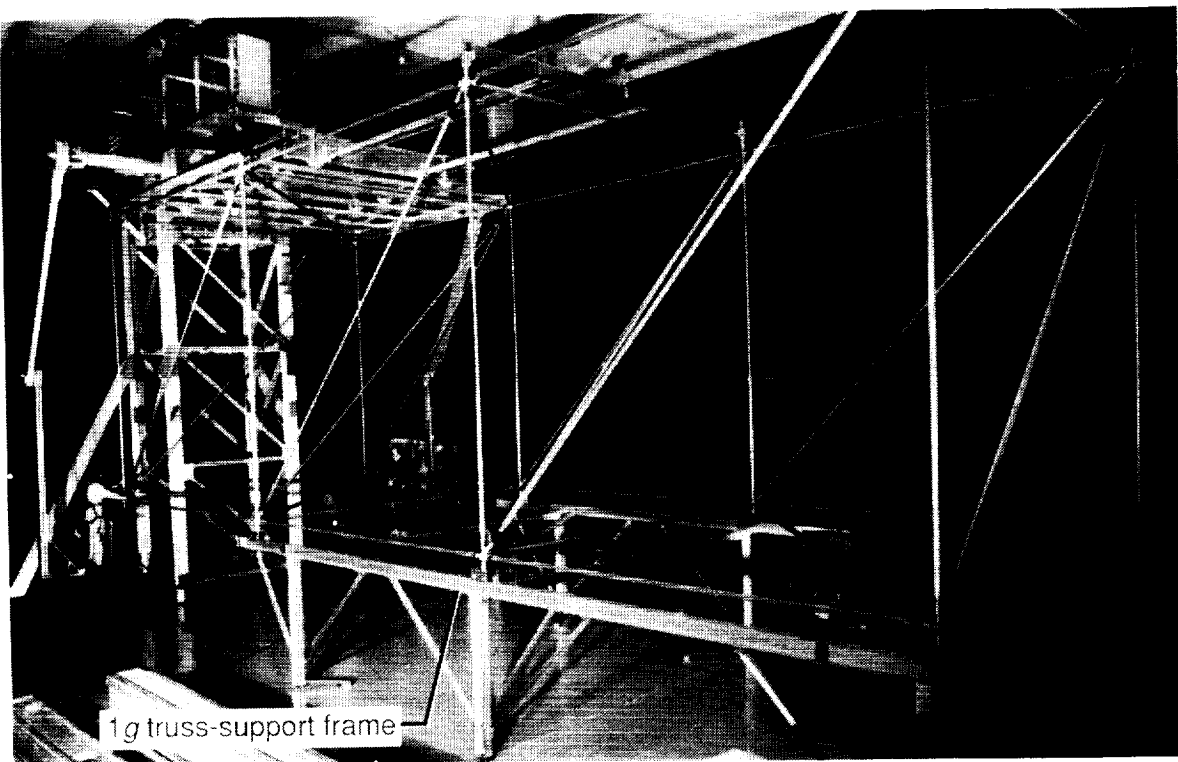

Figure 13. Computer drawing of predeployment of three-bay utility tray system.



(a) Assembly of first bay.



(b) Three-bay truss completed.

Figure 14. Three-bay SSF truss assembly in 1g with MT.

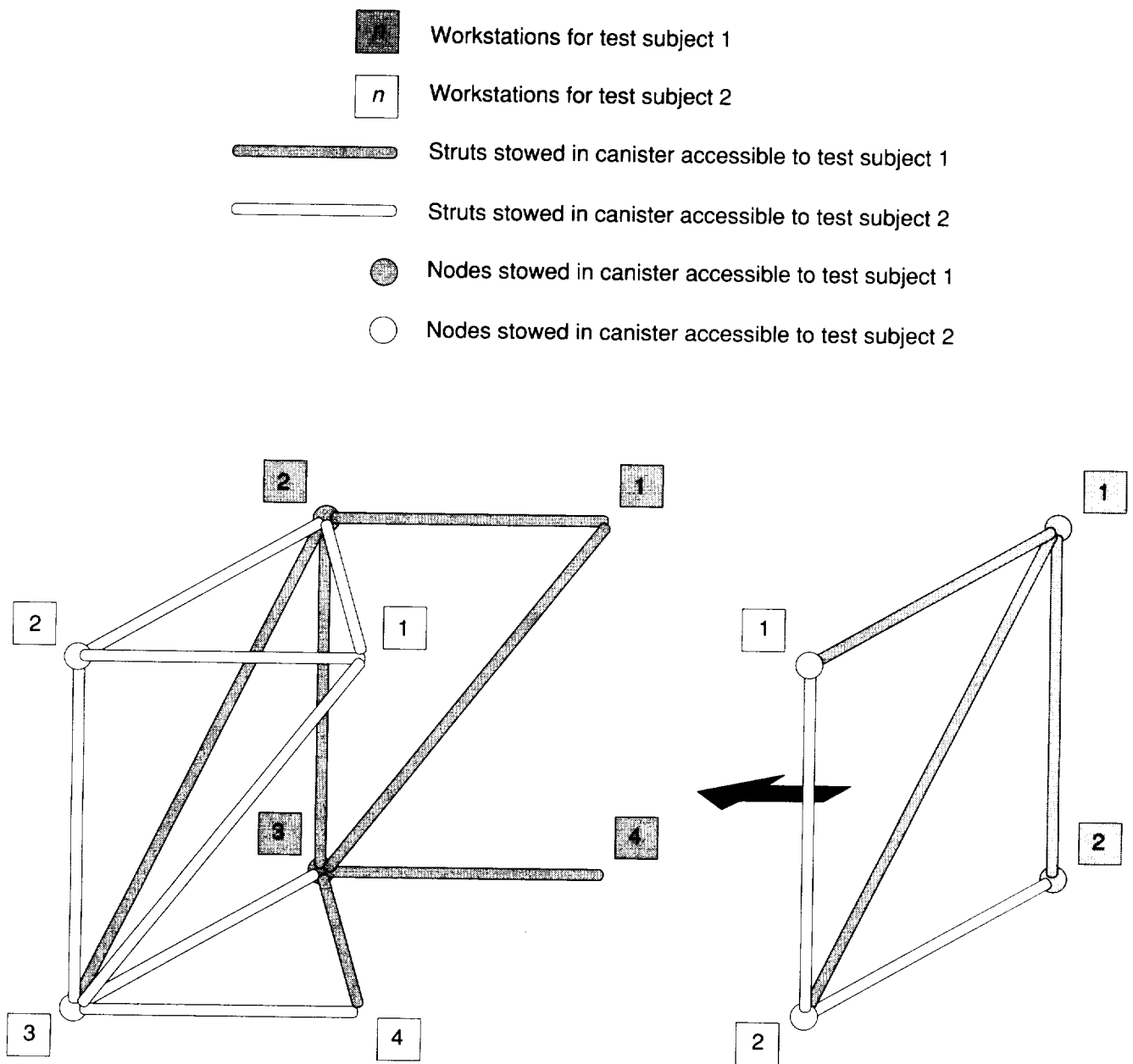

Step 2. Repetitive assemblies of general bay of truss

Step 1. Assembly of first batten frame

Figure 15. Assembly procedure for neutral buoyancy tests.

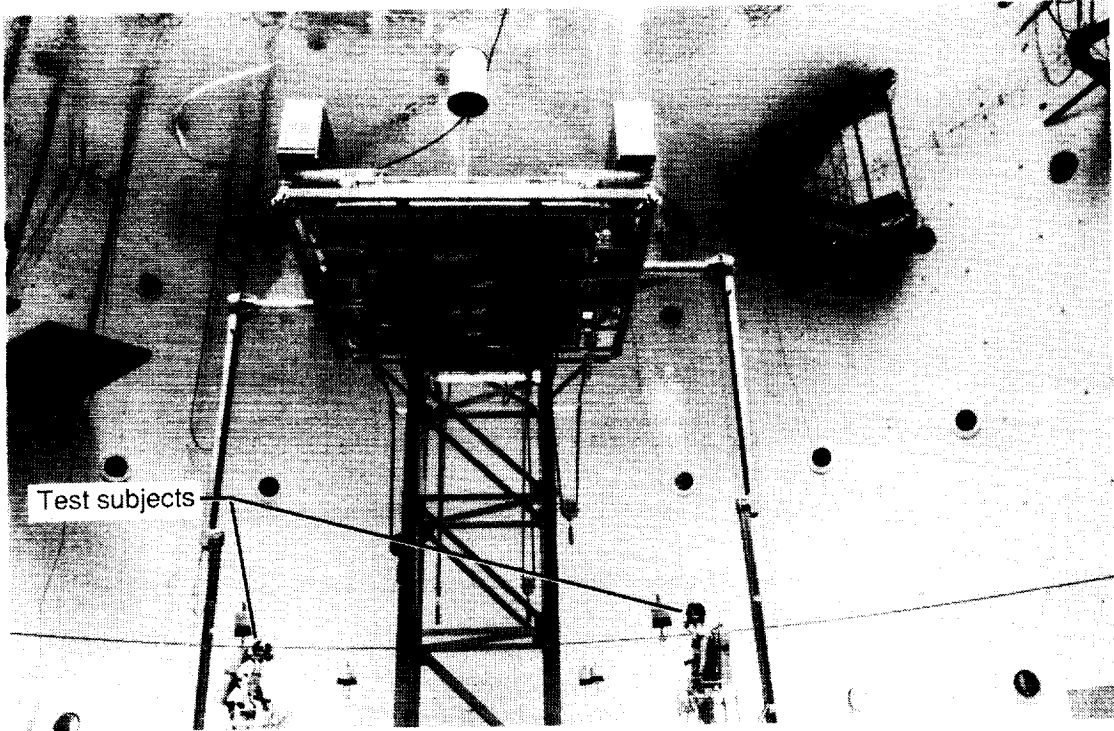

(a) Test subjects in APD foot restraints ready to begin test.

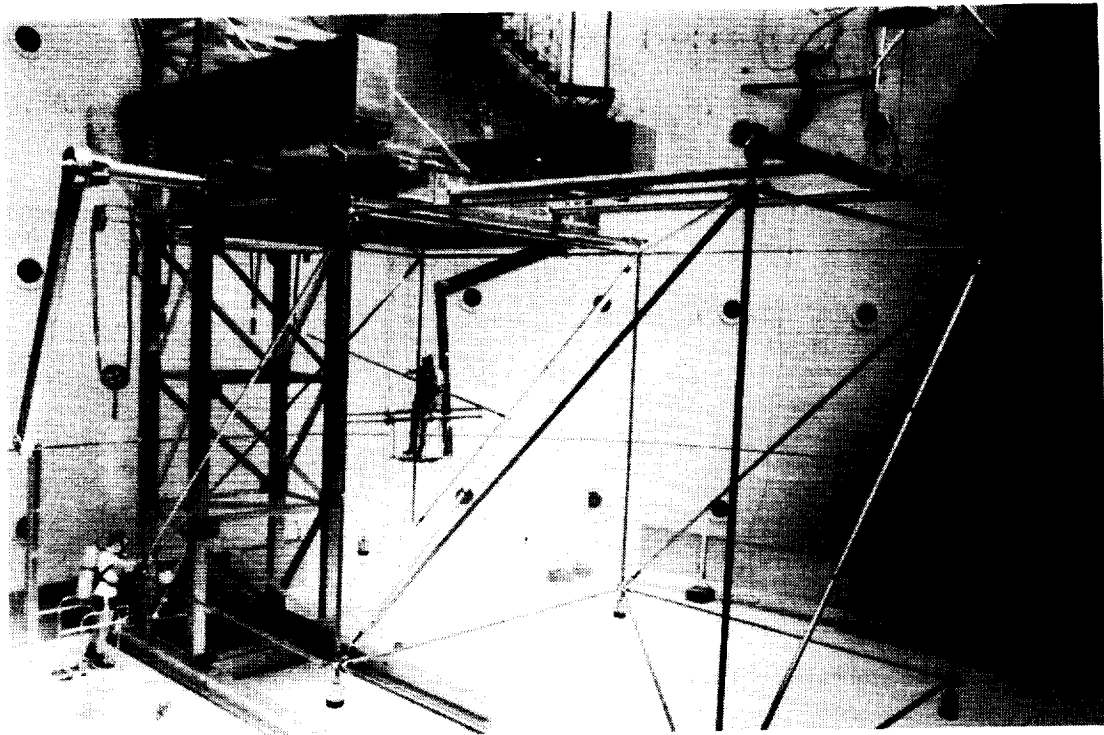

(b) Assembly of second bay.

Figure 16. Neutral buoyancy truss assembly by test subjects in scuba.

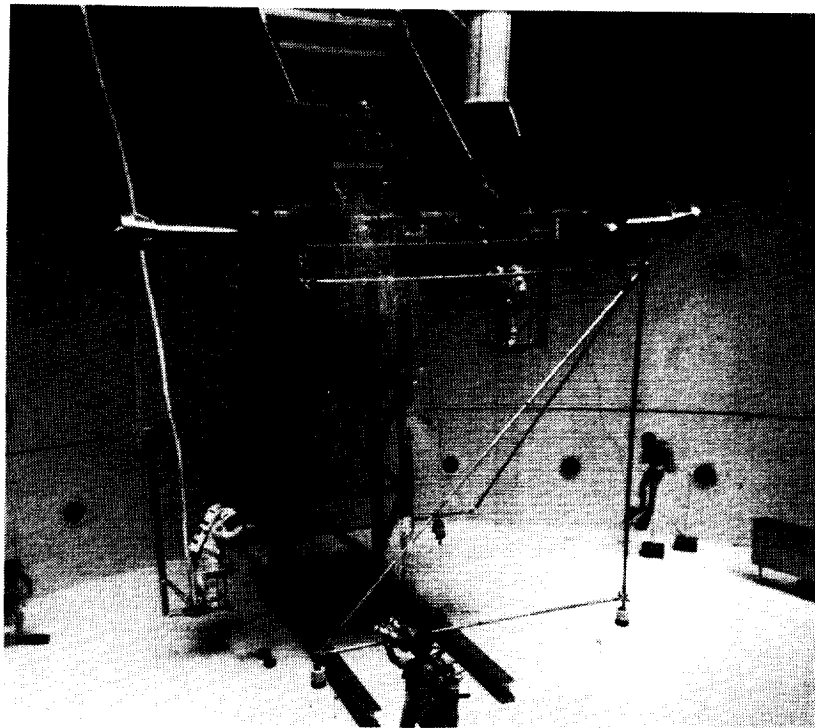

(a) Assembly of first bay.

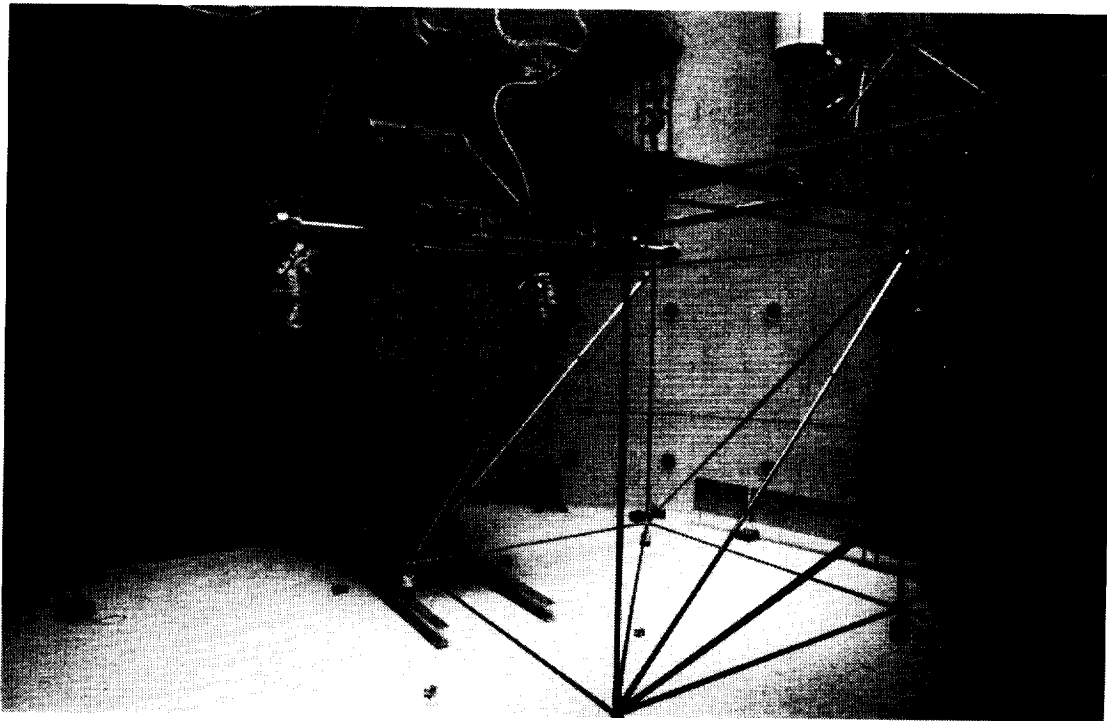

(b) Assembly of third bay.

Figure 17. Neutral buoyancy truss assembly by test subjects in pressure suits.

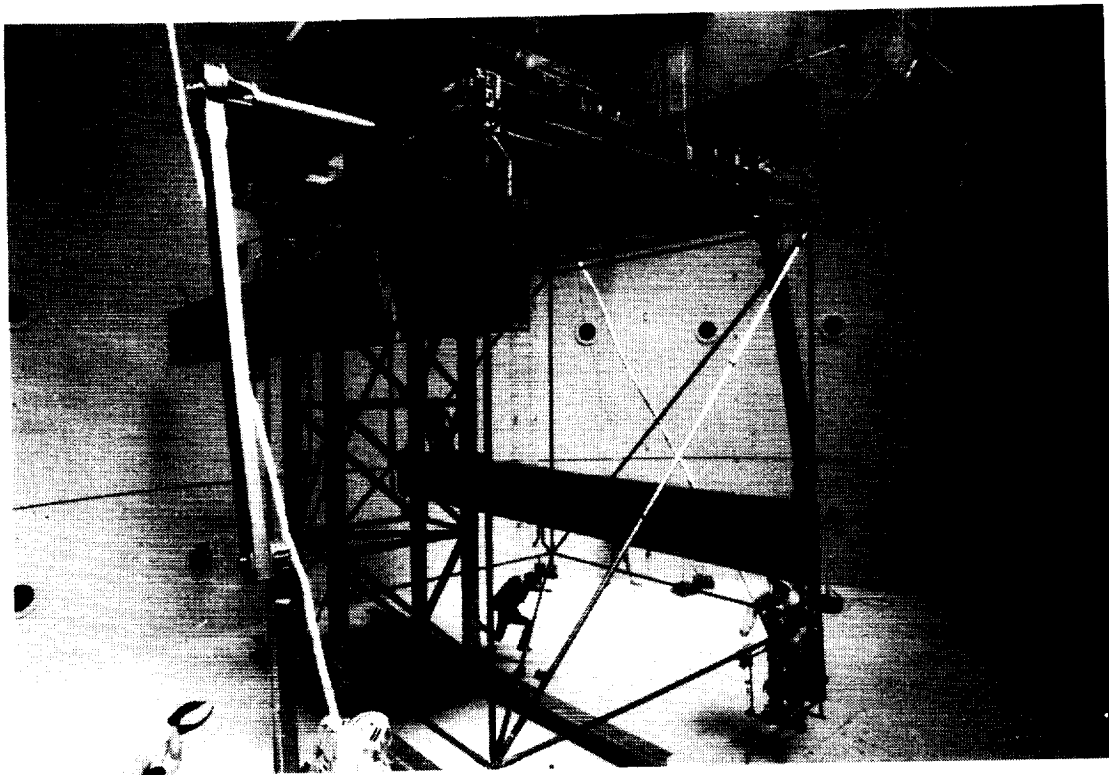

(a) Assembly of first bay.

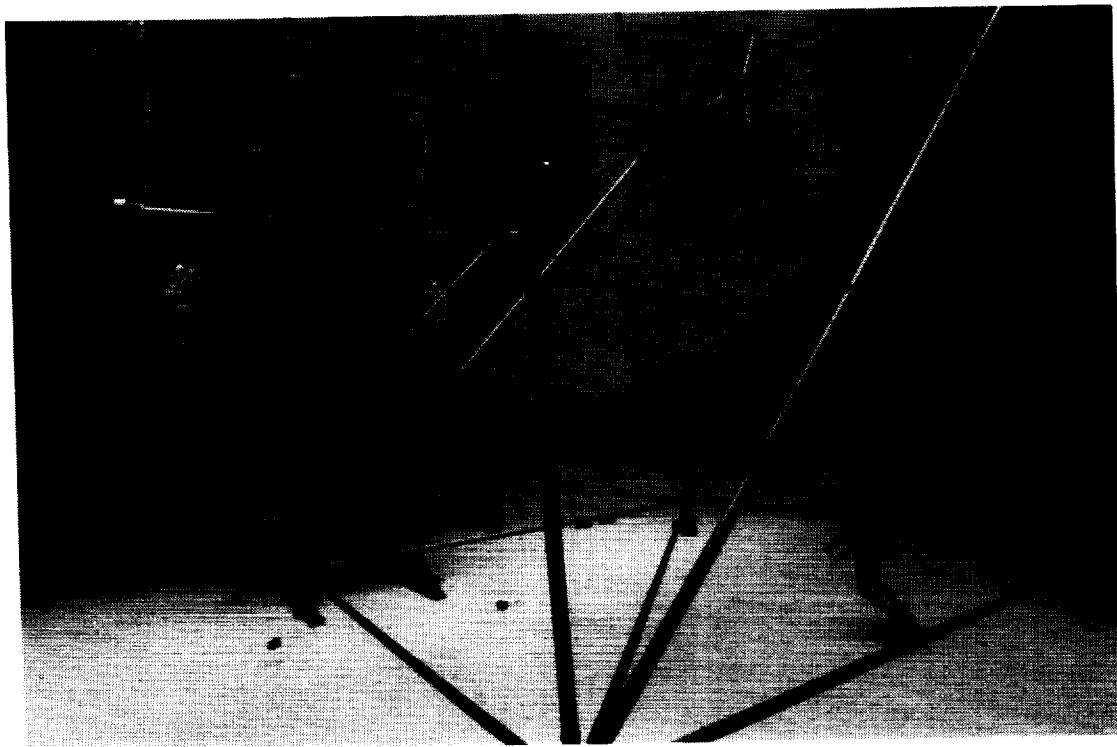

(b) Assembly of third bay.

Figure 18. Neutral buoyancy truss assembly and integration of utility trays by test subjects in pressure suits.



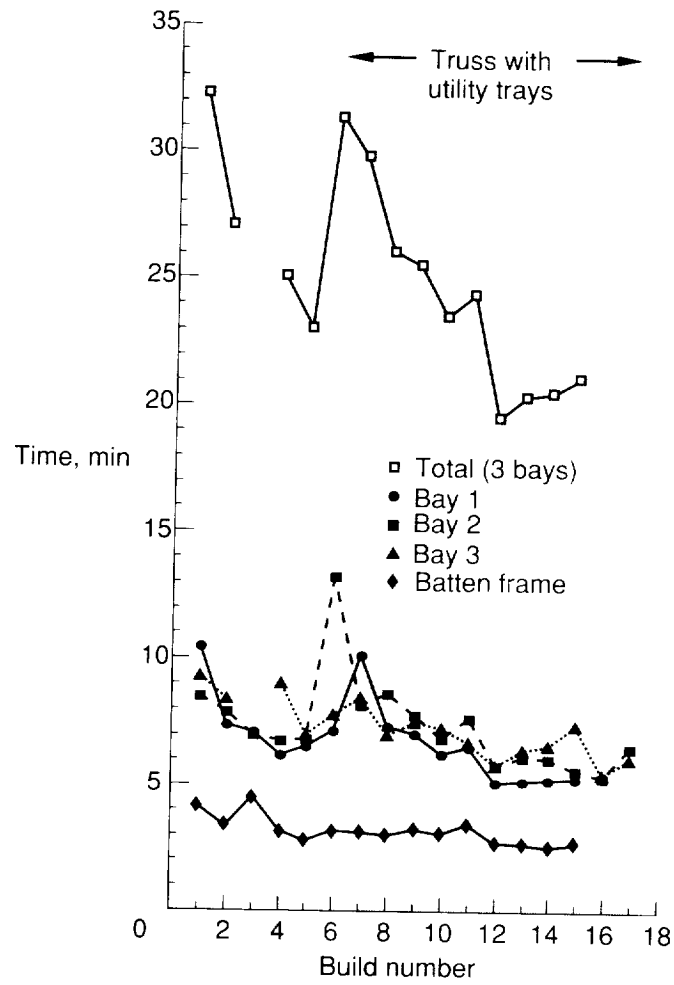

Figure 19. Neutral buoyancy assembly times by trained test subjects in pressure suits.

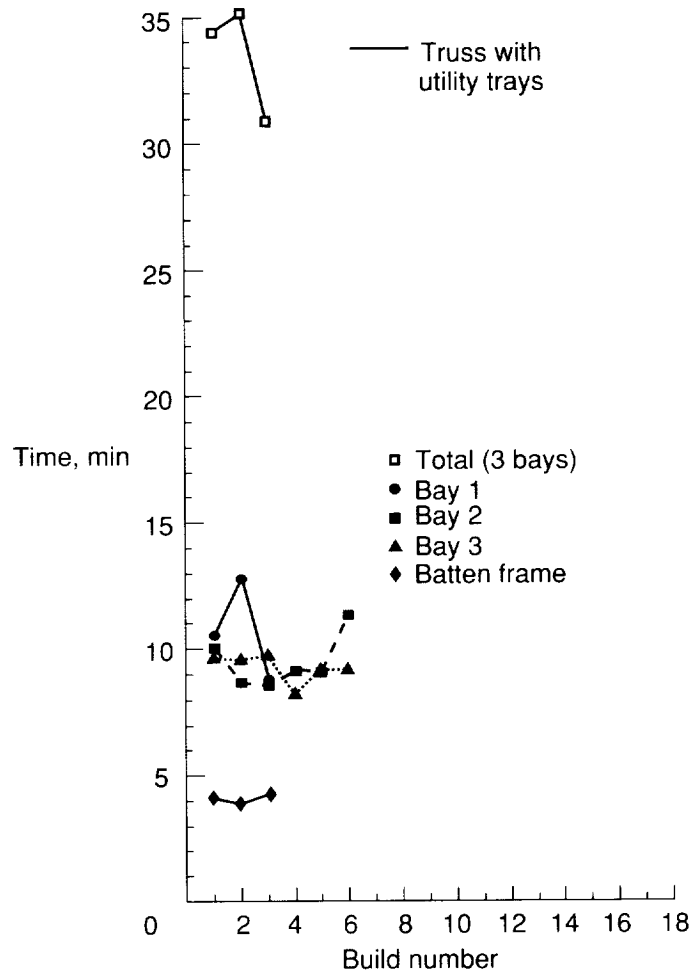
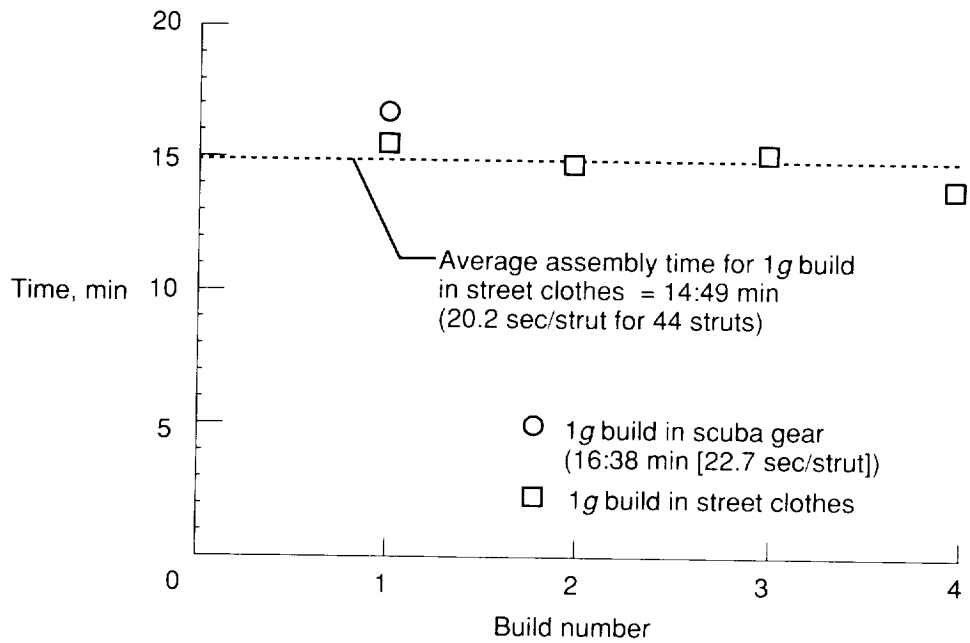
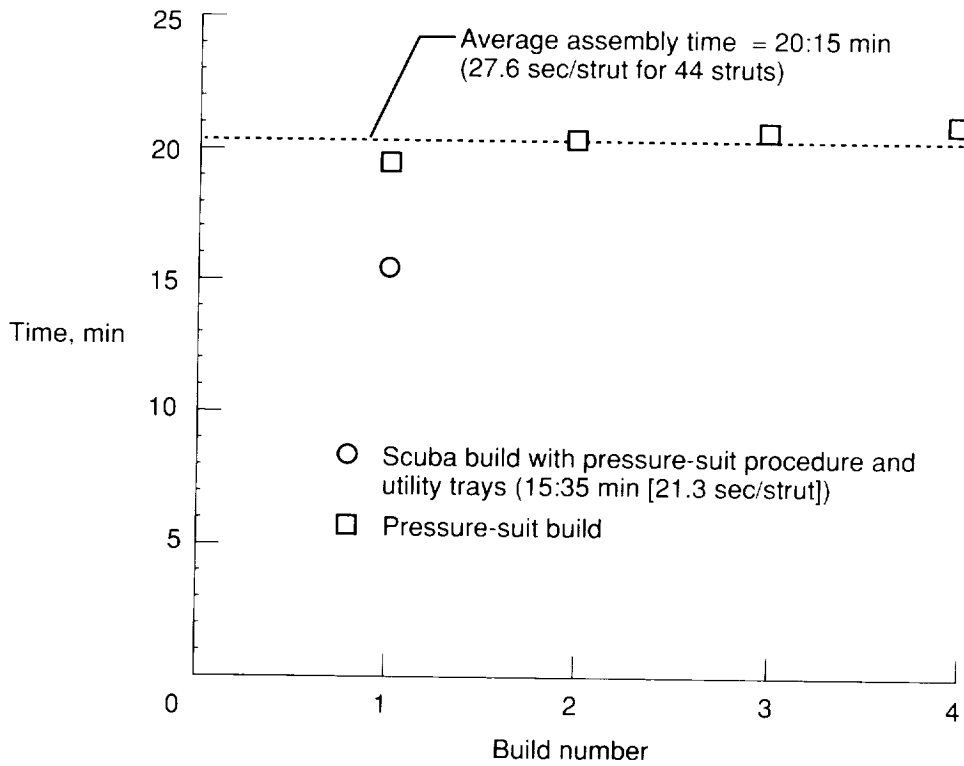

Figure 20. Neutral buoyancy assembly times by astronaut test subjects in pressure suits.



(a) Scuba and 1g builds (without utility trays).



(b) Scuba and pressure-suit builds (with utility trays).

Figure 21. Three-bay truss assembly times.



National Aeronautics and  
Space Administration  
Code JTT  
Washington, D.C.  
20546-0001  
Official Business  
Penalty for Private Use, \$300

**BULK RATE**  
**POSTAGE & FEES PAID**  
NASA  
Permit No. G-27

**NASA**

POSTMASTER: If Undeliverable (Section 158  
Postal Manual) Do Not Return

---

