

1-1-93  
E7485

NASA Technical Memorandum 105973  
AIAA-93-0465

# Nucleate Pool Boiling in the Long Duration Low Gravity Environment of the Space Shuttle

M.M. Hasan, C.S. Lin, and R.H. Knoll  
*Lewis Research Center  
Cleveland, Ohio*

and

M.D. Bentz and J. S. Meserole  
*Boeing Defense and Space Group  
Seattle, Washington*

Prepared for the  
31st Aerospace Sciences Meeting and Exhibit  
sponsored by the American Institute of Aeronautics and Astronautics  
Reno, Nevada, January 11-14, 1993

**NASA**

# NUCLEATE POOL BOILING IN THE LONG DURATION LOW GRAVITY ENVIRONMENT OF THE SPACE SHUTTLE

M.M. Hasan, C.S. Lin,\* and R.H. Knoll  
National Aeronautics and Space Administration  
Lewis Research Center  
Cleveland, Ohio

and

M.D. Bentz and J.S. Meserole  
Boeing Defense and Space Group  
Seattle, Washington

## Abstract

The paper presents the results of an experimental study of nucleate pool boiling performed in the low gravity environment of the space shuttle. Photographic observations of pool boiling in Freon 113 were obtained during the "Tank Pressure Control Experiment," flown on the Space Transportation System, STS-43 in August 1991. Nucleate boiling data from large (relative to bubble sizes) flat heating surfaces (0.1046 by 0.0742 m) was obtained at very low heat fluxes (0.22 to 1.19 kW/m<sup>2</sup>). The system pressure and the bulk liquid subcooling varied in the range of 40 to 60 kPa and 3 to 5 °C, respectively. Thirty-eight boiling tests, each of a 10-min duration for a given heat flux, were conducted. Measurements included the heater power, heater surface temperature, the liquid temperature and the system pressure as functions of heating time. Video data of the first 2 min of heating was recorded for each test. In some tests the video clearly shows the inception of boiling and the growth and departure of bubbles from the surface during the first 2 min of heating. In the absence of video data, the heater temperature variation during heating shows the inception of boiling and stable nucleate boiling. During the stable nucleate boiling the wall superheat varied between 2.8 to 3.8 °C for heat fluxes in the range of 0.95 to 1.19 kW/m<sup>2</sup>. The wall superheat at the inception of boiling varied between 2 to 13 °C.

## Nomenclature

$g$	gravitational acceleration on Earth's surface
$P_{nc}$	partial pressure of the noncondensable gas
$P_t$	tank pressure

$q$	heat flux
$T_1, T_2, T_4, T_5$	fluid temperatures
$T_3, T_6$	heater A and heater B temperatures
$T_7$	jet temperature
$T_s$	saturation temperature based on tank pressure
$T_w$	heater A or heater B temperature
$\Delta T_{sub}$	liquid subcooling, ( $T_s - T_1$ )
$\Delta T_{sat}$	wall superheat, ( $T_w - T_s$ )

## Introduction

A flight experiment titled "Tank Pressure Control Experiment" (TPCE) was performed in the Space Transportation System, STS-43, in August 1991. The TPCE was an autonomous secondary payload carried within a standard Get Away Special (GAS) container. The primary objective of TPCE was to investigate the fluid mixing process in a partially filled tank in a long duration low gravity environment. The fluid mixing is induced by an axial turbulent jet. The mixing process is quantified either in terms of a pressure or temperature equilibration rate. A detailed description of TPCE which includes design and fabrication of the payload, integration of the payload on the Space Transportation System, and the experimental results is given by Bentz.<sup>1</sup> An analysis of TPCE jet induced fluid mixing results in the long duration low gravity environment of STS-43 is presented by Bentz et al.<sup>2</sup>

The initial conditions, such as the tank pressure and the liquid temperature stratification for each test of the TPCE were produced by heaters immersed in the nearly

\*Analex Corporation, Brook Park, Ohio 44142.

E-7485



saturated Freon 113. However, a review of the published literature led us to conclude that there is no relevant experimental data or design experience, on the design of a heater for a nonflowing fluid system in a long duration low gravity environment. Experimental studies<sup>3-7</sup> of the 1960s to investigate the effects of the reduced gravity on pool boiling provide useful information. However, the results from these studies are inconclusive, mainly because of the short duration low gravity environment (2 to 5 sec). Also, most of these investigations were performed with a relatively small heating surface at high heat flux. Extrapolation of the results to low heat flux conditions in a long duration gravity environment is questionable. Siegel<sup>8</sup> provides an excellent review of low gravity boiling works prior to 1966.

More recently, Straub and his co-workers<sup>9-10</sup> carried out a series of pool boiling experiments at low gravity in ballistic rocket flights TEXUS (Technologische Experimente Unter Schwerelosigkeit) and in parabolic flights with KC-135 aircraft. The effects of fluid properties, liquid subcooling and heater geometry were investigated. Straub et al.<sup>11</sup> summarizes the findings of these investigations in a review paper. In their experiment, with Freon 113 using a flat heating surface, the wall heat flux,  $q$ , was varied in the range of 20 to 80 kW/m<sup>2</sup>. A careful observation of the saturated boiling data suggests that steady state nucleate boiling was not achieved even with the lowest heat flux.

Based on the review of pertinent literature, we concluded that there is a complete lack of experimental data to design a heater for TPCE, especially if film boiling is to be avoided. This lack of information, then, makes the heater design and its operation in a long duration low gravity environment a subject of experimental investigation for TPCE. Large flat heaters were designed to operate at very low heat fluxes. Heat fluxes were varied for the range of free convection to the isolated bubble region in normal gravity. This paper presents the experimental results, which include boiling and nonboiling data, during the heating phase of TPCE.

### The Experiment

Figure 1 shows the schematic of the experimental system. It consists of a 0.254-m diameter cylindrical tank with hemispherical domes. The volume of the tank is 0.0137 m<sup>3</sup>. Bentz<sup>1</sup> provides the rationale for selecting the tank geometry and the dimensions. The tank was filled with Freon 113 to about 84 percent by volume. A jet nozzle is positioned along the tank's major axis near the one end of the tank to provide fluid mixing. Two mixer pumps located outside the tank are supplied with vapor free liquid by a liquid acquisition device (LAD).

Two flat heaters, designated as heater A, and heater B, are immersed in the fluid. Heater A, is located within 0.5 cm from the end of the tank wall opposite to the jet nozzle. Heater B, is located off the tank major axis and approximately 2.5 cm away from the wall. Both the heaters are of the same size, except that heater A, is bent to a 12.1-cm radius to follow the curvature of the tank wall. Figure 2 shows the heater configuration and some details of its assembly. The two heaters are constructed of an etched-foil element encased in silicon rubber insulation, which is sandwiched between two 304L stainless steel plates. The heating element is a 9.6-by 6.6-cm rectangle with a 0.64-cm circular cutout to provide passage for the thermistor probe. Each steel plate has a thickness of 0.191 cm, narrowing to 0.089 cm near the perimeter weld. The outside dimensions of the heater assembly are 10.46 by 7.42 cm. The total surface area (both sides of the heater) is 155 cm<sup>2</sup>. The heater assembly is welded to a standoff tube which supports the assembly and contains the leads. The total mass of each heater, excluding the standoff tube and thermistor, is 0.214 kg, and thermal capacitance is estimated to be 0.10 kJ/C. Power is supplied to the heater by a battery pack consisting of 96 F-size alkaline cells.

The primary measurements during the heating phase of TPCE include the tank pressure, heater power, heater surface temperature and the liquid temperature as functions of time. The temperature probes are thermistors encapsulated in stainless steel sheaths. Thermistors T1, T2, T4, and T5 measure the liquid temperatures at various locations in the tank. Exact locations of the thermistors with respect to the tank wall and heaters are given in references 1 and 2. Thermistors T3 and T6 measure the surface temperature of heaters A and B, respectively. Three accelerometers are installed to the tank support to measure acceleration in three axes. In addition to the digital data, video observations are recorded by two modified 8-mm format camcorders. The range, resolution and accuracy of each measuring device are described in detail by Bentz.<sup>1</sup>

Constraints were imposed from both conducting experimentation on the STS and the fluid mixing experiment requirements. One such constraint was the use of a noncondensable gas to provide the necessary amount of liquid subcooling to avoid pump cavitation at higher flowrates. For a well defined boiling experiment, one would like to carefully degas the liquid such that dissolved gases are removed. For TPCE, Freon 113 was first degassed and a small amount of helium was added to provide 3 to 4 °C of liquid subcooling. The partial pressure of the noncondensable gas,  $P_{nc}$ , and the tank total pressure,  $P_t$ , during the experiment varied from 4 to 5 kPa and 40 to 60 kPa, respectively. The STS background acceleration level was around 10<sup>-6</sup> g with disturbance levels of 10<sup>-4</sup> g.



Thirty-eight fluid mixing tests, consisting of various combinations of jet flowrates and heaters were performed. The initial condition of each test run was established by heating the fluid with either heater A, or heater B, or both heaters on. The heating phase for each test lasted for 10 min. Video observation of the first 2 min of the heating period was recorded for each test. There was no video recording between 2 to 10 min of heating. At the end of heating period, the video was turned on 2 sec before the start of the mixing experiment to observe the process at the end of 10 min of heating. The heating rate for each test was constant, but varied from 6.9 to 18.5 W during the test matrix. The heat flux corresponding to the above heating rates, ranged from 0.22 to 1.19 kW/m<sup>2</sup>. To our knowledge, the results of the heating phase of this experiment, constitute the first set of pool boiling data in the long duration low gravity environment of the STS.

### Results and Discussion

The unique feature of the experimental results is the demonstration of steady nucleate pool boiling in a long duration low gravity environment. Figure 3 shows the heater surface temperature,  $T_w$ , as a function of heating time for three different test runs. For run 14 (heater A on), with a heat flux of 1.07 kW/m<sup>2</sup>, the heater temperature reaches a constant value, after approximately 4 min of heating. The heater temperature history thereafter shows the sustainability of nucleate boiling at this heat flux, in low gravity. The same conclusion can be drawn for run 17 with heater B on. However, when both heaters A and B are on simultaneously, the wall heat flux is 0.22 kW/m<sup>2</sup>. The heater temperature in this case increases monotonically, and boiling was not observed during 10 min of heating.

Figures 4(a) to (c) are still photographs taken from the flight videotape for run 37. The sequence of photographs clearly shows the inception, growth and departure of bubbles from the surface of heater B. Figure 4(a), taken 45 sec after heater B was turned on, shows the location of the ullage bubble (bubble corresponding to 16 percent vapor volume). This configuration represents the approximate location of ullage bubble at the start of the heating phase for most of the test runs. In some cases, the bubble was attached to either heater A or heater B. Figure 4(a) also shows the inception of a bubble on the surface of heater B. Figure 4(b) shows the growth of the bubbles while they are still attached to the heater. Time elapsed between Figs. 4(a) and (b) is 42 sec. Four bubbles of sizes ranging from 0.6 to 1.8 cm can be clearly seen on the heater surface. The length of the heater (10.46 cm), is used as a scale to estimate the bubble size. Figure 4(c), taken after 109 sec of heating time, clearly shows the

departure of a bubble from the heater surface. The bubble departure diameter in this case was about 2.5 cm. The bubble diameters at the point of departure ranged between 2.0 to 3.8 cm.

Figure 5 shows heater B surface temperature and the liquid temperature measured by thermistors T6 and T1, respectively, for run 37. Also included in the figure are the tank pressure and the saturation temperature of Freon 113 at the tank pressure. The thermistor T1 measures the liquid temperature farthest from either heater A or heater B. The liquid subcooling is defined with respect to T1. Careful observation of Fig. 5 along with Figs. 4(a) to (c), shows that the heater surface temperature,  $T_w$  (thermistor T6), is slightly below the saturation temperature,  $T_g$ , of Freon 113 at the point of bubble inception. This is due to the presence of noncondensable gas in the system. Also note that during the bubble growth and the bubble departure, the heater temperature continued to increase. This is due to the fact that the heater was quite large (10.46 by 7.42 cm), relative to the bubble sizes, and the temperature was measured only in one location. At the early stage of boiling at this low heat flux only a few bubbles (in some cases one or two) were formed. If the thermistor T6, happened to be away from the point of bubble formation and departure, it did not respond to the events. However, as boiling progressed, bubbles were formed over the entire heating surface. The heater temperature dropped and finally attained a constant value. Figure 5 clearly shows that for run 37, the heater temperature reached a constant value after 4 min of heating. The heater temperature histories in the absence of video data for most of the test runs conclusively demonstrate the sustainability of nucleate pool boiling, at these low heat flux levels in a long duration low gravity environment. For run 37, the heat flux was 0.95 kW/m<sup>2</sup>. The wall superheat,  $\Delta T_{sat}$ , during the stable nucleate boiling for this case was about 3.5 °C for a liquid subcooling,  $\Delta T_{sub}$ , of 3.3 °C.

Heater B temperature variation for run 19, which is almost identical to run 37, is shown in Fig. 6. During the stable nucleate boiling a wall superheat of 3.5 °C was attained for a heat flux of 1.00 kW/m<sup>2</sup>, and liquid subcooling of 3.6 °C. A significant difference between run 19 and run 37, is that for run 19 bubble inception was not observed during 2 min of heating. The values of wall superheat during nucleate boiling for all other runs along with their corresponding heat flux values are listed in Table 1. The table does not include runs 33 to 36, because boiling was not observed in these cases.

Figures 7(a) to (c) show the boiling occurring on heater A for run 14. At the start of the heating period (not shown in figures) the nearly spherical ullage bubble was touching one end of heater A. Figure 7(a) shows



the position of ullage bubble after 58 sec of heating. The ullage assumed a nearly symmetrical position with respect to heater A. The gap between the heater surface and the bubble interface is about 0.5 cm. Figure 7(b) shows boiling inception at 102 sec of heating. Bubble departure was not observed during the first 2 min of video recording. Figure 7(c) is a still photograph from videotape at the end of 10 min of heating. This photograph clearly shows numerous bubbles of varying sizes departing from the heater surface. Heater A surface temperature (thermistor T3), the liquid temperature (T1), and the tank pressure variation ( $P_t$ ) with heating time for run 14 is shown in Fig. 8. Heater temperature reached a constant value after 4 min of heating. The wall superheat,  $\Delta T_{\text{sat}}$ , during nucleate boiling was 2.2 °C.

Straub et al.<sup>11</sup> in their discussion of relatively high heat flux pool boiling results, with Freon 113, in short duration (about 20 sec for a given heat flux) low gravity experiments noted, "In the microgravity experiment after each heat flux step the temperature increase shows a tendency of an asymptotic constant value. It can not be excluded that with a larger heater surface and a longer heat flux period, steady state boiling would have been achieved." The results presented in this paper clearly demonstrate the sustainability of stable nucleate pool boiling in low gravity at considerably lower heat fluxes than those reported by Straub et al.<sup>11</sup>

In most test runs with heater A and some with heater B, boiling inception was delayed and heater wall superheat reached considerably higher values even at these low heat fluxes. Figure 9 shows that for run 7 (heater B on), heater wall superheat,  $\Delta T_{\text{sat}}$ , reached a value of 10.5 °C before boiling occurred. Figure 10 which is a still photograph taken from the video of run 17 at the end of 10 min heating shows a growing bubble (about 5.5-cm diameter) attached to the heater surface. Figures 11 and 12 show the heater A surface temperature variation (T3) as a function of heating time for runs 22 and 21, respectively. For run 21 (Fig. 12) the heater temperature continued to increase for about 7.5 min with no change in tank pressure. The wall superheat reached a value of 13 °C, followed by either violent boiling or flashing of superheated liquid as evidenced by pressure spikes of considerable magnitude and an abrupt drop in heater wall temperature.

### Conclusion

The results of an experimental study of nucleate pool boiling in the low gravity environment of the STS are presented. The experimental data clearly demonstrates that stable nucleate pool boiling is viable in long duration low gravity environments for very low heat fluxes. The data also show that high wall superheat may occur even at these low heat fluxes.

1. Bentz, M.D., "Tank Pressure Control in Low Gravity by Jet Mixing," NASA CR-191012, 1992 (to be published).
2. Bentz, M.D., Meserole, J.S., and Knoll, R.H., "Jet Mixing in Low Gravity: Results of the Tank Pressure Control Space Experiment," AIAA Paper 92-3060, AIAA/SAE/ASME/ASEE 28th Joint Propulsion Conference and Exhibit, July 1992.
3. Usiskin, C.M., and Siegel, R., "An Experimental Study of Boiling in Reduced and Zero Gravity Fields," *J. Heat Transfer*, vol. 83, no. 3, Aug. 1961, pp. 243-253.
4. Siegel, R., and Keshock, E.G., "Effects of Reduced Gravity on Nucleate Boiling Dynamics in Saturated Water," *A.I.Ch.E. Journal*, vol. 10, no. 4, July 1964, pp. 509-517.
5. Cochran, T.H., and Aydelott, J.C., "Effects of Subcooling and Gravity Level on Boiling in the Discrete Bubble Region," NASA TN D-3449, Sept. 1966.
6. Siegel, R., and Howell, J.R., "Critical Heat Flux for Saturated Pool Boiling from Horizontal and Vertical Wire in Reduced Gravity," NASA TN D-3123, Dec. 1965.
7. Cochran, T.H., Aydelott, J.C., and Spuckler, C.M., "Experimental Investigation of Nucleate Boiling Bubble Dynamics in Normal and Zero Gravity," NASA TN D-4301, 1968.
8. Siegel, R., "Effects of Reduced Gravity on Heat Transfer," *Advances in Heat Transfer*, vol. 4, 1967, pp. 143-228.
9. Zell, M., Straub, J., and Weinzierl, A., "Nucleate Pool Boiling in Subcooled Liquid Under Microgravity—Results of TEXUS Experimental Investigations," *Proceedings of the 5th European Symposium on Material Sciences Under Microgravity Conditions*, ESA SP-222, 1984.
10. Zell, M., and Straub, J., "Microgravity Pool Boiling—TEXUS and Parabolic Flight Experiments," *Proceedings of 6th European Symposium on Material Sciences under Microgravity Conditions*, ESA SP-256, Feb. 1987.
11. Straub, J., Zell, M., and Vogel, B., "Pool Boiling in a Reduced Gravity Field," *Proceedings of the 9th International Heat Transfer Conference*, Aug. 19-24, 1990.

TABLE 1.—WALL SUPERHEAT DURING  
NUCLEATE BOILING

Run number	$\Delta T_{sub}$ , °C	$\Delta T_{sat}$ , °C	q, kW/m <sup>2</sup>	Heater
1	4.0	3.6	1.19	B
2	4.0	3.4	1.18	B
3	3.6	3.8	1.14	B
4	3.8	3.8	1.13	B
5	3.9	3.4	1.11	B
6	4.0	3.6	1.10	B
7	4.1	3.5	1.10	B
8	4.7	3.3	1.08	B
9	4.9	2.0	1.11	A
10	4.9	.69	1.10	A
11	4.6	.71	1.10	A
12	4.6	.85	1.08	A
13	4.8	.60	1.08	A
14	4.9	2.2	1.07	A
15	5.0	.66	1.07	A
16	4.6	.68	1.06	A
17	3.8	3.6	1.03	B
18	3.7	3.2	1.01	B
19	3.6	3.5	1.01	B
20	3.5	2.8	1.01	B
21	3.1	.76	1.03	A
22	4.8	.53	1.03	A
23	4.1	.51	1.03	A
24	4.4	.83	1.03	A
25	3.5	3.8	.96	B
26	3.7	3.3	.96	B
27	3.7	3.5	.96	B
28	3.4	3.6	.96	B
29	3.1	.79	.99	A
30	4.3	.47	.99	A
31	3.1	.55	.99	A
32	4.5	.70	.99	A
37	3.3	3.5	.95	B
38	4.1	.36	.96	A

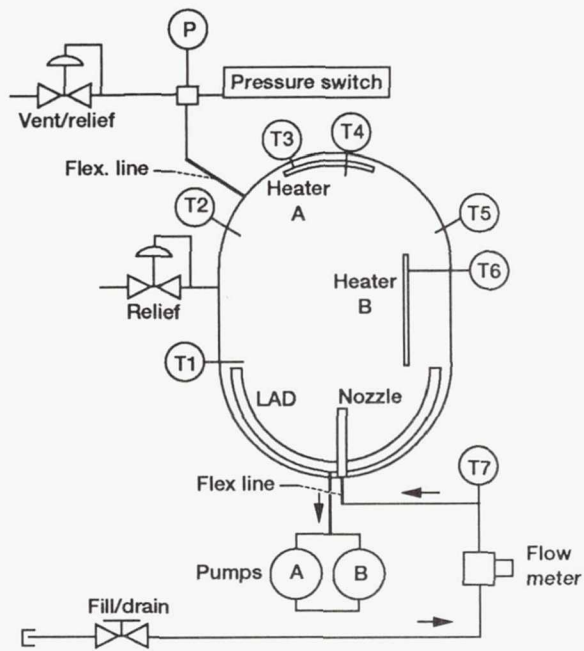

Figure 1.—Schematic of experimental system.

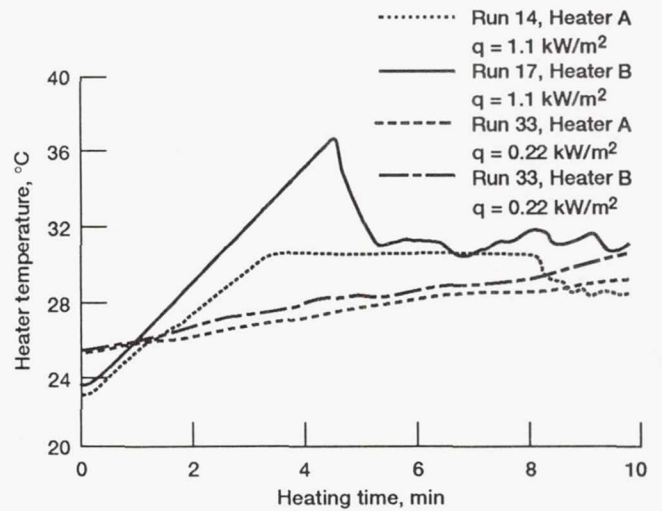

Figure 3.—Heater temperature as a function of time for various heat fluxes.

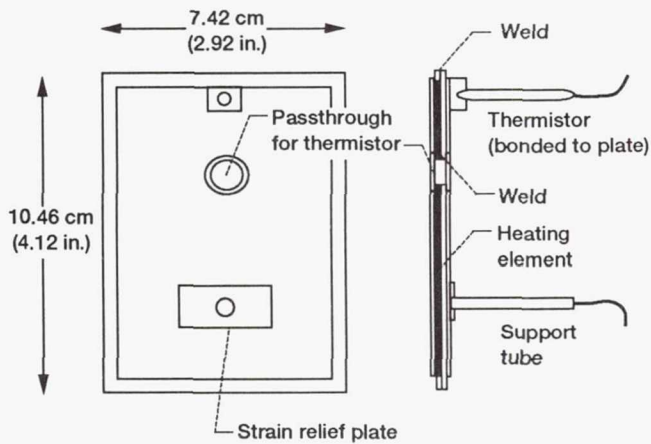
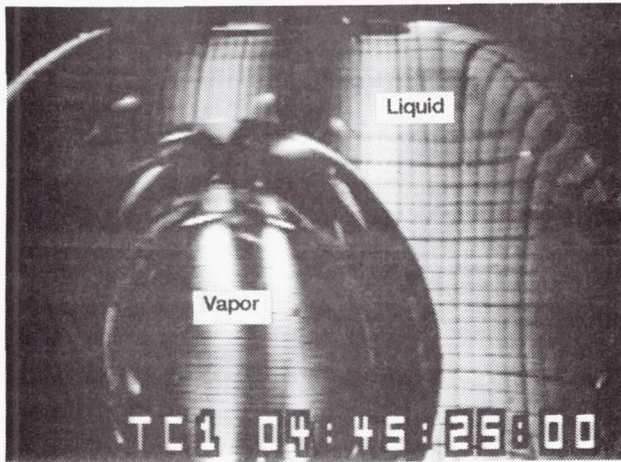

Figure 2.—Heater configuration and assembly.





(a) Bubble formation: Elapsed heating time = 45 seconds.



(b) Bubble growth: Elapsed heating time = 97 seconds.

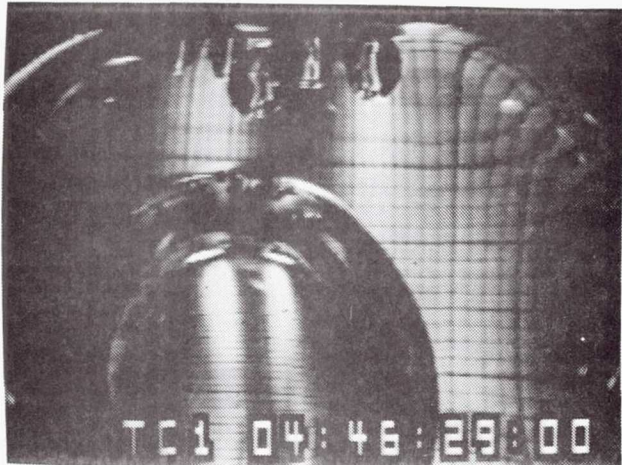

(c) Bubble departure: Elapsed heating time = 109 seconds.

Figure 4.—Bubble formation, growth and departure from heater B; Run no. 37.

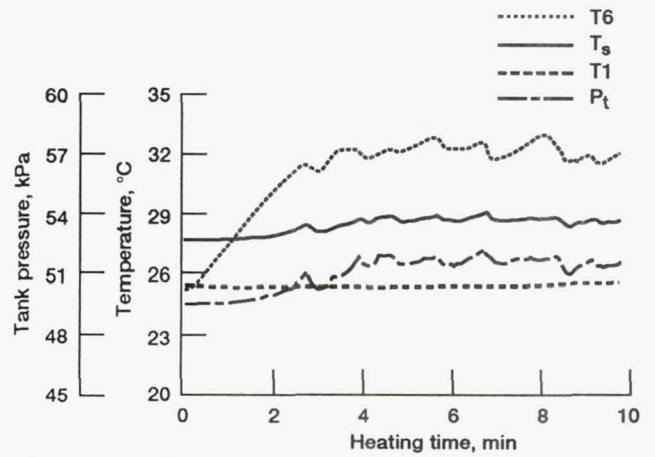

Figure 5.—Heater and liquid temperatures and tank pressure as functions of time: Run no. 37.

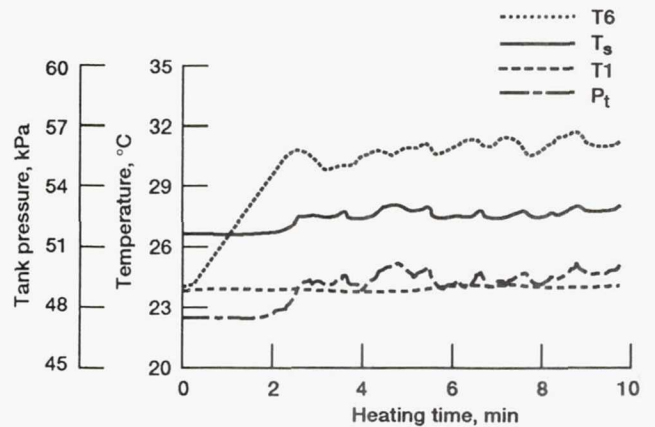
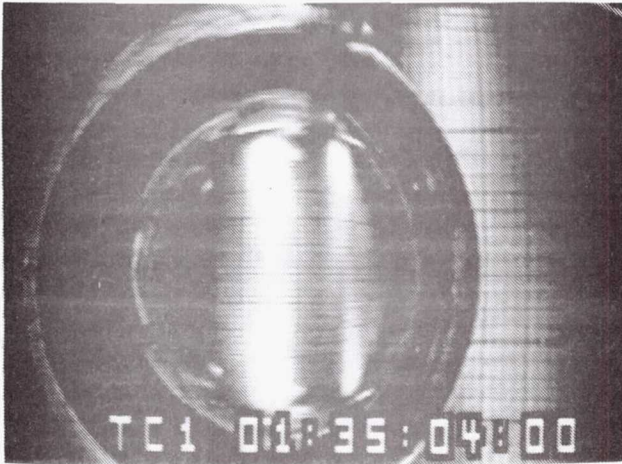

Figure 6.—Heater and liquid temperatures and tank pressure as functions of time: Run no. 19.





(a) Nearly symmetric ullage location time: Elapsed heating time : 58 seconds.



(b) Boiling on the heater surface: Elapsed heating time = 102 seconds.



(c) Boiling process after 9 minutes 45 seconds.

Figure 7.—Boiling process on heater A; Run no. 14.

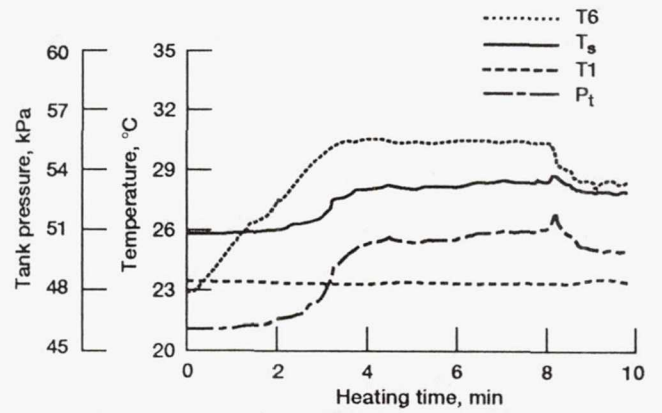

Figure 8.—Heater and liquid temperatures and tank pressure as functions of time: Run no. 14.

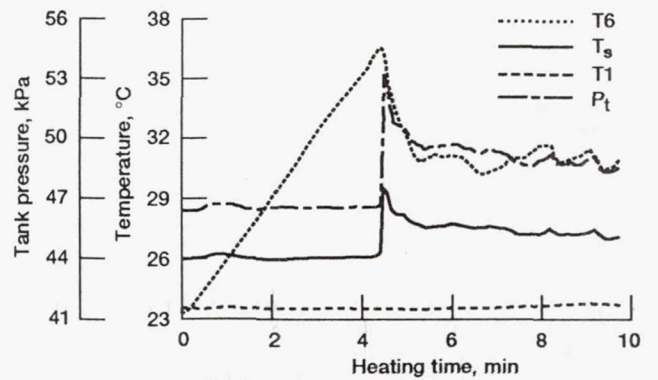

Figure 9.—Heater and liquid temperatures and tank pressure as functions of time: Run no. 17.

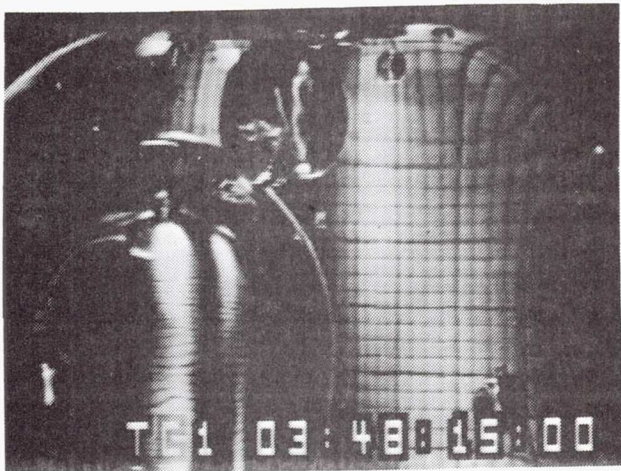

Figure 10.—Bubble growth on heater B: Run no. 17.

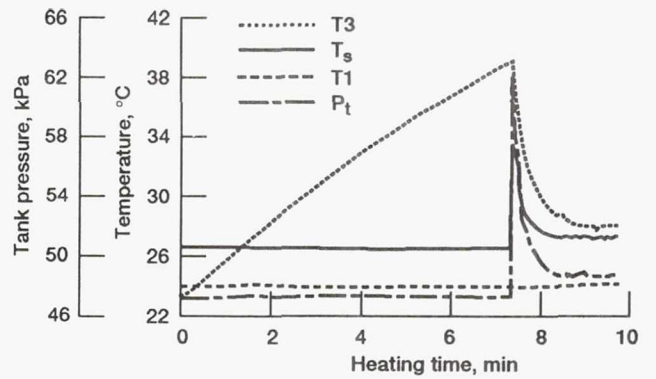

Figure 12.—Heater and liquid temperatures and tank pressure as functions of time: Run no. 21.

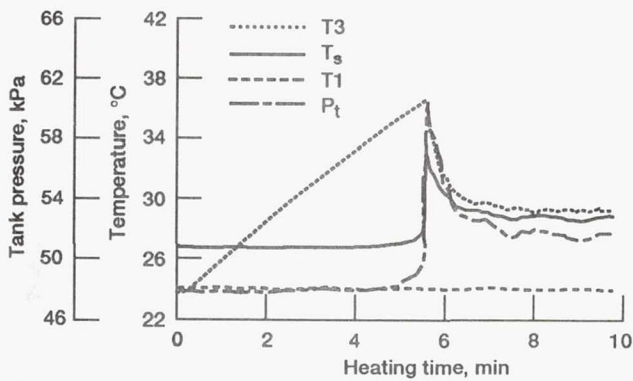

Figure 11.—Heater and liquid temperatures and tank pressure as functions of time: Run no. 22.



# REPORT DOCUMENTATION PAGE

Form Approved  
OMB No. 0704-0188

Public reporting burden for this collection of information is estimated to average 1 hour per response, including the time for reviewing instructions, searching existing data sources, gathering and maintaining the data needed, and completing and reviewing the collection of information. Send comments regarding this burden estimate or any other aspect of this collection of information, including suggestions for reducing this burden, to Washington Headquarters Services, Directorate for Information Operations and Reports, 1215 Jefferson Davis Highway, Suite 1204, Arlington, VA 22202-4302, and to the Office of Management and Budget, Paperwork Reduction Project (0704-0188), Washington, DC 20503.

1. AGENCY USE ONLY (Leave blank)	2. REPORT DATE January 1993	3. REPORT TYPE AND DATES COVERED Technical Memorandum	
4. TITLE AND SUBTITLE Nucleate Pool Boiling in the Long Duration Low Gravity Environment of the Space Shuttle		5. FUNDING NUMBERS  WU-589-01-2C	
6. AUTHOR(S)  M.M. Hasan, C.S. Lin, R.H. Knoll, M.D. Bentz, and J.S. Meserole		8. PERFORMING ORGANIZATION REPORT NUMBER  E-7485	
7. PERFORMING ORGANIZATION NAME(S) AND ADDRESS(ES)  National Aeronautics and Space Administration Lewis Research Center Cleveland, Ohio 44135-3191		10. SPONSORING/MONITORING AGENCY REPORT NUMBER  NASA TM-105973 AIAA-93-0465	
9. SPONSORING/MONITORING AGENCY NAMES(S) AND ADDRESS(ES)  National Aeronautics and Space Administration Washington, D.C. 20546-0001		11. SUPPLEMENTARY NOTES  Prepared for the 31st Aerospace Sciences Meeting and Exhibit sponsored by the American Institute of Aeronautics and Astronautics, Reno, Nevada, January 11-14, 1993. M.M. Hasan, C.S. Lin, and R.H. Knoll, NASA Lewis Research Center. M.D. Bentz and J.S. Meserole, Boeing Defense and Space Group, Seattle, Washington 98101. Responsible person, M.M. Hasan, (216) 433-7494.	
12a. DISTRIBUTION/AVAILABILITY STATEMENT  Unclassified - Unlimited Subject Category		12b. DISTRIBUTION CODE	
13. ABSTRACT (Maximum 200 words)  The paper presents the results of an experimental study of nucleate pool boiling performed in the low gravity environment of the space shuttle. Photographic observations of pool boiling in Freon 113 were obtained during the "Tank Pressure Control Experiment," flown on the Space Transportation System, STS-43 in August 1991. Nucleate boiling data from large (relative to bubble sizes) flat heating surfaces (0.1046 by 0.0742m) was obtained at very low heat fluxes (0.22 to 1.19kW/m <sup>2</sup> ). The system pressure and the bulk liquid subcooling varied in the range of 40 to 60 kPa and 3 to 5°C, respectively. Thirty-eight boiling tests, each of a 10-min duration for a given heat flux, were conducted. Measurements included the heater power, heater surface temperature, the liquid temperature and the system pressure as functions of heating time. Video data of the first 2min of heating was recorded for each test. In some tests the video clearly shows the inception of boiling and the growth and departure of bubbles from the surface during the first 2min of heating. In the absence of video data, the heater temperature variation during heating shows the inception of boiling and stable nucleate boiling. During the stable nucleate boiling the wall superheat varied between 2.8 to 3.8°C for heat fluxes in the range of 0.95 to 1.19kW/m <sup>2</sup> . The wall superheat at the inception of boiling varied between 2 to 13 °C.			
14. SUBJECT TERMS		15. NUMBER OF PAGES 10	
17. SECURITY CLASSIFICATION OF REPORT Unclassified		16. PRICE CODE A02	
18. SECURITY CLASSIFICATION OF THIS PAGE Unclassified	19. SECURITY CLASSIFICATION OF ABSTRACT Unclassified	20. LIMITATION OF ABSTRACT	



National Aeronautics and  
Space Administration

**Lewis Research Center**  
Cleveland, Ohio 44135

Official Business  
Penalty for Private Use \$300

**FOURTH CLASS MAIL**

ADDRESS CORRECTION REQUESTED



Postage and Fees Paid  
National Aeronautics and  
Space Administration  
NASA 451

**NASA**

---