

52-44

140707

p- B-21

Technologies

Henry W. Brandhorst, Jr.

Photovoltaic Technology

Solar cells have been the workhorse of the space program for nearly all missions lasting longer than a few weeks. Several components are needed for reliable power production from solar cells. Solar cells must be interconnected to provide the requisite voltage and current levels. This matrix must be supported on a substrate such as aluminum honeycomb or a plastic like Kapton. The individual cells also must be covered to provide protection against the electrons and protons found in the Earth's radiation belt and in ejecta from the Sun. Finally, some sort of deployment or erection mechanism must be supplied to extend the solar array from the spacecraft. The mass of the system is made up of these components, along with the power management and distribution system and the storage system needed to provide power during the dark phase.

Currently silicon solar cells are the prime power source for satellite use. Maximum individual efficiency is about 14 percent in volume

production of 200-1000 kW. Cell size ranges from 2 by 4 cm to 8 by 8 cm, and the cells cost about \$100 per watt. When these cells are mounted in an array, the overall power produced is about 100 W/m². The largest solar array built to date was that for Skylab and the Apollo Telescope Mount (ATM), with a total power of roughly 20 kW (fig. 8). In low Earth orbit, this array should have produced a bus power of 7.5 kW. (Charging efficiency and the cycle of a 60-minute day followed by a 40-minute night reduces the average power.) Because one-fourth of the array was lost during launch, the total power on orbit was reduced accordingly. The specific power (watts of electricity produced per kilogram of array mass) of these rigid panels was 10-15 W/kg. When combined with the nickel-cadmium electrochemical energy storage system, the total solar power system had a specific power of approximately 6 W/kg. Silicon arrays also powered the first Apollo lunar surface experiments package (ALSEP) on the Moon.



Figure 8

Skylab Solar Power

This photo shows the Skylab space station cluster with its large solar arrays. This is the largest solar power system yet put in space. These panels had a power production capacity of 10-15 W/kg and a total maximum power rating of about 20 kW, but loss of the left array during launch reduced the total power by about one fourth.

Present rigid solar arrays, typified by the Tracking and Data Relay Satellite (TDRS) in geosynchronous orbit, have a specific power of 25 W/kg and a cost of about \$750/W. Total power is 2.7 kW, which is typical of a communications satellite (see fig. 9). A lightweight silicon solar array with a Kapton substrate was tested on the Shuttle in 1984. This array had a specific power of 66 W/kg and was sized to produce 12 kW of power, although only enough cells to produce about 200 W were actually put in place. This array was 102 feet long and 13 feet wide.

Advances expected in the near future include the lightweight, 50-micrometer-thick silicon solar cell blanket. These cells are one-fourth the thickness of conventional cells. The specific power goal for these lightweight arrays is 300 W/kg. These cells and arrays are aimed at applications where mass is critical, such as uses in geosynchronous orbit and exploration of the Moon and the solar system. These cells are also more resistant to the damaging effects of space radiation than thicker silicon solar cells and thus promise longer life in such orbits.

Figure 9

Tracking and Data Relay Satellite (TDRS)

A constellation of three Tracking and Data Relay Satellites is being placed into geosynchronous Earth orbit (GEO) to enable satellites in low Earth orbit (LEO) to be in nearly constant (80% of the time) communication with their ground stations. Signals to and from the LEO satellites will be relayed through the TDRS and a single ground station at White Sands, New Mexico.

These large satellites (2200 kilograms) are powered by solar arrays spanning over 50 feet. The solar arrays provide more than 1700 watts of electrical power and have a projected lifetime of over 10 years. During the short time that the satellite is in the shadow of the Earth, full power is supplied by nickel-cadmium batteries.

Artist: P. J. Weisgerber

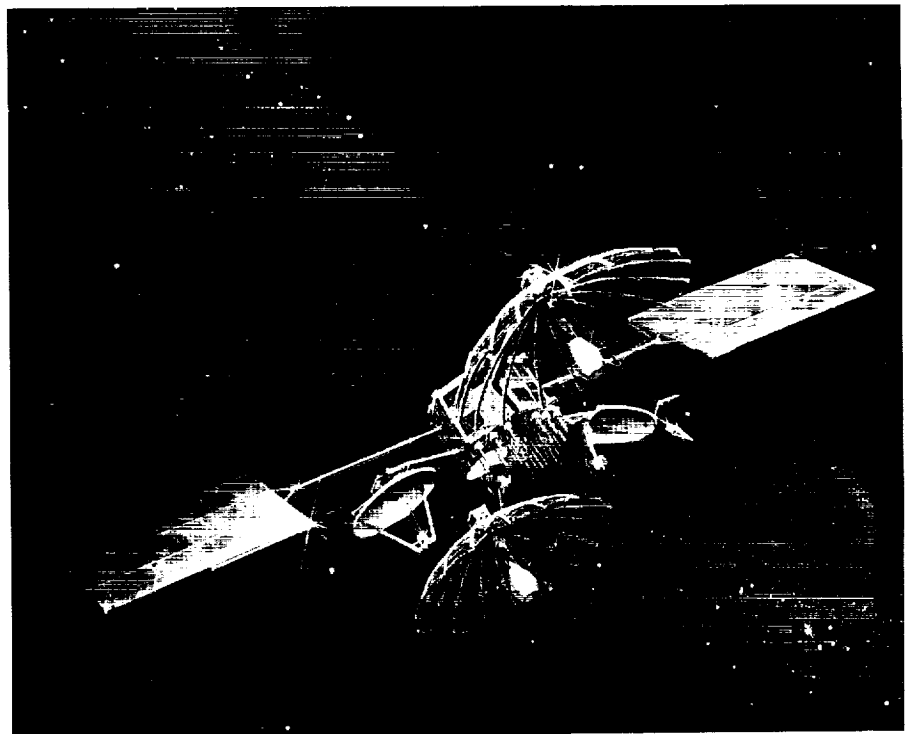

Gallium arsenide (GaAs) solar cells (fig. 10) are being developed as an alternative to silicon cells. These cells have a higher efficiency (17-21%) than silicon cells and are less sensitive to heat. Present production capability is about 10 kW/year. Current costs of GaAs cell arrays are expected to

be about \$1500/W, with a cost goal of \$500/W. Array technology is expected to be similar to silicon cell technology. Gallium arsenide cells were used on the Moon to power the U.S.S.R. Lunokhod rover (fig. 11). Flight of GaAs arrays is expected in the late 1980s.

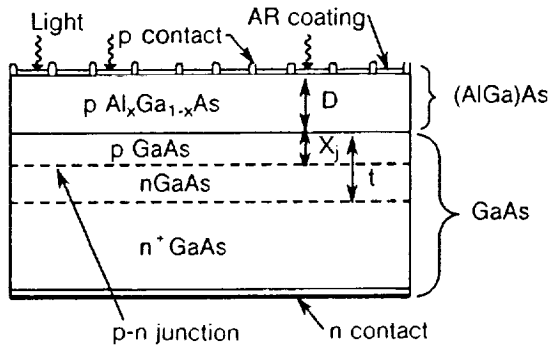

p contact: Au-Zn-Ag
 n contact: Au-Ge-Ni-Ag
 AR coating: Ta_2O_x
 p $Al_xGa_{1-x}As$: $x = 0.87$
 Cell size = 2 cm x 2 cm

$D < 0.5 \mu m$
 $X_j \leq 0.5 \mu m$
 $t > 10 \mu m$

Figure 10

Structure of Aluminum Gallium Arsenide/Gallium Arsenide Solar Cell
 In this advanced version of a gallium arsenide (GaAs) solar cell, the aluminum gallium arsenide [(AlGa)As] layer nearest the top (p contact) increases the efficiency of the cell compared to that of the simple GaAs cell. Gallium arsenide cells can have higher efficiencies than silicon cells, and advanced design GaAs cells may be able to achieve efficiencies of 30 percent.

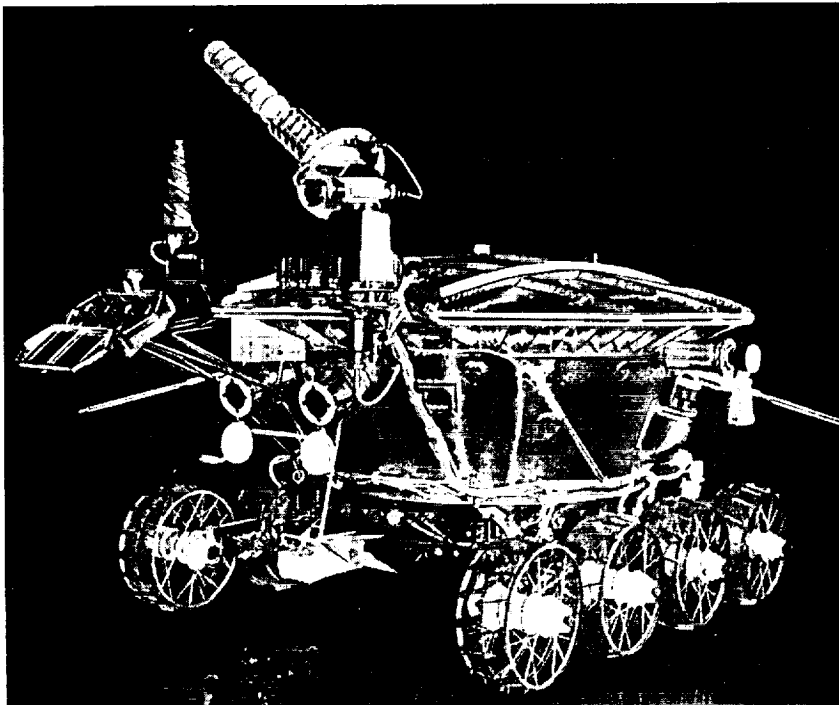

Figure 11

Lunokhod Rover
 The Soviet Lunokhods were unmanned rovers which traveled from 10 km (Lunokhod 1) to nearly 40 km (Lunokhod 2) across the lunar surface transmitting images and a variety of scientific data back to Earth. These Lunokhod rovers were powered by GaAs solar cells.

An emerging technology aimed at achieving lower GaAs array cost is to use sunlight concentration. Miniature Cassegrainian concentrator elements 2 inches in diameter and 1/2 inch thick are being developed (fig. 12). These devices concentrate sunlight about 100 times and illuminate 5- by 5-mm GaAs cells. Because of the small size and novel design, cell operating temperature is about 85°C, not much higher than the

60°C temperature at which a conventional silicon cell array in low Earth orbit operates. The cost of these emerging arrays is expected to be roughly one-third the cost of silicon arrays or about \$150-300/W. Alternative optical concepts, such as reflective or refractive Fresnel lenses, are also under study. Gallium arsenide arrays are expected to produce 160-180 W/m² at a specific power of 25-40 W/kg.

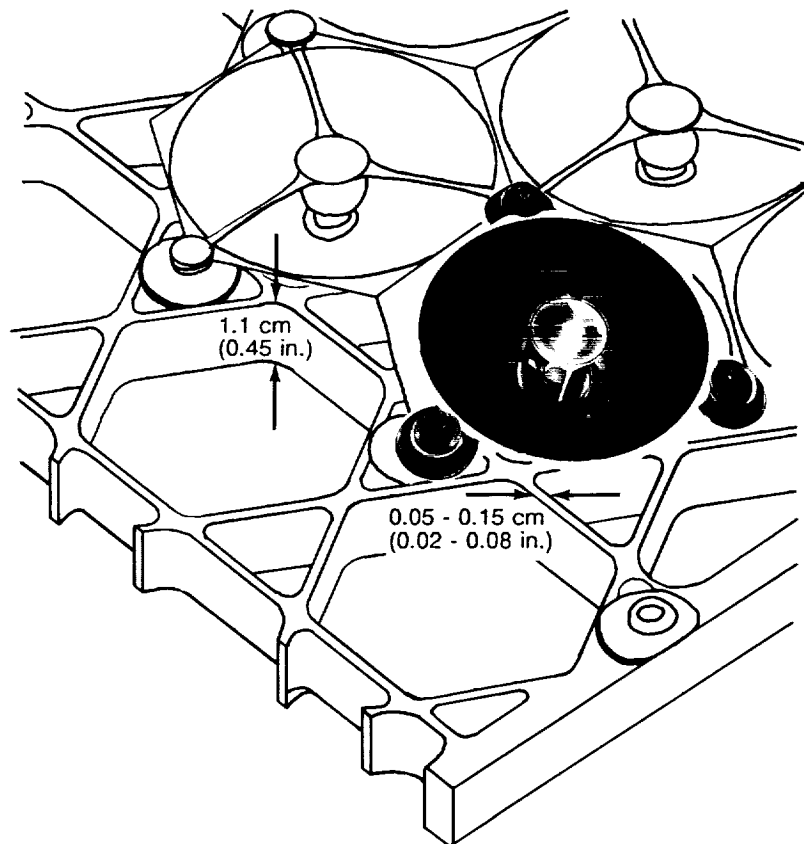

Figure 12

Miniature Cassegrainian Solar Concentrator

Small Cassegrainian optics concentrators, only about 5 cm in diameter and 1.2 cm thick, have been designed to concentrate sunlight on tiny (only 5 by 5 mm) gallium arsenide solar cells. This design provides a basic concentration factor approaching 100 to 1.

They are also more radiation-resistant than silicon arrays, both inherently and because of the shielding provided by the metallic concentrator element. Furthermore, cover-glass shielding can be provided at little increase in mass. This radiation resistance permits operation in heavy radiation orbits within the Van Allen belt (fig. 13) and opens the door to a solar-electric-propelled orbital

transfer vehicle (OTV). This technology is being explored for space station applications. It appears feasible to build such arrays in the 500-kW range (up to 1 MW with advanced higher efficiency cascade cells). Such power levels enable short trip times from LEO to GEO (several trips per month), and this technology appears suitable for lunar base operation.

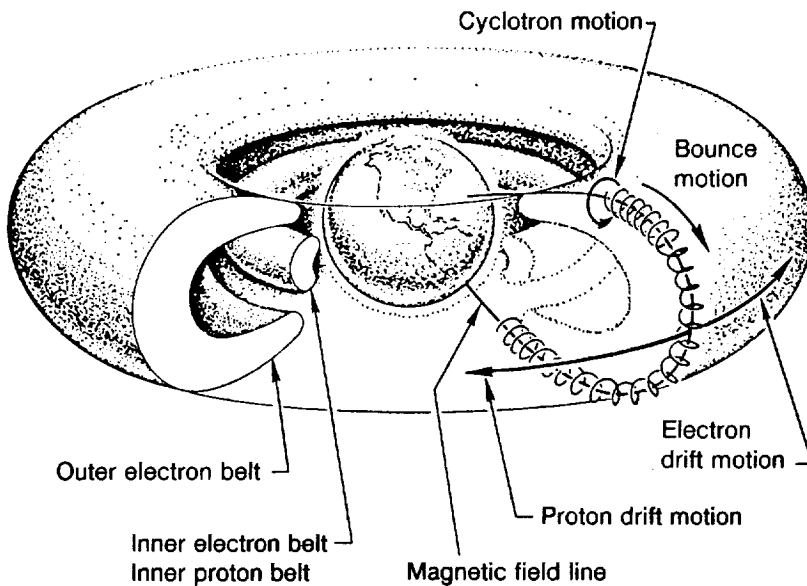

Figure 13

Van Allen Radiation Belt

Named for its discoverer, James A. Van Allen, the Van Allen belt is a zone of high-intensity particulate radiation surrounding the Earth beginning at altitudes of approximately 1000 km. The radiation of the Van Allen belt is composed of protons and electrons temporarily trapped in the Earth's magnetic field. The intensity of radiation varies with the distance from the Earth. Spacecraft and their occupants orbiting within this belt or passing through it must be protected against this radiation.

Ultralightweight GaAs cell technology has produced a cell only 6 micrometers thick with a 14-percent conversion efficiency and a specific power of 5 kW/kg. When coupled with lightweight array technology, such cells have applicability to GEO and lunar base operations.

An emerging cell technology is the cascade cell, made from combinations of elements from the third and fifth columns of the periodic table. Three junction cells arranged in tandem atop one another may be able to achieve 30-percent conversion efficiency at 100 times solar concentration and at 80°C. If development of these advanced cells is successful, very high power per unit area (approaching 300 W/m²) and a specific power of 75 W/kg appear feasible. These technologies may become available about 1990.

Photovoltaic systems could be used for daytime operation on the lunar surface and for power at stations in GEO or lunar orbit. The specific characteristics required

depend on the application. Solar arrays up to 300 kW with silicon planar or GaAs concentrator technology appear reasonable. Ultralightweight arrays based on silicon technology should be available by 1990, with GaAs technology following a few years later.

Operation on the lunar surface adds requirements. First, dust accumulation on cells or optical surfaces will degrade performance, and actual operating temperatures will be greater because of the nearby lunar surface. The dust and lunar environment may also affect the maximum array voltage as a result of arcing phenomena. Finally, arrays must be designed to accommodate the deep temperature cycling of the day-night cycle. The most likely use of solar arrays on the lunar surface will be to power daytime-only operations because the mass of known energy storage for the 2-week lunar night is large and makes the total system less attractive than nuclear power systems.

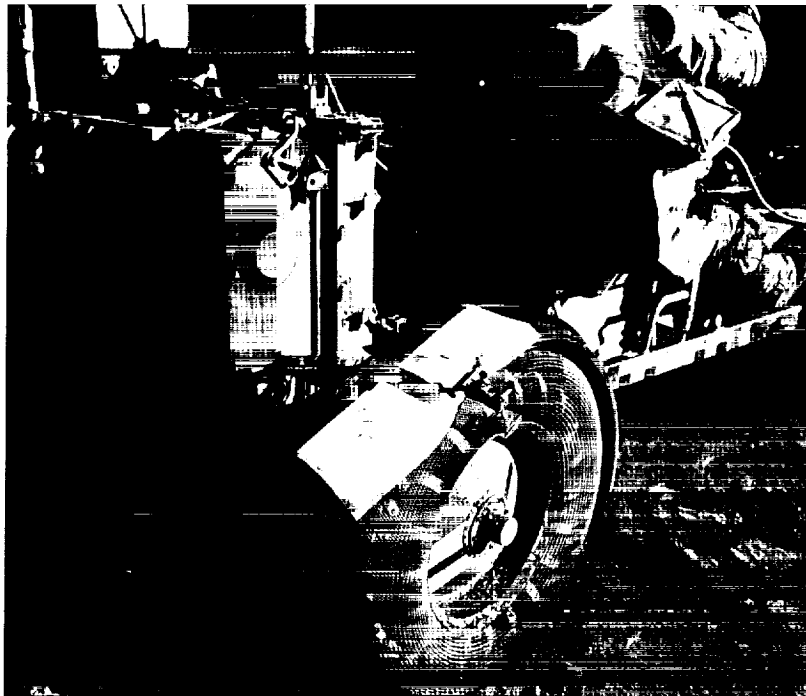
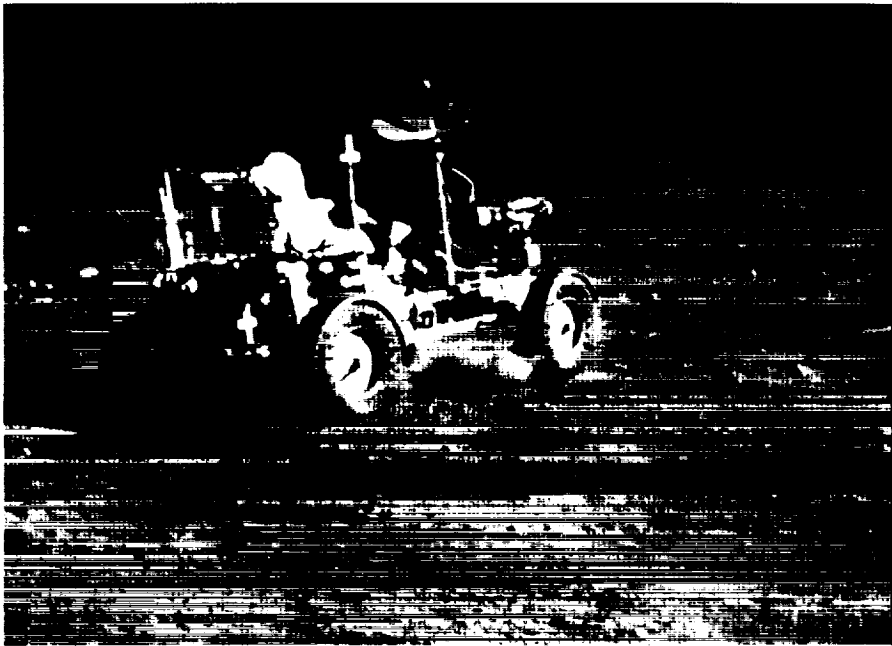

Lunar Dust

During the high-speed "Grand Prix" on the Apollo 16 mission, a large "rooster tail" of dust was thrown up behind the Rover (top), even though each wheel was equipped with a fender. During the first excursion on the Apollo 17 mission, part of the right rear fender was lost. Without the fender, the wheel threw up a big plume of dust which started to cover the Rover and the crew. This was such a hazard that further use of the Rover was in doubt. However, the astronauts rigged a makeshift fender (bottom) using a map, tape, and two clamps from the Lunar Module (LM), and this repair proved satisfactory for subsequent excursions. Thus, if it is not properly controlled, the dust thrown up by moving vehicles on the Moon could be a major contaminant of lunar equipment.

It has been suggested that lunar material could be mined for the production of photovoltaic devices (fig. 14). The production of high-capacity photovoltaics would be limited by the availability of

materials and manufacturing capability in space; thus, it is not considered plausible by 2010. However, the use of lunar-derived systems for energy storage should be investigated.

Figure 14

Production of Solar Cells From Lunar Material

Solar cells made from lunar silicon are a possibility. This block diagram shows a process developed by EMEC Consultants for the production of solar-cell-grade silicon from lunar soil. The process uses aluminum metal to reduce the plentiful silicon in the mineral anorthite, the most abundant mineral on the Moon. This silicon can potentially be purified and fabricated into solar cells.

In the process, aluminum metal becomes aluminum oxide, which is subsequently separated into aluminum and oxygen by electrolysis. Some of the aluminum is then recycled to produce more silicon, and some can be used for construction purposes. The oxygen can be liquefied and used for life support or for rocket propellant. Additional oxygen can be produced by electrolysis of the calcium oxide derived from the anorthite.

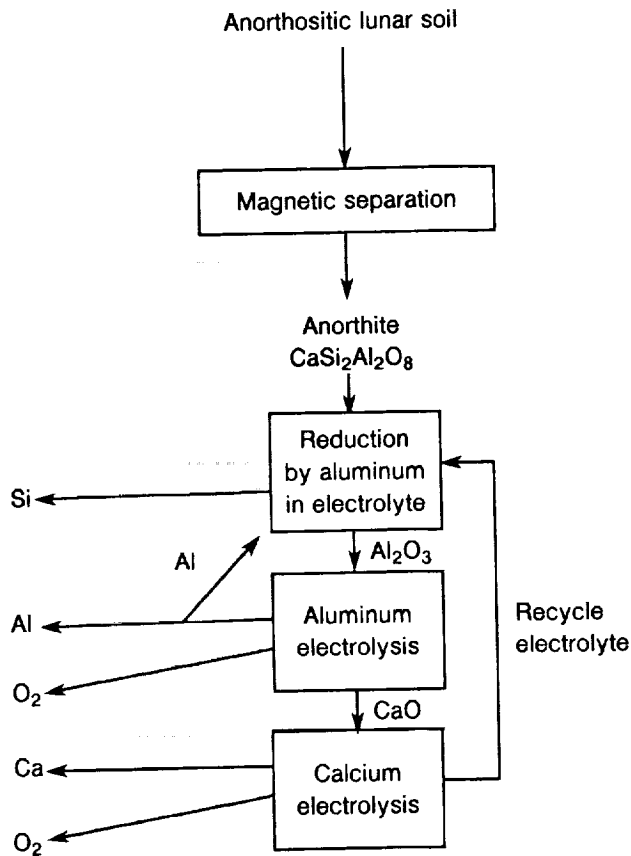

Solar Dynamic Technology

Solar dynamic systems consist of a mirror that focuses sunlight on a receiver (which may contain thermal storage) and a Carnot-cycle dynamic conversion system (with heat radiation). (See figure 15.) The most common conversion cycles studied are the Stirling (fig. 16), Rankine (fig. 17), and Brayton (fig. 18). All have cycle efficiencies in the 25- to 35-percent range. When research

on these systems for space use was terminated in the early 1970s, a Brayton system had been tested for a total of 38 000 hours (about 5 years). Commercial low-temperature (750°F) organic Rankine systems have also operated for tens of thousands of hours. Development of Stirling cycles is proceeding under the SP-100 Program, and space station research may support Brayton and Rankine cycle work.

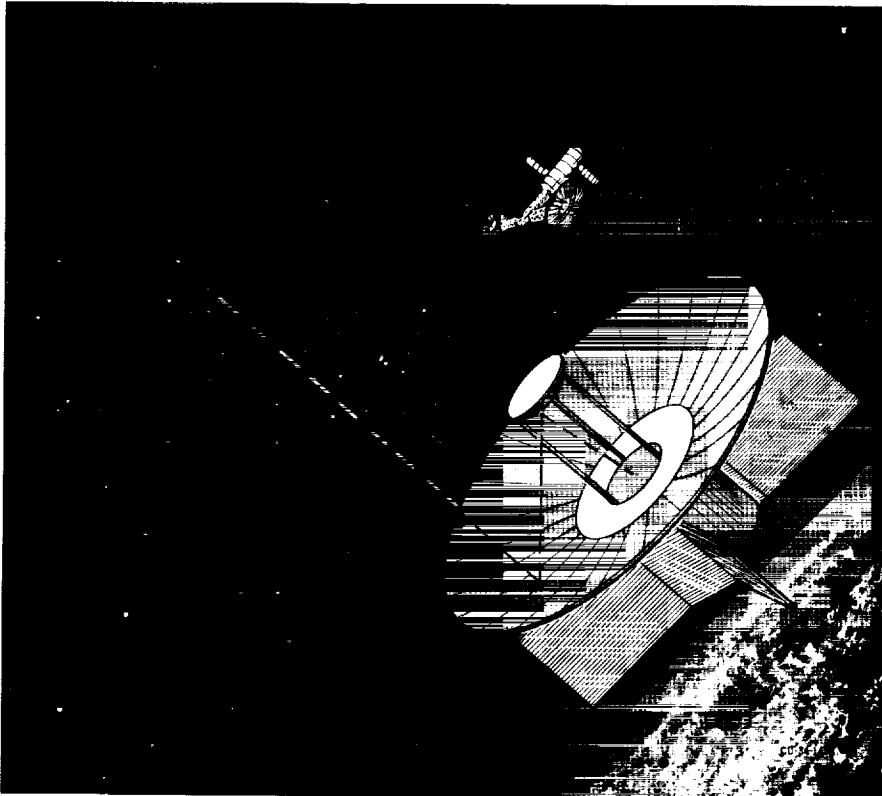

Figure 15

Solar Dynamic Power

Any system that uses solar energy to drive moving machinery which generates electricity is a solar dynamic system. Normally the solar energy is concentrated by mirrors to increase its intensity and create higher temperatures. Here, a Cassegrainian optics concentrator focuses energy on a heat engine.

ORIGINAL PAGE
BLACK AND WHITE PHOTOGRAPH

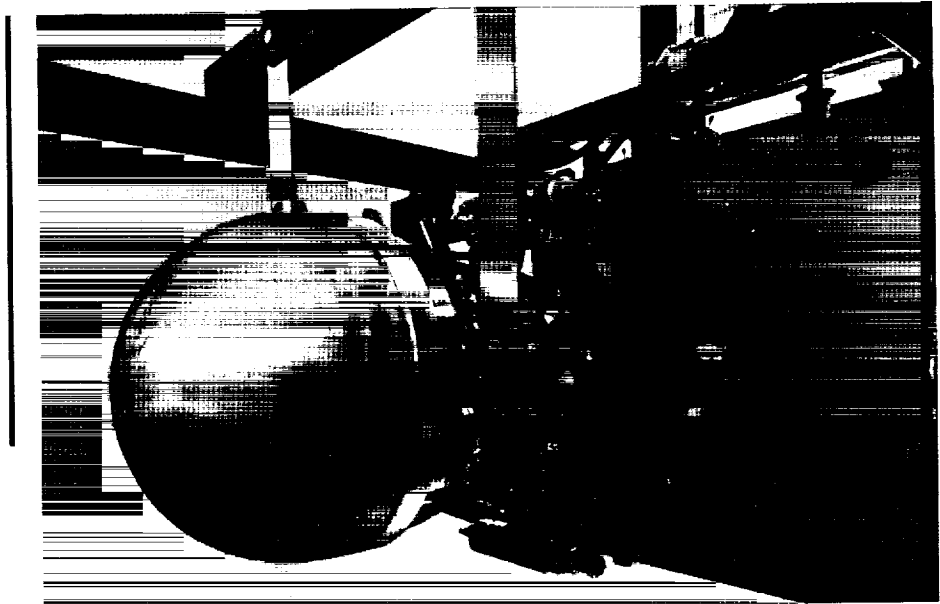
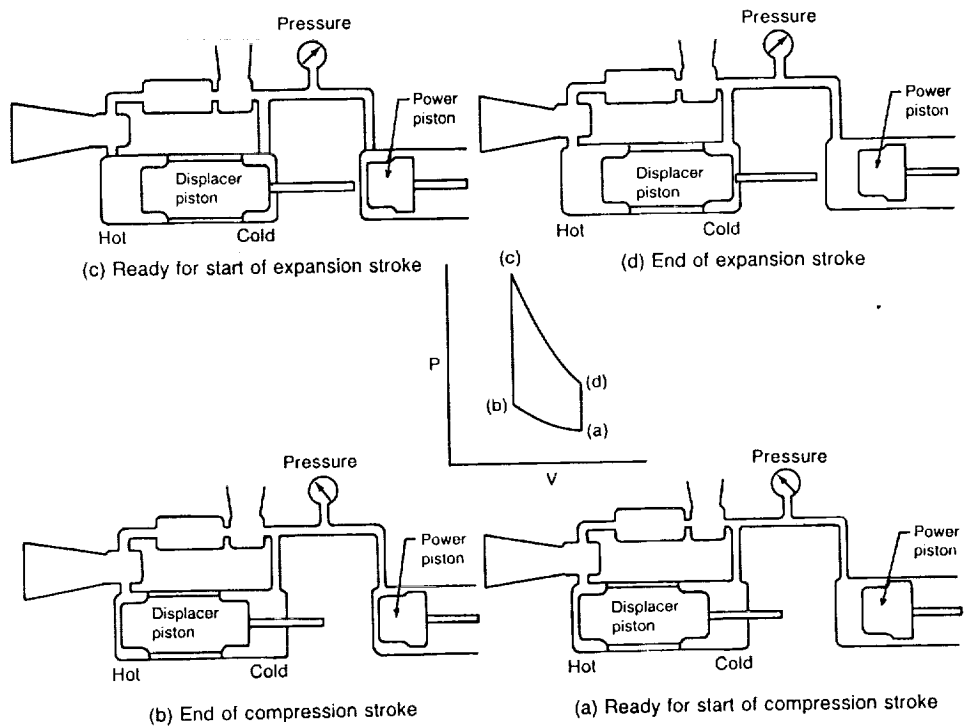

Figure 16

Stirling Cycle

In the Stirling engine, solar energy is used to heat a working gas and move a series of pistons which convert the heat energy into mechanical energy to drive an electric generator. Starting at (a), the power piston is moved in its cylinder by the momentum of the turning electric generator. The piston compresses the gas and reduces its volume until (b) is reached. Then solar heat (from the left) causes the gas to expand and move the displacer piston (c). This heat expansion greatly increases the pressure in the gas transfer line, and the pressure causes the power piston to move. The movement of the power piston turns the electric generator in the expansion stroke (d). Then the displacer piston is allowed to return to its original position (a), and the cycle repeats.



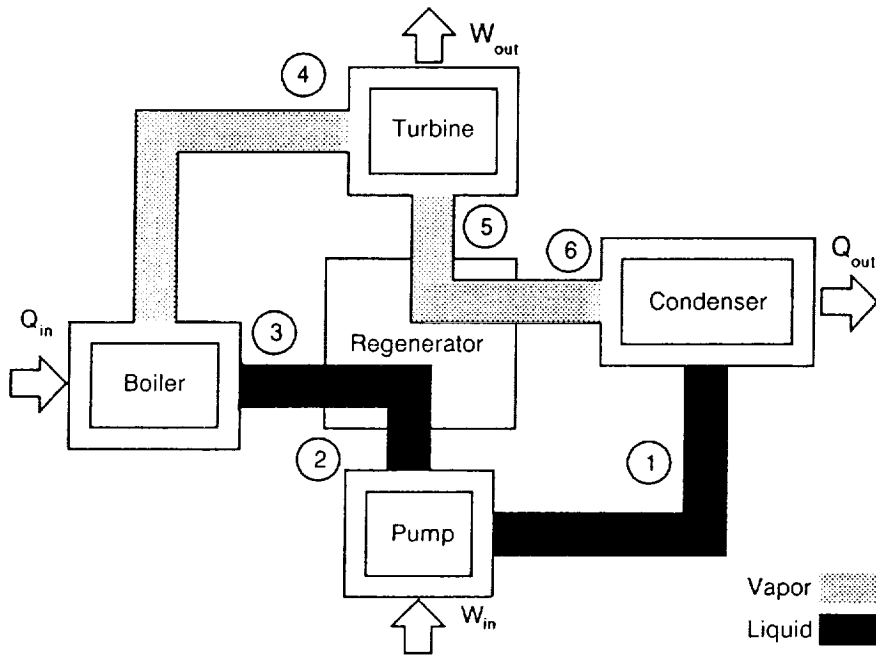

Figure 17

Rankine Cycle

In the Rankine engine, a working fluid (typically an organic liquid) is converted from a liquid to a gas by solar energy and the gas is used to run a turbine connected to an electric generator. The gas is then condensed, recycled, and reheated.

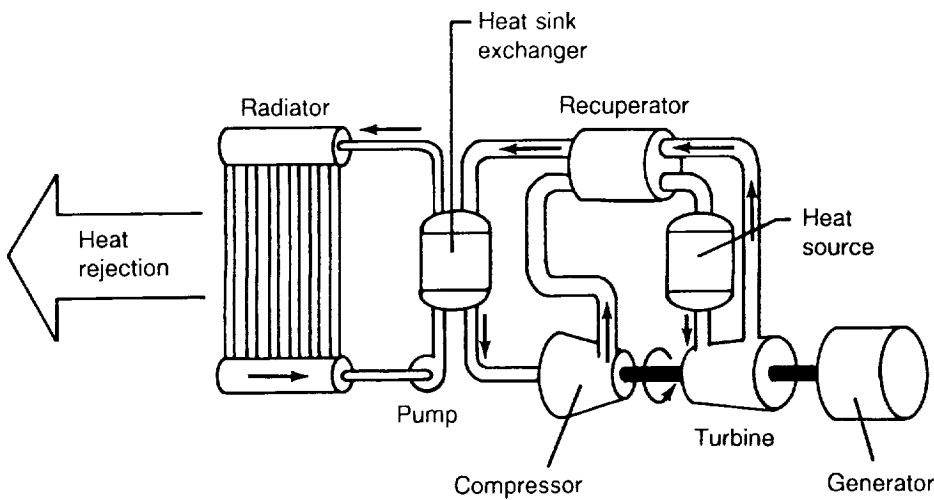

Figure 18

Brayton Cycle

In the Brayton system, power from the gas-driven turbine is used to compress a working gas which is then heated by solar energy to increase its pressure. After passing through the turbine, the gas is cooled in a heat exchanger and recycled through the compressor. In this system, the gas phase is used throughout. All of the systems have efficiencies in the range of 25-35 percent compared to 10-20 percent for direct electric conversion.

Critical system elements are, first, the heat receiver, especially if it includes thermal storage, and, second, lightweight precision collectors operating at 200- to 1000-times concentration. For lunar surface operation during the day, no thermal storage is required. As in the electrochemical storage case, extensive amounts of thermal storage would be required to meet the demands of the 2-week nights. If lunar materials having proper thermal characteristics were available for storage (questionable at this time), it is possible that solar dynamic systems could provide complete power night and day. Further study is required to substantiate this possibility.

Studies on solar Brayton cycles for the LEO space station show that a mirror 21 meters in diameter could produce 80 kW, while a mirror 8.2 meters in diameter could produce 10 kW. Were these size systems to be in continuous sunlight, the comparable powers

would be roughly 175 and 22 kW, with system specific powers of 13 and 10 W/kg. Because thermal storage is one-half the total system mass, eliminating such storage (for lunar day-only operation) would increase system specific power to 26 and 20 W/kg, respectively. With system improvements (mirrors, receivers, radiators), and including other Carnot-cycle engines, specific powers around 40 W/kg (with no thermal storage) are possible at operating temperatures between 1100 and 1300 K. With space station support and with long-term advanced research support, high-performance solar dynamic systems could be available by the year 2000.

These systems require that the waste heat be rejected. Thermal management (radiators, heat sinks) remains a critical technology for solar thermal dynamic systems, just as it does for nuclear power systems.

Direct Use of Solar Energy

Many industrial processes have substantial need for high quality thermal energy. Such applications as volatilization, evaporation, and melting can use thermal energy directly, without an electrical intermediary (fig. 19). The basic elements needed are lightweight mirrors and receivers that can collect, distribute, and deliver thermal energy to its point of use. Technology for direct utilization of solar radiation is being developed for terrestrial applications.

Energy Storage

Energy storage is required to provide power for operations during dark times. The nickel-cadmium battery has been the common

energy storage companion for solar cells on satellites. Specific energy densities (energy per unit mass) of 10 Whr/kg are common at the 10- to 20-percent depths of discharge used to provide cycle life. As a rule, the energy storage subsystem is the heaviest and largest part of a solar power system. Furthermore, NiCd batteries are sensitive to overcharge; hence, each cell must be carefully controlled. This need poses additional system constraints as power system voltage increases to the 100-kilowatt level and beyond.

Individual pressure vessel (IPV) nickel-hydrogen battery systems are being developed to provide increased energy densities (fig. 20). These batteries provide about 15-20 Whr/kg for GEO

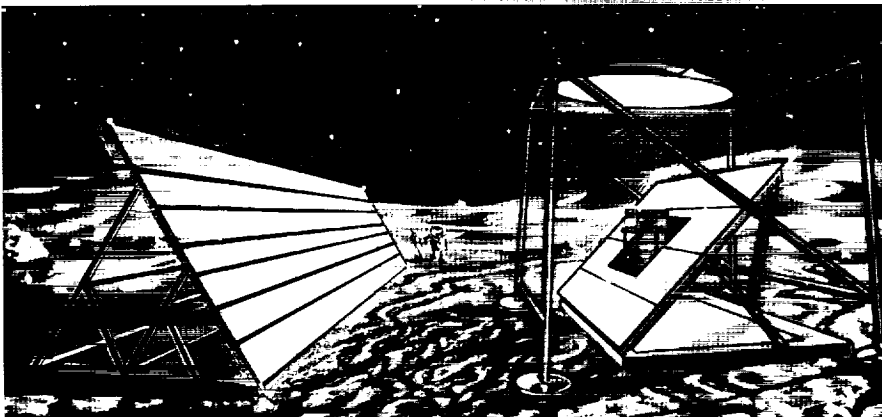
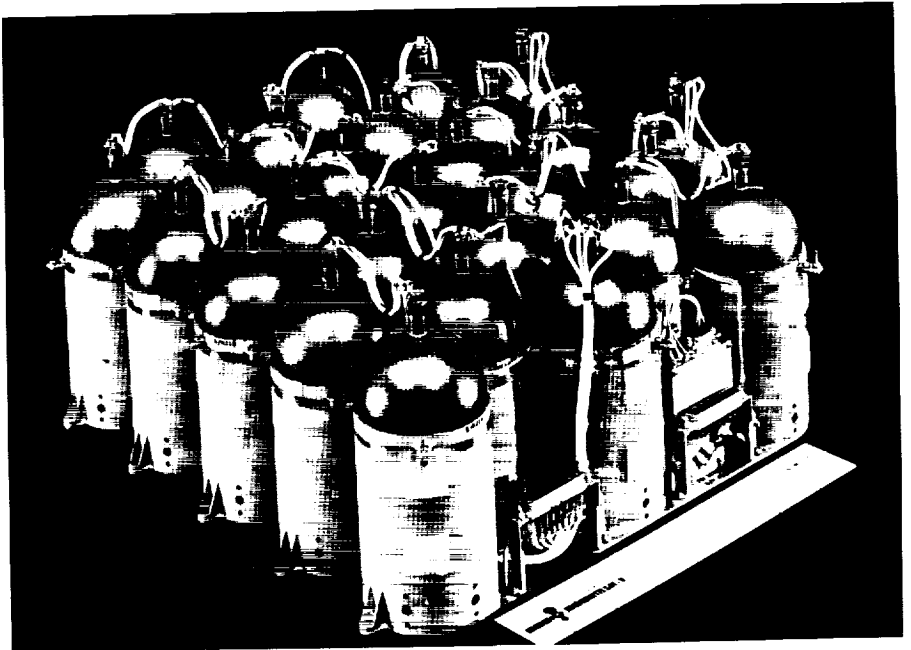

Figure 19

Solar Concentrator System on the Lunar Surface

This system uses a combination of flat and curved mirrors to concentrate sunlight on a furnace. The furnace can be used to extract volatiles, make glass, or melt iron from lunar regolith. Direct use of concentrated solar power can be an important "low tech" source of energy for lunar industrial applications.

ORIGINAL PAGE
BLACK AND WHITE PHOTOGRAPH



System configuration

Figure 20

**Individual Pressurized Vessel
Nickel-Hydrogen Storage Cells**

Individual pressure vessel (IPV) nickel-hydrogen (NiH_2) storage cells contain hydrogen under pressure as one electrode of a battery. The other electrode consists of a nickel plate. Such batteries can provide about 15-20 Whr/kg.

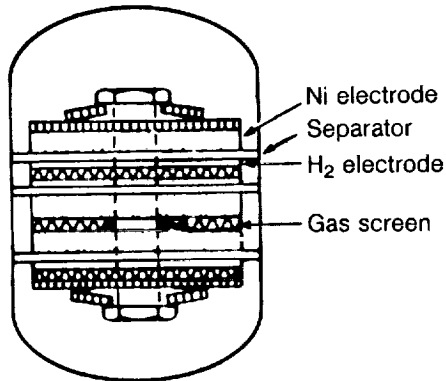

Pressure vessel
cross section

applications. These devices also have applicability to LEO, but they require substantial improvement in cycle life.

There are two high-capacity energy storage systems under consideration for the space station. These are the hydrogen-oxygen regenerative fuel cell (RFC) and the bipolar nickel-hydrogen

battery. The former (fig. 21) has a specific energy density of about 20 Whr/kg and an expected cycle life of 5-7 years. Operating voltage level appears reasonably unconstrained, allowing 150 to 300 volts. This technology is suitable for lunar surface exploration and use in GEO or lunar orbit.

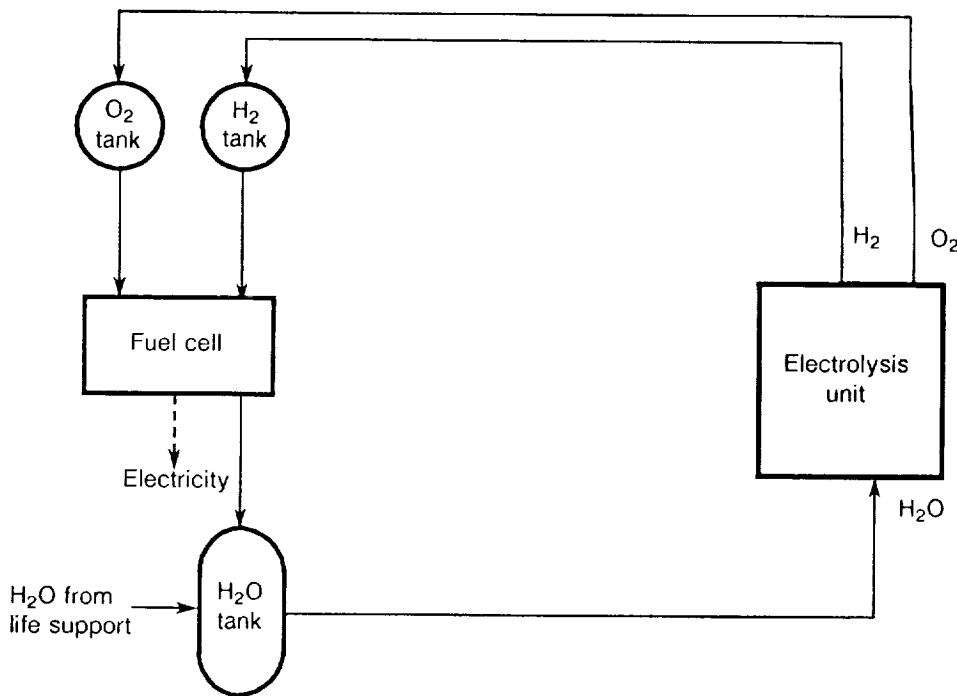

Figure 21

Hydrogen-Oxygen Regenerative Fuel Cell

A hydrogen-oxygen regenerative fuel cell (RFC) system uses electricity supplied from solar cells to electrolyze water into hydrogen and oxygen, which are stored. These gases can be used in a conventional fuel cell to generate electricity and produce water as a byproduct. The water can then be recycled through the electrolyzer. Specific energy density for such a system is about 20 Whr/kg, and the life cycle is expected to be 5-7 years.

Technology advances may offer energy densities of 1000 Whr/kg to lunar applications. A fuel cell separates power delivered from energy stored. Power is determined by the area of the plates; energy, by the volume of the reactants. Thus, when energy densities of 1000 Whr/kg are combined with lightweight solar arrays and high-voltage power management systems, the overall system promises specific powers near 500 W/kg. It should be noted, however, that the mass of a 1000-Whr/kg storage system to provide 100 kW of power during lunar night would be roughly 33 600 kg.

The bipolar NiH₂ technology marries battery and fuel cell technologies to the benefit of both. Chief advantages are substantially increased cycle life over IPV NiH₂, easy high-voltage battery design by adding more plates, and extremely high discharge capability (20 times charging rate). Bipolar NiH₂ systems appear equivalent in mass to state-of-the-art regenerative fuel cells at 100-kW capacities. However, this technology lags that of the hydrogen-oxygen RFC by several years. Furthermore, substantial improvement in basic understanding and in plate and separator technology is required before these cells can even begin

to approach the 1000-Whr/kg potential of the hydrogen-oxygen regenerative fuel cell.

Two additional systems appear capable of high storage densities. These are the rechargeable lithium battery and the hydrogen-halogen (Br, Cl) regenerative fuel cell. Both technologies are in infant stages of development, with issues of materials, cycle life, current densities, separators, and electrolytes. With additional research emphasis, these systems could become available between 1995 and 2000. Because mass is at such a premium on the Moon, and because the energy storage system is the most massive part of a photovoltaic system that supplies continuous power, additional effort should be directed toward innovative energy storage technologies, electrochemical and other.

Flywheels are one example of mechanical energy storage (fig. 22). Although flywheels probably can store in excess of 100 Whr/kg, the overall systems are still heavy (10 Whr/kg) at present. Although these systems may be capable of long lives, this capability has not yet been demonstrated, nor have all failure modes and safety needs been identified.

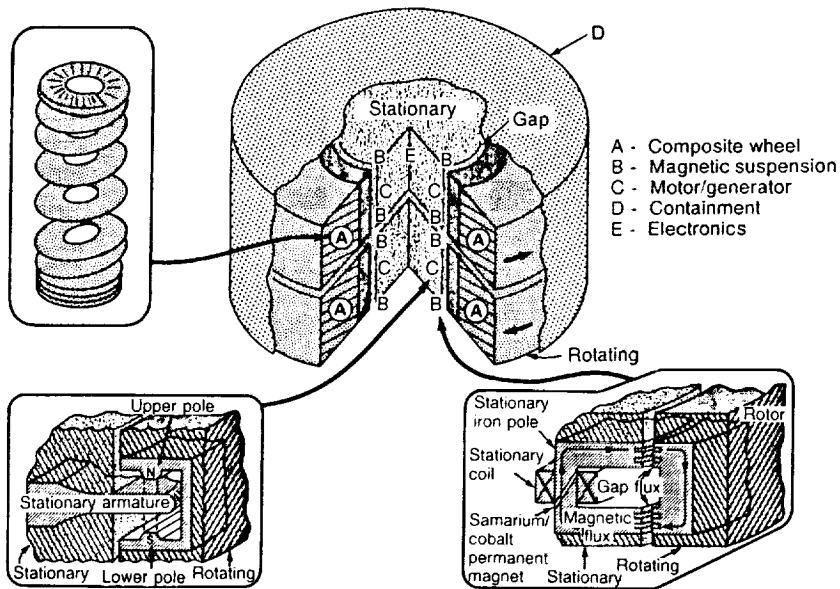
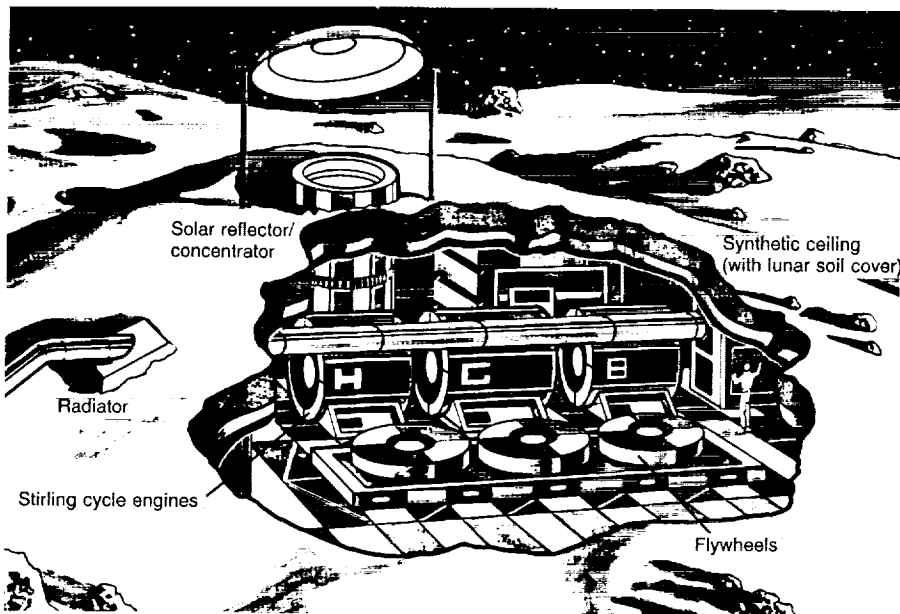

Figure 22

**Advanced Flywheel Energy Storage
a. Diagram**

This unit has two counter-rotating wheels to reduce torque forces on the system resulting from changes in wheel velocity. Advanced high-strength composites may be used for the wheels. Current designs project an energy storage density of about 100 Whr/kg for these systems.



b. Application

Flywheel storage could be used as a nighttime energy source at a lunar base. Here, solar energy is converted to electricity in Stirling heat engines. The electricity spins up the three large flywheels in the floor. Excess heat is carried away by a heat pipe to a radiator.

Solar dynamic systems also require energy storage for operation during the dark phases of a mission. A number of concepts are being considered. Sensible heat storage (that is, heat stored by the natural heat capacity of the material) in the form of a heat sink mass is one possibility. Another is the use of a material such as a salt which is melted during the solar phase and allowed to freeze during the dark phase, thereby releasing the heat of fusion. Technology development programs are presently under way

in the selection of compatible materials and in freeze-thaw phenomena in microgravity.

Within the timeframe of this study, it does not appear that the energy storage technology will be affected by nonterrestrial resources. A variety of candidate technologies with high energy densities have been identified (fig. 23) and must be considered for future energy storage use in GEO and on the Moon.

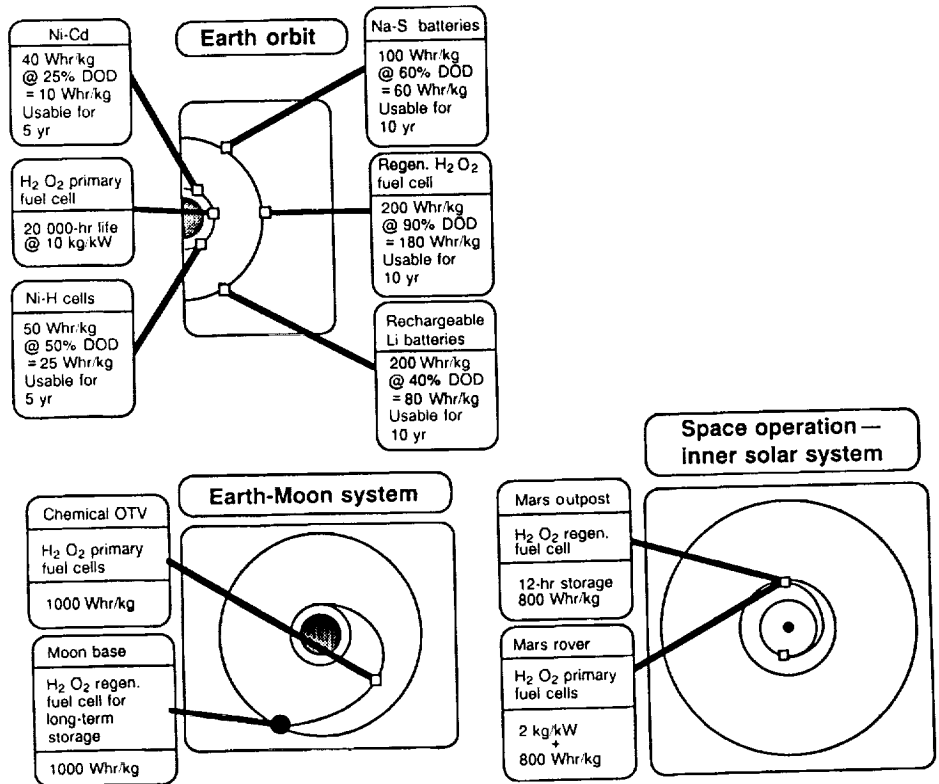

Figure 23

Energy Storage Opportunities 1997

Listed are a variety of energy storage opportunities which will likely be available around 1997. Somewhat different energy storage options are associated with each location. These opportunities are based on current technologies. It is possible that breakthroughs in some of these areas will provide much improved or totally different energy storage possibilities.

Power Management and Distribution

Existing spacecraft power systems are 28 volts dc. This voltage level and type was adequate for the few-kilowatt, dedicated-load missions to date. With the nearly 100-kilowatt electrical power requirements of the space station, however, significantly higher voltage levels and a high-frequency, ac utility-type distribution system are required to deliver this power efficiently to a broad spectrum of national and international users. Compared to existing systems, a 20-kHz ac power management and distribution system provides higher efficiency, lower cost, and improved benefits. The proposed 20-kHz system is based on rapid semiconductor switching, low stored reactive energy, and cycle-by-cycle control of energy flow. This system allows the voltage and wave shapes to be tailored to meet a variety of load requirements, improves crew safety, and provides compatibility with all types of energy sources—photovoltaic, solar dynamic, electrochemical, rotating machines, and nuclear.

Voltage levels on exterior surfaces will likely be set in the 150- to 300-V range by LEO plasma interaction effects. Inside the modules, however, a single-phase, sinusoidal-waveform, 20-kHz distribution system, with a well-regulated 220- or 440-V (root mean square) bus, will minimize wiring mass, transformer weight, conversion steps, and parts. Such a distribution system will provide attendant reductions in the sensing and control complexities required by a redundantly distributed power system with multiple energy sources. Component technology and microprocessor-based innovations in system autonomy will be in hand by the early 1990s to enhance the power system. Requirements pertinent to nuclear systems, such as hardening and high-temperature operation, are being addressed by the SP-100 Program, under which NASA, the Department of Energy, and the Department of Defense are developing space reactor technology.