

Project

APEX

N93-18116

Unclas

G3/18 0141675

(NASA-CR-192056) PROJECT APEX:
ADVANCED PHOBOS EXPLORATION. MANNED
MISSION TO THE MARTIAN MOON PHOBOS
(Michigan Univ.) ~~356-P~~

487085

389P

ORIGINAL PAGE
COLOR PHOTOGRAPH

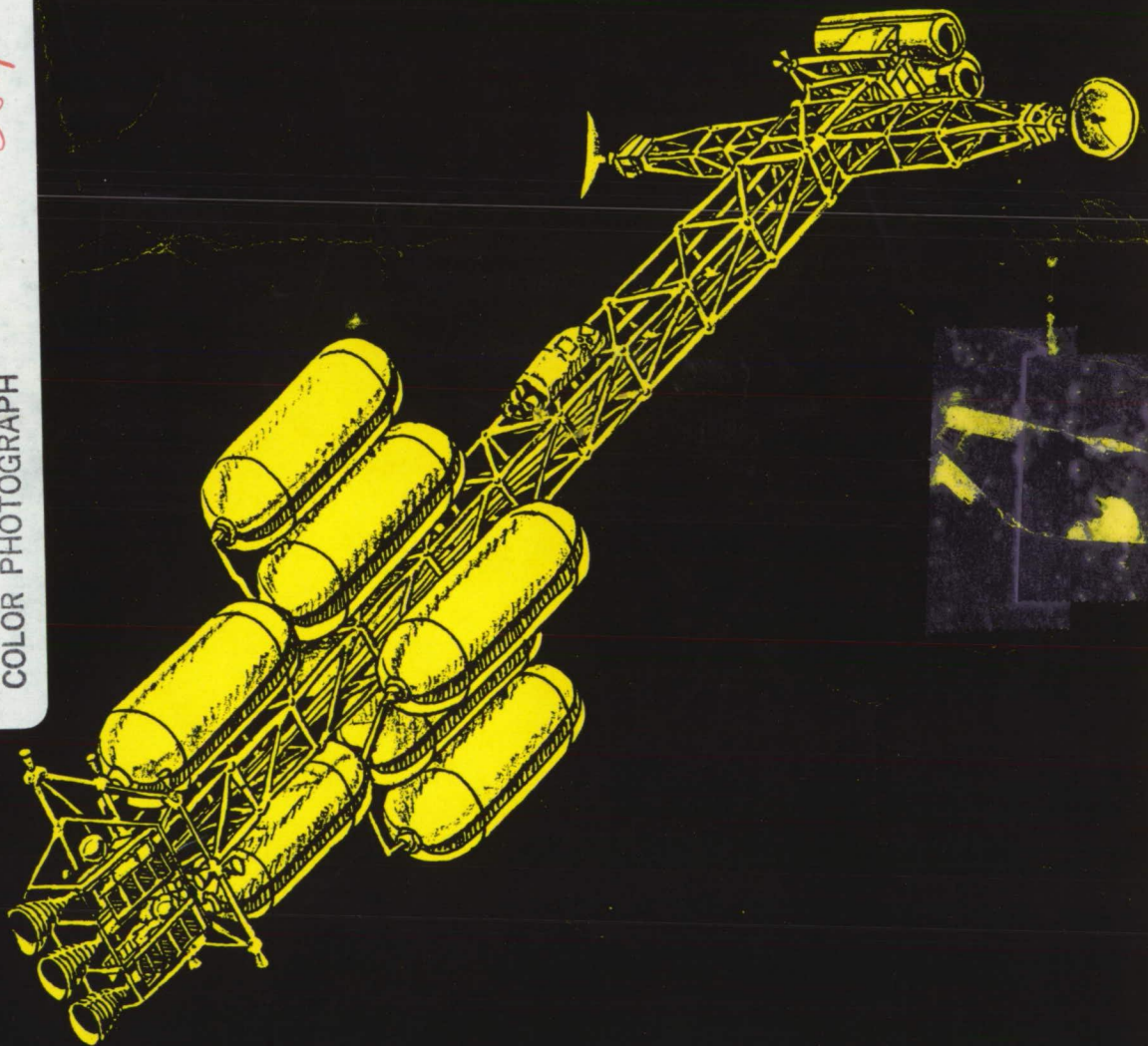

Aerospace Engineering 483
Aerospace System Design

Aerospace System Design

AERO 483

The University of Michigan

**ORIGINAL CONTAINS
COLOR ILLUSTRATIONS**

Project APEX
Advanced Phobos EXploration

Manned Mission to the Martian Moon Phobos

NASA/USRA

April 1992

Abstract	xiii
Foreword.....	xiv
Introduction	1
Project APEX	3
Objectives of Mission.....	3
Mission Motivation	3
Gravity Wells	4
Phobos the Gas Station.....	4
Assumptions	5
Introduction References	5
Phobos and Its Resources	7
Phobos	9
Characteristics of Phobos	9
Composition of a Type 1 Carbonaceous Chondrite	12
Surface Features	12
Value of Resources.....	14
Iron Extraction.....	15
Magnesium Extraction	16
Other Products.....	17
Phobos References	19
Mission Analysis	21
Summary	23
Mission Trajectory	23
Constraints on Trajectory Choice.....	23
Comparison of Conjunction and Opposition classes.....	24
Opposition Class	24
Conjunction Class	24
Radiation and Solar Flare Studies	25
Radiation Studies.....	25
Solar Flare Studies	25
Outline of Chosen Trajectory	29
Course Corrections Requirements.....	31
Earth Departure Maneuver	33
Ship Orientation (with respect to the Sun).....	34
Mission Time Lines.....	36
Phasing and Rendezvous with Phobos	37
Rendezvous with Phobos	37
Processing Plant Orbital Operations	40
Approach and Descent to Landing Site.....	41
Background	41
Landing Site	42
Mars Oblateness Effects.....	42
Relative Motion Mechanics of the Approach	43
Terminal Phase Initiation	48
Attitude Correction Maneuver	49
Braking Maneuver.....	50
Harpooning Maneuver.....	51
Leaving the Landing Site	51
Contingency Planning	52

Reasons and Probabilities.....	53
Procedure for Early Return	54
Mathematical Algorithm	54
Gravity-Assisted Swingbys.....	56
Abort Application.....	63
Mission Analysis References	69
Spacecraft Integration.....	71
Summary	73
Vehicle Analysis	73
Ship Characteristics.....	73
Description of Ship.....	74
Determination of Ship Length.....	76
Radiation Shielding	78
Ship Mass	78
Artificial Gravity	79
Artificial Gravity Configurations	80
Mass	80
Stability	81
Simplicity	81
Cost	81
APEX Artificial Gravity Configuration	81
Reasons for Despin.....	82
Trajectory Corrections.....	82
Emergency Procedures.....	82
Effects of Spin/Despin on Crew.....	82
Reaction Control System (RCS)	83
RCS Configuration.....	83
Rear RCS Truss.....	84
Forward RCS Truss.....	84
RCS Thrusters	85
RCS Fuel Requirements.....	85
Fuel Requirements for Spinning	85
Fuel Requirements fo Trajectory Corrections.....	86
Stability Maintenance.....	87
Near-Phobos Operations	87
Arrival at Earth.....	87
Ship Stability	87
I-DEAS Implementation	90
Planetary Science.....	99
General Experimental Goals for Project APEX.....	101
Justifying An Interplanetary Mission - The Role of the Mission to Phobos.....	101
Scientific Justifications for the Mission to Phobos	102
Further Considerations for a Mission to Phobos.....	102
On-Board Science for Project APEX - Scientific and Experimental Set-Up.....	103
Influential Missions.....	103
The Ph-D Mission	103
The Sortie Can Study, SpaceLab, and STS-42.....	104
The Delta Space Station	104
Areas of On-Board Scientific Investigation.....	105
Human Life Sciences	105
Plant Life Sciences.....	107

Materials Science, Manufacturing, and On-Board Planetary Science	107
Astronomical Observations	108
Personal Research and Isolated, Unattended Experimentation... ..	109
Quarantine Policy	109
Phases of Experimentation	110
Method of Experimentation	111
Equipment and Science Section Layout in Habitation Module	111
Devoted Science Section Layout.....	112
Equipment in Devoted Science Section	112
Other Module Sections Used for Scientific Pursuits.....	114
Equipment for Medical and Exercise Section	114
The Garden and Radiation Sensitive Experimentation	115
Weight, Power, and Thermal Rejection Requirements.....	116
Benefits of On-Board Science.....	116
Phobos Surface Experiments.....	116
Precursory Mission.....	117
Surface Mapping	117
Water Detection.....	117
Surface Strength	117
Phobos Mission	117
Soil Analysis	117
Internal Structure.....	118
Sample Collection	118
Other Studies	118
Mars Surface Experiments	119
Mars Rover.....	119
Atmosphere	119
Soil	119
Surface Studies.....	119
Biology	119
Recover Viking Lander	120
Precursory Missions	120
Viability Mission.....	120
Preparatory Mission	120
Processing Facility Overview.....	121
The Need for a Processing Facility on Phobos	121
Transportation Node for Interplanetary Travel	121
Support for Earth and Mars Missions	121
Design Concepts.....	122
Assumptions	122
Precursory Mission To Phobos	122
Transportation to Mars.....	122
Processing Facility	123
Power.....	124
SP-100 Nuclear Reactor	124
LEVPU	125
Excavation and Transportation.....	125
Transportation of Regolith to Facility.....	126
Processing of Regolith	127
The Crusher	128
Magnetic Separator	129
Oven	129
Cyclonic Separation	130

Storage of Obtainable Resources	130
Usage of Expended Fuel Tanks.....	130
Multiple Temperature Tanks.....	131
Production Capability.....	131
Planetary Science References.....	133
Propulsion	135
Summary	137
Propulsion Systems	137
Propulsion Method Selection	137
Propulsion Candidates.....	137
Fuel Selection.....	138
Specific Engine Characteristics.....	139
Nuclear Thermal Rockets and Dual Mode Operation.....	139
Propulsive Reactor Specifications and Operation.....	140
Power Generation.....	141
Dual Mode Selection.....	142
Initial Calculations	142
Fuel Requirement.....	142
Establishment of Rocket and Mass Equations	143
Calculation of Initial Mass in Low Earth Orbit.....	144
Mission Comparisons.....	146
Use of Chemical First Stage for LEO Escape	147
RCS	148
RCS Types	148
System Configurations	149
Description of the Reactor and its Substructure.....	149
Computer Control.....	150
Subsystem Monitoring	150
Engine Gimbaling	151
Ball and Socket Gimbal.....	151
Actuators	151
Flexible Duct Design.....	151
Rocket Motor Orientation	152
Recommendation.....	152
Mission Plan.....	153
G-loss	153
Discussion	153
Description of G-loss	153
Factors that Affect G-loss	153
Results.....	154
Analysis.....	155
Tank Staging	156
Engine Drop	157
Method of Removal.....	157
Regolith	157
Mission Parameters	158
Analysis.....	158
Results	159
Tanks.....	160
Liquid Hydrogen Storage.....	160
Tank Baffling	160
Refrigeration.....	161

Level Sensors	162
Discrete-point sensing	162
Continuous-level sensing	162
Design considerations	163
System Choice	163
During Main Burns	163
During Ship Rotation	163
Zero G Fuel Management	164
Behavior of Cryogenic Liquids in Zero Gravity	164
Effects of Acceleration Perturbations	165
Systems to Ensure Liquid Only at the Propellant Outlet	165
PMD System Selection	165
Results	166
Safety	167
Reactor Safety	167
Radiation	168
Engine Characteristics	168
Radioactive Output	168
Reactions	168
Reaction Products	169
Shielding Materials	170
Beta and Neutrino Radiation	170
Neutron and Gamma Radiation	170
Shielding Scheme	170
Results	170
Clustering	171
Discussion of Clustering Advantages	171
Reliability	171
Effects of Engine Failure	171
Alternate missions	172
Development Costs	172
Discussion of Potential Problems with Clustering	172
Neutronic Coupling	172
Neutronic Heating of Shut Down Engine	173
Radiation Scattering Between Nozzles	173
Analysis	173
Propulsion References	175
Power	177
Summary	179
Power Generation System	180
Design Requirements	180
Dual Mode Nuclear Thermal Rocket	180
Other Options	181
Solar Photovoltaic Cells	182
Solar Dynamics	182
Fuel Cells and Batteries	182
Other Nuclear Reactors	183
Summary of Power Generation	183
Electrical Power Transmission and Distribution	183
Basic Transmission Layout	183
AC vs DC Distribution	184
Voltage Level	184

Power Cable	185
Conductor Materials.....	185
Insulation.....	186
Summary of the Transmission System.....	187
Distribution Layout	187
Power Conversion	187
Voltage Level Breakdown.....	187
Converter specifications.....	188
Efficiency Improvements	188
System Contingency.....	189
Manufacturing Plan.....	189
Mass Savings.....	189
Bus Distribution Breakdown.....	189
Bus A.....	189
Bus B.....	189
Bus C.....	190
Summary Of Power Distribution.....	191
Backup Power Source	191
Design Requirements	191
Backup Power Source	192
Other Options	193
Batteries.....	193
Thermal Control System	193
Design Requirement.....	193
Heat Pipe Radiators.....	194
Habitation Modules Thermal Control System	195
Propulsion Dual Mode Reactors Thermal Control System.....	196
External Thermal Control System.....	196
Other Radiators Considered	197
Curie Point Radiators	197
Liquid Droplet Radiators.....	197
Power References.....	199
Structures	201
Introduction	203
Habitation Modules	203
Habitation Module Floor Layout.....	203
The Sizing and Number of the Habitation Modules	203
Details of Floor Layout	204
Doors	206
Shielding.....	206
Human Factors	206
Hallways.....	207
Planetary Science	207
Total Floor Space Per Group.....	207
Design of Habitation Module Structure	208
Summary	208
Design Details	208
Design of O-Rings.....	208
Design of Stringers.....	211
Design of Pressure Skin	211
Micrometeoroid Protection	212
Design of Insulation	212

Door Frame Desing	212
Weight Calculation.....	213
Radiation Shielding.....	213
Purpose.....	213
Shielding Materials	214
Location and Quantity of Shielding Material.....	215
Lithium Hydride or Water.....	219
Conclusion.....	219
Airlock Structural Design.....	220
Introduction	220
Summary of Design.....	220
Design Details	221
Sizing of the Airlock	221
Structural Design.....	221
Mass Calculations	223
Special Considerations	223
Cryogenic Tank Design and Implementation.....	223
Introduction	223
Tank Design	224
Inner Micrometeoroid Shield	224
Tank Skin	228
Thermal Jacket	229
Multi-Layer Insulation (MLI)	229
Outer Meteoroid Shield.....	229
Tank Connection Structure.....	230
Propulsion Tanks.....	230
LH2 Tanks for Main NTR Engines.....	230
LH2/LOX Tanks for RCS Attitude Control Thrusters.....	231
Human Factors Tanks.....	233
Requirements and Criteria	
Sizes	233
Power Group Tanks.....	234
Fuel Cell Tanks	234
Truss System	236
Introduction	236
Main Truss.....	236
Design criteria	236
Loads on the Main Truss.....	237
Design Procedure for the Main Truss	238
Analysis of Structural Integrity of Truss.....	242
Mass Analysis of Main Truss.....	245
Communication Truss	246
Design Criteria	246
Loads on the Communications Truss	246
Design Procedure for the Communication Truss	248
Analysis of Structural Integrity of Communications Truss	249
Mass analysis of Communications truss	249
Habitation Module Support Unit.....	249
Design Criteria	250
Loads on the Habitation Module Support Unit.....	250
Design Procedure for the Habitation Module Support Unit.....	253
Analysis of Structural Integrity	256
Mass Analysis of Habitation Module Support Unit.....	256
Landing Gear Design	257

Introduction	257
Design Details	257
Fuel Tank Landing Legs	257
Habitation Module Landing Legs	262
Footpads	262
Structural Analysis	262
Weight Summary.....	264
Structures References.....	267
Human Factors & Life Sciences.....	269
Crew Concerns	271
Crew Size	271
Qualifications	271
Pilot Qualifications.....	271
Mission Specialist Qualifications.....	271
Crew Roles	271
Mission Commander/Pilot.....	272
Co-pilot/Navigator/Communications Officer	272
Life Support Specialists	272
Research Specialists	272
Systems (Power) Specialists.....	272
Additional roles.....	273
Crew Training	273
Initial Training and In-processing.....	273
Physical Training.....	273
Additional training	274
Chain of Command	274
Crisis Situations.....	274
Day-to-Day Situations.....	275
Crew Concerns	276
Social Concerns.....	276
Psychological Concerns	277
Physiological Concerns.....	278
Summary	279
Habitat Layout.....	279
Crew Quarters	280
Hygiene Facilities.....	280
Food Prep (Galley).....	280
Lounge / Entertainment / Wardroom	280
Exercise / Health Maintenance Facility	280
Experiment Lab.....	281
Storage Areas	281
Airlocks	281
Safety Concerns.....	287
Ship-Health Monitoring	287
Fire Detection and Suppression.....	287
Module Escape and Repair.....	288
Life Support.....	289
Summary	289
Crew Requirements.....	289
Things to Recycle.....	290
Air supplies	290
Water Supplies	291

Food supplies.....	291
Supplemental Food.....	292
Recycling Processes.....	292
Air.....	292
Carbon Dioxide.....	293
Biological Contamination.....	293
Water.....	294
Domestic Water Supply.....	294
Water Vapor.....	295
Waste Water.....	295
Food.....	295
Supplementary Food.....	295
Stored Foods.....	296
System Specifications.....	296
Crew Operations.....	296
Summary.....	296
Operations En Route to Phobos.....	296
Daily Routine En Route to Phobos.....	297
Operations During Burns and Solar Flares.....	297
Operations on Phobos.....	297
Daily Routine.....	297
Extra - Vehicular Activity (EVA).....	298
Space Pod.....	298
Space Suits.....	298
Manned Maneuvering Unit (MMU).....	299
Tether System on Phobos.....	299
Human Factors & Life Science References.....	301
Mission Control & Communications.....	303
Mission Control Summary.....	305
Location Selections.....	305
Mission Control Structure.....	305
Additional Staff.....	306
Additional Support Areas.....	306
Communication Systems.....	306
Communication Link Derivation.....	307
Communications Equation.....	307
Free Space Losses.....	308
Wavelength.....	308
Antenna Gain.....	308
Beam Width.....	309
Signal Losses.....	309
Transceiver Inefficiency.....	309
Eb/No Ratio.....	310
Bit Error Rate (BER) and Modulation.....	310
Forward Error Correcting (FEC) codes.....	310
Signal Margin.....	310
Bandwidth.....	311
Communications Users.....	311
On-Earth (OE) vs. In-Earth-Orbit (IEO) Communication Systems.....	312
Background of Deep Space Network (DSN).....	312
Background of Geosynchronous Relay Satellites (GRS).....	312
Connectivity of DSN vs. GRS.....	313

Signal Compatibility of DSN vs. GRS.....	313
Cost of DSN Transmission vs. GRS Transmission.....	313
Selection of GRS System for Communication.....	314
Mars Relay Satellites (MRS) System.....	314
Communication Capabilities.....	315
Connectivity.....	315
Thermal Design.....	315
Guidance and Stability Control.....	316
Power Source.....	316
Phobos Relay Point.....	316
Communication Capabilities.....	317
Size.....	317
Location.....	317
Navigation and Control Systems.....	318
Navigation Sub-Systems.....	318
Star Trackers.....	318
Optical Alignment Sight (OAS).....	319
Inertial Measurement Units (IMU).....	319
Ring Laser Gyroscopes (RLG).....	320
Telemetry Systems.....	321
Long Range Radar System.....	322
Short Range Radar System.....	322
Radar System Derivation.....	322
Radar equation.....	322
Radar Cross Section of Mars and Phobos.....	323
Flight Control Interface.....	323
Redundancy and Backup Software.....	323
GN&C System Operational Modes.....	324
Categorization of Flight Operations.....	324
Spin Stability.....	324
De-Spin Stability.....	325
Course Corrections.....	326
Phobos Approached.....	327
Phobos Landing/Docking.....	328
Computer System.....	329
Layout of Computer Hardware.....	329
Layout of Input/Output Hardware.....	329
Computer Network.....	330
Derivation of Processing Power Requirements.....	330
Reactor Monitoring.....	330
Spent Reactor Monitoring.....	331
Navigation.....	331
Planetary Science.....	331
Crew Entertainment.....	331
General Telemetry.....	331
Communications.....	332
OS Overhead.....	332
Phases of Processing Power Distribution.....	332
Initial Burn Phase.....	332
In-Transit Phase.....	332
Course Correction Phase.....	332
Mission Control & Communications References.....	335

Conclusion.....	337
Summary	339
Cost Analysis.....	339
Future Study and Research.....	341
Future Possibilities	341
Follow up Mars Mission	341
Creation of a gravity environment	341
Phobos-Mars Processing Plant	342
Phobos-Earth Shipments	342
Beyond Mars	342
Conclusion.....	343
Conclusion References.....	345
 Appendix	 347

Abstract

The manned exploration of Mars is a massive undertaking which requires careful consideration. A mission to the moon of Mars called Phobos as a prelude to manned landings on the Martian surface offers some advantages. One is that the energy requirement, in terms of delta V, is only slightly higher than going to the Moon's surface. Another is that Phobos is a potential source of water and carbon which could be extracted and processed for life support and cryogenic propellants for use in future missions; thus Phobos might serve as a base for extended Mars exploration or for exploration of the outer planets.

The design of a vehicle for such a mission is the subject of our Aerospace System Design course this year. The materials and equipment needed for the processing plant would be delivered to Phobos in a prior unmanned mission. This study focuses on what it would take to send a crew to Phobos, set up the processing plant for extraction and storage of water and hydrocarbons, conduct scientific experiments, and return safely to Earth. The size, configuration, and subsystems of the vehicle are described in some detail.

The spacecraft carries a crew of five and is launched from low Earth orbit in the year 2010. The outbound trajectory to Mars uses a gravitational assisted swing by of Venus and takes eight months to complete. The stay at Phobos is 60 days at which time the crew will be engaged in setting up the processing facility. The crew will also conduct planetary science experiments and observations of Mars. The vehicle will then return to Earth orbit after a total mission duration of 656 days. Both stellar and solar observations will be conducted on both legs of the mission.

The design of the spacecraft addresses human factors and life science, mission analysis and control, propulsion, power generation and distribution, thermal control, structural analysis, and planetary, solar, and stellar science. A 0.5g artificial gravity is generated during transit by spinning about the lateral body axis. Nuclear thermal rockets using hydrogen as fuel are selected to reduce total launch mass and to shorten the duration of the mission. The nuclear systems also provide the primary electrical power via dual mode operation. The overall spacecraft length is 110 meters and the total mass departing from low Earth orbit is 900 metric tons.

Foreword

Aerospace System Design (AE 483) has been offered at the University of Michigan every year for the past 26 years. It is one of three courses which meet the senior design requirement for the baccalaureate degree in Aerospace Engineering at the University of Michigan. The first course in Space System Design was offered in the winter term of 1965 by the late Professor Wilbur Nelson and was taught by him 19 times before his retirement in 1976. In 1977 Professor Harm Buning took over the course and has offered it 15 times until his retirement this year. It is now my honor to be the instructor in charge.

In 1985 the Department of Aerospace Engineering became a charter member of the Universities Space Research Association (USRA) Advance Design Program (ADP) which receives its support directly from NASA. An annual grant from NASA/USRA provides funding for a graduate teaching assistant, for travel, for reproduction and distribution of the final report, for construction of the scale model, and for other operational costs. As a part of the NASA/USRA ADP we are assigned technical support from the NASA Lewis Research Center. We gratefully acknowledge this support and extend our special thanks to Vicki S. Johnson, ADP Program Manager, and her colleagues at USRA and to Lisa Kohout, Barbara McKissock, and their colleagues at the NASA Lewis Research Center.

The current project, a mission to the moon of Mars called Phobos, is typical of the large scale efforts taken on by the class. The entire class works on one project as a team effort. The class is divided into smaller teams, each assigned a subsystem to design in full coordination with all the other subsystems. A student project leader and an assistant project leader are elected by the class to direct and coordinate the project. The output of the course consists of (1) a formal oral presentation at the end of the semester, (2) a scale model of the design, (3) a final written report which will be submitted to USRA and NASA, (4) and an oral presentation at the NASA/USRA Annual Conference in Washington, D.C.

From the instructional point of view there are several goals in design courses which differ from those in other courses. Among them are to (1) Learn to deal with open ended problems; (2) Use and integrate knowledge from previous courses; (3) Learn the design process; (4) Become acquainted with the tools of design; (5) Experience teamwork in problem solving; (6) Develop oral and written communication skills. In addition the course in Space System Design intends to arouse interest in the use of space and to develop a final report which is technically correct and sophisticated enough to be useful to NASA and other agencies interested in space.

It is not possible to meet all the goals stated above in one short term but you can judge for yourself how many have been met. In any case, it has been a pleasure for me to have the opportunity to work with such a bright, enthusiastic, capable, and friendly group of students.

Joe G. Easley
Professor of Aerospace Engineering
April 20, 1992

Team Organization

Organizational Chart

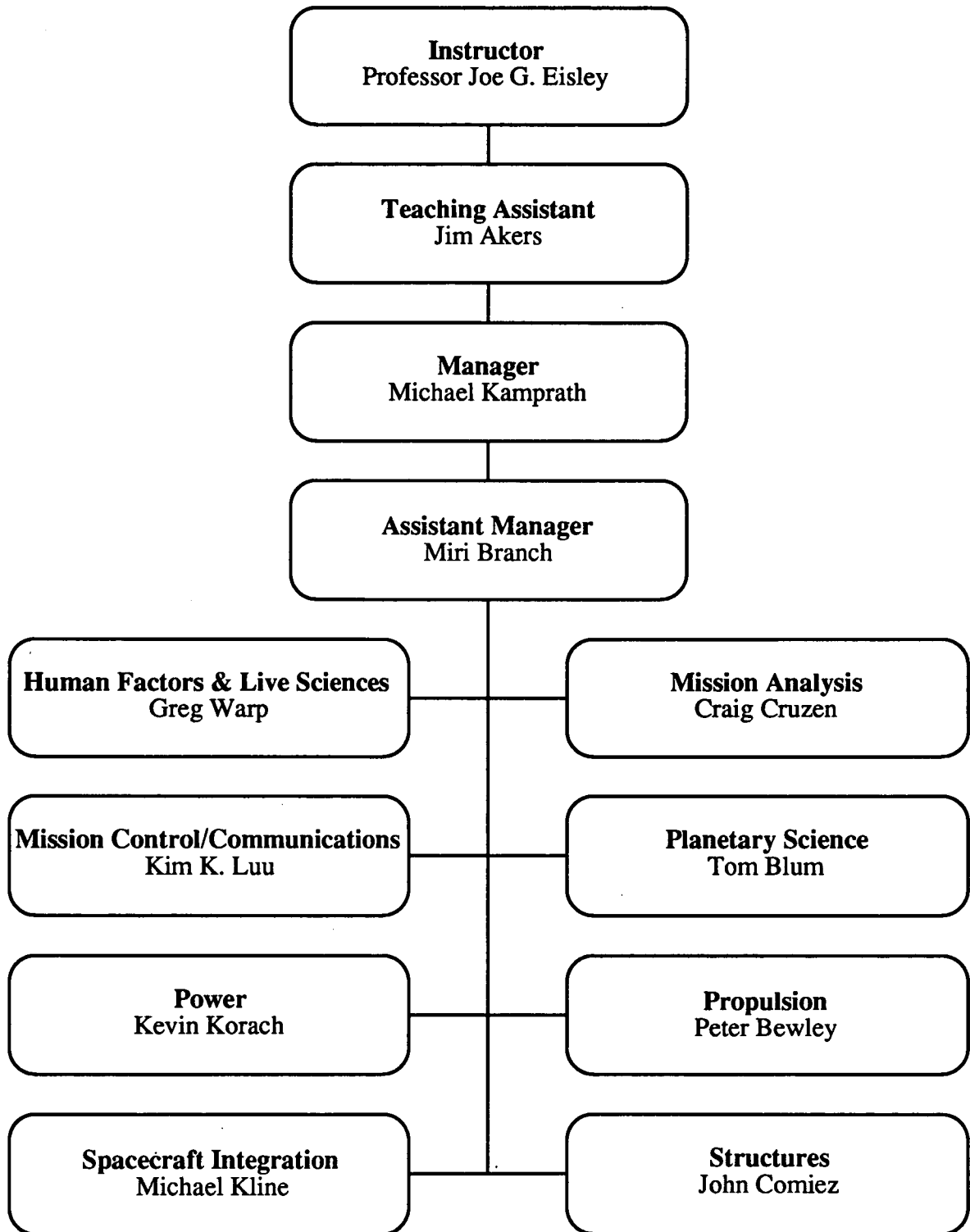

Team Roster

Aerospace Engineering 483

Project APEX

Instructor: Professor Joe G. Easley

Teaching Assistant: Jim Akers

Manager: Michael Kamprath

Assistant Manager: Miri Branch

Human Factors & Life Sciences

Ted Morrison
Stephen Quenneville
Tracy Scott
Ray Tembreull
* Greg Warp
Greg Wieland

Mission Analysis

* Craig Cruzen
Scott DeRaad
Allan Dewey
Todd Hollmann
Lynn Langenderfer
Scott Lingenfelter
Heather Rivard

Mission Control/Communications

Eric Delage
Denny Gentry
Chris Koo
* Kim K. Luu
Jin Tan

Planetary Science

Kathleen Barcroft
* Tom Blum
Stephen Lukachko
Mike Martin
Kevin Mulrenin
Jasen L. Raboin
Kathryn Rise

Power

Tracy Conley
Earl Ford
Enrique Garcia
* Keven Korach
Dave Powers
Ken Wanko

Propulsion

* Peter Bewley
Frederick Coen
Tony Harbaugh
Peter Stuckey
Marcin Taraszkiewicz
Alan Tulkki
Kirk VanNatter

Spacecraft Integration

Patricia Daly
Tom Harrold
* Michael Kline
Dan Rothgeb
Glen Shilland
Cynthia Tarr
Michelle Zimmerman

Structures

* John Comiez
Gretchen Habel
Tim Hawkins
Scott Karlo
Brandon Runnels
Amy Van Horn
Kevin White

(* Denotes Group Leader)

Committee for the Final Report

Jasen L. Raboin: Chairperson

Kathleen Barcroft
Miri Branch
John Comiez
Tracy Conley
Earl Ford
Tony Harbaugh
Tim Hawkins
Michael Kamprath
Lynn Langenderfer
K. Kim Luu
Ted Morrison
Heather Rivard
Dan Rothgeb
Tracy Scott
Ken Wanko

Committee for the Scale Model

Tom Harrold: Chairperson

Tom Blum
Craig Cruzen
Al Dewey
Lynn Langenderfer
Glen Shilland
Pete Stuckey
Al Tulkki
Kirk VanNatter

Illustrations

Ray Tembreull
Al Tulkki

31

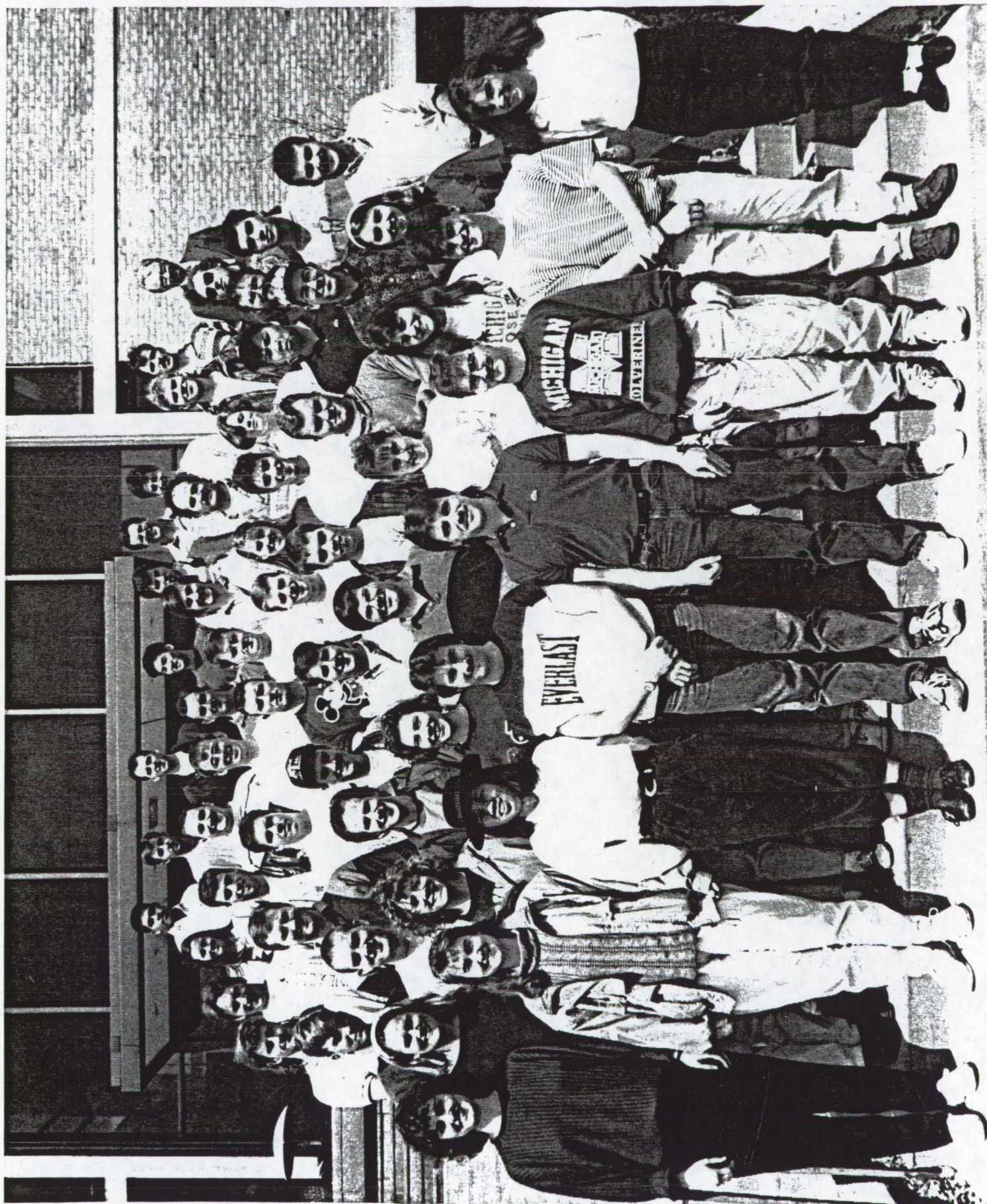



- | | | | | | |
|---------------------|-----------------------|--------------------|----------------------|------------------------|------------------------|
| 1 Miri Branch | 11 Patricia Daly | 21 Todd Hollmann | 31 Jin Tan | 41 Rick Coen | 51 Jasen L. Raboin |
| 2 Kathleen Barcroft | 12 Dan Rothgeb | 22 Brandon Runnels | 32 Kevin White | 42 Kirk VanNatter | 52 Jim Akers |
| 3 K. Kim Luu | 13 Tracy Scott | 23 Tony Harbaugh | 33 Tim Hawkins | 43 Kathryn Rise | 53 Mike Martin |
| 4 Tom Harrold | 14 Peter Bewley | 24 Ray Tembreull | 34 Enrique Garcia | 44 Pete Stuckey | 54 Kevin Mulrenin |
| 5 Craig Cruzen | 15 Heather Rivard | 25 Greg Warp | 35 Julie Edwards | 45 Denny Gentry | 55 Prof. Joe Easley |
| 6 Tom Blum | 16 Michelle Zimmerman | 26 John Comtez | 36 Steve Quenneville | 46 Marcin Taraszkiwicz | |
| 7 Ken Wanko | 17 Lynn Langenderfer | 27 Gretchen Habel | 37 Eric Delage | 47 Earl Ford | Missing: Michael Kline |
| 8 Amy Van Horn | 18 Scott Lingenfelter | 28 Glen Shilland | 38 Greg Wieland | 48 Kevin Korach | Cynthia Tarr |
| 9 Tracy Conley | 19 Scott DeRaad | 29 Steve Lukachko | 39 Scott Karlo | 49 Dave Powers | |
| 10 Michael Kamprath | 20 Ted Morison | 30 Allan Dewey | 40 Al Tulkki | 50 Chris Koo | |

Chapter 1

Introduction

- 1.1 Objectives of Mission
- 1.2 Mission Motivation
- 1.3 Design Assumptions

Project APEX

Project APEX was the mission that the Winter 1992 University of Michigan Senior Aerospace Systems Design Class was assigned to design. It is fundamentally a manned mission to the Martian moon Phobos. The mission is an exploratory one, not only in pure science, but also in space utilization. The naming of the mission is quite logical: APEX stands for Advanced Phobos Exploration. The spacecraft that was designed also received a name. In accordance with proper school spirit, the design class named the craft the *Wolverine*. Throughout the report, it will be referred as such.

In the following pages is a complete description of the design that was produced. It is by no means a complete design; the design class had only four months to complete it. The class did seek, however, to address all the major issues that would be involved with such a mission to Phobos.

Objectives of Mission

Project APEX has several objectives. The first, and most obvious, is to send a crew of humans from Earth to the Martian moon Phobos and then return them safely back to Earth. This is the fundamental goal of any manned, exploratory space mission.

The second objective can be described as the overall reason for this mission. While the astronauts are at Phobos, they are to set up a prototype processing plant. This processing plant will mine the Phobos regolith and turn it into usable forms, such as water, oxygen, hydrogen, and methane. It is not the goal of this mission, however, to depend on the processing plant for propellant for our return trip to Earth. The goal of the processing plant is to aid in future missions to Mars.

The third objective is to conduct and promote scientific endeavors in space. Not only being a part of an overall Mars exploration plan, Project APEX, having an estimated mission length of 1.7 years, provides an invaluable opportunity to conduct experiments in space. A discussion of the type of experiments possible will be given later in this report. But more importantly, such a mission can only stir interest in and create support for the space sciences. Much like the Apollo Missions of the early 1970's, Project APEX is a goal in which most everybody can see accomplishments in because of the fact that it is manned. Unmanned planetary probes would only stir the interest of the scientific community. Manned missions capture the interest of all members of society.

Mission Motivation

The question naturally arises: Why go to Phobos at all? This question can be answered in two contexts. In the context of "now", the reasons are chiefly of scientific origin. First of all, we wish to study Phobos. Phobos is thought to be one of the oldest objects in our solar system. By studying it, it is hoped that much can be learned of the origins of the solar system. Additionally, such a mission provides an invaluable opportunity to study such things as the cosmos, life sciences, and our own solar system.

In the context of the "future", Project APEX is intended to be part of an overall Mars exploration plan. The processing plant that is to be set up will be able to produce chemicals essential to future Mars missions, and because of the location of Phobos in relation to Mar's

PRECEDING PAGE BLANK NOT FILMED

2 INTENTIONALLY BLANK

gravity well, they can be delivered and utilized much more cheaply than if the same supplies were brought from Earth.

Gravity Wells

A gravity well is a conceptual device used to describe the relative difficulty of escaping a body's influence of gravity. The deepness of a body's well is the measure of the energy required to escape the body. The measure is normalized to the gravity of the Earth. To say a body's well is 1000 miles deep means that a person would have expend the energy required to climb a 1000 mile ladder (with the gravity remaining constant) in order to escape the body. This energy measure also applies for descending into a body's gravity well. Energy must be expended in order for one to slow down to be captured by a body's gravity.

The figure below shows the relative difference between the Earth's and Mars' gravity wells. Note that the depth of the Earth's well is about 4000 miles, while the depth of Mars' well is about 1800 miles. Also note that Phobos practically has no well of its own, and that it is just slightly within Mars' gravity well.¹

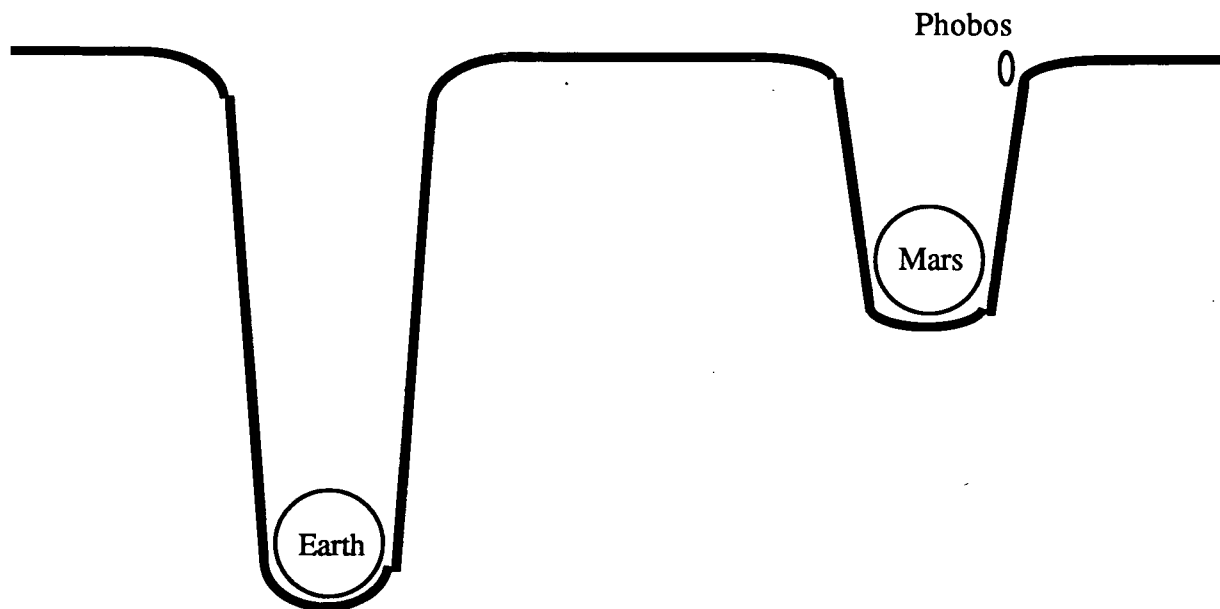

Phobos: the Gas Station

Because Phobos is practically at the top of Mars' gravity well, Project APEX will only have to, more or less, carry enough fuel to ascend Earth's gravity well, stop at Phobos, and then return to and descend back into Earth's gravity well. But for future Mars missions, more fuel will need to be carried in order to descend and ascend Mars' gravity well. Since fuel is the predominate weight in interplanetary spacecraft, the mission mass, and likewise the cost, will inflate considerably.

It is hoped that the processing plant will reduce the cost of Mars exploration by acting as a gas station in space. Future missions would be able to carry only enough fuel to get to Phobos, then "fill up" in order to descend and ascend Mars' gravity well, and finally "fill up"

again to return back to earth. This lessens the amount of fuel needed to be lifted from Earth to orbit, thus requiring fewer launches to build the spacecraft.

Assumptions

Several assumptions were made for the design of Project APEX. These assumptions were made in order to allow the Aerospace Engineering Senior Design Class to concentrate on the design of a spacecraft to carry the astronauts to Phobos.

The first assumption was that a heavy lift launch vehicle would be ready at the time of our mission. This vehicle would be able to lift a mass of 150 metric tons. This assumption was especially useful when the design for the fuel tanks were made.

The second assumption was that Phobos is a Carbonaceous Chondrite type asteroid. The chemical composition of Phobos is not exactly known. There exist good indications that the Phobos regolith is of a useful composition, but it is not certain.

The third assumption was that there would be several precursory missions to Phobos. These missions would be of two types. Some would carry out surface mapping and sampling operations, while others will take equipment needed at Phobos for Project APEX (e.g., the processing plant). What these missions would carry and conduct is discussed later in this report.

The final assumption could also be a design constraint. It is expected that all the technologies discussed in this report are either ready now, or will be by the year 2005. When designing the Wolverine, special care was taken as to not expect an unreasonable development of technology. But of technology that was used, it is assumed that it will be ready on time.

Introduction References

¹ "Race To Mars," p. 79

Chapter 2

Phobos and Its Resources

2.1 Characteristics of Phobos

2.2 Value of Resources

PRECEDING PAGE BLANK NOT FILMED

~~6~~ 6

Phobos

This section will describe some of the physical aspects of Phobos, including its size, orbit about Mars, composition, and possible resources. Evaluation and a possible processing techniques of the resources found on Phobos will be introduced.

Characteristics of Phobos

Figure 2.1¹ shows that Phobos (one of the two moons of Mars) is 27 km long, 21.4 km wide, and 19.2 km high (**Table 2.1**). Stickney crater, which is on the end of Phobos facing Mars, in approximately 10 km in diameter. **Table 2.1**² shows Phobos is in a low, almost circular orbit about Mars, with the semi-major axis equal to 9378 km and the eccentricity of the orbit only 0.015. In addition, Phobos revolves almost over the equator of Mars with an inclination of 1.02 degrees, and with a sidereal period of 7 hours 39 minutes 13.85 seconds.

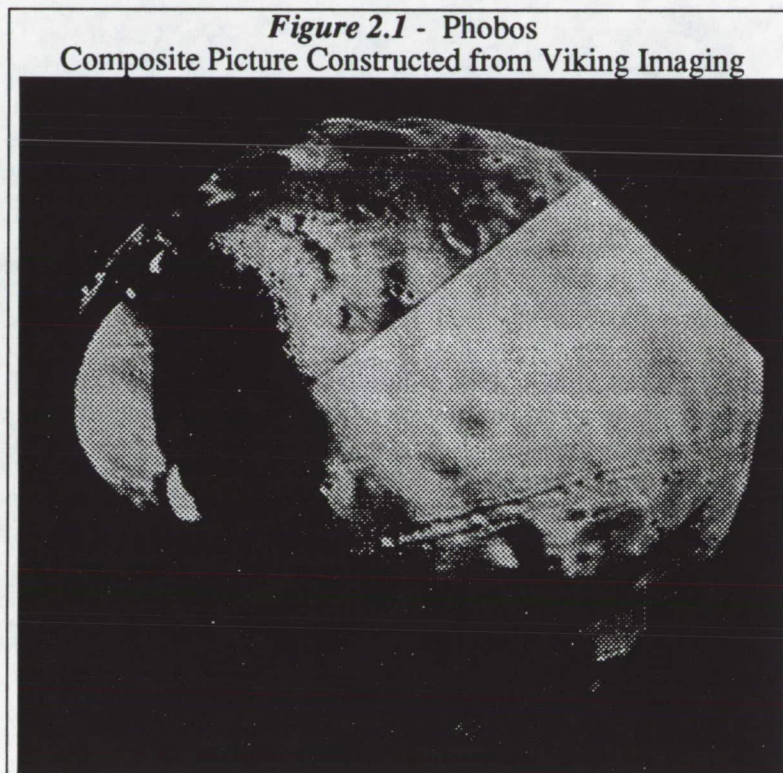

PRECEDING PAGE BLANK NOT FILMED

PAGE 8 INTENTIONALLY BLANK

TABLE 2.1
Dimensions and Orbital Elements of Phobos

Major Orbital Elements

Semi-major axis.....	9378 km (2.76 R _{Mars})
Eccentricity.....	0.015
Inclination	1.02°
Sidereal Period.....	7h 39m 13.85s

Physical Parameters

Longest axis.....	27 km
Intermediate axis.....	21.4 km
Shortest axis.....	19.2 km
Rotation.....	Mars Synchronous
Density.....	2.0 g/cm ³
Mass.....	9.8x10 ¹⁵ kg
Albedo.....	0.05
Surface gravity.....	1 cm/sec ²

Transport to and from the surface is easy due to the low surface gravity of Phobos. The gravity is only 1 cm/sec², which is 1/1000 of Earth's gravity. Its mass of Phobos is estimated to be 9.8 x 10¹⁵ kg with a density of approximately 2.0 g/cm³. Because of its low albedo of 0.05 and low density, Phobos is assumed to be an asteroid that was captured by Mars. Phobos' spectrum of reflectivity shows that it is similar in composition to a type 1 carbonaceous chondrite asteroid, which supports the captured asteroid theory.

Back Side of Phobos That Faces Away From Mars

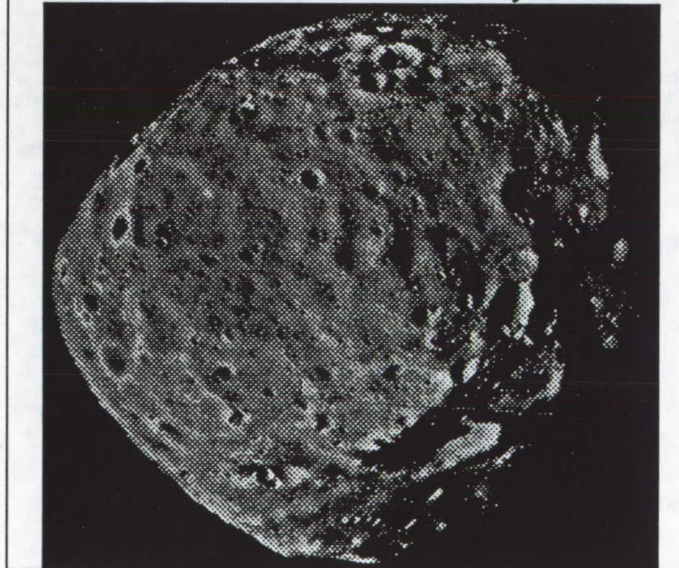

Longitudinal and Lateral Division Superimposed on Image

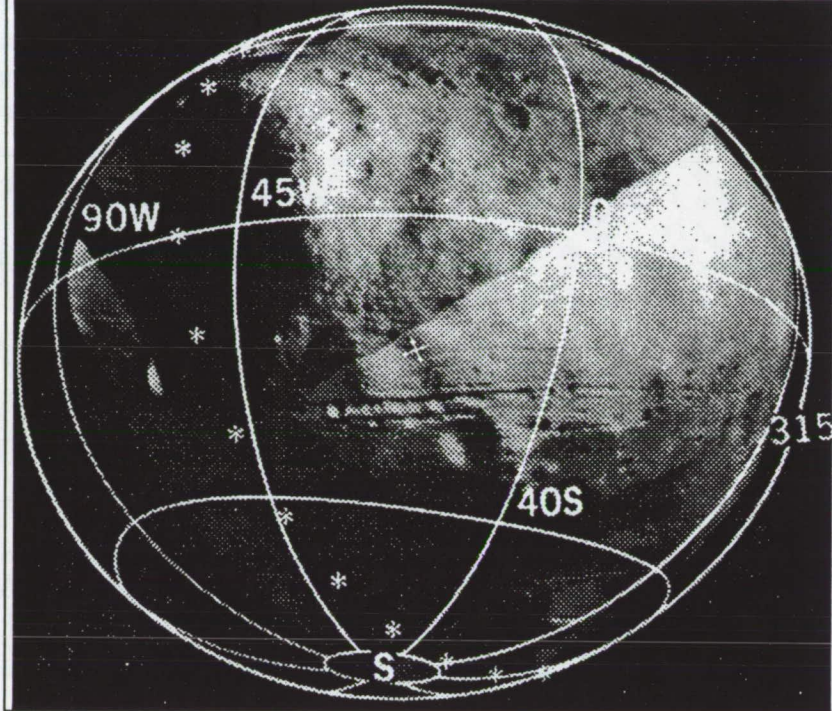

High Resolution Picture of Phobos Surface Features

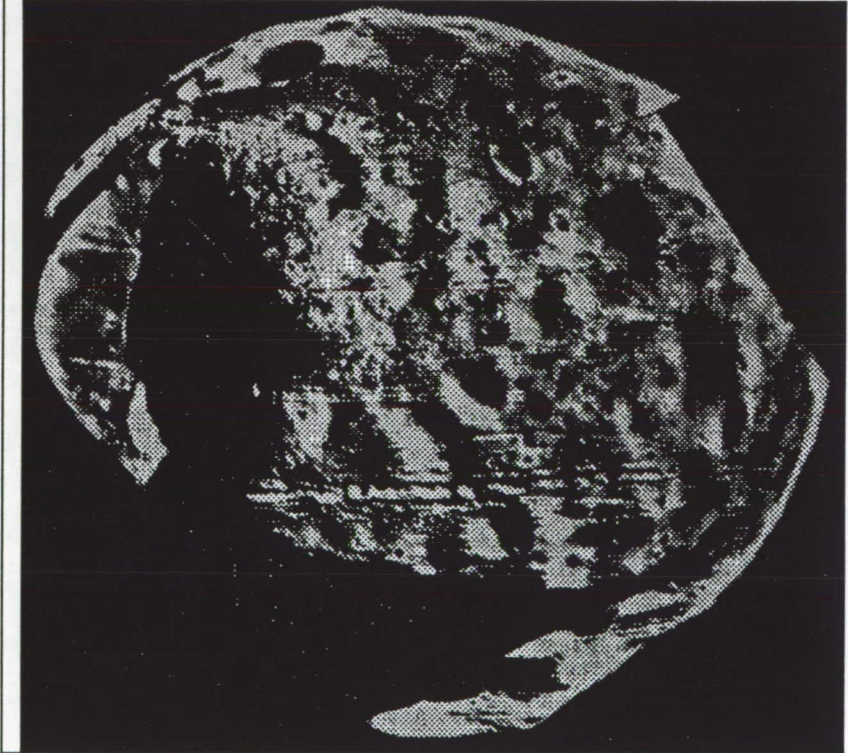

Composition of a Type 1 Carbonaceous Chondrite

Type 1 carbonaceous chondrite meteorites have been analyzed on Earth and their composition is presented in **Table 2.2**³. It can be seen that there is an abundance of SiO₂ and H₂O, in addition to other silicates (MgO, FeO) assumed to be present on Phobos.

Element	Percentage by Weight
<u>Silicate Portion</u>	
SiO ₂	23.08
TiO ₂	0.08
AlO ₃	1.77
Cr ₂ O ₃	0.28
FeO.....	10.32
MnO.....	0.19
MgO.....	15.56
CaO.....	1.51
NiO.....	1.17
Na ₂ O.....	0.76
K ₂ O.....	0.07
P ₂ O ₅	0.27
H ₂ O.....	20.54
<u>Metal Portion</u>	
Fe.....	0.11
Ni.....	0.02
FeS.....	16.88
C.....	3.62
Other.....	3.77

Surface Features

Photometric, polarimetric and radiometric data suggest the surface of Phobos is covered by a deep layer of regolith (weathered rock and sand) which was most likely created by surface weathering and impacts. The cohesion of the regolith (10^4 dyne/cm^2) is lower than that of Phobos as a whole (10^6 dyne/cm^2) which indicates a solid interior lies beneath the regolith⁴. Many of the crater walls, as in **Figure 2.2**⁵, display layering, and measurements of those layers suggest regolith thicknesses from 10-200 meters within Stickney crater⁶.

Figure 2.2 - Wall Slumping and Layering in Craters

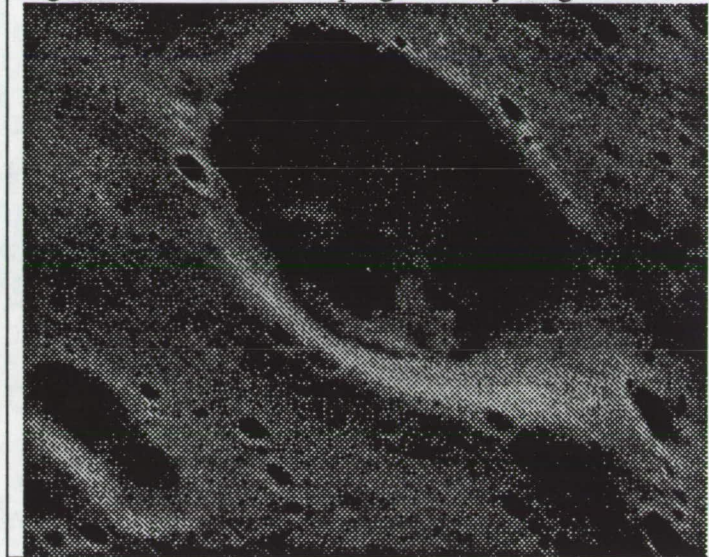

The most unusual surface features of Phobos are:

- the elongated rill-like depressions associated with Stickney,
- the chains and cluster of irregular elongated craters, and
- the parallel linear striations or grooves of uncertain origin⁷.

The elongated rill-like depressions can be seen in *Figure 2.3*⁸. These depressions or troughs originate at Stickney crater and emanate outwards, which suggests the troughs are actually fractures created by the severe meteorite impact which formed Stickney crater.

Figure 2.3 - Grooves Emanating From Stickney

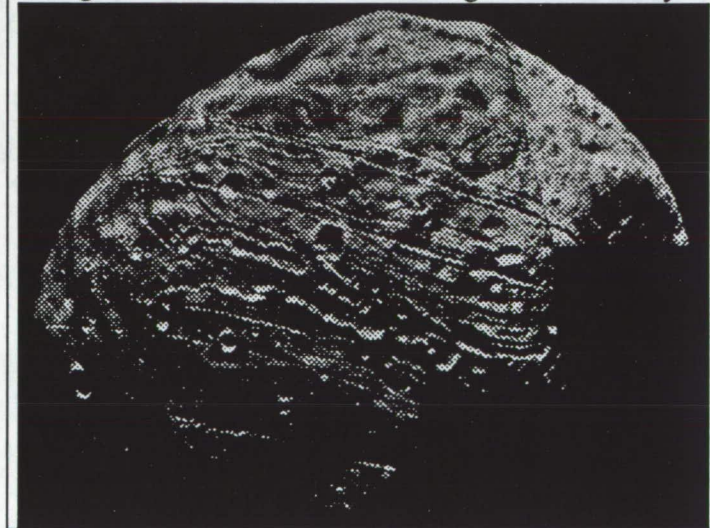

The chains of irregular elongated craters are shown in *Figure 2.4*⁹. These chains consist of craters 50-200 m across, which sometimes cluster into the 'herringbone' pattern characteristic of secondary ejecta. These crater chains are not randomly oriented, but seem to run parallel to Phobos' orbital plane. It is possible that these craters are secondaries which were produced

by clumps of ejecta which originally were thrown out at slightly more than the escape velocity of Phobos, went into orbit about Mars, and subsequently re-impacted the surface¹⁰.

Figure 2.4 - Long Strings of Craters

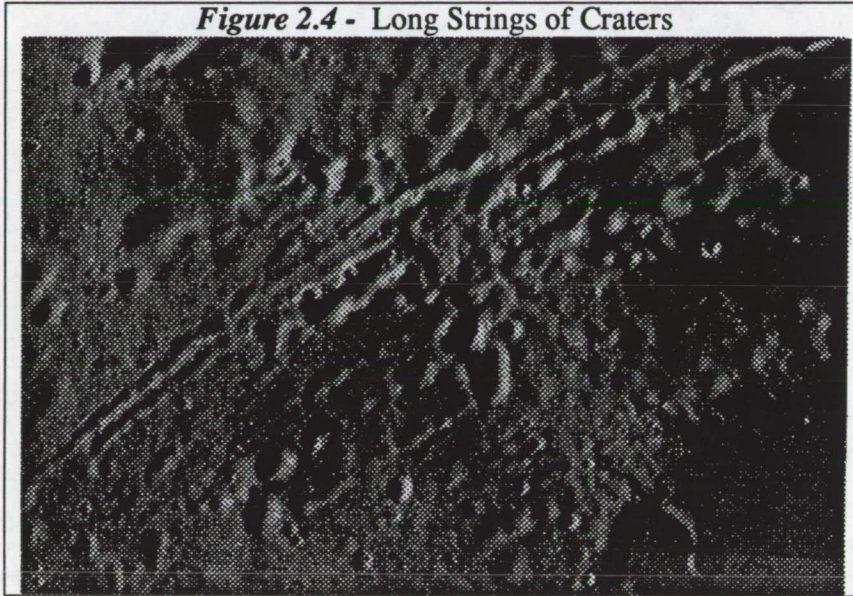

The Linear striations or grooves can also be seen. These striations are typically 120-200 m wide and can be followed individually for more than 5 km. They occur in at least two sets which are not exactly parallel but which do not cross each other. The question remains whether these striations are more properly gouges or cracks, and they appear to lie in small circles perpendicular to the Mars-Phobos direction. It has been proposed that these striations are either; representations of the layering in Phobos, rows of small impact craters, or cracks resulting from tensional stresses. These stresses would be from the strong gravitational pull of Mars, possibly initiated by the impact which caused Stickney crater¹¹.

Value of Resources

Of the elements assumed to compose Phobos, many would be important when processed into water, propellants, and other materials. These materials would then have applications in interplanetary travel, Mars Exploration, base construction, or Earth uses.

For the base on Phobos to be used as a transportation node for inter-planetary travel, the production of water and propellants would be important. Because of the abundance of water on Phobos, a base for water supply could be very valuable and economical. In addition, the water could be processed with electrolysis or thermochemical reactions to yield the propellants, LH_2 and LO_2 . These propellants, however, would only be produced for immediate use since their highly reactive and explosive natures make them difficult to store safely. CH_4 , Methane, is another propellant which is less reactive and more stable than LH_2 or LO_2 , but it yields a lower specific thrust. Methane could also be considered for fuel production.

For the Phobos base to be economically valuable for Earth supply, silicon semi-conductors could be produced with higher precision and lower cost than on Earth. Indeed, Phobos' abundance of silicon and low gravity make it ideal for the crystal growth and vacuum casting for this application. Also of use on Earth and in space are ceramic magnets (MgFe_2O_4).

Ceramic magnets have a wide variety of uses in communications for antennae, cassette tapes, deflection transformers in monitor screens, and computer disks.

For use in the Phobos base and in other space structures, Phobos has many material capabilities. The production of Iron and Magnesium is feasible and will be discussed later. Other possible building materials are ceramics, glass and fiberglass which are processed from Al_2O_3 , MgO , SiO_2 , Na_2O , and CaO . With the exception of Na_2O and CaO , the other elements are found in abundance on Phobos. Unfortunately, the manufacture of metals and metal alloys is not as feasible because only trace amounts exist of the pure metals. In regolith, most metals eventually become oxidized, therefore it is more difficult and costly to extract from their oxidized forms.¹²

Below is a discussion of two of the most feasible materials that could be manufactured. The processes involved are discussed using the resources available on Phobos. These two materials, Iron and Magnesium, could be manufactured from their oxide forms found on Phobos.

Iron Extraction

Ferrous compounds (FeO and FeS) are relatively plentiful on Phobos. *Table 2.2* shows how iron could be extracted from at least one of these compounds (FeO). The compounds should be easily obtained by a magnetic separator which the regolith is run through prior to water extraction. Silicon will reduce FeO into iron at 1300°C according to the equation:

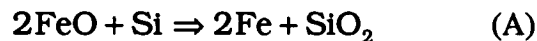

This reaction requires pure silicon which is not present on Phobos. There are as stated before, plentiful quantities of silicon dioxide. Silicon dioxide can be reduced to silicon at 2300°C by the reaction:

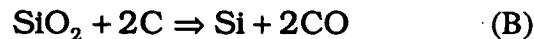

Pure carbon is required for this above reaction, in which Phobos's composition should be approximately 3.62% carbon. However, the simplest method of isolating this carbon would be to reduce one of its gaseous compounds that is released with water vapor in the oven during water extraction. The below reaction demonstrates how carbon monoxide can be reduced to pure carbon:

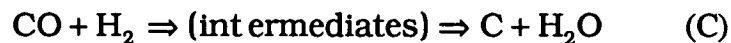

Carbon monoxide can be isolated by use of a condenser which takes advantage of carbon monoxide's unique vapor point.

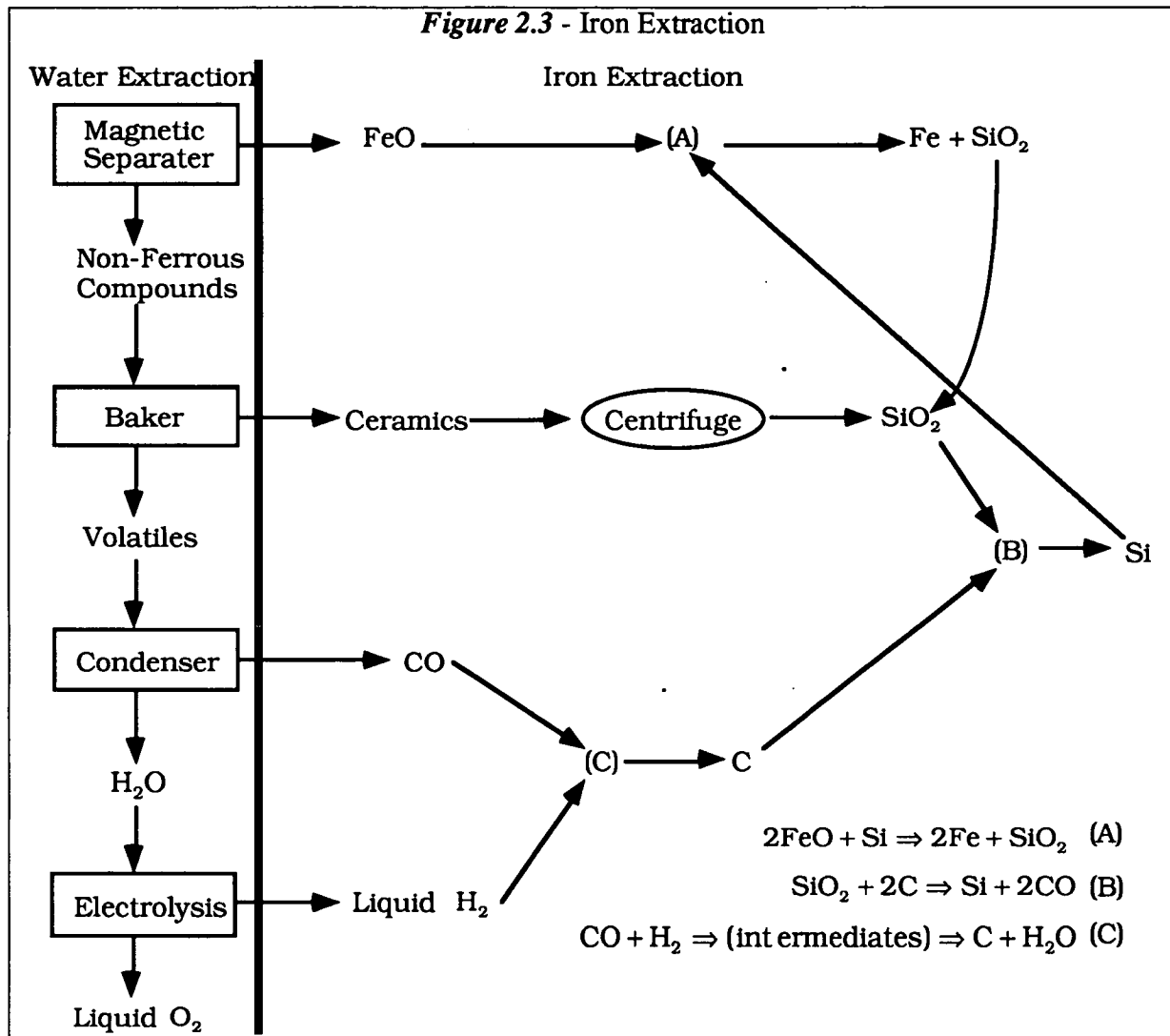

Magnesium Extraction

Phobos should contain an ample amount of magnesium oxide which can be reduced to pure magnesium. The process would involve heating magnesium oxide, silicon, and calcium oxide to 1200° C to produce vaporized magnesium and solid Ca₂SiO₄. The magnesium vapor is then liquefied by a condenser and then poured into molds to form magnesium ingots. The problem of this method is that the quantity of calcium oxide is relatively scarce on Phobos. Glass production, discussed later, will take all the available calcium oxide. Another method which requires a higher temperature (2300° C) uses the following reaction:

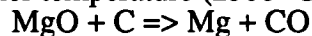

The advantage to this method is that carbon is more plentiful than calcium oxide which is required in the first method. This method does require more energy because of its higher temperature, but nuclear power should provide an ample amount of energy so that this will not be a problem. Therefore, this carbon method will be the preferred method.

Other Products

What other production possibilities exist on Phobos? *Table 2.2* shows that silicon dioxide should be 23% of Phobos composition. Therefore, glass could be produced since 72% of its composition is silicon dioxide. The other compounds that make up the other 28% of glass are also present on Phobos but not in large quantities. Calcium oxide and sodium oxide make up 1.51% and 0.76% of Phobos respectively. However, some small scale production of glass should be possible using entirely Phobos substance.

The carbon gases (CO, CO₂, CH₄) that are released during the water extraction process can be processed into ethylene (C₂H₄). Ethylene is the building block of polymers.

If glass and polymers can be produced then their composite, fiberglass, can also be produced. Fiberglass can be useful as a structure material.¹³

Phobos References

- 1 Thomas C. Duxbury, John D. Callahan, and Adriana C. Ocampo, **Phobos: Close Encounter Imaging From the Viking Orbiters**, NASA Reference Publication 1109, July 1984.
- 2 Cutts, James A., **Mariner Mars 1971 Television Picture Catalog**, Jet Propulsion Laboratory, Pasadena, Ca., 1974, p. 395
- 3 Gomes, Celso B. and Klaus Keil, **Brazilian Stone Meteorites**, University of New Mexico Press, Albuquerque, 1980, p. 44.
- 4 Thomas, P., "Surface Features of Phobos and Deimos", *Icarus*, Vol. 40, Number 2, 1979, p. 266.
- 5 Thomas C. Duxbury, John D. Callahan, and Adriana C. Ocampo, **Phobos: Close Encounter Imaging Form the Viking Orbiters**, NASA Reference Publication 1109, July 1984.
- 6 Ververka, J., and Thomas, P., "Phobos and Deimos: A Preview of What Asteroids are Like?", *Asteroids*, The University of Arizona Press, Tucson, AZ, 1979, p. 642.
- 7 Ververka, J., and Duxbury, T.C., "Viking Observations of Phobos and Deimos: Preliminary Results", **Scientific Results of the Viking Project**, American Geophysical Union, Washington, D.C., p. 4213.
- 8 Thomas C. Duxbury, John D. Callahan, and Adriana C. Ocampo, **Phobos: Close Encounter Imaging From the Viking Orbiters**, NASA Reference Publication 1109, July 1984.
- 9 Thomas C. Duxbury, John D. Callahan, and Adriana C. Ocampo, **Phobos: Close Encounter Imaging From the Viking Orbiters**, NASA Reference Publication 1109, July 1984.
- 10 Ververka, J., and Duxbury, T.C., p. 4217.
- 11 Ververka, J., and Duxbury, T.C., p. 4218.
- 12 IGS, *A Phobos Industrial Production and Supply Base*, University of Texas at Austin, 1986, p. 10-13.
- 13 IGS, p. 20-22.

Chapter 3

Mission Analysis

3.0 Summary

3.1 Mission Trajectory

3.2 Solar Flare Studies

3.3 Rendezvous with Phobos

3.4 Contingency Planning

PRECEDING PAGE BLANK NOT FILMED

PAGE 21-22 INTENTIONALLY BLANK

Summary

The primary duties of the Mission Analysis team were solving the orbital mechanics concerns of Project APEX and planning the overall mission. More specifically, the responsibilities of the group included: calculating the interplanetary trajectories, determining rendezvous and landing methods, creating mission time lines, and finally, planning for mission contingencies.

Project APEX will use an opposition class mission with a total mission time of 656 days. The proposed departure date from Earth will be November 19, 2010. The outbound trajectory includes a Venus swingby to conserve fuel. Once the ship reaches Phobos on October 3, 2011, the stay time for setting up the processing plant and conducting experiments will be sixty days. The ship will then arrive back at Earth on September 5, 2012.

The spacecraft will land on Phobos near Stickney Crater as decided by the Planetary Science group. During landing, the ship will harpoon Phobos with tethers to assist in landing. After landing, the ship will remain tethered to the moon's surface because of the extremely low gravity.

Mission Trajectory

At the beginning of the design process, the Mission Analysis group considered many different mission trajectories. The group then researched and analyzed each trajectory, exploring its pros and cons, until a final trajectory design was reached. In addition, the group had to plan a basic mission time line, including scheduled course corrections.

Constraints on Trajectory Choice

Several factors go into the selection of an appropriate mission trajectory. These include fuel requirements (ΔV 's) for the mission, mission duration, the actual stay time on Phobos, the expected radiation dosage absorbed during the mission, and the proposed launch date corresponding to the trajectory.

ΔV refers to the velocity change required to transfer the spacecraft to a new orbit. Since ΔV is directly related to the amount of fuel required, it is desired for ΔV requirements to be as low as possible. In this mission, as in all other space operations to date, the cost of the project is proportional to the ship weight. Since fuel weight will be nearly 90% of the weight of the ship, this means the fuel weight must be reduced as much as possible.

Mission duration is another important factor. A shorter mission is more desirable because of the following three factors: minimize time spent on an untested vehicle, minimize radiation exposure, minimize physiological effects of reduced gravity.

The purpose of being on Phobos for this first mission is to build a processing plant for converting Phobos' soil to fuel and other useful materials. Since the plant will only require final assembly, the time required for construction by five astronauts should be under 100 days. If the stay time is too long, it will be difficult for the astronauts to function well for the return trip. This is due to the fact that while on Phobos, the crew will spend the entire time in a very low gravity environment. This could prove detrimental to a successful return trip back to Earth.

NASA's guideline for safe radiation values is 33 REM per month. Due to Earth's ozone layer, humans on Earth are exposed to radiation levels that are much less than 33 REM per month. However, unlike Earth, the spacecraft does not have a natural protection from radiation. Because of this, the ship must be properly protected in order to keep the radiation exposure within the NASA guideline. How much shielding is required is directly related to how much radiation the shielding has to repel. The amount of radiation is dependent upon distance from the sun during the trip and the solar flare cycle. Radiation decreases as the square of the distance from the sun. Certain trajectories have a closer approach to the Sun than others, especially those which utilize a Venus swingby. Radiation also increases as the solar flare cycle approaches a maximum. Therefore, it is desirable to plan a mission around a solar minimum. The solar flare cycle is at a minimum in the year 2010 and will reach another minimum every eleven years thereafter.

Minimizing the amount of radiation encountered on the mission will minimize the amount of shielding needed to protect the crew. As a result, the weight, and therefore, the cost will also be minimized.

There are two main issues in determining an appropriate launch date. First, since this is to be a first manned mission to the Mars system which will serve as a stepping stone to future missions, it seems logical that the mission should launch as soon as possible. However, there are also advantages to waiting for the advancement of technology, because as technology advances, the trip is made easier and perhaps less costly.

Comparison of Conjunction and Opposition classes

The Mission Analysis Group was assigned the task of deciding upon the mission length for Project APEX. There are two possible mission types to choose from--conjunction and opposition.

The following is a comparison of the two mission classes¹:

Opposition Class

- Earth and Mars on the same side of the sun
- Mission length from 1/2 to 2 years
- 60-80 day stay time at Mars system
- Generally larger ΔV (fuel) requirements

Conjunction Class

- Earth and Mars on different sides of the sun
- Mission length up to 3 years
- 1 to 1.5 year stay time at Mars system
- Generally smaller ΔV (fuel) requirements

Radiation and Solar Flare Studies

Radiation Studies

Before selecting a specific trajectory, the Mission Analysis group had to determine if the radiation levels on each trajectory were tolerable. Therefore, Mission Analysis had to calculate the total radiation that would be absorbed during the mission. This was done by using a formula that gave radiation levels as a function of time and distance from the Sun. This amount of radiation accounted for solar wind and cosmic radiation. The formula used was²:

$$\text{Radiation} = \frac{(50 \text{ REM / year})}{(\text{Radius from the Sun in AU})^2} (\text{Time at that Radius})$$

Mission Analysis broke the trajectory into segments of a few days each. An average radius was used for each segment, and the time inside each segment was computed. From that information, the radiation levels were calculated for each segment. The segment sizes were then reduced until there was not a significant change in the radiation levels. The levels were then totaled and checked to make sure that they were within the allowable limits supplied by the Human Factors group.

A sample of the segment analysis is given below along with the total REMs estimated for the entire mission and the allowable limits.

Radius from the Sun (AU)	True Anomaly (deg)	Time (days)	Radiation (REM)
0.62	68.57	-----	-----
0.64	75.46	3.34	1.12
0.66	81.73	3.23	1.02
0.68	87.54	3.19	0.94
0.70	93.00	3.18	0.89
0.71	95.62	1.59	0.43
0.72	98.18	1.60	0.42
0.7280	100.20	1.29	0.33

Radiation estimate for entire mission : 94.96 REM

Total Mission Length : 656 days

Allowable Radiation Limit: 33 REM/month

Solar Flare radiation levels were calculated by the Structures group.

Solar Flare Studies

Space missions, because they lack any natural radiation protection, are especially susceptible to radiation from the Sun. Therefore, it is important to have an understanding of solar phenomenon and to predict the level of solar activity at the time of the proposed mission. Background information on solar flare characteristics and a future solar activity prediction follow.

Generally, solar flares are classified according to physical size. The classifications including their relative energy is shown in *Table 3.2*.³

Flare Type (Class)	Size (degrees ²)	Energy (J)
S (Subflare)	<2.0	1 x 10 ²¹
1	2.0-5.1	1 x 10 ²²
2	5.2-12.4	1 x 10 ²³
3	12.5-24.7	1 x 10 ²⁴
4	>24.7	1 x 10 ²⁵

Class 4 flares are the most intense and most energetic. Likewise, subflares are the least intense and least energetic.

Solar radiation is produced when energetic elementary particles, released from the Sun's surface in the form of a flare, collide with molecules in the Sun's atmosphere. X-rays are produced as the kinetic energy of an electron is converted into a photon (electromagnetic wave). When energetic electrons impinge matter in the Sun's atmosphere, the energy not directly transferred to the target atom is converted to an X-ray. Gamma rays produce excited nuclei (a product of atmospheric collisions) as they return to their ground state. To do so, they must discharge surplus energy. This surplus energy is discharged as a gamma ray (photon).⁴ A small fraction of the elementary particles released in a solar flare pass through the solar atmosphere. The radiation types are given in *Table 3.3*.⁵⁶

Radiation Type	Energy Levels
Hard X-rays	> 20 keV
Gamma rays	500 keV-2.2 MeV
Electrons	10 keV -100 keV
Protons	~ 10 Mev

Relative amounts of radiation emitted from each class of flare are loosely scaled with class energy. However, numerous exceptions to this occur where a less energetic flare will produce a greater relative amount of radiation.

The distribution of Class occurrences can be approximated for Classes 1-4 as follows⁷:

Flare Type (Class)	Relative Occurrence
1	89.3%
2	8.90%
3	0.89%
4	0.89%

A solar flare forecast has been generated to predict the number of class one or greater solar flares expected at various intensities of solar activity. The approximate daily frequency of solar flares of Class 1 or greater is related to the Zurich relative sunspot number (R) through the following expression⁸:

$$\text{Number of Daily Occurrences} = R/25$$

The Zurich relative sunspot number can be further defined as⁹: $R=K(10g+f)$

Where: g =number of sunspot groups
 f =number of individual spots
 K =correction factor applied to the observations from each observatory to allow for the size of the telescope, atmospheric conditions, and relative enthusiasm of the observer.

Tabulated values of R^{10} were processed to yield an average <flares per day> during a solar maximum. This result of 5.0 ± 0.35 flares per day was then scaled to provide a prediction base for other levels of solar activity. **Figure 3.1** presents the results. 100% relative solar activity corresponds to a solar maximum and ~0% relative solar activity corresponds to a solar minimum.

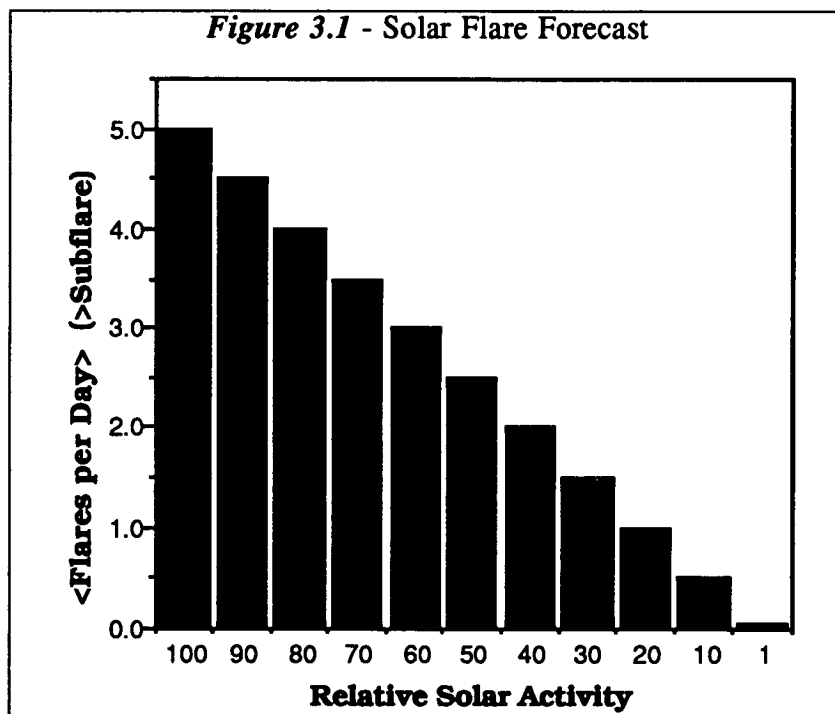

Solar activity predictions are based on the sunspot activity cycle. The sunspot activity cycle is based on the counting of observable sunspots which have roughly an 11-year period. Solar flare activity is proportional to sunspot activity. Thus, a solar maximum refers to a time period in which there exists a peak population of sunspots and conversely of a solar minimum. More specifically, solar flare intensity is proportional to the area of sunspots which generally increases with the number of sunspots. In addition, solar flares are seen to be most intense 1-2 years after a solar maximum when the sunspot areas are greatest.^{11 12}

A prediction of solar activity for the early 21st century was prepared through a statistical analysis of solar activity data from 1750 A.D. to the present.¹³ Using this data, the mean cyclic period between solar maximums and minimums was calculated including the relative error. A prediction was made for solar extremism occurring between 1999 and 2027 by applying this mean to each documented 20th century extremism date and projecting appropriately. Included in this projection was a correction factor to take into account that the

most intense solar activity is seen 1-2 years after a solar maximum. This process yielded data corresponding to each projected extremism including relative errors. This subset was further reduced to yield a mean projection date and the relative error for each extremism. *Table 3.5* of the predicted extremisms and their relative error corresponding to a $\pm 3\sigma$ distribution follows.

Predicted Minimum	Error	Predicted Maximum	Error
Calendar Year 0.0	Years	Calendar Year 0.0	Years
1999.10	1.97	2004.57	2.13
2010.03	2.28	2015.50	2.44
2020.96	2.59	2026.43	2.75
2031.89	2.91	2037.36	3.06

Below is a description of the statistical formula used to generate the extremum predictions and relative errors.¹⁴

$$\text{Mean Difference} = \frac{\sum_{i=1}^{N-1} \text{Year}_{i+1} - \text{Year}_i}{N}$$

N=number of data samples

$$\text{Standard Deviation} = \sigma_N = \sqrt{\frac{\sum_{i=1}^{N-1} \left((\text{Year}_{i+1} - \text{Year}_i) - \text{Mean Difference} \right)^2}{N}}$$

$$\text{Standard Error of the Mean} = \frac{\sigma_N}{\sqrt{N-1}}$$

Figure 3.2 is a graphical representation of the predicted extremisms. The extremisms are connected by straight lines in order to facilitate rough interpolation of solar activity. In actuality, solar activity graphs of this nature are fitted by a skewed gaussian curve. A prediction of this curve was not formulated because the points of interest were the extremisms.

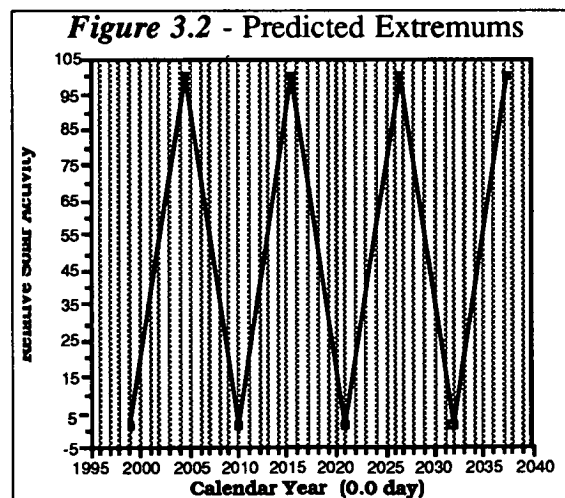

Outline of Chosen Trajectory

Based on the constraints outlined in *Constraints on Trajectory* and the radiation information in *Radiation and Solar Flare Studies*, the Mission Analysis group decided upon an opposition class mission with a launch date in 2010. This mission was described in the NASA Technical Memorandum TM-86477, "Mars Exploration--Venus Swingby and Conjunction Class Mission Modes,"¹⁵ with some modifications to fit the Project APEX guidelines. One such modification includes the adjustment of the departure and arrival orbits due to nuclear safe guidelines set by the United Nations¹⁶. For a craft using nuclear power, the United Nations requires that the vehicle stay above an altitude specified for each planet. This altitude is chosen such that a failed nuclear powered craft will take no less than 100 years to decay through the planet's atmosphere.

The mission trajectory information for Project APEX is summarized below:

- Total Mission Time: 656 days
 - Outbound Leg: 318 days
 - Depart Earth: November 19, 2010
 - Departure Orbit: circular with altitude of 700 km
 - Pass Venus: May 7, 2011
 - Arrive Mars System: October 3, 2011
 - Stay time on Phobos: 60 days
 - Inbound Leg: 278 days
 - Depart Mars System: December 2, 2011
 - Arrive Earth: September 5, 2012
 - Arrival Orbit: elliptical with 700 km perigee, 71,028.9 km apogee
- Radiation Information
 - Total REMs (without shielding): 94.96 REMs
 - Solar flare range: 0-50% of maximum
 - Closest approach to Sun: 0.528 AU
 - # of days inside Venus orbit: 86 days
 - start date inside Venus orbit: February 10, 2011
 - solar flare activity at 20%
 - date leave Venus orbit: May 7, 2011
 - solar flare activity at 28%

There are three different trajectory ellipses which comprise the interplanetary transfers in this mission. The first ellipse describes the path followed by the craft from Earth orbit to Venus fly-by. The second ellipse describes the path followed from Venus fly-by to Mars. The third ellipse describes the path followed from Mars back to Earth. The characteristics of these three ellipses are summarized in *Table 3.6*.

Trajectory	C3-DD	I 1	ECCEN	SMA	THET 1	THET 2	C3-AD
ellipse 1	30.48	3.49	.304	.759	175.7	460.2	119.35
ellipse 2	117.5	.29	.430	1.158	46.2	159.6	30.68
ellipse 3	16.75	-2.62	.287	1.286	193.1	413.5	54.40

Where: C3-DD: Square of the hyperbolic excess velocity at the departure planet (km²/sec²)

- I 1: Inclination of transfer orbit to the planet's orbit at the start of the transfer (degrees)
- ECCEN: Eccentricity of the heliocentric transfer conic
- SMA: Semi-major axis of the transfer conic, in astronomical units
- THET 1: True anomaly at the start of the transfer (degrees)
- THET 2: True anomaly at the end of the transfer (degrees)
- C3-AD: Square of the hyperbolic excess velocity at the arrival planet (km²/sec²)

Figures 3.3 & 3.4 show the outbound and inbound trajectories described above.

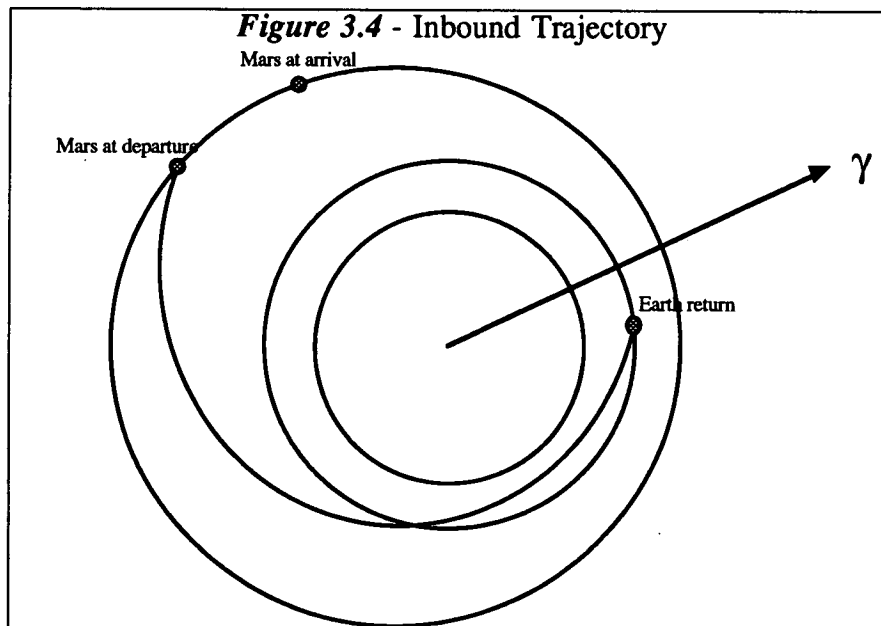
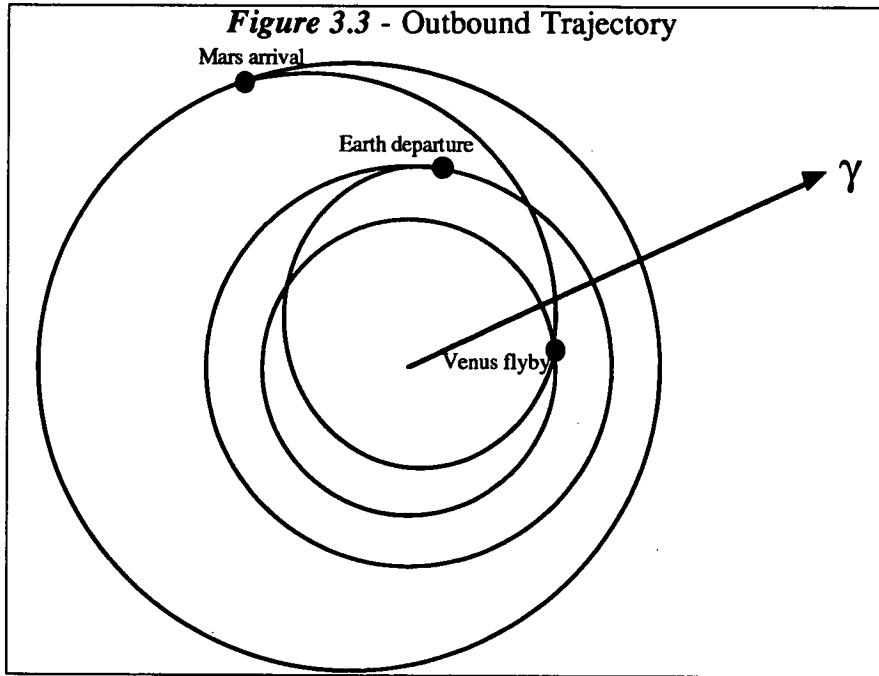

There are four major ΔV 's required for this mission. These ΔV 's are summarized below:

- ΔV (total) approximately 13.14 km/sec
 - ΔV_1 : 4.50 km/sec (Earth orbit to transfer ellipse 1)
 - ΔV_2 : 4.17 km/sec (transfer ellipse 2 to Mars orbit)
 - ΔV_3 : 2.95 km/sec (Mars orbit to transfer ellipse 3)
 - ΔV_4 : 2.82 km/sec (transfer ellipse 3 to Earth orbit)

Method for calculating ΔV 's:

Sample calculation (ΔV_1):

$$V_2 = \sqrt{V_\infty^2 + \frac{2\mu}{r}}$$

Where:

μ = earth gravitational constant¹⁷ = 3.986012×10^5 km³/sec²

r = radius from the center of the earth = 7078 km

V_∞ = Hyperbolic excess velocity¹⁸ = 5.52 km/sec

V_2 = Geocentric escape velocity = 11.962 km/sec

$$V_1 = \sqrt{\frac{\mu}{r}}$$

V_1 = initial circular velocity = 7.504 km/sec

Using V_1 , V_2 , and the angle of inclination, i , ΔV_1 can be calculated using the following relation:

$$\Delta V_1^2 = V_1^2 + V_2^2 - 2V_1V_2\cos(i) = 20.9032 \frac{\text{km}^2}{\text{sec}^2}$$

Where:

i = angle of inclination = 3.49 degrees¹⁹

Therefore, $\Delta V_1 = 4.496$ km/sec.

Course Corrections Requirements

There are several possible sources of error which may lead the ship off course during the mission. These sources of error include:

- inaccuracy of the guidance and navigation systems
- inaccurate engine steering
- inaccurate burn times
- inaccuracy of thrusters during spin/despin

In order to determine how far off course these errors will lead the ship, it is necessary to analyze the trajectory using perturbation theory. This analysis can be approximated by assuming a perturbation in the required ΔV 's. If, for example, the required ΔV_1 is increased by 1% due to any of the errors listed above, the ship will be off course on the first transfer ellipse. Although, it will be only slightly off course at the beginning of this transfer, the error will propagate, and the ship will be significantly off course by the time it reaches its next ΔV . Also, the sooner the ship gets back on course, the less the ΔV that will be required to get it back on course. Therefore, it is necessary to perform course corrections during the transfer. For this mission, it was determined that a total of six course corrections will be required. They are outlined as follows:

OUTBOUND LEG

- shortly after Earth departure
- half way from Earth to Venus (320 degrees from perihelion on ellipse 1)
- during Venus swingby
- half way from Venus to Mars (103 degrees from perihelion on ellipse 2)

INBOUND LEG

- shortly after Mars departure
- half way from Mars to Earth (303 degrees from perihelion on ellipse 3)

It was determined that the largest source of error would come from the engine steering and burn times which primarily result in an error in the magnitude (not the direction) of the required ΔV . A method for estimating errors in the ΔV maneuvers was found.²⁰ Using this method, it was estimated that a total ΔV of 0.011 km/s will be required for course corrections.

Sample Calculation:

Equation:

$$\text{Error in Hyperbolic Excess Velocity} = \frac{\text{Geocentric Speed}}{\text{Hyperbolic Excess Speed}} \times 5 \text{ ft/s}$$

Where 5 ft/s is a standard assumed error.²¹

$$\text{Sample (for trajectory ellipse 1): } \frac{12 \text{ km/s}}{5.45 \text{ km/s}} \times 5 \text{ ft/s} = 11 \text{ ft/s} = 3.35 \times 10^{-3} \text{ km/s}$$

This course correction will take place at the beginning of the first leg immediately following the first ΔV maneuver. The next course correction will take place mid-course between Earth and Venus. This course correction is approximately equal to 10% of the first course correction (.000335 km/s). This method for approximating the mid-course correction was given by Ehrlicke.²² Using the same equation for the other two trajectory ellipses, a summary of the ΔV 's for course corrections is shown in *Table 3.7*.

	First course correction	Mid-course correction
First Leg	$3.35 \times 10^{-3} \text{ km/s}$	$3.35 \times 10^{-4} \text{ km/s}$
Second Leg	$4.0 \times 10^{-3} \text{ km/s}$	$4.0 \times 10^{-4} \text{ km/s}$
Third Leg	$1.90 \times 10^{-3} \text{ km/s}$	$1.90 \times 10^{-4} \text{ km/s}$

In summary, the total ΔV for course corrections was calculated to be 0.011 km/s.

Earth Departure Maneuver

The Mission Analysis group, along with the Propulsion group, performed a study on perigee kicks to determine if they were feasible for project APEX. Perigee kick refers to a maneuver where a spacecraft, initially in a circular orbit, fires thrusters to put itself into a higher, elliptical orbit. This orbit has the same perigee radius as the circular orbit, and an apogee radius some amount larger. After completing one revolution around the Earth, the thrusters are fired at perigee and the spacecraft can either raise its apogee to a even larger radius or achieve escape velocity. This maneuver is done so the spacecraft can increase its orbital energy without taking large losses due to G-Loss. G-Loss refers to the increase in ΔV required to change orbits when the initial ΔV burn time is a large percentage of the orbital period²³. A perigee kick breaks this burn time into two or more shorter burns, reducing the G-loss and thus saving weight in fuel.

The main concern when doing perigee kicks is the radiation received while passing through the Van Allen belts. These are two belts of high radiation surrounding the Earth. These belts change in size due to changes in solar flare activity (the more activity, the larger the belts). Because Project APEX will be launching during a solar minimum, the belts will be at their smallest. For the analysis, an inner radius of 8,000 km and an outer radius of 31,500 km were assumed. These correspond to moderate solar flare activity.²⁴

The radiation levels in the belts were determined by comparing the time the Apollo astronauts spent in the belts. The trajectory that the Apollo astronauts used to pass through the belts was very elliptic (Period = 12.4 days, $e=0.98$, Radius of apogee = 500,000 km) and their passage time through the belts was about one hour each way²⁵. This corresponded to about 4 REM of radiation.

Mission Analysis looked at various elliptic orbits for the single perigee kick scenario. It was determined that for a period range of 2 days - 12 days, there was not a significant difference in passage times. Thus Mission Analysis, in conjunction with Propulsion, decided that a period of 2 days was a best choice. *Table 3.8* shows a comparison of different orbits and their data.

Table 3.8 - Perigee Kick Comparison

Period (days)	Apogee (km)	Delta T (hrs)	Delta V (km/s)	REM/pass
10	385005.7	1.38	3.01	5.56
8	330809.9	1.39	2.99	5.59
6	271842.9	1.41	2.97	5.64
4	205779.0	1.43	2.93	5.74
2	127014.2	1.50	2.82	6.00
1	77395.2	1.63	2.65	6.53
0.5	46137.0	1.96	2.37	7.85

For the 2 day period elliptic orbit, the astronauts will receive approximately 6 REM per passage. This means that for three passages (2 on the ellipse, one to escape) they will receive about 18 REM. They will also receive about 4 REM from the two engine burns, and finally about 6 REM from galactic-cosmic radiation for the remaining 28 days of the month. Their total for 30 days will then be approximately 28 REM, which is below the 33 REM per month limit set by NASA.

Another option is to use two perigee kicks. Although this kind of maneuver would save more weight, the extra reduction is not significant. This would also mean that the spacecraft would

have to travel through the Van Allen belts five times and would raise the radiation amounts received by the crew to unacceptable levels.

Mission Analysis, therefore, recommends that a single perigee kick be used to break up the escape burn into two smaller burns. The first will put the spacecraft on an elliptical orbit with a period of 2 days, and the second will give the spacecraft the required escape velocity to travel to Mars. The measurements of the 2 day ellipse are as follows:

Radius of perigee : 7078 km
Radius of apogee: 127,014 km
Semimajor axis: 67,046 km
Semilatus rectum : 13,409 km
eccentricity : 0.8944
 ΔV required for insertion on ellipse: 2.825 km/s

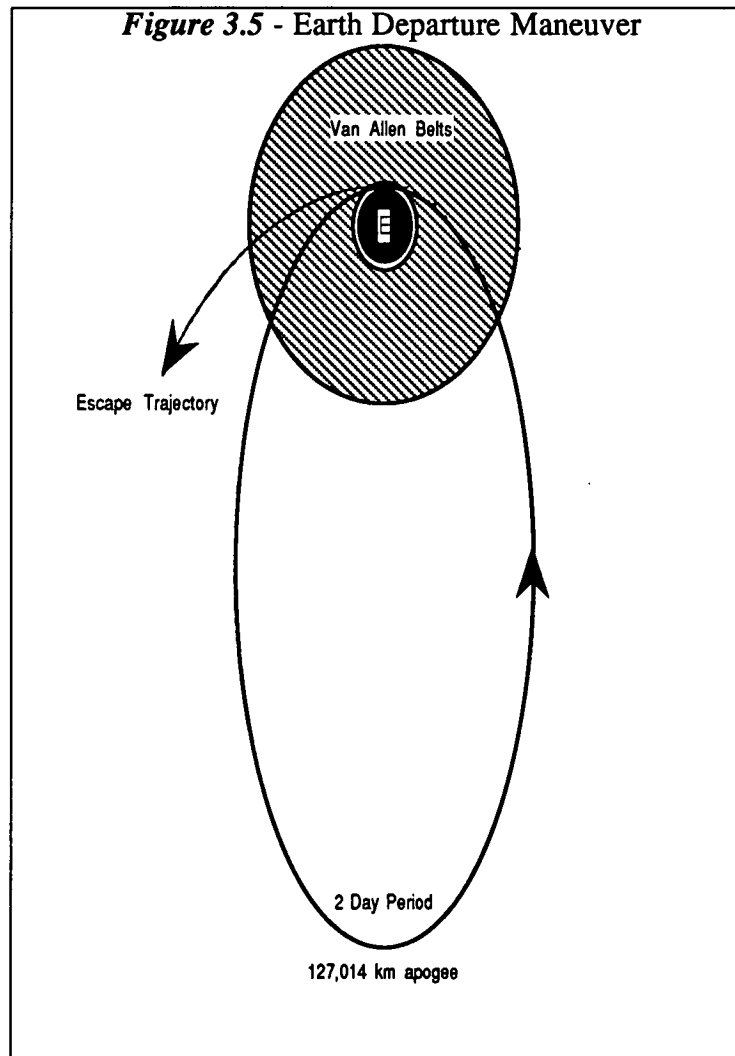

Ship Orientation (with respect to the Sun)

Another concern is the orientation of the spacecraft with respect to the Sun. The major problem being that the exterior of the ship can not become overheated due to exposure to the Sun. It is

desirable to choose an orientation which will not need an additional heat rejection apparatus. This will allow heat rejection to be accomplished without increasing the weight of the spacecraft. With respect to this concern, an investigation into heat rejection options and ship orientation in the orbital plane follows.

An active heat rejection system would use large numbers of active radiators to disperse the solar heat. This would increase the spacecraft weight significantly. Because this increase in spacecraft weight is unacceptable, passive heat rejection was investigated.

A passive heat rejection system would use the natural dissipation properties of the external spacecraft materials to reject solar heat. No additional apparatus would be needed to utilize this system. Because passive heat rejection does not increase the spacecraft weight, it is desirable to use a system of this nature.

Use of a passive system is possible if the spacecraft can be rotated so that each portion of the exterior receives equal heating. This would result in each side of the spacecraft alternating between direct solar exposure and the coldness of space. Thus the absorbed heat of a particular section would be dissipated during the time it was not facing the Sun. The investigation into the ship orientations which allow passive heating follows. In each of these orientations the spacecraft rotation axis is perpendicular to the radial vector to the Sun.

With the rotation axis in the orbital plane, the spacecraft would receive equal heating when the rotation axis was aligned with the orbital velocity vector. However, to maintain this orientation, periodic attitude adjustments would be required. These adjustments would have to be coordinated with an already spinning spacecraft and could cause rotations about other axes. This orientation is undesirable because it must be continually monitored and introduces perturbations in the spacecraft flight stability. Using this orientation also complicates communication tracking, which is undesirable.

With the rotation axis normal to the orbital plane, the spacecraft will also receive uniform external heating, but no attitude adjustments would be required to maintain this orientation. Therefore, it is desirable to orient the rotation axis normal to the orbital plane, thus having the spacecraft rotate in the orbital plane. This orientation causes no obvious communications problems.

Thus, to eliminate a 'hot side' of the spacecraft, the axis of rotation for the spacecraft's artificial gravity needs to be oriented perpendicular to the orbital plane. This configuration is desirable because: it allows passive heating (with no additional spacecraft weight) to be used, no attitude adjustments will be required, and communications should be uninterrupted. *Figures 3.6 and 3.7* show this ship orientation.

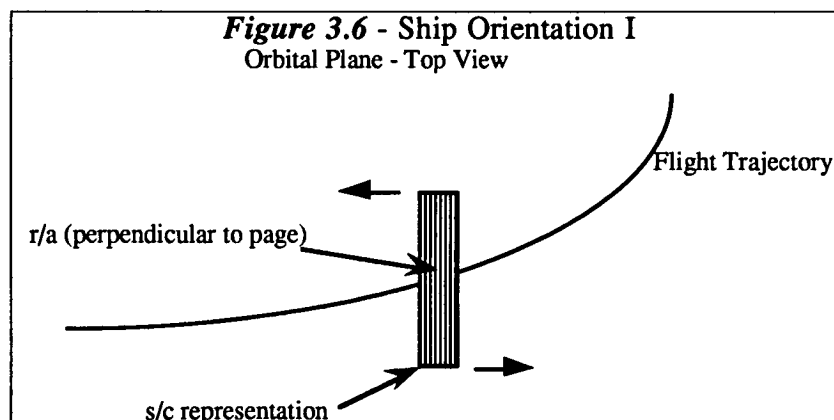

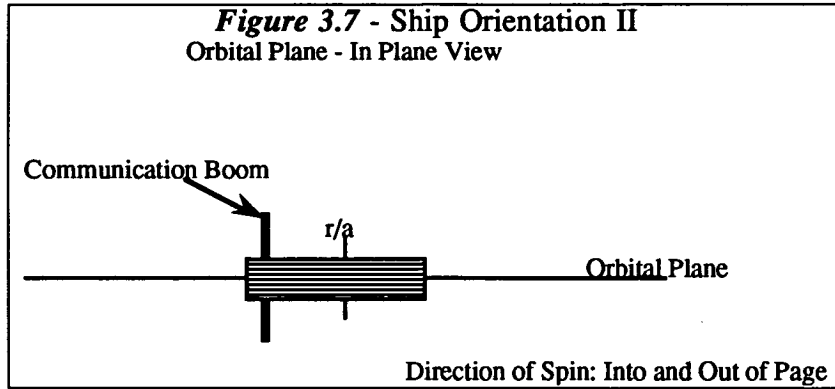

Mission Time Lines

Activities	Nov '10											Dec '10								
	F	S	S	M	T	W	T	F	S	S	M	T	W	T	F	S	S	M	T	W
	19	20	21	22	23	24	25	26	27	28	29	30	1	2	3	4	5	6	7	8
Launch Window																				
Trans Venus Injection (TVI) 25.05 min																				
Trans Venus Coast (TVC)																				

Activities	Feb '11					Mar '11					Apr '11				May '11				Jun '11		
	30	6	13	20	27	6	13	20	27	3	10	17	24	1	8	15	22	29	5	12	19
TVC																					
Inside Venus' Orbit																					
Venus Swing-by 19 hrs																					
Trans Mars Coast (TMC)																					

Once the position is determined, a phasing burn will be done. This phasing burn will take the ship on a smaller elliptical orbit if the ship trails Phobos by less than approximately 82 degrees. The inner orbit is limited by the 3000 km altitude Nuclear Safe Orbit around Mars. If the ship trails Phobos by more than 82 degrees the phasing burn will take the ship on a elliptical orbit that is larger than the orbit of Phobos. After completing half of this phasing ellipse, a small ΔV will be done changing the final orbit to one that is 18 km inside of Phobos' orbit. By doing this, the position of the ship at the end of the phasing will be 6 km from the bottom surface of the moon and directly under the center of mass. This maneuver is done for two reasons. First, Stickney crater is on the bottom of Phobos and being underneath it simplifies the landing trajectory. Second, if the engines were to fail it would not collide with Phobos. Once the ship is under the center of mass, the final phasing burn is done and will be combined with the first landing burn. This scenario is shown in *Figure 3.8*.

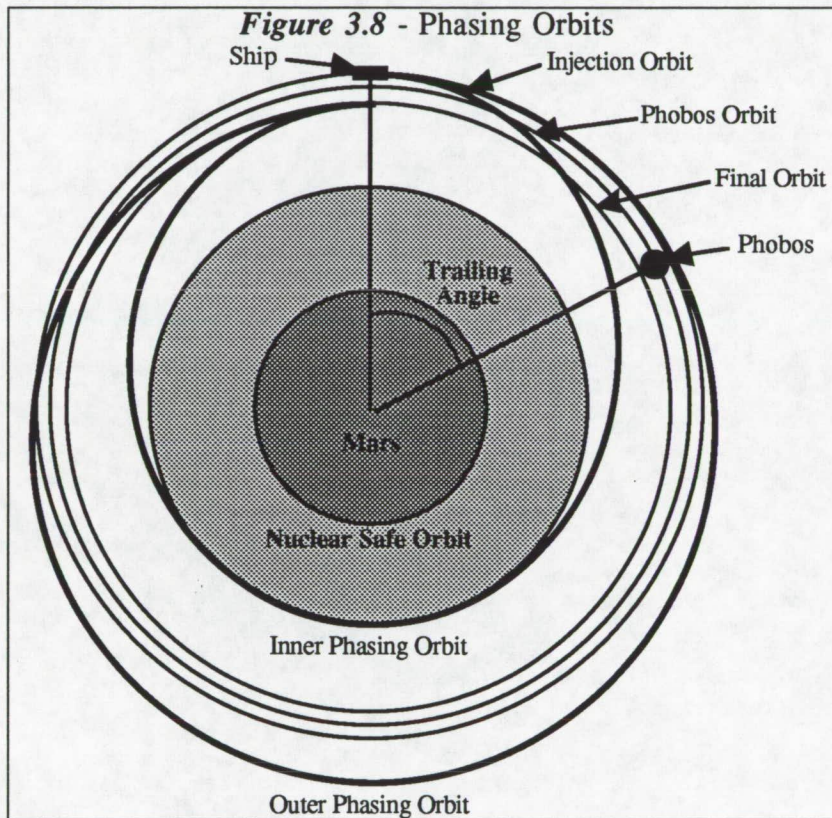

To calculate the ΔV s for these maneuvers the trailing angle is translated into a trailing time. If the trailing angle is less than 82 degrees then the trailing time is subtracted from the orbital period of Phobos, which is 27518 seconds. If the trailing angle is greater than 82 degrees then the trailing time is subtracted from the time it takes Phobos to orbit twice. This is because the ship will be taking an outside orbit and will take longer to do a single orbit allowing Phobos to catch up to the ship. This new time is the transfer time, the time required to meet up with Phobos in a single orbit. Using this time, the radius at the point of the second ΔV must be determined. It is done by using equation 1.2.1 and solving for r given a specific transfer time.

$$\tau = \frac{\pi}{\sqrt{\mu}} \left(\frac{9400 + r}{2} \right)^{\frac{3}{2}} + \frac{\pi}{\sqrt{\mu}} \left(\frac{9360 + r}{2} \right)^{\frac{3}{2}} \quad (1.2.1)$$

Where:

μ = Gravitational Parameter of Mars, 42977.8 km³/s²
 r = Radius far side of transfer ellipse

Equation 1.2.1 could not be solved in closed form, thus the computer program MATLAB was used to solve the equation for each specific transfer time. Once the radius has been determined, the ΔV s can be determined since the ellipses are now totally defined. To determine ΔV_1 , the velocity of the first ellipse must be determined at the point where it matches the orbit of Phobos. The velocity of the 9400 km circular orbit is subtracted from that elliptical velocity. This is seen in equation 1.2.2.

$$\Delta V_1 = \sqrt{\frac{2\mu}{9400} - \frac{\mu}{\left(\frac{9400+r}{2}\right)}} - \sqrt{\frac{\mu}{9400}} \quad (1.2.2)$$

The second ΔV is calculated by subtracting the velocity of the initial transfer ellipse from the velocity of the second half of the transfer ellipse. This calculation is shown in equation 1.2.3.

$$\Delta V_2 = \sqrt{\frac{2\mu}{r} - \frac{\mu}{\left(\frac{9360+r}{2}\right)}} - \sqrt{\frac{2\mu}{r} - \frac{\mu}{\left(\frac{9400+r}{2}\right)}} \quad (1.2.3)$$

The third ΔV is divided into two parts. The first part is the ΔV required to put the ship into a circular orbit with a radius of 9360 km. The second part is the initial landing burn. The first part will be covered here, and the second in the section **Approach and Descent to Landing Site**. The first part of ΔV_3 is calculated in much the same way as ΔV_1 , except that elliptical velocity is subtracted from the circular velocity of the 9360 km circular orbit and the second half of the transfer ellipse is used. Equation 1.2.4 is used to do this calculation.

$$\Delta V_{3(\text{phasing})} = \sqrt{\frac{\mu}{9360}} - \sqrt{\frac{2\mu}{9360} - \frac{\mu}{\left(\frac{9360+r}{2}\right)}} \quad (1.2.4)$$

Table 3.9 gives a brief summary of some of the more important trailing angles and their ΔV s. A positive ΔV is a posigrade, accelerating the ship and a negative ΔV is a retrograde, decelerating the ship. For the third ΔV , the positive y direction is pointing toward Phobos, thus pointing away from Mars. **Table 3.9** also includes the ΔV s for the landing burns discussed in the section **Approach and Descent to Landing Site**, but were included to show the total ΔV s for both the phasing and landing sequences. The maximum ΔV for phasing occurs when the phasing orbit first goes outside of Phobos' orbit, thus at a trailing angle of approximately 85 degrees. This ΔV , including the landing maneuver to be discussed later, is 641 m/s. The maximum time also occurs when the phasing orbit first goes outside of Phobos' orbit. This gives a maximum phasing time of 13.5 hours.

Table 3.9 - Phasing and Landing ΔV s

Trailing angle degrees	Trans Time seconds	$\Delta V1$ km/s	$\Delta V2$ m/s	$\Delta V3 (x)$ km/s	$\Delta V3 (y)$ m/s	$\Delta V4$		Total ΔV km/s	RCS ΔV m/s
						m/s	degrees		
0.0	27524.7	-0.001	-2.3	-0.001	6.4	5.0	249.1	0.016	13.7
5.0	27142.4	-0.011	-2.3	0.009	6.4	5.0	249.1	0.034	13.7
45.0	24084.1	-0.103	-2.4	0.101	6.4	5.0	249.1	0.218	13.8
75.0	21790.4	-0.190	-2.4	0.188	6.4	5.0	249.1	0.391	13.8
80.0	21408.1	-0.206	-2.4	0.204	6.4	5.0	249.1	0.424	13.9
81.9	21266.3	-0.213	-2.4	0.210	6.4	5.0	249.1	0.437	13.9
85.0	48572.1	0.313	-1.8	-0.316	6.4	5.0	249.1	0.641	13.2
90.0	48189.5	0.309	-1.8	-0.312	6.4	5.0	249.1	0.635	13.2
135.0	44745.3	0.277	-1.9	-0.279	6.4	5.0	249.1	0.569	13.3
180.0	41301.2	0.239	-1.9	-0.241	6.4	5.0	249.1	0.493	13.3
225.0	37857.1	0.194	-2.0	-0.197	6.4	5.0	249.1	0.405	13.4
270.0	34413.0	0.142	-2.1	-0.145	6.4	5.0	249.1	0.300	13.5
315.0	30968.9	0.078	-2.2	-0.081	6.4	5.0	249.1	0.172	13.6
360.0	27524.7	-0.001	-2.3	-0.001	6.4	5.0	249.1	0.016	13.7

Processing Plant Orbital Operations

Prior to the spacecraft's arrival, the precursory mission must accomplish two tasks. First, it must put communications satellites into an asynchronous orbit around Mars, which is a radius of 21,000 km. These satellites are to be 120° apart in a 21,000 km orbit. To do this, the cargo carrier will burn into an elliptical orbit around Mars when it first arrives. This elliptical orbit has a apogee of 21,000 km and a perigee of 11,052 km, giving a period of 61,474 seconds. Each time the ship reaches apogee, it is at a point on the asynchronous orbit that is 120° in front of the last time the cargo carrier was at apogee. The satellites will then be inserted into a 21,000 km circular orbit. From there the ship will insert itself into a circular orbit with radius of 9,360 km. Since this orbit is smaller than that of Phobos, the plant will have a shorter period and will pass Phobos every 111 days allowing for pictures and mapping of Stickney crater, which is the second purpose of sending the precursory mission.

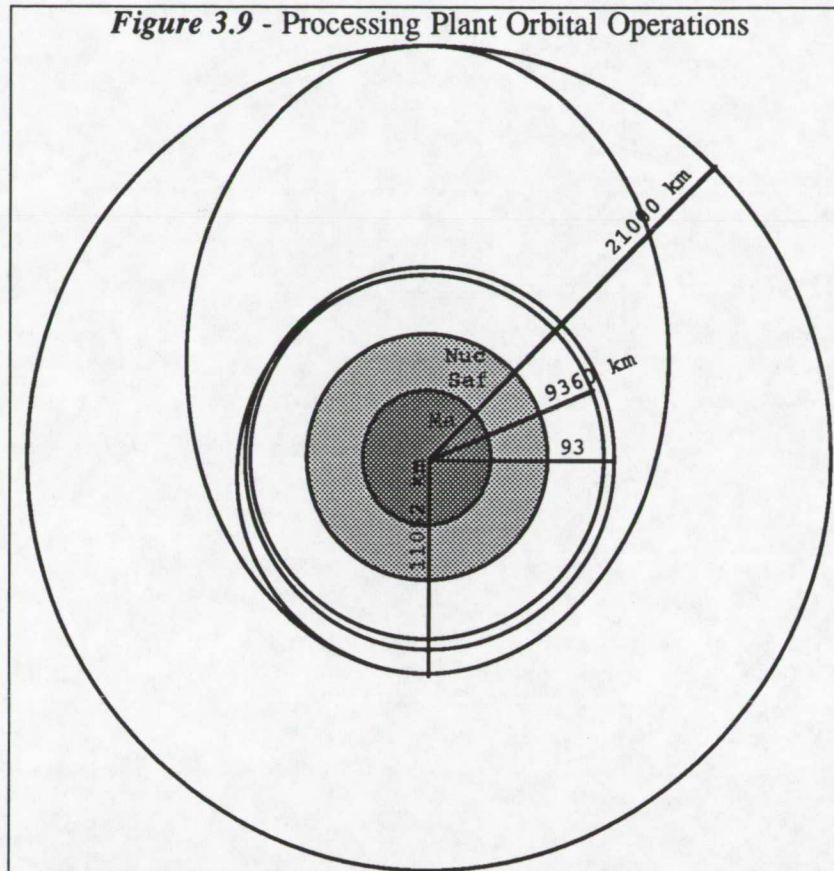

Approach and Descent to Landing Site

Background

Proper landing of the spacecraft on Phobos is the culmination of the mission's efforts up to this point. As a guideline for determining a successful method for achieving this goal, the following rendezvous requirements were established:

- (i) To land the entire spacecraft at the rim of Stickney crater, a formation found at the end of the long axis of Phobos facing Mars.
- (ii) To accomplish this goal using an economy of time, fuel, and maneuvering.
- (iii) To assure the safety of the spacecraft and crew throughout.

Information about the physical aspects of Phobos and the landing site was obtained from the Planetary Science group. Phobos is in a nearly circular, synchronous orbit about Mars with a period of 7 hours 39 minutes and a radius of 9378 km. Because the orbit is synchronous, the landing site holds a constant orientation with respect to Mars, simplifying the approach strategy. Surface gravity on Phobos is extremely low (1 cm/s^2), making the rendezvous maneuver essentially an exercise in docking with Phobos, not orbiting around it. In astrophysics, an object in mutual attraction by two gravity wells will have a *Roche limit*

defined by: $\left(\frac{r}{R}\right) \approx \left(\frac{3m}{M}\right)^{1/3}$ Where: r = radius of sphere of influence for mass m
 R = radius of sphere of influence of mass M

In this equation, r is interpreted as the maximum permitted size of the smaller mass m , after which no more mass could be added to it due to the tidal effects of mass M upon it. In literature on the subject, it is generally acknowledged that 'Phobos comes close to being the same size and shape as its own Roche lobe'.²⁶ This means that the effective gravity on the surface of Phobos, already low for such a small object, is essentially zero in the gravitational field of Mars.

In the rendezvous calculations in this section, the following symbols are used extensively, and are defined here for reference:

$r_0 = 9378 \cdot 10^3 \text{ m}$	[orbital radius of Phobos]
$\mu = 4.29778 \cdot 10^{13} \text{ m}^3/\text{s}^2$	[Mars gravitational parameter]
$n = (\mu/r_0^3)^{1/2} = 2.28274 \cdot 10^{-4} \text{ rad/s}$	[mean motion of Phobos]
$\tau = 7^{\text{h}} 39^{\text{m}}$	[orbital period of Phobos]
$A = 21 \cdot 10^3 \text{ m}$	[length of Phobos along x-axis]
$B = 28 \cdot 10^3 \text{ m}$	[length of Phobos along y-axis]
$C = 12 \cdot 10^3 \text{ m}$	[length of Phobos along z-axis]

Landing Site

The mission objective is to land the spacecraft along the rim of Stickney Crater, a 10-km diameter impact depression that sits at the end of Phobos that perpetually faces Mars. Because no probe has yet taken detailed enough photographs of either Phobos or the landing site, both must be mathematically approximated before approach and landing calculations can be made. Wiesel suggests that Phobos can be best approximated as a tri axial ellipsoid, with axis lengths of 21 km, 28 km, and 12 km.²⁷ The equation that can be written for it, with a Cartesian coordinate axis affixed to its geometric center, is:

$$\frac{x^2}{\left(\frac{A}{2}\right)^2} + \frac{y^2}{\left(\frac{B}{2}\right)^2} + \frac{z^2}{\left(\frac{C}{2}\right)^2} = 1 \quad \text{[ellipsoid with axes A, B, C]}$$

$$\frac{x^2}{\left(\frac{21}{2}\right)^2} + \frac{y^2}{(14)^2} + \frac{z^2}{(6)^2} = 1 \quad \text{[Phobos as tri - axial ellipsoid]}$$

It has been determined by the Planetary Science group that the best estimate for Phobos' center of mass coincides with the geometric center. Using this model, the best estimate for the location of the landing site from Planetary Science group is approximately:

$$x_{\text{site}} = -6 \cdot 10^3 \text{ m}, y_{\text{site}} = -11.5 \cdot 10^3 \text{ m} \quad \text{[approx. landing coordinates]}$$

Mars Oblateness Effects

A pronounced departure from classical two-body motion occurs for objects in low Mars orbit due to the fact that Mars is not exactly spherical. Because Mars rotates, it bulges at its equator. This extra mass at the equator has two net effects on orbiting bodies:

- (i) Regression of the nodes -- When the orbit of a Mars satellite brings it across the equator, the extra force due to the bulge causes a net torque on the orbit, increasing the satellite's inward radial acceleration. Averaged over the entire orbit, the effects of this torque produce gyroscopic effects in the motion of the orbit, causing it to precess.
- (ii) Advance of the perigee -- In addition to the precession effect, the affected orbit also rotates in its own plane because of the torques.

Phobos has an inclination angle for its orbit of 0.01° .²⁸ At worst, this gives a torque moment arm of $9378 \text{ km} \cdot \sin 0.01^\circ = 1.64 \text{ km}$. Because this is so small a distance compared to the overall dimensions of the orbit, the Mars oblateness effects have been neglected. It has been estimated that the regression of the nodes and advance of perigee for Phobos are not appreciable for the accuracy of the calculations used for rendezvous.

Relative Motion Mechanics of the Approach²⁹

Because of the negligible effects Phobos' gravity will have upon the spacecraft on its approach for landing, the rendezvous maneuver is most aptly modeled as position and velocity vector matching of two masses under the influence of the Mars gravity well. The first mass, P, represents Phobos and is a passive target in circular orbit 9378 km from the center of mass of Mars, with mean motion n . The second mass, S, represents the spacecraft and may, in principle, have any position vector that keeps it within the Martian sphere of influence. In practice, however, a description of the relative motion of S with respect to P is most useful when S has a relative distance from P that is small in comparison to the orbital radius of P, namely 9378 km. In addition, the angle between the two position vectors must be small as well. This arrangement is summarized in *Figure 3.10*.

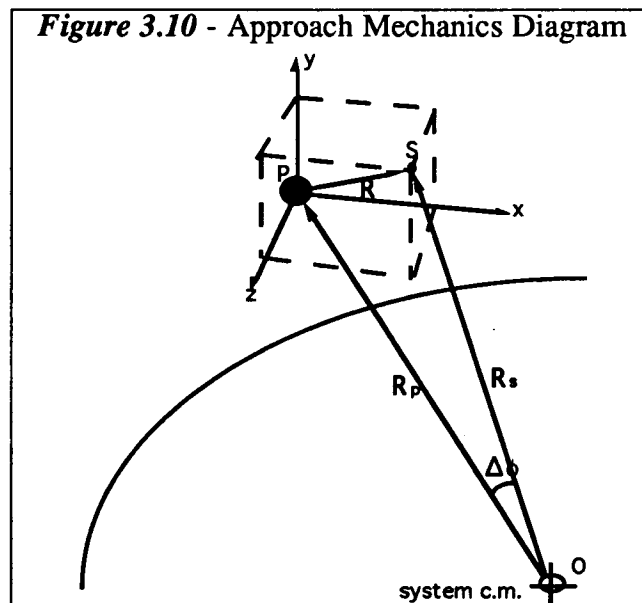

From the diagram, the quantities to be kept small are $\|R\|$ and $\Delta\phi$. With respect to O, Mars' center of mass, Phobos has position vector R_P and the spacecraft has position vector R_S . A moving Cartesian coordinated system is placed at the center of mass of Phobos, with origin labeled P, the y-axis positive in the R_P direction, and the x-axis positive in the V_P direction.

The z-axis completes the right-handed system. For description of the motion of S relative to P, the vector \mathbf{R} joins the ends of \mathbf{R}_p and \mathbf{R}_s . From the diagram, that is:

$$\mathbf{R} = x \mathbf{e}_x + y \mathbf{e}_y + z \mathbf{e}_z \quad [\text{position of ship w.r.t. Phobos}]$$

The position of Phobos and the spacecraft relative to O are:

$$\mathbf{R}_p = r_0 \mathbf{e}_y = 9378 \mathbf{e}_y \quad [\text{position of Phobos w.r.t. O}]$$

$$\mathbf{R}_s = x \mathbf{e}_x + (y+9378) \mathbf{e}_y + z \mathbf{e}_z \quad [\text{position of ship w.r.t. O}]$$

The motion of Phobos relative to O is under the influence of gravity only, or:

$$\frac{d}{dt}(\mathbf{R}_p) = -\frac{\mu}{R_p^2} \mathbf{e}_y$$

The spacecraft may be controlled by a propulsive force (per unit mass) defined by:

$$\mathbf{f} = f_x \mathbf{e}_x + f_y \mathbf{e}_y + f_z \mathbf{e}_z$$

giving it a motion relative to O of:

$$\frac{d^2}{dt^2}(\mathbf{R}_s) = \frac{d^2}{dt^2}(\mathbf{R}_p + \mathbf{R}) = -\frac{\mu}{R_s^3} \mathbf{R}_s + \mathbf{f}$$

The quantity $1/R_s^3$ may be written as $\cos^3 \Delta\phi / (R_p + y)^3$. Assuming $\cos^3 \Delta\phi \approx 1$ ($\Delta\phi$ small) and using the first two terms of the binomial expansion of the denominator (assuming $x/R_p \ll 1$, $y/R_p \ll 1$, and $z/R_p \ll 1$), the acceleration of the spacecraft with respect to O can be written:

$$-\frac{\mu}{R_s^3} \mathbf{R}_s + \mathbf{f} = -\mu \left[\frac{x}{R_p^3} \mathbf{e}_x + \frac{y}{R_p^3} \mathbf{e}_y + \frac{z}{R_p^3} \mathbf{e}_z \right] + \mathbf{f}$$

Calling the true anomaly of Phobos $\theta = -d/dt(\theta) \mathbf{e}_z$, kinematic descriptions of the spacecraft's motion with respect to Phobos can be generated:

$$\begin{aligned} \mathbf{v} &= \left(\frac{d(x)}{dt} + \frac{d(\theta)}{dt} \right) \mathbf{e}_x + \left(\frac{d(y)}{dt} + \frac{d(\theta)}{dt} \right) \mathbf{e}_y + \frac{d(z)}{dt} \mathbf{e}_z \\ \mathbf{a} &= \left(\frac{d^2(x)}{dt^2} + \frac{2d(\theta)}{dt} \frac{d(y)}{dt} + \frac{d^2(\theta)}{dt^2} y - \frac{d(\theta)^2}{dt} x \right) \mathbf{e}_x \\ &+ \left(\frac{d^2(y)}{dt^2} - \frac{2d(\theta)}{dt} \frac{d(x)}{dt} - \frac{d^2(\theta)}{dt^2} y - \frac{d(\theta)^2}{dt} y \right) \mathbf{e}_y \\ &+ \left(\frac{d^2(z)}{dt^2} \right) \mathbf{e}_z \end{aligned}$$

Equating this kinematic description of the motion with the approximation for the gravitational and thrusting acceleration, three differential equations are arrived at for the relative motion of the ship with respect to Phobos:

$$\begin{aligned}\frac{d^2(x)}{dt^2} + 2\frac{d(\theta)}{dt}\frac{d(y)}{dt} + \frac{d^2(\theta)}{dt^2}y - \frac{d(\theta)}{dt}x &= \frac{-\mu x}{R_p^3} + f_x \\ \frac{d^2(y)}{dt^2} - 2\frac{d(\theta)}{dt}\frac{d(x)}{dt} - \frac{d^2(\theta)}{dt^2}y - \frac{d(\theta)}{dt}y &= \frac{\mu 2y}{R_p^3} + f_y \\ \frac{d^2(z)}{dt^2} &= \frac{-\mu z}{R_p^3} + f_z\end{aligned}$$

These equations are simplified considerably with Phobos in a circular orbit, since this makes $d/dt(\theta)$ a constant and has value equal to the mean motion, n . Further, because it is constant, $d^2/dt^2(\theta) = 0$. If the ship is considered under non-thrusting motion (impulsive velocity changes only), $\mathbf{f} = \mathbf{0}$, and the equations become:

$$\begin{aligned}\frac{d^2}{dt^2}(x) + 2n\frac{d}{dt}(y) &= 0 \\ \frac{d^2}{dt^2}(y) - 2n\frac{d}{dt}(x) - 3n^2y &= 0 \\ \frac{d^2}{dt^2}(z) + n^2z &= 0\end{aligned}$$

The third of these equations represents out-of-plane motion and is uncoupled from the other two. It has the well-known form of a simple harmonic oscillator with solution:

$$z(t) = z(0)\cos nt + \left[\frac{dz(0)}{dt}\frac{1}{n}\right]\sin nt$$

where $z(0)$ and $d/dt(z(0))$ are initial conditions at time=0. For the purposes of the rendezvous calculations being performed for this mission, this out-of-plane motion will not be considered. The coupled in-plane equations must be solved simultaneously. The first differential equation can be rewritten as:

$$\frac{d}{dt}\left[\frac{d}{dt}(x) + 2ny\right] = 0$$

which can be immediately integrated to give:

$$\frac{d}{dt}(x) = \frac{d}{dt}(x(0)) + 2n(y - y(0))$$

where the constants of integration have been evaluated in terms of initial conditions $x(0)$ and $y(0)$ at time=0.

When this is substituted into the second differential equation above, the result is:

$$\frac{d^2}{dt^2}(y) + n^2 y = 4n^2 y(0) + 2n \frac{d}{dt}(x)$$

This is again a simple harmonic oscillator, but with a forcing term. Its complete solution consists of the homogeneous solution

$$y_h = A \cos nt + B \sin nt$$

and a constant particular solution:

$$y_p = 4y(0) + \frac{2}{n} \frac{d}{dt}(x)$$

Evaluating A,B in terms of initial conditions, the complete solution for $y=y_h + y_p$ becomes:

** Relative motion in y **

$$y(t) = \left[2 \frac{d \frac{x(0)}{n}}{dt} + 4y(0) \right] + \left[-2 \frac{d \frac{x(0)}{n}}{dt} - 3y(0) \right] \cos nt + \left[\frac{d \frac{y(0)}{n}}{dt} \right] \sin nt$$

Returning above to the expression for $d/dt(x)$, and substituting the solution for y :

$$\frac{d}{dt}(x) = \left[-3 \frac{d(x(0))}{dt} - 6ny(0) \right] + \left[6ny(0) + 4 \frac{d(x(0))}{dt} \right] \cos nt - \left[2 \frac{d(y(0))}{dt} \right] \sin nt$$

which integrates to give the second of the in-plane solutions:

** Relative motion in x **

$$x(t) = \left[x(0) - 2 \frac{d \frac{y(0)}{n}}{dt} \right] + \left[-3 \frac{d(x(0))}{dt} - 6ny(0) \right] t + \left[2 \left[\frac{d \frac{y(0)}{n}}{dt} \right] \cos nt \right. \\ \left. + \left[4 \frac{d \frac{x(0)}{n}}{dt} + 6y(0) \right] \sin nt \right]$$

These two equations give a complete in-plane history of the position of the spacecraft with respect to Phobos given its initial position $x(0)$ and $y(0)$, its initial velocity $d/dt(x(0))$ and $d/dt(y(0))$, and the time period t . In addition, a complete history of the in-plane velocity of the spacecraft can be obtained by differentiating the relative motion equations above. For the purposes of rendezvous calculations, however, this is an unnecessary exercise. It is important to reemphasize at this point that these solutions for the in-plane position are only valid for small $\|R\|$ and small $\Delta\phi$. This restriction is satisfied if the rendezvous analysis is not begun until the spacecraft has neared the end of its phasing transfer orbit that will bring it at time $t=0$ 18km below Phobos' center of mass and with $\Delta\phi$ essentially zero, as outlined in the section **Rendezvous with Phobos**.

Rendezvous with Phobos is accomplished when at a specified time, T , the relative position of the spacecraft is simultaneously equal to the coordinates of the landing site while the relative velocity of the spacecraft is brought to zero. That is:

$$\begin{aligned}x(T) &= -6 \cdot 10^3 \text{ m} \\y(T) &= -11.5 \cdot 10^3 \text{ m} \\z(T) &= 0\end{aligned}$$

$$\frac{d}{dt}(x(T)) = \frac{d}{dt}(y(T)) = \frac{d}{dt}(z(T)) = 0$$

This operation is known as the Terminal Phase Maneuver (TPM), and has three parts. The first, the Terminal Phase Initiation (TPI), is executed at $t=0$ and produces the initial velocity conditions such that at time $t=T$, the position of the spacecraft matches that of the landing site. The second, the Attitude Correction Maneuver (ACM), is performed $0 < t < T$ such that the spacecraft is oriented about its own body axes into the correct configuration for rendezvous. The third, the Braking Maneuver (BM), is executed at $t=T$, and reduces the velocity of the spacecraft such that zero relative velocity exists between it and Phobos. In addition, a fourth procedure is employed in this mission. Because there is essentially zero gravity at the surface of Phobos, a Harpooning Maneuver (HM) is performed after the BM at time T to assure a connection is maintained between the moon and the craft. Each of these four parts of the rendezvous are considered separately as follows. In each discussion, only the in-plane rendezvous solution has been considered. It has been assumed that the spacecraft and Phobos will remain in the same z -plane throughout the entire encounter.

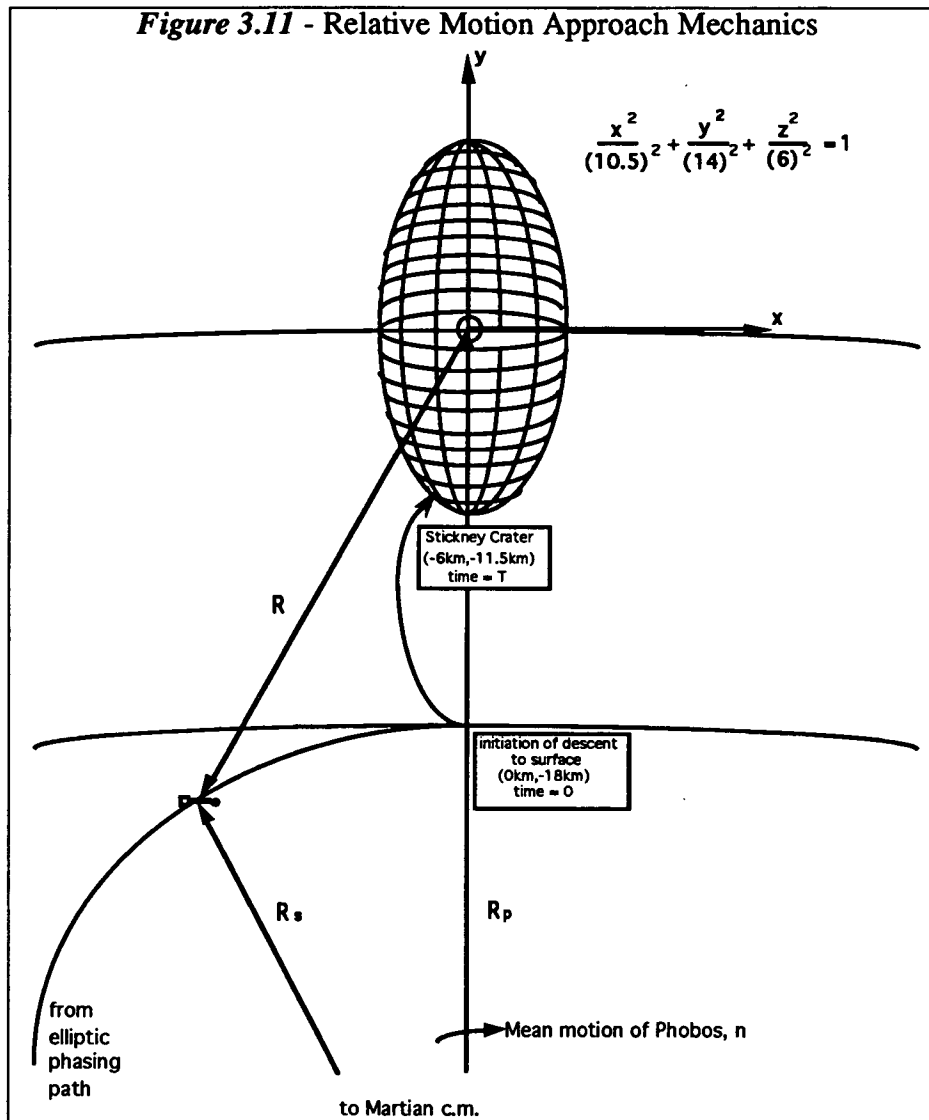

Terminal Phase Initiation -- At $t=0$, the spacecraft will have position and velocity with respect to the Phobos coordinate system of:

$$\begin{aligned} x(0) &= 0 \\ y(0) &= -18 \text{ km} \end{aligned}$$

$$\frac{d}{dt}(x(0)) = V_{\text{trans}}$$

$$\frac{d}{dt}(y(0)) = 0$$

V_{trans} is the speed of the spacecraft at the end of its phasing maneuver, when it is directly below Phobos and about to fall back towards Mars. At this point, a burn must be executed such that the spacecraft will achieve a flight path that will bring it to the landing site during time T. This desired ΔV is found from subtracting the velocity vector of the spacecraft at $t=0$ from the desired velocity vector necessary to achieve rendezvous, or:

$$\begin{aligned}\Delta V_3 &= \left[\frac{d}{dt}(x_{\text{desired}}(0)) - \frac{d}{dt}(x(0)) \right] \mathbf{e}_x + \left[\frac{d}{dt}(y_{\text{desired}}(0)) - \frac{d}{dt}(y(0)) \right] \mathbf{e}_y \\ &= \left[\frac{d}{dt}(x_{\text{desired}}(0)) - V_{\text{trans}} \right] \mathbf{e}_x + \left[\frac{d}{dt}(y_{\text{desired}}(0)) \right] \mathbf{e}_y\end{aligned}$$

The desired velocity components at $t=0$ come from solutions to the relative motion equations of the ship with respect to Phobos given earlier. *Mathematica* software was employed to solve this system, and gave the following solution:

$$\begin{aligned}\frac{d}{dt}(x_{\text{desired}}(0)) &= \frac{-n(2y(T) - 14y(0) - 2y(T)\cos(nT) + 14y(0)\cos(nT) + x(T)\sin(nT) - x(0)\sin(nT) + 6Ty(0)\sin(nT))}{-8 + 8\cos(nT) + 3nT\sin(nT)} \\ \frac{d}{dt}(y_{\text{desired}}(0)) &= \frac{n(2x(T) - 2x(0) + 3nTy(T) - 2x(T)\cos(nT) + 2x(0)\cos(nT) - 3nTy(0)\cos(nT) - 4y(T)\sin(nT) + 4y(0)\sin(nT))}{-8 + 8\cos(nT) + 3nT\sin(nT)}\end{aligned}$$

Thus, the complete solution for Terminal Phase Initiation can be solved by knowing the spacecraft's position at $t=0$, the landing site position at $t=T$, the mean motion of Phobos, and the time period during which the maneuver is to take place. **Table 3.9** illustrates various ΔV_3 's for T from $\tau/8$ to τ . A compromise was chosen between the time required for rendezvous and the relative velocity that is generated between the ship and Phobos. The time needs to be kept low for expediency purposes, and the relative velocity needs to be kept low for safety. The value chosen was $\tau/8$, or

$$T = \tau/8 = 1/8(7^{\text{h}} 39^{\text{m}}) = 3442.5 \text{ seconds} \quad [\text{time for rendezvous}]$$

Time for rendezvous is thus reduced to about an hour, and the relative velocity achieved is on the order of ten meters per second. For this T , solutions for the components of ΔV_3 are given in **Table 3.9**. Depending upon the transfer orbit that is used for phasing with Phobos, ΔV_{3x} varies from -209 m/s to 310 m/s; ΔV_{3y} has value 6.4 m/s regardless. ΔV_{3x} varies so widely because of the large range of eccentricities and semi-major axes of the transfer orbits required for phasing. The closer the phasing orbit resembles the orbit of Phobos, the smaller ΔV_{3x} becomes. Whether an outer or an inner phasing orbit is chosen determines the sign. ΔV_{3y} is constant since all transfer orbits place the spacecraft 18km below Phobos center of mass with zero velocity in the y -direction at time=0. The large velocity change in x will be performed by the main NTR engines of the spacecraft, while the small change in y can be performed using only RCS control. In the event that there is a propulsive failure at $t=0$ and the spacecraft cannot perform the required ΔV_3 , the spacecraft will remain in its transfer orbit and no collision with Phobos will occur. Correct phasing can then be achieved once the failed system is repaired, and the TMI maneuver can be reexecuted. By the end of the Terminal Phase Initiation, the spacecraft will be headed on a flight path that will bring it to the landing site.

Attitude Correction Maneuver -- Before the spacecraft can be expected to rendezvous with its target, it must first achieve the correct orientation with respect to it. Since the spacecraft is to be actually set down on the surface of Phobos, the ACM is charged with configuring the spacecraft's long axis parallel to the surface, with the landing legs ready to accept any excess impulse that occurs at touchdown. It is critical that the correct orientation be achieved before the spacecraft and Phobos meet. Failure of the Attitude Correction Maneuver will require RCS retrograde burns in both the \mathbf{e}_x and \mathbf{e}_y directions such that the flight path is altered to take the spacecraft away from landing site, and either a station keeping attitude with zero relative

velocity to it can be achieved or an orbit is entered that takes the craft around Mars for repairs. However, with the redundancy of the RCS control system, the likelihood of the ACM succeeding is extremely high, and the ship will then achieve its landing configuration before $t=T$.

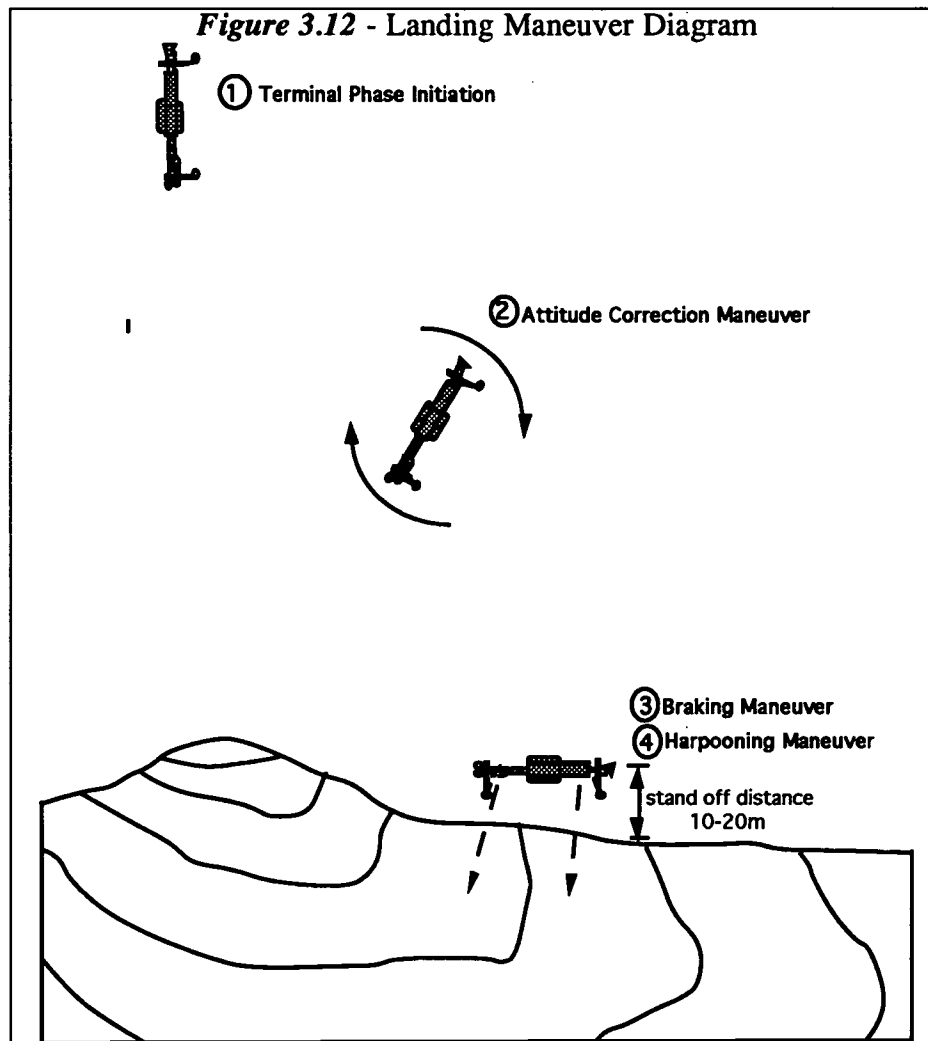

Braking Maneuver -- At $t=T$, the coordinates of the spacecraft match those of the landing site. Bringing the spacecraft's relative velocity with respect to the landing site to zero is then necessary to avoid collision with the surface. It is desirable to perform this braking at a stand off distance from the surface of around 10-20m so that the RCS control jets do not blow any foreign objects onto the ship. This is achieved by simply altering the coordinates of the landing site to add an additional 10-20m of altitude. Since all calculations for the surface of Phobos have been approximated so far in kilometers due to the lack of information about its exact shape, adding the stand off distance will not deter from the accuracy of the previous rendezvous calculations. Certainly, when the actual rendezvous is carried out, terminal guidance radar and line of site adjustments from the pilot will be necessary throughout. The velocity change for the Braking Maneuver is:

$$\Delta V_4 = \left[-\frac{d}{dt}(x(T)) \right] e_x + \left[-\frac{d}{dt}(y(T)) \right] e_y$$

Where:

$$\begin{aligned}\frac{d}{dt}(x(T)) &= [-3 \frac{d}{dt}(x_{\text{desired}}(0)) - 6ny(0)] + [-2 \frac{d}{dt}(y_{\text{desired}}(0))] \sin nT \\ &\quad + [4 \frac{d}{dt}(x_{\text{desired}}(0)) + 6ny(0)] \cos nT \\ \frac{d}{dt}(y(T)) &= [2 \frac{d}{dt}(x_{\text{desired}}(0)) + 3ny(0)] \sin nT + [\frac{d}{dt}(y_{\text{desired}}(0))] \cos nT\end{aligned}$$

and are obtained by differentiating the relative motion equations given earlier and evaluating them at $t=T$.

Harpooning Maneuver -- A correction term is needed in the analysis performed for the Braking Maneuver to compensate for the fact that the landing site does not have the same velocity as the center of mass of Phobos, for which the relative velocity expressions were generated. Since Phobos is a synchronous satellite, it maintains the same orientation with respect to Mars throughout its orbit. This is equivalent to a rotation rate about Phobos' smallest axis equal to the mean motion of Phobos itself. Thus, even when the spacecraft has achieved a relative velocity of zero with respect to the center of mass of Phobos, it will still observe the landing site approaching with a finite velocity, K . This can be determined by considering the solid body rotation of Phobos of magnitude n with a radius of rotation of y_{site} . That is:

$$K = -y_{\text{site}} n \mathbf{e}_x = (-11.5 \cdot 10^3 \text{ m})(2.28274 \cdot 10^{-4} \text{ rad/s}) = -2.62 \text{ m/s } \mathbf{e}_x$$

In addition, the ship will be accelerating towards the site due to the fact that it is in a more shallow orbit than Phobos' center of mass. If Phobos was not 10-20m directly ahead of it, the ship would follow an elliptical orbit back towards Mars. The rendezvous will take advantage of this condition by firing a set of harpoon-tipped cables into the landing site directly following the ΔV_4 burn. The reaction from the firing of these harpoons will reduce the closing velocity further. As the landing site then approaches through its last 10-20m, the slack in the cables will be taken in to assure a taught connection and maintain the desired landing configuration. The ship will touchdown with some small amount of excess impulse that will be absorbed by gas shock absorbers in the landing legs, and can be considered negligible. If the ΔV_4 burn is never achieved, however, the same follow up procedure should still be initiated. Because the relative velocity between the landing site and the ship has been purposely kept low, so long as the Attitude Correction Maneuver was correctly executed, the landing legs of the craft should absorb the maximum excess impulse that could be generated. Again, as before, the redundancy of the RCS control system should alleviate the chances of the burn not being executed.

The spacecraft would now be firmly attached to the landing site and will remain until the 60 day stay time has expired.

Leaving the Landing Site

Once the mission objectives have been accomplished, distancing the spacecraft from Phobos so that a burn to leave the Martian system can be executed, is relatively easily. Once again, the lack of gravity at the landing site serves to simplify the method employed. Any number of possible departure maneuvers can be employed dependent upon the orbit that is desired upon its completion. Perhaps the simplest is to detach the stay cables and execute a small retrograde

ΔV in the y-direction. This maneuver is sufficient for the ship to clear Phobos, since the landing site is found at the very bottom of the moon. Once a comfortable clearance distance has been achieved, a burn of equal magnitude and opposite direction to the "cast-off" burn should be employed, and a posigrade burn in the x-direction with the NTR engines can be performed. This burn from the NTR engines can either be the departure burn from the system, or it can simply place the spacecraft into a circular orbit until the correct phasing for leaving is achieved. If a close swingby of Mars for scientific purposes is desired before leaving, a retrograde burn of the NTR engines can instead be initiated. A diagram of these departure options is labeled *Figure 3.13*.

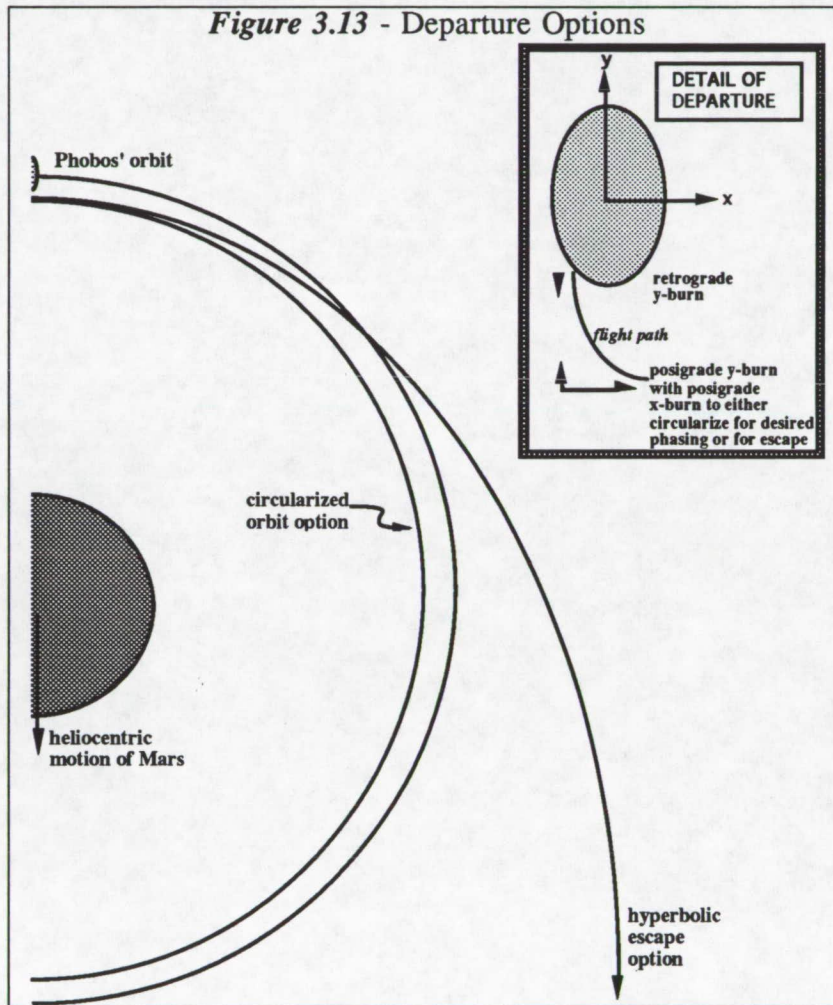

Contingency Planning

The Mission Analysis group was asked to determine reasons for aborting the mission to Phobos after launch, the necessary trajectories to return the astronauts to Earth early, and the reasons for total mission failure. The purpose of this section is to present these results.

Reasons and Probabilities

Working with each team, a list of reasons to abort the mission was coordinated. The probability of each of these problems occurring was also obtained. However, many of the teams were unable to determine such probabilities (this is represented by N/A on the table). Finally, reasons for total mission failure are included.

This information, categorized by each mission team, is given below:

<u>REASON TO ABORT</u>	<u>PROBABILITY</u>
<u>Human Factors</u>	
• Medical Emergencies	
- death of 2 crew members	N/A
• Water loss	N/A
• Air loss	N/A
<u>Propulsion</u>	
• Loss of 2 of the 3 engines	N/A
<u>Spacecraft Integration</u>	
• Loss of spinning capabilities	N/A
- 4 RCS engines fail	
<u>Mission Control</u>	
• Loss of 5 computers	.000163%
• 75% loss of any group of navigation equipment	
- IMU's	.0034%
- Ring Laser Gyros	.00174%
- Star Trackers	1.5%
• If both of the antennas on the rotating platform fail and are irreparable	N/A
<u>Power</u>	
• Loss of 2 of the 3 engines	N/A
• Front radiators	
- if 50% of the radiators fail	N/A
• Rear radiators	
- if 18.75% of the radiators fail after the first burn	N/A
- if 50% of the radiators fail after the second burn	N/A
<u>Structures</u>	
• Hole in Habitation module	N/A
• Chance of any tank or module or communication link or engine breaking away	N/A
• Chance of holes developing in fuel, oxygen or hydrogen tanks	N/A

Planetary Science

- If the reactor melts down or has catastrophic failure

N/A

Procedure for Early Return

In the event that the mission must be aborted, a trajectory must be determined to return the astronauts to Earth using no more fuel than what is onboard the spacecraft. For any location along the mission trajectory, the parameters of a trajectory returning to Earth can be determined from the spacecraft's initial and final heliocentric position vectors and the required time of flight. The algorithm for determining an abort trajectory follows. This procedure is then applied to five locations along the intended mission trajectory to determine if an early return option is available.

Mathematical Algorithm

Given the initial and final heliocentric position vectors of the spacecraft and the required time of flight, the flight parameters of the conical trajectory can be determined. These parameters include geometrical information describing the flight path such as eccentricity, semi-major axis, radius of perigee and apogee, semi-latus rectum and mechanical energy. Also determined by this method is the initial velocity vector necessary to insert the spacecraft on to such a trajectory, as well as the resultant velocity vector upon arrival at the final position.

A system described by the time of flight between two position vectors is satisfied by only one conical trajectory with an initial velocity vector corresponding to the existing direction of motion. A solution to this problem cannot be found directly. Presented below is a series of equations which must be simultaneously satisfied. An iterating approach must be taken to find a solution. The use of universal variables simplifies the mathematics involved, and will be used in the following explanation.

$$A = \sin \Delta v \sqrt{\frac{r_1 r_2}{1 - \cos \Delta v}}$$

A = arbitrary constant Δv = angular change between initial and final positions

r_1 = initial radial distance from Sun r_2 = final radial distance from Sun

$$y = r_1 + r_2 - A \frac{1 - zS}{\sqrt{C}}$$

y = auxiliary variable z = universal variable, change in eccentric anomaly

$$\text{for } z < 0 \quad C = \frac{1 - \cosh \sqrt{-z}}{z} \quad S = \frac{\sinh \sqrt{-z} - \sqrt{-z}}{\sqrt{-z^3}}$$

$$\text{for } z \geq 0 \quad C = \frac{1 - \cos \sqrt{z}}{z} \quad S = \frac{\sqrt{z} - \sin \sqrt{z}}{\sqrt{z^3}}$$

$$x = \sqrt{\frac{y}{C}}$$

x = universal variable, related to change of eccentric anomaly by $x^2 = za$

a = semi - major axis

$$\sqrt{\mu} t = x^3 S + A\sqrt{y}$$

μ = gravitational constant t = time of flight

$$f = 1 - \frac{y}{r_1} \quad g = A\sqrt{\frac{y}{\mu}} \quad \dot{g} = 1 - \frac{y}{r_2}$$

$$\bar{v}_1 = \frac{\bar{r}_2 - f\bar{r}_1}{g} \quad \text{initial velocity vector}$$

$$\bar{v}_2 = \frac{\dot{g}\bar{r}_2 - \bar{r}_1}{g} \quad \text{final velocity vector}$$

An algorithm for determining an abort trajectory is as follows:

1. Evaluate the constant A.
2. Choose a trial z . $z < (2\pi)^2$ A trial z is a guess in the change in the eccentric anomaly.
3. Evaluate the functions S & C for the trial z .
4. Evaluate the variable y .
5. Evaluate the universal variable x .
6. Check the trial value of z . This is done by calculating t and comparing it to the required time of flight. If it does not agree within a desired error adjust the value of z and repeat procedure at 3.

When t has converged to the required time of flight:

7. Evaluate f , g , g' .
8. Evaluate initial and final velocity vectors.

The geometrical information describing the return flight path is found using the universal variable values from above. The following equations demonstrate the calculation of this geometrical information.³⁰

$$\text{Semi - Major Axis} \quad a = \frac{x^2}{z}$$

$$\text{Semi - Latus Rectum} \quad p = \frac{r_1 r_2 (1 - \cos \Delta v)}{y}$$

$$\text{Eccentricity} \quad e = \sqrt{\frac{1-p}{a}}$$

$$\text{Radius of Perigee } r_p = a(1 - e)$$

$$\text{Radius of Apogee } r_a = a(1 + e)$$

$$\text{Mechanical Energy } \epsilon = \frac{-\mu}{2a}$$

Gravity-Assisted Swingbys

In order to determine return trajectories, it was necessary to calculate velocity vectors at any point of the mission. Therefore, the velocity vectors after swinging by Venus and Mars had to be calculated. To calculate these vectors, the following procedure was used.³¹

1. Calculate the velocity vector entering the planet's sphere of influence. This is done using the following equations:

$$V_2 = \sqrt{2\left(\frac{\mu_o}{r_2} + \epsilon_t\right)} \qquad \cos \phi_2 = \frac{h_t}{r_2 V_2}$$

where:

$$\epsilon_t = -\frac{\mu_o}{2a} \qquad h_t = \sqrt{p\mu_o}$$

and: r_2 = the radius from the Sun to the planet
 μ_o = the gravitational constant of the Sun
 h_t = transfer orbit's angular momentum
 ϵ_t = transfer orbit's energy
 a = orbit's semi-major axis
 p = semi-latus rectum

2. Calculate the velocity vector of the planet, V_p . This is just the vector which is tangent to the planet's orbit at the point in time the spaceship will be swinging by that planet.

3. Calculate the velocity vector inside the planet's sphere of influence, V_3 :

$$V_3 = V_2 - V_p$$

4. Calculate the angle change of the velocity vector inside the sphere of influence caused by the swingby. This is done using the following formula:

$$\alpha = 2 \text{Tan} \left[\frac{\mu_p}{V_3 \sqrt{p^2 V_3^2 + 2\mu_p p}} \right]$$

where: μ_p = the gravitational constant of the planet
 p = the distance between the spaceship and the planet at swingby

5. Determine the velocity vector after the swingby, but still in the sphere of influence, V_4 , using α and the magnitude of V_3 , since:

$$|V_4| = |V_3|$$

6. Calculate the new velocity vector outside of the sphere of influence, V_5 :

$$V_5 = V_4 + V_p$$

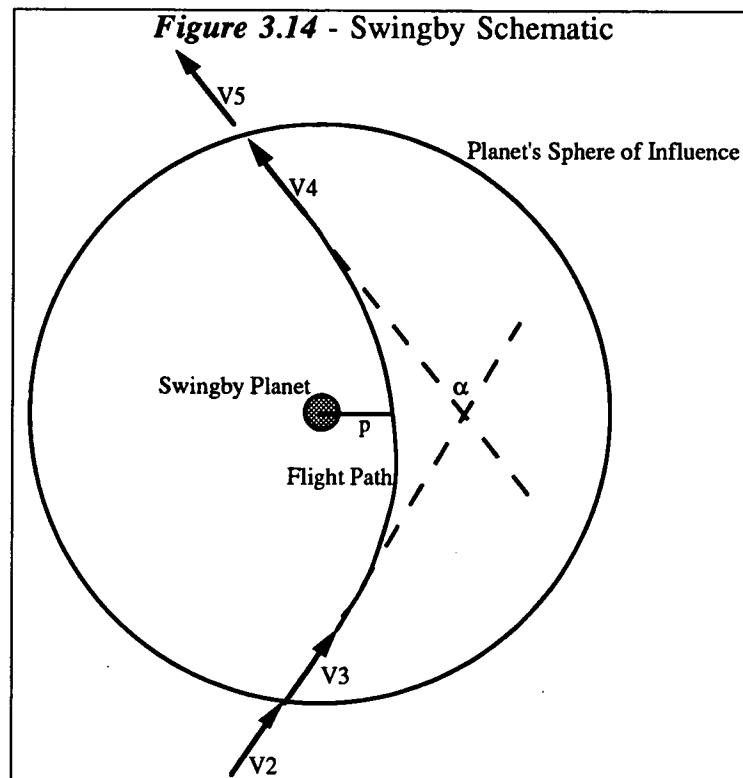

Example: Abort Trajectory

A numerical example of determining the flight parameters for an abort trajectory using the above algorithm will now be presented. This scenario involves determining a return trajectory using a powered Mars flyby.

Spacecraft Initial Position: Mars Flyby
 Julian Date: 2455838.0
 Radial Distance: 1.569391 Au
 Heliocentric Longitude: 89.60855°

Spacecraft Final Position: Earth Orbit
 Julian Date: 2456004.4
 Radial Distance: .992512 Au
 Heliocentric Longitude: 167.0068°

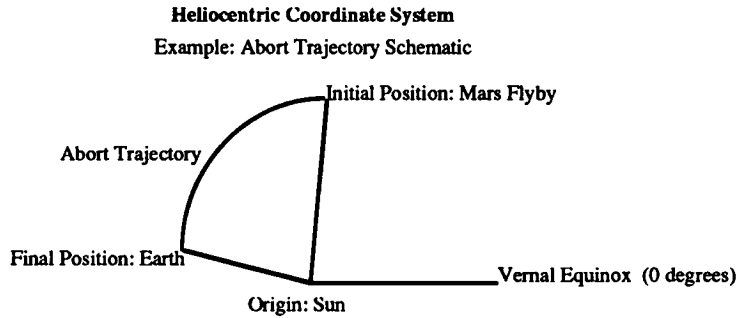

Using the given initial and final information:

$$r_1 = 1.569391 \text{ Au} \quad r_2 = 0.992512 \text{ Au}$$

$$\Delta v = 167.0068^\circ - 89.60855^\circ = 77.39825^\circ$$

$$\text{Time of Flight} = 2456004.4 - 2455838.0 = 166.4 \text{ days}$$

The algorithm for determining an abort trajectory presented above is given below.

1. Evaluate the constant A.

$$A = \sin \Delta v \sqrt{\frac{r_1 r_2}{1 - \cos \Delta v}} = 1.377486$$

2. Initial guess $z=0$. After a series of iterations $z=3.934542$ produces an agreement with the required time of flight to within 10 seconds.

3. For the final z value:

$$C = \frac{1 - \cos \sqrt{z}}{z} = 0.3561151 \quad S = \frac{\sqrt{z} - \sin \sqrt{z}}{\sqrt{z}^3} = 0.1367884$$

4. For the final z value:

$$y = r_1 + r_2 - A \frac{1 - zS}{\sqrt{C}} = 1.495925 \text{ Au}$$

5. For the final z value:

$$x = \sqrt{\frac{y}{C}} = 2.049555 \text{ Au}^{\frac{1}{2}}$$

6. The final value of $z=3.934542$ produces an agreement with the required time of flight to within 10 seconds.

7. For the final z value:

$$f = 1 - \frac{y}{r_1} = 4.680926 \times 10^{-2}$$

$$g = A \sqrt{\frac{y}{\mu}} = 8461932 \text{ s} \quad \text{where } \mu = 3.9641 \times 10^{-14} \frac{\text{Au}^3}{\text{s}^2}$$

$$\dot{g} = 1 - \frac{y}{r_2} = -0.507212$$

8. For the final z value, the initial and final velocity vectors:

$$\bar{v}_1 = \frac{\bar{r}_2 - f\bar{r}_1}{g} = 17.30965 \frac{\text{km}}{\text{s}} \quad @ \quad 171.20594^\circ$$

$$\bar{v}_2 = \frac{\dot{g}\bar{r}_2 - \bar{r}_1}{g} = 30.93123 \frac{\text{km}}{\text{s}} \quad @ \quad 285.91644^\circ$$

The geometric information describing the return flight path is now calculated.

$$\text{Semi - Major Axis} \quad a = \frac{x^2}{z} = 1.067641 \text{ Au}$$

$$\text{Semi - Latus Rectum} \quad p = \frac{r_1 r_2 (1 - \cos \Delta v)}{y} = 0.8140781 \text{ Au}$$

$$\text{Eccentricity} \quad e = \sqrt{\frac{1-p}{a}} = 0.4873376$$

$$\text{Radius of Perigee} \quad r_p = a(1-e) = 0.5473392 \text{ Au}$$

$$\text{Radius of Apogee} \quad r_a = a(1+e) = 1.587942 \text{ Au}$$

$$\text{Mechanical Energy} \quad \epsilon = \frac{-\mu}{2a} = -415.4798 \frac{\text{km}^2}{\text{s}^2}$$

Next, the ΔV required to insert the spacecraft on such a trajectory needs to be calculated. This first propulsive maneuver, to insert the spacecraft on to the derived return trajectory can be done either before or after the Mars swingby. It will be shown that it is more efficient to do the propulsive maneuver after the swingby. **Figure 3.15** is a schematic of the initial conditions.

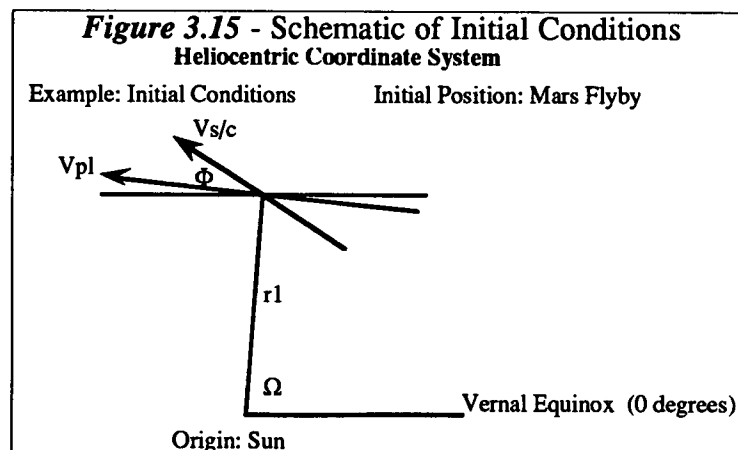

Where: r_1, Ω define the initial heliocentric position of the spacecraft

Note: at Mars flyby, Mars position = Spacecraft position

$\vec{V}_{s/c}$ = Spacecraft velocity vector at point of Mars orbit intersection

\vec{V}_{pl} = Mars' tangential velocity vector

Φ = Angle between $\vec{V}_{s/c}$ & \vec{V}_{pl}

Knowing Mars' circular orbit speed = 24.1294 km/s, and Mars's position at flyby:

$$\vec{V}_{pl} = 24.1294 \frac{\text{km}}{\text{s}} @ 179.60855$$

The spacecraft velocity vector is determined using the following formula:

$$V_{s/c} = \sqrt{2 \left(\frac{\mu_s}{r_1} + \varepsilon \right)} = 19.09099 \frac{\text{km}}{\text{s}}$$

$$\Phi = \frac{\sqrt{\mu_s p}}{r_1 V_{s/c}} = 15.01555^\circ$$

Therefore:

$$\vec{V}_{s/c} = 19.09099 \frac{\text{km}}{\text{s}} @ 164.59300^\circ$$

The first case is when the propulsive maneuver is done before the Mars swingby. It is known that the velocity leaving Mars's sphere of influence must match that needed to insert the spacecraft on to the return trajectory.

$$\vec{V}_5 = \vec{V}_1 = \text{Needed return insertion velocity vector}$$

$$\vec{V}_4 = \text{Velocity of spacecraft wrt Mars after swingby}$$

$$\vec{V}_4 = \vec{V}_5 - \vec{V}_{pl} = 7.44821 \frac{\text{km}}{\text{s}} @ 19.46120^\circ$$

$$\vec{V}_3 = \text{Velocity of spacecraft wrt Mars before swingby}$$

$$V_3 = V_4 = 7.44821 \frac{\text{km}}{\text{s}}$$

α = Swingby turning angle

$$\alpha = 2 \tan^{-1} \left(\frac{\mu_m}{V_3 \sqrt{p^2 V_3 + 2\mu_m p}} \right) = 19.18842^\circ$$

$$\mu_m = \text{Mars' gravitational constant} = 4.305 \times 10^4 \frac{\text{km}^3}{\text{s}^2}$$

$$p = \text{Mars' miss distance, nominal} = 3880 \text{ km (270 nmi)}$$

$$\vec{V}_3 = 7.44821 \frac{\text{km}}{\text{s}} @ 0.27278^\circ$$

\vec{V}_2 = Needed incoming spacecraft velocity vector

$$\vec{V}_2 = \vec{V}_3 + \vec{V}_{pl} = 16.68192 \frac{\text{km}}{\text{s}} @ 179.31145^\circ$$

The propulsive maneuver required to alter the spacecraft velocity is now calculated.

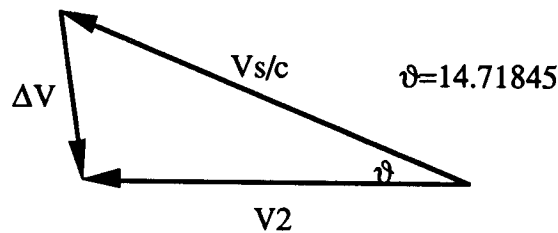

From the Law of Cosines:

$$\Delta V^2 = V_{s/c}^2 + V_2^2 - 2V_{s/c}V_2 \cos \vartheta$$

$$\Delta V = 5.16764 \frac{\text{km}}{\text{s}}$$

The second case is when the propulsive maneuver is done after the Mars swingby. In this case, the velocity of the spacecraft entering Mars' sphere of influence equals the spacecraft's velocity at Mars' orbit intersection.

$\vec{V}_2 = \vec{V}_{s/c}$ = Incoming spacecraft velocity vector

$$\vec{V}_3 = \vec{V}_2 - \vec{V}_{pl} = 7.53944 \frac{\text{km}}{\text{s}} @ 40.60656^\circ$$

$$\alpha = 2 \tan^{-1} \left(\frac{\mu_m}{V_3 \sqrt{p^2 V_3 + 2\mu_m p}} \right) = 18.79870^\circ$$

$$V_4 = V_3 = 7.53944 \frac{\text{km}}{\text{s}}$$

$$\vec{V}_4 = 7.53944 \frac{\text{km}}{\text{s}} @ 59.40526^\circ$$

\vec{V}_5 = Spacecraft velocity vector leaving Mars' sphere of influence

$$\vec{V}_5 = \vec{V}_4 + \vec{V}_{pl} = 21.35491 \frac{\text{km}}{\text{s}} @ 161.84283^\circ$$

The propulsive maneuver required to alter the spacecraft velocity is now calculated.

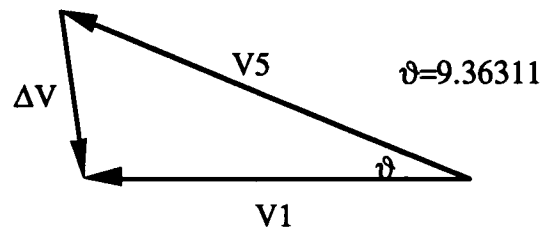

From the Law of Cosines:

$$\Delta V^2 = V_5^2 + V_1^2 - 2V_5V_1 \cos \vartheta$$

$$\Delta V = 5.11993 \frac{\text{km}}{\text{s}}$$

Comparing the two scenarios, it is obvious that it is more efficient to execute the propulsive maneuver after the swingby.

Finally, the ΔV required to insert the spacecraft into Earth orbit upon arrival is calculated. It was decided that the spacecraft will return to a 24 hour elliptical orbit about Earth at 250 nmi. Knowing these characteristics, the necessary Earth orbit insertion velocity can be determined as follows:

$$\text{Semi - Major Axis of Earth Orbit } a = \left(\frac{\text{Period} \sqrt{\mu_e}}{2\pi} \right)^{\frac{2}{3}} = 42241.12246 \text{ km}$$

$$\text{Period} = 24 \text{ hours} \quad \mu_e = 3.986012 \times 10^5 \frac{\text{km}^3}{\text{s}^2}$$

$$\text{Mechanical Energy of Earth Orbit } \varepsilon = \frac{-\mu_e}{2a} = -4.71817 \frac{\text{km}^2}{\text{s}^2}$$

Because it is the most efficient location, the spacecraft is inserted at the perigee radius of the elliptical orbit.

$$\text{Necessary Velocity at Perigee Insertion Point } V = \sqrt{2\left(\frac{\mu_e}{r} + \varepsilon\right)} = 10.34875 \frac{\text{km}}{\text{s}}$$

$r = \text{Radius of perigee} = 6841 \text{ km (250 nmi)}$

The spacecraft velocity vector at Earth arrival is determined using the following formula. The magnitude of the velocity is:

$$V_2 = \sqrt{2\left(\frac{\mu_e}{r_2} + \varepsilon\right)} = 30.93123 \frac{\text{km}}{\text{s}}$$

The angle the spacecraft's velocity vector makes with Earth's tangential velocity vector is:

$$\Phi = \frac{\sqrt{\mu_e p}}{r_2 V_2} = 28.91002^\circ$$

From geometric considerations, the velocity of the spacecraft relative to Earth is:

$$V_r^2 = V_2^2 + V_e^2 - 2V_2V_e \cos\Phi$$

$$V_r = 15.19635 \frac{\text{km}}{\text{s}}$$

The propulsive maneuver needed to match the 24 hour elliptical orbit insertion velocity is:

$$\Delta V = 15.19635 \text{ km/s} - 10.34875 \text{ km/s} = 4.84760 \text{ km/s}$$

Because the spacecraft is inserted directly into Earth orbit, there is no angle change to account for during the propulsive maneuver. This is more efficient than burning into Earth's circular orbit, and then to an orbit about Earth.

Abort Application

Five locations were chosen along the intended mission trajectory to determine if an early return option was available. These locations are only representative of places where an abort may occur, but demonstrate the ability to calculate a return trajectory from any location during the mission. The five locations are:

- Half-way to Venus from Earth
- After Venus swingby
- Half-way to Mars from Venus
- Arriving at Mars
- 30 Day Early Departure from Phobos

To determine the shortest return trajectory, an abort trajectory profile must be compiled. To do so the initial heliocentric position and the desired rendezvous position of the Earth must be known. There then exists a required time of flight for each trajectory. A series of return trajectories with 30 day incremental return flight times are evaluated. Included in the resultant trajectory descriptions are initial and final velocity vectors. From these velocity vectors, ΔV requirements to accomplish a particular trajectory can be determined.

The abort trajectory profile consists of a set of return trajectories and the corresponding necessary ΔV per return time of flight. This information is plotted and fit with a best fit curve. From this curve ΔV requirements for intermediate times of flight can be interpolated. By interpolating, the minimum return time of flight can be found if the quantity of remaining onboard fuel is known.

For each of the five chosen locations, an abort trajectory profile will be given which returns the astronauts to a 24 hour elliptical orbit about Earth at 250 nmi. This return placement was chosen due to its mean efficiency attributes with regards to EOI fuel usage. A 250 nmi altitude also allows for slight altitude insertion errors to remain non-threatening to the safety of the crew and that of Earth. Note that all powered flyby options were evaluated assuming the propulsive maneuver to be executed after flyby completion. A trade-off investigation proved this to be a slightly more efficient use of fuel.

The following pages contain abort trajectory profiles for each of the five investigated locations, as well as trajectory information about the shortest return.

Half-way to Venus from Earth

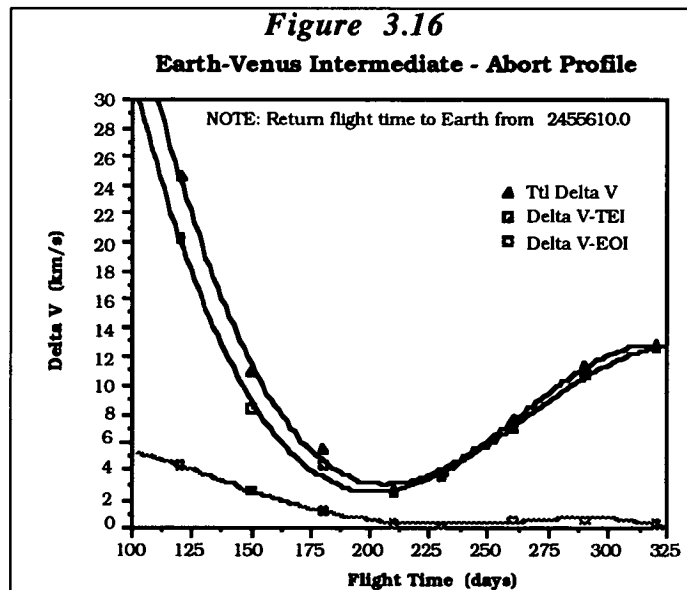

At this location, there is an equivalent amount of fuel for a powered maneuver and an EOI maneuver totaling 10.69 km/s. This would take 155 days to arrive at Earth and is 411.0 days earlier than intended.

After Venus swingby

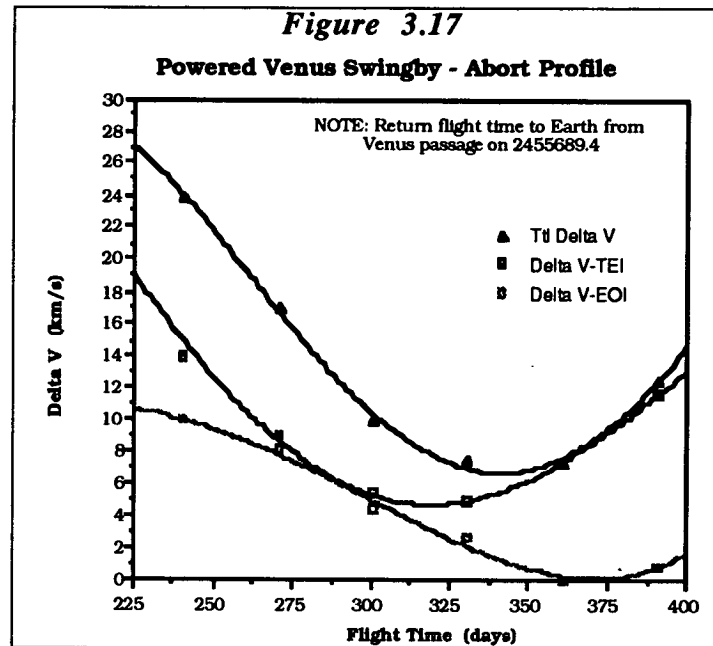

At this location, there is an equivalent amount of fuel for a powered maneuver after a Venus swingby and an EOI maneuver totaling 10.69 km/s. This would take 300 days to arrive at Earth and is 186.6 days earlier than intended.

Half-way to Mars from Venus

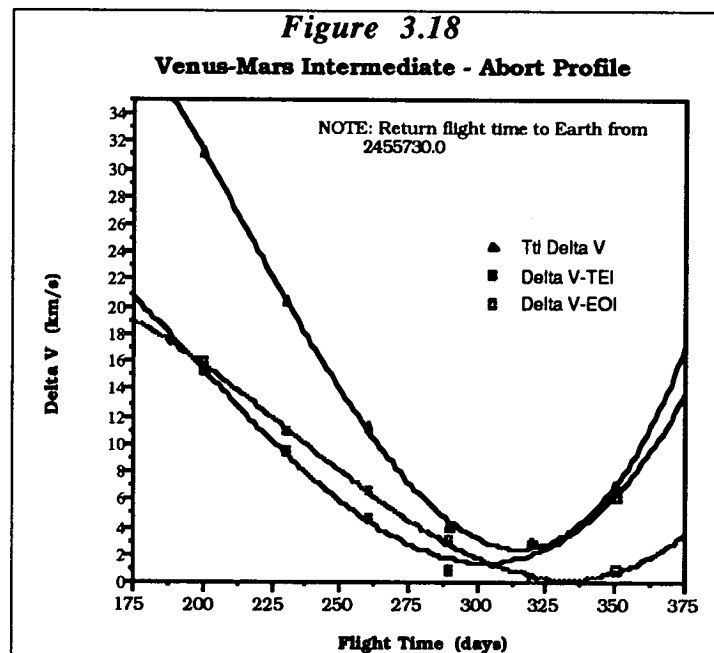

At this location, there is an equivalent amount of fuel for a powered maneuver and an EOI maneuver totaling 10.69 km/s. This would take 262.5 days to arrive at Earth and is 183.5 days earlier than intended.

Arriving at Mars

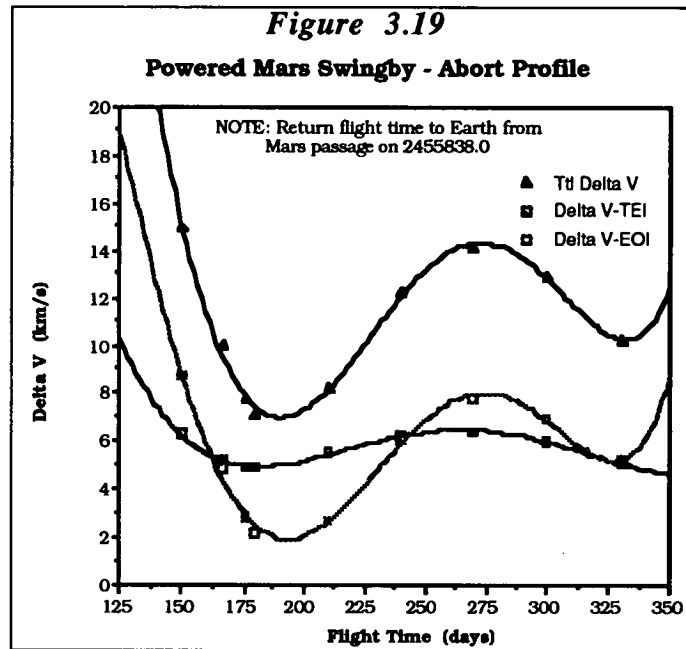

At this location, there is an equivalent amount of fuel for a powered maneuver after a Mars swingby and an EOI maneuver totaling 10.69 km/s. This would take 162.5 days to arrive at Earth and is 175.5 days earlier than intended.

30 Day Early Departure from Phobos

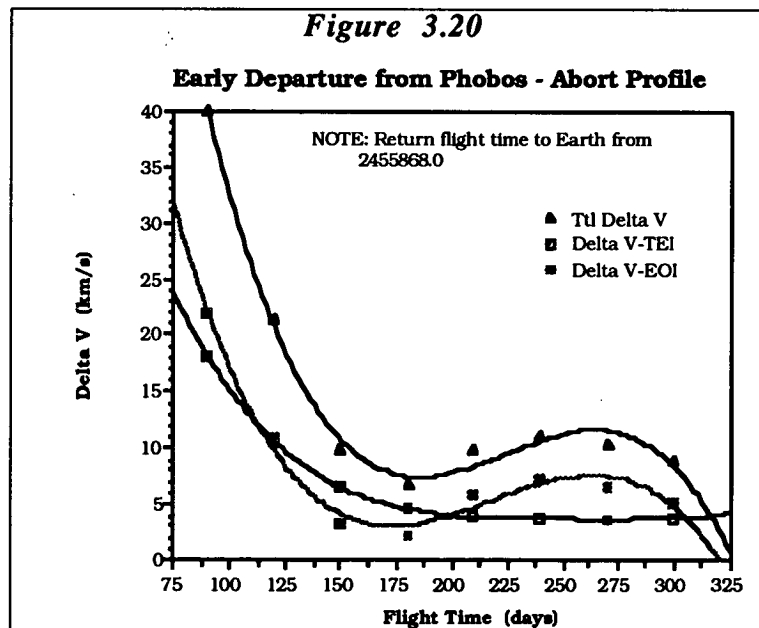

At this location, there is an equivalent amount of fuel for a powered maneuver and an EOI maneuver totaling 5.88 km/s. This would take 180.0 days to arrive at Earth and is 128.0 days earlier than intended. However, this returns the astronauts to a 6 hour elliptical orbit at 1364

nmi. It is unsure whether or not the astronauts can be retrieved at this altitude. Optimization of departure date promises to yield a better insertion orbit.

Another consideration is the delay of launch from Earth resulting in an expired launch window. If this occurs there are several alternative launch dates, the nearest three being³²³³:

- November 22, 2013 Total trip time=634 days, Delta V=9.95 km/s, Stay time=60 days
- February 1, 2014 Total trip time=550 days, Delta V=13.884 km/s, Stay time=90 days
- March 12, 2016 Total trip time=425 days, Delta V=14.042 km/s, Stay time=50 days

Mission Analysis References

- 1 Young, Archie C., John A. Mulqueen, and James E. Skinner, **Mars Exploration Venus Swingby and Conjunction Class Mission Modes**, NASA Marshall Space Flight Center, August 31, 1984.
- 2 Wiesel, W.E., **Spaceflight Dynamics**, McGraw-Hill, 1989.
- 3 Hunt, G., Moore, P., **The Atlas of the Solar System**, Crescent Books, New York, 1990.
- 4 Beiser, A., **Concepts of Modern Physics**, 4th ed., McGraw-Hill Book Co., 1987.
- 5 **The Sun as a Star**, NASA, Washington D.C., 1981.
- 6 Stix, M., **The Sun**, Springer-Verlag, New York, 1989.
- 7 Hunt, G., Moore, P., **The Atlas of the Solar System**, Crescent Books, New York, 1990.
- 8 Hunt, G., Moore, P., **The Atlas of the Solar System**, Crescent Books, New York, 1990.
- 9 Zirin, H., **Astrophysics of the Sun**, Cambridge University Press, New York, 1988.
- 10 Meeus, J., **Astronomical Tables of the Sun, Moon, and Planets**, Willmann-Bell, Richmond, 1983.
- 11 Zirin, H., **Astrophysics of the Sun**, Cambridge University Press, New York, 1988.
- 12 Wentzel, D.G., **The Restless Sun**, Smithsonian Institution Press, Washington D.C., 1989.
- 13 Meeus, J., **Astronomical Tables of the Sun, Moon, and Planets**, Willmann-Bell, Richmond, 1983.
- 14 Lichten, W., **Data and Error Analysis in the Introductory Physics Laboratory**, Allyn and Bacon, Inc., Boston, 1988.
- 15 Young, Archie C., John A. Mulqueen, and James E. Skinner, **Mars Exploration Venus Swingby and Conjunction Class Mission Modes**, NASA Marshall Space Flight Center, August 31, 1984.
- 16 Faymon, Karl and Lisa Kohut, **Mission to Mars**, NASA/University Design Course, NASA Lewis Power Technology Division, January 20, 1986.
- 17 Bate, Roger R., Donald D. Mueller, and Jerry E. White, **Fundamentals of Astrodynamics**, Dover Publications, New York, 1971.
- 18 Young, Archie C., John A. Mulqueen, and James E. Skinner, **Mars Exploration Venus Swingby and Conjunction Class Mission Modes**, NASA Marshall Space Flight Center, August 31, 1984.
- 19 Young, Archie C., John A. Mulqueen, and James E. Skinner, **Mars Exploration Venus Swingby and Conjunction Class Mission Modes**, NASA Marshall Space Flight Center, August 31, 1984.
- 20 Ehricke, Krafft A., **Principles of Guided Missile Design**, D.Van Nostrand Company, Inc., Princeton, New Jersey, 1962.
- 21 Ehricke, Krafft A., **Principles of Guided Missile Design**, D.Van Nostrand Company, Inc., Princeton, New Jersey, 1962.
- 22 Ehricke, Krafft A., **Principles of Guided Missile Design**, D.Van Nostrand Company, Inc., Princeton, New Jersey, 1962.
- 23 Borowski, S.K., **Nuclear Thermal Rocket Characteristics for Human Exploration Initiative Missions**, AIAA-90-1949, July 1990.
- 24 Wiesel, W.E., **Spaceflight Dynamics**, McGraw-Hill, 1989.
- 25 **Apollo 12 Lunar Landing Mission H-1**, Marshall Space Flight Center, NASA, November 7, 1969.
- 26 Wiesel, W.E., **Spaceflight Dynamics**, McGraw-Hill, 1989.
- 27 Wiesel, W.E., **Spaceflight Dynamics**, McGraw-Hill, 1989.
- 28 Wiesel, W.E., **Spaceflight Dynamics**, McGraw-Hill, 1989.
- 29 Buning, Harm, *Course Notes for AE542*, University of Michigan, Fall 1984.
- 30 Bate, Roger R., Donald D. Mueller, and Jerry E. White, **Fundamentals of Astrodynamics**, Dover Publications, New York, 1971.
- 31 Klopp, D.A. and J.C. Niehoff, **The Accessible Regions Presentation of Gravity Assisted Trajectories using Jupiter**, Report # T-18, ITT Research Institute, June 1967.
- 32 Young, Archie C., John A. Mulqueen, and James E. Skinner, **Mars Exploration Venus Swingby and Conjunction Class Mission Modes**, NASA Marshall Space Flight Center, August 31, 1984.
- 33 Soldner, John K. and B. Kent Joosten, **Mars Trajectory Options for the Space Exploration Initiative**, presented at AAS/AIAA Astrodynamics Specialist Conference, Paper AAS 91-438, August 1991.

Chapter 4

Spacecraft Integration

4.0 Summary

4.1 Vehicle Analysis

4.2 Radiation Shielding

4.3 Artificial Gravity

4.4 Reaction Control System

4.5 Stability

71.

Summary

Spacecraft Integration was the focal point of all data concerning the subsystems of the craft and was responsible for the positioning of those subsystems, allocation of resources, and compilation of specifications. Among Integration's primary concerns were the artificial gravity design, configuration of the reaction control system, placement of both thermal and neutronic shielding, design of re-entry method, and assurance of ship stability.

The project Apex spacecraft is 110m long and weighs 893 metric tons. It is propelled by nuclear thermal technology. To provide the five-man crew with 0.5g artificial gravity, it spins end over end at a rate of about 3rpm during all non-propulsive segments of the mission. A reaction control system is responsible for all spin and despin maneuvers, as well as maintaining ship stability and performing minor propulsive maneuvers. Adequate shielding is included to prevent the crew from being exposed to radiation greater than the maximum safe exposure of 33REMs per month. Counter-rotating communication platforms provide uninterrupted data transmission to and from Earth for most of the mission.

Vehicle Analysis

The primary objectives in the design of the spacecraft were 1) to promote the safety of the crew by designing a stable ship that utilizes artificial gravity if necessary; 2) to provide shielding to the crew and ship components against all forms of radiation; and 3) In addition, the ship must be safe, reliable and manufacturable.

Ship Characteristics

The ship characteristics and operational capabilities are as follows:

CREW SIZE:	5 PERSONS
MISSION LENGTH:	1.7 YEARS
MISSION TYPE:	OPPOSITION - OUTBOUND VENUS SWING-BY
SHIP DIMENSIONS:	LENGTH = 110 M WIDTH = 59 M HEIGHT = 45 M
SHIP MASS:	893 METRIC TONNES
ARTIFICIAL GRAVITY:	0.5G
SPIN RATE:	2.67 - 3.06 RPM
PROPULSION SYSTEM:	3 NUCLEAR THERMAL ROCKETS
POWER SYSTEMS:	DUAL-MODE REACTOR (NTR)
VEHICLE POWER CAPABILITY:	
THERMAL SYSTEMS:	HEAT PIPE RADIATORS
FUEL TANKS:	2 FEEDER TANKS + 7 STAGEABLE TANKS
COMMUNICATION TRANSMISSION POWER:	
LIFE SUPPORT SYSTEM:	PARTIALLY CLOSED SYSTEM

Description of Ship

The project Apex spacecraft is 110m long and weighs 893 metric tons. The bulk of the weight is fuel, which accounts for 752 metric tons. At the rear of the craft, we have a nuclear thermal propulsion system. Nuclear thermal propulsion provided the most efficient system for project Apex. The three engines are stacked vertically to increase the stability of the ship while it is spinning. The middle engine will be dropped off when it is no longer needed, and the remaining two will still provide sufficient stability and propulsion to complete the mission. Heat radiators along the side of the engines remove excess heat from nuclear thermal engines (NTEs) during propulsive maneuvers and from power reactors during remainder of mission. A rear reaction control system (RCS) produces thrust to make minor course corrections, attitude adjustments, Phobos docking, spin/despin maneuvers, and to maintain ship stability. The fuel tanks comprise the majority of the ship's mass. There are eight tanks total. Two are stacked vertically, one on each side of the truss. Six more are arranged as shown in *Figure 4.1*. The center of gravity is located right around the center of these six tanks. Star trackers and equipment is located just forward of these tanks. They are located as near to the center of gravity as feasible. During transit, the shuttle craft to be used on Phobos is locked in place just forward of the equipment bay. Upon arrival at Phobos, the craft will be detached via a manned maneuvering unit (MMU), and docked to the airlock at the end of the habitation modules. More radiators provide the habitation modules and communication platform with heat removal. The communication boom is fixed to the main truss and extends outward beyond habitation modules and fuel tanks to provide a constant line-of-sight communication path with Earth. The communication platforms at either end of the booms counter-rotate to maintain an unbroken link with Earth. A forward RCS system provides the second half of the vital maneuvering controls. The two habitation modules are located at the forward end of the ship. The two modules provide redundancy in case of failure in one, and provide the crew with a sense of division between home and work. One module contains the sleeping and eating quarters, and the other contains controls, equipment, experiments. Adequate shielding is provided for the astronauts via general shielding between the inner and outer walls of the modules and specific shielding around the sleeping quarters. The main structural truss runs from the rear RCS to the forward RCS systems and gives the ship a "backbone" to which all other systems can attach. The communication booms solely support the communication platforms.

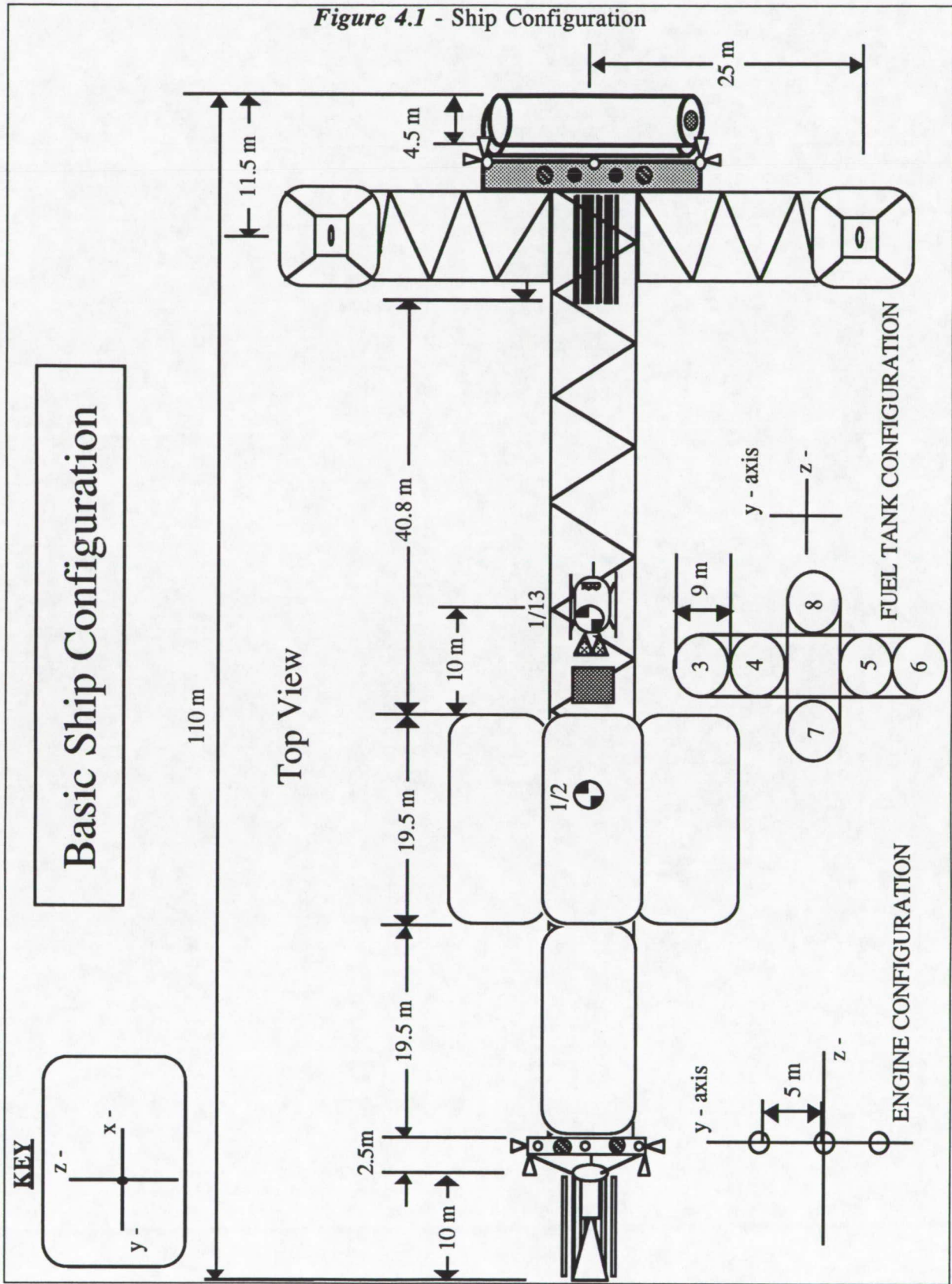

Determination of Ship Length

The length of the spacecraft was determined by both the spin rate and the radius of rotation. Four rpm is the maximum allowable rotation rate to assure the health of the crew. In addition, an artificial gravity in the range of 0.3g to 0.5g was found to be the best compromise between maintenance of crew health and minimization of system mass.

The spacecraft's center of mass was placed such that the radius of rotation (distance from the center of mass to the crew modules) was sufficient to provide a constant artificial gravity of 0.5g. The radius of rotation is between 50 and 65m, depending on the location of the center of gravity at specific points in the mission. The spin rate will be between 2.67 and 3.06 rpm, again depending on the center of gravity location.

Calculations for the minimum radius of rotation are:

Given:
$$a = \frac{V_t^2}{r}$$

Where: a = centripetal acceleration
 V_t = tangential velocity
 r = radius of rotation

and:
$$V_t = \frac{(\text{rpm}) * (2\pi r)}{\left(60 \frac{\text{s}}{\text{min}}\right)}$$

$$a = 4.9 \text{ m/s}^2$$

$$\text{rpm} = 4$$

Gives:

$$\text{minimum } r = 28 \text{ m (approximately)}$$

The position of the center of gravity moves forward along the length of the truss as the fuel is consumed and tanks are staged. For this configuration, the center of gravity is calculated when the tanks were full, for when they were one-half full, and for when they were one-thirteenth full.

Given:

$$X * \sum m_i = \sum (x_i * m_i)$$

where: i = the i th point mass
 m = mass
 x = distance from reactor end of ship
 X = location of the center of gravity

Results:

<u>Fullness of Tanks</u>	<u>C.G. (m)</u>	<u>Radius (m)</u>
full	44	63.75
1/2	45	62.75
1/13	60	47.75

Point masses were used to calculate the center of mass. A spreadsheet (see Appendix) shows the center of mass calculations at the beginning of the mission and for various stages during the mission.

Table 4.1 - Center of Mass Calculation			
Item	Mass (kg)	Position (m)	Mass*Position (kg*m)
Prop/Power engines (3)	22380.0	5.0	111900.0
Heat radiator (rear)	1200.0	5.0	6000.0
Computers (4)	80.0	11.5	920.0
Navigation equipment	75.0	12.5	937.5
Power Bus A	30.0	12.5	375.0
RCS rear	13251.8	12.5	165648.1
Common tanks (2 in rear)	167154.7	22.25	3719191.3
Fuel tank cluster (7)	585041.3	41.75	24425475.7
Power Bus B	200.0	51.5	10300.0
Phobos scientific equip.	150.0	55.0	8250.0
Navigation	75.0	58.0	4350.0
Truss	7000.0	59.0	413000.0
Landing legs	495.0	59.0	29205.0
Travel Pod	5500.0	61.5	338250.0
Portable antenna equip.	650.0	70.0	45500.0
Heat radiator (front)	880.0	97.3	85624.0
Comm. boom	1000.0	103.5	103500.0
2 Antennas	200.0	103.5	20700.0
2 Tranceivers	400.0	103.5	41400.0
4 Star Trackers	20.0	103.5	2070.0
Telescopes & Pointing Sys.	600.0	103.5	62100.0
Solar flare detection	100.0	103.5	10350.0
Power Bus C	300.0	103.5	31050.0
Planar truss	6000.0	105.5	633000.0
RCS (front)	13251.9	105.5	1398070.2
Ext. thermal transport	700.0	105.5	73850.0
LOX/H2 tanks	723.6	105.5	76339.8
LOX/N2 tanks	2638.0	105.5	278309.0
Hab modules	69034.0	107.75	7438413.5
	Σ Mass: 899130		Σ Mass*Pos: 39534079
			Center of Mass: 43.97 (From Rear of Ship)

Radiation Shielding

Three nuclear thermal engines were chosen as the primary propulsion system. With the use of dual-mode reactors for both propulsion and power generation, at least one engine will always be active. Shielding from the NTR's is needed by the fuel tanks, habitation modules, and communication platforms. Repair of antennae on the communication platforms may be necessary during the mission. The repairs would need to be performed by crew members without danger of radiation exposure. The shielding of the engines must provide a "cone of safety" that would encompass the fuel tanks and habitation modules and allow EVA activity.

A layer of shielding was placed between the reactors and the propellant tanks. This layer is made of Tungsten and Lithium Hydride and provides a "cone of safety" for the fuel tanks. The shielding was also configured so that the habitation modules and communication antennae were located in this radiation free zone. It was also determined that 40 meters would be a minimum safe distance from the habitation modules to the radiation-emitting reactors.

In addition to the reactor radiation, radiation shielding against galactic cosmic rays and solar flares is required for crew safety. The maximum allowable dosage of radiation that the astronauts can receive is 65 rems/year. Water and Lithium Hydride will be used to shelter the sleeping quarters of the habitation modules. This configuration will provide radiation protection for the crew for approximately 1/3 of a day that they are in their sleeping quarters. In the case of solar flares, the crew will return to sleeping quarters for protection.

Ship Mass

Mass is a very important aspect of the mission. The total mass of the ship can determine whether or not the mission will be feasible. The total mass of the spacecraft is 893,000 kg.

It is very important that the total mass required for the Project APEX mission be as small as possible. The less mass needed, the less the mission will cost. Fourteen kg of fuel is required for every one kg of payload. This meant that either the efficiency of the propulsion system must be increased or the mass of the dry payload (no fuel) must be reduced. Since the former is a fixed design specification, reducing the dry payload was the focus. This was accomplished by reducing contingency whenever possible (e.g. fuel), using recycling (potable water), and incorporating more than one function into a single component (propulsion/power engines). In these ways the total mission mass is kept below the maximum set limit of 1 million kilograms (beyond which, launch costs begin to outweigh the benefits of the mission).

<i>Table 4.2 - Vehicle Component Mass</i>	
Item	Mass (kg)
Prop/Power engines (3)	22380.0
Heat radiator (rear)	1200.0
Computers (4)	80.0
Navigation equipment	75.0
Power Bus A	30.0
RCS rear	13251.9
Common tanks (2 in rear)	167154.7
Fuel tank cluster (7)	585041.3
Power Bus B	200.0
Phobos scientific equip.	150.0
Navigation	75.0
Truss	7000.0
Landing legs	495.0
Travel Pod	5500.0
Portable antenna equip.	650.0
Heat radiator (front)	880.0
Comm. boom	1000.0
2 Antennas	200.0
2 Tranceivers	400.0
4 Star Trackers	20.0
Telescopes & Pointing Sys.	600.0
Solar flare detection	100.0
Power Bus C	300.0
Planar truss	6000.0
RCS (front)	13251.8
Ext. thermal transport	700.0
LOX/H2 tanks	723.6
LOX/N2 tanks	2638.0
Hab modules	69034.0
Σ Mass: 899130.0	

Artificial Gravity

Due to the long duration of this mission, the safety and comfort of the crew aboard the spacecraft were a high priority. Foremost, the health of the crew must be considered. After extended periods of time in a weightless environment the human body begins to lose muscle mass due to minimal exertion of their muscles. Decalcification of bone tissue also begins resulting in loss in strength and performance. To promote the health, performance, and safety of the crew, a level of 0.5g artificial gravity will be provided to the crew during transit to Phobos and on the return to Earth.

Artificial Gravity Configurations

The three categories of providing artificial gravity include spinning the entire ship (*Figures 1,2*), spinning just the habitation modules (*Figures 3,4*), and not spinning the ship at all. Since artificial gravity was proven to be necessary, the first two categories were investigated based on the constraints of mass, stability, simplicity, and cost.

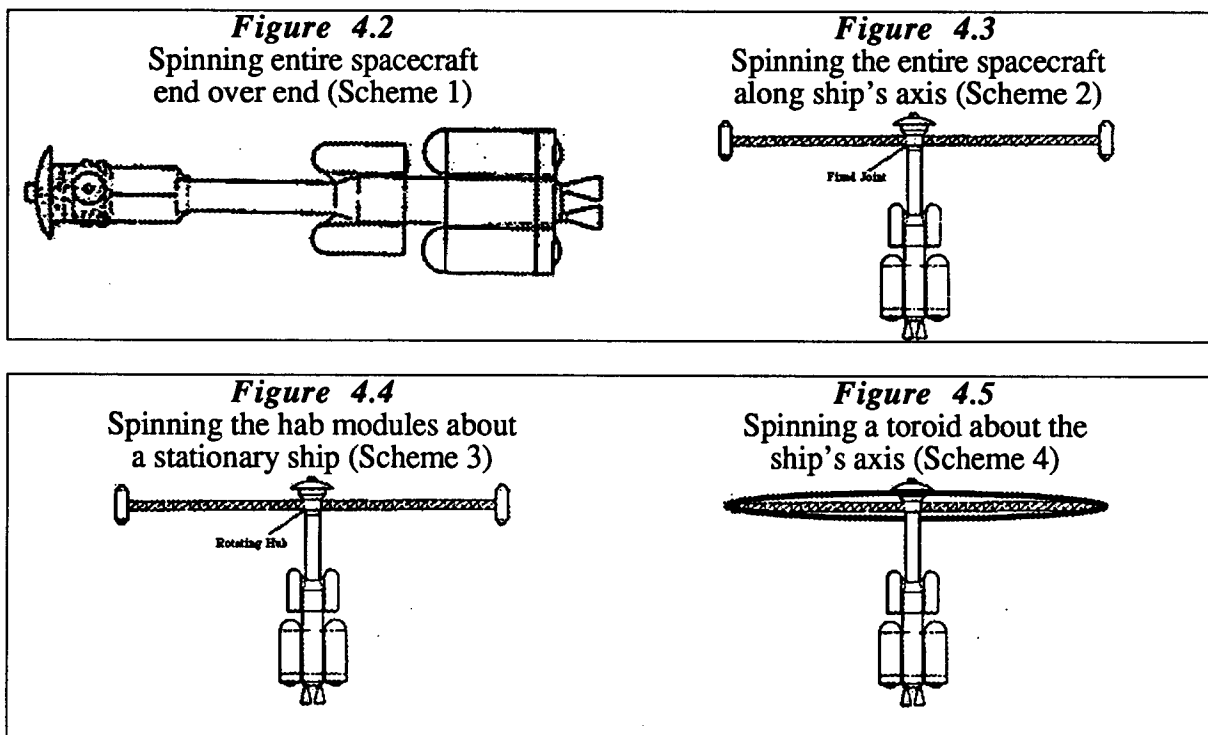

Mass

Because a large radius of rotation is required to produce a 0.5g artificial gravity, the configurations which involved spinning the habitation modules at the end of a long boom (schemes 2 and 3) required much more mass than configurations which involved spinning the entire ship (scheme 1). This is due to the extra material required to place the modules at an appropriate distance from the center of spin. Plus, there is the additional complication of what to put in each module. Many difficulties arise when the crew is split up. There must be food, communications, controls, power, water, and life support in both modules, and since they are separated, feeding these elements to each module would be an extensive undertaking. Designing a passageway which would pass through the hub, allowing the crew to move from one module to the other was considered, but the crew may not react well to such gravity gradients experienced in travelling from one module to another. Placing all the equipment and other materials that the crew did not need during the trip to and from Phobos in one of the modules was not practical because there wasn't enough of such equipment to balance the other habitation module. This meant there would have to be additional mass added to act as a counterbalance for the heavier module. A final possibility was a torus wheel rotating about a hub (see *Figure 4.5* above). This would allow the crew to move about without experiencing much fluctuation in gravity, but involved adding a large amount of mass. Therefore, for our mission scheme 1 is a better means of producing gravity than any of the others.

Stability

In achieving ship stability, the spin axis should have the greatest moment of inertia (see the Section **Ship Stability**). This can be achieved by all schemes with strategic placement of mass. Therefore no scheme outweighs another and the other factors can take precedence

Simplicity

Spinning only the crew modules would involve designing complex connections for the electrical and control systems of the spacecraft. The degradation of different parts of the hub due to friction would also have to be considered. The complexity of the hub which would be required to pass electricity from the power reactor, as well as feed lines for communication, controls and other systems would greatly increase the risk of failure. In addition, long sturdy structural arms would have to be built to mount the hab modules on. They must be strong enough to withstand the forces of spinning and ship acceleration. Thus, the design of an entire spacecraft that would spin would be much more simple than designing crew modules which would rotate about a hub. Again, scheme 1 is preferred.

Cost

The cost of this spacecraft is directly related to the number of launches required to place the spacecraft components in LEO for assembly. To minimize the number of launches needed, the mass of the spacecraft should be minimal. The total mass required for scheme 1 is significantly less than that of the other three configurations. Extra fuel will be required for scheme 1 to despin the entire ship for course corrections; however the added mass is still less than that of the other configurations. Scheme 1 would cost less in both fuel and payload mass than any of the other proposals.

APEX Artificial Gravity Configuration

In terms of mass, stability, simplicity, and cost, spinning the entire spacecraft would be more advantageous than spinning only the crew modules. The only configuration for spinning the whole spacecraft without splitting up the crew or adding extra mass as ballast is one which places the crew modules on one end of the spacecraft and the engines and fuel on the other end, as in *Figure 4.6* below. This was the optimal configuration chosen for the spacecraft.

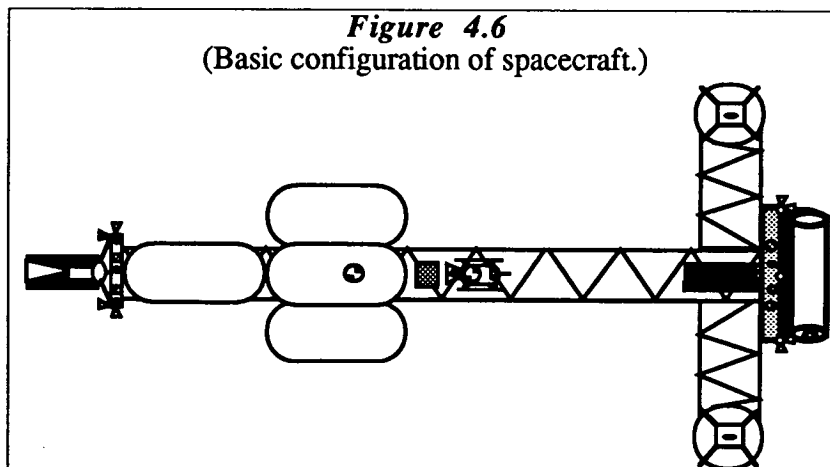

Reasons for Despin

At times during the mission, the spacecraft must return to its non-spinning configuration. Since the limitation of weight is a major concern, and each spin process requires a certain amount of fuel, the minimization of these spin/despin pairs is a serious consideration. Limiting the amount of despins effectively reduces the amount of RCS fuel needed for the mission.

The reasons to despin are to perform trajectory corrections and emergency procedures. These are the only reasons the crew would need to despin the ship, and the total number of despins has been set at eight. This includes four course corrections on the way to Phobos, two course corrections on the way back to Earth, and two despins for contingency procedures.

Trajectory Corrections

The first reason to despin is to perform course corrections during transit. Without course corrections, the small error incurred with each burn would result in a large error in the final destination, and the ship would not reach Phobos. The ship will despin at each course correction, because the corrections cannot be made effectively while the ship is spinning.

On the outbound trip, the corrections will take place halfway to Venus, at Venus, halfway to Phobos, and at Phobos. On the inbound trip the corrections will be made halfway to Earth, and at Earth for a total of six course corrections.

Emergency Procedures

There are some problems that may occur during the mission that would require the ship to despin. These problems are detailed as follows:

- Repairs on equipment outside of the habitation modules
- Mission abort scenarios requiring additional despins
- Contingency fuel for spin/orientation/attitude corrections

The first problem would involve despinning because it is very difficult to perform EVA operations on a spinning ship. The crew's safety would be jeopardized unless the ship was stationary. The second problem would allow the crew to return to Earth safely if there was some problem requiring a mission abortion. The total number of despins allowed for emergency procedures has been set at two, which gives enough fuel to accommodate most emergencies.

Effects of Spin/Despin on Crew

The crew will be subjected to lateral as well as rotational acceleration when the ship is spinning and despinning. It was necessary to determine if there will be any detrimental effects on the crew, or on their ability to perform their duties during these times. It was found that these effects on the crew will be minimal and can be neglected. The lateral acceleration experienced by the crew will be approximately 0.01g, and the length of time that this acceleration is experienced will not be significant. Since the ship can spin and despin in five minutes, the crew will be able to strap into their seats if necessary for the duration of the spinning process without any loss of overall performance.

When the ship spins to create artificial gravity, there is a period of time when the ship is accelerating to the proper speed to produce 0.5g in the habitation modules. During this time, the crew will experience a lateral acceleration as well as an increase in rotational acceleration (gravity). This lateral acceleration, a , is calculated by the equations:

$$\dot{\Theta} = \left(\frac{\text{rev}}{\text{min}} \right) \left(2\pi \frac{\text{rad}}{\text{rev}} \right) \left(\frac{1 \text{ min}}{60 \text{ sec}} \right) \quad (1)$$

$$a = \frac{\dot{\Theta} \times r}{t} \quad (2)$$

Where $\dot{\Theta}$ is the final revolutions per minute (rpm), r is the radius of revolution, and t is the time required to attain that particular revolution rate.

$\dot{\Theta}$ will be between 2.67 rpm and 3.06 rpm. The time required to attain this spin rate will be no less than 5 minutes. By using these numbers in the equations above a lateral acceleration of between 0.0089 and 0.01g is found.

Reaction Control System (RCS)

The Reaction Control System will be used for four main purposes throughout the mission. These purposes are:

- 1) Spinning and Despinning the spacecraft
- 2) Performing Trajectory Corrections
- 3) Maintaining Stability
- 4) Docking with and leaving Phobos

These purposes dictated the configuration and fuel requirements necessary for the RCS system.

RCS Configuration

Concerns affecting the RCS configuration decision included:

- Minimization of the mass of RCS system (including fuel required)
- Interference with other systems (thermal, vibrational, and byproduct emission)
- Thrust required for trajectory corrections (TCs), Phobos docking maneuvers, and trajectory corrections
- Time necessary to despin the craft in emergencies
- Dynamic stability of a rotating craft
- Control of rotation about the three major axes

The RCS thrusters will be placed on two specially designed RCS trusses (14m tall x 20m wide) that extend around the main truss. They absorb the vibrational energy that is created. In addition, they distribute the forces produced by the thrusters evenly, and they thermally isolate the thrusters from critical materials (fuel tanks).

These trusses will be located 11.5 m from the rear and 6.5 m from the front of the ship. The thruster configurations on the front and rear trusses are shown in *Figures 4.6 and 4.7*. This configuration allows the control of dynamic stability about all three axes. Thrusters can be throttled and gimbaled for minor adjustments and reduction of structural stresses.

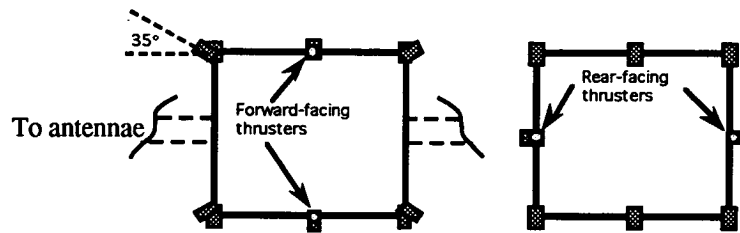

Figure 4.7
Front RCS truss

Figure 4.8
Rear RCS truss

Rear RCS Truss

There were 4 major concerns in placing the rear RCS system.

- Thermal and neutronic radiation from the Nuclear Thermal Engine (NTE)
- Interference with thermal radiators
- Thermal radiation to the main fuel tanks
- Structural stability

The rear-facing RCS thrusters were originally placed such that their exhaust may have had detrimental effects on the above-mentioned radiator panels. The system was reconfigured such that a clearance of about two meters will separate the two systems. This is sufficient to alleviate any concerns.

The heat generated by the RCS system is a second factor that affects the fuel tanks (both RCS and main). The mounting braces will be constructed of a material with a low thermal conductivity. Thrusters will always be directed 90° away from tanks.

Forward RCS Truss

The forward RCS truss faced additional concerns including vibrational, thermal and emission interference with the communication booms, antennae, and hab modules.

As stated before, the RCS truss will absorb the vibrational and thermal energy necessary to allow for normal operation of all nearby systems. However, concern was placed on the direction of the byproducts of combustion (water, ice).

The antennae presented a unique problem. They will be extremely sensitive to abrasions and other surface defects. These surface anomalies will cause significant communication degradation as the mission progresses. To reduce damage to the antennae by high velocity combustion by-products, the x-axis control thrusters (at the corners of each truss) were placed vertically. This eliminated two-thirds of the emissions directed toward the antennae. The remainder of the concern was again the lateral facing thrusters. They are located at the corners of the truss, and angled 35° from lateral. The angle was determined by requiring the thrust vector to pass through the x-axis, thereby producing no net moment.

RCS Thrusters

A liquid hydrogen/oxygen thruster was chosen for its high Isp (435 s). Each thruster weighs 50 kg and provides 6670 N of thrust at maximum throttle. There will be 22 thrusters total with a total mass of 1,100 kg. Each thruster is can be throttled and can be gimballed to approximately 8°

Additional vernier engines of minute mass and thrust may be assimilated into the RCS system if it is found that minor adjustments below the capability of the main RCS engines are necessary.

RCS Fuel Requirements

A major concern in choosing the RCS system is total mass, of which fuel is 75%. Therefore, fuel requirements played an important role in determining the RCS system. Concerns affecting the decision included:

- Minimization of the mass of RCS fuel
- Fuel type
- Fuel tank size, shape and placement
- Number of spin/despin sequences required
- Amount of Phobos maneuvering
- RCS role in trajectory corrections;
- Time necessary to despin the craft in emergencies

Spinning the ship will require 10,000 kg of fuel. An additional 1,000 kg of fuel will be used in stability maintenance; 2,000 kg for near-Phobos operations; 5,000 kg for trajectory corrections; and 900 kg of fuel will cover boil-off, error correction, and extra maneuvers not scheduled in the mission agenda. Total RCS fuel mass will be 18,900 kg. Total RCS system mass will be 20,000 kg.

Fuel Requirements for Spinning

In spinning the ship, the fuel required is dependent upon the moment of inertia of the ship about the Z-axis, desired rpm, number of engines used, thrust produced, separation of front and rear RCS systems, desired spin time, and the Isp of the thrusters. The equation determining time required to spin the ship is:

$$t = \frac{I_{zz} \times \text{RPM} \times (2\pi \frac{\text{rad}}{\text{rev}}) \times (\frac{1\text{min}}{60\text{s}})}{T \times F \times d} \quad (1)$$

Where:

I_{zz}	=	3.81e8
RPM	=	2.85 rpm
t	=	time to full spin speed
T	=	Number of thrusters firing (2)
F	=	Thrust per engine (6670 N)
d	=	Thruster separation (91 m)

yields a time to spin of 187.3 seconds, or 3.1 minutes.

Taking the time required, the Isp, and the thrust, the fuel required is as follows:

$$M_f = \frac{T \times F \times t}{9.81 * I_{sp}} \quad (2)$$

Where:

I_{sp}	=	435 s
t	=	187.3 s
T	=	2
F	=	6670 N
M_f	=	mass of fuel required

the fuel required is 585.1 kg per spin or despin. Since there are 8 spin/despin pairs, the total fuel required is 9,360 kg.

Fuel Requirements fo Trajectory Corrections

The fuel required for the RCS system to perform trajectory correction maneuvers is in the range admissible for the system (WHAT RANGE? WHO DETERMINED THIS? WHAT SYSTEM ARE THEY TALKING ABOUT). A trajectory correction ΔV of about 40 m/s is necessary for the entire trip. The equations describing the fuel required are described below.

The acceleration produced by two thrusters is:

$$a = \frac{F}{M_t} \quad (3)$$

Where:

a	=	acceleration of ship (m/s^2)
F	=	thruster force (two-thruster total) = 13,340 N
M_t	=	total mass of ship (500,000 kg at this point in the mission)

This yields an acceleration of 0.0267 m/s^2 .

A ΔV of 40 m/s can be performed by the RCS system in the amount of time described by the following equation:

$$t = \frac{\Delta V}{a} \quad (4)$$

The ship can perform the ΔV in a time of 1500 s (24 mins). A burn of that length consumes an amount of fuel calculated by Equation 2. Two thrusters at 6670 N each, for 1500 s, consume about 5,000 kg of fuel. This is a significant amount of fuel, but using the Nuclear Thermal Engines is not practical here. The Nuclear Thermal Engines (NTEs) require an amount of time to warm up to operating temperature before they can be fired. After being used for propulsion, they require propellant to cool them down to standard power producing temperature. The costs of this procedure plus the interrupt of power supply and reliance on fuel cells for such a brief amount of time is prohibitive. The RCS system was therefore given the task of performing TCs.

Stability Maintenance

Two thousand kilograms of fuel are provided for attitude corrections. This allows minor translational velocity changes totalling 10 m/s, and rotational velocity changes totalling 4.7 rpm.

A base estimate of about 10% of the total RCS fuel was allocated for error corrections. A more accurate assessment of fuel required for stability maintenance could be performed with a more thorough study. Time limitations prevented a more accurate description. However, since maintaining stability is a process that is never fully predictable, more or less fuel may be required. This is covered by the contingency fuel payload.

Near-Phobos Operations

Once near Phobos, docking procedures will be carried out by the RCS system. Two thousand kilograms will be allocated for these procedures.

It was determined that the ship will need a 5 m/s ΔV to perform the final docking maneuver with Phobos. The same will be required to launch from Phobos. This is obtainable, and agrees with the above projections.

Arrival at Earth

In choosing an arrival scheme for Project APEX, options ranged from a propulsive re-entry into High Earth Orbit (HEO) to aerobraking, from leaving the ship in HEO to bringing it down to Low Earth Orbit (LEO). After considering the choices, it was decided to have the ship enter HEO. From there, it will be brought to LEO by orbital transfer vehicles (OTVs). The crew is taken off the craft and returned to LEO (either Space Station Freedom, or a shuttle) by an OTV before the ship is transferred.

When the ship approaches Earth at the end of the inbound journey, it must be brought into HEO. The two methods considered were aerobraking or the standard all-propulsive stop.

Aerobraking has an advantage over propulsive re-entry, as it requires significantly less energy. Aerodynamic drag helps reduce the velocity required for capture in Earth orbit. Very little fuel is required to stop the high velocity ship, which reduces the ship's mass and cost greatly. But, the necessary size of the aerobrake to accommodate the proposed ship would be quite large. The aerobrake would have to extend past the communications platforms in order to prevent the structure from failing or burning up. Such a massive object could not be taken to Phobos and back. The insertion into HEO must be all-propulsive.

However, moving the ship from HEO to LEO is desirable, since repairs and refueling can be accomplished much more readily and much less expensively from low Earth orbit. Therefore, one or possibly 2 OTVs will be used to push the ship from HEO to LEO, the number being dependent on the amount of fuel that could be carried in the OTV.

Ship Stability

The dynamics of a spinning ship are complex and stability throughout the mission must be assured. The issue of stability of the proposed spinning spacecraft has been investigated. The

effects of perturbations and optimal spin axis have been found. In addition to these, the different methods of maintaining this stability has been researched.

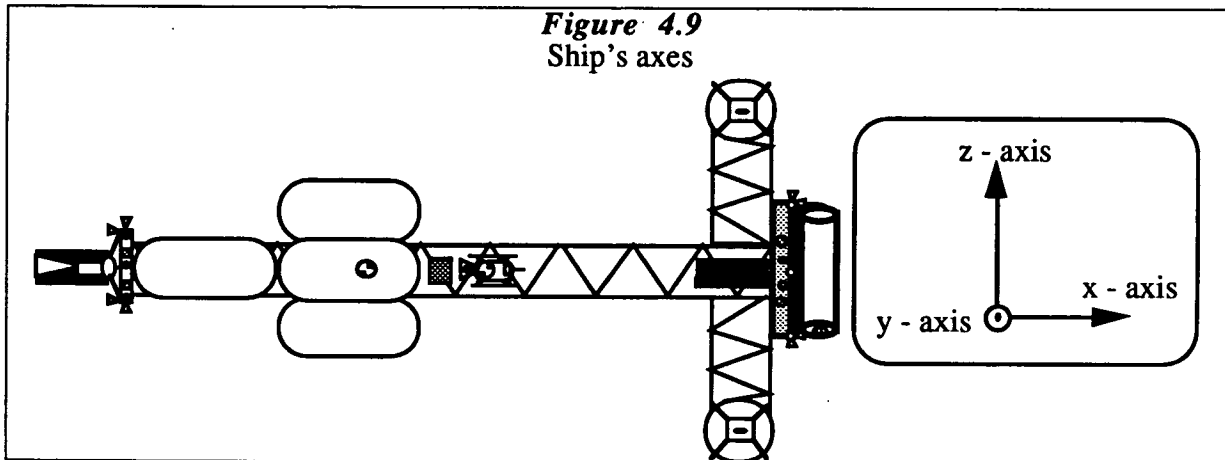

The first issue was to see what kinds of effects perturbations would have on the craft.

Reference condition: rotation at constant rate Ω about the z-axis

$$\omega_x = \delta\omega_x$$

$$\omega_y = \delta\omega_y$$

$$\omega_z = \Omega + \delta\omega_z$$

Where ω are the angular velocities.

Euler's equations for a torque-free rigid body

$$M_x = I_x \dot{\omega}_x + (I_z - I_y) \omega_y \omega_z = 0 \quad (5)$$

$$M_y = I_y \dot{\omega}_y + (I_x - I_z) \omega_x \omega_z = 0 \quad (6)$$

$$M_z = I_z \dot{\omega}_z + (I_y - I_x) \omega_x \omega_y = 0 \quad (7)$$

$I_{x,y,z}$ are the moments of inertia about the respective axes. Assuming that the perturbations $\delta\omega_x$, $\delta\omega_y$, and $\delta\omega_z$ are small compared to Ω , so that their products can be ignored gives angular acceleration, $\dot{\omega}$:

$$\dot{\omega}_z = 0$$

Since ω_z is constant, this implies that $\delta\omega_z = 0$, giving

$$I_x \dot{\omega}_x + (I_z - I_y) \Omega \omega_y = 0 \quad (8)$$

$$I_y \dot{\omega}_y + (I_x - I_z) \Omega \omega_x = 0 \quad (9)$$

Differentiating (9) with respect to time and substituting ω_x from (8), yields

$$\dot{\omega}_y + \frac{(I_x - I_z)(I_y - I_z)}{I_x I_y} \Omega^2 \omega_y = 0$$

Examine the coefficient of ω_y term

$$\frac{(I_x - I_z)(I_y - I_z)}{I_x I_y}$$

If this coefficient is positive, ω_y will vary sinusoidally (stable), otherwise ω_y will increase exponentially (unstable).

For this criteria, it is seen that I_z must be either the maximum or minimum moment of inertia, for stability.

The next issue is the optimal stable spin axis. In its free state, a spin with the minimum kinetic energy (consistent with the constant angular momentum) will be maintained. The Kinetic Energy (T) is:

$$T = \frac{1}{2} I \omega^2 = \frac{1}{2} \frac{H^2}{I}$$

For minimum T (with constant angular momentum, H), I_z must be the largest of the three moments of inertias.

From these two issues, it can be concluded that the optimal stable spin axis is the one with the greatest moment of inertia, therefore a ship must be created having I_z be the largest moment of inertia.

To maintain the artificial gravity, it is necessary for the craft to maintain a stable spin about the desired axis. Looking into the effects of perturbations will reveal the criteria for stable spin.

As depicted in *Figure 4.9*, above, the axes are defined as follows:

- x-axis lies along the truss of the ship
- y-axis perpendicular to the ship axis and to the length of the hab modules
- z-axis perpendicular to the ship axis and parallel to the length of the hab modules

The craft was analyzed for stability of a spin about the z-axis.

It was found that the z-axis is the largest inertia axis at all time when spinning is desired. In these calculations the products of inertia have been neglected because their size with respect to the primary inertias is negligible. Also neglected was the fact that the axes chosen (x-axis along the axis of the ship, y-axis perpendicular to the communication boom, and z-axis parallel to the communication boom) are not the principle axes. This has been neglected for the same reason as the products of inertia.

Calculations show that at the spin times in the mission the inertias are as follows:

Outbound Spin

$$I_{xx} = 1.27e8$$

$$I_{yy} = 6.14e8$$

$$I_{zz} = 7.30e8$$

Inbound Spin

$$I_{xx} = 1.81e8$$

$$I_{yy} = 4.47e8$$

$$I_{zz} = 4.58e8$$

In both legs of the mission, the largest moment of inertia will be I_{zz} . The margin of safety ($(I_{zz}-I_{yy})/I_{yy}$) for the trip is:

Outbound Spin

$$18.89\%$$

Inbound Spin

$$2.46\%$$

I-DEAS Implementation

The CAD/FEA package, I-DEAS, was used to create an accurate, three-dimensional representation of the spacecraft. Exact proportions and details of subsystems can be extracted from the I-DEAS drawings included in the following pages. All components greater than three meters were included. Smaller components do not appear. Some components are simplified (e.g. the main truss) for the purpose of visibility of objects in the background.

Furthermore, I-DEAS was used to perform structural modeling of the main truss, communications truss, and habitation module support unit to determine its capability to perform sufficiently during the APEX mission.

Conceptual Drawings done on I-DEAS CAD Software

Isometric View

SDRC I-DEAS 4.1: System Assembly
DATABASE: GENERIC EXPERIMENTS
VIEW : No stored VIEW
Task: HIERARCHY
stem: No stored SYSTEM

15-APR-92 14:23:54
UNITS : SI
DISPLAY : No stored OPTION
Bin: 1-MAIN
Component: No stored COMPONENT

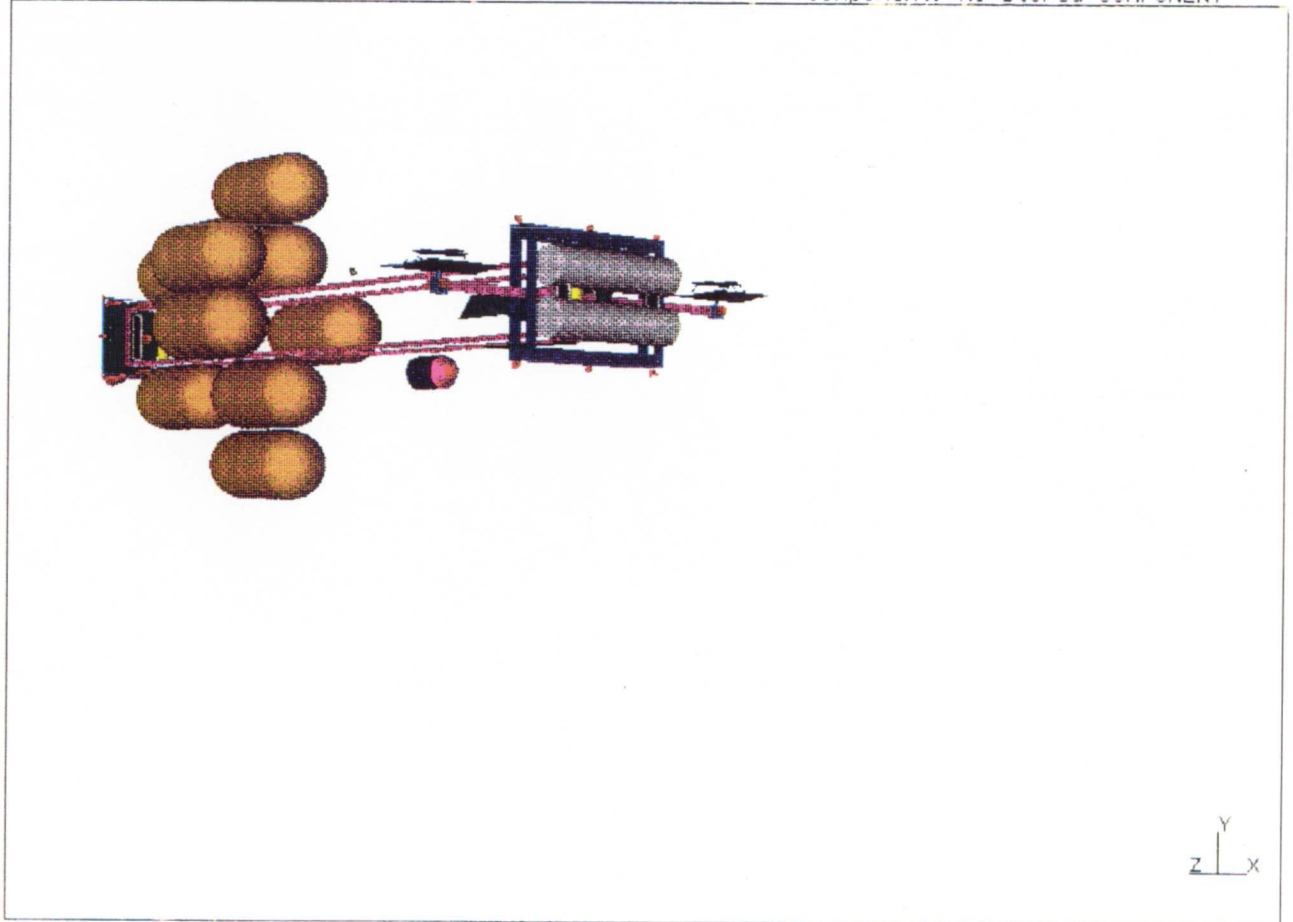

ORIGINAL PAGE
COLOR PHOTOGRAPH

Conceptual Drawings done on I-DEAS CAD Software

Tail View

SDRC I-DEAS 4.1: System Assembly
DATABASE: GENERIC EXPERIMENTS
VIEW : No stored VIEW
Task: HIERARCHY
stem: No stored SYSTEM

17-APR-92 13:19:34
UNITS : SI
DISPLAY : No stored OPTION
Bin: 1-MAIN
Component: No stored COMPONENT

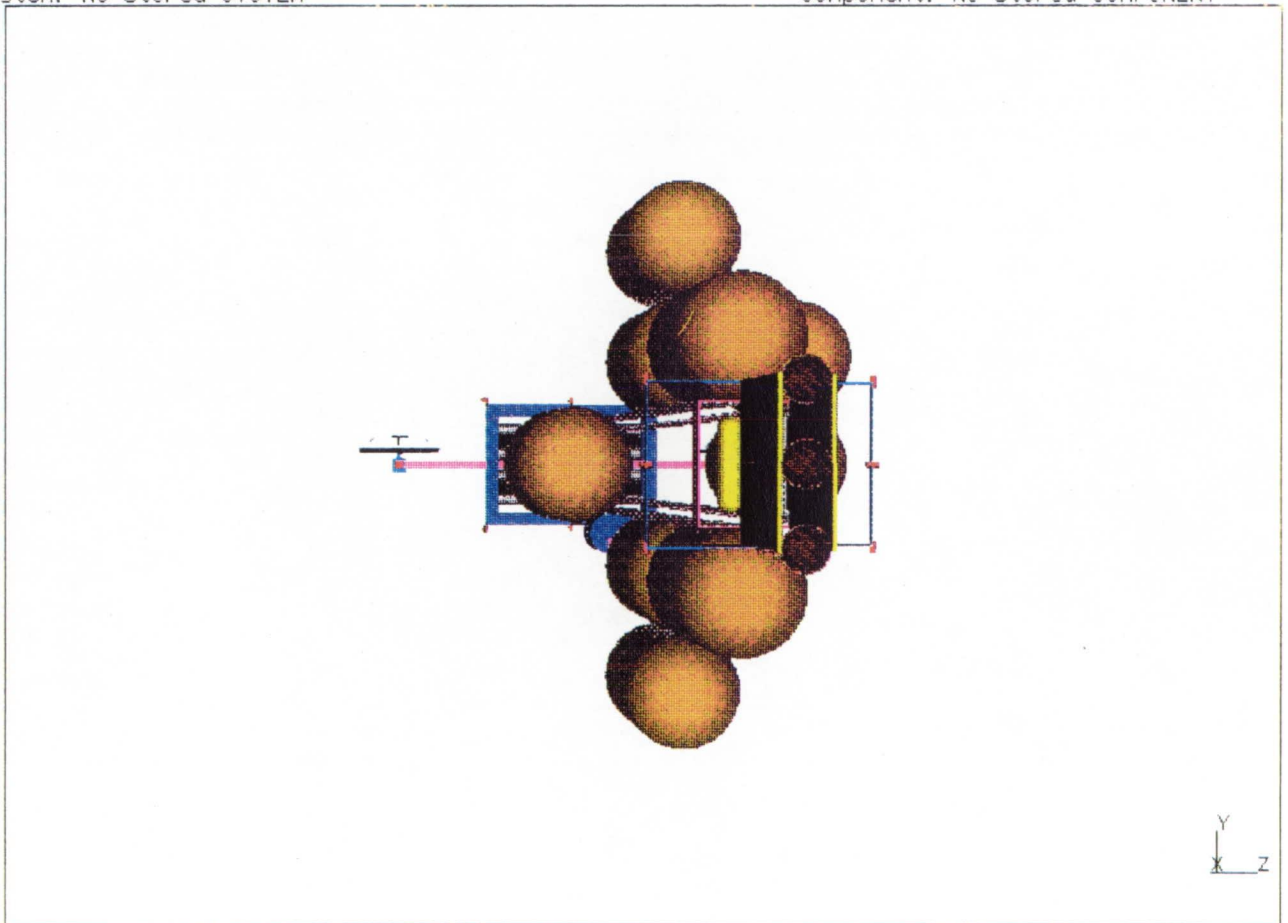

ORIGINAL PAGE
COLOR PHOTOGRAPH

~~92~~ 92 INTENTIONALLY BLANK

Pages 95 - 98 have been deleted in the final report

PRECEDING PAGE BLANK NOT FILMED

~~PAGE 94-98~~ INTENTIONALLY BLANK

Chapter 5

Planetary Science

5.1 Experimental Goals

5.2 Precursory Missions

5.3 Processing Facility

~~99-100~~ INTENTIONALLY BLANK

General Experimental Goals for Project APEX

The logical question to ask ourselves before planning a trip to the Martian system is 'why go?' Some aspects to that question have surely been covered earlier in this report, so this discussion will apply primarily to the scientific objectives of this Mission to Phobos. Here, we consider the place of a Mission to Phobos in space programs that are envisioned for the future, today.

The obvious difference between this and other trips that have been planned to the Martian system is that its primary goal concerns the moon, Phobos, and not the planet, Mars. What is suggested through this mission is to make future missions to the planet economical and more feasible by providing for some of their fuel requirements. The source of this fuel is the regolith of Phobos.

This purpose satisfies some questions in an economic justification for a Mars mission; those related to lower cost. But economic justification is only one of four areas of justification that must be addressed for a Mars mission to become an acceptable option. The other three areas contain questions related to scientific, political, and social concerns.

Justifying An Interplanetary Mission - The Role of the Mission to Phobos

As of now, scientific pursuits are primary in any mission to space, and constitute the overwhelming majority of reasons for any interplanetary mission. Political and strategic missions are many in near Earth circumstances, but, in and of themselves, have no near term impacts on present terrestrial situations. However, they do provide technological advances and national prestige. The Apollo missions were primary examples of this type of impact.

Social concerns are a limited part of near Earth missions, and are somewhat satisfied through operations such as better manufacturing of pharmaceutical drugs, or in satellites that are sent into space to monitor patterns on Earth that affect populations such as weather or disease. In the longer term interplanetary mission, there are presently no tangible social reasons for such a trip beyond proposed schemes of colonization for an overpopulated planet.

Overall, missions for science and strategic, national concerns are by far the biggest constituents of any space mission. Economic justifications for missions start in the pursuit of science where new manufacturing techniques are tried and assessed. However, no full scale manufacturing permanence in space has yet been established. Social justifications are not always, but often found as by-products of potential economic rewards.

When the interplanetary mission is considered alone, it might be found that each of these areas of justification are harder to satisfy through terrestrial concerns. As one gets further from Earth, the benefits become less tangible and lines between these areas of justification become blurred. Scientific reasons for such a trip are many and are not hard to enumerate. Surely, the brainchild for such a mission originated in the scientific community with its wonderment about a red planet. But this is not enough to get a mission such as this off of the ground. It is not until long term economic and political benefits become tangible that such a mission is seriously considered. Unfortunately, social concerns are of minor concern and have only a small, very long term justification in an interplanetary mission.

As this mission is concerned with making a mission to the Martian system economically and politically feasible, it can be viewed as a precursory mission in a larger plan for much greater, permanent human involvement in space. In speaking of this Mission to Phobos, it must be

remembered that no mission in and of itself can satisfy each of these four areas of justification. Each will play a role, and each mission will satisfy one or two of these areas more than the others. The Space Exploration Initiative (SEI) is the present attempt by the United States to formulate this large scale plan, and overall, this mission can be considered as a small element of that overall, long-term mission.

Scientific Justifications for the Mission to Phobos

In most fields of science, an interplanetary mission to the Martian system has its benefits. Each of these fields have enumerated and elaborated in great length possibilities for scientific discovery, and surely, people that work on scientific problems that can be answered by missions to the Martian system can support the mission for the purity of those pursuits themselves. However, this mission in particular is very practical. The concern here is to make future missions possible. NASA objectives in the 5-year plan issued over 10 years ago in 1981 consisted of the following selected points:¹

- Increased Knowledge of the History of Cosmos
 - High Energy Particles, Studies of Intergalactic Space, Etc.
 - Verifying Theory of Relativity
- Origin and Distribution of Life in the Universe; Relationship Between Life and its Habitat
- Role of Health and Man in Space
- STS, Spacelab, Centaur...

It should be noted here that most of the objectives enumerated by NASA are in the interests of the expansion of scientific knowledge and in the support of such missions. In the case of the Mission to Phobos, the ship that has been designed can serve as a carrier for scientific apparatus that will study topics as astrophysics or elementary fluid behaviors, but scientific pursuits in this mission are very specifically geared towards the more practical end of spaceflight such as the third goal listed above. In essence, the division between this practical mission and a mission such as Magellan is somewhat like the considerations that separate engineering from the pure sciences. Reasons for this flight are more akin to the objectives in missions such as Spacelab where monitoring of terrestrial patterns as well as investigations into the occupation and use of space are also conducted.² In particular, scientific objectives for the Mission to Phobos consist of the following:

1. Assessment of the effects of long-duration flights on human and plant physiology.
2. Assessment of possibilities for extraterrestrial fuel and metals production.
3. Assessment of use of extraterrestrial resources for manufacturing of construction products.
4. Judge origin of Phobos.

The Mission to Phobos is a demonstration, fact-finding mission.

Further Considerations for a Mission to Phobos

Much like the situation in Antarctica, the Moon and Martian system will become, in the future, objects of world political bargaining as to who can use what resources from these places. The mining of Phobos will necessitate the establishment of agreements with other spacefaring nations that might also have an interest in the Martian system. Going to Phobos without this dialogue would constitute something on the lines of imperialism as Phobos

would be effectively claimed in the name of the United States. As such action would be a source of friction between the United States and other modern countries, steps must be taken to satisfy the need for agreement. Presently, five U.N. treaties govern the function of nations in space. These are:

- 1967 - Treaty on Principles Governing the Activities of States in the Exploration and Use of Outer Space, Including the Moon and other Celestial Bodies
- 1968 - Agreement on the Rescue of Astronauts, the Return of Astronauts, and the Return of Objects Launched into Outer Space
- 1972 - Convention on International Liability for Damage Caused by Space Objects
- 1976 - Convention on Registration of Objects Launched into Outer Space
- 1979 - Treaty on Principles Governing Activities on the Moon and Other Celestial Bodies

The last mentioned here was signed and ratified by only five countries.³ Given these concerns, a full assessment of the necessary dialogue must be undertaken and pursued before any mission of this type becomes a reality.

On-Board Science for Project APEX - Scientific and Experimental Set-Up

In this section, a conceptual design for the pursuit of science in satisfaction of the goals listed in the section **Scientific Justifications for the Mission to Phobos** is discussed in detail. A short background section describing some of the missions that have influenced this design is included to provide a source for pursuing further information on this subject. For reference, 'on-board' science refers to investigations which can be conducted in or directly adjacent to the habitation modules. Astronomical and solar observations are not included in this section. The area that this section deals with is often times intertwined with the Human Factors section of this project. Thus, references to experimentation that use the facilities of that section or contribute to its success should be expected.

Influential Missions

Four missions are discussed here to show similarities and differences between such a long-duration science program as that which needs to be instituted on this trip and very short-term missions that have been proposed and conducted in the past. A fifth, Skylab, is not discussed here but was also influential in choosing types of experiments to be carried by the ship.

The Ph-D Mission

Proposed by Dr. Fred Singer, the Ph-D Mission was a manned flight designed to go to the Martian moon Deimos. Its purpose was to establish a fully equipped laboratory on the surface of Deimos from which a fleet of rovers on the Martian surface would be controlled. Though the main purpose of this laboratory was to explore the Martian surface, the moons Phobos and Deimos, and to provide the means for immediate analysis of sample returns from all sources, other areas of experimentation such as fluid and suspension behavior in very low gravity were to be performed. The similarity of this mission to the Mission to Phobos is contained primarily in the conduction of experimentation in the Martian system and the use of a manned presence for immediate analysis of soil sample returns and real-time adaptations to changes in received data that might provide for exciting discovery. This is one of the most

compelling reasons for using a manned flight for a mission of the complexity of Project APEX.

The Sortie Can Study, SpaceLab, and STS-42

The Sortie Can Study was undertaken by the Preliminary Design Office of the Marshall Space Flight Center during the years of 1971 and 1972 as a prelude to the design of what is presently known as *Spacelab*. This study was intended to map out a proposal for an autonomous experimental module that would carry various experiments from all fields into space on a regular basis. Some highlights of this study include the use of a boom for deployment of experimental payloads, use of racks and 'workbenches' for conducting experimentation, and an exterior 'pallet' or truss that would house external experimentation that required exposure to the space environment. An airlock was also provided.

The results of the Sortie Can Study were transferred to a European outfit called the European Space Research Organization (ESRO) which took the concept to its maturation as Spacelab. Spacelab was designed as a modular system that would fit inside the Shuttle cargo bay in various combinations of the pallet and module. Unlike the Sortie Can, Spacelab requires the shuttle for its power, thermal rejection, and environment. One of the main goals of the Spacelab program was to make it possible for the investigators whose experiments were flown in Spacelab to communicate with those who would be conducting their experimentation to allow for quasi-direct manipulation of their experiments.

As was apparent in the first Spacelab mission, Spacelab was meant to support both technological advancement and study into manned practice in the space environment, as well as to provide a base for the exploration of fundamental behavior studies in the purer sciences. For example, one of its goals on the first mission was to "investigate the effect of the space environment on body fluid redistribution..." and to "demonstrate the capability of SpaceLab as a technology development and test facility..." however, another goal of the mission was to "investigate fundamental science in vapor, liquid, and solid phase interaction under gravity free conditions."

It is this type of overall service to many facets of science and technology that made the recent shuttle mission, STS-42: IML - The First International Microgravity Laboratory, such a success in terms of the production of useful data. This mission was used for investigations into the effects of the space environment on humans and other life forms including plants and insects, the creation of perfect crystals, and fundamental fluid research in microgravity. Two aspects to mention about this sophisticated layout was the necessity for monitoring of vibrations in the craft and the presence of very unstable biological experiments that required loading on the craft to be delayed until a few hours before launch.

The Delta Space Station

The Delta Space Station study was issued on March 31, 1985 from NASA's Lyndon B. Johnson Space Center. The scientific lab module proposed in this study indicates the benefits of a longer term, more autonomous system than that used for Spacelab. Of the differences, few are apparent regarding the type of science to be performed. Experiments are more directly geared towards fundamental research into the effects of space on both plant and animal life. However, practical considerations such as repair of broken equipment and more elaborate workspace considerations are among the differences that make this much more directly a long duration facility. The lab here maintains a manipulator arm capability and uses acceleration monitoring as well.

Areas of On-Board Scientific Investigation

As mentioned at the end of the section **Scientific Justifications for the Mission to Phobos** there are three main scientific objectives on our Mission to Phobos. These are reproduced below for convenience:

1. Assessment of long-duration flights on human and plant physiology.
2. Assessment of possibilities for fuel and metals production.
3. Assessment of use of extraterrestrial resources for manufacturing of construction products.
4. Determine origin of Phobos.

On-board experiment en route to Phobos and en route back to Earth will primarily address the first, third, and fourth goals with some support investigation into the second objective. The second objective is dealt with through the operation of the mining and processing plant that will be installed on Phobos. This plant is discussed earlier in this report. Generally, on-board experimentation will consist of life science data acquisition and analysis, material science and material processing investigations, and a detailed analysis of regolith obtained from both the Mars surface and the surface of Phobos. The situation of this trip is unique and thus, data taken using trips of this type cannot be accurately reconstructed using a space station.

Human Life Sciences

The crew of five that will fly with the mission will be part of experiments designed to:

1. Investigate the long-term physiological and psychological effects of weightlessness and low-gravity conditions, and radiation exposure.
2. Assess the use of different methods to combat the effects of these degradations including the use of artificial gravity.
3. To investigate the effects of confinement on the mental state of the crew.

These investigations and assessments will make it possible for future missions to be designed that are both physically and psychologically safer for human travel and more conducive and pleasant to crew study and activity.

Because of the nature of this mission, no other animals or insects will be taken on the trip to Phobos.

• Physical and Physiological Changes

For human study, there are many different processes that should be monitored in order to formulate an overall assessment of the changes that take place in the body during weightlessness and low-gravity circumstances. On this mission, there is the unique opportunity to make a controlled assessment in many different stages of weightlessness. Processes to be monitored are chosen in order to provide data on the following areas.

1. Hormonal and mineral balance.
2. Cardiovascular and immune system performance.
3. Neurological system changes.

4. Skeletal decalcification.
5. Blood constituent changes.
6. Alterations in the expenditure of energy.
7. Modifications in cellular activity caused by radiation.

Processes that should be monitored are listed below:

1. Eating patterns.
2. Daily food consumption content.
3. Biochemical constituents of urine, feces, and vomitus.
4. Crew body mass.
5. Blood constituents.
6. Bone density and size.
7. Chromosome changes.
8. Heart rate and electrical pattern.
9. Blood pressure.
10. Leg circumference.
11. Body temperature.
12. Metabolism.
13. Reflexes.
14. Sleep brain activity.
15. Crew impressions of their own physical health.
16. Radiation levels.

Schedules for the acquisition of this data are not set in this design proposal.

Monitoring of these processes may make it possible in the future to predict problems with radiation and physical degradation, and provide answers to the problems surrounding such phenomena as 'space sickness' and spinal extension.

- **Methods to Combat Physical Changes**

Many methods have been suggested that would curb the effects of weightlessness on humans and, indeed, all animals. Since this mission will experience some time without artificial gravity, more data can be acquired that will contribute to the assessment of these methods. Methods that will be investigated will include the use of exercise equipment, the use of a penguin suit to mechanically simulate gravitational conditions, use of approved pharmaceuticals, and the use of artificial gravity. Of these four methods, little is known about the last since it has never been performed in practice.

It was stated in an ad hoc committee assessment of technological needs performed in 1987 that "little is understood about the long term effects of microgravity on the cardiovascular and musculoskeletal systems." In response to this lack of information, the use of these methods combined with process monitoring as outlined in the previous section will provide valuable data. Also, the effect of the gravity gradient induced by artificial gravity can be investigated.

- **Assessment of Psychological Impact**

This type of investigation is undertaken to understand better the effects of confinement and isolation on the mental health of the crew. Since the duration of this trip is about two years, and because the crew will need to be disciplined for this long period of time, there will

inevitably be problems. For example, there will be no real-time communication with Earth after a certain point in the mission, and this will have an isolatory effect. Steps will be taken to avoid these problems and are elaborated in the Human Factors section of this report.

In terms of acquiring data for this investigation, pre-prepared questionnaires regarding crew impressions of personal health and reactions to environmental conditions should be filled out periodically. Personal logbooks should be kept accurately.

Plant Life Sciences

Because weight savings is an important part of making any trip of this duration economically feasible, an investigation into the way plants grow and react to the environment is necessary. Unlike many shorter missions, plants will be investigated from seed to maturity. Methods will be tested for the growth of common terrestrial crops of small quantities such as hydroponics. There is also a psychological return from this type of scientific investigation since limited quantities of whole, fresh food will be available to the crew.

The effects of light and gravity can be separated in the space environment during times of microgravity on the mission. Because of this, fundamental assessments can be made as to the actions of plants in reaction to each of these phenomena separately rather than in their coupled mode on Earth.

A series of experiments will be conducted that will allow for the assessment of radiation effects on the plants. A control experiment on Earth where radiation is absent will be compared to two sets of experiments on the ship: one in a radiation shielded garden area and another in an unshielded radiation area elsewhere in the ship.

Materials Science, Manufacturing, and On-Board Planetary Science

Part of material science investigation conducted on the ship will be geared towards assessing the purity and usefulness of processed materials obtained through the established plant so that their future role in manned Martian missions can be assessed and conclusions as to their possible use in manufacturing can be garnered. Another part of this section will be directed towards answering questions about both Mars and Phobos. Finally, other elements of manufacturing and fundamental research will be addressed.

The regolith processing plant that will be deposited on Phobos will create many different raw materials and gasses that can be used for fuel and construction. Part of making trips to the Martian system frequent and viable is to demonstrate that those fuels and raw materials can indeed be used. It is thus proposed that the crew create simple construction materials from the processed regolith while on-board the ship. Materials that might be obtained and created include glass, brick made from regolith, and isolated pure metals such as aluminum and iron. Fuels can be burned to assess their properties.

A detailed analysis of unprocessed regolith returned from the surfaces of Phobos and Mars will be conducted to find data on constituents and to seek information regarding the histories of the moon and of the red planet. No mission that is undertaken to the Martian system should miss the opportunity to analyze soil from Mars itself in the presence of human beings. The presence of humans will allow immediate adaptation to discoveries found in the Phobean or Martian soil and this advantage should be exploited to the full extent.

Since this mission is long-duration, other tasks can be performed that might make some scientific and economical sense. First, the growth of mercury iodide, organic, and protein crystals can be undertaken. Each of these crystals can be grown and applied during the trip in some small experiment that would show their potential for use in some application of economic or social worth. For example, mercury iodide crystals can be used as x-ray and gamma ray detectors. During the trip, these crystals can be grown and tested for their potential use in applications that require such detection. The same concept applies to organic crystals which can be used for semiconductors and protein crystals that can be used in more effective and purer pharmaceutical drugs. It might also be possible for these crystals to be grown in bulk and sold to industry for a certain price to both enhance the possibilities for their use and to pay for a certain part of the mission.

Fundamental research into fluid and material behavior in the space environment can also be conducted, but since this area of investigation does not fall under one of the main objectives, most of this experimentation will fall under the objectives of the next section.

Astronomical Observations

The astronomical observations the crew will be conducting will be accomplished through the work station in the experimentation section of the modules. While at the station a crew member will have control, by computer, over the equipment on the stable platform. This will enable the crew to observe both specific objects picked for the mission or personal preferences if a crew member were to use this during leisure time.

For this mission a preliminary list of five specific targets was made. The list includes the following, the Earth on both the outbound and inbound trips, Venus as the swing-by is done, the Sun, and the Martian system again on both the inbound and outbound trips.

The equipment as mentioned above will be located out on the stable platform. It will consist of the following, a telescope which is the main component, and the pointing and focusing system, controlled by computer back in the modules. The telescope will need to be designed and built for the platform, with the specifications that it can image the objects it looks at with different wavelengths. The most favorable ones being in the areas of visible, X-ray, and radio, which will give the effect of having three telescopes all rolled into one.

An extremely important astronomical observation will be the detection of solar flares. The astronauts can be warned of times when solar flares are likely by 'ground based' equipment that currently exists. These warnings are insufficient, so the ship must include a solar observatory with an x-ray imager, magnetograph, coronagraph, data processing system, and a dosimeter.

The predictions from Earth equipment are only useful for telling the astronauts when the conditions are such that the probability of a flare is increased. The Space Environment Services Center (SESC) forecasts flares and warning daily. This information will be useful in keeping the astronauts 'on their toes' and close to their shelters when the solar flare danger is high. The SESC can forecast the approximate solar activity for a 27 day period⁴.

The ship will need a solar observatory because (1) Earth based observations will be unable to see a large, and for this mission, important part of the Sun and (2) light speed time delays in getting the information to the astronauts would be unacceptable. Another option, putting two solar satellites on a course around the Sun would solve (1) but not (2). The following

equipment would enable the mission to predict a solar flare 20 to 30 minutes before it occurs with 95% accuracy:⁵

- X-ray imager, 30-40 cm telescope currently planned by NOAA which 'images' Sun every few minutes. Conceptually similar to Skylab's Apollo telescope mount, but more accurate⁶.
- Magnetograph and hydrogen-alpha scanner because there is a large magnetic flux before a flare and one can see a flare in the hydrogen-alpha spectral line⁷
- Computer capable of processing data from this equipment and activating a warning system to inform the astronauts of the danger that they face.
- Dosimeter that reads radiation levels. Indicates when radiation arrives and last stopgap safety measure in case solar detection, or protection from reactor, fails. It should also be hooked into warning system.

It would be difficult for the equipment to work from a rotating ship, but it should be small enough to fit on the counter-rotating part used for communications. With small telescope filter adjustments, this equipment can also be used to study other bodies of interest (such as Mars, Venus, Phobos) as well as allowing other interesting solar observations. In other words, even were there no danger of solar flares, this equipment would be a useful addition to transit studies on the mission.

After the flare occurs, the astronauts will have 8 (worst-case scenario in Venus flyby) to 30 min (while at Phobos) before radiation levels become dangerous. They will use this time to enter the radiation shelters and prepare for the flare.

Personal Research and Isolated, Unattended Experimentation

There will be some experiments that can be and should be conducted on this mission that do not fall under the above three categories. Some examples of this might include more fundamental research into physical behavior of the universe and the conduction of proofs of relativistic theory. Some of these experiments might be selected for a free flight on the mission. There is also the possibility of creating a program where investigators can be selected for stand alone experimentation much like the 'get-away specials' that fly on the Shuttle in which the investigators pay for a portion of the used space. More of this is discussed in the next section.

Since the duration of the trip is long and the potential psychological impacts are dangerous, it is important that the crew keep interested in the mission. Personal research can be one element in this pursuit. Each crew member will have a personal computer outlet in her or his room which can be used to pursue personal research activity. Since each crew member will be primarily a scientist and not an pilot, this might be a more natural circumstance than a day of rigid duty.

Quarantine Policy

Quarantine policy must be considered in any instance where a vehicle will land on an extraterrestrial surface and return to the Earth either into orbit or back to the surface. In this case, we are concerned with the applications of this policy in relation to soil sample return plans. Presently, NASA policy adheres to the following directive:

The conduct of scientific investigations of possible extraterrestrial life forms, precursors, and remnants must not be jeopardized. In addition, the Earth must be protected from the potential hazard posed by extraterrestrial matter carried by a spacecraft returning from another planet. Therefore, for certain space-mission/target-planet combinations, controls on contamination shall be imposed...

This Mission to Phobos falls under 'Category 5' missions where a contact with an extraterrestrial surface and a sample return is involved. For these instances, the potential for harm to the crew, Moon, and Earth must be assessed in order that the sample and craft can be deemed safe for return. This policy would therefore somewhat govern the actions of the ship on the surface of Phobos itself.

In terms of equipment to be landed on Phobos and Mars, sterilization is no longer necessary but is tolerated in circumstances where its performance has no impact on the payload and/or mission cost.

Phases of Experimentation

The trip is broken up into many sections dependent on where the ship is on the flight trajectory at the particular time in question. Experimentation is slated to begin after trans-Venus injection has been completed in November of 2010, and continue throughout the trip except for periods where navigation and course correction are taking place, or when the plant is being built on Phobos. During the flight, there will be periods of both weightlessness and artificial gravity. Soil recovery and analysis will not occur until success in implanting the plant on Phobos is achieved.

Thus, the mission can be generally broken up into scientific categories with schedules to be planned according to one of three general levels of planning; rigid, semi-adaptive, and adaptive. A *rigid* schedule refers to one where the planned course of experimentation should be followed to the point. A *semi-adaptive* schedule is one which can incorporate some sort of improvisational technique. Most experimentation would fall under this qualification. An *adaptive* schedule is one which is based on the circumstances at hand and created with knowledge that must be gained through this mission. Science sections with their durations and planning level are listed below.

Table 5.1 - Science Category Duration and Planning Schedule

<u>Category</u>	<u>Duration</u>	<u>Planning</u>
Human Life Science	Continuous throughout mission.	semi-adaptive
Plant Life Science	Continuous throughout mission.	semi-adaptive
Materials Science - Fundamental Invest. Phobos.	More intensive during en-route to	rigid
Materials Science - Technological Invest.	Continuous throughout mission.	rigid
Manufacturing - Extraterrestrial Const. Mat.	Return to Earth only.	adaptive
Planetary Science - Phobean and Mars Soil Analysis	Return to Earth only.	semi-adaptive
Isolated Experimentation	Performed according pre-established timeline primarily during en-route to Phobos.	rigid
Personal Research	Performed during free time allotted to crew.	adaptive

Method of Experimentation

Science and experimentation on a mission of multi-year duration will have a different fundamental method by which experiments are performed. Experimentation on platforms such as the Shuttle are preconstructed and performed during a short duration flight with the experiment in a self-contained design. Experimentation in a Mission to Phobos will be more akin to the type of experimentation done in laboratories on Earth where the experiment is performed from start to finish with a set of physically separated equipment. On this mission, the experiment might have to be designed and constructed using various sources. This will necessitate more interaction with the crew, and thus more training for the crew in the conduction of various experiments.

Some examples of this fundamental change can be seen in such activities as the preparation of cell cultures for life sciences analysis or in materials science, the analysis of Phobean regolith for determination of its constituents. Many experiments will be designed from start to finish, conducted, and analyzed during the duration of the flight.

There will also be opportunities to confer with experts in all fields of experimentation for accurate design of adaptive experiments. This type of communication can be real-time during the first stages of the mission, but will become progressively detached as the mission progresses towards the Martian system where a communication lag of about 20 minutes exists.

Not all experimentation that is required will be performed on the craft. Data will be sent back to Earth for further analysis at regular intervals. An example of this type of circumstance might come in the analysis of soil regolith. The crew might be involved with acquiring data and determining constituents, but terrestrial laboratories would be more involved with making extrapolatory conclusions from the acquired data. Thus, the scientific role of the crew is one of data acquisition and primary, obvious conclusions. Secondary conclusions must be relegated to a later time as the crew can only perform so many tasks during the mission.

Equipment and Science Section Layout in Habitation Module

Both habitation modules provide platforms for scientific investigation. One particular section of a module is reserved for the performance of the experimentation outlined above. Below, a detailed description of that section, equipment to be used, and supplemental systems that are necessary for the performance of experiments are discussed.

Devoted Science Section Layout

This section is pictured in *Figure 5.1*:

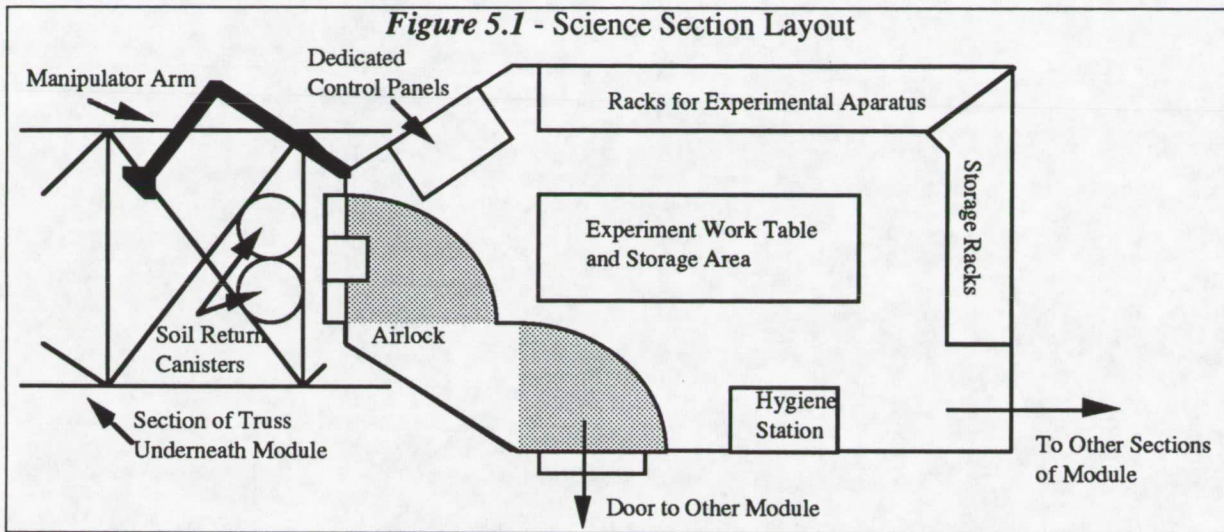

A storage rack located in the food preparation area of this module is not shown in this drawing. This section is devoted to primarily materials science and manufacturing investigations as well as to the get-away special type experiments. The areas that each of the particular bulk equipment take up are listed below:

<u>Bulk Equipment</u>	<u>Floor Area</u>
2 Control Panels	1.16 m ²
4 Experiment Racks	2.59 m ²
Center Experiment Table	3.14 m ²
Storage Racks	1.65 m ²
Extra Storage Rack in Food Preparation Area	2.24 m ²

Equipment in Devoted Science Section

Descriptions of the equipment to be housed in this devoted science section are found below. A visual representation is found in the Human Factors section of the larger report.

- Control Panels and Manipulator Arm

The control panels have three functions. On one control panel, there are facilities to control all equipment outside of the module. This includes both the external manipulator arm and astronomical apparatus on the communication platform. On the other control panel, controls for the operation of exploratory equipment on Phobos and acquisition of data from those sources are located. The control panel that is used to manipulate the arm can be positioned in front of the airlock so that responses to issued commands to the arm can be verified by sight through a window in the airlock. Thus, supported with readout data on velocities, accelerations, and position, accurate positioning can be obtained.

- Airlock Door and Soil Return Canisters

In the airlock door, there will be an opening through which properly stored soil return samples can be brought into the cabin. Individual samples will be sealed from the environment at all times and be stored in the canisters in such a way as to have samples preprepared for experimentation. This is done to avoid habitation module contamination and to allow for the protection of the crew. The soil return canisters are to be built for this method of experimentation. Presently, an allotment for four canisters, each weighing 25 kg (100 kg in total) with payload is called for. Each of these canisters are to be of approximately 3 m³ in volume. These canisters are to be stored in the truss that lies below the airlock door to near the science section in the habitation module and are retrieved through use of the manipulator arm.

- Experiment Racks

The four experimental racks are to hold equipment that will be used to investigate and manufacture items from the soil samples, create crystals and manipulate them, perform fundamental physical research, and house isolated experimentation. The racks are approximately 150 lbs each in structure and support equipment and can hold approximately 1250 lbs of payload each.

Some of these racks will contain computer terminals and communication outlets. For isolated experiments, a set volume and maximum power allotment will be set as design constraints. The experiment must also be completely sealed from the cabin environment for it to be run by the crew autonomously. Thus, a certain part of the racks will be of set volume modules. Other parts of the racks will include large equipment that will help in the conduction of any order of planned experimentation. Some of this equipment will include the following:

1. Furnace.
2. Cooling Bins.
3. Crystal growth apparatus that will allow growth by vapor transport or through solution.
4. Spectrographic analysis equipment (i.e. mass and x-ray florescence).
5. Refrigerator and heater.
6. Optical and electron microscopes and other optical measurement devices.
7. Centrifuge.

- Recording and Data Storage

Video recording equipment will be included in the experimental rack section for use with non-isolated experimentation. Some of the isolated experiments might contain recording devices of their own that are considered separate from the video recording equipment included in the rack.

- Storage Space

A large storage rack section is included in this layout that will serve as a place to put experimental products that are to be reserved for transport back to Earth as well as closed

canister chemicals that are required in the conduction of experiments on-board. Storage sections will also be located above the point of practical reach in artificial gravity conditions within the experiment racks. Further storage is located above the experiment table and space can be allotted below the floor.

- Center Experimental Table

This area will serve as a work area for experiments that are done without the use of external equipment. A maintenance station and preparation station will be housed in the table. The maintenance station will consist of the necessary tools for the electrical and/or mechanical repair of any equipment that is to be used for non-isolated experiments. Thus, an ample supply of adhesives, testing equipment, fasteners, and electrical repair materials will be included. Along with this, provisions for directed lighting, magnification, and item restraint will be included. Variable lighting will also be part of the section so that different experimentation scenarios can be allowed for. The prep station will consist of components for the particular preparation of individual experiments. Thus, measurement apparatus, containers for prepared substances, and washing/disposal facilities will be included. The containers will be sealed so that they will not spill in a microgravity environment or cause a safety hazard

Other Module Sections Used for Scientific Pursuits

Other sections that are used for the acquisition of experimental data include the medical and exercise area for human life sciences, a garden area for plant physiological work, and crew bunks for personal and extended computational work devoted to mission scientific objectives.

Equipment for Medical and Exercise Section

The medical and exercise area is located next to the devoted science center in one of the habitation module. In this area, most of the data acquisition for human physiological and psychological studies will take place. For this purpose, stowable exercise equipment including an exercise bicycle and a rowing machine will be available. For the analysis of vital signs and other body functions, EKG and EEG machines will be installed to monitor heart rate and electrical state, and brain activity respectively. It is also proposed that each crew bunk contain facilities for monitoring brain activity during sleep hours at selected points in the mission. Thermometers, blood pressure measurement equipment, and culture kits should also be provided. Other equipment such as calipers and a Lower Body Negative Pressure Device (LBNPD) or this equivalent should be included to measure changes in body size and fluid distribution respectively.

In addition to this data acquisition equipment, certain imaging and recording devices should be installed. Video and voice recording devices are necessary as are optical and imaging apparatus. Processing equipment for necessary and experimental pharmaceuticals, and for cell cultures is necessitated by the medical facility. Please refer to the habitation module layout for a visual of the medical section.

The Garden and Radiation Sensitive Experimentation

Investigations into plant physiology and possible uses will be conducted in a radiation shielded section of the ship that is called the 'garden'. In this area, selected plants will be grown from seedling to maturity. Vegetables will be harvested and tested as well as used for supplemental food for the crew. Light wavelength and intensity, and nutritional conditions will be completely variable, as will gravitational conditions for seedlings. Gravitational conditions for mature plants will be varied according to the presence of artificial or microgravity. The garden is pictured below.

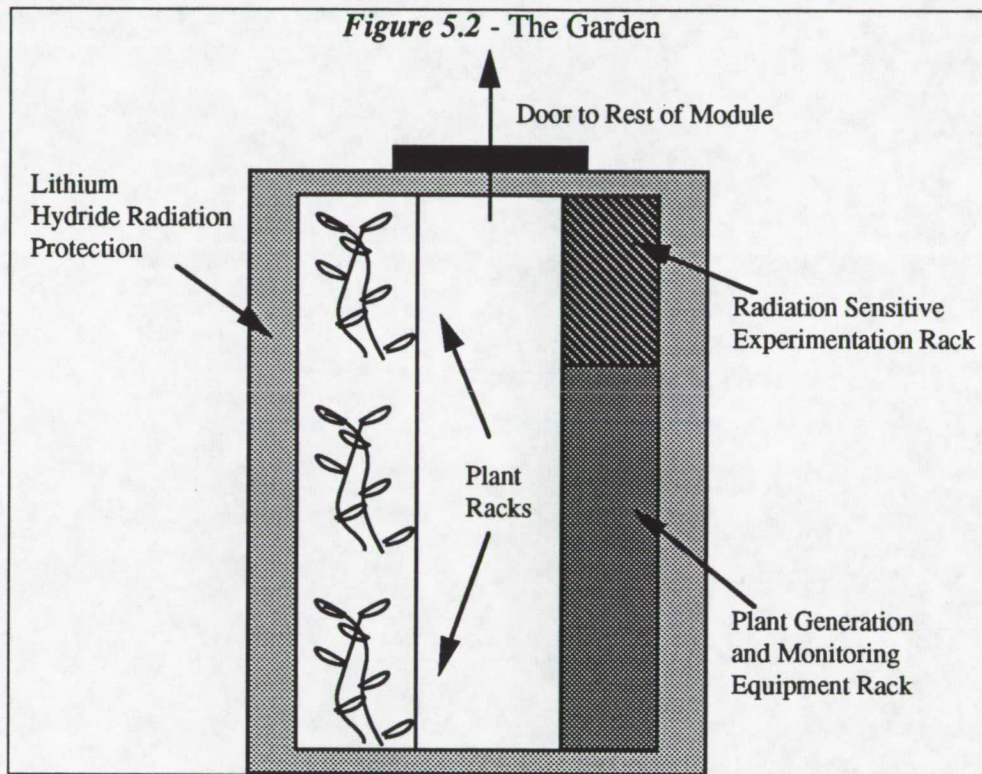

The 'garden' itself will be composed of individual hydroponic chambers that house seedling plants. These chambers should be made useful in both microgravity conditions as well as artificial gravity conditions. Water will be recycled through each chamber individually. Simulated day-night variations should be made possible. Seedlings will be grown from seed in a separate section of the garden area across from the hydroponic chambers. Here, monitoring equipment necessary for the acquisition of data from the garden chamber will be performed. A computer outlet devoted to the construction of the plant environment might be installed in this rack.

The actual makeup of the 'garden' in terms of vegetable and plant selection is found in another section of the larger report.

In this radiation protected zone, radiation sensitive experiments of either isolated experimentation or experimentation that is connected with the satisfaction of the mission scientific objectives will be conducted.

Weight, Power, and Thermal Rejection Requirements

Total weight allowances are listed below for equipment connected with the performance of science on the flight.

<u>Equipment</u>	<u>Weight (metric tons)</u>
Racks, Storage and Experiment	.275
Center Experimental Table	.135
Control Panels	.100
Total Acceptable Payload Includes Support Equipment necessary for conduction of experiments	2.907
Sub-Total	3.417
Plant and Rad. Sensitive Rack	.068
Plant Growth Unit	.165
Total Acceptable Payload	.750
Sub-Total	4.400
Soil Return Samples and Storage Canisters	.100
Grand-Total	4.500

It should be noted that the above total does not include communication or computational facilities, environment maintenance, fire suppression facilities, hygiene stations, safety stations, the airlock, power delivery, or lighting facilities.

Total power requirements have been set at 7 kW electric for average and 10 kW electric maximum. Thermal rejection will total around 9 kW thermal. Power and thermal rejection distribution will split according to the needs of the permanent equipment. As mentioned earlier, isolated experiments will be subject to a set volume, power maximum, and thermal rejection constraints.

Benefits of On-Board Science

In total, the data acquired from this mission will be of immense benefit to the scientific community and provide a demonstrative circumstance that will inspire discovery and further commitment to the permanent presence of humankind in other parts of our solar system.

Phobos Surface Experiments

Although it has been hypothesized that Phobos is a carbonaceous chondrite, very little is known about the composition or the structure of this Martian moon. Further study is necessary to identify the properties of Phobos and the elements present. Surface experiments

are to be conducted in order to determine the exact composition of the surface of Phobos, as well as to return samples to Earth for further study.

Since the presence of water is necessary to carry out the mission as planned, the presence of water in the soil must be positively determined before arrival. In addition, surface mapping and testing of the surface strength of Phobos must be completed.

While on Phobos, further analysis of the soil and the internal structure are to be conducted.

Precursory Mission

Surface Mapping

During the precursory mission, a complete surface map of Phobos will be taken. A high resolution television camera will give a detailed topographic image which can be used to generate three dimensional models of the surface. A long wave radar will also be used to study the topography and the underlying surface structure of Phobos. Mapping of the surface is essential in determining an appropriate landing site. Mass of the camera and the radar is 20 kg and 30 kg respectively.⁸

Water Detection

Another task of the precursory mission is to determine if water is actually present in Phobos' soil. An X-ray fluorescence spectrometer will be used to determine the chemical composition of the soil, looking for water in particular. The X-ray fluorescence spectrometer determines the elements present by recording X-rays emitted when sample is irradiated. Mass: 1.9 kg. Power: 3.5 W. Volume: 76.2 x 152.4 x 254 mm⁹.

Surface Strength

In addition to finding an appropriate landing site and detecting the presence of water, the strength and hardness of the surface must be tested to determine whether the surface is capable of supporting a landed ship. A penetrometer will be placed in the crust to accomplish this. In addition, the penetrometer will study the subsurface structure of Phobos. Equipment included on the penetrometer: TV-camera, gamma-spectrometer (3.5 W, 1.2 kg, 10 kbit/hour), X-ray spectrometer (2 W, .3 kg, 10 kbit/hour), alpha p spectrometer (.5 W, 300 g, 8 kbit/cycle), neutron spectrometer (2 W, .2 kg, 60 bit/hour), accelerometer, thermoprobe, seismometer, magnetometer. Total mass: 44 kg¹⁰.

Phobos Mission

Soil Analysis

While on Phobos, a more complete analysis of soil samples will be carried out.

A neutron spectrometer, which measures the neutrons leaving the surface, will be used to identify the elements present. Mass: 10 kg. Power: 5 W. Volume: 100 mm x 100 mm x 600 mm¹¹.

An X-ray radiometer will be used to determine chemical composition of the soil. Mass: 3.5 kg. Power: 5 W. Information capacity: 19.2Kbits¹².

A thermal emission spectrometer will measure the spectral signature of elements. Power: 20 W¹³.

A gas chromatographer will be used to determine specific gases contained in samples. Mass 18.8 kg. Power: 60W. Volume: 267 x 356 x 406 mm. Information capacity: 26 Mbit¹⁴.

A gamma-ray spectrometer will be included for study of the surface and composition of rocks. Mass: 14 kg. Power: 18W. Information Capacity: 37.4 Kbits¹⁵.

Internal Structure

The inner structure of Phobos will also be studied to gain further insight on its formation history.

Penetrometers identical or very similar to those used on the precursory mission will be placed in previously unexplored regions to determine the homogeneity of the internal structure. While the primary function of the penetrometer on the precursory mission was to determine the strength of the surface, the instrument is capable of taking photographs and analyzing samples below the surface.

Seismometers are used to study inhomogeneities of the inner structure by measuring surface tremors after an impact. Mass: .3 kg. Power: .1 mW¹⁶.

Sample Collection

Soil samples for return to Earth should be retrieved manually since humans will choose less arbitrary samples than any automated retrieval system. Soil sample will be more interesting and helpful in determining properties of Phobos. The hand tools used to obtain soil samples include hammers, chisels, rakes, sieves, tongs, and sample bags. Total mass:15 kg, Total volume:45x45x45 cm. Containers for soil samples must also be included. Mass: 8.2 kg, Volume: 35x35x20 cm¹⁷.

Other Studies

A still picture camera with 3 axis pivot can be used for detailed photographs of the surface near the landing site. Mass: 1.2 kg. Power: 20 W. Information capacity: 26 Mbits¹⁸.

A visible and infrared spectrometer should be included for mapping of surface temperature and study of how Phobos' surface absorbs or reflects heat. Mass: 25.5 kg¹⁹.

A gravitometer will be used to measure the local gravity field. Mass: 6.8 kg. Volume:11.1cm dia x 21.3 cm²⁰.

Mars Surface Experiments

Mars Rover

Mars has been investigated by Orbiting, Mariner, and Viking lander missions. Our objective is to continue the investigations of these missions and also explore new areas. The objective is to acquire more information about Mars in order to facilitate a future manned Martian landing. The rover is to cover as much of the Martian surface as possible while being controlled from the Phobos lander, the Wolverine, and then the controls will be turned over to an Earth control station for further investigation when the lander departs.

In the precursory missions, two remote controlled rovers will be landed on the Martian surface. These Rovers will investigate and monitor specific characteristics of each hemisphere. The Rover will be equipped with automated instruments similar to those used for the Phobos studies.

Atmosphere

Atmospheric conditions will be investigated. Experiments will determine the composition of the atmosphere, the presence of water, and the variations of these materials that occur during the Martian seasons. The Martian planet is supposed to have a active weather system that includes the presence of a continual wind of 35-50 km/hr that can become as large as 150 km/hr for as long as one quarter of the Martian year (6 Earth months). The winds interact with the cloud system and during the periods of high winds, dust storms are created. All these previous determinations will be verified and further investigation done.

Soil

Another area of interest is the Martian soil. Its composition and concentration of water will be determined in addition to the variation of these characteristics within different regions. The formation of the planets crust will be investigated in terms of Tectonics, Granitization, the effect and occurrence of meteorite impact, and the characteristics that lead it to be categorized as a lunar or terrestrial formation. Also of interest is the history of the planet, its evolution, and development. This would entail determination of the planets core and layers, and surface studies.

Surface Studies

Surface studies will map the Martian gravity and magnetic fields, the surface structure, degree of oxidation, and the variation of radiation intensity. This information will also be compared with information about the activity of the sun and the Martian climate to look for possible connections.

Biology

The investigation of the presence or past presence of life on Mars is also a priority. Biological Studies will be done looking for biogenic formations, and life activity. Life activity includes forms of life we know of and also forms that do not exist on Earth. Investigations will also look for fossils of plants, animals, and other organisms that indicate past activity.

Recover Viking Lander

Last in this list of goals is the recovery of the Viking lander that has been on the Martian surface for almost sixteen Earth years. Contact with the lander was lost on November 5, 1982. The interest in its recovery is to see how the exterior and mechanical structures have deteriorated and how the surface has changed since its last transmission to Earth.

Precursory Missions

There must be two precursory missions. The first to occur no later than 1999 (suggested year 1997) and the second to occur by 2007 (suggested year 2005). The first mission will be a viability study of Phobos, and the second mission will bring the necessary equipment to set up the processing plant. Both missions will be launched on the least expensive available trajectory.

Viability Mission

We are working under the assumption that Phobos regolith is composed of useful material such as hydrogen, oxygen, etc, which can be extracted by our processing plant. If this proves false, we will spend an enormous amount of money to send the plant to a useless chunk of rock. Thus, the need for a mission to determine if Project APEX is truly viable. A probe will be sent on the mission to answer two questions: of what is the soil composed and is the surface suitable for a plant? In order to answer these questions, the probe will contain the following equipment:

- TV equipment and spectrometer for surface mapping
- X-rays to make surface distribution maps of oxygen, hydrogen, silicon, and radioactive materials
- cosmic ray emitter to map surface water content
- magnetic field detector
- seismometer
- penetrometer to determine soil strength
- gravimeter

If budget constraints cause the cost of the probe to be cut, the bare minimum acceptable in terms of equipment would be the penetrometer and the equipment to study soil composition. The experimentation performed in the precursory mission is discussed in greater detail in 4.3.1.

Preparatory Mission

The entire processing plant would be launched to Phobos on the second mission. It would be left in a stable orbit, trailing Phobos around Mars. The plant would have intermittent communication with controllers on Earth to assure that it is not damaged and to allow it to some of the extra fuel it brought for the need to be maneuvered into stable orbit if the need occurs. The shipment would contain the plant which would include two reactors, the materials for the gas dynamic pipeline, the storage tanks, the excavation equipment, the heater, and all other equipment which is necessary for the processing plant to operate and which is discussed in detail in the following section.

Processing Facility Overview

The major goal of the APEX mission is to successfully reach the moon Phobos and set up a processing facility on the moon's surface. This facility will extract water from the Regolith (soil) and turn it into cryogenic fuels (liquid Oxygen and Hydrogen). This fuel will not be used for the return trip, but for later missions.

Due to the broad nature of the APEX project, a limited amount of personell were devoted to the research and design of the processing plant. For this reason, only a overview of the procedures and designs are given. Because the focus of the project was on the APEX spacecraft, the processing facility details are not elaborated.

The Need for a Processing Facility on Phobos

We have only begun to touch the benefits from the industrialization of space. The vast potential that lies beyond the bounds of Earth can overwhelm even the most imaginative. This potential will be turned into reality only through an active space program which will tap mankind's unique and progressive ideas. The industrialization of space, as with any project, must be accomplished in stages. The first step is to create a permanent presence in Earth orbit, then take our first steps beyond its immediate vicinity. Eventually, perhaps, we will be able to walk through the solar system, and then scamper among the stars. But man must crawl and learn to walk before he can run. The establishment of a permanent industrial facility on Phobos is the first step to go beyond Earth.

Transportation Node for Interplanetary Travel

Careful planning of the initial steps into the solar system must be done to facilitate future expansion through the solar system. Phobos serves as an ideal outpost for interplanetary travel. Oxygen, hydrogen, and possibly food could be readily available for future expeditions to Mars, Jupiter, Saturn and beyond. These expeditions need carry only enough supplies from Earth to reach the low gravity environment of Phobos. Phobos is free from complications such as atmospheric entry or deep gravity well entry and escape, making it a crucial node for an interplanetary transportation system for either missions outbound from Earth or inbound to Earth.

Support for Earth and Mars Missions

Phobos is ultimately capable of producing 80 cubic miles of H₂O from suitable mining regions if it is assumed to be a Type 1 carbonaceous chondrite body. Oxygen/hydrogen fuel requirements for the next 40 to 50 years in space could conceivably be supported by a single cubic mile of water. Oxygen and hydrogen are not the only resources found on carbonaceous chondrite bodies, others such as aluminum, magnesium, silicon, iron, and nickel are also found. A Phobos base could produce mechanical goods such as material fibers, glass, silicon chips, ceramics, magnets and space truss elements to support all types of space activities with such readily available resources.

The colonization of Mars and the moon could be supported by an extensive industrial facility on Phobos with only periodic manned support. The supply problems associated with

mankind's initial steps beyond Earth could be solved with a semi-autonomous industrial base on Phobos with minimal manned support.

Design Concepts

Design efforts focused on presenting solutions to problems caused by the unique milli-g environment found on Phobos. The design concept for the processing facility on Phobos will cover the following areas:

- materials processing and production
- macroscopic view of base configuration
- mining procedures

Assumptions

A set of assumptions has been established to define the boundaries for the Phobos processing facility design effort. The assumptions presented in this section apply to appropriate areas of the design.

Precursory Mission To Phobos

We assumed a precursory mission has revealed Phobos to be a Type 1 carbonaceous chondrite asteroid with a 20% by mass composition of water. A detailed surveillance will also confirm Stickney Crater as the primary Phobos landing site. Stickney Crater will be assumed to be solid rock covered by as much as 200 meters of regolith. Without these assumptions, our mission to set up the processing plant would be futile.

Transportation to Mars

Phobos base transportation from Earth to Phobos, as a whole unit or in sections, will be accomplished before the APEX mission. The base will be in the same orbit as Phobos around when we arrive. Once our mission arrives to Mars, the plant will be transported to the surface of Stickney crater by the crew of the Wolverine.

Processing Facility

Figure 5.3 shows the basic layout of the processing facility. It is composed of five main parts:

- Power
- Excavation of Regolith
- Transportation of Regolith to Facility
- Processing of Regolith
- Storage of Resources

The plant will be set up near one of the walls that make up Stickney crater. This will allow for maximum radiation shielding for the plant given by the natural surroundings. It is estimated that the facility could be constructed on Phobos in 40 days. This figure assumes that there is 20 personnel-hours per day devoted to the assembly of the processing plant.

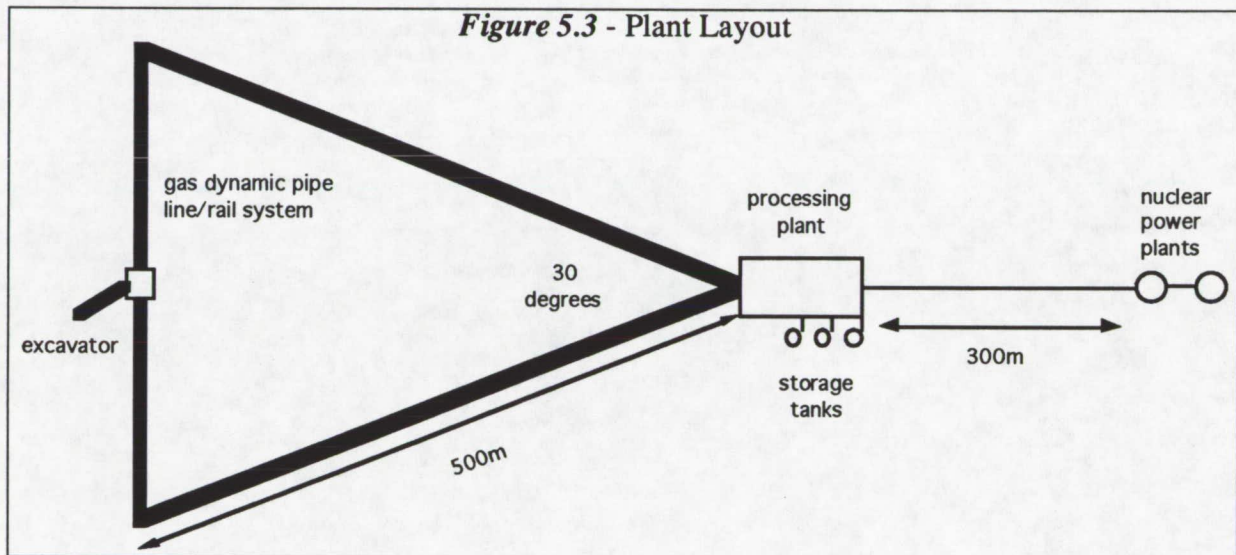

Power

An estimate for power consumption for the water extraction plant was placed near one megawatt. This was based on a estimated 400 kW for the oven to bring the regolith up to 700° C and about 200 kW for electrolysis. The other 400 kW will be needed for blowers, magnetic separator, crusher, etc.

SP-100 Nuclear Reactor

This 1 MW will be produced by two nuclear reactors. *Figure 5.4* is a diagram of a SP-100 550 kW reactor. The SP-100 is a self-contained unit complete with all necessary equipment for immediate operation.

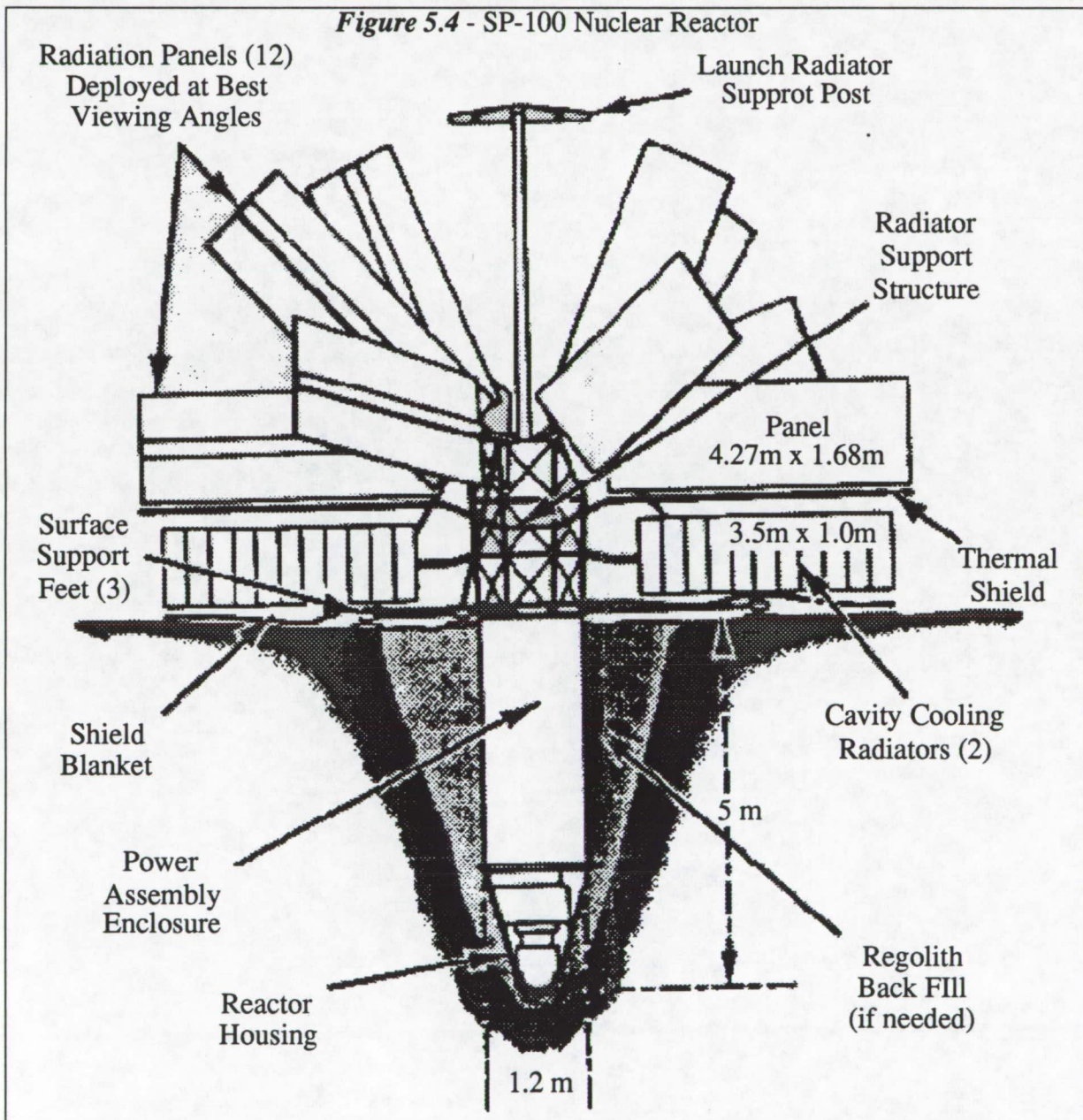

LEVPU

The two reactors shown in *Figure 5.3* will be installed using a LEVPU. The LEVPU is a modified version of a Lunar core sampler used in the Apollo 15 and 17 missions. The LEVPU digs a cylindrical hole and places a casing around it to prevent the hole from caving in. The nuclear reactor is then robotically placed in the casing. The Regolith acts as radiation shielding for the reactors. This allows human operations to occur within 300 m of the reactors. More detailed study on the components of the process are needed to produce more precise estimates.

Excavation and Transportation

The excavation of the Regolith from the surface of Phobos will be accomplished by the excavator like the one illustrated in *Figure 5.5*. Because operation of the plant will take place in a milli-g environment raises two concerns:

- How to scoop the Regolith up and hold it with out the assistance of gravity.
- How to keep the dust in the mining area down to a minimum.

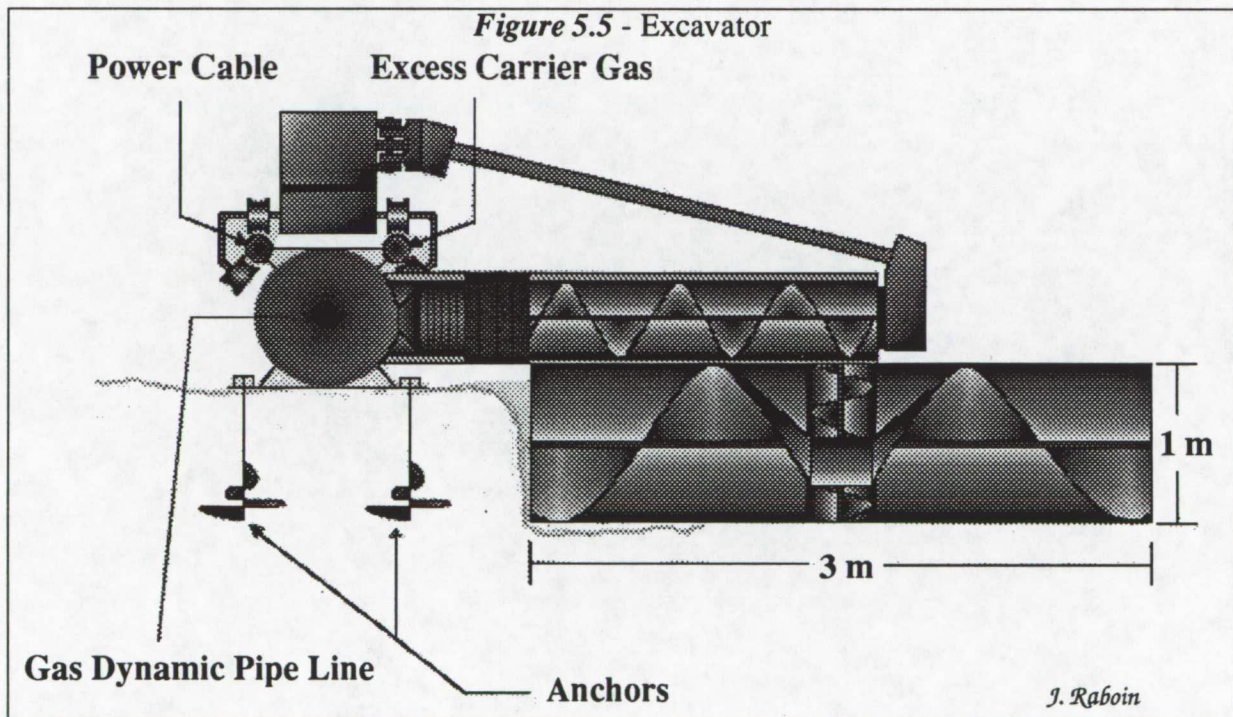

The auger system on the excavation unit swings in an arc, digging up a 3 m x 1 m path of regolith, producing a 4 kg/sec throughput. This auger system does not depend on gravity, the force of the forward motion and the motion auger will transfer the regolith to the pipe line in the milli-g environment. The main auger is partially enclosed while the other two smaller transfer augers are totally enclosed. This will allow for an almost completely dust-free excavation process. The excavation unit will obtain its power through contacts built into the rail system which it rides on. The excavator begins at one end of the lateral section of the pipe line system, excavating the first arc path of Regolith. After completing the arc, the excavator moves to the access hole built into the next section of pipe. The process is repeated until the excavator reaches the end of the lateral length of the pipe way. The pipe

laying device then picks up the excavator and moves it to the next lateral section of the pipe system. An overview of this process is depicted in *Figure 5.6*.

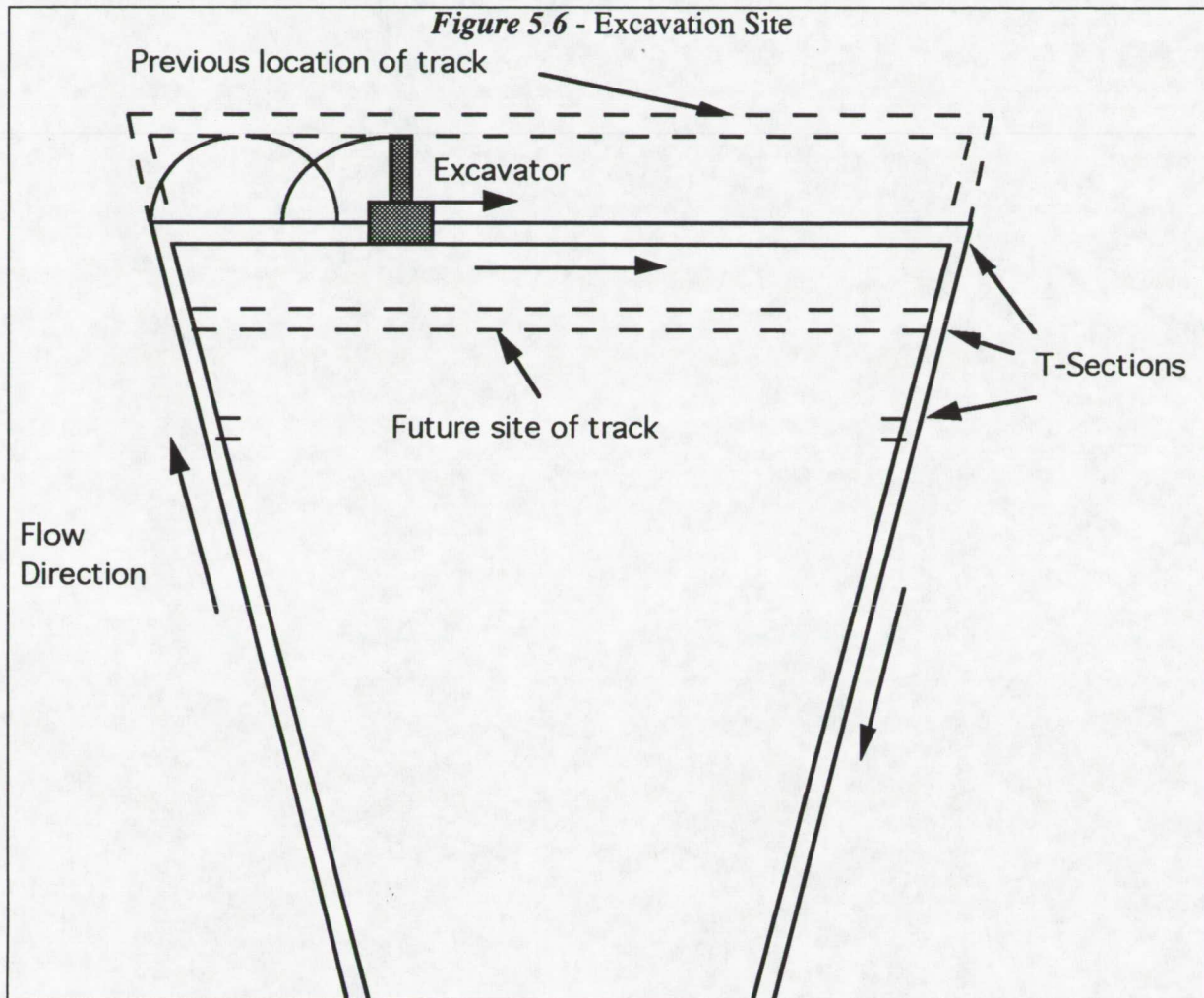

Transportation of Regolith to Facility

Once the auger system has excavated the regolith, it transfers it into a gas dynamic pipe line. The pipe line itself doubles as the transportation device for the regolith and the rail system in which the excavator and the pipe laying machine ride on. The gas dynamic pipe line will be deployed by an automated robotic system which will ride on the rails after the first few sections of pipe are laid and anchored in place by hand. One of the two rails contains the power cables to run the excavator and the other carries excess carrier gas to replenish the system if leakage occurs. Because we are working in a milli-g environment, the regolith can be carried down the pipe line using a carrier gas such as CO_2 . The CO_2 gas will only have to operate at a few milli-bars of pressure in order to transfer the regolith down the pipe. Each 9 m section of pipe will be connected with a T-section shown in *Figure 5.6*. The bottom surface of the T-section will be porous, like a "shuffle board", in which carrier gas can be injected to offset the small downward drift of the regolith due to the milli-gravity. The T-section will also contain a close-off door to either seal off the side exit or the downward flow. All the T-sections except the ones at the end of the radial lengths will have the side exit sealed off during operation. The two end T-sections will have the downward flow sealed off

to redirect the flow down the lateral section of the pipe line to the excavator and back down the other radial length.

Processing of Regolith

*Figure 5.7*²¹ presents a processing chart for water and fuel production. An explanation will now be given for each of its components, starting with the crusher.

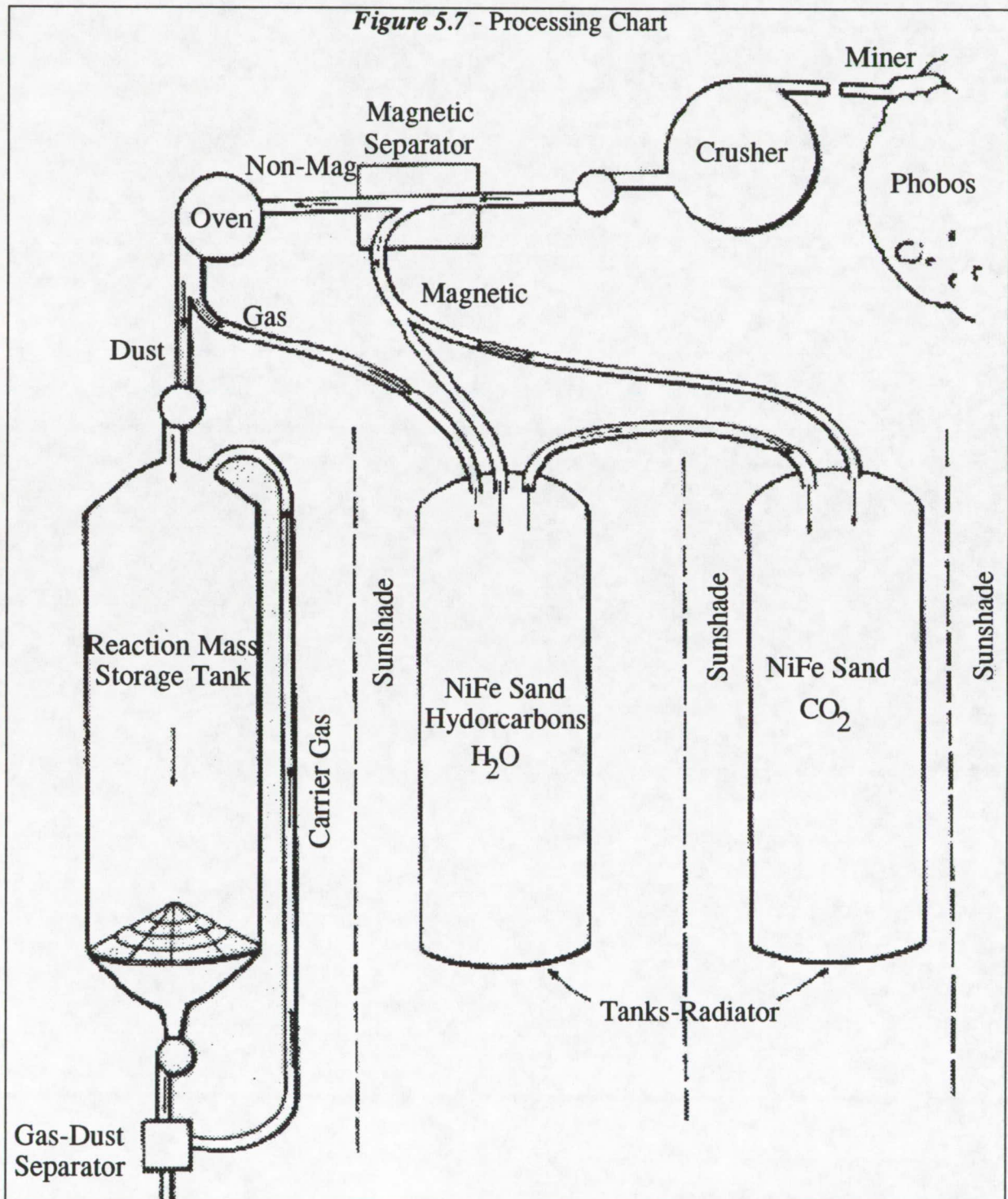

The Crusher

The process starts with the mined regolith entering a crusher which physically breaks down the regolith in order to make magnetic separation easier. The transport of the crushed regolith to other stages of the process is provided by gas dynamic blowers, using a carrier gas such as carbon dioxide under small pressures, about one millibar, to move the regolith particles. *Figure 5.8* shows what the outer view of the crusher might look like. The regolith passes through a series of rocker jaws to break down the large, rough chunks, and then roller type crushers are used to reduce the regolith further to particles about .2 mm in diameter.

Figure 5.8 - Regolith Crusher

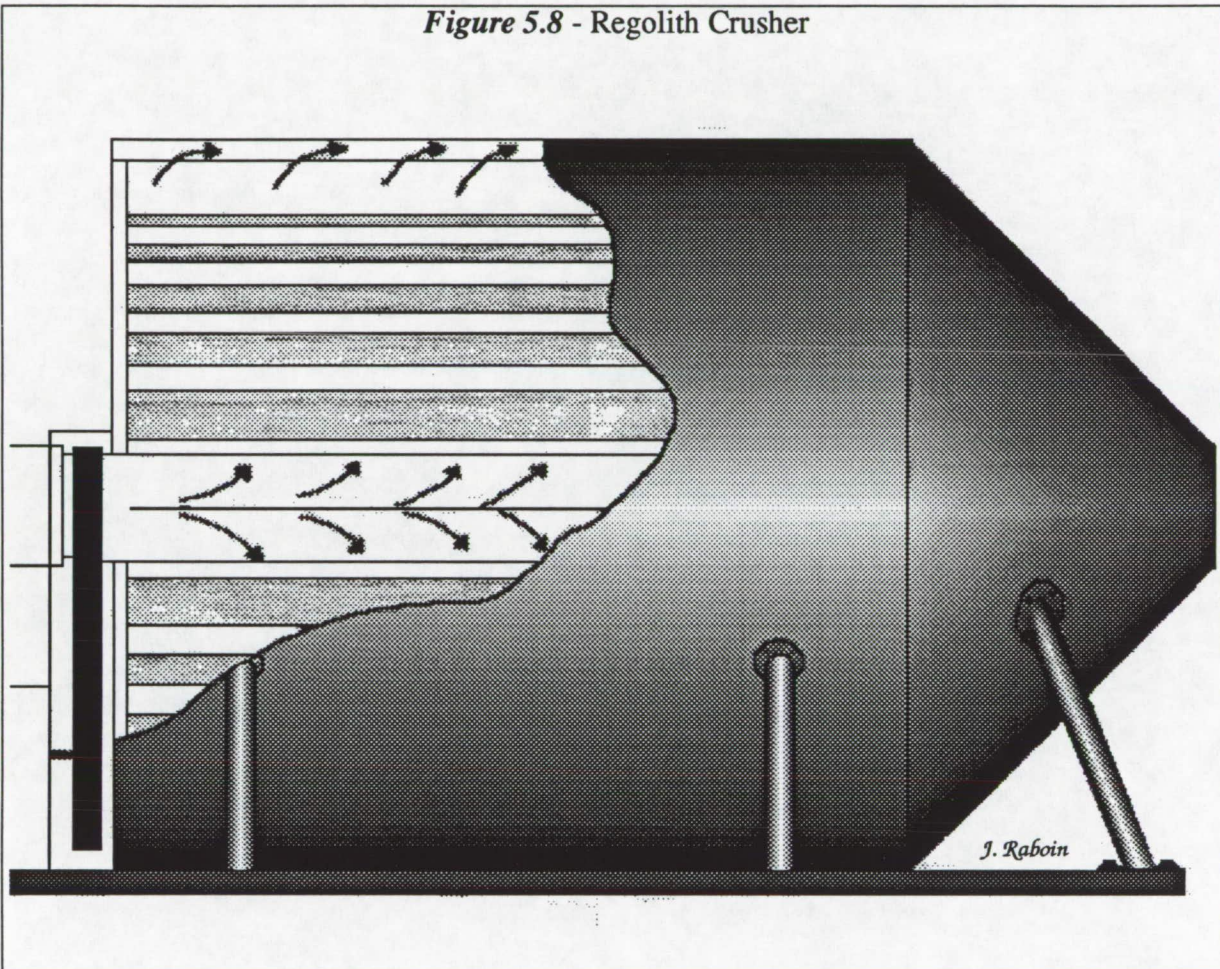

Magnetic Separator

The regolith is transported from the crusher to a magnetic separator which separates out the ferrous compounds (mostly FeO and FeS). *Figure 5.9*²² depicts what a magnetic separator might look like.

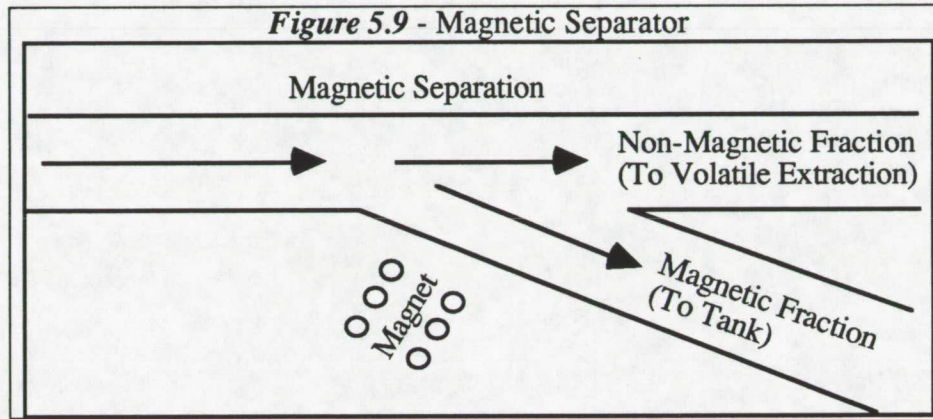

It uses strong magnetic coils to attract the metallic portion of the Regolith toward one side of the flow which then can be separated from the non-metallic portion. The magnetic portion is stored for future processing and the non-magnetic compounds are sent to the oven.

Oven

The oven shown in *Figure 5.10* utilizes the electrical power from the nuclear reactor to heat up the non-ferrous regolith to approximately 700° C. The fine particle Regolith passes through a series of V-gutters to evenly distribute the flow regolith to obtain maximum heat conduction. The regolith flows through the duct, past the heater core elements which causes the chondrite to release water vapor and other volatile gases.

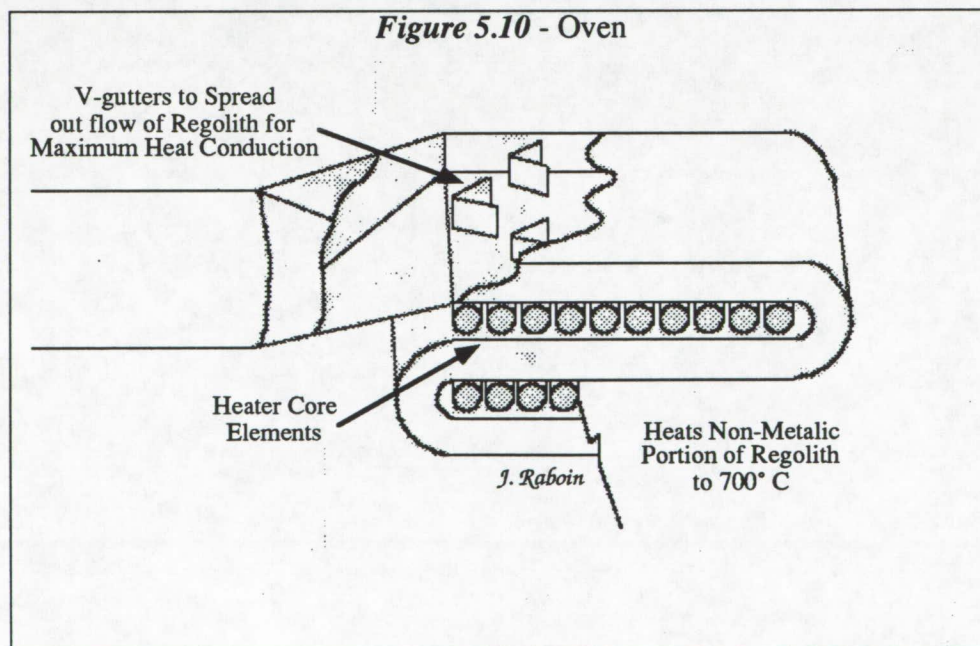

Cyclonic Separation

The dust and gas are then separated by a cyclonic separator like the one shown in *Figure 5.11*²³. The cyclonic separator uses centrifugal forces to force the dust particles up against the outer surface of the pipe. The dust can then be diverted to a separate storage tank. Both the dust and gas are stored in storage facilities for gas extraction and condensation.

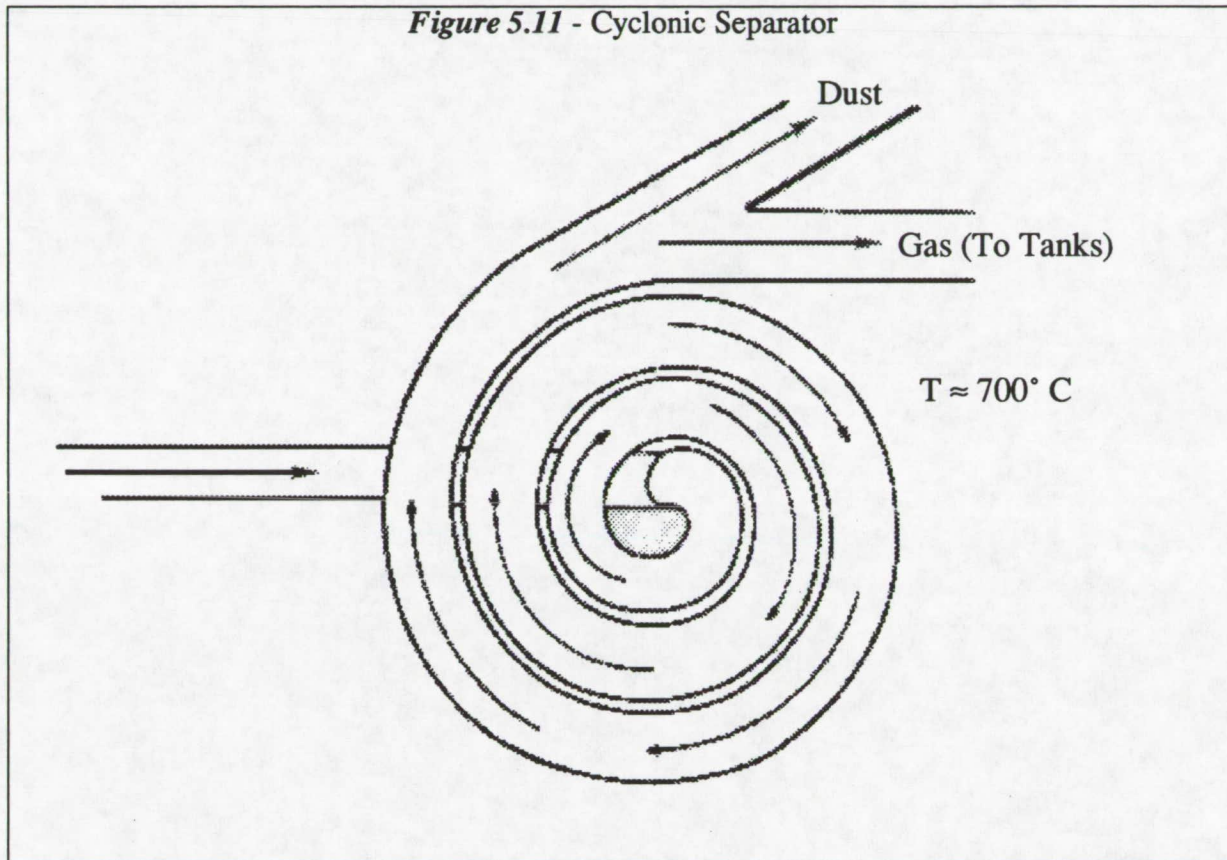

Storage of Obtainable Resources

Storage for water and cryogenics is necessary after production. The need for mass storage is necessary to accommodate the production capacity of the plant. It is also necessary to have a plentiful supply of fuel ready for refueling of future missions.

Usage of Expended Fuel Tanks

A cost effective solution to this problem is to use the expended fuel tanks from the precursory mission of the plant and the empty tanks from the APEX mission. These tanks could accommodate cryogenic fuel and water for a longer duration. They will be transported down to the surface by the maneuvering pod and buried to protect against solar radiation.

Other means of storage may be used like collapsible rubber tanks. These tanks could be easily transported while taking up little room. These tanks could be inflated and then buried or directed toward the dark sky for a heat sink.

Multiple Temperature Tanks

Gases such as sulfur dioxide, hydrogen sulfide, carbon monoxide, carbon dioxide, and methane will also be released during the production of water. Therefore, condensers are needed to separate the water vapor from the carbon compound gases. The use of multiple tanks operating at different temperatures can take advantage of the unique vapor point of each gas when separating them. *Figure 5.12*²⁴ depicts such a set up in the separation of volatile gas from one another.

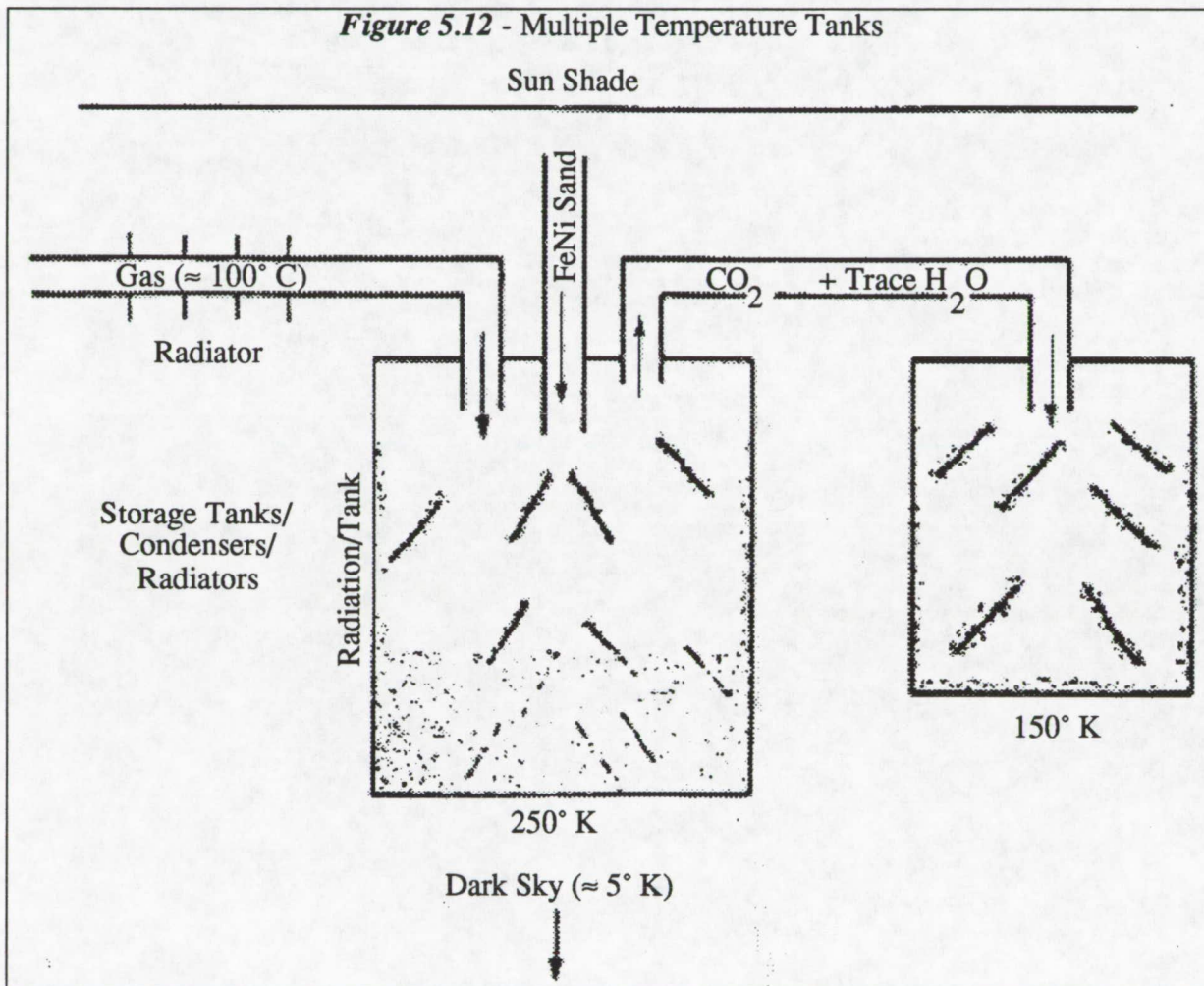

The condensed water will still contain amounts of dissolved H₂S and SO₂ which will be filtered out by an activated carbon bed filter (two filters will be required, one in operation, the other in a regeneration cycle). The water, now purified, can be placed in storage.

Production Capability

As stated earlier, the throughput of the processing facility is 4 kg/sec of raw regolith. Assuming Phobos is 20% water by weight and the extraction process of the water is 50% efficient, the plant will be able to produce:

$$4 \frac{\text{kg(regolith)}}{\text{sec}} \times 2054 \frac{\text{kg(water)}}{\text{kg(regolith)}} \times .50 = 4108 \frac{\text{kg(water)}}{\text{sec}} = 35493 \frac{\text{kg(water)}}{\text{day}}$$

An electrolysis unit can be used to produce the following reaction to create LH₂ and LO₂.

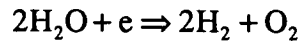

Assuming this process is 90% efficient, the facility can conceivably produce:

$$35493 \frac{\text{kg(water)}}{\text{day}} \times \frac{2}{18} (\% \text{H}_2) \times .90 = 3549 \frac{\text{kg(H}_2)}{\text{day}}$$

$$35493 \frac{\text{kg(water)}}{\text{day}} \times \frac{16}{18} (\% \text{O}_2) \times .90 = 28395 \frac{\text{kg(O}_2)}{\text{day}}$$

With water available, methane can also be produced as a fuel. The carbon dioxide can be isolated from the volatile gases that will be released by the oven and condensed using the distinct vapor point of the gas. A system devised by Ash, Dowler, and Varsi (Ash, *et al.* 1978) will then combine the liquefied gas with water using the following reaction:

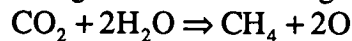

Methane should be valuable to a Lunar base because of the scarcity of hydrogen on the Moon. Transporting methane instead of water to the Moon would be more economical because the oxygen that is in water would be needlessly transported because oxygen is relatively plentiful there. Also, because of the low surface gravity of Phobos and the delta V required to reach Earth, it is actually more cost effective to produce fuel on Phobos and send it to Earth orbit than it is to produce on Earth and lift it into orbit.

Planetary Science References

- ¹ The Cost of Landing Man on Mars, Humboldt C. Mandell Jr.
- ² Spacelab - An International Success Story, Douglas R. Lord.
- ³ Opening the Space Frontier: The Next 20 Years.
- ⁴ *Manned Mars Mission Solar Physics: Solar Energetic Particle Prediction and Warning*, (n87-17767), S.T. Sues, Marshall Space Flight Center.
- ⁵ *Solar Particle Event Predictions for Manned Mars Missions*, (n87-17779), Gary Heckman, U.S. Department of Commerce
- ⁶ *Solar Particle Event Predictions for Manned Mars Missions*, (n87-17779), Gary Heckman, U.S. Department of Commerce
- ⁷ **Race to Mars: The Mars Flight Atlas**, Miles and Booth, 1988.
- ⁸ Surkov, Yuri, *Exploration of Terrestrial Planets from Spacecraft*, Ellis Horwood Ltd, 1990.
- ⁹ Surkov, Yuri, *Exploration of Terrestrial Planets from Spacecraft*, Ellis Horwood Ltd, 1990.
- ¹⁰ Space Research Institute, USSR Academy of Sciences, Mars - 94 *Unmanned Spacecraft Mission to Mars*, March 1991.
- ¹¹ Space Research Institute, USSR Academy of Sciences, Mars - 94 *Unmanned Spacecraft Mission to Mars*, March 1991.
- ¹² Miles, Frank, Booth, Nicholas, *Race to Mars*, New York: Harper and Row, 1988.
- ¹³ Space Research Institute, USSR Academy of Sciences, Mars - 94 *Unmanned Spacecraft Mission to Mars*, March 1991.
- ¹⁴ Miles, Frank, Booth, Nicholas, *Race to Mars*, New York: Harper and Row, 1988.
- ¹⁵ Miles, Frank, Booth, Nicholas, *Race to Mars*, New York: Harper and Row, 1988.
- ¹⁶ Fuchs, Robert A., *Manned Lunar Surface Program*, Hughes Aircraft Company, 1966.
- ¹⁷ Fuchs, Robert A., *Manned Lunar Surface Program*, Hughes Aircraft Company, 1966.
- ¹⁸ Surkov, Yuri, *Exploration of Terrestrial Planets from Spacecraft*, Ellis Horwood Ltd, 1990.
- ¹⁹ Surkov, Yuri, *Exploration of Terrestrial Planets from Spacecraft*, Ellis Horwood Ltd, 1990.
- ²⁰ Miles, Frank, Booth, Nicholas, *Race to Mars*, New York: Harper and Row, 1988.
- ²¹ O'Leary, Brian, **Space Industrialization Volume I**, CRC Press, Boca Raton, 1982, p. 142.
- ²² O'Leary, Brian, **Space Industrialization Volume I**, CRC Press, Boca Raton, 1982, p. 143.
- ²³ O'Leary, Brian, **Space Industrialization Volume I**, CRC Press, Boca Raton, 1982, p. 144.
- ²⁴ O'Leary, Brian, **Space Industrialization Volume I**, CRC Press, Boca Raton, 1982, p. 145.

~~134-136~~ INTENTIONALLY BLANK

Chapter 6

Propulsion

6.0 Summary

6.1 Propulsion Systems

6.2 Engine Characteristics

6.3 Reaction Control System

6.4 System Configuration

6.5 Mission Plan

6.6 Tanks

6.7 Safety

Summary

The primary responsibility of the propulsion group has been to determine the “best” mode of propulsion for our proposed mission. This includes a comparison of various systems (chemical, nuclear electric, nuclear thermal) and consideration of the feasibility of each. For example, could a given system be developed to the desired specifications in the time available before mission launch (i.e., would development of a 1000 second Isp be realistic)? Once the type of propulsion system was chosen (nuclear thermal), specific components and characteristics were considered. A general outline of the system to be used included consideration of the following: engine/reactor characteristics, radiation concerns, nozzle sizes, shielding, configuration of components, and an analysis of the number of engines required to reduce g-losses. Secondary considerations included the calculation of required fuel volumes, a brief discussion of zero-g fuel management, tank baffling, engine gimbaling, and engine detachment. The following chapter summarizes these questions and outlines the system which was chosen to propel this mission.

Propulsion Systems

Propulsion Method Selection

The purpose of the propulsion subgroup of Project Apex has been to find a means of propulsion that will accomplish the needs of the mission. Upon the arrival of the launch date, there will be a launch window of about twelve days to achieve the necessary ΔV . Therefore the propulsion system necessary for this mission must accelerate the ship through its ΔV in this time. If something should go wrong during the initial burn, there must be enough time to make corrections. This requires that the burn be accomplished in less than twelve days.

The propulsion system must be as efficient as possible. The more efficient the system becomes, the less fuel is necessary to complete the mission. The candidate propulsion system must also provide enough thrust to accelerate in the given time frame.

Propulsion Candidates

Candidates that met the requirements were chemical and nuclear thermal rockets. These are the only systems that provide enough thrust to accelerate in the given launch window times. All other systems have thrust to weight ratios which are too low. *Table 6.1* gives typical values for the performance of various types of propulsion methods.¹

It has been determined that a thrust to weight ratio of 0.1 to 0.2 is required to escape from low Earth orbit (LEO) in a reasonable amount of time. In *Table 6.1* it can be seen that only chemical and nuclear thermal rockets can provide thrust to weight ratios in this range. The amount of mass the alternative systems would require to provide the same amount of thrust as chemical and nuclear thermal propulsion would be prohibitive. The power requirement to achieve thrust at this level also becomes prohibitive.

The Isp available from nuclear thermal rockets is at least twice as high as the best Isp available from chemical rockets. The best performance from chemical rockets comes from using liquid oxygen/liquid hydrogen or liquid fluorine/liquid hydrogen systems. The best possible specific impulse for these systems is under 500 seconds. The specific impulse available from nuclear

thermal rockets with present technology is 1000 seconds. This reduces the amount of fuel necessary for the trip significantly.

Table 6.1 - Comparison of Typical Propulsion System Performances

Rocket Method	Isp (seconds)	Thrust/Weight	Mass (kg) Necessary for 1,000,000 N Thrust
Chemical	435	50	1350
Nuclear Thermal	1000	5	20400
Electrothermal	1200	.01	10 Million
Magnetoplasm	8000	.001	102 Million
Ion/Electrostatic	5000	.001	102 Million
Solar Thermal	1000	.01	10 Million

Using chemical propulsion requires a base fuel fraction of 98% or more of the mission mass. This percentage goes up with inclusion of fuel for boil off compensation. Using nuclear thermal propulsion reduces the base fuel fraction to about 85% of the mission mass. This fraction also rises with the inclusion of boil off compensation fuel. These figures are based on a total mission ΔV of 15.1 kilometers per second.

Several assumptions are made regarding the design and operation of the nuclear thermal rockets. At this point it has been shown that operating temperatures in the range of 3000 Kelvins are attainable. With the appropriate nozzle design and fuel flow rate this equates to a specific impulse of 1000 seconds. *Table 6.2* will summarize technology available at this date.^{2 3}

Table 6.2 - Nuclear Thermal Rockets

	NERVA NRX	NERVA	Rocketdyne	Proposed	Phillips PBR
Flow Cycle	Hot Bleed	Topping	Topping	Topping	Topping
Power (MW)	1500	1500	1500	1500	40/liter
Temp. (K)	2500	2700	3100	3100	3000
Thrust (kg)	34,000	34,000	34,000	34,000	34,000
Isp (sec)	825	925	1020	1040	1000
Mass (kg)	5890	5824	6563	7460	1125
T/W	5.77	5.84	5.18	4.56	30
Nuclear Fuel	UC ₂ /C	Composite	Carbide	Carbide	Carbide
Fuel	LH ₂	LH ₂	LH ₂	LH ₂	LH ₂

The NERVA program was terminated in 1972. The data available suggest that the performance provided by the NERVA engines would be a minimum limit with present technology. We expect that future designs will have an operating temperature greater than 3000 K and an Isp greater than 1000 seconds.

Fuel Selection

The characteristics of various fuels have been compared to find the best fuel for this mission. The most important consideration in the selection of a fuel is the Isp available. Another important consideration in the selection of a fuel is storage.

The major obstacle to storage of fuel is boil off. Fuels such as liquid hydrogen have tendencies to leak out and boil away. This complicates the design of storage tanks. Tanks must be heavily insulated to prevent heat from conducting into the tank and causing accelerated boil off. Boil off can be dangerous because it can cause tanks to rupture. Gaseous fuel that is not lost to leakage cannot be used because it cannot be pumped to the engines.

Several fuel types were considered for this mission. *Table 6.3* shows the results of the comparisons.⁴ CO₂, Water, Methane, CO, N₂, Argon, and Hydrogen were the fuels considered.

The Isp of Hydrogen is significantly larger than any other fuel. The difference between the specific impulses of hydrogen and methane is large enough that boil off becomes a minor problem. The fuel fraction penalty due to boil off of hydrogen is not large enough to make the use of methane attractive. Liquid hydrogen has been chosen for these reasons.

Table 6.3 - Fuel Comparisons

Reactor Temp.	Ideal Specific Impulse of Propellants					
	CO ₂	H ₂ O	CH ₄	CO/N ₂	Ar	H ₂
2800	283	370	606	253	165	930
3000	310	393	625	264	172	1000
3200	337	418	644	274	178	1070
3500	381	458	671	289	187	1175

Specific Engine Characteristics

Nuclear Thermal Rockets and Dual Mode Operation

Nuclear thermal energy provides increased performance over chemical systems for purposes of propulsion. The same nuclear thermal reactor which provides energy for propulsion can also provide electrical power at low temperatures. The potential mass savings of using the same reactor for providing both propulsion and electrical power is significant. This mass savings can be accomplished through the omission of a separate power source. If the electrical power source is another reactor, then the mass savings appear through the omission of the reactor and some subsystems. This reduces and simplifies the shielding scheme necessary to prevent neutronic heating of fuel tanks and for protection of a crew.

There are many ways in which a dual mode reactor system can benefit a mission. The first is through direct mass savings through the deletion of an extra reactor. Using a dual mode reactor can save mass indirectly by reducing the amount of fuel necessary to remove decay heat after the reactor has been shut down from a major propulsive burn. In reference to the Project APEX specific ship design, the removal of the power generation reactor improves the mass distribution about the axis of rotation. Mass is distributed farther from the center of rotation and shifts the center of rotation of the ship closer to the rear. This also indirectly reduces the mass of the mission by allowing the overall length of the ship to be shorter.

The conversion of a baseline reactor to dual mode operation does not detract from the performance of the nuclear thermal rocket in any way. There is no additional hardware necessary which could impede flow or reduce performance in any way. However, dual mode operation of a nuclear thermal propulsion unit can increase its overall performance. This is done, as mentioned above, by the decrease in fuel needed to remove decay heat from the

reactor after shutdown. The cool down penalty on the overall specific impulse of the system is reduced through dual mode operation.

The development of dual mode nuclear thermal propulsion and electrical production system is strongly recommended. The potential benefits of a dual mode system can greatly improve the outlook of a mission.

Propulsive Reactor Specifications and Operation

The reactor design chosen for this mission is based on an improved version of a Rocketdyne, NERVA derivative, Carbide reactor.⁵ The engine is operated under a topping/expander cycle. Reactor mass is estimated to be seven metric tons with a thrust of 334,000 N (75,000 lb). The maximum Isp available must be improved to 1040 seconds or higher. Further research must be done to determine the actual maximum Isp necessary at full throttle to ensure an effective Isp of 1000 seconds during normal operation. An effective Isp of 1000 seconds is estimated due to the decrease in Isp during the cool-down period necessary to remove decay heat. Pulse cooling used for taper-off thrust is advised to maintain high performance and efficiency of coolant use.

Using low thrust will allow us to use multiple engines for redundancy without accelerating too quickly. If a high level of thrust is used at the start of a burn which produces a fair acceleration, then the acceleration at the end of the burn could become too high. Using three engines providing a total thrust of 102,000 kg of thrust and assuming an initial mission mass of 893 metric tons, the acceleration at the start of the burn is roughly 0.11 g's. At the end of the burn the acceleration felt will be roughly 0.19 g's. If this thrust was maintained throughout the mission, the acceleration rate would climb to roughly 0.72 g's, with a dry mass of 134,950 kilograms.

The use of three engines allows us to progressively reduce the thrust provided throughout the mission. This allows us to reduce the on time of each engine as well. This will reduce the wear on the engines. The use of multiple engines also provides for redundancy in our systems. Since this is not proven technology, it is necessary to use multiple engines to prevent catastrophe in the event of an engine failure.

There are several characteristics which need to be designed into the nuclear thermal rocket hardware. The rockets must have long lifetimes. The nuclear core must be able to remain in operation for up to 12 hours continuously during full power propulsive maneuvers. In the event that only a single engine is operational during the first two burns, that engine may need to burn for that length of time to achieve the necessary ΔV . The lifetime of the core during non-propulsive time must be three years. In the event that a Hohmann transfer must be used, the engines must remain usable for the entire length of the trip.

There are two conditions at which the main engines will operate for propulsion. The first condition is during major propulsive burns. The engine system will be operating at its best Isp of over 1000 seconds for the majority of this period. The effective Isp for this condition is assumed to be 1000 seconds for purpose of fuel calculation.

The second condition the engines will be operated at occurs during phasing and landing maneuvers at Phobos. Two ΔV maneuvers estimated to be slightly over 300 m/s each are required. The Isp for these maneuvers is assumed to be 700 seconds. An "idle mode" operation Isp of 500 seconds was assumed for lower Isp engines and small ΔV s.⁶ However,

these are specific ΔV s for which an Isp of 700 seconds may be attainable. Further research must be conducted to determine exact Isp limits during off-peak operation.

Normal operation of the dual-mode reactor during propulsion is quite different than during power operation. During propulsion, the reactor contains no working fluid in it when it is first started up. The dual-mode reactor can be started and warmed up very quickly due to this condition. The dual-mode reactor can warm up to maximum power within 60 seconds.⁷ Once the core has been brought to full power, coolant flow must be initiated immediately to prevent overheating.

This coolant commonly used is hydrogen during propulsion. The hydrogen is used in a semiclosed loop to cool the support structure inside the reactor and the thrust nozzle. The coolant flow is then sent back into the direct coolant flow through the core. Once the hydrogen is fully heated in the core, it is exhausted through a converging diverging nozzle to provide thrust.

After a main burn is completed it is necessary to continue to remove heat from the reactor core. The cooling period can be up to 6 hours. This can be accomplished by pulse cooling the core with additional hydrogen coolant. The amount of cool down propellant needed is in the range of 2 to 4 percent of the total fuel used during the burn.⁸ This lower energy hydrogen can be used to continue to provide thrust. However, this thrust is accomplished at lower specific impulse. This lowers the effective specific impulse of the system, but it is still a more efficient method of cooling the core compared with simply wasting the energy and fuel. The decrease in specific impulse is estimated to be about 4 percent.

Due to the decrease in Isp from after-cooling of the core, it is necessary to design the engine such that its maximum Isp combined with the decreased Isp produces the desired effective Isp for the system. There are two possible methods to produce a desired effective Isp. One method is to design the engine with a higher maximum Isp during normal operation. The second method is to provide a closed cooling loop which reduces the amount of propellant used to remove the decay heat. The closed loop cooling system can then be used to provide power if desired.⁹

Power Generation

The normal source of the flow through the tie tubes is the main propellant. The flow originates either directly from the propellant tanks or from flow which has been previously routed through coolant loops in the thrust nozzle. This flow then proceeds via the tie tubes in the core to an outlet in the reactor. This heated propellant is routed to the turbines which power the propellant feed pumps. The flow is again rerouted and sent back through the core. This time the propellant proceeds directly through the flow channels in the fuel elements and is exhausted to space.

Power generation is accomplished through the cooling loop which includes the tie tubes. The loop can be directed through the nozzle if necessary or directly into the support element structures. The flow is heated while cooling the support elements. The flow is then directed out of the reactor as in normal operation. However, instead of powering the propellant feed system, the flow is routed through a power generation loop. The power generation loop is a closed loop through which no working fluid is exhausted.^{10 11}

The working fluid is routed from the core through a turbine and power generation loop. The power generation loop include turbines, compressors, power conditioners, and radiators as may be determined to be necessary.

There are two major limits to the operation of the power generation cycle. The first limit is the allowable temperature of the support elements. The support elements have a maximum temperature capability of about 1000-1200 K. This limits the maximum temperature of the power generation cycle to about 900 K. That is the primary reasoning behind the operating temperature of the core during power generation mode.^{12 13}

The second limit is imposed during operation of the reactor for propulsion. The power generation cycle is not sufficient to cool the reactor during propulsion.^{14 15 16} During this time the main propellant must be routed through the support structure to provide adequate cooling. There must be an alternate power source which would have a duration of approximately 4 hours. This allows for the burn time operation and subsequent cool down period to the point where the power generation mode can provide enough heat removal to further cool the reactor.

Any power generation fluid left in the core at the time a burn is initiated will be flushed out by the main propellant flow. Excess working fluid is necessary to replenish the fluid lost during the core flush at the start of a burn. A tank with reserve power generation working fluid is included for this reason.

If there is a reactor present during a burn which is not being used for propulsion, and it is still operational, then it could be used for power production. This will most likely be the case for all burns except the first. Providing power from the alternate engine is advisable due to the consequence that some cooling is necessary in a shut down reactor that is near reactors which are operating.

Dual Mode Selection

It is possible to use a NERVA derivative reactor in the production of power as well as propulsion. The internal structure of the reactor is not altered to produce power. The external flow of coolant is altered such that it is routed through a closed loop power generation cycle. The potential mass savings in a dual mode system over separate reactors can be significant. Power generation using NERVA derivative reactors can have many other uses beyond dual mode operation. These reactors can be used specifically for electric power generation with electric power in the megawatt range if modifications are made.

Initial Calculations

The fuel and thrust requirements are dependent on the dry mass of the ship. Each NTR provides a thrust of approximately 334,000 N. A standardized tank with a capacity of 75 metric of liquid hydrogen fuel is being used for this mission. The number of engines and tanks can be determined from these values.

Fuel Requirement

The fuel requirement cannot be determined without first establishing the proper equations and parameters. Establishment of the appropriate equations and parameters is the first step taken in

determining the total mission mass. Comparisons of various mission options will be provided after the introduction to the equations and assumptions used.

Establishment of Rocket and Mass Equations

The first step in calculating the mass of a rocket in space is the establishment of the rocket equation and definition of its terms.¹⁷

$$(1) \quad M_o/M_f = \text{EXP}[\Delta V / (g_0 \times I_{sp})]$$

M_o : Initial (wet) mass of stage (kg)

M_f : Final (dry) mass of stage (kg)

ΔV : Change in velocity needed to achieve a desired result (m/s)

g_0 : Earth standard surface gravitational acceleration (m/s^2)

I_{sp} : Specific Impulse (s) of fuel and engine capability

M_o can be calculated given an M_f . From this ratio the amount of fuel needed to accomplish a mission can be computed.

$$(2) \quad M_o = M_f \times \text{EXP}[\Delta V / (g_0 \times I_{sp})]$$

Define:

$$a = \text{EXP}[\Delta V / (g_0 \times I_{sp})]$$

c = contingency fraction of propulsive fuel

M_b = basic starting payload, structure, and ship mass (kg)

M_{fp} = propulsive fuel used in maneuver (kg)

M_{fc} = fuel contingency and boil off compensation (kg)

M_{ft} = total mass of fuel (kg)

M_T = tank mass (kg)

Derive:

$$M_o = a M_f$$

$$M_{fp} = M_o - M_f = a M_f - M_f = (a-1)M_f$$

$$M_{fc} = c M_{fp} = c(a-1)M_f$$

$$M_{ft} = M_{fp} + M_{fc} = (a-1)M_f + c(a-1)M_f = (1+c)(a-1)M_f$$

$$M_f = M_T + M_b$$

$$M_o = M_f + M_{ft} = M_f + (1+c)(a-1)M_f = (M_T + M_b) + (1+c)(a-1)(M_T + M_b)$$

$$(3) \quad M_o = [1 + (1+c)(a-1)](M_T + M_b)$$

With a standardized tank design, the tank mass is an independent variable. The number of tanks and tank mass necessary for a mission is found by iteratively fitting the tank capacity to the amount of fuel necessary. If the tank mass is assumed to be a fraction of the mass of the fuel contained in it, then the equations derived below may be used.

Define:

t = tank fraction of fuel mass

$$M_T = t M_{ft} = t(1+c)(a-1)M_f$$

Derive:

$$M_f = M_b + M_T = M_b + t(1+c)(a-1)M_f$$

$$M_f = M_b / [1 - t(1+c)(a-1)]$$

$$M_{pf} = (a-1)M_f = (a-1)M_b / [1 - t(1+c)(a-1)]$$

$$M_o = M_{pf} + M_{fc} + M_f = \{(a-1)M_b / [1 - t(1+c)(a-1)]\} + c\{(a-1)M_b / [1 - t(1+c)(a-1)]\} + M_b / [1 - t(1+c)(a-1)]$$

$$(4) \quad M_o = M_b \{[(1+c)(a-1)+1] / [1 - t(1+c)(a-1)]\}$$

Equation 3 or 4 is used to calculate the total mass of a stage depending on the establishment of tank masses. Equation 3 must be used to get the most accurate results for a given mission. Equation 4 may be used for a first approximation.

Calculation of Initial Mass in Low Earth Orbit

The initial mass in low Earth orbit (IMLEO) can be calculated once the mass equations have been derived from the rocket equation. The steps necessary to calculate IMLEO for this specific mission will now be discussed.

Several parameters needed to be defined in order to initiate calculations of IMLEO. These parameters are defined in the introduction of the rocket equation. Earth standard gravitational acceleration is accepted to be 9.8 m/s^2 . The other two variables (Isp and ΔV) are defined by rocket engine selection, and the mission destination and trajectory.

The mission destination is the Mars moon Phobos. The trajectory chosen results in a total ΔV of 15107.48 m/s. This value includes ΔV 's for major propulsive burns, minor course corrections, and landing and launch maneuvers at Phobos.

The Isp changes due to the levels of thrust available from throttling engines. The Isp from the nuclear thermal rockets (NTRs) chosen for the main engines has been set to be 1000 seconds. This is the effective Isp during the four major propulsive burns. The effective Isp from the NTRs is assumed to be 700 seconds during throttled operation¹⁸. A separate chemical rocket was chosen for the components of the reaction control system (RCS) for attitude control and minor course corrections. The Isp available from the RCS is 435 seconds.

The Isp was assumed to be 470 seconds for all maneuvers if advanced chemical engines are used in place of the NTRs.

Equation 4 was used as the first step in calculating IMLEO. The total ΔV was used with the tanks as a percentage of the fuel mass. The total mission was assumed to be a single stage with an Isp of 1000 seconds. This gave an upper limit to the possible IMLEO values. From this value it was realized that each maneuver would have to be handled as distinct stages.

The mission was then broken down into the four major propulsive burns which require the main engines. Equation 4 was then applied to each stage. The first stage calculated is the fourth propulsive burn. This is done due to the fact that only payload and ship structure remain at the end of the mission. The value for second stage M_f is set to be the value for M_0 calculated from the first stage. This iteration continues until calculation of the last stage is completed. Calculation through this method gives a lower limit to the possible IMLEOs.

The mission is broken down further into each type of maneuver when acceptable and accurate ΔV s were established and propulsive method was selected. The mission is broken down in steps for ΔV s accomplished by the NTRs at full power, the NTRs at throttled power, and the RCS. The RCS engines are used for ΔV s in the range of tens of meters per second or less. The NTRs are throttled for ΔV s in the range of hundreds of meters per second. The NTRs are used at full power during the main propulsive maneuvers which are in the range of thousands of meters per second.

The ΔV value for escape from Earth orbit is increased due to gravity losses. The thrust to weight ratio in LEO must be close to 1 for gravity loss to be ignored. This would be possible for chemical propulsion. However, this is not desired when using NTRs. A thrust to weight ratio of 0.2 results in an acceptable gravity loss for a mission employing a single burn to escape LEO. The ΔV in LEO increases by approximately 225 m/s. A thrust to weight ratio of 0.1 results in an acceptable gravity loss for a 2 burn perigee-kick mission to escape LEO. The ΔV in LEO increases by approximately 125 m/s.¹⁹ For a more detailed analysis of gravity loss, see the section **Mission Plan**.

A specific tank design and mass has been established. Combinations of a standardized tank size has been used for all stages. A switch to equation 3 was then made. This switch allows more accurate and specific results to be achieved.

The last parameter to set is the fuel boil off rate. This rate has been calculated to be approximately 1% per month for unrefrigerated tanks. The actual compensation needed can be found from the duration of each stage of the mission. The boil off fuel from each of the previous stages is not included in the value of M_f . However, boil off compensation for later stages is assumed to be payload and is included in M_f as useless payload.

The boil off rate is assumed to be zero if refrigerated fuel tanks are used. Leakage and other losses are also assumed to be zero for the purpose of simplifying calculations and due to the insignificant nature of these losses.

Mission Comparisons

The following is a comparison of candidate mission options. The 892 mission was chosen for APEX and will be used as the reference.

The reference case is a mission which includes the following parameters:

- Nuclear Thermal Rockets with effective Isp = 1000 s
- Chemical RCS with Isp = 435 s
- Refrigerated fuel tanks
- T/W = 0.1 for 2 burn perigee-kick LEO escape
- 3 Unrefrigerated Tanks dropped after escape from LEO
- 4 Tanks dropped in Mars orbit
- 2 Permanent tanks
- Basic $\Delta V = 15107.48$ m/s, Gravity loss $\Delta V = 125$ m/s
- Total $\Delta V = 15232.48$ m/s
- Basic payload and ship structure mass of 135 metric tons including only 2 engines

All mission options have a basic payload and ship structure mass of 135 metric tons, including only 2 engines, and a basic total ΔV of 15107.48 m/s.

The mission options were:

1. Reference
2. Optimal tank dropping scheme for refrigerated tanks and 2 burn perigee-kick LEO escape
3. Tanks dropped only on surface of Phobos for refrigerated tanks and 2 burn perigee-kick LEO escape
4. Retain tanks for duration of mission for refrigerated tanks and 2 burn perigee-kick LEO escape
5. Optimal tank dropping with all tanks unrefrigerated and 2 burn perigee-kick LEO escape
6. Optimal tank dropping for single burn escape from LEO for refrigerated tanks and ΔV increase of 225 m/s

7. Optimal tank dropping for single burn escape using a chemical propulsion first stage for refrigerated tanks
8. Optimal tank dropping for all chemical propulsion for refrigerated tanks

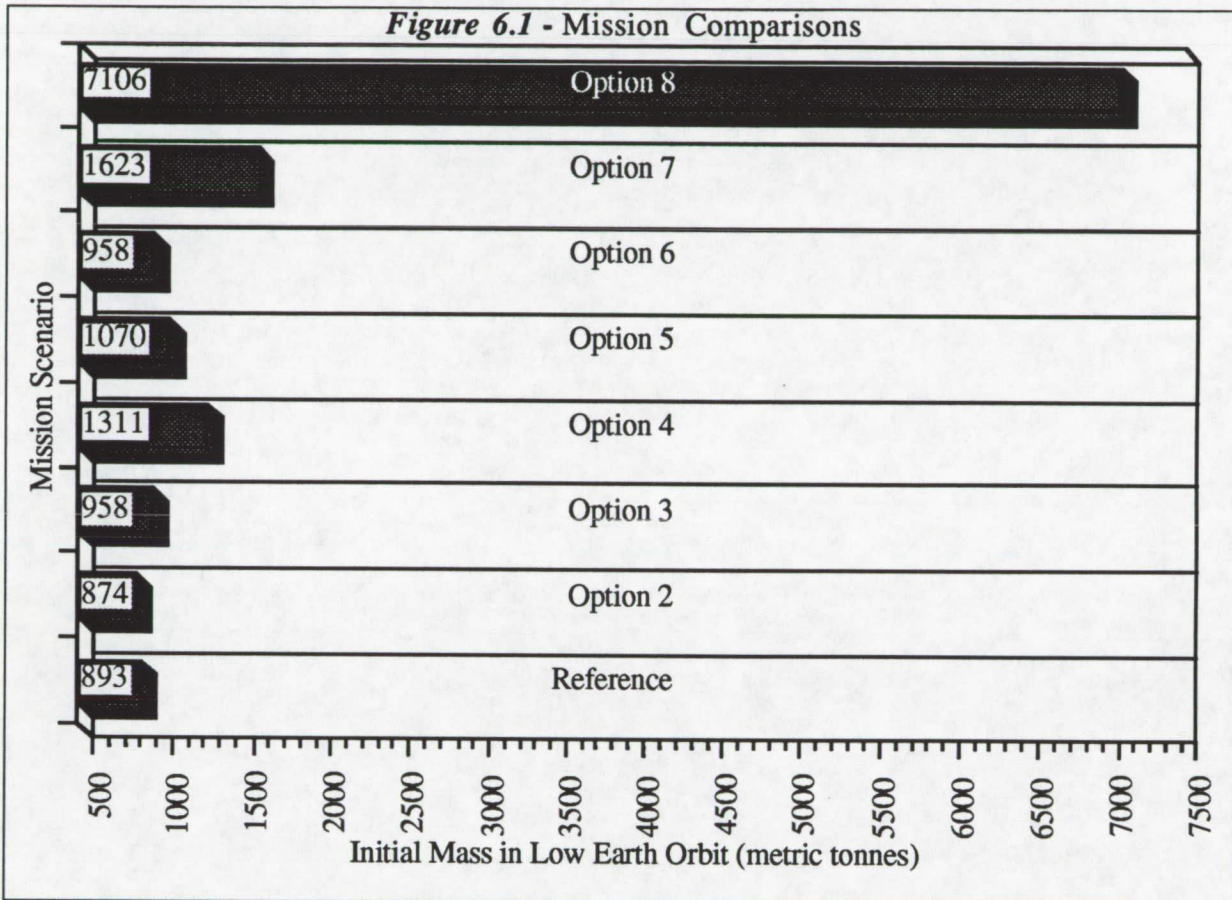

Figure 6.1 shows a comparison of IMLEO between the options. The reference has been chosen for several reasons. The reference option has been chosen due to the fact that it requires the least number of NTRs in comparison to the NTR options. The reference case has been chosen over option 2 for the ship symmetry achieved after the first three tanks are dropped. The reference case achieves a lower IMLEO than all options except option 2. Calculations of IMLEOs presented are given in Appendix A.

Use of Chemical First Stage for LEO Escape

Nuclear safe orbits are an issue of debate. Since our ship is starting in LEO, we have considered using a chemical first stage for the first propulsive maneuver. However the penalties caused by using a chemical first stage make it a poor choice.

The primary reason for not using a chemical propulsion first stage is that it greatly increases the initial mass of the ship. The initial mass in low Earth orbit (IMLEO) for the reference case shown in **Figure 6.2** is 893 metric tons. The IMLEO for a mission using a chemical first stage to escape LEO would be 1623 metric tons. A savings of 730 metric tons is achieved through the exclusive use of nuclear thermal rockets.

There are several side effects to this result. Using only nuclear propulsion reduces the amount of fuel needed for the mission by almost half. Thus, using only nuclear propulsion reduces the number of fuel tanks by half, from 18 to 9.

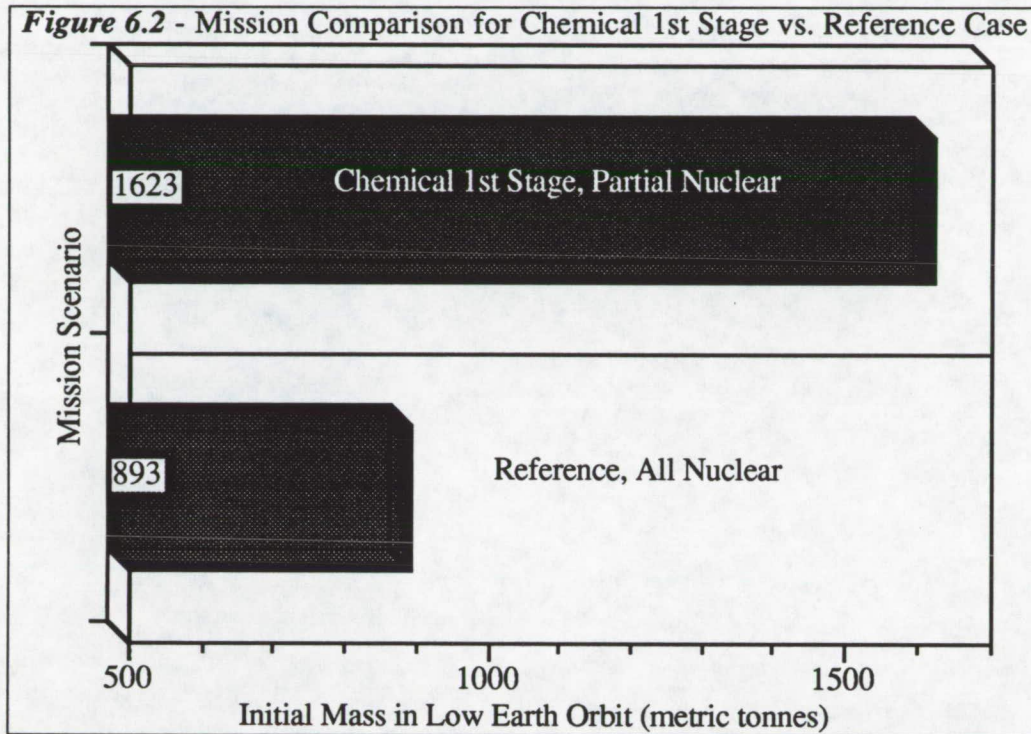

Calculations of IMLEOs presented are given in Appendix A.

Reducing the number of tanks reduces the material cost for producing the tanks. Reducing the amount of fuel by half can essentially cut the total cost of fuel needed in half. This reduction in fuel and tanks reduces the number of launches necessary to put these resources in orbit. The number of launches for fuel alone is cut down to 5 from 9. This can greatly reduce the cost of the mission.

The exclusive use of nuclear propulsion also reduces the complexity of the overall propulsion system. Using two propulsion systems would unnecessarily increase the complexity of the ship and propulsion design. Integration of the two propulsion types would increase the total cost of the mission for that reason alone.

For these reasons, we have decided not to use a chemical first stage.

RCS

RCS Types

Many types of RCS (reaction control system) were evaluated to determine which system would best suit the needs of Project APEX. The systems were evaluated based on thrust, Isp, weight, and fuel types. The table below shows the systems that were evaluated. Note that MMH is monomethyl hydrazine, and that any entry with a ?, was unable to be obtained.

Table 6.4 - Comparison of RCS Types

Name	Thrust (N)	Isp (s)	Fuel/Oxd.	Weight (N)
RS 45	4.448	300	MMH/N ₂ O ₄	7.116
RS 43	22.24	284	MMH/N ₂ O ₄	6.093
RS 25	111.2	285	MMH/N ₂ O ₄	9.429
Peacekeeper Control	311.3	?	MMH/N ₂ O ₄	16.45
Peacekeeper Axial	?	?	MMH/N ₂ O ₄	?
RS 42	444.8	229	MMH/N ₂ O ₄	22.77
RS 21	1334.4	294	MMH/N ₂ O ₄	82.28
RS 28	2668.8	220	MMH/N ₂ O ₄	124.5
Atlas Vernier	4448	187	RP-1/LO ₂	240.2
H ₂ /O ₂ Auxillary	6672	435	LH ₂ /LO ₂	?
RS 41	12009	320	MMH/N ₂ O ₄	676.1
XLR 132	16680	?	MMH/N ₂ O ₄	507.1

From **Table 6.4**, it can be seen that the H₂/O₂ Auxillary system has the highest Isp, and has a relatively good thrust compared to the other engines. It also uses propellants that can be made by the processing plant on Phobos. Therefore this is the RCS system that will be used on the Project APEX mission.

System Configurations

Description of the Reactor and its Substructure

The internal structure of a NERVA derivative reactor consists of a matrix of fuel elements and support elements. The fuel elements are constructed of a graphite superstructure with a Uranium Carbide fuel suspension. The fuel elements have either 7 or 19 co-extruded coolant channels. The extruded channels form the main flow path for hydrogen coolant. Exterior surfaces and coolant channels are coated with either Niobium Carbide or Zirconium Carbide. The Carbide coatings are used to prevent hydrogen abrasion and embrittlement of the fuel elements. These coatings also prevent leaching of fission byproducts into the coolant flow.²⁰

21 22 23

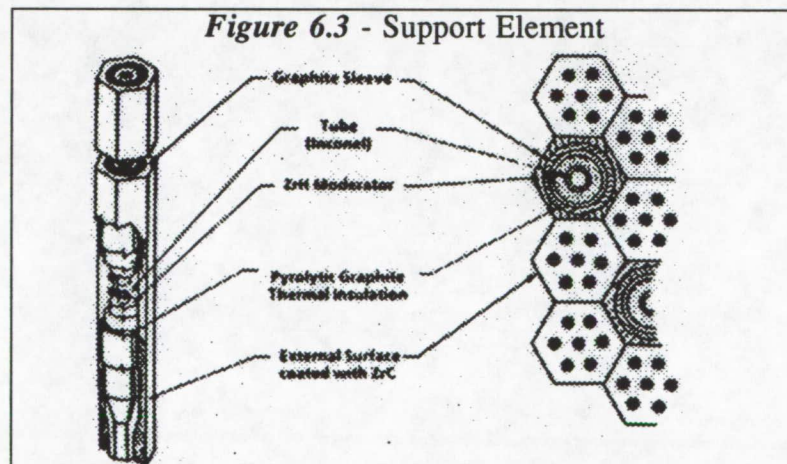

Support elements make up a large part of the semi-closed coolant loop. Support elements are constructed of several layers. The outer layer is a graphite sleeve which is coated by Zirconium

Carbide. The next layer is pyrolytic graphite thermal insulation. The following layer is a Zirconium Hydride moderator. The innermost section of the support element is a hollow tube of Inconel. These tubes are what are referred to as “tie tubes”. Tie tubes are used during propulsion to further cool the Zirconium Hydride moderator in the support elements. The support elements can also be clad in stainless steel for better thermal capabilities.

The Zirconium Hydride moderator aids in maintaining criticality. Criticality of the small mass of fissionable material in the core cannot be maintained without moderation. Beryllium reflectors at the perimeter of the core also aid in maintaining criticality.

Reactor control is accomplished through the use of control drums located about the perimeter of the core. These drums are constructed of a moderator half and a “poison” half. Reactor control is done through rotation of the control drums. The criticality of the core is determined by the rotation angle of the drums. Control is also accomplished through the use of safety rods. These rods damp reactions in the core while it is shut off.

Computer Control

The nuclear reactor in the NERVA engine must be monitored closely to prevent a failure. Approximately 15 sensors will be in place, with 10 active per engine. These sensors will be accessed in a rotation, with sampling once per microsecond. Each engine requires this monitoring.

Without constant monitoring of the reactor in each engine, the chance of a reactor failure is 100% in the first second of operation. The monitoring of the reactor is used by the computers to continuously move the control rods to maintain reactor criticality. Each reactor must be monitored at the same time as the other reactors. Each of 10 sensors requires monitoring on a microsecond scale. Five sensors serve as backups, one per critical system. Coolant levels (liquid hydrogen) should be monitored accurately, but do not need microsecond accuracy.

Subsystem Monitoring

Several facets of the operation of the reactor must be continuously monitored:

- Temperature of the core
- Temperature of the primary coolant system
- Temperature of the secondary coolant system
- Coolant levels (both primary and secondary systems)
- Neutron flux (order of magnitude based)
- Actual reaction rate as a percentage of maximum power.

Since the NERVA engines possess only a second turbopump as a backup coolant “system”, there are fewer sensors required than the above list. The coolant levels will be the amount of fuel left in each tank, which does not need microsecond-accurate accounting. The remaining areas must be monitored on the microsecond scale. The data gained from these monitors will be used to determine the manipulation required of the control rods to maintain criticality in each

reactor. Each of the important facets should have at least two sensors, with at least one backup, for a total of 15 sensors per engine requiring microsecond accuracy.

The coolant level sensors will most likely be a part of the tanks themselves. Accuracy is still required because a pause in coolant flow while an engine is under operation could lead to reactor failure.

Without this constant monitoring and adjusting, the reactor is guaranteed to suffer failure almost immediately. The microsecond accuracy is a must because a nuclear reactor can go from perfect operation to explosion within one second without interference. The minute manipulations of the control rods are the reason the reactors are feasible. Note that because of this phenomena, if computer control is lost, the reactor will be also be lost.

Engine Gimbaling

In order to save weight on the return trip from the Martian system, a decision has been made to jettison a number of rocket motors from the spacecraft in Mars orbit. Since the resulting motor arrangement may be asymmetric or not aligned with respect to the ship's center of gravity, it will become necessary to rotate the powerplants so that their thrust line passes through the ship's center of gravity. It has been decided that a ball and socket scheme of engine gimbaling should be used to compensate for this lack of symmetry.

Ball and Socket Gimbal

As the name implies, this gimbal mount employs a pair of steel alloy bearing blocks with a teflon-fiber spherical socket in between. This design has two very appealing features. First, the nature of the design itself allows high propulsive loads in excess of several million pounds to be placed on the joint. Also, because of the presence of the teflon-fiber bearing with its inherent low coefficient of friction, no lubrication is necessary, making this a maintenance free design.

Actuators

The gimbaling of the engine can be best accomplished by using a series of hydraulic actuators. These actuators would be placed at opposite ends of the joint aligned in pairs with the pitch and yaw axes. This is done because the actuators can only exert a pushing force, hence in order to return the motor to its original position, a pushing force must be applied to the opposite end of the configuration.

Flexible Duct Design

Because of the gimbaling of the motors, all of the fluid lines connecting the motor to the rest of the ship must allow for a degree of flexibility. This is done by introducing a series of bellow joints. This type of joint involves a bellowed section of fuel line reinforced with a steel mesh sheath on the outside as well as rigid restraining members. The bellows themselves are made of stainless steel and will operate at temperature extremes from cryogenic to temperatures in excess of 1000 degrees Fahrenheit. This design is outlined in *Figure 6.4*.

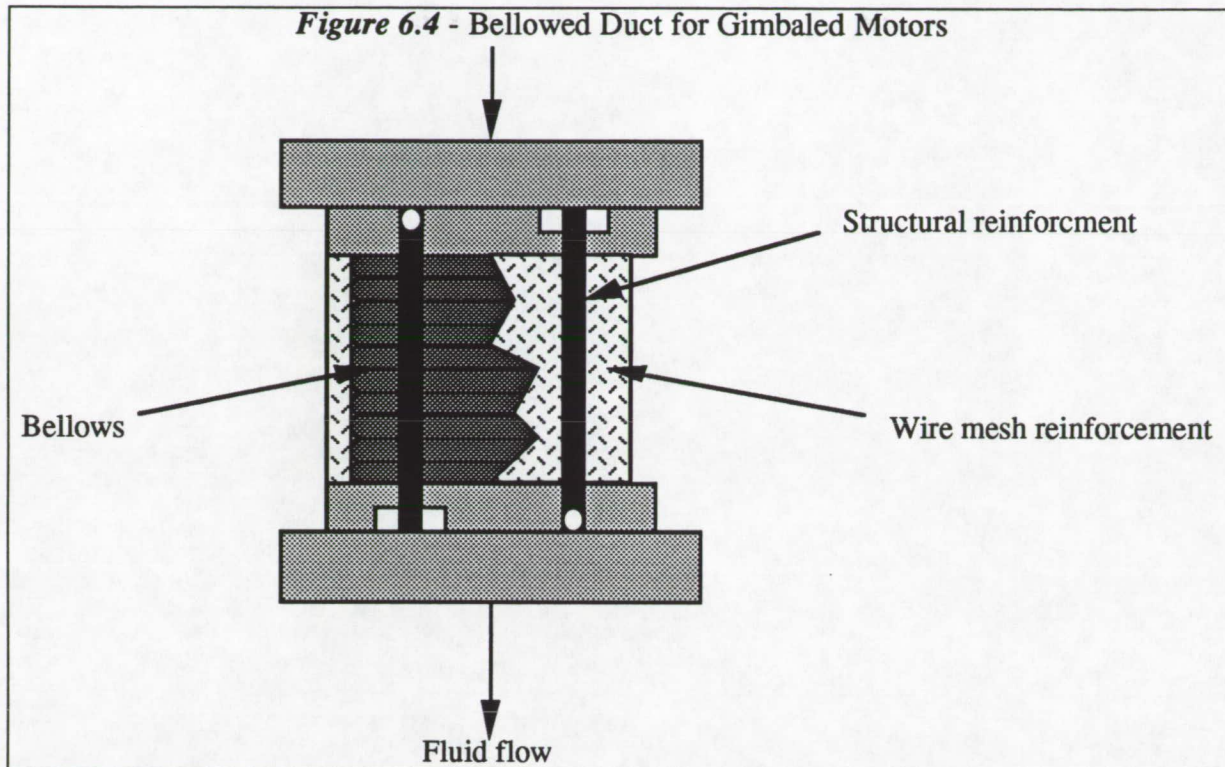

Rocket Motor Orientation

Depending on the number of motors powering the ship on its return journey and their location on the ship, it has been suggested that the motors be oriented so that no resulting moment is generated. This would not necessarily involve gimbaling all of the motors nor orienting their thrust lines through the ship's center of gravity. In the event of a motor failure, the powerplants would then again be reconfigured to cancel out any moment forces. A more reasonable method, however, is to align all of the thrust lines with the center of gravity in the initial phase. This offers two advantages. First, in a motor-out situation, none of the powerplants have to be repositioned in order to maintain directional precision. This reduces the probability of failure of the gimbals to zero after the initial change of orientation. Secondly, the gimbals can be locked in place for the remainder of the journey hence insuring that no misalignment of motors during burn periods can occur. The resultant thrust loss due to any misalignment of the trust line with the direction of travel will be small.

Recommendation

The ball and socket type gimbal is the most practical solution for this spacecraft. It offers not only great structural strength but also the reliability desired for this mission. Furthermore, it is advisable to orient all of the motors' thrust lines through the ship's center of gravity before leaving Mars orbit in order to decrease the probability of the failure of the gimbal system in a crisis situation.

Mission Plan

G-loss

The weight of this mission is exponentially dependent on the total ΔV , it is therefore crucial that we try to minimize the ΔV . Therefore, we have investigated ways to reduce g-loss (ΔV) in Earth departure.

The scheme which we recommend for our mission is a 3 engine, 2 perigee burn scenario. This will reduce our g-loss to below that of our original 5 engine, 1 burn scenario. It will also reduce our mission mass by over 109,000 kg. In addition, it will reduce our production and deployment costs significantly.

Discussion

In the following sections we will explain the causes of g-loss and different ways to overcome it. Then we will present a scheme which will minimize g-loss, mission mass, and mission cost.

Description of G-loss

G-loss is a phenomenon which affects all spacecraft attempting to leave Earth orbit. It arises from the fact that as the ship is attempting to leave orbit it is in motion around the Earth and under the Earth's gravitational pull. This has the affect of bending the departure trajectory and causing the ship to have a higher ΔV to leave Earth's gravitational well.

G-loss varies with the Thrust to Weight ratio (T/W) of the ship as well as the number of perigee burns that we make before leaving Earth's gravitational well.

Factors that Affect G-loss

G-loss is a strong function of a ship's total Thrust to Weight ratio (T/W). It has not been a concern of past unmanned missions since the T/W has been fairly high. In general, if the T/W is above about 0.2 to 0.3 the g-losses are relatively small (see below). Our mission will be carrying a large payload and a large amount of fuel. For this reason our T/W is in the range where G-loss could be a problem.

There are two options to overcome g-loss. One is a 'brute force' method. We can simply keep increasing the number of engines on the ship and shielding and additional fuel until we have a much larger ship but one with a high enough T/W to reduce our g-loss. Another option is to do multiple perigee burns. The effect of this is to put us into a highly elliptical orbit with the first burn(s) and then wait until the ship is at its perigee (closest approach to Earth) and then use the thrusters to leave Earth's gravity well.

Results

As stated above, there are two ways to overcome G-loss. One is to add additional engines to increase T/W. The other is to use multiple perigee burns. We have used our ship's data and the G-loss graph (Figure 6.5) to calculate the following results.

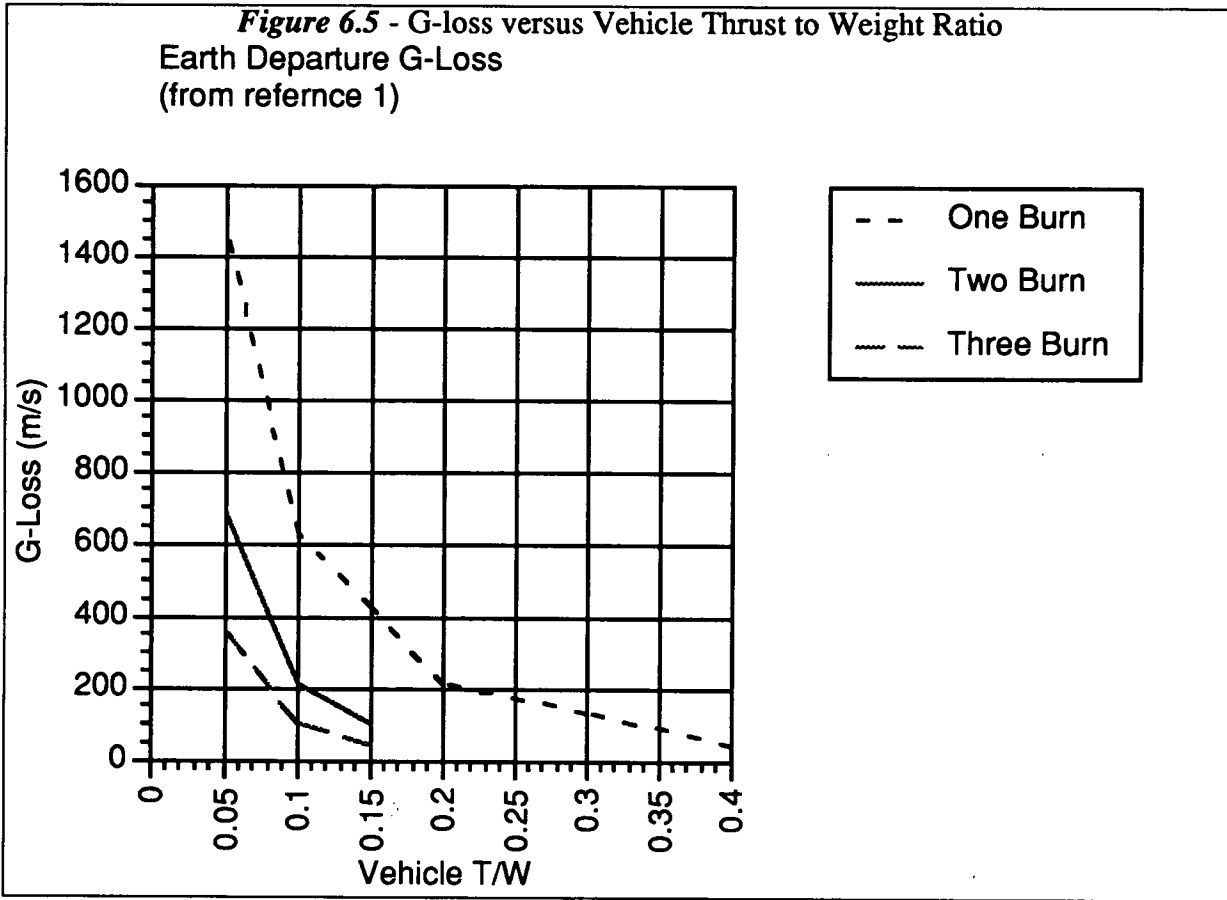

G-loss for a 1 burn scenario

3 engine	.600 km/s
4 engine	.440 km/s
5 engine	.342 km/s

G-loss for a 2 burn scenario

3 engine	.125 km/s	
4 engine	.12 km/s	*
5 engine	.08 km/s	*

G-loss for a 3 burn scenario

3 engine	.06 km/s	
4 engine	.07 km/s	*
5 engine	.03 km/s	*

*These values were included for completeness only. We had to extrapolate to calculate these values and we did not use these values in the analysis.

The previous values have been calculated from:

- Current mission mass = 900,000 kg
- The current mission mass includes the mass of 3 engines. For additional engines, we must carry additional shielding and additional fuel.
- The mass of one engine plus shielding = 6818 kg
- The mass of additional fuel = 47,726 kg per engine (based on 7 kg fuel to 1 kg payload)
- The total extra mass = 54544 kg per engine
- Each engine has a thrust = 34,090 kg

Therefore the T/W for the different scenarios

3 engine	.114
4 engine	.143
5 engine	.170

Based on the above data ²⁴ it appears that the optimum solution to the G-loss problem is a 3 engine, 2 burn scenario. This will provide for a lower ΔV , lower mission mass and lower development costs. It will increase the time in Earth orbit by 12 days.

Analysis

As stated above, a 3 engine, 2 burn mission will provide for a lower mission mass, lower ΔV , and lower development costs. The mass of three engines, shielding and additional fuel is 109,088 less than the mission mass for a 5 engine, 1 burn scenario. We will have a delta V that is .22 km/s lower than the 5 engine, 1 burn scenario and our time in Earth orbit was estimated by mission analysis to be 12 days longer than a 5 engine, 1 burn scenario. It will also reduce our mission costs, since these engines cost about \$2.5 Billion each ²⁵!

For the purpose of comparison I have included the analysis of a 5 engine, 1 burn scenario and an 8 engine, 1 burn scenario.

For a 5 engine 1 burn mission the total mass will be 109,088 kg higher (not including the extra fuel needed due to our higher ΔV), the ΔV will be .22 km/s higher, and the mission cost will be about \$5 Billion higher (not including the cost of additional launches to lift the additional mass into orbit).

For an 8 engine, 1 burn mission the ΔV will be roughly the same as a 3 engine, 2 burn mission, the mission mass will be 272,720 kg higher and the mission cost will be about \$12.5 Billion higher (not including the cost of additional launches to lift the additional mass into orbit).

Therefore we have decided to use a 3 engine, 2 burn scenario to solve the G-loss problem. This will reduce our mission mass by over 109,000 kg (not including the mass saved from having a lower ΔV), reduce our ΔV by .22 km/s, and save us around \$5 Billion in production costs alone.

Tank Staging

A large part of the mass of a space craft is in the materials that make up the fuel tanks. A standard refrigerated tank has a mass of 9100 kg. It is definitely advantageous to drop tanks at some point during the course of a manned Mars mission.

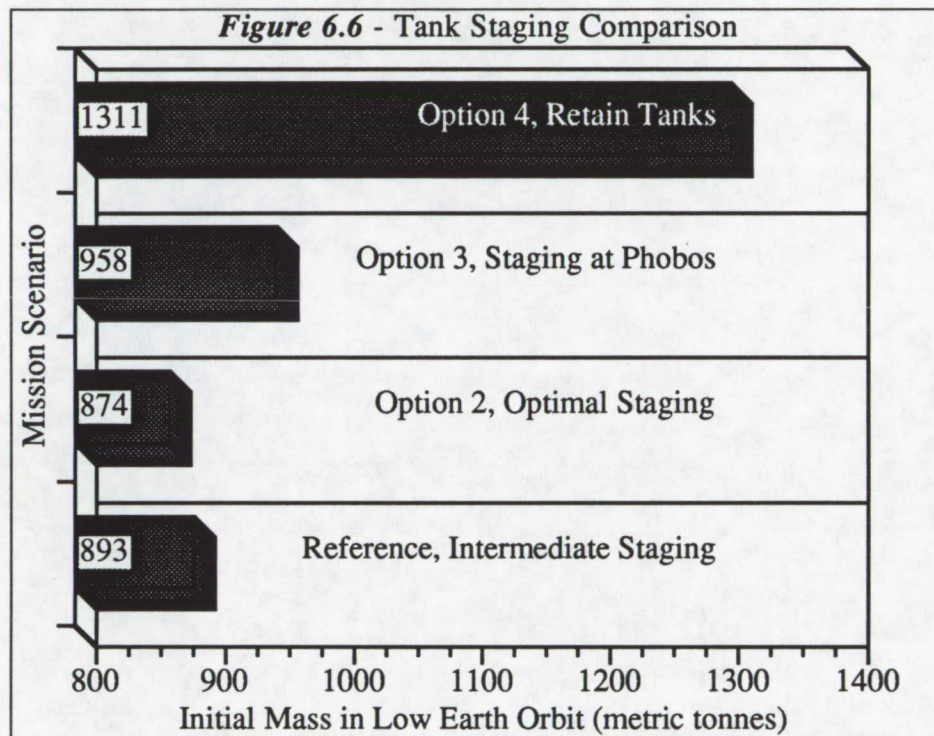

Calculations of IMLEOs presented are given in Appendix A.

This can be seen in the comparison of identical missions which have varying degrees of staging. The effects of staging are shown in *Figure 6.6*. Option 4, retaining tanks throughout the mission, results in an IMLEO of 1311 metric tons. Dropping empty tanks off at Phobos reduces the IMLEO by 418 metric tons. Staging tanks after each ΔV maneuver that empties a tank reduces the IMLEO by an additional 84 tons.

At this point the question of whether or not to follow a policy of complete or partial staging may be answered. It can be seen that the added advantage of complete staging of tanks as compared to dropping tanks at Phobos is smaller than the advantage of staging at Phobos. What are the factors that determine whether or not complete staging is done? Safety, reusability, ship symmetry and number of launches to low Earth orbit (LEO) are the issues which determine the degree to which staging is done.

The reference case is an intermediate tank staging scheme. The tank staging scheme opted for the reference case was chosen to maintain ship symmetry during the majority of the mission. The reference case falls between the optimum staging of option 2 and the staging at Phobos of option 3. A penalty of 19 tons is incurred as compared to option 1. The reference case saves 65 tons over option 3. The differences can be clearly seen in *Figure 6.6*.

Engine Drop

In order to save mass (hence fuel), it has been decided that one engine will be detached and left at Phobos. This section outlines the method that will be used to accomplish this.

Method of Removal

Once the ship has landed on Phobos, the engine will be detached. The first step is to close and cut the four fluid lines that run to the engine. These are the nozzle coolant line (which uses hydrogen), the structural coolant line (hydrogen), the main fuel line (hydrogen), and the power turbine line (which uses a Xenon-Helium liquid mixture). These lines can be sealed with computer controlled valves, and then cut by explosive bolts which attach the lines to the various tanks that feed them. This does not detach the engine from the structure of the ship, nor does it detach the engine from the power turbine connected to it.

The next step is to then fire a harpoon and cable system into the ground of Phobos. This is similar to the method being used to land the ship. This harpoon and cable system can be used to "reel in" the engine, and firmly secure it to the ground.

The final step is to cut the attachment of the engine to the structure of the ship. This also is done using explosive bolts. With this done, the engine can be freely winched to the ground.

It has been decided to remove the center engine of the ship (for gimbaling and stability reasons). Therefore, space has been made in the trusswork of the engine supports so that the harpoon may be fired, and that the engine can be safely removed.

Regolith

One of the considerations involved with a spacecraft which makes use of artificial gravity is maintaining a constant center of gravity (CG) about which the craft will rotate.

The current configuration of the spacecraft's propellant tanks does not maintain a constant CG during the course of the voyage. That is, the CG shifts during operation of primary engines.

One method that has been considered is the addition of regolith to the spacecraft from Phobos. This would allow the CG to be repositioned to maintain artificial gravity, and ship rotation within the design parameters.

This section outlines technical information on why the addition of regolith at Phobos is not a viable option to correct the CG of the spacecraft due to the excessive increase in propellant mass required to transport regolith.

Mission Parameters

The mission parameters require four ΔV 's for a round trip to the Martian moon Phobos during the mission date of 2012. These are:

STAGE

1	$\Delta V = 4490$	m/s
2	$\Delta V = 4170$	m/s
3	$\Delta V = 1760$	m/s
4	$\Delta V = 2720$	m/s

Which translate into mass ratios of:

STAGE

1	$\frac{m_i}{m_f} = 1.5804$
2	$\frac{m_i}{m_f} = 1.5297$
3	$\frac{m_i}{m_f} = 1.1965$
4	$\frac{m_i}{m_f} = 1.3195$

Both the ΔV 's and the mass ratios will be the same whether regolith is added at Phobos or not.

Analysis

The analysis of adding regolith at is based on calculating the fuel-mass requirements of the spacecraft with the following specifications:

1. Contingency+boiloff fuel fraction of primary fuel = 10%
2. Tank mass fraction of total fuel mass = 10%
3. Payload mass = 142 metric tons

Note that this analysis was done during the first iteration of the rocket equations. Therefore, the data used as a reference is not the final configuration. The initial mass to final mass ratio requirements of the APEX Nuclear Thermal Rocket Engine is calculated using the rocket equations established in the section **Initial Calculations**. Since the fuel and reactor operating temperature is known, then the initial to final mass ratio is simply a function of the requirements of mission, that being

$$\frac{M_i}{M_f} = e^{c\Delta V}, \text{ where } c = 1/(g_0 I_{sp})$$

For the current spacecraft configuration

$$I_{sp}=1000s \text{ and } g_0 = 9.81(m/s^2)$$

Using these parameters the total spacecraft mass, total fuel mass, total tank mass is established for a spacecraft with no regolith addition. In addition it is possible to establish the propellant mass used during each burn using the rocket equation. From these specifications the following fuel and tank masses were calculated:

Total fuel mass: 1077.28 MT
Total tank mass: 107.73 MT
Total ship mass: 1327.01 MT

Once this baseline is established it is possible to determine mass addition required at Phobos. Using an approximation of 50% of the fuel mass used during the first burn (of the baseline), as suggested by Spacecraft Integration, it is found that 243.68 MT would be required to be added at Phobos.

Using the original specifications for boil off, tank and payload mass the it is found that the fuel mass required to make a round trip to Phobos would require:

Total fuel mass: 1834.70 MT
Total tank mass: 509.43 MT
Total ship mass: 2486.13 MT

Using the rocket equation the fuel mass for each burn is calculated and compared to the fuel masses necessary for a ship with no regolith added. This is presented in *Figure 6.1*. As seen in Fig. 1 the increase in fuel mass required when regolith is added at Phobos is approximately 87% over the required by the spacecraft. This is an increase of 1159.12 MT due to the increased requirements of fuel and tankage.

Results

From strictly a mass reduction point of view, the addition of regolith at Phobos is an inefficient method of maintaining the CG of the spacecraft and it is recommended that this method not be used. In is very expensive in terms of additional mass required to be placed in orbit. Also there is the addition requirement of man power and machinery required at Phobos to load the regolith on to the spacecraft. In addition a structure would be required to contain the regolith once at Phobos, such as a modified propellant tank.

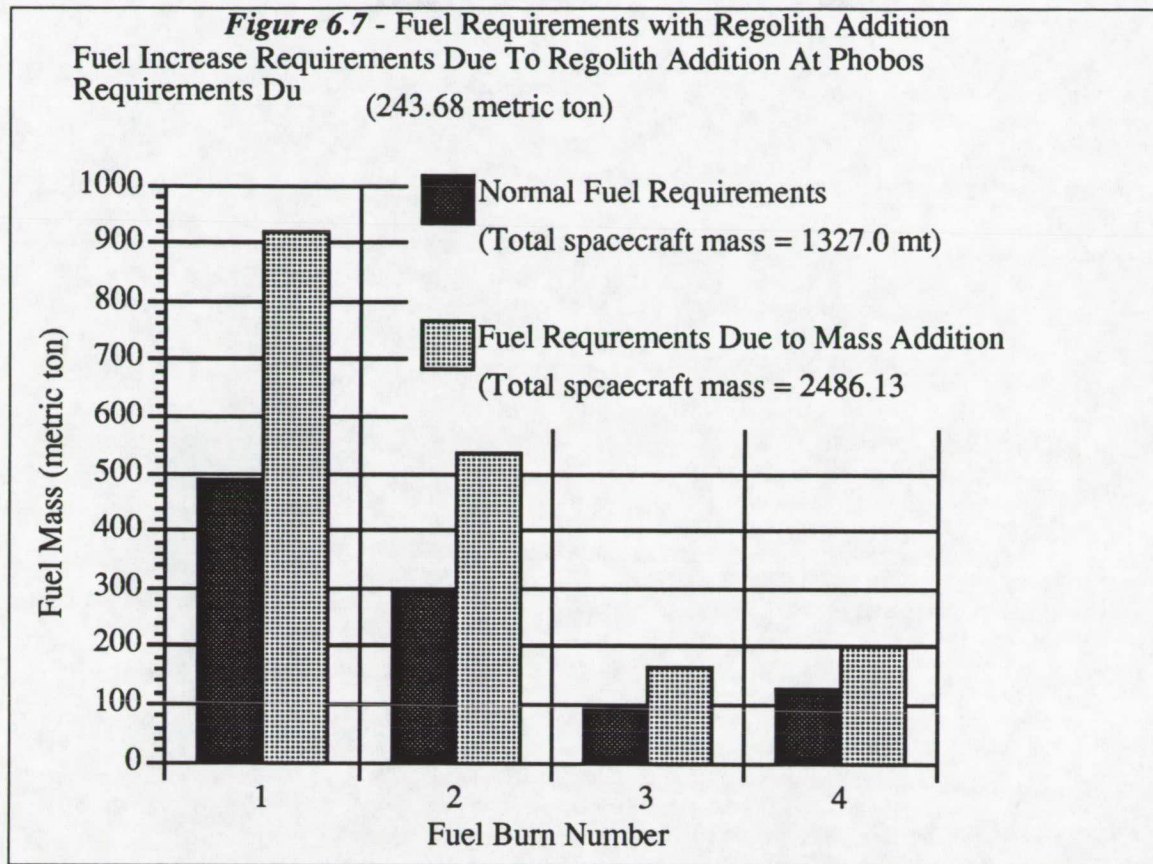

Tanks

Liquid Hydrogen Storage

In calculating the tank sizes needed to house the propellant for the mission, it was necessary to first set the storage parameters for the liquid hydrogen. A pressure of 1 atmosphere has been chosen, at a temperature of 17.9 degrees Kelvin. Higher storage pressures could have been used but these would have translated into heavier propellant tanks. Based on data from reference ²⁶, a density of 73.6 kg/m^3 has been used to calculate the fuel volume from the fuel mass fraction needed for the mission.

Tank Baffling

The following is a qualitative discussion of propellant slosh and the resulting need to baffle the propellant fuel tanks in order to dampen this motion.

Because of the unusual design of our ship, and its frequent starts, stops, and rotations (corresponding to different burns and simulation of gravity) the fuel tanks will likely be characterized by oscillatory fuel. Any motion of the tanks will cause the liquid contents to oscillate back and forth, commonly referred to as propellant slosh. The resulting oscillatory forces and moments on the tank walls are not negligible and must be considered in the dynamic

analysis of the ship. The response of the ship to dynamic excitation during rotation and powered flight can be strongly affected by the sloshing motion of the liquid in the tanks.

There are methods of mathematically analyzing the effects of propellant slosh on the structural dynamics of the system. For example, propellant slosh in a missile can be analyzed by replacing the propellant in the tank with an equivalent spring-mass system to determine the dynamic behavior of the whole booster structure. However, this is an involved process and is not one which we will specifically address in this project. Also, because of the unusual motion of our ship, it is difficult to say exactly what type of baffles will be used. The relative effectiveness of different kinds of baffles for suppressing fuel slosh can be determined only by experimentation²⁷. At this point, then, it is sufficient to acknowledge the fact that some type of baffling will be needed (for example, ring baffles) and that this (fuel slosh) will be a factor in predicting ship dynamics and stability.

Refrigeration

The type of fuel affects the mass of storage tanks. In the storage of liquid hydrogen a lot of mass is used to prevent boil off. The less boil off allowed for, the more the storage tanks will mass. To combat the excess fuel necessary to compensate for boil off and to reduce the mass of the tanks, storage tank refrigeration has been considered.

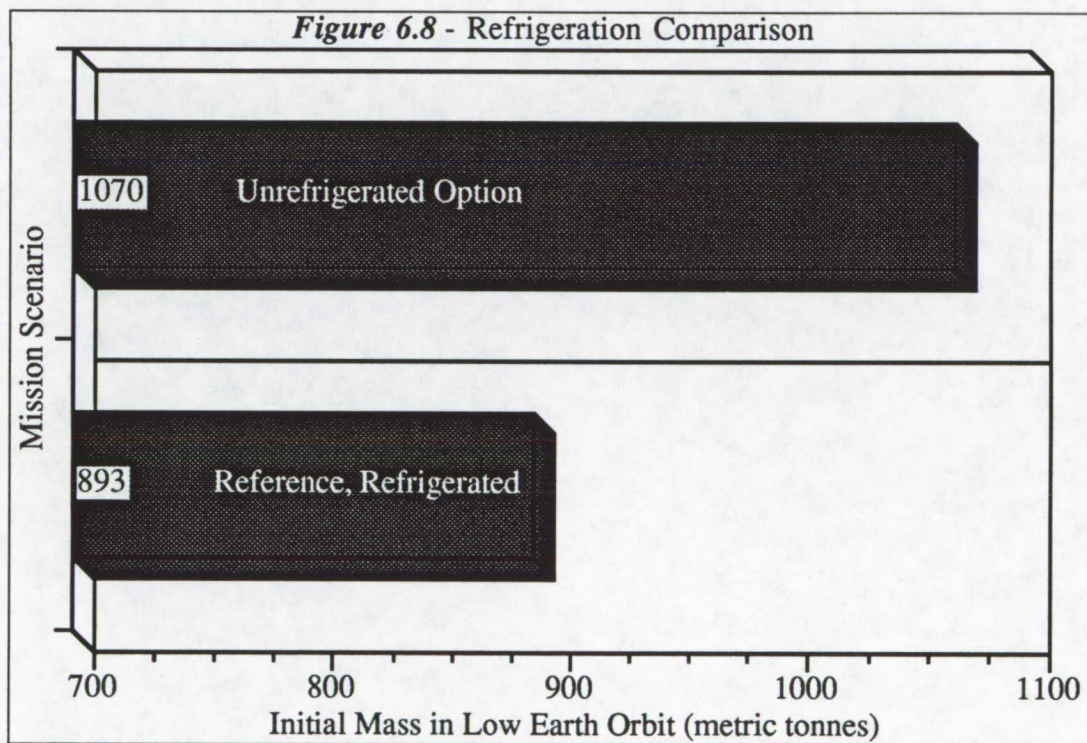

Calculations of IMLEOs presented are given in Appendix A.

There is a mass penalty in the use of tank insulation to reduce fuel boil off. The relationship between insulation thickness and heat conduction is non-linear. As the insulation is thickened, the effectiveness of each additional layer decreases. This means that an optimal point where the decrease in boil off does not compensate for the mass increase due to insulation.

Prior to this optimal point there is a combination of insulation and refrigeration which can further reduce the IMLEO. A boil off rate of 1% with insulation was established. This basic tank has a dry mass of 8717 kg. The mass and power of a refrigeration unit necessary to reduce boil off to zero was then estimated. The estimated mass of the refrigeration unit is 383 kg. The power input required at peak operation is estimated to be 16 KWe²⁸. The refrigerator operates on a Turbo-Brayton cycle. The refrigerated tank has a mass of 9100 kg.

Refrigeration is an important technique to reduce the fuel mass necessary to complete this mission. Due to the high rate of boil off it becomes highly advantageous to refrigerate hydrogen storage tanks. Mission comparisons are shown in *Figure 6.8*. The refrigerated reference case is compared to an unrefrigerated case without altering any other parameters. The reference case has an IMLEO of 893 metric tons. The unrefrigerated mission has an IMLEO of 1070 metric tons. A savings of about 180 metric tons is accomplished through the use of fuel tank refrigeration.

Level Sensors

While our design may not be refined enough to choose actual hardware, it is helpful to consider some of the smaller, yet equally important components to the total system. Included here is a brief discussion of the method in which we could monitor fuel quantities (or oxygen, water and other liquid levels stored on board).

Level sensing is the ability to sense the height of a liquid propellant gas interface above some reference. Accurate and reliable level sensing is difficult to obtain, especially in our case, because of the unusual dynamics of the ship (i.e., where will the fuel be relative to the tank). We would like to address two concerns with the level sensing system:

- Outage control
- Propellant utilization

Hardware that is available to meet these objectives are of two types. These are;

- Discrete-point sensing
- Continuous-level sensing
 - a. over a limited range of height
 - b. over a full range of height

Discrete-point sensing

The probes or sensing element is capable of indicating the liquid level only at the instant of covering or uncovering. In other words, it is capable of detecting the surface of the liquid as it passes a given point on the probe. This system is a simple one and therefore has a high degree of reliability.

Continuous-level sensing

This system is capable of tracking the movement of a liquid surface over a range of height and is not confined to a given level-sensing point. Continuous monitoring of a liquid surface level can be made with one transducer which will indicate the height of the surface at every instant.

Design considerations

- **Fail safe.** Use redundant sensors, possibly combine two systems; type (2) as primary and type (1) as a back-up.
- **Reliability.** What are the predominant failure modes of the particular hardware being used, etc.
- **Location limitations.** Where on the tank is the sensing system going to be mounted? Possibilities include a system mounted inside the tank; outside, with sensors piercing the tank wall (possible structural problems); or outside, without breaking through the tank wall. Aerodynamic heating and engine heat must be considered as well as the need to heat sensors in the cold environment of the cryogenic propellants. Stillwells can be used to circumvent false signals caused by propellant slosh.
- **Compatibility with liquid.** Are the hardware materials compatible with the liquid being monitored?

System Choice

In our system, the tanks will contain a totally-wetting liquid (LH₂) and will be either rotating (during simulated gravity) or accelerating (during main burns). The following situations can then be anticipated:



(1)

Zero-g
condition
prior to
any burns.



(2)

Propellant has
been bottomed.
Vapor trapped
in liquid.



(3)

Bottoming force
was maintained
to permit vapor
rise through
liquid.

During Main Burns

Propellant will stabilize in position (3) for fuel monitoring. This problem is similar to conventional fuel monitoring problems. The use of a tube or stillwell, in which the sensor is housed, will eliminate the turbulence and trapped gas affecting the liquid surface at the sensing point.

During Ship Rotation

Again, fuel should stabilize in position (3) or some variant thereof (depending on if the tank is rotating at the center of gravity or the ship or at some distance from the C.G.).

In both cases, fuel monitoring should not be a problem. It is more difficult to monitor fuel in case (1) which might be present while docked at Phobos. We would want to monitor the fuel quantity while at Phobos to check for boil-off, etc.

Zero G Fuel Management

The ability of a liquid propellant rocket engine to restart in a zero gravity environment has been an important factor in considering the design of long duration spacecraft.

The following section will present the critical factors involved in a zero-gravity liquid propellant rocket engine restart, what systems are available to aid in zero-gravity restart, and which system will best suit the APEX project.

Behavior of Cryogenic Liquids in Zero Gravity

The properties of cryogenic liquid propellant (LH2) to be used in our spacecraft are much different when in a zero gravity environment. Intermolecular forces are the dominate factor in considering the interaction of the fluid and the tank. In addition cryogenics are totally wetting. A totally wetting liquid has a liquid to solid contact angle that is equal to zero (**Figure 6.9**).

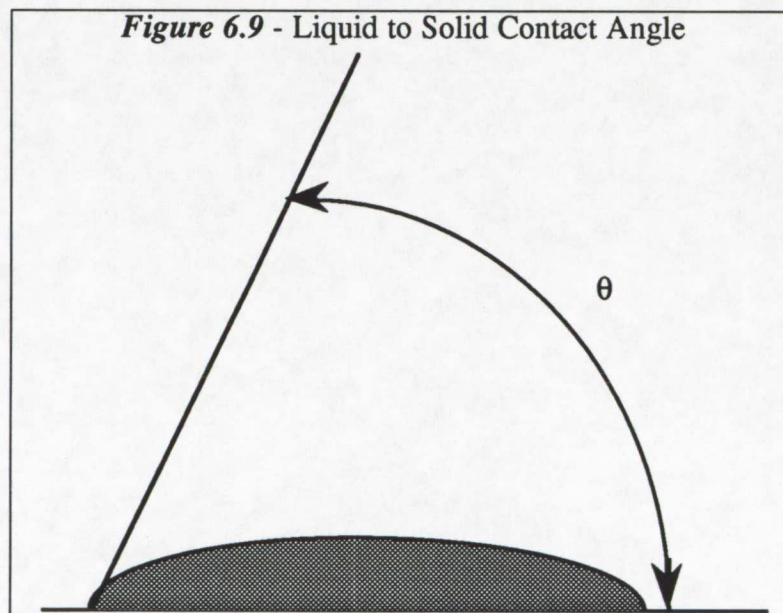

As can be expected under static-equilibrium conditions, the totally wetting liquid will spread over the inside surface of the tank and form some type of vapor-liquid interface (bubble) which minimizes surface tension. The position of the bubble can be determined by minimizing the total capillary energy $\sigma (A_l - A_w) \cos\theta$, where A_l is the liquid-vapor interface area, A_w is the wetted area of the tank, T is the surface tension and θ is the interface contact angle (θ approx.

= 0). Also from this equation it can be shown that the liquid will collect into one volume, instead of several discontinuous volumes, by considering the A_i term in the equation ²⁹.

In light of this one would presume that it should be an easy matter to predict the location of the liquid and vapor within the tank, given the tank size and shape. Although this is true given a tank under static conditions, but the spacecraft will not be a static system during rocket engine firing.

Effects of Acceleration Perturbations

The effects due to acceleration perturbations on the static equilibrium of the propellant-tank system can cause a shift from a continuous liquid system, with a single vapor bubble, to a system with many vapor bubbles. This multi-bubble system will have an adverse effect on the restart performance of the rocket engine during the initial operation of the rocket engines. That is it will be impossible to guarantee that only liquid be present at the tank outlet. There are several different methods which can be considered as propellant management devices (PMDs) to ensure liquid only at the tank outlet ³⁰.

Systems to Ensure Liquid Only at the Propellant Outlet

In order to ensure liquid only at the propellant outlet we will consider several different systems as PMDs. A short explanation of each:

1. **Supercritical Storage Systems:**

Supercritical storage stores the liquid at a pressure greater than the critical pressure. This ensures a single-phase liquid independent of the zero-gravity conditions. The disadvantage of this system is that the storage tanks requires much thicker wall.

2. **Surface Tension Systems:**

Surface tension systems take advantage of the dominance of intermolecular forces in a zero-gravity environment. There are several different types of surface tension devices which make use of screen mesh, tubular type galleries and vane assemblies to maintain liquid only at the propellant outlet.

3. **Positive Expulsion Systems:**

Positive expulsion systems make use of flexible bladders, flexible metal bellows or piston type devices within the tank to maintain liquid only at the propellant outlet.

4. **Inertial Systems:**

An inertial system ensures liquid only at the outlet by providing an acceleration to the spacecraft which caused the liquid within the tank to "bottom out" at the propellant outlet.

5. **Trap Device Systems:**

Trap device system are similar to positive expulsion systems except that the system is external to primary storage tanks. Trap devices are used to operate the rocket engine long enough to bottom the liquid within the primary tanks. Trap devices would then be refilled the spacecraft is under acceleration.

PMD System Selection

In selection of the proper PMD system it has been necessary to consider the requirements of the spacecraft in question. In qualitative terms the PMD should be capable of handling the required

mass flow of the rocket engine, have a minimum mass penalty to the spacecraft and be able to handle cryogenic liquids.

The main disadvantage of the Supercritical Storage System is the increase in tank mass required to handle greater than critical pressure. Since it would be necessary for all primary-fuel storage tanks to handle high pressures, and the need to keep structural mass at a minimum is premium, this system will be dismissed without further consideration.

Surface tension systems are a proven technology and have been used on many space missions. Generally surface tension devices are used in relatively low mass flow systems such as the Orbital Maneuvering System in the Space Shuttle or in a satellite attitude control system.

In general there are three types of surface tension devices which are used to maintain tank liquid in position over the tank outlet: partial communication, total control, and total communication.

The partial communication PMD maintains only a fraction of the fluid over the outlet. This is useful when the liquid is to be bottomed each time the engines are fired. In this method the PMD is refilled when the liquid is bottomed.

The total control PMD holds all liquid over the outlet and is primarily for slosh control. Total communication PMD maintains a flow path for the liquid in the tank to the outlet at all times. One type makes use of galleries along the inside of the tank which maintain contact with the liquid attached to the tank wall. This type of system is used in the Space Shuttle for the Orbital Maneuvering System. The total communication PMDs are generally not able to maintain liquid only at the outlet under large acceleration due to the large size of the device.

Positive expulsion devices (bladder type) are not feasible in the APEX design due to the use of cryogenic liquids. Flexible bladders in use in most systems would not be able to withstand the low temperatures of the cryogenic liquid³¹. This type of system does not meet the requirements of the APEX mission since it involves the use of cryogenic liquids.

An inertial system would increase the mass of the spacecraft since it would require an additional thruster system or at a minimum, additional fuel to operate the current thruster system. Also, this would increase the complexity of the overall propulsion system. Mainly due to the increase of spacecraft mass, this system does not prove beneficial to overall spacecraft performance.

Trap type devices again are similar to the positive expulsion devices, except trap devices such as metal bellows can be used with cryogenic liquids. Since the devices are external to the propellant storage tanks, it may be necessary to refrigerate the device in order to maintain boil off to a minimum.

Additionally, one problem with the trap device is the additional complexity which is introduced into the system. Since trap devices are mechanically active systems as opposed to passive systems (e.g. surface tension devices) the possibility of failure of the trap device may be catastrophic to mission success.

Results

Since reliability and minimum mass penalty are primary concerns, a surface tension device modified to handle propellant mass flow has been chosen. Since the APEX Project will use

refrigerated propellant tanks the problem of boil off and the formation of gas bubbles will be kept to minimum. The PMD will not be required to maintain the mass flow during the entire primary propulsive burn. Inertial effects, once the spacecraft is under full thrust, can be used to maintain liquid over the outlet and the PMD can be by-passed for most of the propulsive burn.

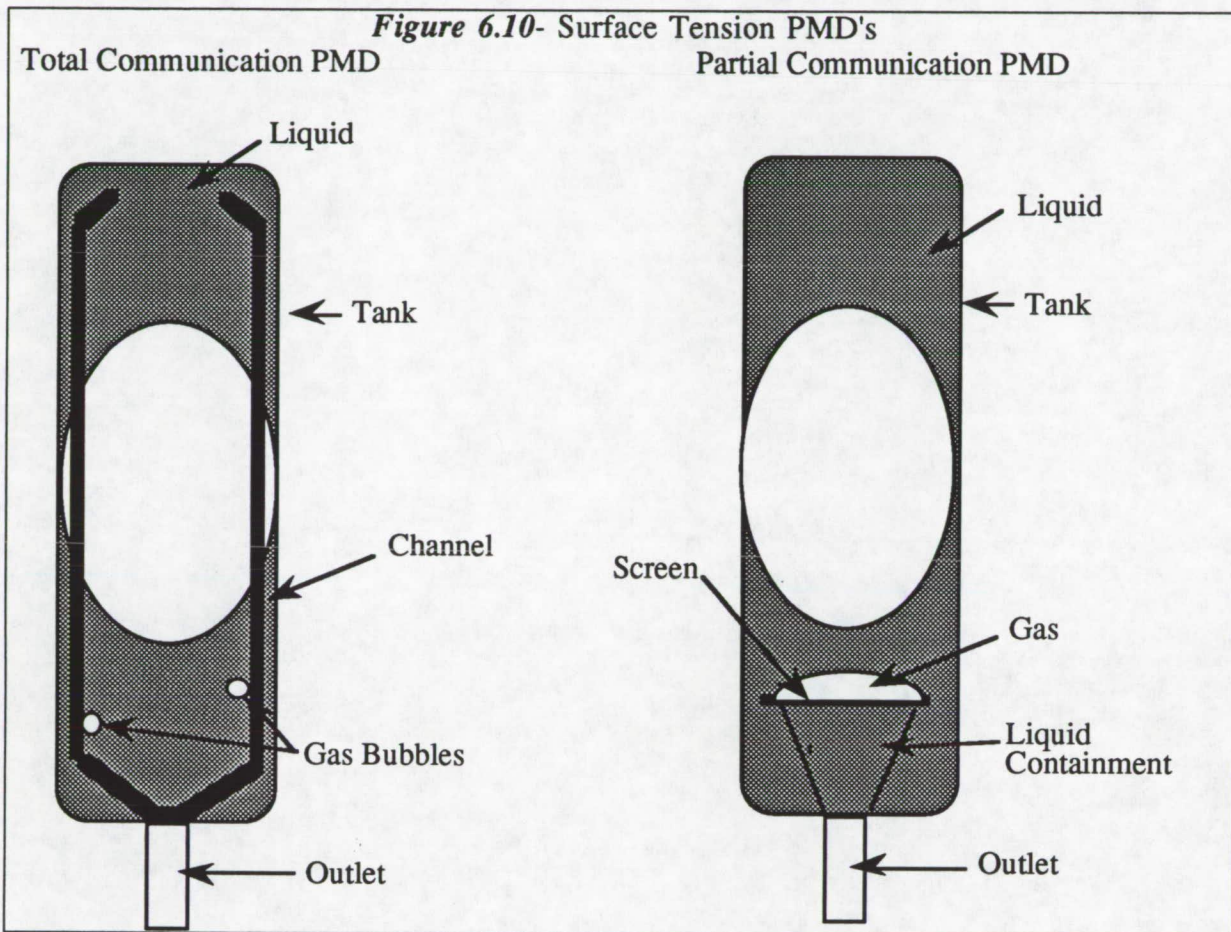

Safety

Reactor Safety

NERVA derivative reactors are provided with redundant and diverse safety features. There are two independent systems for removal of decay heat after shutdown. The primary cooling path is through the main propellant flow channels in each fuel element. A secondary path is established through an independent circuit which includes the tie tubes. The tie tube system is used during normal operation to cool the moderators in the support structure and in the flow loop which powers the propellant feed pumps.³²

Normal reactor control and shutdown are accomplished through the use of control drums situated around the perimeter of the fuel matrix. Shutdown can also be accomplished through the use of reinsertable safety rods.

The reactor also has inherent, passive safety factor. The reactor cannot maintain criticality without the use of the Zirconium Hydride moderator. Without the Zirconium Hydride

moderator the reactor could not begin to produce power. In the event that the reactor overheats, the Zirconium Hydride moderator breaks down. The reactor is irreversibly shut down when this occurs.³³

Radiation

Despite the many advantages of an NTR there are some drawbacks. The primary drawback is the potentially deadly radioactive output produced by the reactors. As such, it is vital that the crew be properly shielded from the deadly effects the reactors. The section of the report investigates the shielding requirements for the NTR.

Engine Characteristics

In our design we are using three NERVA derivative reactors for the propulsion system. These reactors output 1500 MW of thermal power and achieve operational temperatures of 3000 K. (see below) For this configuration, the total mass of each rocket is 6,818 kg including the shielding weight of 5,000 kg.

Radioactive Output

The following sections will detail the reactions undergone in the reactor and the products of these reactions.

Reactions

We will be using enriched uranium for the source of power in our fission reactor. Uranium can undergo over forty different fission reactions. Two of the possible reactions are shown below for reference. Each reaction has three common aspects. First, the reaction is always started by a neutron colliding with a uranium-235 atom. Second, the fission process will liberate more than one neutron (usually two or three). Third, each reaction will also liberate energy³⁴.

2 Possible Uranium-235 Reactions

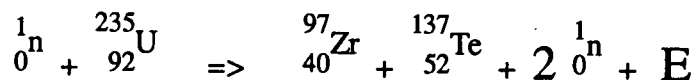
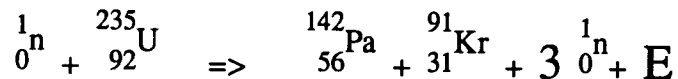

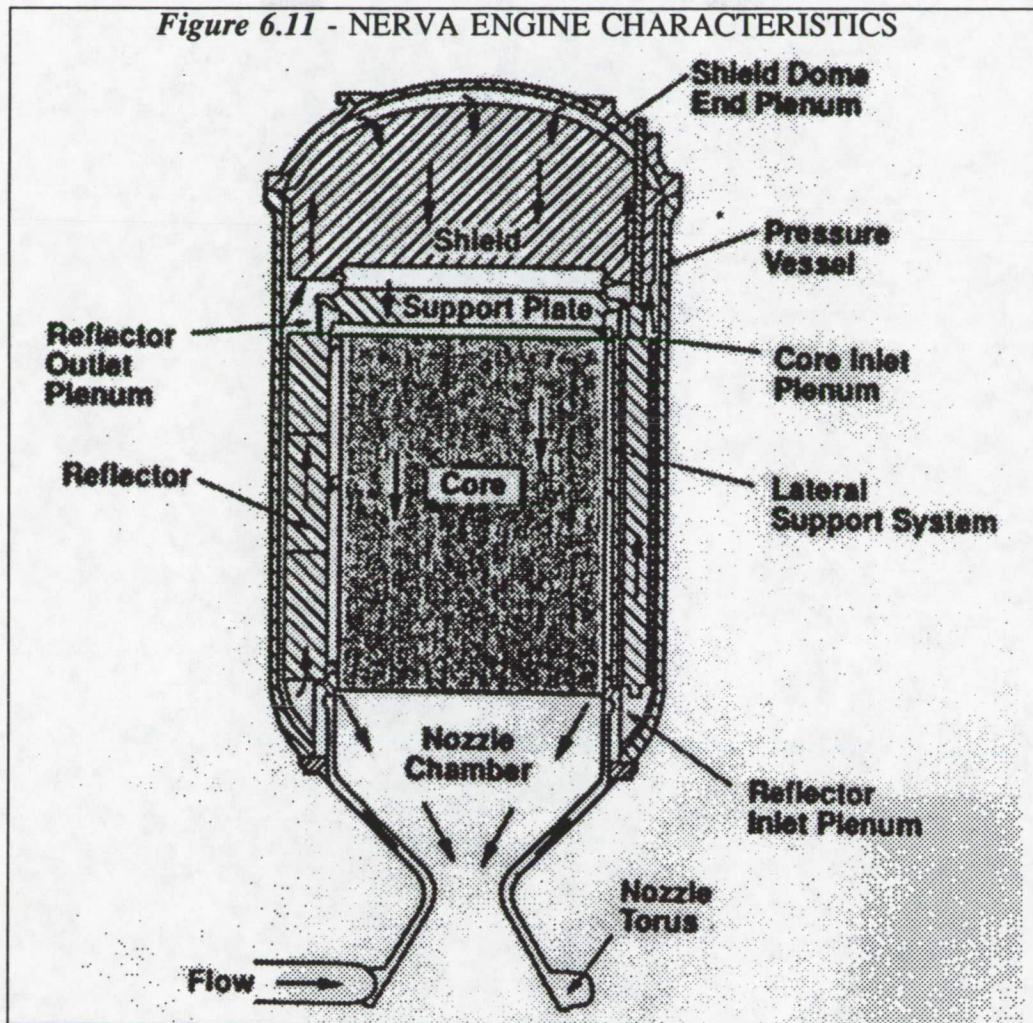

Power(MW)	1500	Mass(kg)	6818
Thrust(kg)	34090	Core Temperature(K)	3000
Isp(s)	825	Lifetime(hr)	10

ORIGINAL PAGE IS
OF POOR QUALITY

Reaction Products

The fission products listed in below are the average results associated with fission decay of the uranium-235 atom. The majority of energy is liberated as heat which will be carried away by the fuel passing over the reactor core. This means that this energy will not pose a threat to the crew. The remaining products (beta particles, gamma rays, neutrinos and neutrons) will give the crew some radiation.

Product	Energy(MeV)
Heat	168
Beta Particles	8
Neutrinos	12
Neutrons	5
Gamma Rays	14

Shielding Materials

As stated in Radioactive Output, there are four main fission products which are produced in the NTR. The products we are concerned with are beta particles, gamma rays, neutrinos and neutrons. The following sections will cover the easily shielded beta and neutrino radiation first. Then neutron and gamma radiation will be covered.

Beta and Neutrino Radiation

The beta particles and neutrinos should not pose a threat to the crew. Beta particles are easily stopped by a thin sheet of any metal. Therefore, these will not even leave the reactor. In addition, neutrinos by their very nature do not interact with anything. This means that we can not shield the crew from them, but when they pass through the crew they will not harm them in any way. So as far as our shielding scheme goes, we primarily must be concerned with blocking gamma rays and neutrons.

Neutron and Gamma Radiation

Because neutrons and gamma rays are fundamentally different, we must use a different shielding scheme for each one. In our research, we have found that neutrons are best stopped by hydrogen. The best solid material to stop neutrons has been experimentally determined to be lithium hydride. Gamma rays on the other hand are blocked well by materials that are extremely dense. There are several materials that could adequately block gamma rays, however, for this mission the material we have chosen is tungsten. This is because of its extremely high density (19.3 g/cc) and very high melting point (3400 C). The high melting point is necessary since the lithium hydride has a low melting point (720 C) and must be shielded from the heat of the reactor.

Shielding Scheme

Determining the proper thicknesses of these materials is extremely difficult to do analytically. The only way to determine the appropriate thicknesses is through use of computer programs or experimentally. The use of computer programs gives only an approximate solution and for that reason we have used results gained experimentally from the NERVA nuclear rocket program.

The tests done during the NERVA program indicate that the optimum shielding scheme is an inner layer of tungsten and an outer layer of lithium hydride with a total mass of 1,500 kg for the inner shield and 3,500 kg for the external shield³⁵. This scheme will provide an effective means of protecting the crew during the burns. The shielding method will provide for an exposure of around 5 rem during the initial burn³⁶. Many different shielding schemes were tried during the NERVA program and this particular scheme was found to provide adequate protection at the lowest weight.

Results

For our design we have used a layer of tungsten closest to the reactor to block the gamma rays and serve as a heat shield. Then, a layer of lithium hydride to block the neutrons. This

shielding scheme will provide acceptable radiation levels during the course of a one to two hour burn and will weigh approximately 5,000 kg per engine.

Clustering

There is more than one way in which we can achieve the thrust levels that we will need for our Phobos mission. We have used a cluster of moderately sized engines for our design. This section outlines the advantages of using a cluster of 3 engines, and the safety this will provide.

Except where noted, the data in the following sections came primarily from references ³⁷ and ³⁸.

Discussion of Clustering Advantages

In the following sections, we will outline the advantages of clustering over one large engine. These advantages are: increased reliability, ability to complete the mission with one or two engines out, we can meet a wider range of missions and lower development costs

Reliability

The engines we will use will have a lifetime of around 10 hrs. Our total mission will only call for about 2.38 hrs broken down as follows: 0.91 hr for initial burn, 0.75 hr for Martian system insertion, 0.11 hr for primary phasing with Phobos, 0.11 hr for the primary landing burn, 0.29 hr for trans Earth burn, and 0.21 hr for Earth orbital insertion. As can be seen, this is only 23.8% of the total lifetime. Our reactors will be extensively tested on Earth and should not fail under normal circumstances. However, on a two year mission there are a number of problems which could arise. Primary among these are micrometeorites, however, there could be any number of unforeseen surprises which could disable an engine.

The big advantage of using more than one engine is the redundancy factor. With a single engine, a failure of any kind would disable the entire mission and leave our astronauts stranded in outer space or on Phobos. With three engines, it would be possible (although not desirable) to finish the mission with one or two engines disabled.

Effects of Engine Failure

As stated above, it will be possible to complete the mission with one or more engine failures. The only time during the mission we will need all three engines working at full power will be during the initial burn. This is because we need to have a high Thrust to Weight ratio T/W to avoid large G-losses (see the section on G-losses). After the initial burn we will have used 50% of our fuel and by the time we are leaving Phobos we will have used 75% of our fuel. Therefore, when we are leaving Phobos we will have a T/W that is high enough that g-losses will not be a factor.

Therefore, after the initial burn it should be possible to complete the mission with just one remaining engine and not have g-loss be a factor. This will also be possible within the engines rated lifetime.

Alternate missions

We can meet a wider variety of missions by developing a smaller engine. The prime mission with near future applications is a lunar mission. It would be possible to complete a lunar mission with just one 34,090 kg thrust engine ³⁹.

This would not only be an additional mission for the engine, but would also provide an ideal testing ground. This would serve several purposes. First, a lunar mission would provide an ideal opportunity to verify the operation of the NTR's in a near Earth environment and work out any remaining bugs/problems under space conditions. Additionally, if there was an unforeseen failure the astronauts could possibly be returned to Earth safely. Second, NTR's would be more economical for a lunar mission because they could carry a larger payload fraction than chemical propulsion.

Also, for future Mars missions more engines could be added to increase the payload or decrease the trip time. These options would not be readily available if we developed only one large engine to meet one specific mission's needs.

Development Costs

There are also economic advantages to a smaller NTR. First, smaller facilities would be required to assemble and test the engine. This is important because it would be impossible to do above ground testing on these engines like was in the 1960's. Radiation standards are much stricter than they were 20 years ago and the public would react very negatively to any open air testing of an NTR regardless of the amount of radioactive emissions. Therefore, extensive underground testing facilities will need to be developed so we can adequately test the engine. The cost of such a facility will be greatly reduced if we develop a smaller rather than larger engine.

There will also have to be fewer tests to determine if the system is reliable enough. To achieve a set reliability, say 99.1%, one would have to test a single large engine over 500 times. However, with three engines, we only need one of the three work so the reliability of each individual engine need not be tested as thoroughly. To achieve a reliability of 99.1% with three engines would only require testing one of the engines less than 100 times. Each test not only takes money but it takes time as well. We could achieve significant cost and time savings by developing a cluster concept.

Discussion of Potential Problems with Clustering

While there are many advantages to clustering, there can be some disadvantages. These disadvantages are neutronic coupling of the reactors, neutronic heating of a shut down engine and radiation scattering from the nozzles. This section will outline these issues, how they pertain to Project APEX, and how they can be overcome.

Neutronic Coupling

Neutronic coupling takes place in a cluster of nuclear reactors regardless of the attempts to stop it from occurring. Coupling occurs because some of the neutrons generated in one reactor escape the system and have the opportunity to react with the fuel rods in one of the other two engines. The question is, whether the coupling effect will cause the engines to overheat.

The MNCP model was used to calculate the effects of neutronic coupling between a cluster of three engines. With all three engines operating at full power (1500 MW each) neutronic coupling was responsible for only .01% of the reactions in the engines. During normal operation this is a negligible effect. We will simply have to monitor the engines as one would normally and we should not have any problems during normal operation.

Neutronic Heating of Shut Down Engine

As stated above, neutronic heating should not pose any problems during normal full power operation. One area that a problem could occur would be if for any reason one of the reactors was shut down. This could occur due to a mechanical failure or later in the mission because we will not need the same amount of thrust for the later burns.

The MNCP code was used to evaluate the power levels generated in a shut down engine by the other two engines in the cluster. The result is that the shut down engine will have a power level of .1% that of the other two engines. If the total power in the other two engines is 3000 MW (1500 MW each) the power generated in the shut down engine will be 300 MW. This is very small when compared to the power that these engines are designed to take. In addition, this is an order of magnitude smaller than the decay heat left in a normal engine shortly after shut down from full power. Therefore, the mechanism that we use to remove the decay heat from the reactor (the power turbine) will be more than adequate to offset the neutronic heating of a shut down engine.

Radiation Scattering Between Nozzles

Because we have three engines separated by a short distance there will be some radiation scattering between the engines. This takes place because radiation that is initially heading away from the ship could strike a nozzle and be redirected back towards the ship.

The MNCP program was again used to calculate the effects of radiation scattering. The results showed that only .3% of the total radiation dose was due to radiation that had been scattered from our nozzles or other structures. In addition, this number for our mission will actually be lower than this for all but the final burn. This is because we will have the fuel tanks between the reactors and the crew. This will further attenuate the radiation that bypasses our shields. For the final burn, the tanks will be almost empty, but for the final burn will only last about 12 minutes and the crew could simply stay in the storm shelter during this time.

Analysis

In conclusion, the benefits of using a cluster of small engines instead of one large engine far outweigh the potential problems involved. A cluster of engines will provide increased reliability, an engine out capability to complete the mission, a wider range of mission profiles and lower development costs. The potential problems such as neutronic coupling, neutronic heating of a shut down engine and radiation scattering have been shown to be relatively minor and easily overcome.

Propulsion References

- 1 Sutton, G., *Rocket Propulsion Elements: An Introduction to the Engineering of Rockets*, John Wiley & Sons, New York, 1986.
- 2 Borowski, S., *Nuclear Thermal Rocket Characteristics for Human Exploration Initiative Missions*, AIAA report 90-1949, AIAA/SAE/ASME/ASEE 26th Joint Propulsion Conference, Orlando, Florida, 16-18 July 1990.
- 3 Henderson, B., *New Thermal Propulsion to Speed Rocket Production*, Aviation Week and Space Technology, January 20, 1992.
- 4 Zubrin, R., *Nuclear Rocketry Using Indigenous Propellants*, Analog: Science Fiction & Fact, Date
- 5 Borowski, S., *Nuclear Thermal Rocket Characteristics for Human Exploration Initiative Missions*, AIAA report 90-1949, AIAA/SAE/ASME/ASEE 26th Joint Propulsion Conference, Orlando, Florida, 16-18 July 1990.
- 6 Borowski, S., *Nuclear Thermal Rocket Characteristics for Human Exploration Initiative Missions*, AIAA report 90-1949, AIAA/SAE/ASME/ASEE 26th Joint Propulsion Conference, Orlando, Florida, 16-18 July 1990.
- 7 Gallimore, A., *Space Nuclear Power Sources: A Brief Discussion of Components and Advanced Concepts*, 1988.
- 8 Borowski, S., *Nuclear Thermal Rocket Characteristics for Human Exploration Initiative Missions*, AIAA report 90-1949, AIAA/SAE/ASME/ASEE 26th Joint Propulsion Conference, Orlando, Florida, 16-18 July 1990.
- 9 Zubrin, R., *The Use of Low Power Dual Mode Nuclear Thermal Rocket Engines to Support Space Exploration Missions*, AIAA report 91-3406, AIAA/NASA/OAI Conference on Advanced SEI Technologies, September 4-6, 1991, Cleveland, Ohio.
- 10 Gallimore, A., *Space Nuclear Power Sources: A Brief Discussion of Components and Advanced Concepts*, 1988.
- 11 Kirk, W., Hedstrom, J., Moore, S., McFarland, R., Merrigan, M., Buksa, J., Cappiello, M., Hanson, D., and Woloshun, K., *An investigation of Dual-Mode Operation of a Nuclear Thermal Rocket Engine*, Los Alamos National Laboratory report LA-12102
- 12 Gallimore, A., *Space Nuclear Power Sources: A Brief Discussion of Components and Advanced Concepts*, 1988.
- 13 Kirk, W., Hedstrom, J., Moore, S., McFarland, R., Merrigan, M., Buksa, J., Cappiello, M., Hanson, D., and Woloshun, K., *An investigation of Dual-Mode Operation of a Nuclear Thermal Rocket Engine*, Los Alamos National Laboratory report LA-12102
- 14 Kirk, W., Hedstrom, J., Moore, S., McFarland, R., Merrigan, M., Buksa, J., Cappiello, M., Hanson, D., and Woloshun, K., *An investigation of Dual-Mode Operation of a Nuclear Thermal Rocket Engine*, Los Alamos National Laboratory report LA-12102
- 15 Chi, J., Holman, R., Pierce, B., *NERVA Derivative Reactors for Thermal and Electrical Propulsion*, AIAA report 89-2770, AIAA/ASME/SAE/ASEE 25th Joint Propulsion Conference, July 10-12, 1989, Monterey, California.
- 16 Beveridge, J., *Feasibility of Using a Nuclear Rocket Engine for Electrical Power Generation*, AIAA/SAE report 71-639, 7th Propulsion Specialist Conference, Salt Lake City, Utah, June 14-18, 1971.
- 17 Sutton, G., *Rocket Propulsion Elements: An Introduction to the Engineering of Rockets*, John Wiley & Sons, New York, 1986.
- 18 Borowski, S., *Nuclear Thermal Rocket Characteristics for Human Exploration Initiative Missions*, AIAA report 90-1949, AIAA/SAE/ASME/ASEE 26th Joint Propulsion Conference, Orlando, Florida, 16-18 July 1990.
- 19 Borowski, S., *Nuclear Thermal Rocket Characteristics for Human Exploration Initiative Missions*, AIAA report 90-1949, AIAA/SAE/ASME/ASEE 26th Joint Propulsion Conference, Orlando, Florida, 16-18 July 1990.
- 20 Zubrin, R., *Nuclear Rocketry Using Indigenous Propellants*, Analog: Science Fiction & Fact, Date
- 21 Kirk, W., Hedstrom, J., Moore, S., McFarland, R., Merrigan, M., Buksa, J., Cappiello, M., Hanson, D., and Woloshun, K., *An investigation of Dual-Mode Operation of a Nuclear Thermal Rocket Engine*, Los Alamos National Laboratory report LA-12102
- 22 Beveridge, J., *Feasibility of Using a Nuclear Rocket Engine for Electrical Power Generation*, AIAA/SAE report 71-639, 7th Propulsion Specialist Conference, Salt Lake City, Utah, June 14-18, 1971.

- 23 Pelaccio, Perry, Oeding, Scheil, *Nuclear Engine Design Technical Assessment Considerations*, AIAA report 90-1950
- 24 Borowski, S., *Nuclear Thermal Rocket Characteristics for Human Exploration Initiative Missions*, AIAA report 90-1949, AIAA/SAE/ASME/ASEE 26th Joint Propulsion Conference, Orlando, Florida, 16-18 July 1990.
- 25 Howe, S., *Assessment of the Advancement and Feasibility of a Nuclear Rocket*, 1985.
- 26 Verkin, B.I., *Handbook of Properties of Condensed Phases of Hydrogen and Oxygen.*, 1991.
- 27 Ring, Elliot, *Rocket Propellant and Pressurization Systems*, Prentice Hall, N.J., 1964.
- 28 Zubrin, R., *The Use of Low Power Dual Mode Nuclear Thermal Rocket Engines to Support Space Exploration Missions*, AIAA report 91-3406, AIAA/NASA/OAI Conference on Advanced SEI Technologies, September 4-6, 1991, Cleveland, Ohio.
- 29 Koster, Jean N. and Sani, Robert L., eds., *Low Gravity Fluid Dynamics and Transport Phenomena*, AIAA Progress in Astronautics and Aeronautics, Vol. 130, 1990.
- 30 Heller, William, ed., *Low Gravity Propellant Orientation and Expulsion*, AIAA Lecture Series, Vol. 6, Western Periodical Co. 1985.
- 31 Heller, William, ed., *Low Gravity Propellant Orientation and Expulsion*, AIAA Lecture Series, Vol. 6, Western Periodical Co. 1985.
- 32 Pelaccio, Perry, Oeding, Scheil, *Nuclear Engine Design Technical Assessment Considerations*, AIAA report 90-1950
- 33 Pelaccio, Perry, Oeding, Scheil, *Nuclear Engine Design Technical Assessment Considerations*, AIAA report 90-1950
- 34 Segal, B., *Chemistry: Experiment and Theory*, 1985.
- 35 Howe, S., *Assessment of the Advancement and Feasibility of a Nuclear Rocket*, 1985.
- 36 Howe, S., *Assessment of the Advancement and Feasibility of a Nuclear Rocket*, 1985.
- 37 Houts, Michael, and Buksa, John, and Bohl, Richard(1992), *Nuclear Thermal Rocket Clustering I: Monte Carlo Analysis of Neutronic Thermal, and Shielding Effects*, 9th Symposium Space Nuclear Power Systems, American Institute of Physics
- 38 Houts, Michael, and Buksa, John, and Bohl, Richard(1992), *Nuclear Thermal Rocket Clustering II: Monte Carlo Analysis of Neutronic, Thermal, and Shielding Effects*, 9th Symposium Space Nuclear Power Systems, American Institute of Physics
- 39 Borowski, S.K.(1991), *The Rational Benefits of Nuclear Thermal Rocket Propulsion for NASA's Lunar Space Transportation System*, AIAA-91-2052

Chapter 7

Power

7.0 Summary

7.1 Power Generation System

7.2 Electrical Power Transmission and
Distribution

7.3 Backup Power Source

7.4 Thermal Control System

Summary

This chapter of project APEX involves the final design of the power source, its transmission, distribution, and thermal control for the Wolverine. Our layout was evaluated for its efficiency and feasibility.

The design of our system was centered around five major design constraints. These are: reliability, weight, commonality, space and cost of the entire project. Each one put limitations on the actual design of our system. Around this criteria we designed our system and formulated our model.

This report is arranged into four distinct sections, each with its own design scheme. These are:

1. The initial power generation system
2. The electrical power transmission
3. Back-up power source
4. Thermal control systems

Due to the levels of power and lifetimes needed for project APEX, a nuclear reactor power source is best suited for electrical power generation. By using a dual mode (propulsion/electric power) nuclear reactor system connected to a Brayton cycle generator, we achieve weight reductions and increased reliability through redundancy. A maximum power output of 200 kWe can be generated at the source.

The electric power generated at the source is distributed through two transmission lines; one serving as a primary, and the other as a backup. Both lines distribute power independently through three busses each (six total). The transmission voltage is 270 VDC. The total power needed by users is 138.5 kWe with a required power at the busses (power available before conversion) is 175 kWe.

Power conversion in our system is achieved through the use of modular, low power converters interconnected to handle large amounts of power and to match the needs of the users. The estimated total mass of the six distribution busses (three primary, three backup) is 970 kg.

For the periods of propulsive burns, the dual mode reactor cannot provide electric power. During these periods, a regenerative, hydrogen-oxygen fuel cells will supply 20 kWe for basic life support and total control capability of the spacecraft. Between burns, the fuel cells regenerate the water produced back into hydrogen and oxygen, thus providing power for all the required burns.

Waste heat is controlled by three separate thermal control systems. Waste heat from the dual mode reactor will be extracted by heat pipe radiators using Helium-Xenon as the working fluid. The total area of the radiators is 146 m² with a total weight of the dual mode reactor radiators of 2000 kg. The waste heat from the habitation module will be radiated by heat pipe radiators with a working fluid of Ammonia. The total area of the radiators is 146 m² with a total system weight of 2200 kg. Black Nickel Chromium or Aluminized Kapton will coat the exterior of the habitation modules to passively control solar radiation.

PRECEDING PAGE BLANK NOT FILMED

178 INTENTIONALLY BLANK

Power Generation System

One limiting factor on future space missions is the amount of available power. Interplanetary missions and return missions to the Moon will require power levels considerably higher than those used in the past. This has led to further research on advanced power sources.

Design Requirements

The main power source must be able to provide the necessary electricity for normal and peak demands by all onboard systems.

System power requirements are as follows:

Life Support Systems	11 kWe
Communications and Computers	6.5 kWe
Cryogenic Cooling of Fuel Tanks	96 kWe
Experiments, Lighting, misc.	24 kWe
Active Thermal Control System	.5 kWe
Total	138 kWe

When an efficiency of 85% for the distribution system is factored in, the main power source must be able to provide 175 kWe of electricity and keep this level as continuous as possible. The year 2005 is the final date at which the source has to be technologically ready in order to allow ample time for construction. Finally, the main power source must be as light as possible.

Dual Mode Nuclear Thermal Rocket

The Dual Mode Nuclear Thermal Rocket (DMNTR) (*Figure 7.1*) is a modified nuclear thermal rocket (NTR) which provides both the ship's propulsion and electrical power. An NTR must have a cooling system to keep the reactor and nozzle from melting. This is accomplished by running the propellant through cooling pipes in the reactor core and on the nozzle. The propellant is then fed through the reactor core again and is expelled out the nozzle. Power is produced by adding a turbo-brayton cycle to the coolant system. During electrical production, Helium-Xenon (He-Xe) is fed through the coolant system instead of the hydrogen used for the propulsive burns. The He-Xe passes through the reactor's cooling pipes and is routed to a turbine to produce power. From the turbine, the He-Xe is passed through heat pipes to radiate the heat and traverses back into the reactor's coolant system. This differs from the propulsive burns in that the cycle is closed. Power can not be produced during a burn because the He-Xe mixture can not remove enough heat to keep the engine cool. During the propulsive burns the power will be produced by a hydrogen oxygen fuel cell.¹

Project Apex will use three nuclear thermal rockets that are designed for dual mode capability. Only one reactor will be necessary for power production, the other two reactors will be used as backups. Each reactor will have its own coolant system with turbomachinery but will share a common radiator. Individual radiator systems would be too heavy.

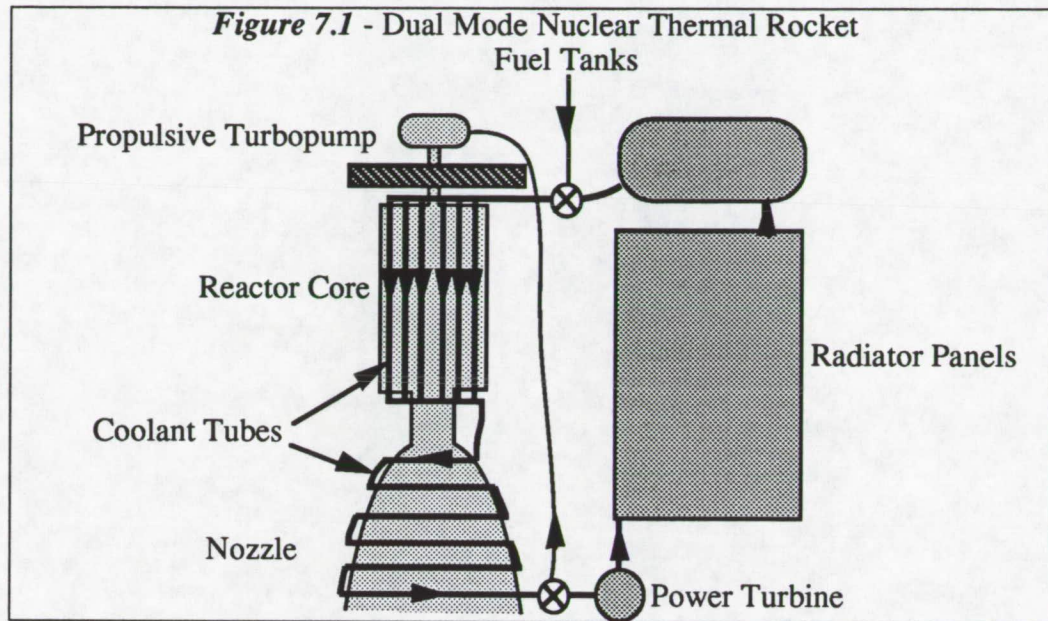

There are several benefits in using a DMNTR instead of having a separate power reactor. A separate power reactor would require additional radiation shielding and safety concerns. This additional shielding would make the separate power reactor system heavier.

Other Options

There are four main systems for power generation that can be used in space:

1. Solar photovoltaic cells
2. Solar dynamic cycles
3. Fuel cells/Batteries
4. Nuclear reactors

The solar-based systems have the advantage in that they are lightweight, but they will not be feasible because the spacecraft will be spinning to provide artificial gravity. Also, solar cells become less effective as time goes on due to degradation and radiation. Micrometeorites also cause the effective area of the solar cell to decrease with time. Fuel cells and batteries are better suited for lower power levels and storage systems. Nuclear reactors are the most attractive system because of their high power output and competitive weight. The different power sources and their power output versus their life time is shown in *Figure 7.2*.

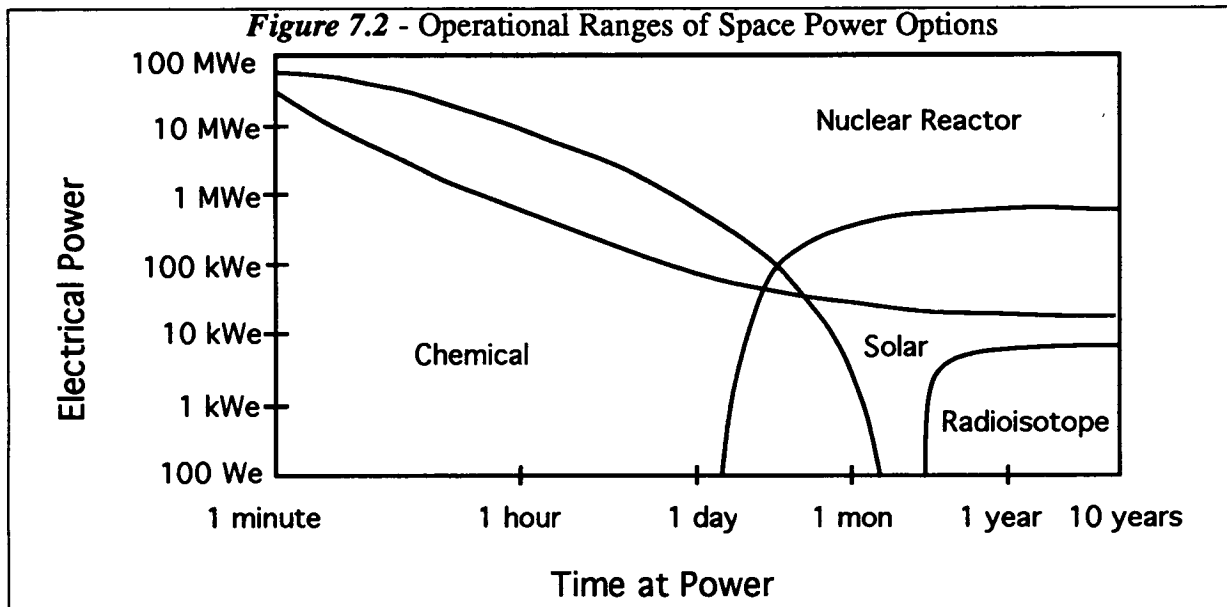

Solar Photovoltaic Cells

Solar photovoltaic cells convert light directly into electricity. This method has been used on several spacecraft including the majority of all earth-orbit satellites. There are, however, several critical drawbacks. Solar cells are lightweight but require a heavy storage system during shadow periods. In order to provide artificial gravity for the astronauts, the spacecraft will be spinning end over end. This will make it extremely difficult to keep the solar cells oriented towards the sun. Also, the amount of solar power drops to 44% of Earth's level near Mars due to the increased distance from the sun. This figure was found by comparing the solar constant at Earth of 1.37 kWe/m^2 and at Mars of $.593 \text{ kWe/m}^2$.² To provide 175 kWe at that distance, the solar array would have to be much larger than anything previously attempted. The spinning of the ship and the large amount of power required significantly reduces the feasibility of solar photovoltaic cells.³

Solar Dynamics

Solar dynamic systems are related to solar photovoltaic but involve collecting and focusing sunlight on a heating element. This in turn heats a liquid which is run through a turbine to produce power. This system takes up less room than solar cells and would have approximately the same weight. It has been considered for use on Space Station Freedom, but will probably not be technologically ready. Solar dynamics also require more precise alignment with the sun than solar cells. The spinning of the spacecraft makes this option impossible.⁴

Fuel Cells and Batteries

Fuel cells 'produce' energy by combining hydrogen and oxygen to make water. The water can then be split into its two original components, and the cycle starts over. This process is inefficient and heavy at our power levels. Batteries also have the same disadvantages. These systems are most efficiently used for low power levels or for storage of emergency power. A

175 kWe battery or fuel cell system would be massive. This prevents fuel cells and batteries from being considered for the main power source.⁵

Other Nuclear Reactors

Nuclear reactors have the advantage in that they can easily produce the large amounts of power required for interplanetary missions and outposts. They also produce their power continuously and are not affected by the movement of the spacecraft. The drawback is that shielding is required on manned missions to protect the crew members from radiation. This leads to increased weight. The SP-100 is one of the current U.S. space nuclear reactor being designed. Its projected weight is 4000 kg at 100 kWe and has a estimated lifetime of 7 years. Through modification of the energy conversion subsystem, the reactor can be scaled to produce over 1 MWe of power. This is attractive for outposts on Mars, Phobos and the moon. On a spacecraft though, the mass needed to provide adequate shielding severely limits its attractiveness as a system. Another option for the nuclear power source is the former Soviet Union's Topaz nuclear reactor. The Topaz is a small thermionic space nuclear reactor that produces 40 kWe. This system has the same mass problems as the SP-100 in the case of human shielding. The low power level also hinders the Topaz from being a serious candidate for the main power source.^{6 7}

Summary of Power Generation

Our electrical system design required that 175 kWe of electrical power be produced for use throughout the ship. This source had to be as light as possible while at the same time be reliable and manageable. For these reasons we chose the DMNTR to generate our needed power.

Electrical Power Transmission and Distribution

In the previous section, we defined the method used to generate electrical power. This section explains how the power is transmitted and distributed to the users throughout the ship. Defined in this report are the following:

- 1) Current Shape (AC or DC)
- 2) Voltage Level
- 3) Cabling and Insulation
- 4) Distribution Layout
- 5) Power Conversion

Basic Transmission Layout

The dual mode nuclear reactor produces 175 kWe of electric power. This energy is transmitted over a 100 meter distance from the reactor to the habitation modules. In order to achieve this, the electric current is shipped at high voltage to the various busses and systems through a main transmission cable. All transmission lines and systems contain redundant counterparts.

AC vs DC Distribution.

The turbine at the ship's main power source produces an AC current at a frequency and voltage level determined by the specific turbine/alternator used. However, a direct current system seems to be the most advantageous and practical method of distribution and transmission.⁸

Alternating current systems provide an efficient and lighter mode for the distribution of the main power generated by the source. The converters and other hardware involved are better suited for our needs. In our studies we found that the alternating current system (20 kHz) is lighter than a direct current system due to the smaller power conditioners.

However, there are five more dominant disadvantages that are present with this alternating current system when compared to a direct current system.

- AC systems are much more expensive than DC systems. DC has been used more extensively in previous space programs and electrical parts have already been designed for our needs.
- AC systems have not been proven very reliable while DC has. This is also due to the widespread use of DC space systems.
- The fault tolerance in AC systems is less than in DC, which is of extreme importance in our case because of the reliability lifetimes that are needed in such a long journey.
- The complexity of integration involved with AC. Magnetic effects produced by AC systems complicate the project, requiring a long and expensive testing period to accommodate for these effects.
- AC systems provide worse power quality than DC systems. All of these disadvantages make our decision to go with a direct current transmission system obvious.⁹

Voltage Level

The AC signal produced by the turbine at our power source will be rectified and converted to a DC current of 270 volts. This will be done by a basic AC/DC transformer. The three driving factors behind our choice of bus voltages are the total mass of the system, the availability of existing power components, and the efficiency of the whole transmission from the source to the user end.

The change in the transmission cable mass is largely dependent on the bus voltage level that we choose to supply. This is because resistance is inversely proportional to the cross sectional area and voltage is proportional to resistance. Therefore, voltage is inversely proportional to the voltage. Increasing the bus voltage decreases the main transmission cabling weight for any power level. The most dominant mass change is seen when the bus voltage increases from a low level to above 100 volts. A voltage of 270 volts was chosen over any other voltage level because above this value, mass savings reduce to a negligible amount. In short, increasing the voltage above this 270 voltage level will not decrease the system mass dramatically.¹⁰ This is illustrated in *Figure 7.3*.

Another limiting factor in determining the bus voltage is the availability of existing electronic parts. Most of the common components such as switching MOSFETS are rated up to 500 volts. With our choice of 270 volts, integrating existing components should not hinder our system.¹¹

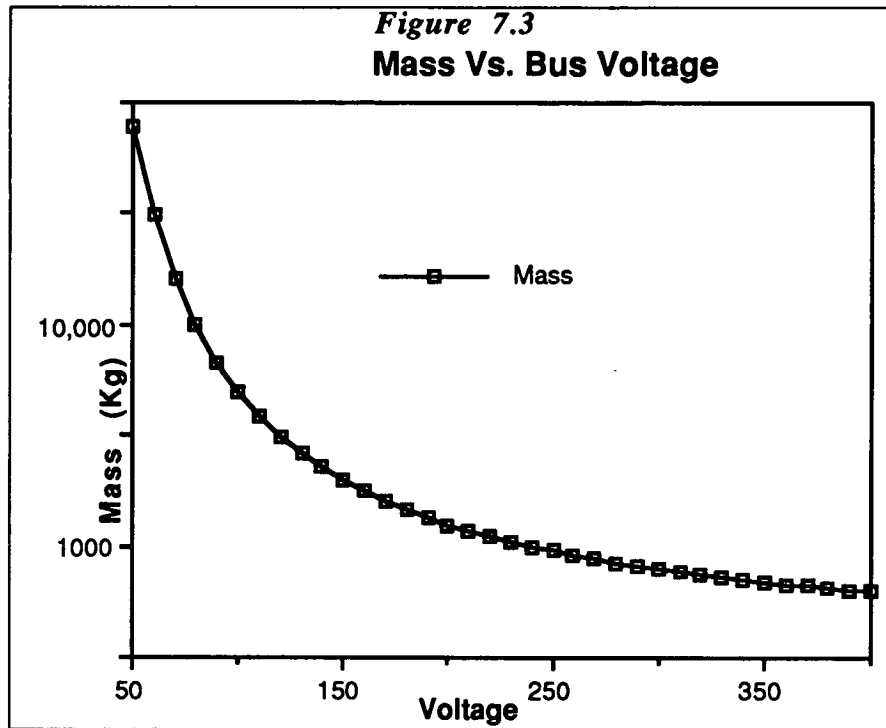

A final consideration in determining the bus voltage is the efficiency losses produced by such environmental concerns as corona inception, and plasma loss. Corona inception is at the worst case scenario when the bus voltage is approximately 307 volts. This is a lower limit, and any voltage under this is not significantly affected. Plasma loss, however, is insignificant due to the space vacuum conditions in which we will be travelling.¹²

Power Cable

Power Cables of the Wolverine's power system were designed in accordance with the specifications presented in the NASA Military Standard 975 and 978 handbooks on power cabling design. These cables will be the main transmitters of the ship's electricity.

Conductor Materials

The conductors will consist of pure copper and aluminum strands spun together to form a power cable which will support the loads of the system.

The material specifications for the power cables for use on the Wolverine were selected with three basic criteria in mind: flexibility, durability, and conductivity. These properties of the conducting material are important considerations when employing the conducting media in such a hostile environment and when losses have to be minimized.

The main power cables responsible for transporting the bulk of the ship's power will consist of multiple strands of copper and aluminum. Each individual strand will be very small (~.5 mm dia) relative to the diameter of the stranded cable itself. The overall diameter of the stranded cable is 10 mm assuming a constant efficiency of 85%. By introducing multiple strands of relatively small diameter, the overall flexibility, durability, and conductivity are improved.

Flexibility is important in routing the cables and increases freedom of moving them once they are in place. By stranding the cable, the smaller individual wires as a whole are much easier to bend than larger stands or a large single strand. Hence flexibility is increased greatly. Also, the recovery of wire to its original shape without damage to the cable is improved.

Durability is important in overall longevity of the transmission system during operation in normal and hostile environments. The power cables must be able to withstand demands put on them by the ship as well as by space. The copper and aluminum strands combined in a stranded construction increases the durability of the cable by providing a redundancy in the cable sections which may be subject to extreme conditions. The aluminum strands spun in with the copper strands tend to strengthen the cable.¹³ Other material properties of the copper, such as ductility, provide durability in instances where the cable would sustain impact.

When determining the size of the electrical power plant and the overall efficiency of the power system one must consider the conductivity of the material being used in the conductors. The conductors on the Wolverine were selected to yield the highest efficiency with the least increase in mass. To obtain this, pure copper was chosen for the main conducting media. Copper has a conductivity of $5.917 \times 10^7 \text{ } (\Omega * \text{m})^{-1}$. The aluminum strands also provide exceptional conductivity ($3.636 \times 10^7 \text{ } (\Omega * \text{m})^{-1}$) and are used to strengthen the cable.¹⁴ Pure copper conductors are used for the larger wires to support the bulk electrical loads and, as in the case of the Wolverine, where the wire resistance is an important consideration.

Insulation

Conductor insulation of the Wolverine's power system was designed in accordance with the specifications presented in the NASA Military Standard 978 handbook on wire and cable design and insulation.

Insulation for the electrical power system will consist of a fluorocarbon resin/polyimide insulation in the form of a spirally wrapped tape around the wire. Polyimide will be the main insulating component of the insulation. Minimum overlap around the conductor will be 50%. A second tape will be wound in the opposite direction of the first consisting of the same overlap percentages. A continuous coating is formed through the use of a sintering process of the tape wrappings. This insulation was chosen because it meets NASA Military Standard 978 specification for space applications.¹⁵

Polyimide, also referred to as "Kapton", has favorable characteristics with regard to spaceflight applications. Its temperature rating, tensile strength, flammability characteristics, low weight and long life make it an excellent material for use in a space applications. Wire insulated with polyimide is relatively stiff. This is advantageous in the assembly of the wire harnesses and vibration isolation.¹⁶

The most important consideration involved in our cabling system design is the total mass. Using basic physical equations based on the density of Copper, Aluminum, and Polyimide

along with the volume of cabling needed, we arrived at a total mass for the conductor system of 497 kg. 422 kg for the cables and 75 kg for the insulation.^{17 18 19}

Summary of the Transmission System

After the power is generated by the DMNTR, it is transmitted from the reactor to the user loads. This is accomplished by running the power through a Copper/Aluminum cable with Polyimide insulation at a voltage and current level of 270 volts DC. This transmission system was shown to be the overall best design because of various reasons including mass, reliability, and cost.

Distribution Layout

The electric power will be distributed through a series of transmission cables and busses to specific users. The main features of the transmission system are shown in diagram 1. This system consists of a primary and a secondary line. Both lines will be able to independently provide 100% of the power needs of the spacecraft and provide contingency in the event of a complete failure in one of the lines. Each line supplies three main power buses, deemed A, B and C (six in total, three for each transmission line). Bus A provides power for the propulsion control computers and is located near the main propulsion engines. Bus B is for the refrigeration of the fuel tanks, and is located next to the fuel tanks. Finally, Bus C distributes electricity to the habitation module systems: life support, thermal control, experimental systems, and communications. Bus C is located next to the habitation modules. The fuel cell is connected to buses A and C to supply power during propulsive burns.

Power Conversion

The main power cables transport the total power of the ship at a transmission voltage of 270 VDC. This voltage is very efficient for the main transmission of power, but has extreme limitations when the power must be distributed to the user. The many different loads that are present on the ship require a wide range of voltage levels (see *Table 7.1*). With this in mind, a scheme for converting the power to usable voltage levels must be employed. To accomplish this, a three bus modular conversion system has been developed. This system will be discussed in the following section.

Voltage Level Breakdown

Each bus converts the main transmission voltage (270 VDC) to the voltage level required by each particular user (see *Table 7.1*). This voltage conversion is achieved via small, low-power, standardized, modular converters connected together to handle the large power requirements of each bus. Modular converter design results in greater efficiency and flexibility of power level conditions.²⁰ Use of modular conversion design allows us to supply different voltage levels from the same bus according to the application needs of the user. Furthermore, modular conversion design results in a decrease in costs due to mass reductions and decreased development costs.

Voltage levels	Applications
5 Volts DC	Computers, logic circuits
± 15 Volts DC	Control Electronics
28 Volts DC	Instruments, other control devices
270 Volts DC	Tank Refrigeration
400 Volts DC	Communication/Transmission

Converter specifications

At the ship's total operational capacity, a tremendous amount of power capacity to feed the individual user loads will be needed. In the past, single, large power converters were used to achieve this function. However, it is our plan to incorporate an advanced modular design to supply the power at an increased efficiency.

This design was chosen because of the large single converter's inefficiency in power conversion, mass, and cost for the power levels encountered in the our system.

The modular design uses small integrated power converters to raise or lower the voltage level supplied to the user. These converters take the input voltage level and switch its polarity at a specified high frequency, thereby creating an alternating current. The signal is then converted to a lower or higher voltage by the use of small transformers integrated into the converter. This new signal is then rectified to a DC signal which is then supplied to the user.

The converters themselves each operate at power levels between 100 and 250 watts. The mass of these converters is estimated at 3.402 kg/kWe of power which are from the specifications shown by Krauthamer, Gangal, and Das. All modules operate have an input voltage of 270 VDC, converting this to four different output voltages depending on the use of the electric power. These applications are listed in *Table 7.1*.²²

Overall, this system proves to have many advantages over the bulk system approach in converting power. As stated earlier, there is an efficiency increase, contingency is incorporated, an easy manufacturing plan develops, and the value of the systems load capacity is cut down.

Efficiency Improvements

The major improvement in the system's efficiency is in the theory of partial loads. When the system is running at peak loads, the efficiencies of both systems are similar. When the total load is at only a percentage of the maximum, however, the modular system's efficiency becomes much greater than the single module converter system. This is because at low levels of power output, losses due to the drive of the converter tend to dominate the system. Therefore, operating the converter below its rated power level results in reduced efficiency. With the modular approach, this problem can be controlled. If the user requires only a percentage of the maximum load, the converters can be connected in parallel to accommodate for large differences in power needs. The converters will be used only according to the amount of power needed to be converted. Therefore, the efficiency of the system is increased.²³

System Contingency

With a modular approach, the design becomes much more reliable and workable. The converters will be manufactured so that, in the event of failure, the other converters will be able to handle the power needs. Also, if necessary, these converters will be replaceable. Consequently, the converters themselves will be very reliable because of their replacement capability.

Manufacturing Plan

Since these modules are small and simple, the initial design will not be as massive as a single large converter. Once the prototype is designed, the others can be duplicated on an assembly line. This gives the modular approach a tremendous advantage in cost over a single converter system.

Mass Savings

The mass of the system is related to the figure of merit of the converters. This figure of merit is basically the product of the power and the switching frequency of the modules, and is given in watts per second. Progressively higher frequencies lead to lower magnetics which leads to a lower overall mass. Mass reductions continue until the frequency reaches approximately 2 MHz. This is why the converters have been designed to meet optimum mass reductions.²⁴

Bus Distribution Breakdown

A bus distribution system is required to transmit the loads to various parts of the ship. The loads are located at three sections of the ship: the reactors, fuel tanks, and habitation modules. At the reactors, computers are needed for constant control. The fuel tanks require cooling by refrigeration to lower the amount of fuel boil off. Finally, a bus system is placed near the habitation modules to distribute the remaining power to life support and all other operational needs. See *Figure 7.4* for an illustration.

Bus A.

Bus A supplies the propulsion control computers with 2 kWe of power. This bus converts the initial 270 VDC into a 5 VDC signal. The conversion system will consist of 30 converter modules, each operating at 100 We at 85% efficiency.²⁵ The load capacity of the converter system is 3 kWe. The required power input to bus A is 2.36 kWe, and the estimated mass is 15 kg.

Bus B

Bus B will deliver 270 VDC. Although no voltage conversion is required at this bus, some kind of regulation and conditioning is needed. The total estimated conditioning and cabling mass is 100 kg. With an estimated efficiency is 85% the total power required is 113 kWe.

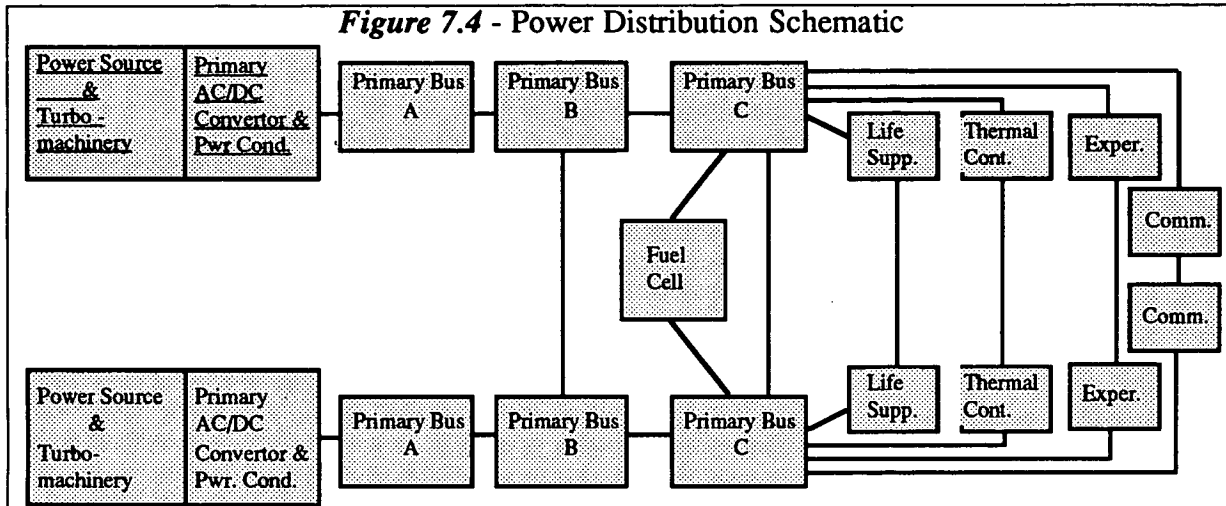

Bus C.

Bus C will supply the habitation module with a total of 40.5 kWe of electric power. It will split power among four sub-busses: life support, thermal control, experimentation and communications.

- Life Support

The life support sub-bus will supply 11 kWe of power to control computers, control electronics, and life support hardware. This bus will have three types of converter modules converting to voltage levels of 5, ± 15 , and 28 volts. 3 kWe of power will be supplied at 5 volts for the main control computers. 5 kWe of power will be supplied at ± 15 volts for control electronics. Finally, 3 kWe of power will be delivered at 28 volts for other life support electronics and hardware.

The conversion system will consist of 100 converters (45 for 5 VDC, 30 for ± 15 VDC and 25 for 28 VDC). The total power output and load capacity is 11 kWe and 17 kWe respectively. The required power input is 12.94 kWe. The total converter efficiency is 85%. Total estimated converter mass is 60 kg.

- Thermal Control

The thermal control sub-bus will supply 0.5 kWe power at 28 volts for thermal control hardware. This will require 5 converter modules rated at 200 kWe and 85% efficiency. The total load capacity is 1 kWe. The input power required is 0.6 kWe. The total mass of the converter is 3.5 kg.

- Communications

The communications sub-bus will supply a total of 5 kWe, 3 kWe at 28 VDC and 2 kWe at 400 VDC (antennas). The conversion system will consist of 75 converter modules (25 for 5 VDC, 85% eff. and 30 for 400 VDC, 80% eff.). The load capacity is 8 kWe. The required input power is 6.03 kWe. Total estimated mass of the conversion system is 30 kg.

- Experimentation

The experimentation sub-bus will supply a total of 24 kWe. The conversion system will use two types of converters to supply voltage levels of ± 5 and 28 VDC. This will require 205 converters (45 for 5 VDC, 85% eff. and 160 for 400 VDC, 85% eff.). The required power input and load capacity of the conversion system is 28.5 kWe and 36.5 kWe respectively. Total mass of the conversion system is 125 kg.

Bus C will have an estimated total conversion mass of 220 kg. The power required by bus C is 48.07 kWe. The total converter efficiency is 83% and the total load capacity is 62.5 kWe.

Bus C will require cabling between the converter units and the user. This will increase the mass significantly. A rough estimate of cabling mass for this section is 150 kg. However, it is not expected to be higher than the total mass of the conversion system.

Summary Of Power Distribution

The total estimated conversion mass of the primary busses A, B and C is 370 kg. The total bus mass depends on the cable mass required from the converters to the user, for which only rough estimates exist. Therefore, total mass of the three primary busses is approximately 485 kg. The backup A, B and C busses are identical to the primary busses. The estimated total mass of all six busses is 970 kg.

The total conversion system is made up of 415 converter modules delivering 138.5 kWe through three main busses. The required power to the busses is 163.43 kWe. Total conversion efficiency of the converter system is 84.7%.

Backup Power Source

Redundancy for power generation is accomplished through multiple Dual Mode Nuclear Thermal Rockets (DMNTRs). On the outbound portion of the mission, there will be 3 DMNTRs that will have the capability of producing the necessary amount of power. After leaving Phobos, there will be 2 DMNTRs on board. This should provide sufficient redundancy of the electrical powerplant.²⁶

The design of the DMNTR does not allow power production during a burn. The He-Xe working fluid to drive the power-producing turbines does not adequately remove the excess heat when the reactor is running at full power. This requires the use of a backup power source to provide electrical power during the burns. The maximum amount of time that power from the DMNTR would be unavailable for electrical power generation would be approximately 6 hours.²⁷

Design Requirements

A backup source must be able to provide the minimum required power for ship operation. During the operation of the backup power source, life support will be given priority, followed by communications and computer systems. The backup power source must be capable of providing 20 kWe.

The difference between normal life support and minimum life support is that minimum life support does not recycle the waste from humans. It is the absolute minimum amount of life support required to keep the crew alive.

Minimum life support	6-7 kWe
Normal life support	11 kWe
Communication and Computers	6.5 kWe

Depending on the power necessary for life support, the remaining power would be available for lighting, experiments, etc.

The total amount of time needed for the backup power source to be used is determined by the length of the propulsive burns. It takes approximately 60 seconds for a Nuclear Thermal Rocket to reach full power. The propulsive burn itself should last under 30 minutes in the case of normal operation. If a propulsive burn is undertaken at less than full power or with fewer engines, the burn time could reach up to 1 hour. It then takes the nuclear reactor approximately 2-3 hours to cool back down to a usable level. Overall, the entire burn sequence lasts approximately 3-4 hours. For an added measure of safety, the backup power source should be able to provide adequate power for 24 hours.

This system should also be lightweight.

Backup Power Source

Project Apex will be using a regenerative $H_2 - O_2$ fuel cell system containing two individual fuel cells to provide backup power to the DMNTR. Each fuel cell will have the capability of providing 20 kw of electric power. During normal operation, only one fuel cell will be used, the second fuel cell is in case of a failure. Combined, this system will be able to provide the 20 kw for up to 24 hours. A fuel cell system was chosen because it is lighter than batteries, capable of higher power levels, and more suitable to the lengthy charge times encountered on this mission. Water based fuel cells are the most common type of fuel cell currently being used. It combines H_2 and O_2 to produce water and electricity. This gives fuel cells an advantage in that it can be integrated with the life support system. This fuel cell system will also be regenerative, allowing the fuel cell to convert the water produced back into H_2 and O_2 through electrolysis.²⁸

Fuel cells have been used in space since the Mercury space program and are currently being used in the Space Transportation System. Another type of fuel cell is the H_2Br_2 system. It has a higher efficiency but is corrosive and potentially dangerous.²⁹

The weight breakdown for this system can be seen in *Table 7.2*.

Fuel Cells (2)	700 kg
Oxygen	500 kg
Hydrogen	26 kg
Miscellaneous	120 kg

This weight does not include the heat rejection radiators. The heat rejection radiators are covered in the thermal control system.^{30 31}

Other Options

There are several other candidates for the role of backup power source. The most notable are battery based systems. Batteries include IPV NiH₂, Bipolar NiH₂, NaS , and NiCd.

Other options such as integral flywheels, magnetic energy storage, and thermal energy storage are attractive but will not be feasible by the mission launch date.³² See *Table 7.3* for specific energies of backup power sources.

	1988	2000+
NiCd Battery	10 - 20	NA
NiH ₂ Battery	50	80
NaS Battery	NA	100
H ₂ -O ₂ Fuel Cell	30	180
Capacitor	10	20
Flywheels	5	20 - 30
Magnetic Energy Storage	30	85
Thermal Energy Storage	NA	125

Batteries

Battery systems, such as NiCd, have been used extensively in small satellites. Currently, advanced batteries such as IPV and Bipolar NiH₂ are more efficient and have higher specific energies than fuel cells. The major drawback is that batteries tend to be heavy and a system designed for Project Apex would be too massive. Batteries also have the problem in that they slowly discharge when not in use. One solution to this problem is the NaS battery. The NaS battery is designed not to discharge when not in use. The disadvantage of this system is that it requires a complex thermal management system.³³

Thermal Control System

Many elements producing heat on the spacecraft. However, the majority of this heat cannot be recycled into productive and efficient uses. Therefore, the waste heat must be managed. If waste heat is not properly managed, the spaceship will heat up and could result in the death of the crew members and structural fatigue of the spacecraft. Waste heat will be generated by the Dual-Mode Reactor, the Habitation Modules, and by the absorption of solar radiation on the outside of the ship. Waste heat will be managed by efficient use of radiator systems and passive thermal control.

Design Requirement

The systems must be capable of rejecting the following amounts of thermal heat:

Habitation Modules	50 kW _{thermal}
Dual Mode Propulsion	1.16 MW _{thermal}

Also, the system must be capable of heat rejection while the ship is rotating. The radiating surface must be designed in such a way to achieve a high probability of success in a meteoroid environment. It should be small, light weight, space tested and must be ready by the year 2005.

Heat Pipe Radiators

A diagram of the general configuration of a heat pipe radiator panel is given in *Figure 7.5*. The major components of this heat rejection system are the thermo-electric pump, piping and bellows, flexible joints, radiator duct, heat exchanger, and the heat pipes. The radiator consists of side-by-side working fluid supply and return ducts, to which heat pipes are bonded or brazed. The heat pipes are titanium extrusions encased in a carbon-carbon composite for protection from micrometeorite damage. The critical technology which needs to be developed is this bonding of titanium to the carbon-carbon composite and enabling the joint to endure under years of high temperature exposure. During operation, the thermal transport loops transfer heat to the heat pipes by conduction in the heat exchanger. The working fluid "flows" from the heat exchanger along the supply ducts of the pipe, distributing the heat along the length of the pipe. Heat is then spread from the heat pipes to the surface of the radiator panels for rejection to space. Through capillary action, the working fluid of the system returns to the heat exchanger as a vapor through the return ducts, to begin the cycle again.

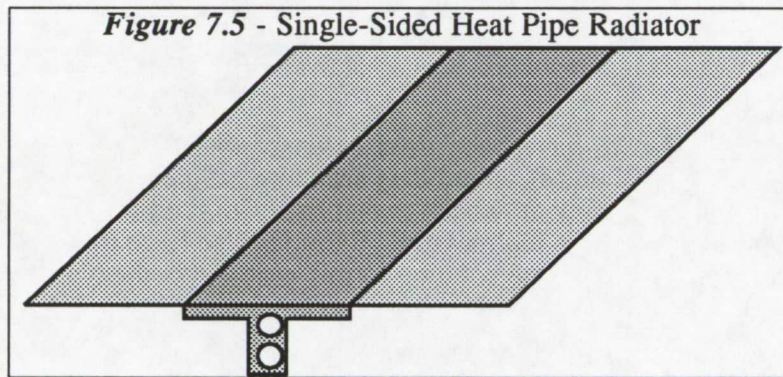

Now the appropriate grey body sizing equation for determining adequate surface rejection area for these radiators is:

$$S = \frac{\text{kW}_{\text{rejected}}}{\epsilon \times C_0 \times T^4}$$

where

- C_0 = radiation constant of black body (5.669×10^{-11})
- S = surface area
- ϵ = emissivity of the chosen surface material
- T = temperature in degrees Kelvin

It is apparent then that heat can be most efficiently radiated with a material of high emissivity and with which, is rejected at a high temperature. For each system it is advantageous to seek the highest emissivity for a material coating, and to reject the heat at the highest temperature possible. However, heat can be rejected from a radiating surface only at temperatures lower

than the temperature at which it is initially given off. It is evident, then, that different systems will be used to optimize each system.³⁴

Habitation Modules Thermal Control System

The working fluid for the radiators of the habitation modules is Ammonia. Emissivity of the panels is 0.8. There will be 4 systems of 12 single sided radiator panels, for a total of 48 panels and total area of 146 m². The total peak heat rejected will be 50 KW_{th}. The actual sizing for the radiators is 126 m², which gives us an extra 20 m² for redundancy. The heat generated by the use of power in the habitation modules is, in general, at a low and varied temperature. Four separate loops accept and reject heat at four different temperatures. The rejection temperatures are 275 K, 294 K, 304 K, and 319 K. Isothermal requirements for the customer's thermal control and the capability to adapt to highly variable thermal loads have led to more advanced thermal management system concepts. These concepts take advantage of two-phase fluid properties including an enhanced thermal capacity (latent heat of vaporization), improved heat transfer coefficients, decreased pumping power requirements, and reduced fluid inventory. The habitation modules' active thermal control subsystem is composed of

- (1) two phase ammonia external thermal transport loops, which transport the heat load from the habitation modules and the power subsystem, and
- (2) two phase water loops internal to the manned modules which transport heat from the equipment and experiment coldplates to the module/external thermal loop interface heat exchangers.

For the weights of the system see *Table 7.4*.

Radiator	880 kg
Internal Transport	620 kg
External Transport	800 kg
Total	2200 kg

The external and internal thermal transport loops for the manned modules are segmented into three separate temperatures levels (275 K, 284 K, and 305 K), to reduce radiator surface area and enhance the isothermal characteristics of the thermal management system. Included is an additional loop which runs hotter (319 K) and rejects the waste heat from the fuel cells and the power subsystem. *Figure 7.6* shows a schematic of the layout for the thermal control systems in the habitation modules.

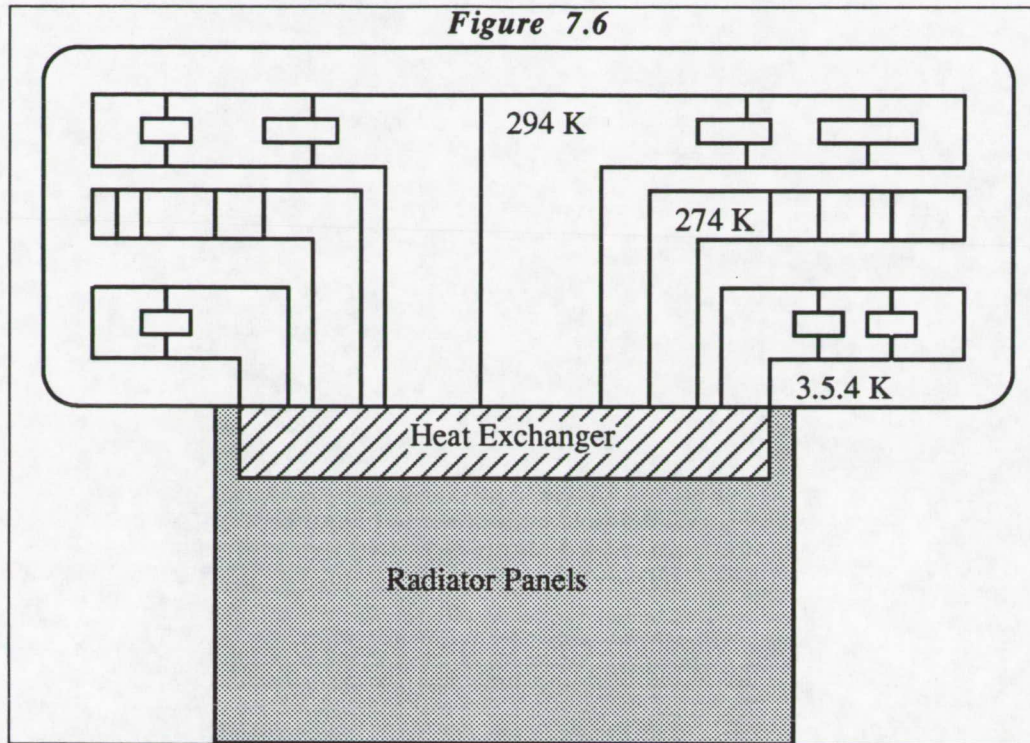

Propulsion Dual Mode Reactors Thermal Control System

The working fluid of dual mode reactor radiators is Helium-Xenon. Emissivity of the panels is 0.8. There will be 4 systems of 12 single-sided radiator panels, for a total of 48 panels with a total area of 146 m². The total heat rejected will be 1.16 MW_{th}. The actual sizing of the radiator panels is 137 m² which allows an extra 9 m² for redundancy. The rejection temperature is 690 K. These panels will be made of extruded titanium and bonded with a carbon-carbon composite. Four heat exchangers will be required, with 12 panels connected to each. The base line panels will be .3048 m wide and 10 m long. They will be supported by a truss structure which will run along the propulsion reactors. For the weight of the system see *Table 7.5*.

Table 7.5 - Dual Mode Radiator Weight Breakdown

Radiators	1200 kg
Transport	800 kg
Total	2000 kg

External Thermal Control System

The ship will be oriented so the x-axis will always point to the sun. The ship will be rotating such that it will be evenly heated. Therefore, the ship's orientation is such that there will be no continuous heating on one side by solar radiation, the use of passive thermal control is possible. The total amount of thermal radiation due to the Sun will be 2.58 KW/m². The habitation modules will be coated with a Aluminized Kapton or Black Nickel Chromium. At this level of heating only the habitation modules require the coating for more thermal control.

Other Radiators Considered

There exist alternative radiator systems that are being developed for space travel that are more efficient than heat pipe radiators. This section will discuss the other systems and explain why they were not chosen for this mission.

Curie Point Radiators

This radiator is almost an entirely passive system, having no moving parts other than the magnetic particles. The radiator works by heating up magnetic particles past their curie point and then sending them off until they cool down below their curie point. Once they regain their magnetism, they are collected by a large magnet. This radiator system would be very efficient and lightweight. Because of the rotation of the ship, the curie point system becomes very complex. This is the reason for our rejection of this radiator type.³⁵

Liquid Droplet Radiators

Liquid Droplet Radiators use a sheet of recirculating droplets to radiate heat. The advantage of this system over heat pipes is that it has a low mass to radiating area ratio. Liquid Droplet Radiators (LDR) would yield substantial mass savings for systems in the Multi-Megawatt range, but would not significantly reduce mass in smaller systems such as the one used for this mission. A major disadvantage of the LDR system is that the required area would be 2-3 times the length of the spaceship. The LDR system would be the constraining factor in the determination of the spacecraft configuration. Since our ship is spinning, the collection of the liquid droplets would be almost impossible. In addition to these difficulties, the LDR system will not be technologically ready by the year 2005, which is necessary for its inclusion as part of Project APEX.³⁶

Power References

- 1 Zubrin, R. M., *The Use of Low Power Dual Mode Nuclear Thermal Rocket Engines to Support Space Exploration Missions*, AIAA/NASA/OAI Conference on Advanced SEI Technologies, Sept. 1991.
- 2 Kohout, Lisa L. and Karl A. Faymon., *Space Power Systems*. NASA Lewis Research Center, February 9, 1987.
- 3 Faymon, K. A. and Lisa Kohout, *Space Power Systems Technology for the Manned Mars Mission: Part 1 - Photovoltaics and Energy Storage Systems*, NASA University Design Course, Jan. 1986.
- 4 Faymon, K. A. and Lisa Kohout, *Space Power Systems Technology for the Manned Mars Mission: Part 2 - Nuclear and Solar Dynamic Systems*, NASA University Design Course, Jan. 1986.
- 5 Faymon, K. A. and Lisa Kohout, *Space Power Systems Technology for the Manned Mars Mission: Part 1 - Photovoltaics and Energy Storage Systems*, NASA University Design Course, Jan. 1986.
- 6 Faymon, K. A. and Lisa Kohout, *Space Power Systems Technology for the Manned Mars Mission: Part 2 - Nuclear and Solar Dynamic Systems*, NASA University Design Course, Jan. 1986.
- 7 Guidici, R. J., *Electrical Power Systems to Mars*, NASA, Marshall Space Flight Center.
- 8 Anderson, Paul M., and Rene Thibodeaux, *Power Distribution Study for 10-100 kW Baseload Space Power Systems*. 1990 IECEC, vol. 1, p. 428.
- 9 Anderson, Paul M., and Rene Thibodeaux, *Power Distribution Study for 10-100 kW Baseload Space Power Systems*. 1990 IECEC, vol. 1, p. 428.
- 10 Anderson, Paul M., and Rene Thibodeaux, *Power Distribution Study for 10-100 kW Baseload Space Power Systems*. 1990 IECEC, vol. 1, p. 428.
- 11 Anderson, Paul M., and Rene Thibodeaux, *Power Distribution Study for 10-100 kW Baseload Space Power Systems*. 1990 IECEC, vol. 1, p. 428.
- 12 Anderson, Paul M., and Rene Thibodeaux, *Power Distribution Study for 10-100 kW Baseload Space Power Systems*. 1990 IECEC, vol. 1, p. 428.
- 13 *NASA-Military Standards 978 Handbook*. Vol. 5, Section 18.3.
- 14 Kenny, Barbara H., Ronald C. Cull, and Kankam, M. David, "An Analysis of Space Power System Masses. 1990 IECEC, vol. 1, p. 484.
- 15 *NASA-Military Standards 978 Handbook*. Vol. 5, Section 18.3.
- 16 *NASA-Military Standards 978 Handbook*. Vol. 5, Section 18.3.
- 17 Halliday, David and Robert Resnick, *Fundamentals of Physics*. New York: John Wiley & Sons Inc. Third Edition, 1988.
- 18 Schwarz, Steven E. and William G. Oldham, *Electrical engineering: An Introduction..* New York: Holt, Rinehart and Winston, 1984.
- 19 Shugg, W. Tillar, *Handbook of Electrical and Electronic Insulating Materials*. New York: Van Nostrand Reinhold Company, 1986.
- 20 Krauthamer, S. M. D. Gangal, and R. Das, *Space Station Freedom Power Supply Commonality Via Modular Design*. 1990 IECEC, vol. 1, p. 403.
- 21 Faymon, K. A. and Lisa Kohout, *Space Power Systems Technology for the Manned Mars Mission: Part 1 - Photovoltaics and Energy Storage Systems*, NASA University Design Course, Jan. 1986.
- 22 Krauthamer, S. M. D. Gangal, and R. Das, *Space Station Freedom Power Supply Commonality Via Modular Design*. 1990 IECEC, vol. 1, p. 403.
- 23 Krauthamer, S. M. D. Gangal, and R. Das, *Space Station Freedom Power Supply Commonality Via Modular Design*. 1990 IECEC, vol. 1, p. 403.
- 24 Krauthamer, S. M. D. Gangal, and R. Das, *Space Station Freedom Power Supply Commonality Via Modular Design*. 1990 IECEC, vol. 1, p. 403.
- 25 Krauthamer, S. M. D. Gangal, and R. Das, *Space Station Freedom Power Supply Commonality Via Modular Design*. 1990 IECEC, vol. 1, p. 403.
- 26 Zubrin, R. M., *The Use of Low Power Dual Mode Nuclear Thermal Rocket Engines to Support Space Exploration Missions*, AIAA/NASA/OAI Conference on Advanced SEI Technologies, Sept 1991.
- 27 Zubrin, R. M., *The Use of Low Power Dual Mode Nuclear Thermal Rocket Engines to Support Space Exploration Missions*, AIAA/NASA/OAI Conference on Advanced SEI Technologies, Sept 1991.
- 28 Faymon, Karl A and Lisa Kohout, *Space Power Systems Technology for the Manned Mars Mission: Part 1 - Photovoltaics and Energy Storage Systems*, NASA University Design Course, Jan. 1986.

- 29 Faymon, Karl A and Lisa Kohout, *Space Power Systems Technology for the Manned Mars Mission: Part 1 - Photovoltaics and Energy Storage Systems*, NASA University Design Course, Jan. 1986.
- 30 Tillmetz, W., *Regenerative Fuel Cells for Space and Terrestrial Use*, 25th Intersociety Energy Conversion Engineering Conference, 1990.
- 31 *Space Shuttle System Summary*, Rockwell International, May 1975.
- 32 Faymon, Karl A and Lisa Kohout, *Space Power Systems Technology for the Manned Mars Mission: Part 1 - Photovoltaics and Energy Storage Systems*, NASA University Design Course, Jan. 1986.
- 33 Faymon, Karl A and Lisa Kohout, *Space Power Systems Technology for the Manned Mars Mission: Part 1 - Photovoltaics and Energy Storage Systems*, NASA University Design Course, Jan. 1986.
- 34 Shuh, H., *Heat Transfer in Structures*, Pergamenan Press Ltd., 1965.
- 35 Chou, John, Westinghouse Corp.
- 36 Hertzberg, A., *Advanced Concepts Liquid Droplet Radiator*, University Of Washington, Sept 1981.

Chapter 8

Structures

8.0 Summary

8.1 Habitation Modules

8.2 Cryogenic Tank Design and
Implementation

8.3 Truss System

8.4 Landing Gear Design

Introduction

During the course of the term, Structures was assigned several tasks. This chapter will present detailed discussions of each of these tasks. The main areas of concern and the order in which they will be treated are:

- 1) Habitation Modules
- 2) Tanks
- 3) Truss Structure
- 4) Landing System

Each of these sections will in turn be divided into their own subsections and then discussed.

Habitation Modules

Structures broke the process of designing the habitation modules into four main tasks. These tasks will be covered in the following order:

- 1) Habitation Module Floor Layout
- 2) Structural Design of the Habitation Module
- 3) Radiation Shielding in the Habitation Module
- 4) Structural Design of the Air locks.

Habitation Module Floor Layout

After a brief summary of the process by which we arrived at the sizing and number of habitation modules, this section will present the details of the habitation module floor layout.

The Sizing and Number of the Habitation Modules

In order to design the habitation modules, it was first necessary to determine the inner dimensions of the habitation modules. In cooperation with Spacecraft Integration and Human Factors, it was decided that there would be two structurally identical habitation modules. Volume requirements, coupled with a desire to have only one floor and to minimize unusable overhead space, dictated an inner length of 16.9 m and an inner diameter of 4.3 m. The floor of the habitation module will be located 0.75 m below the exact center of the cross section. This results in a floor width of 4.02 m. *Figures 8.1 and 8.2* show the size, shape, and positioning of the floor surface.

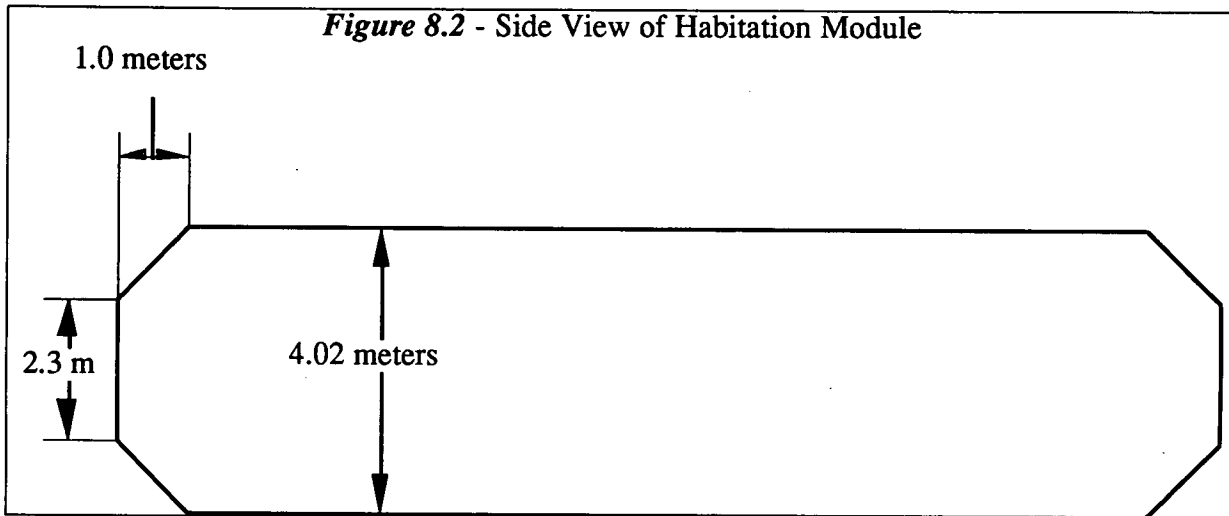
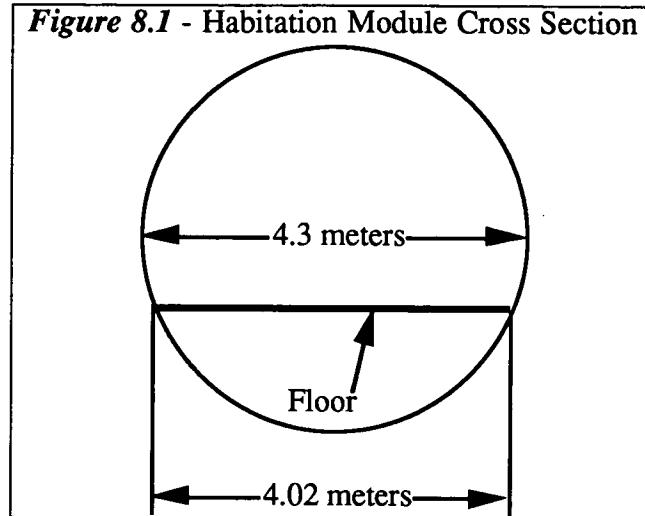

The total floor area available for use was determined as follows:

$$\begin{aligned} \text{Total Floor Area} &= (L) \times (w) - (\text{Area of corners}) = \\ &= (16.9 \text{ m}) \times (4.02 \text{ m}) - 2.0 \text{ m}^2 = 65.938 \text{ m}^2 \end{aligned}$$

The total floor area of both habitation modules is therefore $2 \times (65.938 \text{ m}^2) = 131.8 \text{ m}^2$

For a complete report on the determination of the size and number of the habitation modules see *Spacecraft Integration and Human Factors*.

Details of Floor Layout

The following section is a summary of the results of the floor layout design as depicted in *Figure 8.3*.

Figure 8.3- Habitation Module Layout

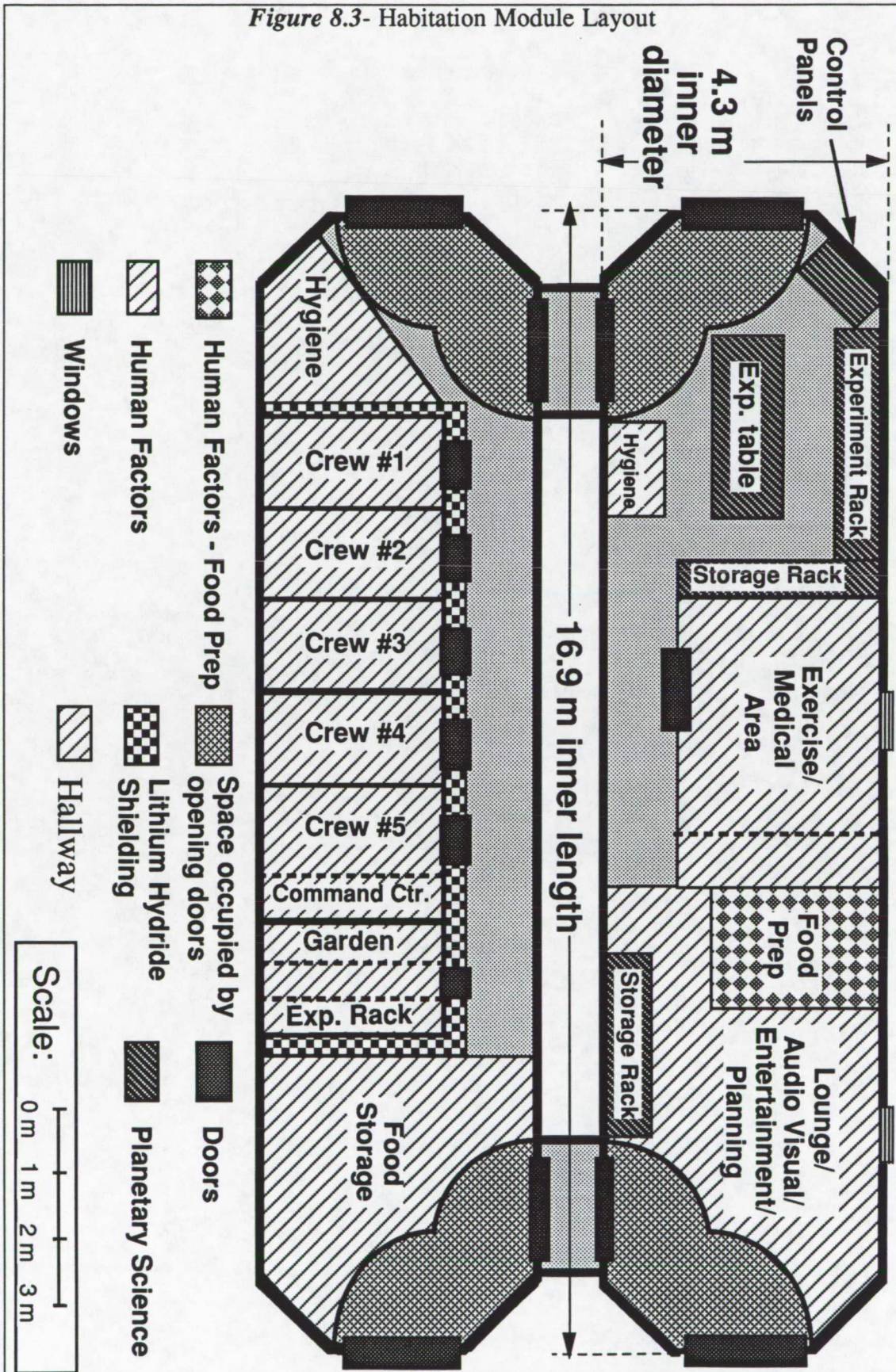

*Doors*A. Door Space

The space required by the side doors and the end doors of each module to swing open is 6.93 m². The four side doors require a radius of 1.62 m to swing and the end doors a radius of 1.8 m to swing open. No objects may be placed in these areas so that the doors may be opened and closed without obstruction.

B. Crew Quarters and Exercise/Medical Area Doors (6)

The doors allowing access to these compartments of the modules are .72 m by .42 m.

C. Garden and Experiment Rack Area Door (1)

The door accessing the garden and experiment rack is .48 m by .51 m.

*Shielding*A. Crew Quarters/Command Center/Garden Shielding

The total area of the Lithium Hydride shielding around this compartment is 2.17 m².

*Human Factors*A. Crew Quarters

Each of the five crew members has a total living space floor area of 4.15 m², with dimensions of 2.88 m by 1.44 m. The total dimensions of the living quarters is 7.2 m by 2.88 m, covering a total floor area of 20.74 m².

B. Hygiene 1

The hygiene facility located next to the crew quarters has a total area of 4.65 m².

C. Hygiene 2

The hygiene facility located near the exercise/medical area is 1.74 m by 1.02 m.

D. Exercise/Medical Area

The dimensions of this compartment are 4.5 m by 3.0 m, with a total floor area of 13.5 m².

E. Command Center

The command center, accessible through a sliding door leading from the Mission Commander's quarters, has a total floor area of 2.07 m², with dimensions of .72 m by 2.88 m.

F. Garden/Experiment Rack/Access Space

The garden has the dimensions of .63 m by 2.88 m, the experiment rack has the dimensions of 1.73 m by 2.88 m, and the accessible space between them is .54 m by 2.88 m. The total dimensions of this compartment are 2.9 m by 2.88 m. Each of objects in this compartment are three dimensional.

G. Food Preparation

The food prep area encompasses 3.24 m by 1.95 m for a total floor area of 6.318 m².

H. Lounge/Audio Visual/Entertainment/Planning
This compartment has a total area of 12.68 m².

I. Food Storage
The storage area for food has a total area of 11.78 m².

Hallways

- A. The approximate hallway space between the crew quarters, command center/garden/experiment rack, hygiene 1, and food storage is 14.57 m² of floor area.
- B. The approximate hallway space between hygiene 2, exercise/medical area, food prep, and lounge is 7.0 m² of floor area.
- C. The approximate hallway space between the control panels, experiment rack, experiment table, and storage rack in the Planetary Science Room is 3.18 m² of floor area.

Planetary Science

- A. Control Panels (2)
The two control panels together have the dimensions of 1.38 m by .84 m for a total area of 1.16 m². The control panels are three dimensional objects.
- B. Experiment Rack
The experiment rack in the laboratory area is 3.6 m by .72 m for a total area of 2.6 m². This is also a three dimensional object.
- C. Experiment Table
The three dimensional table used for lab experiments is 2.91 m by 1.08 m for a total floor area of 3.14 m².
- D. Storage Rack in Laboratory Area
This three dimensional storage rack is .51 m by 3.24 m for a total area of 1.65 m².
- E. Storage Rack Near Food Preparation
This three dimensional storage facility is .69 m by 3.24 m for a total area of 2.24 m².

Total Floor Space Per Group

- A. Human Factors
The total floor space area occupied by elements A-I is 78.61 m².
- B. Hallway Space
The total floor space are occupied by the three hallways is 24.75
- C. Planetary Science
The total floor space area occupied by elements A-E is 10.78 m².

Design of Habitation Module Structure

This section will present the basic structure of the habitation modules. This section will also discuss the process of designing the habitation module structure.

Summary

The habitation module floor layout (see *Figure 8.3*) dictates two cylindrical pressure vessels, each with a 4.3 meter inner diameter and a 16.9 meter inner length. Designing the structure around these dimensions yielded an outer diameter of 4.7 meters and an outer length of 17.3 meters in diameter (see *Figure 8.4*). The design incorporates six doors, two connecting the modules together and four placed at the ends of the cylinders leading to airlocks or to space. Without radiation shielding this design yields a primary structural weight of 6.4 metric tons per module. This estimate includes a micrometeoroid protection and thermal insulation system.

Additional weight must be added to this estimate for the interior systems and for the secondary structure. Radiation shielding will also add weight.

The load limits for the design were determined by the loads the module will experience during launch into Earth orbit. These loads are significantly greater than any loads the modules will be subjected to during the remainder of the mission. In particular, these loads are greater than the loads which will be experienced when the habitation modules are under 0.50 g of artificial gravity.

Design Details

We based our design on a NASA preliminary design of space station habitation modules¹. This section will discuss the following topics:

- 1 - Design of O-Rings
- 2 - Design of Stringers
- 3 - Design of Pressure Skin
- 4 - Design of Micrometeoroid Protection System
- 5 - Design of Insulation
- 6 - Design of Door Frame
- 7 - Weight Calculation

Design of O-Rings

The primary function of the O-Rings is to maintain the circularity of the habitation module cross-section. The O-Rings also serve as attachment points for loads to be transmitted from the inside of the module to the truss structure outside without stressing the pressure skin.

The required O-Ring dimensions and spacing are functions of the diameter of the cylinder and of the internal pressure. Since our diameter and internal pressure were close to those used in the NASA study, we designed our O-Rings to have the same cross-section as in the NASA

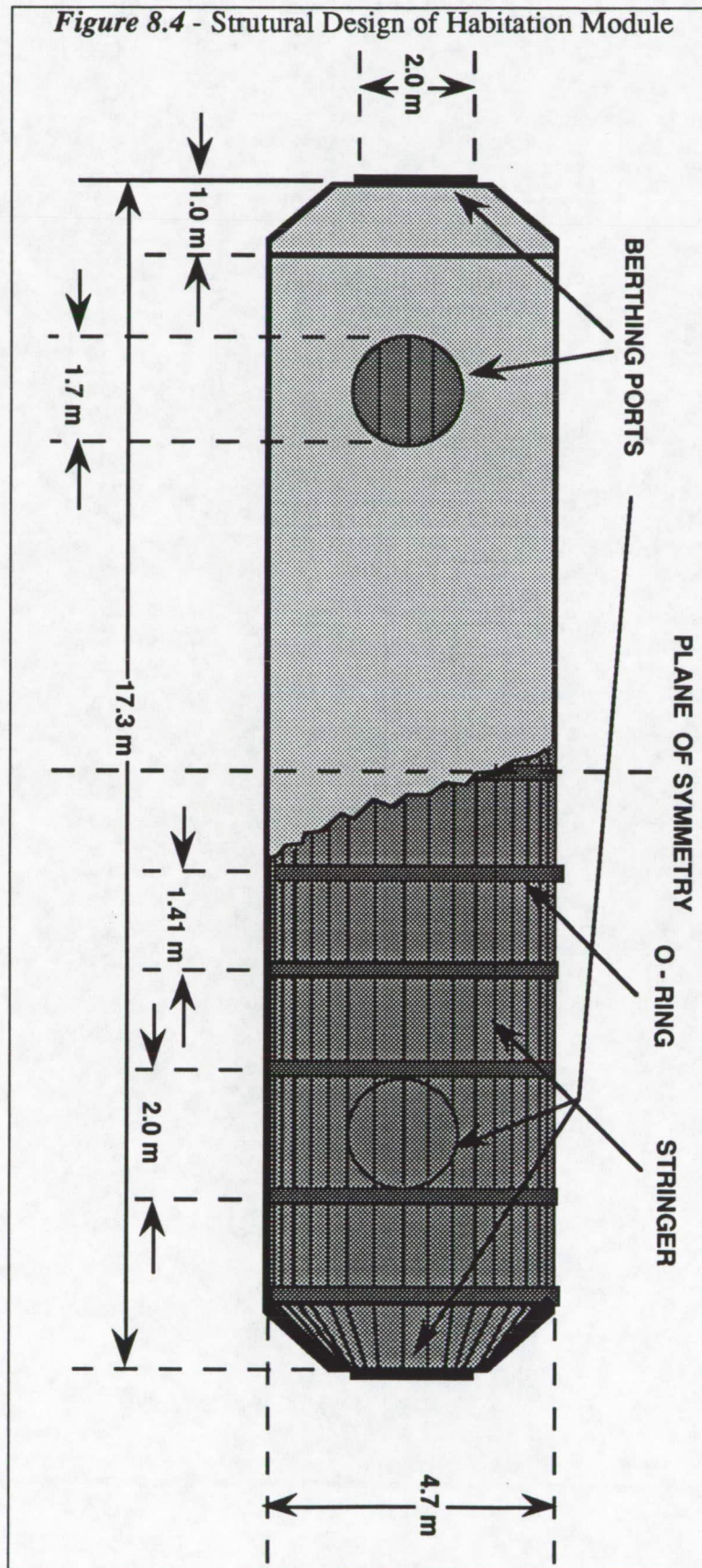

study, and we spaced them at the same axial intervals down the cylinder. Our outer diameter is 4.7 meters compared with 4.4 meters for the NASA module. Our greater diameter is offset, however, by our lower pressure of 78 kPa (NASA used 101 kPa). See *Figure 8.5* for the O-Ring cross-section.

The O - Rings are spaced 1.412 m apart, with 2.0 m spacing for the side berthing ports (the door diameter is 1.7 m). The total length of the module is 17.3 m, with 15.3 m in cylindrical length.

Our 1.412 m spacing matches that used in the NASA report. However, we did do a simple calculation to size this specifically to our module:

$$\frac{(\text{Cylinder length}) - (\text{Total door spacing})}{\text{NASA ring spacing}} = \frac{15.3 \text{ m} - 4.0 \text{ m}}{1.412 \text{ m}} = 8 \text{ spaces}$$

This gives a total of 11 O-Rings.

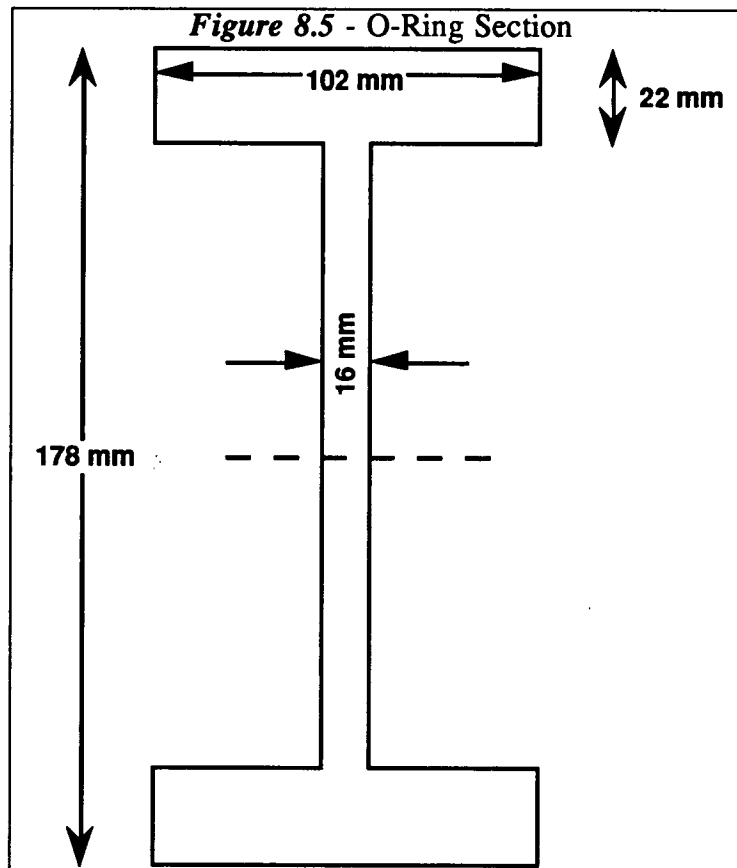

Design of Stringers

The primary function of the stringers is to provide resistance to bending and twisting of the module.

The required stringer dimensions and spacing are determined by the length of the cylinder. We used the same cross-section for our stringers as in the NASA design, but since our cylinders are 17.3 meters long as compared with 10.4 meters for the NASA design, we designed our stringers to have a proportionately denser stringer spacing. Since we could find no more information on the design of modules, we used a linear ratio between the length of the module and the density of the stringer spacing.

Stringer spacing * Module length = Constant

For the NASA module:

Stringer spacing * Module length = 75.7 mm * 10.4 m = 787.3 = Our spacing * 17.3

From this we can determine that our spacing should be $\frac{787.3}{17.3} = 45.5$ mm.

To determine the total number of stringers we performed the following calculations:

Circumference = 2π * Radius, where the Radius in this case is calculated by:

Radius = Outer Radius - Insulation Thickness

Radius = 2.35 m - .050 m = 2.3 m

The corresponding circumference is:

$C = 2\pi * (2.3 \text{ m}) = 14.45 \text{ m}$

Number of Stringers = $\frac{\text{Circumference}}{\text{Stringer Spacing}} = \frac{14.45 \text{ m}}{0.0455 \text{ m}} = 318$ Stringers

Figure 8.4 shows the O-rings properly spaced, but only every tenth stringer is shown to avoid visual clutter. The stringers have rectangular cross-sections 4 mm wide by 50 mm high.

Design of Pressure Skin

We calculated the required pressure skin thickness for our internal pressure of 11 psi using aluminum:

$$\begin{aligned} \text{Thickness} &= \text{Safety Factor} * \text{Pressure} * \text{Radius} / \text{Yield stress} \\ &= 1.4 * 76 \text{ kPa} * 2.30 \text{ m} / 324 \text{ MPa} = .755 \text{ mm} \end{aligned}$$

Using a safety factor of 1.4 yielded a thickness of 0.755 mm. This was much less than the skin thickness used in the NASA study. We found that the minimum skin thickness in the NASA study had been limited by micrometeoroid resistance rather than pressure considerations; hence, we used their value of 1.8 millimeters for the skin thickness.

Micrometeoroid Protection

In order to shield against micrometeoroid collisions, an outer impact skin was needed to protect the pressure skin. Since analysis of rupture thresholds for impact and pressure skins is exceedingly complex, we employed the same micrometeoroid protection system (MPS) as in the NASA design (see *Figure 8.6*). The primary component of this system is a 1.0 millimeter thick aluminum impact skin enclosing the pressure skin. The multi-layer insulation (MLI) (see section: *Design of Insulation*) and the pressure skin itself are also important parts of the MPS. The highly concentrated impacts on the impact skin are distributed by the MLI over a wider area of the pressure skin. However, the pressure skin still must be thickened in order to withstand these loads (see section: *Design of Pressure Skin*).

This MPS was designed to reduce probability of rupture over 10 years to 5%. This criteria along with the micrometeoroid flux as established by the Solar System Exploration Division at Johnson Space Center dictated a 1.0 millimeter thick impact skin for a 50.0 mm spacing between the impact skin and the pressure skin.

Design of Insulation

There is a 50 millimeter thick layer of multilayer insulation (MLI) between the impact skin and the pressure skin. The impact skin is held from crushing the MLI by non-conductive standoffs positioned at 12 axial positions by 37 circumferential positions. Additional standoffs on the ends of the module bring the total number of standoffs to 550. The MLI and the standoffs should be made of materials with very low thermal conductivity. Ideally, the standoffs will also be electrically conductive, allowing the discharge of any static charges which might build up on the impact skin.

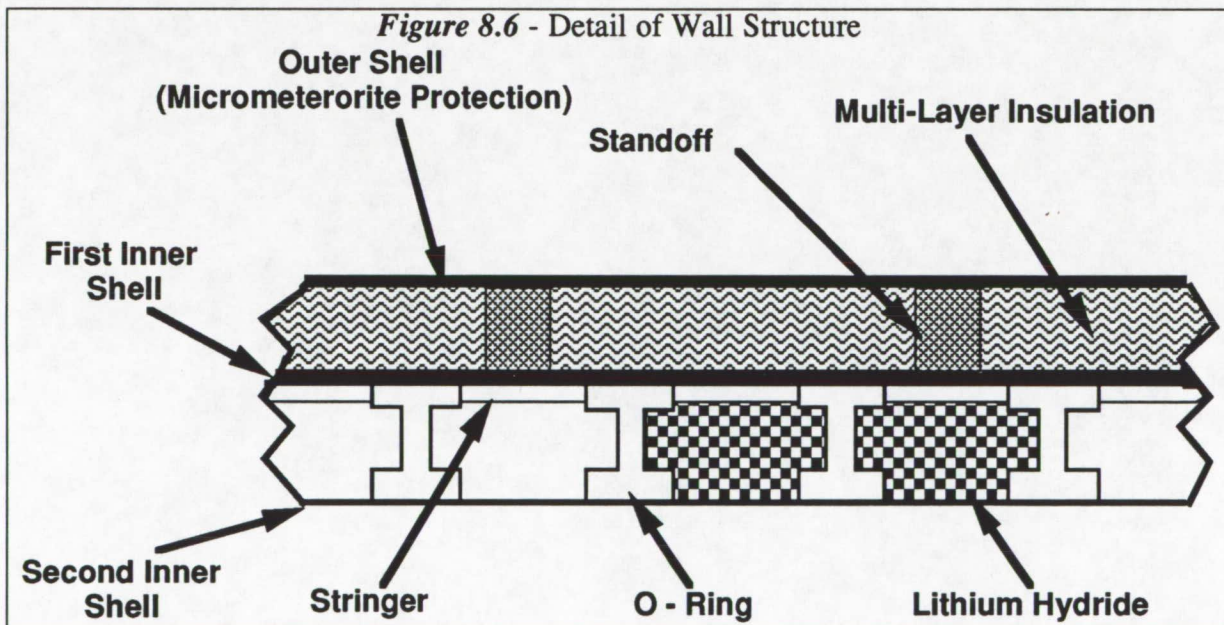

Door Frame Desing

We used a slightly revised version of NASA's berthing ports. We are assuming the two doors connecting the modules to be 1.7 meters in diameter, and the four doors on the ends to be 2.0

meters in diameter. The sizes of the end doors can easily be changed plus .25 or minus .4 meters if required. The same basic design will also be used for the ports on the ends of the modules, except that the berthing ring can connect more easily to the surrounding O - Ring since they are both the same shape.

A more detailed and rigorous door design is outside the scope of the conceptual design emphasis of our project.

Weight Calculation

The following is a list of the volumes of all the aluminum structural elements in the skin design of the habitation module:

Total Ring Volume:	11 rings x .092 m ³ /ring	=	1.012 m ³
Total Stringer Volume:	318 stringers x .00306 m ³ /stringer	=	.9731 m ³
Outer Skin Volume:		=	.2259 m ³
Inner Skin Volume:		=	.398 m ³
Total End Cone Volume:		=	<u>.0232 m³</u>
Total Volume:		=	2.6322 m ³

$$\text{Weight: } 2700 \text{ kg/m}^3 \times 2.6322 \text{ m}^3 = 7107 \text{ kg}$$

The two non-aluminum elements in the structure are the standoffs (made of graphite epoxy) and the multilayer insulation.

For the standoffs, we assumed the same design as the NASA report, and the final weight for their standoff was .154 kg/standoff. Thus, assuming about 550 standoffs in the structure, the total weight is 85 kg.

For the MLI, we assumed a density of about 20 kg/m³, and about 267 m² surface area of insulation. With a thickness of 50 mm, we calculate the weight contribution as follows:

$$20 \text{ kg/m}^3 \times .050 \text{ m} \times 267 \text{ m}^2 = 267 \text{ kg}$$

$$\text{Total weight} = 7107 + 85 + 267 = 7459 \text{ kg}$$

The final weight of the structure is 7.46 metric tons.

Radiation Shielding

Purpose

One of the primary purposes of our mission is to SAFELY transport a human crew from Earth to the Martian moon of Phobos and back. One of the main obstacles standing in our way from completing this task is the level of radiation (both natural and man made) that we will encounter on our voyage. As a result, the structures group has set out to 1) Determine what the most effective materials to shield from radiation are and 2) Determine the optimum location and quantity of these materials to reduce the level of radiation below a certain allowed amount.

Shielding Materials

Before the study into the best radiation materials is discussed, the criteria that these materials were required to have must be mentioned. First and foremost, the materials are required to stop all forms of radiation. There are two types of radiation. The first kind of radiation is composed of matter like neutrons and electrons. Because of secondary gamma ray production, these particles cause the formation of gamma rays when they impact matter and slow down². The second type of radiation is Gamma Rays themselves. In order to reduce the amount of radiation that a person receives, you must stop the Gamma Rays (which are essentially packets of pure energy). In addition, you must also stop the particles of matter, but with a material that does not cause a large amount of Gamma Rays to be released when the particle is stopped. The second criteria is that the material that is chosen for the radiation shield should attenuate the most amount of radiation **per unit mass**. In effect, we want to find a material that reduces a large amount of radiation but does not weigh a lot. The final criteria is that we want a material that will attenuate the most amount of radiation **per unit volume**. In this case, we need a radiation shield that is dense. It will do us no good if we find a material that stops a large amount of radiation and doesn't weigh a lot, but has a volume that would require the walls of the modules to be 2 meters thick to contain all of the material.

The next thing that should be mentioned is how a material will be able to follow the above criteria. First of all, a material stops radiation by being composed of matter³. This matter physically gets in the way of radiation. The radiation then impacts with the matter. The matter then receives a portion of the radiation's energy. After "N" collisions (where N will depend on the material and the energy of the radiation) one of two things will happen. First, if the radiation is composed of particles like electrons or neutrons, the particles will be absorbed into the matter. But remember that Gamma Rays will be released when the particles are absorbed into that matter and when they are being slowed down. If the radiation is composed of energy, after "N" collisions, the energy of the radiation will be used up and the gamma ray will disappear. Many times when a gamma ray impacts with matter, enough energy will be transferred to the matter for an electron to be released by the matter. You then have a gamma ray, and an electron. Then the electron will produce another gamma ray when it is stopped which can produce another electron when it impacts with the matter of the radiation shielding. This exchange shows the need for a material that has a very low amount of secondary gamma ray production.

With these criteria in mind, a couple of materials have shown some promise. The first class of materials that were looked at were the high density materials, specifically Tungsten (density = 19.3 g/cm³) and Lead (density = 11.35 g/cm³).

Tungsten was immediately ruled out because it does not pass the first criteria. It has a large amount of secondary gamma ray production when in the presence of radiation. It would therefore require a thick shield to adequately reduce the amount of radiation down to our desired level.

Lead passed the first criteria by having a low level of secondary gamma ray production. It also passes the third criteria by having a large density. This means that any lead shield we put on the ship would turn out to be thin. In addition, Lead is like most metals in that it is radiation resistant. That means that over a period of time in the presence of radiation, its shielding capacities will not degrade. At this point, it is not obvious whether lead will pass the second criteria. It will be necessary to compare the amount of radiation attenuation per unit mass with other materials.

The second category of materials we looked at were polymers. All polymers were immediately ruled out because they are not radiation resistant. This means that they will degrade in the presence of radiation. Even if these materials provide a high degree of radiation attenuation at the start of the voyage, they will quickly degrade. This will cause the amount of radiation that they stop to decrease. By the end of the voyage, an unacceptably large amount of radiation will be passing through the shield.

The third category of materials we looked at were composites. This group of materials was also ruled out due to their lack of radiation resistance. These materials will degrade (although not as quickly as polymers). Because of this factor, it would be necessary to increase the amount of shielding on the ship so that by the time the voyage was over, there was enough shielding present to adequately shield the ship.

The final category of materials that we looked at were low density materials. Specifically, we looked at Aluminum, Water, and Lithium Hydride.

Aluminum, while being a light strong material was ruled out as a radiation shield because of its large amount of secondary gamma production. It was decided that Aluminum should be reserved for structural purposes only.

Next we looked at Water and Lithium Hydride. Both Water and Lithium Hydride have a low level of second gamma ray production. They are also very radiation resistance, that is, they will not degrade in the presence of radiation. Being a low density, they will not be the best material to satisfy criteria number three, but that criteria is the least important of the three. If Water and Lithium Hydride satisfy the first two criteria, then they still will be very valuable as a radiation shield.

Now that all of the materials have been introduced, it is necessary to compare these materials with respect to criteria #2. As it turns out, Water and Lithium Hydride have identical radiation stopping potential per unit mass⁴. In other words, the mass of water needed to shield a square centimeter is identical to the mass of Lithium Hydride that is needed to shield that same square centimeter. So, water and Lithium Hydride equally satisfy criteria number #2. The final material that has passed criteria #1 and #3 is lead. The question is now, where does lead fit in with respect to criteria #2. In all of the research that was looked at, there was no comparison between the shielding capabilities of lead and the shielding capabilities of Water and Lithium Hydride. Because of this, there is no way of determining which is the better of the shielding materials with respect to criteria #2. But, since Lithium Hydride or Water was used in almost all of the spacecraft shielding designs, we will also use these two materials and not Lead.

In conclusion, both water and Lithium Hydride are (as far as we can determine) superior to all others materials in reference to the two most important criteria, #1 and #2. And, although the very dense materials like lead easily surpass water and Lithium Hydride with respect to criteria #3 (radiation attenuation per unit volume), this criteria is the least important of the three criteria. We therefore have chosen Lithium Hydride and water as our radiation shielding materials.

Location and Quantity of Shielding Material

Now that the radiation shielding material has been picked, it is necessary to determine where and how much of this material will be needed. Note, at this point the use of water as opposed to Lithium Hydride will not be distinguished. The reason for this is that, as mentioned above, the mass of a Lithium Hydride shield is identical to the mass of a water shield needed to produce a certain amount of radiation attenuation.

Originally, Human Factors set a limit of 50 Rem/yr and 25 Rem/month as the maximum amount of radiation an astronaut was allowed to be exposed to. With these limits in mind, it was determined that the most efficient shielding configuration was a heavily shielded storm shelter in addition to lightly shielded habitation modules⁵. A diagram of this configuration is shown as *Figure 8.7*. But, after data on the volume requirements of both the storm shelter and the habitation modules were received, it was determined that the total mass of the radiation shielding for this configuration would be 57.3 Metric Tons. That simplified down to 23.9 Metric Tons for each Habitation Module and a 9.5 Metric Ton Storm Shelter. But, Spacecraft Integration deemed this mass as totally unacceptable. They stated that the mass of the shielding would have to be reduced to under 30 Metric Tons. With this in mind, it was necessary to alter the original maximum radiation requirements. The reasons for this is the following. At a maximum of 50 Rem/yr and 25 Rem/month, a heavily shielded storm shelter and lightly shielded habitation modules is the MOST efficient means of radiation protection⁶. Unless some super material could be found that would shield more radiation per unit mass, the mass of the radiation shield will not decrease. As a result, Human factors deemed that it would be acceptable for the maximum radiation dosage limit be raised from 50 Rem/yr and 25 Rem/month to 65 Rem/yr and 30 Rem/month.

As a result of this increase in the maximum allowed radiation dosage, it was found that the most efficient shielding configuration was not a heavily shielded storm shelter and lightly shielded habitation modules. It was determined that the most efficient shielding configuration was to moderately shield the sleeping quarters of the crew⁷. By raising the radiation limit to 65 Rem/yr, a radiation shield of 16.0 g/cm² of water or Lithium Hydride was deemed acceptable. This shield would completely surround the sleeping quarters of the crew. A diagram of this configuration is shown as *Figure 8.8*. The astronauts would therefore be moderately shielded from the solar wind, Galactic Cosmic Radiation (GCR), and the radiation from the reactor producing power for the approximately 9 hours that they were in their sleeping quarters per day. If a solar flare were to occur, the crew would be protected by returning to their sleeping quarters. Note, in addition to sleeping quarters being shielded, the radiation sensitive experiments and the garden are also within the radiation shield.

With this configuration, it was calculated that the total shield mass would be 21.05 Metric Tons. In addition, we have estimated that the structure needed to contain the radiation shielding will have a mass of 1.0 MT. This yields a total radiation system mass of 22.05 MT.

Figure 8.7 - Storm Shelter Configuration

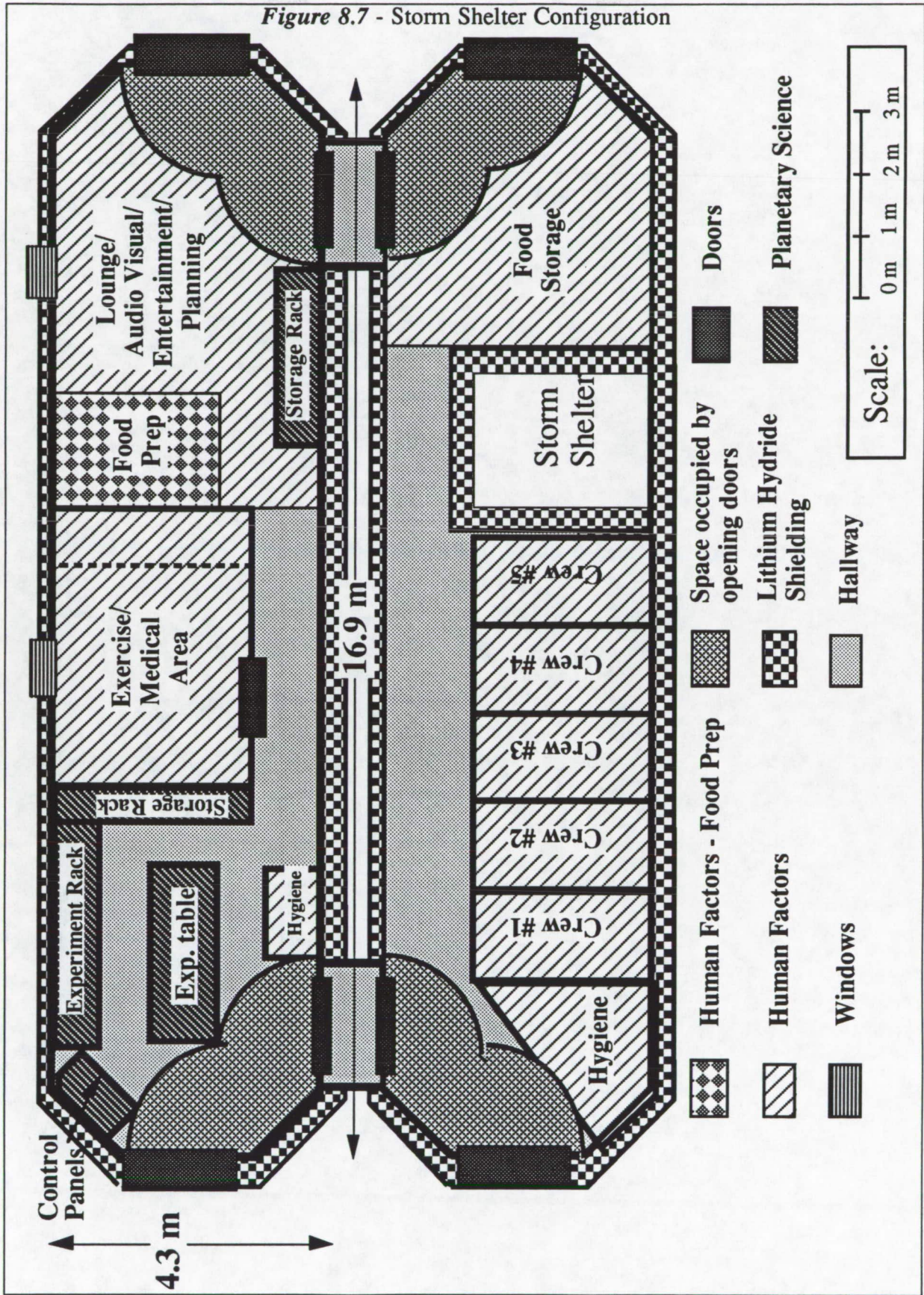
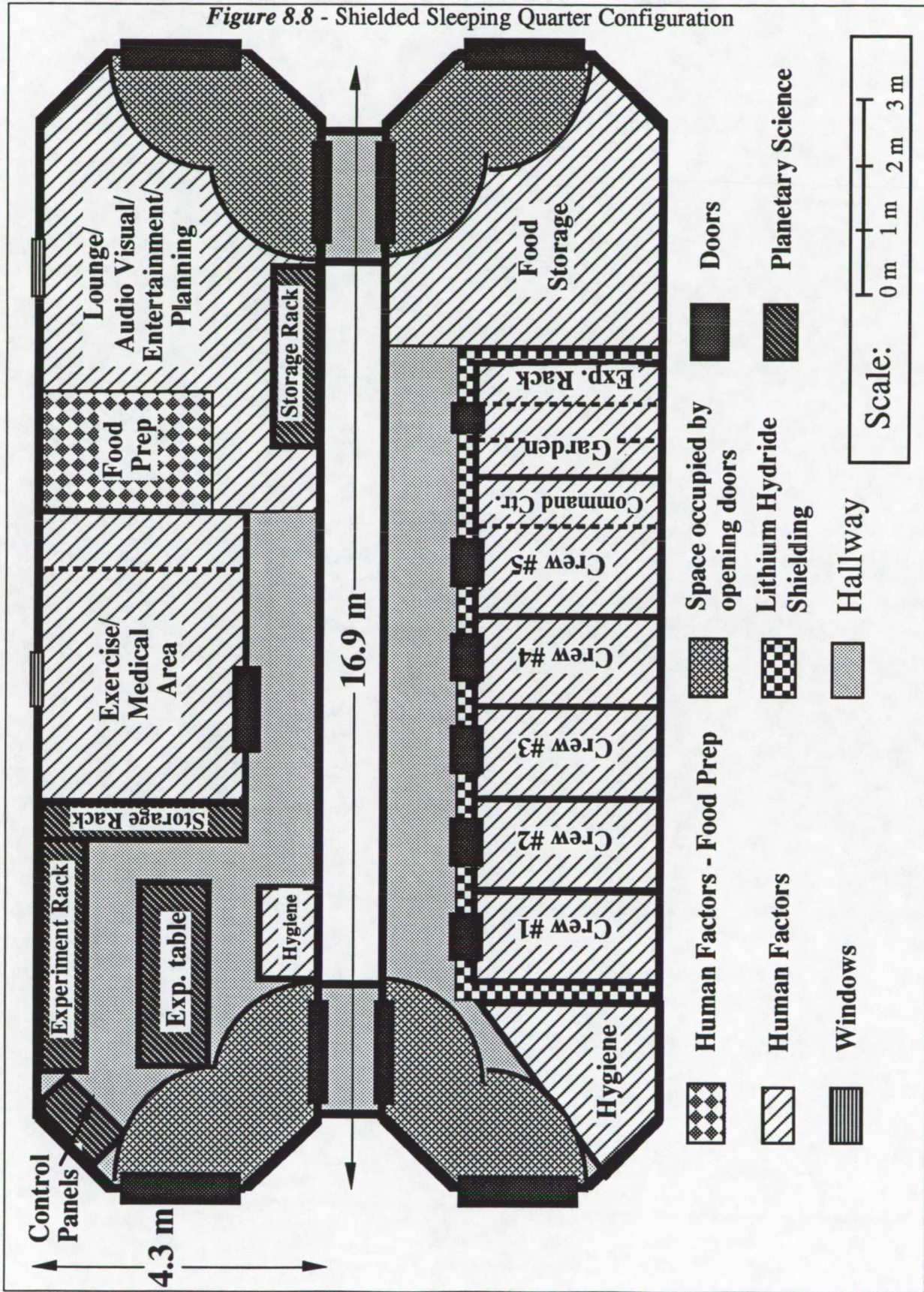

Figure 8.8 - Shielded Sleeping Quarter Configuration



Lithium Hydride or Water

Up until this point, there has not been a distinction between using Lithium Hydride or Water. The reasons for this were that the mass of both of these materials will be the same to produce the same amount of radiation protection. But, to continue with the analysis of the radiation system, it is necessary to distinguish between where one will be used as opposed to the other.

The first thing that should be mentioned is that while the mass of Lithium Hydride or Water necessary to shield the crew is identical, the TOTAL mass of the shielding system will be different. The support structure needed to contain the water will weigh MORE than the support structure to contain the Lithium Hydride. The reason for this is obvious. Water, being a liquid, needs a leakproof container. This is essential, because if the water starts to leak out of its container, not only will it corrode a lot of the materials on the ship, but the radiation protection that it provides will leak out as well. As a result, it would be easy to assume that all of the radiation shielding on board the ship will be Lithium Hydride. But there are other factors to take into account. First, approximately 5 Metric Tons of Water is already needed on board the ship. By using the water as both shielding and usable water we are able to reduce the overall weight of the ship. This is accomplished by replacing some Lithium Hydride with a material (water) that already had to be on the ship anyway. Also, in choosing a radiation material we can not forget criteria #3. This criteria stated that we are looking for a shielding material that has the largest radiation attenuation per unit volume. While water and Lithium Hydride have identical radiation attenuation per unit mass, water being the more dense of the two materials has a higher radiation attenuation per unit volume. As a result, it will be necessary to have 0.205 meter thick walls of Lithium Hydride, but only 0.16 meter thick walls of water.

Because of these two criteria, we have come up with the following configuration. The shielding of the ceiling, walls, and doors of the sleeping quarters will be made of Lithium Hydride. But, the shielding in the floor of the sleeping quarters will be made of water. The reason for placing the water under the floor is that while the ship has artificial gravity, the water will form an even layer giving uniform protection if any air pockets appear in the water shield. These air pockets will result when water is siphoned out of the shield to be used by the crew. One thing that should be noted here is that the configuration of the water shield will be set up so that the initial thickness of the water shield will be greater than the 16.0 g/cm^2 needed to provide protection from radiation. As a result, when the water usage is at its maximum, there will still be at least 16.0 g/cm^2 of water left. But, if the water was in the walls of the sleeping quarters, the water would all be near the floor, and there would be an air gap near the ceiling. This air gap would allow most of the radiation to enter through the radiation shield. As a result, the water shield has been limited to the floor alone.

Conclusion

Lithium Hydride and Water will be used as our radiation shield because it is the most efficient materials in attenuating radiation per unit mass. In addition, these materials do not produce any secondary radiation. These two materials will be used to shield the sleeping quarters. This shielding configuration will produce a maximum level of 65 Rem/yr or 30 Rem/month of radiation to the crew. This level has been deemed acceptable by Human Factors.

Airlock Structural Design

Introduction

In order for the astronauts to leave the habitation modules and enter the pod or perform extra-vehicular activities, an airlock is required. Since there are two habitation modules, there will be an airlock for each habitation module. This section of the report gives the design, location, and mass estimates for the airlocks.

Summary of Design

The design of each airlock is identical. Both are cylindrical pressure vessels 3.0 meters long and 3.75 meters in diameter (see *Figure 8.9*). Each airlock contains three berthing ports. At one end there is a port leading into the habitation module. Located directly on the opposite end is another port for leaving the airlock and entering the pod. The third port is situated along the length of the airlock and is used for entering the outside environment. There is no radiation shielding in the airlock. However, micrometeoroid protection and thermal insulation are present. The design of the micrometeoroid protection and pressure shell thickness is identical to the design of the habitation modules. The total structural mass for both airlocks is 2.2 metric tons.

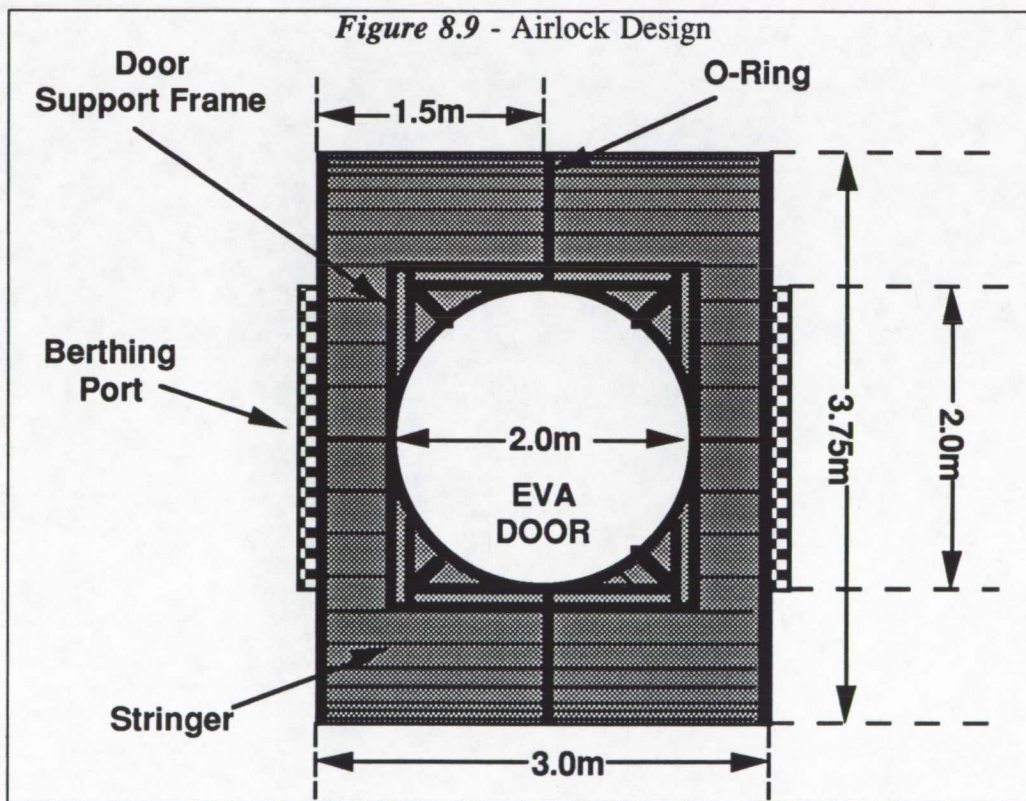

Design Details

The design of each airlock is based on the structural design of the spacecraft's habitation modules. The main difference is that the airlock is of smaller dimensions. This section discusses the following topics relating to the design of the airlocks:

- 1) Sizing of the Airlock
- 2) Structural Design
- 3) Mass Calculations

Sizing of the Airlock

Each airlock is to contain tools and equipment, a ship control system, medical supplies and five space suits. In order to provide enough space for these objects, as well as room for the astronauts, it was determined that each airlock should be cylindrical in shape with a length of 3.0 meters and a diameter of 3.75 meters. The size of the berthing ports on the airlocks was determined from the corresponding dimensions of the berthing ports located on the habitation module and the pod. The airlock ports have to be large enough not only for an astronaut wearing a spacesuit to pass through, but also large enough to carry any objects into or out of the airlock. A port diameter of 2.0 meters fulfills all of these dimensional requirements.

Structural Design

The structure of each airlock is to be made of the same materials and support members as the habitation modules: with the pressure vessel shell, the stringers, and the O-Rings all made of aluminum. The shell of the airlock will consist of three layers. The outside impact shell is 1.0 mm thick and the inner pressure shell is 1.8 mm thick. The 50 mm between the two layers is supported by non-conductive standoffs and filled with thermal insulation. The design of these three parts are identical to the micrometeoroid protection scheme used for the habitation modules. For further details see the sections *Micrometeoroid Protection* and *Design of Insulation*.

- Stringers

To design the stringers of the airlocks, we compared the total length of the airlock to the length of the NASA designed hab module. The NASA designed module determined the required number and spacing of stringers by placing the stringers at selected distances apart and applying the loads the stringers would be placed under during launch. The stresses on the module under these loads were then analyzed. The spacing of the stringers were then varied and the stresses analyzed again. A spacing was chosen that yielded acceptable levels of stress. The NASA module was designed with a total of 180 stringers. The required number of stringers is a function of the length of the module ONLY. Our module has been determined to be 3.75 meters as opposed to the length of the NASA module which was 10.4 meters long. Since we could find no more information on the design of modules, we used a linear ratio between the length of the module and the density of the stringer spacing.

Stringer spacing * Module length = Constant

For the NASA module:

Stringer spacing * Module length = 75.7 mm * 10.4 m = 787.3 = Our spacing * 3.75

From this we can determine that our spacing should be $\frac{787.3}{3.75} = 210$ mm.

To determine the number of stringers in the airlock we performed the following calculations:

Inner Diameter = 2 x [outermost radius - outershell thickness
- insulation thickness - innershell thickness]

Inner Diameter = 2 x [1.875 - .001 - .05 - .0018] = 3.64 m

Circumference of cylinder = π x inner diameter = 3.1416 * 3.64 = 11.4m

Number of Stringers = $\frac{\text{Circumference}}{\text{Stringer Spacing}} = \frac{11.4 \text{ m}}{0.21 \text{ m}} = 55$ Stringers

The cross-sectional dimensions for the stringers are given in the section *Design of Stringers*.

- O-Rings

The other major support members are the O-Rings and the supports for the portholes. To determine the dimensions and the spacing of the O-Rings we again referenced the NASA designed module. The NASA module had a total of 7 O-Rings. The number and dimension of O-Rings is determined by the diameter of the module and the inside pressure of the module. The pressure of the NASA module is 14.0 psi and the diameter of the NASA module is 4.4 m. The maximum pressure of our air lock is 10.4 psi, but we will design it using a pressure of 14.0 to give us an added factor of safety. But, since we have no further data on the design of the O-rings, we will assume that there is a linear relationship between the number of O-Rings and the diameter of the module.

$\frac{\text{Spacing Between O-Rings}}{\text{diameter of module}} = \text{Constant}$

$\frac{\text{Spacing Between O-Rings}}{\text{diameter of module}} = \frac{1.41 \text{ m}}{4.4 \text{ m}} = 0.32 = \frac{\text{Spacing Between O-Rings}}{3.75}$

So the Spacing between O-Rings = (3.75)x(0.32) = 1.2 meters

But, we have decided to have a total of 3 O-Rings spaced every 1.5 meters. We believe that this is acceptable since the pressure that the airlock will be operating at is at the most 10.4 psi while the NASA modules will be operating at a pressure of 14 psi. Since our pressure will be less than the NASA module, the spacing between the O-Rings can be reduced.

The cross-sectional dimensions for the O-Rings can be found in the section *Design of O-Rings*.

- Berthing Ports

The support structure of the air lock that was designed was the berthing ports. The Berthing Port is identical to the design used in the habitation modules. The specifics of this design can be found in the section Design Details.

Mass Calculations

To obtain the mass of the airlocks, the volume of each structural element was determined. The mass of the airlock was found by multiplying the density of aluminum to the total airlock volume. The following is a list of the volumes of all the elements in the shell design of the airlock:

Total Ring Volume: 3 rings x .0723 m ³ /ring =	0.2170 m ³
Total Stringer Volume: 55 stringers x 6.0 x 10 ⁻⁴ m ³ /stringer =	0.0330 m ³
Outer Skin Volume:	0.0353 m ³
Inner Skin Volume:	0.0619 m ³
Total Cylinder End Volume:	<u>0.0376 m³</u>
 Total Volume of Airlock:	 0.3848 m ³
 Mass: 2700 kg/m ³ x 0.3848 m ³ = 1039 kg	 1.04 metric tons
 Insulation Mass: 20kg/m ³ x 0.05m x 57m =	 57 kg
 Total Mass (Both Airlocks):	 2.2 metric tons

Special Considerations

Each airlock should contain some type of blower/exhaust system for cleaning the space suits. When the astronauts are working on Phobos, the suit will collect a large amount of dust and the space suits will need to be "cleaned" off. Also, the airlock should be equipped to treat anyone who might suffer a rapid loss of pressure (the bends). Since the astronauts will be exposed to different pressures it is likely an astronaut could puncture his/her spacesuit and be exposed to the rapid loss of pressure. The airlock would then have to be used to treat the situation by slowly bringing the pressure up. Pure oxygen should be located within the airlocks to assist in the prevention of getting the bends.

Cryogenic Tank Design and Implementation

Introduction

Cryogenic storage was a key issue if the manned mission to the Martian moon Phobos was to be a success. A design for storage tanks capable of handling the unique challenges of a deep-space environment became necessary. Consequently, the structures group set out to identify the concerns of storage in space, and to determine a design that was capable of meeting these concerns. The details leading to the final design for all the tanks on the spacecraft will now be discussed.

Tanks for various applications are necessary throughout the entire spacecraft. Storage tanks are needed for the following areas:

- Storage of LH2 for main NTR engines
- Storage of LOX and LH2 for RCS (attitude control) thrusters
- Storage of LOX and LN2 for atmosphere in crew modules
- Storage of LOX and LH2 for fuel cells (backup power source)

The unique considerations involved in the design and placement of each specific tank type are addressed in sections for each of the system subgroups. The specifications and underlying logic of the tank design are also discussed in their respective system groups.

The first section below discusses the layers which make up the various tank schemes, and connection considerations, for the Structures Group. The second section details design information and criteria that were used for the LH2 / LOX tanks for the Propulsion Group. The third examines concerns of the LOX / LN2 tanks for Human Factors. The fourth, and last, section discusses tank specifications for the Power Group.

Tank Design

An Inner micrometeoroid shield, tank skin, thermal jacket (in the case of LOX and LN2), MLI, and outer micrometeoroid shield are the layers that make up the tank construction scheme. (See *Figures 8.10, 8.11, & 8.12*) In addition, concerns that need to be addressed when designing a tank containment/connection system are addressed.

The only structural elements to the tanks are the the tank skin itself and the outer meteoroid shield. All the other layers that will be detailed below have very little structural significance. They do not add structural integrity to the structure as a whole.

The description of the layers of the tanks will start with the innermost layer and proceed outward.

Inner Micrometeoroid Shield

The Inner Micrometeoroid Shield is a layer of hexcel mesh filled with a porous material. The material chosen was polyester foam, with a density of $\sim 6.2 \text{ Kg/m}^3$. The thickness of the material is $\sim 9.53 \times 10^{-3} \text{ m}$. This thickness was recommended for use in the space environment.⁸

When a small, high energy micrometeorite punctures the tank skin and all of the internal layers, there needs to be a way to seal the small puncture hole. This inner shield is "self-sealing" - that is, when the material is punctured, the cryogenic fluid freezes in a small area around the hole, causing it to plug. The hexcel mesh gives the solid cryogen a stable region in which to form.⁹

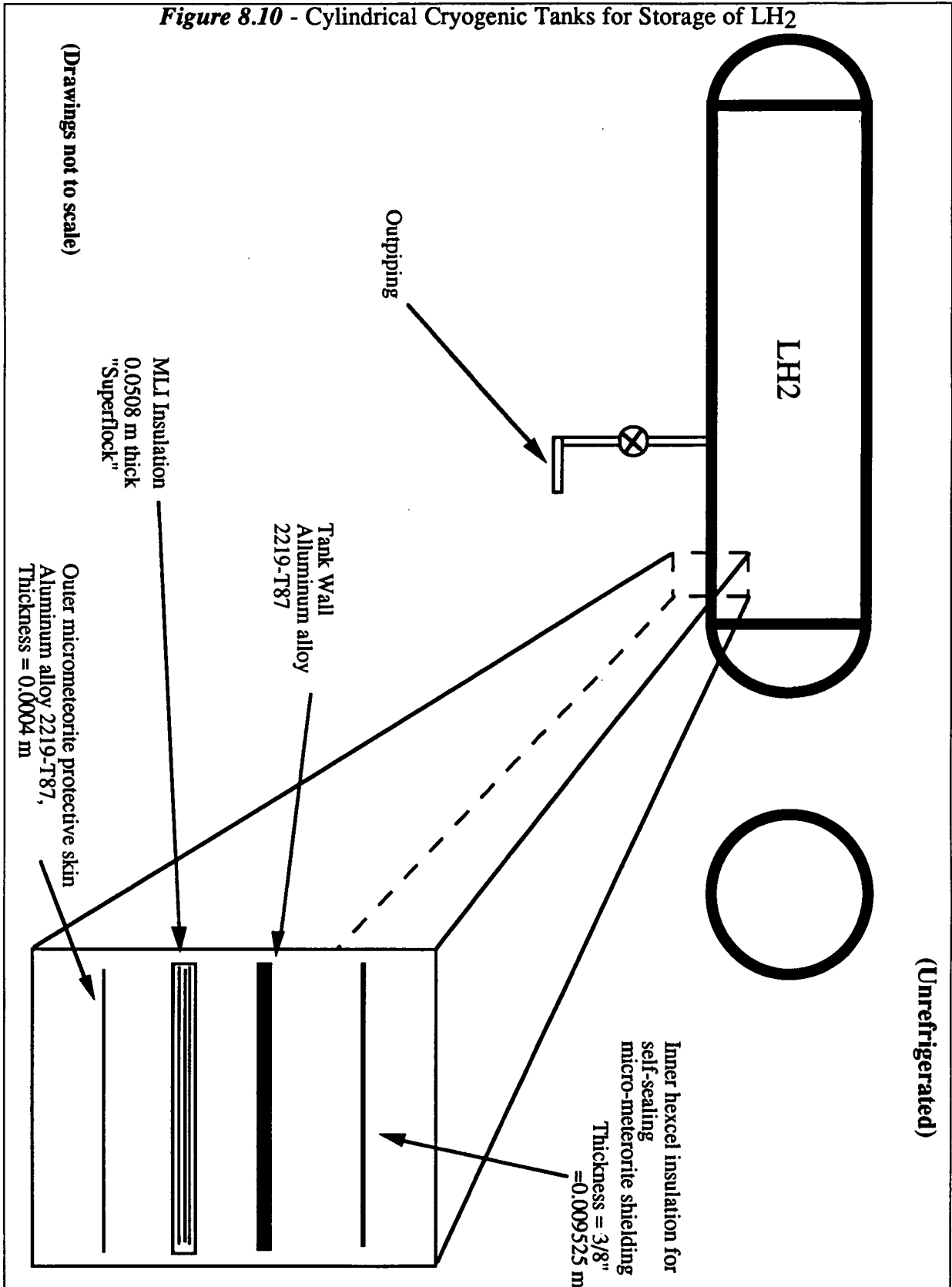

Figure 8.11 - Cylindrical Cryogenic Tanks for Storage of LH2

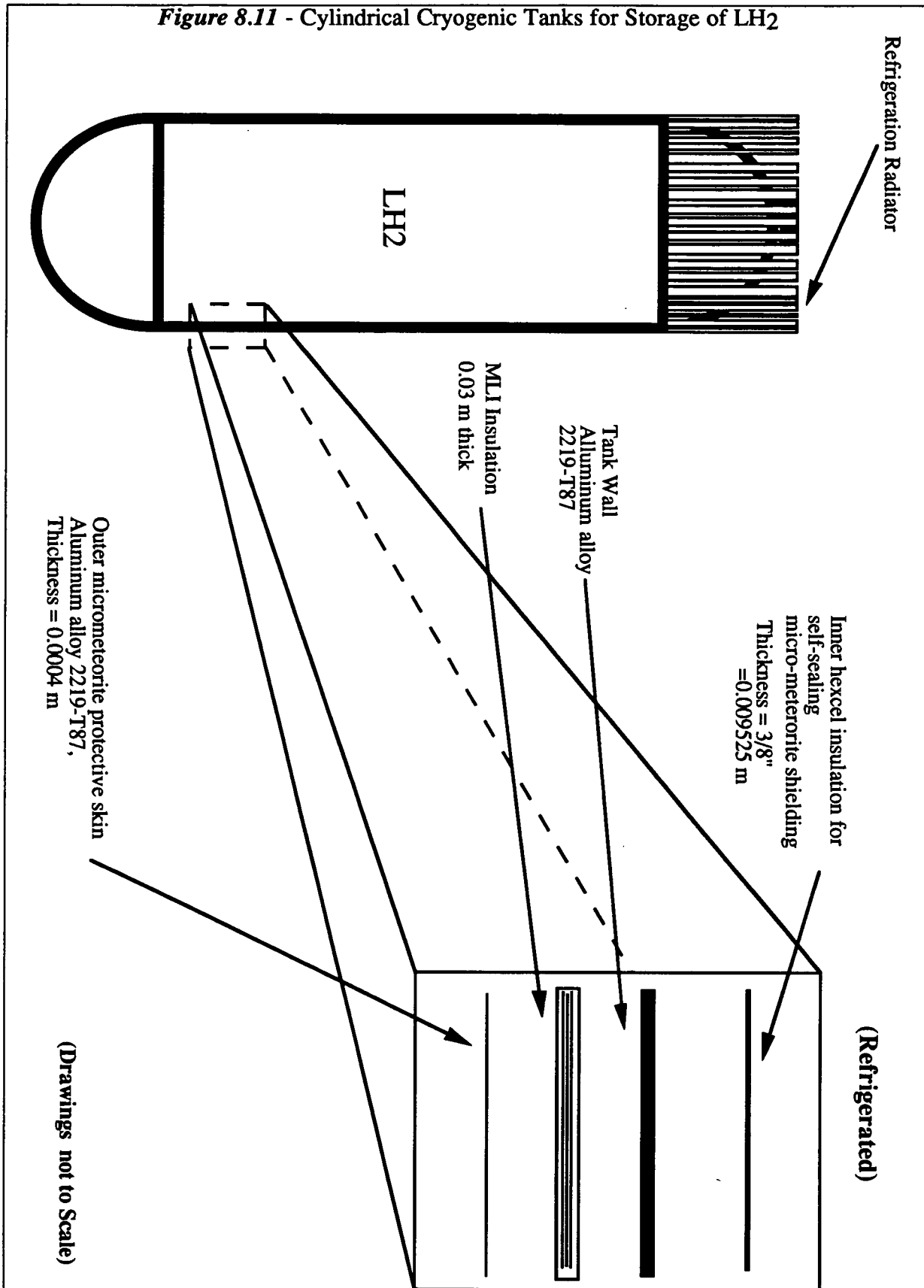
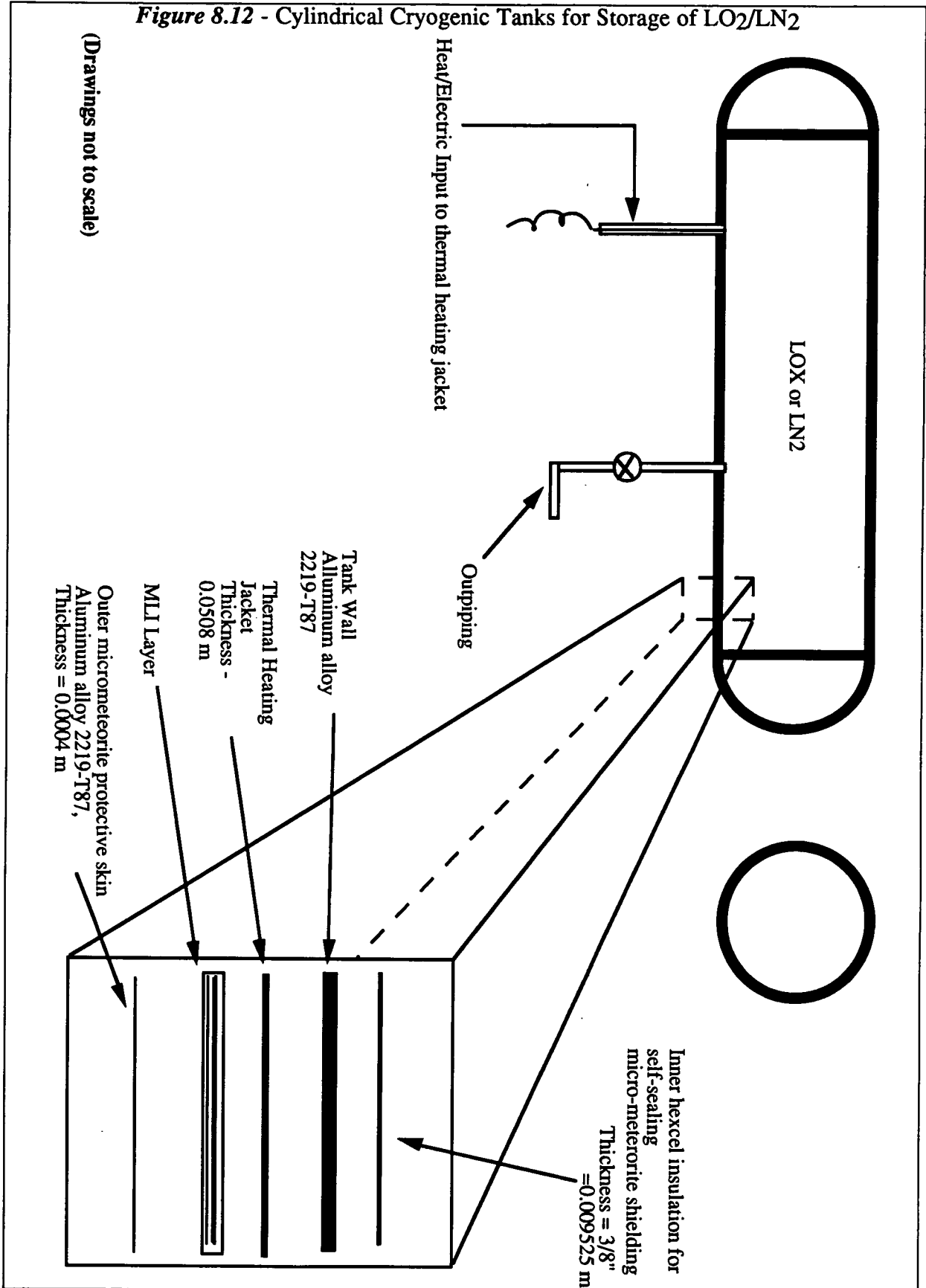

Figure 8.12 - Cylindrical Cryogenic Tanks for Storage of LO₂/LN₂



Tank Skin

The tank skin will be made of an aluminum alloy, 2219-T87. This alloy was chosen due to its favorable properties at cryogenic temperatures, and its extensive use in cryogenic tank construction. It has a relatively-high strength-to-density ratio, good toughness and availability, is weldable, and is low in cost. It is currently used for LOX / LH2 tanks on the Space Shuttle¹⁰.

When calculating the required tank thicknesses, a number of material properties for Aluminum 2219-T87 and desired tank dimensions must be known. The ultimate strength (S_{ut}) of alloy 2219-T87 is $= 4.3 \times 10^8$ Pa, and its density is (ρ) $= 2827$ Kg/m³. The “allowable stress” for the material is defined as follows:

$$\sigma_{\text{allowable}} = (0.25)(S_{ut}) \quad (11)$$

The “allowable stress” for this material is then 1.069×10^8 Pa. The desired internal pressure of the vessels is 1 atm = 101325 Pa. This value was chosen because it is high enough to avoid fuel “sloshing” concerns during rotation, but it is not so high that it dramatically increases the necessary tank skin thickness. Once the mass of each type of fuel was known, it was divided by the density to get the volume.

Once the volume was calculated, the inner dimensions of the tank necessary to contain that volume of liquid cryogen were determined. Tank dimension constraints were governed by the size of the HLLV payload bay, and by the maximum payload mass. We assumed a 150 metric-ton maximum payload, with a 9 m inner diameter maximum payload size.

(Note: A 2.5% ullage was allotted on the refrigerated LH2 tanks, and 10% on all others to minimize losses due to boiloff and alleviate rupture concerns¹².)

Given the diameter of the cylindrical section of the tank, the required thickness of the tank skin was calculated. The following formula was used:¹³

$$T = \frac{(p)(d)(SF_r)}{2(\sigma_a)}$$

where:	T	=	Necessary Thickness (m)
	p	=	Internal Pressure (Pa)
	d	=	Internal Cylinder Diameter (m)
	SF _r	=	Safety Factor against Rupture
	σ_a	=	Allowable Stress (Pa)

(See specific volume/thickness calculations in the specific subsystem sections)

Once the skin thickness was calculated, the mass of the skin was calculated by adding the surface area of the cylindrical section to that of the capped, spherical ends, multiplying the sum by the thickness, and then multiplying that product by the density.

$$\text{Mass of skin} = (\text{Surface Area})(\text{Thickness})(\text{Density})$$

(See specific mass calculations in the specific subsystem sections)

It should be noted that the tank thickness is sufficient to handle stress concentration at the joints, and the in/outpiping locations. It was assumed that the piping into and out of the tanks would be somewhere in the capped, spherical end sections. This is due to the fact that the required thickness, given by the equation above for the cylindrical section, is double the thickness that is necessary in the spherical end sections of the same diameter. So, in effect, a SF_r of 2 was automatically incorporated into the end pieces to take stress concentrations into account.

Thermal Jacket

This layer is used to maintain the desired cryogenic temperatures in the LOX and LN2 tanks of the spacecraft. It will be made of 0.0508 m of PVC closed cell foam (density = 0.006985 Kg/m³). Electric heat coils, or a thermal couple should be placed on the inner surface of the PVC insulation, next to the tank skin. In this configuration, the heat flux will be directed toward the cryogen in the tanks, but will be kept from flowing out through the MLI. Damage to the MLI from the coils will thus be avoided.

This Thermal Jacket has been designed to help prevent freezing as well as boiloff of the cryogen needs to be avoided. Control of the cryogenic temperature in these tanks is critical, and this additional layer will aid in maintaining that necessary temperature stability. At the storage pressure of 1 atm, LOX will freeze at ~ 54.4 K and LN2 at ~ 63.2 K, while they will boil at 90.18 K and 77.4 K respectively. From this data, we decided that the LOX should be kept at ~ 66 K and the LN2 at ~ 75 K. These temperatures are sufficiently above the freezing points of the cryogens, and far enough below their boiling points to avoid potential problems.

One final note is that it must be stressed that this layer is only present on the LOX and LN2 tanks, not on the LH2. (See *Figure 8.10 and 8.11*)

Multi-Layer Insulation (MLI)

Two types of MLI are to be used for the tanks. Multi-Layer insulation is made up of very thin layers of alternating low-conductivity, and high-reflectivity materials, and it is the best material for use on cryogenic tanks in a space environment.

For the main LH2 tanks with refrigeration, the recommended MLI will be 0.03 m thick, with a density of 45.2 Kg/m³ and 20 layers/cm¹⁴. For all the other tanks, we will use "Superflock" insulation that is 0.0508 m thick with 11.8 layers/cm a density of 19.22 Kg/m³.¹⁵ Both thickness values were recommended by AIAA/NASA reports.

The choices of these two MLI's were made on the basis of data available at the time of this writing. "Superflock" has been recommended for use on non-refrigerated tank systems, but data was unavailable on its use in refrigerated systems. The refrigeration data that was available to us uses a different MLI which is more dense than "Superflock". For these reasons, it was decided to go with the two different MLI schemes on the different tanks.

Outer Meteoroid Shield

This shield is made of aluminum alloy 2219-T87 that is 0.4 mm thick. The purpose of this outer shield is to stop the larger, lower-velocity micrometeoroids that could impact the tanks

during the mission. It is on the outside of all the other shields because, in this configuration, it will not only protect the tank skin, but also the MLI and thermal jackets from being damaged by a meteoroid hit.

This thin sheet of Aluminum 2219-T87 acts as a “bumper” for larger meteoroid particles. This thickness was also recommended by an AIAA/NASA report¹⁶.

Tank Connection Structure

For this report we will not design the tank connection structure. Instead, we will list the criteria that this structure must meet for our mission to Phobos :

- There must be Pyro Charges for tank staging, to blow en route, or on the surface of Phobos.
- A deployable fold-out structure to “guide” the tanks down when on the Phobos surface.
- A supporting mini-truss structure that can be disposed of when the tanks are staged. This structure should support the tanks in enough locations to eliminate any potential buckling problems, and have ports to attach to the connections which are welded to the tanks.
- Pieces to connect to the truss structure while in space. A connection “welded” to the outer micrometeoroid shell on the Earth’s surface prior to launch is necessary as a means of securing the tank to the mini-truss structure. These connections should be evenly spaced to divide the cylindrical section of the tank into two equal parts (ie: One connection in the center of the cylindrical section, and one on each end of that section).

Propulsion Tanks

There are a number of concerns that went into the design of the LH2 main tanks, and the LH2/LOX RCS tanks. These include size constraints, refrigeration constraints, tank placement, and staging. Also, maintenance of cryogenic temperatures played a key design role.

The first section below examines the configuration and refrigerators used on the LH2 tanks for the main engines. The second section explains the design and placement of the LH2 / LOX tanks used for the RCS thrusters.

LH2 Tanks for Main NTR Engines

For the entire mission to the martian moon Phobos and back, there are large LH2 fuel mass requirements. To encompass all of this fuel, a volume (including a 10% ullage) of 6930 m³ is necessary.

It was decided that each of the LH₂ tanks would have a 9.0 m diameter and a 19.5 m length (See *Table 8.1* for main LH₂ tank data).

For the LH₂ tanks, we will use an active refrigeration system on five of the tanks to reduce LH₂ boiloff to 750 Kg/month. By reducing boiloff during the duration of the mission, the initial mass of fuel required can be dramatically reduced which will save on HLLV launches and cost. The optimum MLI thickness for a refrigerated tank is ~ 0.03 m. Using a configuration of MLI with characteristics of 0.03 m in thickness with 20 layers / cm and a

density of 45.2 Kg/m^3 , the refrigerator mass is 383 Kg per tank. With the 5 refrigerated tanks, the total mass of the refrigeration radiators is $5(383 \text{ Kg}) = 1915 \text{ Kg}$.¹⁷

Table 8.1 - LH2 Tanks for main NTR Engines

<p>9 tanks with inner cylindrical dimensions of 9 m in diameter x 10.5 m in length Dished ends made of 1/2 sphere w/ 9 m diameter: Total length = 19.5 m Storage @ 1 atm (101325 Pa), $T=17.9 \text{ K}$, $r = 73.6 \text{ Kg/m}^3$. Includes a 2.5% ullage. $S_{\text{Frapture}} = 1.05$</p>			
Each Tank has the following characteristics:			
		<u>Thicknesses:</u>	
Fuel Mass:	75,000 Kg		
Inner micrometeor Shield:	32.56 Kg	$9.53 (10)^{-3}$	m
Tank Skin:	7313 Kg	$4.69 (10)^{-3}$	m
MLI:	747.63 Kg	0.03	m
Outer Meteoroid:	623.5 Kg	$4 (10)^{-4}$	m

Total Tank Mass:	8,716.7 Kg		
Total Fuel Mass:	75,000 Kg		
Mass % of tanks as % of fuel mass:	11.62 %		

Note: 5 of the tanks will be refrigerated. For these five, add an additional mass of 383 Kg per tank for the refrigeration radiators that are necessary. This would cause the total mass of each of these tanks to be 9100 Kg.

LH2/LOX Tanks for RCS Attitude Control Thrusters

The volume of fuel required for the RCS Attitude Control Thrusters for the total mission is approximately 20 m^3 of LH2 and 18 m^3 of LOX. Both tanks are design with a 10% vapor ullage. The tanks are designed to fit between the LH2 main feeder tanks and the heat shield for the NTR engines. (The length of each tank is less than the diameter of the main LH2 feeder tank, so the RCS fuel tanks will be in the protective "cone"). (See **Table 8.2 and 8.3**)

Table 8.2 - LH2 Tanks for RCS Attitude Control Thrusters

2 tanks with inner cylindrical dimensions of 1.5 m in diameter x 5.5 m in length
 Dished ends made of 1/2 sphere w/ 1.5 m diameter: Total length = 7 m
 Storage @ 1 atm (101325 Pa), T=17.9 K, $\rho = 73.6 \text{ Kg/m}^3$. Includes a 10% ullage.
 $S_{\text{rupture}} = 1.4$

		<u>Thicknesses:</u>	
Fuel Mass:	1470.6 Kg		
Inner micrometeor Shield:	1.95 Kg	$9.53 (10)^{-3}$	m
Tank Skin:	92.8 Kg	$9.95 (10)^{-4}$	m
MLI:	32.19 Kg	0.0508	m
Outer Meteoroid:	37.3 Kg	$4 (10)^{-4}$	m

Total Tank Mass:	2(164.25) Kg		
Total Fuel Mass:	1470.6 Kg		
Mass % of tanks as % of fuel mass:	22.3 %		

Table 8.3 - LOX Tanks for RCS Attitude Control Thrusters

2 tanks with inner cylindrical dimensions of 1.5 m in diameter x 4.75 m in length
 Dished ends made of 1/2 sphere w/ 1.5 m diameter: Total length = 6.25 m
 Storage @ 1 atm (101325 Pa), T=66 K, $\rho = 1255 \text{ Kg/m}^3$. Includes a 10% ullage.
 $S_{\text{rupture}} = 1.4$

		<u>Thicknesses:</u>	
Fuel Mass:	22588 Kg		
Inner micrometeor Shield:	1.74 Kg	$9.53 (10)^{-3}$	m
Tank Skin:	82.9 Kg	$9.95 (10)^{-4}$	m
Thermal Jacket:	0.0105 Kg	0.0508	m
MLI:	28.75 Kg	0.0508	m
Outer Meteoroid:	33.3 Kg	$4 (10)^{-4}$	m

Total Tank Mass:	2(146.66) Kg		
Total Fuel Mass:	22588 Kg		
Mass % of tanks as % of fuel mass:	1.30 %		

These tanks do not use a refrigeration system, so boiloff of the LH2 is a concern. A conservative boiloff rate of 1% per month was used when calculating the necessary mass for the trip. The MLI used for the RCS tanks is "Superflock" (30 layers/inch, density of $\sim 19.22 \text{ Kg/m}^3$).¹⁸ The LOX tanks do have an additional layer in their construction, a thermal jacket that, when supplied with heat or power, will maintain the LOX at its required 66 K.

Human Factors Tanks

The tanks for the crew modules must contain the necessary mass of LOX and LN₂ as deemed necessary by Human Factors. In the first section below, requirements of LOX and LN₂ for the mission, and design criteria are discussed. The section that follows details tank sizes.

Requirements and Criteria:

The total mass of each gas (LOX and LN₂) required for the trip is 1260 Kg. This was obtained using values of 450 Kg of LOX and 450 Kg of LN₂. According to data from Human Factors, leakage through the crew modules could be as high as 1 Kg per day. For this, the initial mass of each gas was doubled to 900 Kg. Then, as a safety factor for boiloff, and for contingency against catastrophic failures such as a total loss of cabin atmosphere, an additional 60% of gas was allotted.

Sizes

The size of the LOX tank is 0.75 m in diameter and 2.75 m in total length, while the LN₂ tank is 0.75 m in diameter and 4.25 m in total length. (See *Table 8.4 and 8.5*). As with the RCS LOX tanks, a thermal jacket layer is necessary to keep the tanks at their desired cryogenic temperatures of 66 K (LOX) and 75 K (LN₂). Again, the insulation used here is "Superflock" (30 layers/inch, density of ~ 19.22 Kg/m³).

Table 8.4 - LOX Tank for crew module atmosphere

1 tank with inner cylindrical dimensions of 0.75 m in diameter x 2 m in length Dished ends made of 1/2 sphere w/ 0.75 m diameter: Total length = 2.75 m Storage @ 1 atm (101325 Pa), T=66 K, $\rho = 1255 \text{ Kg/m}^3$. Includes a 10% ullage. $SF_{\text{rupture}} = 1.4$			
		<u>Thicknesses:</u>	
Fuel Mass:	1260 Kg		
Inner micrometeor Shield:	0.38 Kg	$9.53 (10)^{-3}$	m
Tank Skin:	9.12 Kg	$4.98 (10)^{-4}$	m
Thermal Jacket:	0.0023 Kg	0.0508	m
MLI:	6.32 Kg	0.0508	m
Outer Meteoroid:	7.33 Kg	$4 (10)^{-4}$	m

Total Tank Mass:	23.15 Kg		
Total Fuel Mass:	1260 Kg		
Mass % of tanks as % of fuel mass:	1.84 %		

Table 8.5 - LN2 Tank for crew module atmosphere

1 tank with inner cylindrical dimensions of 0.75 m in diameter x 3.5 m in length
 Dished ends made of 1/2 sphere w/ 0.75 m diameter: Total length = 4.25 m
 Storage @ 1 atm (101325 Pa), T=75 K, $\rho = 807 \text{ Kg/m}^3$. Includes a 10% ullage.
 $SF_{rupture} = 1.4$

		<u>Thicknesses:</u>	
Fuel Mass:	1260 Kg		
Inner micrometeor Shield:	0.59 Kg	$9.53 (10)^{-3}$	m
Tank Skin:	14.09 Kg	$4.98 (10)^{-4}$	m
Thermal Jacket:	0.0036 Kg	0.0508	m
MLI:	9.77 Kg	0.0508	m
Outer Meteoroid:	11.32 Kg	$4 (10)^{-4}$	m

Total Tank Mass:	35.78 Kg		
Total Fuel Mass:	1260 Kg		
Mass % of tanks as % of fuel mass:	2.84 %		

Power Group Tanks

There are tanks that need to be designed for the Power Group. These tanks contain the components necessary to operate fuel cells for the ship.

Fuel Cell Tanks

Separate tanks are required for the storage of LOX and LH2 for use in fuel cells.

There are only two tanks that are necessary - one for LOX and one for LH2. Both the LH2 and LOX tanks have the same dimensions, 0.75 m diameter and a 1.75 m total length. (See *Table 8.6 and 8.7*). The LOX needs to be kept at its cryogenic temperature of 66K. Both tanks should be placed close to the crew modules, to avoid power losses in the lines.

Table 8.6 - LH2 Tank for Fuel Cells

1 tank with inner cylindrical dimensions of 0.75 m in diameter x 1 m in length
 Dished ends made of 1/2 sphere w/ 0.75 m diameter: Total length = 1.75 m
 Storage @ 1 atm (101325 Pa), $T=75\text{ K}$, $r = 807\text{ Kg/m}^3$. Includes a 10% ullage.
 $SF_{\text{rupture}} = 1.4$

			<u>Thicknesses:</u>	
Fuel Mass:	37.5	Kg		
Inner micrometeor Shield:	0.24	Kg	$9.53 (10)^{-3}$	m
Tank Skin:	5.8	Kg	$4.98 (10)^{-4}$	m
MLI:	4.02	Kg	0.0508	m
Outer Meteoroid:	4.66	Kg	$4 (10)^{-4}$	m

Total Tank Mass:	14.73	Kg		
Total Fuel Mass:	37.5	Kg		
Mass % of tanks as % of fuel mass:	39.3	%		

Table 8.7 - LOX Tank for Fuel Cells

1 tank with inner cylindrical dimensions of 0.75 m in diameter x 1 m in length
 Dished ends made of 1/2 sphere w/ 0.75 m diameter: Total length = 1.75 m
 Storage @ 1 atm (101325 Pa), $T=75\text{ K}$, $r = 807\text{ Kg/m}^3$. Includes a 10% ullage.
 $SF_{\text{rupture}} = 1.4$

Fuel Mass:	627.5	Kg		
Inner micrometeor Shield:	0.24	Kg	$9.53 (10)^{-3}$	m
Tank Skin:	5.8	Kg	$4.98 (10)^{-4}$	m
Thermal Jacket:	0.0015	Kg	0.0508	m
MLI:	4.02	Kg	0.0508	m
Outer Meteoroid:	4.66	Kg	$4 (10)^{-4}$	m

Total Tank Mass:	14.733	Kg		
Total Fuel Mass:	627.5	Kg		
Mass % of tanks as % of fuel mass:	2.35	%		

Truss System

Introduction

The truss system for our spacecraft is divided into 3 separate parts. These parts, in the order that they will be discussed are:

- 1) Main truss
- 2) Communications Truss.
- 3) Habitation Module Support Unit

Under each section we will discuss the following topics:

- 1) Design criteria for the truss section
- 2) A load analysis on the truss section
- 3) Procedure for determining the design for the truss
- 4) Analysis of Structural Integrity of Truss with Respect to Applied Loads
- 5) Mass Analysis

Main Truss

The first part of the truss system that we looked into was the main truss. In order to design the main truss, it was necessary to first look at the design criteria.

Design criteria

- 1) The structure must completely fit in a single heavy lift launch vehicle and must be deployable into Low Earth Orbit with a minimum possible amount of astronaut participation.
- 2) The structure must have a natural mode frequency of at least one hertz.
- 3) The structure must support all applied loads without failure.

To achieve the deployment requirement, we found it necessary to use a collapsible truss system rather than an erectable truss system. From the start we knew that the main truss would be approximately 100 meters long. If the truss was not collapsible then it would require several launches to transport the main truss into Low Earth Orbit (LEO). A truss system requiring more than a single launch was deemed unacceptable. We also decided that once the truss was collapsed, it had to be deployed with a minimum amount of astronaut participation. A truss that requires dozens if not hundreds of space walks to assemble is of no use to us.

The next criterion was that the ship must have a normal mode frequency of at least one hertz where the frequency of the ship is a factor of the stiffness of the main truss and the location and mass of the components on the ship. A high natural frequency is desired because the higher the natural frequency of the ship, the more dynamic control the astronauts will have over the ship.

Finally, we required that the main truss support all applied loads without failure. With this being an extended mission into space, it is necessary that the truss have a 100% probability of sustaining the known loads that it will encounter. The reason for this is that there will be little if any chance to repair the truss if all or part of the truss fails. Note that a description of the loads are given in the next section.

Loads on the Main Truss

The main truss will be placed under three main loads during the mission. The first load is an axial compressive force. This is due to the acceleration produced when the ship performs thrust maneuvers. The maximum acceleration is 0.56g.

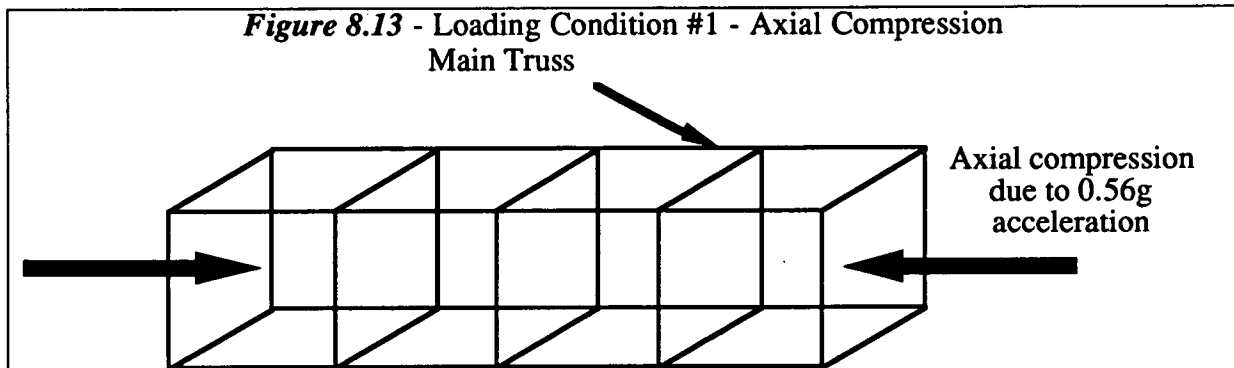

The second load on the main truss is a tensile force due to the artificial gravity. The maximum acceleration of 0.5g is located by the habitation modules where the radius from the axis of rotation is the greatest.

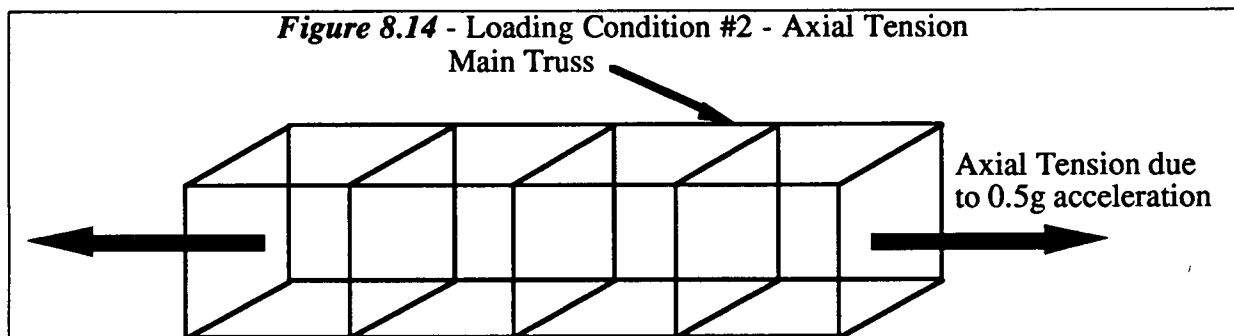

The third load on the main truss will be due to the Spin/Despin procedure. The RCS jets located by the habitation modules and the propulsion engines will produce a moment onto the main truss and cause it to bend. This load will cause a 0.11g transverse acceleration on the main truss. Note, in this case we included the deformed shape of the main truss to clarify the result that the transverse loads will have on the main truss.

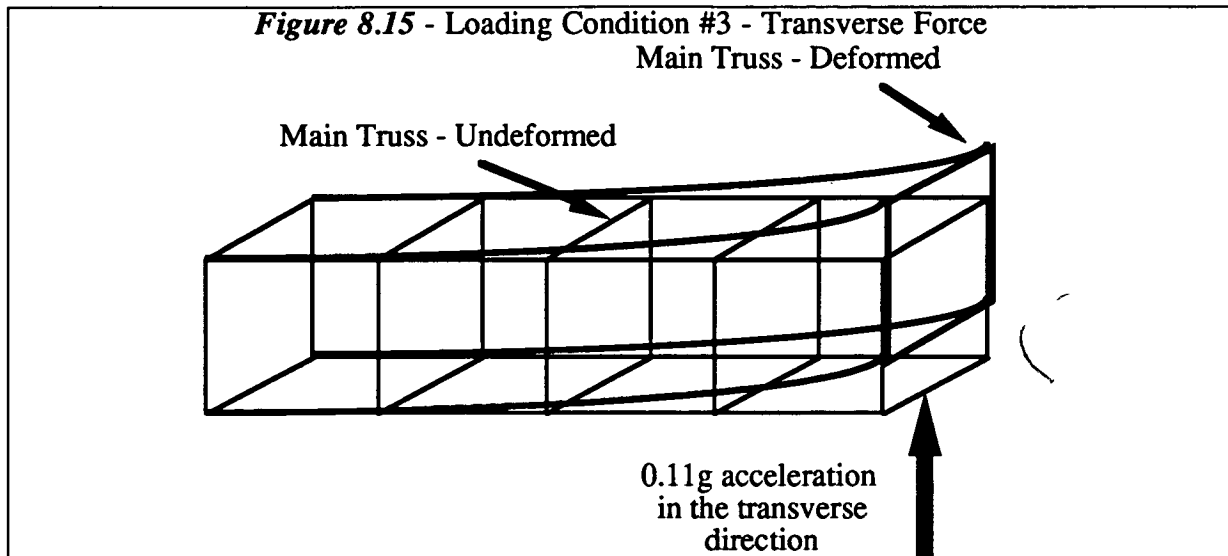

Design Procedure for the Main Truss

Now that we know the criteria that the truss must satisfy, and the loads that the truss will undergo, the next step in coming up with a final design was to look at existing truss systems. The first truss that we examined was the tetrahedral collapsible planar truss used for the Delta Space Station. We considered using three of these planar trusses, running the length of the craft, arranged to form a triangular cross-section. The equivalent cross-sectional area and equivalent stiffness necessary to achieve the lowest natural frequency requirement, was to be computed by static and dynamic analysis of the truss structure. An initial guess at the size required for the structure was to be modeled and analyzed on SDRC I-DEAS. From this analysis the stresses involved would be determined. Based on the calculated stresses, the cross-sectional area as well as the size of the truss members would be altered to comply with a 1.4 factor of safety. However, we decided that the configuration of the planar truss was too complex to be modeled and analyzed in the short period of time that we had.

The next truss that we looked at was a box beam truss. This configuration is a square box with a single diagonal member crossing each side of the box. A diagram of a single cell of this truss is shown in *Figure 8.16*. Note that not all six diagonal members are shown. Only the front three diagonal members were included in the figure to make it less confusing.

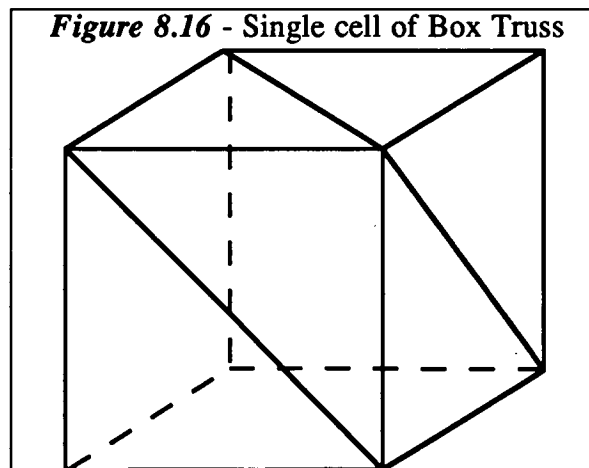

It was decided that for our purposes this was the best existing truss configuration. Because of its simplicity, we will be able to completely analyze this truss. The next step was to look at the method that would be used to deploy the truss into its final position. For this, three energy schemes were looked at. The first scheme was to use an electric motor with a screw or chain drive mechanism to deploy the truss. The second option was to use a Mobile Remote Manipulator System to extend the truss. However, the method we found to be the most efficient was the use of pre-compressed springs in the collapsible members of each bay. This allows the truss to be deployed, once placed in low earth orbit (LEO), without any additional energy expenditure. A result of this is that the only astronaut participation required will be to inspect the extended truss structure to make sure that all of the members have been locked into their extended positions.

Now that the truss has been identified, it is necessary to analyze it to determine its dimensions that will result in the natural frequency of the ship being greater than one hertz. The natural frequency of a structure is dependent on the moment of inertia of the structure. With this in mind, the following Finite Element model was created in SDRC I-DEAS to determine the required moment of inertia of the main truss.

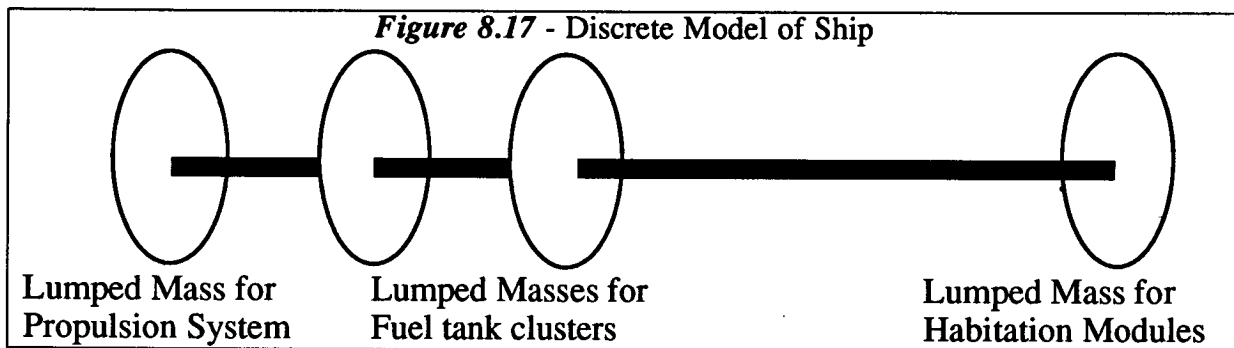

This finite element model consists of a single truss which is modeled as a line with assigned equivalent physical characteristics and material properties. This line has a total length of 91 meters which is the length of the main truss. Lumped masses were then added at their respective points along the actual truss to represent the mass of the main components of the ship. An arbitrary moment of inertia value of $.3 \text{ m}^4$ was chosen and assigned to the truss. A normal mode dynamic analysis on the model was then performed to determine what the lowest natural frequency of the ship would be. The results of the dynamic run stated that the first natural frequency of the ship was much less than one Hertz. This value was deemed unacceptable since our criteria states that the lowest natural frequency has to be at least one Hertz. As a result, the moment of inertia was increased from 0.3 m^4 to 0.35 m^4 and the model was run again. This iterative approach was utilized until the equivalent model produced a lowest natural frequency of approximately one Hertz. The moment of inertia value that corresponded to a lowest natural frequency of one Hertz was 0.5 m^4 .

Knowing the required moment of inertia, an estimate of the member cross-sectional area and configuration of each member could be determined once the length of the longerons were known. To do this, the following approximation of the truss structure was made:

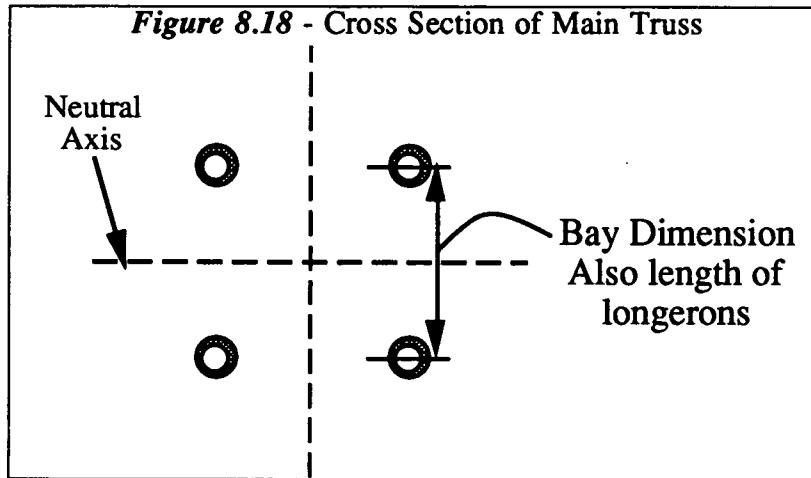

The total moment of inertia was estimated without the effects of the cross members so our final moment of inertia determined by I-DEAS will be larger. The following equations were used to determine the member dimensions:

$$I_{\text{total}} = 4(I_{\text{member}} + A_{\text{member}} * d^2)$$

$$I_{\text{member}} = \frac{\pi}{4} (r_o^4 - r_i^4)$$

$$A_{\text{each member}} = \pi (r_o^2 - r_i^2)$$

I_{total}	=	Total moment of inertia of the truss cross section
I_{member}	=	The moment of inertia of each member
A_{member}	=	The cross-sectional area of each member
d	=	Distance from the neutral axis of each member to the axis of the truss
r_i and r_o	=	The inner and outer radii of the members respectively

It can be seen from the first equation that it is desirable to increase the distance from the neutral axis of each member to the axis of the truss. However, the launch vehicle cargo bay has a diameter of 9.0 m and a length of 40 m and the collapsed truss must completely fit within this cylinder. Noticing the depth of the entire collapsed truss is less the length of a longeron, it can be seen that the length of the members could be maximized by loading the truss perpendicular to the axis of the cylindrical cargo bay. This concept is shown in *Figure 8.19*. This figure is a diagram of the 91 meter truss that has been collapsed. The cross section of the truss lies in the x-y plane, and the length of the truss lies along the z-direction.

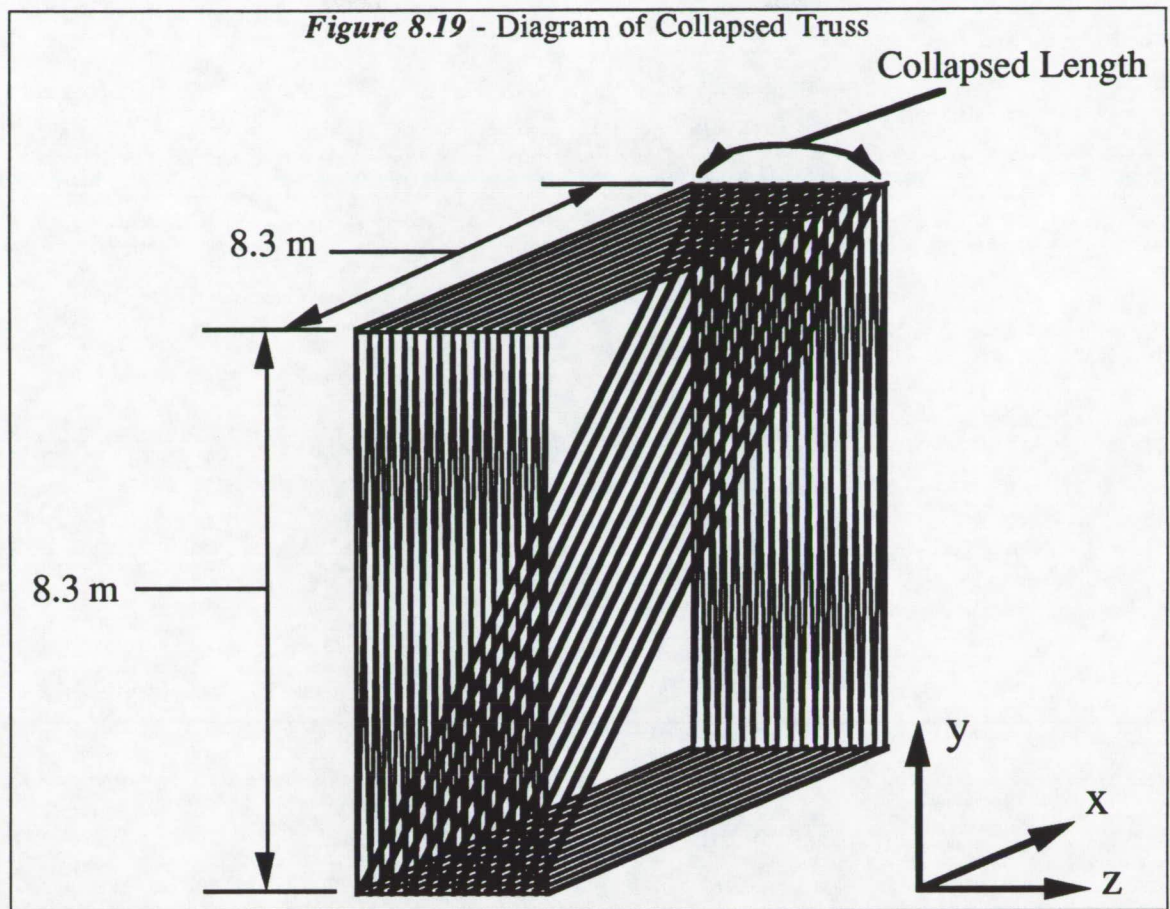

Now, a collapsed truss with the cross sectional dimensions of 8.3m by 8.3 m will fit into the 9.0 m diameter payload shroud if the payload shroud is placed around the collapsed truss so that the cross section of the shroud is in the y-z plane and the lengthwise direction of the shroud is along the x-axis. This is shown in *Figure 8.20*.

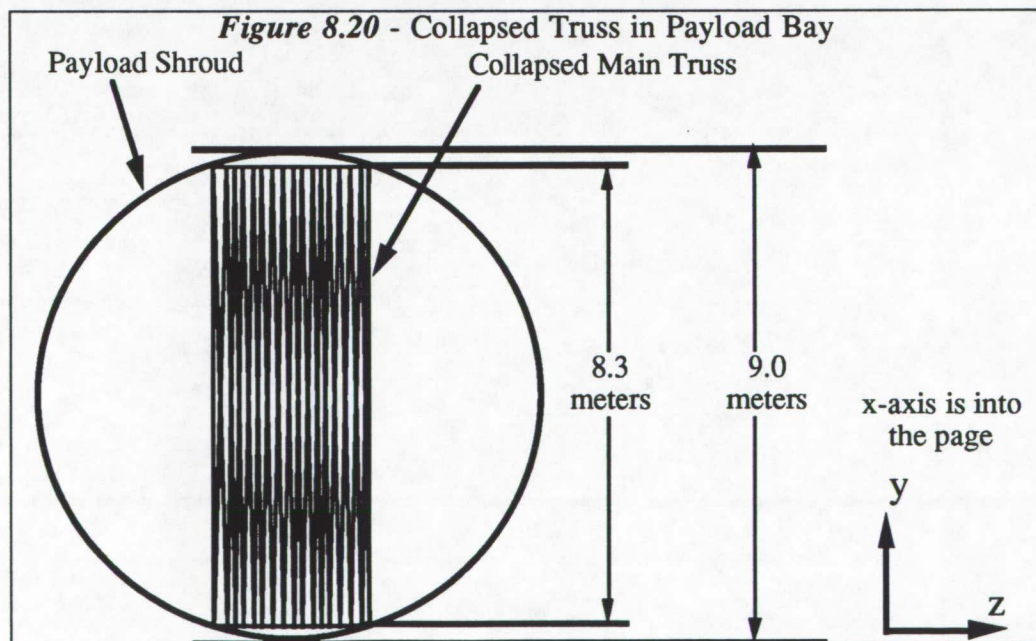

The next step was to determine the number of bays needed to achieve the required length of 91 meters. It was determined that the minimum number of bays required for our range of longeron lengths was 11. Knowing the length of the longerons and the diameter of the cargo bay, the maximum collapsed truss length was determined to be 3.48 m. The collapsed truss length is equal to the total number of bays times twice the outer diameter of a member. From this, the maximum outer diameter was computed to be 0.1582 m. Leaving room for loading, the maximum outside diameter was reduced to 0.1575 m.

Analysis of Structural Integrity of Truss

Once the outer diameter is determined, an analysis of the structural integrity of the truss is needed to determine the inner diameter. To determine the inner diameter, the required moment of inertia to avoid local buckling was calculated. The following equations were used:

$$P = \frac{\pi^2 EI}{L^2} \quad \text{which yields} \quad I = \frac{PL^2}{\pi^2 E}$$

where:

P	=	the maximum expected load with a 1.4 factor of safety
E	=	the elastic modulus of the individual members
I	=	moment of inertia of a member
L	=	length of a member

The maximum load was determined using the following equation:

$$\text{Maximum Load} = (\text{F.S.})(m)(a)$$

F.S.	=	Factor of Safety (in our case 1.4)
m	=	mass
a	=	acceleration

Unfortunately, the wrong mass was used in the calculations. For the calculations, the mass of the habitation modules was used. But, by referring to *Figure 8.21* it can be seen that the maximum load will be on the part of the truss that is located directly next to the propulsive sections.

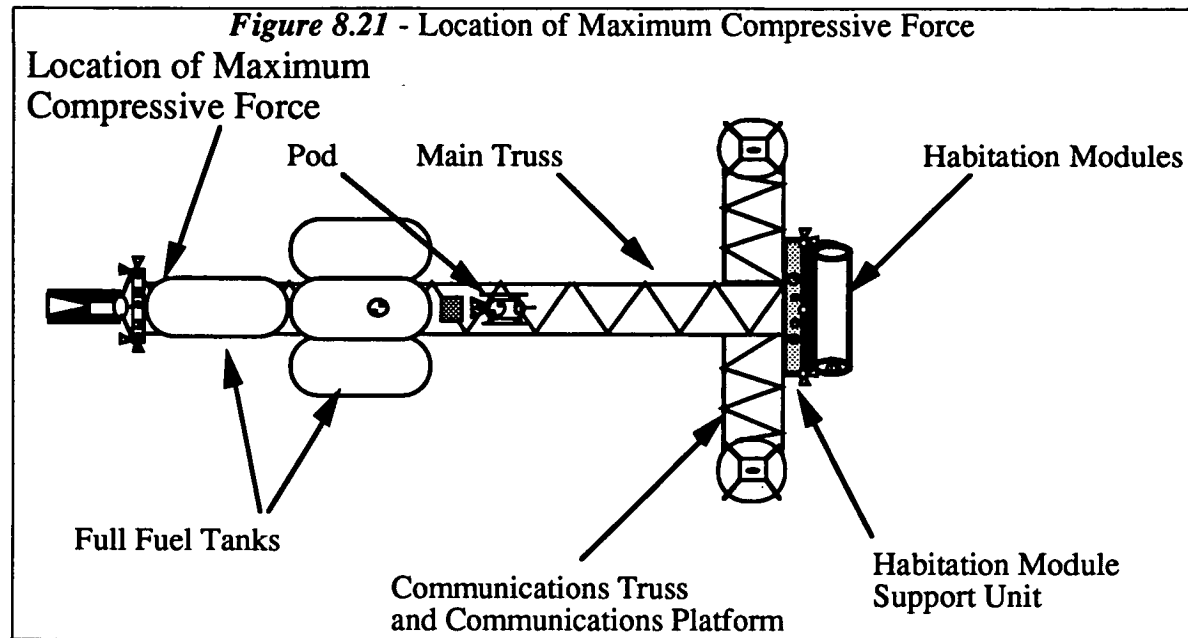

As a result, the correct mass should be the mass of the habitation modules plus the mass of the habitation module support unit, the communications truss and platform, the main truss, the pod, and the full fuel tanks. The correct mass should be:

$$\begin{aligned}
 \text{Mass}_{\text{correct}} &= \text{mass}_{\text{hm}} + \text{mass}_{\text{hmsu}} + \text{mass}_{\text{com truss}} + \text{mass}_{\text{pod}} + \text{mass}_{\text{tanks}} + \text{mass}_{\text{fuel}} \\
 &= 69,034 + 5,624 + 1,059 + 5,500 + 585,041 \\
 &\approx 700,000 \text{ kg}
 \end{aligned}$$

But, for the rest of this report, it will be assumed that the mass that was used is the correct mass. So, using a factor of safety of 1.4, a maximum acceleration of 0.56g due to the thrust and the mass of the habitation modules, the maximum load on the main truss can be determined. Taking this load and dividing it among the four axial members in a cross section, the critical moment of inertia that defines the boundary between buckling on the local level and not buckling can be determined.

$$I_{\text{member}} = \frac{(192080 \text{ N})(8.3 \text{ m})^2}{\pi^2(107 \text{ GPa})} = 1.253 \times 10^{-5} \text{ m}^4$$

Then using our equation that relates the moment of inertia of a hollow tube to the radii of that tube we can determine the minimum inner radius that will prevent local buckling

$$\begin{aligned}
 I_{\text{member}} &= \frac{\pi}{4} (r_o^4 - r_i^4) \\
 1.253 \times 10^{-5} \text{ m}^4 &= \frac{\pi}{4} (.07875^4 - r_i^4) \\
 r_i &= 0.0686 \text{ m}
 \end{aligned}$$

Therefore we have chosen our inner radius to be 0.0686 m. This dimension along with the previously chosen outer radius and member length will prevent buckling from occurring on the local level.

The next step was to determine if buckling would occur on the global level. To do this, the moment of inertia of the entire truss beam will be needed. To obtain this value, our box beam truss with the above specifications was generated on I-DEAS. Once the model was finished, an arbitrary lateral load was placed on the truss. The deflection was obtained and compared to beam theory to give an equivalent moment of inertia.

$$I_{eq} = \frac{FL^3}{dE}$$

where:

I_{eq}	=	equivalent moment of inertia
F	=	arbitrary load
L	=	length of a member
d	=	deflection of the truss structure
E	=	the elastic modulus of the individual members

Restraining one end of the truss and applying a transverse load of 40,000 N, the maximum deflection experienced was 0.291 m. The resulting equivalent moment of inertia when compared to beam theory is 0.976 m⁴. A global buckling analysis was then performed using this I_{eq} . Comparing the maximum load to the critical buckling load we found that the length of our truss is sufficient to avoid global buckling. One thing that should be noted is that the I_{eq} that was obtained here is significantly more than the I_{eq} of 0.5 m⁴ that we obtained above. The reason for this is that this I_{eq} was obtained through an analysis on SDRC I-DEAS that included the diagonal members of the box truss. But the original I_{eq} of 0.5 m⁴ was determined by dynamic analysis. It was then assumed that this I_{eq} was derived SOLELY by the axial members of the box truss. In other words, the box truss was designed so that it would have an I_{eq} of 0.5 m⁴ when only the four axial members are taken into account and the diagonal members are neglected. As a result, it is obvious that when the diagonal members are included in the calculations, the moment of inertia of the truss will increase which it did. As a result, the I_{eq} that we will use is 0.94 m⁴.

As of this point, our truss has satisfied our first (collapsible and self-deployable) criteria and our second (natural frequency) criteria. It has also satisfied portions of our third criteria by proving that it will not buckle on the local or global level. The last step that needs to be performed is a static analysis of the box beam to make sure the maximum stresses due to all three load cases do not exceed the allowable stresses of the material used for the truss.

Before we do these calculations though, it is necessary to choose a material for the truss. Due to the weight constraint, the truss material had to be light weight as well as strong. It was decided that Graphite-Epoxy would be used for our main truss.

The characteristics of the Graphite-Epoxy material are the following:

$\sigma_{allowed}$	=	1.33 GPa
Density	=	1525 $\frac{kg}{m^3}$
Young's Modulus (E)	=	107 GPa

Now that the material has been chosen, the next step in this analysis is to calculate the allowable stress in each of the members of the truss. In this case,

$$\sigma_{\text{allowed}} = \frac{\sigma_{\text{yield}}}{1.4} \quad \sigma_{\text{allowed}} = \frac{1332.8 \text{ MPa}}{1.4} = 952 \text{ MPa}$$

The box truss model in I-DEAS was then loaded based on the propulsive acceleration of the various masses. The maximum stress in a member was found to be 370 MPa. This is almost one-third the allowable stress so it is deemed acceptable.

The next step was to determine if the maximum allowable stresses would be exceeded during the axial tension do to artificial gravity. The maximum load due to artificial gravity will occur at the center of gravity which in our case was located in the truss part of the ship. The force on the truss will vary with distance along the length of the truss because the acceleration varies (zero at the center of gravity and a maximum of 0.5g at the habitation modules). But, it can be calculated using the following equation assuming that all masses are discretized:

$$F = \omega(m_{ft}x_{ft} + m_p x_p + m_{ct}x_{ct} + m_{hm}x_{hm})$$

F	=	maximum force on truss
ω	=	angular velocity of ship
m_{ft}	=	mass of the fuel and the fuel tanks
x_{ft}	=	distance of the fuel and fuel tanks from the center of gravity
m_p	=	mass of the pod
x_p	=	distance of the pod from the center of gravity
m_{ct}	=	mass of the communications truss and all the RCS equipment on the truss
x_{ct}	=	distance of the communications truss et al. from the center of gravity
m_{hm}	=	mass of the habitation modules
x_{hm}	=	distance of the habitation modules from the center of gravity

Using this equation the maximum tensile stress was determined.

The last step in the analysis was to determine if the allowable stresses in the members were exceeded during the Spin/Despin procedure. To do this, the the force provided by the RCS Jets was inputted into our I-DEAS model. A static analysis was then performed to determine the stresses in all of the members of the truss.

Mass Analysis of Main Truss

The total mass of the Main truss was determined by counting the number of members in the main truss. Knowing the lengths of all the members, the inner and outer diameters of these members and the density of the Graphit-Epoxy material that the members are made of, the mass of the entire truss can be determined. In the this case the mass of the members alone yielded 6,147 kg. The next step was to determine the mass of the nodes that connect the members. We have assumed that the weight of each node is approximately 12 kg or 1/3 the weight of each node. This results in a node mass of 576 kg and a total main truss mass of 6723 kg.

Communication Truss

It was necessary to design two trusses which extended outward from the spacecraft to support the communication platforms. These communication platforms need to be placed far enough away from the spacecraft so that no part of the spacecraft will block the transmissions. Therefore, we examined the following parameters.

Design Criteria

We investigated these four design criteria:

- 1) The structure must completely fit in a single heavy lift launch vehicle and must be deployable into lower earth orbit with a minimum amount of astronaut participation..
- 2) The structure must be easily attached to the main truss.
- 3) The structure must extend beyond any other part of the spacecraft in order to avoid transmission interference.
- 4) The structure must support all the applied loads without failure

Loads on the Communications Truss

The three loading conditions on the Communications Truss are identical to the loading conditions on the main truss. But, since the configuration of the Communication truss is different than the main truss, the loading conditions will have different results.

The first loading condition was the 0.56g axial compression on the ship as shown in *Figure 8.22*.

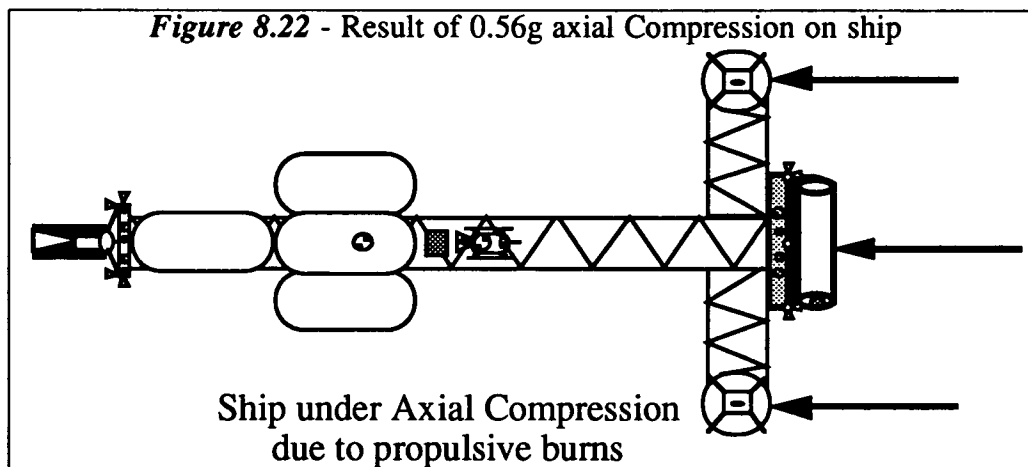

Due to the orientation of the Communications truss, this axial compression on the ship will result in a transverse load on the communications truss as shown in *Figure 8.23*.

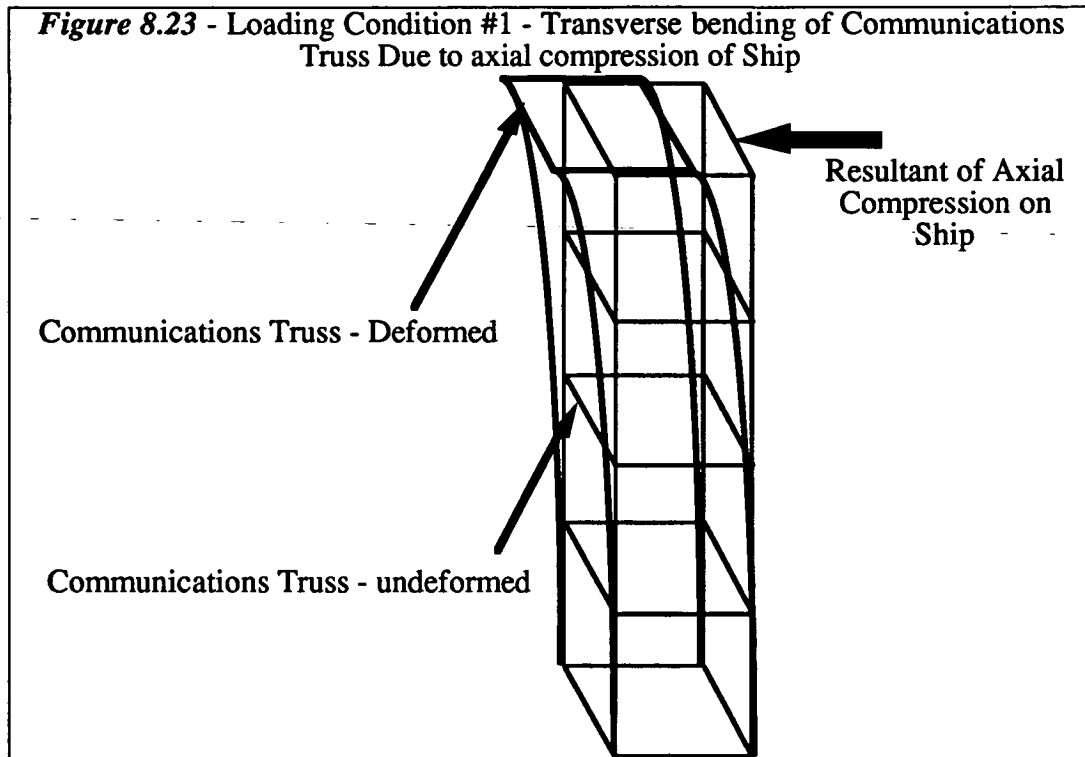

The second loading condition on the Communication Truss is due to the axial tension of the ship while it is under artificial gravity. Note that the maximum value of this force is $0.50g$ at the habitation module. This value will decrease to the value of zero at the axis of rotation. The communications truss is close to the habitation modules so we will assume that they experience the $0.5g$ acceleration. This is a high estimate so we will be in error, but on the safe side. The result of this axial tension on the ship is to put the communications truss under a transverse load. A picture of the deformed shape of the communications truss due to this transverse load is the same as the picture due to Loading condition #1, but instead of the tip of the communications truss deforming to the left as in *Figure 8.23*, it deforms to the right.

The final loading condition on the communications truss is due to the Spin/Despin Procedure. The Spin/Despin maneuver will also place a transverse load onto the communications truss causing it to bend. Looking at *Figure 8.24*, the Spin/Despin maneuver will cause the communications truss to bend out of the page.

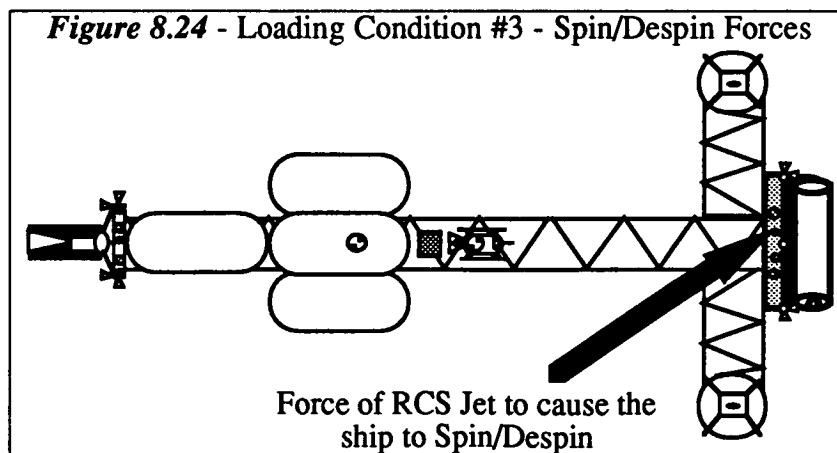

Design Procedure for the Communication Truss

The first step in designing the Communications Truss was to satisfy the first criteria. To achieve this, it was decided that the box beam truss used for the main truss would be used here. As a result, the communications truss is both collapsible so the entire truss will fit in a single heavy lift launch and it is self deployable so astronaut participation will be a minimum.

The next step was to satisfy criteria #2. It was required that the communications truss be located on the main truss just behind the habitation modules. As a result, the obvious solution was to connect the communications module to the main truss. Each cell of the main truss is a cube with all sides having the dimensions of 8.3 m. It was decided that the communications truss will also have the dimensions of 8.3 m on each side. As a result, the nodes of the communication truss line up with the nodes of the main truss and therefore make the connection to the main truss simple. *Figure 8.25* shows this principle.

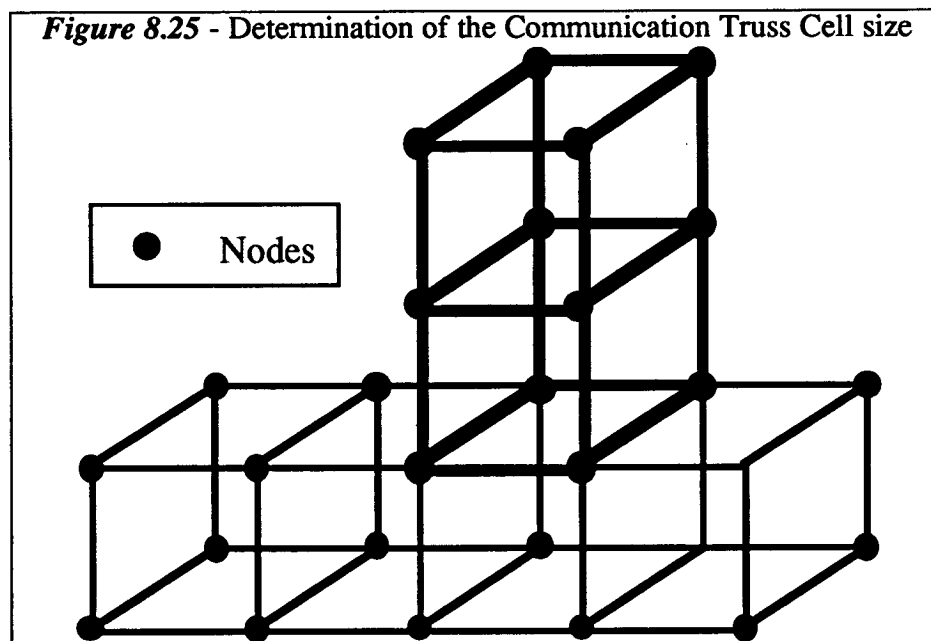

As you can see, by making the cell size of the communications truss the same as the main truss, the nodes line up and can be easily connected. Note that the cells that are in bold are the cells of the communications truss and the lighter lined cells are the main truss.

The third criteria that needed to be satisfied in the design of the communications truss was that it must be long enough to extend beyond all other parts of the ship in order to avoid transmission interference. To satisfy this criterion, it was necessary to look at the overall ship configuration. The furthest point from the center line of the ship was located on the fuel tanks. The maximum distance the fuel tanks extend outward from the ship's main truss is 18 m. We also had to add another 4.5 m to this length to account for the rotation of the dish which is 9 m in diameter. This gives a total distance from the center line of 22.5 m. Using the 8.3 m bay size, we found that we needed 3 bays to achieve this length.

Finally, the last procedure was to perform a structural analysis on the main truss.

Analysis of Structural Integrity of Communications Truss

It was necessary to design the communications truss so that it would support all applied loads without failure. To do this, a structural analysis had to be done with respect to the three loading conditions listed in the section Loads on the Communications Truss.

Since all three loading conditions excite the same response (transverse bending) but in different directions, it will suffice to analyze the communications truss with respect to the largest load. In our case the largest load on the communications truss is due to the propulsive burn and has the value of 0.56g. In order to continue with the structural analysis, it is necessary to find out what the mass of the communications platform that will be placed at the end of the communications truss.

$$\begin{aligned}\text{Mass of Communications platform} &= \text{Antenna dish} + \text{Space Experiments} \\ &= 300 \text{ kg} + 100 \text{ kg} \\ &= 400 \text{ kg}\end{aligned}$$

The force on the end of the communications truss using a 1.4 factor of safety is:

$$\begin{aligned}F &= ma \\ &= (1.4)(400 \text{ kg})(0.56)(9.8 \text{ m/s}^2) \\ &= 3073 \text{ N}\end{aligned}$$

Where:

$$\begin{array}{lll}F & : & \text{Force (N)} \\ m & : & \text{mass (kg)} \\ a & : & \text{acceleration (m/s}^2\text{)}\end{array}$$

Using this as the maximum applied load, and again choosing Graphite-Epoxy for the truss material, a model of the communication truss was constructed on SDRC I-DEAS. It was known that the cross-sectional area of each member would not need to be as large as for the main truss so it was arbitrarily reduced to $7.25 \times 10^{-4} \text{ m}^2$. The inner and outer diameters of each member were then arbitrarily chosen. Restraining one end of the truss and applying 3100 N at the other end gave us a maximum stress of much less than the 1.33 GPa yield strength of the Graphite-Epoxy. In addition, the deflection at the tip of the communications truss which is where the communication platform is located has a value of less than 5 mm. The communication antenna dishes were designed to compensate for movements this small. Therefore, this design is adequate for the communication truss.

Mass analysis of Communications truss

The mass of the members of the communications truss is 490 kg per truss. Using the same assumption that the nodes have 1/3 the mass of a member, the total mass of one truss is 526 kg. The two trusses together have a mass of 1052 kg.

Habitation Module Support Unit

The second part of the truss system that we looked into was the habitation module support unit. In order to connect the habitation modules to the main truss, we needed to investigate the following aspects:

Design Criteria

The design criteria for the habitation module support unit are as follows:

- 1) The structure must completely fit in a single heavy lift launch vehicle and must be deployable into lower earth orbit with a minimum amount of astronaut participation.
- 2) The structure must have sufficient nodal attachment points in order to support the habitation modules.
- 3) The structure must support all applied loads without failure

The first criterion is a reiteration of two aspects found in the main truss, collapsibility and self-deployment. Just like the main truss, the entire Habitation Module Support Unit (HMSU) must completely fit in a single Heavy Lift Launch Vehicle. In addition, it must be self-deploying so that a minimum amount of astronaut participation is required.

The next criterion for the HMSU is that there exist sufficient nodal attachment points from the HMSU to the habitation modules. In order to prevent load concentrations, there must be an adequate number of attachment or contact points between the Habitation Module and the Habitation Module Support Unit.

The final criteria is that the the HMSU must support all of the applied loads without failure.

Loads on the Habitation Module Support Unit

The three loading conditions on the HMSU are identical to the loading conditions on the main truss. But, since the configuration of the HMSU is different than the main truss, the loading conditions will have different results on the HMSU.

The first loading condition is the 0.56g axial compression. But, due to the orientation of the HMSU, this axial compression on the ship will place a transverse load on the HMSU as shown in *Figure 8.26*. One thing that should be noted is that the compressive force is distributed over the entire HMSU and not at just one point as shown in the Figure.

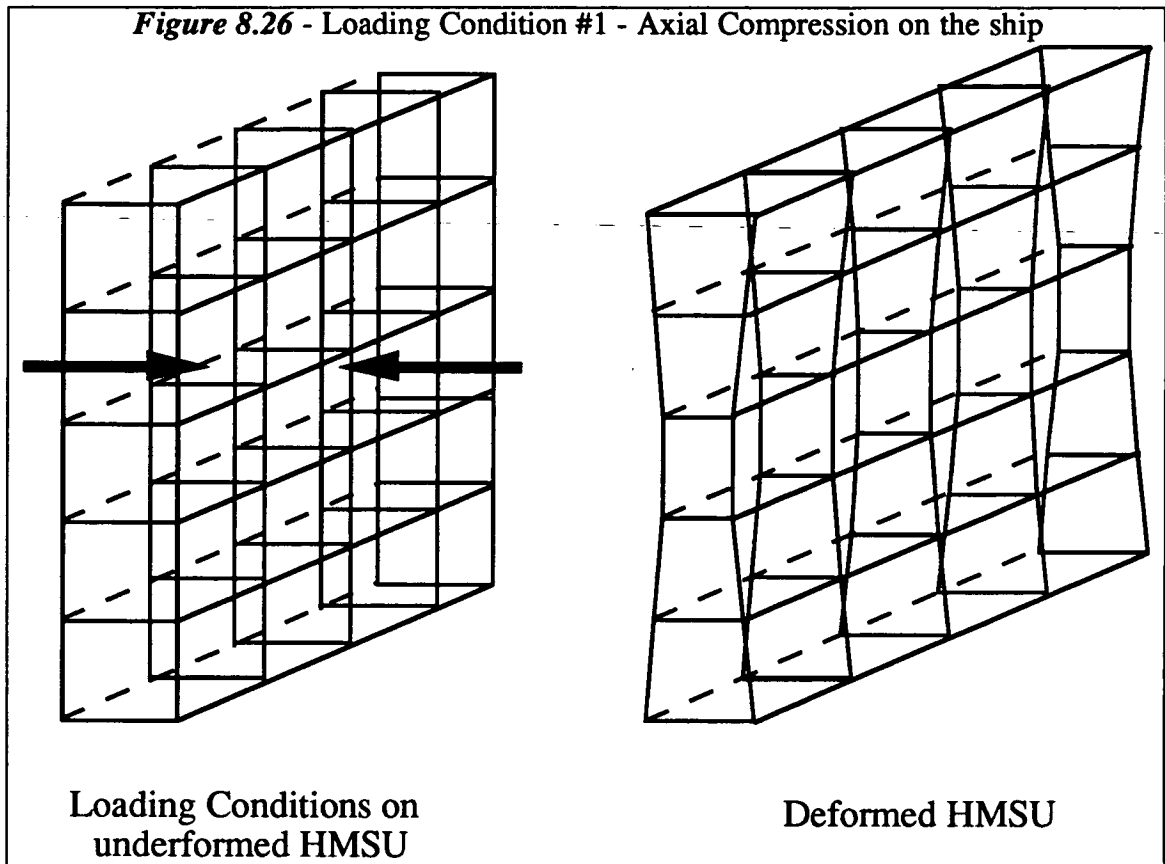

The second loading condition is on the HMSU is due to the axial tension on the ship while it is under artificial gravity. This axial tension on the ship will cause the loads on the HMSU shown in *Figure 8.27*. Again, the loading is distributed over the entire HMSU and not at a single point as shown in the figure.

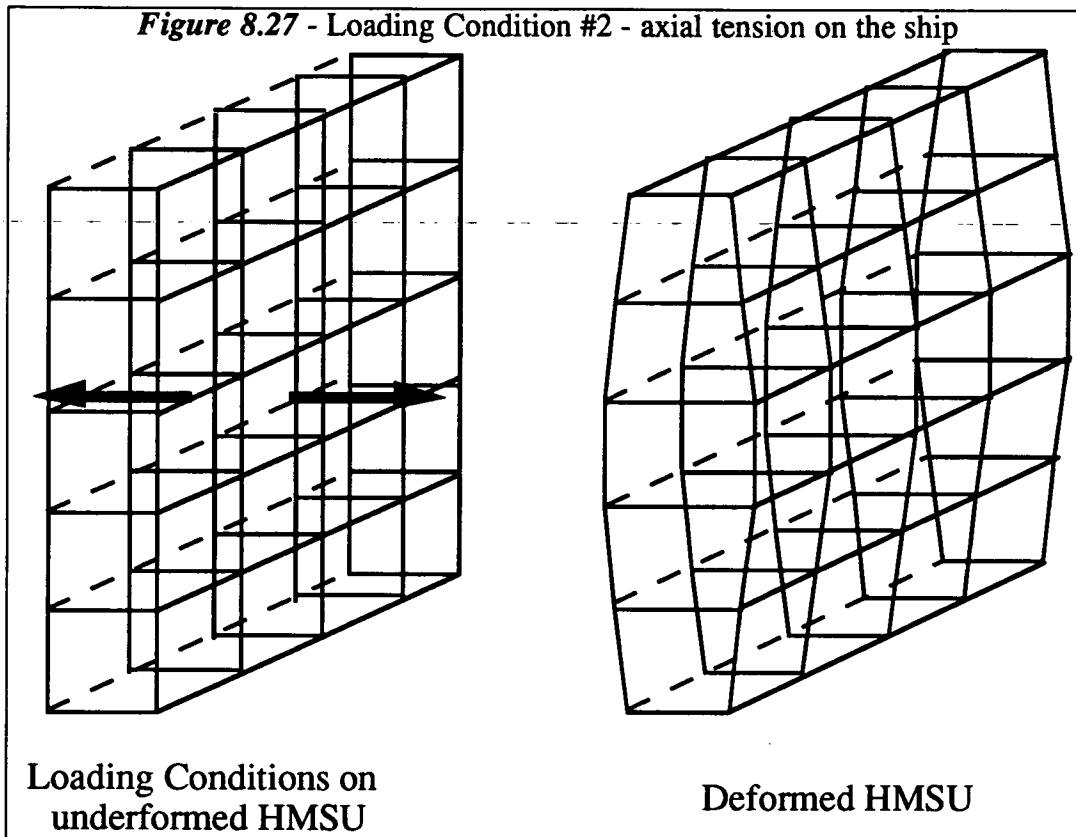

The final loading condition on the HMSU is due to the Spin/Despin procedure. The Spin/Despin procedure is conducted by the RCS thrusters which are located at the center of the long side of the HMSU. **Figure 8.28** (which is a front view only and does not reveal the 1 cell depth of the HMSU) shows a possible deformed shape of the HMSU. The word “possible” is used here because it must be remembered that there are diagonal members on all of the cells. The interaction of the diagonal members is not completely obvious. The actual deformed shape can only be obtained by running the Finite Element Program.

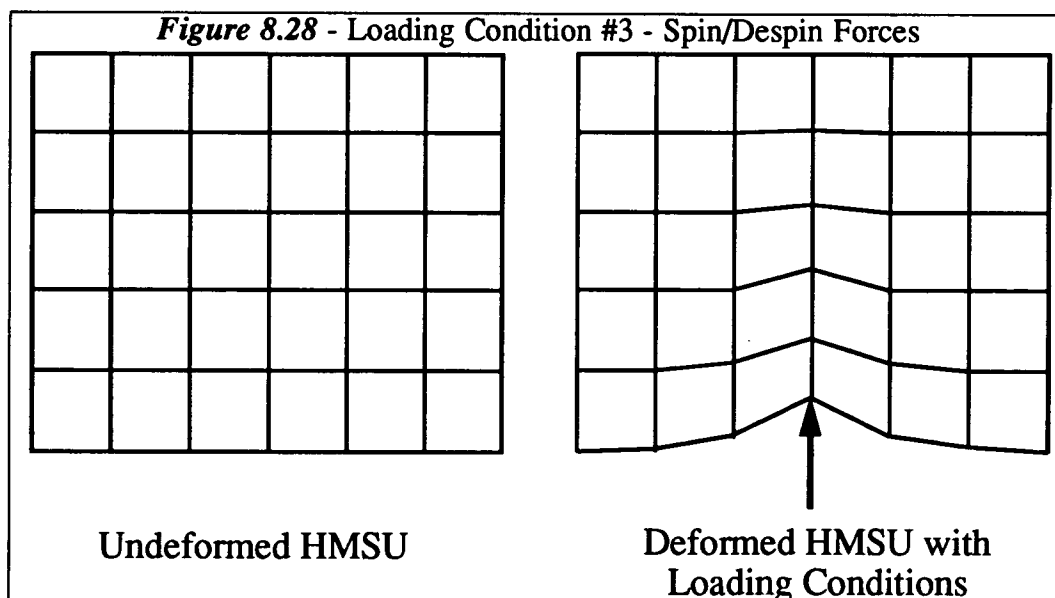

Design Procedure for the Habitation Module Support Unit

The first step in the design of the HMSU was to satisfy Criteria #1. To achieve this criteria, we decided to utilize the box beam truss that was used for the main truss. We would attach several box beam cells side by side and up and down to create a plane for the habitation modules to be connected to. This plane of box beam cells can then be collapsed along its length for transport. By using the box beam truss, the HMSU will be collapsible, and just like the main truss, self-deployable.

The next criteria that must be satisfied is that there exist sufficient nodal attachment points from the HMSU to the habitation modules in order to prevent load concentrations. To satisfy this criteria it is now necessary to determine the number and sizes of the bays of the HMSU

The first step in doing this was to look at the dimensions of the main truss. The end of each cell of the main truss has the dimensions of 8.3 m by 8.3 m. In order for the main truss to be connected to the HMSU, the HMSU must have nodal points at the four locations that correspond to the corners of this 8.3 m by 8.3 m square. Keeping in mind that when we connect the HMSU to the habitation modules we will want as many contact points as possible, we decided that each bay of the HMSU will be a cube with the dimensions of 2.77 m by 2.77 m. In otherwords, the bays of the HMSU are exactly 1/9th of the size of the bays of the main truss.

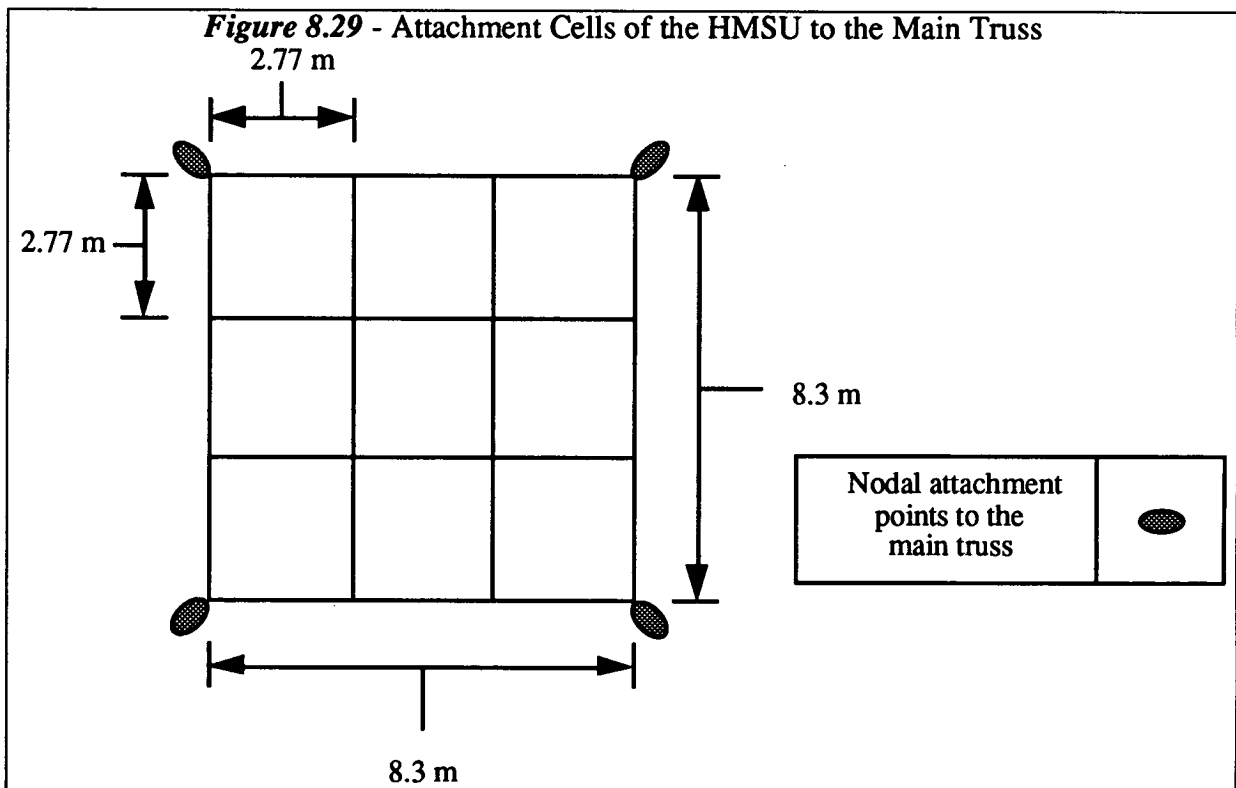

Next, we want to increase the area of the HMSU so that all of the Habitation Modules and part of the air locks are supported. Note, we want to use the HMSU to support the airlocks as well, but, the HMSU can not extend past the end of the airlocks. The reason for this is that the pod will have to dock with the airlock and if the HMSU extends past the end of the airlock, then it will be a dangerous obstruction to the pod when it docks.

The dimensions of the habitation modules are 17.3 m long and 4.7 m in diameter. Allowing 1 m between the two habitation modules for a connecting tunnel and taking into account the two airlocks which are on the ends of the habitation modules, we end up with an area of 23.3 m by 10.4 m as shown by the following picture.

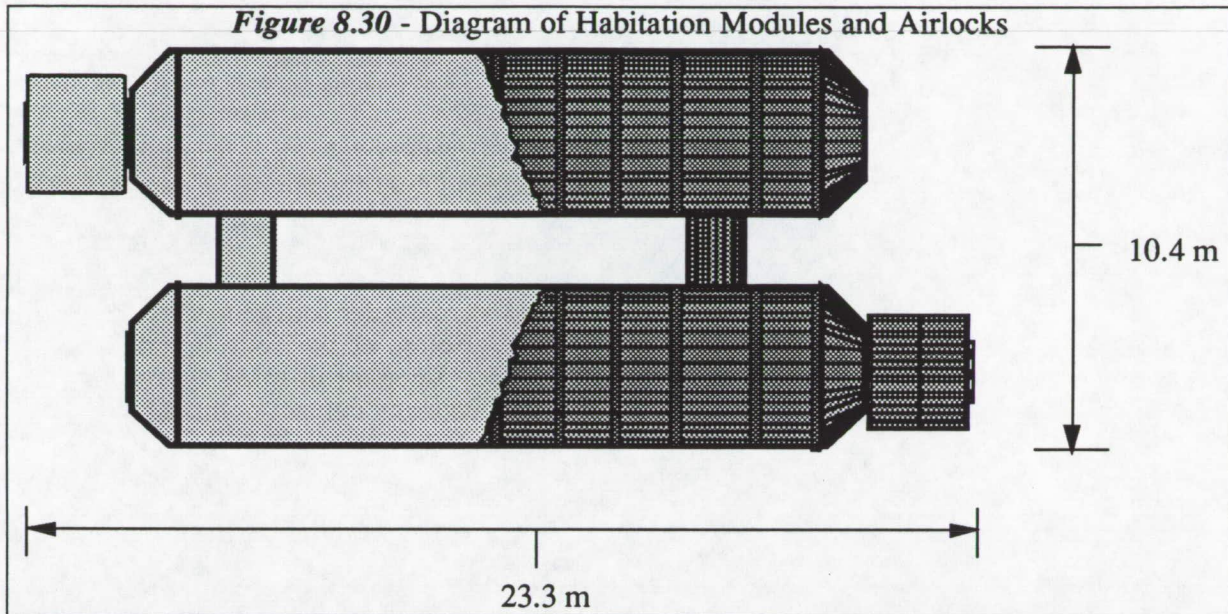

From this diagram we decided on the final configuration of the HMSU. By adding one additional bay on the top of the 9 cells connecting the HMSU to the main truss, one on the bottom, two more bays to the left, and two to the right, the HMSU ends up having the desired dimensions of 19.39 m by 13.85 m by 2.77 m. A diagram of just the HMSU is shown below where the bold square is the outline of where the main truss will connect with the HMSU.

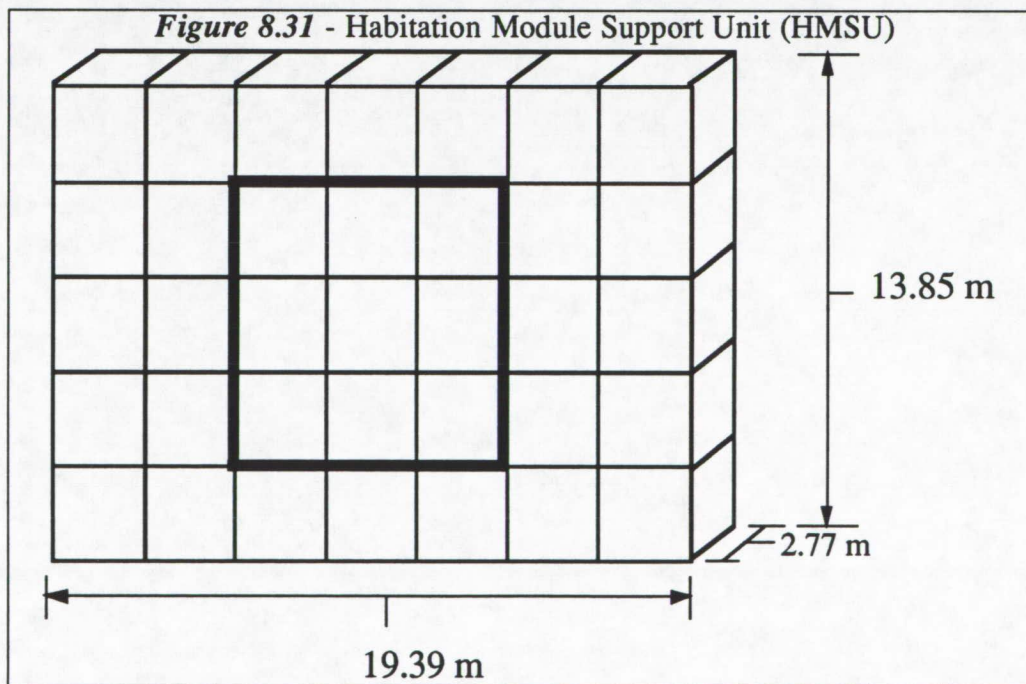

Next, *Figure 8.32* shows the HMSU after being connected to the Habitation Modules and the air locks.

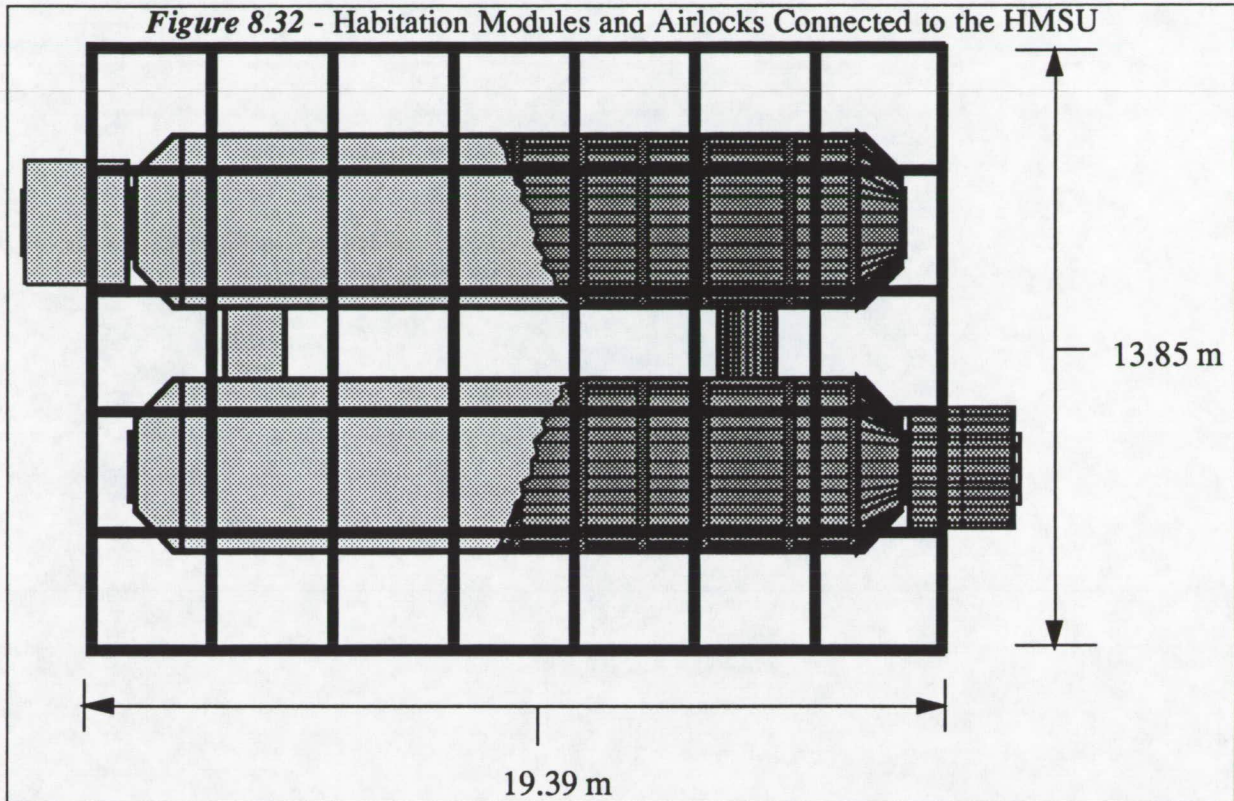

One positive aspect of this HMSU design is that there are now 12 nodal attachment points for each habitation module. Plus, in order to facilitate the attachment of the habitation modules to the HMSU, a method of attaching two beams to each habitation module which runs perpendicular to the bulkheads was devised. The bulkheads are the best choice for attachment to the habitation modules because they offer the most support. The opposite side of these beams can then be attached to the nodes of the HMSU.

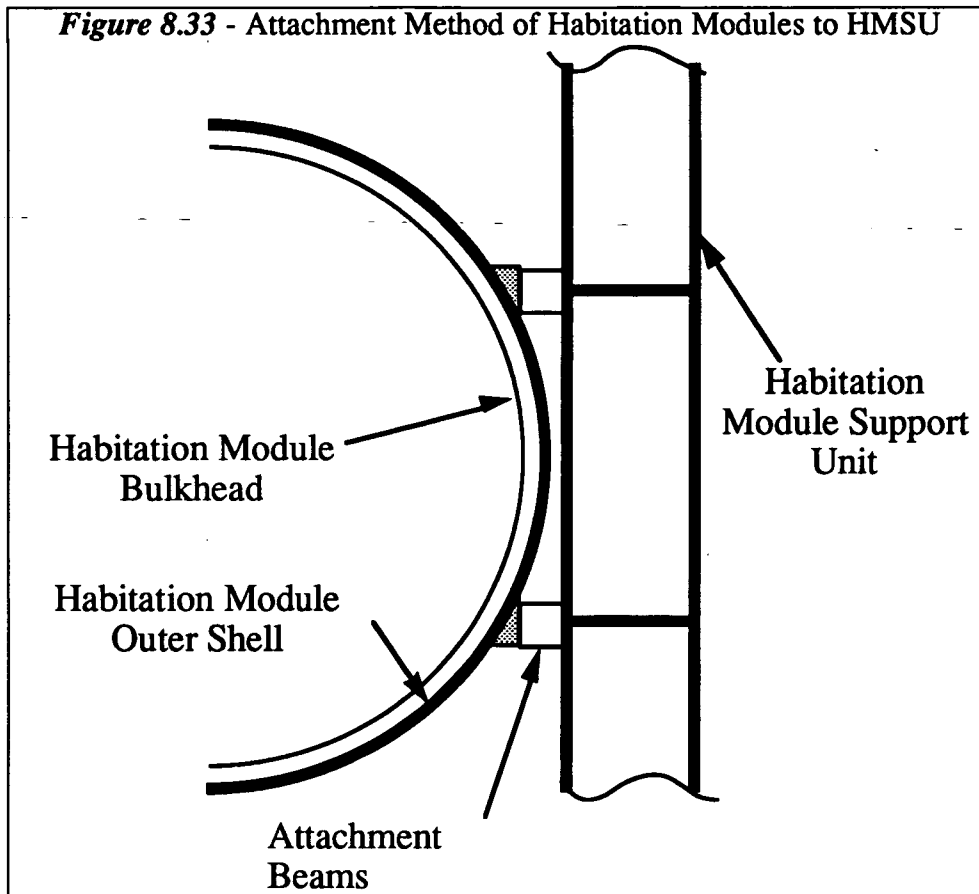

Analysis of Structural Integrity

The final criteria that had to be fulfilled was that the HMSU must support all applied loads. Unfortunately, This step was not completed before the semester ended. Therefore, there is no data on the structural integrity of the HMSU with respect to the applied loads.

Mass Analysis of Habitation Module Support Unit

Because there was no time left to perform a structural analysis of the HMSU, an arbitrary cross section, inner and outer diameter was chosen for the individual members of the HMSU. If future studies are done, a structural analysis should be performed to determine the optimal inner and outer diameters of the members that will result in the lowest mass of the HMSU while keeping the stresses in the individual members low as well.

We arbitrarily chose the cross-sectional area of each member to be 0.0029 m^2 . The outer diameter of each member was set to 0.154 m and the inner diameter to 0.1397 m . The length of the members of each cell are 2.77 meters for the outside members and 3.91 m for the diagonal members. These values result in a total mass of all the members to be $5,232 \text{ kg}$. Following the assumption that the mass of each node is equal to $1/3$ the mass of a member, the total mass of the HMSU is $5,624 \text{ kg}$. The dimensions of the collapsed HMSU are $2.1336 \text{ m} \times 2.77 \text{ m} \times 13.85 \text{ m}$ which were obtained by following the procedure for determining the collapsed dimensions of the truss layed out in the main truss section of this report.

Landing Gear Design

Introduction

In order to touch down onto the surface of Phobos without incurring any damage to the main truss, fuel tanks, habitation modules, or any other structural portion of the spacecraft, a suitable design for landing gear is necessary. However, because the spacecraft will have a tethering system that harpoons into the surface of Phobos, a complex landing leg design including shock absorbers or suspension is not required (see Chapter 8). Instead, the design should be as simplistic as possible, since the 1/1000 g environment and tethering system will allow the ship to be guided to the surface of Phobos gradually.

The legs of the landing gear, like the truss system, will be made of a graphite epoxy composite. The individual struts of the landing gear will each have an outer diameter of .1524 m (approximately 6 inches) and an inner diameter of .1397 m (approximately 5.5 inches). This results in a strut thickness of .013 m (approximately .5 inch).

The landing gear will be located in two different areas of the spacecraft. One location is near the fuel and feeder tanks, and the other location is near the habitation modules. There will be two landing legs per location. Legs of the fuel tank landing gear will be composed of four struts, and legs of the habitation module landing gear will be composed of three struts.

Design Details

The first step in the procedure for designing the landing gear was to determine the lengths of the individual struts. Once the lengths of all the struts for each of the four landing legs were determined, a structural analysis was performed to assure that the legs will not fail during the landing procedure. After determining that the legs were of sound structural design, the total weight of the landing gear was determined.

Fuel Tank Landing Legs

The proposed design for the landing legs near the fuel tanks involves extending the main truss. Two extra bays of the main truss will "flank" the main truss on both sides. The two extra bays will have the dimensions of 8.3 m by 8.3 m by 8.3 m (the same as the main truss bays). The extra bays will be located directly behind the two fuel tanks that are attached to the sides of the main truss, and on either side of the two feeder tanks which are located on top and below the main truss.

A head-on view of one of the two landing legs is depicted in *Figure 8.34*. In this diagram, the two feeder tanks and one of the fuel tanks, located in front of the feeder tanks, are shown. The total distance from the centerline of the truss system and extra bays to the surface of Phobos is 26.15 m, where 4.0 m is reserved for a "clearance zone" to assure that the fuel tanks and any other part of the ship will not come in contact with the surface of Phobos. The remaining 22.15 m is determined from the two 9.0 m diameter fuel tanks stacked on top of each other and the distance from these tanks to the centerline of the truss bays (4.15 m).

The meeting point of the individual struts was determined by a diagonal line drawn from a 30 degree angle from the main truss bay centerpoint to the ground. A 30 degree angle was chosen to provide a landing stability margin for the spacecraft. The diagonal lines drawn from the

flank bay are the projections of the struts on the yz plane. From *Figure 8.34*, the projection of struts 1 and 2 are 24.58 m, and the projection of struts 3 and 4 are 23.40 m. The actual struts are not depicted in this diagram, but can be seen in *Figure 8.35*.

Figure 8.35 depicts the completed leg attached to the extra truss bay. Each of the two legs will contain four struts. The lengths of the struts were determined by using a series of right triangles. For example, the calculation of the lengths of struts 1 and 2 is:

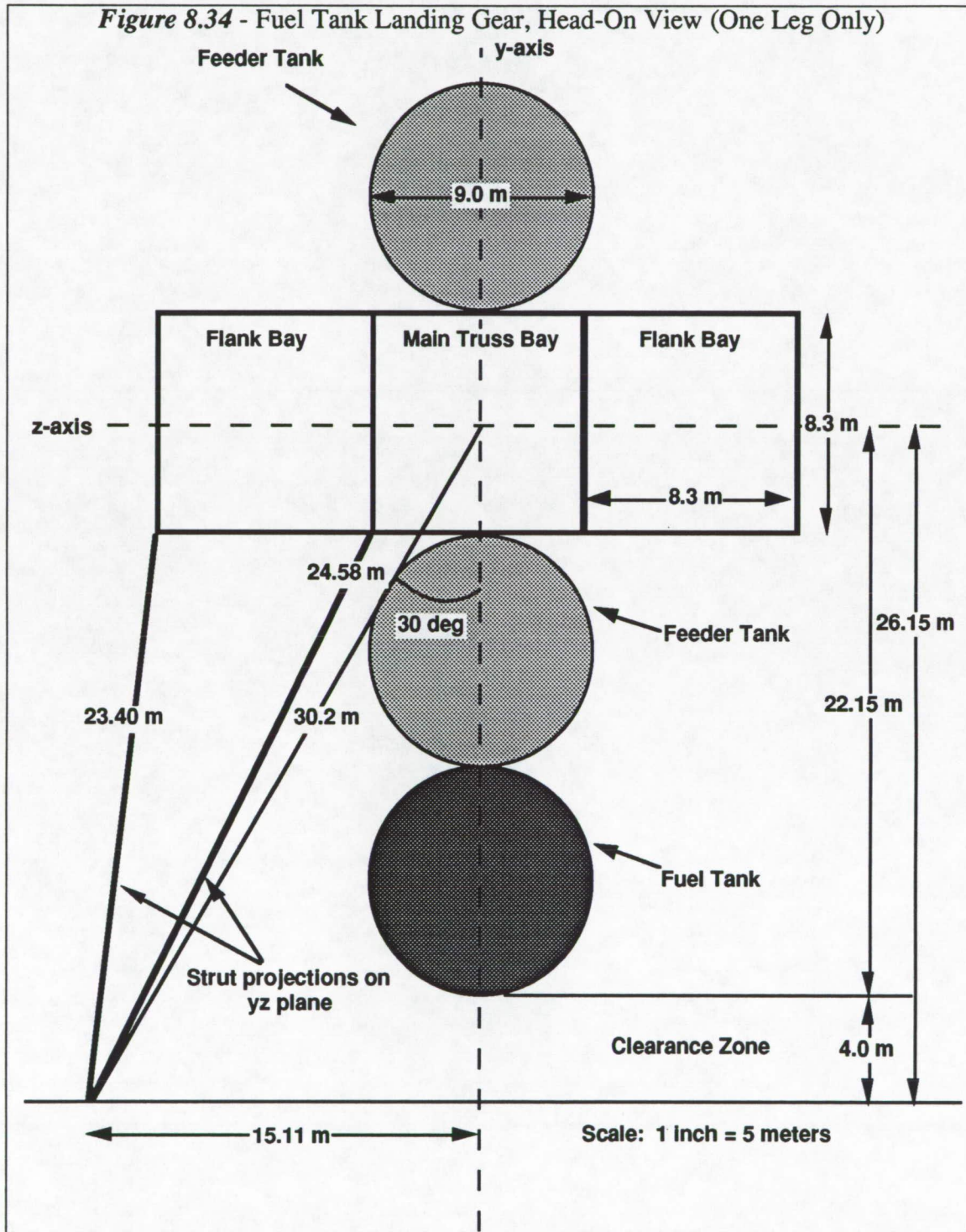

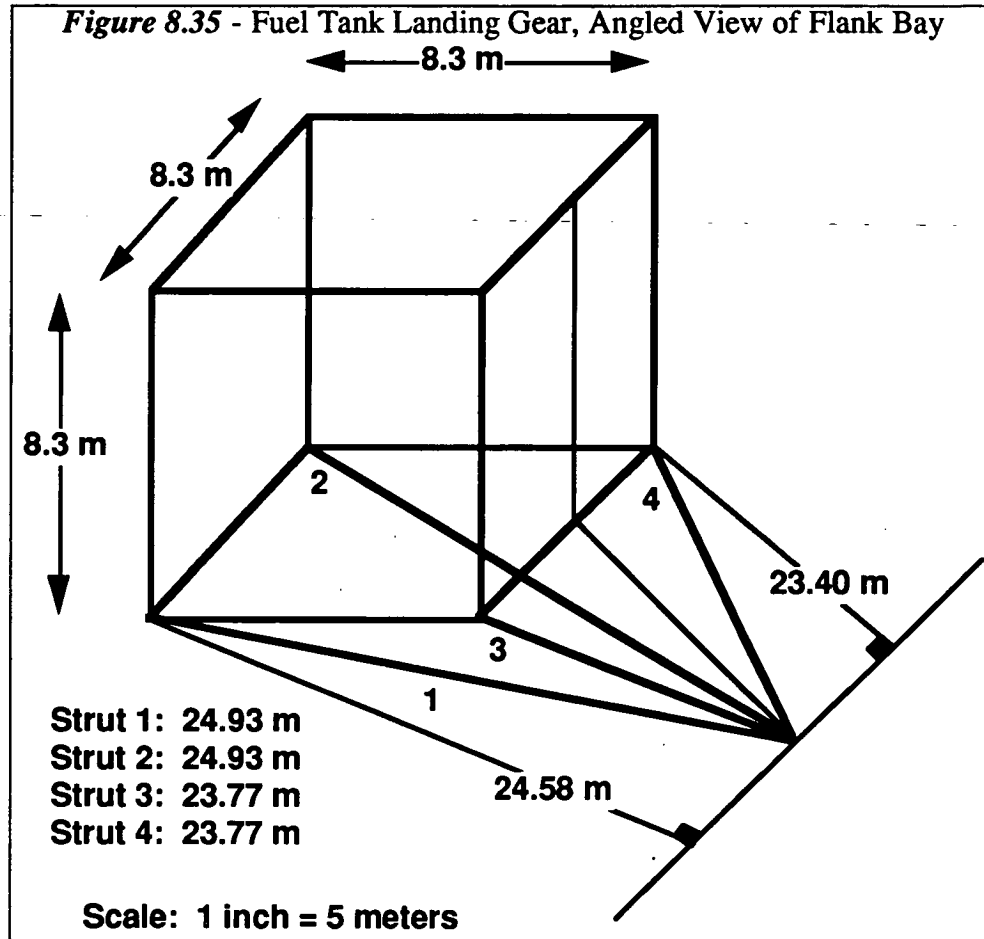

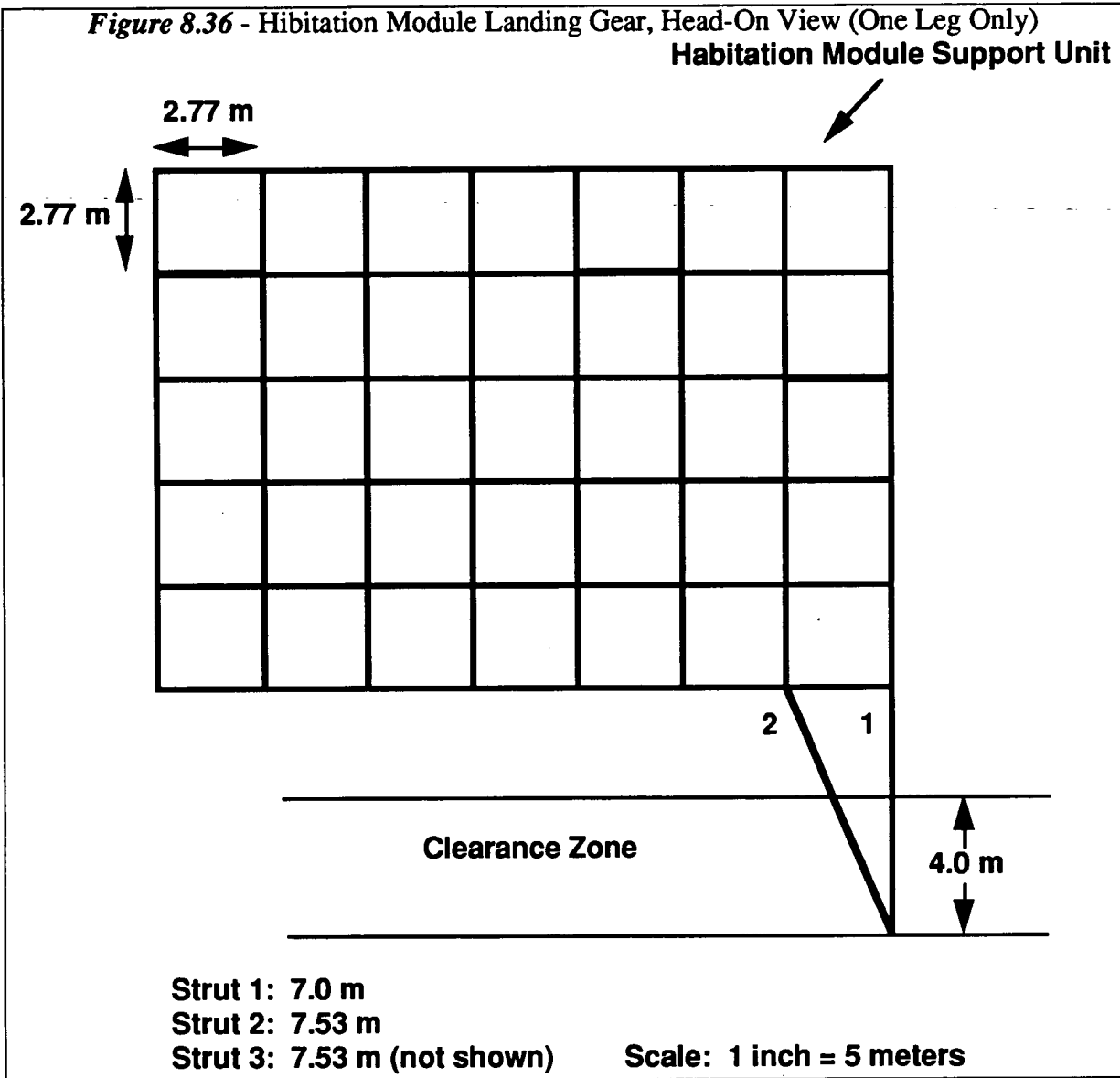
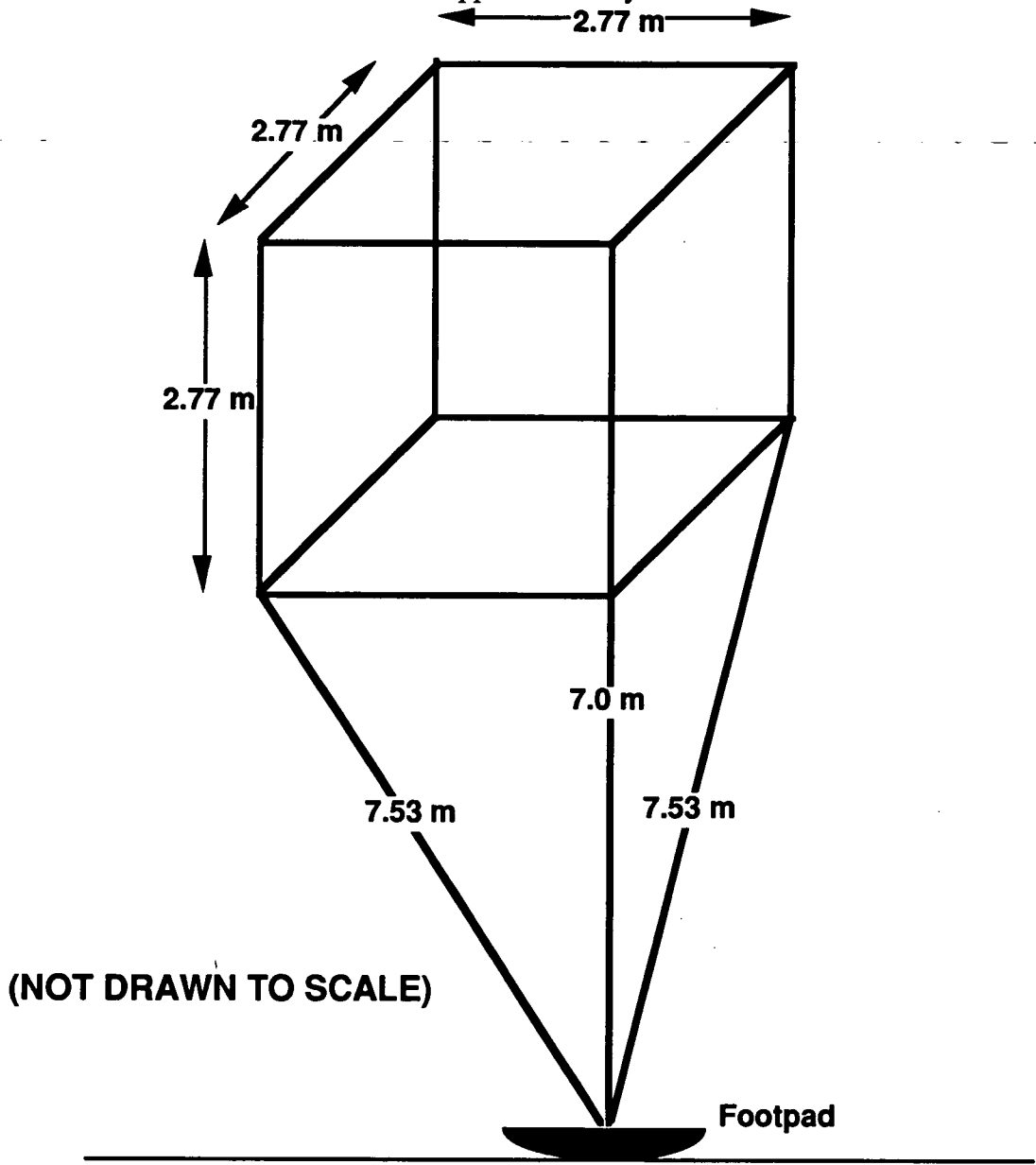

Figure 8.37 - Habitation Module Landing Gear, Angled View of Habitation Module Support Unit Bay



(NOT DRAWN TO SCALE)

Footpad Design

Truss Member Cross Section

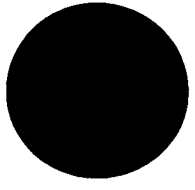

1.83 m

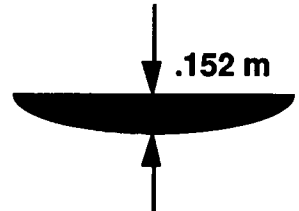

Inner Diameter: .1397 m
Outer Diameter: .1524 m

$$\begin{aligned}
 \text{Strut 1, 2} &= [(\text{Projection of Strut 1, 2 on yz plane})^2 + (1/2 \text{ length of truss bay})^2]^{1/2} \\
 &= [(24.58 \text{ m})^2 + (4.15 \text{ m})^2]^{1/2} \\
 &= 24.93 \text{ m}
 \end{aligned}$$

A similar calculation was used to determine the 23.77 m lengths of struts 3 and 4.

Habitation Module Landing Legs

The proposed design of the landing legs near the habitation modules involves the habitation module support unit. The attachment points of the two landing legs are located on the two bottom end bays of the habitation module support unit. Each bay of the planar truss is 2.77 m by 2.77 m by 2.77 m. *Figure 8.36* depicts the cross-sectional view of one of the legs and its connection to the planar truss. Again, a "clearance zone" of 4.0 m was chosen to assure that the habitation modules or any part of the ship will not come in contact with the surface of Phobos.

Figure 8.37 depicts the complete leg attached to the bottom end truss bay of the habitation module support unit. Unlike the fuel tank landing legs which have four struts per leg, each leg of the habitation module landing gear is composed of three struts. Similar to the fuel tank struts, the length of the struts were determined by right triangles formed by one member of the truss bay, strut 1, which runs directly to the surface of Phobos, and struts 2 and 3. The calculation for the lengths of struts 2 and 3 is as follows:

$$\begin{aligned}
 \text{Strut 2, 3} &= [(\text{Length of truss bay})^2 + (\text{Length of Strut 1})^2]^{1/2} \\
 &= [(2.77 \text{ m})^2 + (7.0 \text{ m})^2]^{1/2} \\
 &= 7.53 \text{ m}
 \end{aligned}$$

Footpads

Each of the four legs of the landing gear will end in a concave footpad that rests on the surface of Phobos. *Figure 8.37* depicts the cross section of the footpad. A diameter of 1.83 m (approximately 6 feet), as well as a depth of .152 m (approximately 6 inches) were arbitrarily chosen.

Structural Analysis

A simple analysis performed on the cross-sectional area of the strut produced the following results, assuming that the strut can be modeled as a simply supported beam.

For this analysis the Cross-sectional area of the truss and the moment of inertia of the truss will be needed.

The cross-sectional area of the strut is:

$$\begin{aligned}
 A &= \pi (r_o^2 - r_i^2) \\
 &= \pi [(.076 \text{ m})^2 - (.064 \text{ m})^2] \\
 &= 5.28 \times 10^{-3} \text{ m}^2
 \end{aligned}$$

where r_o is the outer radius of the strut and r_i is the inner radius of the strut.

The moment of inertia of the strut is:

$$\begin{aligned} I &= (1/4) \pi (r_o^4 - r_i^4) \\ &= (1/4) \pi [(.076 \text{ m})^4 - (.064 \text{ m})^4] \\ &= 1.30 \times 10^{-5} \text{ m}^4 \end{aligned}$$

The first step in this structural analysis was to estimate the maximum landing load. Note that a dynamic structural analysis will not be performed here since such a procedure is extremely complex. Instead, a static structural analysis will be performed, using a large factor of safety which in this case we chose to be 4. The maximum estimated loading is calculated using this factor of safety, the 490,000 kg static load of the spacecraft, and the 0.001g environment of Phobos:

$$\begin{aligned} P_{\text{est}} &= (\text{Factor of Safety}) \times (\text{Mass of Ship}) \times (\text{Gravity}) \\ P_{\text{est}} &= (4) \times (490,000 \text{ kg}) \times (.001) \times (9.8 \text{ m/s}^2) \\ &= 19208 \text{ N} \end{aligned}$$

where P_{est} is the maximum estimated equilibrium static load.

For each of the four landing legs, we can determine the maximum estimated landing load each leg will carry:

$$\begin{aligned} P_{\text{estleg}} &= (1/4) P_{\text{est}} \\ &= 4802 \text{ N} \end{aligned}$$

The equation for the critical buckling load of a simply supported beam is:

$$P_{\text{cr}} = \frac{\pi^2 E I}{L^2}$$

where

$$\begin{aligned} P_{\text{cr}} &= \text{Critical load} \\ E &= \text{Young's Modulus of the individual member} \\ I &= \text{Moment of inertia of each individual member} \\ L &= \text{Length of each individual member} \end{aligned}$$

Rearranging this equation and solving for the length L:

$$L^2 = \frac{\pi^2 E I}{P_{\text{cr}}}$$

The maximum length of a strut that will not buckle under the maximum estimated landing load is:

$$L^2 = \frac{\pi^2 E I}{P_{\text{estleg}}}$$

This equation yields a maximum strut length to prevent buckling to be:

$$L_{\text{strut}_{\text{max}}} = [\pi^2 (1.0342 \times 10^{11} \text{ kg/m}^2) (1.30 \times 10^{-5} \text{ m}^4) / (4802 \text{ N})]^{1/2} = 52.6 \text{ m}$$

This value exceeds all calculated strut lengths. Buckling will therefore not be a problem.

The last step of the structural analysis entailed determining the axial stress in each strut. This can be determined using the cross-sectional area of each strut and the estimated maximum load on each leg:

$$\begin{aligned}\sigma &= \frac{P_{\text{estleg}}}{A} \\ &= (4802 \text{ N}) \times (5.28 \times 10^{-3} \text{ m}^2) \\ &= 909 \text{ kPa}\end{aligned}$$

It has been stated that the yield stress of the graphite epoxy material is 1333 MPa. The estimated loads will not cause a problem since the expected stress in the strut is far less than the yield stress of the graphite epoxy.

Weight Summary

The graphite epoxy material from which the struts will be made has a density of 1525 kg/m³. Based on the inner and outer diameters, the area of each truss member has been found to be 5.28 x 10⁻³ m².

Multiplying the density of the graphite epoxy and the above area, the mass of each strut per meter can be calculated. For example, the mass calculation for struts 1 and 2 of *Figure 8.35* is:

$$\begin{aligned}\text{Mass per meter} &= (\text{Density of graphite epoxy}) \times (\text{Cross-sectional area of each strut}) \\ &= (1525 \text{ kg/m}^3) \times (5.28 \times 10^{-3} \text{ m}^2) \\ &= 8.05 \text{ kg/m}\end{aligned}$$

Using the mass per meter and the length of an individual strut, the mass of any particular strut can be calculated. For example, the mass of strut 1 is:

$$\begin{aligned}\text{Mass of Strut 1} &= (\text{Length of Strut 1}) \times (\text{Mass per meter}) \\ &= (24.93 \text{ m}) \times (8.05 \text{ kg/m}) \\ &= 200.74 \text{ kg}\end{aligned}$$

Repeating the same calculation for each strut of each of the four legs of the landing gear produces the following results:

<u>Fuel Tank Leg</u> (<i>Figure 8.38</i>)	<u>Habitation Module Leg</u> (<i>Figure 8.39</i>)
Strut 1: 200.74 kg	Strut 1: 56.36 kg
Strut 2: 200.74 kg	Strut 2: 60.63 kg
Strut 3: 191.40 kg	Strut 3: 60.63 kg
Strut 4: 191.40 kg	
Total: 784.28 kg	Total: 177.62 kg

Converting kilograms to metric tons (1 metric ton = 1000 kg), the total mass of the landing gear can be determined:

Total mass of fuel tank landing gear (2 legs, 8 struts) = 1.57 metric tons

Total mass of module landing gear (2 legs, 6 struts) = .355 metric tons

Total mass of landing gear (4 legs, 14 struts) = 1.93 metric tons

Structures References

- 1 Kavanaugh, H. C., & Miller, G. J., (1984), Preliminary Design and Analysis of a Shuttle Launched Space Station Manned Habitation Module, NASA, LBJ Space Center.
- 2 Haffner, J. W., Radiation and Shielding in Space
- 3 Haffner, J. W., Radiation and Shielding in Space
- 4 Haffner, J. W., Radiation and Shielding in Space
- 5 George, J. A., "Integrated Shielding Systems for Manned Interplanetary Spaceflight"
- 6 George, J. A., "Integrated Shielding Systems for Manned Interplanetary Spaceflight"
- 7 George, J. A., "Integrated Shielding Systems for Manned Interplanetary Spaceflight"
- 8 Funk, E.D., "Self-Sealing Shields for Micrometeorite Protection", in Advances in Cryogenic Engineering, Vol 11, Plenum Press, New York, 1966 - p. 223
- 9 Funk, E.D., "Self-Sealing Shields for Micrometeorite Protection", in Advances in Cryogenic Engineering, Vol 11, Plenum Press, New York, 1966 - p. 223
- 10 Borowski, S.K., AIAA 91-2052: "The Rationale/Benefits of Nuclear Thermal Rocket Propulsion for NASA's Lunar Space Transportation System", NASA 27th Annual Joint Propulsion Conference, 6/24-26/91
- 11 Barron, Randall F., Cryogenic Systems, 2nd Edition, Oxford University Press, New York, 1985 - pp. 44-45, 359
- 12 Barron, Randall F., Cryogenic Systems, 2nd Edition, Oxford University Press, New York, 1985 - pp. 44-45, 359
- 13 Woodcock, Gordon R., Space Stations and Platforms, Orbit Book Company, 1986
- 14 Zubrin, R. M., AIAA 91-3406: "The Use of Low Power Dual Mode Nuclear Thermal Rocket Engines to Support Space Exploration Missions", AIAA/NASA/OAI Conferences on Advanced SEI Technologies, 9/4-6/91
- 15 Borowski, S.K., AIAA 91-2052: "The Rationale/Benefits of Nuclear Thermal Rocket Propulsion for NASA's Lunar Space Transportation System", NASA 27th Annual Joint Propulsion Conference, 6/24-26/91
- 16 Borowski, S.K., AIAA 91-2052: "The Rationale/Benefits of Nuclear Thermal Rocket Propulsion for NASA's Lunar Space Transportation System", NASA 27th Annual Joint Propulsion Conference, 6/24-26/91
- 17 Zubrin, R. M., AIAA 91-3406: "The Use of Low Power Dual Mode Nuclear Thermal Rocket Engines to Support Space Exploration Missions", AIAA/NASA/OAI Conferences on Advanced SEI Technologies, 9/4-6/91
- 18 Borowski, S.K., AIAA 91-2052: "The Rationale/Benefits of Nuclear Thermal Rocket Propulsion for NASA's Lunar Space Transportation System", NASA 27th Annual Joint Propulsion Conference, 6/24-26/91

PRECEDING PAGE BLANK NOT FILMED

~~266~~ 266 INTENTIONALLY BLANK

Chapter 9

Human Factors & Life Sciences

9.1 Crew Concerns

9.2 Habitat Layout

9.3 Life Support

9.4 Crew Operations

9.5 Extra Vehicular Activity

Crew Concerns

Crew Size

There will be five crew members needed for this mission. Each crew members will meet mission constraints and still effectively cover those roles that are assigned. Each crew member will be easily adaptable and flexible. Each crew member will be cross-trained in one or more areas. In this way, the loss of a crew member will not jeopardize the mission.

Qualifications

The qualifications of the crew will encompass both education and experience. They will have a doctorate degree in either engineering, biological science, physical science, or mathematics. Following this degree, they must have at least 3 years of related, progressively responsible professional experience. This could include going back to school for a degree in another related area of expertise. A master's degree in a particular area will be equivalent to one year of work experience in that field, and a Doctoral degree will be equivalent to three years of related professional experience.

Pilot Qualifications

The pilot will have the following qualifications:

- 1) At least, 1000 flight hours (pilot-in-command jet aircraft); flight test experience is very desirable.
- 2) Ability to pass a NASA Class I space physical (similar to military class I flight physical).
 - Vision 20/50 or better--correctable to 20/20
- 3) Height between 64 and 76 inches.

These qualifications are in accordance with NASA pilot selection criteria.

Mission Specialist Qualifications

The remaining crew members, or mission specialists, will meet the criteria set by a NASA Class II flight physical. They will also have 20/100 vision or better uncorrected, which can be corrected to 20/20.

Crew Roles

First, the requirements were set in order to ensure success of the mission--A manned mission to Phobos. From this list of requirements, the qualities which were essential in a crew specific to this mission were set. From this list of qualities, roles were set for the crew which will work as an outline in the astronaut selection process.

PRECEDING PAGE BLANK NOT FILMED

270
~~INTENTIONALLY BLANK~~

Mission Commander/Pilot

The mission commander/pilot has the responsibility for the vehicle, crew, mission success and safety of flight. The commander must have leadership and management training (Military officers meet this requirement) as well as experience in that area.

Co-pilot/Navigator/Communications Officer

The co-pilot/navigator/communications person is responsible for the craft and mission success in the absence of the commander. The co-pilot must also have leadership and management experience as well as training in space navigation and communications.

Life Support Specialists

The life support specialists are responsible for the maintenance of all life support systems and responsible for insuring that the crew stays mentally and physically well. They are also responsible for seeing that the social needs of the crew are met. They need to be personnel with degree related and experience in such areas as:

- 1) Life Sciences - Biology, Nutrition, Botany, Physical Training, Chemistry
- 2) Medicine - Highly experienced medical personnel

Medical personnel are responsible for the maintenance of Medical equipment and keeping a record of the personnels' injuries and illness. Life support specialists will be responsible for creating a daily schedule for the crew; however, this schedule will have to be submitted to the commander for his approval.

Research Specialists

The research specialists are responsible for all scientific research and experiments. They are also responsible for the collection and analysis of data from research and experimentation during the flight to and from Phobos. They must have experience and training in electronics so that they are able to maintain the research equipment. Finally, they must have degree related and experience in such areas as:

- 1) Physics and Chemistry
- 2) Planetary science
- 3) Astronomy, Geology
- 4) Laboratory experience is desirable

Systems (Power) Specialists

The systems specialist are responsible for ensuring the proper use of available power supply and seeing that the power needs are met throughout the vehicle so that the mission can be completed. They must have degree related and experience related concentration in such areas as:

- 1) Electrical engineering and electronics
- 2) Nuclear engineering
- 3) Power systems repair

Additional roles

In addition to cross training of the crew members in the above roles, all crew members will have Extra Vehicular Activity (EVA) training and will be briefed and provided with the necessary training to assemble the processing plant once they are on Phobos. They must also be able to receive and transmit communications. All personnel will be fully briefed on the mission and well aware of his role in achieving mission success.

Crew Training

Once the selection process has been completed, an intense, long range training program will begin. This program will not only include mission-specific training, such as EVA, but also physical training, leadership training, and training designed to instill and enhance the ability of the crews to work together in all manner of environments.

Initial Training and In-processing

As soon as the initial pool of trainees are selected (on the order of 20 people), they will begin a rigorous program involving physical and mental aptitude tests. This will last approximately two weeks. Three teams of 5 astronauts will then be assigned with the random integration of the five remaining alternates to provide flexibility. The three teams (with their primary members) will be under constant evaluation and observation. The three teams will be competing for the right to go on the mission. The ranking of the three groups will occur after the initial year of training.

Physical Training

The physical training will include two parts: Ground-based and In-flight.

- **Ground based:** The ground based training will be completely team-oriented. It will be a military style format involving weight-training, formation running, and cycling. There will be minimal requirements set and alternates will replace any trainees who suffer serious injury. The replacements will be observed closely to ensure that they are going to be compatible with the team.
- **In Flight:** Because crew members will not have access to the variety of exercise equipment and regimens that are available on Earth, and since working time in zero and reduced gravity is at a premium, it is essential to design efficient exercise prescriptions.

The following exercise prescriptions are to maintain (as closely as possible) the ground-based aerobic capacity, strength and endurance during flight.

IN-FLIGHT PHYSICAL TRAINING PRESCRIPTIONS

	PILOTS	EVA
• Kind:	Aerobic training (legs) Strength training (arms/legs)	Aerobic training (arms/legs) Strength training (arms/legs)
• Device	1) Cycle ergometer 2) Mod. Tri-Max machine	1) Cycle ergometer 2) Mod. Tri-Max machine 3) Climber
• Intensity	1) 70-100% 2) MVC*	1) 70-100% 2) MVC* 3) 70-100%
• Duration	1) 35-45 (min/day) 2) 15 set (10 rep) circuit	1) 35-45 (min/day) 2) 15 set (10 rep) circuit 3) 15-20 (min/day)

* MVC is maximal voluntary contraction ("burn out")

The training protocols will be modified to fit the situation. For example, pilots who need to perform EVA would simply modify their training protocol accordingly. Prior to flight, the astronauts training would be increased 10-15% so the 10% reduction experienced in-flight can be tolerated without adverse effects. In addition, such proposed in-flight exercise can become boring; as a result, they should be supplemented with varied recreational exercise whenever possible.

Additional training

Additional training will not only include technical cross-training and training directly related to the mission. The trainees will enter training programs used to foster leadership and teamwork. Group Leadership Projects (GLP's) will be instituted whereby the three groups will be placed in different scenarios in which a problem needs to be solved. The groups will have to work effectively together in order to solve the problem. This will draw them together into a close-knit group. They will be observed and evaluated throughout these GLP's.

Chain of Command

During the flight, certain situations will arise which require a leadership protocol to be followed. Some situations will arise quickly without warning and needed to be solved just as quickly. Other situations will be normal situations encountered day to day. No matter what the situation, a proper chain of command must be set beforehand so that questions concerning authority and the scope of influence of different personnel are not in doubt.

Crisis Situations

A crisis situation is defined as a situation which arises without due cause or warning. It is a problem which must be acted upon quickly before control is lost. During a crisis situation the chain of command follows the mechanistic organizational model. This type of organization is shown in *Figure 9.1*. This is a formal hierarchy. Thus, the specialists give

their input to the co-pilot, who in turn gives his input to the mission commander. The mission commander then has the final say in all emergency situations. This method is efficient with respect to time, but can cause tension between horizontal departments.

Some characteristics of Mechanistic organizations are the following: specialization by function, a formal hierarchy, and authority governed by rules. Since the authority is governed by rules, emergencies can be solved quickly using Standard Operating Procedures (SOP's), which are predesignated instructions. The formal hierarchy lets everyone know their place so that no one is interfering in another person's job. As a result, there is efficient decision making.

Day-to-Day Situations

This chain of command follows the organic organizational model, used in a day-to-day, social atmosphere. Thus, this is the organizational model that will be used unless a crisis situation occurs. It is shown in *Figure 9.1*.

The "spoked wheel" format attempts to illustrate that every member of the crew has equal input concerning the outcome of decisions that have to be made. This can be time consuming, but gives each crew member more satisfaction since he has a say in what is to be done. Due to group synergy, decisions made by the entire group will be better than the average individual decision. However, group decisions take longer since member acceptance is critical to implementation. This is why individual decisions are needed for crisis situations. These open lines of communication are much more flexible and adaptive than the hierarchial system described above.

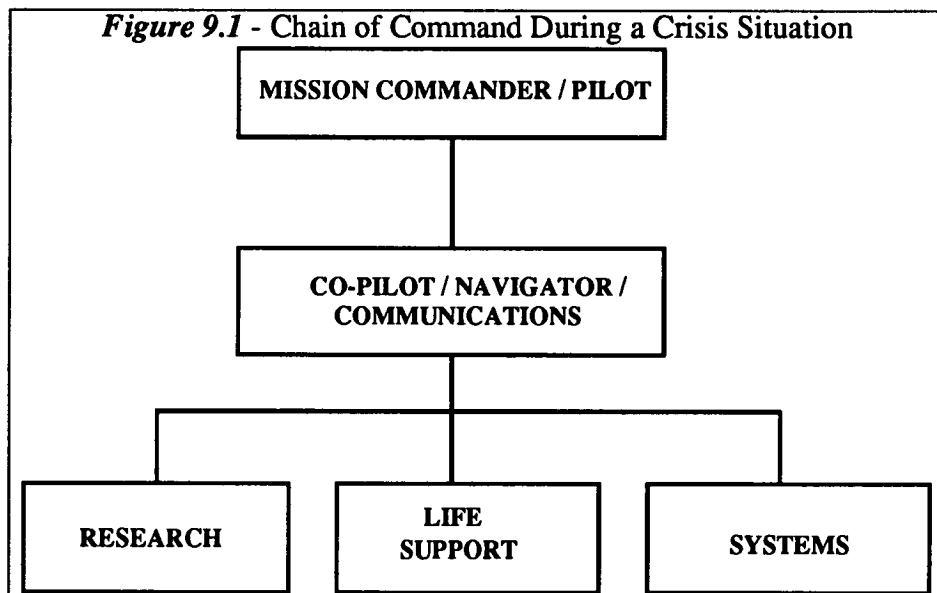

Mechanistic Organization	
Defining Characteristics	Some Consequences
Specialization by Function Formal Hierarchy Authority Governed by Rules (Standard Operating Procedure)	Power Concentrated at Top Primarily Vertical Communication Efficient Decision Making Rivalry Tension Between Departments Low Job Satisfaction

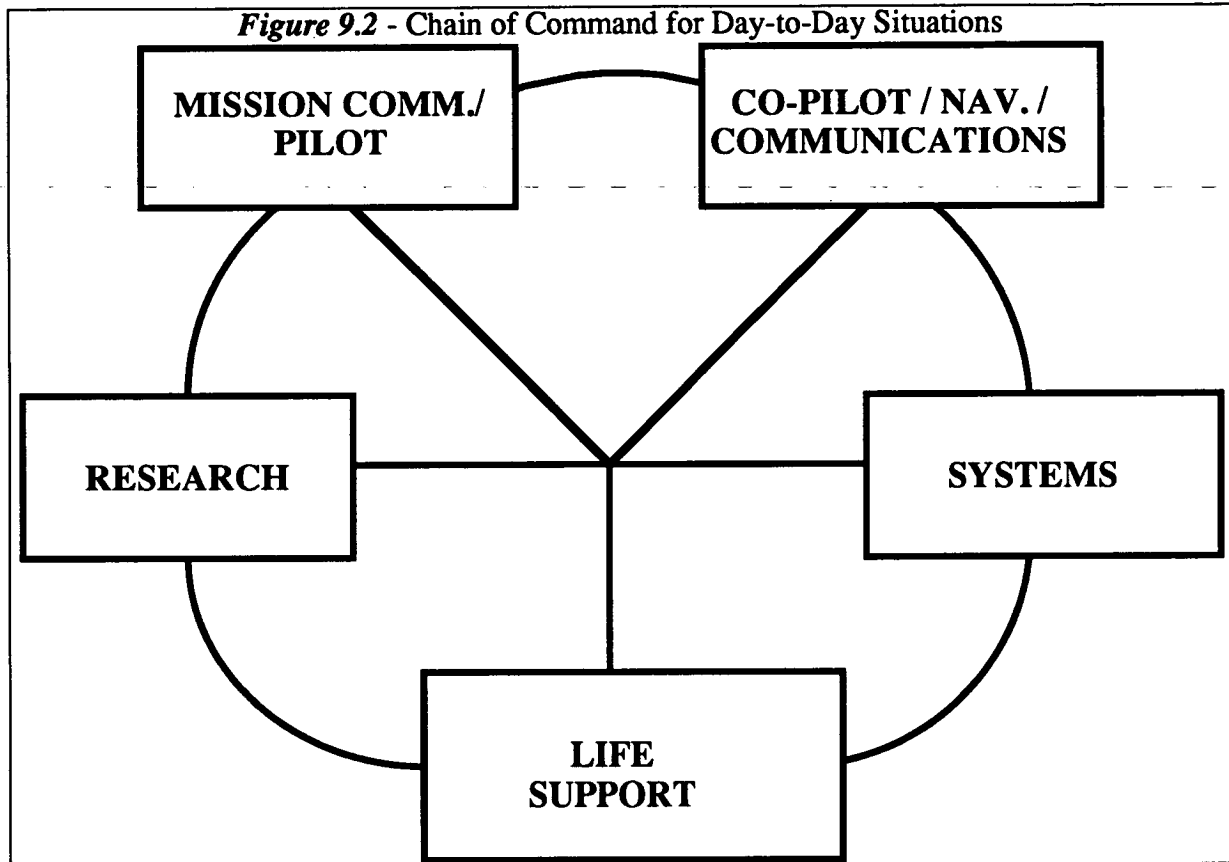

Organic Organization	
Defining Characteristics	Some Consequences
Loosely Defined Network Structure Adjustment and Redefinition of Tasks Through Interaction Communication of Info and Advice Rather Than Orders and Decisions	Felxible/Adaptive Much Lateral Communication Can Be Time Consuming, Less Efficient, But Perhaps More Effective High Job Satisfaction Delegation of Power

Crew Concerns

In the following sections, the social, psychological, and physiological concerns of the crew will be discussed. Due to a lack of studies and information in these areas, the best available options were recommended.

Social Concerns

The following is a list of social problems that are likely to occur:

- Relationships
- Individual vs. Group Needs
- Conflict arousal and resolution
- Resistance to Authority
- Lack of Communication
- Lack of Motivation

This mission will a multisex crew, because it is very likely that a unisex crew will cause political problems. The major problem with a multisex crew is that relationships inevitably will develop; no matter how the crew were screened for acceptance on the mission. To diminish this problem, drugs can be given to lower the sexual urges of the crew, but will not be able to eliminate this problem. It is also very likely that relationships will develop during the intense training sessions before the mission, and learning from these experiences beforehand will enable the crew to cope with similar problems during the actual mission.

Another area of concern is in dealing with individual and group needs. This problem can easily be dealt with during the training sessions where it will be explained that the rewards of having a successful mission as a crew will by far outweigh any individual gains. The astronauts will be taught to work together, but the possibility of social tensions developing is always present. For this reason, it is necessary to address the problem of conflict arousal and resolution. In times when social tensions are high the following solutions may be used to reduce the conflict. The privacy of ones own stateroom can be used to insulate him from his adversary. During this time, they could listen to music to calm down and think rationally about what occurred. They could also have a meeting of the crew in the wardroom to verbalize any arising problems and get input from other, non-involved sources. They may even try 'role playing' to see how each sees his peers. In extreme cases, where harm can come to other crew members or the mission, severe actions could be taken. These could include sedation by drug, confinement to quarters, or even a physical restraint device. These actions are not good for the morale of the crew, but may be a necessary measure to insure proper operation of the vessel. Hopefully, these social conflicts will be kept to a minimum due to the comradeship developed during training.

Another possible problem may arise during crisis situations where resistance to authority is exhibited by one or more crew members. This is a serious problem, as the mission commander's role is clearly defined as having the final decision in any crisis matter. This problem should not occur during any part of the mission since the social structure will be clearly explained during all phases of the training sessions.

During the two year mission there may be periods when crew members will experience low levels of motivation. In this instance it is pertinent that team discussions be centered around the overall importance of the mission. This will hopefully encourage the crew member to realize his individual impact on the mission outcome. In all cases, it is necessary that good lines of communication be maintained among all crew members. It is noted that a lack of communication will only lead to hard feelings among individuals, and deter from the effectiveness of the crew

Psychological Concerns

The following is a list of psychological problems that may occur during the mission:

- Feelings of Loneliness
- Stress
- Boredom

Obviously, some of these psychological issues overlap with the social concerns which were discussed previously. The crew can cope with the loneliness of space by communicating with family and loved ones on Earth as well as remaining socially active with fellow crew members. The problem will also be addressed during training sessions where the crew will be advised of this possibility, and educated on ways to avoid loneliness.

The astronauts can also be trained to recognize stress and how to deal with it, not only in themselves, but in other crew members. Some methods of dealing with stress will include time to relax by putting in a movie or listening to music. It is also possible that an intense workout session in the exercise room may relieve stress. If it becomes a large factor, the stressed person could be given a day off to recuperate. Again, in extreme cases, severe actions may be required where the individual may need to be relieved of his duties.

To deal with boredom, the crew should be supplied with surprises such as calls from family members and other important people. They should also celebrate mission milestones and major events on Earth. It would also be beneficial for the crew to be able to change the environment inside their quarters and maybe elsewhere in the ship.

Some other problems that have occurred on past missions which need to be dealt with are as follows:

- Noise
- Lighting
- Mobility
- Communication
- Sanitation

The problem of noise could be fixed by the fact that each crew member has his own stateroom with enough sound insulation to remove the noise from the machines and people in the cabin. Variable lighting will improve the crew's mental attitude by allowing for a change when they want it. The communication capabilities will be significantly improved by the time this mission date arrives so communication problems will not be a factor. Sanitation and mobility problems will be reduced greatly by the design of the ship. The sanitation rooms are enclosed and will be greatly improved over today's design standards. Since the ship will have artificial gravity, the mobility problems that generally occur in zero g will be eliminated.

Physiological Concerns

The following is a list of physiological concerns:

- Cardiovascular
- Fluid volume/Electrolyte and Water Balance
- Musculoskeletal (bones and muscles)
- Nutrition and Metabolism
- Other Medical Problems
- Hematological Factors
- Respiratory System
- Endocrine System
- Central Nervous System

The problem of losing fluids, from the lower body to the head, was described by the 84-day mission on Skylab. The crew lost 2.2 liters of extracellular fluid from the legs. This number basically seems to be a constant for zero g environments. This loss is just extracellular fluid from the legs being displaced. Thus, the astronauts need to replace these losses which contribute to cardiovascular and hematological changes. Another effect of the water loss is that urinary electrolytes and hormones are increased. The after-effects of this increase are still unknown but need to be researched before this mission takes off. The cardiovascular changes do not appear to have any major effects while in space, but often result in post flight reduced heart size and other problems such as lightheadedness, weakness, and dizziness. Bone demineralization occurs on any long-term mission and is of major concern due to its unknown nature. NASA has concluded from Skylab data that zero g missions lasting up to one year could be safely undertaken. NASA also says that in-flight exercise is a valuable countermeasure for muscle and bone degeneration. This was proven by the data taken from the various Skylab missions. The more the astronauts exercised, the lower the decrease in

their musculoskeletal system. Thus, since Project APEX lasts approximately two years with most of the trip at 0.5 g and various intervals of zero g, more research needs to be done on long term missions in variable g environments. One other factor of importance is the degeneration of the gravity receptors. This would lead to altered sensitivity to linear accelerations and may even cause perceptual illusions when the person returned to one g. Again, this effect needs to be studied further for variable g environments. Many of the factors described above became apparent upon return to the Earth and not in the actual flight itself. They were the results from the 84 day Skylab Mission.

Many of the above problems, due to zero gravity, can be diminished through daily exercise routines (of which 2 hrs/day are scheduled). The actual percentage of diminishment is unknown. This aerobic and anaerobic exercise can be an effective countermeasure to many of the side effects of a low g environment. Furthermore, the crew can take booster shots to replace or slow down the decreasing levels of certain substances inside the body.

The following are some other medical concerns:

- Injury from mechanical forces
- Other naturally occurring diseases
- Burns: thermal, chemical, electrical, radiation
- Abnormal atmospheric mixes
- Heat disorder- hypothermia
- Explosive decompression/Hypoxia/Ebullism Syndrome

To handle injury and burns, the medical facility will be equipped with first aid and minor surgery equipment. Also, radiation will be monitored to avoid harmful levels of exposure. Abnormal atmospheric mixes will be dealt with in the event of any life support failure. Medical problems resulting from other cabin malfunctions will also be remedied and dealt with appropriately. Physicians on Earth will be consulted when dealing with any unidentified medical situations.

Summary

The crew safety is the most important part of any mission. For this reason, they must meet the strict qualifications required to complete the mission. Without certain backgrounds, major aspects of crew safety would be neglected: machines need repairing, people need medical aid, important decisions need to be made quickly. In addition to the safety, the crew must be able to operate efficiently and effectively. This also helps them maintain mental stability. The mind is one of the key factors to address on long-term missions, but it is not the only one. With the unknown effects of zero and 0.5 g environments, physiological problems may arise which need to be dealt with. Thus, to complete the mission, the crew has to be both mentally and physically capable to perform the required tasks. Without them, the mission will ultimately fail.

Habitat Layout

The Habitation Module layout, and the contents of each area in the module are described below. All of the areas of the ship have sufficient and variable lighting, and are well ventilated. Also, the various areas are designed to compensate for either a zero gravity or artificial gravity environment.

Crew Quarters

The crew quarters will each contain a bed, desk, chair, dresser, and various personal momentos. An artists' conception of a typical crew quarter is shown in *Figure 9.3* at the end of this section. The mission commanders' living space will include a command center which will allow complete maneuvering of the spacecraft, and is large enough for three people at a time. This area includes flight controls, main computers, life support system monitoring devices, and communications terminals. It is designed to compensate for spinning, zero, and burn acceleration gravity directions. The chairs can be attached to either the floor or the ceiling and restraints are included to strap the crew down during ship maneuvers. Also, the control center can be rotated to face any direction. All of the living quarters and the command center are radiation shielded. The fact that the command center is located in a radiation protected area is because of the possibility of solar flares. If a course-correction or some other maneuver were necessary during the event of a solar flare, then the crew will still be able to control the spacecraft while in a radiation protected area.

Hygiene Facilities

Both habitation modules will have a main hygiene facility. Hygiene Facility 1 is located near the crew quarters and Hygiene Facility 2 is located near the Exercise/Medical area. They each contain a body waste collection disposal unit (toilet), a bathing facility with a full body shower, hand washing stations, and dressing areas.

Food Prep (Galley)

This area includes all of the necessary equipment for food preparation and temporary storage. It contains a zero gravity refrigerator/freezer which can store enough food for 14 days. Also included are a zero gravity microwave, utensils, plates, pans, napkins, a drink dispenser, a preparation workspace, and a trash compactor. A sink/hygiene area with handi-wipes and the necessary equipment and chemicals to sterilize dishes are also included. This area is located between the Exercise/Medical area and the Lounge area. A drawing of this area can be seen in *Figure 9.4*.

Lounge / Entertainment / Wardroom

This area of the spacecraft is the general entertainment, eating, and meeting area. It provides the crew with a comfortable seating and viewing area and contains a fold away table with chairs, a T.V. with VCR and video games, an audio system, a window, and a communications station. Enough storage space for games, entertainment systems, hobby supplies, and musical instruments has been provided. There is also designated wall space for personal photos and posters. Again, the necessary restraints are included for food trays, seating, etcetera, for a zero gravity environment. A drawing of this area can be seen in *Figure 9.5*.

Exercise / Health Maintenance Facility

This area of the spacecraft includes the equipment necessary to monitor and maintain the health of the crew. It contains various medical supplies and equipment. These include first aid supplies, dental equipment, minor surgery equipment, a medical bench, and health

monitoring systems such as an E.K.G. Also, exercise equipment is included such as a soloflex-type resistance machine, an ergometer bicycle, and a treadmill. This area also includes a window. This area is located between the Food Prep area and the Experiment Lab, and a drawing can be seen in *Figure 9.6*.

Experiment Lab

This area consists of a table and rack which holds the experimental supplies needed to perform various on-board studies such as radiation effects monitoring, food and plant growth, and crystal growth. Also, equipment has been added for planetary observation and research, and celestial mapping. Computer sites and control panels have also been included to run and monitor the experiments. A more detailed description of the experiments can be found in the Planetary Science section. The Experiments are located in two sections of the spacecraft: the main location is adjacent to the exercise / health maintenance facility, and the other is located next to the command center. A drawing of the main experiment location can be seen in *Figure 9.7*.

Storage Areas

These areas are located throughout the ship wherever extra space can be found. The main food storage area is located near the crew quarters. Other storage areas are located above the ceilings, and below the floors of both modules.

Airlocks

The design of the airlocks is included in the Structures section; however, stored in the airlocks will be three hybrid hard suits, two soft suits, and tools necessary for extra-vehicular activity (EVA). Also included in the airlocks will be a vacuum/suction type cleaning device to remove dust from the suits and clothing of the crew members. Each airlock will also contain a command center capable of spinning and de-spinning the spacecraft.

Figure 9.3 - Typical crew quarters

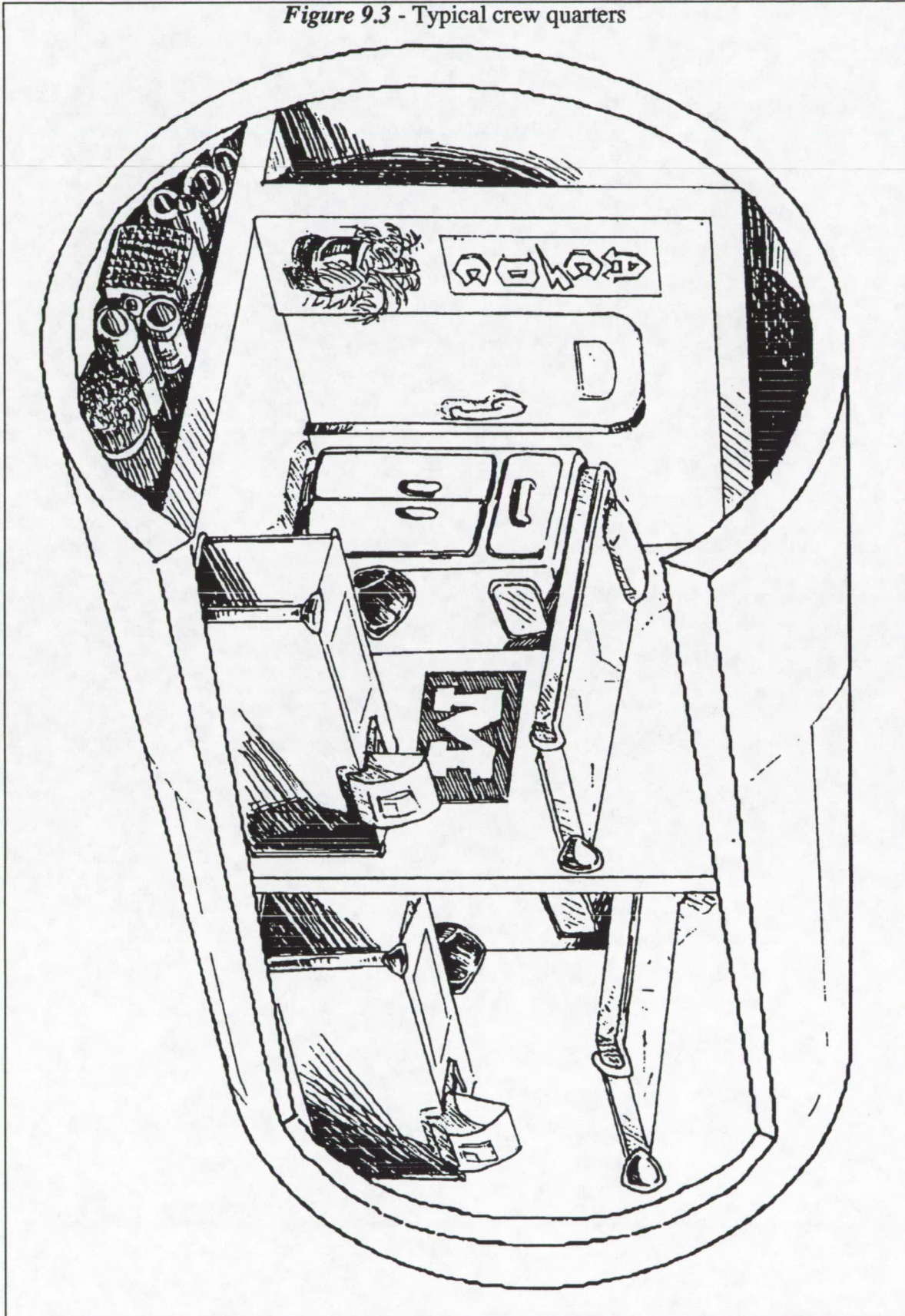

Figure 9.4 - Food Prep (Galley)

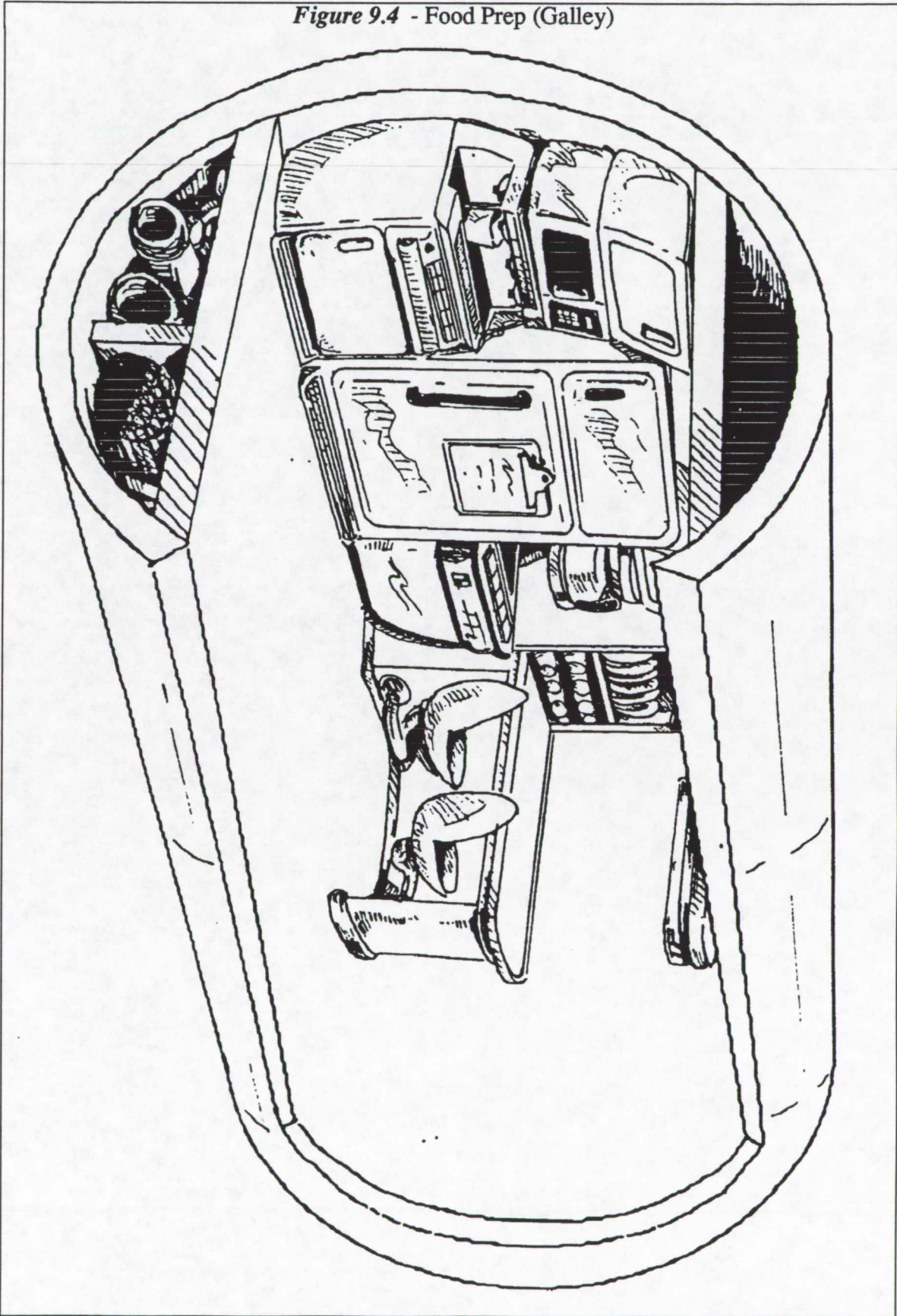

Figure 9.5 - Lounge / Entertainment / Wardroom

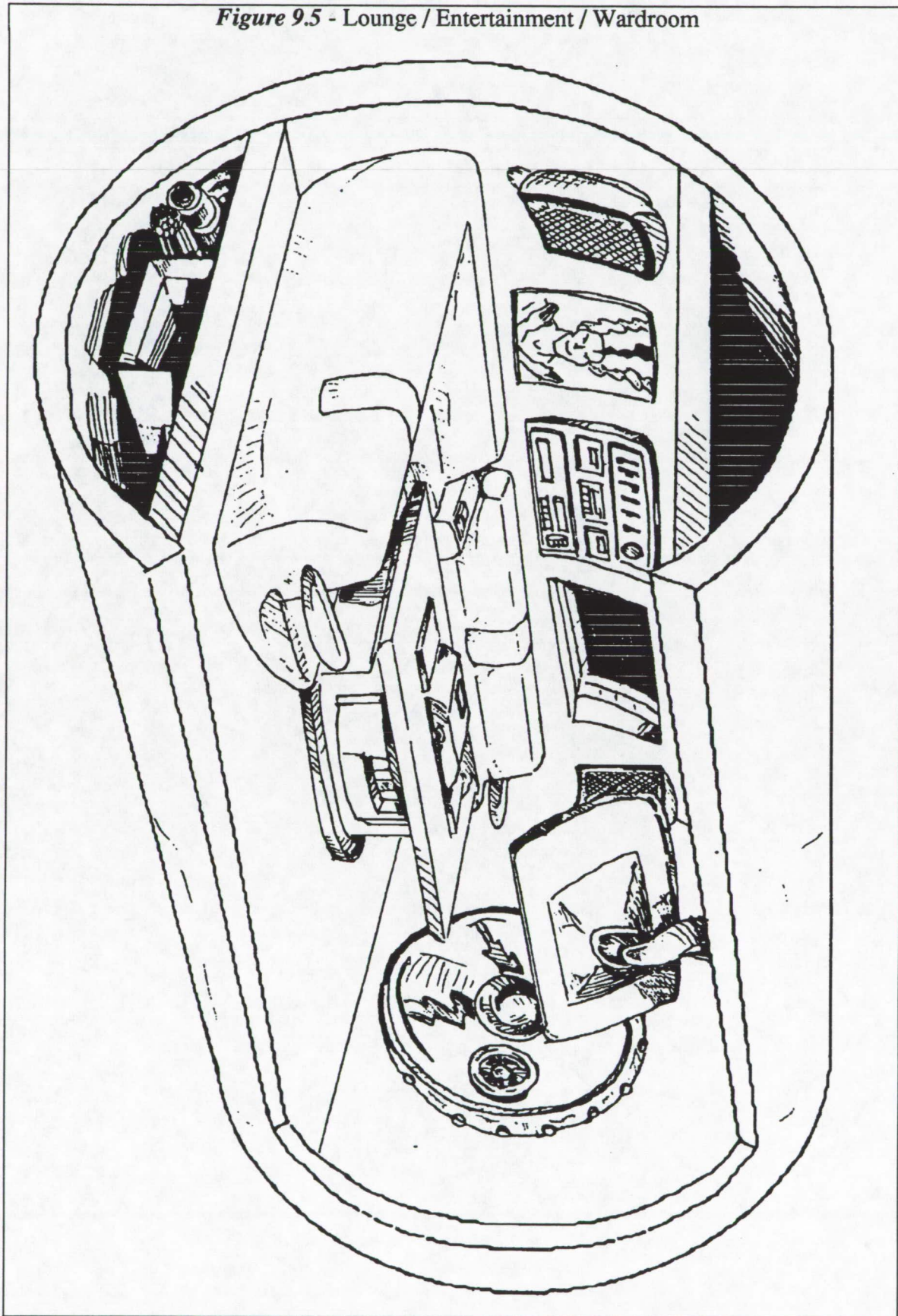

Figure 9.6 - Exercise/Health Maintenance Facility

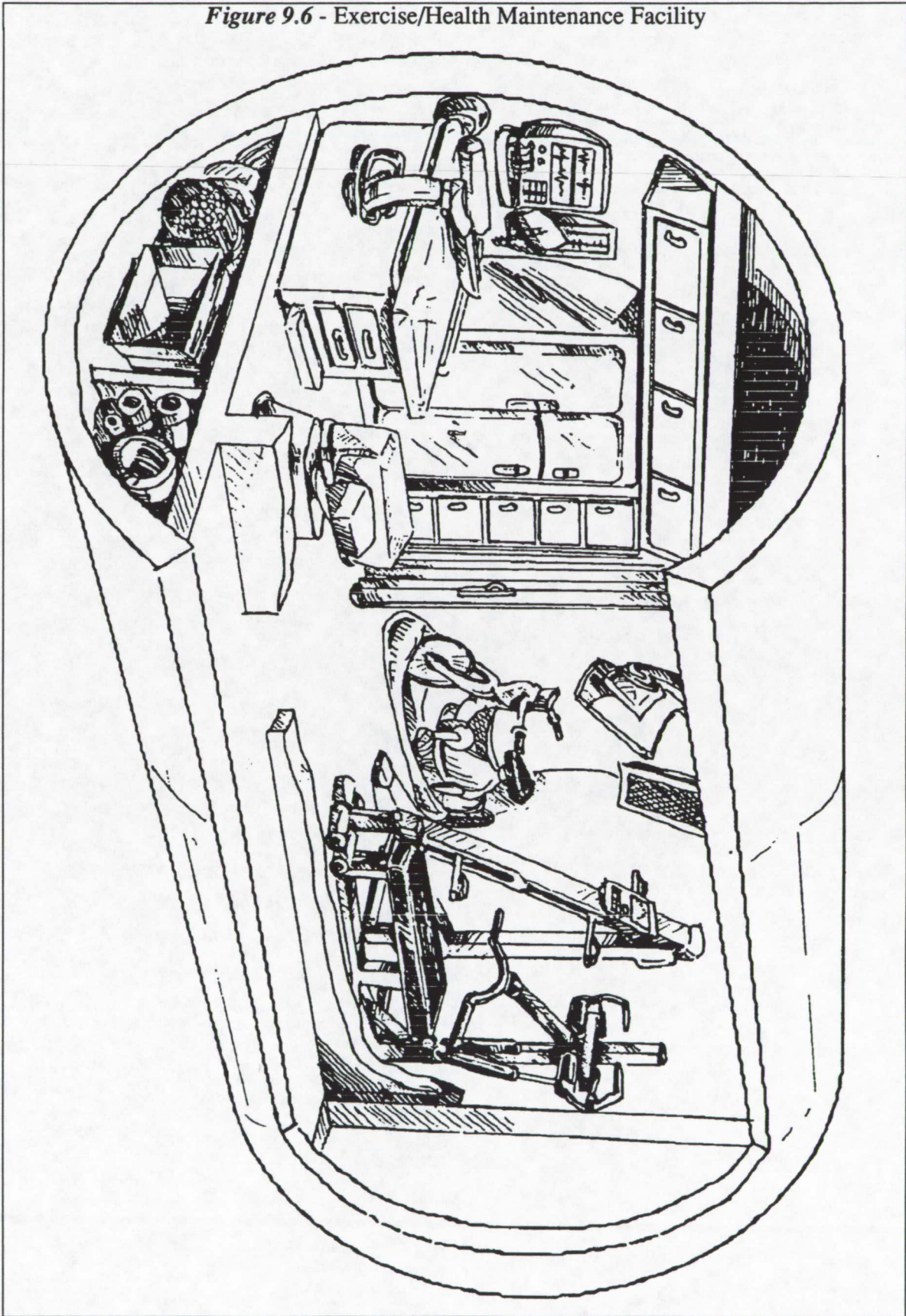
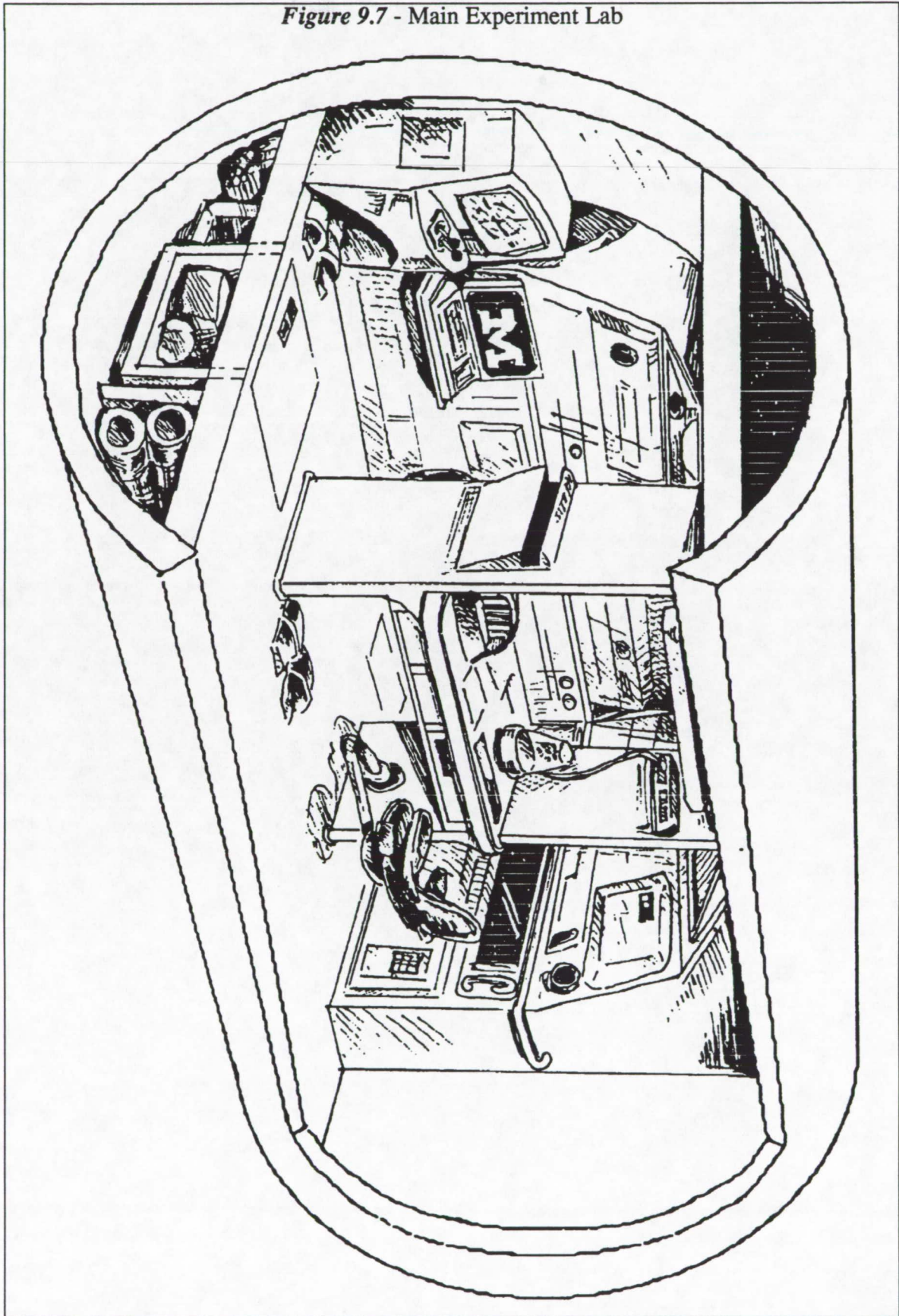

Figure 9.7 - Main Experiment Lab



Safety Concerns

During the mission to Phobos, the safety of the crew is of utmost importance. This is true not only during their everyday routine, but also during any hazardous situation. There are several areas of concern when considering appropriate on-board safety systems. These include Ship-Health Monitoring, Fire Detection and Suppression, and Hab Module Egress, Isolation, and Repair Capability. These areas will be discussed in the following section. The power and mass requirements are included with the Life Support system.

Ship-Health Monitoring

The ship contains sensor control panels located throughout which are designed to alert the crew of problems with the spacecraft. Disaster alarms will sound for serious problems such as propulsive/power failure, life support systems failure, and flame detection. If a less serious problem occurs then a problem alarm will sound which will alert the crew of the problem. The control panels will have lights and gauges to inform the crew of the problem. Examples of these situations include problems with the air and water quality, low or high cabin pressure, low or high temperature, low or high humidity, or smoke detection. This gives the crew time to investigate the problem or to override any automated safety systems. The life support system itself is designed to compensate for any improper conditions. This also includes the possible presence of any air or water contaminants which would then be filtered out. This system will also alert the crew if the Hab Modules are safe to re-enter if they were sealed off at any time. All of these systems will be monitored by Ground Control, but the presence of these control panels will be able to inform the crew directly.

Fire Detection and Suppression

For fire suppression, four types of systems are generally used. One is the standard water spray system which is impractical for space travel. Another is the use of dry chemical fire extinguishers which leaves corrosive deposits, and is hazardous to the crew. A third method is to flood the modules with Carbon Dioxide. However, this is very dangerous to the crew for concentrations necessary to suppress a fire. Concentrations as low as 9% will cause a person to lose consciousness, and higher concentrations would render the crew helpless immediately. The most attractive option is a Halon 1301 system. This is the system currently under use on the Space Shuttle.

The Halon 1301 system can suppress a fire at about a 7% concentration. It works by flooding the Hab Module with the Halon 1301 gas which acts to break the tetrahedral bonds of fire, thereby extinguishing it. Halon 1301 not only vaporizes rapidly in a fire situation, but also leaves no corrosive or abrasive residues. The crew can be exposed to the Halon for about 15 minutes before any ill effects are felt. This gives the crew ample time to escape to an airlock or to the other Hab Module, or to put on a gas mask, (of which there will be enough for each crew member in each Hab Module). However, if a crew member were to be exposed to the Halon for more than 15 minutes the affects would only be temporary nausea and headaches. Following extinguishment of the fire, the Halon gas is then filtered out by the life support system.

Two cannisters of the Halon 1301 gas are located in each Hab Module, and with many discharge nozzles located throughout each Module. Hand-held extinguishers are also located in the living and working areas of the crew. The Halon system can be discharged once for each cannister for a total of four discharges, and additional cannisters can be stored easily in the storage space provided.

The fire detection system will include thermal, smoke, and flame detection devices. These devices will be located both on the ceiling of the living space, and in any closed storage areas including those above the ceilings and below the floors. The power required to run these devices is extremely low. Usually a 12 volt battery is used in residential applications, so our power reactor should suffice. The sensitivity of these devices will be such that if an actual flame is detected then a disaster alarm will sound and the extinguishment system will activate immediately. However, if smoke is detected in a general living area in small quantities, such as a piece of toast burning, then the problem alarm will sound to allow the crew a certain amount of time to override the automated system, and to extinguish the fire with the portable hand-held extinguishers. If the automated system is not overridden within this period of time, then the automated systems will activate. This prevents any unnecessary use of the Halon system.

Module Escape and Repair

Many of the safety features of the spacecraft are already included in the design of the modules themselves. These include the following:

1) Self-Sealing Doors: These doors will automatically seal shut if a hazardous condition exists in one of the modules. Each door will have a manual override near and in between the two doors to be used if necessary, and the force of the door will be large enough to close if blocked by any objects, including humans. This is based on the belief that the safety of the entire crew is more important than only one of its crewmembers. Also, the presence of the manual override and a time delay for less dangerous events will allow the crew to avoid such situations. However, there is no time delay in the event of a disaster alarm, and only a one minute delay in the event of a problem alarm.

2) Module Isolation: All air vents and connections between the modules would also be closed to provide for complete module isolation and safety. This would occur immediately when a disaster alarm is activated.

3) Airlock Escape Design: If necessary, the crew could all escape into one of the airlocks attached to each Hab Module. There will be enough suits in each airlock should the entire crew be in the same module. Also, each airlock will have a small command center capable of de-spinning the spacecraft, and a ship-health control panel to allow the crew to know if the module is safe to re-enter.

4) EVA Transport and Repair: If the crew is isolated in one of the airlocks or Hab Modules, then the crew will then be able to transport themselves to the other Hab Module either using the space pod, or by climbing along a handrail connecting the two airlocks. This would allow them to examine and repair the exterior of the hull, and to access and repair a sealed off isolated module.

5) Module Atmosphere Depletion: If a leak in the hull should occur, then the CELSS (described in the following section) can accommodate for 2.3 kg/day of atmospheric leakage, and a further amount of extra nitrogen and oxygen is being taken along to replenish the life support system in the event of total atmosphere depletion. In the event of a large leak a disaster alarm will sound, the affected module would be isolated, the ship de-spun by the crew (if spinning), and the crew could then examine the hull to locate and repair the hole.

Life Support

In order for the astronauts to function during the entire mission to Phobos and back, there must be several support systems able to withstand the hazards of interplanetary space flight. Possibly the most important support system will be the Closed Environment Life Support System (CELSS). Without this system, the astronauts will not be able survive the hazards of this long mission. This system is extremely complex, but will provide all the necessary food, water and atmospheric requirements that the astronauts will need. The purpose of this report is to give as detailed an explanation as is currently possible about the Life Support System.

Summary

For our life support system to function, it will need to have an initial supply of materials as well as some supplies in storage to make up for the inefficiencies of the system. Our crew of five astronauts will need to have at least:

- 10,400 kg of Food and Supplies
- 27 kW of Power,
- 3,400 kg of Support Equipment that will require 18 m³
- 160 m³ of Open Space within the habitation module.

It should be noted that these numbers reflect the lowest comfort level that astronauts will tolerate for long periods of time. Since the mission is scheduled to last almost two years in length, it would be to the psychological and physiological benefit of the astronauts if some of these numbers were expanded upon. It has been suggested having a 15% contingency food supply to account for any emergencies as well as any unexpected inefficiencies of the system will be adequate for the survival of the astronauts. This will mean that the crew will need to bring along:

- 1000 kg of Oxygen
- 5550 kg of Water
- 4720 kg of Dried Food

It has also been suggested that a 15% expansion of the open volume of the habitation modules is good for the psychological well being of the crew. This will necessitate having 185 m³ of open space. As for the support equipment itself, it is not as constrained by the inhabitants of the habitation modules. They could be designed to fit well within the parameters set above. These suggestions will allow the astronauts to complete their mission with the minimum possible strains upon them, while at the same time using up as little mass as possible.

Crew Requirements

The first main task in describing how the CELLS works is to know what the exact requirements are of the people it will be supporting. This means that the exact daily requirements of food, water, oxygen and other materials that will be needed to maintain the astronaut's health and physical conditioning must be known. The following is a list of the *minimum* daily requirements needed for every person in space:

Drinking Water	1.86 kg
Food Preparation Water	.73 kg
Domestic Water	17.9 kg *
Pure Oxygen	.84 kg
Solid Food (dry)	.73 kg

22.6 kg/person/day

* Domestic Water includes water used for hygiene, laundry, dishes etc.

This comes out to a total of 113 kg/day for a crew of five people. It quickly becomes apparent that, without recycling, this would result in an extraordinarily high amount of mass just to keep the astronauts alive. Fortunately, it is possible to recycle the atmosphere as well as the water on board. This will eliminate the need to carry an enormous amount of supplies that will be required for the mission.

Things to Recycle

With our current technology, many advances have been made with CELSS in order to recycle as much as possible. The most striking breakthroughs have been in recycling the atmosphere and water supplies. These systems have been tested rigorously in both the space programs and underwater programs of many countries. It has been field tested many times, and is almost an exact science. Current technology allows us to recycle approximately 90% of our air supplies, as well as 95% of our water supplies.

Air supplies

Given a 90% recycling rate, and an approximate fourteen day processing time, some rough calculations as to what the initial oxygen supplies can be made:

Pure Oxygen/Crewmember/Day:	.84 kg
Crew:	5
Total Oxygen Necessary/Day:	4.2 kg
Two Weeks Supply:	58.8 kg
Recycling Efficiency:	90%
Cabin Leakage/Day:	.87 kg
Cabin Leakage/2 Weeks:	12.1 kg

So, at the end of the first two weeks, there will still be 47 kg of oxygen within the confines of the cabin, of which 42 kg can be returned into a useable form. This means that every fourteen days, 17 kg of oxygen will need to be added into the atmosphere. For a mission length of about 660 days, a total of 805 kg of oxygen must be added to the atmosphere over the entire mission. So, a minimum necessary supply of 865 kg of oxygen will be necessary to maintain the health of the crew for the duration of the mission. With a 15% contingency supply, our mass of oxygen now would become 1000 kg. This should be more than enough for the astronauts use during the entire mission.

Water Supplies

Similarly, the water supplies can be recycled. Fortunately, current technologies allow us to recycle water at an incredible 95% efficiency. Again, assuming a two week processing time, an estimate on the amount of water that will be required:

Water/Crewmember/Day:	20.5 kg
Crewmembers:	5
Total Water Necessary/Day:	102.5 kg
Two Weeks Supply:	1435 kg
Recycling Efficiency:	95%
Cabin Leakage:	minimal

So, after two weeks of use, our recycling system will have returned 1364 kg of water. This means that the additional 72 kg of water will need to be supplied from storage. Again, for a mission length of about 660 days, a total of 3400 kg of water must be added to the system in order to keep the astronauts safe. This means that our total supply of water will need to be at least 4,820 kg. Again, with a 15% contingency supply, our total mass of water will increase to 5,550 kg.

Food supplies

It should be noted that it is very possible to grow food in space. For large crews, or for extremely long missions, this would be a viable alternative. Unfortunately for us, the technology necessary to grow our own food in space is not very exact. Few studies have actually been conducted in space, especially over long time periods. The few studies that have been made indicate that a very large area is necessary to grow enough food to supply the astronauts, and that the growing times are usually quite long. Therefore, due to the relatively small crew size as well as the short duration of the mission, food recycling is not a viable alternative. Instead, the crew will rely on stored foods, with a supplemental diet coming from a small garden. This is more practical for several reasons:

- a) lots of experience in long term food storage
- b) the food supply is always there, the crew won't have to wait for it to grow
- c) the amount of room inside the habitation modules is significantly reduced, due to getting rid of farming space (which translates into a tremendous weight savings).

So, if the food supply is not to be grown on this mission, all of the provisions necessary for the astronauts to stay healthy must be carried along with the crew. This means using foods that can stay packaged and stored for a long time. Currently, the most common technique of long term food storage is to use freeze drying. This process removes all the water in a given food, thus reducing it's mass as well as it's volume. A major psychological consideration is how food quality affects the moral of the crew. In the past, astronauts have complained bitterly about the poor quality and lack of choice of freeze dried foods. For this reason, planning and selection of the provisions must be done very carefully. The food must be palatable as well as storable. Similarly to the water and atmospheric supplies, the mass of food that will be necessary to store aboard the ship may also be calculated:

Food/Crewmember/Day*	.73 kg
Crewmembers	5
Food/Day	3.65 kg
Food/660 Day Mission**	2409 kg
Total Food Mass†	4,720 kg

- * This is the total mass of dry food that each crewmember must eat in order to maintain their health.
- ** This total mass does not include either packaging weight or the use of whole foods. (Whole foods are necessary for the psychological well being of the crew.)
- † This mass does include packaging weight as well as a varied diet (which includes the use of some whole foods as well as freeze dried foods and flash frozen foods).

As to the volume that this amount of food will take up, this is unknown at this time. The volume will depend on the exact types of food that have been selected. It should be noted that additional food supplies will be necessary for the times when the crew will be working on the processing plant. This time of increased energy use will need to be balanced by a daily increase in energy intake by the astronauts.

Supplemental Food

There will be a small garden on-board that will provide the crew with a supply of fresh vegetables. This will also provide valuable information about the long term effects of space on food growth. This could prove extremely useful in the future colonization of the Moon, as well as Mars.

Recycling Processes

Now that it is known *what* will be recycled, *how* the recycling will take place must be determined. And before it can be decided *how* to recycle our air and water supplies, it must be determined exactly *what* needs to be removed from these two mediums in order for them to be fit for human consumption.

Air

The primary concern in the air supply is getting rid of the carbon dioxide that is exhaled in every breath a crewmember takes. Other factors that need to be taken into account are microbes (and other biological contaminants) as well as particulate levels in the air. All of these concerns must be met. Looking at *Figure 9.8* will facilitate the understanding of this complex system.

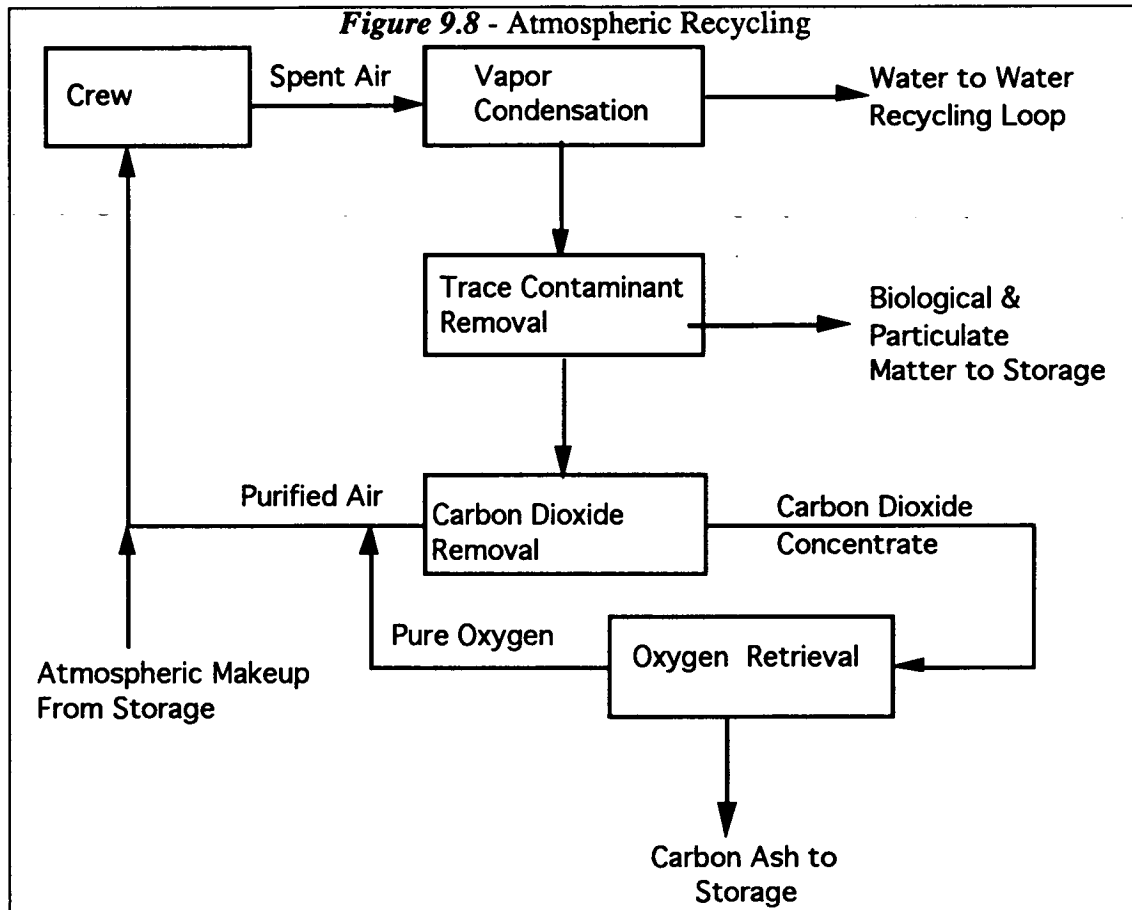

Carbon Dioxide

Carbon Dioxide can be removed from the atmosphere by many means. The safest, most reliable and most effective method of carbon dioxide removal for a long duration is through the use of molecular sieves. The use of a solid amine solution within the molecular sieve allows the process to be used and reused constantly. (Once carbon dioxide has been removed from the air, it is trapped within the amine solution. When the amine solution is then heated, the carbon dioxide is released from solution, allowing the process to begin again.) Once the carbon dioxide is removed from the air, it is concentrated and sent on to a Bosch reactor. This reactor is used to separate the carbon dioxide into its component elements, carbon and oxygen. The oxygen is then released into the atmosphere, to be reused by the crew. The carbon is converted into a fine ash, which can either be used in the garden as a soil base, or stored for future study.

Biological Contamination

As for biological contaminants and particulate levels in the air, a different system must be used. Simple quarantine of the crew before departure, and sterilization of the ship before embarkation, will reduce the chances of both biological and particulate contamination. However, systems will be necessary for safety's sake. A series of special use filters will suffice in removing these threats to the crew's health.

Water

The water supplies will be crucial to the survival of the crew. It is also urgent that these supplies not get contaminated, because microbes grow and spread easily in water environments. Before *what* needs to be removed from the water supplies can be determined, it must be known *where* the water has been. From this knowledge, a system that will work most efficiently can be designed, as seen in *Figure 9.9*.

Domestic Water Supply

The vast majority of the water is used for domestic purposes. This means that the water will come from showers, hand washing stations, laundry facilities, dish washing equipment and other sanitary purposes. These processes contaminate the water supply very little. The primary concern in cleansing this water is to remove any particulates that have gotten into the system. Passing domestic water through progressively finer particulate filters will solve this problem easily. A series of reverse osmosis modules will cleanse the water further of any chemical contaminants, such as soap, or dissolved substances in the water. The clean water is then passed on to a storage tank, where it is heat treated to remove any possible biological contaminants. The substances removed from the water by reverse osmosis can be reused as well. The concentrated brine that comes from reverse osmosis can then be sent to a vapor-compression and distillation system. This system removes any water left within the brine, and allows this water to be reused. The concentrated sludge that is left over from the vapor-compression is then stored.

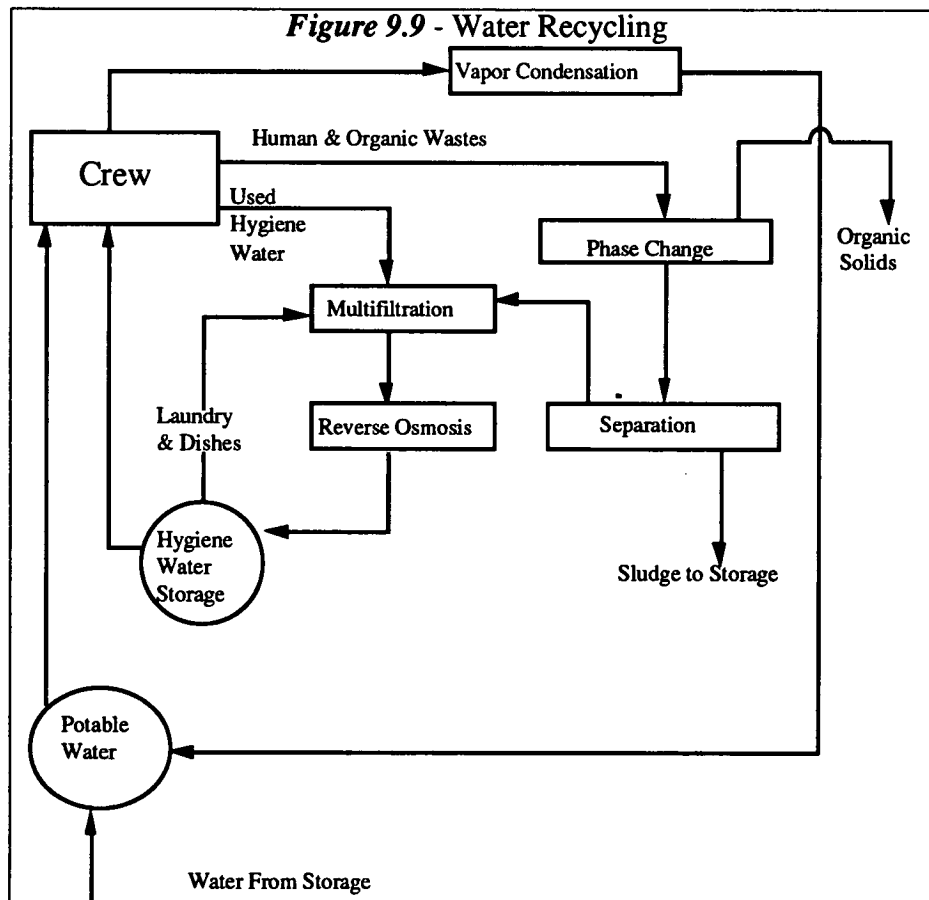

Water Vapor

A second source of water is the atmosphere of the habitation modules itself. There is a sizeable amount of water in the atmosphere of the quarters, and more is added to it every day in the form of sweat (from the crew itself), and steam (from hygiene facilities and food preparation). This water vapor is easily converted into a useable water supply simply by condensing it. A cooled surface condenser will remove as much or as little of the humidity as is desired. The water from the atmosphere then only needs to be stored with the rest of the water supply, where it can be heat treated to remove any biological contamination. It is then ready to use by the astronauts.

Waste Water

The hardest part of water to recycle within a CELSS is the water coming from human and other organic wastes. There are many contaminants within these wastes that must be removed before the water can be used again. This waste water will go through a phase change (by vapor compression and distillation) which will separate most of the solids from liquids. Then, the liquids will pass on to the separation unit, while the organic solids are sent to storage. The separation unit uses dry oxidation to remove all of the trace contaminants that set human waste water apart from the hygiene water. The water that comes out of the separator then goes on to the multifiltration unit (and continue on as described above). The sludge that has been separated out of solution then combines with the organic solids. This mixture can then be used as a nutrient source for the garden, as described below.

Food

The primary source of food for the astronauts will be stored along with the water supplies. Unfortunately, it is quite hard to recycle food efficiently. In order to sustain one astronaut in space for a year, over 100 m² of surface space would be needed to provide the necessary food. This is an enormous amount of room that will clearly not fit within the confines of the habitation modules. But, in order to supplement the crew's diet and to do research on how food does grow in space, a small vegetable garden will accompany the crew on it's mission.

Supplementary Food

The garden is a relatively simple design that will provide a good alternative to the stored foods that astronauts normally eat. The garden will be illuminated by four sun lamps on each level, for a total of twelve lamps. These lamps, each of approximately 300 W, will provide all of the lighting needed by the garden for the vegetables to grow. The garden will use the same water supply as the rest of the crew. Pipes will be inlaid into the soil so that the vegetables will be able to receive water even during those times when there will be no artificial gravity. Nutrient solutions can also be added to the soil throughout this pipe network. The nutrient solution can draw it's supplies from the wastes that are filtered out of the water and air supplies, as well as from stored fertilizers.

Stored Foods

The remainder of the nutritional requirements of the crew will be supplied by stored foods that will be carried along with the astronauts on their mission. As stated above, the crew will require 4,720 kg of dried foods for them to survive comfortably.

System Specifications

In order for all of the above systems to operate, they must have appropriate power supplies as well as room to work in. The following is a list of design specifications that the recycling and control systems will meet:

<u>System</u>	<u>Power Required (in W)</u>
Closed Environment Life Support System	11,000
Crew Accommodations (including lighting)	9,000
Active Thermal Control (i.e. heating & cooling)	260
Health Maintenance	3,820
Sun Lamps (for garden)	3,600
Total	<u>26,680 Watts</u>

If this is rounded off to approximately 27 kW, and then impose a 25% contingency supply, a total of 34 kW will be required. This is the amount of power that the Power Generation Group should allocate to the Human Factors & Life Sciences Group for making the habitation modules safe and useful for the astronauts.

In terms of other physical specifications, the entire CELSS should weigh no more than 3,400 kg, and be able to fit within a volume of 18 m³. Most of these systems can be placed within the walls of the habitation modules so as to take up less of the open space that is required by the astronauts.

Crew Operations

Summary

The nature of the mission provides two distinct categories of crew operations: operations en route to Phobos and operations on Phobos. Throughout the mission all five crew members will operate on the same recommended daily schedule. This is suggested to enhance comradery between crew members and to reduce feelings of isolation. Time schedules for operations consider several activities within a given time block to allow the crew to determine the order in which they would like to perform their duties. This alleviates congestion in small areas by allowing the crew to stagger their activities. The recommended daily schedules are based on a 25 hour day, for this was found to be the natural human mode.

Operations En Route to Phobos

Operations en route to Phobos primarily consist of controlling and piloting the ship, maintaining crew fitness and health, and performing experiments. This phase of the trip contains the most burns and the highest possibility of radiation exposure during the Venus

flyby and/or solar flares. This phase of the trip is performed at an artificial gravity equal to one half of Earth gravity with the exception of burns which will be with zero gravity.

Daily Routine En Route to Phobos

The recommended daily routine is again based on a 25 hour day, and should be broken up into these main time blocks:

- 9.0 hours for testing / experiments / operations / exercise
- 2.0 hours for group planning and conferences
- 4.0 hours for meals and personal hygiene
- 2.5 hours for recreation and personal time
- 7.5 hours for sleep

It should be noted that the sleep times for each crew member will coincide for the psychological reasons mentioned above in the summary.

Operations During Burns and Solar Flares

During burns the crew will be strapped into restraints within the crew quarters/ command module of the ship. The crew will also be restricted to this shielded area for a twelve hour time period around the time of solar flares. It is not necessary for the crew to be strapped in during solar flares unless this time coincides with a burn. The heavily shielded area will provide radiation protection for the crew during increased radiation levels from the Venus flyby or solar flares.

Operations on Phobos

Operations on Phobos consist of setting up the processing plant, maintaining crew fitness and health, and performing experiments. This phase of the trip is performed in zero gravity.

Daily Routine

The recommended daily routine while on Phobos is only slightly different from the daily routine while en route. The main time blocks are as follows:

- 7.0 hours for processing plant set-up (4 crew members at a time)
- 3.5 hours for exercise / experiments / recreation
- 2.0 hours for group planning and conferences
- 5.0 hours for meals and personal hygiene
- 7.5 hours for sleep

The noted differences are seen while the astronauts are on-duty and performing mission related tasks (ie processing plant set-up, experiments, testing, and exercise).

Extra - Vehicular Activity (EVA)

The mission will rely heavily on its EVA system for setting up the processing plant on Phobos. The EVA system will consist of a pod, hybridized space suits, a Manned Maneuvering Unit, and a tether system on Phobos. Each facet of this system is explained in the following paragraphs.

Space Pod

The space pod used in the mission is based on future technology. A pod must be designed to fit the following parameters:

- 5 person capacity
- One Airlock
- Capability of setting up the processing plant in a timely manner (15 minutes)
- Life support system (10.2 psia for eating / hygiene)
- Communications and power systems
- Storage for tools, food, and medical supplies
- Attachment for tether deployment device
- Outdoor lighting

For design purposes, the pod was dimensioned at 5.5 meters high, 4.0 meters wide, and 6.65 meters long. This pod has a proposed weight of 5500 kg. according to current plans for Centaur Module or Grumman Derivative.

Space Suits

The space suits used by the crew for Extra-Vehicular Activity and emergencies will be hybrid models based on future technology. There will be an entry vehicular suit and a surface suit. This mission requires the construction of a processing plant on the surface of Phobos. It will take an estimated 960 man hours to set up the plant. The astronauts will need to have a suit with a large range of mobility especially in the waist and glove areas. The new suits will not require pre-breathing pure oxygen, and will produce an almost zero probability of decompression sickness. The surface suit will have life support provided by a pack the astronaut will wear on his or her back.

The Occupational Safety and Health Administration recommends 20 kg as a comfortable pack weight. Other factors that must be accounted for in the future designs are the lack of significant gravity on Phobos, dust in well-traveled areas, atmospheric conditions, thermal gradients, lighting conditions, and radiation. With these conditions in mind, emphasis for design must be placed on the following specifications: a durable, lightweight suit; an improved glove design; dust contamination protective measures and techniques; and long-term reusability, with a compact and lightweight life support system. Due to temperature changes on the surface, the work schedule must be adapted to minimize the thermal loads on the portable life support system. The material the suits are made of must provide for easy cleansing without deterioration from contact with dust or micrometeoroids. There will be a total of six hybrid hard suits on board located in the airlocks, and they will have the following qualifications:

- double hull which protects against:
 - Radiation
 - Micrometeoroid penetration
 - Poor thermal conditions
- 8.3 psia
- 85 kg ea.
- Minimal maintenance and ease of repair

Manned Maneuvering Unit (MMU)

The Manned Maneuvering Unit will be used to traverse small distances. Primary uses during the trip to Phobos will be to make repairs and to retrieve the pod from the truss of the ship and bring it to one of the airlocks for operations on Phobos. The MMU has the following characteristics:

- Effective range from ship: 100 m
- 4 hrs of routine flying without refueling
- 155 kg ea.
- Backup for Space pod

Tether System on Phobos

To start plant construction, the astronauts will need a system to attach themselves to Phobos. To attach themselves to the surface, spearlike projectiles will be shot into the surface from the pod. Poles will then be attached to these projectiles in a locking fashion similar to vacuum cleaner extensions with tension pins. In between these poles, tethers will be strung. Astronauts will then attach themselves to these tethers by means of a belt equipped with multiple clips on adjustable straps. To work at a particular location, the straps can be tightened and locked in place. To move from one spot to another, the straps can be loosened, and the astronaut can slide himself along the tethers to the desired location. With this tether system, the astronauts will be able to exert force on the plant and secure it to the moon's surface.

~~END~~ 300 INTENTIONALLY BLANK

Human Factors & Life Science References

NASA Information series PMS-019 (JCS) Feb. 1990

Class notes and Handouts from IOE 300 (A business and management course).

NASA SP-413 - Space Settlements- A Design Study - by AMES Research Center; SSD1 #20; 1977.

JCS- 10615 - Shuttle EVA Description and Design Criteria - by EVA Systems Section; SSD2 #15; 1976.

NASA Technical Memorandum 4064 - NASA Information Sciences and Human Factors Program - by IS&HF; SSD 13 #28; 1987.

NASA Reference Publication 1045 - C8600046 - The Physiological Basis for Spacecraft Environmental Limits - by JCS; SSD 13 #51; 1979.

NASA S-83-00188- MGSS: Manned Geo Sortie Study - JCS; SSD1 #18b; 1983.

“NASA to Evaluate Two Suit Designs for Space Station”- Aviation Week and Space Technology - January 11, 1988.

Maneuvering Unit Keyed to Simplicity”, by Craig Covault, Aviation Week and Space Technology, 1/23/84, p. 42-56, information on the Manned Maneuvering Unit (range, training required, weight, propulsion, duration of use)

“EVA Requirement Dispute Threatens To Disrupt Space Station Program”-Aviation Week and Space Technology - March 26, 1990.

Foundations of Space Biology and Medicine Volume III, joint USA/USSR publication, general editors Melvin Calvin (USA), Ang Oleg G. Gzenko (USSR), published by NASA 1975 Chapter 6, Habitability of Spacecraft, p.159-161,186, Yu. A. Petrov information about proximity of areas in ship, human range of motion in design

Space Station Group Activities Habitability Module Study, David Nixon, NASA Contractor Report 4010, Cooperative Agreement NCC2-356, November 1986 information on integration of various areas in ship, compatibility matrix of these areas, crew scheduling guidelines

“Anecdotal Information on Space Adaptation Syndrome”, by Harrison H. Schmitt and Donna Jane Reid, NASA/ Space Biomedical Research Institute USRA/ Division of Space Biomedicine, July, 1985 information of the various effects of spaceflights or zero gravity astronauts have experienced as a reference for future research (experiments to be performed on our mission)

Tethers in Space Handbook - Second Edition, May 1989, p. 63, Editors: Dr. Paul A. Penzo, Jet Propulsion Laboratory and Paul w. Ammann, SRS Technologies Contracted by NASA, Contract number NASW-4341 soil sample return was the trigger for the idea to set up the ground system on Phobos with a series of tethers and harpoon-like projectiles

Manned Maneuvering Unit Design Data Book, Stephen J. Ducsay, Program Manager, Martin Marietta Corporation, February 29, 1980, Contract NAS9-15999 information on storage racks of the MMU during flight

Space Physiology and Medicine, NASA SP-447 Arnauld E. Nicogossian, M.D., NASA and James F. Parker, Jr. Ph.D. BioTechnology, Inc. information on EVA system design constraints and adequacy of life support systems required for these

Harold Reimers, Galley Sub-System Manager, Johnson Space Center, provided dimensions and weights of various galley items

Joe Kosmo, Manned Systems Group, Johnson Space Center, provided insight and information on space suit systems

Louis Trevino - Manned Systems Group, Laurie Weaver - Manned Systems Group, Johnson Space Center, provided friendly directions to the persons who could give the project the information that was needed Johnson Space Center

Fire Protection For Industry, Stephen R. Hoover, 1991, Information on specific fire detection and suppression systems, weight, power, cost, and integration techniques.

Fire Suppression and Detection Systems, John L. Bryan, 1982, Information on Halon 1301 and how it extinguishes fire, acceptable human dosage limits, and the health effects of Halon 1301 compared to alternative systems.

John Giles: NASA Kennedy Space Center (407) 867-7470, Information on the fire detection and suppression system of the Space Shuttle.

Exercise Training Protocols for Astronauts in Microgravity Greenleaf et al. Journal of Applied Physiology 67(6): 2191-2204, 1989

Biomedical Records from SKYLAB Johnston & Dierlin et. al., NASA Washington D.C., 1977

Requirements for Extravehicular Activities on the Lunar and Martian Surfaces, Brown & Schentrup, SAE Technical Paper Series #901427

Design Considerations for Future Planetary Space Suits Joseph Kosmo, SAE Technical Paper Series #901428

Chapter 10

Mission Control & Communications

10.0 Summary

10.1 Communication Systems

10.2 Navigation and Control Systems

10.3 Computer System

PRECEDING PAGE BLANK NOT FILMED

Mission Control Summary

Mission control is an integral part of every space flight. Teams of engineers and technicians monitor spacecraft systems and activities 24 hours a day during missions, using some of the most sophisticated communication, computer, data reduction, and data display equipment available. They monitor important maneuvers of the crew and spacecraft, double-check data to be sure missions are proceeding as expected, and provide expertise when necessary. Although on-board computers are capable of monitoring most systems for the flight crew, the ground control teams are still responsible for following flight activities and must be prepared for major maneuvers, schedule changes, and unanticipated events. From the moment the spacecraft begins its mission to the time it arrives back to Earth orbit, mission control is a hub of communication and mission support^{1 2}.

Location Selections

Mission Control Center (MCC), Building 30 at the Johnson Space Center (JSC) near Houston, Texas, will satisfy the requirements of Project APEX. Since 1965, MCC has been the center for America's manned space program. JSC has been kept current by constant technology upgrades. It will not be necessary to build or renovate a new mission control site; however, consideration must be made to expand mission control facilities at JSC. Due to the projected increase in space missions during the time of Project APEX, larger mission control facilities at JSC may be required to handle the additional traffic without overloading the system. Building 30 at JSC is capable of expanding its role with the installation of the new Geosynchronous Relay Satellites (GRS) communication system. Alternate mission control sites could be set up at the GRS ground station and Goddard Space Flight Center (GSFC) as contingencies. These sites would be manned by personnel from JSC^{3 4} in a crisis. The MCC is further supported by an emergency power building that houses generators and air-conditioning equipment. If a catastrophic failure were to shut down the Houston control center, an emergency facility at the GRS ground station would be activated. The emergency control center is a stripped-down version of the Houston control center, incorporating just enough equipment to let the controllers support the mission to its conclusion or until further reorganization can take place.

Mission Control Structure

Mission control's focal points are the two Flight Control rooms, where flight controllers get information from console computer displays or from displays projected on the wall at the front of the room. Flight controllers who work in the Flight Control room represent only a small part of the MCC mass. Each of the 20 to 30 flight controllers who sit at the consoles in the Flight Control Room has the help of many other engineers and flight controllers who monitor and analyze data in nearby staff support rooms. Some of the important flight controllers that makeup MCC will include the following^{5 6 7}:

- Flight Director (FD)
- Space Communicator (CAPCOM)
- Flight Dynamics Officer (FDO)
- Guidance Officer (GDO)
- Data Processing Systems Engineer (DPS)
- Flight Surgeon (Surgeon)
- Propulsion Systems Engineer (PROP)
- Guidance, Navigation and Control Systems Engineer (GNC)
- Instrumentation and Communications System Engineer (INCO)

The roles of the individual controllers in MCC are exemplified by their titles. Those listed above are just some of the areas in which MCC will keep an extremely close watch during the mission.

Additional Staff

While MCC might be viewed as the center of activity, many multipurpose support groups will participate in planning and support functions. They provide planning expertise for current flight operations, perform periodic support and systems checks, and respond quickly to any in-flight contingency. These groups will be composed of NASA personnel and private government contractors that have contributed to the mission^{8 9}.

Additional Support Areas

In addition to the main Flight Control Center, there are other support areas. The Network Interface Processor (NIP) area processes incoming digital data and distributes the information on a real-time bases to facilities associated with the Flight Control room and support room displays. The system also handles the data uplink that lets Mission Control do such things as keep the spacecraft guidance computer's facts and figures up to date¹⁰.

The data computation also processes incoming tracking and telemetry data and compares what is happening with what should be happening. Another important facility is the voice communications system which enables flight controllers to talk to one another. This system also connects controllers with specialists in support rooms, with flight crew training facilities, and with the crew in the spacecraft. These facilities are only the bare bones of the mission control setup; hundreds of other facilities located throughout the country at other NASA facilities will also support the mission^{11 12}.

Communication Systems

Project APEX maintains a 50 Megabit per second (Mbps) full duplex connection from the ship to Mission Control on Earth to allow voice and video communications, data transmission, and telemetry information to be constantly transmitted. To put things in perspective, at 50 Mbps an entire encyclopedia set can be transmitted in slightly over 1 minute.

There are seven major links in the communications system for Project APEX. They are described individually below:

1. GT: Ground Terminal - A 20-meter diameter dish near Johnson Space Center (Mission Control), transmitting in the S-band to the GRS.
2. GRS: Geosynchronous Relay Satellites - A set of 3 satellites in orbit about Earth with an S-Band downlink to the GT and a 24-meter Ka-band antenna for communications with MVP and MRS.
3. MPV: Mars Piloted Vehicle, the Wolverine spacecraft - Two 9-meter dishes in the Ka-band for communications with GRS.

4. TRP: Transitional Relay Point - A 1-meter antenna mounted on top of the APEX spacecraft, the TRP is intended for use during landing operations on Phobos to reach the MRS. In an extreme emergency, the ship could be de-spun in flight, and the TRP used to contact GRS at comparable data rates.
5. MRS: Mars Relay Satellites - Two satellites in Mars orbit with Ka-band downlinks to the PRP and a 9-meter dish in the Ka-band for link to GRS.
6. PRP: Phobos Relay Point - An antenna mounted on a 50-meter pole on the surface of Phobos, used to contact the MRS. The PRP will be left on Phobos connected to the processing plant when the crew concludes operations on the surface of Phobos
7. EVA: Extra Vehicular Activity - The EVA comm system works in the UHF-band, using half wave dipole antennas, for communications with astronauts' space suits while they are away from the ship.

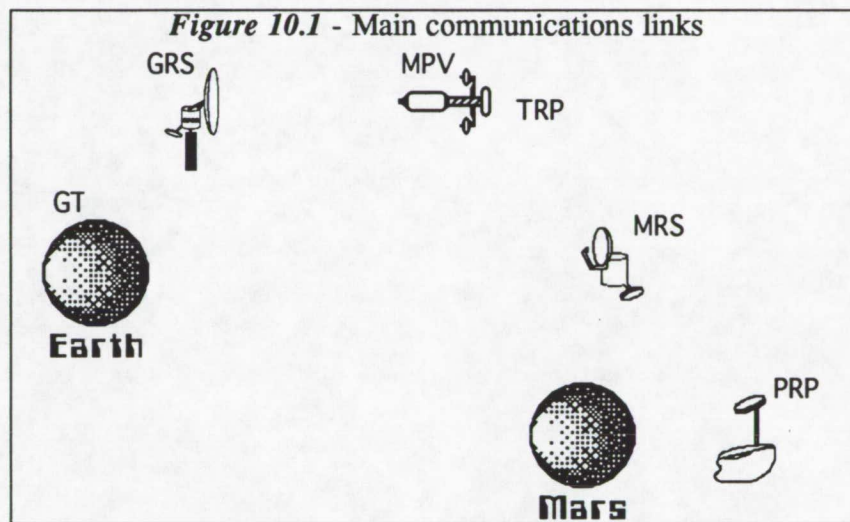

Communication Link Derivation

This section presents the derivation of one of the links in the communications system, the GRS-MPV link. All of the links were derived in a similar fashion. The results are summarized in a table at the end of this section.

Communications Equation

Communications systems are governed by the following equation:

$$Pr = \frac{Pt Gt Gr}{fsl}$$

Pr	≡	power received at destination
Pt	≡	transmitted power
Gt	≡	gains of transmitting antennas
Gr	≡	gains of the receiving antennas,
fsl	≡	free space loss.

Free Space Losses

Free space losses is determined by the following equation:

$$fsl = \left(\frac{4\pi R}{\lambda}\right)^2$$

fsl	≡	free space loss
R	≡	distance between transmitter and receiver
λ	≡	wavelength signal

Wavelength

The wavelength is determined by the following equation:

$$\lambda = \frac{c}{\nu}$$

λ	≡	wavelength signal
c	≡	speed of light
ν	≡	the frequency

We are using Ka-band communications centered on a frequency of 32.05 GHz. The wavelength is 9.36e-3 m.

Antenna Gain

The gain of parabolic antennas is determined using the following formula ¹³:

$$G = \eta \left(\frac{\pi D}{\lambda}\right)^2$$

G	≡	gain
η	≡	antenna efficiency
D	≡	antenna diameter
λ	≡	wavelength

For the GRS:

η	=	.45 ¹⁴
D	=	24 meters
G	=	29197677

For the MPV:

η	=	.45 ¹⁵
D	=	9 meter
G	=	4105923

Beam Width

The beam width, in degrees, for the signal to be at ~50% (3dB) of its strongest value is given by ¹⁶:

$$B = 70 \frac{D}{\lambda}$$

B	≡	Beamwidth
D	≡	antenna diameter
λ	≡	wavelength

For GRS:

$$B = 1.638 \text{ arc minutes}$$

For MPV:

$$B = 4.368 \text{ arc minutes}$$

Signal Losses

Pointing losses arise from misalignment of the two antennas. A value of 1.1 dB is allocated for pointing loss from the ship's antennas. It is assumed that the pointing accuracy of the ship's main antennas will suffer due to the rotation of the ship and the necessity of counter rotating platforms; thus, a large value for pointing loss is assigned. The required pointing accuracy can be determined from this loss budget using the following formula:

$$\text{Loss} = -2.77 \frac{\Phi^2}{\beta^2}$$

Φ	≡	required pointing accuracy
β	≡	3dB beam width

Rearranging terms, a figure of 2.75 arc minutes is required for pointing accuracy.

For the GRS antennas, a pointing loss of 0.27 dB is assigned ¹⁷. This results in a required pointing accuracy of 30.672 arc seconds. Pointing accuracies of 21 arc seconds are possible for Earth orbiting communications satellites ¹⁸ so this is an achievable value.

At 32 GHz, line losses resulting from imperfections in the waveguide from the transceiver to the feed horn can be significant. A line loss of 1.5 dB from feed losses is assumed ¹⁹.

Polarization losses resulting from differing polarization at the transmitter and receiver are assumed to amount to be 0.2 dB ²⁰.

Transceiver Inefficiency

No transceiver can transmit 100% of the power fed into it to the feed horn. Assume development of Ka-band transceivers with an 80% efficiency, resulting in a loss of 2.8 dB.

Eb/No Ratio

The magic number for digital communications systems is the Eb/No ratio, which is the energy per bit over the noise spectral density. Eb is given by:

$$E_b = \frac{P_r}{R}$$

P_r \equiv power received
 R \equiv data rate (bits per second)

No is given by the following relation:

$$N_o = k T_{eq}$$

k \equiv Boltzman's constant
 T_{eq} \equiv noise equivalent temperature (e.g., the energy a black body at temperature T_{eq} would radiate) in Kelvin

The noise equivalent temperature in space is 63.9 K²¹, resulting in $N_o = 8.82e-22$.

After taking the above values, plugging them into the communications equation, and accounting for the effects of system losses, $P_r = 3.08e-13$ (308 femtoWatts). Dividing by the data rate of 50 Megabits/second, $E_b = 6.15e-21$. This gives an Eb/No ratio of 8.43 dB.

Bit Error Rate (BER) and Modulation

The Bit Error Rate (BER) is the probability of any given bit being incorrectly received. For data transfer applications, a BER of e-6 is acceptable²².

Quadrupole Phase Shift Keying (QPSK) has been chosen as the modulation method on this link. To achieve a BER of e-6, QPSK requires a BER of 10.6 dB^{23,24}, which has not been achieved. Thus, forward error correcting code has to be used in order to improve the effective Eb/No ratio.

Forward Error Correcting (FEC) codes

Forward Error Corrections (FEC) codes can be used to detect and correct errors in transmission. Chosen are two of the most powerful codes available. Each block of data is individually fed into a Reed/Salomon encoder, the output of which is fed into a rate 1/2 convolutional code generator. Use of these methods effectively increases the Eb/No ratio by 8.2 dB^{25,26}. However, since these codes add overhead to the transmission, effectively upping the data rate, they reduce the energy per bit E_b , which worsens the Eb/No ratio. These implementation losses amount to 3 dB^{27,28}, meaning that overall the FEC codes add 5.2 dB to the Eb/No ratio.

Signal Margin

Eb/No has to be at least 3 dB above the required value to provide a margin for safety. 3.11 dB margin is achieved on this link.

This margin allows for degradation in the performance of the communications equipment over the course of the mission. For example, the ship's antennas will degrade under the constant bombardment of micrometeorites, while the transceivers will degrade under the effects of ionizing radiation in space. The 3.11 dB margin allows for a 50% loss of the signal strength to these factors and still maintain full communications with Earth.

Bandwidth

The task of finding the required bandwidth for the channel is now discussed. It is desired to transmit 50 Mbps of data back to earth, without error correction overhead. Assume a Reed Solomon encoding with an efficiency of 1.41²⁹. This means for every bit of data, 1.41 bits must be sent. Convolutional codes have efficiencies of 2, 3, or 4³⁰. Assume a code with efficiency 2. Total overhead from coding is 2.82 bits sent for every bit of data. Thus, the 50 Mbps channel requires 141 Mbps.

For QPSK modulation, the bandwidth is given by³¹:

$$B = \frac{(1+p)}{2} R_b$$

B	≡	Bandwidth
p	≡	implementation dependent roll off factor between zero and one
R _b	≡	bit rate

Assume a roll off factor of 1 (which is awful; an actual implementation would be better). With calculations, this results in a bandwidth of 282 MHz.

Communications Users

A 50 Megabits per second full duplex connection to Earth is available throughout the mission. A number of major users of the communications system has been identified:

1. Planetary Science, video on Mars Rover:
The remote robot landing on Mars has a color video camera, whose images will be relayed to Earth. Standard NTSC video with lossless compression requires about 10 Mbps³².
2. Planetary Science, other equipment on Mars rover:
The rover also mounts two photometers and a soil analysis package. These instruments require 1 Megabit per day, which works out to 23 bps.
3. Planetary Science, X-Ray imager:
This is essentially a camera operating in the X-Ray region. It is assumed to require the same data rate as an NTSC video feed, 10 Mbps³³.
4. Other video cameras:
Each of the computer terminals (see below) has a CCD camera, allowing video messages to be sent to Earth. It is assumed that a more stringent compression algorithm will be used to bring the required data rate down to about 4 Mbps³⁴.

5. General ship telemetry:

A small fraction of the telemetry information about general ship systems will be sent back to Earth for trend analysis. 1 Mbps is assigned for this task.

6. Voice feeds:

Audio messages between Earth and Phobos will require 64 kbps each ³⁵.

7. Crew Entertainment:

The latest movies, news, etc., will be sent from Earth to the crew. The data rate on this varies widely. Since this would be low priority information, it would take up the remaining bandwidth after other needs were serviced.

On-Earth (OE) vs. In-Earth-Orbit (IEO) Communication Systems

The On-Earth (OE) and In-Earth-Orbit (IEO) communication system must be capable of providing communications with manned mission elements, monitoring and controlling unmanned mission elements, and providing data for navigation. Furthermore, the communication system must support the criteria of high connectivity, high data rate, and lower cost. Two communication systems - Deep Space Network (DSN) and Geosynchronous Relay Satellites (GRS) - have been analyzed for their capability in satisfying the above criteria. The GRS system proves to be the more capable communications system. Each system and its capability in satisfying the specified criteria will now be presented in the following sections.

Background of Deep Space Network (DSN)

The DSN consists of three preexisting Earth-based facilities which are located in the United States (California), Australia, and Spain, providing operational capabilities for the system: (1) Deep Space Instrumentation Facility (DSIF); (2) Ground Communication Facility (GCF); (3) Network Control Center (NCC). The DSIF consists of a network of a 26 m Deep Space Station (DSS), and a network of 64 m DSS located around the world approximately 120 degrees apart in longitude.

Background of Geosynchronous Relay Satellites (GRS)

The GRS system consists of three satellites in geostationary orbit, set 120 degrees apart, and a ground station located in the United States. The three satellites transmit and receive information to and from space, while the ground station transmit and receive information to and from the three satellites. Presently, no such system exists. However, the Tracking Data Relay Satellite System (TDRSS) most closely resembles this system. The TDRSS consists of four satellites and a ground terminal in White Sands, New Mexico. All satellites point toward Earth to transmit and receive information to and from various users on Earth; therefore, TDRSS does not support communications outside its Earth-centered cone of influence. Furthermore, the TDRSS currently does not support Ka-band frequencies. Therefore, if a GRS system is desired, the TDRSS must be upgraded to support deep space communications and Ka-band frequencies, or a new GRS system must be constructed and deployed.

Connectivity of DSN vs. GRS

The three facilities of the DSN are presently capable of receiving and transmitting information to and from space. A spacecraft in or near the ecliptic plane will always be in view of at least one station, and one station receiving information from space may relay the information to any of the remaining two stations. Because the satellites transmit information to stations at different locations on Earth and any one station may be required to transmit information it has received to the remaining two stations, high signal noise levels (due to rain attenuation, etc.) may result. Therefore, the criterion of high connectivity cannot be totally satisfied by the DSN.

Because all three geostationary satellites of the GRS system transmit and receive information to and from one ground station in the United States, signal noise may be kept at a minimum. Furthermore, since the three satellites are orbiting in high Earth-orbit, they receive less interference from Earth "horizons." A spacecraft (assuming it is not behind the Sun or another planet) will always be in view of the three satellites. Therefore, the criterion of high connectivity is satisfied by the GRS system.

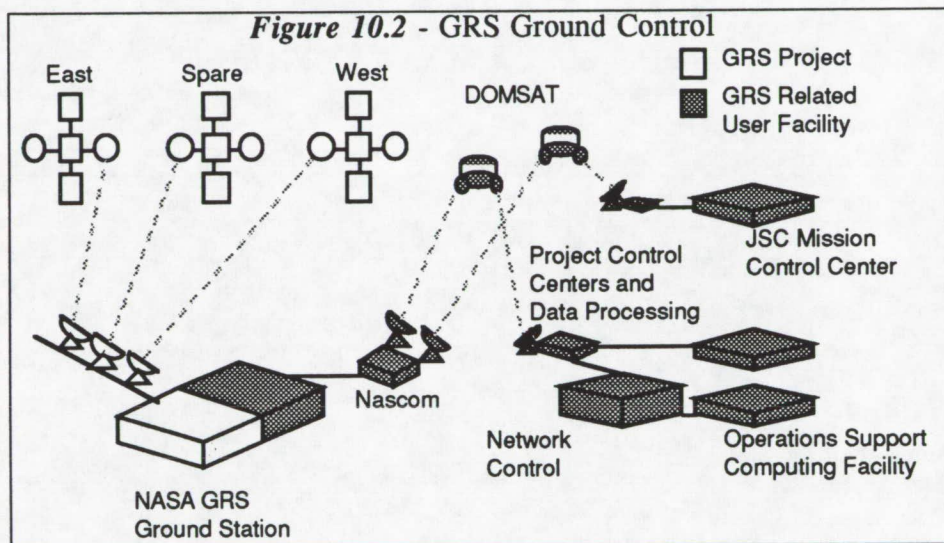

Signal Compatibility of DSN vs. GRS

Presently, the DSN supports both S-band (2200-2300 Mhz) and X-band (8400-8500 Mhz) signals. However, the criterion of high data rates requires the support of Ka-band (31.8-32.3 Ghz) signals. Therefore, unless the DSN is upgraded to support Ka-band signals, the criterion of high data rate cannot be met.

Because all three satellites and the ground station support high rate Ka-band frequencies, the criterion of high data rate is satisfied by the GRS system.

Cost of DSN Transmission vs. GRS Transmission

To satisfy the criterion of low cost, both acquisition and operation costs must be addressed. In terms of acquisition costs, the DSN upgrade to support Ka-band frequencies will cost approximately 250 million dollars. In terms of operation cost, the DSN will require approximately 48 million dollars per year to function with adequate servicing and maintenance. For one year, the total cost of 298 million dollars is relatively low. However, consider a long

range cost over a ten year period. The cost to support the DSN over a ten year period is approximately 730 million dollars.

A significant contributor to the total cost of the GRS system is the initial acquisition cost. The cost will derive from revising an older communications system (such as the TDRSS) or constructing a new one. In either case, satellites must be deployed (or retrieved from orbit as in the case of the TDRSS upgrade). However, once the satellites have been upgraded and deployed into High-Earth-Orbit, operation cost will be minimal since less human interaction than with the DSN is necessary to operate the GRS system. A proposal will be made to build a new GRS system based on the following analysis:

1. Upgrading the TDRSS to Ka-band will require replacing old ground technology (essentially rebuilding the ground terminal), retrieving the four satellites from Earth orbit and reconfiguring them, and deploying the four satellites once again; therefore, the cost of upgrading the TDRSS to support deep space communications and Ka-band frequencies will cost more than constructing a new GRS system.
2. A new GRS system is capable of replacing both TDRSS and DSN by playing the role of deep space and Earth-bound communicator.
3. The new GRS system can help to relieve TDRSS and DSN of information overloads.

Assuming a new GRS system will be constructed, the initial acquisition cost will be approximately 560 million dollars, 310 million dollars more than the DSN acquisition cost. However, note that the annual operation cost for the GRS system is 10 million dollars, 37 million dollars less than the DSN operation costs. Over a ten year period, the total cost associated with the GRS system is approximately 660 million dollars, 70 million dollars less than the total DSN cost. Therefore, in the interests of lower cost, the GRS system is a better choice than its DSN counterpart.

Selection of GRS System for Communication

From the previous analysis of the DSN and the GRS communication systems, the following conclusions are made: the DSN system does not completely satisfy the specified criteria and the GRS system has satisfied all the specified criteria. Therefore, the GRS system is the better communication system for OE and IEO communications and will be incorporated into the design.

Mars Relay Satellites (MRS) System

In order to maintain a large amount of connectivity during missions to the Mars system, it is necessary to have a method for relaying communications signals from the far side of Mars to Earth. This can be achieved using relay satellites in areostationary orbits ($\approx 2.1 \times 10^4$ km). Important criteria for these satellites are their communication capabilities, connectivity with Earth, and basic principles of their design, including thermal, stability, guidance, and power requirements. All design decisions have been based on the criteria that a minimum satellite life span of 10 years is guaranteed. The Intelsat family of Earth-based communication satellites has been able to meet this requirement³⁶, and it is therefore assumed that are satellites will be able to do the same.

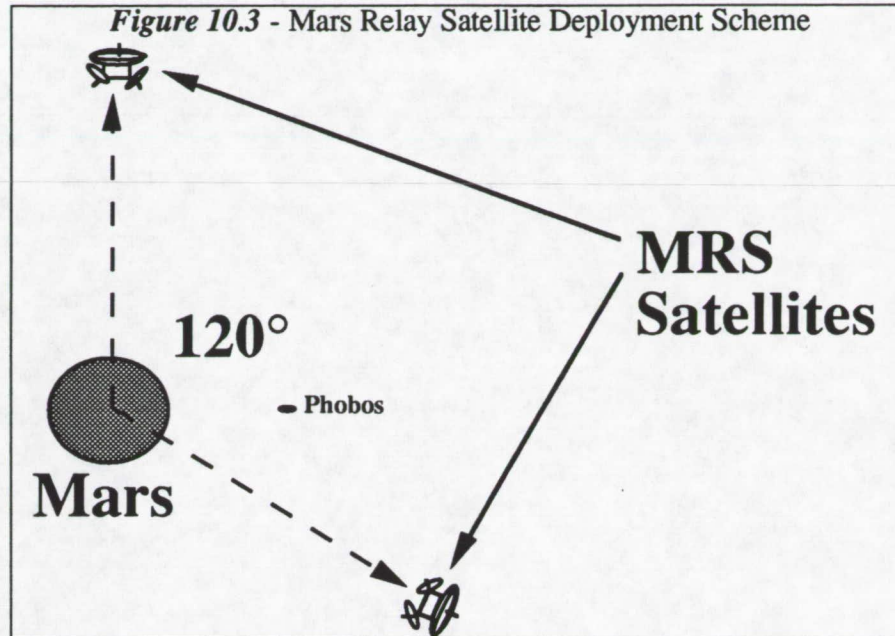

Communication Capabilities

In order to maintain a rate of transmission on the order of 50 Mbps without unreasonable power requirements, the Mars Relay Satellites (MRS) needed to operate in the Ka-band of frequencies for Earth-bound and intra-Mars system transmissions. Antenna size is also restricted by power limitations and transportability. Smaller antennas require more power to operate, but larger antennas are harder to deploy since they are generally folded for transportation and require unfolding upon insertion into orbit.

Essentially, the antennas of the MRS will consist of a main antenna for Earth-bound transmission and a pair of smaller antennas for intra-system use. The main antenna will be a 9-meter parabolic dish, identical to the main antennas on the ship, while the smaller antennas will be 0.6-meter parabolic dishes.

Connectivity

The connectivity goal for Mars system missions is to be in constant contact with the spacecraft and to any other mission specific equipment greater than 90% of the time. To achieve this goal, it is necessary to employ two satellites into areostationary orbit. Placed 120 degrees apart in this orbit (see *Figure 10.3*), they can ensure a near 100% connectivity except when Mars is occulted by the Sun.³⁷

Thermal Design

Two types of satellite configurations were considered in the design of the MRS based on thermal requirements: dual-spin-stabilized and three-axis stabilized satellites. Dual-spin-stabilized spacecraft rotate around an axis parallel to the Sun's north-south axis and maintain normalized yet constantly fluctuating temperatures on the satellites' surfaces. This yields a

simpler design of thermal control equipment but over time, the fluctuations cause significant distortions in antennas which leads to pointing error.³⁸

Three-axis-stabilized satellites experience much larger fluctuations in temperature, but changes are much more gradual and result in smaller pointing errors. It requires a more complex heat rejection system to accommodate three-axis-stabilized satellites, but developments in active thermal control make it the configuration of choice. It was used successfully in the Intelsat V during the 1980's, and given the distances Mars missions will involve, minimization of pointing errors is essential to maintain consistent communication.³⁹

Guidance and Stability Control

Guidance and stability will be accomplished with a combination of fixed momentum wheels and small thrusters. There are momentum wheels along each axis that driven by electric motors, and the thrusters are of the hydrazine burning type typical to satellites.⁴⁰ The on-board computer will monitor inputs from star trackers, Inertial Measurement Units, and accelerometers to make adjustments in the satellite's orientation and location.

Power Source

The MRS cannot use the Solar power systems typical to Earth-based satellites for two reasons: 1) the power requirements for data transmission alone (2100W) exceed the long-term power capabilities of solar array systems, and 2) the solar energy at Mars is much less than at the Earth resulting in even less overall power being available.

An alternative power source is considered. A small nuclear generator is capable of providing the power required by the MRS ⁴¹

Phobos Relay Point

The Phobos Relay Point (PRP) is designed to help meet communications needs by providing a free-standing antenna, which can be utilized by both the spacecraft and the refining factory while on Phobos. The main antennas aboard the spacecraft will be very near to the ground, capable of lower than normal movement freedom, and possibly obscured by local topography; therefore, an alternative communications setup is needed. The PRP will serve this purpose. In the design of the PRP, considered are its communication capabilities, size, and location.

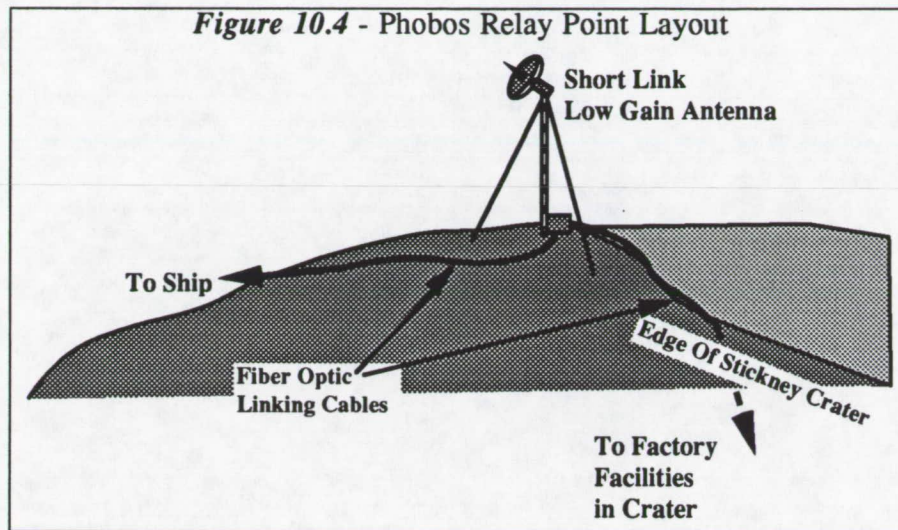

Communication Capabilities

The PRP will have a 2-meter parabolic dish designed to operate in the Ka-band with five channels at 50 Mbps. It will be responsible for relaying information to and from the MRS only. This will require 15 Watts which will be provided by the ship's power sources.

Size

The PRP will consist of the following equipment:

- a 2-meter parabolic antenna
- a transponder
- Three 50-meter poles
- four 70-meter support cables
- 4 km of fiber optic cable

It will weigh approximately 500 kg altogether and will be brought along on the spacecraft to be set up when the crew arrives at Phobos.

Location

The location of the PRP is an important issue. Its main criterion is that it has to be close to Stickney Crater to provide easy access by the crew for setup and maintenance. Because Stickney Crater is located on the near-Mars side of Phobos, the MRS will not be able to access the bottom of the crater once they pass beyond the much narrower horizon of the crater. To a smaller extent, landing on the near side of Phobos causes the same type of problem for the spacecraft when the MRS are occulted by the far side of Phobos. To ensure good communication connectivity, the PRP must be on the highest point near the crater and landing site, giving it the clearance to extend the line of sight horizon of Phobos.

Navigation and Control Systems

Guidance, Navigation and Control (GN&C) of the spacecraft is obtained by the computer-managed interaction of navigation, telemetry, and propulsion systems. The ship's navigation systems consist of General Purpose Computers (GPC), star trackers, an Optical Alignment Sight (OAS), Inertial Measurement Units (IMU), and Ring Laser Gyroscopes (RLG). Telemetry is handled by two radar systems aboard the Wolverine for use in the vicinity of Mars: a long range, high gain system and a shorter range landing radar. Sets of GPC form the primary avionics software that turn the information gathered from these systems into coordinated propulsive maneuvers.

Navigation Sub-Systems

The navigation system's primary function is to enable the spacecraft to sense attitude, position, angular and linear rates of acceleration. Its secondary function is to ensure proper execution of its sub systems through recursive checks on its own system. The navigation system is composed of General Purpose Computers (GPC), star trackers, an Optical Alignment sight (OAS), Inertial Measurement Units (IMU), and Ring Laser Gyroscopes (RLG). Each sub-system and its role in navigation is described in the following sections.

Star Trackers

There are four star trackers on board the spacecraft. The four star trackers are divided into two sets of two star trackers, and one set is placed on each of the two rotating platforms. Because the 9-meter antennas are also stationed on the end of the outstretched counter-rotating platforms, two star trackers must point opposite the antennas to avoid antenna visual interferences. Furthermore, to maximize redundancy, two star trackers must point along the y-axis and z-axis. Therefore, Star Tracker Set One consists of one star tracker pointing along the positive x-axis and another pointing along the y-axis; Set Two consists of one star tracker pointing along the positive x-axis and another pointing along the z-axis.

The primary function of the star trackers is to determine the spacecraft attitude and position; its secondary function is to observe IMU and RLG operations by comparing its calculated angular and linear rates of acceleration with those of the IMU and RLG.

By "tracking" two stars already prescribed in the GPCs' star charts, the star tracker sends inputs of star position to the GPC; by triangulation methods, the GPC then translate the inputs of star position into spacecraft attitude and position. Angular and linear rates of acceleration can also be derived by calculating changes in attitude and position respectively. Hence, the star trackers may also be used to sense angular and linear rates of acceleration and to compare these rates with those of the IMU and RLG to observe system accuracies. *Table 10.1* summarizes the specifications for the star trackers. ^{42 43}

Number	4
Placement	2 sets of 2 on each rotating platform
Orientation	2 pointing along positive x axis; 1 along y axis; 1 along z axis
Pointing Accuracy	2 arc-seconds
Star Fix	Every 60 seconds
Lifetime	7 years
Mass	5 kg each
Dimensions	1 m x 0.5 m x 0.1 m (0.0036 m ³)

Other attitude and position sensors considered were frequency shift sensors and Sun sensors; however, the former cannot function during celestial interferences (i.e., spacecraft is behind a planet or the Sun), and the latter cannot function during planetary interferences (i.e., planet is between spacecraft and Sun).

Optical Alignment Sight (OAS)

There is one Optical Alignment Sight (OAS) stationed within the habitation command module. The primary function of the OAS is to re-calibrate the star trackers should they be in error. A crew member must manually input a star position using the OAS in conjunction with the GPC. Additionally, the spacecraft must be stationary for the OAS to re-calibrate the star trackers successfully (i.e., minimize OAS error); therefore, the spacecraft must de-spin before the OAS can be used. Note that presently an identical instrument is used on the Space Shuttle to re-calibrate their star trackers. *Table 10.2* summarizes the specifications for the OAS. ⁴⁴

Number	1
Placement	Within the habitation command module
Mass	1.1 kg
Dimensions	0.2 m x 0.15 m x 0.1 m

Inertial Measurement Units (IMU)

There are a total of nine IMU on board the spacecraft. The IMU are divided into three sets of three IMU. Each set consists of IMU pointing along the x, y, and z axes to sense angular and linear rates of acceleration along these axes. IMU Set One is positioned within the habitation command module; Set Two is 12.5 meters along the x reference axis; Set Three is 58.0 meters along the x reference axis. Because the sets are distributed at these three locations, dynamic characteristics at most stations of the spacecraft can be determined by direct input and extrapolation.

The primary function of the IMU is to measure linear rates of acceleration of the spacecraft; its secondary function is to measure angular rates of the spacecraft; its third function is to observe star tracker and RLG operations by comparing its calculated angular and linear rates of acceleration with those of the IMU and RLG. Note that the IMU are fully capable of measuring both angular and linear rates with comparable accuracies; however, because RLG more accurately measure angular rates, measurement of linear rates will be the IMU's primary function.

The IMU used are mechanical in nature containing mechanical gyros and accelerometers, a four-gimbal system, and servo motors. The gyros and accelerometers serve as a source of inertia. As the spacecraft rotates, the IMU remain at a constant orientation as the GPC constantly read angular inputs from the four gimbal system and outputs this angular information to the servo motors. Because the IMU maintain a constant orientation, acceleration with respect to a defined coordinate axis can be sensed by the accelerometers. The angular and linear rates of acceleration may then be compared to those of the star trackers and RLG to observe system accuracies.

Note that because the IMU are mechanical in nature, errors are inevitable. A major source of IMU error is due to friction on the gimbals which may lead to gyroscopic drift. This source of error may be avoided altogether if a non-mechanical system is used. An example of such a system is the laser gyro IMU. Because the laser gyro IMU contains no mechanical parts, gyroscopic drift is not a factor. However, since the laser gyro IMU is a recent development yet to be completed, it was not incorporated into the navigation system, though it offers an option for future IMU upgrades.

Table 10.3 summarizes the specifications for the IMU ^{45 46 47}

Number	9
Placement	3 sets of 3 within the habitation command module, at 12.5 m on x reference axis, at 58.0 m on x reference axis
Orientation	3 pointing along each x, y, and z axis
Accuracy	Greater than 1 nm/hr
Error	1 nm/hr
Update Rate	Every 1/100 sec
Lifetime	10 years
Mass	20 kg each
Dimensions	0.2 m x 0.2 m x 0.2 m

Ring Laser Gyroscopes (RLG)

There are a total of nine RLG on board the spacecraft. The RLG are divided into three sets of three RLG. Each set consists of RLG pointing along the x, y, and z axes to sense angular accelerations along these axes. RLG Set One is positioned within the habitation command module; Set Two is 12.8 meters along the x reference axis; Set Three is 58.0 meters along the x reference axis. They are stationed at the same location as the IMU. Because the RLG sets are distributed at three locations, dynamic angular characteristics at most stations of the spacecraft can be determined by direct input and extrapolation.

The primary function of the RLG is to measure angular rates of acceleration of the spacecraft. Its secondary function is to observe proper star tracker and IMU operations by comparing its calculated angular rates of acceleration with those of the star trackers and IMU.

The RLG consist of two separate lasers traversing a cavity in opposite direction. As the spacecraft rolls on an axis perpendicular to the lasers' paths, the time difference between the two lasers in traversing the closed cavity is translated into a frequency change. The GPC then translate this frequency change into a measurement of angular acceleration. This value of

angular acceleration may then be compared to those measured by the star trackers and IMU to observe system accuracies.

Note that because the RLG possess no mechanical parts, gyroscopic drift is totally avoided. There is no warm-up time necessary because they are lighter and more rugged (i.e., can withstand high angular rates up to 800 deg/sec), more reliable, and advocates long term stability. Furthermore, because the RLG are lighter weight and contains no complex mechanical parts, they cost less than the more common mechanical gyroscope.

Table 10.4 summarizes the specifications for the RLG ^{48 49 50}

Number	9
Placement	3 sets of three within the habitation command module, 12.5 m on the x reference axis, 58.0 m on the x reference axis
Orientation	3 pointing along each x, y, and z axis
Accuracy	2 arc-seconds
Lifetime	11 years
Mass	5 kg each
Dimensions	0.7 m x 0.7 m x 0.1 m (0.05 m ³)
Power	3-7 watts

Other devices considered for sensing angular rates of acceleration were the floated gyroscope, dry-tuned-gimbal gyroscope, electrostatic gyroscope, and nuclear-magnetic-resonance gyroscope. The floated gyroscope actually floats the rotating member reducing gimbal friction to almost infinitesimal levels; however, its weight due to fluids, motors, and casing counter balances its minimal friction advantage. The dry-tuned-gimbal gyroscope uses a dynamically tuned resonance condition to simulate frictionless gimbal bearings; however, because it is a mechanical system, it too will possess friction and weight in excess. The electrostatic gyroscope suspends its rotating spherical element in a spherical chamber by electrostatic forces; therefore, friction can be avoided altogether. This device is an alternative option to the RLG, but because the RLG are lighter, they are given priority in the design. The final device considered is the nuclear-magnetic-resonance gyroscope. The gyroscope utilizes the intrinsic properties of certain nuclei and the apparent frequency shift to determine angular rates of acceleration. It is characterized as accurate, small, and highly reliable with sensitivities in the region of 0.01 deg/hr. However, the spacecraft will be subject to vast amounts of radiation, the nuclear-magnetic-resonance gyroscope may not be appropriate for this design.

Telemetry Systems

There are two radar systems aboard the Wolverine for use in the vicinity of Mars. One is a long range, high gain system, while the other is a short range landing radar. The outer range limit for the long range radar precludes its use during majority of the voyage to Phobos. Both the long and short range radars primarily serve to guide the spacecraft into the proper Phobos rendezvous position.

Long Range Radar System

The long range radar system employs the spacecraft's main antennas and uses a sophisticated signal processing setup on the received pulses. Mars can be detected at a range of 1.4 million kilometers. The spacecraft will be moving at approximately 19 km/sec at that point so Mars will be detected when the spacecraft is approximately 20 hours away. The long range system can distinguish Phobos from the larger mass of Mars at a range of 75,000 kilometers, approximately one hour from the rendezvous.

Short Range Radar System

A radar system does not work very well in the short field, e.g., when the distance to the target becomes small compared with the size of the antenna. The main antennas are 9 meters in diameter, meaning that the long range radar system will stop returning meaningful data while the spacecraft is still some distance above the surface of Phobos. For landing operations, a second radar system located at the belly of the ship will be used. The short range system operates at a much higher frequency, in the vicinity of one terahertz. Its maximum range is 40 kilometers; the crew will switch over to the short range system when the landing operation begins and will lock the main antennas into position for landing.

Radar System Derivation

The derivation of the long range radar is presented here. The derivation of the short range radar system was made in a similar fashion.

Radar equation

Radar systems are governed by the following equation:

$$Pr = \frac{Pt Gt Gr \sigma \lambda^2}{(4\pi)^3 R^4}$$

Pr	≡	power received at destination
Pt	≡	transmitted power
Gt	≡	gains of the transmitting antennas
Gr	≡	gains of the receiving antennas
σ	≡	radar cross section of the target,
λ	≡	the wavelength
R	≡	the range

2500 Watts of power available so $P_t = 2500$. Using the spacecraft's main communications antennas as the transmitting and receiving antennas, $G_r = G_t = 4105923$. Likewise, the radar operates in the Ka-band with a wavelength of $9.36e-3$ meters.

With good signal processing, a radar system can function with as little as -140 dBm Watts of received power⁵¹. Rearranging the equation to solve for the maximum range, R:

$$R = \sqrt[4]{\frac{P_t G_t^2 \sigma \lambda^2}{(4\pi)^3 P_r}}$$

Radar Cross Section of Mars and Phobos

The radar cross section of an object in the far field of a radar system is given by the following equation:

$$\sigma = \pi a^2 \Gamma^2$$

σ	\equiv	radar cross section of the target
a	\equiv	radius of the object in question
Γ	\equiv	coefficient for the material composition of the object in question

For Mars, Γ is assumed to be 0.7⁵². The radius of Mars is 3.5e+6 meters. Thus, σ is found to be 1.886e+13. Using this value in the radar equation, the range is calculated to be 1.37 million kilometers.

The radius of Phobos is about 10.7 km. Using the same equation for radar cross section above, and the radar equation, it is concluded that Phobos can be detected from 75,000 km away.

Flight Control Interface

Guidance, Navigation and Control (GN&C) of the spacecraft is obtained through computer interface of all navigation and propulsion systems. Utilizing a pre-programmed flight software, a real time interface between navigation systems and propulsive systems can be obtained. The flight software will in effect control the vehicle through propulsion system commands via data input from navigation system sensors⁵³. Multiple sets of redundant General Purpose Computers (GPC) will be used to form the primary avionics software system. These computers will serve as an interface with the various systems through multiple data buses which serve as a conduit for signals going to and from the various navigation and propulsion systems⁵⁴. *Figure 10.5* will provide a good illustration of the total flight control interface.

Redundancy and Backup Software

Note that navigation system inputs to the flight software system are triply redundant since the data produced are critical to flight safety. Redundant inputs to the flight computers are evaluated and compared to determine their validity. The most usual method of evaluation includes an algorithm to average out small data differences between redundant sensor inputs and to vote out failed sensor inputs⁵⁵. In this case, sensor readings will come from the star trackers (attitude), IMU (acceleration), RLG (angular acceleration) and the short range and long range radar systems (distance). Should the need arise, a backup flight software (BFS) could also be downloaded through via a crew command into the computer systems. The BFS would then serve as the primary flight software for the remainder of the mission.⁵⁶

GN&C System Operational Modes

The GN&C system consists of two operational modes: auto and manual (control stick steering)⁵⁷. In the automatic mode, the primary avionics software system essentially allows the GPC to fly the vehicle. The crew simply selects the various operational sequences. The flight crew may control the vehicle in the control stick steering mode using hand controls, such as the rotational hand controller and translational hand controller. In the control stick steering mode, crew commands must still pass through and be issued by the GPC. There are no direct links between the crew and the spacecraft's various propulsion systems; the Wolverine is an entirely digitally control, fly-by-wire spacecraft. While the spacecraft will in general be left in automatic mode, the option must be left open to manually control the spacecraft if an emergency situation requires such an operation. However, daily flight operations will be left completely to GN&C software control with the crew serving only in a monitoring capacity⁵⁸
59.

Categorization of Flight Operations

During the auto control mode, the GPC will identify five important sequences of flight operations. The sequences are as follows:

1. Spin Stability
2. De-spin Stability
3. Course Corrections
4. Phobos Approach
5. Phobos Landing

The flight sequences are not listed in any order of mission operational sequence and can be initiated at any time by either the crew or the flight software.

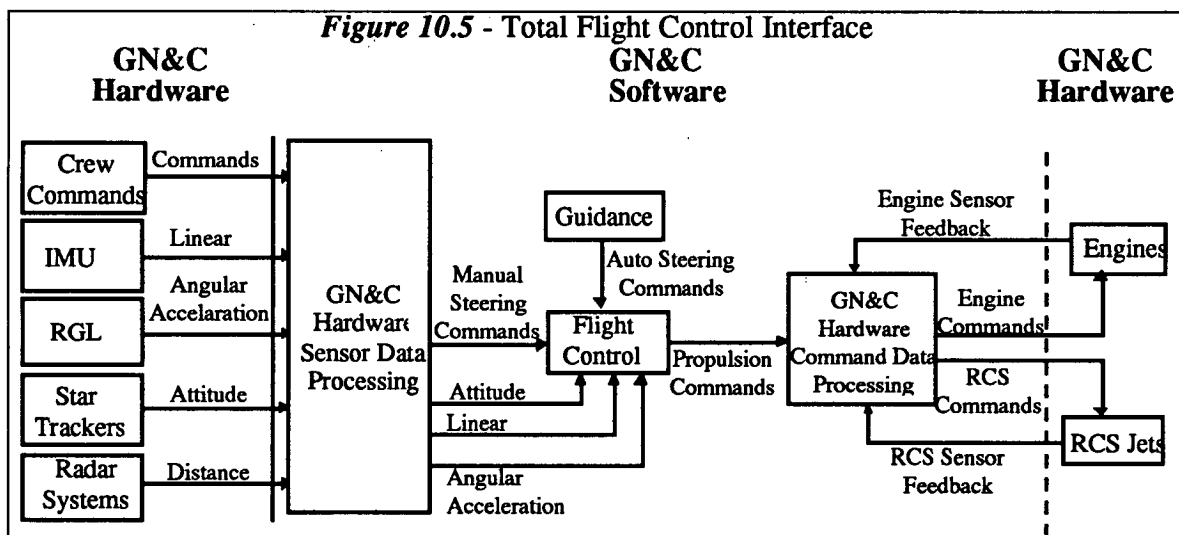

Spin Stability

This flight sequence will be utilized throughout the entire transitory portion of the mission. Its primary function is to maintain the correct angular velocity about the spacecraft's z-axis. Since

a constant gravity force must be maintained in the habitation modules during transit operations, the flight software will be monitoring the rotation of the spacecraft about its z-axis through the help of star trackers, IMU and RLG sensor inputs into the flight computers. The flight computer will determine if the correct angular velocity is maintained for proper g-force exertion on the habitation modules. The flight computer will also issue the proper commands to fire the appropriate RCS jets to maintain the proper angular velocity.

A secondary function of the spin stability flight sequence concerns rotation about the spacecraft x- or y-axis. If rotation is sensed about these axes, the spacecraft's stability has been compromised and proper propulsive commands will be issued to the appropriate RCS jets to regain proper spin stability. Vehicle stability will be re-acquired once rotation about the vehicle x- and y-axes has ceased and proper rotation about the vehicle z-axis has been achieved. The flight computer will continually run through the spin stability algorithm until told to do so otherwise either through crew commands or the flight software⁶⁰.

The following flow diagram clearly illustrates the spin stability portion of the missions flight operations.

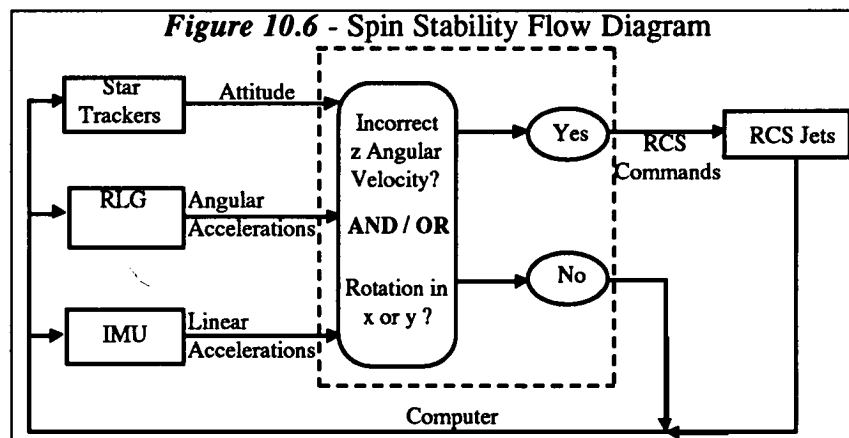

De-Spin Stability

This flight sequence functions in opposition of the spin stability sequence. The primary concern of this sequence deals with maintaining absolutely zero rotation about any of the spacecraft's axes. Once again the flight computer will acquire sensor inputs of the star trackers, RLG and IMU. It will determine if there is any rotation sensed about any of the spacecraft's axes, if necessary, commands will be issued to fire the appropriate RCS jets. This flight sequence will continue until zero rotation has been sensed and the flight computer has confirmed that the spacecraft is no longer rotating. This flight sequence is especially important in the Venus swing-by, course corrections, Phobos approach, and docking on Phobos portions of the mission. Any spin left in the spacecraft can provide for improper execution of these critical flight operations.

The following flow diagram will clearly illustrate the de-spin flight sequence.

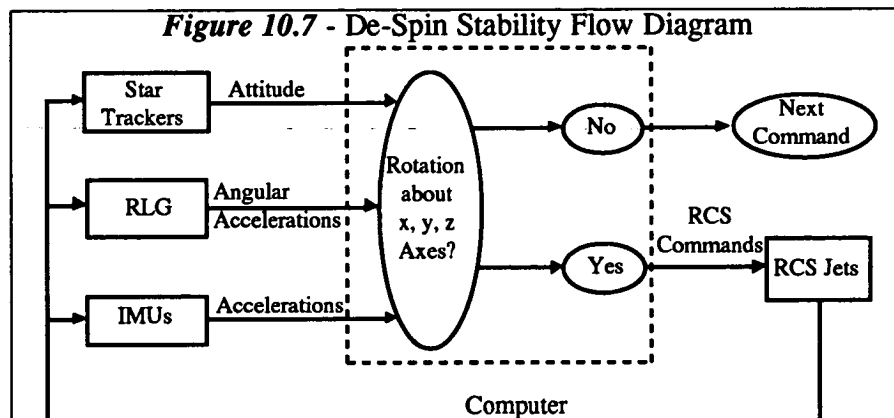

Course Corrections

Course corrections would be necessary at multiple points along the projected mission path. In order to accurately accomplish a course correction, the course correction sequence of the flight software would have to be utilized. The course correction sequence would first begin with the de-spin stability sequence of the flight software. Since an accurate course correction cannot be achieved without zero vehicle rotation, no other flight commands would be issued until the flight computer is assured that the vehicle is no longer rotating.

Barring any difficulties from the de-spin stability sequence, readings from the star trackers would be taken to determine the correct attitude of the spacecraft. This reading will be compared with readings taken from the OAS system. Both attitude readings will be used to recalibrate the star trackers and to acquire an accurate attitude reading for the spacecraft. The attitude reading would then be compared to the projected flight path programmed into the flight software⁶¹. If it is determined that the spacecraft is still within the projected flight path within a certain tolerance, no further commands would be issued and the spacecraft would return back to the spin stability flight sequence. If it is necessary to make corrections, commands would be issued to the appropriate RCS jets, and an attitude adjustment is made under the guidance of the star trackers. This sequence would repeat itself until it is determined that the ship is back on the projected flight path as computed by the flight software.

The following flow diagram depicts the course correction sequence of the mission.

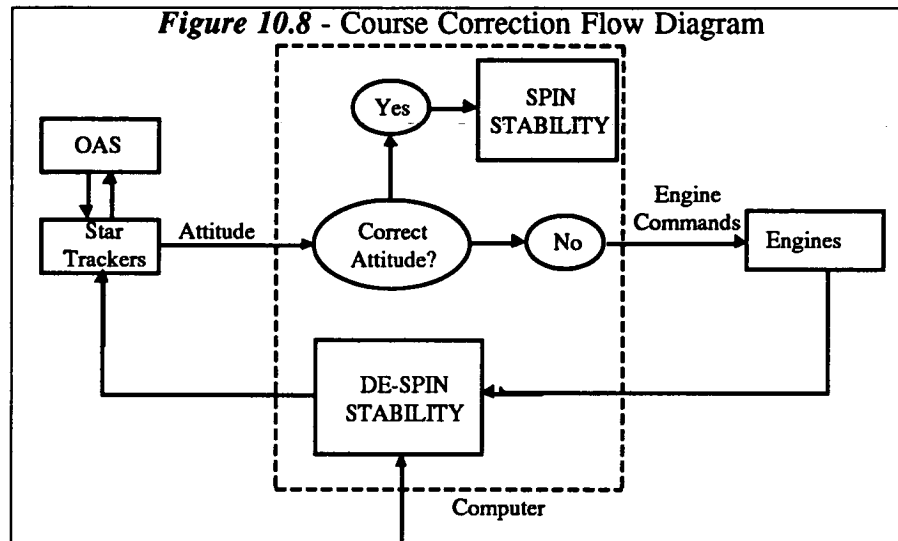

Phobos Approached

One of the more important flight sequences of the mission involves the approach to Phobos. In this particular sequence the flight computers would have to utilize data input from both the star trackers (attitude) and the long range radar system (distance). Both systems would work in conjunction with one another to determine if the spacecraft has obtained the correct attitude and distance from the Phobos to initiate both the orbit insertion and docking on Phobos flight sequences. Once again the de-spin stability flight sequence plays an important role as noted in *Figure 10.9*, the approach flow diagram. If the spacecraft has not accomplished zero rotation, the computer will not initiate the entire Phobos approach flight sequence. This flight sequence as in all the other flight sequences mentioned will continue to run until the operation has been accomplished, or it has been aborted by the crew or the flight computer.

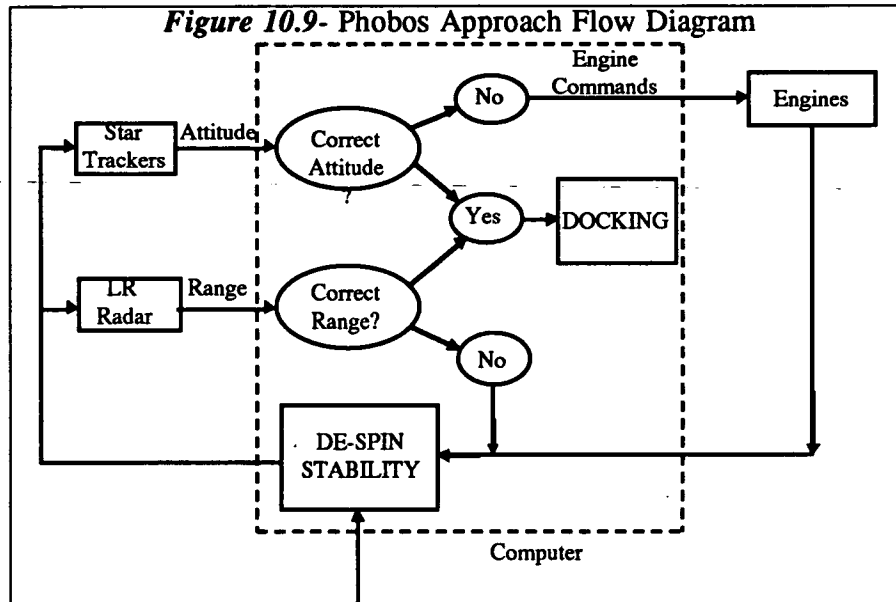

Phobos Landing/Docking

The final flight sequence would be the most intricate of all the previously discussed flight operations. This particular operation deals with the docking procedures on Phobos. As detailed in the Phobos landing flow diagram, *Figure 10.10*, the de-spin stability flight sequence would be initiated once again to assure zero rotation of the vehicle. Vehicle rotation at this point of the mission would not only provide tremendously inaccurate readings from navigational sensors but could prove to be deadly. The short range radar mounted on the bottom of the vehicle would then be used to determine altitude of the spacecraft from the surface of Phobos. If it is determined that the distance is correct to initiate harpoon firing operations, such commands would be issued to the appropriate systems. If it is necessary to make additional attitude adjustments, commands would also be issued to the RCS jets. After harpoons have been launched successfully into the moon surface, the second stage of this docking sequence would commence.

The second stage of this flight sequence involves monitoring the distance the spacecraft is from the moon surface. This is done to determine if the spacecraft has fully landed on the surface. Using the short range radar to determine the altitude of the spacecraft, if the spacecraft has yet to land on Phobos, commands would be issued to the harpoon system to continue reeling in the spacecraft. When the spacecraft has finally landed on Phobos, the docking flight sequence would be completed, and further flight commands would be terminated.

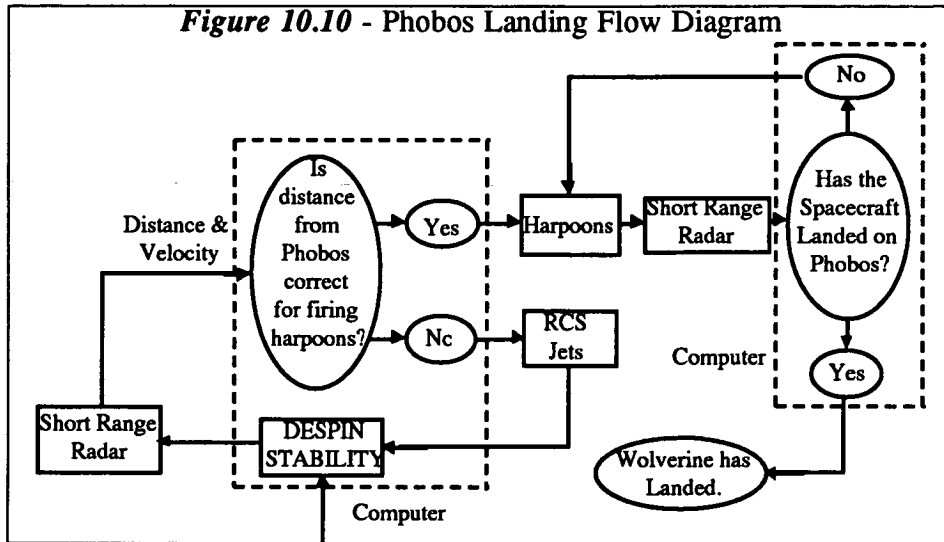

Computer System

The computer system will consist of radiation-hardened, space-ready General Purpose Computer (GPC) which are roughly equivalent to modern day SPARC Stations 1+. It is assumed that this development of the computers will be ready by 2005 when construction of the spacecraft should begin. The GPC will develop 16 MIPS of computer power with sufficient disk and memory capacity to fulfill all tasks. It will run a real time operating system and will have sufficient I/O resources to monitor all spacecraft's systems. This computer system will be approximately 4 times more powerful than radiation hardened computer systems available today.

Layout of Computer Hardware

A total of 144 MIPS of processing power will be required to run the spacecraft's systems, requiring a total of nine GPC to fulfill this requirement. Five of the computers will be in the habitation module, while the other four will be near the engines. All computers will be placed so as to be as physically close to the spacecraft's systems they monitor as possible. All nine computers will be hooked to a FDDI-2 network, described in a later section. One extra computer is carried on board the spacecraft as a spare.

Layout of Input/Output Hardware

The crew will interact with the computer system through terminals placed throughout the habitation module. Each terminal consists of a 16" diameter color LCD screen, keyboard, trackball, CCD camera, and digitizing microphone. Each terminal has a small amount of local processing power to off load graphics operations from the main computers to the terminals. The terminals connect to the FDDI-2 network to communicate with the computers. All terminals are identical and can be reconfigured to perform any function. In practice, certain terminals will be used exclusively for certain ship functions. For example, the terminals in the command center would be used for control of the ship during course corrections, while the terminals in the planetary science lab area would be used to support science activities.

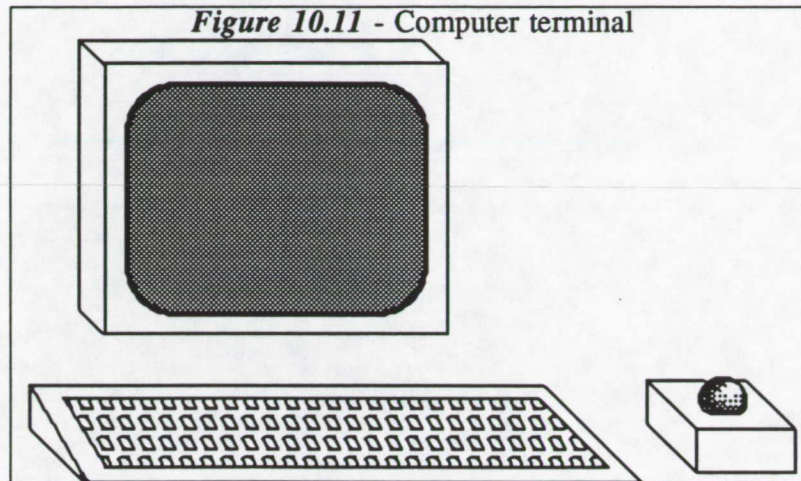

Computer Network

A FDDI-2 network will be used to interconnect the nine GPC aboard ship. FDDI-2 is a high speed (100 Mbps) fiber optic based network, which is currently enjoying success in terrestrial applications^{62 63 64}. Two separate rings are used for a total of 200 Mbps of bandwidth.

FDDI-2 is a very robust networking topology. It is capable of reconfiguring itself after a failure in one or more of the fibers to maintain connectivity. Loss of one fiber can be tolerated with no loss of functionality or speed. Subsequent losses, depending on their location, may isolate sections of the network from each other; however, the isolated sections will still function separately. Since there are two rings, the network can withstand the loss of any two fiber segments with no loss of function.

The FDDI-2 network will be used to carry all data aboard ship, including control information and scientific data. FDDI-2 has the capability to assign priorities to data and reserve a portion of the network bandwidth for high priority data. In this way, control commands (which presumably have a higher priority than data) can be guaranteed access to the net with little latency.

Derivation of Processing Power Requirements

There are eight major factors to be monitored and controlled aboard the spacecraft. Estimations of the processing power required for each function are presented below.

Reactor Monitoring

There are 14 factors which need to be monitored on each reactor. Adjustments must be made each microsecond with one factor per adjustment in round-robin fashion for each reactor. Each adjustment consists of the following operations:

- gather data - 1 LOAD
- retrieve expected data - 1 LOAD
- compute correction - 6 math operations
- send correction to reactor - 1 STOR
- store telemetry - 1 STOR

A total of ten instructions executed per adjustment multiplied by one million adjustments per second yields 10 MIPS per reactor.

Spent Reactor Monitoring

After the initial burn from Earth, one of the spacecraft's three engines will be shut down for the remainder of the voyage. Once it cools, monitoring of this reactor will be performed every ten microseconds, using the same adjustment operations as above. This requires 1 MIP of processing power.

Navigation

Course computation is assumed to be a processor intensive task. The space shuttle uses 4 computers for its course computations to provide redundancy. A value of 25 MIPS is assumed, scaling up from the shuttle's computing power.

If a new course is not being computed, a value of 1 MIP is assigned to allow for basic navigational checks to be performed.

Planetary Science

Planetary Science activities are especially computation intensive, requiring all remaining computing power at each phase, after other systems allocations are completed. During cruise phases, Planetary Science has 36 MIPS allocated, equivalent to about 4 Apollo workstations.

Crew Entertainment

Entertainment, including computer games and video and audio recordings from earth, can require a great deal of processing power, mainly for the display of color video data. Assuming a video image of 512x350 pixels, there are 179,200 pixels to be refreshed per frame. Assume each pixel carries 16 bits of color information, resulting in 2,867,200 bits of information to be updated per screen refresh. Assuming 32 bit load and store operations, this results in 179200 instructions to be executed per screen update. If it is assumed that a refresh is required every 30th of a second (interlaced), 5.4 MIPS are needed to display a video image on screen. Entertainment is allocated 25 MIPS during non-critical mission periods, allowing 4 crewmen to be playing pre-recorded videos, news broadcasts from Earth, or messages from families.

General Telemetry

Monitoring and control of general ship's systems is assumed to take place 10 times per second, assuming that little can go wrong which would need to be corrected more quickly. It is assumed that there are 100,000 factors aboard ship which need to be controlled and monitored, including such things as air pressure and temperature in the habitation modules, stress and strain factors on the ship's truss, and status of the electronic systems. Each factor involves the following instructions:

- Gather current status data: 1 LOAD
- Gather expected data from storage: 1 LOAD
- Compare the values, and compute correction: 6 math instructions
- Send the correction to the system: 1 STOR
- Store telemetry data: 1 STOR

A total of 10 instructions are to be performed per update. Multiplying by 100,000 factors 10 times per second, 10 MIPS of processing power is required.

Communications

Communications with Earth take place at 50 Megabits/second, full duplex. The computer moves 32 bits of data per instruction so 100Mbps/32 yields about 3 MIPS of processing power.

OS Overhead

For a real time operating system, a general overhead of 50% can be assumed⁶⁵. After all other factors are added, the result is multiplied by 1.5 to arrive at total processing power required.

Phases of Processing Power Distribution

The computers' processing power will be divided differently among the 8 tasks listed above depending on the situation. The mission has been divided into three major phases, in terms of the computer processing power distribution.

Initial Burn Phase

The first burn, leaving the Earth system, marks the only time in the mission where all three nuclear thermal engines are operating at full power. This requires that more processing time be devoted to the engines than at other times. The computers are also busy checking the ship's course and introducing small changes in the burn to correct the course.

In-Transit Phase

During cruise phases the spacecraft is tumbling to generate artificial gravity. When the crew arrives at Phobos, the spacecraft will land and begin the work of assembling the processing plant. Much more processing time in this phase is devoted to Planetary Science activities and crew entertainment.

Course Correction Phase

It will occasionally be necessary to stop the spacecraft's tumbling and fire the main engines to change the spacecraft's course for rendezvous with Phobos. During these times, the computers constantly recompute the spacecraft's position and course and make corrections as necessary.

System	Initial Burn	Initial transit	Course Correction
Reactor Monitoring	30	20	20
Spent Reactor Monitoring	0	1	1
Navigation	3	1	25
Planetary Science	28	36	26
Crew Entertainment	0	25	11
General Telemetry	10	10	10
Communications	3	3	3
OS Overhead	48	48	48
Total	144	144	144

Mission Control & Communications References

- 1 Woodcock, Gordon R., Space Stations & Platforms, Malabar, Fl, Orbit Book Co., 1986.
- 2 NASA Public Affairs Office, National Space Transportation System Reference, 1988.
- 3 NASA Public Affairs Office, National Space Transportation System Reference, 1988.
- 4 Corliss, William R., The Viking Mission to Mars, Washington, DC., NASA, 1974.
- 5 NASA Public Affairs Office, National Space Transportation System Reference, 1988.
- 6 Corliss, William R., The Viking Mission to Mars, Washington, DC., NASA, 1974.
- 7 McGraw Hill, Encyclopedia of Science and Technology, New York, McGraw Hill Book Co., 1987.
- 8 NASA Public Affairs Office, National Space Transportation System Reference, 1988.
- 9 Corliss, William R., The Viking Mission to Mars, Washington, DC., NASA, 1974.
- 10 Woodcock, Gordon R., Space Stations & Platforms, Malabar, Fl, Orbit Book Co., 1986.
- 11 NASA Public Affairs Office, National Space Transportation System Reference, 1988.
- 12 Space Info Systems in the Space Station Era, Proceedings of the AIAA/NASA Symposium, Feb. 1988.
- 13 Satellite Communications, Roddy, 1989
- 14 Appendices to a Technology Assessment of Alternative Communications System for the Space Exploration Initiative, NASA Lewis, 1990
- 15 Appendices to a Technology Assessment of Alternative Communications System for the Space Exploration Initiative, NASA Lewis, 1990
- 16 Satellite Communications, Roddy, 1989
- 17 Appendices to a Technology Assessment of Alternative Communications System for the Space Exploration Initiative, NASA Lewis, 1990
- 18 Advanced Technology in Satellite Communications Antennas, Takashi Kitsuregawa, 1990
- 19 Appendices to a Technology Assessment of Alternative Communications System for the Space Exploration Initiative, NASA Lewis, 1990
- 20 Appendices to a Technology Assessment of Alternative Communications System for the Space Exploration Initiative, NASA Lewis, 1990
- 21 Appendices to a Technology Assessment of Alternative Communications System for the Space Exploration Initiative, NASA Lewis, 1990
- 22 Communications Networks, Walrand, 1991
- 23 Aviation Week and Space Technology, May 30, 1988, p. 103 "Honeywell Design for Space Systems Network Passes Critical Review"
- 24 Datamation, May 15, 1989, p. 51 "A System for the 21st Century"
- 25 Appendices to a Technology Assessment of Alternative Communications System for the Space Exploration Initiative, NASA Lewis, 1990
- 26 Satellite Communications, Roddy, 1989
- 27 Appendices to a Technology Assessment of Alternative Communications System for the Space Exploration Initiative, NASA Lewis, 1990
- 28 Satellite Communications, Roddy, 1989
- 29 Communications Systems, Carlson, 1986
- 30 Codes for Error Correction and Synchronization, Waggart, 1988
- 31 Satellite Communications, Roddy, 1989
- 32 Communications Networks, Walrand, 1991
- 33 Communications Networks, Walrand, 1991
- 34 Communications Networks, Walrand, 1991
- 35 Communications Networks, Walrand, 1991
- 36 Communications Satellite System Design, E.M. Noneman, 1980
- 37 Appendices to a Technology Assessment of Alternative Communications System for the Space Exploration Initiative, NASA Lewis, 1990
- 38 Design of Geosynchronous Spacecraft, Brij N. Agrawal, 1986

- 39 Design of Geosynchronous Spacecraft, Brij N. Agrawal, 1986
- 40 Design of Geosynchronous Spacecraft, Brij N. Agrawal, 1986
- 41 Communications Satellite System Design, E.M. Noneman, 1980
- 42 An Introduction to Fiber Optic Systems Design, Briley, 1988
- 43 Aviation Week and Space Technology, May 30, 1988, p. 103 "Honeywell Design for Space Systems Network Passes Critical Review"
- 44 NASA doc
- 45 McGraw Hill, Encyclopedia of Science and Technology, New York, McGraw Hill Book Co., 1987.
- 46 NASA doc
- 47 Inertial Navigation
- 48 Aviation Week and Space Technology, May 30, 1988, p. 103 "Honeywell Design for Space Systems Network Passes Critical Review"
- 49 Space Nuclear Power, Angelo & Buden, 1985
- 50 Optical Devices in Adverse Environments, NASA, 1988
- 51 Professor Val Liepa, University of Michigan EECS Department, Radar and Remote Sensing Specialist
- 52 Professor Val Liepa, University of Michigan EECS Department, Radar and Remote Sensing Specialist
- 53 Star Trackers and Systems Design
- 54 NASA Public Affairs Office, National Space Transportation System Reference, 1988.
- 55 Star Trackers and Systems Design
- 56 NASA Public Affairs Office, National Space Transportation System Reference, 1988.
- 57 McGraw Hill, Encyclopedia of Science and Technology, New York, McGraw Hill Book Co., 1987.
- 58 NASA Public Affairs Office, National Space Transportation System Reference, 1988.
- 59 Woodcock, Gordon R., Space Stations & Platforms, Malabar, Fl, Orbit Book Co., 1986
- 60 McGraw Hill, Encyclopedia of Science and Technology, New York, McGraw Hill Book Co., 1987.
- 61 NASA Public Affairs Office, National Space Transportation System Reference, 1988.
- 62 Aviation Week and Space Technology, May 30, 1988, p. 103 "Honeywell Design for Space Systems Network Passes Critical Review"
- 63 Communications Networks, Walrand, 1991
- 64 Telecommunications Protocols and Design, Spragins, 1991
- 65 Professor Charles Antonelli, University of Michigan EECS Department, Operating Systems Specialist

Chapter 11

Conclusion

11.0 Summary

11.1 Cost Analysis

11.2 Future Study and Research

11.3 Future Possibilities

PRECEDING PAGE BLANK NOT FILMED

Summary

The results presented in this report are the products of a preliminary design study of a Manned Exploration of the Mars moon, Phobos. We propose to use technology which may not exist at this time but can be developed and tested within ten years. Additional areas of advanced research development are needed to support the overall mission success. These include the development of a heavy lift launch vehicle; automated rendezvous and docking capability; maneuverable extravehicular activity suits; telerobotic devices and telepresence robotics; and micro-gravity fuel transfer.

A preliminary estimation indicates that the development and production of the APEX spacecraft will cost \$11.4 billion dollars with an overall mission cost of \$12.7 billion dollars.

The utilization of space resources makes for effective exploration of the planets of the solar system. We propose to use materials that already exist on Phobos in an innovative approach to reduce the need and thus the expense to bring everything from Earth. The economy of utilizing space resources is obvious and the presence of Phobos is the key.

Cost Analysis

A preliminary estimate of the Project APEX systems cost breakdown is shown in *Figure 11.1* (opposite page). The dollar values shown are first order estimates for the main spacecraft system components. The total cost for the spacecraft is approximately \$11.4 billion dollars.

The three Nuclear Thermal Rocket Engines contribute more than 90% of the total spacecraft cost. The research, development, and testing program for NTR's is approximately \$3 billion dollars with each engine costing \$2.5 billion dollars.

The two habitation modules consist of the crew living quarters, the ship control center, and an experimental laboratory. The life support systems include air/water processing and revitalization, medical equipment, on-board safety systems and food provisions. Development costs will primarily focus in designing a 90% efficient partially-closed life support system.

Since the spacecraft is to be assembled in low earth orbit(LEO), nine heavy lift launch vehicles are required to place the components in LEO(*Figure 11.2*). Each HLLV is projected to cost \$40 million dollars with a total launching cost of \$360 million dollars. As support for communications, the two GRS satellites (\$515 million) and the two MRS satellites(\$400 million) will be placed in their perspective orbits prior to the 2010 launch date.

The total estimated Project cost is \$12.7 billion dollars. This cost does not include intermediate operational costs such as on-orbit assembly, loss of component during launch or while in-orbit, or ground support.

System Level Elements (Costs in million of 1992 U.S. Dollars)		
<u>System Element</u>	<u>Subsystem Cost</u>	<u>Total Cost</u>
Propulsion		\$ 10570
Nuclear Thermal Rocket Engines with dual-mode operation	\$ 10500	
RCS Thrusters	\$ 20	
Fuel and Tanks	\$ 50	
Power		
Radiators, Cable, Wiring	\$ 60	\$ 60
Communication		\$ 26
Antennas	\$ 2	
Computers	\$ 10	
Software Development	\$ 10	
Navigation Equipment	\$ 3.5	
Structure		
Truss(s)	\$ 2	\$ 2
Habitation Modules (2)		\$ 400
Structure/Shielding	\$ 51	
Life Support Systems	\$ 33	
Lab Equipment	\$ 116	
EVA		\$ 318
Space suits	\$ 8	
Manned Maneuvering Unit	\$ 10	
Space Pod	\$ 300	
Total Spacecraft Cost (in 1992 U.S. dollars):		\$ 11,400 million dollars

Figure 11.2 - Total Estimated Project Cost (\$Billion)	
Spacecraft	\$11.4
Launch to LEO	\$.36
	Nine HLLV
Support Services	\$.915
	GRS, MRS Satellites
Total Estimated Project Cost (in 1992 U.S. dollars):	\$ 12.7 billion

Future Study and Research

Deeper space exploration, such as Project APEX, requires the development of several critical technologies. The first requirement is a heavy lift launch vehicle with at least 150 metric tons payload capacity with growth to 250 metric tons. Automated rendezvous and docking technology would facilitate building operations in Low Earth Orbit and operations at Phobos. The technologies of robotic teleoperations and telepresence must also be developed to ease the work burden of the crew and to increase efficiency and production. Robotic telepresence can be used for both plant construction and for general ship maintenance. The APEX crew will be performing extended transverse on the Phobos surface and are therefore heavily dependent on the development of rugged, flexible EVA suits. These suits must provide radiation shielding and a self-contained life support system. The handling and transfer of cryogenic propellants produced on Phobos for transfer to vehicles in orbit is critical. The transfer process will take place in a micro-gravity environment which adds additional complications.¹

We propose to assemble the spacecraft in Low Earth Orbit(LEO). Nine heavy lift launch vehicles would be required to place the components into LEO with additional manned sorties to assemble the components. The assembly process itself is a complex problem and an engineering challenge. While a detailed analysis of the assembly process was beyond the scope of this course, we aimed to keep in mind the reality of assembly with, for example, the choice of self-deploying trusses.

Future Possibilities

A processing plant on Phobos will set the stage for many future missions and innovations.

Follow up Mars Mission

The processing plant while it exists in a vacuum of space would not exist in a vacuum of NASA policy. It is a steppingstone which will lower the expense of future missions and a prototype of the industrialization of space. The first follow up mission after the creation of the plant would be an indepth study of Mars. The mission would be a conjunction mission launched in 2014. Although 2014 is at a solar maxima, the majority of the trip time would be the stay on Phobos. Solar radiation levels at Phobos would be very small, and solar flare risks can be met by the creation of a storm shelter, the astronauts first priority when they reach Phobos. Because the second mission is a conjunction mission, the astronauts stay-time in the Martian system will be increased to approximately one and one-half years. In this time period, they could travel to Mars and perform scientific research for an extended period of time.

Creation of a gravity environment

In later conjunction missions, astronauts stay time on Phobos will be longer. This time would be limited because of the degrading effects of a zero gravity environment on the human body. But Phobos's near total absence of gravity is one aspect which will make it possible to alleviate this situation. On future missions, a structure such as the one shown in *Figure 6.1*. could be built to create a partial g or full g environment.

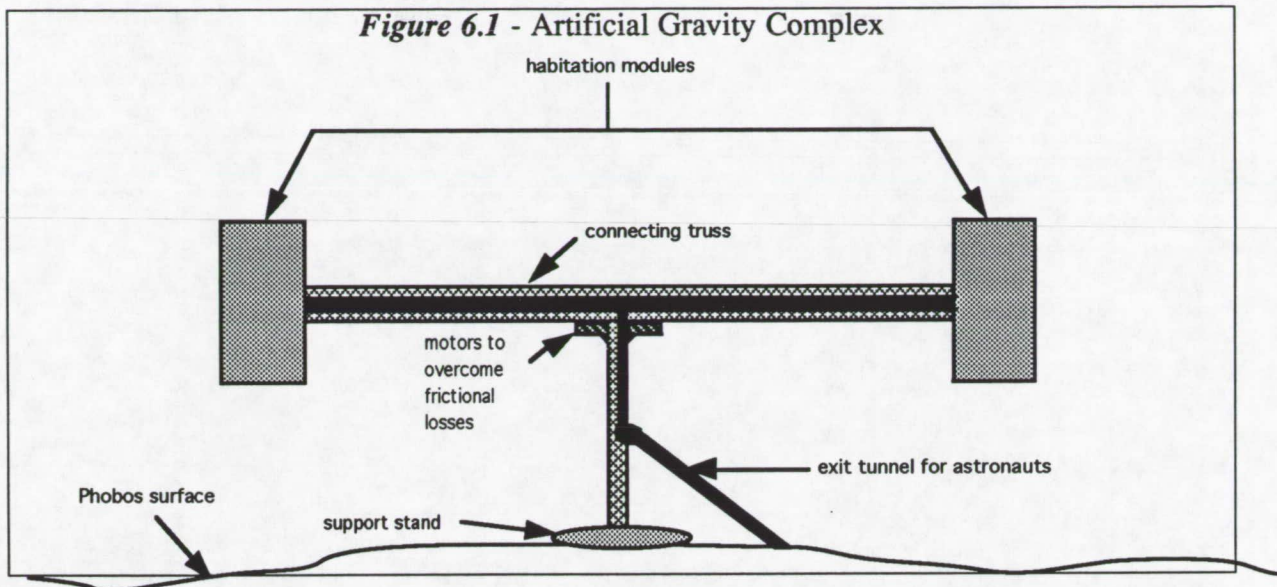

Gravity gradients in such a structure would be small since Phobos gravity is only one centimeter per second squared. The structure would be located approximately one mile from the processing plant; close enough for easy travel back and forth yet far enough so that any problems with kicked up debris would be alleviated. A permanent storm shelter would be located 100 meters from the structure. The ends of this structure would be similar to ship habitation modules. The truss structure would be adjustable so that while when first in use the structure might only provide a .3 g gravity, it could be lengthened until it provided full g.

Phobos-Mars Processing Plant

It is possible to construct a processing plant on Mars which uses the Martian atmosphere to create methane. One problem with this plant is that the Mars atmosphere does not contain hydrogen. Many current plans have this hydrogen shipped from Earth. Instead of the enormous expense of shipping hydrogen from Earth, it may be possible to extract this hydrogen at Phobos and ship it to Mars at a fraction of the cost.

Phobos-Earth Shipments

The majority of the fuel in a trip to Phobos is used in the initial burn. Therefore, refueling at Phobos would only provide cost savings on the less expensive portion of the mission. It would be possible, however, to process the necessary fuel on Phobos, launch it into LEO or HEO, and to fuel the ships there. In this way, great cost savings would be provided on all stages of the trip.

Beyond Mars

Manned trips to Saturn, Jupiter, etc. would be extremely difficult to accomplish in a reasonable amount of time. A Phobos processing plant would be a step toward this type of trip, though certainly not the full solution. It would allow a ship to leave Earth's gravity well, refuel on Phobos, and launch again from the relatively shallow Phobos gravity well.

Conclusion

The difference between this and other proposed missions to the Martian system is that its primary goal is to make future missions to the planet economical and more feasible by providing for some of their fuel requirements. A large part of the cost of any mission is bringing supplies and propellant from Earth. If we can process natural resources into products we need at an outpost, we can avoid bringing them from Earth. The carbonaceous material of Phobos makes it ideal for converting raw materials into water, air, and hydrocarbons for fuel.

This purpose satisfies some questions in an economical justification for a Mars mission; those related to lower cost. But economical justification is only one of four areas of justification that must be addressed for a Mars mission to become an acceptable option. The other three areas contain questions related to scientific, political, and social concerns.

As of now, scientific pursuits are primary in any mission to space and constitute the overwhelming majority of reasons for any interplanetary mission. Political and strategic missions are many in near-Earth circumstances, but, in and of themselves, have no near term impacts on present terrestrial situations. However, they do provide technological advances and national prestige. The Apollo missions were primary examples of this type of impact.

Social concerns are a limited part of near Earth missions, and are somewhat satisfied through operations such as better manufacturing of pharmaceutical drugs, or in satellites that are sent into space to monitor patterns on Earth that affect populations such as weather or disease. In the longer term interplanetary mission, there are presently no tangible social reason for such a trip beyond proposed schemes of colonization for an overpopulated planet.

Overall, missions for science and strategic, national concerns are by far the biggest constituents of any space mission. Economic justifications for missions start in the pursuit of science where new manufacturing permanence in space has yet been established. Social justifications are not always, but often found as by-products of potential economic rewards.

When the interplanetary mission is considered alone, it might be found that each of these areas of justification are harder to satisfy through terrestrial concerns. As one gets further from Earth, the benefits become less tangible and the line between these areas of justification become blurred. Scientific reasons for such a trip are many and are not hard to enumerate. Surely, the brainchild for such a mission originated in the scientific community with its wonderment about a red planet. But this is not enough to get a mission such as this off of the ground. It is not until long term economic and political benefits become tangible that such a mission is seriously considered.

As this mission is concerned with making a mission to the Martian system economically and politically feasible, it can be viewed as a precursory mission in a larger plan for much greater, permanent human involvement in space. In speaking of the Mission to Phobos, it must be remembered that no mission can satisfy each of these four areas of justification. Each will play a role and each mission will satisfy one or two of these areas more than the others. The Space Exploration Initiative (SEI) is the present attempt by the United States to formulate this large scale plan, and overall, this mission can be considered as a small element of that overall, long-term mission.

/

Conclusion References

PRECEDING PAGE BLANK NOT FILMED

¹America at the Threshold, Report of the Synthesis group on America's space exploration initiative, May 1991

Appendix

Propulsion

PRECEDING PAGE BLANK NOT FILMED

Appendix A. Calculation of Initial Mass in Low Earth Orbit

Table 1. Comparison of Mission Options for a Payload and Ship Mass of 135 Metric Tonnes

Engine Usage for Missions with NTRs

Mission Options

Note: Option 8 utilizes engines which have 470 seconds of Isp available during all maneuvers.
 Note: Option 7 has an Isp=470 seconds during Step 12.
 All other steps are valid as stated.

Step	Engine Used and Isp Available	Set	Description
1	Main: 1000 seconds	1	Reference Case, 3 NTR (Isp=1000 s), Refrigerated, Near Optimal Staging, 2 Bum Perigee-Kick LEO Escape
2	RCS: 435 seconds	2	3 NTR (Isp=1000 s), Refrigerated, Optimal Staging, 2 Bum Perigee-Kick LEO Escape
3	Main: 1000 seconds	3	3 NTR (Isp=1000 s), Refrigerated, Staging at Phobos Only, 2 Bum Perigee-Kick LEO Escape
4	RCS: 435 seconds	4	4 NTR (Isp=1000 s), Refrigerated, Retain Tanks, 2 Bum Perigee-Kick LEO Escape
5	RCS: 435 seconds	5	4 NTR (Isp=1000 s), Unrefrigerated, Optimal Staging, 2 Bum Perigee-Kick LEO Escape
6	RCS: 435 seconds	6	6 NTR (Isp=1000 s), Refrigerated, Optimal Staging, Single Bum LEO Escape
7	Main, Throttled: 700 seconds	7	Chemical 1st Stage (Isp=470 s), 2 NTR (Isp=1000 s), Refrigerated, Optimal Staging, Single Bum LEO Escape
8	RCS: 435 seconds	8	Chemical Propulsion (Isp=470 s), Refrigerated, Optimal Staging, Single Bum LEO Escape

Note: Calculations are made in reverse order, from the last stage of the mission progressing to the first stage of the mission.

Note: All masses are stated in kilograms. All delta Vs are stated in meters per second.

Note: RCS fuel is budgeted into the payload mass. Do not use values given for RCS fuel to calculate IMLEO.

Note: Only the mass of 2 engines is included in the ship and payload basic mass.

Calculations

Step 1. Earth Insertion
 Boiloff period of 25 months: 25% Boiloff
 Delta V4 2818.93

Set	Basic Mass	Fuel Boiloff Mass	Tank Mass	Subtotal Fuel Mass	Subtotal Mass	# of Tanks	Subtotal # of Tanks	Sin# NTRs	Subtotal # of NTRs
1	134950	51043	0	18200	51043	204193	2	2	2
2	134950	48010	0	9100	48010	192060	1	1	2
3	134950	51043	0	18200	51043	204193	2	2	2
4	134950	87437	0	127400	87437	349787	14	14	2
5	134950	47882	11971	8717	59853	203520	1	1	2
6	134950	48010	0	9100	48010	192060	1	1	2
7	134950	48010	0	9100	48010	192060	1	1	2
8	134950	129280	0	18200	129280	282430	2	2	0

Step 2. Mid Course Correction
 Boiloff period of 20 months: 20% Boiloff
 Delta V 1.9

Set	Basic Mass	Fuel Boiloff Mass	Tank Mass	Subtotal Fuel Mass	Subtotal Mass	# of Tanks	Subtotal # of Tanks
1	204193	91	0	91	204193	0	2
2	192060	86	0	86	192060	0	1
3	204193	91	0	91	204193	0	2
4	349787	156	0	156	349787	0	14
5	203520	91	0	91	203520	0	1
6	192060	86	0	86	192060	0	1
7	192060	86	0	86	192060	0	1
8	282430	117	0	117	282430	0	2

Step 3. Trans Earth Insertion
Boiloff period of 16 months: 16% Boiloff
Delta V3 2953.53

Set	Basic Mass	Fuel Boiloff Mass	Tank Mass	Subtotal Fuel Mass	Subtotal Mass	# of Tanks	Subtotal # of Tanks	
1	204193	71819	0	122862	276012	0	2	
2	192060	70753	0	118762	271912	1	2	
3	204193	71819	0	122862	276012	0	2	
4	349787	123029	0	210466	472816	0	14	
5	203520	74649	11944	8717	146445	298829	1	2
6	192060	70753	0	9100	118762	271912	1	2
7	192060	70753	0	9100	118762	271912	1	2
8	282546	286677	0	36400	416074	605624	4	6

Step 5. Land at Phobos
Boiloff period of 14 months: 14% Boiloff
Delta V 5

Set	Basic Mass	Fuel Boiloff Mass	Tank Mass	Subtotal Fuel Mass	Subtotal Mass	# of Tanks	Subtotal # of Tanks	Add NTRs	Subtotal # of NTR
1	283472	333	0	1395	283472	0	2	1	3
2	279372	328	0	1370	279372	0	2	1	3
3	283472	418	0	1480	356272	8	10	1	4
4	487736	572	0	2392	487736	0	14	2	4
5	313749	378	0	8717	1520	322466	1	2	4
6	301752	354	0	1396	301752	0	2	4	6
7	271912	319	0	1361	271912	0	2	2	2
8	607595	670	0	9100	418715	617365	1	7	0

Step 7. Initial Landing Burn for Main engines.
Boiloff period of 14 months: 14% Boiloff
Delta V 316.9

Set	Basic Mass	Fuel Boiloff Mass	Tank Mass	Subtotal Fuel Mass	Subtotal Mass	# of Tanks	Subtotal # of Tanks
1	283472	13402	0	136264	296874	0	2
2	279372	13208	0	131971	292581	0	2
3	356272	16844	0	139706	373116	0	10
4	487736	23060	0	233526	510796	0	14
5	322466	15246	2134	163825	339846	0	3
6	301752	14267	0	133029	316019	0	2
7	271912	12856	0	131618	284768	0	2
8	618225	44032	0	463607	662257	0	7

Step 4. Launch at Phobos
Boiloff period of 16 months: 16% Boiloff
Delta V 14.97

Set	Basic Mass	Fuel Boiloff Mass	Tank Mass	Subtotal Fuel Mass	Subtotal Mass	# of Tanks	Subtotal # of Tanks
1	276012	971	0	1062	276012	0	2
2	271912	957	0	1042	271912	0	2
3	276012	971	0	1062	276012	0	2
4	472816	1663	0	1819	472816	0	14
5	298829	1051	0	1142	298829	0	2
6	271912	957	0	1042	271912	0	2
7	271912	957	0	1042	271912	0	2
8	605624	1972	0	418045	607595	0	6

Step 6. Secondary landing burn for RCS.
Boiloff period of 14 months: 14% Boiloff
Delta V 6.41

Set	Basic Mass	Fuel Boiloff Mass	Tank Mass	Subtotal Fuel Mass	Subtotal Mass	# of Tanks	Subtotal # of Tanks
1	283472	427	0	1821	283472	0	2
2	279372	420	0	1790	279372	0	2
3	356272	536	0	2016	356272	0	10
4	487736	734	0	3126	487736	0	14
5	322466	485	0	2006	322466	0	3
6	301752	454	0	1850	301752	0	2
7	271912	409	0	1770	271912	0	2
8	617365	860	0	419575	618225	0	7

Step 8. Secondary Phasing Burn
Boiloff period of 14 months: 14% Boiloff
Delta V 1.79

Set	Basic Mass	Fuel Boiloff Mass	Tank Mass	Subtotal Fuel Mass	Subtotal Mass	# of Tanks	Subtotal # of Tanks
1	296874	125	0	1946	296874	0	2
2	292581	123	0	1913	292581	0	2
3	373116	157	0	2173	373116	0	10
4	510796	215	0	3340	510796	0	14
5	339846	143	0	2148	339846	0	3
6	316019	133	0	1983	316019	0	2
7	284768	120	0	1890	284768	0	2
8	662257	257	0	463864	662514	0	7

Step 9. Initial Phasing Burn
Boiloff period of 14 months: 14% Boiloff
Delta V 310.22

Set	Basic Mass	Fuel Boiloff Mass	Tank Mass	Subtotal Fuel Mass	Subtotal Mass	# of Tanks	Subtotal # Tanks
1	296874	13733	0	149998	310608	0	2
2	292581	13335	0	145505	306115	0	2
3	373116	17260	0	156966	390376	0	10
4	510796	23629	0	257155	534425	0	14
5	339846	15721	2201	181747	357768	0	3
6	316019	14619	0	147648	330638	0	2
7	284768	13173	0	144791	297941	0	2
8	662514	46158	0	510022	708672	0	7

Step 10. Mars Insertion Burn
Boiloff period of 14 months: 14% Boiloff
Delta V2 4174.01

Set	Basic Mass	Fuel Boiloff Mass	Tank Mass	Subtotal Fuel Mass	Subtotal Mass	# of Tanks	Subtotal # Tanks
1	310608	184260	0	36400	334258	531268	4
2	306115	177043	0	27300	322548	510458	3
3	390376	207289	0	364255	597665	0	10
4	534425	283778	0	540933	818203	0	14
5	357768	203860	28540	26151	414148	616320	3
6	330638	190064	0	27300	337712	548002	3
7	297941	172702	0	27300	317494	497944	3
8	708672	1273412	0	154700	1783435	2136785	17

Step 11. Mid Course Corrections
Boiloff period of 9 months: 9% Boiloff
Delta V 8.1

Set	Basic Mass	Fuel Boiloff Mass	Tank Mass	Subtotal Fuel Mass	Subtotal Mass	# of Tanks	Subtotal # Tanks
1	531268	1010	0	2956	531268	0	6
2	510458	971	0	2884	510458	0	5
3	597665	1137	0	3310	597665	0	10
4	818203	1556	0	4896	818203	0	14
5	616320	1172	0	3321	616320	0	6
6	548002	1042	0	3025	548002	0	5
7	497944	947	0	2837	497944	0	5
8	2136785	3761	0	1787196	2140546	0	24

Step 12. Trans Venus Injection
Boiloff period of 3 months: 3% Boiloff
Delta V1 4495.72

Set	Basic Mass	Fuel Boiloff Mass	Tank Mass	Total Fuel Mass	Total Mass	# of Tanks	Total # Tanks	Total # NTR	Mass Ratio	
1	531268	335789	0	26151	670046	893207	3	9	3	6.62
2	510458	328504	0	34868	651052	873830	4	9	3	6.48
3	597665	360033	0	724288	957698	0	10	3	7.10	
4	818203	492885	0	1033818	1311088	0	14	4	9.72	
5	616320	397526	11926	43585	823600	1069357	5	11	7.92	
6	548002	366094	0	43585	703806	957681	5	10	7.10	
7	497944	1011015	0	113321	1328508	1622279	13	18	12.02	
8	2140546	4428420	0	536900	6215616	7105866	59	83	52.66	

Table 2. Initial Mass in Low Earth Orbit (MLEO) Calculation for Varying Payload and Ship Mass for the Reference Case Conditions

Note: The mass of only 2 engines is included as standard with the ship and payload mass.
 Note: RCS fuel is budgeted into the payload mass. Do not use values given for RCS fuel to calculate IMLEO.
 Note: Tanks are dropped such that symmetry of the ship is maintained.

Engine Usage

Step	Engine Used and Isp Available
1	Main: 1000 seconds
2	RCS: 435 seconds
3	Main: 1000 seconds
4	RCS: 435 seconds
5	RCS: 435 seconds
6	RCS: 435 seconds
7	Main, Throttled: 700 seconds
8	RCS: 435 seconds
9	Main, Throttled: 700 seconds
10	Main: 1000 seconds
11	RCS: 435 seconds
12	Main: 1000 seconds

Mission with payload and ship mass of 100 metric tonnes.

Step	1	2	3	4	5	6	7	8	9	10	11	12	Totals
Stage	Earth	Course	Trans Earth	Phobos	Phobos	Secondary	Primary	Secondary	Primary	Mars	Course	Trans	Venus
	Insertion	Correction	Injection	Launch	Land	Landing	Landing	Phasing	Phasing	Insertion	Correction	Injection	
Delta Vs (m/s)	2818.93	1.9	2953.53	14.97	5	6.41	316.9	1.79	310.22	4174.01	8.1	4495.72	
Masses (kg)													
Starting	100000	157594	157594	213024	220484	220484	220484	230908	230908	241590	241590	397738	397738
Tank	18200									18200			26151
Stage Fuel	39394	70	55430	749	259	332	10424	97	10682	137948	756	25350	
Boiloff	0	0	0	0	0	0	0	0	0	0	0	0	0
Subtotal Fuel	39394	70	94824	820	1078	1410	105248	1507	115930	253878	2264	509228	
Subtotal	157594	157594	213024	213024	220484	220484	230908	230908	241590	397738	397738	679239	
# Tanks	2	0	0	0	0	0	0	0	0	2	0	0	3
Subtotal Tanks	2	2	2	2	2	2	2	2	2	4	4	4	7
# Engines	2				1								
Subtotal Engines	2	2	2	2	3	3	3	3	3	3	3	3	3
													Number of Engines
													3
													Number of Tanks
													7
													RCS Fuel (kg)
													2264
													Main Fuel (kg)
													509228
													IMLEO (kg)
													679239
													Tank Mass (kg)
													62551
													Additional Engines
													7460
													Payload (kg)
													100000
													Effective dV (m/s)
													15232.48
													Delta V (m/s)
													15107.48
													G-loss dV (m/s)
													125

Mission with payload and ship mass of 110 metric tonnes.

Step	1	2	3	4	5	6	7	8	9	10	11	12	Totals
Stage	Earth	Course	Trans Earth	Phobos	Phobos	Secondary	Primary	Secondary	Primary	Mars	Course	Trans Venus	
	Insertion	Correction	Injection	Launch	Land	Landing	Landing	Phasing	Phasing	Insertion	Correction	Injection	
Delta V s (m/s)	2818.93	1.9	2953.53	14.97	5	6.41	316.9	1.79	310.22	4174.01	8.1	4495.72	Delta V (m/s) 15107.48
													G-loss dV (m/s) 125
Masses (kg)													Effective dV (m/s) 15232.48
Starting	110000	170927	170927	231046	238506	238506	238506	249783	249783	261337	427971	427971	Payload (kg) 110000
Tank	18200									18200			Tank Mass (kg) 71268
Stage Fuel	42727	76	60119	813	280	359	11276	105	11555	148434	814	278814	Additional Engines 7460
Boiloff	0	0	0	0	0	0	0	0	0	0	0	0	Main Fuel (kg) 552925
Subtotal Fuel	42727	76	102846	889	1169	1528	114123	1633	125677	274111	2447	552925	IMLEO (kg) 741653
Subtotal	170927	170927	231046	231046	238506	238506	249783	249783	261337	427971	427971	427971	RCS Fuel (kg) 2447
# Tanks	2	0	0	0	0	0	0	0	0	0	0	0	
Subtotal Tanks	2	2	2	2	2	2	2	2	2	2	4	4	Number of Tanks 8
# Engines	2	2	2	2	3	3	3	3	3	3	3	3	
Subtotal Engines	2	2	2	2	3	3	3	3	3	3	3	3	Number of Engines 3

For Mission with payload mass of 120 metric tonnes.

Step	1	2	3	4	5	6	7	8	9	10	11	12	Totals
Stage	Earth	Course	Trans Earth	Phobos	Phobos	Secondary	Primary	Secondary	Primary	Mars	Course	Trans Venus	
	Insertion	Correction	Injection	Launch	Land	Landing	Landing	Phasing	Phasing	Insertion	Correction	Injection	
Delta V s (m/s)	2818.93	1.9	2953.53	14.97	5	6.41	316.9	1.79	310.22	4174.01	8.1	4495.72	Delta V (m/s) 15107.48
													G-loss dV (m/s) 125
Masses (kg)													Effective dV (m/s) 15232.48
Starting	120000	184260	184260	249069	256529	256529	256529	268657	268657	281085	458205	458205	Payload (kg) 120000
Tank	18200									18200			Tank Mass (kg) 71268
Stage Fuel	46060	82	64809	876	301	386	12128	113	12428	158920	871	297027	Additional Engines 7460
Boiloff	0	0	0	0	0	0	0	0	0	0	0	0	RCS Fuel (kg) 2630
Subtotal Fuel	46060	82	110869	958	1259	1645	122997	1758	135425	294345	2630	591371	Main Fuel (kg) 591371
Subtotal	184260	184260	249069	249069	256529	256529	268657	268657	281085	458205	458205	458205	IMLEO (kg) 790099
# Tanks	2	0	0	0	0	0	0	0	0	0	0	0	
Subtotal Tanks	2	2	2	2	2	2	2	2	2	2	4	4	Number of Tanks 8
# Engines	2	2	2	2	3	3	3	3	3	3	3	3	
Subtotal Engines	2	2	2	2	3	3	3	3	3	3	3	3	Number of Engines 3

Mission with payload and ship mass of 130 metric tonnes.

Step	1	2	3	4	5	6	7	8	9	10	11	12	Totals
Stage	Earth	Course Correction	Trans Earth Injection	Phobos Launch	Phobos Land	Secondary Landing	Primary Landing	Secondary Phasing	Primary Phasing	Mars Insertion	Course Correction	Trans Venus Injection	
Delta V's (m/s)	2818.93	1.9	2953.53	14.97	5	6.41	316.9	1.79	310.22	4174.01	8.1	4495.72	Delta V (m/s) 15107.48
Masses (kg)													G-loss dV (m/s) 125
Starting	130000	197593	197593	267091	274551	274551	274551	287531	287531	300833	516302	516302	Effective dV (m/s) 15232.48
Tank	18200									36400	36400	26151	Payload (kg) 130000
Stage Fuel	49393	88	69498	940	322	413	12980	121	13301	179070	982	326773	Tank Mass (kg) 80751
Boiloff	0	0	0	0	0	0	0	0	0	0	0	0	Additional Engines 7460
Subtotal Fuel	49393	88	118891	1028	1350	1763	131871	1884	145173	324242	2866	651015	Main Fuel (kg) 651015
Subtotal	197593	197593	267091	267091	274551	274551	287531	287531	300833	516302	516302	869226	IMLEO (kg) 869226
# Tanks	2	0	0	0	0	0	0	0	0	0	0	0	RCS Fuel (kg) 2866
Subtotal Tanks	2	2	2	2	2	2	2	2	2	2	2	2	Number of Tanks 9
# Engines	2	2	2	2	1	3	3	3	3	3	3	3	Number of Engines 3
Subtotal Engines	2	2	2	2	3	3	3	3	3	3	3	3	

Reference Mission with payload and ship mass of 135 metric tonnes.

Step	1	2	3	4	5	6	7	8	9	10	11	12	Totals
Stage	Earth	Course Correction	Trans Earth Injection	Phobos Launch	Phobos Land	Secondary Landing	Primary Landing	Secondary Phasing	Primary Phasing	Mars Insertion	Course Correction	Trans Venus Injection	
Delta V's (m/s)	2818.93	1.9	2953.53	14.97	5	6.41	316.9	1.79	310.22	4174.01	8.1	4495.72	Delta V (m/s) 15107.48
Masses (kg)													G-loss dV (m/s) 125
Starting	134950	204193	204193	276012	283472	283472	283472	296874	296874	310608	531268	531268	Effective dV (m/s) 15232.48
Tank	18200									36400	36400	26151	Payload (kg) 134950
Stage Fuel	51043	91	71819	971	333	427	13402	125	13733	184260	1010	335789	Tank Mass (kg) 80751
Boiloff	0	0	0	0	0	0	0	0	0	0	0	0	Additional Engines 7460
Subtotal Fuel	51043	91	122862	1062	1395	1821	136264	1946	149998	334258	2956	670046	Main Fuel (kg) 670046
Subtotal	204193	204193	276012	276012	283472	283472	296874	296874	310608	531268	531268	893207	IMLEO (kg) 893207
# Tanks	2	0	0	0	0	0	0	0	0	0	0	0	RCS Fuel (kg) 2956
Subtotal Tanks	2	2	2	2	2	2	2	2	2	2	2	2	Number of Tanks 9
# Engines	2	2	2	2	1	3	3	3	3	3	3	3	Number of Engines 3
Subtotal Engines	2	2	2	2	3	3	3	3	3	3	3	3	

Mission with payload and ship mass of 140 metric tonnes.

Step	1	2	3	4	5	6	7	8	9	10	11	12	Totals
Stage	Earth	Course Correction	Trans Earth Injection	Phobos Launch	Phobos Land	Secondary Landing	Primary Landing	Secondary Phasing	Primary Phasing	Mars Insertion	Course Correction	Trans Venus Injection	
Delta V's (m/s)	2818.93	1.9	2953.53	14.97	5	6.41	316.9	1.79	310.22	4174.01	8.1	4495.72	Delta V (m/s) 15107.48
													G-loss dV (m/s) 125
Masses (kg)	140000	210926	210926	285113	292573	310773	310773	325466	325466	340522	549203	549203	Effective dV (m/s) 15232.48
Starting Tank	18200			18200						18200			Payload (kg) 140000
Stage Fuel	52726	94	74188	1003	365	468	14693	137	15056	190481	1045	351844	Tank Mass (kg) 89468
Boiloff	0	0	0	0	0	0	0	0	0	0	0	0	Additional Engines 7460
Subtotal Fuel	52726	94	126913	1097	1462	1929	141606	2066	156662	347143	3111	698987	Main Fuel (kg) 698987
Subtotal	210926	210926	285113	310773	310773	325466	325466	340522	549203	549203	935915	935915	IMLEO (kg) 935915
													RCS Fuel (kg) 3111
# Tanks	2	0	0	0	2	0	0	0	0	0	0	0	
Subtotal Tanks	2	2	2	2	4	4	4	4	4	4	6	6	Number of Tanks 10
# Engines	2	2	2	2	3	3	3	3	3	3	3	3	
Subtotal Engines	2	2	2	2	3	3	3	3	3	3	3	3	Number of Engines 3

Mission with payload and ship mass of 150 metric tonnes.

Step	1	2	3	4	5	6	7	8	9	10	11	12	Totals
Stage	Earth	Course Correction	Trans Earth Injection	Phobos Launch	Phobos Land	Secondary Landing	Primary Landing	Secondary Phasing	Primary Phasing	Mars Insertion	Course Correction	Trans Venus Injection	
Delta V's (m/s)	2818.93	1.9	2953.53	14.97	5	6.41	316.9	1.79	310.22	4174.01	8.1	4495.72	Delta V (m/s) 15107.48
													G-loss dV (m/s) 125
Masses (kg)	150000	224259	224259	303136	310596	328796	328796	344341	344341	360270	579436	579436	Effective dV (m/s) 15232.48
Starting Tank	18200			18200						18200			Payload (kg) 150000
Stage Fuel	56059	100	78877	1066	386	495	15545	145	15929	200966	1102	370056	Tank Mass (kg) 89468
Boiloff	0	0	0	0	0	0	0	0	0	0	0	0	Additional Engines 7460
Subtotal Fuel	56059	100	134936	1166	1552	2047	150481	2192	166410	367376	3294	737433	Main Fuel (kg) 737433
Subtotal	224259	224259	303136	303136	328796	328796	344341	344341	360270	579436	579436	984361	IMLEO (kg) 984361
													RCS Fuel (kg) 3294
# Tanks	2	0	0	0	2	0	0	0	0	0	0	0	
Subtotal Tanks	2	2	2	2	4	4	4	4	4	4	6	6	Number of Tanks 10
# Engines	2	2	2	2	3	3	3	3	3	3	3	3	
Subtotal Engines	2	2	2	2	3	3	3	3	3	3	3	3	Number of Engines 3

Table 3. One-Way Outbound to Phobos, IMLEO Calculation for Varying Payload and Ship Mass, Utilizing the Reference Case Option

Note: RCS fuel is budgeted into the payload mass. Do not use values given for RCS fuel to calculate total mass.
 Note: Tanks are dropped such that symmetry of the ship is maintained.

Engine Usage

Step	Engine Used and Isp Available
1	RCS: 435 seconds
2	RCS: 435 seconds
3	Main, Throttled: 700 seconds
4	RCS: 435 seconds
5	Main, Throttled: 700 seconds
6	Main: 1000 seconds
7	RCS: 435 seconds
8	Main: 1000 seconds

Outbound Mission to Phobos with payload and ship mass of 100 metric tonnes.

Step	1	2	3	4	5	6	7	8	Totals
Stage	Phobos Land	Secondary Landing	Primary Landing	Secondary Phasing	Primary Phasing	Mars Insertion	Course Correction	Trans Venus Injection	
Delta Vs (m/s)	5	6.41	316.9	1.79	310.22	4174.01	8.1	4495.72	Delta V (m/s) 9318.2
Masses (kg)									G-loss dV (m/s) 125
Starting	100000	118200	118200	123788	123788	129515	198287	198287	Effective dV (m/s) 9443.2
Tank	18200							8717	Payload (kg) 100000
Stage Fuel	139	139	5588	52	5726	68772	377	124699	Tank Mass (kg) 26917
Boiloff	0	0	0	0	0	0	0	0	Main Fuel (kg) 204786
Subtotal Fuel	139	277	5588	329	11315	80087	707	204786	IMLEO (kg) 331703
Subtotal	118200	118200	123788	123788	129515	198287	198287	331703	
									RCS Fuel (kg) 707
# Tanks	2	0	0	0	0	0	0	1	
Subtotal Tanks	2	2	2	2	2	2	2	3	Number of Tanks 3
# Engines	2								
Subtotal Engines	2	2	2	2	2	2	2	2	Number of Engines 2

Outbound Mission to Phobos with payload and ship mass of 110 metric tonnes.

Step	1	2	3	4	5	6	7	8	Totals
Stage	Phobos Land	Secondary Landing	Primary Landing	Secondary Phasing	Primary Phasing	Mars Insertion	Course Correction	Trans Venus Injection	
Delta Vs (m/s)	5	6.41	316.9	1.79	310.22	4174.01	8.1	4495.72	Delta V (m/s) 9318.2
Masses (kg)									G-loss dV (m/s) 125
Starting	110000	128200	128200	134261	134261	140472	215062	215062	Effective dV (m/s) 9443.2
Tank	18200							8717	Payload (kg) 110000
Stage Fuel	150	150	6061	56	6211	74590	409	134804	Tank Mass (kg) 26917
Boiloff	0	0	0	0	0	0	0	0	Main Fuel (kg) 221667
Subtotal Fuel	150	301	6061	357	12272	86862	766	221667	IMLEO (kg) 358584
Subtotal	128200	128200	134261	134261	140472	215062	215062	358584	
									RCS Fuel (kg) 766
# Tanks	2	0	0	0	0	0	0	1	
Subtotal Tanks	2	2	2	2	2	2	2	3	Number of Tanks 3
# Engines	2								
Subtotal Engines	2	2	2	2	2	2	2	2	Number of Engines 2

Outbound Mission to Phobos with payload and ship mass of 120 metric tonnes.

Step	1	2	3	4	5	6	7	8	Totals
Stage	Phobos Land	Secondary Landing	Primary Landing	Secondary Phasing	Primary Phasing	Mars Insertion	Course Correction	Trans Venus Injection	
Delta Vs (m/s)	5	6.41	316.9	1.79	310.22	4174.01	8.1	4495.72	Delta V (m/s) 9318.2
Masses (kg)									G-loss dV (m/s) 125
Starting	120000	138200	138200	144734	144734	151429	231838	231838	Effective dV (m/s) 9443.2
Tank	18200							17434	Payload (kg) 120000
Stage Fuel	162	162	6534	61	6695	80409	441	150161	Tank Mass (kg) 35634
Boiloff	0	0	0	0	0	0	0	0	Main Fuel (kg) 243799
Subtotal Fuel	162	324	6534	385	13229	93638	826	243799	IMLEO (kg) 399433
Subtotal	138200	138200	144734	144734	151429	231838	231838	399433	
									RCS Fuel (kg) 826
# Tanks	2	0	0	0	0	0	0	2	
Subtotal Tanks	2	2	2	2	2	2	2	4	Number of Tanks 4
# Engines	2								
Subtotal Engines	2	2	2	2	2	2	2	2	Number of Engines 2

Outbound Mission to Phobos with payload and ship mass of 130 metric tonnes.

Step	1	2	3	4	5	6	7	8	Totals
Stage	Phobos Land	Secondary Landing	Primary Landing	Secondary Phasing	Primary Phasing	Mars Insertion	Course Correction	Trans Venus Injection	
Delta Vs (m/s)	5	6.41	316.9	1.79	310.22	4174.01	8.1	4495.72	Delta V (m/s) 9318.2
Masses (kg)									G-loss dV (m/s) 125
Starting	130000	148200	148200	155207	155207	162387	248613	248613	Effective dV (m/s) 9443.2
Tank	18200							17434	Payload (kg) 130000
Stage Fuel	174	174	7007	65	7180	86227	473	160267	Tank Mass (kg) 35634
Boiloff	0	0	0	0	0	0	0	0	Main Fuel (kg) 260680
Subtotal Fuel	174	348	7007	413	14187	100413	886	260680	IMLEO (kg) 426314
Subtotal	148200	148200	155207	155207	162387	248613	248613	426314	
									RCS Fuel (kg) 886
# Tanks	2	0	0	0	0	0	0	2	
Subtotal Tanks	2	2	2	2	2	2	2	4	Number of Tanks 4
# Engines	2								
Subtotal Engines	2	2	2	2	2	2	2	2	Number of Engines 2

Outbound Mission to Phobos with payload and ship mass of 140 metric tonnes.

Step	1	2	3	4	5	6	7	8	Totals
Stage	Phobos Land	Secondary Landing	Primary Landing	Secondary Phasing	Primary Phasing	Mars Insertion	Course Correction	Trans Venus Injection	
Delta Vs (m/s)	5	6.41	316.9	1.79	310.22	4174.01	8.1	4495.72	Delta V (m/s) 9318.2
Masses (kg)									G-loss dV (m/s) 125
Starting	140000	158200	158200	165680	165680	173344	265389	265389	Effective dV (m/s) 9443.2
Tank	18200							17434	Payload (kg) 140000
Stage Fuel	186	186	7480	70	7664	92045	505	170372	Tank Mass (kg) 35634
Boiloff	0	0	0	0	0	0	0	0	Main Fuel (kg) 277561
Subtotal Fuel	186	371	7480	441	15144	107189	946	277561	IMLEO (kg) 453195
Subtotal	158200	158200	165680	165680	173344	265389	265389	453195	
									RCS Fuel (kg) 946
# Tanks	2	0	0	0	0	0	0	2	
Subtotal Tanks	2	2	2	2	2	2	2	4	Number of Tanks 4
# Engines	2								
Subtotal Engines	2	2	2	2	2	2	2	2	Number of Engines 2

Outbound Mission to Phobos with payload and ship mass of 150 metric tonnes.

Step	1	2	3	4	5	6	7	8	Totals
Stage	Phobos Land	Secondary Landing	Primary Landing	Secondary Phasing	Primary Phasing	Mars Insertion	Course Correction	Trans Venus Injection	
Delta Vs (m/s)	5	6.41	316.9	1.79	310.22	4174.01	8.1	4495.72	Delta V (m/s) 9318.2
Masses (kg)									G-loss dV (m/s) 125
Starting	150000	168200	168200	176152	176152	184301	282164	282164	Effective dV (m/s) 9443.2
Tank	18200							17434	Payload (kg) 150000
Stage Fuel	197	197	7952	74	8149	97863	537	180478	Tank Mass (kg) 35634
Boiloff	0	0	0	0	0	0	0	0	Main Fuel (kg) 294442
Subtotal Fuel	197	395	7952	469	16101	113964	1005	294442	IMLEO (kg) 480076
Subtotal	168200	168200	176152	176152	184301	282164	282164	480076	RCS Fuel (kg) 1005
# Tanks	2	0	0	0	0	0	0	2	
Subtotal Tanks	2	2	2	2	2	2	2	4	Number of Tanks 4
# Engines	2								
Subtotal Engines	2	2	2	2	2	2	2	2	Number of Engines 2

Outbound Mission to Phobos with payload and ship mass of 160 metric tonnes.

Step	1	2	3	4	5	6	7	8	Totals
Stage	Phobos Land	Secondary Landing	Primary Landing	Secondary Phasing	Primary Phasing	Mars Insertion	Course Correction	Trans Venus Injection	
Delta Vs (m/s)	5	6.41	316.9	1.79	310.22	4174.01	8.1	4495.72	Delta V (m/s) 9318.2
Masses (kg)									G-loss dV (m/s) 125
Starting	160000	178200	178200	186625	186625	195258	298940	298940	Effective dV (m/s) 9443.2
Tank	18200							26151	Payload (kg) 160000
Stage Fuel	209	209	8425	78	8633	103682	569	195835	Tank Mass (kg) 44351
Boiloff	0	0	0	0	0	0	0	0	Main Fuel (kg) 316575
Subtotal Fuel	209	418	8425	497	17058	120740	1065	316575	IMLEO (kg) 520926
Subtotal	178200	178200	186625	186625	195258	298940	298940	520926	RCS Fuel (kg) 1065
# Tanks	2	0	0	0	0	0	0	3	
Subtotal Tanks	2	2	2	2	2	2	2	5	Number of Tanks 5
# Engines	2								
Subtotal Engines	2	2	2	2	2	2	2	2	Number of Engines 2

Outbound Mission to Phobos with payload and ship mass of 170 metric tonnes.

Step	1	2	3	4	5	6	7	8	Totals
Stage	Phobos Land	Secondary Landing	Primary Landing	Secondary Phasing	Primary Phasing	Mars Insertion	Course Correction	Trans Venus Injection	
Delta Vs (m/s)	5	6.41	316.9	1.79	310.22	4174.01	8.1	4495.72	Delta V (m/s) 9318.2
Masses (kg)									G-loss dV (m/s) 125
Starting	170000	188200	188200	197098	197098	206216	315716	315716	Effective dV (m/s) 9443.2
Tank	18200							26151	Payload (kg) 170000
Stage Fuel	221	221	8898	83	9118	109500	600	205940	Tank Mass (kg) 44351
Boiloff	0	0	0	0	0	0	0	0	Main Fuel (kg) 333456
Subtotal Fuel	221	442	8898	525	18016	127516	1125	333456	IMLEO (kg) 547807
Subtotal	188200	188200	197098	197098	206216	315716	315716	547807	RCS Fuel (kg) 1125
# Tanks	2	0	0	0	0	0	0	3	
Subtotal Tanks	2	2	2	2	2	2	2	5	Number of Tanks 5
# Engines	2								
Subtotal Engines	2	2	2	2	2	2	2	2	Number of Engines 2

Outbound Mission to Phobos with payload and ship mass of 180 metric tonnes.

Step	1	2	3	4	5	6	7	8	
Stage	Phobos Land	Secondary Landing	Primary Landing	Secondary Phasing	Primary Phasing	Mars Insertion	Course Correction	Trans Venus Injection	Totals
Delta Vs (m/s)	5	6.41	316.9	1.79	310.22	4174.01	8.1	4495.72	Delta V (m/s) 9318.2
Masses (kg)									G-loss dV (m/s) 125
Starting	180000	198200	198200	207571	207571	217173	332491	332491	Effective dV (m/s) 9443.2
Tank	18200							26151	Payload (kg) 180000
Stage Fuel	233	233	9371	87	9602	115318	632	216046	Tank Mass (kg) 44351
Boiloff	0	0	0	0	0	0	0	0	Main Fuel (kg) 350337
Subtotal Fuel	233	465	9371	552	18973	134291	1185	350337	IMLEO (kg) 574688
Subtotal	198200	198200	207571	207571	217173	332491	332491	574688	RCS Fuel (kg) 1185
# Tanks	2	0	0	0	0	0	0	3	
Subtotal Tanks	2	2	2	2	2	2	2	5	Number of Tanks 5
# Engines	2								
Subtotal Engines	2	2	2	2	2	2	2	2	Number of Engines 2

Outbound Mission to Phobos with payload and ship mass of 190 metric tonnes.

Step	1	2	3	4	5	6	7	8	
Stage	Phobos Land	Secondary Landing	Primary Landing	Secondary Phasing	Primary Phasing	Mars Insertion	Course Correction	Trans Venus Injection	Totals
Delta Vs (m/s)	5	6.41	316.9	1.79	310.22	4174.01	8.1	4495.72	Delta V (m/s) 9318.2
Masses (kg)									G-loss dV (m/s) 125
Starting	190000	208200	208200	218043	218043	228130	349267	349267	Effective dV (m/s) 9443.2
Tank	18200							26151	Payload (kg) 190000
Stage Fuel	244	244	9843	92	10087	121136	664	226151	Tank Mass (kg) 44351
Boiloff	0	0	0	0	0	0	0	0	Main Fuel (kg) 367218
Subtotal Fuel	244	489	9843	580	19930	141067	1245	367218	IMLEO (kg) 601569
Subtotal	208200	208200	218043	218043	228130	349267	349267	601569	RCS Fuel (kg) 1245
# Tanks	2	0	0	0	0	0	0	3	
Subtotal Tanks	2	2	2	2	2	2	2	5	Number of Tanks 5
# Engines	2								
Subtotal Engines	2	2	2	2	2	2	2	2	Number of Engines 2

Outbound Mission to Phobos with payload and ship mass of 200 metric tonnes.

Step	1	2	3	4	5	6	7	8	
Stage	Phobos Land	Secondary Landing	Primary Landing	Secondary Phasing	Primary Phasing	Mars Insertion	Course Correction	Trans Venus Injection	Totals
Delta Vs (m/s)	5	6.41	316.9	1.79	310.22	4174.01	8.1	4495.72	Delta V (m/s) 9318.2
Masses (kg)									G-loss dV (m/s) 125
Starting	200000	218200	218200	228516	228516	239087	366042	366042	Effective dV (m/s) 9443.2
Tank	18200							34868	Payload (kg) 200000
Stage Fuel	256	256	10316	96	10571	126955	696	241508	Tank Mass (kg) 53068
Boiloff	0	0	0	0	0	0	0	0	Main Fuel (kg) 389350
Subtotal Fuel	256	512	10316	608	20887	147842	1304	389350	IMLEO (kg) 642418
Subtotal	218200	218200	228516	228516	239087	366042	366042	642418	RCS Fuel (kg) 1304
# Tanks	2	0	0	0	0	0	0	4	
Subtotal Tanks	2	2	2	2	2	2	2	6	Number of Tanks 6
# Engines	2								
Subtotal Engines	2	2	2	2	2	2	2	2	Number of Engines 2

Table 4. One-Way Inbound to Earth, Total Mass Calculation for Varying Payload and Ship Mass Utilizing the Reference Case Option

Note: RCS fuel is budgeted into the payload mass. Do not use values given for RCS fuel to calculate IMLBO.

Note: Tanks are dropped such that symmetry of the ship is maintained.

Note: Two engines are provided for redundancy if necessary. Only one engine is required until the total mass reaches 675 metric tonnes.

Engine Usage

Step	Engine Used and Isp Available
1	Main: 1000 seconds
2	RCS: 435 seconds
3	Main: 1000 seconds
4	RCS: 435 seconds

Mission with payload and ship mass of 100 metric tonnes.

Step	1	2	3	4	Totals
Stage	Earth	Course	Trans Earth	Phobos	
	Insertion	Correction	Injection	Launch	
Delta Vs (m/s)	2818.93	1.9	2953.53	14.97	Delta V (m/s) 5789.33
Masses (kg)					
Starting	100000	157594	157594	213024	Payload (kg) 100000
Tank	18200				Tank Mass (kg) 18200
Stage Fuel	39394	70	55430	749	
Boiloff	0	0	0	0	Main Fuel (kg) 94824
Subtotal Fuel	39394	70	94824	820	IM Phobos (kg) 213024
Subtotal	157594	157594	213024	213024	
					RCS Fuel (kg) 820
# Tanks	2	0	0	0	
Subtotal Tanks	2	2	2	2	Total # of Tanks 2
# Engines	2	2	2	2	
Subtotal Engines	2	2	2	2	Total # Engines 2

Mission with payload and ship mass of 110 metric tonnes.

Step	1	2	3	4	Totals
Stage	Earth	Course	Trans Earth	Phobos	
	Insertion	Correction	Injection	Launch	
Delta Vs (m/s)	2818.93	1.9	2953.53	14.97	Delta V (m/s) 5789.33
Masses (kg)					
Starting	110000	170927	170927	231046	Payload (kg) 110000
Tank	18200				Tank Mass (kg) 18200
Stage Fuel	42727	76	60119	813	
Boiloff	0	0	0	0	Main Fuel (kg) 102846
Subtotal Fuel	42727	76	102846	889	IM Phobos (kg) 231046
Subtotal	170927	170927	231046	231046	
					RCS Fuel (kg) 889
# Tanks	2	0	0	0	
Subtotal Tanks	2	2	2	2	Total # of Tanks 2
# Engines	2	2	2	2	
Subtotal Engines	2	2	2	2	Total # Engines 2

Mission with payload and ship mass of 120 metric tonnes.

Step	1	2	3	4	Totals
Stage	Earth Insertion	Course Correction	Trans Earth Injection	Earth Phobos Launch	
Delta Vs (m/s)	2818.93	1.9	2953.53	14.97	Delta V (m/s) 5789.33
Masses (kg)					
Starting Tank	120000	184260	184260	249069	Payload (kg) 120000 Tank Mass (kg) 18200
Stage Fuel	46060	82	64809	876	
Boiloff	0	0	0	0	Main Fuel (kg) 110869
Subtotal Fuel	46060	82	110869	958	IM Phobos (kg) 249069
Subtotal	184260	184260	249069	249069	RCS Fuel (kg) 958
# Tanks	2	0	0	0	
Subtotal Tanks	2	2	2	2	Total # of Tanks 2
# Engines	2	2	2	2	
Subtotal Engines	2	2	2	2	Total # Engines 2

Mission with payload and ship mass of 130 metric tonnes.

Step	1	2	3	4	Totals
Stage	Earth Insertion	Course Correction	Trans Earth Injection	Earth Phobos Launch	
Delta Vs (m/s)	2818.93	1.9	2953.53	14.97	Delta V (m/s) 5789.33
Masses (kg)					
Starting Tank	130000	197593	197593	267091	Payload (kg) 130000 Tank Mass (kg) 18200
Stage Fuel	49393	88	69498	940	
Boiloff	0	0	0	0	Main Fuel (kg) 118891
Subtotal Fuel	49393	88	118891	1028	IM Phobos (kg) 267091
Subtotal	197593	197593	267091	267091	RCS Fuel (kg) 1028
# Tanks	2	0	0	0	
Subtotal Tanks	2	2	2	2	Total # of Tanks 2
# Engines	2	2	2	2	
Subtotal Engines	2	2	2	2	Total # Engines 2

Mission with payload and ship mass of 140 metric tonnes.

Step	1	2	3	4	Totals
Stage	Earth Insertion	Course Correction	Trans Earth Injection	Earth Phobos Launch	
Delta Vs (m/s)	2818.93	1.9	2953.53	14.97	Delta V (m/s) 5789.33
Masses (kg)					
Starting Tank	140000	210926	210926	285113	Payload (kg) 140000 Tank Mass (kg) 18200
Stage Fuel	52726	94	74188	1003	
Boiloff	0	0	0	0	Main Fuel (kg) 126913
Subtotal Fuel	52726	94	126913	1097	IM Phobos (kg) 285113
Subtotal	210926	210926	285113	285113	RCS Fuel (kg) 1097
# Tanks	2	0	0	0	
Subtotal Tanks	2	2	2	2	Total # of Tanks 2
# Engines	2	2	2	2	
Subtotal Engines	2	2	2	2	Total # Engines 2

Mission with payload and ship mass of 150 metric tonnes.

Step	1	2	3	4	Totals
Stage	Earth Insertion	Course Correction	Trans Earth Injection	Earth Phobos Launch	
Delta Vs (m/s)	2818.93	1.9	2953.53	14.97	Delta V (m/s) 5789.33
Masses (kg)					
Starting Tank	150000	224259	224259	303136	Payload (kg) 150000 Tank Mass (kg) 18200
Stage Fuel	56059	100	78877	1066	
Boiloff	0	0	0	0	Main Fuel (kg) 134936
Subtotal Fuel	56059	100	134936	1166	IM Phobos (kg) 303136
Subtotal	224259	224259	303136	303136	RCS Fuel (kg) 1166
# Tanks	2	0	0	0	
Subtotal Tanks	2	2	2	2	Total # of Tanks 2
# Engines	2	2	2	2	
Subtotal Engines	2	2	2	2	Total # Engines 2

Mission with payload and ship mass of 160 metric tonnes.

Step	1	2	3	4	Totals
Stage	Earth Insertion	Course Correction	Trans Earth Injection	Earth Phobos Launch	
Delta Vs (m/s)	2818.93	1.9	2953.53	14.97	Delta V (m/s) 5789.33
Masses (kg)					
Starting Tank	160000	237591	237591	321158	Payload (kg) 160000 Tank Mass (kg) 18200
Stage Fuel	59391	106	83567	1130	
Boiloff	0	0	0	0	Main Fuel (kg) 142958
Subtotal Fuel	59391	106	142958	1236	IM Phobos (kg) 321158
Subtotal	237591	237591	321158	321158	RCS Fuel (kg) 1236
# Tanks	2	0	0	0	
Subtotal Tanks	2	2	2	2	Total # of Tanks 2
# Engines	2	2	2	2	
Subtotal Engines	2	2	2	2	Total # Engines 2

Mission with payload and ship mass of 180 metric tonnes.

Step	1	2	3	4	Totals
Stage	Earth Insertion	Course Correction	Trans Earth Injection	Earth Phobos Launch	
Delta Vs (m/s)	2818.93	1.9	2953.53	14.97	Delta V (m/s) 5789.33
Masses (kg)					
Starting Tank	180000	264257	264257	368986	Payload (kg) 180000 Tank Mass (kg) 26917
Stage Fuel	66057	118	96011	1298	
Boiloff	0	0	0	0	Main Fuel (kg) 162069
Subtotal Fuel	66057	118	162069	1416	IM Phobos (kg) 368986
Subtotal	264257	264257	368986	368986	RCS Fuel (kg) 1416
# Tanks	2	0	1	0	
Subtotal Tanks	2	2	3	3	Total # of Tanks 3
# Engines	2	2	2	2	
Subtotal Engines	2	2	2	2	Total # Engines 2

Mission with payload and ship mass of 170 metric tonnes.

Step	1	2	3	4	Totals
Stage	Earth Insertion	Course Correction	Trans Earth Injection	Earth Phobos Launch	
Delta Vs (m/s)	2818.93	1.9	2953.53	14.97	Delta V (m/s) 5789.33
Masses (kg)					
Starting Tank	170000	250924	250924	350963	Payload (kg) 170000 Tank Mass (kg) 26917
Stage Fuel	62724	112	91322	1235	
Boiloff	0	0	0	0	Main Fuel (kg) 154046
Subtotal Fuel	62724	112	154046	1346	IM Phobos (kg) 350963
Subtotal	250924	250924	350963	350963	RCS Fuel (kg) 1346
# Tanks	2	0	1	0	
Subtotal Tanks	2	2	3	3	Total # of Tanks 3
# Engines	2	2	2	2	
Subtotal Engines	2	2	2	2	Total # Engines 2

Mission with payload and ship mass of 190 metric tonnes.

Step	1	2	3	4	Totals
Stage	Earth Insertion	Course Correction	Trans Earth Injection	Earth Phobos Launch	
Delta Vs (m/s)	2818.93	1.9	2953.53	14.97	Delta V (m/s) 5789.33
Masses (kg)					
Starting Tank	190000	277590	277590	387008	Payload (kg) 190000 Tank Mass (kg) 26917
Stage Fuel	69390	124	100701	1361	
Boiloff	0	0	0	0	Main Fuel (kg) 170091
Subtotal Fuel	69390	124	170091	1485	IM Phobos (kg) 387008
Subtotal	277590	277590	387008	387008	RCS Fuel (kg) 1485
# Tanks	2	0	1	0	
Subtotal Tanks	2	2	3	3	Total # of Tanks 3
# Engines	2	2	2	2	
Subtotal Engines	2	2	2	2	Total # Engines 2

Mission with payload and ship mass of 200 metric tonnes.

Step	1	2	3	4	Totals
Stage	Earth	Course	Trans Earth	Phobos	
	Insertion	Correction	Injection	Launch	
Delta Vs (m/s)	2818.93	1.9	2953.53	14.97	Delta V (m/s) 5789.33
Masses (kg)					
Starting	200000	290923	290923	405030	Payload (kg) 200000
Tank	18200		8717		Tank Mass (kg) 26917
Stage Fuel	72723	130	105390	1425	
Boiloff	0	0	0	0	Main Fuel (kg) 178113
Subtotal Fuel	72723	130	178113	1555	IM Phobos (kg) 405030
Subtotal	290923	290923	405030	405030	RCS Fuel (kg) 1555
# Tanks	2	0	1	0	
Subtotal Tanks	2	2	3	3	Total # of Tanks 3
# Engines	2				
Subtotal Engines	2	2	2	2	Total # Engines 2

Mission with payload and ship mass of 210 metric tonnes.

Step	1	2	3	4	Totals
Stage	Earth	Course	Trans Earth	Phobos	
	Insertion	Correction	Injection	Launch	
Delta Vs (m/s)	2818.93	1.9	2953.53	14.97	Delta V (m/s) 5789.33
Masses (kg)					
Starting	210000	304256	304256	423053	Payload (kg) 210000
Tank	18200		8717		Tank Mass (kg) 26917
Stage Fuel	76056	136	110080	1488	
Boiloff	0	0	0	0	Main Fuel (kg) 186136
Subtotal Fuel	76056	136	186136	1624	IM Phobos (kg) 423053
Subtotal	304256	304256	423053	423053	RCS Fuel (kg) 1624
# Tanks	2	0	1	0	
Subtotal Tanks	2	2	3	3	Total # of Tanks 3
# Engines	2				
Subtotal Engines	2	2	2	2	Total # Engines 2

Mission with payload and ship mass of 220 metric tonnes.

Step	1	2	3	4	Totals
Stage	Earth	Course	Trans Earth	Phobos	
	Insertion	Correction	Injection	Launch	
Delta Vs (m/s)	2818.93	1.9	2953.53	14.97	Delta V (m/s) 5789.33
Masses (kg)					
Starting	220000	317589	317589	441075	Payload (kg) 220000
Tank	18200		8717		Tank Mass (kg) 26917
Stage Fuel	79389	142	114769	1552	
Boiloff	0	0	0	0	Main Fuel (kg) 194158
Subtotal Fuel	79389	142	194158	1693	IM Phobos (kg) 441075
Subtotal	317589	317589	441075	441075	RCS Fuel (kg) 1693
# Tanks	2	0	1	0	
Subtotal Tanks	2	2	3	3	Total # of Tanks 3
# Engines	2				
Subtotal Engines	2	2	2	2	Total # Engines 2

Mission with payload and ship mass of 230 metric tonnes.

Step	1	2	3	4	Totals
Stage	Earth	Course	Trans Earth	Phobos	
	Insertion	Correction	Injection	Launch	
Delta Vs (m/s)	2818.93	1.9	2953.53	14.97	Delta V (m/s) 5789.33
Masses (kg)					
Starting	230000	330921	330921	459097	Payload (kg) 230000
Tank	18200		8717		Tank Mass (kg) 26917
Stage Fuel	82721	148	119459	1615	
Boiloff	0	0	0	0	Main Fuel (kg) 202180
Subtotal Fuel	82721	148	202180	1763	IM Phobos (kg) 459097
Subtotal	330921	330921	459097	459097	RCS Fuel (kg) 1763
# Tanks	2	0	1	0	
Subtotal Tanks	2	2	3	3	Total # of Tanks 3
# Engines	2				
Subtotal Engines	2	2	2	2	Total # Engines 2

Table 5. Calculation of Mission Mass Given Thrust and G Levels

Calculation of mission masses allowable for varying number of engines and acceleration rates.

1 G = 9.8 m/s²

# Engines-	1	2	3	4	5	6	7	8
Thrust (kg)	34000	68000	102000	136000	170000	204000	238000	272000
G's/Mission Mass								
0.1	340000	680000	1020000	1360000	1700000	2040000	2380000	2720000
0.11	309091	618182	927273	1236364	1545455	1854545	2163636	2472727
0.12	283333	566667	850000	1133333	1416667	1700000	1983333	2266667
0.13	261538	523077	784615	1046154	1307692	1569231	1830769	2092308
0.14	242857	485714	728571	971429	1214286	1457143	1700000	1942857
0.15	226667	453333	680000	906667	1133333	1360000	1586667	1813333
0.16	212500	425000	637500	850000	1062500	1275000	1487500	1700000
0.17	200000	400000	600000	800000	1000000	1200000	1400000	1600000
0.18	188889	377778	566667	755556	944444	1133333	1322222	1511111
0.19	178947	357895	536842	715789	894737	1073684	1252632	1431579
0.2	170000	340000	510000	680000	850000	1020000	1190000	1360000
0.21	161905	323810	485714	647619	809524	971429	1133333	1295238
0.22	154545	309091	463636	618182	772727	927273	1081818	1236364
0.23	147826	295652	443478	591304	739130	886957	1034783	1182609
0.24	141667	283333	425000	566667	708333	850000	991667	1133333
0.25	136000	272000	408000	544000	680000	816000	952000	1088000
0.26	130769	261538	392308	523077	653846	784615	915385	1046154
0.27	125926	251852	377778	503704	629630	755556	881481	1007407
0.28	121429	242857	364286	485714	607143	728571	850000	971429
0.29	117241	234483	351724	468966	586207	703448	820690	937931
0.3	113333	226667	340000	453333	566667	680000	793333	906667
0.31	109677	219355	329032	438710	548387	658065	767742	877419
0.32	106250	212500	318750	425000	531250	637500	743750	850000
0.33	103030	206061	309091	412121	515152	618182	721212	824242
0.34	100000	200000	300000	400000	500000	600000	700000	800000
0.35	97143	194286	291429	388571	485714	582857	680000	777143
0.36	94444	188889	283333	377778	472222	566667	661111	755556
0.37	91892	183784	275676	367568	459459	551351	643243	735135
0.38	89474	178947	268421	357895	447368	536842	626316	715789
0.39	87179	174359	261538	348718	435897	523077	610256	697436
0.4	85000	170000	255000	340000	425000	510000	595000	680000
0.41	82927	165854	248780	331707	414634	497561	580488	663415
0.42	80952	161905	242857	323810	404762	485714	566667	647619
0.43	79070	158140	237209	316279	395349	474419	553488	632558
0.44	77273	154545	231818	309091	386364	463636	540909	618182
0.45	75556	151111	226667	302222	377778	453333	528889	604444
0.46	73913	147826	221739	295652	369565	443478	517391	591304
0.47	72340	144681	217021	289362	361702	434043	506383	578723
0.48	70833	141667	212500	283333	354167	425000	495833	566667
0.49	69388	138776	208163	277551	346939	416327	485714	555102
0.5	68000	136000	204000	272000	340000	408000	476000	544000
0.51	66667	133333	200000	266667	333333	400000	466667	533333
0.52	65385	130769	196154	261538	326923	392308	457692	523077
0.53	64151	128302	192453	256604	320755	384906	449057	513208
0.54	62963	125926	188889	251852	314815	377778	440741	503704
0.55	61818	123636	185455	247273	309091	370909	432727	494545
0.56	60714	121429	182143	242857	303571	364286	425000	485714
0.57	59649	119298	178947	238596	298246	357895	417544	477193
0.58	58621	117241	175862	234483	293103	351724	410345	468966
0.59	57627	115254	172881	230508	288136	345763	403390	461017

Table 6. Burn Times for Reference Case Mission

Step	Description	Engine Used and Isp Available	Fuel Mass kg	Thrust N	Delta V m/s	Time to Burn hours
1	Earth insertion	Main: 1000 seconds	51043	668182	2818.93	0.2080
2	Mid-course correction	RCS: 435 seconds	91	6682	1.9	0.0161
3	Trans-Earth injection	Main: 1000 seconds	71819	668182	2953.53	0.2926
4	Launch from Phobos	RCS: 435 seconds	971	6682	14.97	0.1721
5	Land on Phobos	RCS: 435 seconds	333	6682	5	0.0590
6	Secondary Landing	RCS: 435 seconds	427	6682	6.41	0.0757
7	Primary Landing	Main, Throttled: 700 seconds	13402	233864	316.9	0.1092
8	Secondary Phasing	RCS: 435 seconds	125	6682	1.79	0.0222
9	Primary Phasing	Main, Throttled: 700 seconds	13733	233864	310.22	0.1119
10	Mars Insertion	Main: 1000 seconds	184260	668182	4174.01	0.7507
11	Mid-course corrections	RCS: 435 seconds	1010	6682	8.1	0.1790
12	Trans Venus Injection	Main: 1000 seconds	335789	1002273	4620.72	0.9120
Total			673003		15232.48	2.9084

Table 7. Tank Capacity and Mass Establishment

Number of Tanks	Mass Capacity	Volume Cubic Meters	Unrefrigerated Tank Mass	Refrigerated Tank Mass
1	75000	1045	8717	9100
2	150000	2090	17434	18200
3	225000	3135	26151	27300
4	300000	4181	34868	36400
5	375000	5226	43585	45500
6	450000	6271	52302	54600
7	525000	7316	61019	63700
8	600000	8361	69736	72800
9	675000	9406	78453	81900
10	750000	10452	87170	91000
11	825000	11497	95887	100100
12	900000	12542	104604	109200
13	975000	13587	113321	118300
14	1050000	14632	122038	127400
15	1125000	15677	130755	136500
16	1200000	16722	139472	145600
17	1275000	17768	148189	154700
18	1350000	18813	156906	163800
19	1425000	19858	165623	172900
20	1500000	20903	174340	182000
21	1575000	21948	183057	191100
22	1650000	22993	191774	200200
23	1725000	24038	200491	209300
24	1800000	25084	209208	218400
25	1875000	26129	217925	227500
26	1950000	27174	226642	236600
27	2025000	28219	235359	245700
28	2100000	29264	244076	254800
29	2175000	30309	252793	263900
30	2250000	31355	261510	273000
31	2325000	32400	270227	282100
32	2400000	33445	278944	291200
33	2475000	34490	287661	300300
34	2550000	35535	296378	309400
35	2625000	36580	305095	318500
36	2700000	37625	313812	327600
37	2775000	38671	322529	336700
38	2850000	39716	331246	345800
39	2925000	40761	339963	354900
40	3000000	41806	348680	364000
41	3075000	42851	357397	373100
42	3150000	43896	366114	382200
43	3225000	44941	374831	391300
44	3300000	45987	383548	400400
45	3375000	47032	392265	409500
46	3450000	48077	400982	418600
47	3525000	49122	409699	427700
48	3600000	50167	418416	436800
49	3675000	51212	427133	445900
50	3750000	52258	435850	455000

Number of Tanks	Mass Capacity	Volume Cubic Meters	Unrefrigerated Tank Mass	Refrigerated Tank Mass
51	3825000	53303	444567	464100
52	3900000	54348	453284	473200
53	3975000	55393	462001	482300
54	4050000	56438	470718	491400
55	4125000	57483	479435	500500
56	4200000	58528	488152	509600
57	4275000	59574	496869	518700
58	4350000	60619	505586	527800
59	4425000	61664	514303	536900
60	4500000	62709	523020	546000
61	4575000	63754	531737	555100
62	4650000	64799	540454	564200
63	4725000	65844	549171	573300
64	4800000	66890	557888	582400
65	4875000	67935	566605	591500
66	4950000	68980	575322	600600
67	5025000	70025	584039	609700
68	5100000	71070	592756	618800
69	5175000	72115	601473	627900
70	5250000	73161	610190	637000
71	5325000	74206	618907	646100
72	5400000	75251	627624	655200
73	5475000	76296	636341	664300
74	5550000	77341	645058	673400
75	5625000	78386	653775	682500
76	5700000	79431	662492	691600
77	5775000	80477	671209	700700
78	5850000	81522	679926	709800
79	5925000	82567	688643	718900
80	6000000	83612	697360	728000
81	6075000	84657	706077	737100
82	6150000	85702	714794	746200
83	6225000	86747	723511	755300
84	6300000	87793	732228	764400
85	6375000	88838	740945	773500
86	6450000	89883	749662	782600
87	6525000	90928	758379	791700
88	6600000	91973	767096	800800
89	6675000	93018	775813	809900
90	6750000	94064	784530	819000
91	6825000	95109	793247	828100
92	6900000	96154	801964	837200
93	6975000	97199	810681	846300
94	7050000	98244	819398	855400
95	7125000	99289	828115	864500
96	7200000	100334	836832	873600
97	7275000	101380	845549	882700
98	7350000	102425	854266	891800
99	7425000	103470	862983	900900
100	7500000	104515	871700	910000