

199301042

Session VI. Airborne Doppler Radar / NASA

N93-19610

Comparison of Simulated and Actual Wind Shear Radar Data Products

Dr. C. Britt, Research Triangle Institute
L. Crittenden, Research Triangle Institute



***Comparison of Simulated and Actual
Windshear Radar Data Products***

**Dr. C. Britt, RTI
L. Crittenden, RTI**

Comparison of Simulated and Actual Windshear Radar Data Products

**Charles L. Britt and Lucille H. Crittenden
Research Triangle Institute
Research Triangle Park, NC 27709**

**Abstract for Proposed Technical Talk for the
Fourth Combined Manufacturers' and Technologists'
Airborne Wind Shear Review Meeting
Williamsburg, Virginia
April 14-16, 1992**

Abstract

Prior to the development of the NASA experimental wind shear radar system, extensive computer simulations were conducted to determine the performance of the radar in combined weather and ground clutter environments. The simulation of the radar used analytical microburst models to determine weather returns and synthetic aperture radar (SAR) maps to determine ground clutter returns. These simulations were used to guide the development of hazard detection algorithms and to predict their performance.

The structure of the radar simulation will be reviewed. Actual flight data results from the Orlando and Denver tests are compared with simulated results. Areas of agreement and disagreement of actual and simulated results are pointed out.

**COMPARISON OF SIMULATED AND ACTUAL
WINDSHEAR RADAR DATA PRODUCTS**

Charles L. Britt, Ph.D
Lucille H. Crittenden

VIEWGRAPH TITLES

Slide 1 -

Introduction - Comparison of Simulated and Actual Windshear Radar Data Products by Charles L. Britt and Lucille H. Crittenden.

Slide 2-

This is an overall flow chart of the Radar Simulation program developed for NASA by RTI personnel. The simulation inputs include: 1) a NASA-developed microburst data base for simulation of microburst radar returns; 2) synthetic aperture radar (SAR) maps from the Environmental Research Institute of Michigan (ERIM) for calculation of stationary ground clutter; and 3) a discrete target data base for simulation of moving ground clutter. A Monte Carlo technique is used to calculate the in-phase (I) and quadrature (Q) signals for each range cell of the radar. These signals are processed to power, velocity and hazard index using various signal and data processing algorithms.

Slide 3-

An example of a synthetic aperture radar (SAR) map of the Denver area. This map is used to determine the ground clutter level in the simulation.

Slide 4 -

This chart shows how the NASA flight test data is used to drive the simulation to permit direct comparison of simulated and actual radar data products.

Slide 5-

An example of a Denver ground scattering coefficient (σ_0) map obtained from NASA flight test data in July 1991. The location of runway 26R at Denver Stapleton airport is shown on the map. It should be noted that although the radar map is in σ_0 units, the actual values of σ_0 are valid only in the region where the antenna beam center intercepts the ground. Slides 10 and 11 show true σ_0 levels corrected for antenna pattern effects.

Slide 6-

An example of a simulated Denver ground scattering coefficient (sigma-zero) map using the NASA flight test data to provide aircraft position data for the simulation. This map is plotted for the same instant of time slide 5.

Slide 7-

This is a plot comparing simulated ground clutter levels with ground clutter levels obtained from flight tests. An ERIM supplied algorithm was used in the simulation to correct for the difference in incidence angles between the angles used in obtaining the SAR data and the angles required by the simulation.

Slide 8-

Plot similar to slide 7 except the ERIM incidence angle correction is not used for the simulation. Better correlations between flight and simulated data are obtained in this case. In both cases, an antenna tilt of -3 degrees is used.

Slide 9-

Plot of the frequency of occurrences of various clutter levels for flight and simulated data. The simulation used the SAR maps with no correction for incidence angle differences.

Slide 10-

Values of ground scattering coefficient (sigma-zero) obtained from a sample of flight data on a Denver approach to runway 26R. The aircraft altitude was 620 feet when the data were taken.

Slide 11-

Data taken under conditions similar to slide 10 except obtained from the simulation. The SAR clutter maps used in the simulation were uncorrected for incidence angle differences. Note that the mean value of sigma-zero is somewhat larger in this simulated case.

Slide 12-

Correlation calculations to determine if the simulation and flight data are properly registered spatially. The highest correlation is obtained with a lag of 2 range bins (288m) in the simulation using the SAR clutter maps. This indicates a difference of this magnitude in the coordinate systems used. For future comparisons of flight and simulated data, this registration error will be corrected.

Slide 13-

Conclusions from the results to date in the comparison of simulated and flight test data products. The comparison of simulated and flight data will continue.

**COMPARISON OF SIMULATED AND
ACTUAL WINDSHEAR RADAR DATA
PRODUCTS**

Charles L. Britt, Ph.D

Lucille H. Crittenden

**Research Triangle Institute
525 Butler Farm Rd. Suite 108
Hampton, VA 23666**



RADAR SIMULATION

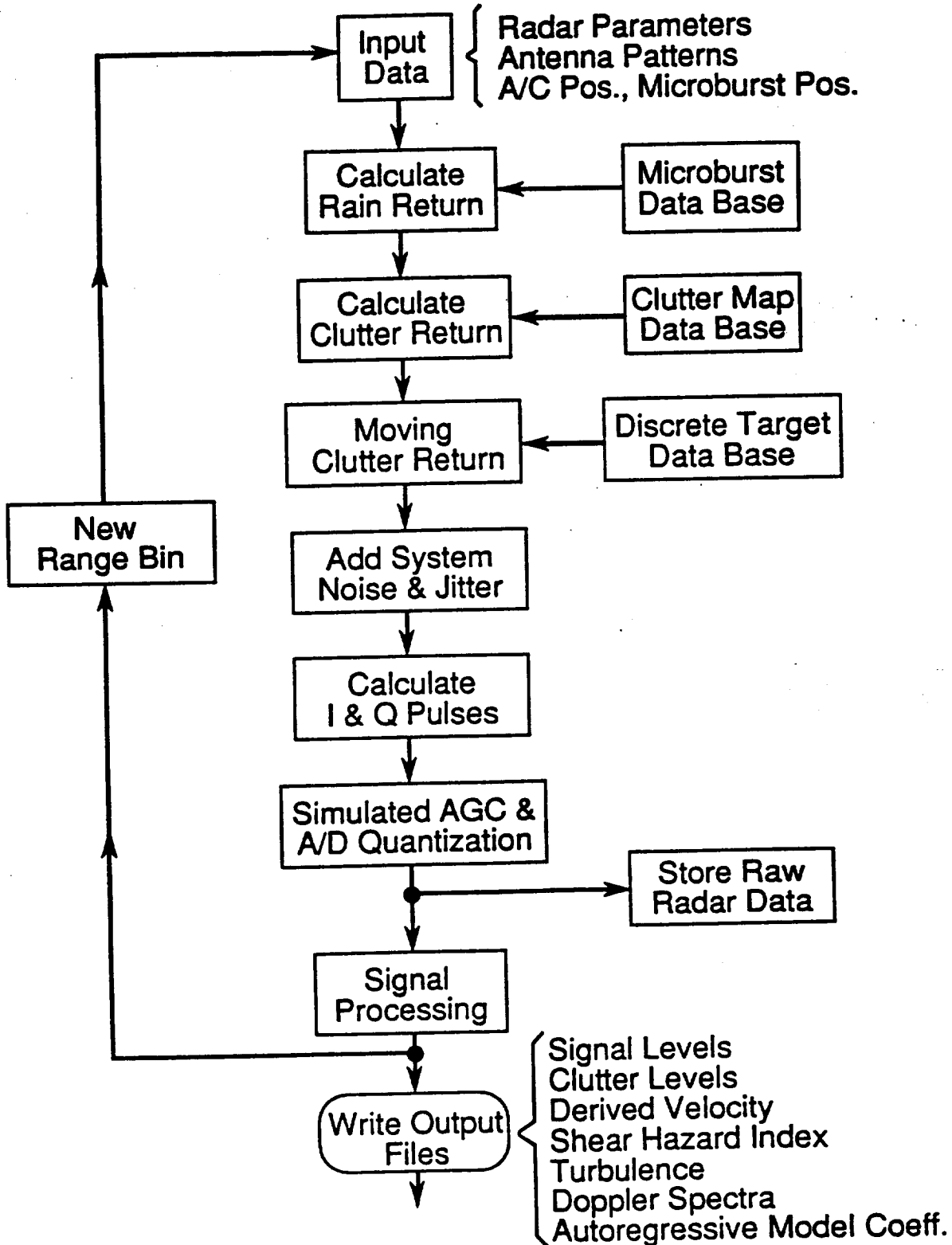

DENVER STAPLETON INTERNATIONAL
Image 1, 2nd Step West
915 records, 683 elements/sec.

90 1

683

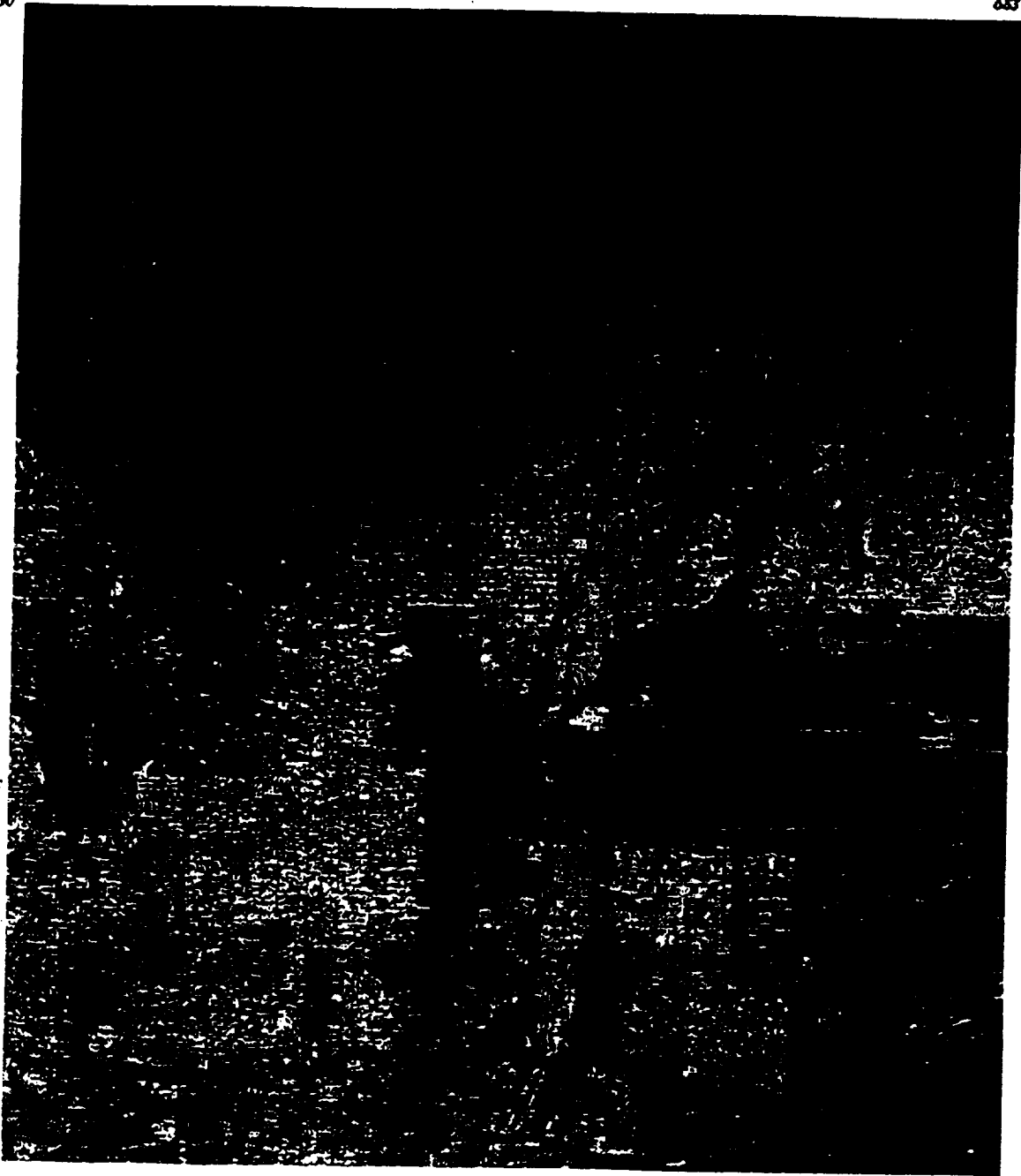

ORIGINAL PAGE IS
OF POOR QUALITY

COMPARISON OF SIMULATED AND ACTUAL RADAR DATA PRODUCTS

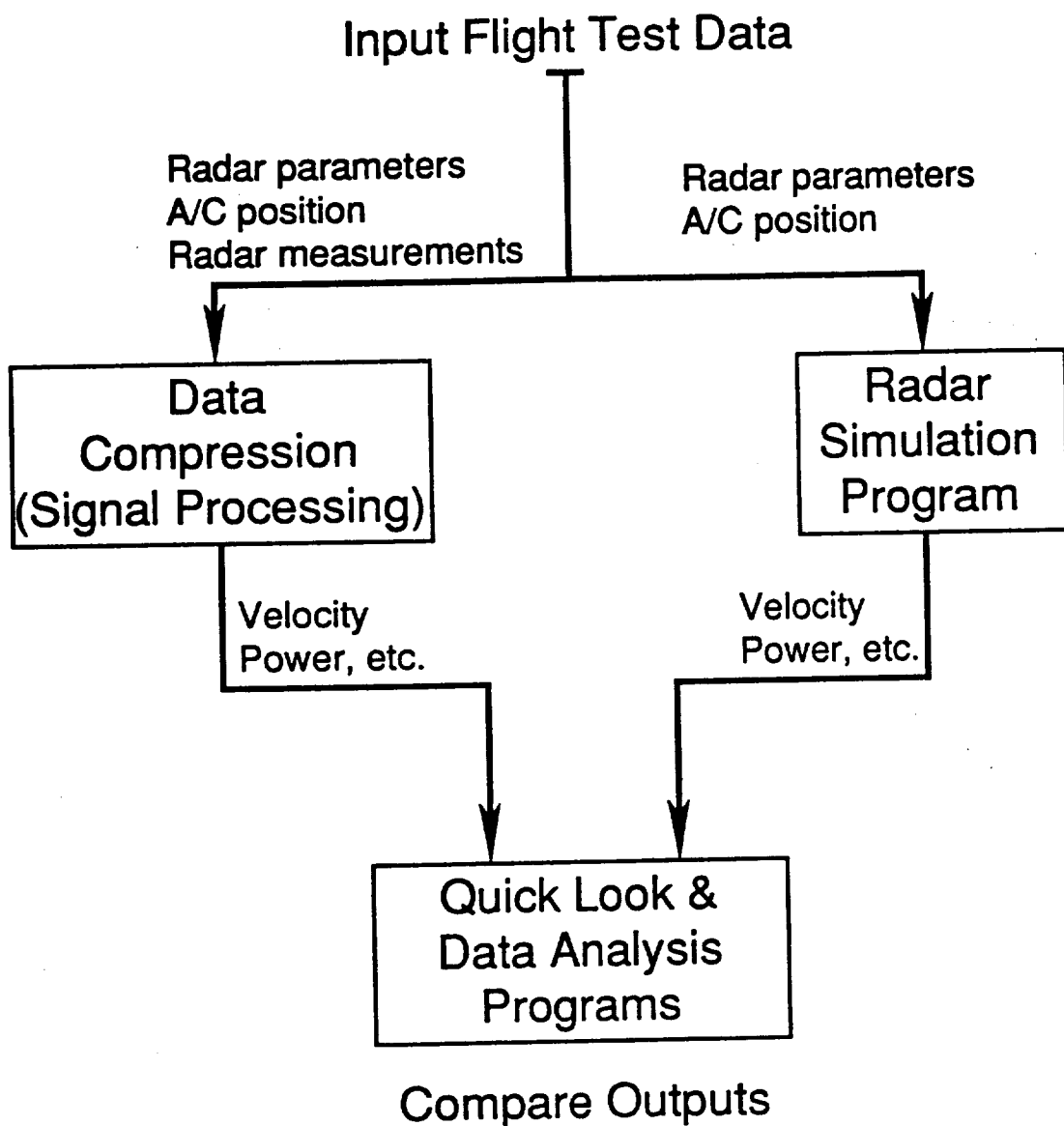

R-Max (m) = 13876. Center = 0.00 . Tilt = -3.00

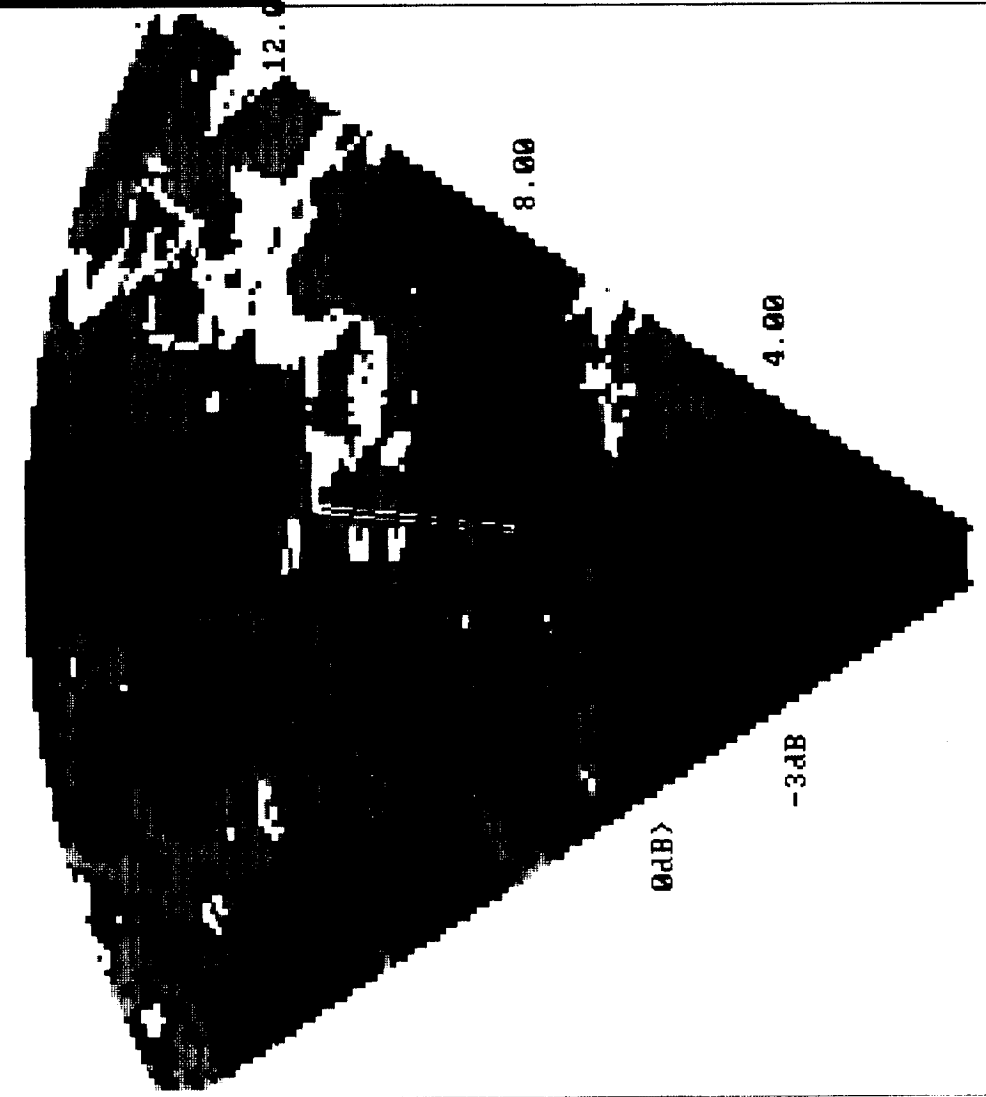

```

*CURSOR*
LAI 39.7503
LON -104.8723
RC 7328.
AZ 0
TILT -2.38
FRM 1117.
BIN 46.
VAL
  
```



DATE 7: 7:91

TIME 22:23: 1

FRAME # 1185

R-Min (m) = 781. SIGMA ZERO - DB Alt (ft) = 998.

ORIGINAL PAGE
COLOR PHOTOGRAPH

0.550

R-Max (m) = 13876. Center = 0.00 Tilt = -3.00

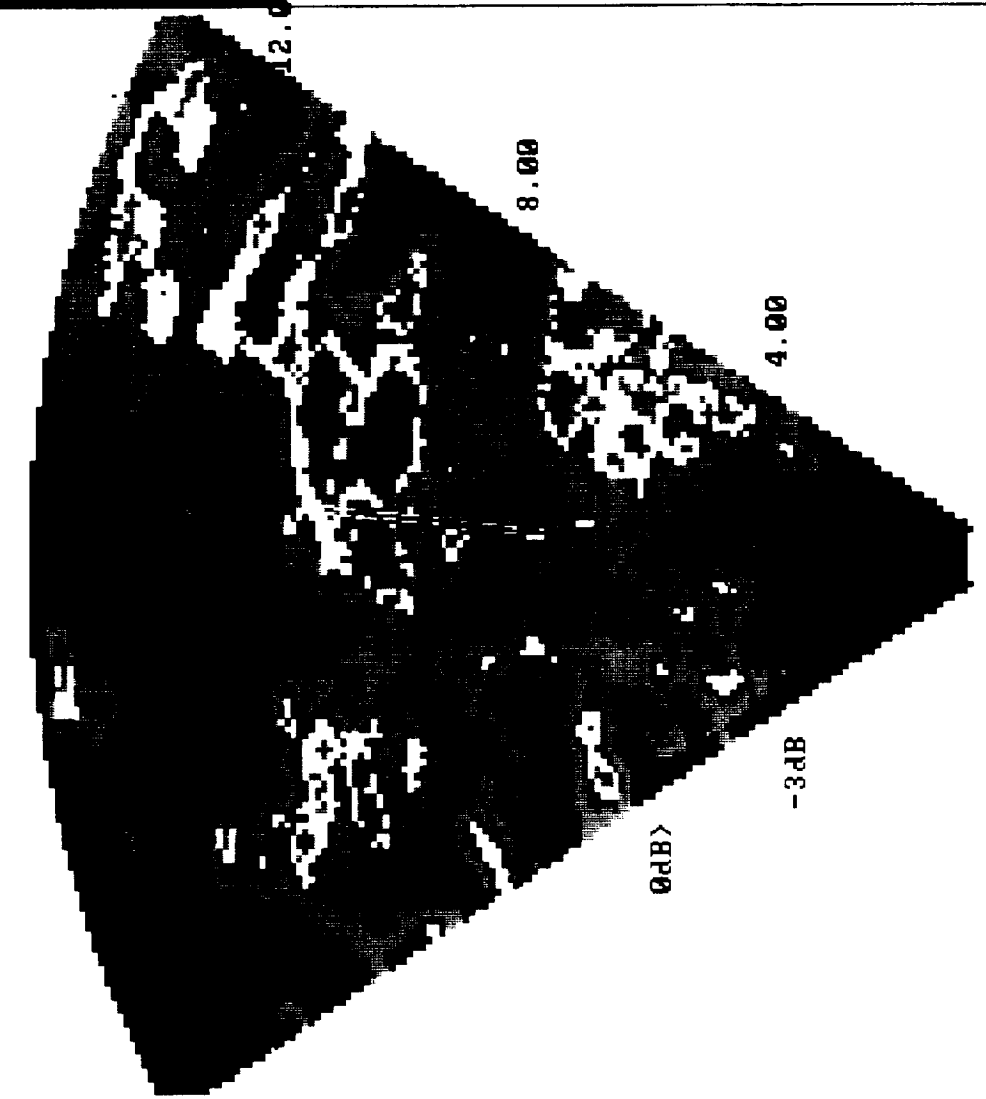

CURSOR

LAI	39.7503
LON	-104.8723
RC	7328.
AZ	0.
TILT	-2.38
FRM	1117.
BIN	46.
VAL	

DATE 7: 7:91

TIME 22:23: 1

FRAME # 1193

R-Min (m) = 781. SIGMA ZERO - DB Alt (ft) = 998.

ORIGINAL PAGE
COLOR PHOTOGRAPH

Clutter Level Comparison-Denver

Incidence Angle Differences Corrected

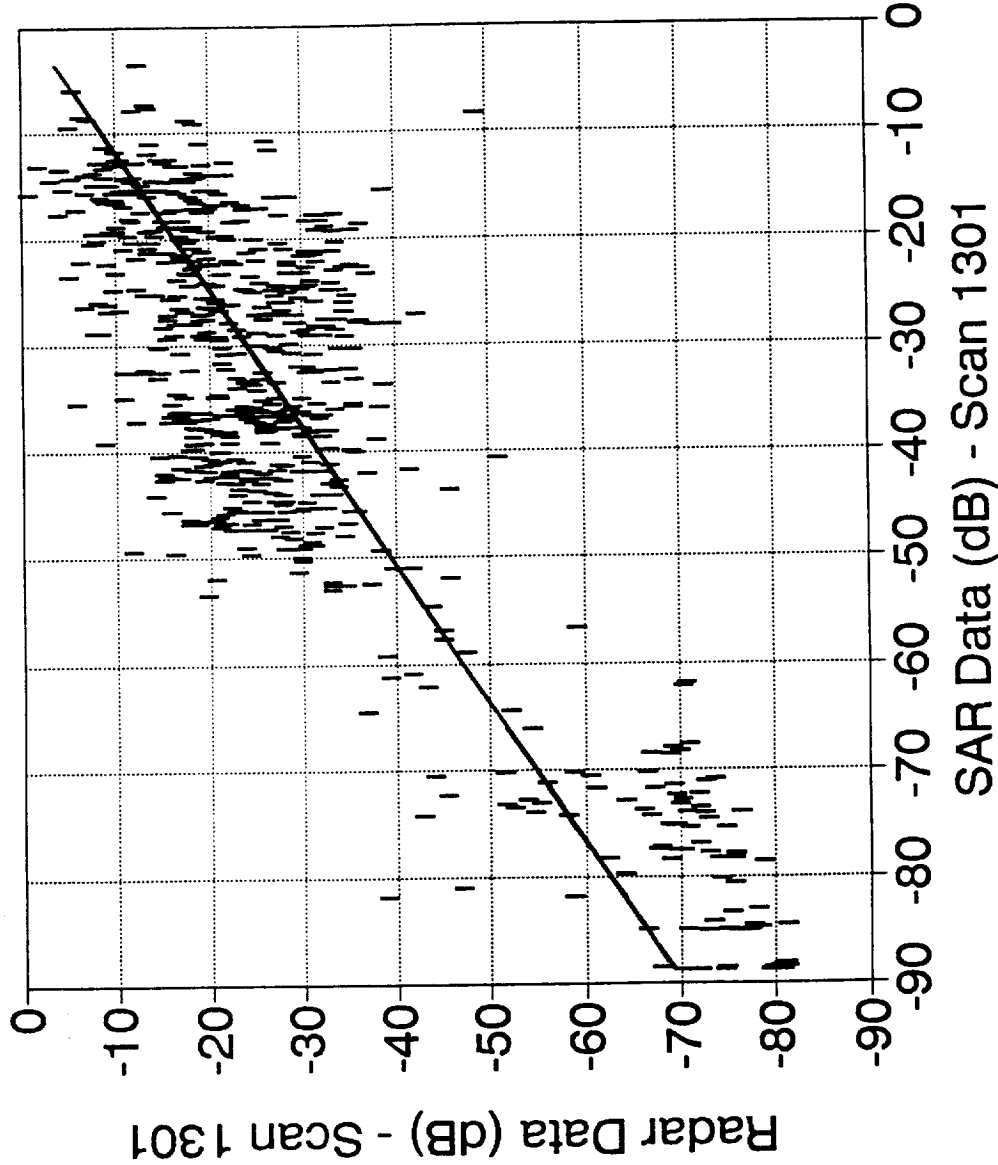

P. 552

Clutter Level Comparison-Denver

Incidence Angle Differences Uncorrected

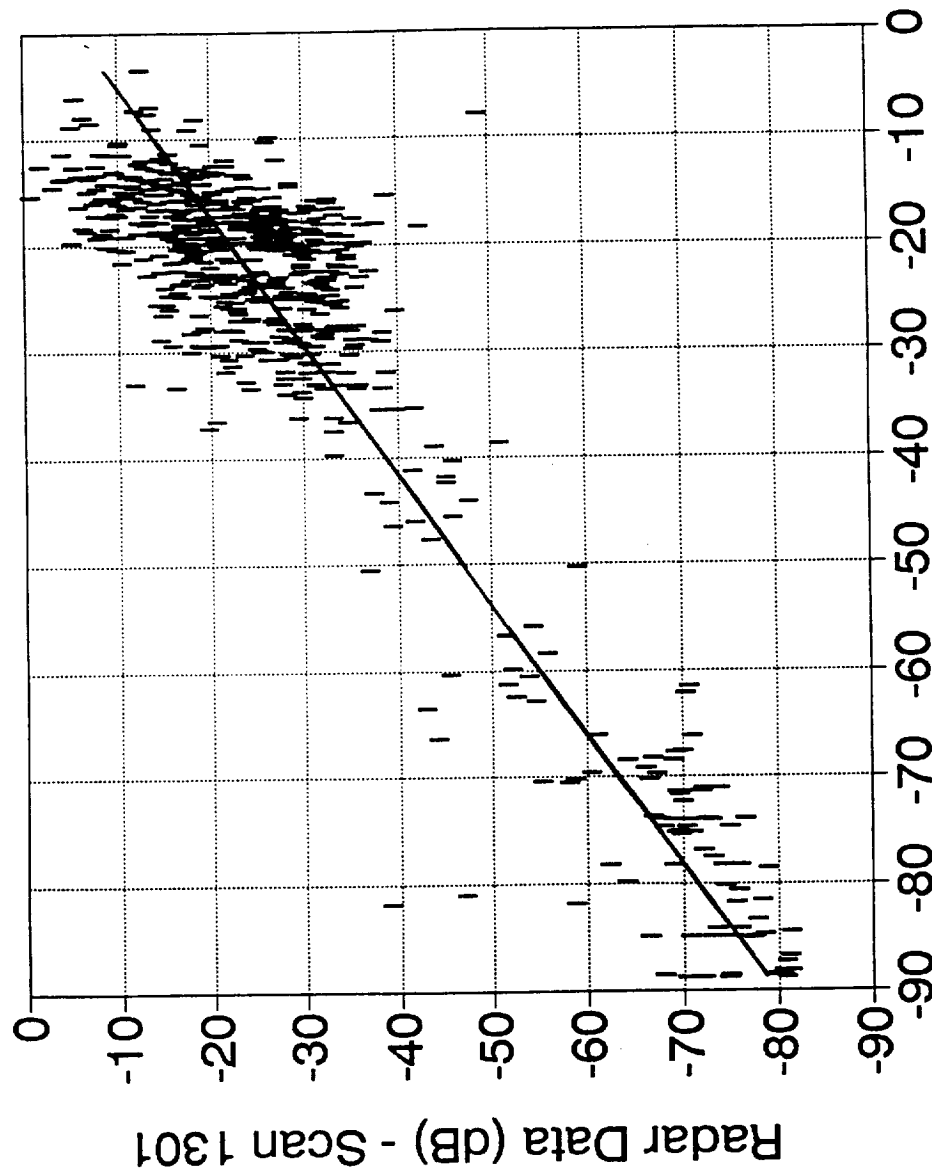

4 Cell Average
Regression, E=7.2

Ant. Tilt = -3 deg.



CLUTTER LEVELS

Denver Approach, Tilt=-3, Scan 1301

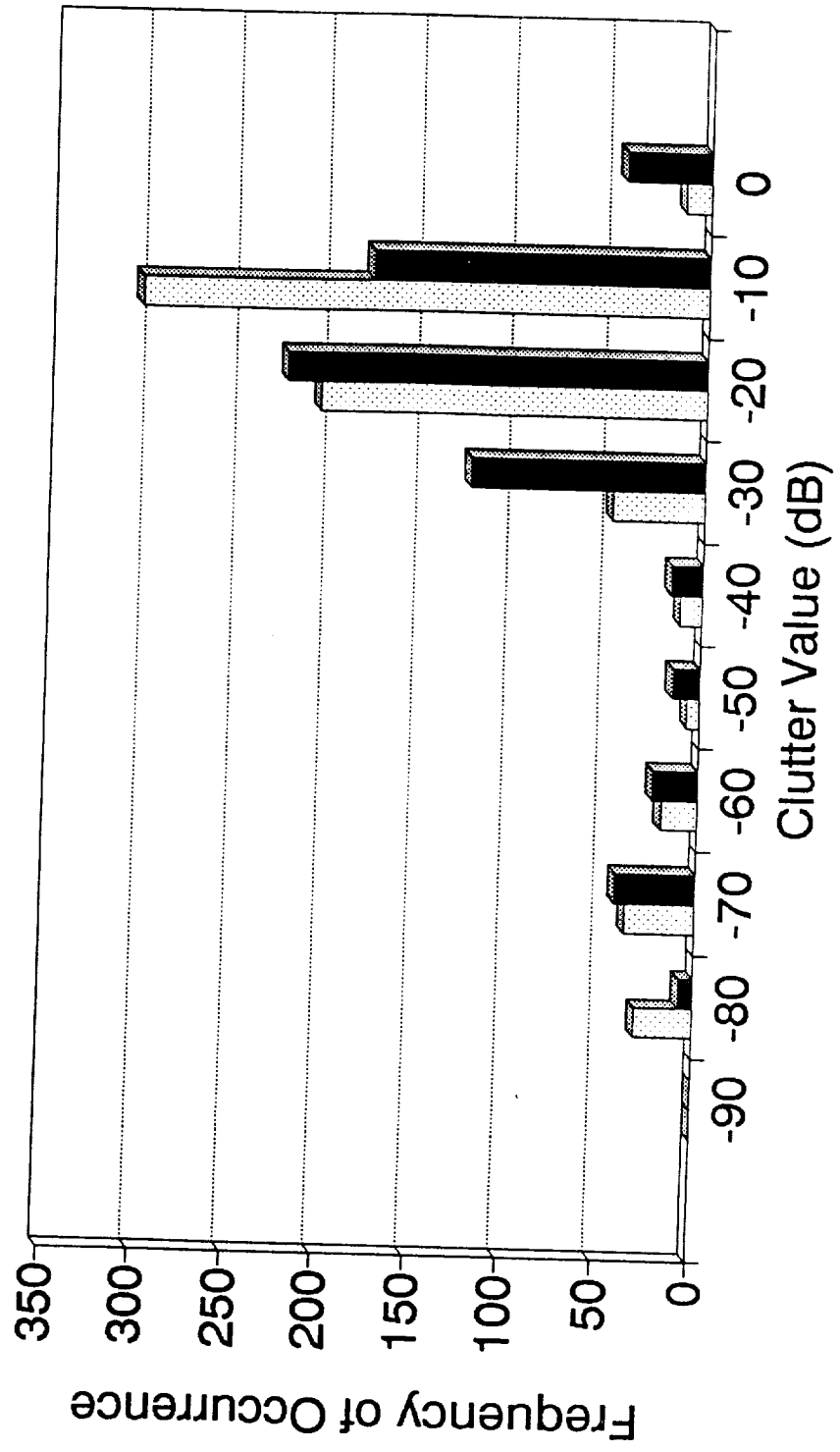

SCATTERING COEFFICIENT

Flight, DN1C2S1.M6, Frms 1791-1915

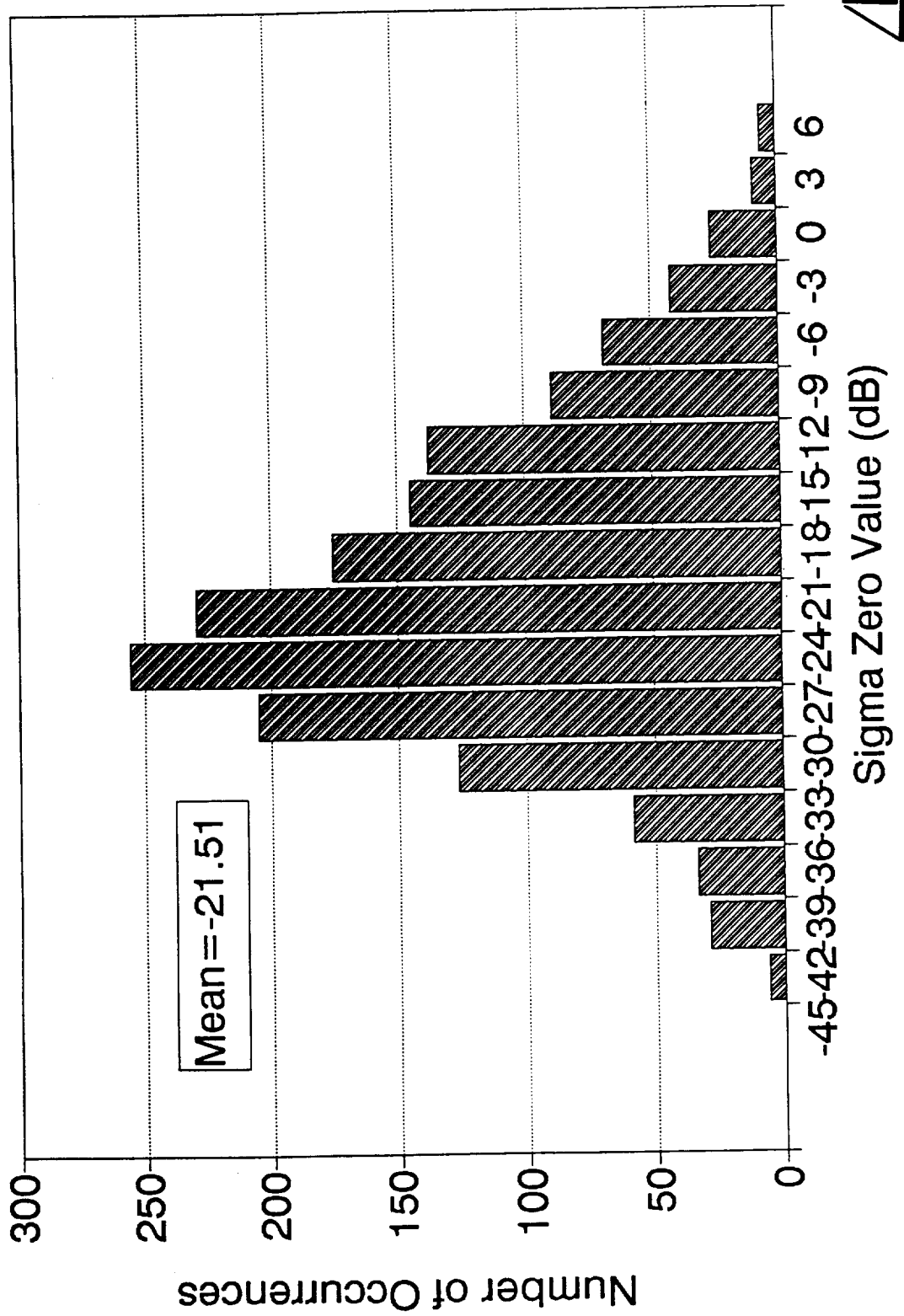

SCATTERING COEFFICIENT

Sim, DN1C2S1.M6, Frms 1791-1915

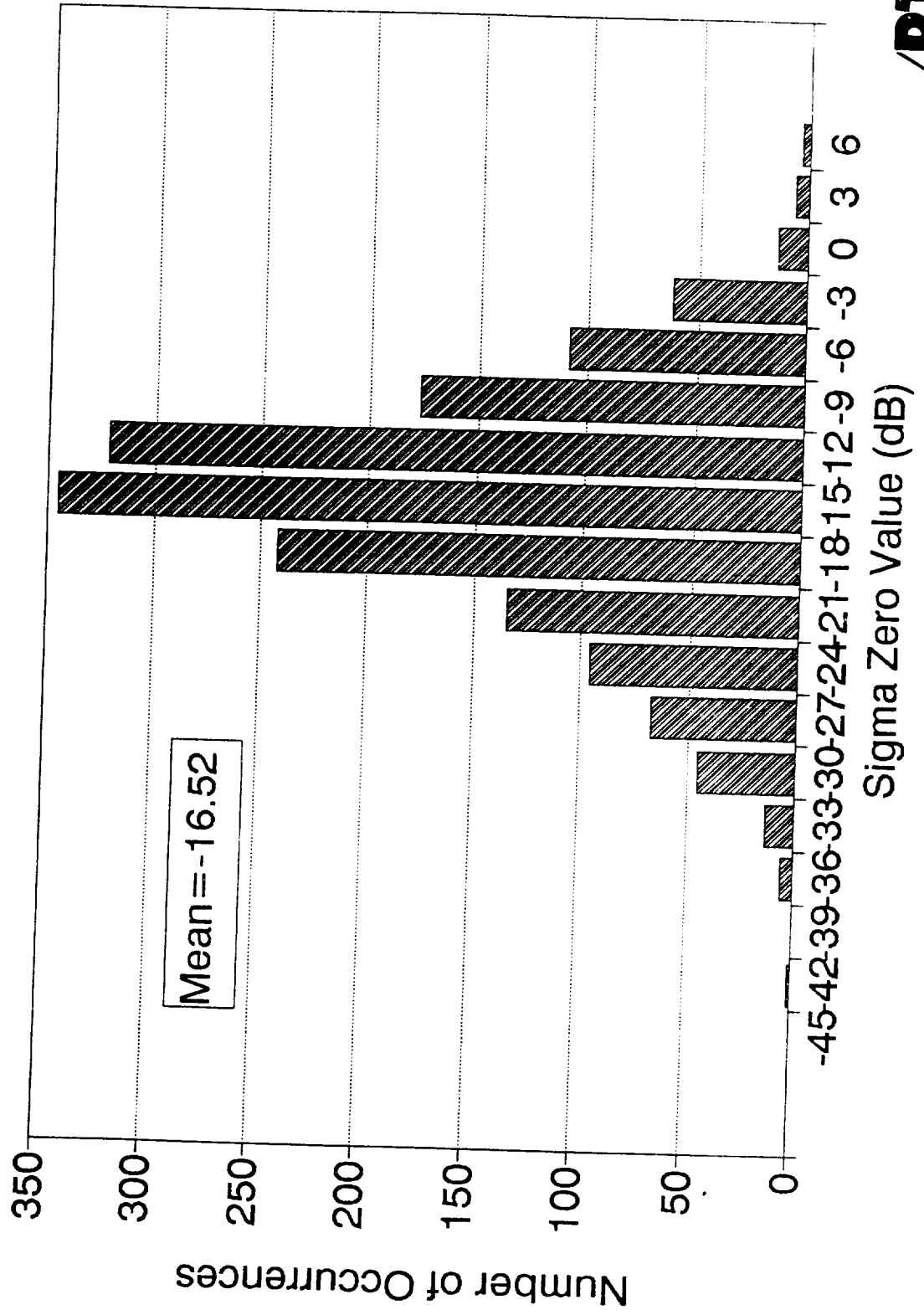

SAR MAP & DATA CORRELATION

Sigma Zero, Denver Approach, Tilt = -3

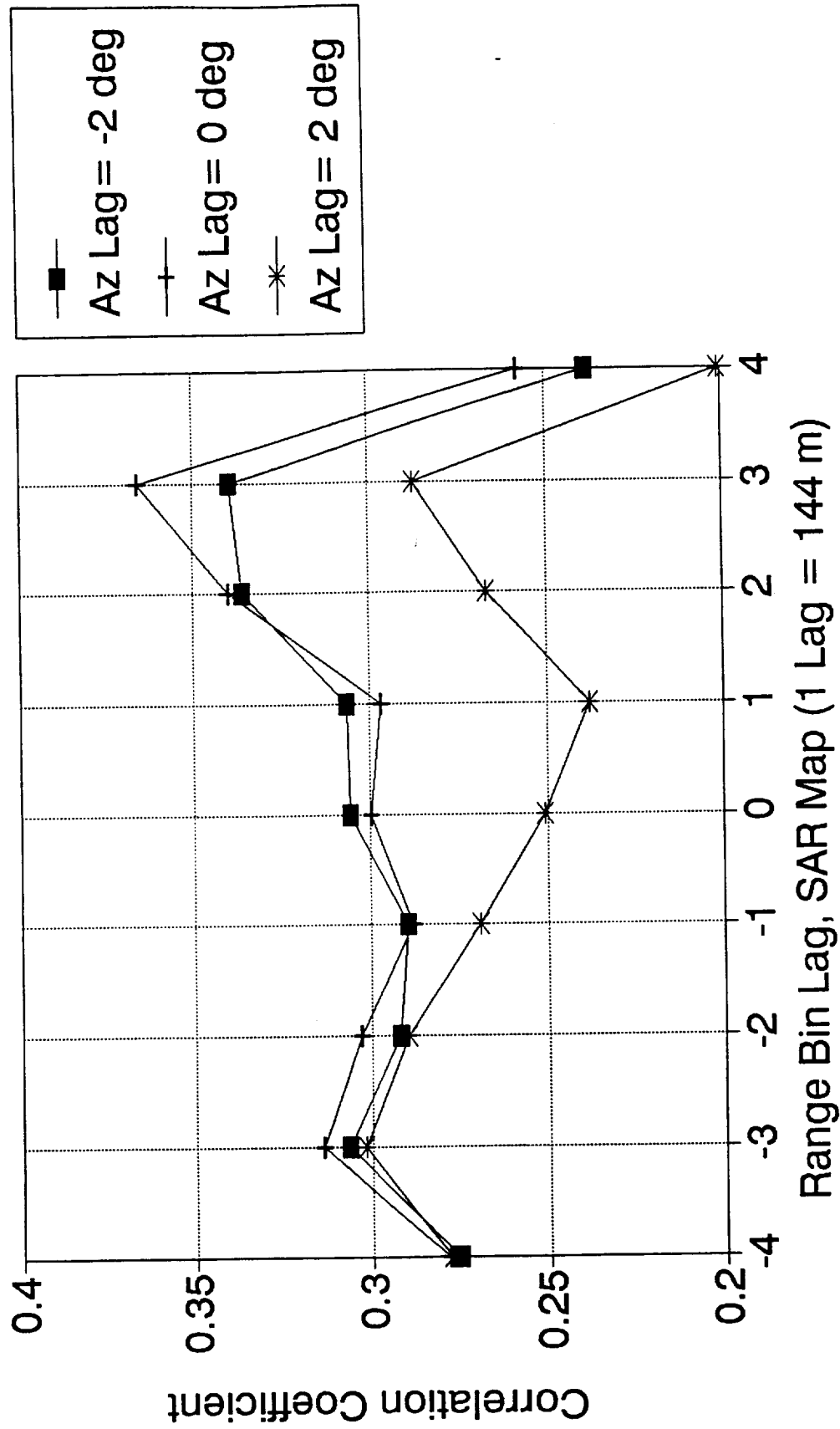

CONCLUSIONS

- **SIMULATION IS EXCELLENT TOOL FOR PREDICTION OF RADAR PERFORMANCE**
- **FOR ACCURATE CLUTTER FROM SAR MAPS IMPROVED INCIDENCE ANGLE CORRECTION ALGORITHMS MUST BE DEVELOPED**
- **USE OF NASA COLLECTED CLUTTER DATA WITH SIMULATED MICROBURSTS MAY PROVE TO BE THE BEST SIMULATION MODE**



Comparison of Simulated and Actual Wind Shear Radar Data Products Questions and Answers

Q: Bruce Matthews (Westinghouse) - I think you have made a case that you have a good simulation of clutter, but how would you include that simulation of clutter into a radar? When would that be adequate?

A: Les Britt (RTI) - You mean to check the radar to certify it or something like that?

Q: Bruce Matthews (Westinghouse) - In your summary you state: "Simulation is an excellent tool for prediction of radar performance." You have just talked about a clutter model. How does that clutter model reflect what the radar equipment is? Do you have models for that also?

A: Les Britt (RTI) - We have in our simulation a baseline radar system which is basically our experimental system. That is what we use. We tried to simulate the flight system as well as we could, and that is our radar model that is in the simulation. The same number of A to D bits and that sort of thing.

Q: Brac Bracalente (NASA Langley) - So I guess you could add somebody else's design in there by proper modifications for their particular radar?

A: Les Britt (RTI) - Yes, if we knew all the parameters we could put someone else's radar model in there.

Q: Bruce Mathews (Westinghouse) - Does NASA recommend the use of the ADWRS clutter simulation with manufacturer furnished parameters as an adequate or reasonable alternative to other means of simulation, such as an RF injection driven by the SAR clutter maps?

A: Les Britt (RTI) - I think this has to do with the certification or system evaluation. I can't speak for NASA, but I doubt if they recommend either one. I don't think anybody knows. I think it is up to the manufacturer or perhaps the RTCA to determine how to evaluate the system.

Q: Jim Evans (MIT) - The clutter power not at the aircraft velocity is a key element of radar simulation performance. How are you modeling transmitter receiver instability residues, and the antenna side lobes with radome on, especially those at negative elevation angles? What experimental measurements have been or will be done to validate the assumptions?

A: Les Britt (RTI) - I will take the second part first. The antenna model used in the simulation is actually a table of measured data taken with the antenna and radome, over plus or minus 90 degrees, in the NASA anechoic chamber. So it includes all the side lobes. The data was taken in two principle planes but it was searched in three dimensions for any spurs or little peaks, and we did find one small peak which is in the data. We modeled a full 3-D pattern using the two principle planes with an interpolation scheme to go between the two principle planes. The first part of the question was the transmitter receiver instability. I brought some slides to show how we do that in the simulation. For each range bin we generate a series of I&Q depending on how many pulses we simulate. Currently it is running around 128. We model the clutter in the return

with a Monte Carlo technique which uses a set of random phased scatterers. Each range bin is divided up into five or six thousand incremental areas, each one assigned a random phase which is held fixed over the 128 pulse variation. The transmitter error is modeled with a random phase error which is currently a white noise model. In other words, it is changed from pulse to pulse in accordance with a normal distribution, which is an input parameter. You input the variance and it pulls out a transmitter phase error which is modeled as a linear function. You can also put a frequency drip in there, if you want to. It is modeled from pulse to pulse. You can get more elaborate with the phase model but that is the one we are currently using. We use an RMS phase error now of 5 degrees. We have run it up to 10 or 20 to see what effect it has, but that is currently what we are using. How is it validated? Basically by estimates from Collins and what have you. We talked to some tube manufacturers when we went through this two or three years ago, to get some number to put in there. It does not represent every transmitter, but we feel like it represents ours fairly well.