

HORIZON AEROSPACE

• 18333 EGRET BAY BOULEVARD, SUITE 300
• HOUSTON, TEXAS, USA 77058 • (713) 333-5944
• TELEFAX (713) 333-3743

91-21
141333
N93-230-803

SPACE BIOLOGY INITIATIVE
PROGRAM DEFINITION REVIEW

TRADE STUDY 3

HARDWARE MINIATURIZATION

vs.
COST

FINAL REPORT

Prepared by:

HORIZON AEROSPACE

L. Neal Jackson, President
John Crenshaw, Sr. Engineer

and

EAGLE ENGINEERING, INC.

W.L. Davidson
F.J. Herbert
J.W. Bilodeau
J.M. Stoval

EAGLE TECHNICAL SERVICES

T. Sutton

Prepared for:

GE GOVERNMENT SERVICES
Houston, Texas
Contract No. G966016-J45

June 1, 1989

Foreword

The "Hardware Miniaturization Versus Cost Trade Study" was performed as part of the Space Biology Initiative (SBI) Definition Trade Studies Contract which is a NASA activity intended to develop supporting data for JSC use in the Space Biology Initiative Definition (Non-Advocate) Review to NASA Headquarters, Code B, scheduled for the June-July, 1989 time period. The task personnel researched, acquired, recorded, and analyzed information relating to miniaturization of space biology equipment. The study data provides parametric information indicating the factors which influence the cost and design for categories and functions of SBI hardware.

This effort is one of four separate trade studies performed by Eagle Engineering, Inc. (EEI). Although the four trade studies address separate issues, the subject of SBI Hardware, the objectives to document the relative cost impacts for the four separate issues, and the intended audience are common for all four studies. Due to factor beyond control of the study management organizations, the trade studies were required to be completed in approximately one half of the originally planned time and with significantly reduced resources. Therefore, EEI immediately decided to use two proven time-and-resource-saving principles in studying these related SBI issues. The first principle employed was commonality. The study methodology was standardized where appropriate, the report formats were made the same where possible, a common database was developed, and the cost analysis techniques development and consultation was provided by a common team member. An additional benefit of this application of commonality with standardized material is to facilitate the assimilation of the study data more easily since the methods and formats will become familiar to the reader. The second principle employed was the phenomenon of the "vital few and trivial many" or sometimes known as the "Pareto principle" (see SBI #96). These are terms which describe the often observed phenomenon that in any population which contributes to a common effect, a relative few of the contributors account for the bulk of the effect. In this case, the effect under analysis was the relative cost impact of the particular SBI issue. If the phenomenon was applicable for the SBI hardware, EEI planned to study the "vital few" as a method of saving time and resources to meet the limitations of the study deadlines. It appears the "vital few and trivial many" principle does apply and EEI adopted the Principle to limit the number of hardware items that were reviewed.

The study was performed under the contract direction of Mr. Neal Jackson, Horizon Aerospace Project Manager. Mr. Mark Singletary, GE Government Services, Advanced Planning and Program Development Office, provided the objectives and policy guidance for the performance of the trade study. The direct study task personnel include:

EEI Project Manager:	Mr. W.L. Davidson (Bill)
Trade Study Manager:	Mr. Frank J. Herbert
Cost Analysis Techniques Leader:	Mr. James W. Bilodeau (Jim)
Visual Materials Support:	Mr. J.M. Stovall (Mike)
Information Management Leader:	Mr. Terry Sutton (Eagle Technical Services)

Table of Contents

Foreword	ii
Table of Contents	iii
List of Figures	v
List of Tables	vi
List of Abbreviations and Acronyms	vii
Glossary and Definitions	ix
1.0 Introduction	1
1.1 Background	1
1.2 Task Statement	1
1.3 Application of Trade Study Results	1
1.4 Scope	1
1.5 Methodology	2
1.5.1 Data And Documentation Survey	2
1.5.2 Database Development	2
1.5.3 Costing Techniques Summary	2
1.5.4 Survey Data Integration	2
1.5.5 Cost Analysis	3
1.6 Definition of Miniaturization	3
1.6.1 Size Reduction	3
1.6.2 Performance	3
2.0 Executive Summary	6
2.1 Assumptions And Groundrules	6
2.2 SBI Candidate Hardware Items For Miniaturization	6
2.3 Miniaturization Cost Impacts	6
2.4 Performance Assessment	7
2.5 Future Work	7
2.6 Conclusion Summary	7
3.0 Trade Study Database	14
3.1 Database Files	14
3.2 Database Management	14
3.3 Database Use	14
4.0 Documentation Survey	15
4.1 Documentation Sources	15
4.1.1 Complete SBI Trade Study Bibliography	15
4.1.2 Trade Study Bibliography For Miniaturization	15

4.2 Documentation Data	15
5.0 Trade Study	22
5.1 Relative Cost Analysis of Previous Hardware	22
5.2 SBI Hardware Sample Selection	22
5.3 SBI Miniaturization Candidate Selection	23
5.4 Miniaturized SBI Hardware Performance Impact Analysis	23
5.4.1 On Orbit Crew Utilization	23
5.4.2 Hardware Diagnostics/Repair	23
5.4.3 Equipment Accuracy	24
5.5 Relative SBI Miniaturization Cost Impact Analysis	24
5.5.1 Empirical Cost Relationships	24
5.5.2 GGS Miniaturization Cost Analysis	24
6.0 Conclusion	31
6.1 Discussion	31
6.2 Important Guidelines	31
6.3 Other Considerations	32
Appendix A - Space Biology Hardware Baseline	A-1
Appendix B - Complete SBI Trade Study Bibliography	B-1
Appendix C - Cost Assessment Techniques Summary	C-1
Appendix D - Data Base Definition	D-1
Appendix E - Detailed Hardware Description	E-1

List of Figures

Figure 1.5 Space Biology Initiative Definition Review Trade Study Logic Flow	5
Figure 5.3 Gas-Grain Simulation Facility	30

List of Tables

Table 1.4 SBI Hardware Categories and Functions	4
Table 2.1-1 Common SBI Trade Study Assumptions and Groundrules	8
Table 2.1-2 Miniaturization Trade Study Assumptions and Groundrules	9
Table 2.2-1 93 / 34 Analysis for SBI Hardware	10
Table 2.2-2 Possible Candidate List for Miniaturization	11
Table 2.2-3 Best Possible Candidate List for Miniaturization	12
Table 2.5 Miniaturization Analysis	13
Table 4.1.2 Bibliography for Miniaturization Trade Study	16
Table 5.2-1 Database Listing of SBI Hardware Vital to Program Cost Impact Analysis	26
Table 5.2-2 Database Listing for Miniaturization Sample Selection Assessment	27
Table 5.2-3 Database Listing of Miniaturization Candidate Sample Set	28
Table 5.3 Exobiology Facility/GGS - Miniaturization Analysis	29

List of Abbreviations and Acronyms

AI	Artificial Intelligence
ARC	Ames Research Center
BmRP	Biomedical Research Project (Human/Crew Members)
BRP	Biological Research Project (Non Human/Rodents, primates or plants)
BPMF	Bioinstrumentation & Physiological Monitoring Facility
BSHF	Biological Specimen Holding Facility
CAD	Computer Aided Design
CDR	Critical Design Review
CELSS	Closed Ecological Life Support System
ChEC	Crew Health Care
COTS	Commercial Off-The-Shelf
CR	Change Request
DDT&E	Design, Development, Test and Evaluation
DMS	Data Management System
DRI	Denver Research Institute
ECF	Exercise Countermeasure Facility
ECLSS	Environmental Control and Life Support System
EDCO	Extended Duration Crew Operations
EHS	Environmental Health System
EPDS	Electrical Power Distribution System
FEAST	Flight Early Acquisition Systems Test
FSU	Functional Support Unit
GGs	Gas Grain Simulator
HMF	Health Maintenance Facility
HPLC	High Performance Liquid Chromatography
HQUL	Hardware Quantity and Usage List
HRF	Human Research Facility
JSC	Johnson Space Center
KSC	Kennedy Space Center
LAN	Local Area Network
LSE	Laboratory Support Equipment
LSLE	Life Sciences Laboratory Equipment
LSRF	Life Science Research Facility
MDE	Mission Dependent Equipment
MDU	Medical Development Unit
MLI	Multi-Layer Insulation
MRDB	Mission Requirements Data Base
MSK	Major Subcontractor
NASA	National Aeronautics and Space Administration
NSTS	NASA Space Transportation System
OTS	Off-The-Shelf
PI	Principal Investigator
PMC	Permanent Manned Capability
PMS	Pulmonary Monitoring System
POCC	Payload Operations Control Center

RMOAD	Reference Mission Operational Analysis Document
SAIS	Science & Applications Information System
SBHB	Space Biology Hardware Baseline
SBI	Space Biology Initiative
SSF	Space Station Freedom
SSFP	Space Station Freedom Program
SSIS	Space Station Information Systems
TDRSS	Tracking and Data Relay Satellite System
TFU	Theoretical First Unit
WAN	Wide Area Network

Glossary and Definitions

Assembly

An accumulation of subassemblies and/or components that perform specific functions within a system. Assemblies can consist of subassemblies, components, or both.

Certification

The process of assuring that experiment hardware can operate under adverse Space Station Freedom environmental conditions. Certification can be performed by analysis and/or test. The complete SSFP definition follows. Tests and analysis that demonstrate and formally document that all applicable standards and procedures were adhered to in the production of the product to be certified. Certification also includes demonstration of product acceptability for its operational use. Certification usually takes place in an environment similar to actual operating conditions.

Certification Test Plan

The organized approach to the certification test program which defines the testing required to demonstrate the capability of a flight item to meet established design and performance criteria. This plan is reviewed and approved by cognizant reliability engineering personnel. A quality engineering review is required and comments are furnished to Reliability.

Component

An assembly of parts, devices, and structures usually self-contained, which perform a distinctive function in the operation of the overall equipment.

Experiment

An investigation conducted on the Space Station Freedom using experiment unique equipment, common operational equipment of facility.

Experiment Developer

Government agency, company, university, or individual responsible for the development of an experiment/payload.

Experiment unique hardware

Hardware that is developed and utilized to support the unique requirements of an experiment/payload.

Facility

Hardware/software on Space Station Freedom used to conduct multiple experiments by various investigators.

Flight Increment

The interval of time between shuttle visits to the Space Station Freedom. Station operations are planned in units of flight increments.

Flight increment planning

The last step in the planning process. Includes development of detailed resource schedules, activity templates, procedures and operations supporting data in advance of the final processing, launch and integration of payloads and transfer of crew.

Ground operations

Includes all components of the Program which provide the planning, engineering, and operational management for the conduct of integrated logistics support, up to and including the interfaces with users. Logistics, sustaining engineering, pre/post-flight processing, and transportation services operations are included here.

Increment

The period of time between two nominal NSTS visits.

Interface simulator

Simulator developed to support a particular Space Station Freedom or NSTS system/subsystem interface to be used for interface verification and testing in the S&TC and/or SSPF.

Integrated logistics support

Includes an information system for user coordination, planning, reviews, and analysis. Provides fluid management, maintenance planning, supply support, equipment, training, facilities, technical data, packaging, handling, storage and transportation. Supports the ground and flight user requirements. The user is responsible for defining specific logistics requirements. This may include, but not be limited to resupply return in term of frequency, weight, volume, maintenance, servicing, storage, transportation, packaging, handling, crew requirements, and late and early access for launch site, on-orbit, and post-mission activities.

Integrated rack

A completely assembled rack which includes the individual rack unique subsystem components. Verification at this level ensures as installed component integrity, intra-rack mechanical and electrical hookup interface compatibility and mechanisms operability (drawer slides, rack latches, etc.).

Integration

All the necessary functions and activities required to combine, verify, and certify all elements of a payload to ensure that it can be launched, implemented, operated, and returned to earth successfully.

Orbit replaceable unit (ORU)

The lowest replaceable unit of the design that is fault detectable by automatic means, is accessible and removable (preferably without special tools and test equipment or highly skilled/trained personnel), and can have failures fault-isolated and repairs verified. The ORU is sized to permit movement through the Space Station Freedom Ports.

Payload integration activities

Space Station Freedom payload integration activities will include the following:

Pre-integration activities shall include receiving inspection, kitting, GSE preps and installation, servicing preps and servicing, post deliver verification, assembly and staging (off-line labs), rack and APAE assembly and staging, alignment and post assembly verification.

Experiment integration activities shall include experiment package installation into racks, deck carriers, platforms, etc., and payload to Space station interface verification testing. When the Freedom element is available on the ground, Space Station Freedom integration activities (final interface testing) shall include rack or attached payload installation into Freedom element (e.g., pressurized element, truss structure, platform) and shall include payload-to-element, interface verification, followed by module, truss, or platform off-loading of experiments, as required, for launch mass for follow-on increments, Space Station Freedom integration activities shall include rack or attached payload installation into the logistics element and verification of the payload-to-logistics element interface.

Integration activities (final interface testing) shall include: rack or attached payload installation into Space Station Freedom element (e.g., lab module, truss structure, platform) on the ground, when available, and shall include payload to element interface verification, configure and test for station to station interface verification, followed by module, truss or platform off-loading of experiments, as required, for launch mass.

Launch package configuration activities shall include configuring for launch and testing station to NSTS interfaces, (if required), stowage and closeout, hazardous servicing, (if required), and transport to the NSTS Orbiter.

NSTS Orbiter integrated operations activities shall include insertion of the launch package into the orbiter, interface verification (if required), pad operations, servicing, closeout, launch operations, and flight to Space Station Freedom.

On-orbit integration activities shall include payload installation and interface verification with Space Station Freedom.

Hardware removal that includes rack-from-module and experiment-from-rack removal activities.

Payload life cycle

The time which encompasses all payload activities from definition, to development through operation and disbursement.

Permanent manned capability (PMC)

The period of time where a minimum of capabilities are provided, including required margins, at the Space Station Freedom to allow crews of up to eight on various tour durations to comfortably and safely work in pressurized volumes indefinitely. Also includes provisions for crew escape and EVA.

Physical integration

The process of hands-on assembly of the experiment complement; that is, building the integrated payload and installing it into a standard rack, and testing and checkout of the staged payload racks.

Principal Investigator

The individual scientist/engineer responsible for the definition, development and operation of an experiment/payload.

Rack staging

The process of preparing a rack for experiment/payload hardware physical integration: encompasses all pre-integration activities.

Space Station Freedom

The name for the first United States permanently manned space station. It should always be interpreted as global in nature, encompassing all of the component parts of the Program, manned and unmanned, both in space and on the ground.

Subassembly

Two or more components joined together as a unit package which is capable of disassembly and component replacement.

Subsystem

A group of hardware assemblies and/or software components combined to perform a single function and normally comprised of two or more components, including the supporting structure to which they are mounted and any interconnecting cables or tubing. A subsystem is composed of functionally related components that perform one or more prescribed functions.

Verification

The process of confirming the physical integration and interfaces of an experiment/payload with systems/subsystems and structures of the Space Station Freedom. The complete SSFP definition follows. A process that determines that products conform to the design specification and are free from manufacturing and workmanship defects. Design consideration includes performance, safety, reaction to design limits, fault tolerance, and error recovery. Verification includes analysis, testing, inspection, demonstration, or a combination thereof.

1.0 Introduction

1.1 Background

The JSC Life Sciences Project Division has been directly supporting NASA Headquarters, Life Sciences Division, in the preparation of data from JSC and ARC to assist in defining the Space Biology Initiative (SBI). GE Government Services and Horizon Aerospace have provided contract support for the development and integration of review data, reports, presentations, and detailed supporting data. An SBI Definition (Non-Advocate) Review at NASA Headquarters, Code B, has been scheduled for the June-July 1989 time period. In a previous NASA Headquarters review, NASA determined that additional supporting data would be beneficial in clarifying the cost factors and impact in the SBI of miniaturizing appropriate SBI hardware items. In order to meet the demands of program implementation planning with the definition review in late spring of 1989, the definition trade study analysis must be adjusted in scope and schedule to be complete for the SBI Definition (Non-Advocate) Review.

1.2 Task Statement

The objective of this study is to determine the optimum hardware miniaturization level with the lowest cost impact for space biology hardware. Space biology hardware and/or components/subassemblies/assemblies which are the most likely candidates for application of miniaturization are to be defined and relative cost impacts of such miniaturization are to be analyzed. The study will provide a mathematical or statistical analysis method with the capability to support development of parametric cost analysis impacts for levels of production design miniaturization.

1.3 Application of Trade Study Results

The SBI cost definition is a critical element of the JSC submission to the SBI Definition (Non-Advocate) Review and the results of this study are intended to benefit the development of the SBI costs. It is anticipated that the GE PRICE cost estimating model will be used to assist in the formulation of the SBI cost definition. The trade study results are planned to be produced in the form of factors, guidelines, rules of thumb, and technical discussion which provide insight on the effect of miniaturization on the relative cost of the SBI hardware. The SBI cost estimators are required to define input parameters to the PRICE model which control the cost estimating algorithms. These trade study results can be used as a handbook of miniaturization cost effects by the SBI cost estimators in developing and defining the required PRICE input parameters.

1.4 Scope

The space biology hardware to be investigated has been defined and baselined in Appendix A which is titled Space Biology Hardware Baseline (SBHB). By study contract direction, no other space biology hardware has been considered. The complexity and importance of the subject could warrant an extensive study if unlimited time and resources were available. However, due to the practical needs of the real program schedule and budget, the depth of study has been adjusted to satisfy the available resources and time. In particular, cost analyses have emphasized the determination of influential factors and parametric relationships rather than developing

detailed, numerical cost figures. While program objectives and mission requirements may be stable in the early program phases, hardware end item specifications are evolving and may change many times during the design process. For this reason, the trade study analyses have focused on the category and function of each hardware item (Table 1.4) rather than the particular, current definition of the item. In the process of acquiring trade study data, certain information could be considered a snapshot of the data at the time it was recorded for this study. The data have been analyzed as defined at the time of recording; no attempt has been made to maintain the currency of acquired trade study data.

1.5 Methodology

The methodology used in performing the Miniaturization Trade Study, shown in Figure 1.5, consists of the initial, important phase of search and acquisition of related data; followed by a period of data integration and analysis; and, finally, the payoff phase where candidate items and implementation factors are identified.

1.5.1 Data And Documentation Survey

A literature review and database search were conducted immediately upon study initiation. Information pertaining to the miniaturization of commercial and space flight research hardware was considered for applicability to the study task.

1.5.2 Database Development

An analysis of the trade study data needs was performed to provide an understanding of the logical database design requirements. Based on the knowledge gained in the database analysis, the trade study data structures were developed and implemented on a computer system. The pertinent information collected from the data and documentation survey was input to the trade study database.

1.5.3 Costing Techniques Summary

Costing techniques used in previous projects were surveyed and historical cost factors were collected for review of applicability to this trade study. The applicable data were identified for use in cost analysis to demonstrate relative cost impacts of miniaturization for space biology technology hardware.

1.5.4 Survey Data Integration

The Space Biology Hardware Baseline was reviewed and the hardware that had potential for miniaturization was identified as candidates for miniaturization. The technical data collected from the survey was integrated with the Space Biology Hardware Baseline and an analysis of candidates, specifications, cost, and miniaturization applications was performed.

The initial survey data analysis was performed to select a sample of the SBHB items which could be potential candidates for miniaturization. With limited study time and a SBHB of 93 items, a method was needed to separate the items which could have the most cost impact and

were worthy of study resource application. The "vital few and trivial many" method (SBI #96) was used. This method applies the principle that in any population which contributes to a common effect (cost), a relative few of the contributors account for the bulk of the effect (cost). All SBHB items were listed in descending order of probable acquisition cost. Weight was used as an indication of probable acquisition cost based on historical experience in previous space programs. It was found that 34 percent of the items (32 items) accounted for 93 percent of the mass or probable cost (Table 5.2). Therefore, consideration was immediately limited to these 32 items. The miniaturization candidate sample set was chosen from Table 5.2 based on amenability to miniaturization.

The sample set was then subjected to a more detailed analysis to determine important factors relative to miniaturization and to select the most representative candidate for final analysis. By this process, a reasonable effort could be devoted to analyze one example case more thoroughly.

1.5.5 Cost Analysis

Analyses were performed to demonstrate the relative cost impact to miniaturize the candidate items. Additional study was dedicated to the final selected item. Based on this analysis, the relative relationship of miniaturizing space biology hardware to cost was assessed.

1.6 Definition of Miniaturization

1.6.1 Size Reduction

The miniaturization of a hardware item will be designated in terms of percentage. The range of percentage miniaturization will normally vary between 10% and 90% in increments of 10%. The miniaturization in this trade study will deal with weight reduction as the size of a hardware item is reduced. That is a 10% miniaturization means a 100 kg item will be reduced to 90 kg. We will also assume that volume will be reduced 10% (i.e. 100 M³ would be reduced to 90 M³).

1.6.2 Performance

The SBI hardware item, after miniaturization, (10% or 90%) must meet or exceed the original performance requirements as set by the Principle Investigator (PI). There may be a new technological development that reduces the size of the various parts within a hardware item. However, if the hardware fails to be compatible with other units or in providing accurate results then the miniaturization is of no benefit.

Table 1.4 SBI Hardware Categories and Functions

<u>SBI HARDWARE CATEGORIES</u>	<u>FUNCTIONS (Applicable to each Category)</u>
Cardiovascular	Analysis
Cytology	Calibration
Environmental Monitoring	ELSS
Exobiology	Collection
Hematology	Health Maintenance
Histology	Measurement
Logistics	Preparation
Miscellaneous	Stowage
Neurophysiology	
Plant Sciences	
Pulmonary	
Surgical Science	
Urology	

Figure 15-1 Space Biology Initiative Definition Review Trade Study Logic Flow

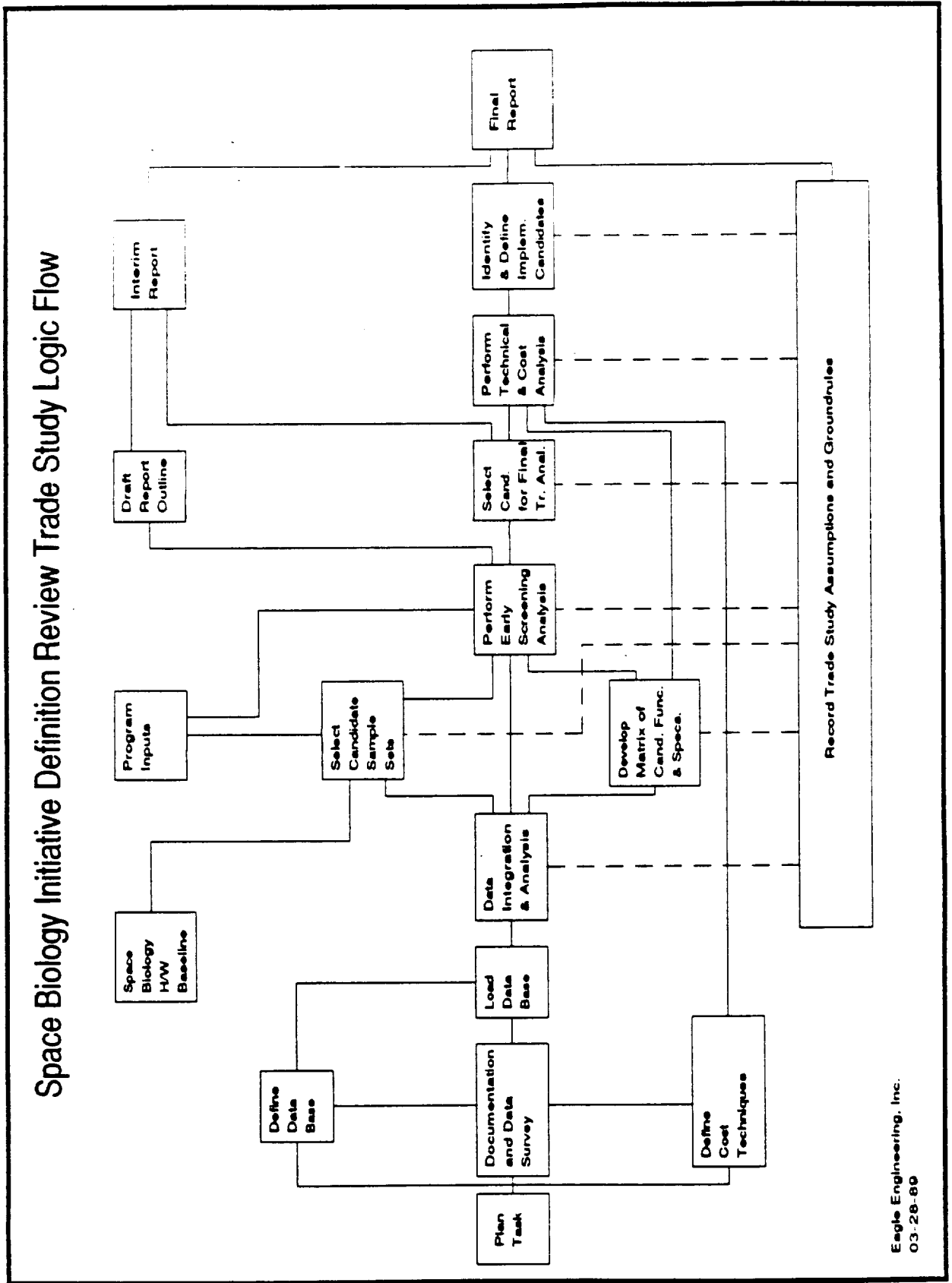

2.0 Executive Summary

2.1 Assumptions And Groundrules

In the process of performing the subject trade study, certain data or study definition was not available or specified. Assumptions and groundrules have been established to document, for the purposes of this trade study, the definition of important information which is not a definite fact or is not available in the study time period. Major assumptions and groundrules which affect the four EEI trade studies are provided in a list common to all of the studies (Table 2.1-1). The assumptions which primarily affect the miniaturization study are documented in a separate list (Table 2.1-2).

2.2 SBI Candidate Hardware Items For Miniaturization

The baseline candidate list of 93 SBI hardware items is shown in Appendix A with an "S" by each item. Space flight history has established that project costs are most significantly affected by space equipment weight. To determine which SBI hardware warranted the most study resources, the SBI hardware list was prioritized by mass (Table 2.2-1 repeated from Table 5.2-1) showing the top 32 items which represent 93% by mass, 87% by volume and 85% by power (watts) of the total 93 items. The 32 hardware items in Table 2.2-1 were reviewed and selective judgments were recorded on the potential for miniaturization (Table 2.2-2 repeated from Table 5.2-2). The list in Table 2.2-2 was then reviewed and reduced by dropping those items with insufficient definition and those items which may only have a potential for being reduced in size by 0 - 10%. The miniaturization candidate sample set listing the best possible 20 candidates for miniaturization is provided in Table 2.2-3 (repeated from Table 5.2-3).

2.3 Miniaturization Cost Impacts

The gas grain simulator (hardware item 169) was selected from the candidate sample set for an indepth analysis. Using Appendix E and the gas grain simulator (GGS) information as shown in Section 5, a relative cost impact factor was developed for each of the 8 assemblies of this GGS (Table 5.3). The relative cost factors (design factor and complexity are discussed in Appendix C) shown in Table 5.3 are subjective and a small change in these factors has a profound change on the relative cost factor for miniaturization. For example, the GGS assembly III, Aerosol, and assembly V, Spectrometry, have the same mass and the same amount of miniaturization. However, due to a difference in factors (n and df) the relative cost for miniaturization is totally different. Assembly III, is a 13% increase while assembly V is a decrease of .03% in relative cost for miniaturization.

Table 2.3 shows the final analysis of the GGS along with the other 3 top SBI hardware items. The GGS was chosen for detailed analysis due to the total mass and the availability of data. The mass percent column was added to this Table 2.3 to show the method of calculating the prorated cost percent. (Mass Percent times the cost factor % equals the cost prorata %.) Those subsystems with less than 10% miniaturization were not considered in this calculation and, therefore, do not show up in the cost prorata. The overall cost increase as shown in Table 2.3 and 5.3 indicates that the GGS would have a 5.16% increase in cost for miniaturizing some of the individual subsystems.

The results of this trade study, though somewhat limited in scope, indicate that miniaturization will almost invariably increase cost. The greater the degree of change required to achieve miniaturization, the greater will be the cost. However, a large degree of the redesign cost increase for miniaturization can be offset by virtue of weight reduction.

2.4 Performance Assessment

The groundrule has been established that the equipment performance specifications must be satisfied with any method chosen for hardware implementation. Therefore, the performance and accuracy of the equipment should not be an issue. The various components within the subsystems of the GGS may not be compatible with being miniaturized without affecting performance. There is always a risk with new technology and new equipment that the final performance would be degraded with miniaturization. The components of the subsystem as well as the performance of the entire hardware unit must be compatible.

2.5 Future Work

The analysis shown in Table 2.3 for the GGS can be done for all the hardware items to estimate the cost impact for miniaturization.

The life cycle cost relationship was not addressed in this trade study; however, future trade studies should address the effects.

The hardware items that have common components and the feasibility of miniaturizing a common component would be a tremendous cost savings.

Future trade studies should look at all related medical/science programs (i.e. CHeC, etc.) for miniaturization.

2.6 Conclusion Summary

Miniaturization of SBI hardware that is complex will generally add to the cost of development. The heavier items (Mass) will give the greatest potential return for miniaturizing. Miniaturizing may allow more experiments to be placed on-board SSF than had previously been planned. Life cycle cost impacts were not added in this trade study, but should be for future studies. Weight restrictions for the total SSF payload may require miniaturization to reduce the weight and volume of a specific hardware item or it will not be flown.

Table 2.1-1 Common SBI Trade Study Assumptions and Groundrules

- 1) Where project, hardware, and operations definition has been insufficient, detailed quantitative analysis has been supplemented with assessments based on experienced judgement of analysts with space flight experience from the Mercury Project through the current time.
- 2) Space flight hardware cost is primarily a function of weight based on historical evidence.
- 3) The effects of interrelationships with space biology and life science hardware and functions other than the SBI baseline hardware are not considered in the trade study analyses.
- 4) Trade study information, once defined during the analysis for the purpose of establishing a known and stable baseline, shall not be changed for the duration of the trade study.
- 5) Hardware life cycle costs cannot be studied with quantitative analyses due to the unavailability of definition data on hardware use cycles, maintenance plans, logistics concepts, and other factors of importance to the subject.
- 6) The SBI hardware as identified is assumed to be designed currently without any special emphasis or application of miniaturization, modularity, commonality, or modified commercial off-the-shelf adaptations.
- 7) It is assumed that the required hardware performance is defined in the original equipment specifications and must be satisfied without regard to implementation of miniaturization, modularization, commonality, or modified commercial off-the-shelf adaptations.

Table 2.1-2 Miniaturization Trade Study Assumptions and Groundrules

- 1) Availability of data on hardware definition was a factor in selecting the best possible miniaturization candidates.
- 2) Absence of specific equipment historical data required using empirical data for cost analysis.

Item #	Hardware Name #	Hardware Item Name	Mass		Power		Volume	
			Kg	Accumul.	(Watts)	Accumul.	M ³	Accumul.
1	168	CELSS	1000	1000	1300	1300	1.92	1.92
2	169	Gas Grain Simulator	800	1800	1500	2800	1.92	3.84
3	84	Soft Tissue Imaging System	300	2100	800	3600	.96	4.80
4	77	Hard Tissue Imaging System	136	2236	300	3900	.29	5.09
5	126	Scintillation Counter	90	2326	500	4400	.24	5.33
6	74	Force Resistance System	70	2396	100	4500	.40	5.73
7	145	Automated Microbic System	70	2466	110	4610	.20	5.93
8	155	Total Hydrocarbon Analyzer	70	2536	250	4860	.20	6.13
9	161	Inventory Control System	70	2606	500	5360	.20	6.33
10	162	Lab Materials Pack & Hand. Equip.	70	2676	500	5860	.20	6.53
11	163	Test/Checkout/Calibration Instrumentation	70	2746	200	5860	.20	6.73
12	106	Neck Baro-Cuff	45	2791	145	6205	.13	6.86
13	113	Blood Gas Analyzer	45	2836	250	6455	.13	6.99
14	61	Mass Spectrometer	41	2897	200	6655	.09	7.08
15	112	Plant HPLC Ion Chromatograph	40	2917	200	6855	.12	7.2
16	147	Head Torso Phantom	32	2949	0	6855	.12	7.32
17	63	Pulmonary Gas Cylinder Assem.	30	2979	0	6855	.09	7.41
18	110	Plant Gas Chromatograph/Mass Spectro- meter	25	3004	100	6955	.20	7.61
19	115	Chemistry System	23	3027	100	7055	.08	7.69
20	138	Hematology	23	3050	200	7255	.07	7.76
21	34	Sample Preparation Device	22	3072	150	7405	.17	7.93
22	165	Experiment Control Computer System	20	3092	400	7805	.05	7.98
23	62	Pulmonary Function Equip Stor. Assem.	20	3112	0	7805	.05	8.03
24	82	Motion Analysis System	20	3132	100	7905	.05	8.08
25	99	Animal Biotelemetry System	20	3152	100	8005	.05	8.13
26	100	Blood Pressure & Flow Instrumentation	20	3172	200	8205	.06	8.19
27	109	Venous Pressure Transducer/Display	20	3192	100	8305	.05	8.24
28	129	Cell Handling Accessories	20	3212	50	8355	.05	8.29
29	57	Bag-in-Box	19	3231	0	8355	.15	8.44
30	111	Plant Gas Cylinder Assem.	19	3250	0	8355	.09	8.53
31	119	Gas Cylinder Assembly	19	3269	50	8405	.09	8.62
32	130	Cell Harvester	19	3288	50	8455	.06	8.68
93 SBI H/W Items			89 Items have 3535 kg mass	10.0M³ of volume	10,359 watts of power	4 Items are TBD (all are small)		

Table 2.2-1 List of SBI Hardware Vital to Program Cost Impact Analysis

Item # Prioritized by Mass	Hardware Item #	Hardware Item Name	Sufficient Data Available	Miniaturization Level (Percent)				Assessment Confidence Level
				0-10	10-20	20-50	50+	
1	168	CELSS				X		High
2	169	Gas Grain Simulator Facility			X			X
3	84	Soft Tissue Imaging System	No					
4	77	Hard Tissue Imaging System	No					
5	126	Scintillation Counter		X				X
6	74	Force Resistance System		X				X
7	145	Automated Microbic System			X			
8	155	Total Hydrocarbon Analyzer	No					
9	161	Inventory Control System			X			X
10	162	Lab Materials Pack & Hand. Equip.		X				X
11	163	Test/Checkout/Calibration Instrumentation			X			X
12	106	Neck Baro-Cuff			X			X
13	113	Blood Gas Analyzer	No					
14	61	Mass Spectrometer		X				X
15	112	Plant HPLC Ion Chromatograph	No					
16	147	Head Torso Phantom			X			X
17	63	Pulmonary Gas Cylinder Assem.		X				X
18	110	Plant Gas Chromatograph/Mass Spec			X			X
19	115	Chemistry System		X				X
20	138	Hematology		X				X
21	34	Sample Preparation Device						
22	165	Experiment Control Computer System			X			X
23	62	Pulmonary Function Equip Stor. Assem.		X				X
24	82	Motion Analysis System			X			X
25	99	Animal Biotelemetry System		X				X
26	100	Blood Pressure & Flow Instrumentation	No					
27	109	Venous Pressure Transducer/Display			X			X
28	129	Cell Handling Accessories						
29	57	Bag-in-Box		X				X
30	111	Plant Gas Cylinder Assem.	No					
31	119	Gas Cylinder Assembly						
32	130	Cell Harvester			X			X

Table 2.2-2 Miniaturization Assessment Review for Sample Selection

Item # Prioritized by Mass	Hardware Item #	Hardware Item Name	Miniaturization Level (Percent)			Assessment Confidence Level	
			10-20	20-50	50+	Low	High
1	168	CELSS		X			X
2	169	Gas Grain Simulator Facility		X			X
5	126	Scintillation Counter	X			X	
6	74	Force Resistance System	X			X	
7	145	Automated Microbic System		X			X
9	161	Inventory Control System		X			X
11	163	Test/Checkout/Calibration Instrumentation		X		X	
12	106	Neck Baro-Cuff		X			X
14	61	Mass Spectrometer	X			X	
16	147	Head Torso Phantom	X				X
18	110	Plant Gas Chromatograph/Mass Spec	X			X	
19	115	Chemistry System	X			X	
20	138	Hematology	X			X	
22	165	Experiment Control Computer System		X			X
24	82	Motion Analysis System		X			X
25	99	Animal Biotelemetry System					X
27	109	Venous Pressure Transducer/Display	X			X	
28	129	Cell Handling Accessories	X				X
29	57	Bag-In-Box	X			X	
32	130	Cell Harvester		X		X	

Table 2.2-3 Miniaturization Candidate Sample Set

H/W Item #	Priority # by Mass	H/W Item Name	Lowest Assembly Component Level Possible	Mass (kg)	Mass Percent	Percent Miniaturization	Relative Cost Factor %	Cost Pro-rated %
168	1	CELSS*	Modified Plant Growth Gas & Liquid Handling Water Condensation Nutrient Delivery Crop Research Chamber-seed Germ.	27. 27. 27. 27. 635. 7. 750.				
169	2	TOTAL GGS	Chamber Environment Mont. Aerosol Gen. Optics/Imaging Spectrometry Particle Computer Storage	200. 80. 150. 80. 150. 50. 50. 40. 800.	25. 10. 18.75 10. 18.75 6.25 6.25 5. 100.	<10 30 30 <10 30 10 30 10	+16 +13 - (-.03) +15 +13 (-.01)	1.6 2.43 . (-.56) .93 .81 (-.05) 5.16
84	3	Soft Tissue Imaging TOTAL		300.				
77	4	Hard Tissue Imaging TOTAL		136.				
Notes: * Revised mass figures as of 5/5/89								

Table 2.3 Miniaturization Cost Impact Analysis

3.0 Trade Study Database

The trade study database has been implemented on the dBase IV program by Ashton-Tate. The database definition including a database dictionary is provided in Appendix D.

3.1 Database Files

Four types of dBASE IV files were created for the Space Biology Initiative (SBI) Trade Studies database. These files are database files, index files, report files and view files. Database files have the file name extension dbf. A database file is composed of records and records comprise fields which contain the data. Index files have the file name extension ndx. Index files are used to maintain sort orders and to expedite searches for specific data. Report files have the file name extension frm. Report files contain information used to generate formatted reports. View files contain information used to relate different database (dbf) files. View files link different database files into a single view file.

3.2 Database Management

The development of the SBI Trade Studies database consist of two major steps, logical database development and physical database development. Defining attributes and relationships of data was the major emphasis of the logical database development. The attributes and relationships of the data were determined after analysis of available data and consultation with other SBI team members. Based on the knowledge from the logical database development, the physical structure of the database was developed and implemented on a computer. Setting up the database on a computer was the second major development process. The first step of this process was to determine how to store the data. dBASE IV allows data to be stored as character, numeric, date or logical data types. The second step was to create the database files. After the database files were created, the actual data was entered. For a complete listing of the database structures see Appendix D.

3.3 Database Use

To the maximum extent possible, data generated in performance of this trade study was stored in the database. This approach not only facilitated analysis and comparison of trade data, but also enabled the efficient publication and editing of tables and figures in the study report. In addition, the data are available in the database for future evaluation using different screening logic and report organization.

4.0 Documentation Survey

An extensive survey was made to collect all the latest information pertaining to miniaturization and associated cost experience. Library searches were made using titles, authors, key words, acronyms, phrases, synonyms, time periods and any possible activities related to miniaturization. Interviews with personnel (both in-person and by telephone) having knowledge of the study subject were made throughout the initial portion of the study.

4.1 Documentation Sources

4.1.1 Complete SBI Trade Study Bibliography

The complete list of all references used in the four Eagle Engineering, Inc. trade studies is provided in Appendix B. A unique EEI SBI reference index number has been assigned to each information source.

4.1.2 Trade Study Bibliography For Miniaturization

Particular reference information from Appendix B that is of special importance to miniaturization is repeated in Table 4.1.2. All references were used to gain background information for the final analysis of the candidate selection and for the degree of miniaturization.

4.2 Documentation Data

The Physiological Monitoring System (PMS) used on Skylab had unique monitoring sensors. These sensors had built-in microminiaturized amplifiers that were developed by the Denver Research Institute (DRI). These amplifiers were developed under the management of NASA JSC and were microminiaturized specifically for the PMS. These same basic sensors with the microminiaturized amplifiers are to be used for the SBI Bioinstrumentation & Physiological Monitoring Facility (BPMF) (Group 3 in Appendix A). See reference SBI-69 & 70. However, no cost information was available to indicate the cost required to accomplish the PMS miniaturization. No documentation could be located that dealt directly with miniaturization and the related relative cost of miniaturizing. The literature did not reveal any reference to cost factors nor did any of the interviews reveal any reference to cost factors.

Table 4.1-2 Bibliography for Miniaturization Trade Study

ID #	AUTHOR	TITLE	VOL. NO.	PUBLISHER	REPORT/DOCUMENT NUMBER	PUBLISHER LOCATION	DATE
SB101	Kozarsky, D.	MUS Inputs		Lockheed Life Sciences Program Office	Lockheed Memo	Washington, DC	01/19/89
SB102	Kozarsky, D.	Latest Space Station Rack Studies		NASA MSFC		Huntsville, AL.	02/02/89
SB103	Holt, A.	PMWG-SS Freedom Assly. Seq. Trial Pyl. Manifest		Payload Manifest Working Group (PMWG)		Reston, VA.	12/09/88
SB104	Shannon, J.	Business Practice Low Cost System Activity		NASA JSC		Houston, TX.	11/12/75
SB111	NASA	Reference Mission Operational Analysis Document (RMOAD) For The Life Sciences Research Facilities.		NASA JSC	NASA TM B9604	Houston, TX.	02/01/87
SB112	Breiling, R.	Cost Risk Analysis Using Price Models		RCA Price Systems		Moorestown, NJ.	09/01/87
SB113	Fogleman, G.Schwartz, D.Fonda, M.	Gas Grain Simulation Facility: Fundamental Studies of Particle Formation And Interactions	1	NASA Ames Research Center	NASA ARC/SSS 88-01	Moffet Field, CA.	08/31/87
SB114	JPL	Flight Projects Office Payload Classification Product Assurance Provisions		JPL	JPL D-1489 Rev. A	Pasadena, CA.	04/30/87
SB115	PRC Systems	Cost Estimate For The Search for Extraterrestrial Intelligence (SETI) Revised		PRC Systems Services		Huntsville, AL.	06/15/87
SB116	NASA SSPO	Space Station Commonality Process Requirements Rev.B		NASA SSPO	SSP 30285 Rev. B	Reston, Virginia	09/15/88

Table 4.1-2 Bibliography for Miniaturization Trade Study

ID #	AUTHOR	TITLE	VOL. PUBLISHER NO.	PUBLISHER	REPORT/DOCUMENT NUMBER	PUBLISHER LOCATION	DATE
SB117	Webb, D.	Technology Forecasting Using Price - H		Rockwell International		Anaheim, CA.	04/17/86
SB118	NASA	Classification Of NASA Office Of Space Science And Applications (OSSA) Space Station Payloads		NASA JSC		Houston, TX.	/ /
SB119	NASA	Life Science Research Objectives And Representative Experiments For The Space Station (Green Book)		NASA Ames Life Science Division		Moffet Field, CA.	01/01/86
SB120	NASA	Medical Requirements Of An In-Flight Medical System For Space Station		NASA JSC	JSC 31013	Houston, TX.	11/30/87
SB121	TRW	A Study Of Low Cost Approaches To Scientific Experiment Implementation For Shuttle Launched And Serviced Automated Spacecraft		TRW Systems Group	Contract NASM - 2717	Redondo Beach, CA.	03/19/89
SB122	LMSC	Low-Cost Program Practices For Future NASA Space Programs		LMSC	LMSC-D387518	Sunnyvale, CA.	05/30/74
SB123	Steward, L GMiller, L	Biomedical Equipment Technology Assessment For The Science Laboratory Module		Management and Technical Services Company		Houston, TX.	08/01/86
SB124	General Electric	WP-3 Commonality Plan		General Electric	NASS-32000	Philadelphia, PA	04/22/88
SB125	NASA	Microbiology Support Plan For Space Station		NASA JSC	JSC-32015	Houston, TX.	09/01/86

Table 4.1-2 Bibliography for Miniaturization Trade Study

ID #	AUTHOR	TITLE	VOL. PUBLISHER NO.	REPORT/DOCUMENT NUMBER	PUBLISHER LOCATION	DATE
SBI26	NASA	Concepts And Requirements For Space Station Life Sciences Ground Support And Operations	NASA JSC	LS-70034	Houston, TX.	04/11/88
SBI27	NASA	Spacelab Mission 4 Integrated Payload Requirements Document	NASA JSC	SM-SE-03	Houston, TX.	06/01/85
SBI28	General Dynamics	Life Sciences Payload Definition And Integration Study	IV General Dynamics	CASD-NAS-74-046	San Diego, CA.	08/01/74
SBI29	General Dynamics	Life Sciences Payload Definition and Integration Study - Executive Summary	I General Dynamics	CASD-NAS-74-046	San Diego, CA.	08/01/74
SBI30	NASA	SL-3 Ames Research Center Life Sciences Payload Familiarization Manual	Ames Research Center	ADP-81-50-001	Moffet Field, CA.	02/01/81
SBI31	Rockwell Intl.	EMS Data Data Package 2.3A S4200.2 Methodology Definition - Commonality Analysis Trade Study	Rockwell International	SSS 85-0168	Downey, Ca.	10/04/85
SBI32	Rockwell Intl.	EMS Data Data Package 2.2B S4201.2, Module Commonality Analysis	Rockwell International	SSS 85-0137	Downey, CA	09/06/85
SBI33	General Electric	Space Station Work Package 3 Definition And Preliminary Design Commonality Candidates	General Electric Space Systems Division	DRD - 19	Philadelphia , PA	05/10/85
SBI34	Rockwell Intl.	EMS Data Data Package 2.3A S4203.2, Module Outfitting/System Commonality Analysis	Rockwell International	SSS 85-0158	Downey, CA	10/28/85

Table 4.1-2 Bibliography for Miniaturization Trade Study

ID #	AUTHOR	TITLE	VOL. PUBLISHER NO.	REPORT/DOCUMENT NUMBER	PUBLISHER LOCATION	DATE
SB135	NASA JSC	Space Station Freedom Human-Oriented Life Sciences Research Baseline Reference Experiment Scenario	JSC- Medical Sciences Space Station Office	Blue Book	Houston, TX.	10/01/88
SB139	NASA JSC	July 1988 Progress Report On Experiment Standard User Interfaces Study	JSC - Life Sciences Project Division		Houston, TX.	07/01/88
SB140	Rockwell Intl.	EMS Data Data Package 2.3A S4207.2, GSE Commonality Analysis	Rockwell International	SSS 85-0099	Downey, CA	10/04/85
SB141	NASA OSSA	Life Sciences Space Station Planning Document: A Reference Payload For The Life Sciences Research Facility	Office of Space Science and Applications	NASA TM 89188	Washington, D.C.	01/01/86
SB144	Huffstetler, M.	Skylab Biomedical Hardware Development	AIAA 20th Annual Meeting		Los Angeles, CA	08/22/74
SB146	Anderson, A.	Progressive Autonomy - For Space Station Systems Operation	AIAA		New York, NY	06/05/84
SB147	NASA JSC	Life Sciences Research Laboratory (LSRL) Human Research Facility for Space Station Initial Operating Configuration (IOC) Science Reqs.	NASA JSC	JSC 20799	Houston, TX	10/01/85
SB148	MDAC	Crew Health Care System (CHec) Development Plan	Mcdonnell Douglas Space Station Co.		Houston, TX.	01/28/89
SB149	Minsky, M.	Engines of Creation	Anchor Press		New York, NY	01/10/86
SB150	MDAC	Crew Health Care	MDAC	MDC H3924	Houston, Texas	11/01/88

Table 4.1-2 Bibliography for Miniaturization Trade Study

ID #	AUTHOR	TITLE	VOL. PUBLISHER NO.	REPORT/DOCUMENT NUMBER	PUBLISHER LOCATION	DATE
SB154	NASA JSC	Mission Integration Plan	NASA JSC	SSP 30000 Appendix D	Houston, TX.	04/30/86
SB155	Pacheco	Analyzing Commonality in a System	Boeing	NASA STI Facility	Baltimore, MD.	03/01/88
SB156	NASA MSFC	Spacelab Configurations				/ /
SB168	Hamaker, Joe	Telephone Interview relating to MSFC history and techniques for cost estimating.	Cost Analysis Branch Chief MSFC		Huntsville, Al.	04/27/89
SB169	Booker, Clef	Personal Interview	Man-Systems Division JSC		Houston, TX.	04/04/89
SB170	Evans, Jim	Personal Interview	Life Science Project Division JSC		Houston, TX.	04/19/89
SB176	Trowbridge, John	Personal interview relating CHEC experience to miniaturization, modularity and make-or-buy	McDonnell Douglas		Houston, TX.	03/29/89
SB178	McFadyen, Gary	Personal Interview relating to life science hardware background at JSC	Southwest Research Institute		Houston, TX.	04/10/89
SB180	McFadyen	Bioengineering on SBI hardware	Southwest Research Institute		San Antonio, TX.	04/06/89
SB181	Allen, Joe	Personal interview - S.S. Life Science AIAA Meeting	Space Industries		Houston, TX.	04/07/89
SB182	Averner, Maurice	Personal interview on CELSS	NASA HQ. CELSS Coordinator		Washington, DC.	04/07/89
SB183	Fogleman, B. PhD	Personal interview relating to Gas Grain Simulation Facility	NASA AMES		Moffet Field, CA.	04/06/89

Table 4.1-2 Bibliography for Miniaturization Trade Study

ID #	AUTHOR	TITLE	VOL. PUBLISHER NO.	REPORT/DOCUMENT NUMBER	PUBLISHER LOCATION	DATE
SB184	White, Bob	Personal Interview relating to modularity and commonality	NASA JPL		Pasadena, CA.	04/10/89
SB185	Grumm, Richard	Personal interview relating to SBI hardware	NASA JPL		Pasadena, CA.	04/11/89
SB186	Boeing	U.S. Lab Review Workshop				/ /
SB187	McGillroy, B.	Personal Interview on CELSS	NASA AMES		Moffet Field, CA	05/05/89

5.0 Trade Study

5.1 Relative Cost Analysis of Previous Hardware

The microminiaturized amplifier that was used in the Skylab PMS and will also be used in the SBI BPF was developed and miniaturized by the Denver Research Institute (DRI). This organization no longer exists and no cost data can be found related to this development. NASA JSC who contracted DRI to do the work does not have the cost data (Ref. SBI#70, personal interview with Jim Evans NASA JSC SE).

There may be other historical data concerning miniaturization and related cost information, but this data was not found in the time frame of this study.

5.2 SBI Hardware Sample Selection

The Space Biology Hardware Baseline list is shown in Appendix A. This list has 169 hardware items, however, only 93 of these items are categorized for SBI functions. This list was based-lined December 1988 and then updated 23 March 1989. Many of these items are in the conceptual phase; however, some are existing hardware items that are in existence today. There will more than likely be future additions and deletions to this baseline list.

The initial survey data analysis was performed to select a sample of the SBHB items which could be potential candidates for miniaturization. With limited study time and a SBHB of 93 items, a method was needed to separate items which could have large cost impact and were worthy of study resource application. The following methods was used. All SBHB items were listed in descending order of probable acquisition cost. Weight was used as an indication of probable acquisition cost based on historical experience in previous space programs. It was found that 34 percent of the items (32 items) accounted for 93 percent of the mass or probable cost (Table 5.2-1). The accumulated volume (8.68M³) of the 32 items represents 87% of the total volume. The accumulated power (8455 watts) represents 82% of total power requirements

The prioritized list of "vital" hardware items was considered for miniaturization. This list was further examined for those items that can be considered as a sample set of candidates for possible miniaturization (Table 5.2-2). This list showing the possible level of miniaturization was developed using all available resources within the constraints of this trade study. This assessment of possible candidates for miniaturization is based upon the best knowledge of the SBI hardware items at the time of this study. There will be additions and deletions from this list as new developments and techniques become known. The items for which miniaturization estimates were left blank in this table ("No" under Sufficient Data) indicates they are new developments still in the conception phase. Selected items from Table 5.2-2 are listed in Table 5.2-3 as the set of best possible candidates for some degree of miniaturization. The candidate sample set in Table 5.2-3 does not include those items where the degree of miniaturization was considered to have low potential at this time (0-10%) or items for which sufficient data was not available for assessment.

5.3 SBI Miniaturization Candidate Selection

Within the candidate sample set (Table 5.2-3) there is one item which was selected as the best candidate to be analyzed in greater detail. The Gas Grain Simulator (GGS) was selected for detailed analysis due to the availability of data (Ref. Appendix E), cooperation of the personnel at ARC (Ref. SBI #83), and the fact that the GGS is the heaviest of all the SBI hardware items (Ref. SBI #87 info on CELSS updated Mass).

The GGS is the only item in the baseline list (Appendix A) for Exobiology. The GGS consists of eight assemblies/subsystems as shown in Table 5.3. There are 21 major hardware subassemblies for the GGS shown in Table 5.3 and Figure 5.3. The percentage (%) of possible miniaturization for each of these 21 hardware subassemblies is shown in Table 5.3 (Ref. SBI#83, telephone interview with Guy Fogleman - Ames). The amount of miniaturization (percentages) selected for the eight subsystems was estimated by projecting the operational use and future development of the hardware. Complexity, hybrid systems, function of each unit, interrelated functions, and overall compatibility, were some of the factors considered in making the final decision of the amount of miniaturization. The GGS hardware has not been built nor have (RFP) gone out at the time of this study. The estimates made for miniaturization are highly subjective and may or not be feasible when more is understood concerning the overall GGS.

5.4 Miniaturized SBI Hardware Performance Impact Analysis

5.4.1 On Orbit Crew Utilization

Most of the experiments using SBI hardware are being conceived to have minimum crew interface. There will be some time required for initial setup and calibration for the individual experiments. These programs and time lines have not been worked out at the time of this report. Miniaturization which violated any operational human factor parameters or ergonomics would not be allowed. Therefore, The possible miniaturization of various hardware items should not effect the utilization of crew time.

5.4.2 Hardware Diagnostics/Repair

Miniaturization of the SBI hardware will not effect the reliability of the components/assemblies. Any design or redesign that includes miniaturization must maintain the original hardware integrity for accurate experiment results. However, the methods of implementing miniaturization and modularity may often be in conflict. Miniaturization uses maximum component integration and packaging efficiency. Modularity may comprise these aspects to allow modular construction. A modular concept would allow a faulty unit to be replaced with a spare unit aiding in hardware diagnostics and repair. Extensive repairs such as replacing individual components within a unit are not in the present design concept. Since miniaturization objectives could deter the implementation of modularity, hardware diagnostics and repair performance could be reduced.

5.4.3 Equipment Accuracy

By groundrule direction, all SBI hardware must be implemented to satisfy the required performance specifications whether constructed using miniaturization or not. Therefore, any miniaturization of assemblies/components can not jeopardize the accuracy of the hardware.

5.5 Relative SBI Miniaturization Cost Impact Analysis

5.5.1 Empirical Cost Relationships

Cost estimating relationships (CERV's) use systems weight and a complexity, n, as the principle factors in deriving design and development (DD) and theoretical first unit (TFU) costs. The exponent, n, increases as complexity increases being on the order of .2 for simple packaged systems, on the order of .4 for mechanisms or simple packaged electronics, and on the order of .6 for distributed complex systems. See Appendix C for a detailed treatment of cost estimating methods including cost estimating relationships.

In the process of analyzing the cost impact of miniaturizing an SBI hardware element, both weight and complexity come into play. Also, one must consider the design factor, df, in cases where more design effort is required or where a redesign is required in order to miniaturize a piece of hardware. As explained in Appendix C, the reduction in weight due to miniaturizing an element and the cost of the redesign effort needed to do so tend to offset each other. The relationship below is used in Appendix C to perform a parametric analysis of cost impact due to miniaturization (weight change and cost change due to redesign necessary to make an item smaller):

$$\text{Cost} = \text{df} * (C_1 * (\text{Wt})^n)$$

Where:

w = weight of a module or assembly or part

n = a complexity exponent

df= a design factor reflecting the amount of new design required

C₁= constant, taken as unity for comparative purposes.

To understand the relative impact of these factors, several items that can be miniaturized have been identified and the cost impact of miniaturization calculated using the foregoing factors. No actual cost data will be presented in this trade study.

5.5.2 GGS Miniaturization Cost Analysis

Table 5.3 gives the assumptions (design factors and system complexity factors) that were used with the empirical equation from Section 5.5.1. To read Table 5.3 left to right:

Roman numbers are the subsystems mass/weight in kilo grams.

Amount of miniaturization has three columns showing percentages. The components listed under the subsystems were analyzed for miniaturization and then the entire subsystem was given a percentage figure.

The design factor (df) without miniaturization was not considered and therefore a 1.0 was used for this column.

The complexity factor (n) was varied according to the proposed design of that subsystem.

The new design factor(df) is the factor for the anticipated new design or redesign of that subsystem.

The mass percent column is the percent of the subsystem mass to the total mass.

The relative cost factor percent is the percent increase in cost for that subsystem using the factors and analysis described in section 5.5.1.

The last column is the percent of each subsystem prorated. The mass percent times the relative cost factor percent equals the prorate percent.

The appropriate totals are shown at the bottom.

The results from this analysis indicates that there would be a increase in cost of 5 percent for the overall GGS.

The amount of miniaturization shown and the amount of cost increase for each assembly is shown in the last two columns of Table 5.3. These figures are dependant upon the subjective assumptions that were made for df and n factors. The number III and V assemblies have identical weight and miniaturization, but because the df and n factors are different, assembly III shows an increase in cost while V shows a decrease. The total cost increase for miniaturization of this particular hardware item was 5.16%. Most of the SBI hardware items are complex hybrid systems that will require a new or redesign for miniaturization. A large redesign or new design would increase the design factors which would in turn increase the cost. This would also have an effect on the overall design. The miniaturization cost increase percentages are shown in the last column of Table 5.3. The sum of the assembly percentages can be used to estimate a relative cost increase or decrease for the total SBI hardware item based on the amount of miniaturization of each assembly. Miniaturization will generally increase the cost as shown in this analysis. Qualified life cycle cost reduction has not been addressed in the miniaturization cost impact analysis. See appendix C Section 7.0 for a subjective assessment of miniaturization life cycle costs.

Table 5.2-1 Database Listing of SBI Hardware Vital to Program Cost Impact Analysis

ITEM # PRIORITIZED BY MASS	HW ITEM #	HARDWARE ITEM NAME	ACCUM % OF ITEMS	MASS (kg)	ACCUM MASS	ACCUM MASS PERCENT	ACCUM POWER PERCENT	ACCUM VOLUME PERCENT
1	168	CELSS Test Facility	1	1000.0	1000	28	13	19
2	163	Gas Grain Simulator	2	800.0	1800	51	27	33
3	84	Soft Tissue Imaging System	3	300.0	2100	59	35	46
4	77	Hard Tissue Imaging System	4	136.0	2236	63	38	51
5	126	Scintillation Counter	5	90.0	2326	66	42	53
6	74	Force Resistance System	6	70.0	2396	68	45	57
7	145	Automated Microbial System	8	70.0	2466	70	46	59
8	155	Total Hydrocarbon Analyzer	9	70.0	2536	72	48	61
9	161	Inventory Control System	10	70.0	2606	74	53	63
10	162	Lab Materials Packaging & Handling Equipment	11	70.0	2676	76	58	65
11	163	Test/Checkout/Calibration Instrumentation	12	70.0	2746	78	60	67
12	106	Neck Baro-Cuff	13	45.2	2791	79	61	69
13	113	Blood Gas Analyzer	14	45.0	2836	80	63	70
14	61	Mass Spectrometer	15	40.7	2877	81	65	71
15	112	Plant HPLC Ion Chromatograph	16	40.0	2917	83	67	72
16	147	Head/Torso Phantom	17	32.0	2949	83	67	73
17	63	Pulmonary Gas Cylinder Assembly	18	30.0	2979	84	67	74
18	110	Plant Gas Chromatograph/Mass Spectrometer	19	25.0	3004	85	68	76
19	115	Chemistry System	20	23.0	3027	86	69	77
20	138	Hematology System	22	23.0	3050	86	71	78
21	34	Sample Preparation Device	23	22.0	3072	87	73	79
22	165	Experiment Control Computer System	24	20.1	3092	87	77	80
23	62	Pulmonary Function Equipment Stowage Assembly	25	20.0	3112	88	77	80
24	82	Motion Analysis System	26	20.0	3132	89	77	81
25	99	Animal Biotelemetry System	27	20.0	3152	89	78	81
26	100	Blood Pressure and Flow Instrumentation	28	20.0	3172	90	80	82
27	109	Venous Pressure Transducer/Display	29	20.0	3192	90	81	82
28	129	Cell Handling Accessories	30	20.0	3212	91	82	83
29	57	Bag-in-Box	31	19.0	3231	91	82	84
30	111	Plant Gas Cylinder Assembly	32	19.0	3250	92	82	85
31	119	Gas Cylinder Assembly	33	19.0	3269	92	82	86
32	130	Cell Harvester	34	19.0	3288	93	82	87

NOTES:

1. Total number of SBI hardware items = 93.
2. 89 items have 3535 kg mass, 10,359 Watts power, and 10 cubic meters volume.
3. 4 items are not currently defined, but all are small.

Table 5.2-2 Database Listing for Miniaturization Sample Selection Assessment

Priority # of Items by Mass	HW Item Number	HARDWARE NAME	SUFFICIENT DATA	MINIATURIZATION LEVEL (Percent)	CONFIDENCE LEVEL
1	168	CELLS Test Facility	Yes	20-50	High
2	169	Gas Grain Simulator	Yes	20-50	High
3	84	Soft Tissue Imaging System	No		
4	77	Hard Tissue Imaging System	No		
5	126	Scintillation Counter	Yes	20-50	Low
6	74	Force Resistance System	Yes	10-20	Low
7	145	Automated Microbal System	Yes	20-50	High
8	155	Total Hydrocarbon Analyzer	No		
9	161	Inventory Control System	Yes	20-50	High
10	162	Lab Materials Packaging & Handling Equipment	Yes	0-10	Low
11	163	Test/Checkout/Calibration Instrumentation	Yes	20-50	Low
12	106	Neck Baro-Cuff	Yes	20-50	High
13	113	Blood Gas Analyzer	No		
14	61	Mass Spectrometer	Yes	10-20	Low
15	112	Plant HPLC Ion Chromatograph	No		
16	147	Head/Torso Phantom	Yes	10-20	High
17	63	Pulmonary Gas Cylinder Assembly	Yes	0-10	Low
18	110	Plant Gas Chromatograph/Mass Spectrometer	Yes	10-20	Low
19	115	Chemistry System	Yes	10-20	Low
20	138	Hematology System	Yes	10-20	Low
21	34	Sample Preparation Device	Yes	0-10	Low
22	165	Experiment Control Computer System	Yes	20-50	High
23	62	Pulmonary Function Equipment	Yes	0-10	Low
24	82	Stowage Assembly	Yes	20-50	High
25	99	Motion Analysis System	Yes	10-20	High
26	100	Animal Biotelemetry System	No		
27	109	Blood Pressure and Flow Instrumentation	No		
28	129	Venous Pressure Transducer/Display	Yes	10-20	Low
29	57	Cell Handling Accessories	Yes	20-50	High
30	111	Bag-in-Box	Yes	10-20	Low
31	119	Plant Gas Cylinder Assembly	No		
32	130	Gas Cylinder Assembly Cell Harvester	Yes	0-10	High
			Yes	20-50	Low

Table 5.2-3 Database Listing of Miniaturization Candidate
Sample Set

Priority # of Items by Mass	HW Item Number	HARDWARE NAME	MINIATURIZATION LEVEL (Percent)	CONFIDENCE LEVEL
1	168	CELSS Test Facility	20-50	High
2	169	Gas Grain Simulator	20-50	High
5	126	Scintillation Counter	20-50	Low
6	74	Force Resistance System	10-20	Low
7	145	Automated Microbal System	20-50	High
9	161	Inventory Control System	20-50	High
11	163	Test/Checkout/Calibration Instrumentation	20-50	Low
12	106	Neck Baro-Cuff	20-50	High
14	61	Mass Spectrometer	10-20	Low
16	147	Head/Torso Phantom	10-20	High
18	110	Plant Gas Chromatograph/Mass Spectrometer	10-20	Low
19	115	Chemistry System	10-20	Low
20	138	Hematology System	10-20	Low
22	165	Experiment Control Computer System	20-50	High
24	82	Motion Analysis System	20-50	High
25	99	Animal Biotelemetry System	10-20	High
27	109	Venous Pressure Transducer/Display	10-20	Low
28	129	Cell Handling Accessories	20-50	High
29	57	Bag-in-Box	10-20	Low
32	130	Cell Harvester	20-50	Low

Gas-Grain Simulator Hardware	Mass (kg)	Miniaturization Possible Potential Percentage Reduce			df Without Minimal	Complexity Exponent n	New Design Factor df	Mass Percent	Relative Cost Factor Percent	Cost Percent
		9-10%	10%	30%						
I. General Purpose Experiment Chamber/Containment Subsystem	200						25			
1. Chamber		X								
2. Vibration isolation, chamber support and containment		X								
II. Chamber Environment Regulation/Monitoring Subsystem	80			30%	1.0	1.25	10	+16%	+1.6	
3. Temp., pressure, and humidity monitor thermocouple pressure diaphragm leak detectors		X	X	X						
4. Gas handling			X							
III. Aerosol Generation/Measurement Subsystem	150			30%	1.0	1.30	18.75	+13%	+2.43	
5. Aerosol generator, dryer, charge neutralizer				X						
6. Size analyzers				X						
7. CN counter				X						
8. Electrostatic classifier				X						
IV. Chamber Illumination, Optics, and Imaging Subsystem	80						10			
9. Fiber optics system		X								
10. Continuous spectrum light source (UV source)		X								
11. Camera, lenses		X								
V. Spectrometry/Optical Scattering Subsystem	150			30%	1.0	1.20	18.75	-03%	-.56	
12. Monochromator				X						
13. Photodetectors				X						
14. Spectrometer				X						
15. Required Lamps		X								
VI. Particle Manipulation and Positioning Subsystem	50		10%		1.0	1.20	6.25	+15%	+ .93	
16. Acoustic levitator		X								
17. Particle injection mechanism			X							
18. Particle retrieval mechanism			X							
VII. Computer Control and Data Acquisition Subsystem	50			30%	1.0	1.30	6.25	+13%	+ .81	
19. Computer				X						
20. User Interface CRT Keyboard Joy stick Mouse		X								
VIII. Storage Locker	40		10%		1.0	1.0	5	-01%	-.05	
21. Storage locker			X							
Total for GGS	800						100		+5.16	

Table 5.3 Exobiology Facility/GGS - Miniaturization Analysis

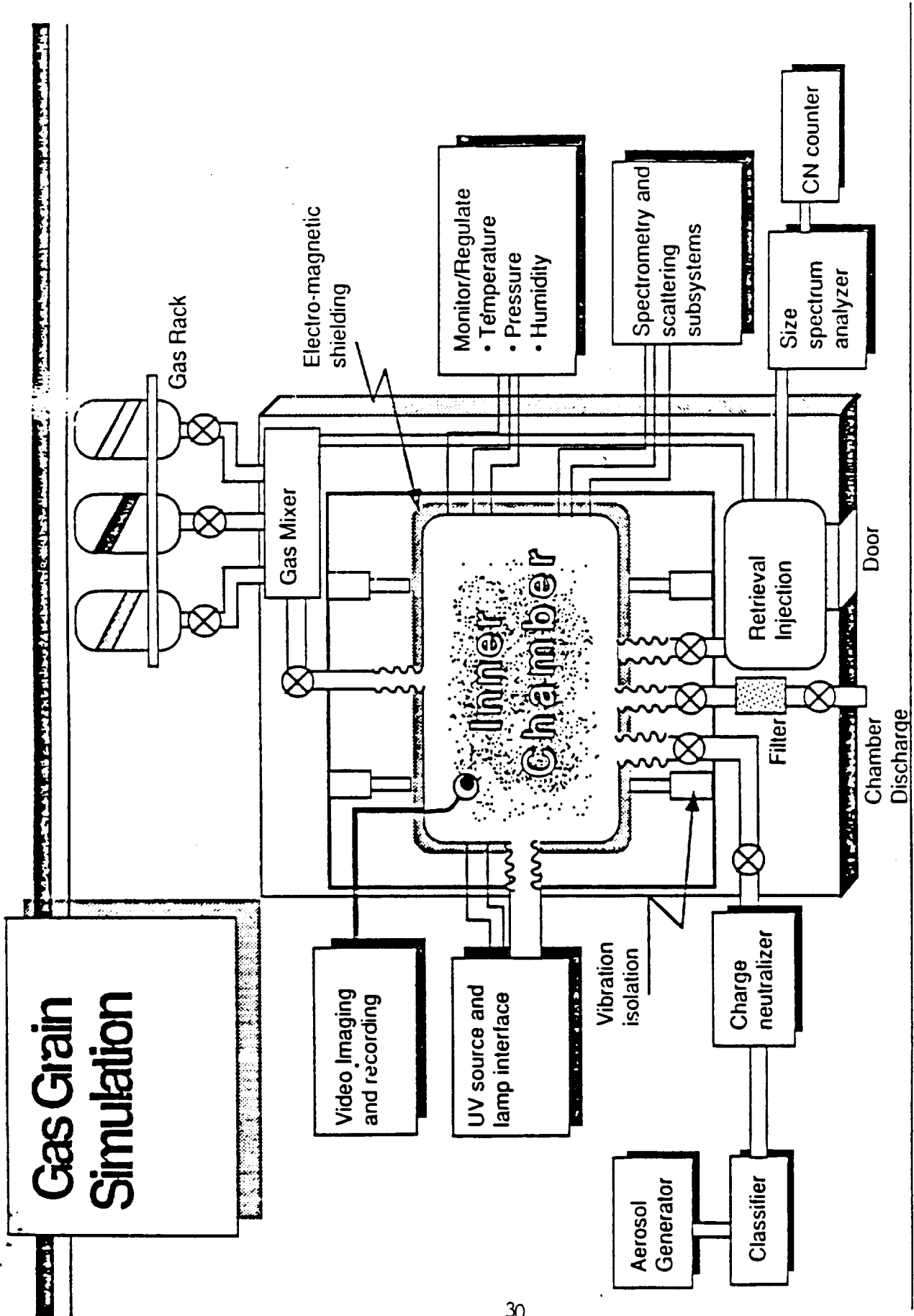

Figure 5.3

6.0 Conclusion

6.1 Discussion

The items selected for miniaturization (Table 5.2-3) are the best possible candidates based upon their mass, complexity, anticipated use, and information known at the time of this trade study. The results of the cost analysis indicates that miniaturization will generally increase cost. Each assembly/component must be considered separately. It can generally be said that the more complex a system, the greater the cost for miniaturization. This would indicate that some of these items may not be adaptable to miniaturization due to the high increase in cost even when life cycle costs are factored into the analysis.

Life cycle costs were not considered in this trade study; however, miniaturization of payload items could be expected to reduce life cycle costs.

If there were a fixed payload allowable mass assigned to SBI, the use of miniaturization would allow more experiment items per unit of mass. The net result would be that miniaturization would enable the accomplishment of more science within the fixed assigned SBI mass. This benefit could be equated to a cost benefit which might compensate for the additional development expense required for miniaturized hardware. This cost benefit analysis could not be performed in this trade study because of a lack of information.

It would appear that miniaturizing the heaviest items would provide the greatest return on the investment since any cost reduction is a function of the absolute amount of mass eliminated. That is, a 100 kilogram item reduced 20 percent would save 20 kilogram, whereas a 20 percent reduction of a 5 kilogram items would only save 1 kilogram.

A final consideration is that, in the future, some significant SBI hardware item could be excluded from consideration due to a very large mass normally associated with the item. In a case of this nature, it would have to be reduced through miniaturization or not included at all.

6.2 Important Guidelines

- Miniaturization will generally add development cost to the SBI hardware.
- The more complex hybrid systems will add the greatest cost for miniaturization.
- The miniaturization of larger (heavier) items will give a greater return in weight savings than the smaller items.
- Miniaturization is more likely to be cost beneficial when life cycle cost are factored into the overall analysis.
- There may be additional benefits to the science program by increasing the science hardware item (more Experiments) when reducing individual items through miniaturization.

- Not all items can be miniaturized.

6.3 Other Considerations

The interrelationship of these trade studies has not been considered. There could be considerable cost savings with an overall trade study of miniaturization, modularity, commonality, modified COTS versus new build items and other hardware items (Not SBI). See Section 2.6 for other recommendations for future work.

Appendix A - Space Biology Hardware Baseline

LIFL SCIENCES HARDWARE LIST FOR THE SPACE STATION FREEDOM ERA

December 1988
 up Dated 23 Mar 1983

H/W ITEM #	HARDWARE ITEM NAME	SOURCE CODE	UNIT HARDWARE PARAMETERS		
			VOLUME (cu. m)	MASS (kg)	POWER (watts)

1.8 METER CENTRIFUGE FACILITY (1)

SPECIMEN SUPPORT GROUP (1A)

1	1.8 M Centrifuge	C	2.40	1100	1500
2	Equipment Washer/Sanitizer	W	0.96	320	2500
3	Life Sciences Glove Box (Copy 1 of 2)	W	0.96	350	800
4	Modular Habitat Holding System	C	0.48	200	500
5	Plant Growth Module	C	0.10	50	550
6	Primate Module	C	0.10	50	220
7	Rodent Module	C	0.07	40	230

BIOLOGICAL SAMPLE MANAGEMENT FACILITY (2)

BIOWASTE COLLECTION & MONITORING GROUP (2A)

8	Fecal Monitoring System (24 Hr)	E	0.12	25	50
9	Urine Monitoring System (24 Hr)	E	0.20	60	50

BIOLOGICAL SAMPLE STORAGE GROUP (2B)

10	Freeze Dryer	W	0.07	19	140
11	Freezer (-20 deg. C)	W	0.48	120	300
12	Freezer (-70 deg. C)	W	0.48	120	300
13	Freezer Cryogenic (-196 deg. C) w/ Snap Freezer	W	0.09	20	0
14	Radiation Shielded Locker (Copy 1 of 2)	W	0.20	80	0
15	Refrigerator (4 deg. C)	W	0.48	120	300

LIFE SCIENCES HARDWARE LIST FOR THE SPACE STATION FREEDOM ERA

December 1988

H/W ITEM #	HARDWARE ITEM NAME	SOURCE CODE	UNIT HARDWARE PARAMETERS		
			VOLUME (cu. m)	MASS (kg)	POWER (watts)

BIOLOGICAL SAMPLE MANAGEMENT FACILITY (2), (con't)

SAMPLE COLLECTION AND PROCESSING GROUP (2C)

16	Animal Tissue Biopsy Equipment	S	0.03	8	0
17	Blood Collection System	S	0.02	1	0
18	Centrifuge Refrigerated	W	0.15	40	450
19	Centrifuge Standard Lab	E	0.09	26	200
20	Digital Thermometer	W	0.01	2	34
21	Drug Administration Equipment	E	0.01	1	0
22	Electrofusion Device	S	0.06	TBD	TBD
23	Fixation Unit	S	0.02	4	0
24	Fluid Handling Tools/System	W	0.48	80	100
25	Laboratory Sciences Workbench	W	0.96	300	700
26	Life Sciences Glove Box (Copy 2 of 2)	W	0.96	350	800
27	Microscope System (Stereo Microscope Subset, Copy 2	W	0.25	80	200
28	Muscle Biopsy Equipment	S	0.01	1	0
29	Perfusion & Fixation Unit	S	0.01	2	0
30	Plant Care Unit	S	0.05	10	50
31	Plant Harvest/Dissection Unit	S	0.01	4	20
32	Radioimmunoassay Prep Device	E	0.01	2	0
33	Saliva Collection Unit	S	0.01	1	0
34	Sample Preparation Device	S	0.17	22	150
35	Shielded Isotope Container	E	0.02	22	0
36	Specimen Labeling Tools/Device	W	0.01	4	20
37	Surgery/Dissection Tools	W	0.06	20	0
38	Sweat Collection Device	S	0.01,005	TBD	0.15

LIFE SCIENCES HARDWARE LIST FOR THE SPACE STATION FREEDOM ERA

December 1988

H/W ITEM #	HARDWARE ITEM NAME	SOURCE CODE	UNIT HARDWARE PARAMETERS		
			VOLUME (cu. m)	MASS (kg)	POWER (watts)

BIOLOGICAL SAMPLE MANAGEMENT FACILITY (2), (con't)

RODENT SUPPORT GROUP (2D)

39	CO2 Administration Device	S	0.01	3	0
40	Rodent Blood Collection System	S	0.03	10	50
41	Rodent Caudal Vertebrae Thermal Device (CVTD)	S	0.01	2	50
42	Rodent Guillotine	S	0.01	4	0
43	Rodent Restraint	S	0.01	3	0
44	Rodent Surgery Platform	S	0.01	3	0
45	Rodent Surgery/Dissection Unit	S	0.01	3	0
46	Rodent Urine Collection System	S	0.03	10	50
47	Rodent Veterinary Unit	S	0.03	10	0

PRIMATE SUPPORT GROUP (2E)

48	Primate Blood Collection System	S	0.05	2	140
49	Primate Handling Equipment	S	0.01	1	0
50	Primate LBNP Device	S	0.05	3	140
51	Primate Surgery Platform	S	0.04	5	0
52	Primate Surgery/Dissection Unit	S	0.02	5	0
53	Primate Urine Collection System	S	0.01	10	14
54	Primate Veterinary Unit	S	0.03	10	0
55	Small Primate Restraint	S	0.05	2	0

LIFE SCIENCES HARDWARE LIST FOR THE SPACE STATION FREEDOM ERA

December 1988

H/W ITEM #	HARDWARE ITEM NAME	SOURCE CODE	UNIT HARDWARE PARAMETERS		
			VOLUME (cu. m)	MASS (kg)	POWER (watts)

BIOINSTRUMENTATION & PHYSIOLOGICAL MONITORING FACILITY (3)

PULMONARY ANALYSIS GROUP (3A)

56	Bag Assembly	S	0.01	1	0
57	Bag-in-Box	S	0.15	19	0
58	Doppler Recorder	E	0.01	1	0
59	Electronics Control Assembly	S	0.08	13	100
60	Mask/Regulator System	S	0.01	3	30
61	Mass Spectrometer	S	-0.02.087	4040.7	100200
62	Pulmonary Function Equipment Stowage Assembly	S	0.39.051	20	0
63	Pulmonary Gas Cylinder Assembly	S	0.09	30	0
64	Rebreathing Assembly	S	0.02	1	0
65	Spirometry Assembly	S	0.01	1	0
66	Syringe (3 Liter Calibration)	S	0.01	2	0

PHYSICAL MONITORING GROUP (3B)

67	Accelerometer And Recorder	S	0.04	16	35
68	Anthropometric Measurement System	S	0.02	TBD/	0
69	Cameras	W	0.15	50	150
70	Compliance Volumometer	S	0.06.015	TBD/6	TBD/30
71	Electroencephalogram (EEMG)	S	0.06	TBD 2	TBD
72	Electromyograph (EMG)	E	0.01	2	20
73	Force Measurement Device	E	0.01	1	10
74	Force Resistance System	S	0.40	70	100-220
75	Fundus Camera	S	0.03.003	TBD 2	TBD Bat. of
76	Goniometer And Recorder	E	0.01	2	25

LIFE SCIENCES HARDWARE LIST FOR THE SPACE STATION FREEDOM ERA

December 1988

H/W ITEM #	HARDWARE ITEM NAME	SOURCE CODE	UNIT HARDWARE PARAMETERS		
			VOLUME (cu. m)	MASS (kg)	POWER (watts)

BIOINSTRUMENTATION & PHYSIOLOGICAL MONITORING FACILITY (con't)

PHYSICAL MONITORING GROUP (3B) (con't)

77	Hard Tissue Imaging System	S	0.29	136	300
78	Mass Calibration Unit	S	0.01	2	0
79	Mass Measurement Device-Body	E	0.65	35	15
80	Mass Measurement Device-Micro	W	0.08	17	15
81	Mass Measurement Device-Small	W	0.08	17	15
82	Motion Analysis System	S	0.05	20	100
83	Plethysmograph Measuring System	S	0.01	3	30
84	Soft Tissue Imaging System	S	0.96	300	800
85	Tonometer	S	0.01:0.0002	TBD-06	0 Bat 0P
86	Video System	E	0.10	30	300

NEUROPHYSIOLOGICAL ANALYSIS GROUP (3C)

87	EEG Cap	S	0.01	2	0
88	EEG Signal Conditioner	S	0.01	2	20
89	Electro Impedance Meter	E	0.01	1	0
90	Electro-oculograph (EOG)	E	0.01	2	20
91	Neurovestibular ECDI	E	0.09	11	120
92	Neurovestibular Helmet Interface Box	E	0.01	2	20
93	Neurovestibular Helmet Assembly	E	0.04	13	110
94	Neurovestibular Helmet Restraint	E	0.01	2	20
95	Neurovestibular Optokinetic Stimulus	E	0.01	2	20
96	Neurovestibular Rotating Chair	E	0.12	38	220
97	Subject Restraint System	E	0.05	18	0
98	Visual Tracking System	S	0.01	2	20

LIFE SCIENCES HARDWARE LIST FOR THE SPACE STATION FREEDOM ERA

December 1988

H/W ITEM #	HARDWARE ITEM NAME	SOURCE CODE	UNIT HARDWARE PARAMETERS		
			VOLUME (cu. m)	MASS (kg)	POWER (watts)

BIOINSTRUMENTATION & PHYSIOLOGICAL MONITORING FACILITY (con't)

CARDIOVASCULAR GROUP (3D)

99	Animal Biotelemetry System	S	0.05	20	100
100	Blood Pressure And Flow Instrumentation	S	0.06	20	200
101	Cardiodynamic Monitor	S	0.02	4	150
102	Electrocardiograph (ECG)	S	0.01	2	20
103	Holter Recorder	S	0.01	2	0
104	Human Biotelemetry System	E	0.05	17	140
105	LBNP Device	E	0.16	20	55
106	CAROTID SINUS BARORECEPTOR STIMULATOR (Neck Baro-Cuff)	S	0-10-132	TBD 45.2	TBD-145
107	Physiological Hemodynamic Assess Device	E	0.05	18	100
108	Ultrasonic Imaging System	W	0.20	70	600
109	Venous Pressure Transducer/Display	S	0.05	20	100

PLANT MONITORING GROUP (3E)

110	Plant Gas Chromatograph/Mass Spectrometer	S	0.20	25	100
111	Plant Gas Cylinder Assembly	S	0.09	19	0
112	Plant HPLC Ion Chromatograph	S	0.12	40	200

LIFE SCIENCES HARDWARE LIST FOR THE SPACE STATION FREEDOM ERA

December 1988

H/W ITEM #	HARDWARE ITEM NAME	SOURCE CODE	UNIT HARDWARE PARAMETERS		
			VOLUME (cu. m)	MASS (kg)	POWER (watts)

ANALYTICAL INSTRUMENTS FACILITY (4)

BIOLOGICAL SAMPLE ANALYSIS GROUP (4A)

113	Blood Gas Analyzer	S	0.13	45	250
114	Chemistry Analysis System	E	0.10	30	200
115	Chemistry System	S	0.08	23	100
116	Continuous Flow Electrophoresis Device	S	0.06	TBD	TBD
117	ELISA Reader	E	0.02	6	100
118	Gas Chromatograph/Mass Spectrometer	W	0.20	25	100
119	Gas Cylinder Assembly	S	0.09	19	0
120	High Performance Liquid Chromatograph	W	0.12	40	100
121	Incubator (35-65 deg C Copy 1 of 2)	W	0.16	50	400
122	Osmometer	E	0.02	5	20
123	pH Meter/Ion Specific Analyzer	W	0.02	7	5
124	Qualitative Reagent Strip And Reader	S	0.03	.10	100
125	Radioimmunoassay	E	0.05	20	0
126	Scintillation Counter	S	0.24	90	500
127	Spectrophotometer (UV/VIS/NIR)	W	0.11	40	300
128	Urine Analysis System	E	0.16	55	400

CELL ANALYSIS GROUP (4B)

129	Cell Handling Accessories	S	0.05	20	50
130	Cell Harvester	S	0.06	19	50
131	Cell Perfusion Apparatus	S	0.06	TBD	TBD
132	Centrifugal Incubator (5% CO2 @37 deg C Copy 1 of 2)	E	0.16	40	300
133	Centrifugal Incubator (5% CO2 @37 deg C Copy 2 of 2)	E	0.16	40	300

LIFE SCIENCES HARDWARE LIST FOR THE SPACE STATION FREEDOM ERA

December 1988

H/W ITEM #	HARDWARE ITEM NAME	SOURCE CODE	UNIT HARDWARE PARAMETERS		
			VOLUME (cu. m)	MASS (kg)	POWER (watts)

ANALYTICAL INSTRUMENTS FACILITY (4) (con't)

CELL ANALYSIS GROUP (4B) (con't)

134	Centrifuge Hematocrit	S	0.01	2	20
135	Chromosomal Slide Preparation Device	S	0.01	2	20
136	Fluoromeasure Probe	S	0.05	TBD	TBD
137	Flow Cytometer	E	0.24	36	500
138	Hematology System	S	0.07	23	200
139	Image Digitizing System	S	0.25 c3	70-114	500
140	Microscope System (Optical & Stereo Macroscope Subsets)	W	0.40	100	400
141	Mitogen Culture Device	E	0.01	2	20
142	Skin Window Device	S	0.01	2	0
143	Slide Preparation Device	E	0.01	2	20

LIFE SCIENCES HARDWARE LIST FOR THE SPACE STATION FREEDOM ERA

December 1988

H/W ITEM #	HARDWARE ITEM NAME	SOURCE CODE	UNIT HARDWARE PARAMETERS		
			VOLUME (cu. m)	MASS (kg)	POWER (watts)

LAB SUPPORT EQUIPMENT FACILITY (5)

ENVIRONMENTAL MONITORING & CONTROL GROUP (5A)

144	Accelerometer Subsystem	W	0.10	30	200
145	Automated Microbic System	S	0.20	70	500 //C
146	Dosimeter, Passive	W	0.09	35	0
147	Head/Torso Phantom	S	0.12	TBD 32	0
148	Incubator (35-65 deg C Copy 2 of 2)	W	0.16	50	400
149	Microbial Preparation System	S	0.01	2	20 //C
150	Radiation Shielded Locker (Copy 2 of 2)	W	0.20	80	0
151	Reuter Microbiology Air Sampler	S	0.01 .005	1.75	0
152	Solid Sorbent Air Sampler	S	0.01	5	0
153	Spectrometer (Proton/Heavy Ion)	S	0.03	10	20
154	Tissue Equivalent Proportional Counter	S	0.01 .001	TBD 2	0
155	Total Hydrocarbon Analyzer	S	0.20	70	250

HARDWARE MAINTENANCE GROUP (5B)

156	Battery Charger	W	0.03	10	100
157	Camera Locker	W	0.30	100	0
158	Cleaning Equipment	W	0.20	70	500
159	Digital Multimeter	W	0.06	20	50
160	General Purpose Hand Tools	W	0.10	30	0

LOGISTICS CONTROL GROUP (5C)

161	Inventory Control System	S	0.20	70	500
162	Lab Materials Packaging & Handling Equipment	S	0.20	70	500
163	Test/Checkout/Calibration Instrumentation	S	0.20	70	200

LIFE SCIENCES HARDWARE LIST FOR THE SPACE STATION FREEDOM ERA

December 1988

H/W ITEM #	HARDWARE ITEM NAME	SOURCE CODE	UNIT HARDWARE PARAMETERS		
			VOLUME (cu. m)	MASS (kg)	POWER (watts)

CENTRALIZED LIFE SCIENCES COMPUTER FACILITY (6)

LIFE SCIENCES DATA GROUP (6A)

164	Digital Recording Oscilloscope	W	0.03	10	100
165	Experiment Control Computer System	S	0.05	20	400
166	Multichannel Data Recorder	E	0.09	30	150
167	Voice Recorder	S	0.01-0.03	1-26	0 Bat nP

CLOSED ECOLOGICAL LIFE SUPPORT FACILITY (7)

FEAST GROUP (7A)

168	CELSS Test Facility	S	1.92	1000	1300
-----	---------------------	---	------	------	------

EXOBIOLGY FACILITY (8)

GAS/GRAIN GROUP (8A)

169	Gas Grain Simulator	S	1.92	800	1500
-----	---------------------	---	------	-----	------

From Neal Jackson 5/23/89

LIFE SCIENCES HARDWARE LIST FOR THE SPACE STATION FREEDOM ERA

Baselined: December 1988

H/W ITEM #	HARDWARE ITEM NAME	SOURCE CODE	UNIT HARDWARE PARAMETERS			UNIT HARDWARE PARAMETERS			R
			VOLUME (cu. m)	MASS (kg)	POWER (watts)	VOLUME (cu. m)	MASS (kg)	POWER (watts)	
16	Animal Tissue Biopsy Equipment	S	0.03	8	0				A
17	Blood Collection System	S	0.02	1	0				J
22	Electrofusion Device	S	0.06	TBD	TBD				J
23	Fixation Unit	S	0.02	4	0				A, J
28	Muscle Biopsy Equipment	S	0.01	1	0				A
29	Perfusion & Fixation Unit	S	0.01	2	0				A
30	Plant Care Unit	S	0.05	10	50				A
31	Plant Harvest/Dissection Unit	S	0.01	4	20				A
33	Saliva Collection Unit	S	0.01	1	0	0.001	0.2	0	J
34	Sample Preparation Device	S	0.17	22	150				J, A
38	Sweat Collection Device	S	0.01	TBD	0	0.005	5.05	15	J
39	CO2 Administration Device	S	0.01	3	0				A
40	Rodent Blood Collection System	S	0.03	10	50				A
41	Rodent Caudal Vertebral Thermal Device (CVTD)	S	0.01	2	50				A
42	Rodent Guillotine	S	0.01	4	0				A
43	Rodent Restraint	S	0.01	3	0				A
44	Rodent Surgery Platform	S	0.01	3	0				A
45	Rodent Surgery/Dissection Unit	S	0.01	3	0				A
46	Rodent Urine Collection System	S	0.03	10	50				A
47	Rodent Veterinary Unit	S	0.03	10	0				A
48	Primate Blood Collection System	S	0.05	2	140				A
49	Primate Handling Equipment	S	0.01	1	0				A
50	Primate LBNP Device	S	0.05	3	140				A
51	Primate Surgery Platform	S	0.04	5	0				A
52	Primate Surgery/Dissection Unit	S	0.02	5	0				A
53	Primate Urine Collection System	S	0.01	10	14				A
54	Primate Veterinary Unit	S	0.03	10	0				A
55	Small Primate Restraint	S	0.05	2	0				A
56	Bag Assembly	S	0.01	1	0				J
57	Bag-in-Box	S	0.15	19	0				J
59	Electronics Control Assembly	S	0.08	13	100				J
60	Mask/Regulator System	S	0.01	3	30				J
61	Mass Spectrometer	S	0.02	10	100	0.087	40.7	200	J
62	Pulmonary Function Equipment Stowage Assembly	S	0.39	20	0	0.051	20	0	J
63	Pulmonary Gas Cylinder Assembly	S	0.09	30	0				J
64	Rebreathing Assembly	S	0.02	1	0				J
65	Spirometry Assembly	S	0.01	1	0				J
66	Syringe (3 Liter Calibration)	S	0.01	2	0				J
67	Accelerometer And Recorder	S	0.04	16	35				J

A-ARC, J-JSC, *-Prime

Updated: 3/22/89

LIFE SCIENCES HARDWARE LIST FOR THE SPACE STATION FREEDOM ERA

Baselined: December 1988

H/W ITEM #	HARDWARE ITEM NAME	SOURCE CODE	UNIT HARDWARE PARAMETERS			UNIT HARDWARE PARAMETERS			R
			VOLUME (cu. m)	MASS (kg)	POWER (watts)	VOLUME (cu. m)	MASS (kg)	POWER (watts)	
68	Anthropometric Measurement System	S	0.02	TBD	0			J	
70	Compliance Volumometer	S	0.06	TBD	TBD	0.0152	16	130	
71	Electroencephalogram (EEMG)	S	0.06	TBD	TBD		2		
74	Force Resistance System	S	0.40	70	100			220	
75	Fundus Camera	S	0.03	TBD	TBD	0.003	2	Battery Op	
77	Hard Tissue Imaging System	S	0.29	136	300				
78	Mass Calibration Unit	S	0.01	2	0				
82	Molton Analysis System	S	0.05	20	100				
83	Plethysmograph Measuring System	S	0.01	3	30				
84	Solt Tissue Imaging System	S	0.96	300	800				
85	Tonometer	S	0.01	TBD	0	0.000226	0.06	Battery Op	
87	EEG Cap	S	0.01	2	0				
88	EEG Signal Conditioner	S	0.01	2	20				
98	Visual Tracking System	S	0.01	2	20				
99	Animal Biotelemetry System	S	0.05	20	100				
100	Blood Pressure And Flow Instrumentation	S	0.06	20	200				
101	Cardiodynamic Monitor	S	0.02	4	150				
102	Electrocardiograph (ECG)	S	0.01	2	20				
103	Holter Recorder	S	0.01	2	0				
106	Neck Baro-Cuff	S	0.10	TBD	TBD	0.132	45.2	145	
109	Venous Pressure Transducer/Display	S	0.05	20	100				
110	Plant Gas Chromatograph/Mass Spectrometer	S	0.20	25	100				
111	Plant Gas Cylinder Assembly	S	0.09	19	0				
112	Plant HPLC Ion Chromatograph	S	0.12	40	200				
113	Blood Gas Analyzer	S	0.13	45	250				
115	Chemistry System	S	0.08	23	100				
116	Continuous Flow Electrophoresis Device	S	0.06	TBD	TBD				
119	Gas Cylinder Assembly	S	0.09	19	0				
124	Qualitative Reagent Strip And Reader	S	0.03	10	100				
126	Scintillation Counter	S	0.24	90	500				
129	Cell Handling Accessories	S	0.05	20	50				
130	Cell Harvester	S	0.06	19	50				
131	Cell Perfusion Apparatus	S	0.06	TBD	TBD				
134	Centrifuge Hematocrit	S	0.01	2	20				
135	Chromosomal Slide Preparation Device	S	0.01	2	20				
136	Fluorescence Probe	S	0.05	TBD	TBD				
138	Hematology System	S	0.07	23	200				
139	Image Digitizing System	S	0.25	70	500	0.03		11.4	
142	Skin Window Device	S	0.01	2	0				

LIFE SCIENCES HARDWARE LIST FOR THE SPACE STATION FREEDOM ERA

Baselined: December 1988

H/W ITEM #	HARDWARE ITEM NAME	SOURCE CODE	UNIT HARDWARE PARAMETERS			UNIT HARDWARE PARAMETERS			R E S P
			VOLUME (cu. m)	MASS (kg)	POWER (watts)	VOLUME (cu. m)	MASS (kg)	POWER (watts)	
145	Automated Microbic System	S	0.20	70	500	0.2	70	110	J
147	Head/Torso Phantom	S	0.12	TBD	0		32		J
149	Microbial Preparation System	S	0.01	2	20	0.01	2	110	J
151	Reuter Microbiology Air Sampler	S	0.01	1	0	0.005	1.45		A.J.
152	Solid Sorbent Air Sampler	S	0.01	5	0				J
153	Spectrometer (Proton/Heavy Ion)	S	0.03	10	20				J
154	Tissue Equivalent Proportional Counter	S	0.01	TBD	0	0.001	2	0	J
155	Total Hydrocarbon Analyzer	S	0.20	70	250				J
161	Inventory Control System	S	0.20	70	500				A.J.
162	Lab Materials Packaging & Handling Equipment	S	0.20	70	500				A.J.
163	Test/Checkout/Calibration Instrumentation	S	0.20	70	200				A.J.
165	Experiment Control Computer System	S	0.05	20	400				J.A.
167	Voice Recorder	S	0.01	1	0	0.003	0.26	Battery Op	J
168	CELSS Test Facility	S	1.92	1000	1300				A
169	Gas Grain Simulator	S	1.92	800	1500				A

Appendix B - Complete SBI Trade Study Bibliography

Appendix B - Complete SBI Trade Studies Bibliography

ID #	AUTHOR	TITLE	VOL. PUBLISHER NO.	REPORT/DOCUMENT NUMBER	PUBLISHER LOCATION	DATE
SBI01	Kozarsky, D.	MUS Inputs	Lockheed Life Sciences Program Office	Lockheed Memo	Washington, DC	01/19/89
SBI02	Kozarsky, D.	Latest Space Station Rack Studies	NASA MSFC		Huntsville, AL.	02/02/89
SBI03	Holt, A.	PMWG-SS Freedom Assly. Seq. Trial Fyl. Manifest	Payload Manifest Working Group (PMWG)		Reston, VA.	12/09/88
SBI04	Shannon, J.	Business Practice Low Cost System Activity	NASA JSC		Houston, TX.	11/12/75
SBI05	NASA	Off-the-Shelf Hardware Procurement	NASA JSC	NASA MEMO HB/73-M286	Houston, TX.	05/16/73
SBI06	NASA	OTS Technology Use For Space Shuttle Program	NASA JSC	NASA MEMO	Houston, TX.	11/20/73
SBI07	NASA	Proposed Space Shuttle Directive On OTS HW.	NASA JSC	NASA MEMO NB/74-L149	Houston, TX.	06/20/74
SBI08	NASA	Cancellation Of Space Shuttle Directive On OTS	NASA JSC		Houston, TX.	10/01/74
SBI09	NASA	Agency Balloon Pyl. Util. of Avail. Equip. & Exper	NASA JSC	NASA PLAN 323-50-XX-71	Houston, TX.	05/25/76
SBI10	NASA	Space Shuttle Program DTO/DSO Noncritical Requirements Document	Flight Support Equipment Office - JBC	NSTS 21096	Houston, TX.	08/01/88
SBI11	NASA	Reference Mission Operational Analysis Document (RMDAD) For The Life Sciences Research Facilities.	NASA JSC	NASA TM 89604	Houston, TX.	02/01/87
SBI12	Breiling, R.	Cost Risk Analysis Using Price Models	RCA Price Systems		Moorestown, NJ.	09/01/87
SBI13	Fogleman, G. Schwart, D. Fonda, M.	Gas Grain Simulation Facility: Fundamental Studies of Particle Formation And Interactions	1 NASA Ames Research Center	NASA ARC/SSS 88-01	Moffet Field, CA.	08/31/87

Appendix B - Complete SBI Trade Studies Bibliography

ID #	AUTHOR	TITLE	VOL. PUBLISHER NO.	REPORT/DOCUMENT NUMBER	PUBLISHER LOCATION	DATE
SB114	JPL	Flight Projects Office Payload Classification Product Assurance Provisions	JPL	JPL D-1489 Rev. A	Pasadena, CA.	04/30/87
SB115	PRC Systems	Cost Estimate For The Search for Extraterrestrial Intelligence (SETI) Revised	PRC Systems Services		Huntsville, AL.	06/15/87
SB116	NASA SSPO	Space Station Commonality Process Requirements Rev. B	NASA SSPO	SSP 30285 Rev. B	Reston, Virginia	09/15/88
SB117	Webb, D.	Technology Forecasting Using Price - H	Rockwell International		Anaheim, CA.	04/17/86
SB118	NASA	Classification Of NASA Office Of Space Science And Applications (OSSA) Space Station Payloads	NASA JSC		Houston, TX.	/ /
SB119	NASA	Life Science Research Objectives And Representative Experiments For The Space Station (Green Book)	NASA Ames Life Science Division		Moffet Field, CA.	01/01/86
SB120	NASA	Medical Requirements Of An In-Flight Medical System For Space Station	NASA JSC	JSC 31013	Houston, TX.	11/30/87
SB121	TRW	A Study Of Low Cost Approaches To Scientific Experiment Implementation For Shuttle Launched And Serviced Automated Spacecraft	TRW Systems Group	Contract NASW - 2717	Redondo Beach, CA.	03/19/89

Appendix B - Complete SBI Trade Studies Bibliography

ID #	AUTHOR	TITLE	VOL. PUBLISHER NO.	REPORT/DOCUMENT NUMBER	PUBLISHER LOCATION	DATE
SB122	LMSC	Low-Cost Program Practices For Future NASA Space Programs	LMSC	LMSC-D387518	Sunnyvale, CA.	05/30/74
SB123	Steward, L Ghiller, L	Biomedical Equipment Technology Assessment For The Science Laboratory Module	Management and Technical Services Company		Houston, TX.	08/01/86
SB124	General Electric	WP-3 Commonality Plan	General Electric	NASS-32000	Philadelphia, PA	04/22/88
SB125	NASA	Microbiology Support Plan For Space Station	NASA JSC	JSC-32015	Houston, TX.	09/01/86
SB126	NASA	Concepts And Requirements For Space Station Life Sciences Ground Support And Operations	NASA JSC	LS-70034	Houston, TX.	04/11/88
SB127	NASA	Spacelab Mission 4 Integrated Payload Requirements Document	NASA JSC	SM-SE-03	Houston, TX.	06/01/83
SB128	General Dynamics	Life Sciences Payload Definition And Integration Study	General Dynamics	CASD-NAS-74-046	San Diego, CA.	08/01/74
SB129	General Dynamics	Life Sciences Payload Definition and Integration Study - Executive Summary	General Dynamics	CASD-NAS-74-046	San Diego, CA.	08/01/74
SB130	NASA	SL-3 Ames Research Center Life Sciences Payload Familiarization Manual	Ames Research Center	ADP-81-50-001	Moffet Field, CA.	02/01/81
SB131	Rockwell Intl.	EMS Data Data Package 2.3A S4200.2 Methodology Definition - Commonality Analysis Trade Study	Rockwell Internation	SSS 85-0168	Downey, Ca.	10/04/85

Appendix B - Complete SBI Trade Studies Bibliography

ID #	AUTHOR	TITLE	VOL. PUBLISHER NO.	REPORT/DOCUMENT NUMBER	PUBLISHER LOCATION	DATE
SBI32	Rockwell Intl.	EMS Data Data Package 2.2B S4201.2, Module Commonality Analysis	Rockwell International	SSS 85-0137	Downey, CA	09/06/85
SBI33	General Electric	Space Station Work Package 3 Definition And Preliminary Design Commonality Candidates	General Electric Space Systems Division	DRD - 19	Philadelphia , PA	05/10/85
SBI34	Rockwell Intl.	EMS Data Data Package 2.3A S4203.2, Module Outfitting/System Commonality Analysis	Rockwell International	SSS 85-0158	Downey, CA	10/28/85
SBI35	NASA JSC	Space Station Freedom Human-Oriented Life Sciences Research Baseline Reference Experiment Scenario	JSC- Medical Sciences Space Station Office	Blue Book	Houston, TX.	10/01/88
SBI36	NASA SSP0	Space Station Approved Electrical Electronic, And Electromechanical Parts List	Space Station Program Office	SSP 30423 Rev. A	Reston, Virginia	11/15/88
SBI37	NASA SSP0	Space Station Program Design Criteria and Practices	Space Station Program Office	SSP 30213 Rev. B	Reston, Virginia	07/30/88
SBI38	MDAC	Manufacturing Management Plan	McDonnell Douglas	DR MU-01	Houston, TX	/ /
SBI39	NASA JSC	July 1988 Progress Report On Experiment Standard User Interfaces Study	JSC - Life Sciences Project Division		Houston, TX.	07/01/88
SBI40	Rockwell Intl.	EMS Data Data Package 2.3A S4207.2, BSE Commonality Analysis	Rockwell International	SSS 85-0099	Downey, CA	10/04/85
SBI41	NASA OSSA	Life Sciences Space Station Planning Document: A Reference Payload For The Life Sciences Research Facility	Office of Space Science and Applications	NASA TM 89188	Washington, D.C.	01/01/86

Appendix B - Complete SBI Trade Studies Bibliography

ID #	AUTHOR	TITLE	VOL. PUBLISHER NO.	REPORT/DOCUMENT NUMBER	PUBLISHER LOCATION	DATE
SBI142	Buroni, A. Pasucci, B	The ORDH test equipment and its goals	ESA		Milan, Italy	10/01/78
SBI143	Shiohari, A.	Standardization and Program Effect Analysis - Final Report	111 Aerospace Corporation		EI Segundo, CA	01/01/75
SBI144	Huffstetler, W.	Skylab Biomedical Hardware Development	AIAA 20th Annual Meeting		Los Angeles, CA	08/22/74
SBI145	Powell, A.	Commonality Analysis For The NASA Space Station Common Module - 36 IAF Meeting, October 7-12 1985	Fergamon Press		New York, NY	10/07/85
SBI146	Anderson, A.	Progressive Autonomy - For Space Station Systems Operation	AIAA		New York, NY	06/05/84
SBI147	NASA JSC	Life Sciences Research Laboratory (LSRL) Human Research Facility for Space Station Initial Operating Configuration (IOC) Science Reqts.	NASA JSC	JSC 20799	Houston, TX	10/01/85
SBI148	MDAC	Crew Health Care System (CHec) Development Plan	McDonnell Douglas Space Station Co.		Houston, TX.	01/28/89
SRI149	Minsky, M.	Engines of Creation	Anchor Press		New York, NY	01/10/86
SBI150	MDAC	Crew Health Care	MDAC	MDC H3924	Houston, Texas	11/01/88
SBI151	NASA JSC	Columbus Reference Configuration Report	NASA JSC	RP 1213800000	Houston, TX.	05/31/88
SRI152	NASA HD	Shuttle/Payload I/F Definition Document for Middeck Accommodations	NASA HQ	NSTS 21000	Washington, DC	03/01/88

Appendix B - Complete SBI Trade Studies Bibliography

ID #	AUTHOR	TITLE	VDL. PUBLISHER NO.	REPORT/DOCUMENT NUMBER	PUBLISHER LOCATION	DATE
SBI153		Rack Accommodations Users Manual				/ /
SBI154	NASA JSC	Mission Integration Plan	NASA JSC	SSP 30000 Appendix D	Houston, TX.	04/30/86
SBI155	Pacheco	Analyzing Commonality in a System	Boeing	NASA STI Facility	Baltimore, MD.	03/01/88
SBI156	NASA MSFC	Spacelab Configurations				/ /
SBI157	Rockwell Intl.	Space Shuttle Management II Proposal	Rockwell Intl.	SD 72-SH-50-2		05/12/72
SBI158	LMSC	Space Shuttle Management II Proposal	LMSC	LMSC-D157364		05/12/72
SBI159	MDAC	Space Shuttle Program Management Proposal	MDAC	E0600		05/12/72
SBI160	MSFC	MSFC Space Station CER's Report	MSFC	PRC D-2185-H		12/01/82
SBI161	NASA JSC	CERV Target Costs for Benchmark and Reference Configurations	JSC CERV Office		Houston, TX.	06/15/88
SBI162	CBO	Cost Estimating For Air Missiles	Congressional Budget Office		Washington, D.C.	01/01/83
SBI163	Evans, Jim	Meeting with Jim Evans Technical Assistant. NASA Space and Life Sciences	Eagle Engr.		Houston, TX.	04/19/89
SBI164	Whitlock, R.	JSC Cost Analysis Office	Eagle Engr.		Houston, TX.	04/11/89
SBI165	PRICE	PRICE Users Newsletter	12			10/01/88
SBI166	General Electric	PRICE H Reference Manual				01/01/88
SBI167	NASA JSC	Satellite Services Workshop	11.2 NASA JSC	JSC 20677	Houston, TX.	11/06/85

Appendix B - Complete SBI Trade Studies Bibliography

ID #	AUTHOR	TITLE	VOL. PUBLISHER NO.	REPORT/DOCUMENT NUMBER	PUBLISHER LOCATION	DATE
SBI68	Hamaker, Joe	Telephone interview relating to MSFC history and techniques for cost estimating.	Cost Analysis Branch Chief MSFC		Huntsville, Al.	04/27/89
SBI69	Booker, Clef	Personal Interview	Man-Systems Division JSC		Houston, TX.	04/04/89
SBI70	Evans, Jim	Personal Interview	Life Science Project Division JSC		Houston, TX.	04/19/89
SBI71	Heberlig, Jack	Telephone interview relating to make-or-buy lessons learned from Apollo	International Business Machines (IBM)		Houston, TX.	03/10/89
SBI72	Loftus, Joe	Telephone interview relating to make-or-buy history	Assistant Director (Plans) JSC		Houston, TX.	03/14/89
SBI73	Christy, Neil	Telephone interview relating to hardware development student experiments, and make-or-buy			Houston, TX.	03/15/89
SBI74	McAllister, Fred	Telephone Interview	Man-System Division, JSC		Houston, TX	03/14/89
SBI75	Trowbridge, John	Interview relating to CHEC make-or-buy	McDonnell Douglas		Houston, TX.	03/17/89
SBI76	Trowbridge, John	Personal interview relating to CHEC experience to miniaturization, modularity and make-or-buy	McDonnell Douglas		Houston, TX.	03/29/89
SBI77	Nagel, John	Personal Interview relating to LSLE make-or-buy experience	Eagle Technical Services		Houston, TX	03/27/89
SBI78	McFadyen, Gary	Personal Interview relating to life science hardware background at JSC	Southwest Research Institute		Houston, TX.	04/10/89

Appendix B - Complete SBI Trade Studies Bibliography

ID #	AUTHOR	TITLE	VOL. PUBLISHER NO.	REPORT/DOCUMENT NUMBER	PUBLISHER LOCATION	DATE
SB179	Booker, Clef	Personal Interview - Minaturization on amplifiers, computers and modularity	NASA JSC/SP 341 Man-System Division		Houston, TX.	04/04/89
SB180	McFadyen	Bioengineering on SBI hardware	Southwest Research Institute		San Antonio, TX.	04/06/89
SB181	Allen, Joe	Personal interview - S.S. Life Science AIAA Meeting	Space Industries		Houston, TX.	04/07/89
SB182	Averner, Maurice	Personal interview on CELSS	NASA HQ. CELSS Coordinator		Washington, DC.	04/07/89
SB183	Fogleman, G. PhD	Personal interview relating to Gas Grain Simulation Facility	NASA AMES		Moffet Field, CA.	04/06/89
SB184	White, Bob	Personal Interview relating to modularity and commonality	NASA JPL		Pasadena, CA.	04/10/89
SB185	Grumm, Richard	Personal interview relating to SBI hardware	NASA JPL		Pasadena, CA.	04/11/89
SB186	Boeing	U.S. Lab Review Workshop				/ /
SB187	McGillroy, B.	Personal Interview on CELSS	NASA AMES		Moffet Field, CA	05/05/89
SB188	NASA JSC	Life Science Flight Experiments Program Life Sciences Laboratory Equipment (LSLE) Descriptions	NASA JSC	JSC-16254-1	Houston, TX.	09/01/86
SB189	Boeing	Space Station Program Commonality Plan Draft 3	Boeing	D683-10112-1		10/31/88
SB190	GE Govt. Service	Life Sciences Hardware List for the Space Station Freedom Era - Baseline December 1988 Updated 3/22/89	GE Government Services		Houston, TX.	03/22/89

Appendix B - Complete SBI Trade Studies Bibliography

ID #	AUTHOR	TITLE	VOL. PUBLISHER NO.	REPORT/DOCUMENT NUMBER	PUBLISHER LOCATION	DATE
SB191		NASDA Standard Rack Envelope Study Status	NASDA			/ /
SB192		Spacelab Payloads Accommodations Handbook	NASA MSFC	SLP/2104	Huntsville, Al.	08/16/85
SB193		Station Interface Accommodations for Pressurized and Attached Payloads	NASA			02/01/89
SB194		Life Sciences Study for the Space Station	Management and Technical Services Co.		Houston, TX.	08/01/84
SB195	Crenshaw, John	Personal Interview with John Crenshaw - Discussion of standardized avionics (mounted on racks) in airlines.			Houston, TX.	05/16/89
SB196	Juran, J.M.	The Non-Pareto Principle Mea Culpa				/ /
SB197	Arabian, D.	Beware Off-the-Shelf Hardware	NASA JSC		Houston, TX.	10/17/73
SB198	SB198NASA JSC	Experimenting with Baroreceptor Reflexes	NASA Tech Briefs	No. 11	New York, NY	12/01/88

Appendix C - Cost Assessment Techniques Summary

1.0 Introduction

1.1 Relative Cost Impact Analysis Task

JSC and GE Government Services are developing the SBI hardware cost estimate to be presented to NASA Headquarters. The cost related task in these trade studies is to develop and present factors which assist the cost estimators in using tools to develop the effect of the trade study specialty area (miniaturization, modularity and commonality, and Modified COTS) on SBI cost estimates. The life cycle costs are most important in judging the long term benefits of a new project. However, consideration of life cycle costs requires knowledge of the probable project life, operational use time lines, maintenance concepts, and logistics relationships. These data are not available at the time of these initial trade studies. Therefore, the trade studies address primarily the relative cost impact analysis of the design and development phase of the SBI. Life cycle costs are dealt with on a comparative, subjective basis in order to illustrate the influence of life cycle cost factors on the various trade study subjects.

1.2 Documentation Approach

The application of cost methods as applied to SBI trade studies involves some methods common to all of the studies and others that apply uniquely to a specific trade subject. Therefore, the selected approach to the problem is to deal with cost methods and cost trends in this appendix that is to be a part of each study report. In the cost appendix, subsequent sections of Section 1.0 deal with various methods examined for the trade studies, Section 2.0 defines the cost estimating relationship (CER's) and their factors and sensitivities, and Section 3.0 deals with specific variations and parameters of interest with respect to each trade study. Sections 4, 5 and 6 provide brief discussions of testing, SE&I and project management costs, Section 7.0 life cycle effects, and Section 8.0 summarizes the conclusions.

1.3 Cost Method Overview

Cost methods considered and evaluated in the course of this effort include the basic types listed below:

- a. Detailed cost build-up method. The detailed cost estimate is compiled using estimates from specialists in the various design disciplines and is constructed from a spread of hours required in design, labor rates, overhead and other factors affecting the cost of DDT&E.
- b. General Electric PRICE. The PRICE H model is a sophisticated cost modeling program requiring a variety of inputs including weight, manufacturing complexities, and design complexity plus secondary factors.
- c. Cost estimating relationship (CER's). The simplest cost estimating tools are empirical relationships based primarily on system weight and derived to match past experience on previous programs.
- d. Cost impact analysis methods. Parametric studies to establish and/or to quantify cost drivers and cost trend effects.

The choice between the foregoing alternatives was narrowed to options c and d which are used in combination as described in the balance of this report. Initial SBI cost estimates will be developed in a separate effort using PRICE H. Therefore, the task in the trade studies is to provide data and/or factors which will be helpful in assisting cost estimators in the use of the tools from which the actual estimates will be formulated. A secondary purpose is to develop parametric trend data that will help the reader understand the potential impact of the various trade study subjects on cost, i.e. miniaturization, commonality, and the use of commercial products (COTS) in lieu of new design.

Empirical cost relationships use system weight as the primary factor in deriving development and theoretical first unit (TFU) costs. A series of such relationships can be used to reflect the inherent complexity of different types of space-borne systems, i.e., one relationship for structural or mechanical systems, a second for packaged electronics, and a third for complex distributed hybrid systems. This approach has its roots in past program experience in that the end results are usually compared with past program actual costs and the relationships adjusted to match what has happened on similar system development during their life cycle. References SBI No. 60 and SBI No. 61 were used as a data source for CER's. Also, a discussion was held with the cost analysis specialist at JSC and MSFC (ref. SBI No. 64 and No. 68) as part of the effort to determine whether or not other cost work has been accomplished on the SBI trade study subjects.

As will be seen in the ensuing sections and in the trade studies proper, the results and trends also employ second order effects such as the amount of new design required, the impact of sophisticated technology and alternate materials.

Regardless of how one approaches the subject of cost development or cost trends there are three fundamental principles are involved in evaluating costs, cost drivers and cost trends (ref. SBI No. 65). These are as follows:

1. Estimates require reasoned judgments made by people and cannot be automated.
2. Estimates require a reasonably detailed definition of the project hardware that must be acquired or developed before estimates can be made.
3. All estimates are based upon comparisons. When we estimate, we evaluate how something is like or how it is unlike things we have seen before.

The SBI Program estimates are particularly challenging because the definition of the hardware items and the data that will permit comparisons is not detailed and complete. We are dealing with some items in their earliest conceptual phase of definition.

A couple of study principles should also be mentioned because they may help us understand the validity of the results we obtain. These are:

1. The sensitivity that study results show to variations in assumption provides an indication as to the fundamental nature of the assumption. If results are highly sensitive to variations in assumption then the assumption should be used with caution. Extrapolations are particularly hazardous in such instances. On the other

hand if results are not highly sensitive, then scaling over a wide range may be feasible, although extrapolations of cost values can yield misleading results in any event and should always be applied carefully.

2. Parametric approaches may be necessary in order to understand trends due to the absence of specific data for use in the study. Parametric in the sense used here means the arbitrary variation of a given parameter over a range of expected values, while holding other values constant.

The costing relationships used in SBI trade studies are applicable to space systems and are founded on past programs as described in references SBI No. 60 and No. 61. The only questions, therefore, are whether or not they can be used on SBI hardware (which does use subsystems similar in nature to other manned space systems) and how accurately they can be scaled to fit the range of SBI sizes. Insofar as practical, these questions have been circumvented by means of reporting cost trends in lieu of cost values.

2.0 General Development Cost Methods

2.1 Empirical Methods

As stated in Section 1.3 CER's are empirical cost estimating relationships that express expected costs on the basis of past program experience. Empirical cost estimating requires some sort of systems definition plus good judgement in the selection of the constants, and exponents. The nature of a system element or assembly, and the size/weight of the item are primary cost drivers. The most predominant variable is the exponent of the weight term in the following generalized equation:

$$\text{Cost} = df * (C_1 (Wt)^n) + C_2 (Wt)^n$$

- Where
- wt = weight of the system, module or assembly
 - n = an exponent selected on the basis of system complexity
 - df = a factor reflecting the amount of new design required (design factor)
 - C₁ = constant selected to establish the cost trend origin
 - C₂ = a constant to reflect special requirements such as tooling - can be zero

Adjustments to the weight exponent and the constants yields values which show dramatic cost increases as a function of weight but decreasing cost per pound as the weight is increased. Cost relationships always show these trends when applied to launch vehicles, spacecraft, or payloads. Therefore, it is assumed that they apply to biology equipment (for space) as well. Economies of scale are present in all such systems. The larger the system, assembly, or component, the lower its cost per pound. There is, however, a limitation to the applicability of CER's to SBI hardware

due to size limitations. All CER's have a range of applicability and produce consistent results in terms of cost per pound over that range. The limitation comes into play when extrapolating outside the range of applicability, particularly where the size is small. Unfortunately, this limitation may be a factor in SBI hardware elements and assemblies due to their size being relatively small compared to manned spacecraft systems. Therefore, when a CER yields costs in a very high range, on the order of \$100,000/lb. or \$220,000/Kg, or higher, caution and judgement are necessary to avoid the use of misleading results.

2.2 System Complexity Exponents (n)

Past experience in estimating costs with empirical methods suggests that the exponent, n , increases with increasing system complexity and as a function of the degree to which a system is distributed. For example, relatively simple, structure or packaged power modules may be represented by $n = 0.2$. The cost of more complex mechanical systems and structures which are comprised of a variety of components and assemblies can be represented by an exponent, $n = 0.4$ and the most complex distributed electronics call for an exponent on the order of 0.5 to 0.6. Inasmuch as the SBI systems involve all the foregoing elements plus sophisticated sensors, it may be necessary to use exponents that are as high as 0.8 or 1.0 to represent cost trends of parts of the SBI systems. Reference No. 60 uses an exponent, n , equal to .5 for development when historical data are not available. This value has been used in SBI Reference No. 60 for displays and controls, instrumentation and communications, all of which are comprised of distributed electronics and is consistent with the range recommended here (.5 to .6).

The dramatic effect of the system complexity exponent is illustrated by Figure 2-1. Figure 2-1 is a plot of cost per pound vs. complexity exponent, n , for a range of values of n between 0.1 and 1.0. As can be seen from the figure, 1000 units of weight costs 0.2% per unit weight as much at $n = 0.1$ compared to the cost at $n = 1.0$. The point is that care must be exercised in making a proper selection of exponent in order to achieve reasonable accuracy in estimating actual costs.

The historical use of lower exponents for simple, packaged systems, and the use of higher values for complex distributed systems matches common sense expectations. To express it another way, one can safely assume that the cost of a system will be influenced dramatically by the number of different groups involved in the design, by the number of interfaces in the system, and by the complexity of the design integration effort required. Distributed power and data systems invariably cost more (per pound) to develop than do packaged elements. However, the degree to which this applies to SBI is not clear due to the fact that biological systems tend to be more packaged and less distributed than do other space systems.

2.3 Design Factors (df)

Figure 2-2 defines the design factors that represent the degree of new design required in a development. On the low side is the factor representing the use of existing designs that require very little modification, integration or testing. For all new current state-of-the-art designs which involve no new technology, the design factor is 0.9 to 1.0. The factor for new design requiring advancement in technology is expressed as greater than unity and can be as high as 2 or 3 for efforts that dictate a multiple design path approach to achieve the desired goals. Price H refers to this type of factor as the engineering complexity factor and uses design values similar to those

in Figure 2-2. However, Price H varies the experience of the design team as well as the complexity and the difficulty of the design.

2.4 Method Summary

The SBI trade studies will all require a definition of system element size, complexity and degree of new design. These factors may have to be varied over a range of probable values to evaluate trends, but they will all come into play in costing comparisons.

FIGURE 2-1
Effect of Exponent "n" on Cost

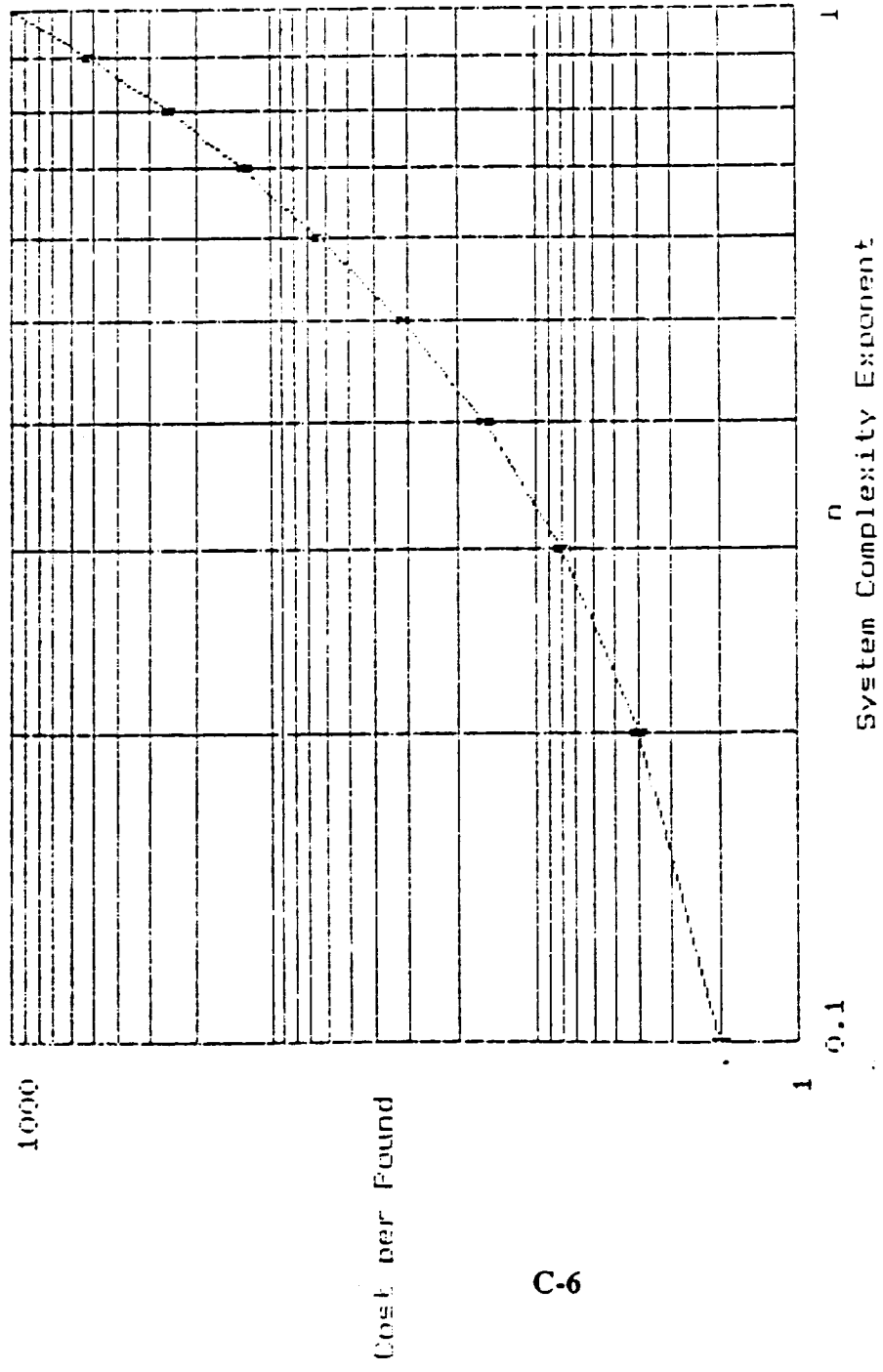

Figure 2-2 Design Factors

Design Factor	Description of the Design Task
.1 to .2	Off-The-Shelf. Minor design modifications and little or no qualification testing required
.3 to .4	Design Exists. Some new design drawings required Minimum integration costs involved
.5 to .6	Design exists but requires significant modification. On the order of 40% to 50% to existing drawings.
.7 to .8	Similar designs exist but mostly new drawings required No new technology involved in electronics, structure etc.
.9 to 1.0	New design with all new drawings. Little or no new technology required
1.0 to 3.0	All new design, new technology required. May require multiple attack on new technology problems

3.0 Cost Methods Applicable to Specific Trade Studies

Three of the four studies are discussed separately in this section although there are common elements associated with them that were not covered in Section 2.0. The intent is to examine the prime cost drivers that come into play with the subjects of miniaturization, modularity and commonality, use of COTS, and compatibility between spacecraft. Rack compatibility is covered in Section 7.4 under life cycle costs.

3.1 Hardware Miniaturization Cost Drivers

Fundamentally the variables of system (or component) weight, system complexity, and difficulty of design all influence miniaturization cost trends. For the purposes of this section weight and design difficulty will be varied, while system complexity will be treated as a series of constants, each being evaluated separately. Materials changes will not be dealt with even though it is valid to assume that the use of titanium, graphite, steel or composites will adversely affect cost. In fact, the dense materials (titanium and steel) will adversely affect cost due to weight and cost due to manufacturing complexity as well.

Given the foregoing exclusions, the miniaturization cost trends have been dealt with by parametric variation of the system size, and the degree of new design needed to achieve a given degree of miniaturization. The selected values of miniaturization vary between 10% and 90% in increments of 10%. In other words, if an unminiaturized system size is treated as 100%, Tables 3-1 through 3-4 show the effect on cost of weight reduction between zero and 90% on the first line. In order to include the effect of system complexity, Tables 3-1 through 3-4 are provided for values of $n = 0.2, 0.4, 0.6, \text{ and } 0.8$.

The columns in the tables vary the design difficulty between a minimum change (.1 to .2 on Figure 2-2) and an all new design (0.9 to 1.0 on Figure 2-2). However, Tables 3-2 through 3-4 show the minimum design change as unity for reasons of simplifying the numbers. Thus the minimum design change number becomes 1.0 in lieu of 0.15 and the all new design becomes 6.0 which represents a relative value, compared to the minimum change value, i.e. $0.90 / 0.15 = 6.0$.

The use of Tables 3-1 through 3-4 is simple. Numbers less than 1.0 indicate a cost reduction and the degree of same, while numbers above 1.0 represent cost increases and the relative size of the increase. For example, using a 50% size reduction, and miniaturization requiring an all new design ($df = 6$) for $n = 0.4$, table 3-2 shows that the cost will be on the order of $4 \frac{1}{2}$ times the cost for an unmodified item that is not miniaturized. In like manner, one can deduce that the cost of an all new design that achieves a 90% reduction in size (was 20 lbs., is 2.0 lbs.) will cost approximately $2 \frac{1}{2}$ (2.4 from Table 3-2) the amount of an unmodified design.

Figure 3-1 is included to illustrate the cost trends for various systems complexity factors between $n = .2$ and $n = .8$. The curves all use a design factor $df = 1.0$ and all have been normalized so that the unminiaturized weight is unity. The purpose of Figure 3-1 is to show the effect of complexity factors on cost as weight is reduced. No design modification effects are included in Figure 3-1 so the curves indicate complexity trends only. To generate an estimate of the relative cost of miniaturization including redesign effects, one must multiply the cost factor (Figure 3-1) by a design factor as is done in Tables 3-1 through 3-4.

Table 3-1
Miniaturization Guide Chart
n=.2

% Miniaturization df	df									
	0	10	20	30	40	50	60	70	80	90
Design Integration Only	1.00	.98	.96	.93	.90	.87	.83	.79	.73	.63
Significant Modification Req'd (30%)	2.00	1.96	1.92	1.86	1.80	1.74	1.66	1.58	1.46	1.26
Major Modification Req'd (50%)	3.00	2.94	2.88	2.79	2.70	2.61	2.49	2.37	2.19	1.89
All New Design	6.00	5.88	5.76	5.58	5.40	5.22	4.98	4.74	4.38	3.78

Table 3-2
Miniaturization Guide Chart
n=.4

% Miniaturization df	df									
	0	10	20	30	40	50	60	70	80	90
Design Integration Only	1.00	.96	.92	.87	.82	.76	.69	.62	.53	.40
Significant Modification Req'd (30%)	2.00	1.92	1.84	1.74	1.64	1.52	1.38	1.24	1.06	.80
Major Modification Req'd (50%)	3.00	2.88	2.76	2.61	2.46	2.28	2.07	1.86	1.59	1.20
All New Design	6.00	5.76	5.52	5.22	4.92	4.56	4.14	3.72	3.18	2.40

Table 3-3
Miniaturization Guide Chart
n=6

% Miniat. df	df									
	0	10	20	30	40	50	60	70	80	90
Design Integration Only	1.00	.94	.86	.81	.74	.66	.58	.49	.38	.25
Significant Modification Req'd (30%)	2.00	1.88	1.72	1.62	1.48	1.32	1.16	.98	.76	.50
Major Modification Req'd (50%)	3.00	2.82	2.58	2.43	2.22	1.98	1.74	1.47	1.14	.75
All New Design	6.00	5.64	5.16	4.86	4.44	3.96	3.48	2.94	2.28	1.50

Table 3-4
Miniaturization Guide Chart
n=8

% Miniat. df	df									
	0	10	20	30	40	50	60	70	80	90
Design Integration Only	1.00	.92	.84	.75	.67	.57	.48	.38	.28	.16
Significant Modification Req'd (30%)	2.00	1.84	1.68	1.50	1.34	1.14	.96	.76	.56	.32
Major Modification Req'd (50%)	3.00	2.76	2.52	2.25	2.01	1.71	1.44	1.14	.84	.48
All New Design	6.00	5.52	5.04	4.50	4.02	3.42	2.88	2.28	1.68	.96

Figure 3 -1

Variation of Cost as a Function of Weight

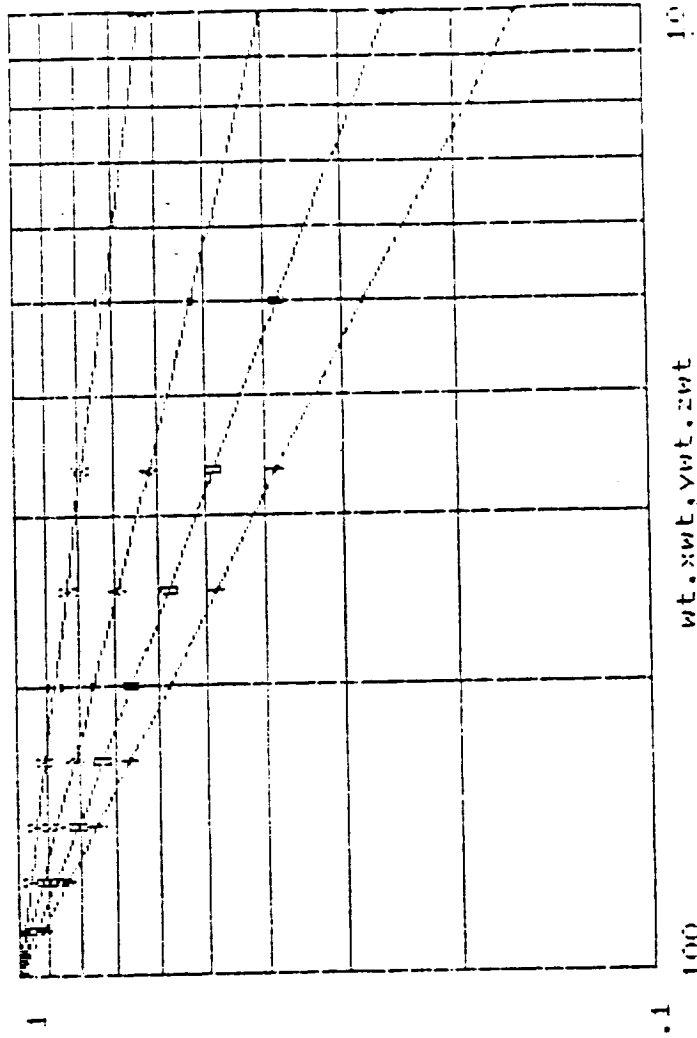

Cost Factor from Tables 3-1 thru 3-4
 $cost(wt, xwt, ywt, zwt) = df * (wt)^n / wt$

The examples are not meant to suggest that certain combinations of miniaturization and design difficulty are more rational than others, but were selected simply to demonstrate table usage. It is conceivable that a modest degree of miniaturization is achievable with modest design ($df = 2$).

Caution is advised! for several reasons:

1. Some items cannot be reduced in size.
2. Some items should not be reduced in size.
3. Significant size reductions may require technology breakthroughs in materials, electronics, displays, etc. that could complicate the SBI development task.
4. Substitute materials will often negate weight reductions and raise costs even higher than estimated by the tables.

Notwithstanding all the adverse possibilities, one could conceivably reduce size and cost by miniaturizing an item or an assembly.

3.2 Modularity and Commonality

Common system modules, assemblies or components can have a profound impact upon development cost because of the potential savings associated with the use of a common module in more than one SBI hardware item. The following examples serve to illustrate this fact.

Table 3-5 shows the impact of using learning to reduce costs. For example, consider the case where sixteen units are to be constructed for a given SBI application of a system rack or drawer, but the item in question can be used in four applications rather than in only a single place. If the system is to be produced in small quantities, exotic tools and automation are not cost effective and the item is normally assembled using piece parts. Such systems usually have learning factors of 80%, i.e., each time the number of units is doubled (SBI Ref. No. 68), the cost of the nth unit is 80% of the previous cycle's end product cost. To be specific, the 2nd unit costs .8 times the first unit, the 4th unit .8 times the second, etc. See Table 3-5. In the case of a built-up drawer or rack which is used in four places, 16 units for prototypes, test, flight hardware, etc., becomes 64. As can be seen from Table 3-5, the cost of the 64th unit is 26.2% of the 1st unit and 64% of the 16th unit. The average cost for 64 items is reduced to 37.4% of the first unit cost compared to 55.8% of the first unit cost for 16 items. The lower the learning, the less dramatic the unit cost reduction, but for any item that is fabricated by other than completely automated processes, there is a cost reduction to be realized by common use in more than one application.

If one considers the programmatic input of multiple applications, there also exists the opportunity to avoid duplicate design and development efforts. For the sake of simplicity, we will confine this discussion to D&D plus fabrication and assume that four separate developments each require a test program. This being the case, we can treat a single, dual, triple and quadruple application in terms of the D&D effort and include the effect of reduced costs due to learning as well.

D&D = Design and Development Cost
 TFU = Theoretical First Unit Cost
 L.F. = .80
 Number of articles required per application = 16

Then:

Let CP_1 = Cost of a single program,
 Let 35% D&D = TFU Cost

$$C.P_1 = 1.0 D\&D_{cost} + [.35 D\&D * L.F.] 16$$

$$= 1.0 D\&D + [.35 D\&D * .558] 16$$

$$C.P_1 = 1.0 D\&D + 3.1248 D\&D = 4.1248 D\&D$$

Normalized cost = $C.P./4.1248 D\&D$

In a similar manner, the cost of 2, 3 and 4 applications can be calculated which yields the data in Table 3-6.

TABLE 3-5
Learning Factor Table
 All First Articles are 100%

Quantity		2	4	8	16	24	32	64
0.95	N th	95.0%	90.3%	85.7%	81.5%	79.0%	77.4%	73.5%
	Aver.	97.5%	94.4%	90.8%	87.0%	84.65	83.0%	79.1%
0.90	N th	90.0%	81.0%	72.9%	65.6%	61.7%	59.0%	53.1%
	Aver.	95.0%	88.9%	82.2%	75.2%	71.3%	68.5%	62.0%
0.85	N th	85.0%	72.3%	61.4%	52.2%	47.5%	44.4%	37.7%
	Aver.	92.5%	83.6%	74.2%	64.9%	59.7%	56.2%	48.3%
0.80	N th	80.0%	64.0%	51.2%	41.0%	35.9%	32.8%	26.2%
	Aver.	90.0%	78.6%	69.3%	55.8%	49.8%	45.9%	37.4%

Notes:

1. Nth refers to the 2nd, 4th etc article in the fabrication of identical articles by the same process
2. "Aver.", refers to the average cost of the 1st through the Nth article under the same conditions
3. The External Tank learning factor has been estimated at 80% (0.80) due to the relatively large amount of manual labor that goes into the fabrication process. In general the more manual the process, the greater the learning and the smaller is the number from the table that applies.
4. As the learning factors approach unity the reduction in cost for each succeeding cycle is reduced and 1.0 represents a fully automated process wherein the first article and the Nth article cost is the same.
5. For the purposes of the SBI trade studies we can use the guidelines that the manual fabrication and assembly processes of sheet metal have learning factors of 80% to 90% while the more automated and repetitive processes range between 90% and 95% or even as high as 97%. There probably won't be any automated processes where the costs of a number of articles remains the same as the first article cost.

Table 3-6
Cost of Multiple Applications

Applications	D&D Cost	Production Cost	Normalized Total Cost Per Application
1	1.0 (D&D)	3.1248 (D&D)	1.00
2	.50 (D&D)	5.1408 (D&D)	.744
3	.33 (D&D)	6.7704 (D&D)	.628
4	.25 (D&D)	8.3776 (D&D)	.568
5	.20 (D&D)	9.785 (D&D)	.523

Figure 3-2 is a linear plot of the foregoing information based upon a theoretical first unit (TFU) cost of 35% * (DD), Figure 3-3 is based on a TFU of 15% * (DD). Figures 3-2 and 3-3 illustrate two facts. The first is that a significant cost reduction result from the use of hardware in more than a single application. The second is that the point of diminishing cost return occurs rapidly beyond the third application.

Modularity, although similar to commonality in some respects, offers other advantages as well. However, one must acknowledge that modular designs may cost more initially than non-modular designs due to the tendency for them to require added weight for packaging and more design integration due to an increase in the number of interfaces present in the system. Nevertheless, such systems have lower life cycle costs because of simplicity in assembly, repair, replacement, problem diagnosis and upkeep in general. Also there are the advantages of being able to upgrade individual modules with new technology and/or design improvements without impacting the rest of the system and without complicated disassembly and assembly to affect a module changeout.

Thus, if modules can be made common, the system possesses the attributes of modularization and offers potential cost savings from the multiple use of various system modules. The long and short of it is that the system cost can be reduced and the system flexibility and life cycle attributes improved. Common elements in modular designs should be a major, high priority goal in all SBI systems.

3.3 Modification of Existing Hardware (COTS) vs. New Hardware Build

Commercial off-the-shelf (COTS) hardware has been used for space applications sporadically since the early days of manned space flight and it poses the same cost-related challenges today as it did 25 years ago. The variables involved are the cost of the item, the cost of modification to meet space flight requirements, and the cost of demonstrating the hardware's reliability in qualification testing.

Past experience indicates that the cost of hardware modification is normally the primary cost factor of the cost elements listed. In an effort to assign an order of magnitude to modification costs, the weight of the COTS, the degree of modification (design factor, *df*), and the nature of the system (weight and system complexity, *n*) are used as prime cost drivers. Table 3-6 and 3-7 show the cost of modification against size (*wt*), and for systems with complexity factors (*n*) of .2 and .4. The higher order complexity factors are assumed to be not applicable on the basis that COTS is usually procured as modules or assemblies and then integrated into a larger system as necessary.

The costs shown in Tables 3-7 and 3-8 are based upon the assumption that COTS modifications are approximately the same cost as are redesigns to existing systems. The degree of modification (or redesign) is reflected in the design factor, *df*. The degree of system complexity is reflected by the system complexity factor, *n*. The range of weights over which these parameters are varied was selected on the basis that few items to be modified would be heavier than 50 Kg and that the small items less than 5 Kg would be procured as components or small assemblies which would be used in the design of a new system. The assumed size limit can be modified if necessary but were made to keep the number of weight variables in a reasonable size range with modest increments between each one. Here, again, caution is needed when applying CER type relationships to small items and to items where the portion of a hardware element being modified is small. See paragraph 2.1 for a discussion of scaling limitations.

Specific modifications to COTS may be simple enough to invalidate the assumption that modifications and redesign costs are similar. If so, alternate COTS modification cost methods will be required and will reflect greater savings. Thus, the foregoing assumption degrades gracefully because it is conservative from a cost point of view.

A popular viewpoint today is that modified COTS is always less costly than is a new design. This belief is reflected in the emphasis on "make or buy" in recent NASA RFP's and also in recent cost seminars held by major aerospace companies. Nonetheless, some cost specialists express the opinion that modifications to COTS greater than 30-35% probably makes a new design preferable. The COTS vs. new design trade study deals with these subjects so this part of the report will be confined to cost trends only. From the viewpoint of modification costs alone it appears straightforward that COTS has great cost reduction potential and should be seriously considered whenever a commercially available system element exists that can be utilized in SBI.

In order to illustrate the cost trends for modification costs and modification cost per pound, Figure 3-4 and 3-5 are included. Figure 3.4 represents minor modifications ($df = .15$) and $n = .2$, and, therefore, shows the lowest cost per pound of any of the cases in Tables 3-7 and 3-8. Figure 3-5 is for the case of substantial modifications and $n = .4$, $df = .55$ and thus represents a high side cost case. The figures both show the trends that are typical for the values presented in the tables.

Figure 3-2
 Effect on Cost of Multiple
 Applications of Hardware

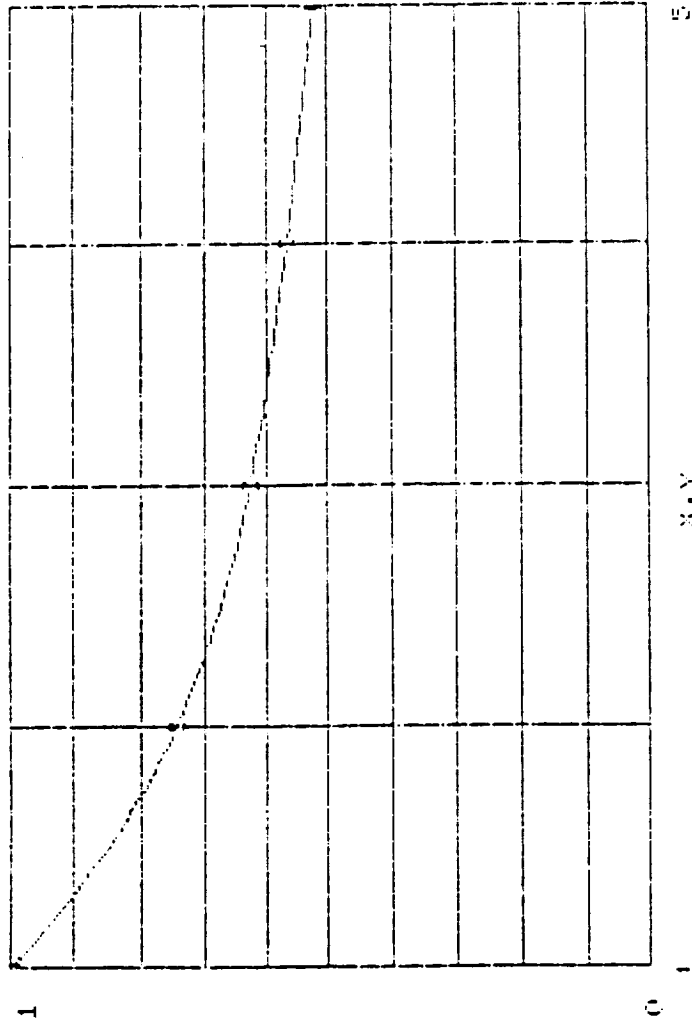

Relative Cost of
 Hardware used in
 Multiple Places

Number of Hardware Uses

First Unit Cost (TFU) = .35*(Dev. Cost)

Learning Factor = 80%

Figure 3-3
 Effect on Cost of Multiple
 Applications of Hardware

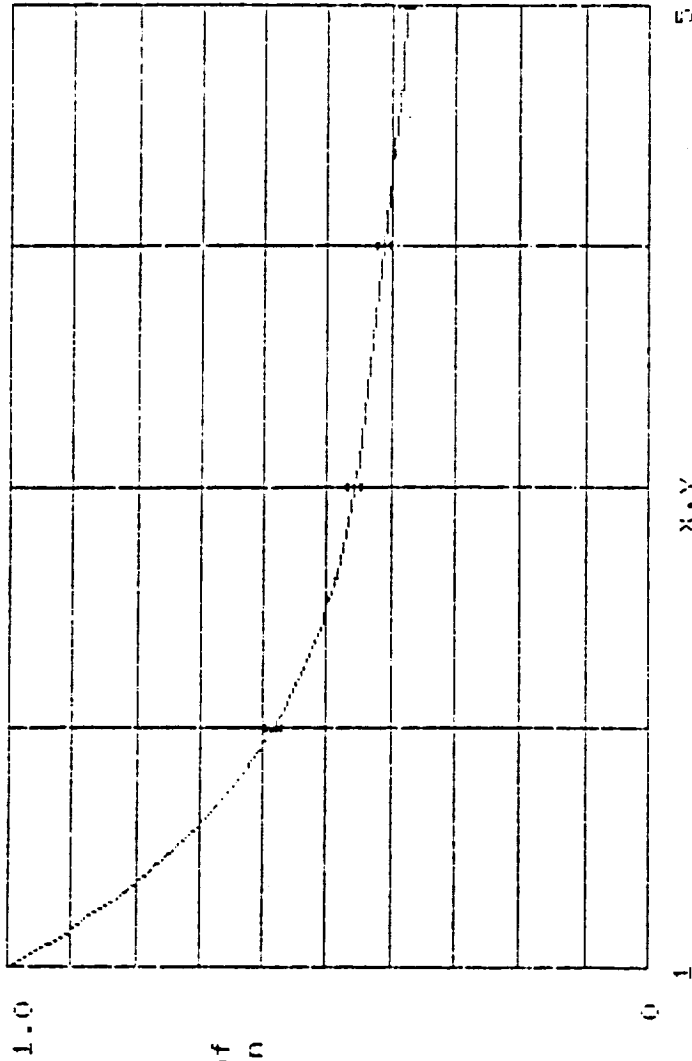

Relative Cost of
 Hardware Used in
 Multiple Places

Number of Hardware Uses

First Unit Cost (TFU) = $.15 \times (\text{Dev. Cost})$

Learning Factor = 80%

Table 3-7 Cost of Modifying Commercial Off-the Shelf Hardware

System Complexity Factor (n) =.2

Design Factor Weight of Part Modified	Minor Mods df=.15		Modest Mods df=.35		Substantial Mods df=.55		Major Mods df=.75	
	Mod. Cost	Cost/kg	Mod. Cost	Cost/kg	Mod. Cost	Cost/kg	Mod. Cost	Cost/kg
Weight =5 kgs	242.3	48.46	565.4	113.1	888.5	177.7	1212	242.3
Weight = 10 kgs.	278.3	27.83	649.5	64.95	1021	102.1	1392	139.2
Weight = 20 kgs.	319.7	15.99	746.0	37.3	1172	58.62	1599	79.93
Weight = 30kgs.	346.7	11.56	809.1	26.97	1271	42.38	1734	57.79
Weight = 40 kgs.	376.0	9.182	857.0	21.42	1347	33.67	1836	45.91
Weight = 50 kgs.	384.0	7.681	896.1	17.92	1408	28.16	1920	38.40

Notes: 1) All costs are in thousands of dollars

Table 3-8 Cost of Modifying Commercial Off-the Shelf Hardware

System Complexity Factor (n) = .4

Weight of Part Modified	Design Factor	Minor Mods df = .15		Modest Mods df = .35		Substantial Mods df = .55		Major Mods df = .75	
		Mod. Cost	Cost/kg	Mod. Cost	Cost/kg	Mod. Cost	Cost/kg	Mod. Cost	Cost/kg
Weight = 5 kgs.		391.4	78.28	913.3	182.7	1435	287.0	1957	391.4
Weight = 10 kgs.		516.5	51.65	1205	120.5	1894	189.4	2582	258.2
Weight = 20 kgs.		681.5	34.08	1590	79.51	2499	148.5	3408	170.4
Weight = 30 kgs.		801.5	26.72	1870	62.34	2939	97.96	4008	133.6
Weight = 40 kgs.		899.3	22.48	2098	52.46	3297	82.43	4496	112.4
Weight = 50 kgs.		983.2	19.66	2294	45.88	3605	72.10	4916	98.32

Notes: 1) All costs are in thousands of dollars

Figure 3 - 4
 Variation of Cost & Cost/Kg for COTS Mode
 df=.15 n=.2

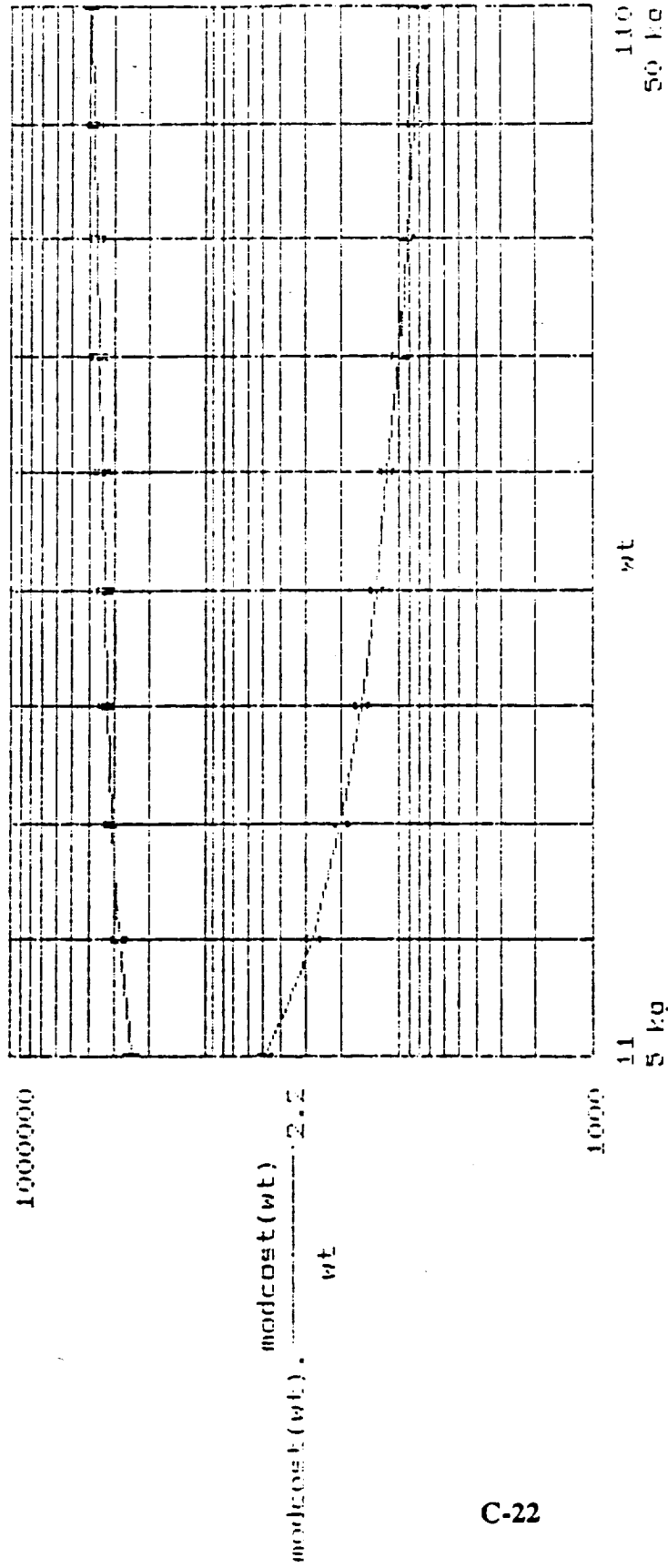
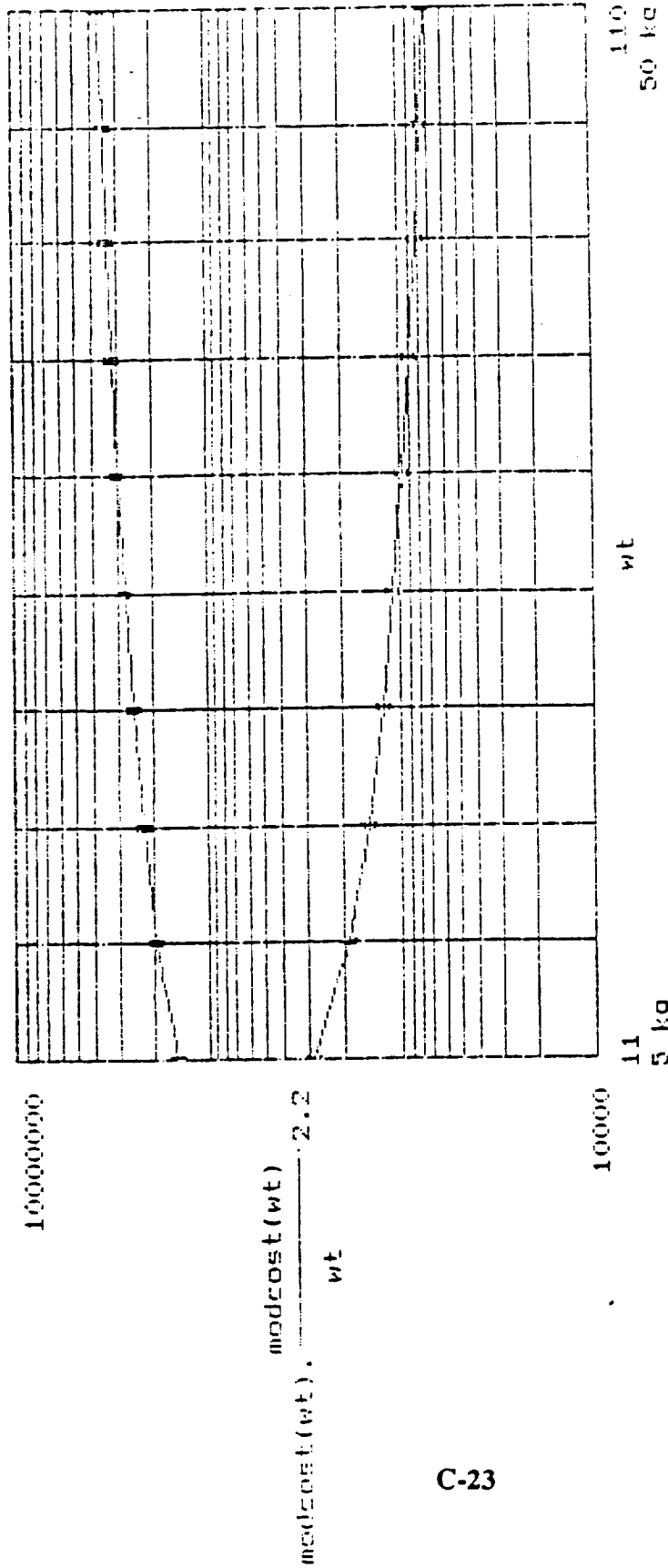

Figure 3 - 5
 Variation of Cost & Cost/kg for COTS Mods
 df=.55 n=.4



4.0 Testing Costs

A cursory treatment of testing costs is presented so as to make the cost picture as complete as possible. However, the applicability of test costs to SBI has not been validated and the guidelines presented should be applied with care only where a similarity exists between SBI elements and/or subsystems, and other manned spacecraft systems.

4.1 Test Hardware

Test hardware costs in past manned programs have included the cost of labor and materials for major test articles used to verify design concepts. However, test hardware cost relationships exclude element tests, component tests, qualification and certification tests. The cost of labor and material for the design, procurement, installation, checkout and operation of the instrumentation system on major test articles is included and as one might expect, these factors drive the cost of test hardware up to a value greater than the first unit cost.

The CER's examined put the cost of test hardware at 30% more than the theoretical first unit (TFU) cost, i.e. $1.3 * \text{TFU}$. It should be noted that this cost is to demonstrate and to verify the operation of the designed hardware and should not be construed to include experimentation and testing to acquire biological information of an experimental or research character.

4.2 Integration Assembly and Checkout (IACO)

This factor is most commonly estimated as a function of TFU costs or test hardware costs. It will generally run on the order of 10 - 20% of test hardware costs for manned systems, but care must be exercised in applying such a rough rule of thumb to SBI. Therefore, a simple CER is suggested in cases where PRICE H estimates have not yet been formulated. The CER is as listed below:

$$\text{IACO} = .3 (1.3 \text{ TFU})^{0.7}$$

The resulting estimate can only be generated when all other hardware costs are available.

4.3 Test Operations

Test operations CER's indicate that costs generally run on the order of 20% to 30% of the cost of test hardware plus integration, assembly and checkout costs. However, as is the case with other test related items of cost, the applicability to SBI hardware has not been validated. Nonetheless, the order of magnitude could be used for SBI estimates pending specific definition of test requirements for the various experiments.

Examination of the SBI hardware list (Ref.SBI No. 87) and the Life Science Laboratory Equipment description (Ref. SBI No.88) suggests that test operations could vary from little or nothing all the way up to the level indicated in CER's and approximated above.

5.0 SE&I Costs

SE&I cost for the design and development phase are generally expressed as a function of the DDT&E + Systems Test Hardware + IACO + Test Operations + GSE costs. However, the lower end of the validity range is almost \$1.0 billion of DDT&E costs and the applicability to SBI is extremely doubtful. For that reason, it is recommended that the preliminary SBI SE&I cost be taken as 10% to 15% of the SBI total system development cost until a detailed estimate or a PRICE H value is generated.

6.0 Program Management Costs

Program management costs usually run 5% of the total of all other costs, i.e., 5% of the sum of DDT&E + IACO + Test Hardware + Test Operations + GSE + SE&I (for DDT&E) costs. Inasmuch as there is no basis to assume that SBI program management cost is any more or any less than other types of programs, it seems reasonable to use a very preliminary value of this order of magnitude for budgetary estimating purposes.

7.0 Life Cycle Costs

As noted previously in this appendix, life cycle cost information is not available and therefore only a subjective treatment of the subject is possible. Nonetheless, Table 7-1 provides some worthwhile insights concerning all the SBI trade study subjects being addressed by Eagle. Taken singly, these subjects reveal the following probable life cycle impacts.

7.1 Study No. 3 - Miniaturization

The possible reduction of cost due to the impact of weight reduction is more theoretical than achievable. Indications are fairly clear that most attempts to miniaturize will cost rather than save money. Therefore, one must conclude that the reason for attempting size reductions is other than cost savings. It is beyond the scope of this write-up to postulate or to speculate further.

7.2 Study No. 4 - Modularity and Commonality

If the SBI program-wide support can be mobilized to support modular design and the development of hardware for common application to a number of SBI experiments and/or facilities, the cost benefit should be very significant. All the factors noted in Table 7-1 tend to substantiate this conclusion and only the programmatic direction and support has any identifiable cost or problem related to it.

Modular designs and common equipment should be a top priority requirement, goal and objective of SBI effort.

7.3 Study No. 5 - COTS vs. New Hardware

COTS should be regarded as a slightly trickier subject than commonality due to the potential pitfalls and cost penalties that can be incurred in its application to spaceflight. Nonetheless, the potential cost savings are large enough so that judicious use of COTS where it fits with the SBI program appears to be a cost-wise approach which could yield tremendous cost benefits for only nominal technical risk. Technical risk which can be offset by care in selecting, testing, and screening the procured items.

The use of modified COTS in lieu of a new design appears to pay off until the modification cost approaches the cost of an optimized new piece of hardware. The cut-off point has not been defined but would make an interesting and worthwhile follow-on study. Intuitively one would expect to find a series of cut-off points that are a function of the hardware complexity, and therefore, the cost and complexity of the modification program.

7.4 Study No. 6 - Rack Compatibility

To a greater degree than the other SBI trade studies, this subject seems to defy analysis that could give cost trend indications or life cycle cost indicators. Nevertheless, if one assumes that the inter-program coordination of rack compatibility can be accomplished with a reasonable effort, there exists the possibility to lower cost, to reduce the cost of data normalizing and

comparison, and improved scientific data return might possibly be a companion benefit to lower experimentation costs.

The entire spectrum of life cycle costs beyond the design and program management phase that would accrue due to compatibility all appear to be very positive and beneficial. Logistics, ground processing, pre-flight checkout, operations, repair and replacement all would be impacted in a beneficial way by this approach. A comparable achievement that comes to mind is the establishment of standard equipment racks by the International Air Transport Association (IATA). The benefits apply to a large number of items (commercial transports) and of course the impact is greater, but the concept has been a true bonanza to all the world's commercial airlines. Rack compatibility is potentially a smaller sized cousin to IATA's achievement.

Table 7 -1 Life Cycle Cost

Phase	Study No. 3 Hardware Miniaturization	Study No. 4 Modularity and Commonality	Study No. 5 COTS vs. New Hardware	Study No. 6 Rack Compatibility
Design	Design change always required. Cost of redesign may be partially offset by size & weight reduction.	Requires programmatic support and some allowance for increased weight and cost in design phase.	Dependent upon availability and suitability of commercial modules and/or elements for SBI system application.	Requires inter-program coordination/communication and direction which is very difficult to achieve.
Development	Fabrication may be complicated due to size reduction.	Development, manufacture or procurement is facilitated by modularity. Commonality cost impacts all positive.	Modified COTS appears to have significant potential advantage. Requires sound make or buy analysis & eval.	Common source would be highly desirable but will be hard to do due to specification differences & organiz. barriers
Test and Evaluation	Test costs may increase due to difficulty in set-up and trouble shooting.	Module testing, integrated testing and test trouble shooting are simplified and cost savings result.	Testing impact appears to be negative due to need for extra qualification tests and periodic retest (screening).	Should have only minor impact which stems from differences in test requirements.
Sustaining Engineering	No significant impact pro or con is apparent.	Individual engineering groups can operate with less systems integration effort.	Should be automatically supported by vendor's program. Generally positive. Mods could pose problems.	Responsibility may be difficult to establish and to identify. Problem potential is small due to type of hardware.
Technology Upgrade	May be less likely due to absence of alternate hardware availability.	Facilitated and made easier by modular design.	Not predictable. Experience indicates that it can vary from easy and to very painful and awkward.	Should be possible within a rack or module. Compatibility will reduce the overall cost of inserting new tech. upgrades.
Maintenance and Operations	Possible adverse impact on maintenance due to small size. Operation should not be affected.	Common module impacts on maintenance, logistics and operations are all positive & highly significant.	Maintenance of unmodified portion could pose problem. Operation not affected if reliability is adequate.	Design for long life should mean small scale preventive maintenance is all that is required.
Replacement	May be less costly due to size and favorable impact on logistics.	Can be accomplished in planned phases and/or steps with minimum disruption to system operation.	COTS use suggests that low cost replacements are available. Advantage can erode with age.	Standard interfaces can only work to reduce the cost of replacement. Fewer spares, standard procedures etc.
Overall Life Cycle Cost Impact	Tends to look negative. The need to miniaturize must be based upon reasons other than cost.	Life cycle cost impacts are all highly favorable except for design phase coordination & possible weight penalties.	Very significant life cycle cost advantage inherent in COTS. However, initial selection and mod program must be prudent.	Whatever the cost of inter-program coordination, ICD's etc., the impact on overall NASA cost is very beneficial

8.0 Recommendations

1. Perform a follow-on effort to generate a designer's "John Commonsense" manual for cost avoidance and/or reduction. The manual should be a series of simple groundrules and guidelines to help reduce Space Biology Initiative Program costs. Where possible, a series of tables or curves to help assess the potential cost gain should be included.
2. Mount an effort to accumulate an SBI historical cost data base. The objective should be at least two-fold. First, identify the breakpoint for various cost trade-offs. Examples are presented in Figures 3-2 and 3-3 which show that commonality soon reaches a point of diminishing return insofar as it pertains to development and manufacturing. Given such breakpoints, explore the possibility of additional life cycle cost benefits which result from reduced sparing, simplified logistics, reduced maintenance, etc. Second, obtain enough historical cost information to permit the development of CER's that are properly scaled for the range of sizes in question. Existing CER's have limitations that may invalidate their use on SBI. Therefore, actual cost data from ongoing SBI efforts would provide a valuable asset to future work of a similar nature.
3. Consider a follow-on program to develop a rule-based or expert system that could be used for quick cost estimates and cost comparisons. Such an effort can only proceed in parallel with item 2, above, but the development time is such that it should begin as soon as practical.
4. Generate a comprehensive compendium of cost estimating relationships and apply them to SBI. Subsequently, make comparisons with other cost estimating methods in an attempt to remove the existing programmatic skepticism about the voodoo and black magic of cost predictions.

Bibliography

- A. MSFC Space Station CER's Report PRC D-2185-H, Contract NAS8-33789, December, 1982.
- B. CERV Target Costs for Benchmark and Reference Configurations - JSC CERV Office Presentation, June 15, 1988.
- C. PRICE Users Newsletter, Volume 12, Number 3, October, 1988.
- D. Cost Estimating for Air to Air Missiles, Congressional Budget Office, January, 1983.
- E. PRICE H™ Reference Manual, General Electric Company, 1988.
- F. SBI Team Contact Report - Joe Hamacke, April 27, 1989.
- G. SBI Contact Report - Richard Whitlock, April 11, 1989.
- H. Report No. MSC-01248, ASSCAS Cost Handbook, Contract NAS 9-9018, January, 1970.

Appendix D - Database Definition

Appendix D - Database Definition

The database files for the SBI trade Studies were developed using dBASE IV. The database files consist of dbf, ndx, and frm files. The dbf files are dBASE IV database files. NDX files are the index files for the dbf (database) files. The frm files are report files for the trade study candidate and bibliography reports. The SBI trade study database consist of 4 database files with 78 fields of information. A complete listing of the database structure and dictionary is included in this database definition.

Database Structure For SBI Trade Studies

Structure for database: W:hardware.dbf

Number of data records: 93

Date of last update : 05/30/89

Field	Field Name	Type	Width	Dec
1	HW_ID	Character	3	
2	HW_NAME	Character	50	
3	HW_DESCRTN	Character	254	
4	HW_FACILIT	Character	55	
5	INFO_SOURC	Character	250	
6	HW_MASS	Numeric	6	3
7	HW_VOLUME	Numeric	8	6
8	HW_POWER	Numeric	4	
9	HW_VOLTAGE	Numeric	6	
10	HW_HEIGHT	Numeric	6	
11	HW_WIDTH	Numeric	6	
12	HW_DEPTH	Numeric	8	
13	REMARKS	Character	50	
14	RECORD_DAT	Date	8	
15	GROUP	Character	50	
16	CATEGORY	Character	50	
17	FUNCTION	Character	60	
18	FAC_ID	Character	4	
19	GROUP_ID	Character	4	
20	MIN_LEVEL	Character	5	
21	CONFIDENCE	Character	5	
22	SUFFIC_DAT	Character	4	
23	PRIORITY	Character	2	
24	MIN_LV_POT	Character	6	
25	MIN_EST_CF	Character	6	
26	MOD_LV_POT	Character	6	
27	MOD_EST_CF	Character	6	
28	COM_LV_POT	Character	6	
29	COM_EST_CF	Character	6	
30	SYS_COMPLX	Character	6	
31	DSN_COMPLX	Character	6	
32	BUY_LV_POT	Numeric	4	
33	BUY_MOD_LV	Numeric	4	
34	BUY_EST_CF	Character	4	
35	BUY_OTTS_PT	Numeric	4	
36	BUY_DAT_AV	Character	4	
37	MOD_CAN	Logical	1	
** Total **			968	

Structure for database: W:biblio.dbf

Number of data records: 98

Date of last update : 05/26/89

Field	Field Name	Type	Width	Dec
1	BB_ID	Character	5	
2	AUTHOR_NO1	Character	16	
3	AUTHOR_NO2	Character	12	
4	AUTHOR_NO3	Character	12	
5	ART_TITLE	Character	135	
6	BOOK_TITLE	Character	100	
7	VOLUME_NO	Character	3	
8	PUBLISHER	Character	42	
9	PUBL_LOC	Character	32	
10	DATE	Date	8	
11	PAGE_NOS	Character	4	
12	ABSTRACT	Character	100	
13	ACQUIRED	Character	20	
14	COST	Numeric	6	
15	LOANED	Character	4	
16	REP_DOC_NO	Character	22	
17	MOD	Logical	1	
18	MIN	Logical	1	
19	COTS	Logical	1	
20	RACK	Logical	1	
** Total **			526	

Structure for database: W:rack_com.dbf

Number of data records: 166

Date of last update : 05/26/89

Field	Field Name	Type	Width	Dec
1	IF_ITEM	Character	38	
2	UNITS	Character	8	
3	UNIT_SYS	Character	1	
4	ITEM_TYPE	Character	12	
5	VALUE	Character	50	
6	MODULE	Character	25	
** Total **			135	

Structure for database: W:comm_mod.dbf

Number of data records: 153

Date of last update : 05/30/89

Field	Field Name	Type	Width	Dec
1	HW_ID	Character	3	
2	COMM_MOD	Character	30	
3	COUNT	Numeric	1	
4	COST_DECSC	Numeric	4	2
5	MASS	Numeric	4	2
** Total **			43	

Appendix D - Database Dictionary for Space Biology Initiative Trade Studies

Hardware.dbf This is the database file for SBI hardware.

Field 1	HW_ID	Unique identification number for each hardware item
Field 2	HW_NAME	Hardware name
Field 3	HW_DESCRTN	Hardware description
Field 4	HW_FACILIT	Facility where SBI hardware is used
Field 5	INFO_SOURC	Information source for SBI hardware data
Field 6	HW_MASS	Hardware mass
Field 7	HW_VOLUME	Hardware volume
Field 8	HW_POWER	Hardware power requirement
Field 9	HW_VOLTAGE	Hardware voltage requirements
Field 10	HW_HEIGHT	Hardware height
Field 11	HW_WIDTH	Hardware width
Field 12	HW_DEPTH	Hardware depth
Field 13	REMARKS	Remarks concerning SBI hardware equipment
Field 14	RECORD_DAT	Update of last record
Field 15	GROUP	Hardware group
Field 16	CATEGORY	Hardware category
Field 17	FUNCTION	Hardware function
Field 18	FAC_ID	Hardware facility ID number
Field 19	GROUP_ID	Hardware group ID number
Field 20	MIN_LEVEL	Miniaturization level for hardware
Field 21	CONFIDENCE	Confidence level for miniaturization
Field 22	SUFFIC_DAT	Is there sufficient data to make a decision of hardware miniaturization?
Field 23	PRIORITY	Priority level for hardware item based on mass
Field 24	MIN_LV_POT	Miniaturization level potential for the hardware item
Field 25	MIN_EST_CF	Confidence level for miniaturization
Field 26	MOD_LV_POT	Modularity potential for hardware item
Field 27	MOD_EST_CF	Confidence level for modularity estimate
Field 28	COM_LV_POT	Commonality potential for hardware item
Field 29	COM_EST_CF	Confidence level for commonality estimate
Field 30	SYS_COMPLX	System complexity for hardware item
Field 31	DSN_COMPLX	Design complexity for hardware item
Field 32	BUY_LV_POT	Percent Buy for Hardware Item
Field 33	BUY_MOD_LV	Percent modification to Buy Hardware Item
Field 34	BUY_EST_CF	Confidence Level for Make-or-Buy Estimate
Field 35	BUY_OTL_PT	Percentage of COTS hardware that does not require modification
Field 36	BUY_DAT_AV	Is sufficient data available for make-or-buy estimate
Field 37	MOD_CAN	Logical field can the hardware item be modularized Y or N

biblio.dbf**This is the database for bibliography information.**

Field 1	BB_ID	Identification number for the reference
Field 2	AUTHOR_NO1	First author
Field 3	AUTHOR_NO2	Second author
Field 4	AUTHOR_NO3	Third author
Field 5	ART_TITLE	Title of article
Field 6	BOOK_TITLE	Title of book
Field 7	VOLUME_NO	Volume number
Field 8	PUBLISHER	Publisher
Field 9	PUBL_LOC	Publisher's address
Field 10	DATE	Date of publication
Field 11	PAGE_NOS	Page number of reference
Field 12	ABSTRACT	Abstract
Field 13	ACQUIRED	Where the reference was acquired
Field 14	COST	Cost of reference
Field 15	LOANED	Where the reference was loaned from
Field 16	REP_DOC_NO	Report or document number
Field 17	MOD	Was this reference used on the modularity trade study? y or n
Field 18	MIN	Was this reference used on the miniaturization trade study? y or n
Field 19	CUTS	Was this reference used on the make-or-buy trade study? y or n
Field 20	RACK	Was this reference used on the rack compatibility trade study? y or n

rack_com.dbf**This is the database file for the rack comparison study.**

Field 1	IF_ITEM	I/F item being compared, i.e. power converters
Field 2	UNITS	Units of comparison, i.e. inches
Field 3	UNIT_SYS_	Unit system, i.e. metric
Field 4	ITEM_TYPE	Functional Grouping of IF Item i.e. Data Mgmt.
Field 4	VALUE	Value of the comparison
Field 5	MODULE	Module, i.e. U.S. Lab

comm_mod.dbf**This is the design modularity and commonality database**

Field 1	HW_ID	Unique identification number for each hardware item
Field 2	COMM_MOD	Modularity function/assembly
Field 3	COUNT	Used to total hardware items in COMM_MOD Field
Field 4	COST_DECSC	Cost description
Field 5	MASS	Mass of hardware item

Appendix E Detailed Hardware Description

	<h2>Controlled Ecological Life Support System</h2>		Hardware Status Mod existing
			Revision Date Apr 4, 1989
Title Germination Experiment Kit			Hardware Description Modified Plant Growth Unit.
Element No 1	Revision A		
Project FEAST			
Objective 1.) Provide a means for initial screening of plant cultivars in terms of their ability to germinate in μ -g. 2.) Determine root-shoot orientation under μ -g conditions.			Desired Features/Functions 1. Lighting : LED @ $>180 \mu\text{mol/sq.m/s}$ 2. Basic nutrient delivery 3. Video recording and/or downlink capability
Hardware Specifications Weight (Kg) 27.3 Height (m) .253 Width (m) .440 Depth (m) .516 Temp Range Ambient Peak Power (Kw) .300 Cont Power (Kw) .150			
Power Source STS Mid-deck.			
Data Downlink Reqs 1.5 MBPS Video; 1.6 KBPS Voice			Item Specific Support Eqipt Plant Growth Module
Rack Mounted/Stowed STS Middeck			
Hardware Specifications			
			Design Status Modification to PGU required.
			Development Cost (\$K) 5,700
			Development Time (months) 12
			Anticipated Launch Date 1992 & 1996
			Risk Category 1

CELSS/FEAST Hardware Data Sheet

Report Date : 4/5/89

Germination Experiment Kit
Science Justification
Identified Experiments CELSS Germination Studies.
History Utilizes existing PGU design with modification for germination studies.
Problem/Issues&Concerns none
Vendor Source List
Interface Requirements STS Mid-deck.
Special Considerations none
Safety Issues none
Flight Opportunity USML-1 (3/92) & USML-4 (5/96)
Notes 1.) Two flights needed : Possible flights are USML-1 and USML-4. REV A : Revised cost 4/4/89 from \$5250K to \$2700K to reflect changes in Cost Estimates.

CELSS/FEAST Hardware Data Sheet

Report Date 4/5/89

Gas/Liquid Handling Experiment H/W
Science Justification Evaluation of physical principles for FEAST.
Identified Experiments
History Existing liquid/gas transfer, mixing and separation technologies for μ -g from previous space flight vehicles and payloads.
Problem/Issues&Concerns none at present
Vendor Source List none at present
Interface Requirements Standard KC-135, NSTS or SL.
Special Considerations Containment of liquids and gases.
Safety Issues none
Flight Opportunity USML-2 (8/93)
Notes REV A : Revised cost 4/4/89 from \$3000K to \$1500K. Changed Unit No. from 3 to 2 to reflect Cost Estimate categorization; added misc data to various categories.

<h2>Controlled Ecological Life Support System</h2>		Hardware Status	Planned
		Revision Date	Apr 4, 1989
Title		Water Condensation & Re-cycling Exp H/W	
Element No	3	Revision	A
Project		FEAST	
Objective		Hardware Description Spacelab, NSTS middeck or KC-135 size experiment package for water condensation studies.	
1.) To determine problems associated with water condensation technologies under μ -g. 2.) Demonstrate and prove-out conceptual designs.			
Hardware Specifications Weight (Kg) 27.3 Height (m) .253 Width (m) .440 Depth (m) .516 Temp Range Ambient Peak Power (Kw) .300 Cont Power (Kw) .150		Desired Features/Functions 1. Video recording and/or downlink capability 2. Water vapor source and water reservoir 3. Condensation chamber with cooling 4. Stream processing capability at various rates 5. Monitoring capability of : relative humidity, liquid volume, process rates	
Power Source Standard platform source.		Item Specific Support Equlpt none	
Data Downlink Reqs			
Rack Mounted/Stowed Rack Mounted or Stowed.			
Hardware Specifications		Design Status New Design	
		Development Cost (\$K) 2,900	
		Development Time (months)	
		Anticipated Launch Date 1995	
		Risk Category 4	

4A

CELSS/FEAST Hardware Data Sheet

Report Date: 4/5/89

Water Condensation & Re-cycling Exp H/W
Science Justification
Identified Experiments
History
Problem/Issues&Concerns
Vendor Source List
Interface Requirements
Special Considerations
Safety Issues
Flight Opportunity USML-3 (1/95)
Notes 1.) Two flights may be required. 2.) May only require KC-135 flight to validate. 3.) REV A : Revised cost 4/4/89 from \$5800K to \$2900K. Changed Unit No. from 2 to 3 to reflect Cost Estimate categorization.

CELSS/FEAST Hardware Data Sheet

Report Date 4/5/89

<h2>Controlled Ecological Life Support System</h2>		Hardware Status	Planned
		Revision Date	Apr 4, 1989
		Hardware Description	
Title		Nutrient Delivery Test H/W	
Element No	4	Revision	A
Project		FEAST	
Objective		<p>1. To evaluate plant nutrient delivery concepts under μ-g conditions for CELSS technology development.</p>	
Hardware Specifications		<p>Weight (Kg) 27.3 Height (m) .253 Width (m) .440 Depth (m) .516 Temp Range Ambient Peak Power (Kw) .300 Cont Power (Kw) .150</p>	
Power Source		Standard mid-deck power source or equivalent	
Data Downlink Reqs		.05 KBPS Command; 1.5 KBPS Digital; 1.5 MBPS Video; 1.6 KBPS Voice	
Rack Mounted/Stowed		Stowed	
Hardware Specifications		<p>Design Status</p> <p>New Design</p>	
		Development Cost (\$K)	3,475
		Development Time (months)	24
		Anticipated Launch Date	1992 & 1996
		Risk Category	4

CELSS/FEAST Hardware Data Sheet

Report Date 4/5/89

Nutrient Delivery Test H/W

Science Justification

Provides test and demonstration of nutrient delivery systems for CELSS technologies.

Identified Experiments

History

None

Problem/Issues&Concerns

Vendor Source List

None

Interface Requirements

Special Considerations

Safety Issues

Flight Opportunity SLS-2 (7/92) & IML-4 (3/96)

Notes

REV A : Revised cost 4/4/89 from \$6850K to \$3475K.

CELSS/FEAST Hardware Data Sheet
Report Date 4/5/89

Controlled Ecological Life Support System		Hardware Status Planned
		Revision Date Apr 4, 1989
Title CELSS Test Facility		Hardware Description Crop growth research facility for seed-to-seed crop studies under μ -gravity. IOC Station Freedom implementation.
Element No 5	Revision A	
Project FEAST		
Objective 1.) To provide a facility for conducting plant productivity studies from seed to maturity (in some instances seed to seed) with mixed crops and in mixed maturities under μ -gravity conditions. 2.) Assess system reliability and maintainability for CELSS technologies.		
Hardware Specifications Weight (Kg) 634.7 Height (m) 1.89 Width (m) 1.05 Depth (m) 0.91 Temp Range S.S. Ambient Peak Power (Kw) 2.0 Cont Power (Kw) 1.5		Desired Features/Functions 1. Modular subsystem elements to allow for design evolution. 2. LED lighting system 3. Standard double rack size. 4. Complete control of inputs and outputs to Station ambient atm. 5. Implements automation and expert systems. 6. Full complement DAS. 7. Maximized degree of closure
Power Source Standard Rack power		Item Specific Support Equipmt CTF Germination and Storage Chamber.
Data Downlink Reqs .05 KBPS Command, 1.5 KBPS Digital, 1.5 MBPS Video, 1.6 KBPS Voice		
Rack Mounted/Stowed Rack Mounted		
Hardware Specifications 1. Lighting : 0 - 3000 μ mol/sq.m/s 2. Modular nutrient delivery system 3. Sealed enclosure w/ access and windows 4. Fully controllable HVAC 5. Pressure compensation system 6. Water condensation & re-cycling capability 7. Control of internal gaseous environment (O2, CO2, N2) 8. Microbial monitoring capability 9. Monitoring, control and data acquisition systems 10. Automated specimen handling 11. Growing Area: 0.71 sq.m, max growing height : 0.85 m 12. Self-contained with modular subsystems 13. Full control of parameters withing specified ranges		Design Status New Design
		Development Cost (\$K) 42,050
		Development Time (months) 72
		Anticipated Launch Date 1998
		Risk Category 3

CELSS/FEAST Hardware Data Sheet

Report Date 4/5/89

CELSS Test Facility
Science Justification Hardware is mandatory for development of future CELSS technologies and advanced life support systems.
Identified Experiments Hardware to be used in meeting CELSS Project FEAST objectives.
History Major design elements derived from non-flight Crop Growth Research Chamber (CGRC) requirements.
Problem/Issues&Concerns Nutrient delivery system, lighting, & power.
Vendor Source List None at present.
Interface Requirements Standard Space Station Freedom rack interfaces.
Special Considerations None
Safety Issues None
Flight Opportunity PMC S.S. Freedom
Notes <ol style="list-style-type: none">1. Establish reliability baseline for CELSS hardware2. Needs maintenance scenario and possibly S/E for same.3. Current crop candidates are : Potatoes, soybeans, wheat, tomato, lettuce, radish, rice, onion, legume & spinach. <p>REV A : Revised cost 4/4/89 from \$15,000K to \$42,050K to reflect incorporation of CROP elements into CTF. Revised growing area from 1.5 - 2.0 sq.m to 0.71 sq.m, power from 1.8kW to 2.0 Kw peak and 1.2 - 1.3 kW cont to 1.5kW, mass changed from 1000 kg to 634.7 kg.</p>

CELSS/FEAST Hardware Data Sheet

Report Date 4/5/89

<h2>Controlled Ecological Life Support System</h2>		Hardware Status Planned	
		Revision Date	
Title CTF Germination Chamber		Hardware Description Provides germination environment for seed germination prior to planting in the CELSS Test Facility, Approx. the size of STS Middeck Locker	
Element No 6	Revision NR		
Project FEAST		Desired Features/Functions 1. Air-tight chamber 2. Humidity controlled 3. Heat, shock and vibration isolated	
Objective 1. To provide environment for germinating seeds prior to planting in the CTF. 2. To provide seed storage.			
Hardware Specifications Weight (Kg) 6.8 Height (m) .253 Width (m) .440 Depth (m) .516 Temp Range S.S. Ambient Peak Power (Kw) .300 Cont Power (Kw) .150		Item Specific Support Equlpt none	
Power Source none required			
Data Downlink Reqs none			
Rack Mounted/Stowed Stowed			
Hardware Specifications Approximately the size of a NSTS Middeck Locker.		Design Status New Design	
		Development Cost (\$K) 800	
		Development Time (months) 12	
		Anticipated Launch Date 1998	
		Risk Category 1	

CELSS/FEAST Hardware Data Sheet

Report Date 4/5/89

CTF Germination Chamber
Science Justification Provides germination of seeds prior to planting in the CTF. Reduces operational power demand on CTF. Provides seed storage.
Identified Experiments none
History Plant Growth Unit.
Problem/Issues&Concerns none
Vendor Source List none
Interface Requirements
Special Considerations
Safety Issues
Flight Opportunity PMC Space Station Freedom
Notes 1. Provides for two separate and independent compartments: a.) Seed storage compartment and b.) Germination compartment. 2. Seed compartment could also be used for misc. equipment stowage

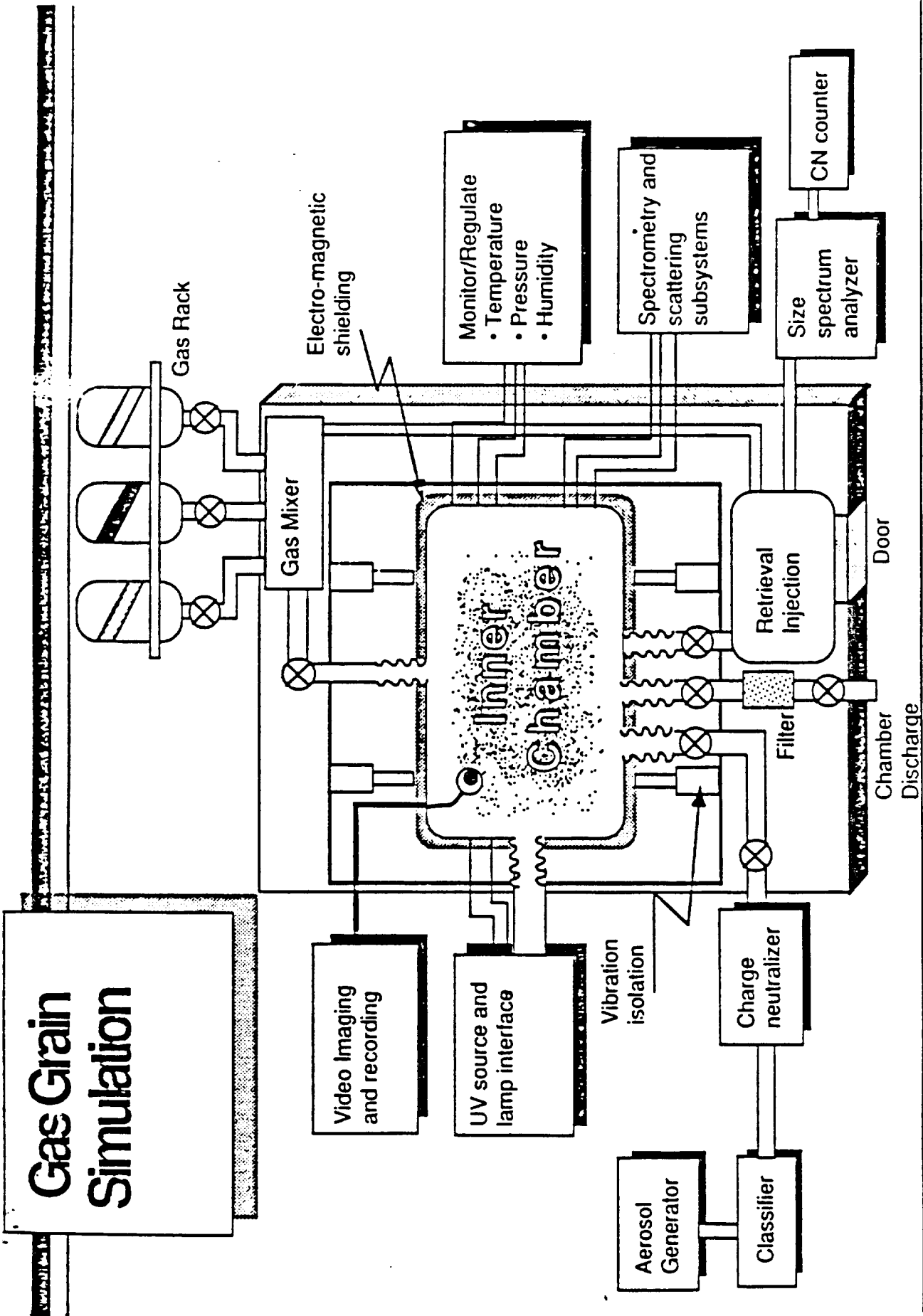

GGSF Chamber

Ports and component connections indicated

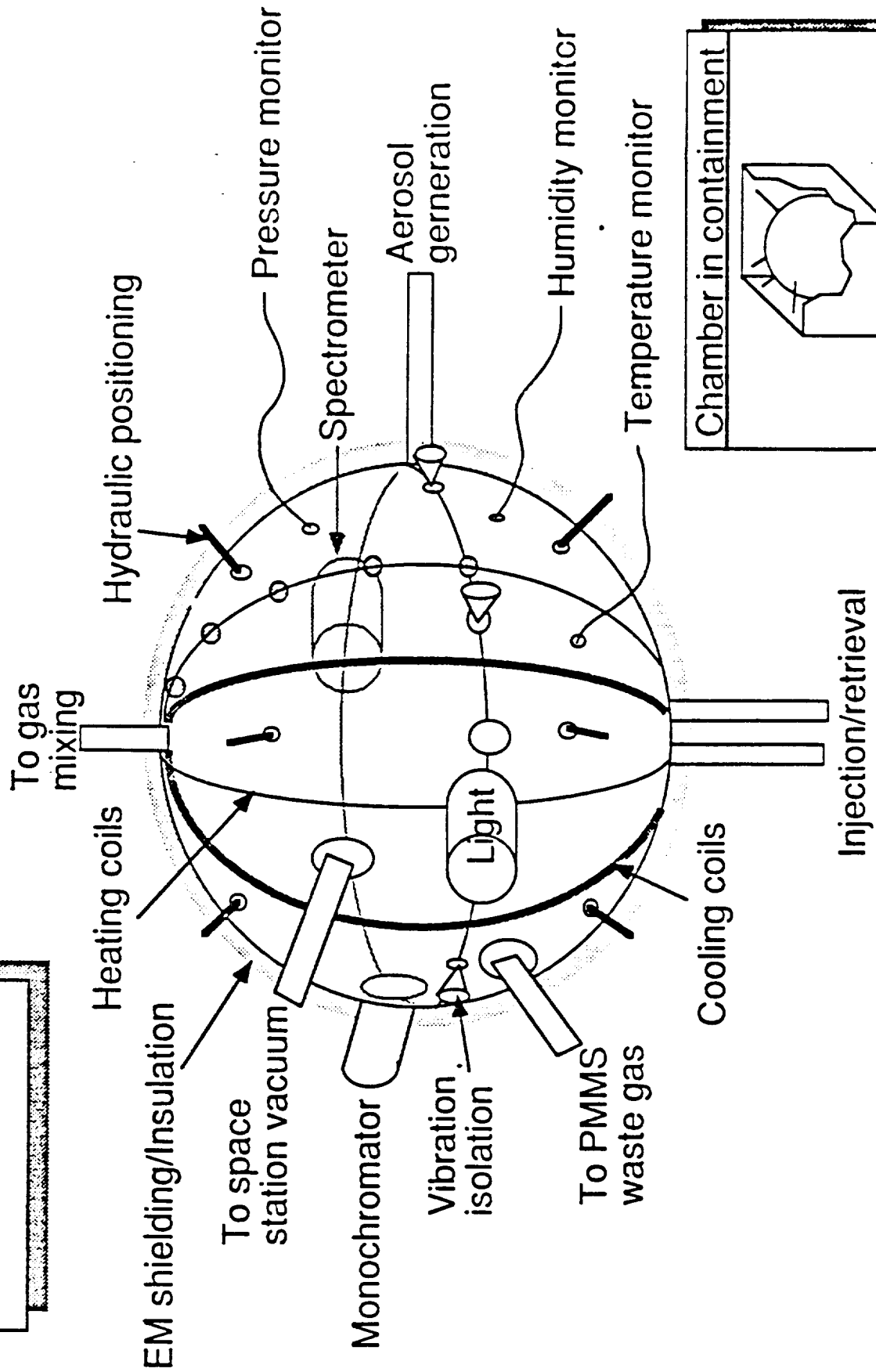

Chamber in containment

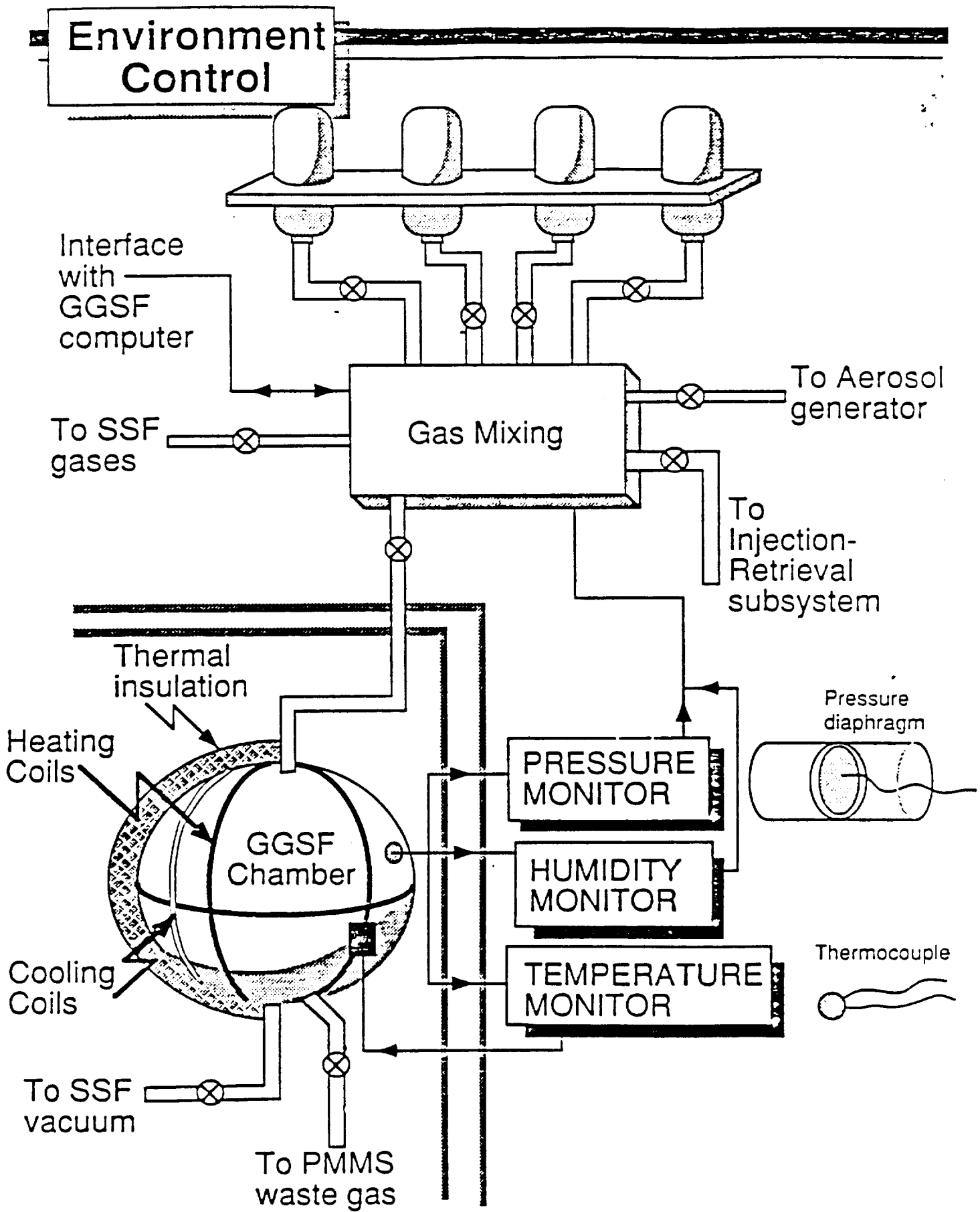

Aerosol Generation- Measurement

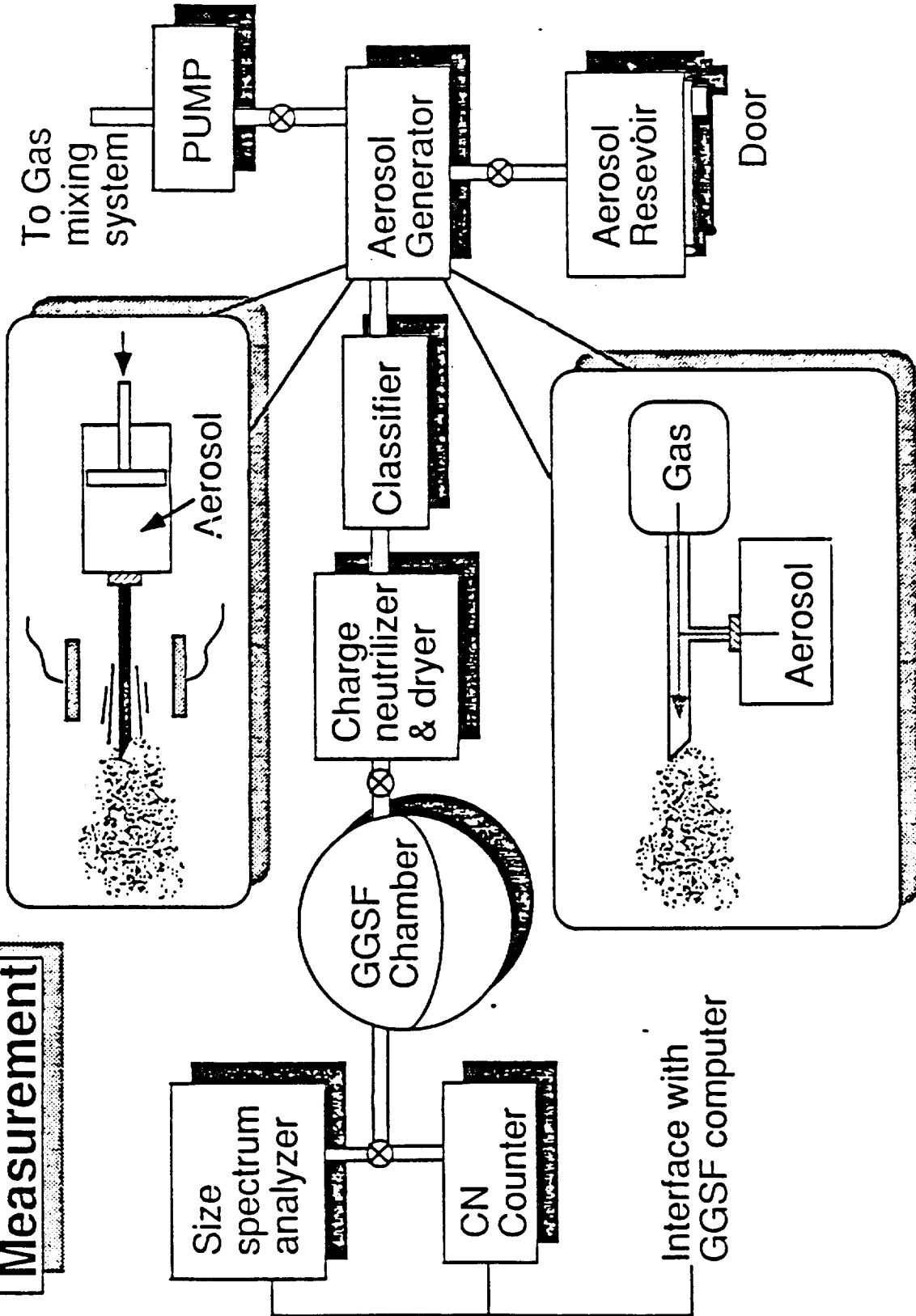

Spectrometry and Scattering

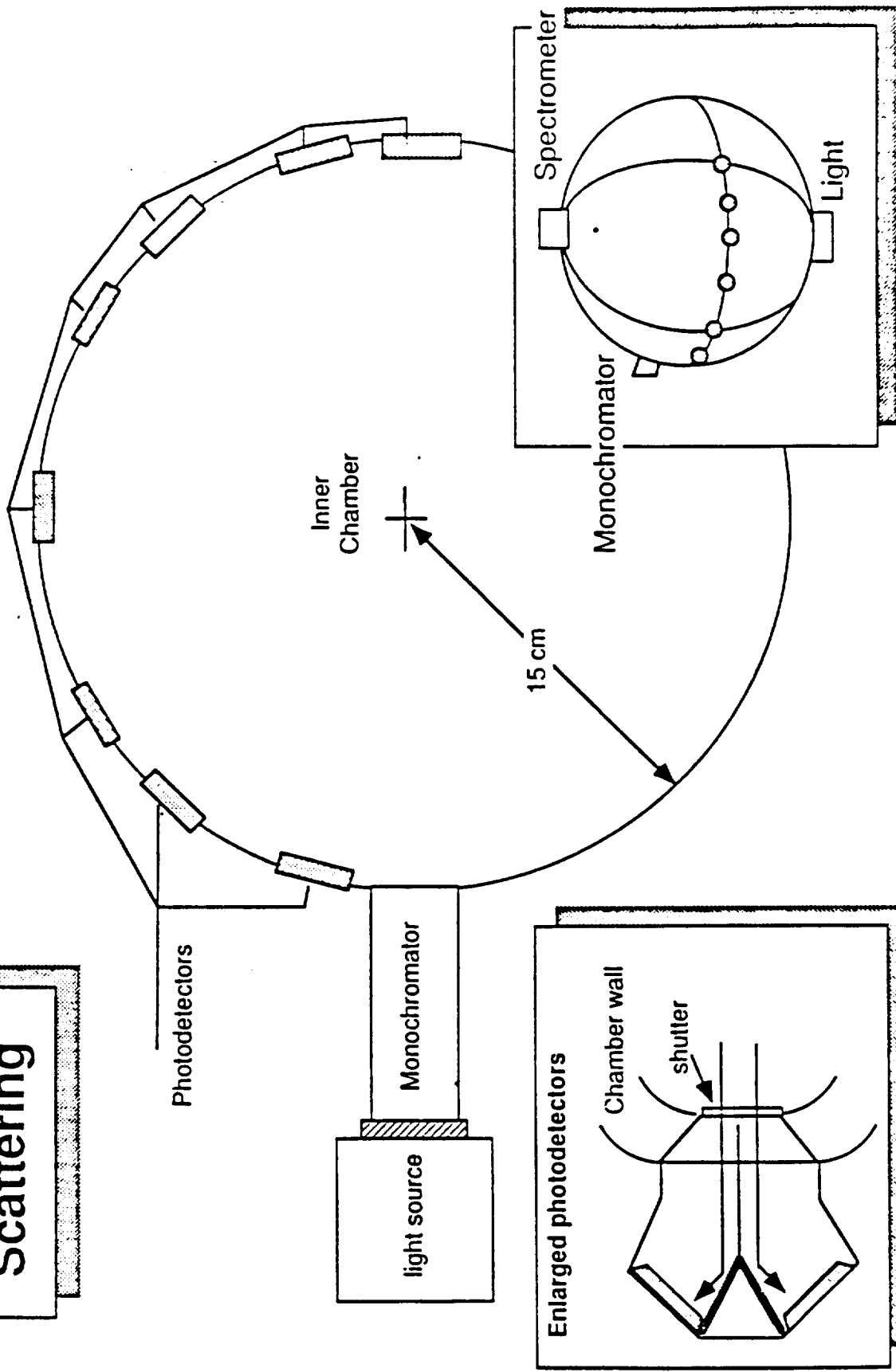

Computer Control

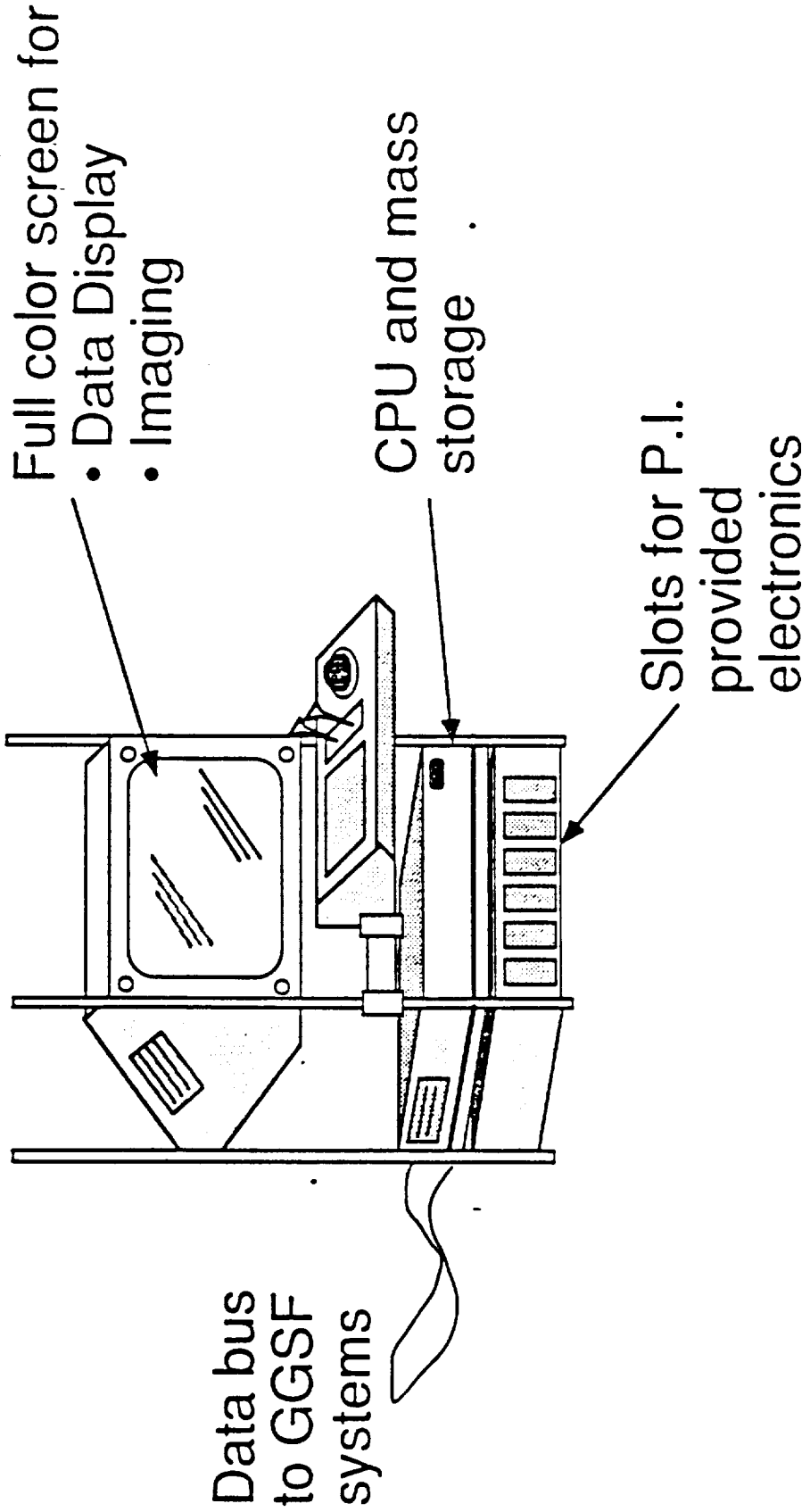

Storage Locker

Refrigerator

Bottle holders

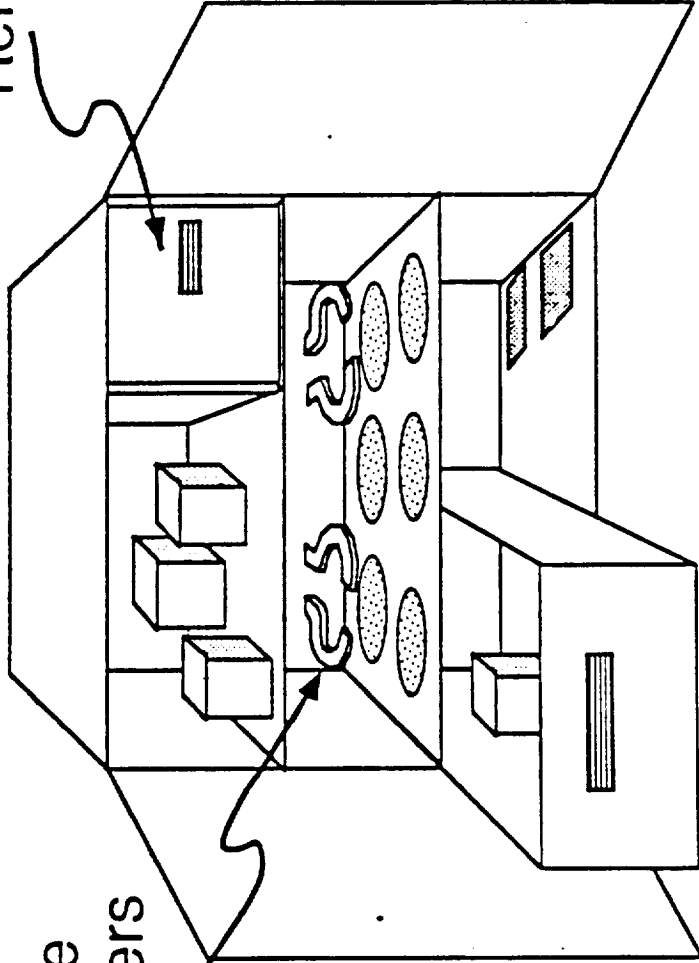

Gas-Grain Simulation Facility: Description

The Gas-Grain Simulation Facility (GGSF), currently under development by the Exobiology Flight Experiments Program at Ames Research Center, is a facility-class payload proposed for the Space Station. The GGSF will be used to simulate and investigate fundamental chemical and physical processes such as the formation, collision and interaction of droplets, grains and other particles.

The Gas-Grain Simulation Facility will occupy a Space Station double rack. It will consist of several subsystems supporting an adaptable 10 liter experiment chamber. Subsystems will provide environmental control (e.g., temperature, pressure, gas mixture and humidity), measurement equipment (e.g., video cameras, optical particle counters, spectrometers, and photometers), and energy sources. Subsystems will also furnish: command and control capability; mechanisms for producing, injecting, and removing particles and clouds of particles; and levitation devices for positioning particles and keeping them in fixed positions away from the chamber walls. GGSF mass and power requirements are estimated to be 700 to 800 Kg and 1500 W peak (750 W average) respectively.

The GGSF will be modular in design; that is, it will have an adaptable configuration allowing subsystem components to be connected in a number of ways. Modularity will also allow the GGSF to evolve. At an early stage, the GGSF would be capable of supporting those experiments which promise high scientific yield and require only a few subsystems. Further, modularity will allow outdated subsystems to be replaced. New experiment chambers will be brought to the Space Station once a year so the GGSF will have a very long, useful lifetime (i.e., 10 years).

The facility's computer will control all operations of the facility during an experiment and have an autonomous decision making capability. Data exchange requirements, estimated at 20 to 40 kilobytes per day, are modest. Data/command uplinks will occur about twice per week. Aside from time needed for the initial set-up and calibration of experiments, crew time requirements will be minimal.

One possible GGSF operational sequence is as follows: A chamber designed for a series of experiments is "plugged in" to the GGSF and subsystems are attached in the configuration necessary for the first experiment. A command is then given to begin the execution of preprogrammed instructions for performing the experiment. After the first experiment is completed, the system may be reconfigured for the second experiment. When the sequence of experiments associated with the first chamber is completed, the chamber is removed and stored for return to Earth and a second chamber is attached for the next sequence of experiments.

Since many of the suggested GGSF experiments require gravitational accelerations of 10^{-4} to 10^{-5} g, it will be necessary to consider the background gravitational gradient when deciding where in the Space Station to place the GGSF. The GGSF will take advantage of some of the user support systems supplied by the Space Station such as the 10^{-3} torr "house" vacuum and data from the accelerometer system. Also, given the delicate physical and chemical properties of some particles generated in the GGSF, some preliminary sample analysis on the Space Station may be desirable. Such analysis will require special sample handling equipment and analytical tools. For example, some GGSF experiments will use a Scanning Electron Microscope, a Gas Chromatograph, a Mass Spectrometer, a (micro) mass measurement system, and/or a High Pressure Liquid Chromatograph if they are available.

Gas-Grain Simulation Facility: Science Rationale/Objectives

In many astrophysical and geological systems (atmospheric clouds, interstellar clouds, planetary rings, Titan's organic aerosols, Martian dust storms, etc.), processes involving small particles significantly contribute to the overall behavior of the system. Grain nucleation and aggregation, low velocity particle collisions, and charge accumulation are a few of the processes that influence such systems. Particles undergoing these processes include interstellar grains, protoplanetary particles, atmospheric aerosols, combustion products, and pre-biotic organic polymers.

The ability to simulate and investigate these types of systems and processes would present an exciting opportunity to answer long-standing scientific questions concerning the life and death of stars, the formation of the Solar System, and the connection between the Solar System's evolution and the appearance of life. These investigations would also increase our understanding of processes of immediate concern such as acid rain formation, ozone depletion, and climatic change on Earth. Furthermore, investigation of particle systems is essential to the achievement of NASA's scientific goal to attain a deep understanding of the Solar System, Earth, and the origin of life.

Many particle systems are not well understood because parameters relevant to these systems are poorly determined or unknown. Examples of such parameters are the coagulation rate of aerosol particles, the size distribution of particles nucleated from a gas, and the dependence of aggregation efficiency on material properties. Due to rapid particle settling in a 1g environment, these parameters are difficult and in many cases impossible to measure in experimental simulations on Earth.

In the study of small particle processes relevant to scientific issues mentioned above, the demands on experiment design are severe. Two common requirements are low relative velocities between particles and long time periods during which the particles must be suspended. Generally, the suspension times required are substantially longer than can be attained in 1g. Furthermore, for many studies, Earth's gravity can interfere directly with the phenomenon under study (e.g., weak inter-particle forces) or preclude the establishment of proper experimental conditions (e.g., a convection-free environment). Consequently, many processes are not amenable to experimentation in 1g.

However, in the Earth-orbital environment, the effects of gravity are reduced by a factor of as much as one million. In this environment, previously impractical or impossible experiments become feasible. Small-particle processes which cannot be studied on Earth can be investigated in Earth-orbit with a general-purpose microgravity particle research facility such as the Gas-Grain Simulation Facility (GGSF).

The GGSF, a facility-class payload proposed for the Space Station, will be used to simulate and investigate fundamental chemical and physical processes such as the formation, collision and interaction of droplets, grains and other particles. Scientific issues that can be addressed with the Gas-Grain Simulation Facility are relevant to the disciplines of exobiology, planetary science, astrophysics, atmospheric science, biology, and physics and chemistry. To date, twenty candidate GGSF experiments have been identified and described in detail. The candidate experiments are as follows:

1. Low-Velocity Collisions Between Fragile Aggregates
2. Low-Energy Grain Interaction/Solid Surface Tension
3. Cloud Forming Experiment

4. Planetary Ring Particle Dynamics
5. Aggregation of Fine Geological Particulates in Planetary Atmospheres
6. Condensation of Water on Carbonaceous Particles
7. Optical Properties of Low-Temperature Cloud Crystals
8. Ice Scavenging and Aggregation
9. Synthesis of Tholin in Microgravity and Measurement of its Optical Properties
10. Metallic Behavior of Aggregates
11. Investigations of Organic Compound Synthesis on Surfaces of Growing Particles
12. Crystallization of Protein Crystal-Growth Inhibitors
13. Dipolar Grain Coagulation and Orientation
14. Titan Atmospheric Aerosol Simulation
15. Surface Condensation and Annealing of Chondritic Dust
16. Studies of Fractal Particles
17. Emission Properties of Particles and Clusters
18. Effect of Convection on Particle Deposition and Coagulation
19. Growth and Reproduction of Microorganisms in a Nutrient Aerosol
20. Long Term Survival of Human Microbiota in and on Aerosols

The GGSF will be sufficiently flexible to accommodate the above as well as many other scientifically important investigations without compromising the requirements of any particular investigation. By extending the range of conditions in which experiments can be performed, the GGSF will be a powerful tool for studying the physics of small particles and grains. Important advances in our understanding of the many small-particle phenomena should follow from the new ability to study subtle small-particle effects and interactions.

Gas-Grain Simulation Facility: Hardware

The Gas-Grain Simulation Facility (GGSF) consists of eight subsystems which are complimentary and interdependent. All of the subsystems are necessary for meeting the facility science requirements. The GGSF subsystems and hardware are as follows:

1. General Purpose Experiment Chamber/Containment Subsystem
(Includes ports, feed-throughs, subsystem interfaces, double- or triple-containment, vibration isolation, EM shielding, etc.)
2. Chamber Environment Regulation/Monitoring Subsystem
(For regulation and monitoring of temperature, pressure, and humidity. Includes gas-handling system, filters, etc.)
3. Aerosol Generation/Measurement Subsystem
(Includes aerosol generators, size spectrum analyzers, CN counter, electrostatic classifier, dryer, charge neutralizer, etc.)
4. Chamber Illumination, Optics, and Imaging Subsystem
(Includes UV sources, camera with optics, various lamps, photometer, etc.)
5. Spectrometry/Optical Scattering Subsystem
(Includes spectrometers, lasers, photodetectors and other support equipment for light scattering measurements, etc.)
6. Particle Manipulation and Positioning Subsystem
(Includes acoustic levitator, particle injection mechanisms, particle retrieval mechanisms, etc.)
7. Computer Control and Data Acquisition Subsystem
(Includes microcomputer and console, data bus, data storage, control electronics, etc.)
8. Storage Locker
(For storing special gas mixtures, fluids for aerosol generators, interfaces and adaptors, PI-provided hardware, samples produced in experiment runs, film, etc.)

Gas-Grain Simulation Facility: Hardware Definitions

General Purpose Experiment Chamber/Containment Subsystem: The Gas-Grain Simulation Facility (GGSF) experiment chamber for studying small-particle processes and interactions in microgravity.

Chamber Environment Regulation/Monitoring Subsystem: A Gas-Grain Simulation Facility (GGSF) subsystem that establishes, regulates, and removes the gas-mixture in the GGSF chamber as well as monitors and regulates the chamber/gas temperature, pressure, and humidity.

Aerosol Generation/Measurement Subsystem: A Gas-Grain Simulation Facility (GGSF) subsystem that generates and introduces into the GGSF chamber aerosol clouds of various concentration, particle-size, and dispersion and monitors the cloud size-distribution and total concentration.

Chamber Illumination, Optics, and Imaging Subsystem: A Gas-Grain Simulation Facility (GGSF) subsystem that provides optical imaging of processes occurring in the GGSF chamber and provides various light/energy sources.

Spectrometry/Optical Scattering Subsystem: A Gas-Grain Simulation Facility (GGSF) subsystem that measures light-scattering and extinction properties of aerosol/dust clouds and single grains.

Particle Manipulation and Positioning Subsystem: A Gas-Grain Simulation Facility (GGSF) subsystem that mechanically and/or aerodynamically injects particles into the chamber, manipulates them by acoustic and/or aerodynamic levitation, and retrieves samples from the chamber.

Gas-Grain Simulation Facility Computer Control and Data Acquisition Subsystem: A Gas-Grain Simulation Facility (GGSF) subsystem which provides computer and electronic control of experiments, data acquisition and storage.

Gas-Grain Simulation Facility Storage Locker: A locker to store Gas-Grain Simulation Facility (GGSF) support materials such as PI-provided equipment and special dust or aerosol mixtures for a planned suite of experiments and to store samples for return to Earth.

LIFE SCIENCES FLIGHT PROGRAMS CHANGE REQUEST

Reference Documentation:

Life Sciences Hardware List for the Space Station Freedom Era. R-0006

Description of Change:

Change the Exobiology Facility section to reflect the following:

EXO BIOLOGY FACILITY (8)

	Volume (cu. m)	Weight (kg)	Power (watts)
Gas-Grain Simulation Facility Hardware Group (8A)	2.40	800	1500
1. General Purpose Experiment Chamber/Containment Subsystem	0.48	200	0
2. Chamber Environment Regulation/Monitoring Subsystem	0.23	80	200
3. Aerosol Generation/Measurement Subsystem	0.45	150	300
4. Chamber Illumination, Optics, and Imaging Subsystem	0.20	80	200
5. Spectrometry/Optical Scattering Subsystem	0.20	150	300
6. Particle Manipulation and Positioning Subsystem	0.16	50	200
7. Computer Control and Data Acquisition Subsystem	0.20	50	300
8. Storage Locker	0.48	40	0

Justification/Rationale:

This Change Request identifies the component subsystems of the Gas-Grain Simulation Facility (8A) and includes the volume, weight and power estimates for each subsystem. The additional 0.48 cubic meters of volume indicated in this Change Request is required for storage of items such as special gas mixtures, fluids for aerosol generators, experiment-produced samples to be returned to Earth, and film. These changes reflect further refinement of the Gas-Grain Simulation Facility requirements.

**SPACE STATION FREEDOM / SPACELAB MODULE
COMPATIBILITY**

TRADE STUDIES

**JOHNSON SPACE CENTER
HOUSTON, TEXAS
77058**

SPACE BIOLOGY

INITIATIVE

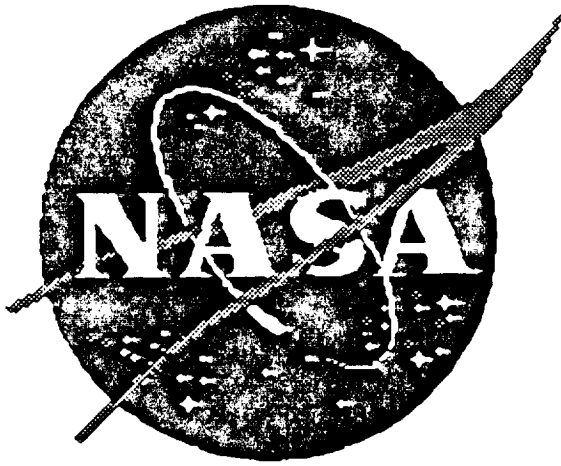

Space Biology Initiative
Program Definition Review

Lyndon B. Johnson Space Center
Houston, Texas 77058

*HORIZON
AEROSPACE*

Space Station Freedom/ Spacelab Modules Compatibility

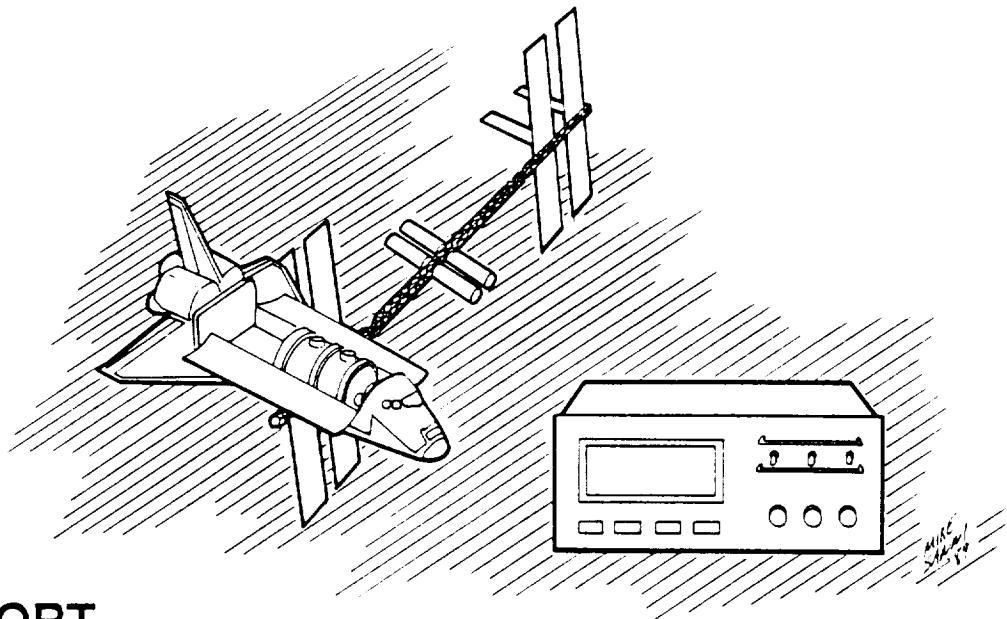

FINAL REPORT

June 1, 1989