

NASA
Technical Memorandum 104763

Johnson Space Center

***Research and
Technology***

Annual Report 1992



About the cover...

The illustration depicts NASA exploration aimed at acquiring knowledge about the universe, matter, and the processes that underlie the evolution/development of life on the planet Earth. The envisioned program infrastructure includes shuttles, Space Station Freedom, lunar and Mars outposts, observatories, and probes. The spinoffs of NASA research, technology, and development that benefit our Nation are highlighted. The illustration was conceptualized by Dr. Kumar Krishen and created by artist Vicki Cantrell.

Foreword

Through our strategic planning process, the Johnson Space Center (JSC) has outlined two key roles for meeting the technology needs of space exploration. First, the Center will ensure that technologies are available when needed. Second, we will develop needed technologies that are unique to Center missions and in those areas where we have particular expertise and facilities. We are emphasizing the following research and technology areas: Human Spacecraft Development, Human Support Systems, and Human Spacecraft Operations. In all of our efforts, we actively seek and foster collaboration with other NASA Centers, Government agencies, academic and research communities, and industry. In fiscal year (FY) 92 we have initiated vigorous efforts in the areas of life sciences and support systems, human support technologies, solar system sciences, space transportation systems, and space systems technology. We have invested significant resources in the development of infrastructures

such as facilities and partnerships that will enable us to address major technologies and cost-effective approaches for present and future space missions. We are also very active in providing assessments of our research and technology projects for commercial applications. This, we believe, will strengthen our Nation's competitiveness in the commercial sector through spinoffs of our space technology.

This report will provide you with summaries of some of our investigations currently being pursued or those concluded during FY92. Your comments and suggestions would be appreciated and should be addressed to Dr. Kumar Krishen, code IA4, NASA Johnson Space Center, Houston, TX 77058. Dr. Krishen can be reached by phone at 713-244-8583 or via fax at 713-244-8589.

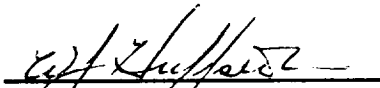

William J. Huffstetler, Jr.
Manager, New Initiatives Office



Introduction

The primary roles and missions of JSC incorporate all aspects of human presence in space. Therefore, the Center is involved in the development of technology that will allow humans to stay longer in Earth orbit, allow safe flight in space, and provide capabilities to explore the Moon and Mars. The Center's technology emphasis areas include human spacecraft development, human support systems and infrastructure, and human spacecraft operations. Safety and reliability are critical requirements for the technologies that JSC pursues for long-duration use in space. One of the objectives of technology development at the Center is to give employees the opportunity to enhance their technological expertise and project management skills by defining, designing, and developing projects that are vital to the Center's strategy for the future.

In addition to these, JSC is developing technologies required to improve the efficiency and effectiveness of program management and Center operations. One area addressed at JSC during the past 3 years has been mission operations efficiency (MOE), aimed at reducing the ongoing cost of Shuttle mission operations. The concern here extended to the combined operation of Shuttle and Space Station Freedom (SSF) and the possibility that substantial costs could be incurred without the use of advanced technology in flight operations at JSC. Substantial progress in the MOE study included development of process flows, process breakdown structure, cost data base, operations cost model, and process productivity/performance measurement. Automation technologies for mission operations and crew training were identified which would provide substantial cost savings in all future mission operations at JSC.

The Center contributes substantially to interagency technology development efforts. In particular, the Center leads the space operations technology area for the Space Technology Interdependency Group. This group is led by NASA and the Air Force, but includes participation from the Navy, Army, SDIO, Defense Advanced Research Projects Agency, and the Department of Energy. As a result of the

human spaceflight emphasis, JSC technology has wide applications to civil and commercial areas. Such applications are continually assessed and potential spinoffs identified.

This report is intended to communicate within and outside the Agency our research and technology (R&T) accomplishments, as well as inform Headquarters program managers and their constituents of the significant accomplishments that have promise for future Agency programs. While not inclusive of all R&T efforts, the report presents a comprehensive summary of JSC projects in which substantial progress was made in the 1992 fiscal year. At the beginning of each project description, names of the Principal Investigator (PI) and the Technical Monitor (TM) are given, followed by their JSC mail codes or their company or university affiliations. The funding sources and technology focal points are identified in the index.

This report is organized in five sections:

The **Life Sciences** section describes projects aimed at understanding at a fundamental level the effects of space environment on humans. The successful completion of the international Spacelab missions IML-1 and SL-J was a highlight of the life sciences program at JSC. The Center has also made substantial progress in developing medical standards and equipment for SSF and planetary exploration programs. Ongoing studies are defining cardiovascular, muscular, bone, neurosensory, gastrointestinal, and metabolic adaptations to spaceflight. Countermeasures to the adverse effects of the space environment and to the biochemical, nutritional, physiological, and psychological alterations associated with microgravity are also being researched and developed. Substantial ground-based efforts are being made in toxicology and microbiology to ensure the safety and quality of the spacecraft environment. JSC also continues to develop methods for radiation risk assessment. In addition to substantial life sciences results described in this report, JSC has made significant upgrades to the training devices used to preadapt astronauts to some of the sensory rearrangements experienced in spaceflight.

The **Human Support Technology** section describes projects in a variety of disciplines to ensure safety and continued productivity of humans in space and on planetary surfaces. Technologies and capabilities being developed at JSC include biomechanics, expert systems, artificial intelligence, and environmental impacts on human performance. A great deal of effort is being expended on developing models for simulating the work and rest performance of humans in space and on planetary surfaces. The ultimate objectives are to (1) design human spacecraft, systems, and operations; (2) predict human performance in a certain situation in space; and (3) train humans continually before and during a flight or a stay on a planetary surface. JSC is researching the use of computer-aided training, fuzzy logic for control applications, and human/computer interfaces. Significant progress has been achieved in most of these efforts within the past 3 years. This section describes work on human/machine interfaces, use of artificial intelligence in decision making, and software methods to evaluate and enhance human performance.

The **Solar System Sciences** section reports on a sampling of projects in which substantial progress was made during FY92. Research topics include meteorites, cosmic and planetary dust, Earth orbital debris, remote sensing of Earth, space radiation environment, in situ resource utilization, lunar and planetary materials, and origins of planetary structure. In FY92, accomplishments included studies on indigenous space resource utilization and man-made and hypervelocity particles in low Earth orbit, as well as development of orbital debris environment models and methods for measuring terrestrial ages of New Mexico meteorites.

Space Transportation projects described include human support systems and space operations that are part of the Agency's transportation infrastructure. Projects on autonomous guidance, navigation, and control; computer-automated assistance; rendezvous expert systems; information and control strategies; a flight director weather system; maintainability model and data base development; vehicle health monitoring; experimental investigations of spacecraft glow; and

orbital acceleration research are included in this section.

The **Space Systems Technology** section encompasses projects on materials and structures; automation and robotics; on-orbit assembly, maintenance, and on-orbit servicing/ life support/ propulsion; and power, thermal, communications, and tracking systems. In FY92, JSC made excellent progress in regenerative life support, thermal control, fault tolerant robotics, fluid storage and supply systems, and remote manipulator systems. JSC has continued to make outstanding contributions in the evolutionary, innovative, and mission-driven technologies for space systems.

Several JSC organizations have provided support in developing this report. Most notable contributions were made by the Center Operations, Information Systems, Space and Life Sciences, Mission Operations, and Engineering directorates. Dr. Robert Ried coordinated all of the Engineering Directorate inputs. The schedule of this report provides a formidable challenge because most of the work was to be completed during December 1992. The contributors are, therefore, commended for their timely response. The colleagues listed below coordinated specific sections of this report and provided the summaries preceding their sections. Detailed questions should be directed to me, the section coordinators, or the principal investigators listed in the index.

Steven Gonda, Ph.D. (code SD)
Life Sciences
Phone: 713/483-8745

Barbara Woolford (code SP)
Human Support Technology
Phone: 713/483-4701

David Thompson, Ph.D. (code SN)
Solar System Sciences
Phone: 713/483-6090

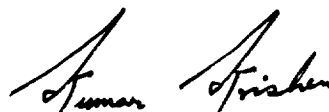

Kumar Krishen, Ph.D.
Chief Technologist

Contents



Section I ***Life Sciences***

- I-1 Summary
- I-5 Significant Tasks

Section II ***Human Support Technology***

- II-1 Summary
- II-5 Significant Tasks

Section III ***Solar System Sciences***

- III-1 Summary
- III-5 Significant Tasks

Section IV ***Space Transportation Technology***

- IV-1 Summary
- IV-5 Significant Tasks

Section V ***Space Systems Technology***

- V-1 Summary
- V-5 Significant Tasks

Index

Section I

Life Sciences

Summary



Life Sciences Summary

NASA's lead center for Life Sciences, the Johnson Space Center, continues to develop resources and conduct scientific investigations that will serve as the underpinnings of the human space program. Knowledge of how microgravity affects biological systems has been significantly advanced from results obtained from the 1991 Spacelab-Life Sciences 1 (SLS-1) mission, and continues with the successful completion in 1992 of the international spacelab missions IML-1 and SL-J. Scientists from around the world participating in these efforts are now analyzing results that will help reveal the role of gravity in shaping life as we know it, and help us to learn how living organisms adapt to the microgravity environment.

Progress continues in developing the medical standards and equipment for the international Space Station Freedom (SSF) and for planetary exploration and habitation. The Extended Duration Orbiter Medical Project (EDOMP) is identifying decrements in crew health and performance associated with extended missions. Ongoing research efforts in defining and, as necessary, countering cardiovascular, muscular, bone, neurosensory, gastrointestinal, and metabolic adaptations to the spaceflight environment are being aggressively pursued under this program. Medical monitoring equipment, standards, and countermeasures that arise from the EDOMP will be used for still longer missions planned for the Shuttle and Space Station Freedom Programs.

Ground-based activities in toxicology and microbiology this year are helping to establish and ensure the quality and safety of the spacecraft environment. The development of well documented spacecraft maximum allowable concentrations for individual chemicals is important to the management of spacecraft air quality. Recent development of analytical instruments that can monitor the air quality in the spacecraft in real time and the establishment of exposure standards for each chemical contaminant offer the ability to manage air quality problems during missions. A kinetic tetrazolium-based assay for determining microbial susceptibility to

disinfectants was developed that can be used without toxic organic solvents. This assay has broad application for use in evaluating potential disinfectants for water, air, and surfaces aboard spacecraft and on Earth.

Development efforts continue for potential countermeasures to the biochemical, nutritional, and physiological alterations associated with fluid redistribution during head-down bed rest and during exposure to microgravity. Plasma volume was successfully restored during 5 to 10 days of head-down bed rest by using 2- or 4-hour periods of lower body negative pressure. Altered sympathoadrenal and cardiovascular function was suggested from studying the action of two cardioactive drugs, phenylephrine and isoproterenol, in healthy subjects who underwent 21 days of head-down bed rest. The unexpected observation of an altered cardiovascular response to these drugs in the absence of a significant decrease in body fluids suggests that the physiological adaptation to microgravity that contributes to orthostatic intolerance (dizziness and fainting) may occur even if an individual is well hydrated. A noninvasive method for determining energy expenditure, based on the use of stable (nonradioactive and nontoxic) isotopes of hydrogen ^2H and oxygen ^{18}O , was found to be useful for measuring energy expenditure during spaceflight.

Several new cell-culture model systems were developed to study cellular physiology and assess radiation risk. An in vitro endothelial cell culture system was developed to evaluate the regulation of fluid. These cells line the circulatory system and have been shown to respond to atrial natriuretic factor (ANF), a hormone important in fluid regulation. Results obtained using this model were consistent with a correlation between postulated levels of circulating ANF and edema during spaceflight. Studying human cells that have been treated with radiation similar to that found in space is an important approach to understanding the effects of exposure to charged-particle radiation during long spaceflights. A human epithelial cell line was found to be highly resistant to neoplastic transformation from charged particles (heavy ions). In another study, charged particles of high linear-energy transfer were found to produce irreparable

mutagenic lesions as well as chromosome breaks and exchanges in mammalian cells.

A system for detecting gas-phase formation in the body during hypobaric decompression was developed, and ultrasound monitoring of vascular gas-phase formation in tendons and ligaments was successful.

Accomplishments associated with the Space Station Program included refinement of the Crew Health Care System (CHeCS), which will be used to meet crew health needs during all phases of SSF operations. Design concepts were further developed for the Medical Equipment Computer (MEC), which will provide medical care information on board SSF during its permanently manned capability phase. The MEC will assist crew medical officers with patient care and will provide automated data collection functions for the three CHeCS components: the Exercise Countermeasures Facility (ECF), the Environmental Health System (EHS), and the Health Maintenance Facility (HMF).

During the past year, the Crew Health Care System's Simulations Team sought to clarify issues surrounding ECF, EHS, and HMF hardware and procedures during the man-tended capability phase of SSF operations. HMF prototype hardware evaluated from a human factors perspective included a defibrillator, a ventilator and respiratory support pack, a prototype crew medical restraint system, and an advanced life support pack. In addition, procedural and systems integration issues concerning decontamination, consumables, and medical evacuation and transport from SSF to Space Shuttle were identified.

The past year has seen significant upgrades to the training devices used to preadapt astronauts to some of the sensory rearrangements experienced in spaceflight.

The following articles provide more information about these significant advances in life sciences research and technology.

Section I

Life Sciences

Significant Tasks



A Rapid Tetrazolium-Based Biocide Assay

TM/PI: Duane L. Pierson, Ph.D./SD4
PI: Raymond P. Stowe/KRUG
David W. Koenig, Ph.D./
KRUG
Saroj K. Mishra, Ph.D./KRUG
Reference: LS 1

Bacteria in aqueous environments attach to surfaces, where their subsequent growth leads to biofilm formation. These biofilms promote corrosion of surfaces by several mechanisms. Sloughing releases large numbers of bacteria into the water, which may present a threat to the health of those drinking that water. Biofilm formation enhances bacterial resistance to antibiotics, quaternary ammonium compounds, chlorine, and iodine. *Pseudomonas cepacia*, a bacterial species highly adaptable to adverse conditions, has been isolated from the potable water supply of several Space Shuttle flights. A means of rapidly determining the iodine resistance of such isolates is needed so that remediation can be implemented quickly to prevent system failure and protect crew health.

Microbial susceptibility to iodine and other disinfectants is currently determined using standard plate-count, isotopic uptake, or other methods. These methods are time-consuming and costly. Recently, colorimetric (tetrazolium) assays have been developed as an alternative to traditional methods. Tetrazolium salts are groups of water-soluble, quaternary ammonium compounds that yield intensely colored, water-insoluble formazan crystals upon metabolic reduction by living cells. Normally, organic solvents are needed to solubilize

the crystals so that the formazan can be visualized by spectrophotometry. Because these solvents are toxic to cells and their enzyme systems, these assays traditionally are limited to endpoint measurements.

We have developed a biocide assay that overcomes this limitation by eliminating the need for toxic organic solvents. We combined the tetrazolium compound 3-(4,5-dimethylthiazol-2-yl)-2,5-diphenyl-tetrazolium bromide (MTT) with the nonionic detergent Triton X-100. The formazan product is dispersed homogeneously throughout the solution without harming the cells, and spectrophotometric absorbance can be measured continuously.

This method was used to determine the iodine sensitivity of two strains of *Pseudomonas cepacia* that were isolated from two Space Shuttle water systems. As shown in fig. 1, *P. cepacia* isolated from the STS-39 mission was more resistant than the *P. cepacia* isolated from STS-48. Both Shuttle strains were more resistant to iodine than *P. cepacia* ATCC 49129 or *Escherichia coli* 208 (isolated from a drinking-water distribution system).

Use of this assay with a 96-well microplate allows a single isolate to be screened for susceptibility to many disinfectants simultaneously and quickly, within 40 minutes to 4 hours. This method has broad applications for use in evaluating potential disinfectants for water, air, and surfaces aboard spacecraft and on Earth.

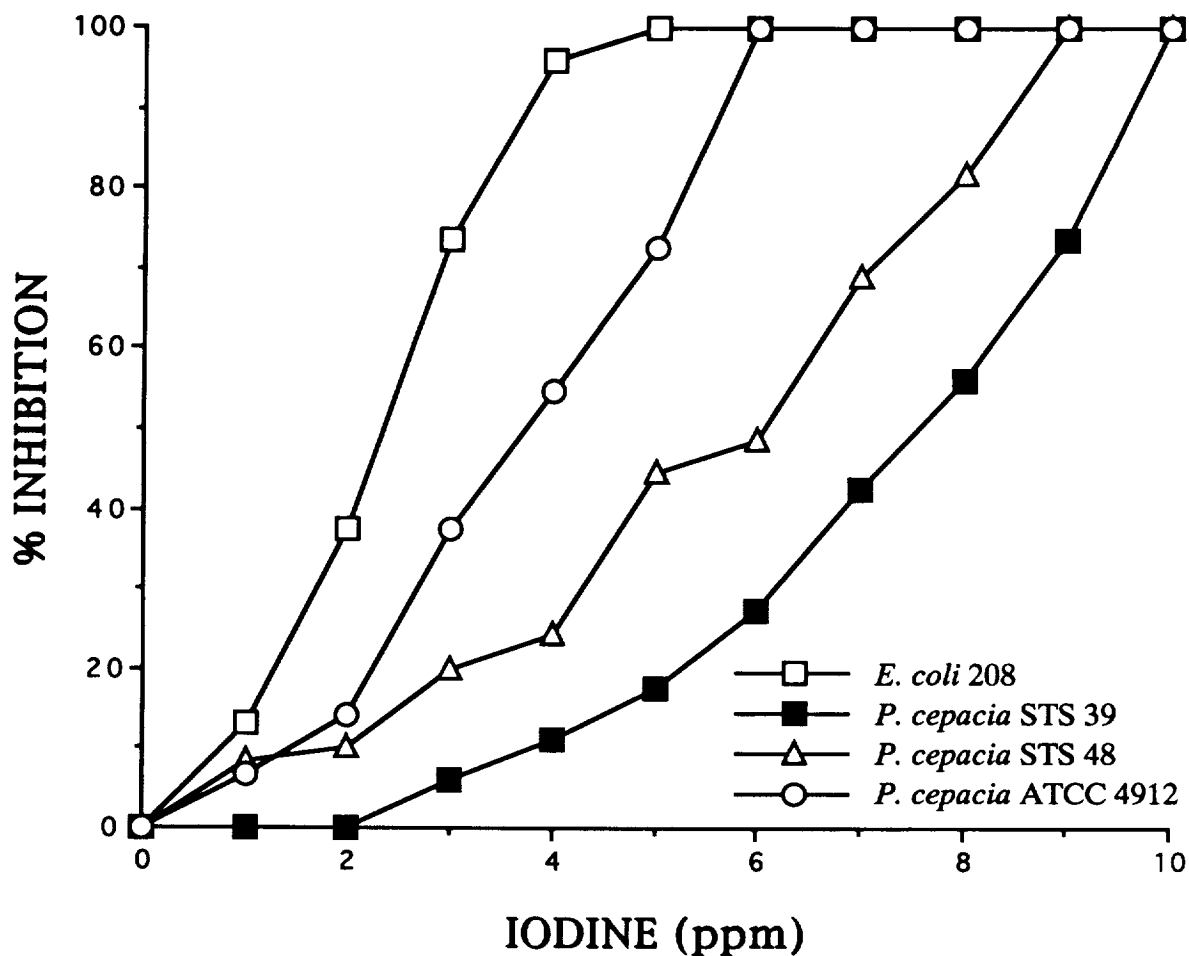

Figure 1. Aliquots of a bacterial suspension were plated into a 96-well microtiter plate. Iodine was added to the wells to final concentrations of 1-10 ppm. After a 10-min incubation, sodium thiosulfate was added to neutralize the iodine. Plates were shaken and 4X trypticase soy broth was added followed by MTT. An electron coupler, 2-phenazine methosulfate, was added to enhance the reaction rate. Triton X-100 was added (1.0% final conc.), and formazan production was followed in a microplate reader using a test wavelength of 590 nm and a reference wavelength of 650 nm.

Spacecraft Maximum Allowable Concentrations for Individual Contaminants

TM/PI: John T. James, Ph.D./SD4
PI: Harold Kaplan, Ph.D.
Martin E. Coleman, Ph.D./SD4
Reference: LS 2

In the closed environment of spacecraft, the most immediate need of the crewmembers is to have safe air to breathe. The quality of spacecraft air can deteriorate gradually, as unremoved contaminants accumulate, or abruptly, if a chemical leaks from containment or if synthetic material burns. NASA has established spacecraft contamination limits for airborne chemicals since the earliest days of manned spaceflight. At present, spacecraft maximum allowable concentrations (SMACs) have been established for exposure periods of 7 days. These values were set almost 20 years ago without documentation, and are not suitable for managing short-term (e.g., 1-hour) or long-term (e.g., 180 days) exposures to chemicals.

In the past, setting contaminant limits for different exposure times has not been a priority because air quality was assessed only after each mission by analyzing samples taken during the mission. Recent developments in analytical instrumentation are beginning to provide real-time, onboard analytical capabilities. Consequently, it is becoming possible to manage air-quality problems during Shuttle missions, and it will be possible to measure contaminants as they accumulate during long stays on Space Station Freedom. To design appropriate instruments and interpret the measurements they produce, SMACs are being set and documented for individual contaminants.

The present effort involves thorough literature searches for toxicity data on the chemicals of interest. These data are critically reviewed and key studies are identified. Each toxic effect that a chemical can induce is analyzed separately to determine the exposure limit that would protect crewmembers from that specific effect. Typically, for each exposure time, the most sensitive toxic effect is used to determine the SMAC. Often, the

short-term SMACs may protect against an effect such as central nervous system (CNS) depression, whereas a long-term SMAC for the same chemical may protect against liver injury or cancer.

The short-term SMACs are set to permit some risk of mild, temporary effects as long as those effects do not impair a crewmember's ability to handle a chemical contamination emergency. For example, mild irritation of the eyes or respiratory system is acceptable for 1- and 24-hour SMACs; however, a mild performance decrement caused by CNS depression would not be acceptable. For long-term SMACs, the values are set to protect against *any* adverse effect. For cancer risk, the chemical contamination limit of each compound is set at the upper 95% confidence limit of a 0.01% risk. Other long-term exposure effects that may be of concern include hepatotoxicity, nephrotoxicity, neurotoxicity, or respiratory-system damage.

In cooperation with the National Research Council Committee on Toxicology, the JSC Toxicology Group has established working guidelines to ensure that toxicological data are interpreted consistently for each chemical. If human data are available, they are used preferentially over animal data. If animal data are used, a tenfold species factor must be used to extrapolate to humans unless sufficient data are available to ensure that the animal species is no less sensitive than humans. The most sensitive animal species must be used and a no-observed-adverse-effect level must be determined from the animal exposures. Since crewmembers are most likely to be exposed to chemicals by inhalation, that mode of exposure is preferred over other routes of administration. Extrapolations from short exposures to long exposures depend on whether the toxic effect is of a threshold or cumulative nature. For cumulative-type effects, the SMACs must decrease with increasing exposure time. On the other hand, if a short-term limit is below a threshold concentration at which a specific type of injury can occur, then long-term SMACs need not decrease with increasing time.

By carefully developing the rationale for setting SMACs, it becomes possible to integrate spaceflight effects into the final number. When a limit has been determined for Earth-based

exposures, the toxicologist must consider whether the changes induced by spaceflight would cause astronauts to be more susceptible to the toxic effect. For example, there is no reason to believe that astronauts would become more susceptible to irritants, CNS depressants, hepatotoxins, or nephrotoxins. On the other hand, they may become more susceptible to cardiac-arrhythmogenic chemicals, hematotoxins, and immunotoxins. Determining the spaceflight factor to apply during the analysis is based on the frequency and severity of the flight-induced effect.

Documentation on SMACs will be published by the National Academy Press. Table 1 presents SMACs developed for 12 of the more important chemicals that could be present in spacecraft air.

New, well documented SMACs are being set for chemicals that are important to the management of spacecraft air quality during contingencies and after long-term accumulation. These limits are needed to interpret results of hardware offgassing, establish air-revitalization goals, and set contaminant-monitoring limits. The values also will be used to manage chemical contamination problems once onboard chemical monitoring becomes available. The SMACs and their support documentation are proving useful to regulatory agencies that deal with closed (indoor) environments, including those on spacecraft.

Table 1. Spacecraft Maximum Allowable Concentrations (ppm)

Chemical	Potential Exposure Period				
	1 hour	24 hours	7 days	30 days	180 days
acetaldehyde	10	6	2	2	2
2-butanone	50	50	10	10	10
carbon dioxide	13000	13000	7000	7000	7000
carbon monoxide	55	20	10	10	10
dichloromethane	100	35	15	5	3
Freon 113	50	50	50	50	50
hydrazine	4	0.3	0.04	0.02	0.004
methanol	30	10	7	7	7
2-propanol	400	100	60	60	60
toluene	16	16	16	16	16
trimethylsilanol	150	20	10	10	10
xylene	100	100	50	50	50

As shown in this table, the 7-day, 30-day and 180-day SMACs for many contaminants are the same. Because most contaminants are irritants or CNS depressants, their effects depend on concentration rather than on time. Dichloromethane is a CNS depressant; however, below the CNS threshold it also causes cardiac and liver injury after long-term exposure. Hence its long-term SMACs decrease with increasing exposure time. Similarly, hydrazine is a hepatotoxin and causes increasing injury as the exposure time increases. Both chemicals are carcinogens, but their potency is sufficiently low that risk of cancer is not significant in setting the SMACs.

Heavy-Ion-Induced Genetic Changes in Mammalian Cells

TM/PI: Chul-hsu Yang, Ph.D./SD4
PI: Laurle M. Craise/Lawrence
Berkeley Laboratory,
California
Marco Durante, Ph.D./
University of Napoli, Italy
Reference: LS 3

NASA and other space agencies are preparing for the next steps in human space exploration: establishing a permanently inhabited space station, building a lunar outpost, and planning exploratory missions to Mars. All of these steps will involve humans living in environments very different from those on Earth. The biological effects of radiation on the Moon and on Mars, for example, will be many times greater than that on or near Earth and must be characterized to protect human health.

We report here studies of the mutagenic effects of heavy ions in mammalian cell cultures. We found that charged particles of high linear-energy transfer (LET) can produce irreparable mutagenic lesions as well as chromosome breaks and exchanges. We used two types of cells for these studies: rat embryonic cells (Rat-2) for the mutation experiments and mouse embryonic cells (C3H10T1/2) for the chromosome aberration studies. Cells were irradiated either with a 250 kVp Philips X-ray machine or with heavy ions accelerated using the Bevalac device at Lawrence Berkeley Laboratory.

To select Rat-2 cells for HPRT mutants, cells first were grown to confluence in Eagle's Minimum Essential Medium (MEM) supplemented with 10% fetal calf serum. The confluent cells were irradiated with X rays or heavy ions, and then plated on 6-thioguanine (6-TG)-free medium to determine survival and to promote expression of mutations. About 5×10^5 cells were seeded into 100-mm tissue culture dishes and subcultured every 3 to 4 days. After about 10 days of incubation, exponentially growing cells were trypsinized, counted, and plated into two sets of 100-mm dishes: one with regular medium (to determine survival) and one with 6-TG (30 mg/ml) medium (to select 6-TG-resistant mutants). Cells

were plated at about 200 per dish to determine survival and at about 2×10^5 per dish to determine mutations. Visible colonies usually were found after 15 days of incubation.

For chromosome-aberration analysis, confluent C3H10T1/2 cells were dissociated immediately after irradiation with trypsin-EDTA solution, counted, and plated into 100-mm dishes at low density ($2-5 \times 10^5$ cells per dish). Chromosome spreads were obtained using standard methods. Briefly, one day after plating, cells were treated with 1.0 mg/ml Colcemid for 2 to 3 hrs, treated with hypotonic (0.075 M) potassium chloride for 20 min, and then fixed with a solution of 3 parts methanol to 1 part glacial acetic acid. Cells were spread on a clean slide, air-dried, and the chromosomes stained with Wright's stain. Chromosome aberrations were scored under a phase-contrast microscope.

The relative biological effectiveness (RBE) of X rays, carbon, silicon, argon, iron, and uranium particles, at the mutation frequency induced by 300 rad of X rays, is listed in table 1. The RBE increased with LET to about 85 keV/mm and decreased to 1.0 for uranium particles (LET = 1692 keV/mm). Of all the charged particles studied, 320 MeV/u silicon ions were most effective in causing HPRT mutations.

We also examined repair of potential mutagenic lesions in Rat-2 cells that had been irradiated by silicon and neon particles. Mutation frequency was significantly reduced in cells exposed to 425 MeV/u neon or 670 MeV/u silicon ions and then incubated for 24 hours (figs. 1 and 2). Delayed plating had no effect, however, in cells irradiated with 320 MeV/u silicon ions (fig. 3). Mutation frequencies were about the same for cell irradiated by one or by four fractions of argon ions (400 MeV/u; 120 keV/mm) with delayed-plating interval of 2 hrs (fig. 4). These results suggest that high-LET heavy ions can cause somatic mutations and produce irreparable lesions in mammalian cells.

Figure 5 shows chromosomal aberrations from 220 kVp X rays, and fig. 6 from 600 MeV/u iron particles (LET=200 keV/mm). Chromosome breaks, exchanges, gaps, and chromatid aberrations

in C3H10T1/2 cells were scored after various doses. There was no significant increase of chromatid aberrations. Increasing the dose of either X rays or iron particles had no effect on chromatid aberrations, and only slightly increased the frequency of chromosome gaps. X rays and iron particles were the most effective in inducing chromosome breaks and exchanges. The RBEs determined at various X-ray dose levels are listed in table 2.

We conclude that high-LET charged particles can produce somatic mutations effectively in mammalian cells. The RBE value increased with LET to about 5.0 around 90 keV/mm and then decreased to about 1.0 at 1692 keV/mm. These results are similar to those reported by other investigators. Our data also showed that mutagenic

lesions induced by high-LET heavy particles can be irreparable, and that acute and chronic exposure to these particles can be equally effective in inducing mutations.

X rays and high-LET iron particles were very effective in inducing chromosome breaks and exchanges, but not chromosome gaps or chromatid aberrations. The low frequency of chromatid aberrations found in this study is not unexpected, since most cells were at the G1 stage during irradiation. For a given dose, iron particles were more effective than X rays in producing chromosome aberrations, especially breaks. This high efficiency in causing chromosome breaks and exchanges may be related to the fact that high-LET heavy ions can cause double-strand breaks in DNA.

Table 1. RBEs for Heavy Ions That Induce HPRT Mutations in Rat-2 Cells

Type of Radiation	Initial Energy	Residual Range in Water (cm)	LET (keV/μm)	RBE
X rays	220 kVp	—	2.6	1.0
Carbon	290 MeV/u	13.0	14.0	1.0
Silicon	670 MeV/u	21.0	50.0	2.5
Silicon	320 MeV/u	4.5	85.0	5.0
Iron	600 MeV/u	7.6	200.0	4.6
Uranium	960 MeV/u	—	1692.0	1.0

Table 2. RBEs for Chromosome Aberrations Induced by 600 MeV/u Iron Particles

Chromosomal Aberration	X-ray Dose (Gy)	RBE
Breaks	1	5.00
	2	4.00
	4	3.33
	6	3.00
	8	2.96
Exchanges	1	2.00
	2	2.00
	4	1.74
	6	1.71
Gaps	2	2.50
	4	2.50
	6	2.70
	8	2.66

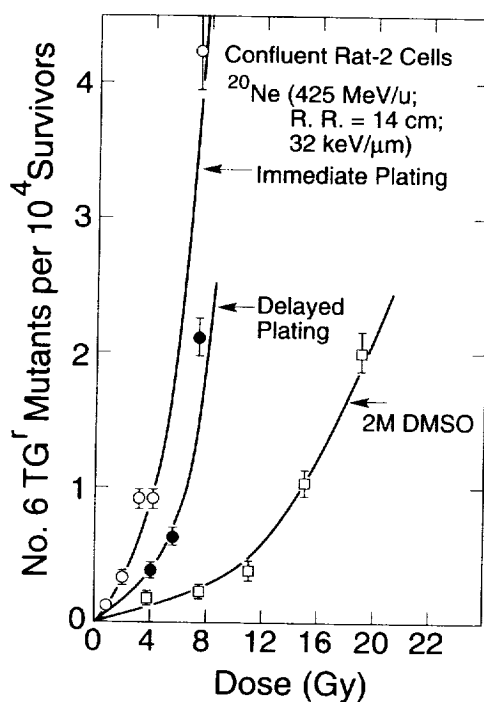

Figure 1. The number of 6-TG^r mutants produced by irradiating confluent Rat-2 cells with 425 MeV/u neon ions was reduced by waiting 24 hours to plate the cells. DMSO (2M) given during irradiation further protected the cells.

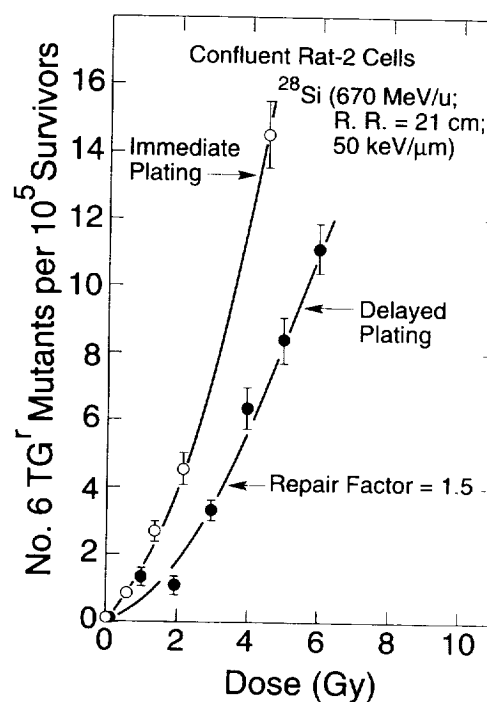

Figure 2. Confluent Rat-2 cells kept at 37°C for 24 hours after irradiation with 670 MeV/u silicon ions showed significant repair.

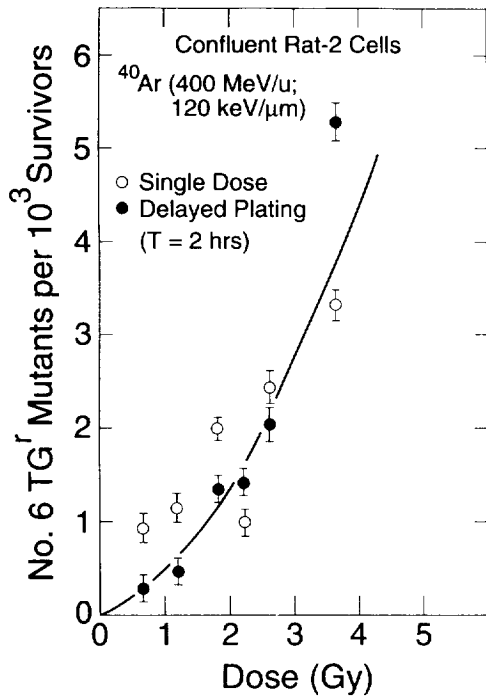

Figure 3. Confluent Rat-2 cells irradiated by 320 MeV/u silicon ions showed no repair of potential mutagenic lesions.

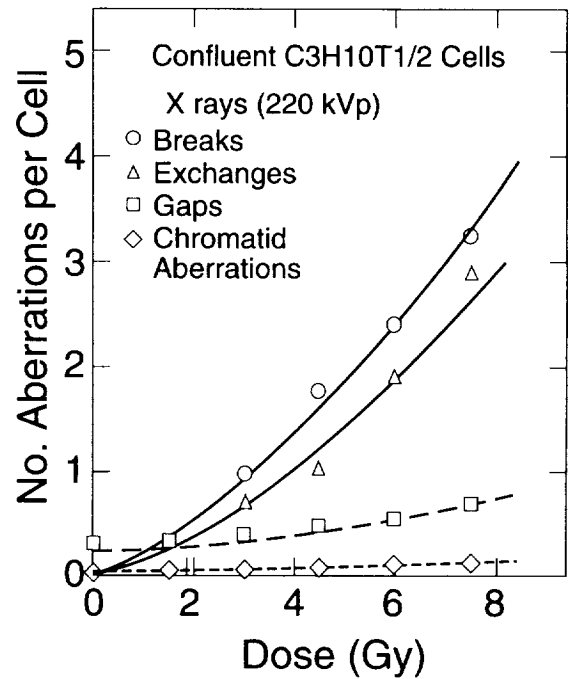

Figure 5. Chromosome aberrations induced by X rays in confluent C3H10T1/2 cells.

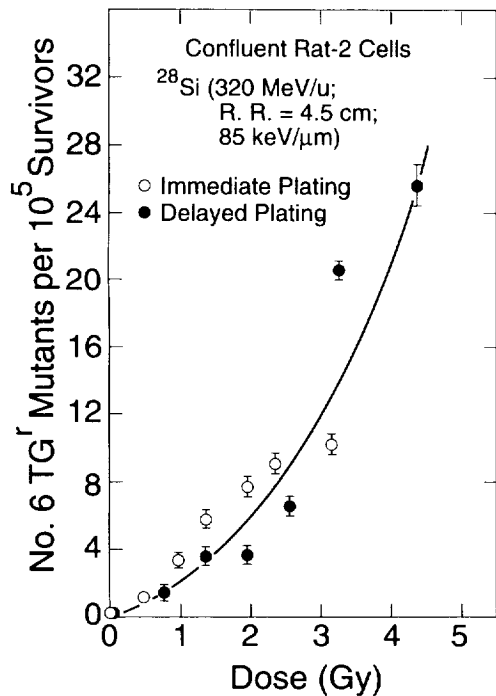

Figure 4. Mutations induced by a single dose or by four equal fractions of 400 MeV/u argon ions. No significant difference was observed between singly and multiply irradiated cultures.

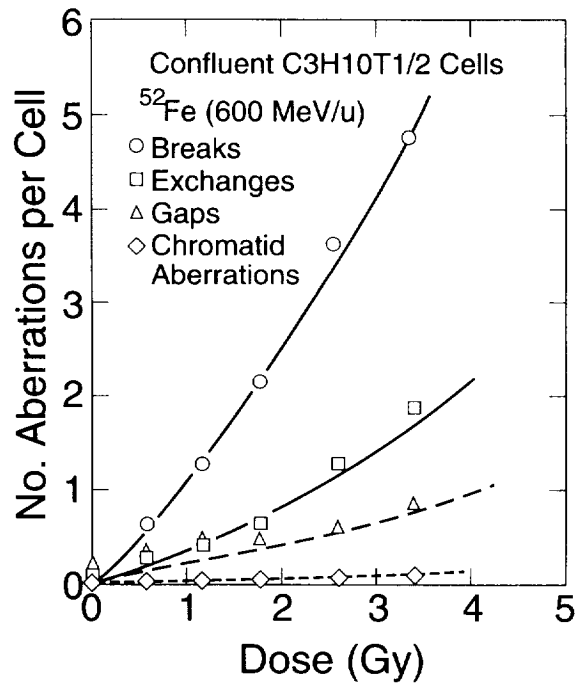

Figure 6. Dose-response curves for chromosome aberrations induced by 600 MeV/u iron particles.

Development of Human Epithelial-Cell Systems for Radiation Risk Assessment

TM/PI: Chul-hsu Yang, Ph.D./SD4
PI: Laurie M. Cralse/Lawrence
Berkeley Laboratory,
California

Reference: LS 4

Long-term human space exploration, whether on shuttles, space stations, or trips to the Moon or Mars, is rapidly becoming a reality. The unique physical factors of the space environment confer unique health hazards, particularly on long missions far from Earth's magnetosphere. Crewmembers on lunar or Mars missions will unavoidably be exposed to ionizing radiation as they travel through the inner trapped proton belt, the outer trapped electron belt, and the galactic cosmic rays of interplanetary space. Exposure to charged particles from solar-particle events also is a distinct possibility. The energy absorption and ionization pattern of charged-particle radiation are quite different from those of gamma rays and neutrons. Although much is known of the biological effects of gamma rays and neutrons, little if anything is known of how charged-particle radiation affects humans. Studying human cells that have been treated with radiation similar to that found in space is one way of addressing this lack of knowledge.

We have developed a model for studying the carcinogenic effect of charged particles at the cellular and molecular level using human mammary epithelial cells. The cells used in the studies reported here (cell line 184B5), obtained from Dr. Martha R. Stampfer, are immortal and nontumorigenic. When grown to confluence, 184B5 cells form a monolayer and stay in the G1 phase. Agar tests were negative, indicating anchorage-dependent growth.

Heavy ions were accelerated using the Lawrence Berkeley Laboratory's Bevalac device, and the resulting heavy-ion beam was used to irradiate the cells. Cells from stock culture were plated into T-25 flasks containing growth media, grown to

near-confluence, and then exposed to the heavy-ion beam at room temperature. Cells then were dissociated by trypsin-EDTA solution, counted, and plated, after which cells were subcultured or used for transformation tests as needed.

For transformation studies, log-phase 185B5 cells were irradiated and plated into dishes with enriched media (MCDB-170). Cells were subcultured weekly, and part of the cell population was seeded into Eagle's Minimum Essential Medium (MEM) containing 10% calf serum to select for growth variants. This assay, similar to that for C3H10T1/2 cells, was used to study morphological transformation of growth variants. Anchorage-independent growth was determined by plating cells into 0.33% agar medium with MEM; colonies containing more than 50 cells were counted as transformants. Tumorigenesis was tested by injecting 10^6 - 10^7 cells in 0.2 ml serum-free media subcutaneously on the backs of nude mice.

In attempts to transform cells into various stages of neoplasia, growth variants obtained from 185B5 cells were irradiated with 2.2 Gy of iron particles (600 MeV/u). The frequency of transformation was about 10^{-4} - 10^{-3} per survivor. In MEM with 4 to 10% serum, growth variants proliferated steadily, doubling in about 5 days, while the 185B5 cells slowly died off. (These variants also grew well in medium MCDB 170, doubling in less than 2 days.) A karyotypic analysis of a growth variant (F5-1M/10), selected from MEM supplemented with 10% serum, showed that these cells were near-diploid and stable in karyotype after many passages in culture (fig. 1). Some of the growth variants selected by MEM with lower concentration of serum, however, had significant karyotypic change at high passages. The reason for this difference between different growth variants is unknown. It is possible that medium with low serum may enhance selection of cells at later stages of transformation.

The cloned variant (F5-1M/10) maintained density-inhibition of growth for many passages (fig. 2). An additional irradiation of 2.2 Gy of iron particles (600 MeV/u) was needed to induce transformed foci. These foci persisted in culture after several passages (fig. 2), indicating that they were true

transformants. Another growth variant (M/4), selected from medium with 4% serum, was transformed with 3 Gy of argon ions (570 MeV/u). Transformed foci were found and cloned. When cells from a cloned focus were plated at low density in dishes, all cells formed dense colonies (fig. 3). These results indicated that heavy-ion-induced loss of density-inhibition of growth was irreversible.

Agar tests of cells cloned from transformed foci revealed large colonies several weeks after plating. Interestingly, these transformed cells did not produce tumors in athymic nude mice, even 6 months after subcutaneous injection of $2-4 \times 10^6$ cells. After clones from many transformed foci failed to produce tumors in vivo, we irradiated cells cloned from soft agar. Only one of the cloned transformants, after having received two additional doses (2.2 Gy each) of 600 MeV/u iron particles, produced a small nodule (2 to 3 mm in diameter) in an athymic mouse. This nodule persisted for many months without further growth.

Other studies of cultured mouse cell lines and embryonic hamster cells showed that a single exposure of low- or high-LET radiation was sufficient to induce transformants that were tumorigenic in vivo. Single radiation doses delivered to other cell types such as rat tracheal cells, however, caused only preneoplastic changes.

Radiogenic transformation, therefore, seems to be species- and tissue-dependent. Our results suggest that epithelial cells from the adult human mammary gland are highly resistant to neoplastic transformation by radiation. A single radiation dose causes only one step of change in the multistep process of carcinogenesis. These steps seem to proceed from growth variant, anchorage-independent growth, and tumorigenic. Similar findings have been observed with human epidermal keratinocytes. This resistance to radiogenic transformation may be related to the genomic stability of human cells. Therefore, it will be very important to study chromosomal changes in human cells transformed to various stages of carcinogenesis.

In our laboratory, Southern blot and DNA hybridization of media variants and transformants growing in soft agar have revealed no obvious deletions in the p53 or Rb tumor-suppressor genes; polymerase chain-reaction analyses are underway. Obtaining growth variants from 185B5 cells is a major advance in radiogenic transformation study with human epithelial cells. These media variants are easy to grow in culture, contain no viral oncogenes, maintain their density-inhibition growth property, and have stable karyotypes. They can be used as model systems for quantitative and mechanistic studies on Earth as well as in space.

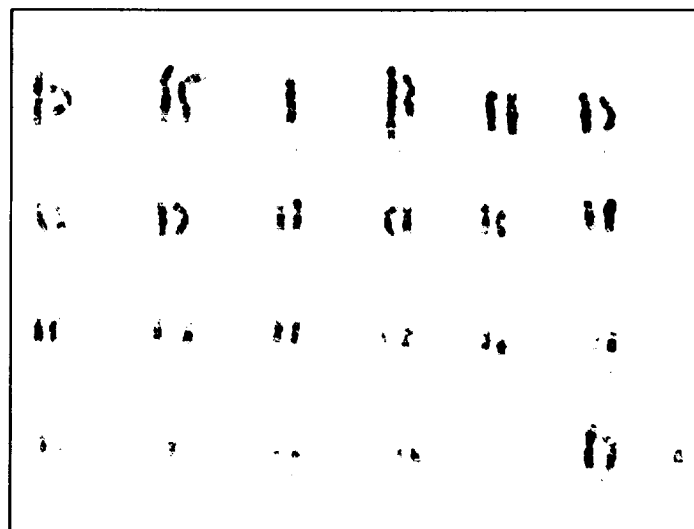

Figure 1. Karyotype of growth variant (184B5 F5-1 M/10) obtained from immortal human mammary epithelial cells (185B5). Chromosomes were G-banded.

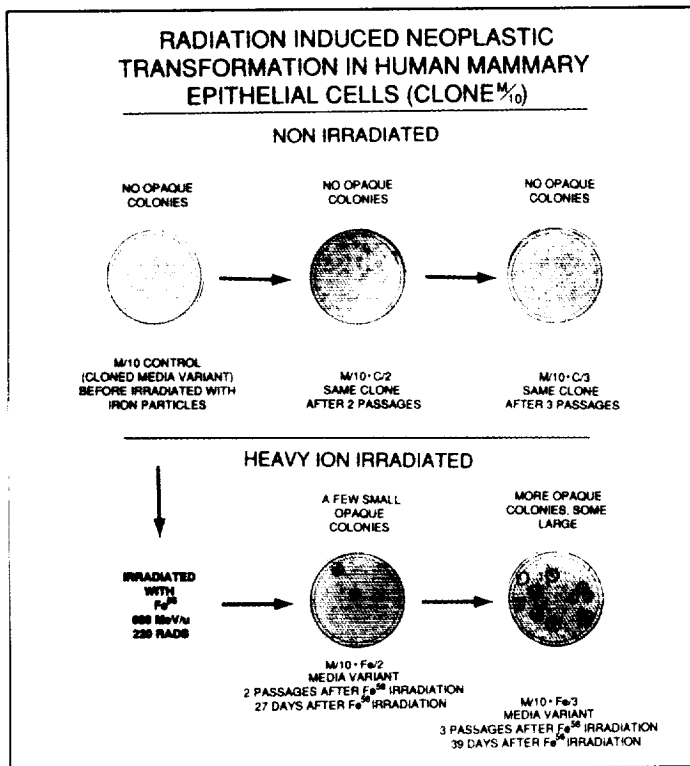

Figure 2. Transformation of growth variant (184B5 F5-1 M/10) by 600 MeV/u iron particles. Transformed foci were found in irradiated cells and persisted for several passages in culture.

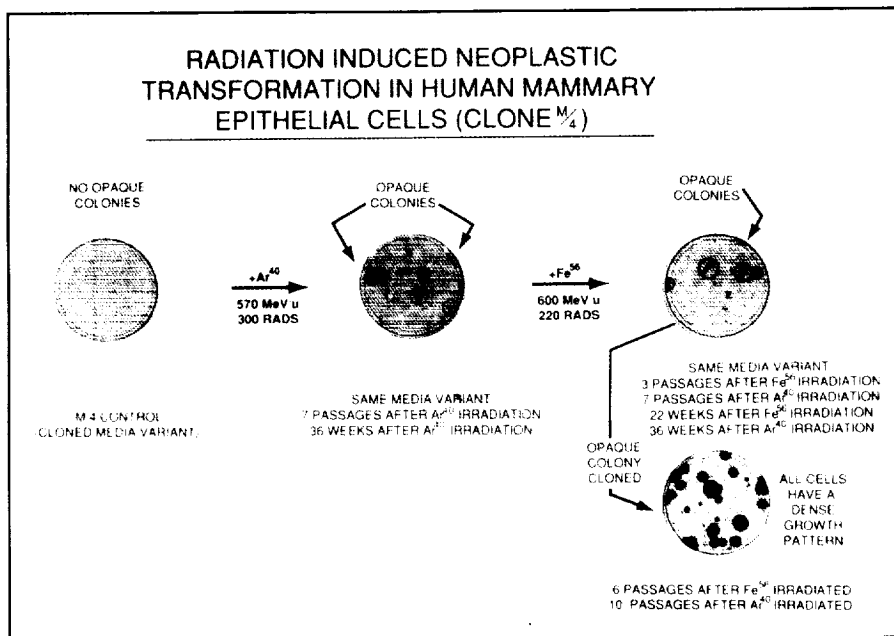

Figure 3. Transformation of growth variant (185B5 F5-1 M/4) by argon and iron particles. Colonies from cells of transformed foci showed dense growth after irradiation throughout many passages.

Macromolecular Permeability of Endothelium

TM/PI: Peggy A. Whitson, Ph.D./SD4
PI: John E. Wagner/Rice University
Larry V. McIntire, Ph.D./Rice University
Reference: LS 5

Exposing humans or animals to microgravity results in body fluid redistribution. This redistribution may be responsible for such conditions as edema (swelling) and space motion sickness. Fluid transport from the circulatory system to other parts of the body is influenced in part by the concentration gradient of macromolecules across the endothelium (cells that line the circulatory system). Control of fluid egress from the circulatory system thus depends on the ability of the endothelium to maintain high concentrations of macromolecules in the blood. Therefore, it is important to understand the permeability of the endothelium and how it is controlled.

Hormones acting on the endothelium generally bind to receptors. This receptor-ligand binding often causes the generation of secondary messengers within the cell, most notably calcium, cAMP and cGMP. We have investigated the effect of these secondary messengers on brain endothelial cell permeability to albumin in vitro (fig. 1). Our findings indicate that increasing concentrations of

cAMP and cGMP decrease albumin permeability, but increasing intracellular calcium increases permeability.

One hormone that has been shown to be important in fluid regulation and control is atrial natriuretic factor (ANF). This polypeptide is secreted by the atrial tissues of the heart in response to an increase in blood pressure. Its concentration in blood is thought to increase during initial exposure to microgravity and has been shown to decrease below normal levels 24 hours after launch. We have found that ANF decreases permeability of endothelial cells to albumin in vitro (fig. 1), a finding consistent with the hypothesis that the body seeks to prevent edema associated with increasing blood pressure. It also is consistent with correlation between spaceflight edema and circulating ANF levels.

The permeability of macromolecules as a function of molecular size also was explored using different sized dextran molecules. The sieving effect of transformed brain endothelial cells was demonstrated in vitro. This kind of analysis is important in determining exactly how the macromolecules traverse the endothelial barrier. The data shown in fig. 2 are consistent with a model that predicts that the smaller molecular weight species cross the endothelium by traveling primarily between cells, while the larger molecules travel by way of transcytosis (engulfment by a vesicle for transport through the cell).

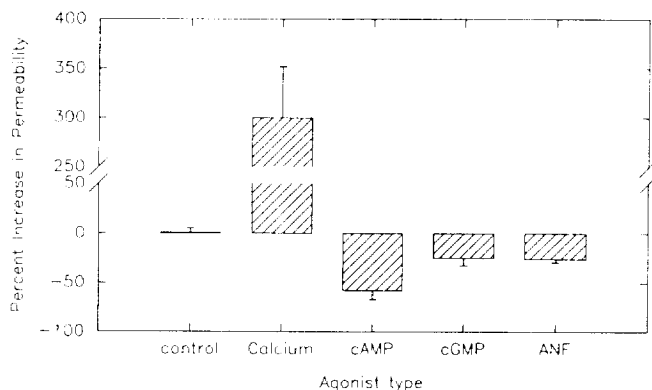

Figure 1. Increases in the permeability of bovine pulmonary-artery endothelial cells due to various agonists.

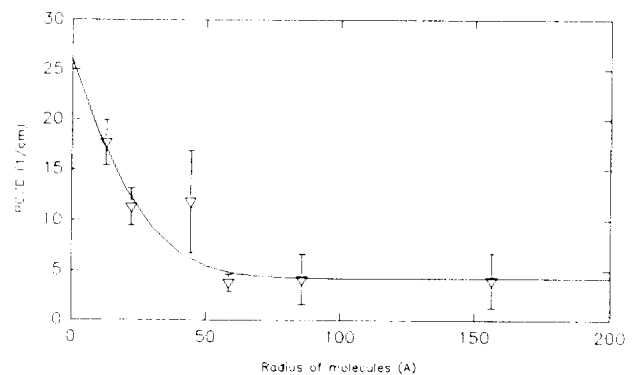

Figure 2. Sieving effect of endothelial cells.

The Role of the Sympathoadrenergic System During Head-Down Bed Rest

TM/PI: Peggy A. Whitson, Ph.D./SD4
PI: W. Jon Williams, Ph.D./SD4
Charles A. Stuart, M.D./
University of Texas Medical
Branch, Galveston
Suzanne M. Fortney, Ph.D./
SD5
Helen W. Lane, Ph.D./SD4
Nitzza M. Clntrón, Ph.D./SD4
Reference: LS 6

Exposure to microgravity during spaceflight induces several physiological changes as part of the adaptation process. Although humans can adapt successfully to microgravity, adaptation involves several significant consequences when they return to Earth. Among the most significant is orthostatic intolerance, or the tendency to become dizzy or lightheaded when exposed to cardiovascular stress. This problem, experienced to some degree by all astronauts during landing, starts at the beginning of flight. Without gravity, which normally pulls blood and other body fluids toward the feet, these fluids move away from the feet, toward the torso and head. Pressure sensors in the arteries interpret this change to mean an increase in blood volume, and perceived "extra" fluid is excreted. This reduction in body water is believed to be part of the cardiovascular deconditioning process that leads to orthostatic intolerance. Because being dizzy or fainting can cause significant problems during landing, much research has focused on the physiological mechanisms underlying orthostatic intolerance.

This report describes results from a study of two drugs, phenylephrine (PE) and isoproterenol (ISO), given to healthy men during 21 days of simulated microgravity (head-down bed rest). PE stimulates the alpha-adrenergic receptors on blood vessels and causes constriction of these vessels, resulting in increased blood pressure. ISO stimulates the beta-adrenergic receptors on the heart and blood vessels, which increases heart rate and decreases blood pressure. In this study, subjects' blood pressure, heart rate, and cardiac output were monitored. The

amount of water in the body was calculated using the deuterium oxide (D₂O) dilution method. The amount of water in the blood (plasma volume) was measured using the ¹²⁵I-human serum albumin (RISA) dilution method.

PE or ISO was infused in an increasing, stepwise fashion. At each infusion step, cardiovascular performance was assessed by measuring heart rate, blood pressure, and cardiac output. From these data, average blood pressure and total peripheral resistance (TPR, the resistance to blood flow due to constriction of the blood vessels) in response to the drug were calculated. Statistical analysis of the changes in TPR during PE infusion indicates that the vascular response (i.e., blood vessel response that results in a change in blood pressure) to PE is increased throughout bed rest (maximum of 43.5% increase per unit dose of PE) compared to the response to PE before bed rest (17.2% increase per unit dose of PE). Bed rest did not significantly alter the cardiovascular response to ISO. Surprisingly, neither total body water nor plasma volume changed during or after bed rest.

From these studies we concluded that

- During bed rest, the vascular response (elevated blood pressure) to PE was exaggerated. This vascular supersensitivity may reflect altered density or affinity of alpha1 adrenergic receptors.
- Neither total body water nor plasma volume changed during bed rest. This unexpected result suggests that cardiovascular deconditioning during bed rest can occur in the absence of a sustained decrease in body fluids and, therefore, altered cardiovascular function may not depend on chronic reduction in either total body water or plasma volume.

These studies have provided physiological, pharmacological, and biochemical evidence of altered sympathoadrenal and cardiovascular function during a 21-day head-down bed rest. These changes may contribute to the orthostatic intolerance experienced by astronauts upon return to Earth. Future studies will focus on hydration and electrolyte status and their contributions to sympathoadrenal and cardiovascular function.

Change in TPR During PE Infusion
as a Function of Bed Rest

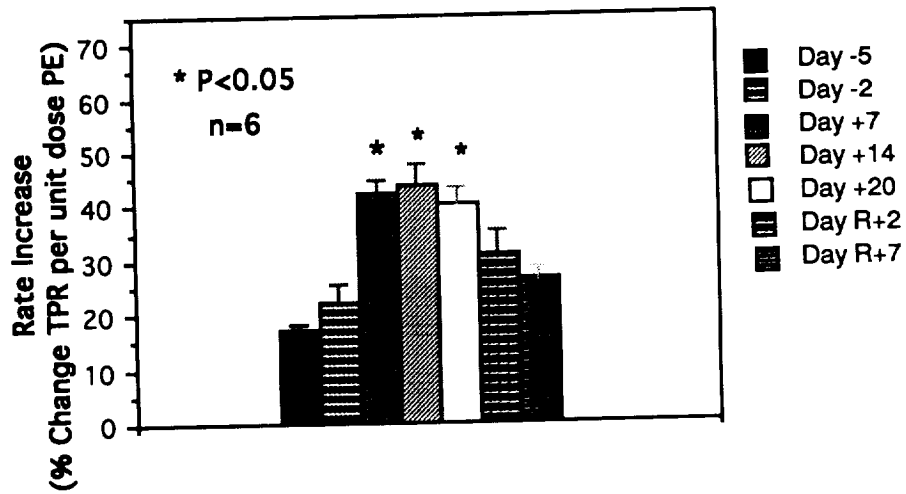

Change in TPR During ISO Infusion
as a Function of Bed Rest

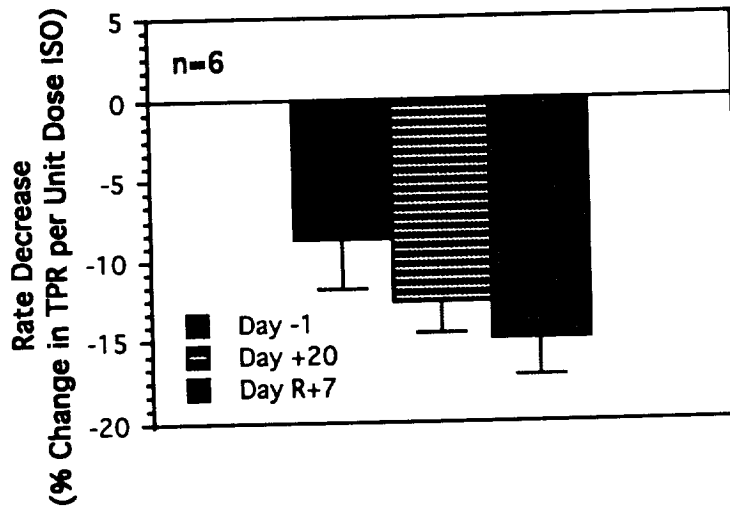
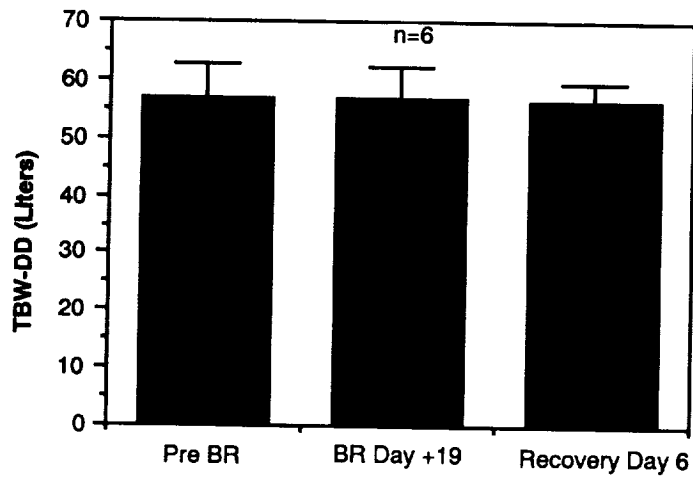

Figure 1. The vascular response to infusion of PE was significantly ($p < 0.05$) exaggerated during 21 days of head-down bed rest (top panel). The bottom panel shows the change in the vascular response to ISO infusion during the same bed rest study.

Total Body Water Estimate Using Deuterium-Oxide Dilution Method



Plasma Volume Determination During a 35-Day Bed Rest Study

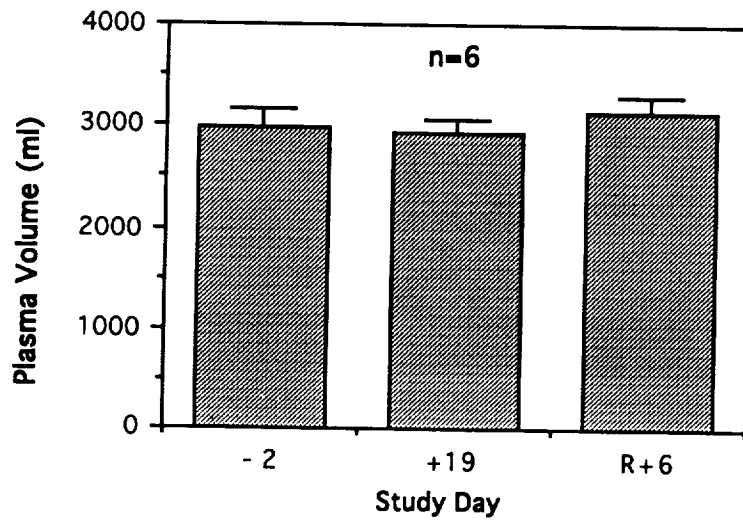

Figure 2. Bed rest (BR) had no effect on total body water as measured by the D₂O dilution method (top panel) or plasma volume (bottom panel).

Stable-Isotope Enrichment of Shuttle Drinking Water

TM/PI: H. W. Lane, Ph.D./SD4
PI: E. K. Gibson, Jr., Ph.D./SN2
R. J. Gretebeck, Ph.D./SD4
R. A. Sockl/LESC
D. A. Schoeller, Ph.D./
University of Chicago
Reference: LS 7

Exposure to microgravity induces physiological and biochemical changes that may interfere with the health and normal functioning of humans in space. The availability of nutrients and the energy required to function in microgravity also may differ from those on Earth.

The Nutritional Biochemistry and Stable Isotope Laboratories at JSC are using water labeled with isotopes of hydrogen (^2H , deuterium) and oxygen (^{18}O , "heavy oxygen") to determine human energy expenditure. Both isotopes are stable (nonradioactive), occur naturally, and are nontoxic at the levels used. Subjects drink a small amount of the labeled water, and the labels are traced in their urine or saliva over a period of days. The rate of disappearance of ^{18}O is used to calculate CO_2 production, with a correction for water turnover calculated from the disappearance of ^2H . The corrected CO_2 value is converted to energy expenditure in joules. This method has been used successfully in healthy and clinical populations.

Preliminary reports had suggested that the drinking water on the Space Shuttle was already enriched in ^2H and ^{18}O ; thus if these isotopes were to be used to determine energy expenditure, the amount and variability of these enrichments had to be determined. Water on the Shuttle is a by-product of electricity production by the fuel cells. Water samples from several Shuttle missions were analyzed to determine isotopic enrichment, and to compare enrichment levels of water from several

Shuttle vehicles as well as water from the same vehicle on different flights. Figure 1 shows the ^{18}O values from several missions. These values were higher than the normal range produced by meteoric precipitation, but remained very similar between the different vehicles and missions.

Another study involved analyzing the hydrogen and oxygen gas used in one Shuttle's fuel cells, and comparing these results with those of several water samples collected during a single flight (fig. 2). This study showed that the relative amount of ^{18}O in the drinking water did not change during flight, and was consistent with the isotopic enrichment of the oxygen gas used by the fuel cells. The ^2H enrichment of the water samples also remained relatively constant during the mission, and was consistent with the composition of the hydrogen gas loaded on the Shuttle. The hydrogen gas sample collected upon landing was slightly enriched relative to the sample collected before launch and the water samples during flight. This result may reflect collection of the sample when the storage tank was depleted. These results confirm that the water on the Shuttle vehicles is enriched relative to drinking water on Earth and also suggest that the source of this enrichment is the hydrogen and oxygen gas used in the fuel cells, not the reactions that occur within the fuel cells. The isotopic enrichment of Shuttle drinking water can now be predicted simply by analyzing the fuel cell gases before launch.

The information gained from analyzing water samples from previous missions was used to adapt the normal procedures for using ^2H and ^{18}O to determine energy expenditure for use during spaceflight. Figure 3 illustrates isotope elimination rates and predicted energy expenditure using this modified approach with one crewmember-subject from STS-45. These results indicate that ^2H and ^{18}O can be used to determine energy expenditure on short spaceflights.

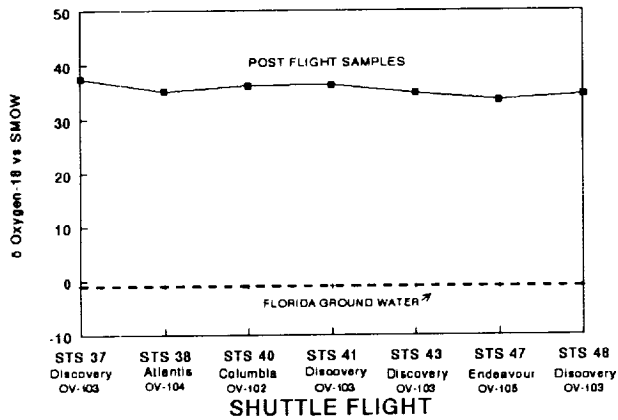

Figure 1. Oxygen-18 enrichment of potable water from several Space Shuttle missions.

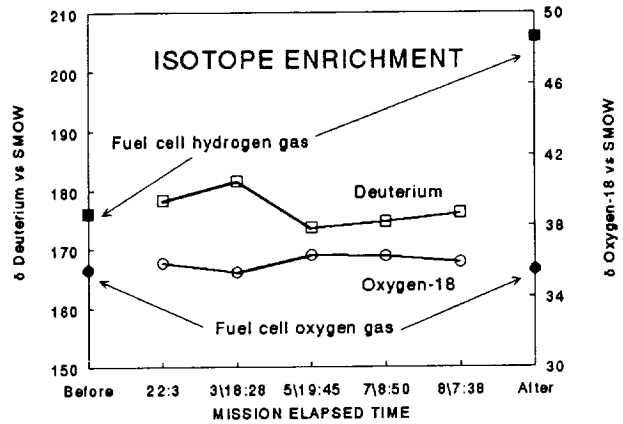

Figure 2. Deuterium (open squares) and oxygen-18 (open circles) enrichment of water collected during Space Shuttle flight STS-45 (Columbia, OV-102). Fuel cell hydrogen (closed squares) and oxygen (closed circles) gas samples were collected before and after flight.

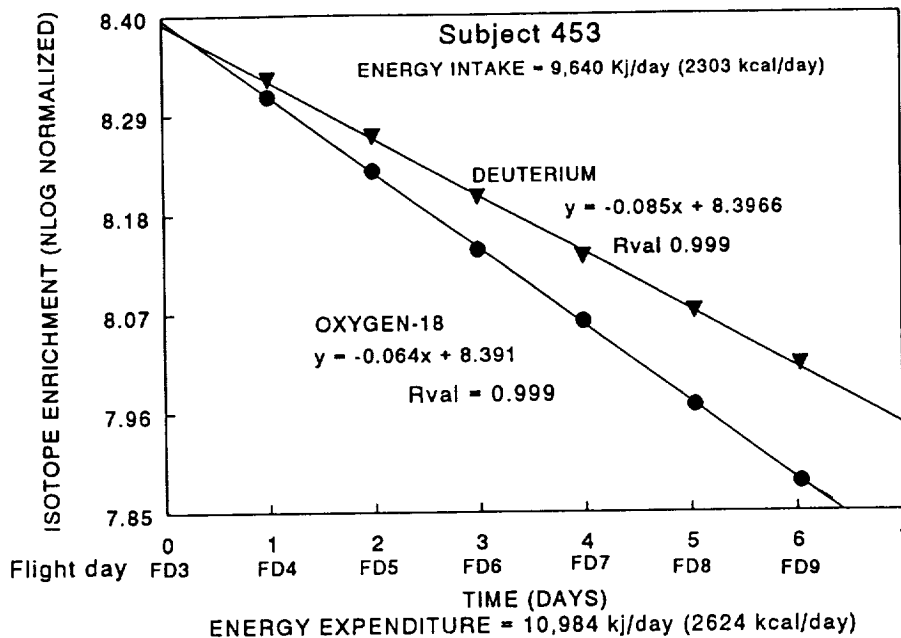

Figure 3. Isotope elimination and resulting estimate of energy expenditure in one subject during Space Shuttle flight STS-45.

Alternatives for Crew Health Care System Computer Development

TM/PI: Charles W. Lloyd, Pharm.D./SD2
PI: Marilyn Scott/KRUG
Reference: LS 8

The Medical Equipment Computer (MEC) is being designed to provide primary medical care information on board Space Station Freedom during permanently manned capability. A Macintosh interface on a notebook type computer, the MEC will assist the Crew Medical Officer (CMO), the astronaut medical care provider, in patient care, and will provide automated data-collection functions for the three components of the Crew Health Care System (CHeCs) (the Exercise Countermeasures Facility, the Environmental Health System, and the Health Maintenance Facility).

The efficiency of the MEC must be such that it will perform better than an equivalent paper system, and will allow the users to record and access all medical data accurately and quickly to support required medical operations on Freedom. CMOs will be trained to operate the MEC and will be supported by an onboard medical diagnostic and therapeutic system.

MEC development has included writing detailed software specifications based on medical simulations, and integrating software and hardware. Specifically, the MEC system must

- Provide a paperless medical record
- Support ICU level of care for one patient for up to 3 days
- Support a four-member crew for 90-day increments
- Support nominal and other medical events including hyperbaric treatments
- Incorporate industry-standard commercial off-the-shelf (COTS) hardware and software
- Collect data from CHeCS equipment

The MEC will include the following components:

- Medical Records, which will allow the CMO access to store, retrieve, and update patient chart data
- Automated Instrumentation Monitoring, which will automatically collect data from instruments, sample it, and present it for review and storage within the medical record
- Medical Reference, which will provide an integrated set of text and graphics material to clarify medical questions that arise during a "patient encounter"
- Decision Support, which will assist the CMO in making diagnoses and decisions regarding therapy
- Drug Interaction, which will store pharmaceutical information and check for adverse interactions
- Inventory Management, which will provide the user with inventory management and control for supplies and pharmaceuticals

All components of the MEC have been defined and used. COTS software selected to reside on the MEC includes both Mac-on-Call and Iliad for decision support and Stat-Ref! for medical reference. The inventory management system and medical record capability have been developed using 4th Dimension, a relational data base of the Macintosh. Medical history, findings from physical and laboratory examinations, and aeromedical summaries are being included in the medical record.

Future plans for the MEC include finishing the development of the first MEC prototype and defining others; modifying and integrating COTS medical software to enable all MEC components to communicate with the Medical Record component; expanding the quantity and quality of the medical scenarios to broaden the underlying understanding of the capabilities and limitations of the MEC; "acting out" medical scenarios; and developing communication software for medical instrumentation, Freedom's data management system, and the Space Station Control Center.

Crew Health Care System Simulations for Space Medicine Programs

TM/PI: Charles W. Lloyd, Pharm.D./
SD2
PI: Smith L. Johnston, M.D./
KRUG
Reference: LS 9

During the past year, the Simulations Team of the Crew Health Care System (CHeCs) sought to clarify issues surrounding necessary hardware and procedures for the Health Maintenance Facility (HMF), Environmental Health System (EHS), and Exercise Countermeasures Facility (ECF) during the man-tended capability (MTC) phase of Space Station Freedom. Medical consultants, NASA flight surgeons, and astronauts participated in several simulations to achieve the goals described below.

As a first step, the following HMF prototype hardware was evaluated from a human factors perspective: a defibrillator, a ventilator and respiratory support pack, a restraint system, an advanced life support pack, and a hyperbaric airlock. Next, procedural and integration issues concerning decontamination, consumables, and medical evacuation and transport from Freedom to a Space Shuttle were identified. Stepwise simulations to test these devices and their associated procedures were then performed in KRUG Life Sciences' CHeCS facility and JSC's Shuttle Full Fuselage Trainer, hyperbaric airlock and Freedom mockups, KC-135 aircraft, Weightless Environment Training Facility (WETF), and hyperbaric chamber. These activities culminated in two complex simulations involving a high fidelity electrocution/advanced cardiac life support scenario with evacuations from the Space Station Node 2 to the airlock and Space Shuttle. Specific accomplishments are described below.

All evaluations of the CHeCS MTC stowage systems were completed, and designs of the storage trays for HMF and EHS supplies and equipment were finalized. Electrocardiograph and defibrillation functions of the LifePack-10

Defibrillator/Pacer were evaluated with an animal subject aboard the KC-135; the pacer function will be tested next, followed by evaluations in hyperbaric facilities. The functions of the LAMA & COMOX ventilators were verified during parabolic flight and under hyperbaric conditions. These simulations helped drive the design of the respiratory support pack and the portable oxygen supply pack, prototypes of which will be delivered in early 1993. Future evaluations will include simulations with a 55 kg animal aboard the KC-135. Modifications to the crew medical restraint system and advanced life support (ALS) system pack continue, with hardware delivery expected in mid-1993. A mockup of the hyperbaric airlock at McDonnell Douglas' Oceanus facility was extensively reconfigured to reflect recent Space Station restructuring, and to allow CHeCS medical hardware items to be used in simulations both in the airlock and in the WETF. Two intravenous fluid infusion systems were tested in simulation configurations on KC-135 flights, with the conclusion that an IV flow device can be used with a pressure-cuff system for quantified fluid delivery. This device will be incorporated into the ALS pack.

Issues surrounding transport and evacuation to the Space Shuttle were evaluated on KC-135 flights using the restraint system prototype and a transfer tunnel mockup to test translation of an injured crewmember. Design changes for the restraint system and Shuttle interfaces derived from these simulations are in progress. Future KC-135 simulations will use mockups of the node, transfer tunnel, and Shuttle and take the worst-case scenario from stabilization and transport to configuration in the Shuttle for transport home. Finally, nominal and contingency contamination and decontamination procedures were developed throughout the year.

Upgrades to the Preflight Adaptation Trainers

TM/PI: Deborah L. Harm, Ph.D./SD5
PI: William G. Crosler/KRUG
Millard F. Reschke, Ph.D./SD
Donald E. Parker, Ph.D./
Miami University
Reference: LS 10

The past year has seen significant upgrades to the training devices used to preadapt astronauts to some of the sensory rearrangements experienced in spaceflight. Descriptions of both trainers, the Tilt-Translation Device (TTD) and the Device for Orientation and Motion Environments (DOME), were presented in the 1988 and 1989 Research and Technology Annual Reports. The overall goal of Preflight Adaptation Training (PAT) is to reduce the incidence of space motion sickness (SMS) symptoms and spatial orientation disturbances experienced by crewmembers during spaceflight.

The PAT-DOME system is a 12-ft spherical dome in which subjects can be placed in one of three positions: on-side, supine or seated. Computer-generated video images projected on the dome interior by two video projectors provide a wide-angle field-of-view. Images of different surroundings, such as the Shuttle middeck and flight deck, Spacelab, Space Station or a series of interconnected rooms, can be presented. The subject uses hand controls, including a joystick and a force-plate surface, to visually "move around" the virtual environment displayed by the projectors in a manner similar to "flying" an aircraft flight simulator. Signals from the controllers drive the visual scene motion in a way that induces the perception that the trainee is moving around in a stationary room. Recognizing and maintaining one's orientation with respect to the environment under these novel perspectives is a complex and difficult task that requires considerable practice. Training in the DOME system allows crewmembers to become highly skilled at this task before flight and thus reduce orientation disturbances during flight.

This year the computer-image generator and associated custom software were upgraded to

enhance the subject's perceived self-motion. The new image-generator relies on state-of-the-art commercially available graphics-computing hardware. What makes the system unique is the software developed for compensating the video images for projection on the dome, and the fact that this compensation is done in real time. Flight simulators use analogous systems that require multimillion dollar image-generator computer systems that have high maintenance costs. By using standard graphics computers, the hardware and maintenance costs are greatly reduced and upgrading is simplified. The new compensation software enables alignment of two high-resolution video outputs on adjacent parts of the dome interior surface to minimize image distortion. In addition, software modifications developed in house permit other computers in the system to send movement commands in real time to the image generator so that virtual movement can be controlled efficiently by either the operator or the subject. These software improvements greatly simplify use of the system and reduce the time required to set up for each session, change the training conditions, and restart tests.

The PAT-TTD system was modified to enhance the motion-profile characteristics necessary for optimal training. The TTD combines a tilting chair-restraint assembly with a translating (linear movement only) visual surround. A longer visual surround was constructed to allow twice the displacement amplitude, higher translating velocities, and lower frequency profiles than the original. The new surround is stronger and features easily replaced side and top panels, so that downtime for repairs can be minimized. The drive system for the surround was also modified to reduce backlash and jerkiness, resulting in smoother movements that enhance training effectiveness.

Software was developed for Macintosh computers used for data acquisition, display, and analysis of data for both training devices. The software allows subject responses to be measured quantitatively during training sessions. Sophisticated analysis of sensory physiological and perceptual responses is essential for making scientifically valid decisions as to the best test conditions for adaptation training.

Physiological and perceptual responses to the different sensory stimulus conditions produced by each training device are evaluated during ground-based and in-flight studies. Data from investigations planned for 1993, along with earlier results, will be used to optimize training protocols and training schedules.

A preliminary evaluation of the usefulness of the education, demonstration, and experience components of PAT devices in reducing SMS was

encouraging. A group of 15 crewmembers participating in PAT-related experiments demonstrated a 33% improvement in motion sickness symptoms compared to a group of 40 nonparticipating crewmembers. The hardware and software enhancements to the PAT systems, along with fine-tuning the stimulus conditions, are expected to lead to even greater reductions in SMS.

ORIGINAL PAGE
BLACK AND WHITE PHOTOGRAPH

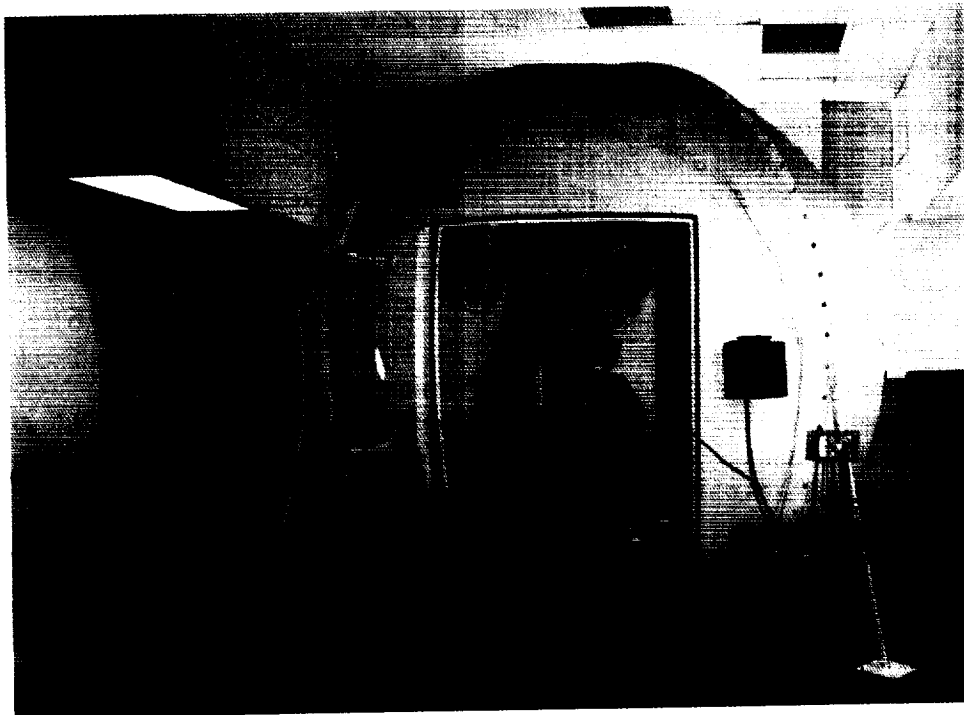

Figure 1. The Device for Orientation and Motion Environments (DOME) preflight adaptation trainer is a large spherical dome positioned over a rotating platform on which a subject restraint system and two projectors are mounted. Full field-of-view computer-generated virtual environments are projected on the interior surface of the dome. Hand controllers allow the subject to engage in six degrees of freedom of virtual movement through the visual environment.

Mechanisms by Which Lower Body Negative Pressure Improves Orthostatic Responses

PI: S.M. Fortney, Ph.D./SD5
Reference: LS 11

Extensive ground-based studies have been conducted to evaluate potential countermeasures for orthostatic intolerance after spaceflight or its analogues. Hyatt and West (*Aviat. Space Environ. Med.* 48:120-4, 1977) found that the combination of "fluid loading" (consuming a liter of an isotonic salt solution) and a 4-hour exposure to -30 mmHg lower body negative pressure (LBNP) restored not only plasma volume but also orthostatic responses after 7 days of bed rest. They were uncertain of the exact mechanism by which this technique improved orthostatic function, but suggested it may be related to increased plasma volume and fluid retention in the body.

One purpose of the study reported here was to determine whether the duration of the negative-pressure exposure could be reduced to 2 hours and still restore plasma volume and improve orthostatic function during bed rest. By obtaining measurements of fluid, electrolyte, and endocrine responses before and after LBNP treatment, the mechanisms by which this protocol is effective may be revealed.

Ten healthy men underwent 2 days of ambulatory control and 13 days of 6° head-down bed rest.

Each subject's blood volume was measured 2 days before the bed rest period and on the last day of bed rest using ¹²⁵iodine-labeled human serum albumin to measure plasma volume (PV), and ⁵¹chromium-labeled autologous red blood cells to measure red cell mass (RCM). Urine volume, aldosterone (ALD), and antidiuretic hormone (ADH) were determined from each 24-hour pooled collection. LBNP "ramp" tests were performed before and after the 4-hour or 2-hour LBNP treatments to measure heart rate (EKG), blood pressure (manual sphygmomanometry), and cardiac stroke volume (continuous wave echocardiography). From these values, pulse pressure (SBP-DBP) and total peripheral vascular resistance (Mean Arterial Pressure/CO) were calculated.

The blood volume and endocrine responses are shown in table 1. The effect of bed rest and the LBNP treatments on the cardiovascular responses at -50 mmHg LBNP are shown in table 2.

I concluded that either a 2-hour or a 4-hour LBNP treatment, with saline loading, could restore plasma volume after 5 to 10 days of head-down bed rest. However, only the 4-hour LBNP/saline treatment significantly improved the heart rate response to LBNP. Increased secretion of ADH and ALD may contribute to the LBNP-induced fluid retention.

Table 1. Plasma Volume and Urinary Endocrine Results

	PreBR	Pre4hr	Post4hr	Pre2hr	Post2hr
PV (ml)	3157 (161)	2918* (132)	3144 (173)	2987* (131)	3109 (146)
ADH (ng)	136 (33)	114 (15)	177+ (26)	93 (18)	155+ (42)
ALD (ng)	16 (4)	35* (4)	54* (5)	37* (7)	46* (7)

* differs from PreBR, P < 0.05.

+ differs from PreSoak, P < 0.05.

BR - Bed rest

Table 2. Cardiovascular Responses at -50 mmHg LBNP

	PreBR	Pre4hr	Post4hr	Pre2hr	Post2hr
Heart rate (bpm)	103 (5)	122* (3)	127* (4)	113*+ (4)	121* (4)
Pulse pressure (mmHg)	34 (3)	24* (2)	25* (4)	26 (3)	27 (4)
TPR (mmHG/(1/min))	21 (2)	22 (1)	22 (2)	24 (2)	22 (2)
Stroke volume (ml)	49 (6)	34* (3)	31* (5)	36 (4)	37 (5)

*significantly different from PreBR (ANOVA).

+significantly different from pretreatment (ANOVA).

A System for Accurate Measurement of Pointing Responses

TM/PI: Jacob J. Bloomberg, Ph.D. / SD5
PI: William P. Huebner, Ph.D./ KRUG
Reference: LS 12

Astronauts adapt to the microgravity environment of spaceflight by reinterpreting the relationship between sensory input and motor output. This neural recalibration is inappropriate, however, for a terrestrial one-g environment, leading to inappropriate postural, gait and ocular responses upon return to Earth.

As part of a set of ground-based experiments exploring the mechanisms of sensory-motor adaptation, we investigated how adaptation of the vestibulo-ocular system (the neural circuitry responsible for generating stabilizing eye movements in response to head movements) affects a subject's ability to point to remembered targets. The ultimate goal of this effort is to devise a measure that can counteract detrimental aspects of the adaptation of the vestibulo-ocular and pointing systems.

Before differences in vestibulo-ocular and pointing responses could be quantified, an accurate means of measuring pointing direction was needed. Because existing techniques used in other laboratories were cumbersome, complicated, or too inaccurate, we devised a novel way to use some new, commercially available hardware (Proxima Corporation, San Diego, California) that provides easy-to-determine yet accurate measurements of pointing responses.

A special display panel is used to project an image on a computer monitor onto a display screen (fig. 1). As images on the monitor change, the images on the display screen change. We equipped the display panel with an auxiliary scanning device

that scans the display surface of the projected image for user-initiated light bursts, supplied with the aid of a hand-held laser pointer (fig. 1). The scanner interprets these light bursts as computer mouse-clicks, as if the user had initiated the mouse clicks directly from the computer. In this way, the computer can be controlled remotely using a device to generate special light bursts on the display screen. This is the application intended for this hardware by the manufacturer.

We realized that such a hardware system could be used to measure pointing responses (fig. 2). The subject is provided with a special hand-held laser pointer to allow the intended direction of pointing to be indicated. (In fact, humans can point more accurately using a pointer than they can using a finger.) We have written software that momentarily displays a target on the screen, and then dynamically records the coordinates of a laser spot on the blank display screen as the subject attempts to place the laser spot on the remembered target position. Thus, we can easily record both the steady-state error of the pointing response as well as the trajectory used by the subject in arriving at the final pointing position. The display window has a resolution of 640 units horizontal by 480 units vertical; the program can provide the screen coordinates of the laser spot immediately, without the need for tedious data reduction.

Figure 1a

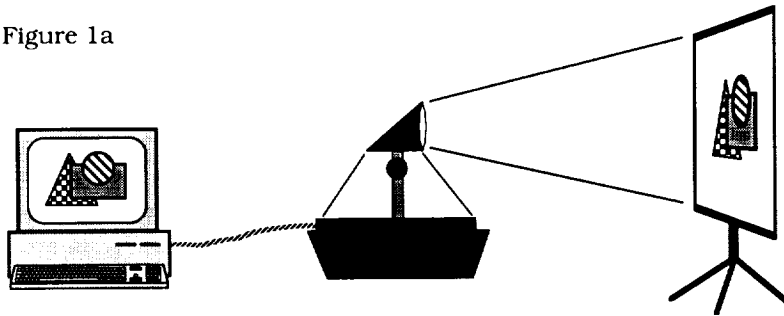

Figure 1b

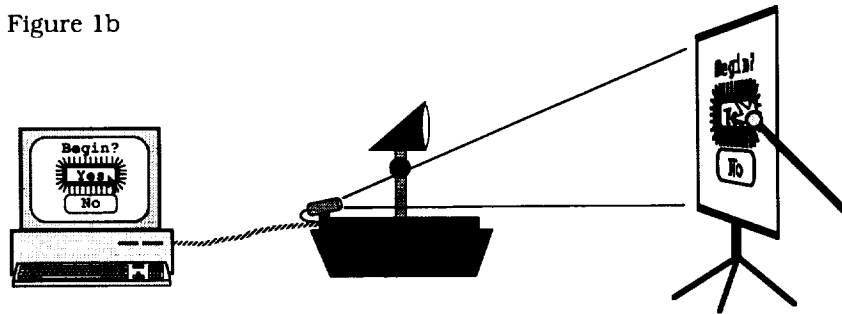

Figure 1. A display panel projects images from a computer monitor onto a screen (panel a); using a hand-held laser pointer, subjects can control the computer remotely (panel b).

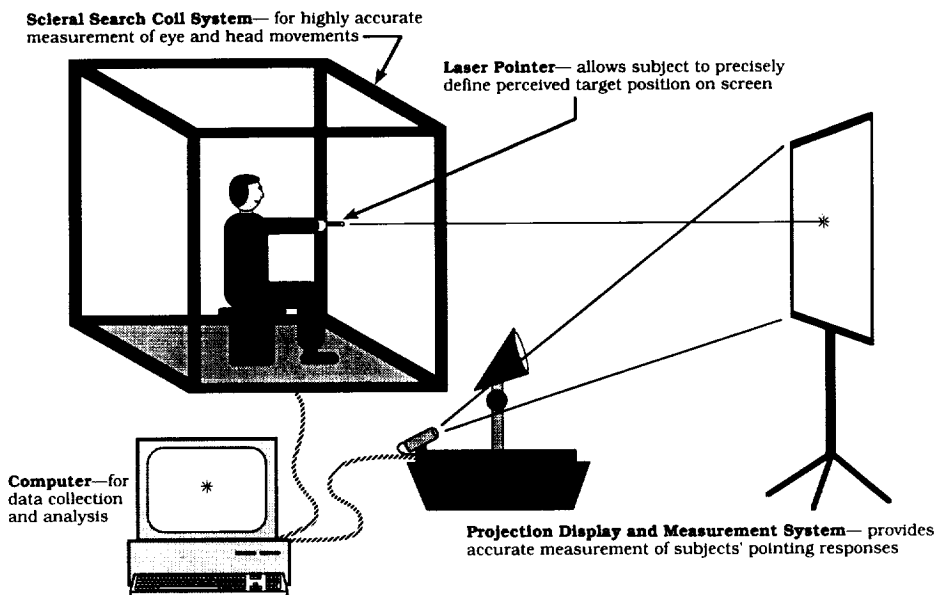

Figure 2. The monitor display system can be used to measure pointing responses.

Behavior and Performance in a Spaceflight Analogue

TM/PI: Albert W. Holland, Ph.D./SD5
PI: JoAnna Wood, Ph.D./KRUG
Stephen T. Vander Ark/KRUG
Laura G. Williamson, Ph.D./
KRUG
Reference: LS 13

The Behavior and Performance Laboratory (BPL) at JSC is tasked with maintaining and enhancing the psychological health, well-being, and performance of crewmembers on long-duration space missions. Efforts in these areas focus on ensuring that

- crewmembers can adapt to mission demands.
- mission design, work, and habitation conditions are consistent with what is necessary to safely and successfully conduct long-duration space missions.
- teams and individuals can perform adequately during extended flights.

To this end, the BPL conducted *La Chalupa-30*, an investigation into how isolation and confinement affect human behavior during a 30-day simulated space mission. The analogue was an underwater habitat, selected for its similarities to a space station environment, such as physical isolation and layout, crew characteristics, and types of tasks to complete. The investigation began with a crew of four men, selected by the Marine Resources Development Foundation, the operators of the habitat and cosponsors of this mission. One man left the mission during the fourth day because of illness; the remaining men conducted a variety of personal and team activities during the 30-day mission.

The habitat is located in 30 feet of water and is made up of 2 cylindrical chambers connected by a trapezoidal wetroom (fig. 1). Total habitable volume within the habitat is approximately 55.63 m³ (1964.66 ft³). The maximum hatch depth during high tide is approximately 7.01 m (23 ft), creating an ambient pressure within the vessel of 1289.77 mmHg (24.94 psi or 1.69 ata).

The study served to evaluate remote data-gathering procedures and equipment in a field setting, as well as to assess aspects of living and working under isolated and confined conditions. A primary data-collection technique tested in *La Chalupa-30* was the BPL's Incentive-based Field Recording System (IFRS) software. This customized, Microsoft Windows-based software permits questionnaires to be administered to subjects via a portable computer and stores responses in individual, confidential data bases. Questions are presented on screen; responses can be selected using a mouse or typed in using the keyboard. To increase compliance, subjects were presented with one of several preselected visual displays with an audio message after they completed the questionnaire. These displays represented "postcards" from home, and were designed to provide an incentive to finish the questionnaire.

Other methods of data collection tested in this study included a set of computer-based cognitive tests called the Automated Neurological Assessment Metrics. Also assessed was the use of question cards where items were read and spoken narrative responses were recorded using a microcassette recorder. Evening meal activities and team debriefs were videotaped. Two-way video and audio links were assessed as well. Finally, topside personnel compiled detailed logs during the mission to document all activities. Using several ways of collecting data allowed us to assess the quality of information obtained with each method, to assess crew preferences, and to have several sources of information from which to draw conclusions.

Repeated-measures data were collected for many variables within three topic areas. The first, health and well-being, focused on the physical and emotional health of the crew, including physical symptoms, psychological symptoms (e.g., anxiety or depression), sleep quality and quantity, cognitive processes, coping strategies, environmental perceptions (e.g., crowding, danger, monotony), and encouragement and support from family and controllers. The second area, task-work variables, focused on planning and conducting work and included assessment of workload, task

performance, and task goals over the course of the mission. Finally, team variables assessed the crew's perception of leadership, team functioning, and team goals as the mission progressed.

Evaluation of data collection procedures and equipment indicated that

- The IFRS software was effective for collecting self-report, repeated-measures data. The absence of missing data suggested that the "postcards" increased compliance over other methods used in remote environments.
- Since each person may prefer to respond in different ways (e.g., spoken vs. typed responses), multiple methods of data collection were helpful for eliciting pertinent information.
- Two-way audio and video link was perceived as a significant means of promoting a sense of tight coordination between crew and controllers.

- The subsea analogue proved to be an excellent platform for investigations preparing for Space Station.

Other conclusions indicated that overall, the crew experienced little difficulty in health and well-being, team functioning, and task-work during the 30-day mission, and felt that a 60-day mission would be no worse. However, they did feel that significant countermeasures would be necessary for missions longer than about 90 days. The men wanted additional space to store personal effects, and reported that personal space was critical, particularly the ability to shut oneself off from the others from time to time. Finally, they stated that one 30-minute opportunity to communicate with family members during each week would be sufficient; two tended to interfere with focus on mission objectives.

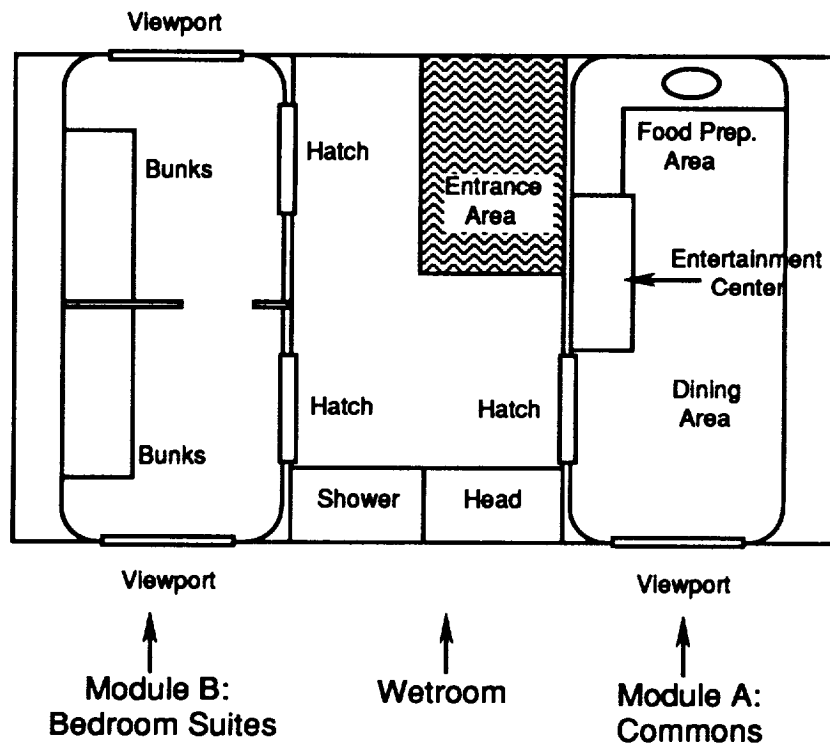

Figure 1. Diagram of Underwater Habitat used in *La Chalupa-30*.

Project ARGO: The Effect of Musculoskeletal Activity on the Formation of a Decompression Gas Phase

TM/PI: Michael R. Powell, Ph.D./SD5
PI: James Wallgora, M.S./SD5
William Norfleet, M.D./SD5
K. Vasantha Kumar, M.D./
KRUG
Reference: LS 14

Astronauts have reported a lower incidence (0% reported) of decompression sickness (DCS) during extravehicular activity (EVA) than would be predicted (23% mild DCS expected) from decompression studies performed in ground-based laboratories. Moreover, in Earth-based decompression studies, the incidence of joint pain sufficient to abort the trial and require immediate recompression was 4.7%. The probability of completing x successful ("bends-free") decompressions in n EVAs with a given failure rate, p , is given by the equation

$$f(x) = {}^n C_x p^x (1-p)^{n-x} \text{ for } x = 1, 2, \dots, n.$$

If the true risk of DCS is 4.7%, including the Soviet cosmonaut experience (no DCS reported in 73 trials at an average tissue ratio of 1.8), the probability of successfully completing the entire series without severe joint-pain DCS by both groups ($N = 110$) is $P_{\text{success}} = 2.2\%$. Statistically speaking, mild DCS must have been encountered on the basis of Earth-based results ($P_{\text{success}} < 10^{-6}$).

We hypothesize that the anomaly in incidence can be traced to a physiologically significant reduction in tissue gas micronuclei formed by stress-assisted nucleation. To examine this question, we studied the degree of whole-body gas phase formation during head-down bed rest by means of Doppler ultrasound bubble detection. In NASA JSC tests, altitude DCS generally presented first in the ankle, knee or hip (83% = 73/88). We found a statistically significant relation between the maximum precordial Doppler Grade and the incidence of DCS in that extremity, although not necessarily a causal relation between circulating

gas bubbles and joint pain. The risk of DCS with maximum Doppler Grade III or IV was considerably higher than Grades 0, I, or II.

During spaceflight, a reduction in the effects of stress-assisted nucleation and/or the number of tissue gas micronuclei is a strong possibility. This would result from the reduction in activity (hypokinesia) of the lower limbs and the lack of weight-bearing loads (adynamia) on the legs in space.

This hypokinesia study consisted of 3 days of reduced activity of the postural muscles followed by a hypobaric decompression on the fourth day. The bed rest group "crossed over" and remained ambulatory for a minimum of 2 weeks. Subjects were selected to match the astronaut population as much as possible in age, sex, height, weight, body surface area, percent body fat, and physical fitness level. The subjects were randomly assigned either to Group A₁ [bed rest] or Group C₂ [ambulatory controls]; half of all test subjects began with bed rest and the remainder as controls. Bed rest subjects remained at the hospital during this portion of the protocol.

Four days later, one bed-rested subject at a time was exposed to a reduced pressure of 6.5 psi or a tissue ratio (TR) of 1.78. (The $TR_{t_{1/2} 360}$ means that the ratio of inert gas, in a compartment with a 360-minute half time, to the ambient pressure was 1.78.) The time at reduced pressure was 3 hours in a hypobaric chamber without an oxygen prebreathe period. All subjects breathed 100% oxygen while performing simulated EVA exercises (upper body) for a period of 3 hours. The test frame holding the exercise equipment was designed so that work could be performed by the bed-rested individuals while they were recumbent.

Tissue gas-phase formation was monitored using the standard precordial Doppler ultrasound techniques employed at NASA JSC in previous hypobaric trials. Data collected from the Doppler ultrasound monitoring were analyzed by integrating Doppler Spencer precordial Grade (intensity or "bubble gas volume" versus time). This is shown in fig. 1 and a pair-wise depiction of the maximum Doppler Grades for each subject in

fig. 2. In this study, the tendency to form a Doppler-detectable decompression gas phase was different in bed rest versus ambulatory individuals. A chi square test, after grouping the Doppler results into Grades 0 - II and III - IV, showed the difference between ambulatory and bed rest to be significant at the $p = 0.02$ level.

One bed rest subject reported very mild joint-pain DCS. Two subjects were found to have an atrial septal defect (ASD) by saline contrast echocardiography. Both of these subjects showed atypical symptoms of DCS. One developed a paresthesia in the left leg during the ambulatory decompression, and the other developed an abdominal rash and orthostatic intolerance during the bed rest decompression.

For purposes of analysis and prediction, Doppler gas volume (GV) can be described as a power function of the type

$$y = A x^B.$$

For ambulatory individuals, the GV as a function of the TR in the 360-minute half-time compartment is given by

$$GV = (9.08 \times 10^{-2}) [TR_{360}]^{4.65}.$$

The GV calculated for the bed rest subjects was 0.303. It can be determined that this GV would be produced in ambulatory individuals by a TR of 1.27 by an equivalent group of active, ambulatory test subjects in one g. To effect this equivalent TR in the 360-minute compartment would have required our bed rest subjects to breathe oxygen for 175 minutes.

One individual in the series was known from previous NASA decompression experience to be a proficient generator of decompression-induced vascular bubbles and thus to yield an anomalously large GV. If this individual is screened from the current analysis, a new line can be constructed with parallel slope to the one-g case. The GV is reduced for this adjusted group, and the expected incidence of mild DCS becomes approximately 1% and severe DCS 0.4% (assuming a continuum model for severe DCS).

The hypothesis upon which the experiment was planned postulates that tissue micronuclei are formed more readily in the lower extremities since gravitational forces are exerted most on these tendons and ligaments as they are stretched and contracted with the full loads of the body on them. They daily carry from 60 to 90 kilograms as individuals walk around. Astronauts in microgravity still perform considerable movement with the lower extremities, but the forces on the lower limbs are greatly reduced since they must counteract inertia only.

We can imagine the continual formation, under one-g conditions, of tissue micronuclei that last 5 to 15 hours. When gravitational forces are removed leaving only inertial forces, the formation rate is reduced, and the density of micronuclei thus is decreased relative to one-g conditions.

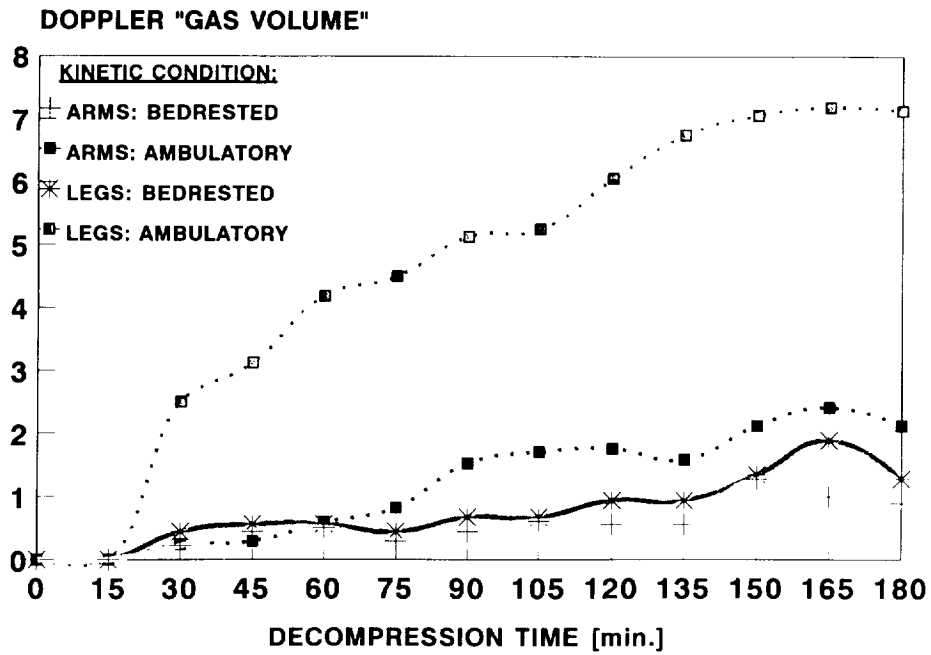
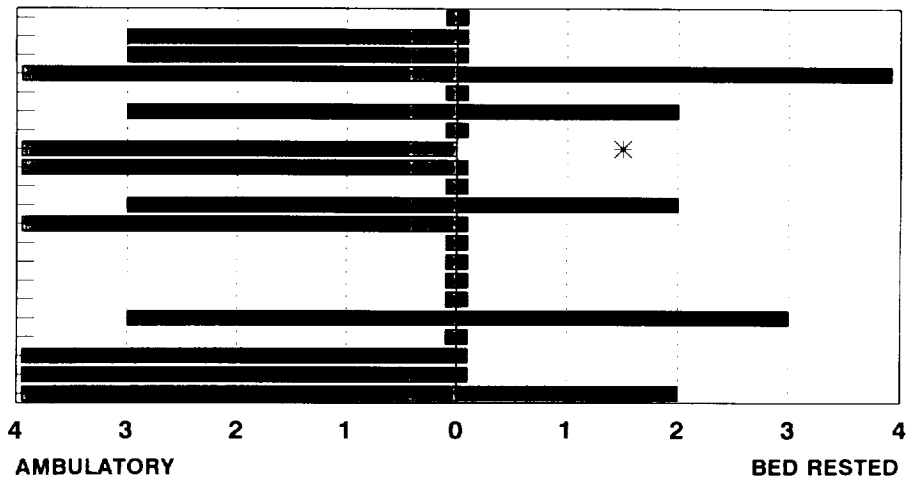

Figure 1. Decompression stress in ambulatory versus hypokinetic individuals.



* = Withdrawn from study

TR₅₀ = 1.78

Figure 2. Spencer Precordial Doppler Grade for ambulatory and bed rest subjects.

Techniques for In-Suit Detection of a Decompression-Induced Gas Phase

TM/PI: Michael R. Powell, Ph.D./SD5
PI: James Wallgora, M.S./SD5
William Hall, B.S./KRUG
Karl Lofstin, Ph.D./KRUG
Reference: LS 15

Decompression sickness (DCS) can pose problems any time an individual is exposed to reduced atmospheric pressure, such as that associated with extravehicular activity (EVA). The risk of DCS in divers, aviators, and astronauts typically is reduced by using a stepwise decompression schedule, but these tend to be time-consuming and somewhat restrictive. We sought to identify a device to detect gas-phase formation in the body during hypobaric decompression that could be modified for use in EVA operations.

Doppler ultrasound flowmeters are among the easiest devices to use for this purpose. For precordial probes, we use an instrument built by the Institute of Applied Physiology and Medicine (Seattle, Washington) that includes three individual transducing crystals arranged in an arc with 6-cm focus and a gate range of 60 to 70 mm. The triple head provides improved blood flow sounds with temporal stability. Although it recognizes small numbers of gas bubbles better than a single transducer, it is less able to discriminate many bubbles. We also improved the signal-to-noise ratio of Doppler precordial signals in many subjects by using a pulsed wave system, which allows myocardial wall motion to be bypassed so that only the blood flow in the pulmonary artery is received. The audio signal quality can be improved further by using a cutoff filter that eliminates signal frequencies of less than about 700 Hz.

We used the device described above to begin to develop a computer-assisted method specifically targeted to detecting bubbles (Spencer Grades I - IV) during EVA. For computer-assisted analysis, it will be necessary to define the signal characteristics in terms of amplitude, frequency,

and duration. Spencer Grades I, II, and III are manifested by brief increases in amplitude and frequency in the Fast Fourier Transform (FFT) sonogram and spectrogram. These increases appear randomly and can be distinguished from valve noise. The presence of Spencer Grade IV is the measure best associated with a high probability of DCS. Grade IV does not develop discrete bubble signals but shows characteristic changes in amplitude, with modest increases in the FFT sonogram and spectral frequency power from 2K to 4K over the entire cardiac cycle. Heart-valve motion also seems to display characteristic signals, namely (1) demodulated Doppler signal amplitude considerably above the Doppler-shifted blood flow signal, even for Grade IV, and (2) demodulated Doppler frequency shifts considerably greater (often by several kHz) than the upper edge of the blood flow envelope.

Other modifications of the blood flow signal could be exploited for analysis of the presence of gas bubbles. These modifications include perturbations in blood flow pattern in accordance with Poiseuille's law; flow changes with a change in Reynold's number; increased pulsatility index or decreased diastolic flow or "runoff"; or changes in flow signal intensity indicative of unresolvable microbubbles. We believe that this knowledge will aid in the construction of a real-time, computer-assisted discriminator to recognize bubble signals within the blood flow while eliminating cardiac motion artifacts, preferably without the need for implanted transducers.

Another system under development to detect and quantify decompression-induced gas bubbles in the blood is based on the fact that gas bubbles modify the blood in which they flow and the tissues in which they are spawned. Candidate systems under consideration include serum lactate dehydrogenase, creatinine phosphokinase, and myoglobin. Changes in these serum factors, which can be detected in finger-stick blood samples, would represent a different kind of integrated signal over the period of decompression.

Requisite Conditions for Neurologic Decompression Sickness During Hypobaric Decompression

TM/PI: Michael R. Powell, Ph.D./SD5
PI: James Wallgora, M.S./SD5
William Norfleet, M.D./SD5
K. Vasantha Kumar, M.D./
KRUG
Reference: LS 16

Decompression sickness (DCS) can manifest itself in many forms, including neurologic DCS (from the formation of gas bubbles in the brain or spinal cord or from gas embolization of the brain or cord) and painful DCS in tendons and ligaments of joints.

The possibility of gas bubbles passing through either a patent foramen ovale (PFO) or through the pulmonary capillary network has been of considerable interest. The transpulmonary route has received significant study, with pulmonary artery hypertension strongly suspected to be the major causative event. Although many microbubbles would be needed to elevate pulmonary pressure, this increase could be expected in hypobaric decompression because of the preponderance of bubbles in the venous return.

Openings in the interatrial septum are present in 25% of the population. Recent evidence from a study of SCUBA divers and professional deep-sea divers, however, does not indicate a strong relationship between the presence of a PFO and an increased incidence of neurologic DCS. Since arterial gas embolization requires both a PFO and bubbles, a good study requires knowledge of decompression-induced gas bubbles. This occurrence is difficult to assess with diving data, since the presence and number of right-atrium bubbles typically can only be inferred from the decompression profile (that is, depth and time at depth). Hypobaric decompression often generates large numbers of circulating microbubbles, the optimal circumstance for arterialization. We have compared our results with those reported in the literature for SCUBA divers.

We evaluated the possibility of arterialization through both the pulmonary and atrial-septum routes in a series of hypobaric chamber decompressions. We found no indication of central nervous system (CNS) DCS or peripheral nerve involvement in the 25% of our test subjects who showed abundant decompression-induced gas microbubbles (e.g., Spencer Grade IV). This was somewhat surprising, since PFOs have been found at autopsy in about 20% to 30% of the population. However, microbubbles of radius less than 50 microns are generated primarily in muscle tissue capillaries during decompression and then are liberated during muscle contraction into the central venous return. Because of their size, they may not be sequestered by the pulmonary vascular filter.

Since CNS DCS in astronauts would occur during extravehicular activity, and thus treatment may not be available within the optimal time frame, deliberate prevention of CNS DCS is the primary option.

To delineate the pathophysiology of neurologic DCS, it is necessary to establish a relative descriptor of the number of gas bubbles present in those who develop DCS during decompression. This descriptor, the precordial Doppler ultrasound bubble "grade," was the focus of our study. In altitude decompressions, the gas loads to the right heart could be considerably greater than in SCUBA diving and thus increase the risk of neurologic DCS.

Determining an atrial septum defect requires using an ultrasound echocardiograph or other device to detect microbubbles in agitated saline following provocation (augmentation) by a Valsalva maneuver. If microbubbles in the left atrium are ascertained without provocation, the opening is referred to as a resting PFO. Gas bubbles in the systemic arterial system also can be detected readily in the middle cerebral artery (MCA), a vessel possessing good signal-to-noise ratio. With proper angulation of a hand-held probe over the temporal region of the skull, over a relatively thin region of osseous tissue, the ultrasound beam can be made to insonate the vessel.

Ultrasound monitoring of vascular gas-phase formation was performed using a commercially

available 2 MHz pulsed Doppler ultrasound device. Standard precordial Doppler ultrasound techniques, similar to those used previously in NASA hypobaric trials, were used. The same instrument was used for the MCA.

Saline contrast echocardiography was performed by drawing fluid rapidly back and forth between two syringes after adding a small volume of air (just enough to fill the syringe hub). This fluid then was injected in a bolus through a catheter placed in the antecubital vein, with the subject lying in the left lateral decubitus position and breathing normally.

Most individuals, even those who had numerous gas bubbles present in the right heart (Spencer Grade IV), had no ultrasonically detectable gas bubbles in the systemic arterial circulation. There was no evidence of arterialization, though the pulmonary capillary barrier was present.

We encountered two individuals with resting PFOs who also exhibited Spencer Grade IV bubbles during decompression. One individual showed arterialization and (peripheral) nerve involvement. The other subject showed no evidence of right-to-

left shunting and arterialization as revealed by insonation of either the left ventricular outflow tract or the MCA. Neither individual gas bubbles nor an increase in Fast Fourier Transform amplitude from temporally nonresolved microbubbles were detected. Saline contrast in this subject showed microbubble echoes in the left atrium. The fact that microbubbles were not arterialized in this subject indicates that the left-to-right (L-R) pressure gradients were not reversed. Saline injection, but not decompression, seems to reverse the gradients more often. Since resting PFOs are relatively common (10% of the population), and Grade II microbubbles are present in approximately 4% of SCUBA divers, and neurologic DCS is found in less than 0.01% of SCUBA divers, the L-R gradient must remain in the vast proportion of cases.

Section II

Human Support Technology

Summary

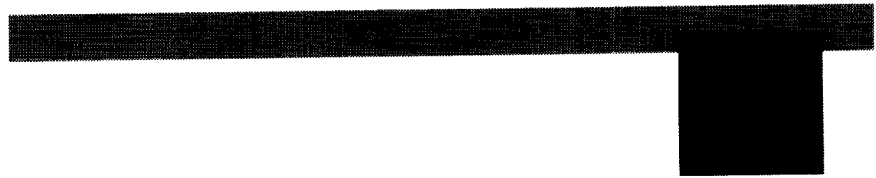

Human Support Technology Summary

The Human Support Technology section includes a variety of disciplines, ranging from biomechanics to artificial intelligence applied to human decision making problems. The common goal of all these disciplines is to make the job of predicting, training, and carrying out spaceflight missions easier.

The human-computer reach model was applied to workstation design for Space Station Freedom. KC-135 flights and computer models were used. Computer models of lighting were also evaluated against real-world tests to determine whether they were accurate enough to predict viewing conditions in space. Similarly, a validation of the shoulder reach envelope led to a new formulation of the problem and a much better fit with empirical data.

In pure biomechanics, a cycle pedal was instrumented to measure the loads exerted on it when a crewmember exercises, and hand performance in three gloves was measured.

The research on human factors in Spacelab led to three papers. One deals with STS-50, USML-01, and several factors therein. Another focuses on translation through the tunnel in STS-47. The final paper of this group is on workload analysis.

The Human-Computer Interaction Laboratory (HCIL) has been very active, with four papers representing its work. One paper is on a joint project with HCIL and the Space Shuttle Earth Observation Project to use a geographical

information system in which the advantages for training, in-flight use, and postflight indexing are explained. The second and third paper cover continuing research on human-computer interfaces to electronic procedures and to medical decision support systems, respectively. Finally, both the HCIL and the Intelligent Systems Branch researched human interfaces to intelligent systems.

JSC has been studying improving real-time Shuttle control and analysis with five papers. One is about a scheduling system in a spreadsheet format that allows for constraints. Another deals with the problem of coordination between multiple expert systems, a growing problem in the Mission Control Center. Software Vehicle Health Management describes developing yet more expert systems for Mission Control. The problems of people who are not programmers yet need to interface with a computer are dealt with in "Advanced Software Development Workstation," which describes a way of chaining previously written software. Finally, "Adaptive Fuzzy Logic Control" describes the application of fuzzy logic to a tethered satellite's dynamics for retrieval.

The sum of these papers is that Human Support Technology is a wide field with growing emphasis on computer technology as it can aid the designers and users of spacecraft.

Section II

Human Support Technology

Significant Tasks



PRECEDING PAGE BLANK NOT FILMED

II-4

Integrating Microgravity Test Data with Human Computer Reach Model

TM: Dean Jensen, Ph.D./SP34
James Maida/SP34
PI: Mihriban Whitmore Ph.D./
LESC
Randy Morris/LESC
Ann Aldridge, Ph.D./LESC
Abhilash Pandya/LESC
Reference: HST 1

Crew workstations on board space vehicles such as the Space Station Freedom will be equipped with computers. A keyboard and a cursor control device will be the primary interfaces for directly manipulating text and on-screen objects at these computer-based workstations. At some workstations, hand controllers will be used to control remote manipulators. All these tasks will be monitored through the displays. The human factors challenge is to provide an optimal human-systems interface which will accommodate a wide range of users and tasks in a microgravity environment. In order to facilitate this objective, a series of experiments has been conducted at the Flight Crew Support Division, Johnson Space Center. The primary goal of these experiments was to resolve the anthropometric issues concerning the workstation design, such as human capabilities and limitations. The maximum reach envelope mapped on the workstation was critical since the workstation display panel would have various controls and switches to be manipulated by the crewmembers. Two approaches, "Performance-based" and "Model-based" analyses, were integrated to investigate the human reach mapped on the workstation display panels.

Ground and microgravity evaluations were conducted at an aluminum rack representing the workstation design. Five subjects participated in the study. The subjects ranged in stature from a 5th percentile Japanese female to a 95th percentile American male. They performed the maximum reach sweeps on a cardboard grid located on the display panels. They extended their right arm as far as they could and drew the reach sweeps

starting from the far-left point. The ground, one-gravity (g) evaluations provided familiarization with the hardware and the methodology. Each subject performed three sets of five complete reach sweeps with shoulder movement and three sets of five with no shoulder movement. While performing the sweeps, they kept their eyes closed to be consistent with the zero-g data. Microgravity evaluations were conducted on board NASA's KC-135 Reduced Gravity Aircraft which simulates a shirt sleeve "weightless" environment similar to the spaceflight environment. A parabolic arc is flown to produce microgravity which lasts an average of 23 seconds and is surrounded by a 2-g pull-up and pull-out. While performing the reach sweeps in the microgravity environment, the subjects used the foot restraints to stabilize themselves in front of the workstation. Two to three sweeps were completed per parabola and each subject spent two parabolas for maximum reach sweeps. Their eyes were closed so that they could achieve their zero-g neutral body posture within a couple of seconds. The experiments were video-taped to be used for graphical analysis.

A 3-dimensional interactive graphics package, PLAID, was used to generate anthropometrically correct computer-human models. These models were created for the subjects who participated in the experiment based on their anthropometric measurements. All of the subjects' actual reach sweeps were then compared to their computer generated reach sweeps. The goal was to investigate the variability of the reach sweeps for the subjects, both individually and collectively, to establish the reach areas on the workstation display panels. In addition, the anthropometrically correct computer-human models were generated to represent a 5th percentile Japanese female and a 95th percentile American male and their maximum reach sweeps were created to establish the maximum limits of the feasible reach area at the display panels. The viewing distances and the viewing cones were also implemented in these models to incorporate the limitations and capabilities regarding the viewability while performing the reach sweeps.

Initial findings demonstrated that the one-g data was significantly close to the computer-generated

data. On the other hand, the microgravity data varied from the model-generated data. Some of the variability was attributed to the built-in assumptions of the graphical model. For example, the zero-g neutral body posture built in the model is considered to be the same for all the individuals. However, it was observed during the flights that all of the subjects' zero-g neutral body posture differed. Another reason for the variance in the data was attributed to the subjects' movements in sagittal plane due to the plane turbulence. This created difficulty in smooth drawings of the reach sweeps. It should be noted that this study was a first attempt to use the performance-based and model-based approaches simultaneously. The sample size was limited to five subjects. Therefore, no statistical analyses were performed. Instead, the visual observations are presented.

Integrating the two approaches was a very efficient method to determine the maximum reach sweeps (fig. 1). The real-time evaluations provided human-in-the-loop experimentation. The variation in the individual anthropometric dimensions and the differences in the zero-g neutral body posture were captured through the in-flight videotapes. On

the other hand, only a limited number of subjects could be tested since they needed to be KC-135 flight certified. The setup time in between the sessions needed to be short to avoid wasting data collection opportunities. This required flexibility in the test plan to compensate for the unexpected problems. Overall, evaluations in a microgravity environment have proven to be constructive since the effects of microgravity were not the same for the different subjects. The microgravity flights have given a hands-on opportunity to determine the maximum reach for different individuals. Using the model-based approach, the data was smoothed to establish a feasible maximum reach region. The parameters, such as the viewing cones and distances which were not feasible to quantify during the flights, were included in the system. This allowed the investigators to observe all the parameters simultaneously, while establishing the human reach characteristics in a microgravity environment. This approach also provided an understanding of the advantages and limitations of both approaches when used individually.

ORIGINAL PAGE
BLACK AND WHITE PHOTOGRAPH



Figure 1. Subject performing reach sweep on board KC-135.

A Comparison and Validation of Computer Lighting Simulation Models for Space Applications Using Empirically Collected Data

PI: James C. Malda/SP34
Abhllash K. Pandya/LESC
Ann M. Aldridge, Ph.D./LESC

Reference: HST 2

Extravehicular activities performed in space require proper lighting conditions. The placement and properties of lights and materials used is highly constrained by power consumption limits, heat dissipation issues, and available space. An accurate lighting model capable of simulating complex 3-dimensional environments would be a valuable tool for space applications. This model could be used to deal with complex visibility issues and aid in the optimum selection of lights, materials, and views for space operations. This concern has provided the thrust to research and validate computer models used for these lighting applications.

Three classes of models were chosen for this validation: "standard" ray tracing, radiance, and radiocity. The "standard" ray tracing (Rshade) program, by Craig E. Kolb (Princeton, New Jersey), traces light from the eye point to the light sources in the environment while reflecting the rays in accordance with surface properties. The radiance program, by Greg J. Ward (Lawrence Berkeley Laboratory, California), extends the ray tracing method by using a Monte Carlo technique to compute interreflections between surfaces. The radiocity program, by Min-Zhi (University of Pennsylvania, Pennsylvania), computes a view-independent lighting solution which balances the energy flux of each surface with respect to every other surface in the environment. Of the three modeling packages, radiocity is least suited for space applications. Radiocity requires that the lighting simulation being done be contained within a closed environment due to the methodology of the energy flux equilibrium computation. In addition, this computation is highly memory intensive and specular reflections are not modeled.

A simple geometry, consisting of a room with two cubes and a light source, was created and used as input to the various model formats. Figure 1 illustrates the arrangement of the cubes, the light source, and the viewing vector. The view was adjusted such that both the directly and indirectly illuminated surfaces of the cubes were visible. Figure 2 shows the output of the ray trace and radiance computations. In theory, light rays emanating from the source should strike cube 1 and, depending on the reflectance properties of cube 1, illuminate the surface of cube 2. In the ray trace image it is clear that the interreflections are not present. On the other hand, radiance output shows the expected result without any arbitrary ambient terms. In the radiance view, cube 2 does in fact show the reflected light from cube 1.

An experimental setup similar to the one run in the lighting model comparison was set up in NASA's Lighting Environment Test Facility. A photometer was used to measure the reflectance properties (luminance/illuminance) of the boxes, the floor, the wall, and the luminance of the light source. In addition, photometric measures were taken at both the directly and indirectly lit surfaces of the boxes. The same scene was created in the graphics environment and was converted to the radiance format. The two measures of luminance, one on box 1 (direct light) and one on box 2 (interreflected light), agreed within experimental error with the calculated luminances on these surfaces (table 1). Figure 3 is a comparison of the output of the radiance model with the video camera view of the experiment.

An experiment to extend this work to space applications was set up at the Systems Integration Facility's Shuttle mock-up where all lights in the facility were shut off except for the Shuttle's mid- and forward-payload-bay lights. Camera views of the payload were recorded on a Panasonic video recorder. The Shuttle, with the various structures present during the mock-up session, was created in the graphics environment and output to the radiance format. Payload bay light and material parameters for the computer model were estimated based on published results. Figure 4 shows model versus actual Space Shuttle view of a low lighting

situation. Considering all the assumptions, the view generated from the model is very reasonable. Future work needs to focus on validation of even more complex lighting situations. In addition, it is

imperative that a more rigorous data collection effort to extend the data base of light and material properties for Space Station Freedom be initiated.

Table 1. Validation Results

	Box 1 (direct light)	Box 2 (indirect light)
	(ft-lamberts)	(ft-lamberts)
Measured range	6.5-7.9	0.10-0.12
Computed range	3.0- 7.0	0.05-0.30

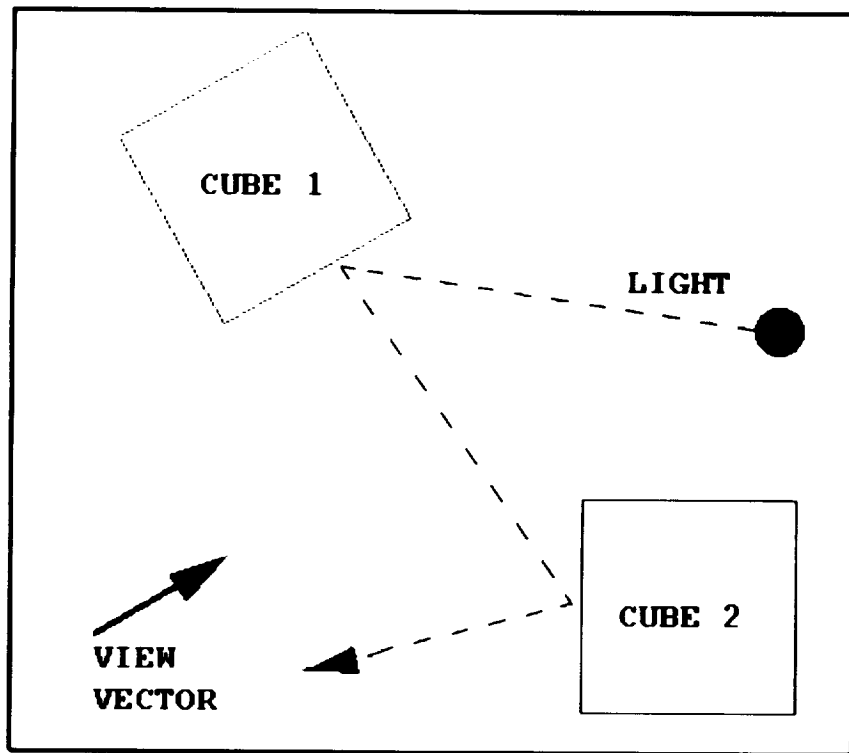

Figure 1. Top view of experimental scene geometry.

ORIGINAL PAGE
BLACK AND WHITE PHOTOGRAPH

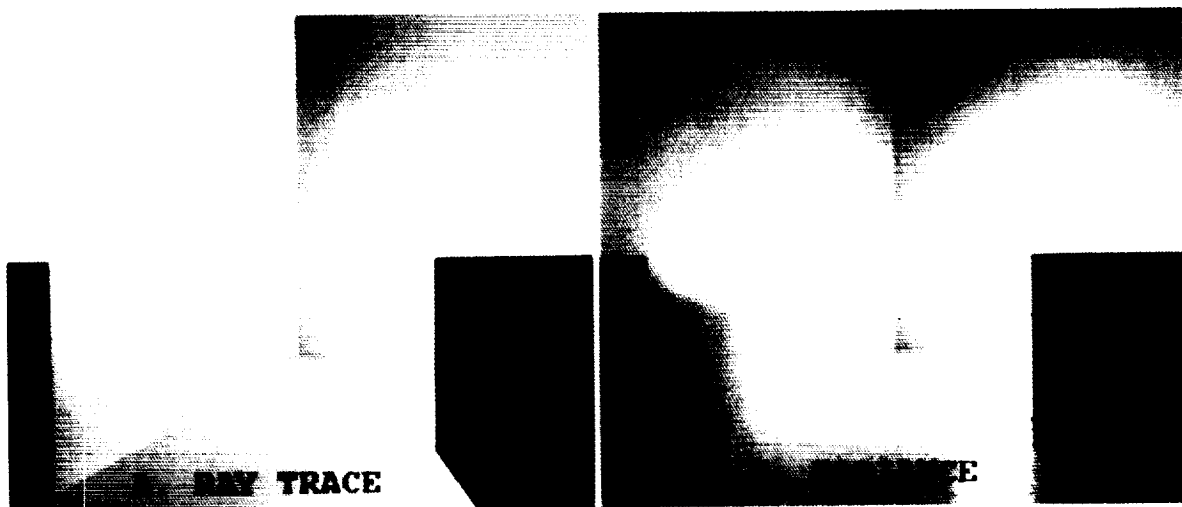

Figure 2. Comparison of ray trace and radiance.

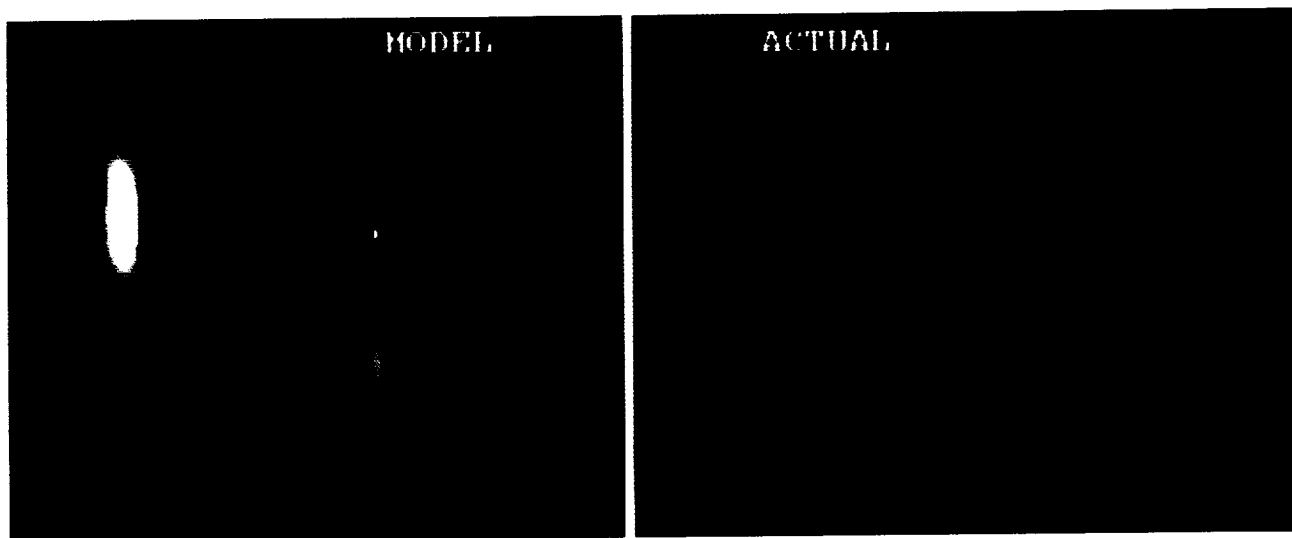

Figure 3. Model versus actual view of lighting experiment.

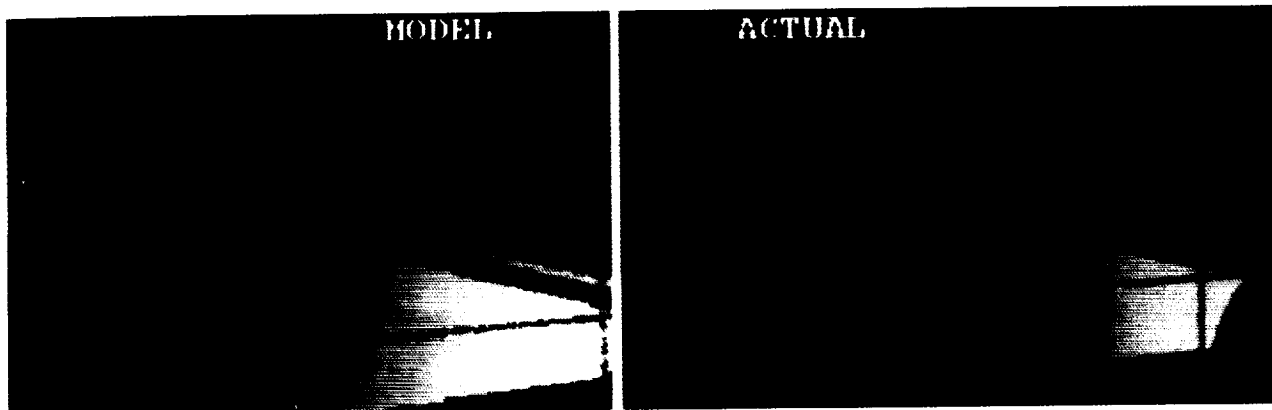

Figure 4. Model versus actual view of Space Shuttle.

Validation of the Clavicle/ Shoulder Kinematics of a Human Computer Reach Model

PI: James C. Maida/SP34
Ann M. Aldridge, Ph.D./LESC
Abhllash K. Pandya/LESC
Reference: HST 3

An accurate human-computer reach model capable of simulating complex 3-dimensional tasks would be a valuable tool in the evaluation of work space volumes. This model could be used to design workstations, configure hand holds/foot restraints, and simulate realistic motions on Earth and in microgravity environments. Essential to accurate reaching with the arm is a comprehensive model of the shoulder girdle. The complexity of the shoulder motion and the interdependence of the joints affecting the shoulder complex have been studied for years. The model we use simplifies the shoulder motion into two joints, a *clavicle joint* and a *humerus joint*. This simplification still allows the prediction of accurate motions.

Early computer models have had a clavicle joint with two degrees of freedom and a humerus joint with three degrees of freedom. These models did not have an automatic clavicle/humerus interaction. Often the clavicle joint motion was ignored because of the difficulty in moving both the upper arm and the clavicle independently. This has led to unrealistic reach volumes and motions. In 1989 E. M. Otani at the University of Pennsylvania developed equations relating the clavicle motion and humerus motion to the elevation and abduction of the shoulder complex. Large discrepancies (10-15 cm) exist between the Otani model and measured data. Extensions proposed in this work have reduced reach errors to subcentimeter accuracy in all axes and in all planes of rotation.

Measurements of reach sweeps were obtained using a low-frequency magnetic tracking device (Polhemus Navigation Sciences, McDonnell Douglas Electronics Company). A magnetic sensor was secured to the upper arm near the elbow joint and provided positional information relative to a fixed coordinate system. A wooden frame was

built to hold the magnetic source in order to reduce distortions in the magnetic field caused by metal in the environment. This frame was elevated to shoulder height in order to have maximum sensitivity over the range of the arm sweeps. Attached to the wooden frame was a wooden rod used to stabilize the subjects. Each subject was positioned with this rod centered in his back and was directed to keep his back secured against this rod at all times during the sweep. This minimized the upper body motion during the sweeps and still allowed natural (unconstrained) motion. Repeated sweeps over the range of motion of the subject in three orthogonal planes were recorded: a forward sweep, a side sweep, and a horizontal sweep. In addition, horizontal and random stretched (extreme) sweeps were also collected.

The motion of the shoulder complex can be described in spherical coordinates by determining the elevation angle and the abduction angle of the end effector (elbow or fingertip) (fig. 1). The model computes the clavicle angles of elevation and abduction given the shoulder angles. The humerus angles of elevation and abduction are calculated from the geometry to position the arm at the determined shoulder complex elevation and abduction. A major concern in the accurate characterization of the shoulder complex was the location of the joint centers of rotation of the clavicle and the humerus joints. The previous computer model placed the rotation points of the clavicle joint and humerus joint at the physical locations of both ends of the clavicle bone in the human figure. However, allowing the shoulder clavicle complex to rotate at these points generated reach envelopes which were much larger than measured. Figure 2 shows side sweeps generated with and without joint center lowering. The lower portions of the computed sweeps fit the measured data. However, the horizontal and the vertical regions have unacceptably large errors. To resolve this discrepancy, the joint centers needed to be adjusted. In order to determine the optimal joint center location for each individual, we used an iterative process. Figure 3 shows the maximum and average errors resulting from lowering the clavicle and humerus joint centers for a particular individual. Optimal values were selected for each

individual based on these plots. The lowering of both the clavicle and humerus joint centers by the appropriate amount allowed for the entire side sweep to coincide with the measured data. This represents a significant improvement over the previous reach model.

Preliminary analysis indicate that it may be possible to relate the amount of joint center lowering to a standard anthropometric measure.

The amount of joint center lowering for each individual was plotted versus the height of the subject. A linear fit to this data provides a method for approximating the adjustment of the shoulder joint centers. More data needs to be collected and other anthropometric measures need to be correlated to solidify this result.

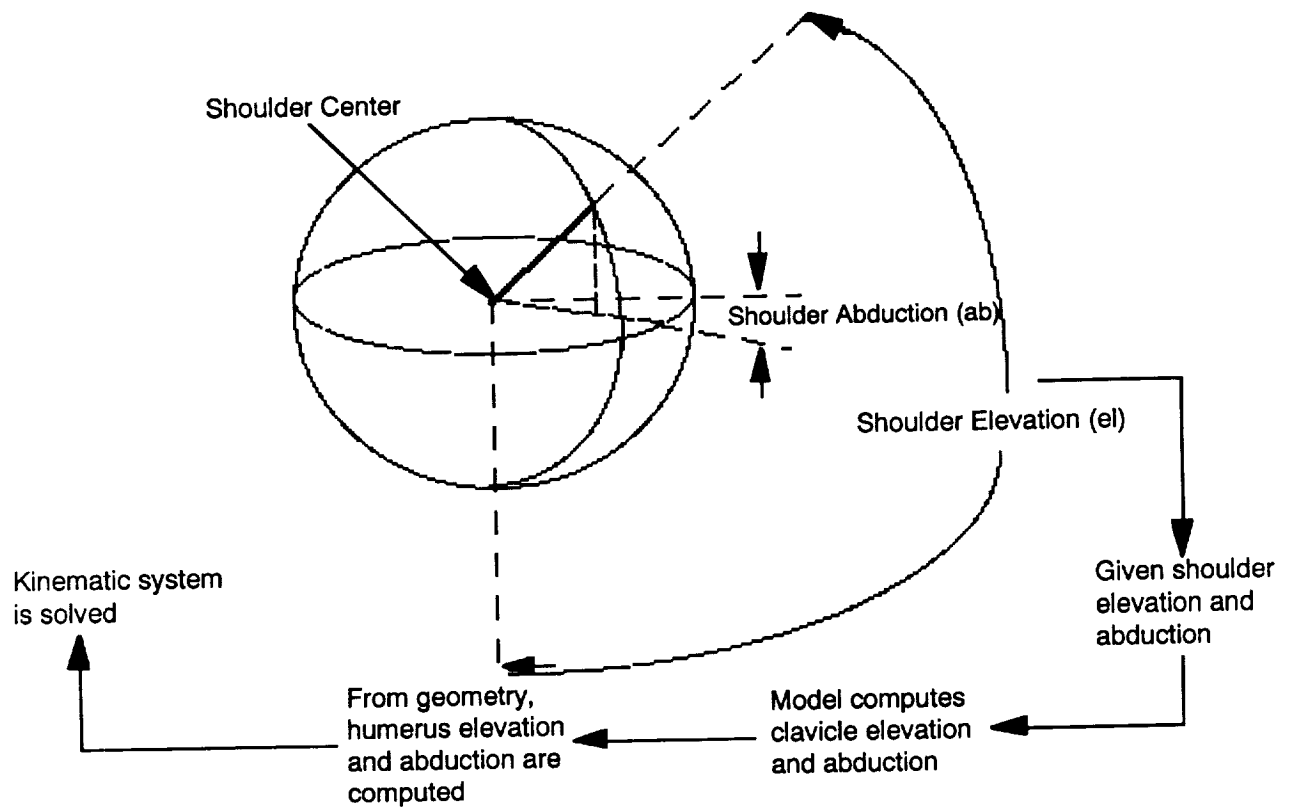

Figure 1. Shoulder kinematic model overview.

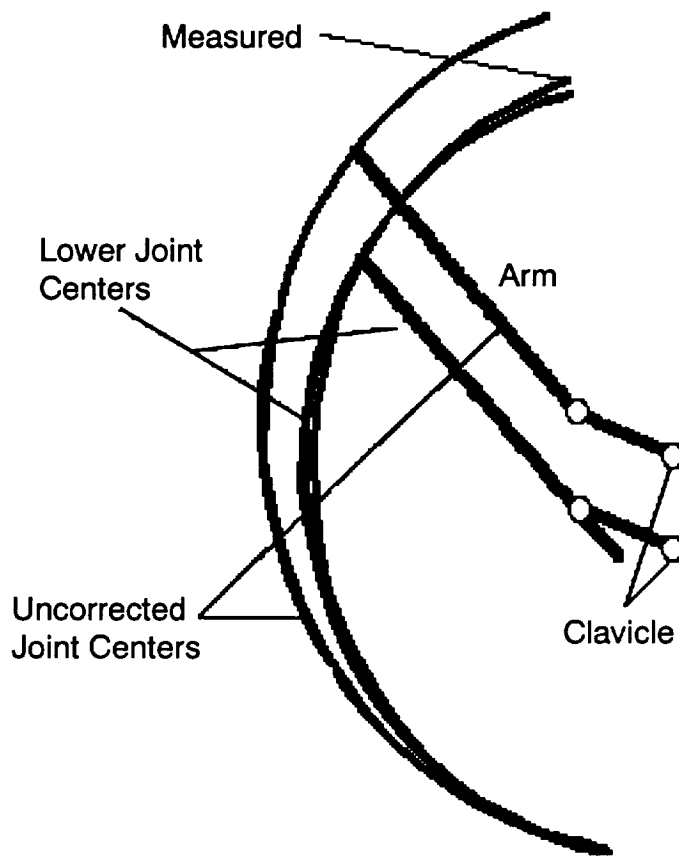

Figure 2. Measured versus computed reach sweeps (with and without joint axis correction).

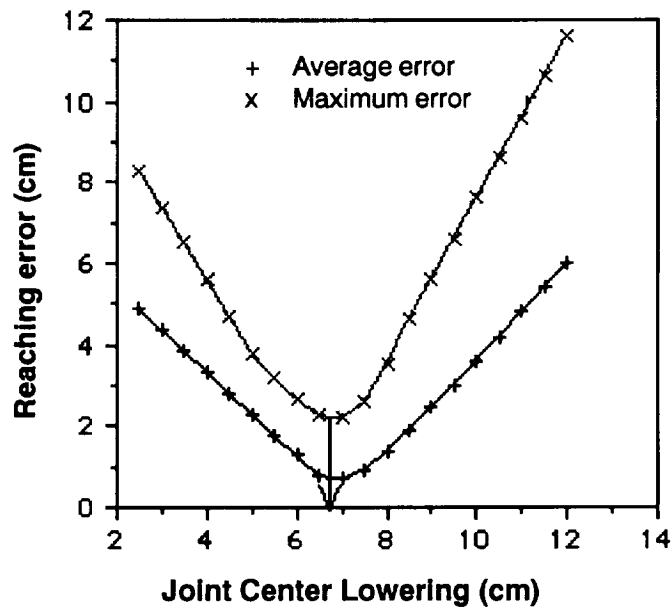

Figure 3. Location of optimal joint center.

Cycle Ergometer Biomechanical Evaluations

**PI: Glenn K. Klute/SP34
Jeff Pollner/LESC**

Reference: HST 4

Extended periods of weightlessness are known to cause deleterious consequences to many of the systems of the human body. One area of concern is the weakening of the musculo-skeletal system which occurs when the stimulus of gravity is removed.

On Earth, the muscles and bones of the lower body are constantly subjected to stresses from the force of gravity. In response, they maintain their strength and integrity. However, when the stress is removed as it is in weightlessness, the stimulus for upkeep no longer exists. Lack of use leads to decrease in strength and even atrophy.

For astronauts, the consequences of this weakening are serious. Even with less than two weeks in weightlessness, some individuals may not have the strength to function properly upon return to Earth gravity. For longer durations in weightlessness, as there would be for the Space Station or a mission to Mars, the problems are more serious. The legs, having not been utilized for such a period may not even have the strength to support the weight of the individual upon arrival at Mars or upon return to Earth.

One of the primary avenues being investigated for countering this weakening due to weightlessness is exercise. High intensity activities performed for a sufficiently long period of time supply the loads to the muscles and bones needed to maintain their strength and integrity.

There are several modes of exercise which are currently either in use or under consideration as possible countermeasures. One such form of exercise frequently used on the Shuttle is ergometer cycling. Part of the evaluation of the effectiveness of an exercise activity as a countermeasure is to determine the loads that are put on the legs of the astronaut while performing it.

The Anthropometry and Biomechanics Laboratory (ABL) is developing and building an instrumented ergometer pedal system to measure the forces applied to the legs while riding the cycle ergometer (fig. 1).

The pedal is designed and instrumented to measure two components of the applied force (normal and tangential) as well as the crank and pedal angles. This information can be used to determine how much force is applied to the rider's legs throughout the pedalling cycle. It also provides information as to the rider's cycling technique.

This pedal will be used with the prototype cycle ergometer during parabolic flight on NASA's KC-135 aircraft. An initial investigation will aim at providing a biomechanical description of cycling in weightlessness. This will include determining the magnitude of the pedal forces and how these forces vary over the pedalling cycle. These data can be compared to forces on the legs during other modes of exercise. It is anticipated that the loads from cycling will be much less than when running on a tethered treadmill.

Examining the rider's motions will allow potentially injurious movements to be identified. In addition, knowledge of the cycling technique will aid in prescribing preflight training.

Further studies will be conducted to evaluate different ergometer protocols. For example, we will determine how the biomechanics vary with speed of cycling and with the resistance the ergometer provides.

In summary, these evaluations will quantify loads being applied to the riders' legs, help in the evaluation of the cycle ergometer as a countermeasure, supply design requirement information and aid in the development of ergometer protocols. These studies are being conducted in an effort to aid astronauts in safely completing long-duration missions in weightlessness.

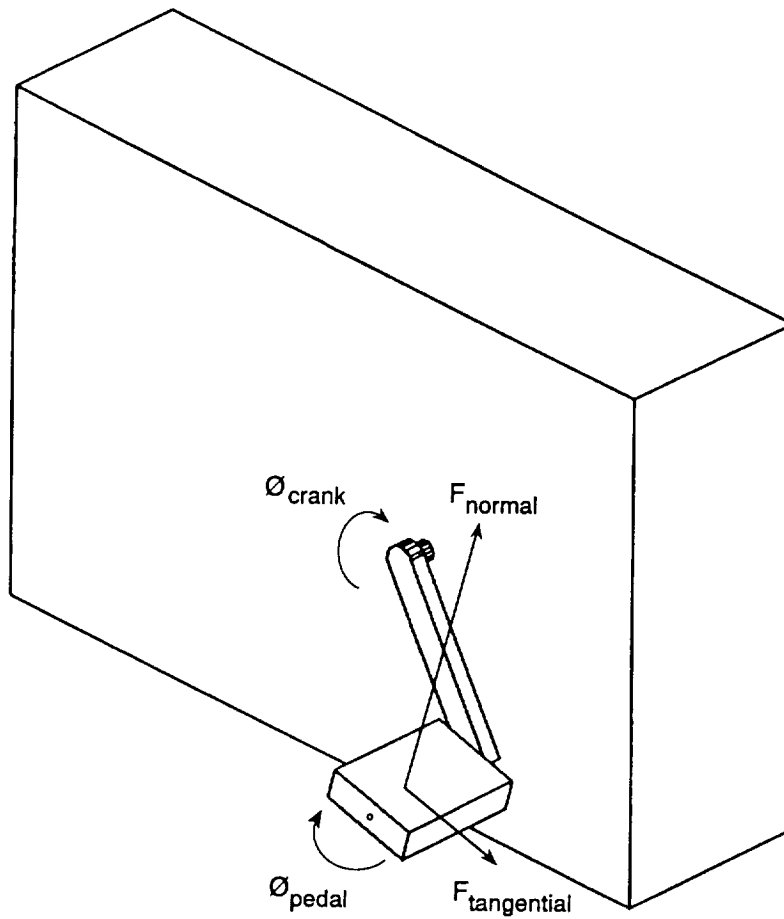

Figure 1. Sketch of instrumented ergometer pedal system.

Gloved Hand Performance Evaluations

PI: Glenn K. Klute/SP34
Ram Bishu, Ph.D./University
of Nebraska

Reference: HST 5

The capabilities of the human hand such as dexterity, manipulability, and tactile perception are unique and render the hand a very versatile and effective multipurpose tool. Indeed, because the hand is such an effective tool, its performance is one of the most critical components for EVA success. However, the protection requirements caused by the EVA environment are often at odds with human performance requirements. Tests which identify effective glove technologies are a topic of research at the Anthropometry and Biomechanics Laboratory at JSC.

To protect the astronaut from the EVA environment, EVA gloves must provide protection against various hazards. Since the EVA environment includes the extremes of both hot and cold, the hand must be protected from both conductive and radiative heat transfer.

Additionally, a high cycle life of the gloves is also required due to the numerous operations performed with the gloved hand during an EVA. Wear and tear, or abrasion resistance, is also an important aspect. Puncture protection, also critical, is required because the EVA glove is pressurized during use.

Balancing against the protective requirements of EVA gloves is the need for effective work performance. The EVA glove must provide an adequate range of motion to allow the astronaut to grasp a tool or handrail. The capability to sense an object or structure, or the preservation of tactile capability, is also important. Muscle performance, such as grip, pulp, and pinch strength are often critical functions of EVA tasks. In addition to strength measures, the ability to perform repetitive tasks without undue fatigue is also important because EVAs are typically scheduled for seven

hours in length. Another performance requirement is dexterity, which is commonly defined as the skill and ease in using the hands. Typical EVA tasks such as translation, manual material handling, connecting interfaces, system activation, and mechanical interface engagement all require a high level of dexterity.

To assess the effects of glove design and technology on performance, three different EVA gloves, shown in fig. 1, were recently tested to measure performance characteristics. The parameters measured included two strength measures (grip strength test and pinch strength test), two dexterity measures (nut and bolt assembly test and a rope knot tying test), and a tactility measure (two point discrimination test). The independent variables included gender, glove type (with or without the thermal micrometeoroid garment), inflation pressure, and glove make. Figure 2 shows the results of the male test subjects who performed a grip strength test bare-handed, and with developmental gloves A, B, and C. As expected, the bare-handed test condition yielded the highest grip strength. Glove B, which had a different metacarpal joint than gloves A or C, yielded the highest gloved hand grip strength.

The use of standardized tests to evaluate gloved hand performance via precise measurements will decrease subjective judgments and aid in glove technology selection. Results of these tests will lead to the development of new gloves for both NASA and industry that will improve human work performance and productivity in challenging environments.



Figure 1. Performance tests were recently conducted on the three different EVA gloves shown in the photograph above.

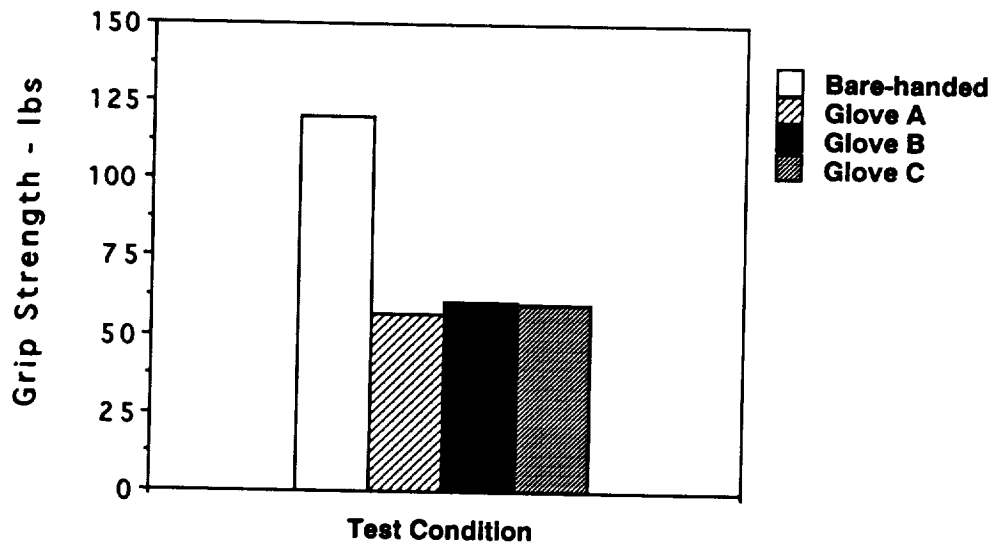

Figure 2. Male grip strength results for gloves A, B, C and bare-handed.

Human Factors Analyses of STS-50/USML-01

TM: Susan Adam/SP34
PI: Anton Koros/LESC
Manny Diaz/LESC
Mihriban Whitmore, Ph.D./LESC
Randy Morris/LESC
Reference: HST 6

The 13-day United States Microgravity Laboratory-01 (USML-01) mission, the longest to date for the Space Shuttle, offered the Crew Interface Analysis Section team ample opportunity to investigate various interfaces between the crew and their spacecraft. Detailed Supplementary Objective (DSO) 904 served as a cursory field study of several mission critical issues during STS-40. On STS-50, the DSO was directed to the assessment of three issues to allow a more comprehensive analysis. The areas studied were the glovebox, the lower body negative pressure (LBNP) experiment hardware, and the acoustic environment. Besides developing specific recommendations for each of these interfaces, human factors engineers are continuing to apply and refine methodologies for the microgravity environment. The ongoing DSO remains dedicated to the evaluation of the three categories of human factors interfaces:

- **Human-machine.** This includes all hardware and software with which the crew must interact—from the use of the most simple system, such as a pen or handhold; to the most complex, such as the on-board computer to monitor and control the Shuttle during landing.
- **Human-environment.** Examples of interfaces falling in this category are lighting, noise, vibration, acceleration, and air quality.
- **Human-human.** This category includes crew-to-crew communications as well as crew-to-ground communications.

Three data collection methodologies were common to each of the evaluations: completion of in-flight/postflight questionnaires, participation in structured debriefs with the crew, and application of human

factors design principles. The glovebox and LBNP evaluations also included examination of still photographs and analysis of mission video. Dedicated sound level measurements were collected for the noise evaluation.

The major objectives of the glovebox assessment were to evaluate the glovebox, user restraint system, and mobility aids for usability, adjustability, accessibility, and fit for the crew. Figure 1 depicts a crewmember working at the glovebox. Computer models of crewmembers interfacing with the glovebox and its associated equipment and restraints were generated by the Graphics Analysis Facility (GRAF). Crewmembers' body positioning during various tasks, as well as arm reach envelopes, were simulated. Lessons learned from this study will lead to design recommendations for future microgravity workstations and restraint and mobility aids.

The objective of the LBNP project is to reverse spaceflight-induced cardiovascular changes through reduced pressure on the crewmember's lower body. On STS-50, the LBNP human factors study sought to characterize performance effects due to microgravity and to formulate more predictive microgravity factors to aid in the timing of future missions. Figure 2 shows a subject during the LBNP ramp protocol. Specific recommendations to optimize display locations, push-button and rotary switch operation, labeling, and cable routing were forwarded. This study will lead to the derivation of adaptive strategies and human factors guidelines for optimizing the LBNP system as it matures and becomes an integral part of Space Station Freedom.

In the final evaluation, sound level measurements and astronauts' comments were correlated to assess the acceptability of the acoustic environment to the crew. Based on the STS-50 noise measurements gathered, GRAF personnel generated figures depicting acceptable verbal communication distances for reliable communication during various noise conditions. Figure 3 depicts the maximum distance a crewmember would be able to communicate effectively (i.e., at about 90% intelligibility for sentences) on the middeck with the vacuum cleaner operating. The light section of

the cone represents the distance two crewmembers would prefer to assume to communicate during operation of the vacuum cleaner. Application of this methodology before a mission will help to

identify situations in which communication (without headsets) would be impaired so that operational impacts can be avoided.

ORIGINAL PAGE
BLACK AND WHITE PHOTOGRAPH

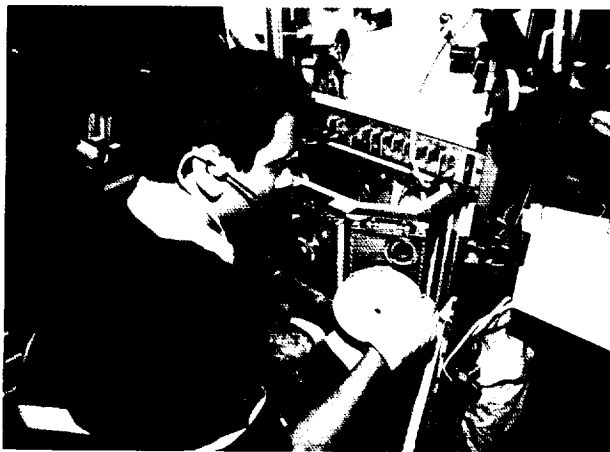

Figure 1. An STS-50 crewmember using the glovebox.

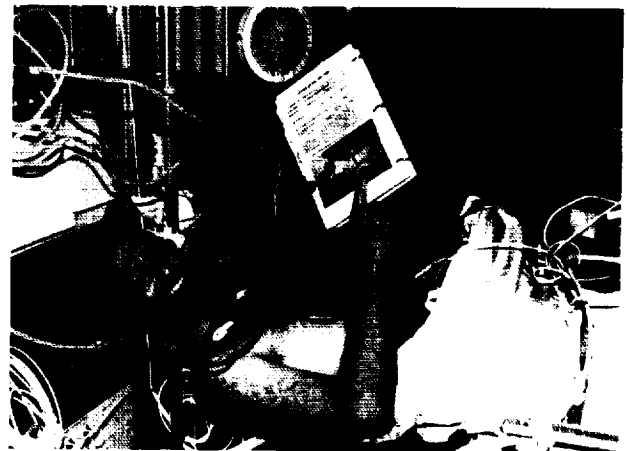

Figure 2. A subject undergoing LBNP ramp protocol.

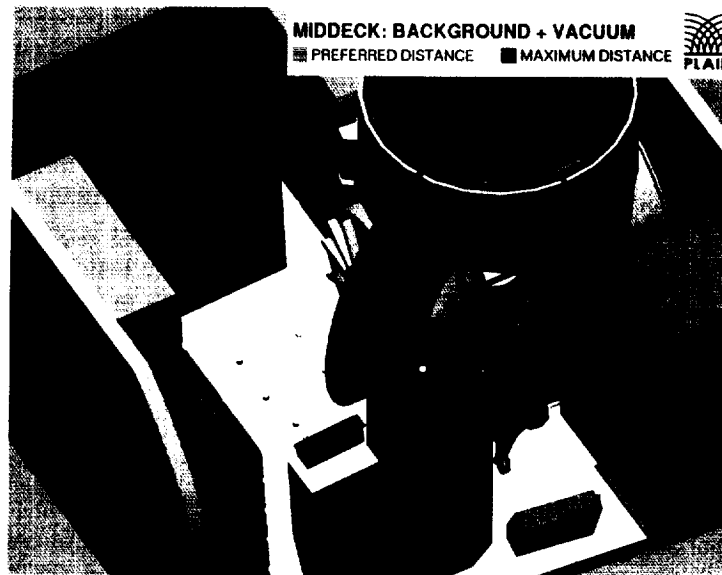

Figure 3. Maximum verbal communication distance during vacuum cleaner operation.

Human Factors Investigation of Translation Through the STS-47/ Spacelab Japan Transfer Tunnel

TM: Susan Adam/SP34
PI: Tomas F. Callaghan/LESC
Reference: HST 7

STS-47 was launched aboard the Orbiter Endeavour from Kennedy Space Center on September 11, 1992. The Primary objective of this flight was to successfully perform the planned operations of the Spacelab-Japan (SL-J) payload. The Spacelab Module was flown on STS-47 to provide a shirt-sleeve working environment for the mission crew. The module is a cylindrical room five meters in diameter and seven meters long, and is contained within the Shuttle payload bay (fig. 1).

The Spacelab transfer tunnel connects the Orbiter middeck with the Spacelab module, and is the only way for the crew to travel between these two nodes of operation. Figure 2 shows the inside of the tunnel, which is a cylindrical structure with an internal unobstructed diameter of 1.00 meters (40 inches). The total diameter is actually 1.19 meters (47 inches) but is limited by handrails and a duct which runs along its bottom. It is 5.75 meters (18.88 feet) long. The airlock (tunnel adapter) is 2.31 meters (7.58 feet) long, producing a total travel distance of 8.25 meters (26.5 feet) from middeck to Spacelab.

While in the tunnel, crewmembers' main purpose was to move from one place to another. This offered an excellent opportunity to investigate translation times and techniques, and to evaluate tunnel design.

The main tool used in this study was a questionnaire, which was administered pre-, in-, and postflight. Video of translations through the tunnel was also collected, but was too limited to facilitate formal analysis.

The following summarizes the crewmembers' responses to the questionnaire on translation and Spacelab transfer tunnel design:

- Transfer tunnel design is satisfactory, although the sides of any microgravity transfer tunnel should be as smooth as

possible. (This may require redesign of hatches and handrails.)

- There is little agreement as to whether the time to go through the tunnel was different for the two directions (toward middeck or Spacelab). However, a large volume of stowed items in the airlock and the 90 degree tunnel jog were noted as things that could cause differences.
- Most crewmembers agreed that there was little difference in the techniques used to go in the two directions, although, again, a large volume of stowed items in the airlock and the tunnel jog were noted as things that could cause technique differences.
- Most crewmembers agreed it took different amounts of time to travel with and without equipment. The reasons for the time difference involved one hand being encumbered, and equipment size and fragility.
- Techniques also seemed to change between travel with and without equipment. Differences noted were a different center of gravity, the need to compensate for torque forces when carrying equipment, and the fact you did not have to always carry equipment—you could give it a push down the tunnel, then catch up to it and grab it at the other end.
- Size of equipment did not seem to change translation time, although the tight squeeze through the stowage in the airlock and a particularly fragile piece of equipment could cause slower movement.
- Equipment size makes some difference in translation techniques, but only when it is exceptionally large or fragile. Also, equipment that allows you to hold it close to your body makes for easier translation.
- Practice affects translation time, but only during the initial days of the mission. Adaptation takes place quite quickly.
- Translation techniques are affected in a similar way to times. Again, learning is rapid.
- The obvious differences in tunnel sections, like the packed airlock and the 90 degree jog, affect translation ease and techniques. It was noted that the smoother parts of the tunnel are

easier to navigate. Also, the jog was seen as beneficial by some, because it prevented entering the Spacelab too fast.

- In general, crewmembers noted that a handrail-less and duct-free tunnel would be better. They said these are obstacles which had to be avoided, and that even if you were motionless in the middle of the tunnel, you could get yourself going without translation aids.

It should be noted that the in-flight administration of the questionnaire provided a larger number of additional comments and much more detail than the other administrations. This enabled greater insight into the space environment and translation.

Based on the results of this study, the following recommendations are made:

- Make the sides of any microgravity transfer tunnel as smooth as possible.
- Design tunnels to provide a "straight shot," without jogs or excessive stowage.
- Instruct astronauts during the training phase of a mission of the differences in translating with and without equipment, and translating with equipment of different sizes and fragility. (Perhaps experienced astronauts should provide short, formal instruction for first-time fliers.)
- Adjust the timeline (if time is critical) for the first days of a mission to account for the short learning curve involved in crewmember translation in microgravity.
- Ensure crew questionnaires are formally timed and completed in flight.

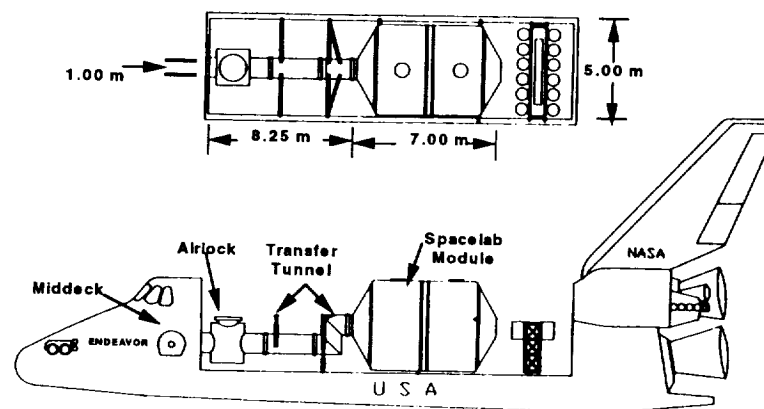

Figure 1. The Spacelab module and transfer tunnel in the Shuttle payload bay, and their dimensions (in meters).



Figure 2. The inside of the transfer tunnel.

Human Workload Analysis

TM: Susan Adam/SP34
Barbara Woolford/SP3
PI: Manuel Diaz/LESC
Reference: HST 8

Human mental workload in microgravity has not been systematically studied and is not completely understood. However, it is known that the effort required to maintain performance can become increasingly significant as mission duration and complexity increase. The human workload analysis project seeks to advance current understanding of mental workload through two programs of investigation. The first line of research is aimed at improving methodologies through the use of computer simulation and performance modeling techniques for assessing workload imposed by a microgravity environment. The second line of research focuses on the development of workload prediction as a metric for evaluating spacecraft systems proposed for future extended duration spaceflight.

The Crew Interface Analysis Section has completed an initial evaluation of the usefulness of computer simulation and performance modeling. The intent was to determine whether a computer model of remote manipulator system (RMS) operations (fig. 1) could be manipulated in the laboratory to address issues which will become more important as spaceflight becomes increasingly complex and of longer duration. Results suggested that computer simulation and performance modeling provide an excellent tool for assessing human performance in human-machine systems. It was found that such modeling could be directed toward improving system efficiency by increasing the understanding of basic capabilities of the human component in the system and the factors that influence these capabilities. In a joint effort between NASA and Brooks Air Force Base, computer simulation and performance modeling techniques are being applied to determine whether two EVA crewmembers and one IVA crewmember can reasonably be expected to replace the wide field/planetary camera in the allotted time during the STS-61 Hubble Space Telescope (HST) Servicing Mission. In support of this effort, a

front-end analysis of the wide field/planetary camera replacement was completed in preliminary form. We believe that the driving force for this mission will be excessive workload, possibly leading to fatigue and exhaustion. Examination of the points during HST servicing that may result in excessive workload will lead to recommendations to the HST Flight Systems and Servicing Project concerning

- expectation of degraded performance
- the need to change task allocation across crewmembers
- the need to expand the timeline or
- the need to increase the number of EVAs

For the second line of research, the development of workload prediction as a metric, a synthetic work environment was used to examine the utility of response surface methodology (RSM) central-composite designs (fig. 2) for predicting mental workload. This was the first in a series of studies that will ultimately establish system operating conditions for proposed spacecraft systems which do not overload the capabilities of the operator. The results of these studies will advance current understanding of the relation between the simultaneous effects of various systems operating conditions and how they impact the mental workload imposed by spacecraft systems proposed for extended duration spaceflight.

Figure 1. Deployment of Gamma Ray Observatory during STS-37.

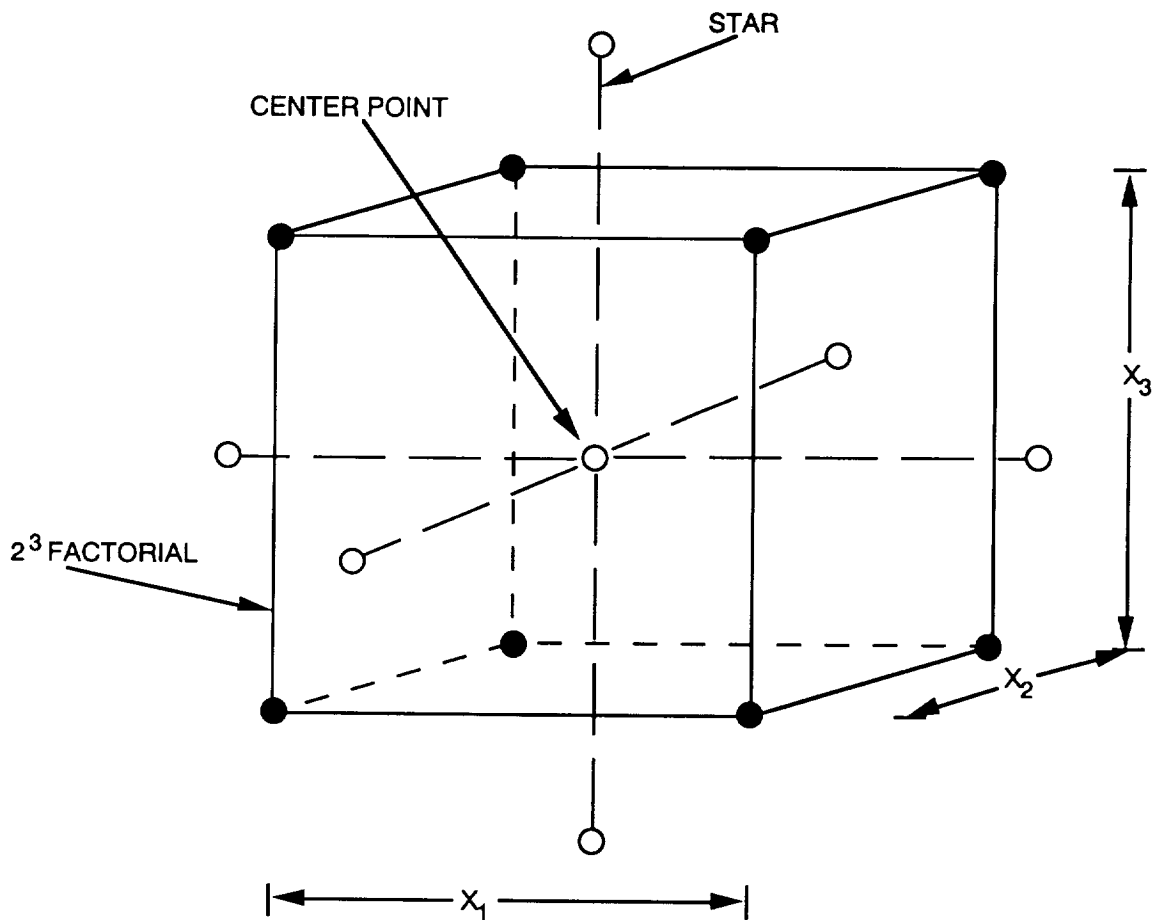
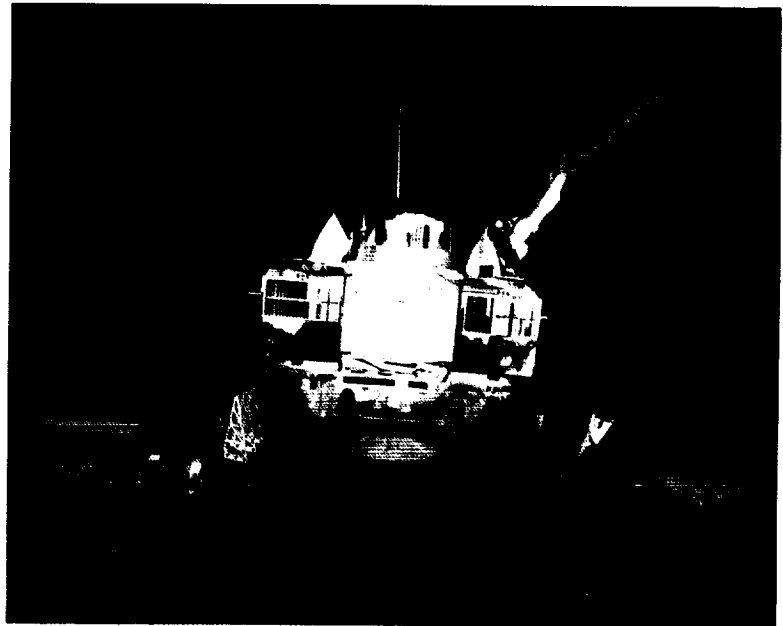

Figure 2. Geometric representation of a second-order, central composite design.

Geographic Information Systems in Space Systems

TM: Frances Mount/SP34
PI: Kevin M. O'Brien/LESC
Steven E. Chrisman/LESC
Benjamin J. Beberness/LESC
Reference: HST 9

A Geographic Information System (GIS) is a spatial data base that provides users with a variety of sources of visual information and a means to manipulate that information within a single system. It has been predicted that a GIS will be the next addition to the automated desk top of the computer literate. The GIS wedes the data storage and management capabilities of the computer with high resolution graphics in a system focused on the spatial relationships among different types of information. The results are detailed, flexible, visual representations of spatially coded information; information previously acquired from sources such as maps, photographs, and almanacs. Dynamic GISs replace static and separate maps and related reference materials as a powerful tool for merging, overlaying, comparing and analyzing information.

Since identifying GIS technology as a valuable tool for future space systems, the Human-Computer Interaction Laboratory (HCIL) has established three goals. These goals are to

- Stay abreast of current GISs and trends in GIS technology, and make that information available to the NASA community
- Develop an understanding of the human processing issues involved in using a GIS
- Become involved in implementing a GIS from the ground up

An extensive review of current GIS systems and supporting technology has been completed. The HCIL is currently in the process of writing a paper that addresses the GIS and decision making (e.g., site selection) in the context of a psychological model. The HCIL is also collaborating with a user group at JSC in order to implement a GIS. This effort is described in more detail in the following paragraph.

The HCIL and the Space Shuttle Earth Observation Project (SSEOP), both at JSC, are currently developing a Geographic Information System to support SSEOP tasks. This collaboration provides the HCIL with a platform by which to test our understanding of GIS concepts. It also equips us with a working system to evaluate iterative interface designs. Three SSEOP tasks have been identified that can benefit from the implementation of a GIS:

- **Training of astronauts.** Astronauts are trained to locate and identify photographic sites (e.g., changes in fresh water supplies, deforestation, etc.) during a mission.
- **Real-time Support.** During a mission, researchers support the Shuttle crew's Earth-looking photographic efforts by providing them with updated information about potential photo sites. Dynamic factors such as changes in weather patterns or geological activity (e.g., cloud clearing over a part of the Amazon that is rarely visible, the development of a hurricane, or an erupting volcano) make it imperative that daily updates about potential sites be given to the crew.
- **Cataloging and Indexing.** Following a mission, SSEOP personnel must catalog each frame of film and record important characteristics (e.g., location, geographic features, cloud cover, etc.). The number of photographs taken per mission has dramatically increased from 475 on STS-1 to over 4000, averaging about 1800 frames per mission. Each of the three tasks requires the integration of multiple sources of information (e.g., paper maps, electronic data, Shuttle flight parameters, corporate knowledge, meteorological data, etc.). Though the goal of each task is different, each involves integrating multiple sources of information, interpreting the data, then determining appropriate photographic locations.

A prototype of a GIS that supports each of these three tasks has been developed by the HCIL. The GIS prototype is based on task analysis and interview results with SSEOP personnel. With a good working understanding of these tasks and the information sources needed to support them, along with regular feedback from SSEOP, we have been

able to demonstrate the potential for vast improvements with the implementation of GIS technology. GIS implementation reduces the reliance on static, paper-based products, integrates sources of information into a single system, and provides the users with a powerful tool for performing their tasks. Figure 1 is an example of SSEOP's end product, an Earth-looking photograph. Figure 2a displays the real-time support portion of the prototype. Figure 2b displays the cataloging and indexing portion of the prototype.

GISs are capable of enhancing many site selection tasks that will take place in future space systems. Endeavors such as Mission to Earth are ideal candidates for GIS implementation due to their

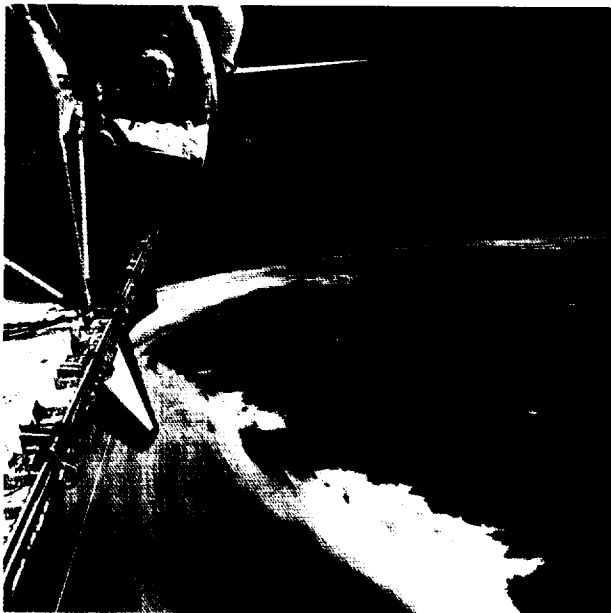

Figure 1. Earth-looking photography, the end product of Space Shuttle Earth Observation Project.

geographic and spatial nature. Lunar and Mars exploration is also highly geographic and spatial, and will require NASA to select sites for landing, research, colonization and resource extraction activities. A permanently manned Space Station Freedom will exponentially increase the need for streamlining Earth-looking photography efforts. The Human-Computer Interaction Laboratory intends to make our knowledge about human-computer interaction and GIS technology available to these ventures.

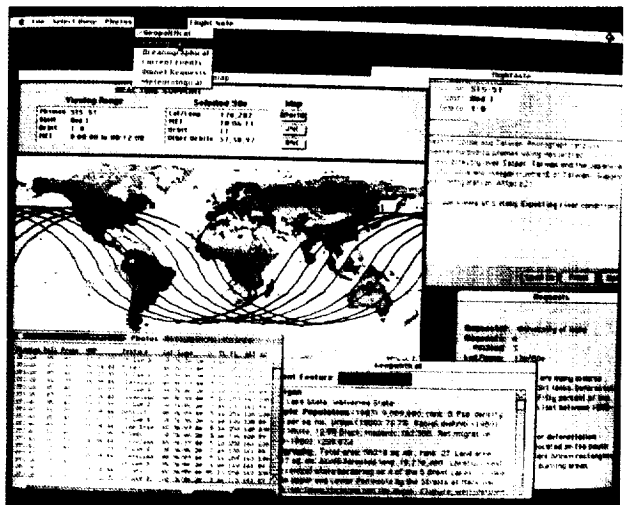
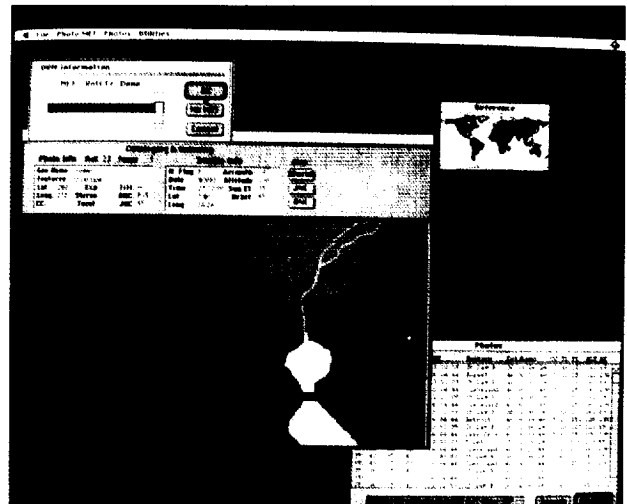

Figure 2. Prototypes of the GIS for (a) the real-time support task and, (b) the cataloging and indexing task that integrate and computerize various sources of information that are currently paper-based.

Human-Computer Interface to Electronic Procedures Research

TM: Frances Mount/SP34
PI: Michael O'Neal/LESC
Timothy McKay/LESC
Reference: HST 10

A key issue in improving human-computer interfaces (HCIs) to electronic procedure systems is to identify design characteristics that will lead to usable, effective systems. Once identified, the characteristics can be studied in detail and optimized in controlled environments. Results can then be transferred, tested, and applied in actual production environments.

Research is being performed in the Human-Computer Interaction Laboratory (HCIL) to study the characteristics of HCIs to electronic procedure systems. Research results and ideas are also being tested through evaluation of complete paper and electronic procedure systems, both on the ground and on Space Shuttle flights.

Several factors are critical to HCIL electronic procedures research. First, procedures are viewed as a tool used to complete a task; they are not a task in themselves and should therefore be unintrusive. Also, paper is the current presentation standard for procedural information, and can be used as a performance baseline. Finally, the optimal HCI for electronic procedures may be task- and context-dependent.

An experiment was recently completed in the HCIL that studied the effect of format (checklist or flowchart) and contingency (the amount of nonsequential flow) on reading times for electronic procedures. Two groups of subjects each performed the same set of three procedures. The procedures contained 0%, 33%, and 67% of "IF" statements. The procedures were presented to one group in checklist format, and to the other group in flowchart format.

As expected, reading time increased as contingency level increased. At each contingency level, no significant performance differences were found between the two formats. Also, no interaction was found between format and contingency level for

procedure reading time. The flowchart format created for the experiment, designed to be very similar to the checklist format (identical wording, similar step presentation density, and only one symbol shape), could be a factor in the lack of differences found between formats. Further insight could be gained by manipulating the above factors. If further research confirms the lack of differences found in this study, a single procedure format could be adopted for electronic procedure systems such as Space Station Freedom, resulting in a cost savings from reduced training and procedure development times.

A study is underway to help determine HCI requirements for electronic procedure systems in a space environment. The electronic procedures portion of the Human Factors Assessment (HFA-EPROC) will evaluate the use of both paper and computer procedures for computer tasks and noncomputer tasks. The program will fly aboard NASA Space Shuttle flight STS-57 (SpaceHab 1) in 1993 and on future SpaceHab missions, with a ground study being performed beforehand.

The HFA-EPROC study will collect objective and subjective performance measures using both paper and computer procedures for a simulated Space Station Freedom computer task and for an on-orbit soldering task. Advantages and disadvantages of both paper and computer presentation of crew procedures will be identified and studied. Specific interface capabilities will be examined using paper and computer procedures to help determine design requirements for a powerful, usable electronic procedure system. Data for the study will be gathered from the computer programs, from videotape recorded during the tasks, and from a questionnaire.

In the space environment, paper presentation of procedures is more familiar, but electronic procedures are more easily launched and updated in flight. Future, longer duration space missions will rely primarily on electronic procedures, making the optimal design of electronic procedures a critical issue.

The computer selected for use in the HFA-EPROC study is the portable Macintosh Powerbook (fig. 1). The study will be conducted in the SpaceHab

Commercial Middeck Augmentation Module (fig. 2). The computer task will be performed at the SpaceHab workbench. The soldering task will be performed with a glovebox at the SpaceHab workbench, with the computer located on the forward lockers to the left of the workbench.

Specific interface capabilities to be examined in the study include accessing diagrams, accessing help information, presenting notes, cautions, and warnings, logging mission elapsed time (MET) information, crew annotations, and accessing malfunction procedures. Data gathered on the questionnaire will include acceptability and usability ratings of the above capabilities, identification of the most significant advantages

and disadvantages of paper and computer procedure presentation, rating the effectiveness of coordinating the procedures into an effective overall environment, and rating the extent to which working with the procedures intruded into the performance of the primary task.

The HCIL is continuing research into the HCI to electronic procedure systems, both in the lab and in space. As more results are obtained, the HCIL will create a human performance model for the interface to electronic procedures. The model will be used for current and future space programs and for other electronic procedure systems.

Figure 1. Close-up view of PowerBook 170 computer to be used for the HFA-EPROC study.

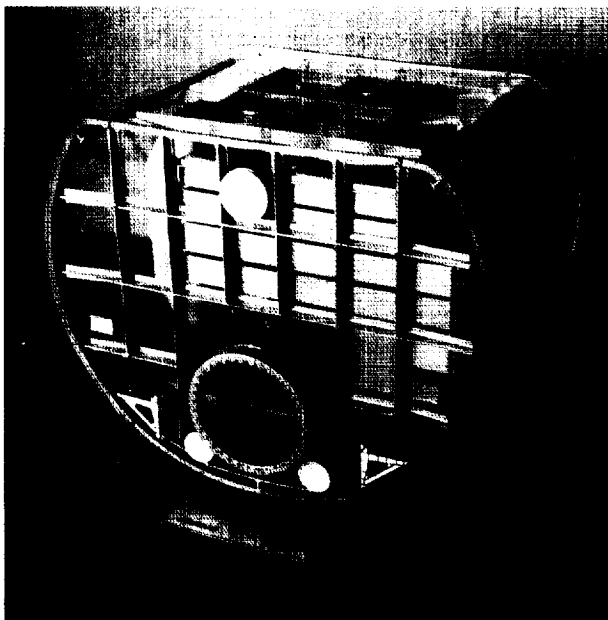
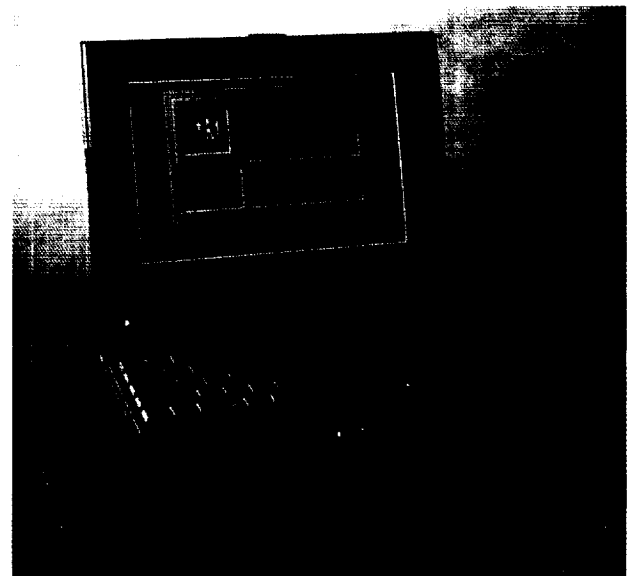

Figure 2. Model of the SpaceHab Commercial Middeck Augmentation Module.

Human-Computer Interface to Medical Decision Support Systems for Space

TM: Frances E. Mount/SP34
PI: Jurlne A. Adolf/LESC
John Gosbee/LESC
Steve J. Wolf/LESC
Reference: HST 11

For the longer and more complex missions of Space Station Freedom (SSF), and the distant missions to the Moon and Mars, more sophisticated health care delivery systems will be needed. Furthermore, crewmembers on Moon and Mars missions will become increasingly independent of Earth-based support facilities. Because of this increased complexity and independence, reliance on computer-based medical support systems by the crew medical officer and other crewmembers is inevitable. Therefore, improved human-computer interfaces, especially those for decision support systems (DSS), are needed to ensure successful missions. One such system is a computer-based medical decision support system which enables health care delivery during flight by both the crew medical officer and other crewmembers. The SSF Health Maintenance Facility (HMF) intends to include an integrated system composed of, but not limited to, medical procedures, drug interactions, a reference data base, and an expert system.

Research is being conducted by Human-Computer Interaction Laboratory personnel in the JSC Flight Crew Support Division to improve the design of human-computer interfaces during the use of computer-based medical DSS. The goal of enhancing the human decision-making process began with identifying several important human-computer interaction (HCI) issues by performing a detailed literature review from both medicine and human factors, establishing several contacts with the medical community, and evaluating the interfaces of existing medical expert systems. The eight HCI research areas are given in table 1.

Work focused on the first HCI issue, decision making errors, for a variety of reasons: relatively little research has been done; there were roots in

psychological-based theory; and demonstrations of biases in medical environments have been reported. In fact, anecdotal evidence suggests that one such decision-making error, anchoring, may have been encountered when the Navy fielded a new diagnostic DSS on their submarines.

However, there is more than anecdotal evidence that the human reasoning process is flawed in systematic ways. There is a tendency to use ingrained, well-practiced rules of thumb. Therefore, it is conceivable that a DSS could assist the health care provider at precisely those points where it is needed most. Using a DSS to prevent systematic medical decision-making errors is a relatively novel approach. In addition to eliminating the biases of the human decision maker, the DSS itself may also contribute to other systematic decision-making errors. To further our understanding of how medical personnel make decisions (i.e., diagnose), with and without a DSS, a preliminary model of the medical decision-making task was developed (fig. 1). Certain decision-making errors occurring within the model are eliminated with the introduction of a DSS; others are created or enhanced.

Current plans call for laboratory research to demonstrate and characterize the existence of decision-making errors, beginning with the anchoring phenomenon. From this research, HCI design solutions will be developed and tested to eliminate or reduce the effects of these biases. Last August, the research approach was presented as a poster at the American Psychology Association conference in Washington, D.C.

Table 1. HCI Research Areas

<u>Research Areas</u>	<u>Examples</u>
1. Decision-making Errors	Do physicians anchor on their first diagnosis?
2. Communication Variables	Does the concurrent presentation of unrelated information generate misleading cues?
3. Explanation Facility Issues	How should the rationale be explained?
4. Decision Making Issues Under Pressure	How does time pressure affect cognitive processes?
5. Trust/Acceptance Variables	What HCI issues affect the confidence of decisions?
6. Time-Consuming Data	What types of displays reduce input time or data required?
7. Medical Terminology Diversity	How can a metathesaurus be used with different user populations?
8. Temporal-based Reasoning Issues	How does the presentation of information affect decision making across time?

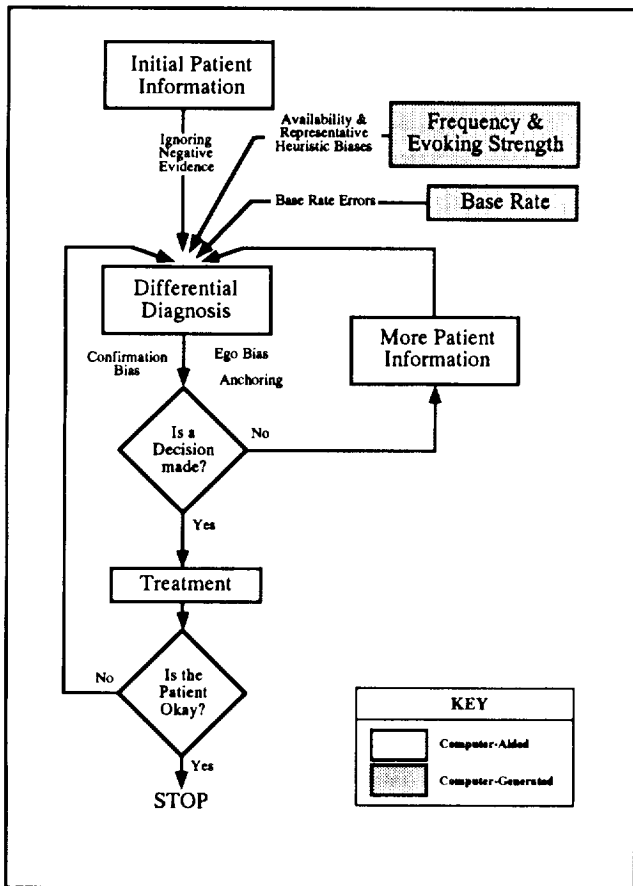

Figure 1. A preliminary model of medical decision-making.

Human-Computer Interaction Design for Intelligent Systems

PI: Jane T. Malln, Ph.D./ER22

Reference: HST 12

Demand is growing among mission controllers for the capability to develop expert system applications. Expert systems are being used to support and automate real-time monitoring and fault detection and management. Effective human-computer interaction design is critical to the success of these potentially complex software systems to ensure that they are usable and robust. The goal of this project has been to develop concepts for accessible processes and tools for prototyping and engineering these systems. It is hoped that the results will lead to processes and tools that help mission controllers participate substantially in the development of robust and usable expert system applications.

This year the project has focused on development of concepts for methods and on tools for requirements analysis and specification, design, and system evaluation. This has included a process definition and application of research concepts. A key design concept is "operational prototyping," which integrates human interaction design considerations into intelligent system prototyping. Another key concept is "information requirements," which define the task-relevant

information messages exchanged between the expert system and the user through the user interface medium. Another concept is the broadening of usability evaluations to include utility. Not only is it important that information is conveyed effectively by the user interface, but also that it is the appropriate information for the situation. This work is available as a briefing, "Recommendations for Tools and Methods for Human-Computer Interaction Design for Intelligent Systems."

Concepts from this work have been applied during development of a Space Shuttle Real-Time Data System (RTDS) case, the Payload Deployment and Retrieval System Decision Support System (PDRS DESSY). DESSY is an expert system prototype which supports Remote Manipulator System (RMS) flight controllers in monitoring and detection of failures during operations. DESSY has operated during missions in the Mission Control Center, supporting monitoring of deploying and latching operations. Figure 1 summarizes some of the positive design impacts of the project work on the DESSY prototype.

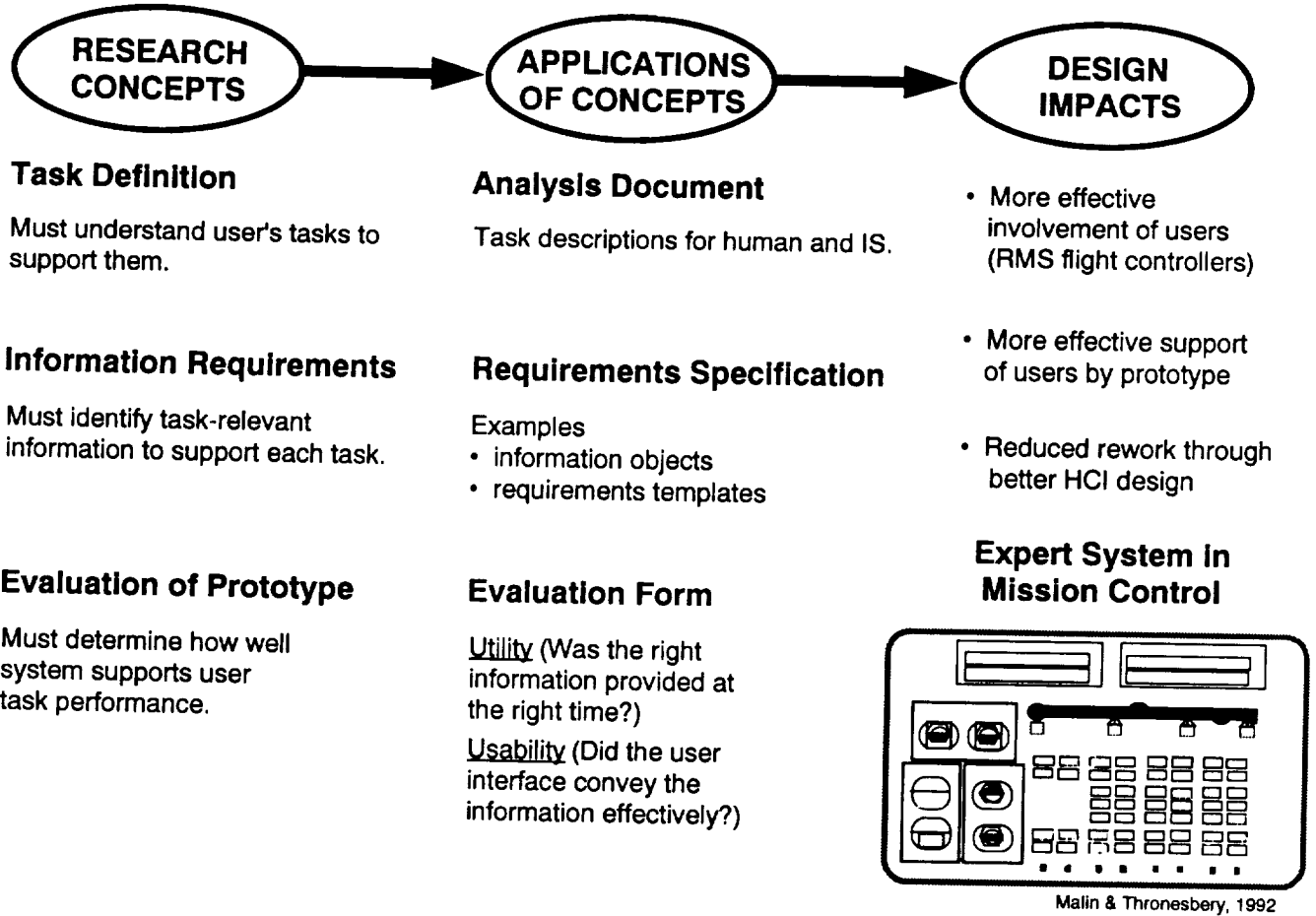

Figure 1. Human-computer interaction (HCI) design for intelligent systems (IS): impacts on a Space Shuttle RTDS prototype.

Interfaces to Intelligent Systems

TM: Frances Mount/SP34
PI: Kevin O'Brien/LESC
Evan Feldman/LESC
Reference: HST 13

Intelligent computing systems are playing larger and larger roles in the maintenance and operation of complex mechanical systems. While the intelligent systems algorithms are interesting in and of themselves, understanding the human operator's response to the advice of an automated intelligent system is critical to predicting overall system performance. In essence, the intelligent system acts in much the same way that a human advisor would. Events are observed, information is summarized, analysis is made, and a response is recommended. As with any advice, the recipient interprets the advice and selects a response. To predict the response of a human operator, the factors determining the intelligent system's influence must be understood.

The day-to-day importance of this knowledge is illustrated in the role of intelligent advice in system failures. System alarms, a form of intelligent system advisor, are frequently reported as being disabled or ignored by human operators. In the case of a commercial airliner crash, the crew ignored critical advice from an advisor they deemed uninformative. The result was an incorrect and fatal response.

Instances such as these have prompted researchers to look for critical factors in how advice is received and acted on. One school of thought proposes that decision making improves as the number of independent information sources increases. Derived from Signal Detection Theory, this position starts with the assumption that the detectability of some event or "signal" can be represented in terms of distance between the signal and background noise. When two independent signals are combined (fig. 1), Euclidean geometry shows that the distance between the combined information and noise is greater than that between an individual signal and noise. The logical extension is that an operator presented with advice along with other system status information will

perform better than an operator given advice alone (fig. 2). Supporting research has shown that people accurately identify more colors when the colors vary on both brightness and saturation than colors varying on saturation alone. Further, when given multiple opportunities to listen for a faint sound, people are more likely to correctly determine whether the sound was present or not.

Can studies on basic perceptual events generalize to the system control environment? In the studies described above, one might expect the subject to say, "I'm just not sure whether or not I heard anything." Uncertainty surrounds the perception of some event. When monitoring an operating system, there is rarely uncertainty as to the number on a gauge. Rather, the operator might be heard saying, "I know what the numbers are, but I'm not sure what they tell me." Uncertainty is related to whether the number reflects nominal operations or a system failure. When attempting to classify system status based on numbers, it is less clear that receiving multiple sources of information will improve performance.

The task of classifying numbers has been shown to benefit from reducing uncertainty, as do perceptual events (colors, sounds), leading one to expect that the classification of numerical information might also benefit from multiple sources of information. In studies conducted at Purdue University and the University of Florida, Robert Sorkin and his colleagues conclude that people benefit from criterion information in making number classification decisions, but benefits from having multiple sources of information are not clearly demonstrated.

Research simulating system monitoring and diagnosis (fig. 3) conducted in the Human-Computer Interaction Laboratory (HCIL) demonstrated decreasing gains from increasing the number of information sources. The studies also demonstrated that as the quality of the advice declines, the influence of other sources of information increases. Studies are currently examining the roles of information grouping and advice message format on operator performance.

The work conducted at the HCIL has been presented at the Association for Computing

Machinery's Computer-Human Interaction 1992 Annual Conference and at the Space Operations, Applications, and Research 1992 Annual Workshop and has been submitted to the Human Computer Interface International 1993 Annual

Conference. The results of these studies will allow us to better predict how messages from automated intelligent systems will influence the overall performance of humans in system monitoring tasks.

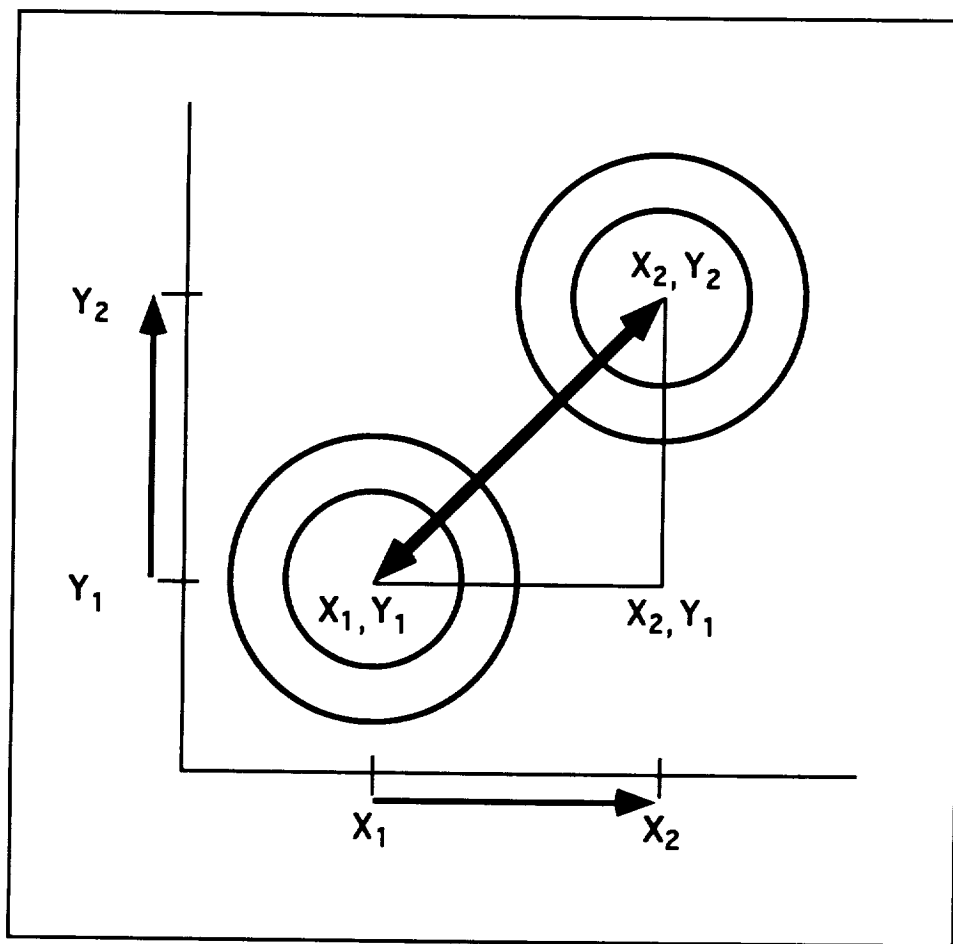

Figure 1. Signal strength represented in terms of distance. The distance between the combined signal (X_2, Y_2) and noise (X_1, Y_1) is greater than that between either of the separate signals (X_2, Y_1) and (X_1, Y_2) and noise.

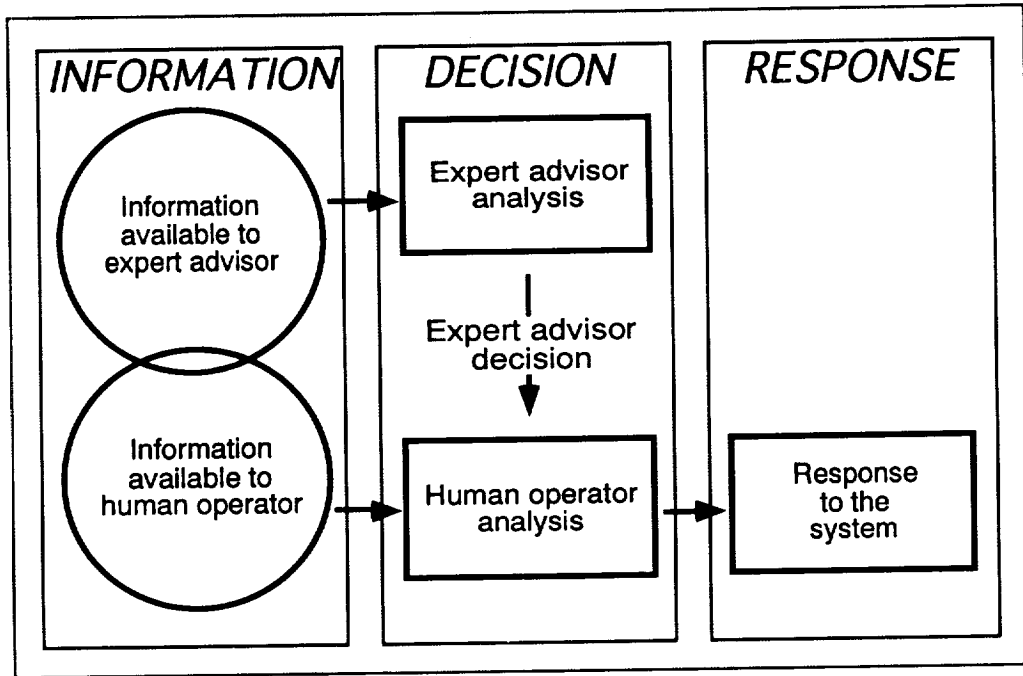

Figure 2. Flow chart representing the system monitoring and diagnosis process with an automated intelligent system advisor and a human operator.

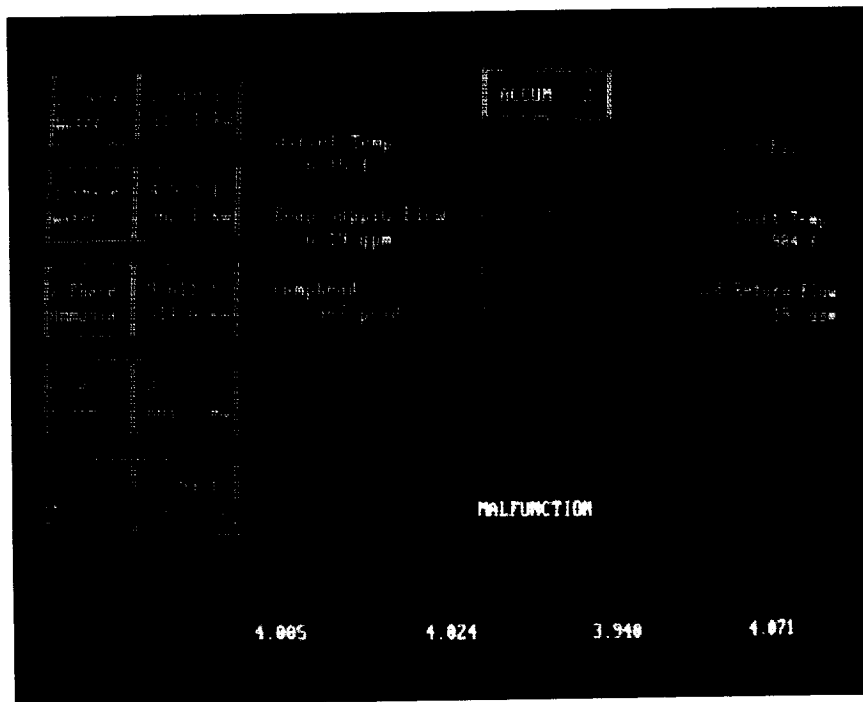

Figure 3. Display from the system operating simulation used to study the effect of advice on operator performance.

Computer Aided Planning and Scheduling System

PI: Christopher J. Culbert/PT4
Dr. Barry Fox/MDSSC
Reference: HST 14

The Computer Aided Planning and Scheduling System (COMPASS) is a generic interactive planning and scheduling system which is provided to aid NASA centers in solving any type of scheduling problem, especially scheduling problems which cannot be solved using commercial products. COMPASS has many key features.

COMPASS is interactive. It is much like a spreadsheet used to create and revise activity schedules. In a typical scenario, the user loads activity and resource data from a data file, creates a schedule by invoking a series of high-level scheduling and editing commands, and saves the resulting schedule in a data file where it can be retrieved for later publication and modification.

COMPASS is generic. It is suitable for a wide range of problems. It can be used to manage activities that are subject to timing constraints, ordering constraints, Boolean conditions, and the availability of resources.

COMPASS is data driven. The system does not employ any problem specific heuristics or constraints. Instead, all constraints and world models are described in the input data.

COMPASS provides the capability to specify the following characteristics of an activity: priority, predecessors, successors, temporal constraints, nonconcurrent activities, earliest start, latest finish, preferred and excluded intervals, resource requirements, and condition requirements. Resource descriptions may be piecewise constant or piecewise linear. Resources may be produced, consumed or used and then returned by an activity. Times may be specified in an absolute (date) or relative format. Conditions are static states of the external world. Activities may request specific conditions.

COMPASS is flexible. The user controls the sequence of the scheduling process and the general placement of activities on the time line. At the same time, the user can rely upon the system to place activities only at feasible times, taking into consideration all of the constraints imposed upon an activity and the resources it requires. The user can schedule activities one at a time to carefully control the resulting product, or the user can command the computer to schedule everything automatically without human intervention.

COMPASS is customizable. In order to provide support to a wide range of problems, COMPASS is easily customized. The modular design of COMPASS allows for easy addition of new commands, heuristics, and optimizing algorithms. The source code is available along with the executable, so the customer can control the customization effort if desired.

The significant accomplishments of FY92 include:

- Delivery of a customized version of COMPASS to the Systems Engineering Simulation (SES) Facility and to Spacehab
- Enhancement of data representations
- Porting COMPASS to the PC
- Development of an interactive editor

In FY92 emphasis was placed on customizing COMPASS to specific scheduling problems and integrating the resulting system into the operational world. We worked one-on-one with the customers in order to ensure a smooth transition from manual to computerized operations. In FY92 our two primary customers were the SES Facility and Spacehab. To support these customers, a variety of new reports, both textual and graphical, were written in PostScript. In the case of the SES, a new user interface was developed.

Data representations were enhanced to support our new customers. Among other enhancements, the data structure now supports variable length durations and comments.

To expand the horizons in which COMPASS can be used, the graphical version of COMPASS was

ported to an IBM PC using Desqview X. This will provide more people with access to the graphical version of COMPASS. Previously, PC users were limited to the nongraphical version.

In response to the user community, an interactive data editor was developed. It allows the user to modify unscheduled activities or to create new activities to add to the schedule.

Isaid, a customized version of COMPASS, was produced jointly by the Software Technology Branch and Information Systems Branch to support the scheduling of the SES Facility. Isaid is in operational use, providing weekly schedules for the facility. The system allows the schedule manager to perform trade-off analysis, to maximize use of the facility, and to respond to last minute changes while ensuring valid schedules. COMPASS has greatly simplified the process of publishing schedules.

COMPASS is in operational use in Huntsville, Alabama, at the Marshall Space Flight Center (MSFC) where Spacehab missions are being scheduled. COMPASS has been used to create the schedules for Spacehab 01, which is scheduled to

fly April of 1993 and is now being used to create schedules for Spacehab 02. MSFC negotiates astronaut time with JSC and then uses COMPASS to schedule Spacehab activities within the negotiated times. Future plans include an interface between JSC's and MSFC's scheduler so that blocks of astronaut time will not have to be pre-allocated.

In FY93 the focus of COMPASS activity will remain the same as in FY92: to customize and integrate COMPASS into the operational arena.

COMPASS will continue to be used to schedule future Spacehab flights. Past successes have shown COMPASS to be a very useful product in scheduling and producing required reports for Spacehab.

COMPASS may form the basis for scheduling one of the Shuttle Mission Simulators (SMS). Lessons learned from facility scheduling for the SES should apply to the facility scheduling for the SMS.

Cooperating Expert Systems

PI: Christopher J. Culbert/PT4
Colln Clark/MDSSC

Reference: HST 15

Knowledge-based system technologies have successfully bridged the growing gap between low-level control systems and human control in narrow applications. Although only a few have been integrated into the domain of spacecraft operations, many applied research projects have shown that knowledge-based systems can provide human workload relief and are able to perform routine operations for individual spacecraft systems. True integration, however, cannot be achieved by simply attaching a knowledge-based controller to every subsystem. Current mission control operations clearly demonstrate that communication and cooperation among controllers is a mandatory requirement for a robust control organization. Coordination and cooperation among knowledge-based controllers, whether human or heterogeneous, requires a body of design and implementation guidelines, the development of which is one of the aims of this project.

The purpose of the Cooperating Expert Systems (CoopES) project is to define and develop guidelines, methodologies, and tools for distributed cooperating systems and to apply them to develop and deliver tools and techniques to appropriate customers.

Although cooperation can be achieved in many different ways, we are pursuing two primary architectures for cooperation, hierarchical and peer-to-peer. Each approach has advantages and disadvantages. Generally speaking, the hierarchical approach provides efficiency at the expense of flexibility, and the peer-to-peer approach provides the opposite.

A hierarchical organization provides centralized locations to define overall system behavior; it provides a natural partition to organize knowledge that is relevant to two or more systems simultaneously, and it simplifies the human-machine interface. However, a hierarchical organization imposes some rigidity on the system

and creates single failure points. While overall communications are generally more efficient, the hierarchy can create bottlenecks that adversely impact overall system performance.

A peer-to-peer organization provides flexibility, redundancy, and fault tolerance. This allows real-time reconfiguration under changing mission requirements and evolutionary development during a spacecraft life cycle. Peers can function as a hierarchy if necessary. However, a peer-to-peer organization consumes more resources in the decision-making process. In some cases, the time or space requirements of a peer-to-peer decision could become unacceptable. Currently, we cannot guarantee the upper bounds of resource use.

Prior to FY92, two expert systems were developed which could be used to evaluate cooperative, distributed systems issues. These systems have been put into a distributed, cooperative test-bed that focused on evaluating a hierarchical organization of cooperating expert systems.

Distributed system features from the test-bed have been used in new versions of the real-time data system (RTDS) in the Mission Control Center. These cooperative features have proven successful on numerous Shuttle flights since their incorporation. Currently the CoopES tests are being used to implement and study distributed, adaptive control techniques. These new techniques will be a keystone of future control center capabilities.

In FY92, our primary emphasis was the development of a system based on the peer-to-peer architecture. Our goal was to create independent agents that would cooperate without hierarchical supervision to solve a real-world problem. As part of our distributed systems work, we had identified a potential loading problem for the RTDS as it will need to expand to accommodate Space Station operations. We developed a system of self-organizing, distributed control agents that automatically balance the loads in a data distribution network. The agents organize themselves at run time, and, therefore, do not need any precoded information regarding the location of other agents with whom they must communicate.

Processed telemetry is the data being distributed and the loads can be based on the CPU loads of the agents supplying the data, on the overall network loads, or on the number of parameters being supplied by the agents. Negotiation is achieved through a simple offer and bid system. Agents who need data submit requests and each supplying agent bids on the request based on one of the three load metrics. Figure 1 shows the user interface where the upper and right quadrants represent the three load metrics and the lower left quadrant shows the bidding process.

Separate studies on distributed scheduling show that major issues remain to be solved. In particular,

practical experiments under development will provide insights into protocols to coordinate human scheduler actions and improve schedule quality. Distributed support packages have been built and other groups have used them in their own work. In particular, these products are part of an ongoing distributed simulator study. All this work relies entirely on standard tools (UNIX, C, and CLIPS) and approaches (object-oriented design and protocols). More experimental languages, such as LISP, are no longer present in the system. All CoopES software runs on a wide range of UNIX platforms (Sun, Masscomp, DeC, and IRIS).

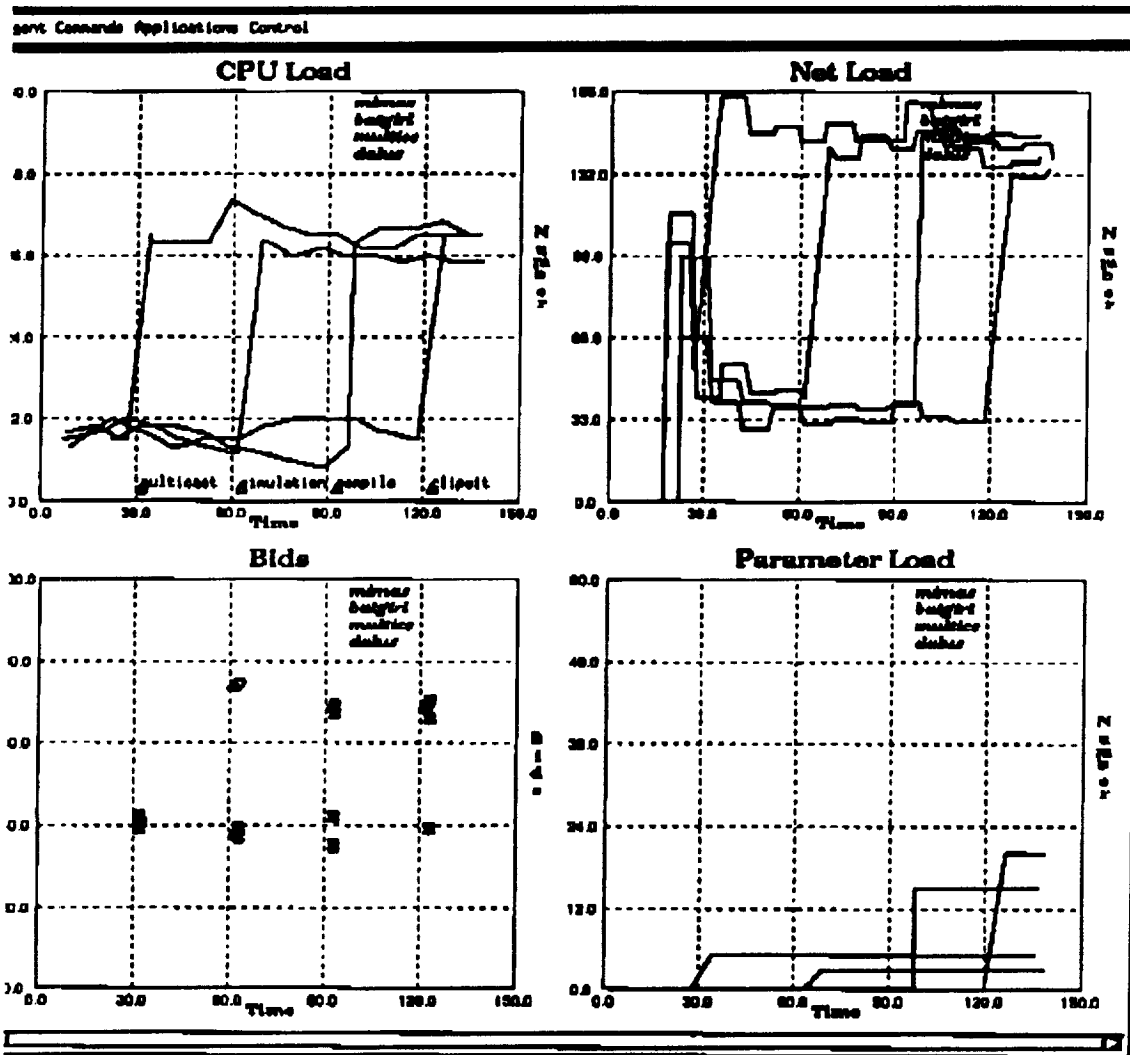

Figure 1. CoopES load-balancing user interface screen.

Software Vehicle Health Management

PI: James Villarreal/PT4
Reference: HST 16

The Software Technology Branch (STB) at JSC is investigating the application of advanced software techniques to various problems within the technical area called Vehicle Health Management (VHM). These activities include the development of applications and tools for solving VHM problems (e.g., real-time fault detection, isolation and recovery (FDIR)) and the development or integration of software tools applicable to the broader scope of VHM.

The definition of VHM is a broad one, including the determination and manipulation (i.e., control) of the condition of a vehicle or subsystem during the pre-operations, operations, and postoperations phases of the system life cycle. VHM comprises sensors, software, and system architecture. Integrated VHM (IVHM) involves the integration of health management across the entire vehicle. Because VHM promises increased safety and reliability, simultaneously with reduced costs, it is important to NASA.

The STB identifies, evaluates, and develops software technologies for use in NASA information systems in support of institutional and space systems development and operations. The STB acts as a bridge between the research world and the operations world, providing a space operations and development focus for the application of promising research into all areas of software technology.

VHM software is just one of the many software technologies (and VHM may benefit from many of the other software technologies) that the STB is evaluating and developing. VHM software has been defined by the following major elements:

- Time-Critical Fault Detection, Isolation, and Recovery (FDIR)
- Nontime-Critical FDIR
- Software Development Environments
- Advanced Software Management Capabilities

To develop a hands-on understanding of VHM software in systems operation, the STB is working with operations personnel to develop real-time FDIR applications within the Mission Control Center (MCC) at JSC. Using lessons learned from developing several similar applications, the next goal will be to develop a generic VHM tool for solving related problems.

The scope of VHM extends far beyond real-time FDIR. Therefore, the STB is also investigating several projects that take a broader view of VHM. These projects involve defining requirements for software tool sets applicable to various phases of the vehicle life cycle (e.g., system design, postoperations analysis). These requirements may drive the integration of existing software tools, the development of new tools, or both. It may allow the same tools to be used by different groups of engineers for different phases of the vehicle life cycle.

One part of this task in FY92 focused on identifying important VHM applications within the MCC. The goals for this part of the task were as follows:

- Identify a set of important VHM problems within the MCC that might benefit from the application of advanced software techniques
- Implement specific solutions for these problems
- Work within mission control to test and install the resulting applications within the MCC
- Subsequently, evaluate the feasibility of developing a generic tool capable of being used to solve similar VHM problems

To pursue these goals, the STB established a relationship with the Real-Time Data System (RTDS) task within the Mission Operations Directorate (MOD) at JSC. RTDS had developed multiple RVHM-like applications within the MCC and had very similar FY93 goals. Through this collaborative effort and discussions with JSC flight controllers, potential applications within the MCC were identified and several applications were selected for study. Two applications, the AC Motor and the Secondary Delta Pressure signature

analysis and fault detection applications are currently being developed.

The STB is also investigating several other VHM project proposals that take a broader view of VHM (i.e., outside of the real-time FDIR phase of operations). For the design phase of the vehicle life cycle, the STB is investigating the requirements for an integrated set of tools (e.g., tools for analyzing fault propagation, sensor placement, fault tolerance, reliability, redundancy, and cost). To support vehicle turn-around and maintenance, the STB is studying the need for an integrated tool set for analyzing data gathered during testing or actual operations. One or more of these projects may be selected by the STB for serious study during FY93.

The STB is currently collaborating with the RTDS task, and working with JSC flight controllers, to analyze and automate (automation will be restricted to an advisory capability) two similar fault detection, isolation, and recovery (FDIR) applications within the MCC: the AC motor monitor and the secondary delta pressure monitor.

Using the AC motor monitor, electrical, general instrumentation, and lighting flight controllers monitor current usage on Shuttle alternating current buses to identify known signatures of Shuttle apparatuses (e.g., fan motors, vent doors) as they turn on and off, and to identify known failure signatures as well as unknown signatures.

Using the secondary delta pressure monitor, guidance and navigation (G&C) flight controllers similarly monitor secondary delta pressures on G&C equipment during Shuttle ascent and descent.

Downlink data from both of these applications is currently displayed on paper strip charts. Flight controllers examine these recordings during missions to monitor systems and to identify anomalies.

The goal of this project is to provide a technological alternative to the examination of strip chart recordings by ground controllers for the identification of anomalies within Shuttle flight systems. Potential benefits may include automated identification of known nominal and failure signatures, notification of unidentifiable signatures, automated fault detection and early warning,

selective attention, information reduction, improved data display, or elimination of the strip chart recorders.

While we are examining several potential advanced software solutions, neural networks have been identified as a potential technology for solving these problems.

Finally, we are investigating several VHM project proposals that take a broader look at VHM:

- VHM Modeling Tool Set
- VHM Postoperations Diagnostic Tool Set

Each of these projects involve interaction and coordination with researchers and developers within NASA centers, industry, and academia, as well as the integration of the tools and technologies produced by these organizations.

The VHM Modeling Tool Set project suggests the need to integrate existing tools for use when designing VHM into new systems. Technology areas include fault propagation and fault tolerance, reliability, cost estimation, sensor placement, system modeling, etc. Tools currently exist in all of these areas. This project would work with these tools and their developers to define the requirements for such a tool set. Related activities currently exist and the STB would coordinate with these projects.

The VHM Postoperations Diagnostic Tool Set project aims to study the tool set requirements of postoperations analysis. The resulting integrated tool set would be used to evaluate system, subsystem, and component health through analysis of test and/or operations data. The goal of such a tool set would be to reduce system or vehicle turn-around and maintenance costs. Again, the STB would coordinate with other related active projects.

Advanced Software Development Workstation

PI: Ernest M. Fridge III/PT4
Dr. Charles L. Pltman/PT4
Dr. Michael Izygon/Barrrios

Reference: HST 17

NASA has many complex software systems that contain millions of lines of code. The development, use, and maintenance costs of such complex information systems are very high. The challenging goal of the Advanced Software Development Workstation (ASDW) task has been to reduce the cost of large complex software systems while improving their quality. The main objective of the ASDW has been to provide productivity enhancements, specifically, advanced software methods, tools, and processes, that will help to achieve this challenging goal and thus benefit a broad range of NASA programs. The Mission Control Center and the flight analysis and design system (FADS), which will support the Space Shuttle and Space Station Freedom, have been the initial targets for technology transfer.

The ASDW task is applying advanced software technologies, such as computer-aided software engineering (CASE), knowledge-based technology, software reuse, object-oriented development and programming, and intelligent user interface systems, to all phases of software development, use, maintenance, and evolution (except system testing). The ASDW task has been composed of four subtasks:

- Parts composition system (PCS) with engineering script language (ESL)
- INTelligent user interface development tool (INTUIT)
- Framework programmable platform (FPP) with configurable control panel (CCP) and IDEF3, a graphical process description capture method
- Development and use of software engineering methods and knowledge engineering methods and applications to test and prove these technologies

The PCS/ESL is a composition system that allows aerospace engineers with minimal programming experience to develop software applications graphically by connecting reusable software components together. INTUIT (INTelligent User Interface development Tool) is a knowledge-based shell that, once configured for a complex application such as a trajectory simulation, allows users to easily set up the input data streams for runs so that programs run properly the first time.

The focus of the FPP subtask is the management and control of the software development process within an integrated life cycle environment. Specifically, the focus of the FPP is the development of a horizontal tool, a CCP, for describing, managing, and controlling the system development processes used on large complex projects. At the heart of the CCP will be a tool that implements the graphical IDEF3 method for describing complex processes. The knowledge engineering methods being developed under the fourth subtask provide the steps which should be followed to engineer INTUIT, ESL, and CCP type knowledge bases. The software engineering methods being used and enhanced, including object-oriented development and programming, are also providing technology transfer to Space Shuttle software maintenance programs. The applications being developed to test these software technologies are carefully chosen so that they directly demonstrate to potential users the benefits of these technologies. For example, the data organization scheme and the screen presentation methods from an INTUIT application that was developed for the simulation program called Space Vehicle Dynamics Simulation (SVDS) were delivered to Rockwell's Orbit Design Group for use in the FADS.

Several significant accomplishments were achieved in 1992. The first prototype of the FPP/CCP was delivered, and it embodies and communicates, in a very effective and interactive way, the requirements that a tool for managing the software development process must possess. Initial testing of the PCS/ESL prototype was completed, using flight mechanics tool kit as the reusable software components library, and a report describing final testing, results, and conclusions (with required

enhancements) is planned for next year. An INTUIT knowledge base was prototyped for a test library (TLIB) application on the Mission Operations computer to demonstrate the capabilities of an intelligent user interface, and a report on methods for building constraints into INTUIT knowledge bases was also completed. The addition of a CLIPS expert system engine to INTUIT was begun to supplement the current ART-IM expert system, which is the fundamental layer beneath INTUIT today. Finally, a configurable, commercial CASE tool to support object-oriented development and generation of program specifications was identified, tested, and

used, and technology transfer has begun by making other JSC programs aware of this tool's capabilities.

The ASDW task has developed advanced software methods and processes, and requirements for advanced software tools, and has begun technology transfer to NASA programs through test applications on real NASA projects and through training. It is through technology transfer that ASDW results will be disseminated to other NASA programs and thus help NASA achieve the goal of reducing the cost of large, complex information systems while improving their quality.

Adaptive Fuzzy Logic Control

PI: Robert N. Lea/PT4
James A. Villarreal/PT4
Reference: HST 18

The objective of this task is to investigate the applications of fuzzy logic to control and expert systems. Specifically, methods of developing adaptive systems are being studied and applications to space control and decision-making problems are being evaluated.

A tethered payload system exhibits nonlinear characteristics that challenge conventional control strategies. Since the tether has elasticity and mass, and the end bodies have six degrees-of-freedom, their interactive dynamic makes the complete system extremely complex. Also, the system has natural librational and longitudinal oscillations. With a conducting tether, as manifested for TSS-1, there exists an interaction between the Earth's geomagnetic field and the current passing through the tether. As a result there is a phenomenon known as "skip rope" in the tether. Retrieval of the tether becomes complicated and, in some cases, unstable—possibly endangering the vehicle and the crew.

A performance measurement between a fuzzy logic and the baseline controller for TSS-1 (fig. 1) has shown reductions in length error using fuzzy logic. Furthermore, simulations have shown that the fuzzy logic controller considerably reduces libration angles vital during the retrieval process. Since the results were completed late in the ensuing TSS-1 program, it is critical that development continues to support future flights. Coordination of this activity has been conducted with the Marshall Spaceflight Center-Tether Project Control, the TSS-1 Payload Integration Manager, the Engineering Directorate-Tether Analysis Group, and the Mission Operations Directorate-Tether Control during flight.

Advanced sensor systems with intelligence and a distributed nature will be required for activities such as proximity operations and traffic control around the Space Station Freedom (SSF). These systems will receive various types of measurements from multiple sensors and perform the necessary

data fusion for the navigation, guidance and control systems. SSF operational requirements require that these systems be composed of passive-type, low-power sensors. (Based on the current design, the SSF operations are expected to be power limited and computing resources limited.) An important feature is that the system should be capable of handling imprecise and approximate measurements as well as sensor failures.

Fuzzy rules provide a framework to implement the human thinking process; i.e., the rules reflect the human thought process, such as "If the object is far-left then rotate the camera to the left side." The task of the tracking controller is to command these gimble drives so that the pointing axis of the camera is along the line-of-sight vector that is estimated from the measurements.

Fuzzy logic can be used advantageously in autonomous orbital operations that require the capability of handling imprecise measurements from sensors. An approach to a camera tracking system has been developed to support proximity operations and traffic management around the SSF (fig. 2).

A software simulation for on-orbit relative motion has been created with camera model and gimble drives to test the fuzzy controller. Fuzzy sets and fuzzy logic based reasoning are used in a control system that use images from a camera and generates the required pan and tilt commands to track and maintain a moving target in the camera's field-of-view. Five test cases are designed to test the controller for proximity operations trajectories. Capabilities of the control system can be expanded to include approach, hand over to other sensors, and caution and warning messages.

A translational and rotational controller has been combined to create a six degree-of-freedom controller for a spacecraft to perform proximity operations (fig. 3). These operations include V-bar approach, R-bar approach, station keeping and fly-around operations. Results have demonstrated that the fuel usage during these operations are very comparable with those in the human-in-the-loop simulations, and the vehicle trajectory is maintained within the desired flight envelop. The controller design is based on the rules used by the

crew during these operations. If implemented into Shuttle operations, these techniques will reduce crew workload.

A generic rotational controller has been created which is based on fuzzy logic principles and phase plane concepts. The controller can now be adapted or applied to a variety of spacecraft.

- With the use of a high fidelity Shuttle simulation, it has been shown that the fuzzy controller uses less fuel and provides a better response.

- Efforts are underway to extend these techniques toward the approach and docking operations from 50 feet inside so that the vehicle can get closer. This will help reduce the crew work load and free them to perform important experimental activities.
- The fuzzy controller has been delivered to the Automation and Robotics Division of the Engineering Directorate for potential use in the SAFER vehicle.

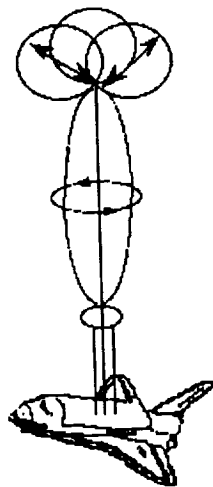

Figure 1. Fuzzy logic-based tether control.

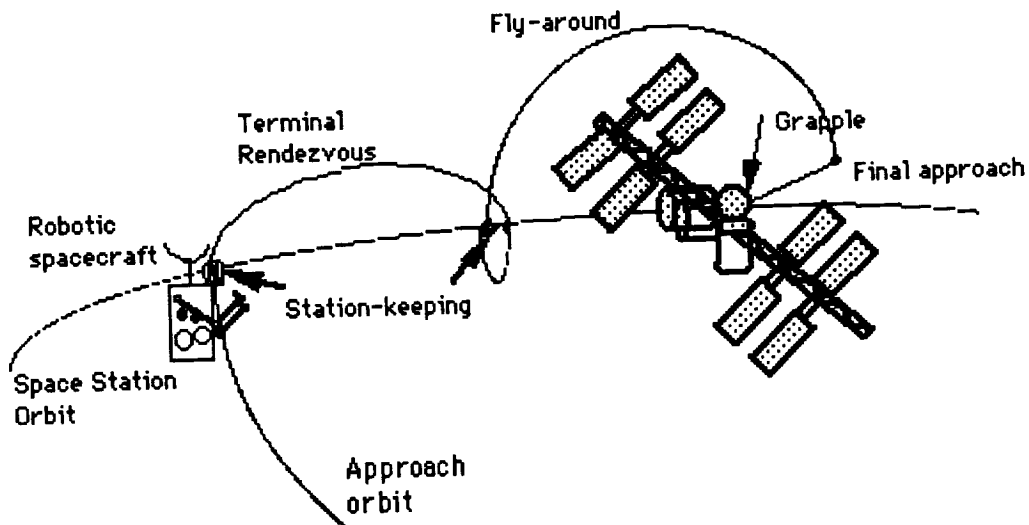

Figure 2. Fuzzy camera tracking system applications.

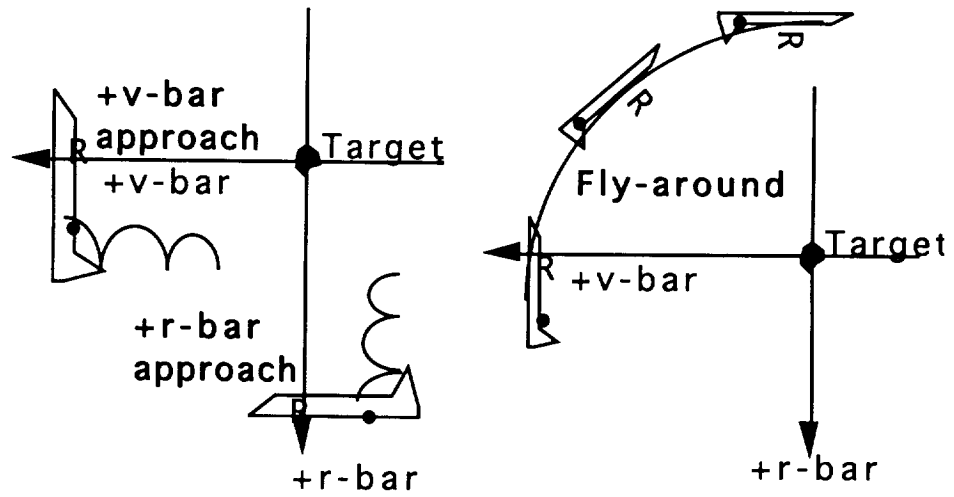

Figure 3. Six DOF controller for proximity operations.



Section III

***Solar System
Sciences***

Summary



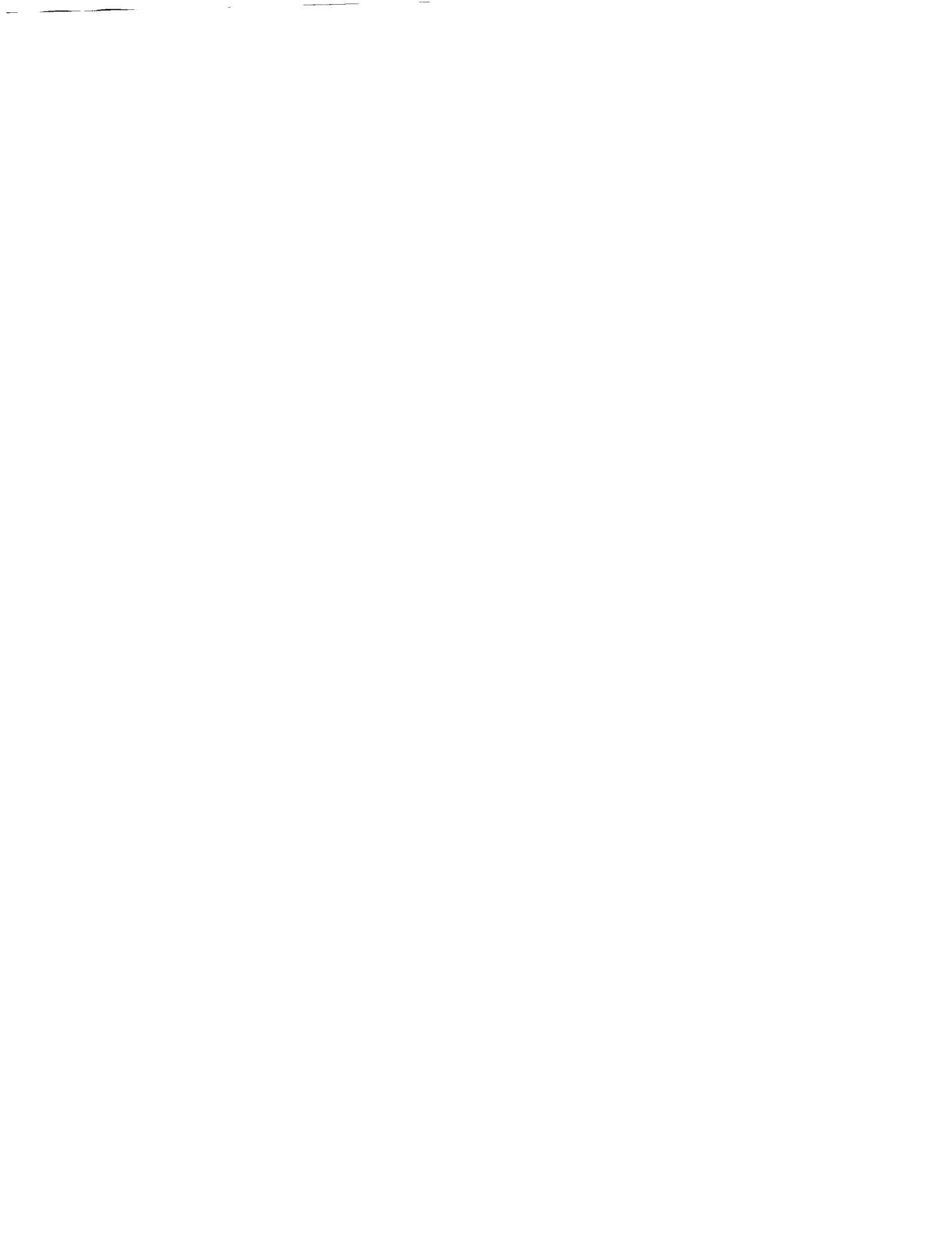

Solar System Sciences Summary

Research at the Johnson Space Center (JSC) in Solar System Sciences during FY92 covered a number of disciplines and was broad in scope and varying in its relationship to science as a centerpiece of many of NASA's current initiatives in space. It included new investigations of

- Meteorites
- Cosmic and interplanetary dust
- Earth-orbital debris
- Remote sensing of Earth
- Space radiation environment
- Analysis of lunar and planetary material
- Origin and evolution of planetary structure

Highlights of new accomplishments include (1) Indigenous Space Resource Utilization Studies, (2) man-made and natural hypervelocity particles in low Earth orbit, (3) models of the orbital debris environment, and (4) measuring the terrestrial ages of New Mexico meteorites. The following is a limited presentation of some of these investigations.

Indigenous Space Resource Utilization (ISRU) is ranked among the highest priority technologies with potential to lower the cost of the Space Exploration Initiative. The studies in this project focus on providing the technology base to begin using ISRU in our lunar base plans. Three subtopics were addressed: lunar soil simulant development, analysis, and storage; design and construction of an oxygen test-bed; and lunar mission (Artemis and First Lunar Outpost) experiment development.

There have been several attempts in this century to establish the accumulation rate of meteorite falls at the Earth's surface. Reported here is a study that used the observed concentration of meteorites in Roosevelt County, New Mexico, and the apparent age of the sediments composing the meteorite recovery surfaces to calculate the meteorite flux rate.

Also reported is a study of the "Chemistry of Micrometeoroid Experiment" from the Long Duration Exposure Facility (LDEF). The findings showed the presence of man-made debris on LDEF's trailing edge which was unexpected as most previous debris models assumed debris sources in highly circular orbits to totally dominate, essentially to the exclusion of other sources. A detailed study modeled the LDEF observations and concluded that debris sources in highly elliptic orbits and of modest inclinations, such as transfer vehicles of geosynchronous payloads, were substantially underestimated in the past.

Results of orbital debris modeling are providing new insight on how to protect against, measure, and manage the orbital debris environment. As a result of this work, all space-faring nations have voluntarily taken steps to reduce the possibility of future explosions in orbit.

Section III

***Solar System
Sciences***

Significant Tasks



PRECEDING PAGE BLANK NOT FILMED

Indigenous Space Resource Utilization Studies

PI: David S. McKay, Ph.D./SN
Thomas A. Sullivan, Ph.D./
SN4
Carlton C. Allen, Ph.D./LESC

Reference: SSS 1

Indigenous Space Resource Utilization (ISRU) is ranked among the highest priority technologies with potential to lower the cost of the Space Exploration Initiative (SEI). One of the five stated goals for the SEI is that it "shall research the utilization of space resources." The National Commission on Space, the Ride Report, the Augustine Committee, and the Synthesis Group all placed high emphasis on this technology after reviewing the future of the space program. The studies in this project focus on providing the technology base to begin using ISRU in our lunar base plans. Three subtopics have been addressed:

- Lunar Soil Simulant Development, Analysis, and Storage
- Design and Construction of an Oxygen Test-bed
- Lunar Mission (Artemis and First Lunar Outpost) Experiment Development

Terrestrial simulants of lunar material must be made available for distribution to the research community. Simulants of lunar rocks and soils with appropriate properties, although difficult to produce in some cases, will be essential to meeting the system requirements for lunar exploration. To address this need, a new lunar regolith simulant, JSC-1, has been developed.

JSC-1 is a glass-rich basaltic ash which approximates the bulk chemical composition and mineralogy of lunar soil. It has been ground to a grain size distribution within the range of lunar regolith samples and is available in large quantities (> 1000 kg).

JSC-1 was produced specifically for large- and medium-scale engineering tests in support of future human activities on the Moon. Such studies include those in which physical properties are

important, such as material handling, construction, excavation, and transportation. The material is also appropriate for research on dust control and spacesuit durability. JSC-1 can be used as a chemical or mineralogical analog to some lunar soils for resource studies such as oxygen or metal production, sintering, and radiation shielding.

Approximately 20,000 kg of JSC-1 simulant is currently available for distribution to qualified investigators. The material is stored at the Texas A&M University Lunar Soil Simulant Laboratory. We have described simulant preparation, characterization and availability in a recent publication entitled "JSC-1: A New Lunar Regolith Simulant," *Lunar and Planetary Science XXIV*, 1993.

A supply of oxygen will be critical to any permanent base on the Moon, and extensive studies are under way to develop methods of producing oxygen from lunar rocks and soil. One of the best-studied proposals involves the reaction of iron oxide in glass and minerals with hydrogen at elevated temperatures:

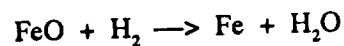

This reaction results in the reduction of iron oxide to iron metal, with the concomitant release of water. The water is decomposed to yield oxygen, and the hydrogen is recycled as a reactant.

This process has been demonstrated repeatedly in our laboratory, and others, using a variety of simulants. We recently reported results from the first tests on actual lunar material in an article titled "First Oxygen From Lunar Basalt," *Lunar and Planetary Science XXIV*, 1993.

We are currently building an oxygen test-bed designed for two purposes: scaleup of the oxygen production process, and investigation of supporting technologies required for a production unit.

The test-bed (fig. 1) is built around a single zone tube furnace with a cylindrical steel retort. The retort can hold hundreds of grams of lunar simulant material. Compared to our previous experiments, this represents an increase of over two orders of magnitude in the amount of material reacted and water produced. Lunar simulant samples are

loaded into the furnace retort which is then sealed and heated. The system design allows evacuation of the retort and purging with argon prior to the introduction of hydrogen. Reaction progress is monitored using a water sensor, and total oxygen yield is determined by measuring the weight loss of the sample.

A lunar oxygen production unit will require a variety of supporting technologies, including remote furnace control, separation of water from hydrogen, and purification of the gas prior to reuse. The test-bed is designed to provide practical experience in all of these areas. The furnace controller is configured for operation via a networked personal computer. An in-line condenser will be added to the off-gas line to separate most of the water. Final purification of the hydrogen prior to recycling will be accomplished by the polymer electrolyte cell in a commercial hydrogen generator.

This study, performed by Eagle Engineering for the Solar System Exploration Division, developed preliminary conceptual designs for ISRU experiments to be carried to the Moon by the Artemis (Common Lunar Lander) and First Lunar Outpost missions. The study included two parts: a survey of flight hardware and a set of spacecraft point designs. Results have been published as Eagle Reports 92-317, 92-318, and 92-319.

This part of the effort consisted of a survey of the known flight hardware that has already been developed and that might be used in a lunar program. This includes materials processing furnaces from Skylab, Spacelab, and Shuttle; Viking instrumentation such as the sample scoop; and gas chromatograph-mass spectrometer, television cameras, etc. Instruments under development were also included, and new experimental hardware was proposed. The mass, power, volume, etc. of these experiments were cataloged. This survey has proved to be a valuable resource for designers of lunar resource experiments.

Complete designs of experiments for the release and analysis of lunar volatiles and oxygen were produced (figs. 2 and 3). The designs were based on a proof-of-concept mission for an Artemis

lander and a pilot plant to be operated at the First Lunar Outpost.

Volatiles (solar wind implanted hydrogen, carbon, nitrogen, etc.) will be released by stepwise heating of regolith samples. The gas composition will be analyzed by a miniature mass spectrometer. Oxygen production units were designed around two different methods: hydrogen reduction and acid leaching. Hardware to perform surface sampling and analysis, experiment control and monitoring, communications, and thermal control was included in the design.

The point designs include preliminary estimates of component and total system mass and power requirements. These were kept within the current mission design constraints. System engineering studies were begun and top-level engineering drawings confirmed the suitability of the system for further development.

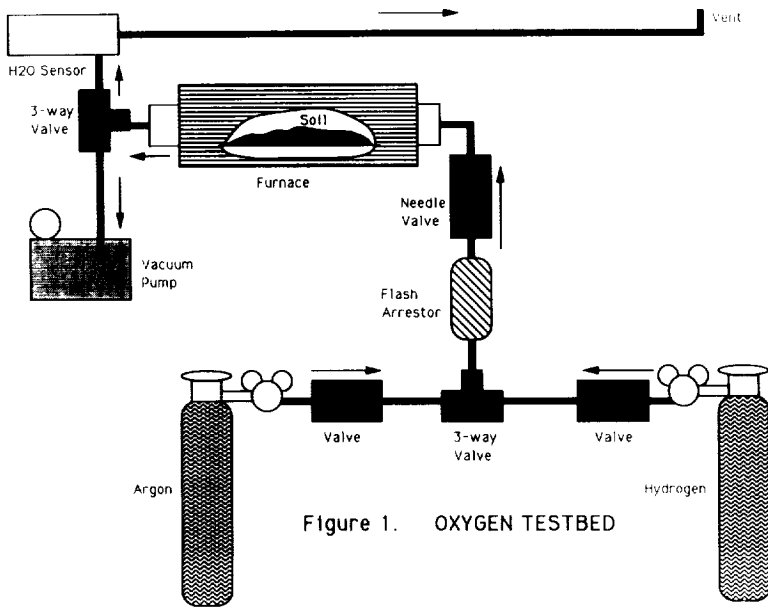

Figure 1. Oxygen test-bed.

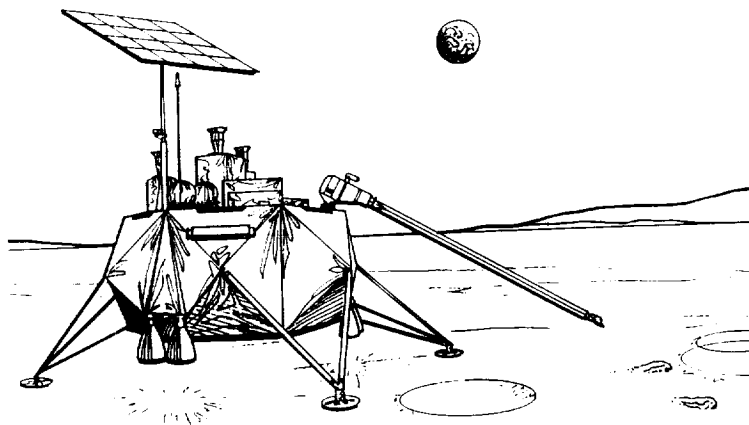

Figure 2. Artemis ISRU experiment — side view.

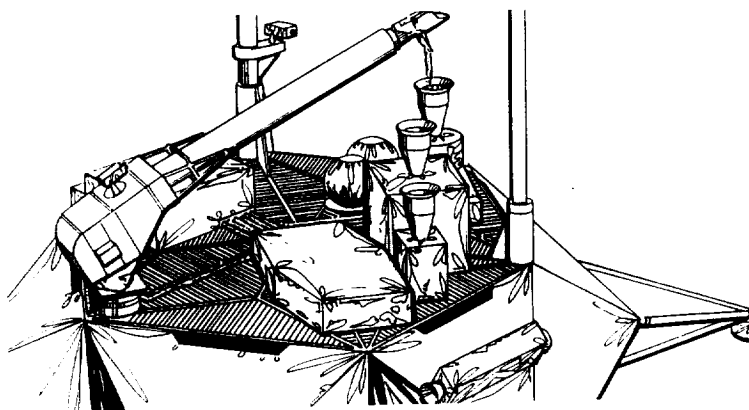

Figure 3. Artemis ISRU experiment — top view.

Measuring the Terrestrial Ages of New Mexico Meteorites

PI: Michael E. Zolensky, Ph.D./
SN21

Reference: SSS 2

There have been several attempts in this century to establish the accumulation rate of meteorite falls at the Earth's surface. This topic has gained importance with the growing realization of the possible threat from Earth-crossing asteroids and other extraterrestrial bodies. It is now well established that these foreign objects can have a major influence on natural processes on Earth. Recently, we used the observed concentration of meteorites in Roosevelt County, New Mexico, and the apparent age of the sediments composing the meteorite recovery surfaces to calculate the meteorite flux rate. Due to extremely favorable climatic and geomorphologic factors, Roosevelt County is the most prolific source of meteorite finds in the Americas. The meteorites are found in shallow basins, where high prevailing winds have blown away all cover sands to expose the meteorites present in the soil horizon. In our study, we took the age of these recovery basin surfaces to be 16,000 years before present, based on thermoluminescence (TL) and radiocarbon dating of material from adjacent basins in Roosevelt County. Nobody had performed age-dating of the actual meteorite recovery basins. However, from this assumed age and a consideration of the meteorite concentration and weathering factors, we inferred a meteorite flux to the Earth in excess of previous estimates by a factor of 5 to 10.

Because our meteorite flux estimate was so much greater than those from other techniques, we decided to test our assumptions by performing the first dating study (using TL techniques) of soil samples from the two most prolific meteorite recovery surfaces in Roosevelt County. Unlike some other radiometric dating methods such as ^{14}C , TL dating is based on an accumulation of signal. Grains of quartz and feldspar act as natural "dosimeters"; the passage of ionizing radiation through these grains, from the radioactive decay of naturally occurring uranium, thorium and

potassium isotopes within the sediment or soil, results in electrons being trapped at atomic-level defects in the crystal structure. On heating, the trapped electron population is liberated and a portion of these electrons recombine with the emission of light to produce a TL signal. The intensity of the TL signal measured at any particular temperature gives a measure of the energy required to liberate that portion of the electrons.

The TL clock is set to zero either by heating or by exposure to light, although in the latter case a small residual signal remains. To obtain a TL age estimate for a particular sediment sample, we need to know an estimate of the radiation dose absorbed by the mineral grains since their last exposure to light and an estimate of the annual dose of radiation as a result of the concentration of uranium, thorium and potassium isotopes within the sediment and from the flux of cosmic rays.

We selected the two most prolific meteorite-producing deflation surfaces in Roosevelt County for dating. We selected sites where wind had recently exposed material, bedding planes were well exposed, and there was no evidence of reworking by animals and roots. All samples were taken from a uniform radiation environment, i.e., there were no walls, faults or channels adjacent to sample sites. Two core samples were collected in each deflation surface, with the duplicate sample sites 300 m apart within each basin. The critical factor in performing this sampling was to not expose the interior of the soil cores to light.

The TL measurements were performed by Prof. Helen Rendell at the Geography Laboratory of the University of Sussex. TL signals are measured during the heating of samples in an argon atmosphere; TL output and temperature are recorded on a dedicated microcomputer. A critical step in the TL dating procedure is the measurement, either directly or indirectly, of the concentration of uranium, thorium, and potassium within the sample. The potassium content of the samples was measured directly by atomic absorption spectrophotometry. The beta activity of each sample is also measured and used to calculate the uranium and thorium contents.

The final TL ages determined for the Roosevelt County meteorite recovery surfaces ranged from 53 to 95 thousand years before present. All four of the Roosevelt County samples were far older than any soil samples previously analyzed from the Western U.S. High Plains. The measured TL levels in the samples are close to saturation, indicating that the age estimates obtained should be regarded as minimum ages for the samples. Nevertheless, we have shown that the meteorite recovery surfaces, and the residence time of the meteorites found on them, are much older than previously suspected. This result is supported by recent radiocarbon dating (by Dr. Tim Jull of the University of Arizona) of several Roosevelt County meteorites, some of which exceed 40 thousand years in age and are either at or beyond the limit for that dating technique. We find that the ages of these meteorite accumulation surfaces range up to circa 95 thousand years, making the Roosevelt County finds approximate terrestrial contemporaries to those of most meteorite accumulation zones in Antarctica.

Finally, the great terrestrial age of the Roosevelt County meteorites easily explains their high population. We conclude that unexpectedly high meteorite fluxes are not necessarily required to produce the observed meteorite accumulations in Roosevelt County. Rather, the dominant factors permitting such meteorite accumulations there are a persistent arid climate coupled with a fortuitously recent period of deflation which has excavated down to locally, extremely old surfaces. Future work to further constrain the meteorite flux rate at the Earth will come from studies of well preserved meteorites found in other arid regions including the Nullarbor Plain of Southern Australia, the Namib Desert in Namibia, the Atacama Desert in Chile, the northern Sahara Desert in Algeria and Libya, the Gobi Desert in Mongolia, and the Antarctic and Greenland polar ice caps.

Man-Made and Natural Hypervelocity Particles in Low Earth Orbit

PI: Friedrich Hörz, Ph.D./SN4
Reference: SSS 3

The Chemistry of Micrometeoroid Experiment (CME) was among 57 instruments on board the Long Duration Exposure Facility (LDEF) which was retrieved in January 1990 after some 5.7 years in low Earth orbit (LEO). Analysis of these LDEF instruments has provided a wealth of information on the physical and chemical LEO environment and its effects on diverse materials, including insights into spacecraft design and operations.

Specifically, LDEF presents an unprecedented opportunity to study the collisional hazard created by hypervelocity particles and to determine the relative roles of natural versus man-made impactors. The largest hypervelocity crater observed on LDEF was some 6 mm in diameter and was caused by a projectile approximately 1 mm in diameter. As a consequence, LDEF can only address relatively small particles, most of them <0.1 mm in size. While such particles are the most abundant on a number frequency basis, they nevertheless reflect a restricted mass-range relative to the total collisional hazard in LEO. The CME was designed to yield compositional information of particles in LEO by analyzing their fragmented or molten residues inside hypervelocity impact craters formed in metal targets. We report some preliminary results of such analyses, together with some first order conclusions.

The compositional analyses used Scanning Electron Microscope - Energy Dispersive X-Ray Analysis (SEM-EDX) methods in which the electron beam of a Scanning Electron Microscope (ISI-SR50) excites x-rays that are recorded with an energy dispersive system (LINK eXL Analyzer) to yield qualitative spectra about the relative proportions of specific elements. The CME exposed high purity gold (>99.99% Au) on LDEF's trailing edge (LDEF location A03) and aluminum (series 100; >99% Al) close to the leading edge (LDEF location A11), each collector some 1m² in surface area and containing numerous impact pits.

While any nonspinning space-platform, such as LDEF or the Space Station Freedom, sweeps through space, it will encounter more particles on those surfaces that point into the direction of motion (= leading edge) and of relatively high encounter velocities ($V_{\text{mean}} = 21$ km), as opposed to surfaces pointing in the opposite direction, i.e., toward the rear (= trailing edge), where total flux and encounter speed ($V_{\text{mean}} = 12$ km/s) are lowest, akin to the "windshield effect" caused by driving rain. As a consequence, the effective particle flux can be an order of magnitude higher in the forward-facing direction, and the forward-facing aluminum surfaces have, therefore, many, many more and larger craters than the rearward-pointing gold collectors.

We used a largely statistical approach in the compositional analyses to date, at the deliberate expense of detailed investigations using other methods, such as Transmission Electron Microprobe (TEM) or Secondary Ion Mass Spectrometry (SIMS). The current objective is to provide a survey-type assessment of particle types encountered by LDEF, which is important in its own right, and to identify a representative suite of materials worthy of the time-consuming TEM and SIMS analyses. To date, all impact craters >30 μm ($N = 199$) on the trailing edge gold were analyzed, yet only about a third of the craters >75 μm in diameter ($N = 415$) on the leading edge aluminum collectors have been analyzed. Approximately 50% of all craters do not yield projectile signatures, however, because many projectiles vaporized upon impact and left no impactor material in the craters that could be detected by SEM-EDX. This statement is strictly true for the gold collectors only because pure aluminum debris can generally not be detected on collectors that are also made of aluminum. Among the residues detected and analyzed, we recognize a great deal of compositional diversity. It is, however, easy to classify most spectra into interplanetary dust and man-made debris, and, indeed, into specific subgroups. The natural particles are dominated by chondritic compositions, followed by single minerals, such as olivine, pyroxene or Ni-Fe sulfides, all commonly observed in meteorites. Among man-made impactors, Al-bearing materials dominate the trailing edge gold collectors; the

“miscellaneous” category includes stainless steel, Cu- or Ag-rich materials, and various paint flakes.

Each crater analyzed has a measured diameter and by applying experimentally derived crater scaling laws that account for differences in target materials (Al versus Au) and for variable mean encounter velocities for the two major pointing directions, we converted each crater into an associated projectile mass. By accounting for total exposure time and surface area analyzed, we finally plotted the resulting particle fluxes in cumulative fashion in fig. 1. Note the dominance of natural, cosmic dust particles (top panel) on the forward-facing aluminum surfaces and the approximate order of magnitude difference in absolute flux between trailing- (AO3) and leading-edge (A11) locations, consistent with the findings H. A. Zook reported in "Deriving the Velocity Distribution of Meteoroids from the Measured Meteoroid Impact Directionality on the Various LDEF Surfaces" in NASA CP-3134. Nevertheless, more man-made impactors encounter the trailing edge than do natural particles and, as illustrated in the bottom panel, pure aluminum particles vastly dominate the miscellaneous category on the AO3 gold surfaces. As already stated, this populous aluminum debris cannot be characterized on the A11 aluminum collectors, unfortunately. The relative ratios of chondritic, olivine + pyroxene (ol/px) and Ni-Fe sulfides are approximately constant for both viewing directions.

The presence of man-made debris on LDEF's trailing edge was unexpected as most previous debris models assumed debris sources in highly circular orbits to totally dominate, essentially to the exclusion of other sources. A detailed study by D. J. Kessler entitled "Origin of Orbital Debris Impacts on Long Duration Exposure Facility's (LDEF) Trailing Surfaces" in *LDEF—69 Months in Space, Second Post Retrieval Symposium* modeled the above LDEF observations and concluded that debris sources in highly elliptic orbits and of modest inclinations, such as transfer vehicles of geosynchronous payloads, were substantially underestimated in the past.

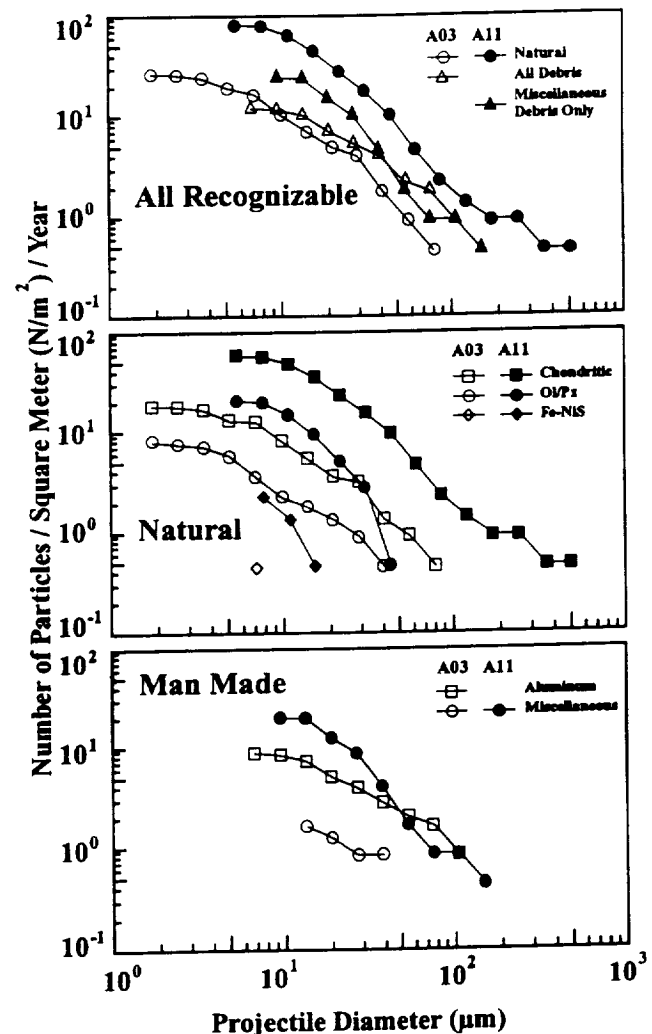

Figure 1. Resulting particle fluxes plotted in cumulative fashion.

Models of the Orbital Debris Environment

PI: D.J. Kessler/SN
R.C. Reynolds/LESC
P.D. Anz-Meador/LESC
Reference: SSS 4

The earliest models describing a population of undetected orbital debris in Earth orbit were developed by NASA in the 1970s. These models were based on past and predicted breakups of satellites in Earth orbit. They used incomplete data and a number of simplifying assumptions; consequently, the model predictions were highly uncertain. Even so, they demonstrated that by the 1990s, orbital debris would likely represent a greater hazard to Earth-orbiting spacecraft than natural meteoroids. Today, measurements of the population of small orbital debris resulting from over 100 satellite breakups in orbit are in general agreement with these early model predictions. Measurements of orbital debris too small to be cataloged by the U.S. Space Command (smaller than about 20 cm in diameter) have been made by a number of sensors. The best measurements have been by the Long Duration Exposure Facility (LDEF) satellite, the Haystack and Goldstone ground radars, and the Air Force's Ground-Based Electro-Optical Deep Space Surveillance System telescopes. In addition, ground tests have been conducted to more accurately determine the amount of debris generated when satellites break up in orbit. As a result, models describing the orbital debris environment have become more complicated and more varied, depending on their application.

Today, NASA has developed a large number of orbital debris models usually with different objectives and different customers in mind. The customers include the experimenters, policy makers, and design engineers. These differing customer needs divide the models into three types: support, evolutionary, and engineering. Support models are of interest primarily to the experimenter, although a policymaker will find some of the support models of interest. The results of evolutionary models are of interest to the

policymaker, and engineering models are used by spacecraft design engineers. The following is a description of some of the more important orbital debris models which have been recently developed or improved.

These models address a specific problem associated with orbital debris. For example, a recent model was developed to convert a set of orbital element sets into an expected impact crater distribution around an orbiting spacecraft. This model was used to evaluate the consistency between the directionality predicted by the orbits of objects in the U.S. Space Command Catalogue and the orbital debris impact craters found on LDEF. The model results lead to the conclusion that the Catalogue would have to contain a much larger number of highly elliptical orbits to be consistent with the LDEF data. This conclusion is consistent with some other support models. Models such as this, which relate one set of measured parameters to another set of measured or modeled parameters, are essential to comparing various measurements and modeling results to one another, as is necessary in the development of the engineering model discussed later.

Another recent model calculates the area to mass ratio of orbiting explosion fragments from changes in orbital characteristics over a period of several years. This model has demonstrated that area to mass ratios can vary widely for a given size orbiting fragment, which accounts for much of the uncertainty in predicting the future position of cataloged debris.

A "particle-in-a-box" model is a semianalytical model which approximates the long-term evolution of debris in orbit with a few particle sizes moving randomly in a large box. Objects enter the box through launches into the box and also through the fragments generated by explosions or collisional breakups within the box; objects are removed from the box at a rate predicted by atmospheric decay. The model demonstrates that under certain conditions a stable environment may result; however, under other conditions, an unstable environment could exist where the amount of orbital debris would continue to increase until most orbiting spacecraft had collisionally fragmented.

Expanding the concepts of the particle-in-a-box model, the critical density model calculates the conditions under which an unstable environment would exist. That is, given the current satellite sizes and types of orbits of objects currently in orbit, what is the number density of satellites required to generate collisional fragments at a rate that is faster than they are removed by atmospheric decay? This critical density calculation is shown in fig. 1, and is compared with the number density resulting from the objects in the December 1989 U.S. Space Command Catalogue. The results predict that some regions of low Earth orbit are already above the critical density. While there is some uncertainty in this prediction, it does demonstrate that the amount of orbital debris at some altitudes will likely increase, even if few new objects are launched into these altitudes. Predicting exactly how and at what rate this might occur is the task of the evolutionary models.

An evolutionary model consists of a specific set of support models (such as traffic, satellite breakup, atmospheric drag, and flux models) tied together to predict the changing orbital debris environment. The traffic models describe the rates that international payloads, rocket bodies, and associated debris are placed into various orbits. If an object explodes (as determined by the traffic model) or breaks up from an accidental collision (as determined from the flux model), then the satellite breakup model is used to determine the number, size, and new orbits of the resulting fragments. The atmospheric drag model calculates the decaying orbit parameters as a function of time. The flux model converts the orbital characteristics of each orbiting object into collision probabilities.

The NASA evolutionary model is called EVOLVE. Figure 2 is an example output from EVOLVE showing the predicted changes in the flux of 1 cm and larger orbital debris over the next 100 years, assuming various future operational practices. Case 1 assumes that the world continues to place objects in orbit and also allows objects to explode in orbit at the same rate as averaged over the last 20 years. This causes a significant increase in the population at 1000 km altitude over the next 100 years. At 400 km, the varying atmospheric density produced by the 11-year solar cycle causes a varying flux with a

general trend upward. Case 2 assumes that explosions are stopped in the year 2000. This results in a decrease in the environment, especially at 400 km altitude. However, after about the year 2030, sufficient objects are breaking up as a result of collisions that the environment again begins to increase. Collisions occur at an average relative velocity of 10 km/sec. Consequently, the combination of number density and high-collision velocities results in kinetic energy, rather than the stored energy of a chemical explosion, being the dominant energy source causing satellites to break up after 2030 under the case 1 and 2 assumptions. Case 3 minimizes the growth of kinetic energy in orbit by requiring upper stages launched after the year 2000 to reenter after delivering their payload, and payloads launched after the year 2030 to reenter at the end of their operational life (assumed to be 10 years). Even so, there is still a small upward trend, due to collisions in the predicted 1 cm and larger population at 1000 km, consistent with the critical density model prediction in fig. 1.

Other evolutionary models have been independently developed by other organizations. The Technical University of Braunschweig in Germany has developed a model called CHAIN. Through a Memorandum of Understanding, NASA and the University modeling teams meet every 6 months to exchange results and recommend various model tests. This exchange in information has improved the capabilities and confidence that each team has toward its models. The CHAIN model results agree with the trends predicted by the EVOLVE model; however, the differences in satellite breakup models used by each produce differing predictions of the current 1 cm environment. Measurements by the Haystack Radar of the 1 cm population tend to support the EVOLVE model.

An early version of EVOLVE has been given to the Air Force's space debris modeling working group, which has modified it and put it into a user friendly format for use on its debris analysis workstation. This workstation is planned to support future Department of Defense programs.

An engineering orbital debris model combines the outputs of other orbital debris models with

An engineering orbital debris model combines the outputs of other orbital debris models with measurements of the environment to produce an environment definition model that can be used by spacecraft design engineers. Figure 3 shows the environment predicted in 1995 at 500 km altitude by the engineering model in SSP-30425 which was recently approved for use in the design of Space Station Freedom. For an engineering model to be useful for the design engineer, many simplifying assumptions are contained within the model. These assumptions are tested using the EVOLVE model, support models, and measurements of the environment. As new measurements and modeling results become available, many of the assumptions could change and subsequently change the form of the engineering model.

All three types of orbital debris models are providing new insight on how to protect against, measure, and manage the orbital debris environment. The uncertainty in the models has been reduced to the point that all space-faring nations have voluntarily taken steps to reduce the possibility of future explosions in orbit. Through a continued exchange of data and modeling results, both on a national and international scale, there is emerging a consensus on the need to limit the orbital lifetime of future upper stages and payloads. The exact date that this will be necessary will depend on a further reduction in the uncertainty of model predictions.

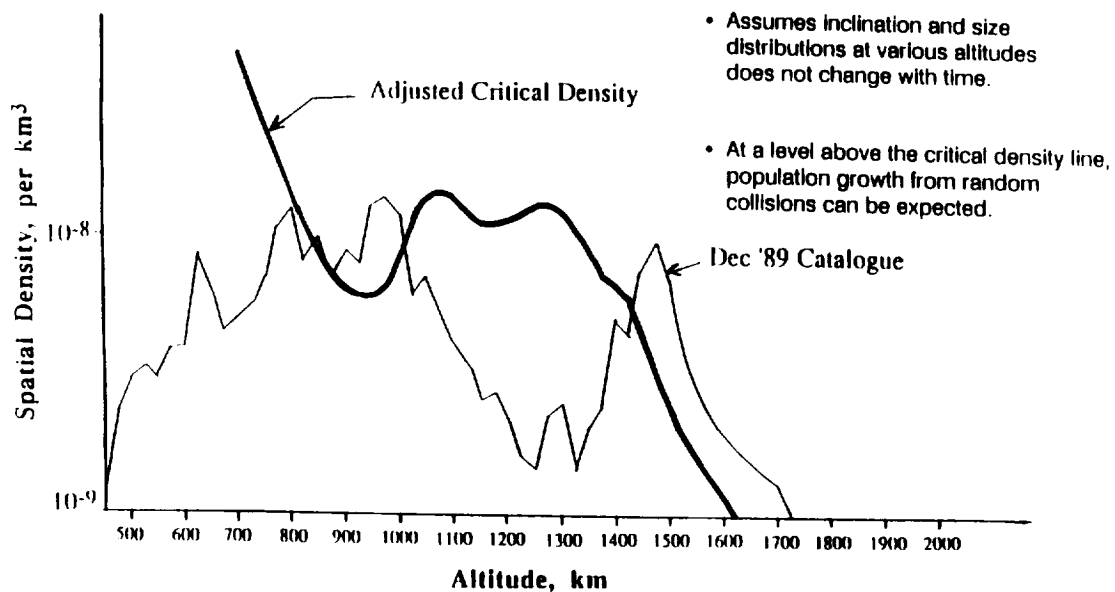

Figure 1. Critical density compared to 1989 cataloged population.

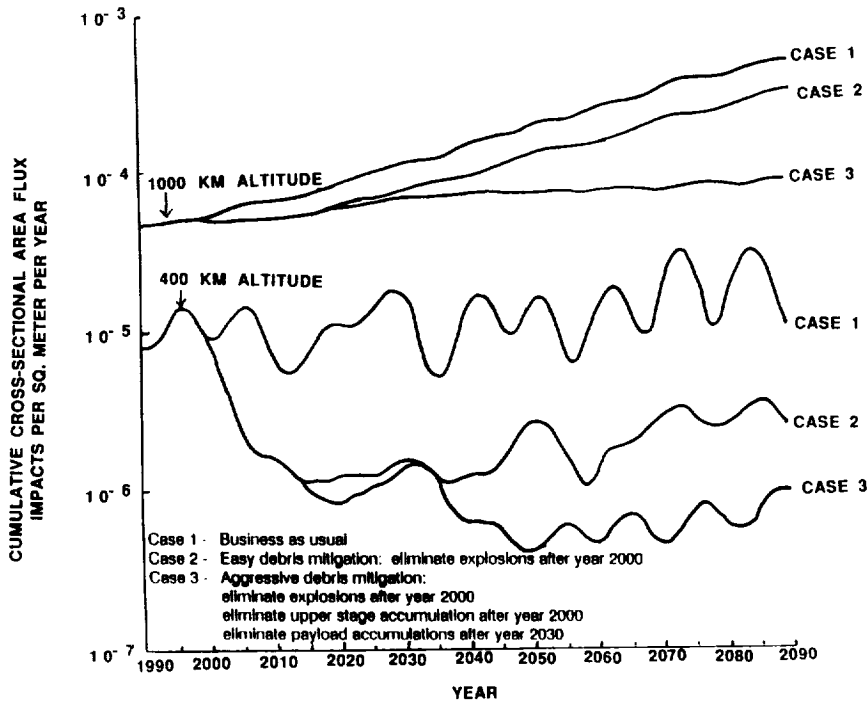

Figure 2. EVOLVE model projection of 1 cm and larger orbital debris flux for three possible operational practices. All assume a continuation of current launch rate.

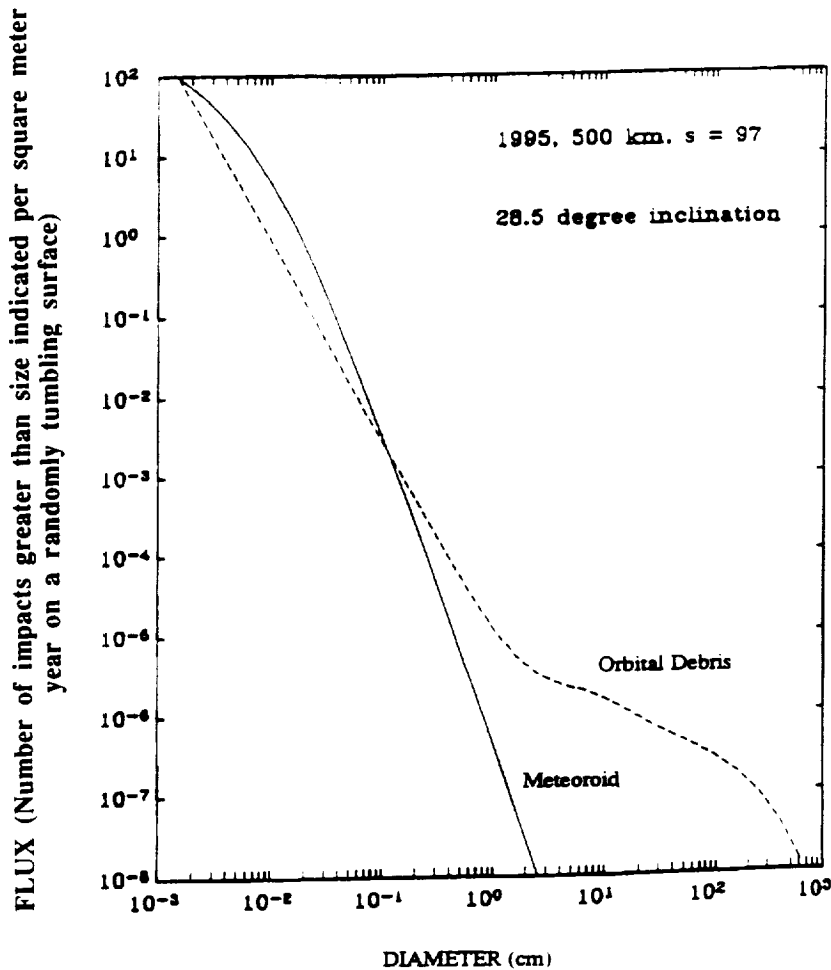
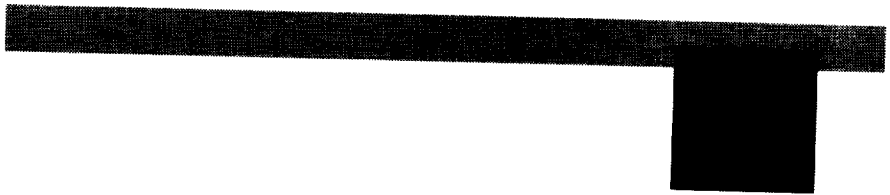

Figure 3. Comparison of meteoroid and orbital debris fluxes as a function of size from the NASA engineering models used for Space Station Freedom design.

Section IV

***Space
Transportation
Technology***

Summary



Space Transportation Technology Summary

The Space Transportation Technology activities at JSC are focused on increasing the operability and capability of human missions and spacecraft, developing an architecture and technology base for future human transportation, and space assembly and servicing. One important segment of JSC's 1992 activity was in the autonomous guidance, navigation, and control (GN&C) area. Specific technologies addressed included new sensors/sensing devices, ground and onboard GN&C algorithms, and vehicle monitoring systems to provide an autonomous ascent GN&C for the Space Shuttle and other launch vehicles. The Electrical Actuation Technology Bridging (ELATB) program is aimed at defining, developing, and demonstrating the maturity, efficiency, and operational cost/schedule benefits of electrical actuation technology in lieu of hydraulic systems for existing and future vehicles. Both GN&C and ELATB are multicenter programs, bridging the resources, expertise, and facilities to achieve cost-effective approaches for all future programs of the Agency.

The Artificial Intelligence Printer Controller (AIPC) project was completed and transferred to the Space Transportation System Operations contractor in June 1992. The objective of this project is to prototype and assess the use of artificial intelligence to automate the monitoring task functions of the printer controller position for the Operational Support Team. The AIPC system has resulted in direct Shuttle operations cost reductions of approximately \$700k annually. Furthermore, it has demonstrated the capability to improve operations efficiency by identifying expected problems and potential resolutions.

An application software package called the Rendezvous Operations Software System (ROSS) was developed and certified for mission support in April 1992. The ROSS is designed to assist the rendezvous guidance and procedures officer in flight control duties at the JSC Mission Control Center. Specifically, this software package

monitors data displays and makes recommendations to the flight director concerning Space Shuttle guidance, navigation, and crew procedures during labor-intensive rendezvous operations.

A significant activity for JSC in 1992 was the development of the Playback Trainer (PBT), a training facility for the flight controller. The PBT is used to separate failure recognition training objectives from integrated Space Shuttle mission simulations. This training tool has demonstrated a reduction in the total amount of integrated training required and an improvement in the quality of flight controller training. The applications of this tool continue to be investigated in many flight control areas.

A key development for the safe and efficient conduct of a Space Shuttle mission is the awareness of and response to weather conditions at various sites of interest around the world. A prototype of a Flight Director Weather System (FDWS) was developed for assimilation of real-time weather data so that weather-dependent decisions can be made quickly and definitively. This system is functionally oriented and has a user-friendly graphics interface. The FDWS has proven to be of great benefit to flight directors at the Center.

An investigation of the maintainability of modern space facilities was addressed through the development of a computer-based analysis tool. Currently, a test for this prototype is being developed for the maintenance problems that the managers of various Space Station Freedom work packages would like to have investigated. In another effort, a self-contained diagnostic capability, including sensors, processing system, and a storage and retrieval system for the vehicle health monitoring of the orbital maneuvering subsystem and reaction control subsystem was investigated. Algorithms will be developed to analyze the data generated by the sensors for trending purposes and information extraction. This is considered a high-priority technology by the Agency and has the potential for significant cost-savings and enhancement of safety.

The experimental investigation of spacecraft glow (EISG) is aimed at the study and analysis of space

PREVIOUS PAGE BLANK NOT FILMED

glow emissions in the ultraviolet, visible, and infrared wavelength ranges. Significant accomplishments in 1992 included the completion of instrument development and the assembly required to initiate system certification tests at JSC.

The Orbital Acceleration Research Experiment (OARE) has developed an accelerometer system capable of measuring low-level acceleration with heretofore unobtainable accuracy, resolution and sensitivity (nano-g) along the Orbiter's principal axes. This information will provide a better understanding of vehicle aerodynamics and related fluid mechanics in the free molecular flow regime as well as expanding the technology data base for orbital drag predictions to be used in space transportation systems designs, future large space structures, attitude and orbital control systems, and orbit maintenance and energy management concepts development. In addition, the OARE will also provide a capability to characterize the low frequency microgravity environment available on the Orbiter. Understanding the microgravity environment is essential since this is one of the major capabilities the Agency can exploit for commercial activity in space.

This section contains details of the projects briefly mentioned in this summary.

Section IV

***Space
Transportation
Technology***

Significant Tasks



Autonomous Guidance, Navigation and Control Technology Bridging Program

PI: Gene McSwain/EG22
Reference: STT 1

A multicenter NASA team is developing technology for autonomous guidance, navigation, and control (GN&C) systems. The four NASA centers cooperating in these activities are Johnson Space Center, Kennedy Space Center, Langley Research Center, and Marshall Spaceflight Center. NASA and contractor programs have been used to demonstrate technology that can be incorporated into the Shuttle and other NASA programs. Close coordination with the Level II Shuttle Program Office ensures that the technology being developed has direct application to and will benefit the Shuttle program or other near term NASA programs. Specific dialogues were initiated in the past year with engineers working on the Marshall Space Center National Launch System (NLS) and the McDonnell Douglas Delta launch vehicle.

The specific objectives of this RTOP are to develop and demonstrate technology in the areas of new sensors/sensing devices, ground and onboard GN&C algorithms, and vehicle monitoring systems to provide a more autonomous ascent GN&C for the Shuttle and other launch vehicles. Objectives also include improvements in the ground systems functions, such as wind measurement and day-of-launch steering update, that support the onboard system. When technology advances support other flight phases (such as wind measurement for Shuttle entry and landing), demonstrations for these applications will be undertaken as well.

The 1992 activities continued to focus on ways to improve launch availability in relation to winds aloft. Significant conclusions were

- The use of pulsed-Doppler systems (lidar and radar profilers) for wind soundings
- Improvements in day-of-launch trajectory shaping through use of rapid wind measurement

- Improvements in onboard GN&C systems for launch vehicles in order to reduce operational costs and improve launch availability and flexibility

Radar profiler wind soundings obtained during the launches of eight Shuttle missions were used for postflight reconstructions of the ascent trajectories and were compared with the standard reconstructions that normally use Jimsphere balloon soundings. The two types of reconstruction were comparable for four of the flights. For the other four, however, the profiler soundings produced better matches with the flight data, demonstrating that the profiler wind more closely resembles what the Shuttle actually encountered. This information is being reviewed with Shuttle program personnel.

In addition, a general definition of Shuttle program wind measurement system requirements was developed, documented, and reviewed to serve as a basis for future decisions on wind measurement systems for the Shuttle and possibly other NASA launch vehicle programs.

In the area of wind sounding demonstrations, the emphasis shifted to the landing phase. A comparison demonstration of a solid state lidar and a small, portable Doppler radar was planned in conjunction with a test of the Shuttle automatic landing system (autoland) at Edwards AFB on STS-53. However, the autoland test was canceled and the lidar/radar profiler test was moved to Kennedy to reduce costs and was rescheduled for February 1993.

Development of improvements to ground and onboard algorithms for boost-phase ascent flight resulted in the release of a document titled "A Benchmark Guidance, Navigation and Control System for Future Launch Vehicles," (McDonnell Douglas Transmittal Memo 5.23.7.10-233, 2 October 1992). The document details a Shuttle GN&C formulation with evolutionary improvements based on the new Shuttle day-of-launch ground-based trajectory shaping program and the McDonnell Douglas Delta launch vehicle GN&C. Also included are criteria for consistency in evaluating alternative launch vehicle GN&C formulations.

This information was reviewed with MSFC GN&C engineers, who are finding it useful in their assessments of candidate GN&C formulations for the NLS program. Of particular use to that group are the evaluation criteria for consistency in and the adaptive features of the benchmark GN&C formulation which compute the proper steering commands for any single engine failure.

The benchmark system borrowed from the Delta vehicle the concept of loading a wind profile onboard based on soundings made close to launch time and computing steering commands to fly the desired aerodynamic angle of attack and sideslip to minimize structural loads. The benchmark, however, made significant improvements in the method used to compute the steering commands required immediately after tower clear, which are critical in determining overall performance and launch availability. Engineers working on the Delta program have expressed interest in adapting these improvements back to their own vehicle, in light of a launch scrub this past summer due to their nonoptimal choice of initial steering commands.

Finally, in related work, the Shuttle active load-alleviation feature was studied because of evidence uncovered in last year's RTOP work that, with the introduction of day-of-launch steering commands, overall vehicle loads may actually be increased by this feature, rather than decreased. Analysis showed that the load-alleviation feature does indeed attenuate wind disturbances of "large" scale (that is, large scale shear layers and major changes in the jet stream), but that these disturbances, which typically persist for long periods of time, are now accounted for in the steering command updates based on the measured wind on the day-of-launch. On the other hand, "medium" scale wind disturbances are amplified, rather than attenuated, by the load alleviation feature. Small scale disturbances are short-lived, small in magnitude, and beyond the bandwidth capability of the Shuttle control system.

The amplification of medium scale disturbances is inherent in the use of accelerometers as a means of sensing and responding to these disturbances and cannot be eliminated without also eliminating the

attenuation effect of the large scale disturbances. However, RTOP personnel have made use of advances in control system design theory developed in the last 5 years (Robust Control Theory) to minimize the amplification effect using H-infinity optimization techniques. Initial results, working in just the pitch channel, show a 75% decrease in the amplification. Work is continuing on a design for the highly coupled lateral channels (roll-yaw), which necessitates a multivariable approach.

In summary, significant progress has been made on this RTOP in the following areas:

- Demonstrating the usefulness of pulsed-Doppler wind sounding systems for shortening the timeline and improving the accuracy of calculating day-of-launch steering commands, a practice which has become standard in the launch vehicle industry
- Demonstrating the usefulness of pulsed-Doppler wind sounding systems for improving the accuracy of postflight reconstructions, which are helpful in detecting flight anomalies and tracking subsystem trends
- Improving the technology transfer from industry to NASA, from NASA to industry, and from one NASA program to another
- Demonstrating the application of advanced control system theory to practical problems
- Improving the overall understanding of the interaction of launch vehicle dynamics and winds

Electrical Actuation Technology Bridging Program

PI: Don C. Brown/EG1
Reference: STT 2

The Electrical Actuation Technology Bridging (ELATB) program is sponsored by the Headquarters Office of Space Systems Development (OSSD) to define, develop, and demonstrate the maturity, efficiency, and operational cost/schedule benefits for existing and future vehicles of electrical actuation (ELA) technology in lieu of hydraulic systems. Five NASA centers, JSC, LeRC, MSFC, KSC and SSC, are team members in an innovative cooperative approach to advanced technology development and transfer, whereby the resources of each center are effectively used and all potential users/customer programs are defined and coordinated with directly. Figure 1 depicts ELATB team roles and responsibilities. ELA technology applies to the spectrum of aeronautic and space vehicles and has enormous commercial potential (such as use in electric autos), offering a huge payoff to the nation for leading the development of this technology. An ELATB program top-level "roadmap" (fig. 2) was developed and is continually updated to highlight the primary focus and flow of the program.

The following significant accomplishments were made during the year.

JSC was responsible for overall management of the multicenter ELATB program, performing technical integration, budget management, planning, and scheduling until July of this year. These responsibilities were then transferred to LeRC by agreement with the NASA Office of Space Systems Development ELATB program responsible manager. An integrated video presentation of the ELATB program and the state-of-the-art in electrical actuation technologies were developed by JSC and presented to industry. Copies were distributed to all ELATB team members and NASA Headquarters representatives for use in future program briefings.

The JSC Navigation, Control, and Aeronautics Division's actuator test set was christened for

operation, and evaluation testing for possible space vehicle adaptation was completed on a Parker-Hannefin-built electrohydrostatic actuator (EHA) used in commercial air transport nose-wheel steering applications (~10 kW). Rockwell developed a plan for testing various ELATB designs using a common set of operating parameters typical in vehicle flight control applications. The test procedure was used to test MSFC and LeRC prototype electromechanical actuators (EMAs) and several industry electrical actuators using both AC induction and brushless permanent magnet motor technologies.

A JSC-sponsored Lamar University study of state-of-the-art advanced development progress in high power battery technology supporting ELA flight control applications was performed. Results were incorporated into ELATB plans for demonstrating end-to-end integrated ELA/power source capabilities. KSC and JSC surveyed industry, DoD, and other entities to determine the status and maturity of advanced battery and alternative electrical power source technologies (flywheels, fuel cells, turbo-alternators).

In response to program concerns about advanced electrical power source development progress, system design, and test issues, JSC initiated a project to develop a multi-purpose programmable ELA power source simulator (ELAPSS). ELA power source requirements were studied and baselined for National Launch System (NLS) and Shuttle solid rocket booster (SRB) thrust vector control (TVC) systems, and ELAPSS requirements and design concepts were developed. Industry responded favorably to an ELAPSS presentation at a September MSFC workshop. Subsequent funding constraints resulting from the NLS cancellation required the ELATB program to postpone the development of the ELAPSS. The project was closed out in October.

A detailed study was completed at KSC on the Shuttle SRB TVC ground processing work flows and individual activity costs. Results indicate that on a Shuttle SRB TVC, use of ELA instead of hydraulics would save a minimum of \$3M per flight and reduce processing time by 78%. Further study is indicating these estimates are very conservative and do not consider recurring costs in

administrative and support services, such as safety analysis/tracking/disposition, equipment/tool maintenance, documentation.

MSFC successfully completed and tested an in-house design of a permanent magnet brushless motor and breadboard controller, using integrated gate bipolar transistors (IGBTs) for high-power switching to approximately 18-20 kW power levels. Further controller development is continuing to increase the power capability to typical TVC levels of 40 kW and higher. Development of a quad-redundant actuator capable of providing 60 kW output power was initiated and testing is scheduled in early 1993. MSFC also completed development and testing of advanced ELAs for launch vehicle propellant control valve (PCV) applications. A number of industry Independent Research and Development ELA units were developed and tested at MSFC during the year, with impressive results. Moog has successfully tested an in-house permanent magnet brushless motor technology to 38 hp, meeting the Space Shuttle main engine rate and load requirements. An ELATB Program workshop was held at MSFC in September of this year, at which these systems were openly demonstrated. Specific splinter sessions were held to discuss issues and recommendations for near-term development of higher power ELAs to support heavy lift TVC applications; i.e., advanced/redesigned solid rocket motors, heavy lift launch vehicles or an NLS derivative.

A LeRC/General Dynamics ELA using an AC induction motor with field-oriented control technology and a prototype high power controller with IGBTs and built-in test was further developed and demonstrated to approximately 25 kW output power level. Development and testing continues toward a proof-of-concept at the 40 kW level. Two Moog roller-crew mechanical actuators were procured for integration with the motor/controller designs, which included an optimized dual-stator, split-rotor motor design to facilitate dual/quad redundant testing through the controller and motor. NLS EMA Advanced Development Program funding was supporting the development and demonstration of the AC induction motor with field-oriented control technology. The cancellation

of NLS has impacted the planned progress at General Dynamics in testing this system at higher power ranges. Some shift in ELATB program funding was made to continue this effort.

SSC completed an industry search, procurement, and evaluation testing of an ELA designed for valve control applications in ground support equipment (GSE). SSC is evaluating and documenting the potential cost benefits of utilizing ELAs in the many ground test and checkout fluid distribution systems at the center. Indications are that replacement of current hydraulic valves would pay off measurably in SSC ground support operations and maintenance costs.

In summary, the project is becoming well focused, moving toward an eventual hot-fire test of a prototype advanced redundant ELA system on the MSFC Technology Test Bed. Through increased cooperation and consensus, the team has developed a strategy to demonstrate an ELA system proof-of-concept and its benefits to NASA through space vehicle and GSE applications. We need to continue to work on replacing the old "stovepipe" communications paradigm with a "network" model, to maximize the effectiveness of the team and its resources, and to promote target user programs. ELA technology that can support flight vehicle engine TVC and propulsion control valve/main oxidizer valve applications has been demonstrated. Prototype flight systems are being baselined for development. Current power source technology can be adapted or developed to support ELAs for space applications. Collaboration between the ELATB program and NASA battery technology initiatives and the United States Advanced Battery Consortium (USABC) initiative should be established and progress leveraged/shared. Opportunities for ELATB program synergy with electric airplane and Space Exploration Initiative ELA technology application is a secondary project objective.

ELECTRICAL ACTUATOR/POWER TECHNOLOGY BRIDGING PROGRAM

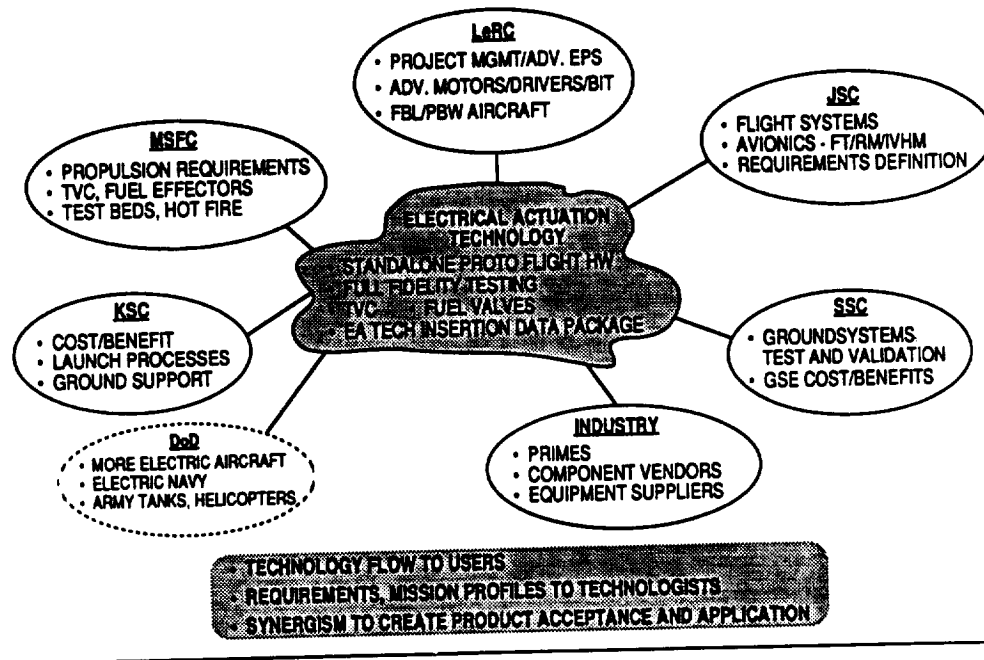

Figure 1. The ELATB program grew out of the Strategic Avionics Technology Working Group as a pilot program to do business a new way. Five NASA research and flight centers provide representatives to ensure that electrical actuation technology development meets mission and vehicle requirements. The NASA team works with industry to develop and test prototype flight hardware items designed to be stand-alone replacements for existing hydraulic TVC and fuel effectors on launch vehicles. The team will provide cost/benefit analysis, recommendations for launch process improvements and technology insertion data packages to program managers. The team maintains close contact with DOD work and test programs demonstrating several types, sizes, and redundancy capabilities of electrical actuation.

ELECTRICAL ACTUATION TECHNOLOGY BRIDGING ROADMAP

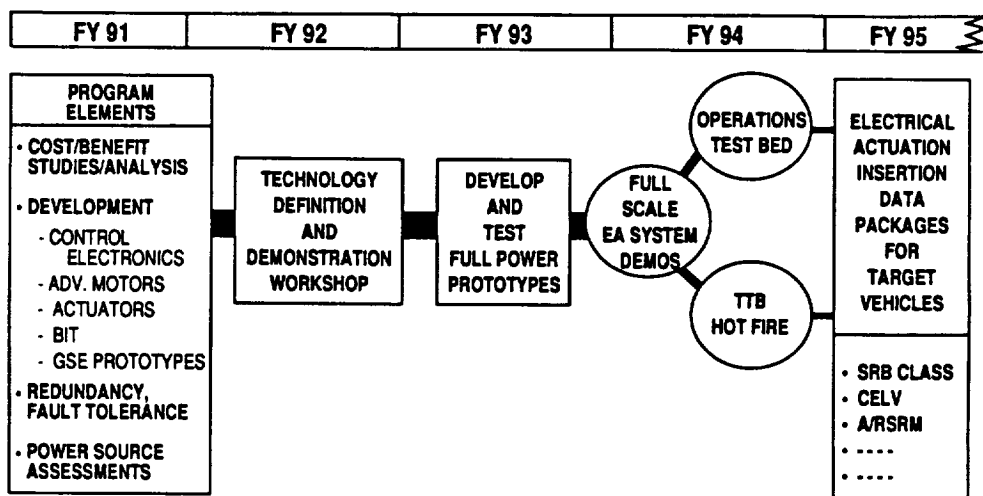

Figure 2. This roadmap shows key milestones across five program years. The program elements shown on the left are integrated and demonstrated to produce the deliverables—several data packages for technology insertion into target vehicles. In FY92 we accomplished a significant milestone with the Technology Definition and Demonstration Workshop held at MSFC on September 29 to October 1, 1992. Over 130 people attended the workshop with a large representation from industry to exchange information and witness the hardware demonstrations. In FY93 and FY94 the plan is to demonstrate two 60 Hp EMAs to full power meeting force, rate and fault tolerance requirements for a SRB drop-in replacement for TVC. Then one actuator will proceed to the TTB for Hot Fire tests at MSFC and the other will be inserted into the Operations Test Bed at KSC.

Computer-Operated Automated Assistance

PI: Mitchell Macha/DK
Reference: STT 3

The Artificial Intelligence Computer Program (AIPC) system was transferred from the Mission Systems Contractor (MSC) to the Space Transportation System Operations Contractor (STSOC) on June 30, 1992. STSOC obtained flight certification of the AIPC Ops 1 platform and is nearing the completion of the AIPC Ops 2 platform installation. Subsequently, the Artificial Intelligence Printer Controller (AIPC) Research and Technology Objectives and Plans (RTOP) is complete and below is an executive summary on the AIPC RTOP.

The Space Shuttle Ground Systems Division (SSGSD) at JSC is responsible for the Mission Control Center (MCC) ground systems hardware and software to support the Space Shuttle Program (SSP). The MCC consists of many computer-driven systems that generate, process, and store tremendous amounts of status and configuration data that must be monitored to ensure the ground systems integrity. Automating the mundane and repetitive data monitoring tasks is one way to increase productivity and reduce the possibility of failure due to incorrect or untimely human responses.

The AIPC RTOP began in FY90 to develop and assess the use of artificial intelligence (AI) techniques to automate the monitoring functions of the printer controller position of the operational support team (OST), thereby reducing SSP mission support costs. The mission operation computer (MOC) and the dynamic standby computer (DSC) systems provide printed real-time status and configuration error messages and advisories which are reviewed by the printer controller during missions, simulations, pad tests, and other support activities. The printer controller reports significant or anomalous event messages to the appropriate OST member, who takes corrective action or monitors the situation to ensure the operational integrity of the MCC ground-based computer

systems. The controller also logs certain less urgent information. The FY90 AIPC prototype successfully demonstrated an automated monitoring capability of the MOC computer system for the Computer Supervisor (ComSup) OST position.

The FY91 AIPC prototype expanded the FY90 capabilities and successfully demonstrated an automated monitoring capability of a MOC/DSC dual machine computer system environment for the ComSup OST position.

The FY92 AIPC work focused on distribution and monitoring of the MOC/DSC computer systems for the remaining five OST positions (Trajectory, Command, Netcom, Telemetry, and DFE Playback). Additionally, SSGSD management secured additional funding to meet all of the remaining user requirements, to harden the AIPC system to meet SSP operational requirements, and to provide the capability to support dual operations (fig. 1).

The AIPC OPS 1 platform provided STSOC with the capability to support a single Space Shuttle operation. STSOC procured and is installing the AIPC OPS 2 and independent verification test hardware platforms. With installation and flight certification of the OPS 2 platform, STSOC can support dual flight operations and can achieve maximum staffing reductions for the OST printer controller positions. At the end of FY91 activities, STSOC saw that the AIPC system could automate the printer controller position and canceled a planned staffing increase of three for the printer controller position for FY93. In the first quarter of FY93, the printer controller position will be removed from the team. These changes will result in an additional cost savings of eight work year equivalents to NASA. The AIPC OPS 1 platform began supporting generic flight simulations in August 1992 and supported the STS-47 mission in a flight-following mode in September 1992. The AIPC OPS 1 platform was flight certified and supported the STS-52 and STS-53 mission operations. The AIPC system has resulted in direct STS operations cost reductions of approximately \$700k annually and improved operations efficiency

through expeditious problem identification and resolution. The AIPC RTOP successfully demonstrated the practical benefits of an automated printer controller capability in the MCC and provided the necessary groundwork that resulted in successful operational implementation.

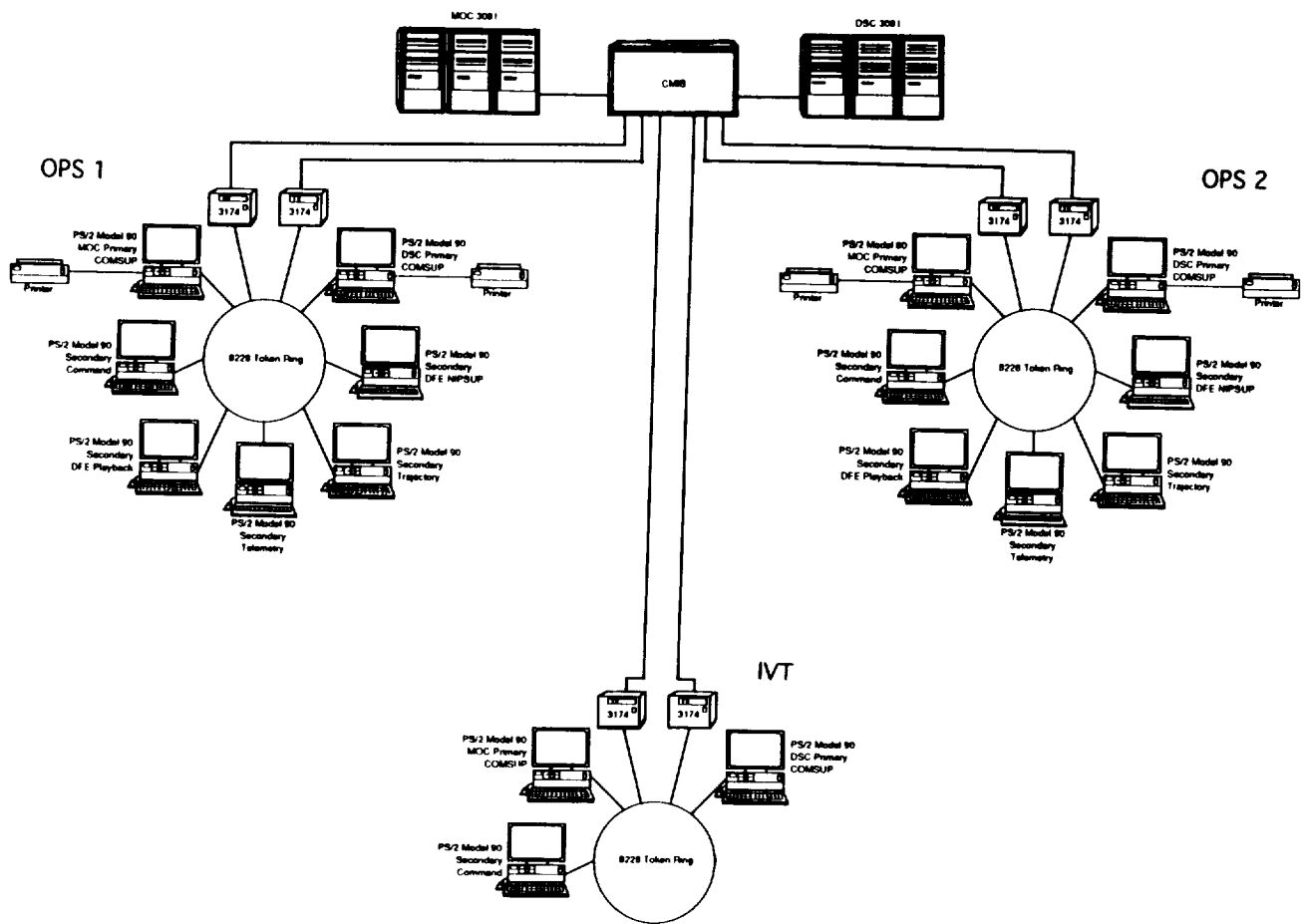

Figure 1. AIPC hardware configuration.

Rendezvous Expert System

PI: H.K. Hiers/ER2

Reference: STT 4

The objective of this project is to develop workstation application software to assist the Rendezvous Guidance and Procedures Officer (RGPO) in flight control duties at the Mission Control Center (MCC). The project is funded by the Office of Space Systems Development, Advanced Programs Division, and implementation of the software is closely coordinated with the Trajectory Operations Branch of the Mission Operations Directorate.

The RGPO is the flight controller responsible to the Mission Flight Director for onboard rendezvous operations and procedures in the Mission Control Center (MCC). Specifically, the RGPO monitors data displays and makes recommendations to the Flight Director concerning guidance, navigation, and crew procedures during Shuttle missions in which a rendezvous with another spacecraft is planned.

The standard MCC displays contain digital data received via telemetry from the Shuttle, plus ground-computed data. These data are presented in a textual format which requires careful attention to ensure correct interpretations of the data and data trends. The workstation software developed in this project adds a significant level of automation to the current labor-intensive mode of operation and provides data in more easily interpreted graphical forms.

The result of the FY91 and FY92 development was an application software package called the Rendezvous Operations Software System (ROSS) (fig. 1). ROSS was implemented in the generic X Windows programming environment and was designed to operate under MCC workstation executive software. ROSS was integrated into a Concurrent (Masscomp) 6600 workstation in the MCC, and in April 1992 was certified for mission support.

ROSS was used for the first time in a mission support role on STS-49 in May 1992. This complex mission included three rendezvous with the stranded Intelsat VI satellite. Significant savings in

Shuttle Reaction Control System fuel resulted from ROSS's ability to optimize the Shuttle plane control faster than the Mission Operations Computer (MOC) in the MCC. In addition, the relative trajectory was monitored more efficiently than ever before with the tools provided by ROSS. Later in 1992, ROSS was also used to support the European Retrievable Carrier (EURECA) operations on STS-46 and the Canadian Experiment (CANEX) operations on STS-52. With the introduction of ROSS, mission support staffing was reduced by one person, promising significant manpower savings for the increased number of rendezvous simulations and flights expected in the future.

ROSS performs computations on rendezvous-critical data and presents results in specialized "window" displays used by the RGPO and support personnel for monitoring the progress of the rendezvous. Some of the windows available are

- Graphical representation of the Shuttle attitude in the LVLH (Local Vertical/Local Horizontal) frame of reference
- Event timer windows for time-to-attitude, time-to-planar crossing, time-to-Vbar/Rbar
- Caution and warning alarm windows for free-drift alarm, rendezvous radar alarm, and star tracker alarm
- Plot windows for Shuttle/target in-plane and out-of-plane relative motion
- General purpose plot window for any telemetry parameter
- User-interactive trajectory planning window

A number of ROSS enhancements have been identified for continued development in FY93. These include

- Automatic timeline-driven checklist
- Navigation state convergence checker
- Additional relative motion plotting and trajectory planning capabilities

ROSS is one of the MCC workstation applications planned for the Common Control Center (CCC) for Space Station Freedom and Shuttle on-orbit operations. ROSS was recently rehosted on the prototype CCC workstation with ease, proving that ROSS is machine independent.

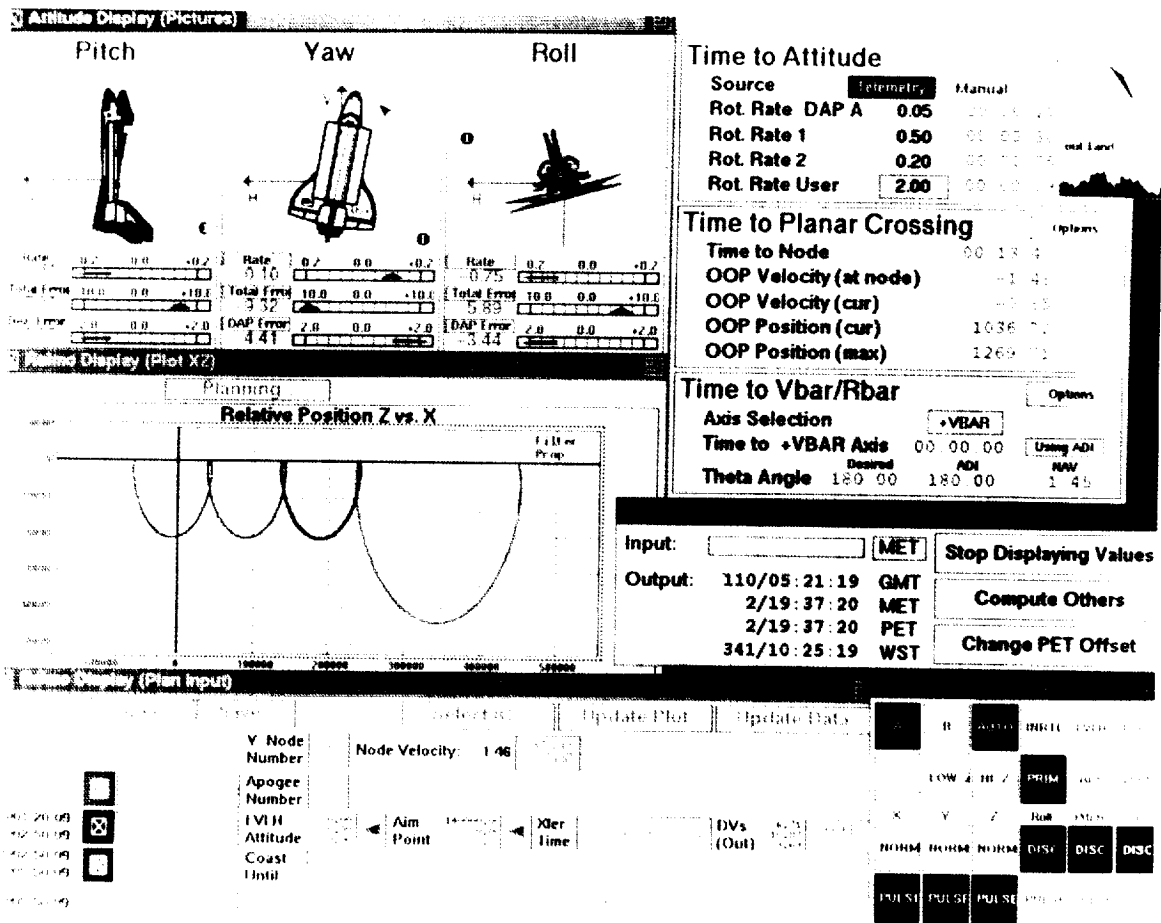

Figure 1. Rendezvous Operations Software System (ROSS) Display.

Playback Trainer

PI: James T. Ruszkowski/DG48
Reference: STT 5

The playback trainer (PBT) facility was developed for flight controller training in the Space Shuttle Program. The project was funded with FY92 RTOP funds from the Real-Time Data System (RTDS) project at JSC. The PBT is used to separate failure recognition training objectives from integrated Shuttle mission simulations. It will reduce the total amount of integrated training and improve the overall quality of flight controller training.

The PBT is capable of playing back recorded simulations, key mission phases, and malfunction signatures. It can also monitor Space Shuttle flights during real time.

The PBT provides failure recognition training by duplicating the displays used by flight controllers during missions and simulations and then allowing the flight controller to play back recorded files to these displays. The files contain all failure recognition objectives for flight controller training.

Before the introduction of this trainer, the Mission Operations Directorate (MOD) had very limited nonintegrated training facilities for flight controllers. All flight controller training objectives had to be seen during integrated simulations. However, with the introduction of the PBT and another facility called the Flight Controller Trainer (FCT), MOD now has at its disposal two additional facilities that allow division of flight controller training into integrated objectives and failure recognition objectives.

Integrated objectives are needed for interdisciplinary communications during integrated simulations. Failure recognition objectives, which make up approximately 40 percent of all objectives, are those that are significant to only one flight control discipline.

Because such a large percentage of training objectives are of the failure recognition type, the potential exists for a significant cost savings through reducing the number of integrated

training hours. Integrated simulations cost approximately \$40,000 an hour, whereas total cost of the PBT was approximately \$250,000. Also, training experience on the PBT will prepare flight controllers for integrated simulation training.

The PBT (fig. 1) consists of three DEC 5000/200 workstations to run the displays and one SUN 3/60 workstation to run the menus for the trainer. All four of these workstations use the RTDS LAN to obtain the data that is played back on the PBT. The RTDS LAN provides a medium for recording data during simulations and missions, and it gives the user the capability to monitor missions in real time.

At the end of 1992, the PBT facility was approximately 90% complete. During 1992, training on the PBT was available for the following flight control disciplines: booster, data processing system, guidance, navigation, and control, propulsion, maintenance mechanical and crew systems (MMACS), electrical generation and integrated loading (EGIL), instrumentation and communications, and spacelab computer data management system (SL CDMS).

By February of 1993, lessons will be available for three more flight control disciplines: Spacelab EGIL, Spacelab environment emergency and consumables management (SL EECOM), and EECOM.



Figure 1. Playback trainer facility for training flight controllers in failure recognition.

Flight Director Weather System

PI: Linda A. Perrine/DF72
Arthur N. Rasmussen/DF72
Reference: STT 6

The Flight Director Weather System (FDWS) originated in response to a request by the Shuttle Flight Director Office to provide operations automation in the Mission Control Center (MCCA). The flight director is responsible for the overall performance of the flight control team as it monitors a Shuttle mission. The team's goal is to achieve mission objectives with the highest possible level of safety. FDWS was developed to contribute to safe and efficient mission operations by providing automated weather information to the flight director.

A key element of safe and efficient conduct of a Shuttle mission is awareness of and response to the weather conditions at various sites of interest around the world. FDWS provides the flight director with real-time weather data displayed graphically so that weather-dependent decisions can be made quickly and definitively. The previous primary source of weather information for the flight director was an audio voice link with weather office personnel. The flight director had to jot down sets of numbers describing wind directions and speeds and runway designators. During busy periods such as prelaunch and deorbit/reentry, this form of data transmission was unacceptably slow and distracting.

The FDWS originated as a proof-of-concept prototype to determine if a somewhat intelligent weather display application could transmit weather data to the flight director and thereby increase operations efficiency and lower risk. The prototype became a favored tool because it could expedite data transmission, was easy to use, and was well received by flight directors. After an upgrade to make it fully operational, it is now a standard for all Shuttle missions.

The system has a user-friendly graphical interface. It displays various sites; fig. 1 shows the display for the Dryden Flight Research Center at Edwards Air Force Base and fig. 2 shows Kennedy Space

Center. At the left in fig. 1 are shown the five main runways used by the Shuttle, labeled with their approach names. The wind towers, shown in their locations relative to the runway, are labeled with their names (T150, T180, etc.). Each tower is depicted by a standard meteorological symbol called a "wind barb" that tells the current wind direction and speed. The symbol is an arrow with a small circle for a head and feathers for a tail. Each regular feather indicates 10 knots, each short one 5 knots, and a triangular feather 50 knots. Thus tower T150 shows a 50-knot wind from the north and T044 shows a northwesterly flow at 45 knots; the plus sign shown for T180 is the standard symbol for zero knots. (The data shown in the figure are for demonstration purposes; an actual combination of winds as portrayed would be extremely unlikely.) The left half of the display thus gives the state of winds at the site with a glance.

In the right upper portion of the display is shown a tabular form of the data. The table includes both the measured data and its decomposition into headwind, tailwind and crosswind components. Both average and peak values for the tower's sample period are shown. The system is aware of the flight rules used to determine the suitability of a runway for a shuttle landing. Flight rule criteria exceeded by current conditions are highlighted with a red background in the tabular display. By scanning the rows, a flight director can quickly and accurately determine which runway approaches are appropriate choices for landing. (The sample data in the figure show all runways to be out of limits.) Separate sets of criteria can be invoked; as shown in the display's heading, the daytime ("DAY") limits have been selected (criteria are maximums of 25 knots headwind, 10 tailwind, and 15 crosswind). The lower portion of the display is a Cartesian plot of the wind components over a recent time interval. Both the knot range and time range are scalable by the flight director. The data shown in the plot are those for the active approach of current interest. The approach is easily selected; both the selected approach and its associated wind tower are highlighted in yellow on the runway display (approach 05 and tower T150 in the figure).

FDWS has proven to be of great benefit to flight directors. It provides capabilities such as “situation at a glance” and history information that had been unavailable previously. Its direct, simple set of displays and its easy-to-use configuration selection

have allowed it to be easily integrated into the flight directors’ regimen. Its ready acceptance and continued use are the best testimonials to its success, and it now contributes to safer and more effective missions.

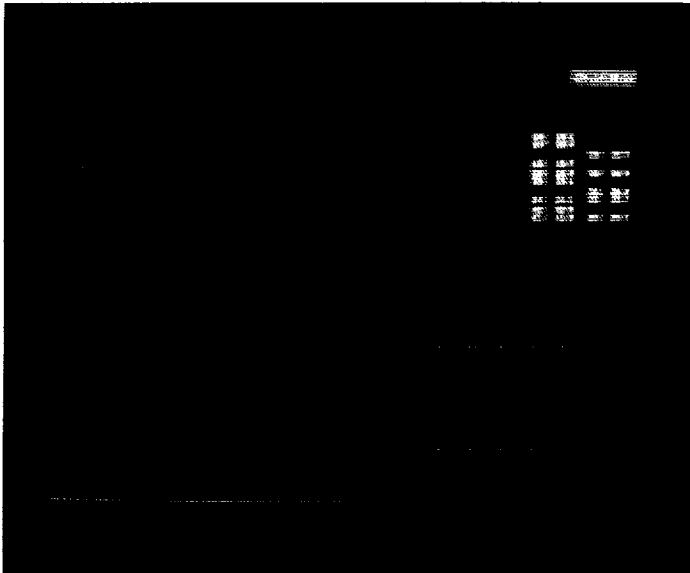

Figure 1. FDWS display at DFRC.

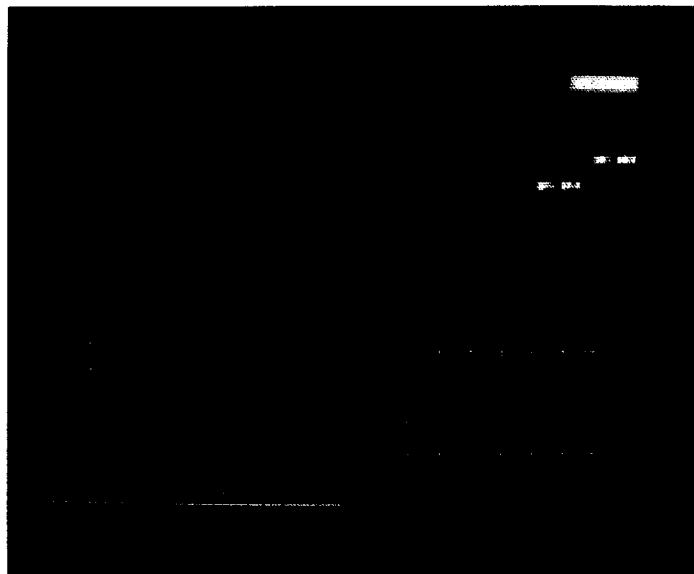

Figure 2. FDWS display at KSC.

Maintainability Model and Data Base Development

PI: A.J. Mitchell/NB22
Reference: STT 7

NASA must ensure that new space system designs meet maintainability requirements and will be maintainable during their expected life. Therefore a computer-based analysis tool (simulation model) is being developed for evaluating the maintainability of modern space facilities. This evaluation can be of crew time utilization, or it can be more extensive, such as an estimate of the probability that a particular experiment can be conducted without interruption.

Correct assessment of the maintainability characteristics of a newly developing or proposed space system must consider the complete space system. The assessment must include not only the reliability and maintainability of the space system components, but also the logistics support and the mission operations of the system. Maintenance cannot be performed without logistics support and mission success cannot be separated from maintenance and logistics support. This model will consider all three areas. Figure 1 shows the scope of the planned model.

Several existing NASA models were examined at the beginning of this design project. Johnson Space Center's reliability and maintainability assessment tool (RMAT) focuses on reliability and maintainability (R&M), whereas SIMSYLS focuses on logistics needs as a function of component reliability. Neither of these models can really answer the question: "Will a space facility be able to successfully perform the mission for which it is designed?" This model, by integrating R&M, logistics, and mission operations, will address this question.

An object-oriented design approach is being used. Object-oriented programming (OOP) languages were designed for large-scale simulation models. The use of OOP forces good program design and logical location of both data and methods, simplifying program maintenance. Object-oriented software also provides a reusable code. Using a

pure programming language offers much more control over model processes than does a traditional simulation language, such as SLAM.

The model design process involves defining the roles needed in the model and the relation of the roles. Each role will be modeled by an object or a class of objects. The intent of object-oriented design is to make each of the objects entirely self-managing. The working definitions of the model roles are shown in fig. 2, in which the arrows represent the lines of communication between the roles.

An operations model of a system must contain an operations module and various resource consumption modules. The following modules have been designed and are in various stages of coding and testing:

- The operations schedule module describes the day-to-day tasks to be performed by the systems and equipment which make up the entity modeled. Examples of specific tasks are experiments and stationkeeping operations such as reboost.
- The operations manager module will simulate the day-to-day occurrences in a typical mission control complex as they relate to the space facility. To ensure that operations can be accomplished, the operations manager must gather the resources needed to perform various tasks and resolve any conflicts that occur when two or more tasks demand the same resource. Statistics are to be kept of on-time task rates, tasks cancellation rates, resource utilization rates, delay times, and delay rates.
- The maintenance module contains information required for both preventive and corrective maintenance. It describes the repair procedure for each piece of equipment modeled.
- The ground support module describes supply and resupply activity needed to keep the spacecraft operational, including repair and transportation of returned parts. This module accounts for the delay times normally experienced by limited on-site spares storage

volume and for consumable resupply. The ground support module may also supply resources needed to carry out tasks such as fault isolation or remote guiding of robotic activities.

- Equipment maintenance will be driven by demand on the systems. Therefore, the systems module must contain the data and/or ground rules for systems response to equipment failure and system demand.
- The data output module provides time series and event-oriented statistics. These statistics should closely resemble the data elements usually required to monitor any large-scale maintenance operation. The most important of these statistics is operational availability, the ratio of uptime to total time. The model should be able to summarize and display the equipment availability on a time basis, such as by year.

In order to test the developing model, the maintenance managers of various Space Station Freedom Program work packages will be asked to define problems that they would like to have solved. These problems will become the test cases to validate the logic and to prove the capability of the model. Their identification will allow our planning to encompass "real world" questions, suggest further inputs and outputs, and give definite test points in the schedule. The problem definitions are expected to span our allowable inputs, such as crew schedules, crew specialization, tools, and maintenance scheduling. The output data will be further refined by defining a general output format that can answer specific questions.

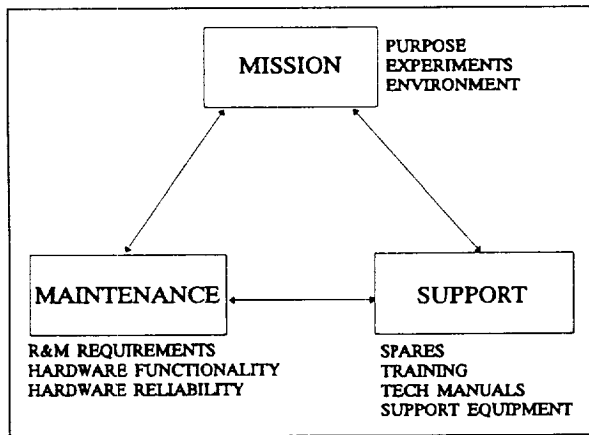

Figure 1. Model scope.

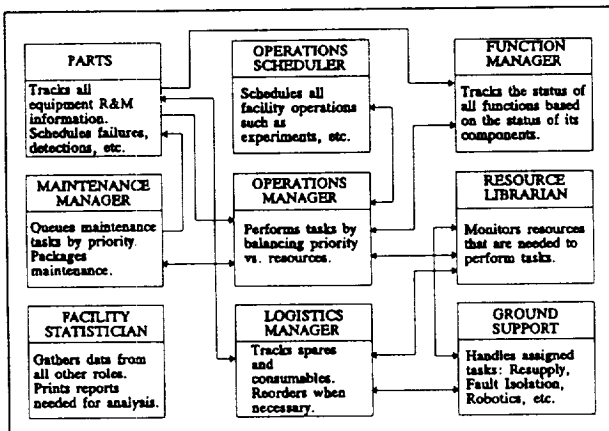

Figure 2. Model roles.

Vehicle Health Monitoring for OMS/RCS

PI: Richard J. Schoenberg/EP4
Reference: STT-8

Reusable spacecraft propulsion systems like the Space Shuttle orbital maneuvering subsystem (OMS) and reaction control subsystem (RCS) are highly complex and require substantial ground processing between flights. One method for lowering the operations costs of reusable spacecraft systems is to reduce the maintenance operations required to ensure flight readiness. A vehicle health monitoring (VHM) system has been proposed as one method of maintenance reduction. The objective of the OMS/RCS VHM program is to collect existing representative key technologies and demonstrate their applicability on representative space hardware, namely the OMS and RCS qualification test articles at White Sands Test Facility (WSTF). The OMS/RCS VHM demonstration program goes from bench testing of key sensor technologies on actual propulsion system hardware to application of those technologies on the actual test articles. The program includes algorithm development for data processing and data recording and retrieval systems.

This program will provide early insight into the potential payback from the application of VHM to propulsion systems. Benefits would be a reduction in the required ground turnaround operations and the identification of pending hardware failures. The use of Shuttle hardware in this program adds a level of realism not otherwise available. Finally, this program provides a high-profile, near-term application of VHM technologies. Although these VHM activities are centered around application to Space Shuttle propulsion systems, the technologies demonstrated should be applicable to other reusable propulsion and fluid systems.

After each Space Shuttle mission, a significant amount of ground testing is performed on each of the flight systems to ensure readiness for the next flight. The overall approach to reducing the turnaround activities associated with the OMS and RCS is to gather subsystem data in flight to satisfy

operational checkout requirements otherwise satisfied by ground testing. The existing OMS and RCS qualification test articles at WSTF, also known as the Fleet Leader test articles, will be the test beds for this VHM demonstration program. The test articles are flight-like in configuration, comparable to the Orbiter systems. They use primarily qualification-level hardware.

The culmination of the OMS/RCS VHM program will be the development and demonstration of a self-contained diagnostic capability including sensors, processing system, and data storage and retrieval system. The sensor suite will consist of existing sensors on the OMS and RCS that can be used for VHM purposes and new nonintrusive sensors specific to the VHM system. The use of nonintrusive sensors minimizes the impact of VHM system implementation on the vehicle. Algorithms will be developed to analyze trends in the data generated by these sensors and to extract information. A data storage device will be used for postflight or post-test data retrieval.

The three major activities in the current VHM program are being run in parallel. Boeing Space and Defense Group is conducting a 7-month study of ground turnaround requirements for OMS and RCS to determine candidate high payback focus areas for VHM. Boeing will develop a data base of available sensor technologies applicable to the OMS and RCS that could be included in the VHM sensor suite and make recommendations for OMS/RCS VHM system implementation. Boeing will also provide information and lessons learned from their operational commercial aircraft systems.

Instrumentation engineers from Lockheed Engineering and Sciences Company are performing a feasibility study and developing a preliminary design of an onboard data recording system. This breadboard data recording system will eventually be used during VHM demonstration at WSTF to simulate an end-to-end VHM system architecture.

WSTF is responsible for all of the component testing in the VHM program. This testing is important for two reasons. First, it is of critical importance to understand how a given component responds during normal operation. This characteristic response will be used as baseline data

to allow for detection of failure conditions. Second, the component testing also develops an understanding of the new nonintrusive sensors being applied to these components.

Three major areas of emphasis have been undertaken at WSTF: (1) performance monitoring of the propellant valves on the primary RCS (PRCS) thrusters, (2) investigating various methods to detect propellant vapors, and (3) investigating methods to reduce required turnaround activities on the OMS and RCS pressurization systems.

The PRCS thruster uses a set of pilot-operated solenoid valves to regulate the flow of monomethylhydrazine (MMH) and nitrogen tetroxide (NTO) to the combustion chamber. Each valve consists of a pilot stage and a main stage. The pilot-operated valve (POV) for oxidizer use has been a problem in recent years because either the pilot stage sticks when commanded to open or the valve opens more slowly than required. This problem has been traced to contamination of the valve by iron or nickel nitrates in the poppet and seat area. The primary VHM project for the POV is to develop a nonintrusive method to detect valve movement, both pilot and main stage. Two different methods have been used to analyze valve movement: acoustic emission sensor and Hall effect sensor. Test results at the valve level have shown that both can detect pilot and main stage movement. Hot-fire tests at the thruster level at simulated altitude conditions have produced favorable results. Acoustic emission sensors have also been investigated for applications to other components. Testing was performed on two parallel isolation valves on the OMS Fleet Leader system to determine which one was leaking. The sensor correctly identified the leaking valve without any intrusion into the system.

The second major area of VHM emphasis at WSTF is the detection of propellant vapors. Propellant vapor detection is important from an overall VHM standpoint, especially for a reusable hardware system. Two methods have been investigated, point sensors and spectroscopic techniques. If proven feasible, these methods could be applied to detecting vapor external to hardware (leaks past joints or seals) or internal to hardware (migration

of propellant vapor into helium system). Information has been collected on a variety of point sensor candidates capable of detecting propellant vapors. One such sensor, using a conductive polymer, was obtained for FY93 testing. Spectroscopic techniques have also been investigated. Using a Fourier transfer infrared spectrometer, a series of tests to characterize the spectral response of MMH vapor in helium showed a characteristic absorption feature in the near infrared region.

The third area of emphasis at WSTF has been to investigate methods to reduce ground processing required for the helium pressurization system components. Tests run in conjunction with the scheduled OMS Fleet Leader firing gathered data on the helium regulator during system operation to compare against ground turnaround requirements. Only existing sensors on the system were used, but at a higher sample rate than on the actual Orbiter systems. Results from these tests have shown that ground tests on the regulator could possibly be reduced or eliminated by using this operational data. Additional testing is planned for the RCS pressurization system regulators. In addition, plans are in work for extending this approach to other pressurization system components, such as the check valve and isolation valves.

Experimental Investigations of Spacecraft Glow

TM: Jlm Visentlne/ES5
PI: Dr. Gary Swenson/LNSC
Reference: STT 9

The Experimental Investigations of Spacecraft Glow (EISG) is a Shuttle flight experiment began in 1990 as part of the NASA In-Space Technology Experiment Program (In-STEP). The primary objective of this experiment is to study and characterize Spacecraft glow emissions in the ultraviolet, visible, and infrared wavelength ranges. These chemiluminescent light emissions are produced by interactions of spacecraft surface with the surrounding atmosphere as well as with the naturally occurring atmosphere at orbital altitudes. Such glow emissions have affected a number of NASA and DOD missions in the past. For example, ultraviolet emissions produced contamination that led to film-fogging for the ultraviolet telescope during Spacelab 1. A clear example of such glows occurring on the surfaces of the Space Shuttle is shown in fig. 1 in which the surface of the OMS pods and vertical stabilizer appear to glow.

A pallet-based set of instruments to be developed for the experiment will include a visible imaging spectrometer, an ultraviolet imaging spectrometer, and a pair of cryogenically cooled infrared detectors to measure intensities and spectral distributions of Shuttle glow emissions. Included in the design will be a passively controlled sample plate with varied surface composition to investigate glow emissions from spacecraft surfaces. A nitrogen gas release system will study and characterize gas-phase glow emissions. Experimental cameras and a dedicated experiment processor will be part of the package of instruments used to record sensor outputs and control operations during the flight. Figure 2 shows the various instruments and how they will be integrated on a pallet in the cargo bay of the Space Shuttle.

To more fully characterize the effects of altitude and temperature on the intensity and wavelength of glows it is desirable to incorporate specific mission operations into the flight. These operations require four Orbiter darkness periods at low Earth orbit. Two circular orbits at approximately 160 nautical miles will provide the higher altitude and two elliptical orbits with a perigee at only 90 nautical miles will provide a lower altitude. The two elliptical orbits in which the altitude is decreasing during the time of data acquisition will provide an opportunity to observe the effect of the atmospheric density change on spacecraft glow.

The results of this experiment will enable NASA and other users to develop new materials and surface treatments that can reduce the effect of glow interference. If this is not practical, it may be necessary to alter procedures or design guidelines to mitigate the effects of glow during future Shuttle flights and space station missions in low Earth orbit.

Significant accomplishments during 1992 include the completion of instrument development (sensors, electronics, software and mechanical systems) and the assembly required to initiate system certification tests at JSC. The anticipated flight schedule is January 1994 aboard STS-62.

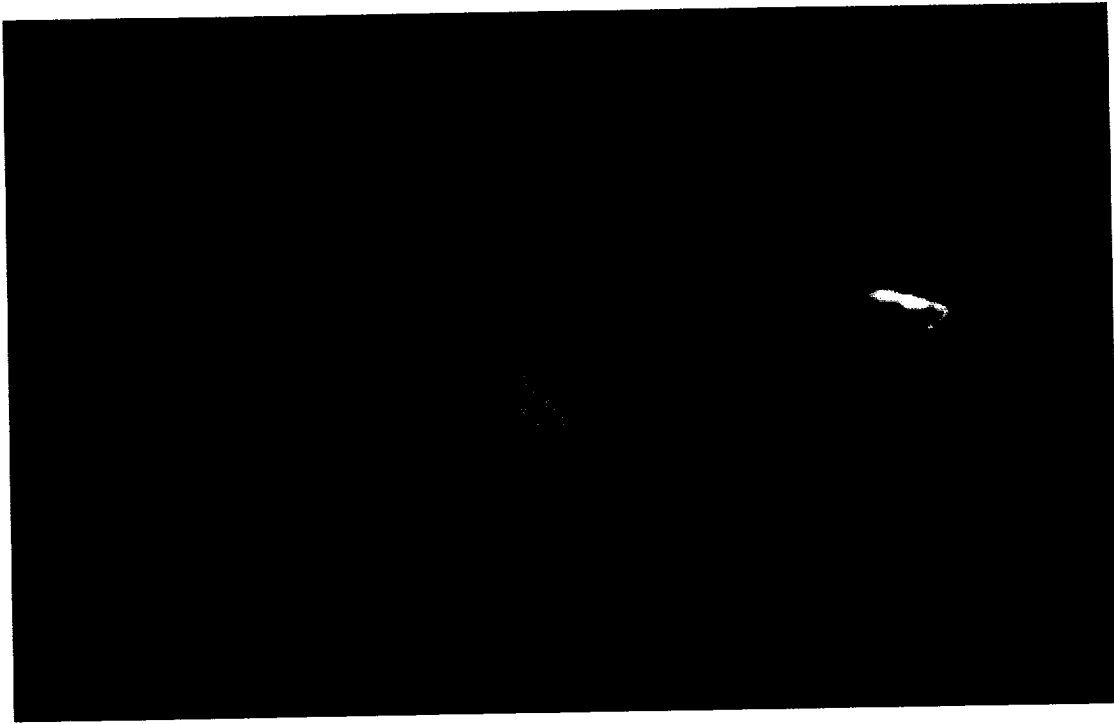

Figure 1. Space Shuttle glows produced during STS-39 by nitric oxide (NO) chemical releases within Discovery's cargo bay. Surface and gas-phase glows are visible in the photograph.

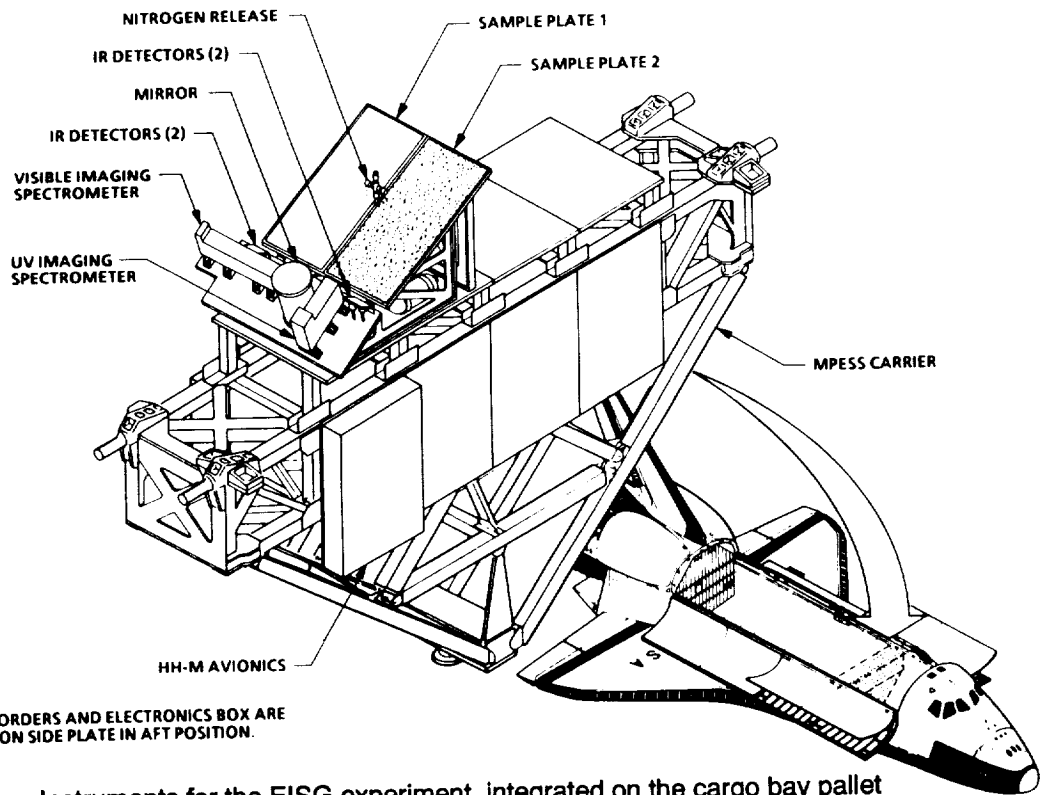

Figure 2. Instruments for the EISG experiment, integrated on the cargo bay pallet of the Shuttle.

Orbital Acceleration Research Experiment

PI: R.L. Glesecke/ID3
Reference: STT 10

The Orbital Acceleration Research Experiment (OARE) has been developed as part of the Orbiter Experiments (OEX) program funded by the Office of Aeronautics and Space Technology. The development of the OARE and its integration into the OV-102 vehicle is being managed by the New Initiatives Office at the Johnson Space Center. Flight data processing and analysis is being performed by the OARE Principal Technologist at the Langley Research Center.

The objective of the OEX program has been to collect data in the technology disciplines that augment the research and technology base for future spacecraft design. Flight data relative to these disciplines have been collected by unique experiments compatible with the flight operational capabilities of the Space Shuttle Orbiter. The OEX program has provided the ability to characterize the upper-atmosphere flight environment and its interaction with flight vehicles on orbit and during entry. The use of the Orbiter as a test bed has provided in situ data from environments and flight regimes that are not accessible by the ground researcher.

The objective of the OARE is to provide accurate measurement of accelerations along the Orbiter's principal axes in the free-molecular flow flight regime at orbital altitudes and through the rarefied flow transition regime during entry. The OARE provides the first ability for quantitative measurements of the drag of the rarefied atmosphere upon the Orbiter. This information will provide a better understanding of vehicle aerodynamics and related fluid mechanics in the free molecular flow regime and will extend the upper atmosphere data base. In addition, the OARE will expand the technology data base for orbital drag predictions to be used in space transportation systems designs, future large space structures, attitude and orbital control systems, and orbit maintenance and energy management concepts development. The OARE will also

provide a capability to characterize the low frequency microgravity environment available on the Orbiter. The understanding of the microgravity environment is essential since this is one of the major capabilities the Agency can exploit for commercial activity in space.

The OARE is an accelerometer system capable of measuring low-frequency (less than one Hz), low-level acceleration with heretofore unobtainable accuracy, resolution, and sensitivity (nano-g). The OARE comprises a sensor system with an electrostatically suspended proof mass and, more importantly, a built-in facility for automatic, periodic calibrations of sensor DC offsets (bias) and scale factors throughout the mission. The sensor system provides orthogonal, three-axis acceleration data coinciding with the principal body axes of the Orbiter. To achieve a wide measurement range, each sensor axis has three ranges which are automatically selected in response to large changes in the sensed acceleration level. The most sensitive range is ± 100 micro-g, with a corresponding resolution of 3 nano-g. The highest range is ± 25 milli-g, with a resolution of 800 nano-g.

The OARE's in-flight calibration capability overcomes one of the greatest obstacles to absolute accuracy in measuring micro-g levels of acceleration—the difficulty in calibrating highly sensitive accelerometers in the presence of Earth's gravity. Furthermore, periodic calibrations throughout the mission greatly reduce sensor shifts related to time and temperature variations. The in-flight calibration is achieved by mounting the sensor system on a two-axis rotary calibration table that is automatically commanded to sequentially rotate each sensor's axis 180 degrees to determine bias and then rotate each sensor at precise rates to obtain known levels of centripetal acceleration for scale factor determination.

The OARE produces acceleration data at an effective data rate of 10 samples per second. These raw data may be tape recorded on board for post-flight processing and analysis. However, because the OARE is required to measure the low-frequency aerodynamic accelerations over long orbital time periods, the instrument has its own

internal data processing and storage capability. The internal data processing software, which may be modified from flight to flight, currently uses a trimmed-mean filter algorithm to extract the steady-state acceleration signal. The processed data are then stored in a solid-state memory within the OARE. After the Orbiter returns to the Kennedy Space Center (KSC), these data are transferred to discs by OARE's ground support equipment. A microprocessor within the OARE processes and stores the data and controls the ranging, calibration, and other in-flight experiment functions.

The OARE components are mounted on a shelf assembly that is attached to a keel support in the bottom of Payload Bay #11 (fig. 1), allowing precise alignment with the Orbiter's body axes. Figure 2 shows the layout of the components and also shows the cover that provides a measure of passive thermal control for the OARE.

On its first flight, STS-40, in June 1991, the OARE experienced significant hardware anomalies which limited the accuracy of the data collected. The data obtained on this mission did, however, demonstrate the capability of the OARE instrument to resolve the extremely low levels of aerodynamic accelera-

tion experienced by the Orbiter at orbital altitudes. The STS-40 problems were corrected and the OARE was returned to KSC in March 1992.

On its second flight, STS-50, in July 1992, the OARE performed quite well. The 14 days of data collected during the mission are undergoing final processing at the Langley Research Center. Initial data processing was done to determine the net acceleration vector at the location of the Crystal Growth Furnace (CGF) during STS-50. Analysis results were given to the microgravity science community, which is investigating the possible need to reorient the CGF on its next flight to minimize the acceleration along its most critical axis. The OARE did experience a few problems, however, during STS-50. The most significant problem—the degradation of scale factor data in the Y and Z axes when the OARE was operating in its most sensitive range—has increased the effort required by the Principal Technologist in reducing the data. The cause of this problem has been isolated and it, as well as the others that occurred on STS-50, will be corrected by March 1993, when the OARE is to be returned to KSC for its flight on STS-58 in August 1993.

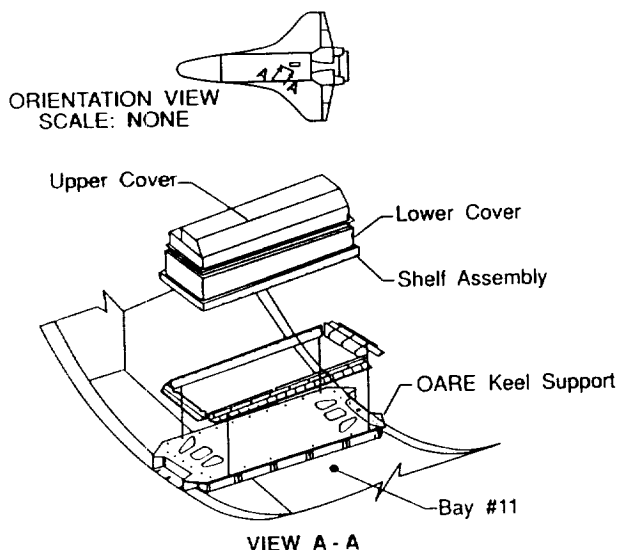

Figure 1. OARE location on Orbiter OV-102.

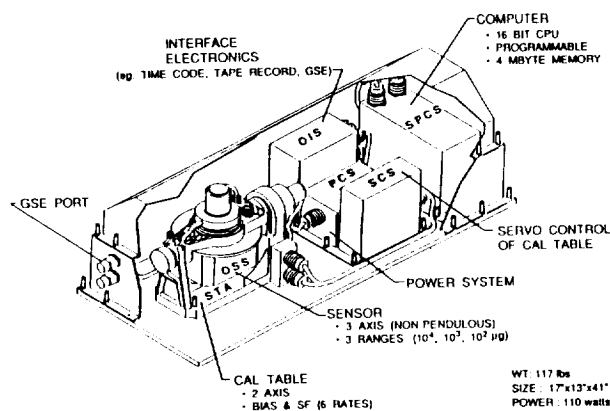
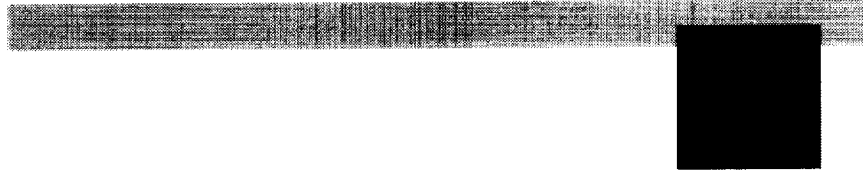

Figure 2. Layout of OARE components.

Section V

Space Systems Technology

Summary



Space Systems Technology Summary

The Space Systems Technology section describes projects on diverse technical disciplines including life support, thermal control, extravehicular activity, information transmission and processing, propulsion and power, automation and robotics, computational sciences, structures and mechanics, and materials. The JSC research and technology (R&T) objective is to enhance performance of human spacecraft systems and operations and develop those systems needed for human exploration of the solar system.

A key area of JSC R&T is the development of a regenerative life support system for long-duration missions and planetary outposts. Three projects on modeling of the regenerative life support system plant growth chambers, controlled ecological life support system, and regenerative life support systems integration are included in this section. JSC has made substantial progress in developing the infrastructure to evaluate economically and technically feasible methods of combining physiochemical and biological components to form an integrated life support system.

For the most efficient thermal management concepts, the design and development of the ultralight fabric reflex tube (UFRT) radiator was completed in 1992. Ten UFRTs were fabricated: eight of one type fabric and two of another. Partial testing of several UFRTs was found acceptable. The UFRT design takes advantage of partial gravity on planetary surfaces. Further work on the optimization of UFRT geometry, materials, and fabrication techniques will continue in 1993, in addition to further testing the units already fabricated.

In robotics and automation, JSC continued to progress in several areas. The closed-loop control of the Shuttle remote manipulator system (SRMS) using force-torque sensor inputs is aimed at enhancing the productivity of extravehicular activity-supported SRMS assembly tasks using the JSC Manipulator Development Facility.

An electronic cuff checklist (ECC) was conceptualized and preliminary design was completed. Accomplishments included developing access to the text and graphics data base via a touch screen rather than a digital display and three toggle switches. Engineering design trades were made and the software training tools were developed for both creating and loading the contents of the ECC with a Macintosh workstation. Testing of the software will continue, as will development of ECC for Space Shuttle flights STS-61 and/or STS-63.

In the fault tolerant robotics area, a concept to dynamically absorb induced failures in either the mechanisms, electronics, or control systems was demonstrated. An overall design of the three-level fault tolerant test-bed, along with the in-depth design and testing of a 2-DOF fault tolerant gimbal module, was completed.

An expert system for monitoring the position of the SRMS is being investigated. This application provides a substitute for live video, which allows the SRMS MCC operators to visualize arm operations. The ultimate objective is the capability to present graphically the physical relationship between the Space Shuttle, SRMS, and the payload attached to the SRMS. The guidelines for human interface with artificial intelligence are being developed in a project that addresses human-computer interaction concerns. Guidance for intelligent system designers considers the complexity of computer systems and the possibility of creating dependency for humans to the point of losing creativity and expertise. An innovative approach for the Overview Data Base and Data Search (ODBDS) project was developed in FY92. The ODBDS helps the flight controllers to identify standard mission events, anomalies, timelines, etc., from historical missions, thus enabling them to quickly request pertinent telemetry from one or more historical flights. The ultimate goal of this project is to bring needed information, both textual and telemetry, to the operator as quickly as possible for the purpose of analyzing current missions and/or system performance. Substantial progress has been made on this project during FY92.

A computational control workstation was designed and constructed for rapidly simulating motions or rigid and elastic multibody systems. This project provides support to multibody systems, such as Space Station Freedom (SSF), planetary and Earth observation spacecraft, and lunar/Mars rovers. Tests performed yielded simulation results three to four times faster than other programs, but still agreed with the results of those other programs. Several other tests were performed during FY92 which identified inefficient processes. Progress has been made in improving user interfaces.

In FY92, the design concept review and a preliminary design review (PDR) were completed for the venting membrane system (VMS) aimed at removing metabolic carbon dioxide and water vapor in the advanced EVA life support system. This system uses a pumped liquid solvent of a cesium carbonate solution and two hollow fiber membrane (HFM) modules. In the next phase, improvements in refining solvent/catalyst mixture and the use of a new radial flow HFM module will be investigated. JSC also successfully completed the preliminary design review and the critical design review of the subcritical liquid storage and

supply system for the advanced extravehicular activity mobility unit. It has the advantage of operating at any pressure and can be made lighter. A PDR was also conducted on the venting hydride cooler (VHC), another project in support of advanced EVA life support. The VHC utilizes metal hydride reactions to provide a low-temperature heat sink for the liquid cooling garment in the extravehicular mobility unit (EMU). Based on the PDR data, current weight and volume estimates for a VHC supporting an 8-hour EVA are 0.45 cubic feet and 80 pounds.

The static feed electrolyzer (SFE) designed and ground-tested for electrochemical water analysis was approved by NASA Headquarters for use during the Space Station Program flight implementation phase (Phase C/D). The experiment will be conducted in the middeck payload locker to determine the effect of microgravity conditions on cell voltage operation.

This section contains brief descriptions of the projects mentioned in this summary. Considerable progress was made during FY92 in developing the concepts into tangible hardware and software for further testing in the operational space environment.

Section V

Space Systems Technology

Significant Tasks

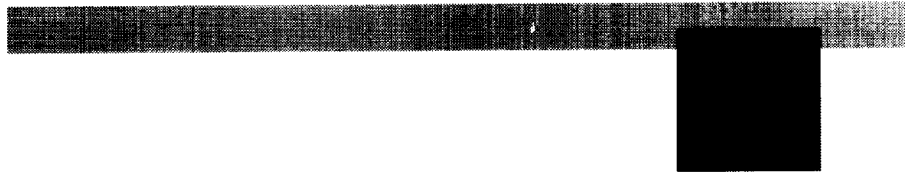

Regenerative Life Support Systems Integration

PI: H. Eugene Winkler/EC3
Reference: SST 1

As part of the NASA Office of Advanced Concepts and Technology (OACT) Regenerative Life Support Program, the JSC Crew and Thermal Systems Division (CTSD) initiated buildup during FY92 of an advanced life support Systems Integration Research Facility (SIRF), a test-bed utilizing the unique 6-meter altitude chamber and associated support facilities at JSC. The goal of the SIRF project is to provide the system-level integration, operational test experience, and performance data necessary to proceed confidently with the design, development, fabrication, and testing of a regenerative physical/chemical life support system, including thermal control, required for human space exploration. Trade studies, analysis, integration, and long-duration testing will be performed to evaluate technology readiness and bridge the gap between existing subsystems, sensors, and monitoring/control methods and the technologies for development of an integrated physical/chemical regenerative life support and thermal control system for human space exploration. Key technical issues which will be addressed include optimal system configurations, sensitivity to operational parameters, system-level monitoring and control strategies, advanced sensor technology performance, human-machine interactions, regenerative subsystems compatibility, and long-term operational characteristics.

The life support and thermal control functions of SIRF have been allocated to three major systems: the air revitalization system (ARS), the water recovery system (WRS), and the thermal control system (TCS). These systems and the subsystems which comprise them are controlled by an integrated system that can provide process control as well as supervisory control functions. The operations of the ARS, WRS, and TCS are supported by facility systems designed to provide necessary interfacing functions such as external gas supply and venting. A major facility support system is the human interface to the WRS, which

provides for the collection of urine and wash water wastes for subsequent processing by the WRS.

As shown in fig. 1, the upper level of the three-level chamber is a sealed control volume from which the ARS draws an air stream for CO₂ removal and reduction, O₂ generation, and trace contaminant removal. Metabolic inputs of CO₂, H₂O vapor, and heat are introduced to the control volume via the facility's human atmospheric simulator (HAS). The middle level of the SIRF chamber is reserved for the ARS subsystems and the internal TCS components, which interface with air circulation ducting originating from the upper level control volume. On the lower level of the chamber reside the WRS subsystems and the human interface support system that collects waste water streams for distribution to the WRS.

During FY92, extensive effort was concentrated on acquisition of the ARS subsystems for the initial integrated testing and on facility readiness of the 6-meter chamber for installation and testing of these subsystems. Through a memorandum of understanding with AiResearch, CTSD obtained an adsorbent zeolite 4-bed molecular sieve CO₂ removal subsystem packaged specifically to interface with the SIRF. The unit was tested at AiResearch prior to shipping and was installed on the middle level of the 6-meter chamber upon delivery at JSC. Figure 2 shows the current configuration of the chamber's middle level. The CO₂ removal subsystem (left) is integrated both with the HAS ducting (center) and with the air circulation and conditioning loop (upper right) of the upper level control volume. Also visible in the center of the air circulation loop is the SIRF's condensing heat exchanger, the major internal component of the TCS. Performance testing of the CO₂ removal subsystem is scheduled to begin during the first quarter of FY93. Also scheduled for FY93 are the deliveries and subsequent performance testing of the Sabatier CO₂ reduction subsystem and the water electrolysis O₂ generation subsystem. Integrated testing of the ARS subsystems is currently scheduled to begin during the third quarter of FY93. Progress on the WRS primarily included design of the human interface support systems and their installation in the lower level of the chamber and initiation of procurement activities for a catalytic oxidation post-treatment subsystem.

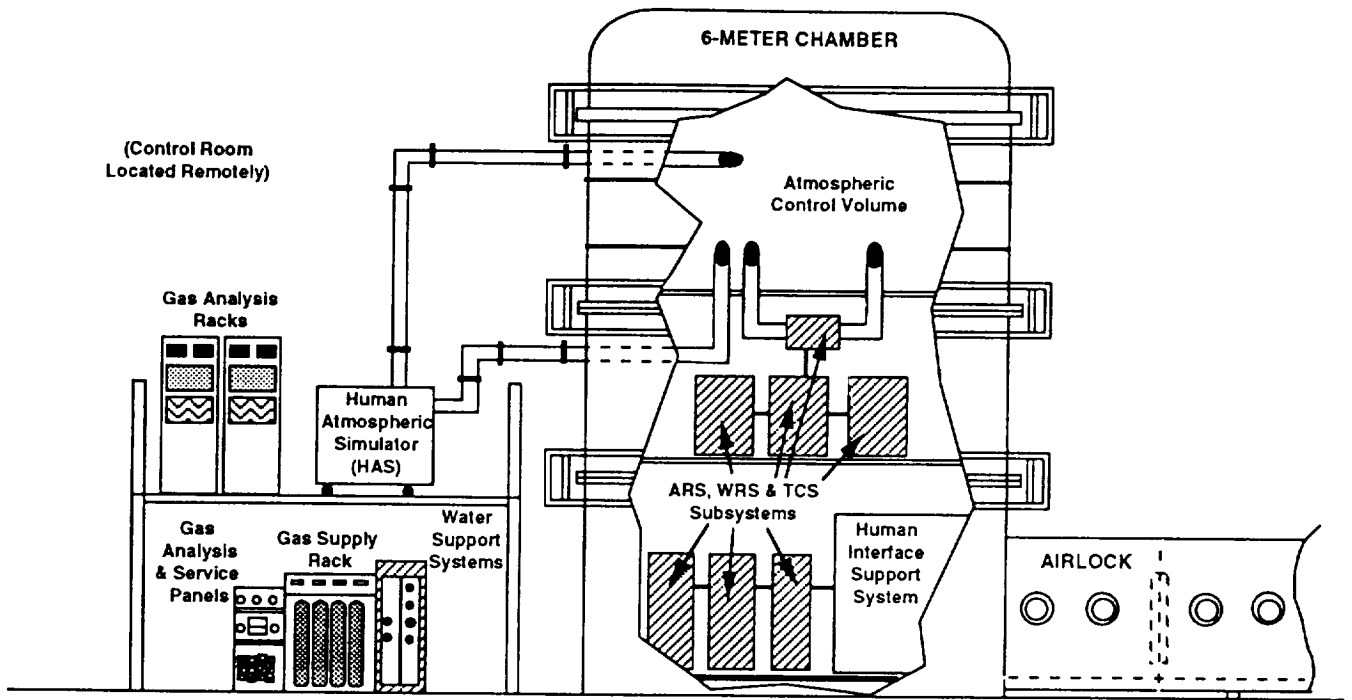

Figure 1. Systems Integration Research Facility (SIRF) 6-meter chamber configuration.

ORIGINAL PAGE
BLACK AND WHITE PHOTOGRAPH



Figure 2. View of middle level of SIRF 6-meter chamber.

Controlled Ecological Life Support Systems

PI: Donald L. Henninger/EC3
Reference: SST 2

The Controlled Ecological Life Support Systems (CELSS) project is concerned with development of regenerative life support systems for long-duration missions. Such life support systems will recycle the air, water, and wastes, and produce food-using plants. The envisioned system will include physico-chemical and biological components combined to form an integrated life support system. No previous attempts have been made to combine these two technological approaches.

Two major test-bed facilities have now been built: the Variable Pressure Growth Chamber (VPGC), completed in FY91, and the Ambient Pressure Growth Chamber (APGC). During 1992, a wheat characterization crop was grown in the VPGC in 84 days (fig. 1). During 1993 the VPGC will undergo modifications to allow plant growth at reduced atmospheric pressures.

The APGC, completed in 1992, was designed to serve as an ambient pressure control for tests performed in the VPGC at reduced atmospheric pressures. In addition, the APGC includes several design improvements, based on crop tests in the VPGC. They include improved thermal control and ventilation systems, enhanced instrumentation and monitoring capability, a unique irrigation system that is compatible with both hydroponic and solid support substrate plant growing methods (fig. 2), motorized control of plant growth tray elevation, enhanced microbiological monitoring capability, and recycling of recovered humidity condensate into nutrient solution for plant irrigation. In addition, a precision oxygen analyzer and an ethylene gas chromatograph, to be used with both chambers, were brought on line.

Evaluation of solid support substrates or soils for plant growth in a CELSS is a component of this RTOP. This includes evaluation of lunar simulants and development of artificial soils. Zeoponics is the cultivation of plants in zeolite and apatite substrates that contain essential plant growth elements. These plant growth elements are slowly released into "soil" solution where they become available for plant uptake. The overall goal of this research is to develop synthetic soil systems wherein all plant growth nutrients are supplied by the plant growth medium for many growth seasons with only the addition of water. During 1992, a first generation zeoponics substrate was developed and evaluated through detailed kinetics experiments and plant growth experiments. Evaluations are continuing, and early results have already been incorporated into a second generation zeoponics medium.

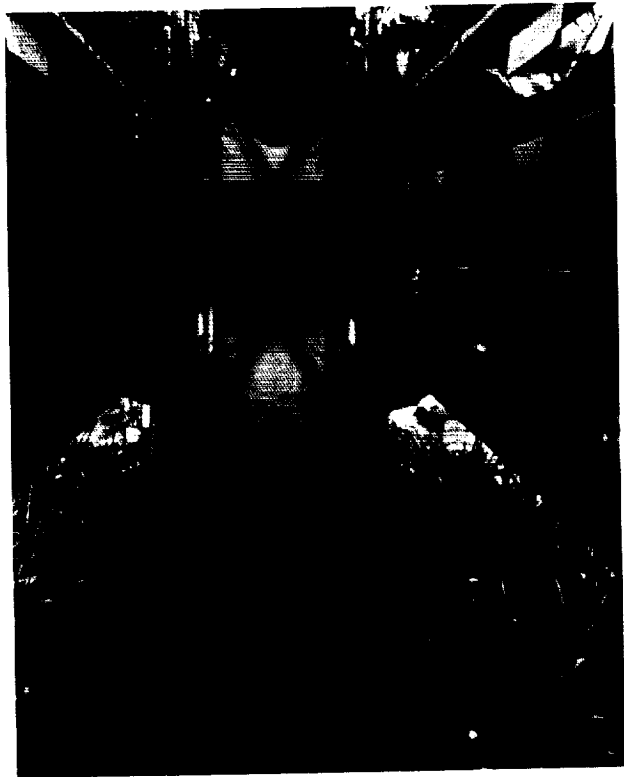

Figure 1. Internal view of the wheat verification crop in the Variable Pressure Growth Chamber.

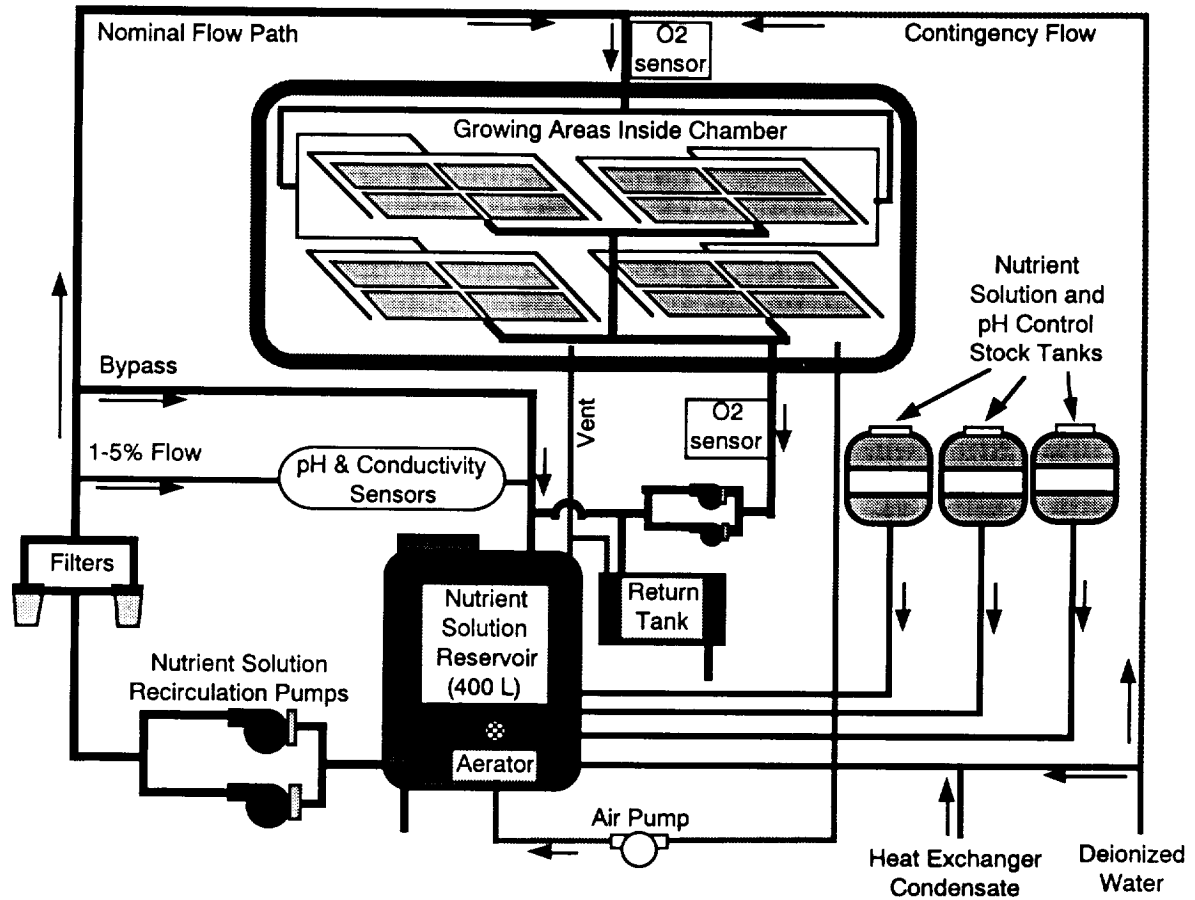

Figure 2. Schematic of dual-function fluid delivery system supporting one-half of the 11.4 m² (123 ft²) of plant growing area within the Ambient Pressure Growth Chamber (APGC). Two identical systems are present within the chamber; separate systems supply the plant growing areas on each chamber side.

Modeling of the Regenerative Life Support System Plant Growth Chambers

PI: M. A. Edeen/EC7
Reference: SST 3

Long-duration manned planetary missions will require life support systems with high degrees of closure to maintain self-sufficiency. Current technologies will not provide the necessary degree of closure to support long-term planetary missions without significant resupply penalties. The Regenerative Life Support Systems (RLSS) test-bed was developed to test the integration of biological and physicochemical components, both of which will be required for a closed life support system. The RLSS consists of the Ambient Pressure Growth Chamber (APGC) and the Variable Pressure Growth Chamber (VPGC), which are used to study how plants respond to various environmental conditions and how they interact with physicochemical life support systems that have been integrated with the chambers.

In support of the testing performed in these chambers, a high fidelity analytical model of each chamber has been developed. The simulations of the VPGC and APGC include component models which represent each piece of plant support hardware as well as models for wheat and lettuce growth. The lettuce model was developed from a series of experiments conducted in the VPGC in August of 1991. The experiment designed to collect data, the lettuce model resulting from the data, and the original VPGC model (VPGCM) were the deliverables from FY91 funding. Efforts this year focused on improving the VPGCM control characteristics to more closely match those of the actual chamber, developing a model of the APGC, and developing a model for wheat growth based on available literature.

The efforts to improve the control characteristics of the model resulted in the development of two separate models for each chamber. The control algorithm of the detailed model developed in FY91 was improved so that it matched the responsiveness of the chamber. Over short time periods, this

model can predict system temperatures, CO₂ levels, dew point temperatures, etc., which would be seen in response to a change in system conditions such as the lights turning off, or to a hardware malfunction such as the blower failing. However, this level of detail led to a complex model which took an inordinate amount of computer time when full-length crop simulations were run. To alleviate this problem, a simplified model was also developed for each chamber which is used for studying plant response to varying environmental conditions. This model is very accurate for long-term simulations and does not require a great deal of computer time.

After being validated with historical data, these models will be used to predict chamber performance before crops are planted and to optimize test conditions for maximum CO₂ removal, water production, or other parameters of interest. Additionally, the models will be used to determine if the current fault responses are appropriate for the system and to look at how best to integrate physicochemical systems with the plant growth chambers.

Ultralite Fabric Reflux Tube Radiator

PI: John Thornborrow/EC2
Patricia A. Petete/EC2
Reference: SST 4

The Bubble Membrane Radiator (BMR) project was initiated in March 1988 to continue development of promising thermal management concepts for space applications. The initial concept studied could be used on missions such as a long-duration planetary probe during which low-temperature heat rejection would be required for cooling the habitat and scientific equipment. Work on the second phase of BMR development was finished during FY92 with the completion of the steady-state condensation with rotational acceleration boundary layer examiner (SCRABLE) code. The computer program was developed to calculate the thermal hydraulic behavior of the bubble membrane radiator. Various materials compatibility tests were also performed in cooperation with Oregon State University.

Work was refocused during FY92 from the bubble membrane radiator concept to fabrication and testing of ultralight fabric reflux tubes (UFRT) because of a need for heat rejection concepts that take advantage of gravity in lunar base thermal management. Four technical tasks were initiated on the UFRTs in FY92: (1) fabrication and testing of ultralight reflux tubes, (2) evaluation of the radiative properties of the components and assembled reflux tubes, (3) a study on the need for and design of radiating fins for the UFRTs, and (4) development of tougher UFRTs.

The goal of task 1 was to fabricate and test a first generation of UFRTs. Ten UFRTs were fabricated, eight of one type of fabric and two of another type of fabric. Three UFRTs were tested in a thermal vacuum environment in the Crew and Thermal Systems Division's chamber E, shown in the photograph (fig. 1). Five UFRTs were damaged during shipping and handling. The three tested were exposed to environmental temperatures of 325 K, 255 K, and 144 K at a pressure of 10^{-4} kPa. The performance of the current UFRT design met

all expectations. Tests indicated that the UFRT design operated isothermally along the condenser region and performs as anticipated under nominal operating conditions.

Under task 2, seventeen samples of fabric were sent to JSC for optical properties measurements. Emissivity and absorptivity measurements were taken and the data were analyzed at Battelle, Pacific Northwest Laboratory. Further evaluation is planned for FY93. UFRT optimization study was also initiated under task 2. Areas of optimization included the UFRT geometry, materials, and fabrication techniques. The results of this study indicated a recommended specific mass of <2 kg/m² and specific power of 1.5 kW/kg. All indications are that these goals are attainable.

The third task assessed possible fin designs and their usefulness for the UFRTs. A simplified analysis was conducted using linearized/averaged heat and temperature profiles. Preliminary analysis indicated that, with careful design, fins can provide significant mass savings.

Task 4, development of tough UFRT technology, was deferred until FY93.

Plans for FY 93 include fabrication of tougher UFRTs and life testing of a UFRT at the University of Oregon. The tougher UFRT will also be tested if additional funding becomes available.

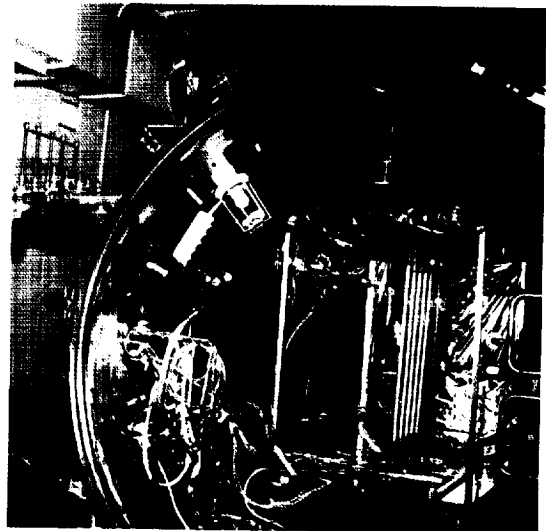

Figure 1. Thermal vacuum test chamber.

Closed-Loop Control of the Shuttle Remote Manipulator Using Force-Torque Sensor Inputs

PI: Donald A. Barron/ER3
Reference: SST 5

Closed-loop force control provides compliance in a manipulator to accommodate external forces and torques applied to the arm's endpoint either by a human operator or by contact with surrounding structures. The objective of this project on Shuttle Remote Manipulator System (SRMS) closed-loop control is to demonstrate the application of force feedback control in raising the productivity of extravehicular activity-supported SRMS assembly tasks using the JSC Manipulator Development Facility (MDF).

The project is a spinoff from one that investigated the feasibility of applying the research technology in force control developed at other NASA research centers to the SRMS. Analytical efforts and experiments from the earlier project indicated that within the framework governed by the SRMS constraints (i.e., low onboard sampling rate, limited onboard computational power, endpoint force sensing only and rate-controlled servos), candidate force control laws were transferable from a simulated environment to three different robotics facilities at JSC. Each of the test manipulators has certain characteristics that could be part of the flight SRMS (i.e., transport lag, friction, structural flexibilities, large payload, servo nonlinearities, and low sampling rate). The three manipulator test facilities, the Robotics Research RR-1607, the Manipulator Development Facility (MDF) and the Dynamic Docking Test Facility (DDTF), were used to demonstrate active compliance for constrained motion tasks such as payload berthing/docking, panel door opening, orbital replacement unit box insertion, surface tracing, and pin-in-socket insertion.

Because of the arm's limited bandwidth imposed by the structural flexibilities (i.e., gearbox and link), and a low onboard sampling rate (12.5 Hz), high frequency contact forces such as those that

occur during high velocity impact cannot be actively controlled using any force feedback control scheme. Controlling these impact forces, however, can be and has been done numerous times during past Shuttle missions by approaching contact surfaces at very low speeds. Controlling contact forces at steady state (i.e., active compliance) was achieved on the JSC manipulators using the previously developed control laws.

Active compliance can be shown to be a useful feature of a manipulator required to work in the presence of and as an assistant to human operators. During future Shuttle missions, the SRMS will play a major role in supporting the crew during extravehicular activity (EVA) to assemble the Space Station Freedom (SSF). One of the assembly scenarios was used during STS-49 to support a demonstration of the Assembly of Station by EVA Methods (ASEM). Figure 1 shows the Multiple Purpose Experiment Support Structure (MPESS) pallet grappled by the SRMS, with one astronaut floating at the top of the attachment fixture and the other EVA crewmember free floating near the sill. The MPESS was to be installed on the ASEM attachment fixture when the crew pulled the pallet legs into docking with the ASEM berthing adapters. The demonstration was, however, unsuccessful due to the insufficient compliance built into the SRMS.

A mockup of the STS-49 ASEM test was set up in the MDF to demonstrate the application of active compliant control. The MDF, located in building 9A at JSC, consists of a 6-DOF, 50-ft long, hydraulically actuated manipulator. The arm has a joint configuration similar to the SRMS's and is controlled from a Shuttle-like aft flight deck station using handcontrollers. It is used primarily for astronaut training and engineering evaluation of techniques in handling, deploying, and capturing payloads under simulated on-orbit conditions.

Compliant control in a single DOF was implemented as shown in fig. 2 and demonstrated for the ASEM mockup test. Using an arm configuration similar to the one shown in fig. 1, the lower MPESS pallet legs were grappled and pulled along the sill with approximately 10 lb of force, which in turn caused the MDF arm to move the pallet along

the sill at roughly 1 inch per sec. The magnitude of the input force and the resulting arm's motion can be adjusted by varying the force controller gains.

Future tasks will demonstrate compliant control in all six DOFs by using the newly developed MDF manipulator which can carry a larger payload, up to 500 lb. Six DOFs compliant control was difficult to realize using the current MDF arm due to the inherent mechanical limitations. The arm is rated for a 50-lb payload, but the MPES mockup is

roughly 70 lbs. The wrist-mounted force sensor available at the time of testing has a rather limited torque range (400 in-lb max), and tended to limit the amount of force that can be exerted at the pallet legs, which are 120 inches away from the sensor. With a 70-lb mockup payload in a one-g environment, applied forces of such a small magnitude (10 lb) will be corrupted if any drift occurs in the payload orientation.



Figure 1. Multiple Purpose Experiment Support Structure pallet being grappled by the Shuttle remote manipulator.

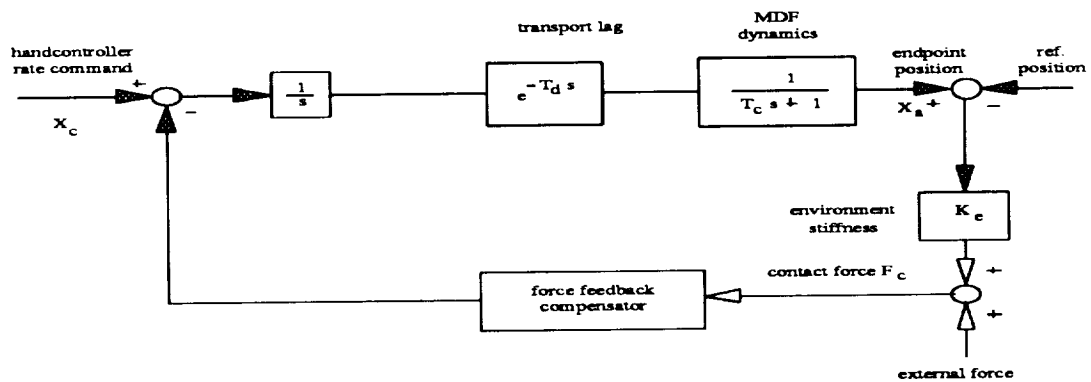

Figure 2. One-DOF Compliant Control Block Diagram.

Extravehicular Mobility Unit Electronic Cuff Checklist Development

PI: Jose A. Marmolejo/EC6

Reference: SST 6

Since the amount of information required by the astronaut has grown as extravehicular activity (EVA) missions have grown in both number and complexity, alternatives to the paper checklist procedures currently used by Shuttle EVA astronauts have been explored. The goal of this in-house project is to demonstrate that an electronic cuff checklist could replace the need for the current paper checklist (which has met recent criticism). The current EVA cuff checklist is limited to twenty-five 3.5-inch by 4.5-inch pages (50 including front and back) of text and simple graphics. It is cumbersome to use and time-consuming to assemble, and is rarely up-to-date with current training procedures due to difficult configuration management control.

At JSC, an electronic version of the paper checklist described above is currently under development. It is expected to improve astronaut EVA productivity by providing a portable, self-contained information display system which will allow the crewmember to have ready access to a much larger data base. Worn over the space suit arm assembly (as is the current paper cuff checklist), the electronic cuff checklist information display will provide easy access to a text and graphics data base of greater than 500 pages via a touch screen integrated onto a high-resolution electroluminescent display. This data base is both reprogrammable and expandable via a serial data port to accommodate the data requirements of various Shuttle EVA mission tasks. The data base contents are easily and quickly accessed by a unique "sextant" screen protocol developed in house. In addition, improved training is expected since the astronaut can be provided earlier access to the latest data bases. A "hypercard" training tool is being developed to allow the astronaut the opportunity to define the contents (and acquisition) of the unit's data base. The hypercard training tool also allows efficient loading of the data base because captured

images (including photographs) can be directly inserted into the electronic cuff checklist. The additional benefit of better configuration management control will be an access-controllable electronic data base.

The electronic cuff checklist development program consists of two phases. This current year's activities, which make up the major part of Phase I, include the development of a ground-testable preprototype unit (fig. 1). This battery-powered unit includes an off-the-shelf electroluminescent display, driver electronics, memory, serial data programming port, and touch screen activation. Accomplishments included numerous engineering design trades and the development of software training tools for both creating and loading the contents of the electronic cuff checklist via a Macintosh workstation. Valuable inputs have been provided by personnel from Shuttle crews, Man-Systems Division (Human Computer Interface Group), Mission Operations Directorate (Flight Data File Office and EVA/Crew Systems Section), and Crew and Thermal Systems Division (EVA Branch). In Phase II, EVA flight evaluation units of the electronic cuff checklist will be developed for Shuttle flights STS-61 and/or STS-63.

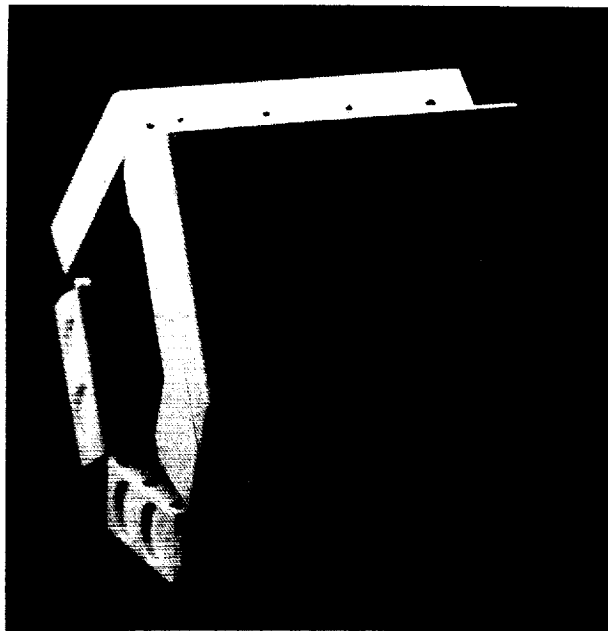

Figure 1. Electronic cuff checklist Phase I ground test article with sextant screen.

Fault Tolerant Robotics

PI: John Chladek/ER4
Reference: SST 7

Space-based robotic systems must employ failure tolerance to assure safety and mission success by minimizing operational limitations and constraints imposed on robotic systems. Tasks are being worked to develop safe and reliable control and operations of robotic systems which could transparently absorb any drastic controls or electro-mechanical failure. This would eliminate the current operational restrictions imposed on robotic systems due to their risk of producing uncommanded motion caused by component or control failures. These concepts would also allow task continuance with full coordinated control while accommodating a failure in the system.

JSC developed and tested in house a dual actuator manipulator joint design which could transparently absorb robotic actuator electromechanical failures. The concept investigated incorporates two servomotor modules powering a dual input differential mechanism which drives an output joint. The redundant design would allow one servomotor module to suffer an electrical or mechanical failure and still continue driving the joint output with minimum disturbance. Engineering modeling and simulation were used for initial analysis, primarily of failure transient effects. Differential gear train dynamics were modeled, with torsional flex for the elastic mechanical components to include torsional resonance phenomena. Several mechanical configurations were assessed, and the effects of fault transient response were studied. A test-bed was designed and developed for comparing operational transient responses, including dynamic ones, of the mechanical configurations to simulated responses. One architectural configuration implemented in the mechanism test-bed was that of dual servo modules driving gearboxes before the differential, which then drove an output joint inertial load (fig. 1). Control concepts were tested for transient stability during the induced failures. The differential drive concept provides significant benefits over other proposed space-based redundant drive manipulator joints. It mechan-

ically removes the direct coupling between the redundant servomotor modules and allows continued operations of the joint after any of three single-failure modes which would stop operations of other proposed concepts. Papers on the design were presented at the 1991 IEEE International Conference on Robotics and Automation and at the 1992 International Symposium on Robotics and Manufacturing.

The in-house differential drive development task was completed with successful correlation of acquired data from the mechanism test-bed to validate the analysis. It demonstrated the capability of the concept to dynamically absorb induced failures in the mechanisms, electronics, or control systems. Imprecision in the mechanism components of the test-bed contributed noise disturbances that reduced measurement accuracy. These results led to the recommendation to apply the differential drive concept to a high precision actuator joint which could be incorporated into an existing manipulator to demonstrate the research technology in an operating system. This application awaits future funding.

A second task addresses the fundamental concerns of fault tolerance in robotics-safe control of the whole manipulator system—and at the individual joint level. A research grant was provided to the University of Texas (UT) at Austin to create a program for developing fault tolerant reconfigurable manipulator structures and adaptive control concepts. The adaptivity must apply not only at the individual actuator joint level but also to coordinated control of all cooperating joints of the robotic system, similar to dynamic resource allocation in other current systems.

The goal of this task is to address three new areas in robotics: developing a fault tolerant joint module which is compact and scalable in size, implementing various sizes of these scalable modules into readily reconfigurable manipulator architectures tailored to the application, and developing sophisticated decision-making system controls to drastically improve failure tolerance capability at the individual joint level. Control of such configurations requires continuing research into disturbance rejection from failure occurrences.

Adaptive control techniques are under development using fault-tree selection and decision-tree procedures.

The approach is to provide structural redundancies and alternative control capabilities that allow four levels of fault tolerance in a modular manipulator architecture. The first level is in the dual actuator module (prime mover) with independent servo controllers. This module becomes a common building element. The second level is accomplished by parallel or redundant mechanism structures. The third level of fault tolerance uses criteria-based decision-making software in a fault tree structure for controlling the first two levels of fault tolerance capabilities during disturbances (failures), and the fourth level provides duality of the entire mechanism. The first three layers will be demonstrated in a test-bed composed of a 4-legged, 16-motor, 4-gimbal mechanism prototype (fig. 2). The mechanism will be capable of evaluating fault

tolerance and recovery at several levels, both mechanically and electrically.

A recent accomplishment of the UT effort includes the overall design of the three-level fault tolerant test-bed, along with the in-depth design and testing of a 2-DOF fault tolerant gimbal module. This gimbal module will be another common element in the mechanism test-bed. A previous accomplishment was the design and development of a compact dual fault tolerant actuator module that is scalable and forms the first level for modular reconfigurable manipulator systems (fig. 3). It serves as a model for the gimbal module in the fault tolerant test-bed. A sophisticated decision-making package utilizing adaptive controller synthesis or linearized gain scheduling for reacting to internal disturbances (failures) continues in development, and will be incorporated to dramatically improve the fault tolerance capability of the mechanisms.

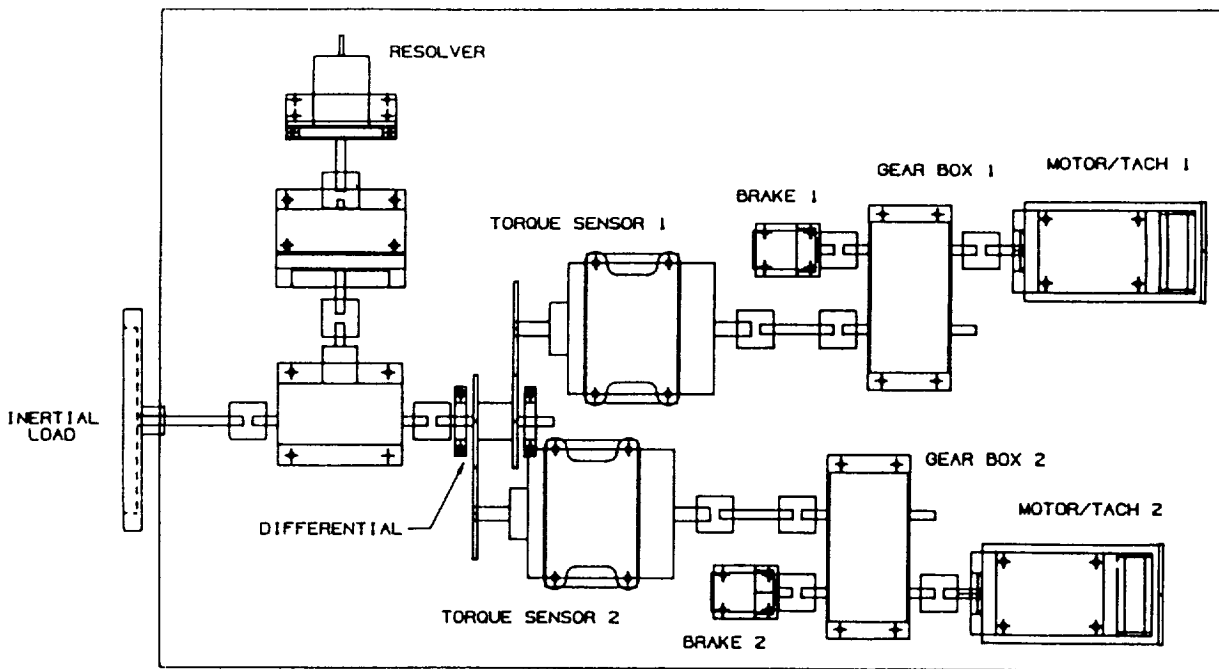

Figure 1. Failure tolerant joint test assembly.

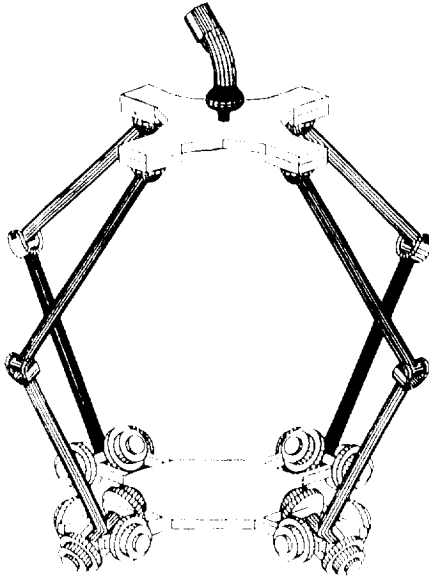

Figure 2. 3-Level fault tolerant test-bed 6-DOF, parallel, and redundant actuators; 16 inputs.

ORIGINAL PAGE
BLACK AND WHITE PHOTOGRAPH

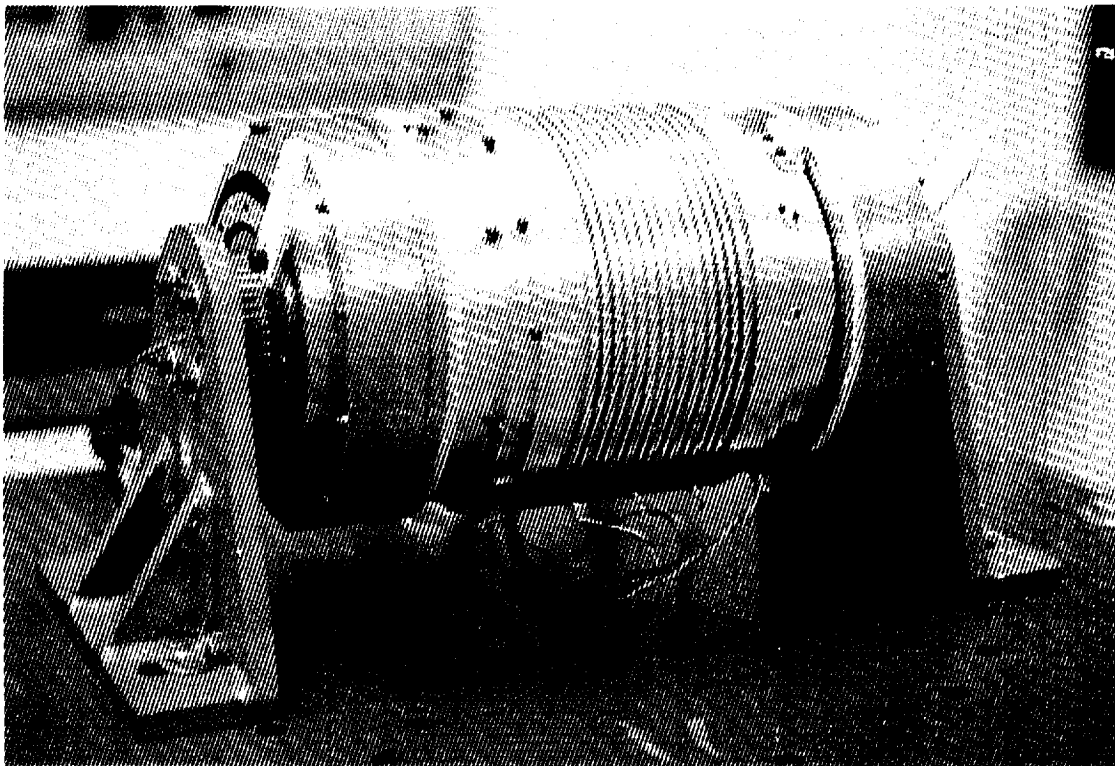

Figure 3. Actuator module.

Remote Manipulator System Position Monitor

PI: Linda A. Perrine/DF72
Reference: SST 8

The remote manipulator system (RMS) position monitor is the first step in Mission Control Center (MCC) operations toward a graphical presentation of the physical relationship between the Shuttle, the RMS, and the payload attached to the RMS. This expert system represents significant progress in presenting telemetry to the flight controller in a manner that is much more meaningful than any form of presentation on the current console hardware in the MCC. The RMS operator in the MCC has traditionally relied on digital presentation of RMS joint angles and other telemetry used in conjunction with the video downlinked by the crew to interpret the current position of the arm during payload operations. The crew often requires control of the on-board television cameras, thus preventing the ground from viewing live video during payload activities. The RMS position monitor application has provided a substitute for live video which allows the MCC RMS operators to visualize arm operations. This application has been shown frequently on NASA Select TV when live video is not available.

The position monitor actually evolved from a preceding application known as telemetry monitor. The telemetry monitor application made the first use of color for presentation of RMS telemetry to the flight controllers. It allowed all RMS telemetry to have limit violations presented with color rather than requiring separate hardware, as do the consoles, to indicate out-of-limit conditions. Once the RMS displays were converted to take full advantage of the color workstations, the next logical progression was to take advantage of the graphics abilities that workstations provide and current consoles lack. This was done by depicting the three axis views of the Orbiter and the position of the RMS as shown in fig. 1. In the upper right quadrant of fig. 1 is a portion of the telemetry monitor application. The flight controller has the flexibility to select any of the three graphical views in any quadrant, or can locate any combination of

telemetry displays and/or plotted data in any of the four quadrants as shown in fig. 2. The position monitor application provides the flexibility to give the flight controller as much information as required, in the most meaningful appropriate presentation, as quickly as possible.

The position monitor application has supported all 1992 missions which included RMS operations. Highlights included STS-49, which featured an EVA in conjunction with RMS/Intelsat operations, and STS-46, which deployed the Eureka-1 payload using the RMS. Each new mission that requires payload maneuvering by the RMS has a graphical model of the payload developed by the RMS flight planning system, which then provides the model of the payload used within the position monitor application.

The Robotics Section of the Mission Operations Directorate is currently upgrading their preflight RMS planning system to incorporate newer technology that provides improved resolution of the RMS and payloads as well as faster graphics, which will be able to keep up to movement of the RMS in real time. This new technology involves a solid surface model of both the arm and payload and will be developed on Silicon Graphics workstations which specialize in the latest in workstation graphics technology. The position monitor application will be ported to the Silicon Graphics workstations so that flight controllers can combine their flight planning and real-time monitoring capabilities during future console operations.

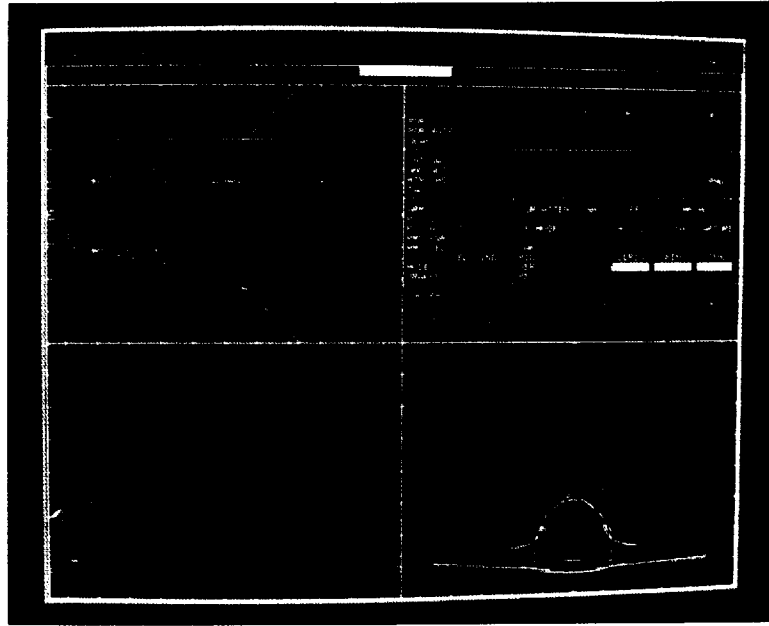

Figure 1. Graphic displays of the RMS in relation to the Orbiter from three angles. Telemetry monitor application is in the upper right quadrant of the screen.

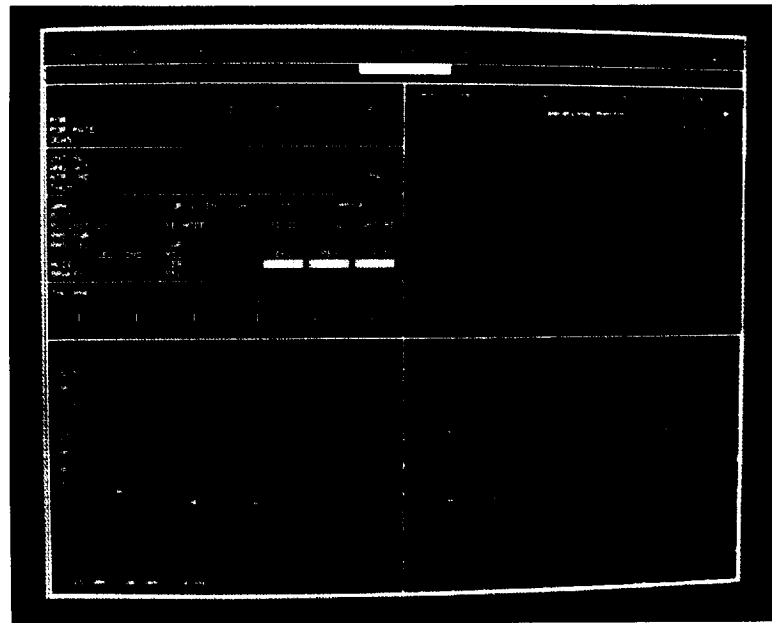

Figure 2. Combined display of telemetry and plotted data.

Guidelines for Human Interface with Artificial Intelligence

PI: Jane T. Malin/ER22
Reference: SST 9

Intelligent systems are becoming more common as support systems for flight controllers performing real-time monitoring and fault management. This project has addressed major human-computer interaction concerns of users. One is that expert systems might be black boxes that promote dependency rather than expertise because of limited user access to data. Another is that they might be too complex to understand and too cumbersome to verify, update, or control, due to complex sets of rules and unnatural "explanations" of system conclusions. In the real-time space mission control environment, where even expert users can expect the unexpected, these are important concerns. This project has developed guidance for intelligent system designers that addresses the unique human-computer interaction issues raised by these systems.

The approach has been interdisciplinary, with a project team that included experts in mission operations systems, intelligent systems, human-computer interaction, and software engineering. The project did not focus on the user interface medium or on task allocation, as a human factors project would. Instead, the project identified the types of information requirements that intelligent system designers need to focus on if they are to avoid complexity and black box problems. A design to promote user understanding and control of an intelligent system must provide highly informative displays of the status of the monitored system. It must also replace rule-based explanation facilities for intelligent system conclusions with self-explanatory displays of evidence that promote easy second-guessing and correction of the system by the user. An example of this approach to explanation is in fig. 1, which shows plots of critical supporting evidence for intelligent system conclusions.

With new information on distributed expert systems and monitoring procedure, case studies of NASA real-time monitoring and fault management

intelligent systems continued. University grantees developed a prototype generator of self-explanatory numerical simulations of engineered systems, based on qualitative representation of device behavior. A one-day tutorial seminar, "Human-Computer Interaction Design: Making Intelligent Systems Team Players," was presented at Johnson Space Center. Volume 3, "Overview for Designers" (TM-104751), has been added to "Making Intelligent Systems Team Players," the set of NASA Technical Memorandums produced from this work. These papers have been distributed widely to designers, system developers, and researchers throughout NASA and beyond.

These concepts have had positive impacts on the design of Space Shuttle and Space Station Freedom (SSF) systems. The concepts have been used in development and evaluation of DESSY, a robust real-time data system (RTDS) expert system prototype to support monitoring and detection of failures in the Space Shuttle remote manipulator system. Consultation offered on human-computer interaction design for SSF advanced automation engineering prototypes has had significant positive impacts. A striking example is the improvement of the "status-at-a-glance" display for the thermal control system automation project. The old display used a complex schematic view of the system; the new one uses understandable plots of critical data and data relationships.

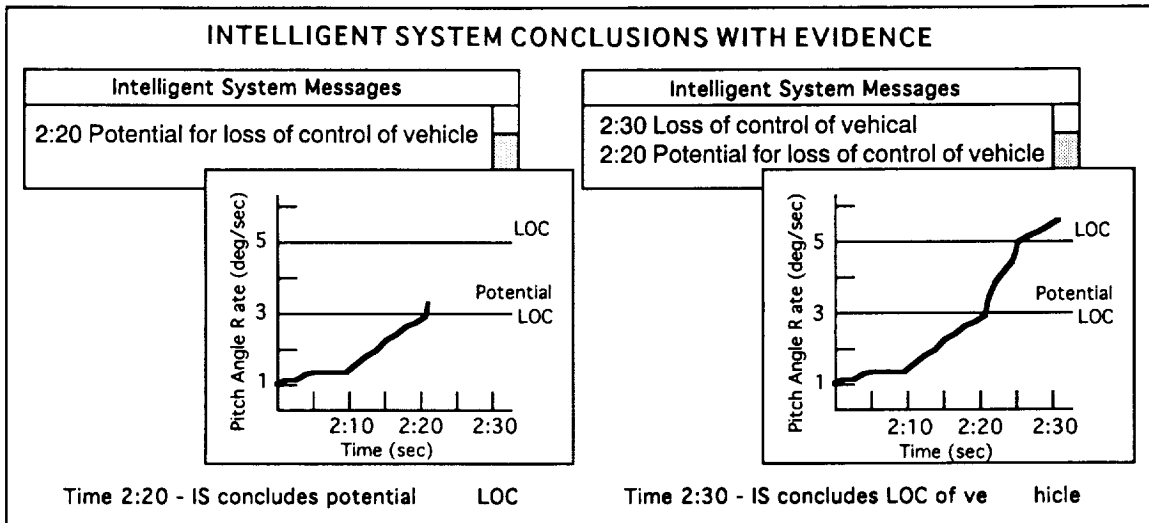

Figure 1. Displaying evidence supporting intelligent system conclusions.

Mobile Liquid Venting Membrane Separator

PI: Gretchen A. Thomas/EC6
Reference: SST 10

The venting membrane system (VMS) will remove metabolic carbon dioxide and water vapor in an advanced EVA life support system. This year, both a design concept review and a preliminary design review (PDR) were completed for the VMS being developed under contract NAS 9-18588 by Lockheed Missiles and Space Company. This system uses a pumped liquid solvent of a cesium carbonate solution and two hollow fiber membrane (HFM) modules to remove carbon dioxide and humidity from the EMU vent loop. As shown in fig. 1, the solvent absorbs CO_2 and H_2O in the scrubber module. It is then pumped around the loop to the stripper module, and desorbs the CO_2 and H_2O through the stripper module to space vacuum.

A 1/8-scale VMS was delivered to JSC at the PDR, along with an analysis model which has been correlated with the results of subscale testing.

According to model predictions, a full-scale VMS module would be approximately 2.0 cubic feet in volume and require 5.75 watts of pumping power. Secondary to the contract objectives, it has been shown that the VMS could also be used to remove waste heat from the EMU by venting water overboard through the stripper module and using the low temperature solvent loop as a heat sink for the liquid cooled garment. In this case, the total weight and volume of the full-scale module would actually be reduced to 1.6 cubic feet and 6.5 watts. With dilution in the CO_2 concentration in the VMS by the addition of water, the CO_2 reaction rates are enhanced, thereby requiring less membrane surface area. Phase II activities for this contract will include refining the solvent/catalyst mixture and incorporating a new radial flow HFM module. Successful completion of these tasks will help to reduce the total system volume by increasing the CO_2 and H_2O reaction rates. The reduction goal for the development unit is from 1.6 to 0.5 or 1.1 cubic feet.

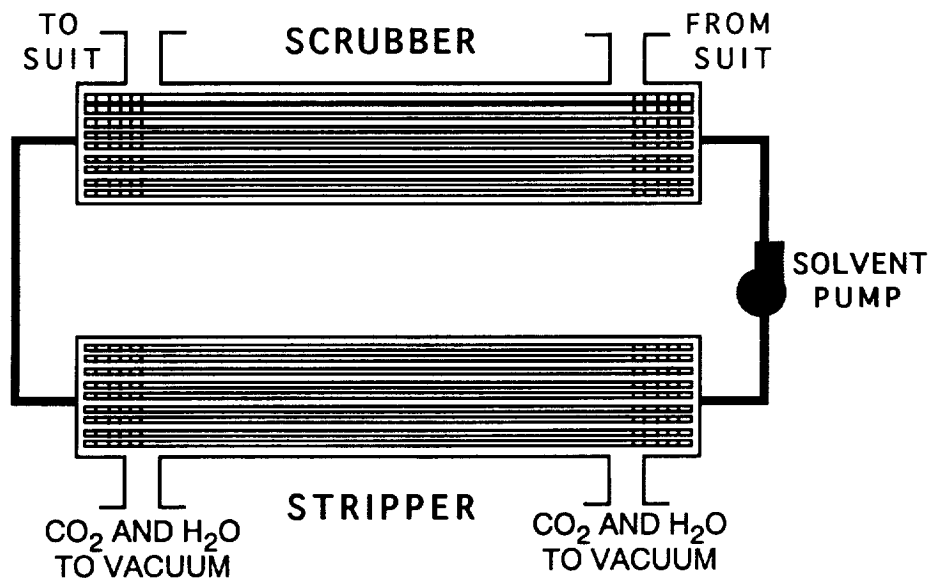

Figure 1. Venting membrane system.

Extravehicular Activity Surface Systems for Portable Life Support

PI: Chau Pham/EC4
Reference: SST 11

The subcritical liquid oxygen system (fig. 1) will provide oxygen for an advanced extravehicular activity life support system. All cryogenic oxygen systems to date have used liquid oxygen in its supercritical state, allowing one-phase material that can be measured and handled more easily under zero-g conditions. The disadvantage is that tanks are heavier because high pressures (greater than 732 psi) are required for such a system. The advantage of the Subcritical System is that it can operate at any pressure and can be made lighter weight, but the two-phase liquid problem must be considered. This project uses the magnetic property of liquid oxygen, rather than gravity, to position the fluid where it is needed. This characteristic can be used to allow only liquid out of the tank outlet tube, force liquids to hot spots in a heat exchanger in which convection would naturally drive away the fluid, and allow accurate measurement of the fluid during filling and draining of a cryogenic tank.

The vessel will supply 3.25 pounds of oxygen from a tank 5.5 inches in diameter and 11 inches long. To do this with high pressure gas would take a pressure of 8600 psi with a tank weight of 18 pounds versus 5 pounds for a cryogenic tank.

The contractor for this effort is Oceaneering Space Systems of Webster, Texas. The preliminary design review and the critical design review for the storage and supply system for an advanced EVA mobility unit were completed successfully.

This system will be tested under one-g conditions after the tank has been fabricated. Analytical predictions have shown that the system can operate upside down and on its side for limited duration. What is truly needed is a long-duration zero-g test. A proposal has been submitted by Oceaneering to the "In Step" program to fly this tank as part of a zero-g experiment on the Shuttle. A decision will be made by the middle of 1993.

This technology will be used in the "Fast Track EMU" funded by code R. It is the precursor of a zero-g EMU to be used on Space Station Freedom after the year 2000.

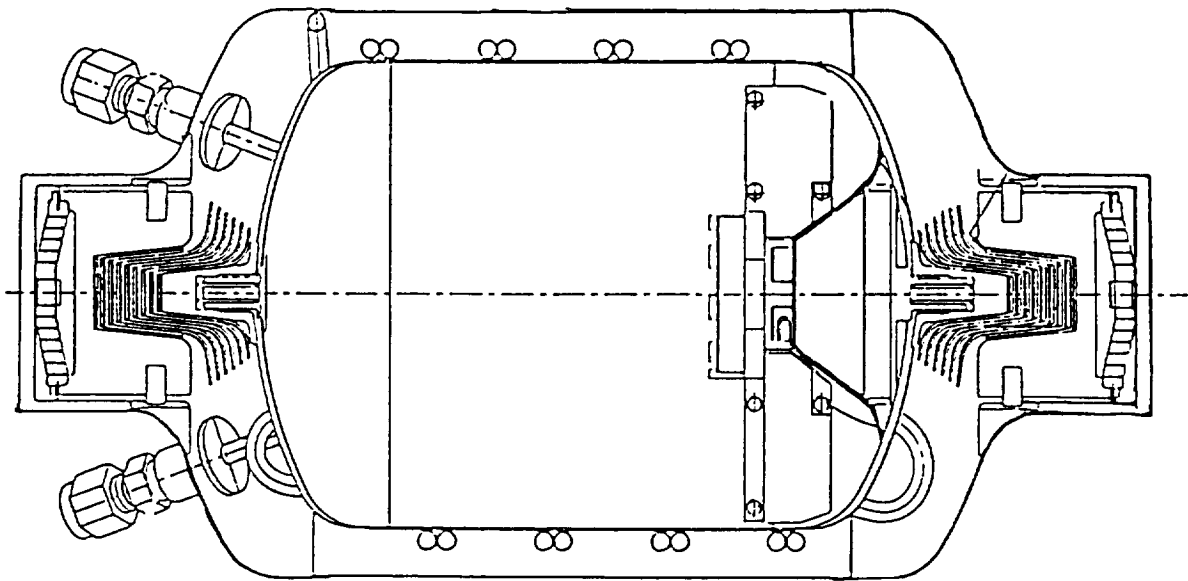

Figure 1. Subcritical Liquid Oxygen Storage and Supply System.

Hydrogen Venting Metal Hydride Heat Sink

PI: Gretchen A. Thomas/EC6
Reference: SST 12

The venting hydride cooler (VHC) will provide thermal control for an advanced EVA life support system. This year both a design concept review and a preliminary design review (PDR) were completed for the VHC provided by Hydrogen Consultants, Inc. of Littleton, Colorado, under contract NAS 9-18597. The VHC utilizes metal hydride reactions to provide a low temperature heat sink for the liquid cooling garment (LCG) in the extravehicular mobility unit (EMU). The addition of EMU waster heat to a metal hydride causes hydrogen gas to be liberated in an endothermic reaction. Because this endothermic reaction takes place at 40°F (4.4°C), the hydride tubes can then be used as a heat sink to cool the LCG water. The hydrogen gas that is liberated in this process is then vented overboard to space vacuum. A hydride-based system, used in combination with a radiator, as illustrated in fig. 1, could be used instead of a water sublimator, which vents water vapor to space

vacuum. The consumable savings would be significant, venting less than 1 pound of hydrogen compared with nearly 10 pounds of water for one 7-hour EVA.

The hydride which was selected for the VHC at the PDR is a lanthanum-nickel-manganese (LaNi₄MnH₆) hydride alloy. It has very high heat capacity per pound of hydrogen desorbed, 8931 Btu/lbm H₂ (20.77 MJ/kg). (Compare this with the heat capacity of water sublimation: 1038 Btu/lbm H₂O [2.415 MJ/kg].) Furthermore, the La-Ni-Mn alloy has inherent safety advantages because the hydrogen pressure for this alloy is subatmospheric, approximately 0.178 atm (18 kPa). This means that if the system were to develop a leak on orbit, the air would leak into the hydride, and there would be no danger of hydrogen contamination of vehicle cabin atmosphere. Based on PDR data, current weight and volume estimates for a VHC supporting an 8-hour EVA (6 hours at 1000 Btu/hr metabolic rate plus 2 hours at 500 Btu/hr) are 0.45 cubic feet and 80 pounds.

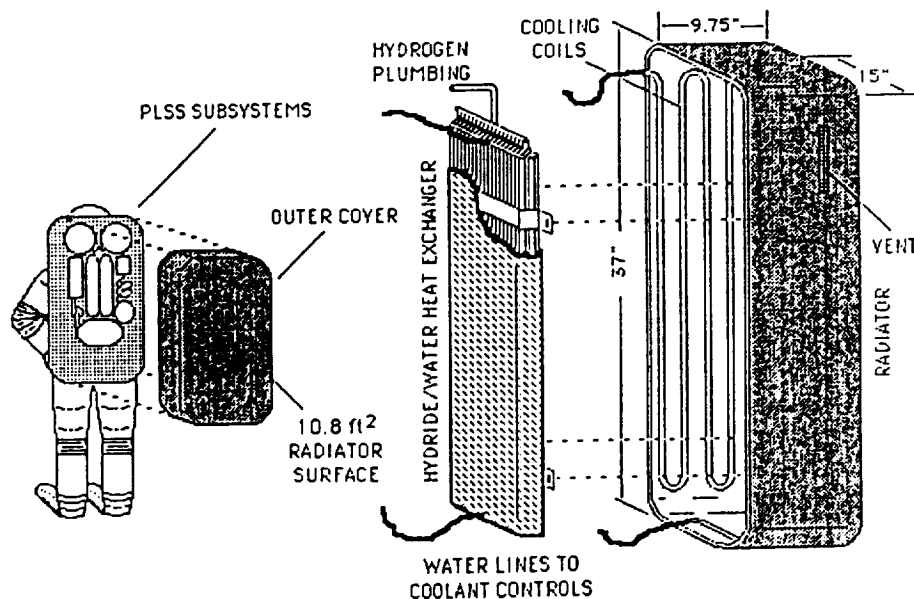

Figure 1. Water lines to coolant controls.

Electrolysis Performance Improvement Concepts Study

PI: Robert Cusick/EC3
Reference: SST 13

Work began in 1991 to develop a flight experiment with the objectives of demonstrating and validating the static feed electrolyzer (SFE) concept in microgravity and investigating ways a microgravity environment may improve SFE performance. If successful, the results of this shuttle middeck experiment can be used to improve the SFE process efficiency for such activities as life support, propulsion, energy storage, and space manufacturing. The space environment is needed for this experiment because the SFE process has not been operated in microgravity, data on gas and liquid transport in microgravity is very limited, and one-g test results are compromised by buoyancy and by gravity-affected fluid configuration within the electrolysis cells.

The experiment will be conducted in a middeck payload locker. Three electrochemical water electrolysis cells will be operated at various current densities and temperatures over a 5-day period to determine the effect of microgravity conditions on cell voltage operation. Table 1 provides the operating conditions of these three cells as they are

now planned. A lower cell-voltage operation may result from microgravity effects on the distribution of liquid electrolyte, the gas/liquid interfaces with the cell, and the capillary forces on fluids within the pores of the cell electrode, electrolyte matrix, and anode. A dedicated experiment processor will control all operations of the cells and will provide for monitoring and control of critical parameters and data storage. The experiment is designed for independent operation, requiring only electrical energy, and cabin air for cooling. The water supply for the electrolysis will be self-contained in the experiment and be obtained from an H₂/O₂ combiner (fuel cell concept). Likewise, the N₂ supply for the atmosphere with the enclosure around the mechanical/electrical assembly will be self-contained. A single on-actuator of the experiment is all that is needed by the operator. The experiment is designed to be compatible with the weight, power, and heat rejection capability of a standard middeck payload locker (fig. 1).

During 1992, the experiment successfully completed the Phase B preliminary design review and the non-advocate review at NASA Headquarters, and was approved by the Flight Experiment Review Board to enter the Space Station flight implementation phase (Phase C/D).

Table 1. Epics Operation Conditions

Vehicle Conditions	
Middeck Total Pressure, kPa (psia)	101.3 ± 1.4 (14.7 ± 0.2)
Middeck Temperature, K (F)	292 to 300 (65 to 80)
Nominal Operating Conditions	
Number of Units	3
Current Density mA/cm ² (ASF)	34 to 171 (32 to 160)
Operating Pressure, kPa (psia)	108.3 ± 0.2
Operating Temperatures, Nominal, K (F)	319, 331 and 344 (115, 135 AND 160)

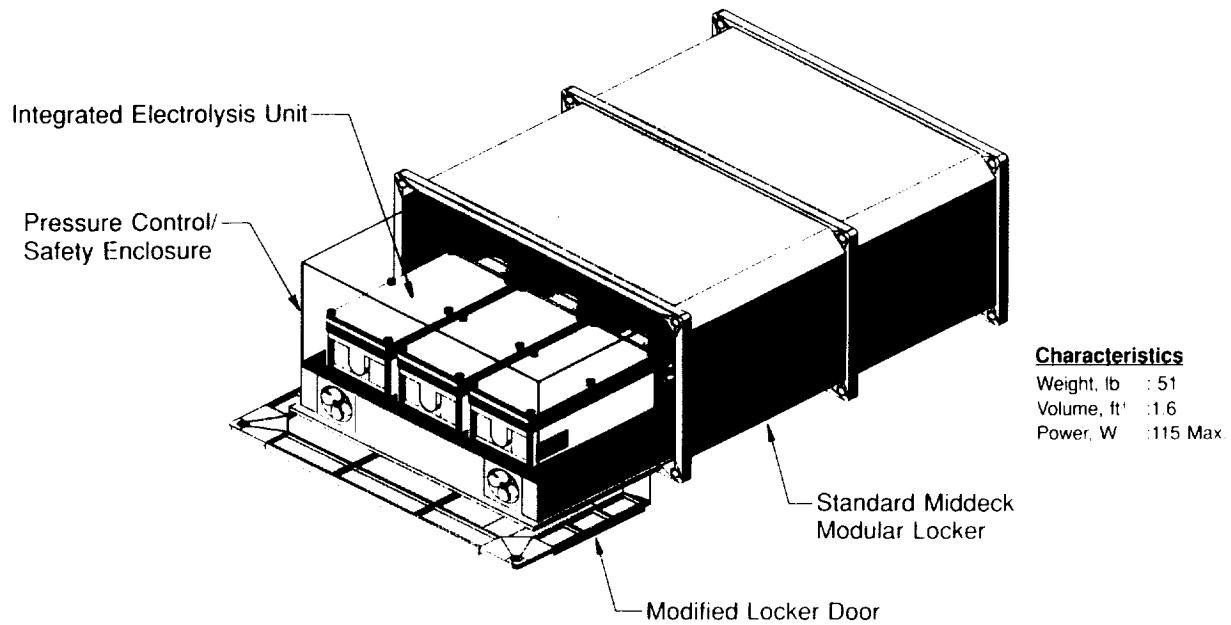

Figure 1. Electrolysis Performance Improvement Concept Studies (EPICS) experiment packaging concept (in locker).

Overview Data Base and Data Search

PI: Linda A. Perrine/DF72
Reference: SST 14

The Overview Data Base and Data Search (ODDS) project was originated by Mission Control Center (MCC) flight controllers who are responsible for monitoring the Space Shuttle environmental control and life support systems (ECLSS). The ECLSS flight controllers place a high dependence on comparison of previous Shuttle flight telemetry to the current mission flight data to identify trends which indicate anomalous system behavior. The ODDS project was initiated to provide a user-friendly software application which could give flight controllers quick access to all previous Shuttle flight telemetry as well as information about each previous mission such as mission events, anomalies, and timelines, which enable the controller to request pertinent telemetry from one or more pertinent historical flights.

Beginning in 1993, a new telemetry archiving system, the Orbiter Data Reduction Complex (ODRC), will give flight controllers immediate access to all previous Shuttle mission telemetry via a centralized system which stores historical telemetry on an optical disk jukebox and current flight data on high-speed magnetic disk. This is the system with which ODDS was designed to interface for retrieval of historical and current flight data.

The ODDS project had a 3-year life span, receiving funding through the RTOP process for FY90 through FY92. The project began with a rapid prototyping phase which was demonstrated directly to flight controllers from several disciplines and provided rapid feedback for user-interface definition. From there, the informational mission data was gathered by flight control personnel and entered into a commercial UNIX relational data base package. The original data base definition was implemented with Informix and has since been ported to run with Oracle. A simple data base query interface was developed which required flight controllers to learn a new means of searching

through the information within ODDS (fig. 1). At the same time, other project personnel developed a telemetry plotting package with a point-and-click user interface to allow the flight controller to point at the feature of the plot he or she desires to modify. Another feature of the plotting package's user interface is the rapid means of selecting pertinent historical telemetry from one plot window and "overlying" the historical data to the current mission data in real time or "near real time" (fig. 2). This provides the operator with a quick means of comparing a particular system's current performance with that on a previous mission. By making use of the mission information stored in ODDS, the operator can narrow the search through the historical missions by vehicle identification, line-replaceable-unit serial number, historical anomaly, or mission event, etc. The ultimate goal of ODDS is to bring as much information, both textual and telemetry, to the operator as quickly as possible for the purpose of identifying the current mission's system performance.

ODDS completed a flight-following phase for each 1992 Shuttle mission and will begin to interface with the ODRC system in 1993. The ODDS prototype is now being split into two separate applications, a Mission Information System (MIS) and a generic plot utility that can support other applications in addition to ODDS. The MIS is being upscaled to include all flight control disciplines and the information products they generate during the flight. Standard products such as the Anomaly Report, Chit (two-way memo between MOD and Engineering during the flight), Attitude Timeline, Standard Mission Event Timeline, LRU serial number data base, and many others are to be included in a centralized Oracle data base available to all flight control personnel. This continuation of the ODDS project in a central Mission Information System is being funded directly by MOD in 1993. In coming years, it is anticipated that the MIS will be available to merge with other data base applications such as the Electronic Flight Data File system and the Ground System Data Repository planned for Space Station.

Computational Control Workstation (Information and Control Research and Technology)

PI: John Sunkel/EG241
Reference: SST 15

The computational control workstation has been designed and constructed for rapidly simulating motions of rigid and elastic multibody systems. Three aspects of the device distinguish it from other simulation programs. First of all, computational speed is the result of a parallel arrangement of four processor. Second, one uses a series of windows and menus on a computer terminal, together with a keyboard and mouse, to provide a mathematical and geometrical description of the system under consideration. The third hallmark is a facility for animating simulation results.

Project objectives in FY92 were to

- Assess the effort needed to set up, run, and display results of a simulation, and improve the “friendliness” of the device where necessary.
- Establish confidence in the algorithms that derive, encode, and solve equations of motion of multibody systems.
- Compare computational speed of workstation with that of other multibody software.

Accomplishments of the FY92 include the identification of inefficient processes and improvement in user interfaces. In tests performed thus far, the workstation yields simulation results that agree with those of other programs, and is three to four times as fast (table 1). Two papers on the workstation were presented at the Fifth Annual NASA/NSF/DoD Workshop on Aerospace Computational Control in Santa Barbara, California, August 17 - 19, 1992. A 3-day training class was held for civil servants and support contractors.

The workstation represents an advance in the state of the art in simulating motions of elastic multibody systems. Up to now, the length of time required to perform such simulations has made analysis impractical.

The computational control workstation is applicable to any project that requires simulations of motions of multibody systems and evaluation of control law performance; for example, Space Station, planetary and Earth observation spacecraft, and lunar or Mars rovers.

Table 1. Comparison of Simulation CPU Time, in seconds

Case	Workstation	SCS (Cyber 930)
I One rigid body	87	169
II One rigid body, 5 pieces	115	373
III Five rigid bodies	117	383
IV One elastic body	734	3084
V One elastic body, 5 pieces	352	1326
VI Five elastic bodies	352	1331

Index

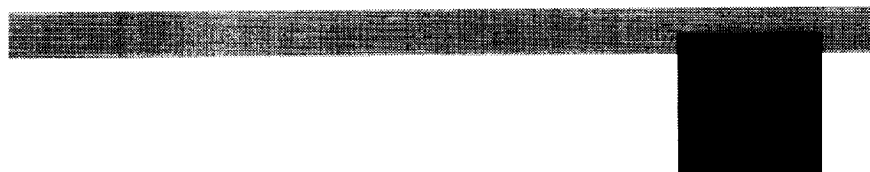

Index

Life Sciences (LS)

LS 1 A Rapid Tetrazolium-Based Biocide Assay

Funded by: 199-04-11-20
TM/PI: Duane L. Pierson, Ph.D./SD4
PI: Raymond P. Stowe, Ph.D./KRUG
David W. Koenig, Ph.D./KRUG
Saroj K. Mishra, Ph.D./KRUG
Task Performed by: Johnson Space Center
KRUG Life Sciences

LS 2 Spacecraft Maximum Allowable Concentrations for Individual Contaminants

Funded by: 199-04-11-08, 199-08-17-15
TM/PI: John T. James, Ph.D./SD4
PI: Harold Kaplan, Ph.D.
Martin E. Coleman, Ph.D./SD4
Task Performed by: Johnson Space Center
National Research Council Committee on
Toxicology

LS 3 Heavy-Ion-Induced Genetic Changes in Mammalian Cells

Funded by: 199-04-11
TM/PI: Chui-hsu Yang, Ph.D./SD4
PI: Laurie M. Craise/Lawrence Berkeley
Laboratory, California
Marco Durante Ph.D./University of Napoli,
Italy
Task Performed by: Johnson Space Center
Lawrence Berkeley Laboratory, CA
University of Napoli, Italy

LS 4 Development of Human Epithelial-Cell Systems for Radiation Risk Assessment

Funded by: 199-04-11
TM/PI: Chui-hsu Yang, Ph.D./SD4
PI: Laurie M. Craise/Lawrence Berkeley
Laboratory, California
Task Performed by: Johnson Space Center
Lawrence Berkeley Laboratory, CA

Note: Technical Monitor (TM)
Principal Investigator (PI)

PRECEDING PAGE BLANK NOT FILMED

LS 5 Macromolecular Permeability of Endothelium

Funded by: 199-18-11-15
TM/PI: Peggy A. Whitson, Ph.D./SD4
PI: John E. Wagner/Rice University
Larry V. McIntire, Ph.D./Rice University
Task Performed by: Johnson Space Center
Rice University

LS 6 The Role of the Sympathoadrenergic System During Head-Down Bed Rest

Funded By: 199-18-11-01
TM/PI: Peggy A. Whitson, Ph.D./SD4
PI: W. Jon Williams, Ph.D./SD4
Charles A. Stuart, M.D./The University of Texas Medical Branch, Galveston
Suzanne M. Fortney, Ph.D./SD5
Helen W. Lane, Ph.D./SD4
Nitza M. Cintrón, Ph.D./SD4
Task Performed by: Johnson Space Center
The University of Texas Medical Branch, Galveston

LS 7 Stable-Isotope Enrichment of Shuttle Drinking Water

Funded by: 199-18-11-18
TM/PI: H.W. Lane, Ph.D./SD4
PI: E.K. Gibson, Jr., Ph.D./SN2
R. J. Gretebeck, Ph.D./SD4
R. A. Socki./LESC
Dale A. Schoeller, Ph.D./University of Chicago
Task Performed by: Johnson Space Center
KRUG Life Sciences
Lockheed Engineering and Sciences Company
Department of Medicine, University of Chicago

LS 8 Alternatives for Crew Health Care System Computer Development

Funded by: 199-02-31-01-44
TM/PI: Charles W. Lloyd, Pharm.D./SD2
PI: Marilyn Scott/KRUG
Task Performed by: Johnson Space Center
KRUG Life Sciences

LS 9 Crew Health Care System Simulations for Space Medicine Programs

Funded by: 199-02-31-01-42
TM/PI: Charles W. Lloyd, Pharm.D./SD2
PI: Smith L. Johnston, M.D./KRUG
Task Performed by: Johnson Space Center
KRUG Life Sciences

- LS 10 Upgrades to the Preflight Adaptation Trainers**
 Funded by: 199-16-11-12
 TM/PI: Deborah L. Harm, Ph.D./SD5
 PI: William G. Crosier/KRUG
 Millard F. Reschke, Ph.D./SD
 Donald E. Parker, Ph.D./Miami University
 Task Performed by: Johnson Space Center
 KRUG Life Sciences
 Miami University
- LS 11 Mechanisms by Which Lower Body Negative Pressure Improves Orthostatic Responses**
 Funded by: 199-14-11-13
 PI : S.M. Fortney, Ph.D./SD5
 Task Performed by: Johnson Space Center
 KRUG Life Sciences
- LS 12 A System for Accurate Measurement of Pointing Responses**
 Funded by: 199-16-11-48
 TM/PI: Jacob J. Bloomberg, Ph.D./ SD5
 PI: William P. Huebner, Ph.D./KRUG
 Task Performed by: Johnson Space Center
 KRUG Life Sciences
- LS 13 Behavior and Performance in a Spaceflight Analogue**
 Funded by: 199-06
 TM/PI: Albert W. Holland, Ph.D./SD5
 PI: JoAnna Wood, Ph.D./KRUG
 Stephen T. Vander Ark/KRUG
 Laura G. Williamson, Ph.D./KRUG
 Task Performed by: Johnson Space Center
 KRUG Life Sciences
- LS 14 Project ARGO: The Effect of Musculoskeletal Activity on the Formation of a Decompression Gas Phase**
 Funded by: 199-04-11-01
 TM/PI: Michael R. Powell, Ph.D./SD5
 PI: James Waligora, M.S./SD5
 William Norfleet, M.D./SD5
 K. Vasantha Kumar, M.D./KRUG
 Task Performed by: Johnson Space Center
 KRUG Life Sciences
- LS 15 Techniques for In-Suit Detection of a Decompression-Induced Gas Phase**
 Funded by: 199-04-11-01
 TM/PI: Michael R. Powell, Ph.D./SD5
 PI: James Waligora, M.S./SD5
 William Hall, B.S./KRUG
 Karin Loftin, Ph.D./KRUG
 Task Performed by: Johnson Space Center
 KRUG Life Sciences

LS 16 Requisite Conditions for Neurologic Decompression Sickness During Hypobaric Decompression

Funded by: 199-04-11-01
TM/PI: Michael R. Powell, Ph.D./SD5
PI: James Waligora, M.S./SD5
William Norfleet, M.D./SD5
K. Vasantha Kumar, M.D./KRUG
Task Performed by: Johnson Space Center
KRUG Life Sciences

Human Support Technology (HST)

HST 1 Integrating Microgravity Test Data with Human Computer Reach Model

Funded by: 506-71
TM: Dean Jensen, Ph.D./SP34
James Maida/SP34
PI: Mihriban Whitmore, Ph.D./LESC
Randy Morris/LESC
Ann Aldridge, Ph.D./LESC
Abhilash Pandya/LESC
Task Performed by: Johnson Space Center
Lockheed Engineering and Sciences Company

HST 2 A Comparison and Validation of Computer Lighting Simulation Models for Space Applications Using Empirically Collected Data

Funded by: RTOP# 199-06
PI: James C. Maida/SP34
Abhilash K. Pandya/LESC
Ann M. Aldridge, Ph.D./LESC
Task Performed by: Johnson Space Center
Lockheed Engineering and Sciences Company

HST 3 Validation of the Clavicle/Shoulder Kinematics of a Human Computer Reach Model

Funded by: RTOP# 199-06
PI: James C. Maida/SP34
Ann M. Aldridge, Ph.D./LESC
Abhilash K. Pandya/LESC
Task Performed by: Johnson Space Center
Lockheed Engineering and Sciences Company

- HST 4 Cycle Ergometer Biomechanical Evaluations**
 Funded by: Space Human Factors 199-06-11
 Human Performance
 PI: Glenn K. Klute/SP34
 Jeff Poliner/LESC
 Task Performed by: Johnson Space Center
 Lockheed Engineering and Sciences Company
- HST 5 Gloved Hand Performance Evaluations**
 Funded by: Space Human Factors 199-06-11
 Human Performance
 PI: Glenn K. Klute/SP34
 Ram Bishu, Ph.D./University of Nebraska
 Task Performed by: Johnson Space Center
 University of Nebraska
 Lockheed Engineering and Sciences Company
- HST 6 Human Factors Analyses of STS-50/USML-01**
 Funded by: OSSA 199-06-11-13
 TM: Susan Adam/SP34
 PI: Anton Koros/LESC
 Manny Diaz/LESC
 Mihriban Whitmore, Ph.D./LESC
 Randy Morris/LESC
 Task Performed by: Johnson Space Center
 Lockheed Engineering and Sciences Company
- HST 7 Human Factors Investigation of Translation Through the STS-47/Spacelab Japan Transfer Tunnel**
 Funded by: OSSA 199-06-11-13
 TM: Susan Adam/SP34
 PI: Thomas F. Callaghan/LESC
 Task Performed by: Johnson Space Center
 Lockheed Engineering and Sciences Company
- HST 8 Human Workload Analysis**
 Funded by: OSSA 199-06-11-34
 TM: Susan Adam/SP34
 Barbara Woolford/SP3
 PI: Manuel Diaz/LESC
 Task Performed by: Johnson Space Center
 Lockheed Engineering and Sciences Company
 Brooks Air Force Base
- HST 9 Geographic Information Systems in Space Systems**
 Funded by: 506-71
 TM: Frances Mount/SP34
 PI: Kevin M. O'Brien/LESC
 Steven E. Chrisman/LESC
 Benjamin J. Beberness/LESC
 Task Performed by: Johnson Space Center
 Lockheed Engineering and Sciences Company

- HST 10 Human-Computer Interface to Electronic Procedures Research**
 Funded by: 506-71
 TM: Frances Mount/SP34
 PI: Michael O'Neal/LESC
 Timothy McKay/LESC
 Task Performed by: Johnson Space Center
 Lockheed Engineering and Sciences Company
- HST 11 Human-Computer Interface to Medical Decision Support Systems for Space**
 Funded by: 199-06
 TM: Frances Mount/SP34
 PI: Jurine A. Adolf/LESC
 John Gosbee/LESC
 Steve J. Wolf/LESC
 Task Performed by: Johnson Space Center
 Lockheed Engineering and Sciences Company
- HST 12 Human-Computer Interaction Design for Intelligent Systems**
 Funded by: RTOP 506-71-51-01
 PI: Jane T. Malin, Ph.D./ER22
 Task Performed by: Johnson Space Center
 The MITRE Corporation
- HST 13 Interfaces to Intelligent Systems**
 Funded by: 506-71
 TM: Frances Mount/SP34
 PI: Kevin M. O'Brien/LESC
 Evan Feldman/LESC
 Task performed by: Johnson Space Center
 Lockheed Engineering and Sciences Company
- HST 14 Computer Aided Planning and Scheduling System**
 Funded by: 906-21
 PI: Christopher J. Culbert/PT4
 Dr. Barry Fox/MDSSC
 Task Performed by: Johnson Space Center
 McDonnell Douglas
- HST 15 Cooperating Expert Systems**
 Funded by: 906-21
 PI: Christopher J. Culbert/PT4
 Colin Clark/MDSSC
 Task Performed by: Johnson Space Center
 McDonnell Douglas

HST 16 Software Vehicle Health Management

Funded by: 906-21
PI: James Villarreal/PT4
Task Performed by: Johnson Space Center
The MITRE Corporation

HST 17 Advanced Software Development Workstation

Funded by: 906-21
PI: Ernest M. Fridge III/PT4
Dr. Charles L. Pitman/PT4
Dr. Michel Izygon/Barrios
Task Performed by: Johnson Space Center
Barrios Technology, Inc.
University of Houston Research Institute for
Computing and Information Systems

HST 18 Adaptive Fuzzy Logic Control

Funded by: 906-21
PI: Robert N. Lea/PT4
James A. Villarreal/PT4
Task Performed by: Johnson Space Center
Togai Infralogic
LinCom
Loral
McDonnell Douglas

Solar System Sciences (SSS)

SSS 1 Indigenous Space Resource Utilization Studies

Funded by: 593-82
PI: David S. McKay, Ph.D./SN
Thomas A. Sullivan, Ph.D./SN4
Carlton C. Allen, Ph.D./LESC
Task Performed by: Johnson Space Center
Lockheed Engineering and Sciences Company

SSS 2 Measuring the Terrestrial Ages of New Mexico Meteorites

Funded by: 452-12
PI: Michael E. Zolensky, Ph.D./SN21
Task Performed by: Johnson Space Center

SSS 3 Man-Made and Natural Hypervelocity Particles in Low Earth Orbit

Funded by: 152-88
PI: Friedrich Hörz, Ph.D./SN4
Task Performed by: Johnson Space Center

SSS 4 Models of the Orbital Debris Environment

Funded by: 906-34
PI: D.J. Kessler/SN
R.C. Reynolds/LESC
P.D. Anz-Meador/LESC
Task Performed by: Johnson Space Center
Lockheed Engineering and Sciences Company

Space Transportation Technology (STT)

STT 1 Autonomous Guidance, Navigation and Control Technology Bridging Program

Funded by: 906-11
PI: Gene McSwain/EG22
Task Performed by: Johnson Space Center

STT 2 Electrical Actuation Technology Bridging Program

Funded by: 906-11
PI: Don C. Brown/EG1
Task Performed by: Johnson Space Center

STT 3 Computer-Operated Automated Assistance

Funded by: 906-21
PI: Mitchell Macha/DK
Task Performed by: Johnson Space Center
Loral
IBM

STT 4 Rendezvous Expert System

Funded by: 906-21
PI: H. K. Hiers/ER2
Task Performed by: Johnson Space Center
Lockheed Engineering and Sciences Company

STT 5 Playback Trainer

Funded by: 906-21
PI: James T. Ruszkowski/DG48
Task Performed by: Johnson Space Center
Rockwell
Unisys

STT 6 Flight Director Weather System

Funded by: 906-21
PI: Linda A. Perrine/DF72
Arthur N. Rasmussen/DF72
Task Performed by: Johnson Space Center
The MITRE Corporation

STT 7 Maintainability Model and Data Base Development

Funded by: 323-43
PI: A.J. Mitchell, NB22
Task Performed by: Johnson Space Center
Loral

STT 8 Vehicle Health Monitoring for OMS/RCS

Funded by: 906-11
PI: Richard J. Schoenberg/EP4
Task Performed by: Johnson Space Center
Lockheed Engineering and Sciences Company
Boeing

STT 9 Experimental Investigations of Spacecraft Glow

Funded by: 506-74
PI: Dr. Gary Swenson
Task Performed by: Lockheed Missiles and Space Company

STT 10 Orbital Acceleration Research Experiment

Funded by: 506-48
PI: R.L. Giesecke/ID3
Task Performed by: Johnson Space Center
Langley Research Center

Space Systems Technology (SST)

SST 1 Regenerative Life Support Systems Integration

Funded by: 593-41
PI: H. Eugene Winkler/EC3
Task Performed by: Johnson Space Center
CTSD
Lockheed Engineering and Sciences Company
AiResearch
Hamilton Standard/Life Systems, Inc.

SST 2 Controlled Ecological Life Support Systems

Funded by: 199-61
PI: Donald L. Henninger/EC3
Task Performed by: Johnson Space Center

SST 3 Modeling of the Regenerative Life Support System Plant Growth Chambers

Funded by: 199-61
PI: M. A. Edeen/EC7
Task Performed by: Johnson Space Center
McDonnell Douglas

SST 4 Ultralite Fabric Reflux Tube Radiator

Funded by: 593-41
PI: John Thornborrow/EC2
Patricia A. Petete/EC2
Task Performed by: Johnson Space Center
Batelle, Pacific Northwest Laboratory

SST 5 Closed-Loop Control of the Shuttle Remote Manipulator Using Force-Torque Sensor Inputs

Funded by: 595-11
PI: Donald A. Barron/ER3
Task Performed by: Johnson Space Center
Lockheed Engineering and Sciences Company

SST 6 Extravehicular Mobility Unit Electronic Cuff Checklist Development

Funded by: 506-71/906-21
PI: Jose A. Marmolejo/EC6
Task Performed by: Johnson Space Center

SST 7 Fault Tolerant Robotics

Funded by: 506-59
PI: John Chladek/ER4
Task Performed by: Johnson Space Center
University of Texas at Austin
Lockheed Engineering and Services Company

- SST 8 Remote Manipulator System Position Monitor**
 Funded by: 595-12
 PI: Linda A. Perrine/DF72
 Task Performed by: Johnson Space Center
 The MITRE Corporation
- SST 9 Guidelines for Human Interface with Artificial Intelligence**
 Funded by: 595-12
 PI: Jane T. Malin/ER22
 Task Performed by: Johnson Space Center
 The MITRE Corporation
 Ohio State University
 Northwestern University
- SST 10 Mobile Liquid Venting Membrane Separator**
 Funded by: 593-43
 PI: Gretchen A. Thomas/EC6
 Task Performed by: Johnson Space Center
 Lockheed Engineering and Sciences Company
- SST 11 Extravehicular Activity Surface Systems for Portable Life Support**
 Funded by: 593-43
 PI: Chau Pham/EC4
 Tasks Performed by: Johnson Space Center
 Oceaneering Space Systems
- SST 12 Hydrogen Venting Metal Hydride Heat Sink**
 Funded by: 593-43
 PI: Gretchen A. Thomas/EC6
 Task Performed by: Johnson Space Center
 Hydrogen Consultants, Inc.
- SST 13 Electrolysis Performance Improvement Concepts Study**
 Funded by: 506-74
 PI: Robert Cusick/EC3
 Task Performed by: Johnson Space Center
 Life Systems, Inc.
- SST 14 Overview Data Base and Data Search**
 Funded by: 906-21
 PI: Linda A. Perrine/DF72
 Task Performed by: Johnson Space Center
 Intergraph Corporation
- SST 15 Computational Control Workstation (Information and Control Research and Technology)**
 Funded by: 506-59
 PI: John Sunkel/EG241
 Task Performed by: Johnson Space Center

REPORT DOCUMENTATION PAGE

Form Approved
OMB No. 0704-0188

Public reporting burden for this collection of information is estimated to average 1 hour per response, including the time for reviewing instructions, searching existing data sources, gathering and maintaining the data needed, and completing and reviewing the collection of information. Send comments regarding this burden estimate or any other aspect of this collection of information, including suggestions for reducing this burden, to Washington Headquarters Services, Directorate for Information Operations and Reports, 1215 Jefferson Davis Highway, Suite 1204, Arlington, VA 22202-4302, and to the Office of Management and Budget, Paperwork Reduction Project (0704-0188), Washington, DC 20503.

1. AGENCY USE ONLY (Leave blank)	2. REPORT DATE 1993	3. REPORT TYPE AND DATES COVERED Technical Memorandum, Fiscal Year 1992	
4. TITLE AND SUBTITLE JSC Research & Technology Annual Report 1992		5. FUNDING NUMBERS	
6. AUTHOR(S)			
7. PERFORMING ORGANIZATION NAME(S) AND ADDRESS(ES) Lyndon B. Johnson Space Center Houston, Texas 77058		8. PERFORMING ORGANIZATION REPORT NUMBER S-713	
9. SPONSORING / MONITORING AGENCY NAME(S) AND ADDRESS(ES) National Aeronautics and Space Administration Washington, D.C. 20546-001		10. SPONSORING / MONITORING AGENCY REPORT NUMBER NASA-TM-104763	
11. SUPPLEMENTARY NOTES			
12a. DISTRIBUTION / AVAILABILITY STATEMENT Unclassified/Unlimited Publicly Available Subject Category 99		12b. DISTRIBUTION CODE	
13. ABSTRACT (<i>Maximum 200 words</i>) Johnson Space Center research and technology accomplishments during fiscal year 1992 are described and principal researchers and technologists are identified as contacts for further information. Each of the five sections gives a summary of overall progress in a major discipline, followed by detailed, illustrated descriptions of significant tasks. The five disciplines are Life Sciences, Human Support Technology, Solar System Sciences, Space Systems Technology, and Space Transportation Technology. The report is intended for technical and management audiences throughout NASA and the worldwide aerospace community. An index lists project titles, funding codes, and principal investigators.			
14. SUBJECT TERMS Research Projects, Research and Development, NASA Programs, Technology Utilization, Space Technology Experiments,		15. NUMBER OF PAGES	
		16. PRICE CODE	
17. SECURITY CLASSIFICATION OF REPORT Unclassified	18. SECURITY CLASSIFICATION OF THIS PAGE Unclassified	19. SECURITY CLASSIFICATION OF ABSTRACT Unclassified	20. LIMITATION OF ABSTRACT Unlimited