

NASA-TM-108726

(NASA-TM-108726) TECHNOLOGY FOR
SPACE STATION EVOLUTION. VOLUME 3:
EVA/MANNED SYSTEMS/FLUID MANAGEMENT
SYSTEM (NASA) 327 p

N93-27786
--THRU--
N93-27802
Unclas

G3/18 0163614

Poor Reproducibility

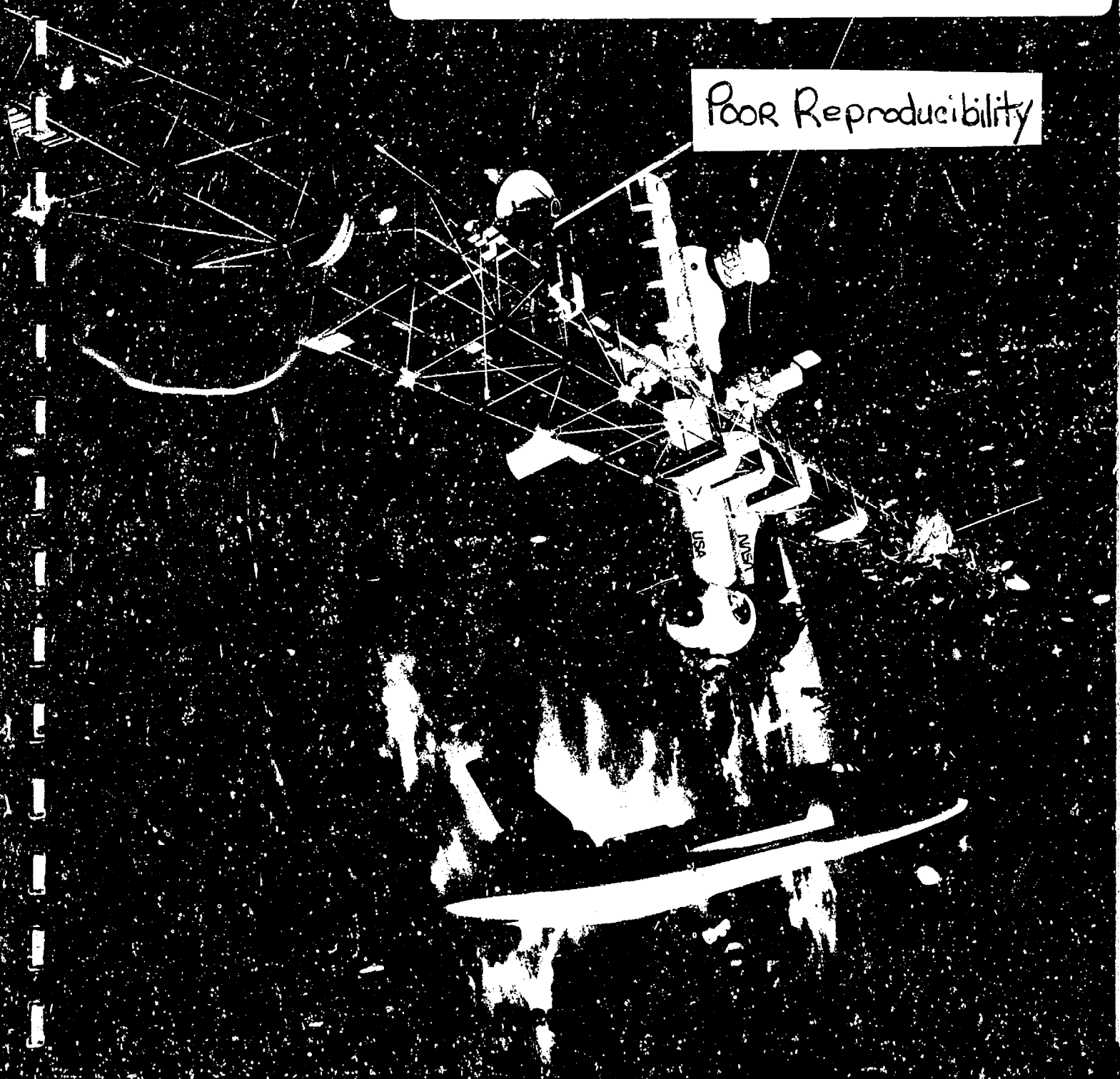

omit 73
P.5

FOREWORD

~~GENERAL PURPOSE~~
COLOR ILLUSTRATIONS

Space Station *Freedom*, now under development, is a manned low Earth orbit facility which will become part of the space infrastructure. Starting in the mid 1990s, *Freedom* will support a wide range of activities, including scientific research, technology development, commercial ventures and, eventually, serve as a transportation node for space exploration. While the initial facility will not be capable of meeting all requirements, the space station will evolve over time as requirements and on-board activities mature and change. The space station design, therefore, allows for evolution to:

- expand capability,
- increase efficiency, and
- add new functions.

It is anticipated that many of the evolutionary changes will be accomplished through on-orbit replacement of systems, subsystems, and components as technology advances. Therefore, technology development is critical to ensure the continuing operation and expansion of the facility.

The Office of Aeronautics, Exploration and Technology (OAET) has sponsored development of many of the technologies that are now part of Space Station *Freedom*'s baseline design. Evolutionary and operational aspects of *Freedom* continue to be an important thrust of OAET's Research and Technology (R&T) efforts.

This workshop has been an important step in our understanding of the space station's baseline systems, the evolutionary scenarios including the station's role in space exploration, and the technologies that will be necessary to meet evolutionary and growth requirements.

It is anticipated that application of the information acquired through the workshop will lead to further technology development efforts to benefit *Freedom* and will lead to continued collaboration between the Space Station *Freedom* Program and the technology development community.

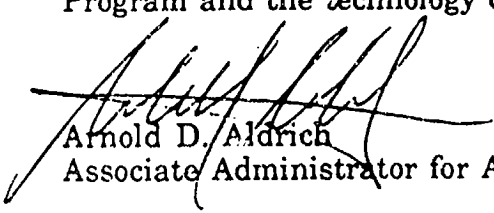

Arnold D. Aldrich
Associate Administrator for Aeronautics, Exploration and Technology

MAY 2 1993

CLARIFICATION

Since the workshop was conducted in January of 1990, there have been some organizational changes throughout the agency. The Office of Aeronautics and Space Technology (OAST) has been reorganized to include the former Office of Exploration and is now called the Office of Aeronautics, Exploration, and Technology (OAET). Also, the Human Exploration Initiative (HEI) has been expanded and renamed the Space Exploration Initiative (SEI). Some of the materials in these proceedings were prepared after the workshop, and, therefore, references to new organizational entities and new programs may be found in certain sections.

TECHNOLOGY FOR SPACE STATION EVOLUTION - A WORKSHOP
Technology Disciplines (EVA/MANSYS - FLUIDS)

VOLUME III

Foreword	i
Contents	iii
Introduction to Volume III	1
<u>Extravehicular Activity/Manned Systems</u>	
Level III Subsystem Presentations:	
Extravehicular Activity System - Michael N. Rouen, JSC	5-1
Man Systems - Distributed System for Space Station Freedom - J. L. Lewis, JSC	33-2
Invited Presentations:	
EVA/Manned Systems - Dr. James Jenkins, NASA/RC	59-3
Evolution of Space Station EMU PLSS Technology Recommendations - Richard C. Wilde, Hamilton Standard	69-4
Evolving EVA System Capability for the Evolving Space Station Freedom Requirements - Howard Slade, McDonnell Douglas Space Systems Co.	113-5
EVA and Telerobot Interaction - Dr. Kelli Wilshire, LaRC	121-6
Simplified Aid for Crew Rescue (SAFR) - H. Thomas Fisher, Lockheed Missiles and Space Co.	141-7
Evolving Technologies for Space Station Freedom Computer- Based Workstations - Dean Jensen and Marianne Rudisill, JSC	165-8
Man-Systems Integration and the Man-Machine Interface - Joseph P. Hale, MSFC	181-9
Work/Control Stations in Space Station Weightlessness - Charles A. Willits, NASA/SSFPO	193 -omit
Human Interface Research to Support Evolution Space Station - James O. Larimer, ARC	195 -omit
<u>Fluid Management System</u>	
Level III Subsystem Presentation:	
Fluid Management System (FMS) Fluid Systems Overview - R. S. Baird, JSC	199 -10
Invited Presentations:	
Space Station Fluid Resupply - Al Winters, Boeing Aerospace and Electronics	225 -11
Propulsion Needs for Lunar/Mars Missions - Gordon Woodcock, Boeing Aerospace and Electronics	241 -12
Space Station Fluid Management Logistics - Sam Dominick, Martin Marietta Space Systems	261 -13
The Resupply Interface Mechanism - Barney Gorin, Fairchild Space Co.	293 -14

Orbital Storage and Supply of Subcritical Liquid Nitrogen -
John Aydelott, LeRC
Superfluid Helium Needs and Resupply on Space Station -
Dr. Michael Dipirro, GSFC

307-15

323-16

INTRODUCTION

NASA's Office of Aeronautics and Space Technology (OAST) conducted a workshop on technology for space station evolution January 16-19, 1990, in Dallas, Texas. The purpose of this workshop was to collect and clarify Space Station *Freedom* technology requirements for evolution and to describe technologies that can potentially fill those requirements. OAST will use the output of the workshop as input for planning a technology program to serve the needs of space station evolution. The main product of the workshop is a set of program plans and descriptions for individual technology areas. These plans are the cumulative recommendations of the more than 300 participants, which included researchers, technologists, and managers from aerospace industries, universities, and government organizations.

The identification of the technology areas to be included, as well as the development of the program plans, was initiated by assigning NASA chairmen to the eleven technology disciplines under consideration. The disciplines are as follows:

- Attitude Control and Stabilization (ACS)
- Communications and Tracking (C&T)
- Data Management System (DMS)
- Environmental Control and Life Support Systems (ECLSS)
- Extravehicular Activity/Manned Systems (EVA/MANSYS)
- Fluid Management System (FMS)
- Power System (POWER)
- Propulsion (PROP)
- Robotics (ROBOTICS)
- Structures/Materials (STRUCT)
- Thermal Control System (THERM)

Each chairman worked with a panel of experts involved in research and development in the particular discipline. The chairmen, with the assistance of their panels, were responsible for selecting invited presentations, identifying and inviting Space Station *Freedom* Level III subsystem managers, and focusing the discussion of the participants. In each discipline session, presentations describing status of the current programs were made by the Level III subsystem managers and by OAST program managers. After invited presentations by leading industry, university, and NASA researchers, the sessions were devoted to identifying technology requirements and to planning programs for development of the identified technology areas. Particular attention was given to the potential requirements of the Human Exploration Initiative (HEI). The combined inputs of the participants in each session were incorporated into a package including an

overall discipline summary, recommendations and issues, and proposed development plans for specific technology areas within the discipline. These technology discipline summary packages were later supplemented by the chairmen and their panels to include the impact of varied funding levels on the maturity of the selected technologies. OAST will review the program plans and recommended funding levels based on available funding and overall NASA priorities and incorporate them into a new OAST initiative advocacy package for space station evolution technology.

These proceedings are organized into an Executive Summary and Overview and five volumes containing the Technology Discipline Presentations.

Volume III consists of the technology discipline sections for Extravehicular Activity/Manned Systems and the Fluid Management System. For each technology discipline in this volume, there is a Level 3 subsystem description, along with the invited papers for that discipline.

Extravehicular Activity/Manned Systems

Level III

Subsystem Presentations

omit

TECHNOLOGY FOR SPACE STATION EVOLUTION
- A WORKSHOP

EXTRAVEHICULAR ACTIVITY SYSTEM

MICHAEL N. ROUEN
JOHNSON SPACE CENTER

51-54
163615
p- 22

N93-27787

**TECHNOLOGY FOR SPACE STATION EVOLUTION -
A WORKSHOP**

Presentation Outline

EVAS PROGRAM STATUS

DEFINE EVAS BASELINE

BASELINE FUNCTIONAL REQUIREMENTS

DEFINE EVOLUTIONARY EVAS

EVOLUTIONARY EVAS FUNCTIONAL REQUIREMENTS

TECHNOLOGY STATUS

EVAS PROGRAM STATUS

PROGRAM HISTORY

Phase A & B studies supported the need for Routine EVA to:

Assemble, Maintain, and Service
Space Station Freedom
Satellites
Spacecraft
Experiments

As a result requirements emphasized:

Utilization constrained by human, not hardware
Life cycle costs
Reduced crew overhead

Configuration selection studies were done during Phase B that:

Looked at 10 options of EMU including:
Modified and Unmodified NSTS EMUs
New Space Station Freedom EMUs
Non-Anthropomorphic Systems

Looked at Vehicle options including:
2 Pressure Station
Walk Around Prebreather

Treated demand parametrically over the range of 1 to 5 per week

Resulting selected configuration was a new design SSF EMU that used regenerative technologies and was automatically serviceable.

EVAS PROGRAM STATUS

PROGRAM HISTORY (continued)

October 1986 Critical Evaluation Task Force (CETF)

Reduced EVA tasks by reducing Space Station Scope and moving components inside

Set Planned EVA frequency at 1 EVA/Week

Baselined Space Station Based EVA at PMC

Phase 1 Scale Down

Eliminated some requirements for early user EVA

Stretched out the schedule

Tanner Technical Audit

Eliminated Non-venting requirement based on user needs

Scrub 89

Eliminated Routine EVA requirement

Directed use of NSTS EMU to provide Contingency EVA when the Orbiter is present

Eliminated 2nd Air Lock

10

EVAS BASELINE DEFINATION

The EVAS consists of hardware, applications software, and the EVAS common interfaces with other systems and elements which provide the capability for the space station crew to perform contingency tasks in an unpressurized environment. All other EVA will be performed during orbiter resupply periods. The EVAS will support maintenance, repair, and inspection of space station systems and elements. The EVAS consists of the following items:

- 1) Space station based NSTS Extravehicular Mobility Unit (EMU) that provides an anthropomorphic pressure suit, portable life support, and EVA crew communications, and physiological monitoring.
- 2) EVAS Service and Performance Checkout Unit (SPCU) provides for the resupplying of EVAS equipment between EVAs. The SPCU includes umbilicals which interface EVAS equipment to the servicing equipment to support EVA operations and intravehicular operations during EMU donning and transition to vacuum. The SPCU provides performance checkout and instrumentation verification of serviceable EVAS equipment.
- 3) Airlock chamber depress/repress equipment and controls
- 4) EVA hyperbaric life support and chamber pressurization equipment and controls
- 5) EVA translation and mobility aids (including those required to Space Station Manned Base [SSMB] assembly
- 6)
- 7) EVA external lighting (including docking and proximity operations lighting)
- 8) EVA support equipment and generic tools including crew positioning devices required to support SSMB assembly
- 9) EVA external equipment storage (including lockers and other equipment holding fixtures)
- 10) EV contamination detection and decontamination unit

11)

TECHNOLOGY FOR SPACE STATION EVOLUTION - A WORKSHOP

EXTRAVEHICULAR ACTIVITY SYSTEM - BASELINE DEFINATION

The EVAS provides for contingency tasks in an unpressurized environment and consists of:

- 1) Space Station Based NSTS Extravehicular Mobility Unit (EMU)
Anthropomorphic Pressure Suit
Communications
Portable Life Support,
Physiological Monitoring
- 2) EVAS Service and Performance Checkout Unit (SPCU)
Reservicing of EVAS equipment
Umbilicals
Performance Checkout Of
Servicable EVAS Hardware
- 3) A/L Depress/Repress
- 4) Hyperbaric Life Support
- 5) Translation and Mobility aids
- 6) EVA Support Equipment and Tools
- 7) EVA External Lighting
- 8) EVA Support Equipment and Tools
- 9) EVA Storage
- 10) EV Contamination Detection and
Decontamination

11)

The System Definition is Controlled by "Architectural Control Document
Extravehicular Activity System" SSP 30256

TECHNOLOGY FOR SPACE STATION EVOLUTION - A WORKSHOP

EXTRAVEHICULAR ACTIVITY SYSTEM - BASELINE FUNCTIONS

- EVA Mobility** - moving in a zero-gravity, vacuum environment
- EVA Dexterity** - precisely performing tasks involving the hands without excessive force, undue fatigue, or injury to the hands.
- EVA life support** - maintenance of a pressurized, breathable, thermally comfortable atmosphere & protection from the space environment.
- EVAS Service & Performance Checkout** - prepare and maintain ready EVAS equipment while requiring minimum IV time. This includes:
 - Reservicing Expendables
 - Monitoring of Expendables
 - Go/No-Go Status
 - Routine Prep for Use
 - Intravehicular Support
- Equipment Recharge** - recharge of portable, powered equipment batteries.
- Communications** - providing proper information to perform the EVA tasks. It consists of:
 - Voice to and from the SSF
 - Voice Between EVA Crew
 - Data to the Space Station
- EVA Crew Tracking** - maintaining constant knowledge of the position of the EVA crewperson to maintain safety and protection of space station external systems.

EVAS BASELINE FUNCTIONS

EVAS Information Management is those activities required to service, detect failures, and maintain histories for the EVAS hardware, to store and manipulate EVAS user data and C&W information.

EVA Maintenance/Service is the planned and unplanned manual maintenance and servicing required to keep all hardware items of the EVAS functional and available for use. NSTS EMUs have limited on-orbit maintenance capability making it necessary to replace at the NSTS EMU end item level.

EVA equipment external storage is the activity to provide EVAS hardware which remains external the necessary berthing, enclosure/protection, and/or restraints to allow proper storage. The storage devices allow EVA crew access to the stored items. Provision for temporary storage at a high use worksite is made to minimize crew overhead.

EVA Decontamination and Detection is the detection and removal of any hazardous contamination which the EVA crewperson encounters while performing EVA to a safe level before the crewperson reenters the airlock to avoid contamination of the Internal Space Station.

Airlock Depress/Repress Control is the dynamic control of the depress/repress cycle. It includes the ability to stop the cycle and to control rate. Manual initiation from inside or outside the airlock or by the IVA crew from inside the adjacent resource node is provided.

EVA Crew and Equipment Transstation is the activity to allow the EVA crewperson access to all parts of the Space Station, Platform, and Payloads while attached to the Space Station.

EVA External Lighting supplies adequate lighting during the night cycle or into shadowed areas to allow visual access by the EVA crewperson and visual tracking of the EVA crew using closed circuit TV. The function includes both fixed and movable lights and the ability to easily switch lights. EVA lights also support docking, berthing, and proximity operations.

TECHNOLOGY FOR SPACE STATION EVOLUTION - A WORKSHOP

EXTRAVEHICULAR ACTIVITY SYSTEM - BASELINE FUNCTION'S

EVAS Information Management - activities to service, detect failures, and maintain histories for the EVAS hardware, to store and manipulate EVAS user data and C&W information.

EVA Maintenance/Serviceing - Planned & Unplanned manual maintenance and servicing of the EVAS NSTS EMUs have limited on-orbit maintenance capability requiring replacement at the NSTS EMU end item level

EVA Crew and Equipment Retrieval - retrieving an incapacitated EVA crewmember who is detached from the Space Station. Crew retrieval capability used for detached equipment retrieval

EVA Equipment External Stowage - provides the necessary berthing, enclosure/protection, and/or restraints to allow proper storage of External EVAS equipment.

EVA Decontamination and Detection - Detection and Removal Hazardous Contamination to a Safe Level Before Reentry to the Airlock

Airlock Depress/Repress Control - Dynamic Control of the Depress/Repress Cycle.

EVA Crew and Equipment Translation - EVA crewperson access to all parts of the Space Station, Platform, and Payloads while attached to the Space Station.

EVA External Lighting - Adequate lighting during the night cycle

EVAS BASELINE FUNCTIONS

EVA Restraint Is all activities to properly, safely, and easily restrain both the EVA crewperson and all hardware items which are moved during EVA.

Hyperbaric operations consists of all unique activities required to provide a hyperbaric chamber facility for medical treatment / procedures requiring atmospheric pressures higher than nominal module pressure. It includes life support, pressurization/depurization, thermal control, and lighting. Life Support includes breathing gas mixture control and fire detection and suppression

**TECHNOLOGY FOR SPACE STATION EVOLUTION -
A WORKSHOP**

EXTRAVEHICULAR ACTIVITY SYSTEM - BASELINE FUNCTIONS

EVA Restraint - Safely, and easily restrain both the EVA crewperson and all hardware items which are moved during EVA.

Hyperbaric Operations - Providing a hyperbaric chamber facility for medical treatment/procedures. Includes life support, pressurization/depressurization, thermal control, and lighting.

EVAS EVOLUTION DEFINATION

The EVAS consists of hardware, applications software, and the EVAS common interfaces with other systems and elements which provide the capability for the space station crew to perform routine tasks in an unpressurized environment. The EVAS will support installation/assembly, maintenance, repair, inspection, and servicing of space station systems and wear items.

The EVAS consists of the following items:

- 1) Space Station Extravehicular Mobility Unit (EMU) that provides an anthropomorphic pressure suit, portable life support, and EVA crew communications, physiological monitoring, and EMU mounted lights.
- 2) EVAS Service and Performance Checkout Subsystem (SPCS) which provides for the regeneration and servicing of EVAS equipment between EVAS, automatic performance checkout and instrumentation verification of the EVAS components (including Built In Test Equipment [BITE/self testing), umbilicals which interface EVAS equipment to the servicing equipment for both normal and contingency EVA operations, and intravehicular support during EMU donning and transition to vacuum.
- 3) Airlock chamber depress/repress equipment and controls
- 4) EVA hyperbaric life support and chamber pressurization equipment and controls
- 5) EVA translation and mobility aids (including those required to Space Station Manned Base [SSMB] assembly
- 6) EVA crew and equipment retrieval subsystems and retrieval subsystems servicing
- 7) EVA external lighting (including docking and proximity operations lighting)
- 8) EVA support equipment and generic tools including crew positioning devices required to support SSMB assembly
- 9) EVA external equipment storage (including lockers and other equipment holding fixtures)
- 10) EV contamination detection and decontamination unit
- 11) Extravehicular Excursion Unit (EEU) seat

FOR SPACE STATION EVOLUTION - A WORKSHOP

EXTRAVEHICULAR ACTIVITY SYSTEM - EVOLUTION DEFINITION

The EVAS provides for routine tasks in an unpressurized environment and consists of

- 1) Extravehicular Mobility Unit (EMU)
Anthropomorphic Pressure Suit
Communications
EMU Mounted Lights.
Portable Life Support,
Physiological Monitoring
- 2) EVAS Service and Performance Checkout Subsystem (SPCS)
Reservicing of EVAS equipment
Umbilicals
Automatic Performance
Checkout
- 3) A/L Depress/Repress
- 4) Hyperbaric Life Support
- 5) Translation and Mobility aids
- 6) Crew and Equipment Retrieval
- 7) EVA External Lighting
- 8) EVA Support Equipment and Tools
- 9) EVA Storage
- 10) EV Contamination Detection and
Decontamination
- 11) EEU Sear

The System Definition is Controlled by "Architectural Control Document
Extravehicular Activity System" SSP 30256

EVAS EVOLUTION FUNCTIONS

EVA Mobility is the ability of the EVA crewperson to move in a zero-gravity, vacuum environment as required to accomplish useful tasks.

EVA dexterity is the ability of the EVA crewmember to precisely perform tasks involving the hands without the use of excessive force, the generation of undue fatigue, or the infliction of injury to the hands.

EVA life support is the maintenance of a pressurized, breathable, thermally comfortable atmosphere as well as protection from the space environment.

EVAS service and performance checkout is the activity required to prepare and maintain in a ready state EVAS equipment for EVA while requiring a minimum of time or attention from IV crewmembers. This includes:

- Reservicing of reusable EVA expendables
- Continuous monitoring of expendables
- Automated performance checkout
- Go/no-go status upon request and prior to use
- Routine prep for use
- Reservicing of non-recoverable EVA expendables
- Automated performance checkout
- Reverification following ORU replacement

Powered EVA equipment is the electrical recharge of portable, powered equipment batteries

Communications provides the EVA crew person the proper information in order to perform the EVA tasks. It consists of voice and data to and from the Space Station, video to the Space Station, text and graphics transfer from the Space Station to the EVA crewperson, and voice communication between EVA Crew members. The EVA Crew will communicate with the STS Orbiter via the Space Station.

TECHNOLOGY FOR SPACE STATION EVOLUTION - A WORKSHOP

EXTRAVEHICULAR ACTIVITY SYSTEM - EVOLUTION FUNCTIONS

- EVA Mobility** - moving in a zero-gravity, vacuum environment
- EVA Dexterity** - precisely performing tasks involving the hands without excessive force, undue fatigue, or injury to the hands.
- EVA life support** - maintenance of a pressurized, breathable, thermally comfortable atmosphere & protection from the space environment.
- EVA'S Service & Performance Checkout** - prepare and maintain ready EVAS equipment while requiring minimum IV time. This includes:
 - Regenerating Recoverable Expendables
 - Reservicing Expendables
 - Automated Performance Checkout
 - Reverification After Maintenance

Equipment Recharge - recharge of portable, powered equipment batteries.

Communications - providing proper information to perform the EVA tasks. It consists of:

Voice and Data to and from the SSF
Text & Graphics from the SSF to EVA

Video to the Space Station
Voice Between EVA Crew

EVAS EVOLUTION FUNCTIONS

EVA Crew Tracking is the maintenance of a constant knowledge of the position of the EVA crewperson with sufficient accuracy to maintain safety of the crewperson and protection of space station external systems.

EVAS Information Management is those activities required to operate, service, detect failures in, and maintain performance histories for the EVAS hardware, to store and manipulate user data and C&W information, and to allow "hands-free" EVA access by the EVA crewperson, and to provide appropriate command/response and information services to the OMS.

EVA Maintenance/Service is the planned and unplanned manual maintenance and servicing required to keep all hardware items of the EVAS functional and available for use. This includes periodic cleaning, lubrication, and other preventive maintenance of the EMU, as well as cleaning the SSA of biological contaminants.

EVA Crew and Equipment Retrieval is the activities required to retrieve an incapacitated EVA crewmember who has become detached from the Space Station. An awaiting EVA crewmember will assist with ingress of the rescued person. This capability accommodates separation from any point on the Space Station and provides acquisition and return to the A/L within the EMU expendable reserve time. This function shall not additionally jeopardize the safety of another crewmember. Capability for crew retrieval shall be used for detached equipment retrieval when appropriate. The function includes the EVA activities required to release a trapped or pinned EVA crewperson.

EVA equipment external stowage is the activity to provide EVAS hardware which remains external the necessary berthing, enclosure/protection, and/or restraints to allow proper storage. The storage devices allow EVA crew access to the stored items. Provision for temporary storage for a high use worksite is made to minimize crew overhead.

EVA Decontamination and Detection is the detection and removal of any hazardous contamination which the EVA crewperson encounters while performing EVA to a safe level before the crewperson reenters the airlock to avoid contamination of the Internal Space Station.

Airlock Depress/Repress Control is the dynamic control of the depress/repress cycle. It includes the ability to stop the cycle and to control rate. Manual initiation from inside or outside the airlock or by the IVA crew from inside the adjacent resource node is provided.

TECHNOLOGY FOR SPACE STATION EVOLUTION - A WORKSHOP

EXTRAVEHICULAR ACTIVITY SYSTEM - EVOLUTION FUNCTIONS

EVA Crew Tracking - maintaining constant knowledge of the position of the EVA crewperson to maintain safety and protection of space station external systems.

EVAS Information Management - activities to operate, service, detect failures in, and maintain performance histories for the EVAS hardware. To store and manipulate user data and C&W information, and to allow "hands-free" EVA access by the EVA crewperson, and to provide appropriate EVA command/response and information services to the OMS.

EVA Maintenance/Serviceing - Planned & Unplanned manual maintenance and servicing of the EVAS

EVA Crew and Equipment Retrieval - retrieving an incapacitated EVA crewmember who is detached from the Space Station. Crew retrieval capability used for detached equipment retrieval

EVA Equipment External Stowage - provides the necessary berthing, enclosure/protection, and/or restraints to allow proper storage of External EVAS equipment.

EVA Decontamination and Detection - Detection and Removal Hazardous Contamination to a Safe Level Before Recentry to the Airlock

Airlock Depress/Repress Control - Dynamic Control of the Depress/Repress Cycle.

EVAS EVOLUTION FUNCTIONS

EVA Crew and Equipment Translation is the activity to allow the EVA crewperson access to all parts of the Space Station, Platform, and Payloads while attached to the Space Station.

EVA External Lighting supplies adequate lighting during the night cycle or into shadowed areas to allow visual access by the EVA crewperson and visual tracking of the EVA crew using closed circuit TV. The function includes both fixed and movable lights and the ability to easily switch lights. EVA lights also support docking, berthing, and proximity operations.

EVA Restraint is all activities to properly, safely, and easily restrain both the EVA crewperson and all hardware items which are moved during EVA.

Hyperbaric operations consists of all unique activities required to provide a hyperbaric chamber facility for medical treatment/procedures requiring atmospheric pressures higher than nominal module pressure. It includes life support, pressurization/depressurization, thermal control, and lighting. Life Support includes breathing gas mixture control and fire detection and suppression

TECHNOLOGY FOR SPACE STATION EVOLUTION - A WORKSHOP

EXTRAVEHICULAR ACTIVITY SYSTEM - EVOLUTION FUNCTIONS

EVA Crew and Equipment Translation - EVA crewperson access to all parts of the Space Station, Platform, and Payloads while attached to the Space Station.

EVA External Lighting - Adequate lighting during the night cycle

EVA Restraint - Safely, and easily restrain both the EVA crewperson and all hardware items which are moved during EVA.

Hyperbaric Operations - Providing a hyperbaric chamber facility for medical treatment/procedures. Includes life support, pressurization/depressurization, thermal control, and lighting.

EVAS TECHNOLOGY STATUS

To be REGENERABLE a SSF funded technology program was in place that investigated:

- For Heat Removable
 - Indirect Ice Pack
 - Vapor Compression
 - Wax / Radiator with Thermal Electric Heat Pump
 - Metal Hydride Heat Pump
- For CO2 Removal
 - Amine Bed (2 versions)
 - Electrochemically Regenerable Chemical Adsorber
 - Metal Oxides (2 versions)
- For power supply
 - Flywheels (study only)
 - Fuel Cell with Hydride H2 Storage
- For Oxygen supply
 - High Pressure Electrolysis (2 versions)

EVAS TECHNOLOGY STATUS

To be **AUTOMATICALLY SERVICIABLE** a SSF funded technology program was in place that investigated computer automation in support of

- Automatic Recharge Fault Detection and Analysis
- Automatic Status Monitoring Fault Recovery / Repair
- Automatic Checkout Trending Analysis
- Calibration Time in Service Logging
- Configuration Control Inventory Management

To **REDUCE CREW OVERHEAD** a SSF funded technology program was in place the investigated:

- In the Life Support Arena
 - Automatic Cooling Control Heads Up Display (2 versions)
 - Electronic Oxygen Regulators
- In the 8.3 psi Suit Arena
 - Hard Suit Technology
(Ames AX 5) Mixed Hard / Soft Suit Technology
(JSC Mk III)
 - Gloves (Multiple versions)



Lyndon B. Johnson Space Center

MAN-SYSTEMS DIVISION

J. L. LEWIS, PhD / SP

MAN-SYSTEMS DIVISION

MAN-SYSTEMS DISTRIBUTED SYSTEM FOR SPACE STATION FREEDOM

52-54

163616

p-24

N93-27788



Lyncon B. Johnson Space Center

OVERVIEW

MAN-SYSTEMS DIVISION

J. L. LEWIS, PhD / SP

1. DESCRIPTION OF MAN-SYSTEMS
 - DEFINITION
 - REQUIREMENTS
 - SCOPE
 - SUBSYSTEMS
 - TOPOLOGYS
2. IMPLEMENTATION
 - APPROACH
 - TOOLS
3. MAN-SYSTEMS INTERFACES
 - SYSTEM TO ELEMENT
 - SYSTEM TO SYSTEM
4. PRIME/SUPPORTING DEVELOPMENT RELATIONSHIP
5. SELECTED ACCOMPLISHMENTS
6. TECHNICAL CHALLENGES



Lyndon B. Johnson Space Center

MAN-SYSTEMS: DEFINITION

MAN-SYSTEMS DIVISION

J. L. LEWIS, PhD / SP

CREW INTERFACES WITH SYSTEMS AND EQUIPMENT

- **REQUIREMENTS DEFINITION AND INTEGRATION**
- **HARDWARE**
- **DESIGN, DEVELOPMENT, TEST, AND EVALUATION**
- **SUBSYSTEM MANAGEMENT**
- **OPERATIONAL SUITABILITY ASSESSMENT**



Lyndon B. Johnson Space Center

MAN-SYSTEMS REQUIREMENTS	MAN-SYSTEMS DIVISION
	JIM LEWIS

<p>PROGRAM LEVEL DOCUMENTS</p> <ul style="list-style-type: none">• PROGRAM DEFINITION REQUIREMENTS DOCUMENT, SSP 30000• ARCHITECTURAL CONTROL DOCUMENT: MAN-SYSTEMS, SSP 30257• BASELINE CONFIGURATION DOCUMENT<ul style="list-style-type: none">• HAB MODULE• LAB MODULE• LOG MODULE• NODES• AIRLOCK• TRUSS• INTERFACE REQUIREMENTS DOCUMENTS<ul style="list-style-type: none">• ELEMENT-TO-ELEMENT• SYSTEM-TO-SYSTEM• SYSTEM-TO-ELEMENT• MAN-SYSTEMS INTEGRATION STANDARD, NASA STANDARD 3000, VOL IV <p>PROJECT LEVEL DOCUMENTS</p> <ul style="list-style-type: none">• PRD, JSC 31000• SRD-0001• ELEMENT CEI SPECIFICATIONS <p>SYSTEMS INTEGRATION MANAGEMENT DOCUMENTS</p> <ul style="list-style-type: none">• MAN-SYSTEMS INTEGRATION PLAN• CREW COMPARTMENT CONFIGURATION DRAWING• HUMAN COMPUTER INTERFACE GUIDE• DATA BASE DEVELOPMENT AND CONFIGURATION MANAGEMENT



Lyndon B. Johnson Space Center

MAN-SYSTEMS: SCOPE	MAN-SYSTEMS DIVISION
J. L. LEWIS, PhD / SP	

MAN-SYSTEMS DISCIPLINE PERSONNEL DEFINE AND INTEGRATE MAN-SYSTEMS REQUIREMENTS FOR ALL U.S. AND INTERNATIONAL ELEMENTS. THE MAN-SYSTEMS DISCIPLINE INCLUDES TERMS VARIOUSLY REFERRED TO AS HUMAN FACTORS, HUMAN ENGINEERING, ERGONOMICS, MAN-MACHINE INTERFACE, AND MAN-MACHINE ENGINEERING.

IN ADDITION, MAN-SYSTEMS TECHNICALLY MANAGES:

- MAN-SYSTEMS HARDWARE DEVELOPMENT AND ASSOCIATED HUMAN ENGINEERING } WP-01
- FLIGHT CREW INTEGRATION } WP-02
- CREW HEALTH CARE SYSTEM DEVELOPMENT } WP-03
- NODE AND CUPOLA OUTFITTING
- FLIGHT TELEROBOTICS SERVICER
 - WORKSTATION DEFINITION
 - CREW INTEGRATION
 - OPS SUITABILITY ASSESSMENT

AS SUPPORTING DEVELOPMENT MAN-SYSTEMS FURNISHES:

- CREW EQUIPMENT
- INTEGRATION AND ANALYSIS
- MOCKUPS AND TRAINERS

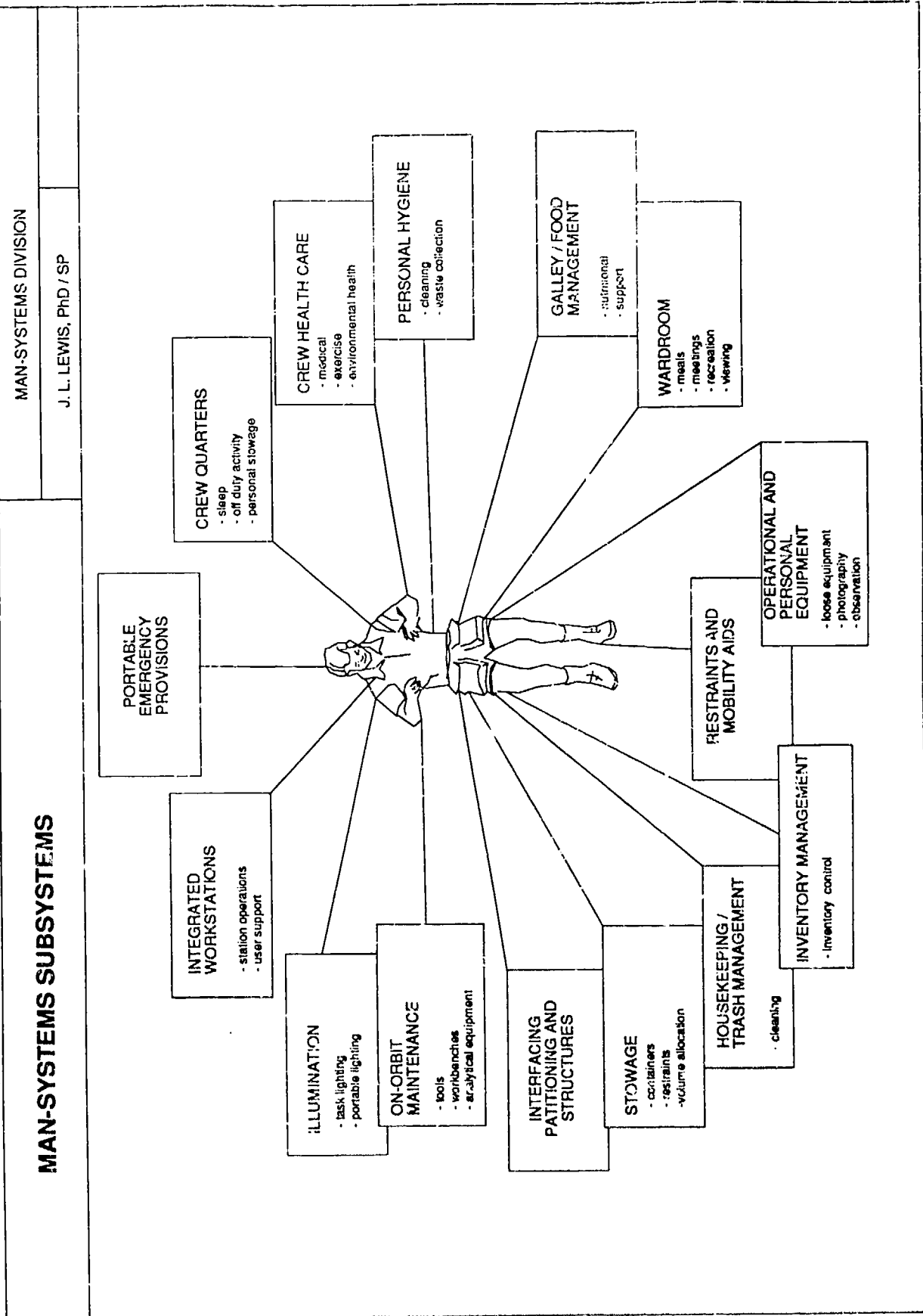



Lyndon B. Johnson Space Center

MAN-SYSTEMS ARCHITECTURAL CONSIDERATIONS

MAN-SYSTEMS DIVISION

J. L. LEWIS, PhD / SP

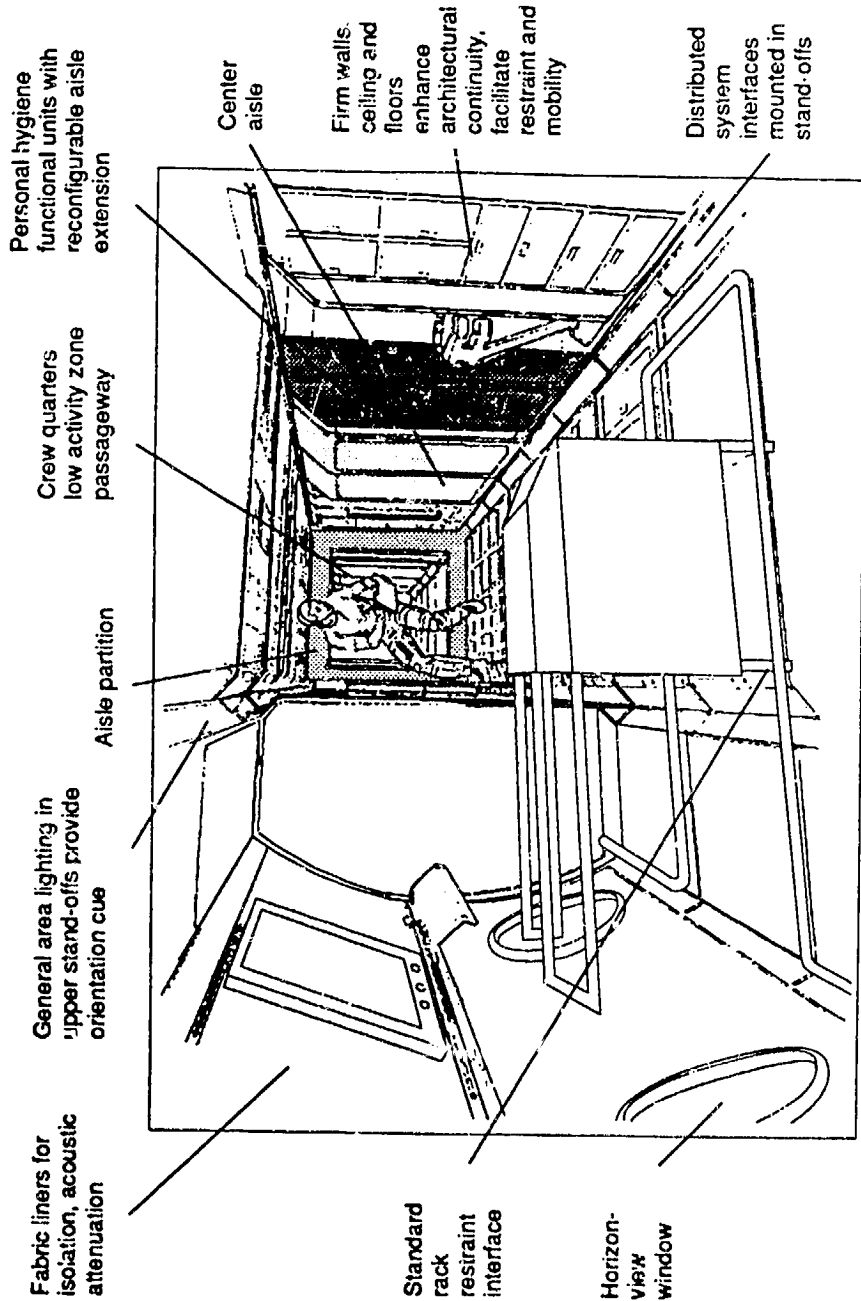



Lyndon B. Johnson Space Center

HABITATION MODULE

MAN-SYSTEMS DIVISION

J. L. LEWIS, PhD / SP

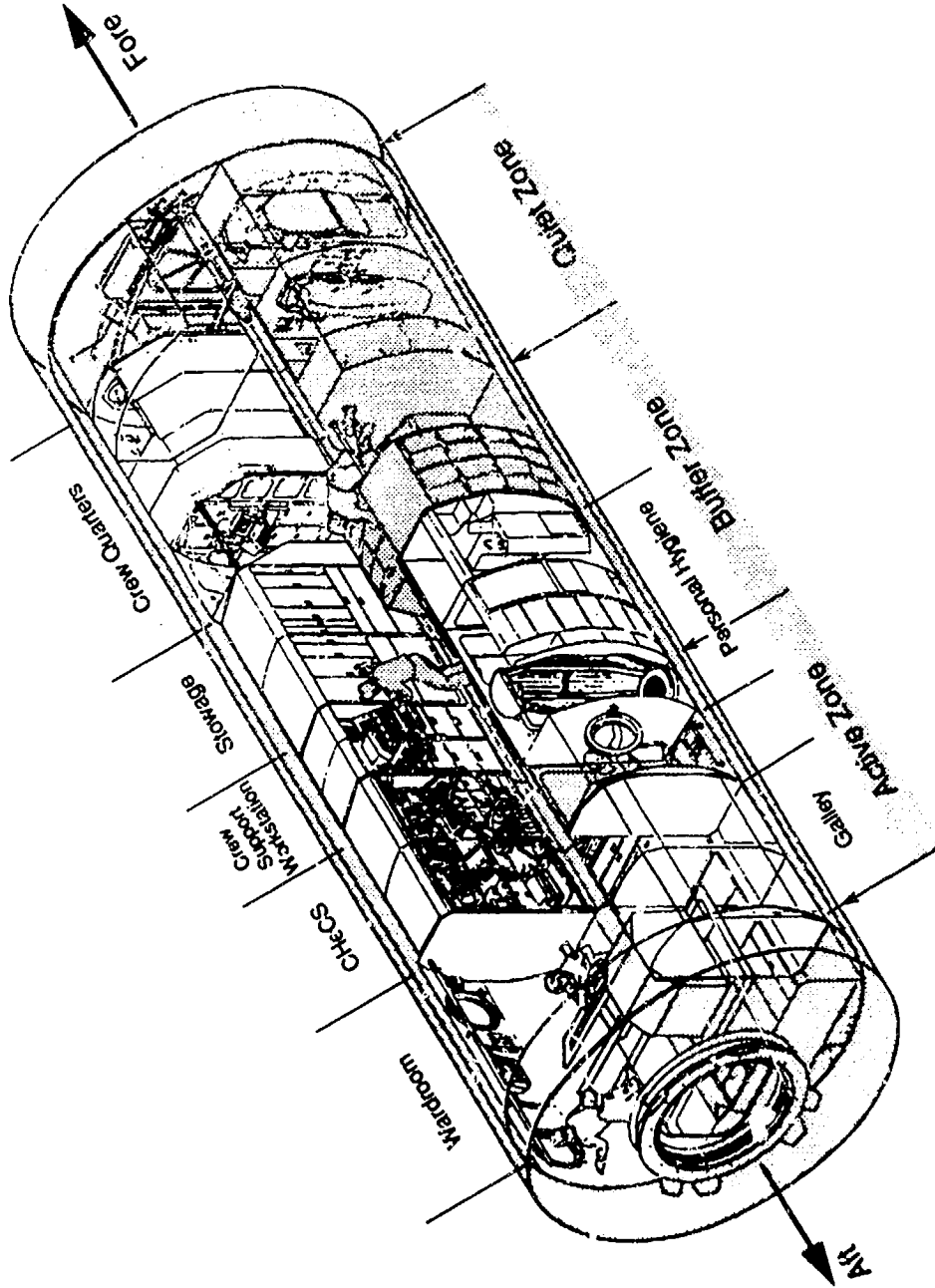



Lyndon B. Johnson Space Center

MAN-SYSTEMS, LABORATORY MODULE (TYPICAL)

MAN-SYSTEMS DIVISION

JIM LEWIS

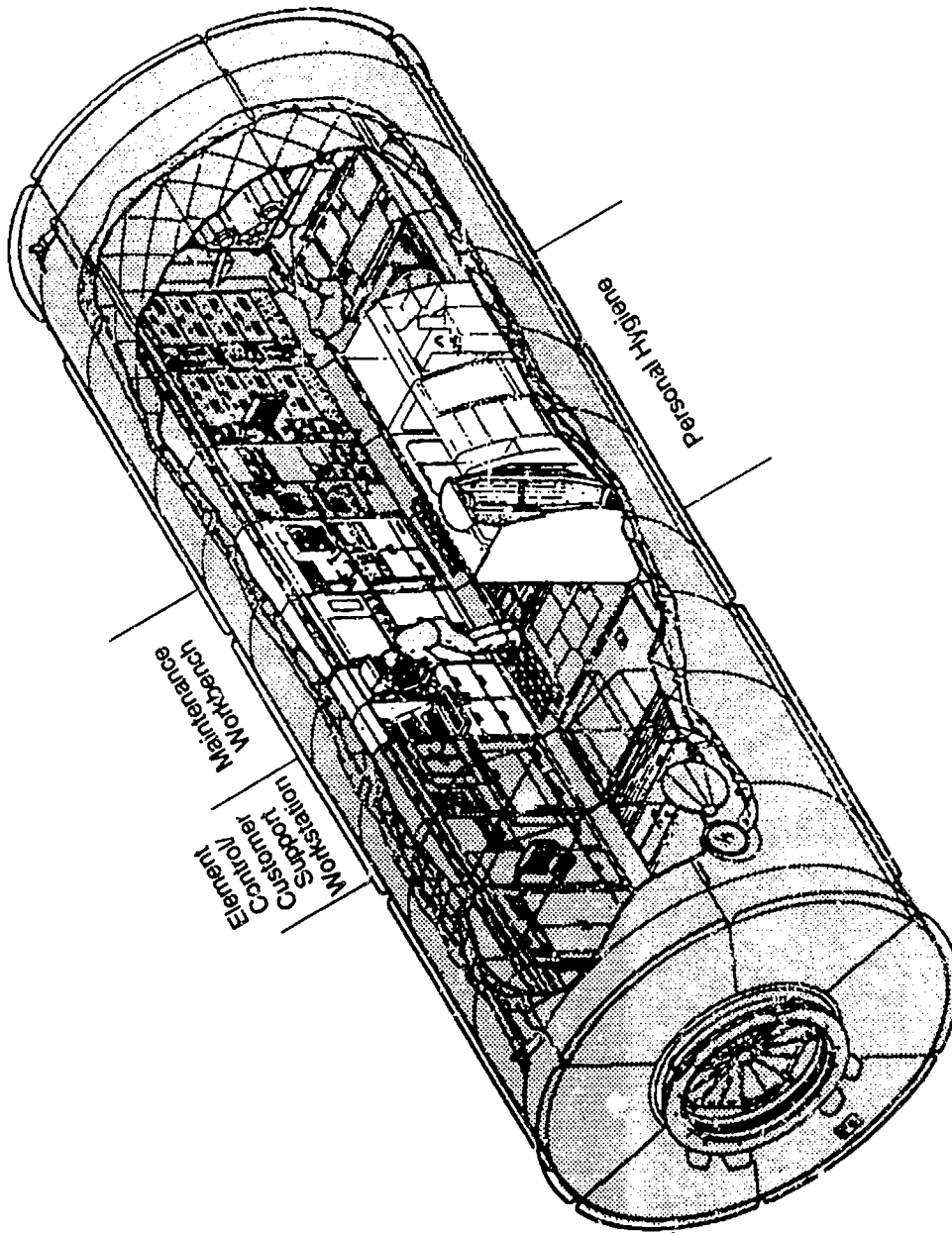



Lyndon B. Johnson Space Center

MAN-SYSTEMS SUBSYSTEMS

MAN-SYSTEMS DIVISION

J. L. LEWIS, PhD / SP

Node (typical) Requirements Definition and Requirements Integration

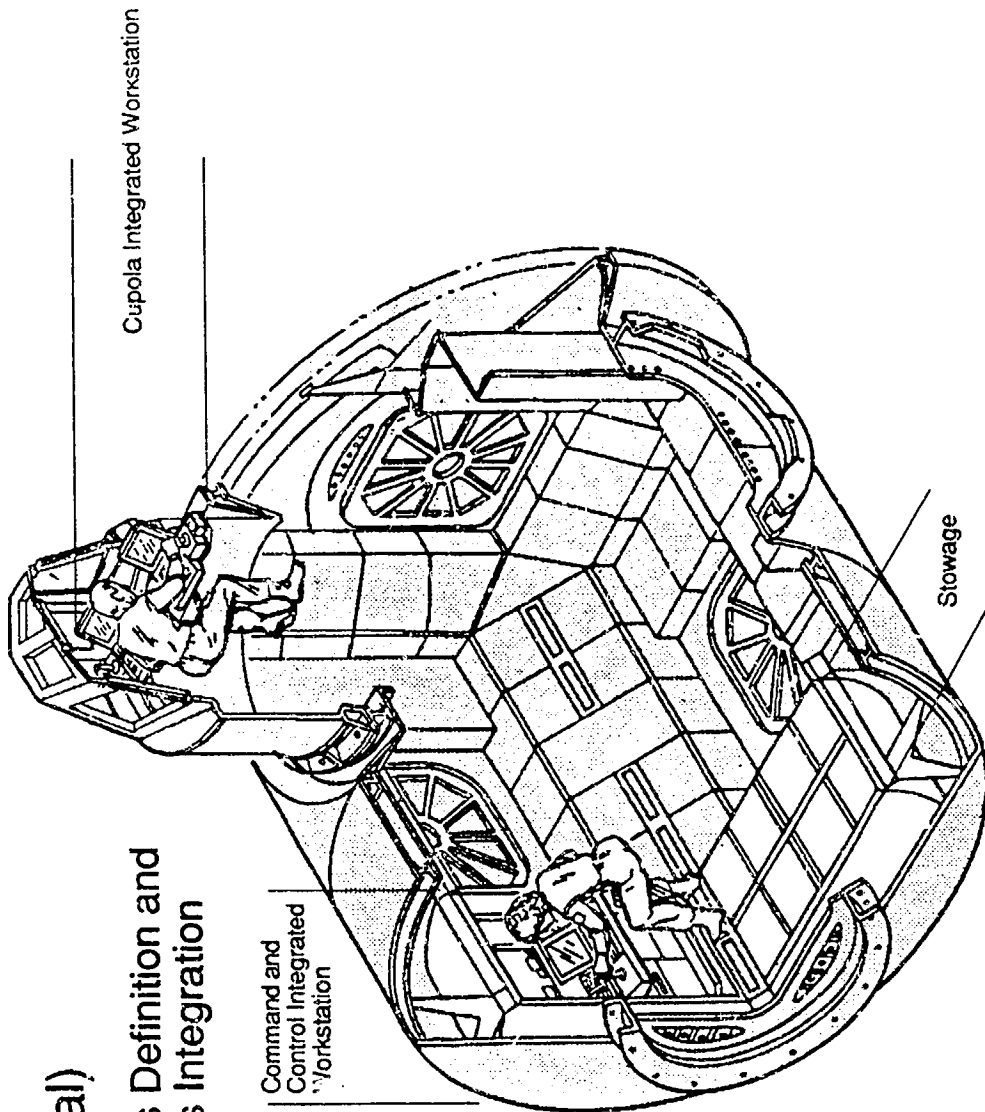



Lyndon B. Johnson Space Center

MAN-SYSTEMS DIVISION

J. L. LEWIS, PhD / SP

U.S. HAB TOPOLOGY

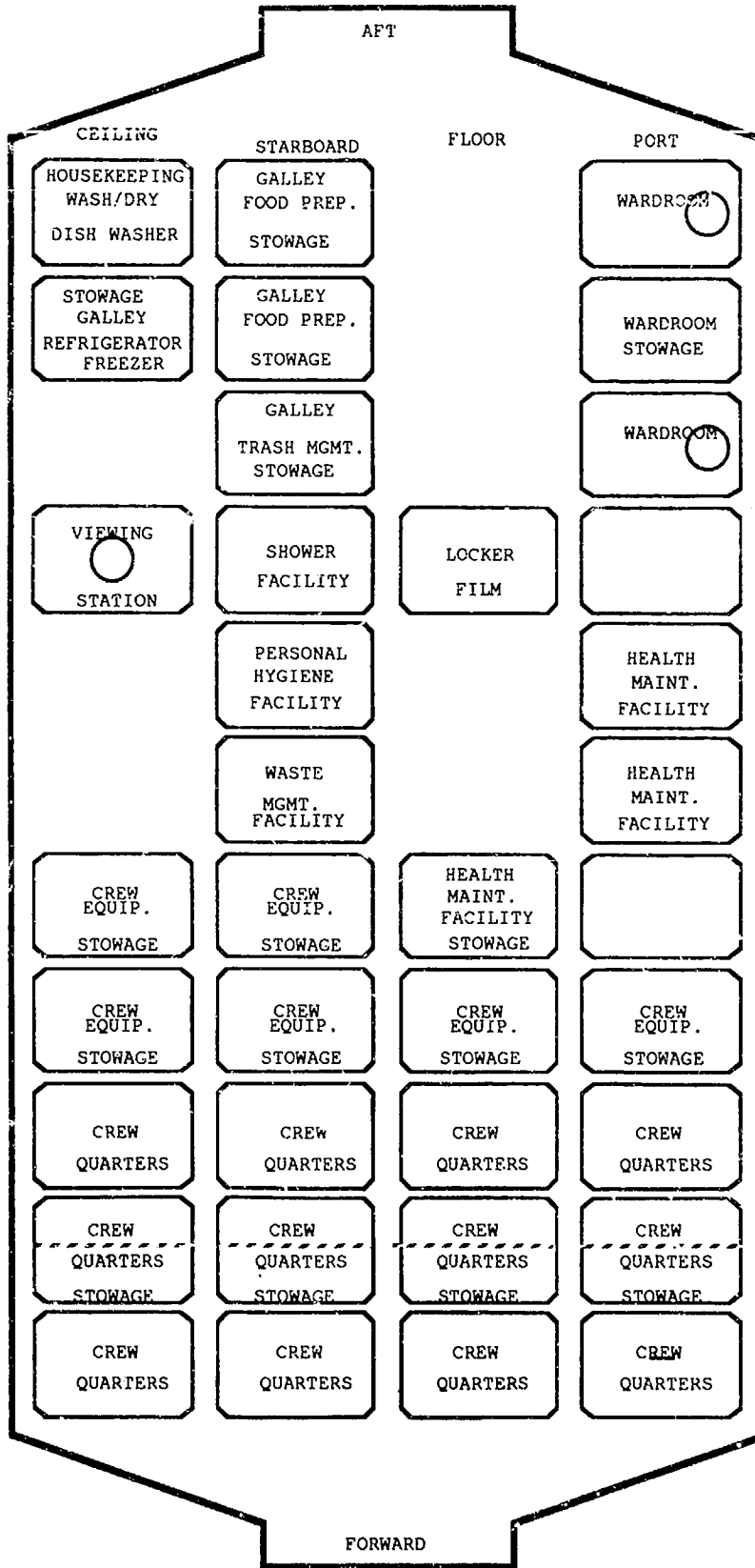

INFORMATION PRESENTED IN THIS ILLUSTRATION IS PRELIMINARY AND DOES NOT REPRESENT BINDING DESIGN REQUIREMENTS

PRELIMINARY TOPOLOGY HABITATION MODULE



Lyndon B. Johnson Space Center

MAN-SYSTEMS DIVISION

J. L. LEWIS, PhD / SP

U.S. LAB TOPOLOGY

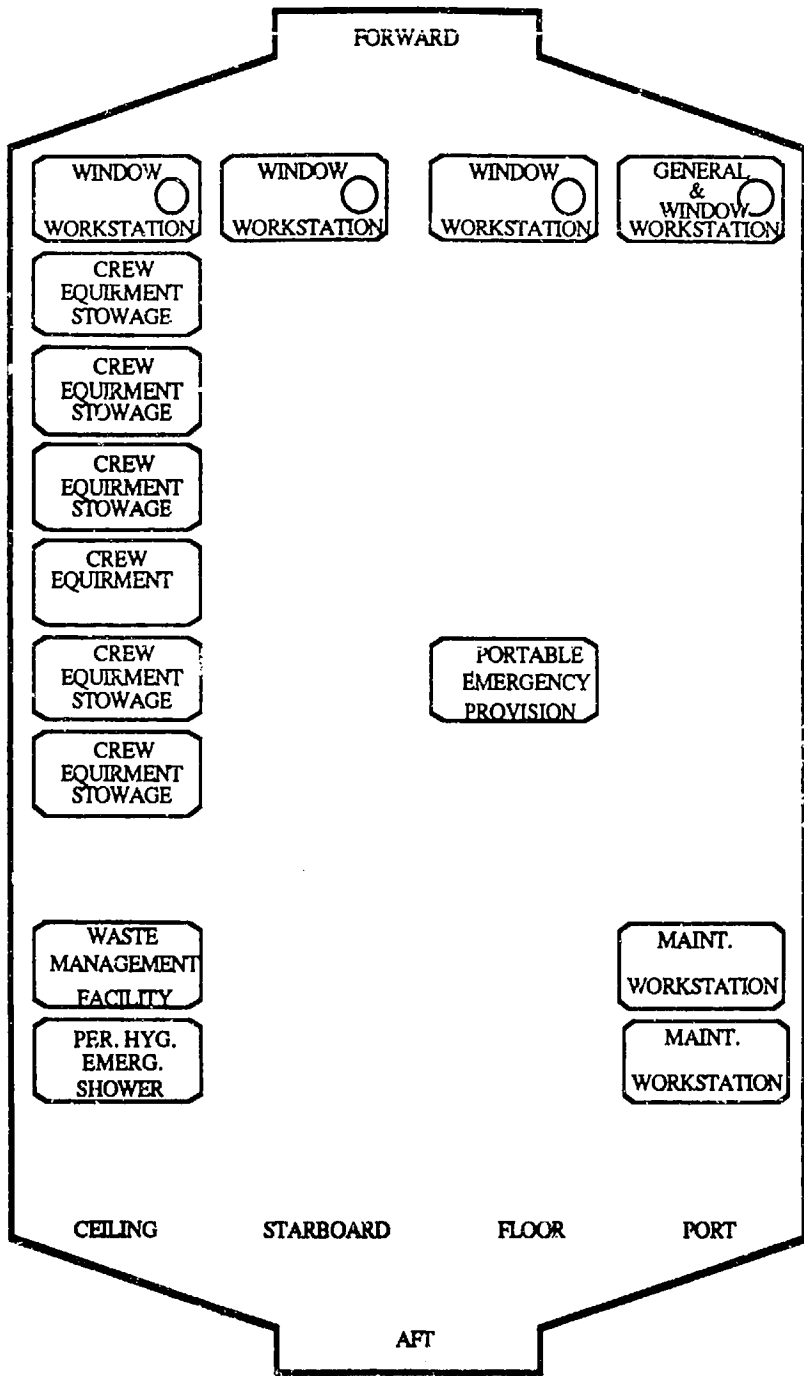

INFORMATION PRESENTED IN THIS ILLUSTRATION IS PRELIMINARY AND DOES NOT REPRESENT BINDING DESIGN REQUIREMENTS

**PRELIMINARY TOPOLOGY
U. S. LABORATORY MODULE**

PRELIMINARY AC NODE TOPOLOGIES

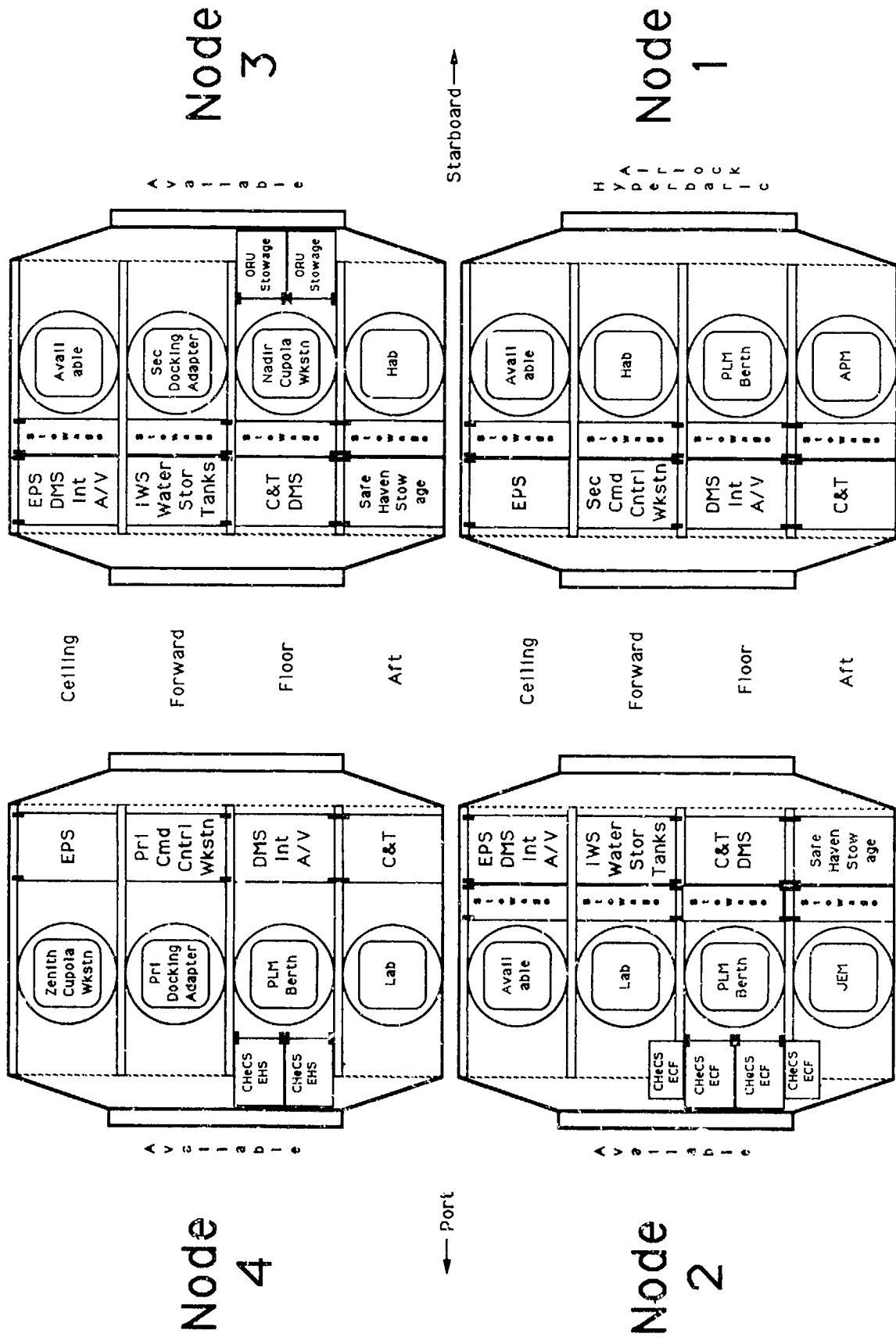



Lyndon B. Johnson Space Center

IMPLEMENTATION: APPROACH	MAN-SYSTEMS DIVISION J. L. LEWIS, PhD / SP
<p style="text-align: center;">TO PROVIDE PERSONNEL, TOOLS, AND FORUMS TO FACILITATE</p> <p style="text-align: center;">THE INTEGRATION OF ALL CREW INTERFACES ACROSS ALL SPACE</p> <p style="text-align: center;">STATION ELEMENTS AND SYSTEMS SO AS TO INCREASE CREW</p> <p style="text-align: center;">SAFETY AND PRODUCTIVITY.</p>	



Lyndon B. Johnson Space Center

IMPLEMENTATION: TOOLS	MAN-SYSTEMS DIVISION
	J. L. LEWIS, PhD / SP

<p>MAN-SYSTEMS INTEGRATED TEST BED</p> <ul style="list-style-type: none">• WEIGHTLESS ENVIRONMENT TRAINING FACILITY• NEUTRAL BUOYANCY LABORATORY• SPACE STATION MOCKUP AND TRAINER FACILITY• MOBILE REMOTE MANIPULATOR DEVELOPMENT FACILITY
<p>HUMAN COMPUTER INTERFACE LABORATORY</p> <ul style="list-style-type: none">• DEFINES REQUIREMENTS FOR OPTIMIZED INTERACTIONS BETWEEN HUMANS AND COMPUTERS• WORKSTATION DESIGN• DISPLAY CONTENT AND FORMAT AND USE OF TEXT AND GRAPHICS



Lyndon B. Johnson Space Center

IMPLEMENTATION: TOOLS	MAN-SYSTEMS DIVISION
	J. L. LEWIS, PhD / SP

<p>GRAPHICS ANALYSIS FACILITY</p> <ul style="list-style-type: none">• PERFORMS SYSTEMS ENGINEERING ANALYSES OF MAN-MACHINE INTERFACES, FLIGHT OPERATIONS, VEHICLE AND PAYLOAD DESIGN, AND MISSION PLANNING• UTILIZES INTERACTIVE CUSTOMIZED 3-D COMPUTER GRAPHICS PACKAGE (PLAID)• INCLUDES UNIQUE MAN-MODELING SOFTWARE WITH EXTENSIVE ANTHROPOMETRIC DATA BASE <p>ANTHROPOMETRIC AND BIOMECHANICS LABORATORY</p> <ul style="list-style-type: none">• QUANTIFIES HUMAN PERFORMANCE CAPABILITIES UNDER SHIRTSLEEVED AND SPACESUITED CONDITIONS• MEASURES STRENGTH AND MOTION IN ONE-G AND SIMULATED ZERO-G CONDITIONS (VIA NEUTRAL BUOYANCY AND KEPLERIAN FLIGHT)• MEASURES STATIC AND DYNAMIC ANTHROPOMETRY (STATURE AND REACH ENVELOPES)
--



Lyndon B. Johnson Space Center

IMPLEMENTATION: TOOLS	MAN-SYSTEMS DIVISION
	J. L. LEWIS, PhD / SP

<p>LIGHTING LABORATORY</p> <ul style="list-style-type: none">• PERFORMS ANALYSES OF FACTORS RELEVANT TO THE ASTRONAUT'S ENVIRONMENT• AMBIENT AND SPECIAL LIGHTING NEEDS ARE ACCESSED FOR BOTH IVA AND EVA ACTIVITIES• EVALUATES DESIGN CONCEPTS FOR LIGHTS, ALIGNMENT AIDS, DOCKING TARGETS, ETC. <p>MAN-SYSTEMS TELEROBOTICS LABORATORY</p> <ul style="list-style-type: none">• PERFORMS RESEARCH CONCERNING HUMAN INTERFACES WITH MANIPULATOR/TELEBOTIC/ROBOTIC SYSTEMS• SUPPORTS DEVELOPMENT OF THE FLIGHT TELEROBOTIC SERVICER PROGRAM• DEVELOPS MAN-MACHINE REQUIREMENTS, CONCEPTUAL DESIGN INPUTS, AND DESIGN EVALUATIONS FOR TELEROBOTIC WORKSTATIONS, ROBOT DESIGN, AND ROBOT SENSOR SYSTEMS
--



Lyndon B. Johnson Space Center

IMPLEMENTATION: TOOLS	MAN-SYSTEMS DIVISION
	J. L. LEWIS, PhD / SP

FOOD SYSTEMS ENGINEERING FACILITY

- DEVELOPMENT OF SPACE STATION FOOD SYSTEM AND ANCILLARY EQUIPMENT
- DEVELOPMENT OF FOOD PRESERVATION TECHNIQUES, EXTENDED SHELF LIFE STUDIES, OPTIMUM STORAGE METHODS, FOOD HEATING TECHNOLOGY, FOOD HANDLING EQUIPMENT DESIGN, AND PROCESSING AND PACKAGING TECHNIQUES

ELECTRONIC STILL CAMERA LABORATORY

- RESEARCH AND DEVELOPMENT OF HIGH RESOLUTION DIGITAL CAMERA SYSTEM
- FABRICATION AND TESTING OF PROTOTYPE AND PROTOFLIGHT DIGITAL CAMERA SYSTEMS
- DEVELOPMENT OF IMAGE PROCESSING SYSTEMS TO SUPPORT THE HIGH RESOLUTION DIGITAL CAMERA SYSTEM



Lyndon B. Johnson Space Center

IMPLEMENTATION: TOOLS

MAN-SYSTEMS DIVISION

J. L. LEWIS, PhD / SP

PERSONAL HYGIENE/HOUSEKEEPING LABORATORY

- DEVELOPMENT OF PERSONAL HYGIENE/HOUSE KEEPING SOFTGOODS AND CONSUMABLES
- DEVELOPMENT OF THE PERSONAL HYGIENE/HOUSE KEEPING ASSOCIATED HARDWARE
- ONE-G AND ZERO-G TESTING OF THE HARDWARE AND ASSOCIATED CONSUMABLES



Lyndon B. Johnson Space Center

MAN-SYSTEMS INTERFACES

MAN-SYSTEMS DIVISION

JIM LEWIS

SYSTEM TO ELEMENT

SYSTEM TO ELEMENT	HAB	LAB	LOG	ESA	JEM	NODES	AIRLOCK	HAL
RESTRAINTS MOBILITY AIDS	●	●	●	●	●	●	●	●
WARDROOM	●		●					
GALLEY/FOOD MANAGEMENT	●		●					●
PERSONAL HYGIENE	●	●	●					●
CREW HEALTH CARE	●	●	●	●	●	●	●	●
STOWAGE	●	●	●	●	●	●	●	●
PORTABLE EMERGENCY PROVISIONS	●	●	●	●	●			
CREW QUARTERS	●		●					
OPERATIONAL PERSONAL EQUIPMENT	●	●	●	●	●	●	●	●
HOUSEKEEPING/TRASH MANAGEMENT	●	●	●	●	●	●	●	●
ILLUMINATION	●	●	●			●	●	●
ON-ORBIT MAINTENANCE	●	●	●	●	●	●	●	●
INTERFACING PARTITIONS STRUCTURES	●	●	●	●	●	●	●	●
INTEGRATED WORKSTATIONS	●	●	●	●	●	●	●	●
INVENTORY MANAGEMENT	●	●	●	●	●	●	●	●



Lyndon B. Johnson Space Center

MAN-SYSTEMS DIVISION

JIM LEWIS

MAN-SYSTEMS INTERFACES

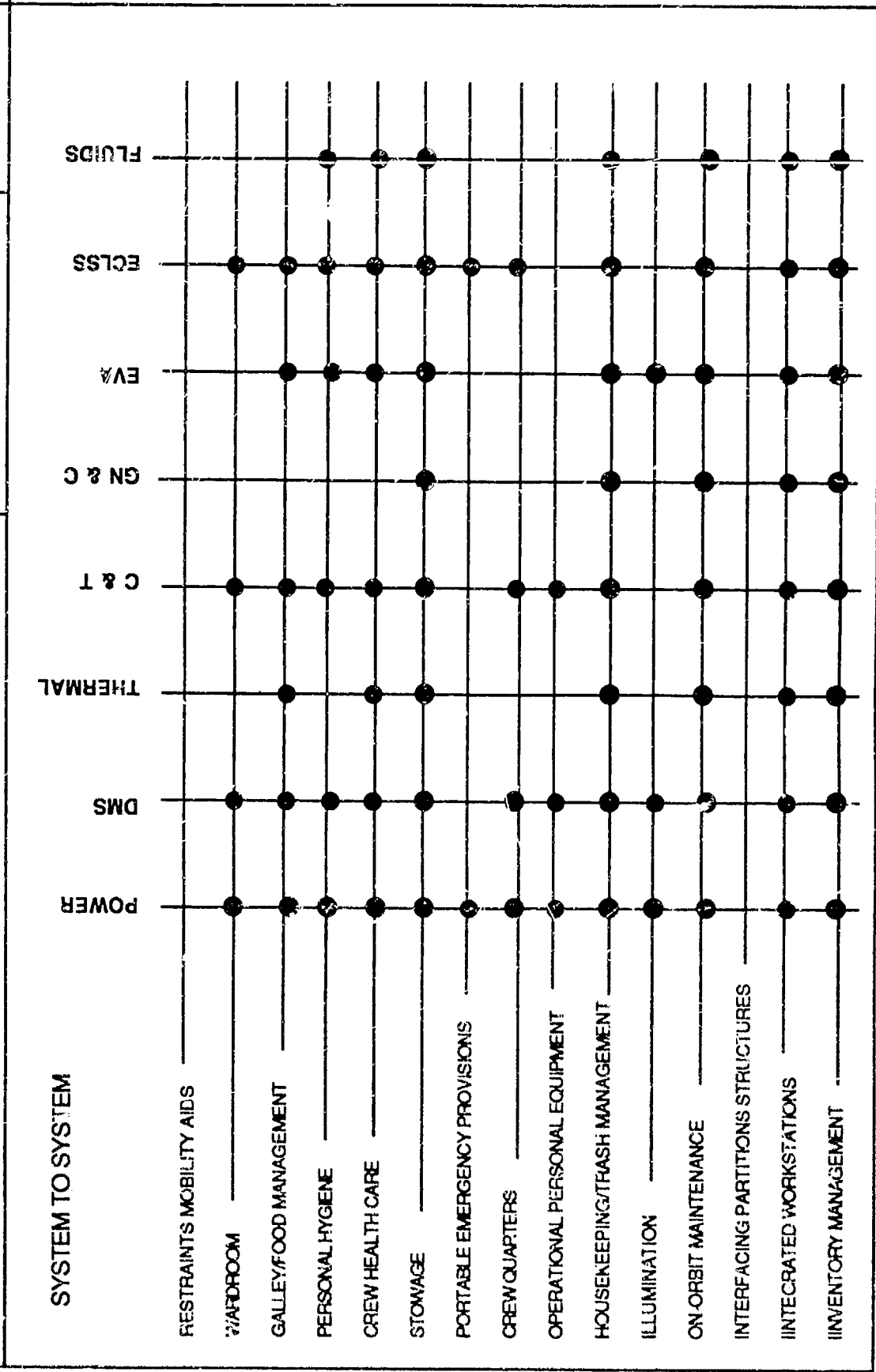



Lyndon B. Johnson Space Center

PRIME/SUPPORTING DEVELOPMENT RELATIONSHIP

MAN-SYSTEMS DIVISION

JIM LEWIS

SUBSYSTEMS	SSM	WP 01	WP 02	WP 03	SPRT DEV	INT'L
		MSFC	JSC	GSFC		
1 CREW QUARTERS	L. WEAVER	X			X	
2 RESTRAINTS & MOBILITY AIDS	J. BOHANNON	X	X		X	X
3 CREW HEALTH CARE	J. ELLIS		X		X	
4 OPS & PERSONAL EQUIPMENT	J. THOMAS/T. FLETCHER	X	X		X	X
5 PORTABLE EMERGENCY PROVISIONS	J. NOELKE	X	X		X	X
6 INTEGRATED WORKSTATIONS	D. JENSEN	X	X	X		X
7 GALLEY/FOOD MANAGEMENT	H. RIEMERS/C. BOURLAND	X			X	
8 PERSONAL HYGIENE	P. GROUNDS	X			X	X
9 ILLUMINATION	WHEELWRIGHT/JONES	X	X		X	X
10 WARDROOM	R. JONES/N. PAUSBACK	X			X	
11 STOWAGE	J. LEW/J. MADIGAN	X	X		X	X
12 HOUSEKEEPING/TRASH MANAGEMENT	H. RIEMERS	X	X		X	X
13 INTERFACING PARTITIONS	R. JONES	X	X		X	X
14 IN-FLIGHT MAINTENANCE	F. MOUNT	X	X		X	X
15 INVENTORY MANAGEMENT	J. LEW/W. PRAUS	X	X		X	X



Lyndon B. Johnson Space Center

SELECTED ACCOMPLISHMENTS

MAN-SYSTEMS DIVISION

J. L. LEWIS, PhD / SP

KC-135 ZERO G PROTOFLIGHT ANALYSIS

- SHOWER
- RESTRAINTS DESIGN EVALUATION

MAN-SYSTEMS INTEGRATION TEST BED

- WETF EVALUATIONS
 - UTILITY REEL/TRAY EVALUATION
 - TRUSS ASSEMBLY
- 1 G MOCKUPS
 - CUPOLA EVALUATION
 - INTERIOR DESIGN EVALUATIONS

PLAID

- VIEWING ANALYSIS
- ASSEMBLY SEQUENCE

INTEGRATION STANDARDS

- MAN-SYSTEMS INTEGRATION STANDARDS NASA STD 3000, VOL IV
- HUMAN COMPUTER INTERFACE GUIDE

INTERNAL ARCHITECTURE

- EXTENSIVE EVALUATION TO ESTABLISH BASIC LAYOUT
- DEVELOPED AND IMPLEMENTED MODULAR CONCEPTS



Lyndon B. Johnson Space Center

TECHNICAL CHALLENGES	MAN-SYSTEMS DIVISION
	J. L. LEWIS, PhD / SP

**INTEGRATION OF MAN-SYSTEMS REQUIREMENTS
ACROSS ALL SPACE STATION FREEDOM ELEMENTS**

**Extravehicular Activity/Manned Systems
Invited Presentations**

omit

Office of
Aeronautics and
Space
Technology

NASA

EVA/MANNED SYSTEMS

A Presentation to the

Technology for Space Station Evolution:
A Workshop

James P. Jenkins, Ph.D.

JANUARY 16, 1990

N 93 - 27789

53-54
1103617

P-10

HUMAN FACTORS R&T (SPACE)

CRST

CREWSTATION DESIGN

- **Development of human-computer interface technology and graphical presentations, including multi-dimensional visual and aural displays**
- **Provide a technology base for autonomous vision and other perceptual systems, virtual workstation technology, and computational vision systems**
- **Develop databases and models of human strength, motion and body positions in micro-gravity environments**

SPACE HUMAN FACTORS PROJECT

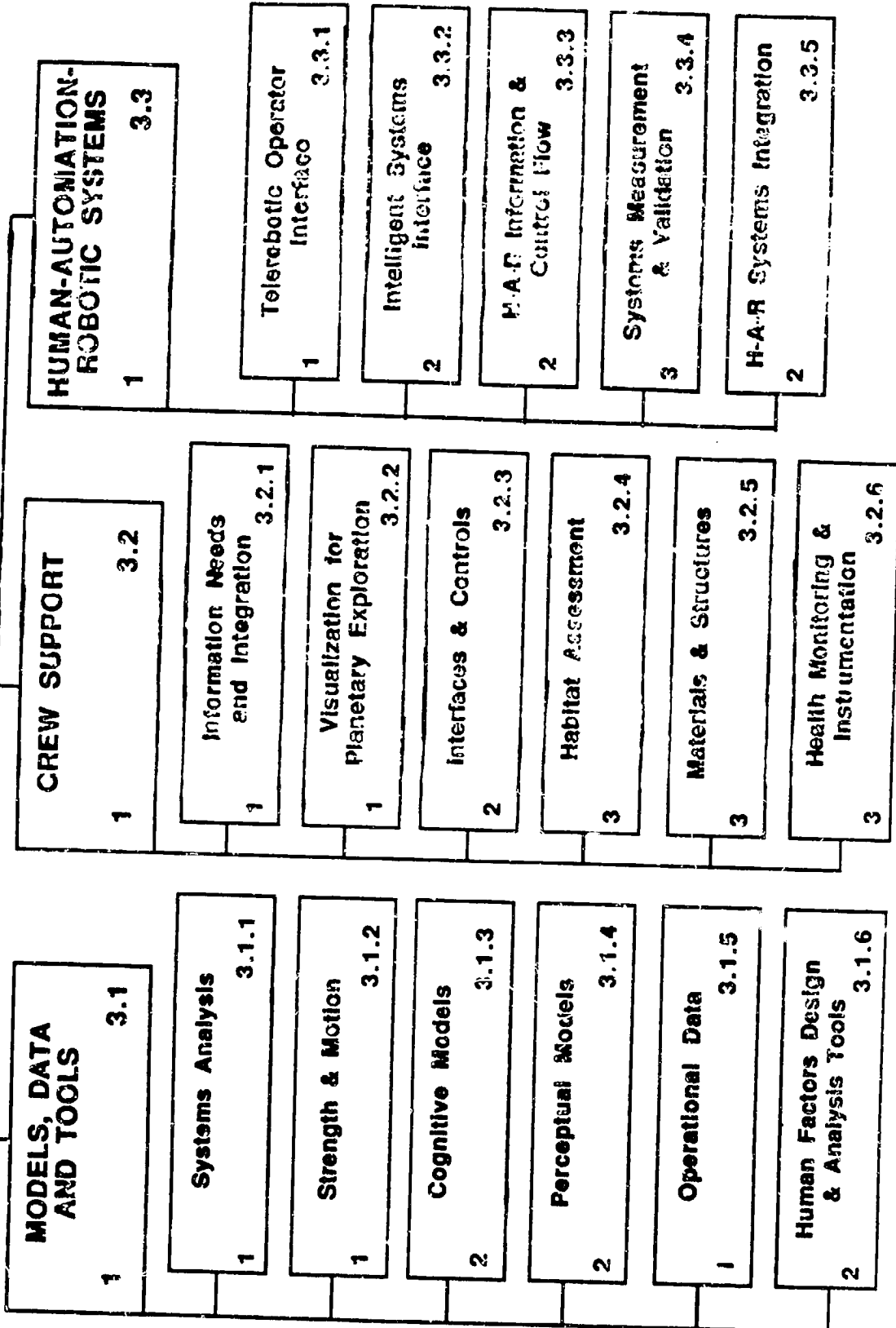

CREWSTATION DESIGN

OAST

R&T SCOPE

Methods and tools for design, validation and use of human-system interfaces

PAYOFF

Safe, efficient and productive performance by astronauts in the space environment; orders of magnitude cost reduction in space systems through use of these methods and tools for design, validations, operational employment and training.

BENEFITS

Improved methods and interface design tools in support of Station and Shuttle
Database of human strength, motion and decisionmaking performance
Methods for conducting safe, productive work

TECHNICAL CHALLENGE

- Model human capabilities, such as strength, motion and cognitive tasks
- Translate available knowledge and experience about human performance into methods and tools for design of human-system interfaces
- Provide valid human performance prediction and assessment methods

CREWSTATION DESIGN

OAST

FUNDING: DETERMINED BY IMMEDIATE DECISIONS ON FY90 AND FY91 FOR BASE R&T AND EXPLORATION BUDGETS

FY 1991 Zero--gravity database for human motion
FY 1992 Advanced display media developed
FY 1993 Test of human strength prediction model
FY 1994 Expert system architecture and interfaces for SSF applications
FY 1995 Advanced information displays for Shuttle and Shuttle/Station maneuvers

AGENCY THRUST: Primary - Space Station
Secondary - Transportation

CENTERS: JSC, ARC

R&T HUMAN

FACTORS: EVA TECHNOLOGY

OAST

RC24

R & T SCOPE

EVA suit systems (i.e. suit, Portable Life Support System, helmet, gloves, mobility aids, displays and controls) for Station and exploration missions

PAYOFF

Enabling technology for all aspects of Station and Exploration Programs
Order of magnitude increase in EVA system capability

BENEFITS

Enables extensive construction/assembly in space environment
No pre-breathe, increased dexterity and mobility to increase productive EVA time
Reliability increased to match mission requirements; on-site maintainability

TECHNICAL CHALLENGE

- Protection while meeting mission requirements (no pre-breathe, maximum mobility radiation, debris and dust protection, weight reduction) and biomedical needs
- Serviceability and reliability
- Flexibility in design (single design base with multiple mission adaptations)

EVA TECHNOLOGY

OAST

**FUNDING: DETERMINED BY IMMEDIATE DECISIONS ON FY90 AND
FY91 FOR BASE R&T AND EXPLORATION BUDGETS**

FY 1992/93 Dexterous glove developed
FY 1994 Completion of suit display and information management design
FY 1995 Flight test of advanced PLSS components
FY 1998 Advanced Suit flight test

**AGENCY THRUST: Primary - Space Station
Secondary - Transportation**

CENTERS: JSC, ARC

EXTRAVEHICULAR ACTIVITY (EVA)

—OAS—

Development of technologies for:

- EVA suits
- end-effectors
- mobility concepts
- Portable Life Support Systems (PLSS)
- gloves
- information systems
- tools

for EVA activities and work for Space Station Freedom

EXTRAVEHICULAR ACTIVITY (EVA)

OASD

A PROPOSED STRATEGY FOR DEVELOPMENT OF NEXT GENERATION EVA SUIT/SYSTEM

- **Development of a consensus among NASA Offices and Centers that Shuttle EMU is a baseline**
- **Agreement that when technology or engineering deficiencies exist, a coordinated program will be followed by NASA Offices and Centers**
- **Recognition that technology development and engineering research proceeds from the evolutionary base**

EXTRAVEHICULAR ACTIVITY (EVA)

—OAS—

PROPOSED STRATEGY (continued)

- **A set of analyses on EMU requirements for Orbiter and Station operations must be performed to identify baseline requirements (beyond what is known now)**
- **Technology and advanced development research proceed from these analyses, such that the technological or engineering deficiency is known**
- **A NASA Management Plan for EMU Technology and Advanced Development research will be developed and, after concurrence by NASA Offices and Centers, will be the roadmap for future research**

EVOLUTION OF SPACE STATION EMU PLSS TECHNOLOGY RECOMMENDATIONS

69

Richard C. Wilde
EVA Systems Engineering Manager
January 17-18, 1990

54-64
~~1008~~-27790
p. 33



UNITED
TECHNOLOGIES
HAMILTON
STANDARD

Space & Sea Systems

EMU PLSS TECHNOLOGY RECOMMENDATIONS

Human physiology drives the EMU PLSS hardware functions. Two major considerations constrain the implementation of these functions:

- Provide unobtrusive support for crewmembers performing EVA, i.e., make EVA easier and safer.
- Support EVA from a vehicle with well-defined but linked resources, i.e., reduce logistical and support overheads.

Improving the EMU in the PLSS technology areas recommended supports these considerations.

O2 SUPPLY STORAGE

For small systems like EMU PLSS gaseous O2 (GOX) remains the storage medium of choice. Supercritical and liquid O2 systems are larger owing to insulation requirements, require on-board power to maintain conditions or convert to gas, are not amenable to long term charged storage due to boil-off requirements and require an on-orbit cryoplant or storage which is not currently baselined for station.

The central issues for GOX storage are storage pressure and how to recharge the tanks after use.

Recharge technology is a driver. Both mechanical compressor and electrolytic decomposition of water concepts are being developed, but it is not yet clear which technology will be more compatible with Space Station operations. These efforts should be continued.

O₂ SUPPLY STORAGE

Recommended Future Approaches

- Continue gaseous O₂ recharge development
- Compressor
- Electrolysis

Principal Advantages

- Provides smallest volume PLSS O₂ supply consistent with recharge safety
- Provides on-orbit recharge of both primary and secondary PLSS O₂ supplies

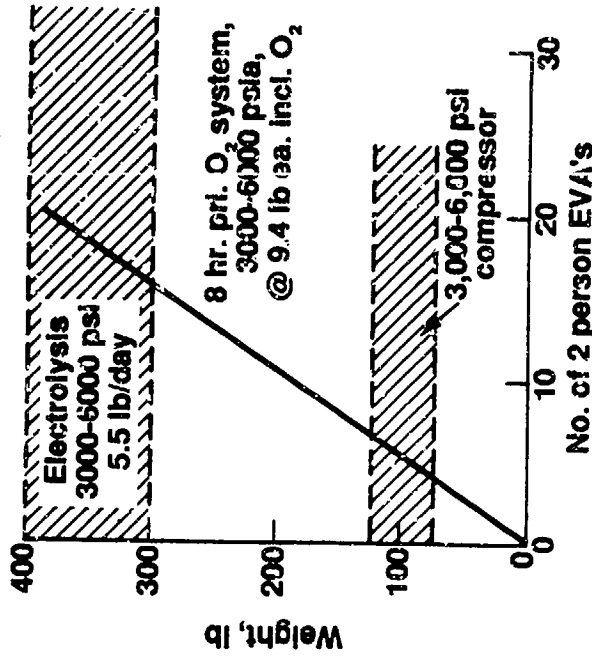
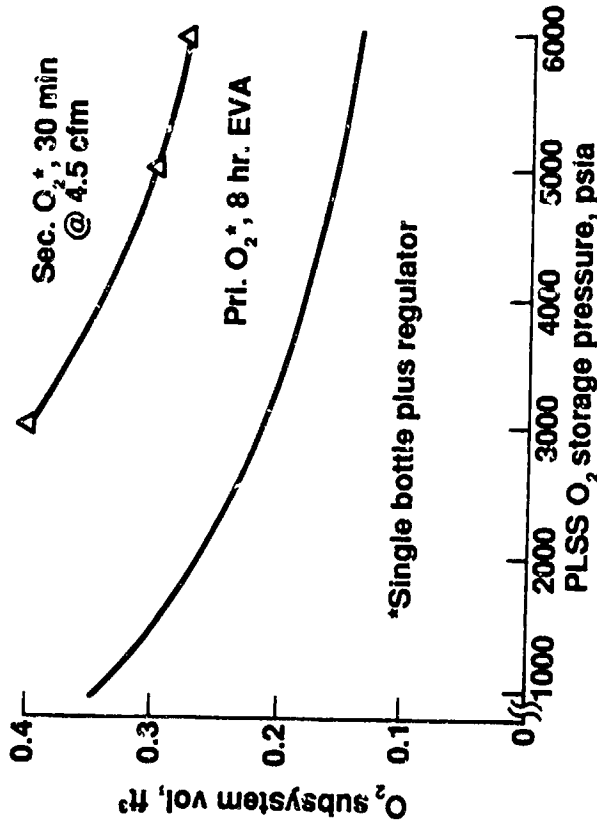

Space & Sea Systems



UNITED
TECHNOLOGIES
HAMILTON
STANDARD

O₂ SUPPLY STORAGE

(Continued)

Other desired attributes

- Minimum volume on the back
- Safe - fire & contamination
- Quick recharge for EVA contingencies
- Minimal crew reserve effort
- Safe, reliable, compact, low power recharge facility

Current status

- NSTS, EMU:
 - Primary: Operational 950 psi GOX
 - Secondary: On-orbit rechargeable 6,000 psi GOX
- SSF EMU
 - Primary: Ground rechargeable 3,000 - 5,000 psi GOX
 - Secondary: On-orbit rechargeable 6,000 psi compressor

75

74

PRECEDING PAGE BLANK NOT FILMED



H19.02

Space & Sea Systems

O2 Supply Regulators

Mechanical O2 regulators have been satisfactory to date. They are operational for NSTS EMU and are baselined in the Space Station AEMU. They are designed for fire safety and system design accommodates their droop characteristics. Mechanical O2 regulators are autonomous. They would operate even if all other PLSS subsystems had failed.

The electronic O2 regulator second stage presents an opportunity to eliminate all droop characteristics, and more importantly, to change suit pressure at will. This feature is potentially useful for softening a suit or gloves to perform particularly demanding EVA tasks. An electronic regulator would be used at the primary O2 loop. If that loop or its power supply went down, a mechanical regulator in the secondary loop would handle the safety functions.

O₂ SUPPLY REGULATORS

Recommended Future Approach

- Continue use of mechanical regulators
- Develop electronic primary regulator second stage as back-up for dexterous glove

Principal Advantage

- Reducing suit pressure during a manually demanding EVA may enhance productivity

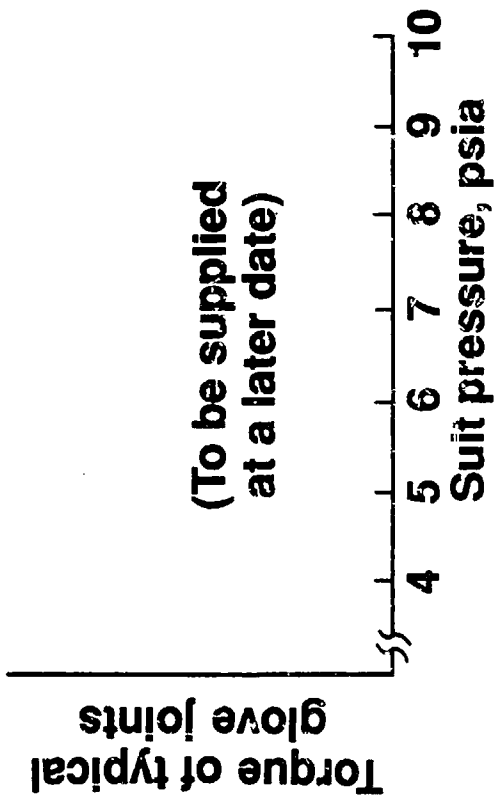

Space & Sea Systems



UNITED
TECHNOLOGIES
HAMILTON
STANDARD

O₂ SUPPLY REGULATORS

(Continued)

Other desired attributes

- Stable operation
- Minimum droop with flow and supply pressure
- Operation independent of other subsystems
- Reliable operation after long periods of disuse

Current status

- STS, EMU:
 - Primary: Mechanical 950 psi
Single stage
 - Secondary: Mechanical 6,000 psi
Dual stage
- SSF EMU
 - Mechanical 3,000 - 6,000 psi
Dual stage
- NASA A/D programs
 - Electronically controlled
 - Variable pressure second stage

CO2 CONTROL

LiOH has been the CO2 removal mechanism for all short manned space flights, including Apollo's two week missions. Regenerable CO2 removal makes sense for Space Station EMU when EVA sortie rates drive the weight of expendable LiOH above the power and weight penalties for regenerable CO2 removal.

Metal oxide is the most mature concept for EVA use, having been developed mostly under the NASA A/D programs and is currently baseline for the station AEMU.

CO₂ CONTROL

Recommended Future Approach

- Continue metal oxide development

Principal Advantage

- On-orbit regenerable — saves re-supply weight

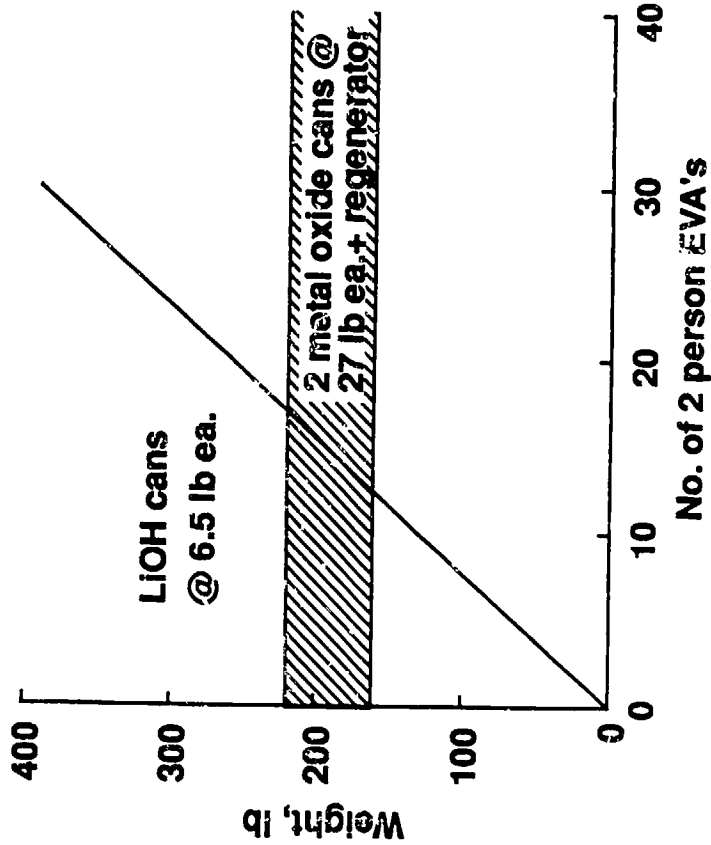

Space & Sea Systems



CO₂ CONTROL (CONT'D)

Other Desired Attributes

- Low volume
- Regenerable on-orbit with low power at low temperature
- Long shelf life
- High cycle life
- Insensitive to relative humidity
- Static system — no moving parts
- Non-venting capability
- Quick regeneration/changeout for contingency EVA's

Current Status

- STS EMU: LiOH, ~0.13 ft³ and 6.5 lb for 7 hrs.
On-orbit replaceable, non-regenerable
- SSF AEMU: Metal oxide, ~0.13 ft³ and 27 lb for 8 hrs.
On-orbit replaceable and regenerable
- NASA A/D programs
 - Metal oxide
 - Metal oxide + desiccant
 - ERCA liquid hydroxide/membrane
 - electrochemically regenerated

PRIME MOVERS

High speed fans, operating at above 100,000 RPM, offer significant volume reductions in the fan and motor mechanical elements. The fundamental acoustic frequencies are also well above the voice frequencies that carry speed information, so speed interference is reduced. The main development concern is bearings for operation in pure O₂. Magnetic bearings may be a good starting point.

The present fan-pump-separator for Shuttle EMU was optimized for small volume by mounting these centrifugal wheels on a single 19,000 RPM motor shaft. Due to the very small size of the water pump, it is potentially contamination sensitive and does not pump if started in a gas-bound condition.

Scroll pumps act more like positive displacement pumps, thus offering increased tolerance to contamination and gas inclusion. The chief development concern today is the eccentric coupling/drive mechanism which must also keep the orbiting scroll "pointing North".

PRIME MOVERS

Recommended Future Approaches

- Evaluate scroll machines (pump and fan/pump) — include couplings and drives
- Evaluate high speed fan — include bearings
- Update electric, electronic and electro-magnetic (EEE) parts availability for use in motors. Shrink motor electronics volume to 1/2 and improve efficiency ~15%.

Principal Advantages

- Scroll machines: Quiet operation, long life, insensitivity to gas inclusion and contamination (pump)
- High speed fan: Small volume, reduced speech interference
- EEE parts: Reduced volume, reduced power consumption

	Wt, lb	Vol, in ³	Power, watts
Scroll pump*	~2	~80	~5-6
120K rpm fan*	~3	~60-80	~20 @ 8.3 psi
SSF EMU pump	2	70-80	8
SSF EMU fan	4.5	150	45 @ 8.3 psi
STS EMU fan/pump/separator	5	150	38 @ 4.3 psi

*With updated EEE parts

Space & Sea Systems



PRIME MOVERS (CONTINUED)

Motor electronics volume could be reduced to approximately 1/3 of present volume if the MIL-approved EEE parts list were to include the following types of parts now available commercially:

- Monolithic devices for motor control circuits. Motor control functions are presently implemented using discreet components. Commercial monolithic devices are available that perform the following function in single devices:
 - Filtering
 - Speed signal
 - Digital drive signal
 - Position/speed feedback and Hall sensor Interface
 - "Soft" start: reduces EMI by starting motor slowly
- Surface Mount Technology for motor electronic devices.
- Low resistance MOSFET devices for power switching - will increase motor efficiency also.

Current estimates of motor efficiency improvement are on the order of 15% in the baseline SS AEMU. This would yield a power savings of 9 watts, and permit ~ 7% reduction in battery size.

PRIME MOVERS (Cont'd)

Other Desired Attributes

- Long life
- High reliability
- Low EMI signature

Current Status

- STS EMU
 - Integral fan, pump and water separator, canned motor
 - 3 centrifugal wheels on one 19,000 rpm shaft
 - Pump magnetically driven
 - Fan flow 6 cfm @ 1.0 in. H₂O
 - Pump flow 240 lb/hr at 2 psi
 - Separator flow ~11 lb/hr @ 16.6 psid
- SSF AEMU
 - Separate fan/separator and pump
 - Fan: 19,000 rpm, 6.5 cfm @ ~5 in. H₂O, centrifugal
 - Pump: Vane or scroll, canned motor, 240 lb/hr @ 9.7 psi

Space & Sea Systems



COMFORT

Some subtleties of EV crew comfort are not fully understood at this time. In theory, the liquid cooling garment suppresses sweating over the torso so that the latent metabolic heat load is mostly from respiration, with a relatively small portion coming from the head. Cooling garment temperature is controllable by the crewmember as a function of work load and personal preference. There should be no cold spots in the suit and the cooling garment should be dry after EVA.

There is evidence that the comfort control system does not work like this all the time. Sometimes, the cooling garments are wet after EVA, indicating either condensation or sweating. Occasionally, the crew has reported cold hands. It is not understood if cold hands result from low local temperature at the hands or are a symptom of a cold body resulting from re-evaporation of moisture from a wet cooling garment.

The NASA/JSC A/D program which developed the automatic cooling control algorithm did not address these issues to the point where this problem could be solved for the STS EMU. This problem should be understood and solved for EVA operation from evolved SSF.

COMFORT

Recommended future approaches

- Understand “Cold Astronaut” problem
- Evaluate no vent flow over torso
- Evaluate heating hands and/or feet

Principle advantages

- Improved crew acceptance
- Improved EVA productivity



COMFORT (Cont'd)

Other Desired Attributes

- Adjustable comfort control
- Accommodates full range of metabolic loads and external environments
- No local hot, cold or wet areas
- Minimize sweating

Current Status

- STS EMU
 - Liquid cooling over torso, arms and legs
 - Gas cooling over head, hands and feet
 - Manual cooling control, no heating
- SSF AEMU
 - Liquid cooling over torso, arms and legs
 - Gas cooling for head and hands, no cooling for feet
 - Automatic cooling control, no heating
- NASA A/D program
 - Automatic cooling control algorithm

Space & Sea Systems



HEAT REJECTION

Both Apollo and Shuttle EMU use sublimators and stored water for heat rejection. This is a good choice for the following reasons:

- Adequate water availability with acceptable penalties. The Shuttle Orbiter is fuel-cell powered and makes excess water as a by-product. Apollo LM was battery powered, but carried sufficient water for EVA.
- Small volume/weight system on the back does not encumber the EVA crew.

Space Station originally mandated non-venting because closed ECLSS loops did not produce excess water for EVA use. Non-venting EMU helped make SSF attractive to the scientific user community by removing issues of contamination deposition and obscuration from consideration. However, the large weight and volume of the EMU non-venting heat concepts made the baseline SS AEMU unacceptably large and heavy.

"Scrub '89" opened some of the ECLSS loops and eliminated the EVA non-venting requirement. However, a requirement for one hour of non-venting operation may still exist, and some future scenarios for evolved SSF may require non-venting EVA. Future logistical restrictions may also favor part or full time non-venting capability to save weight of water to orbit.

For these reasons the development of promising, non-venting heat sinks should continue.

HEAT REJECTION

Recommended Future Developments

- Continue ice chest development
- Continue metal hydride development
- Continue wax-radiator development

Principal Advantages

- Provide non-venting capability
- Reduce resupply penalty

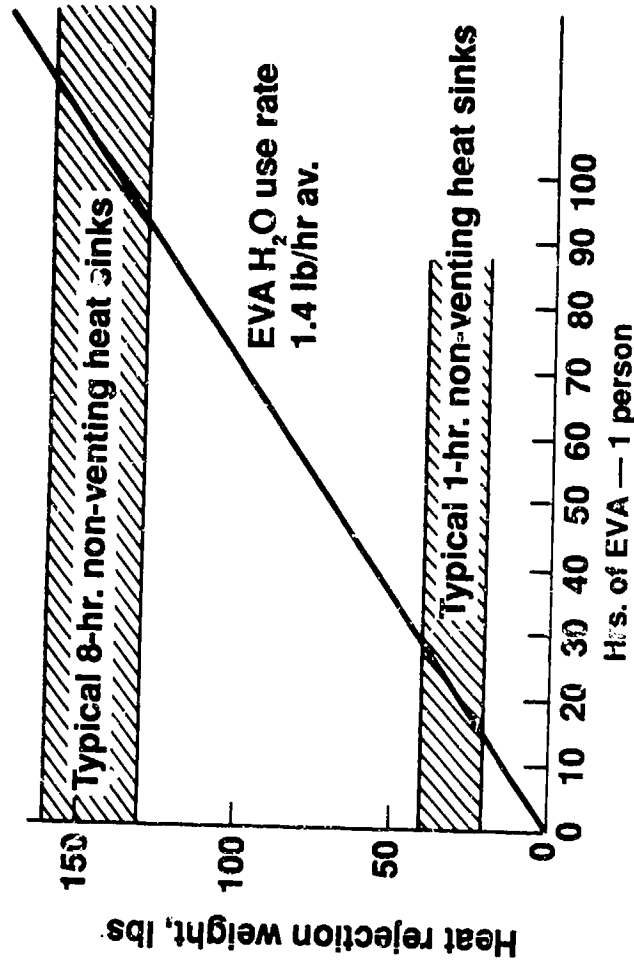

Space & Sea Systems



HEAT REJECTION (cont'd)

Desired Attributes

- Small volume
- Regenerable on-orbit
- Low power
- Insensitive to external environment extremes
- Quick recharge/changeout for contingency EVA's
- Minimal crew reservice effect
- Reliable, compact, low power recharge/regeneration facility

Current Status

- STS EMU
 - Sublimator, stored water, 100% venting for 7 hrs., ~12 lbs and 0.2 ft³
- SSF AEMU
 - Baseline: TE-wax-radiator, 100% non-venting for 8 hrs, 150 lbs, 2.0 ft³, 20 watts av.
 - 3 ft³ version: Metal hydride, 7-hr venting, 1-hr non-venting, (TBD) lbs, TBD ft³
- NASA A/D programs
 - Ice chests: Direct and indirect contact
 - Vapor cycle heat pump w/radiator
 - TE-wax-radiator w/65°F wax
 - 50°F wax radiator
 - Metal hydride heat sinks, venting and non-venting



POWER SOURCES

The Shuttle EMU uses a silver-zinc battery which remains the highest energy density rechargeable battery in production today: 42 watt-hr/lb. Its late 1970's design is optimized for low volume, which results in a rated cycle life of 10 cycles and a wet shelf life of 120 days. Work is underway to extend wet shelf life and 180 days has been achieved to date.

Meanwhile, the quest for advanced secondary (rechargeable) batteries continues in industry. Driven by common needs of military equipment and electric vehicles for high energy density, and by opposing needs for long shelf life and high cycle life, battery development has taken two tracks. Long life, high density, but non-rechargeable lithium primary batteries are now becoming commonplace in the marketplace. On a slower track, secondary lithium and silver-iron batteries are only now beginning to emerge from the laboratory.

It is time to review current developments in secondary batteries to evaluate their potential use in supporting EVA from evolved SSF.

Fuel cell development for EVA applications has progressed to the demonstration hardware stage. The application is potentially interesting because of its small size relative to the extended duration silver-zinc battery baselined for the SS AEMU. The fuel cell would share the primary O₂ supply with the EMU pressurization subsystem, and could share its nickel hydride hydrogen storage subsystem with a hydride heat sink. This EMU concept would require presence of a hydrogen recharge facility in the air lock, which is not presently in the baseline.

POWER SOURCES

Recommended future development

- Continue fuel cell development
- Evaluate advanced secondary batteries, eg. lithium, silver-iron

Principle advantages

- Batteries:
 - High energy density, 45-55 w-hr/lb
 - Long shelf life, years
 - High cycle life, hundreds
- Fuel cell
 - Low volume
 - Integrates well with metal hydride heat sink

Space & Sea Systems



H1007

POWER SOURCES (Cont'd)

Desired Attributes

- High power density
- Low volume
- Flat voltage/time characteristic
- High peak power capability
- Long shelf life
- Safety
- High cycle life
- 16 hr. max. recharge
- Quick, easy replacement
- Minimal crew reservice effect
- Safe, reliable, compact, low power recharge facility

Current Status

- STS EMU
Silver zinc battery, 42 W-hr/lb
16.8V, 404 W-hr, 10 cycle
9.6 lb, 142 in³, 120 day wet life
- SSF AEMU
Silver zinc battery, 26 W-hr/lb
28V, 1355 W-hr, 40 cycle
53 lb, 925 in³, 180+ day wet life
- NASA A/D program
H₂/O₂ fuel cell, 25 W-hr/lb
Hydride alloy: Cerium-free mischmetal
Penta nickel
28+4/-2V, 930 W-hr
38 lb, 415 in³

Space & Sea Systems



CONTROLS

Apollo and Shuttle EMU's use manual control of communication, display, comfort, crew safety and backup functions. Most of these controls are located on the chest in a Display and Control Module (DCM). Only a purge valve is located elsewhere, on the helmet.

Voice control for comm. display and comfort functions is baseline in the SS AEMU to help overcome some of the drawbacks to chest-mounted controls, which are:

- Some controls are not visible. Some crewmembers wear a forearm mirror to see these controls.
- Mechanical linkages from a DCM have to cross the entry closure in the AEMU rear-entry suit.
- The DCM intrudes on the work space in front of the EMU for some of the EV crew, especially those with shorter arms.

Voice control in the AEMU has helped reduce the number of comm and display controls from 3 to 2 which simplifies finding a suitable location for the remaining comfort, crew safety and backup controls. Continuing to develop such non-manual controls will ultimately improve the EMU's convenience and will enhance EV productivity.

CONTROLS

Recommended Future Developments

- Continue voice actuation development
- Identify and evaluate other promising control technologies, eg, eye motion control

Principal Advantages

- Hands-free operation more convenient than manual operation
- Reduces number of manual controls on EMU — inconvenient location
- Simplifies packaging — eliminates manual/mechanical leakages to remote actuators

Voice control supports reduction of 8 EMU control switch functions to 2

101

STS EMU

Power mode

- * CWS
- * Fan
- Feedwater
- * Volume control (2)
- * Display intensity
- * Push-to-talk

SSF AEMU

Mode Ack/Select

*Functions under voice control in SSF AEMU

Space & Sea Systems



UNITED
TECHNOLOGIES
HAMILTON
STANDARD

CONTROLS (Cont'd)

Desired Attributes

- Convenient, accessible location
- No inadvertent actuation
- Positive, unambiguous actuation
- Two-step actuation where feasible, e.g., command/execute or enable/actuate
- Easy detection of control state where feasible, e.g., valve position indicator

Current Status

- STS EMU
 - Manual controls located on chest and helmet (no automatic controls)
- SSF AEMU
 - Voice actuation of comm, display and comfort functions
 - Manual control of backups and crew safety functions, located on helmet and either over-the-shoulder or chest
- NASA A/D programs
 - Voice control of helmet mounted display

103

PRECEDING PAGE BLANK NOT FILMED

102
PATENTED



Space & Sea Systems

DISPLAYS

The current STS EMU uses a 12 character, alphanumeric display for EMU status information. EV task prompts use cuff cards to pre-identified procedures. This is adequate for Shuttle where EV tasks have been well defined and the crews well trained on Earth before their one-to-two week flights. Crews are expected to remain aboard station from three to six months and the potential number of EV tasks, contingency and planned, will be greater owing to the long duration use of Station. Hence, the need is foreseen to perform EV tasks for which crewmembers have not been specifically trained. Such tasks will proceed more quickly and with more confidence with the ability to display text and graphics to the crewmember in real-time.

NASA A/D program work to date in helmet-mounted displays is promising. Other display locations that reduce EMU volume include the body (chest or wrist), hand-held, or structure mounted. Holographic properties makes it possible to project 3-D images. EV task aids such as these will improve EVA productivity and reduce ground training requirements.

DISPLAYS

Recommended Future Developments

- Continue HMD development
- Evaluate holographic projections
- Evaluate direct view displays, e.g.
 - Body mounted
 - Hand held
 - Structure mounted

Principal Advantages

- Future displays can display more information (text and graphics) than present EMU
- Text and graphics can convey task procedure information. Present EMU displays EMU status only. Cuff cards are used as prompts to EVA tasks.
- Task training can be reduced if real-time instructions can be displayed
- Unanticipated EV tasks can be performed, i.e, tasks not specifically trained for on the ground

Space & Sea Systems



DISPLAYS (Cont'd)

Desired Attributes

- Viewable in bright sunlight and darkness
- Low power requirement
- Low cooling requirements
- Freeze-frame TV image initially, ultimately moving TV images
- Where applicable
 - Video compatible input
 - Voice actuation of image control
- For helmet-mounted displays:
 - Virtual see-thru image
 - High information density
 - Bincular image
 - Wide field of view
 - Non pupil forming

Current Status

- STS EMU
 - Back-lit 12 character LCD display (formerly LED) on chart — EMU status alpha-numeric only
 - Cuff cards for pre-identified EV tasks
- SSF AEMU
 - Helmet mounted display with requirements for 640x480 pixel display in 1.25x1.0 in. LCD (best industry responses are for 557x346 pixel 1.25x1.0 LCD and 640x200 in. 1.4x1.1 in LCD)
- NASA A/D program
 - Helmet mounted display concepts using CRT and 320x220 pixels in 1.0x1.0 in. LCD

Space & Sea Systems



UNITED
TECHNOLOGIES
HAELTON
STANDARD

SENSORS

The STS EMU uses sensor technology from the late 1970's. The electrochemical CO₂ sensor is no longer available and is being replaced. Sensor technology is changing very rapidly now with the advent of digital signal processing, fiber optic data transmittal and "smart sensors" that contain integral error correction and signal conditioning. In addition, "mono-machines", mechanical and electromechanical devices fabricated by integrated circuit methods on a mono-meter scale are beginning to receive serious research attention.

These advances in sensor technology warrant evaluation for application in EVA equipment for evolved SSF. This equipment could make good use of the miniature, error-correcting and rugged sensors now being developed for industrial and military applications.

SENSORS

Recommended future developments

- Evaluate current technologies for miniature pressure temperature and proximity sensors
- Evaluate / develop sensors with
 - Integral signal conditioning
 - Integral data formatting
 - Fiber optic data output
 - Miniature connectors

Principle advantages

- Small size
- Compatible with all-digital signal processing



SENSORS (Cont'd)

Desired Attributes

- Small size
 - Low power consumption
 - Mechanically rugged
 - Useable signal output level
 - Simple mechanical interface
- Small error band
 - No hysteresis
 - Long calibration interval
 - Highly repeatable
 - High EMI tolerance

Current Status

- STS EMU
 - Electrochemical CO₂ sensor no longer available — being replaced
 - Other sensors use thermister and strain gages of late 1970's technology
- SSF AEMU
 - Uses new STS CO₂ sensor with relative humidity capability added
 - Uses current technology for pressure and temperature sensors
- NASA A/D program
 - N/A

Space & Sea Systems



**Evolving EVA System Capability for the Evolving
Space Station Freedom Requirements**

Howard Slade

McDonnell Douglas Space Systems Co.

Technology for Space Station Evolution Workshop

January 16-19, 1990

Dallas, Texas

35-54
163619
p-7

N93-27791

EVOLVING EVA SYSTEM CAPABILITY FOR THE EVOLVING SPACE STATION FREEDOM (SSF) REQUIREMENTS

INTRODUCTION

- SSF capability phased over the next 35 years
 - First Element launch 1995
 - Manned tended capability 6/1996
 - Permanent manned capability (PMC) 7/1997
 - Assembly complete 7/1999
 - Phase 2 operation: 2001 and beyond
 - Transportation node: 2010 and beyond?
 - Design life 30 years - out to ~2025

- The expanding SSF capability requires expanding EVA (manned activities) and telerobotic operations
 - NASA is in the process of defining approach to phased capability
 - Present planning emphasis is on phasing of manned EVA
 - EVA and telerobotics must be balanced

— SPACE STATION FREEDOM

McDonnell Douglas • GE • Honeywell • IBM • Lockheed

PRE-SCRUB '89 BASELINE

- NSTS EMU for assembly
- Up to 156 EVAs/year (3 per week) at PMC
- Up to 250 EVAs/year (~5 per week) for growth
- 2 Airlocks with capability to support two 2-man EVA crews
- Heavy use of telerobotics where cost effective

APPROACH SHIFT RESULTING FROM SCRUB '89

- Reduce program front end EVA costs
- Maximize telerobotics capability with target being 100%. EVA as contingency only. One SSF Airlock only
- Allocated EVA time per year 40 to 80 man hours
- Convergence of EVA demand and EVA allocation still in question for Phase I space station
- EVA demand for SSF outyears anticipated to be high
 - Transportation node
 - Increased maintenance, upgrades
 - Consideration of Phase II users?
- NASA assessing various EVA options to meet SSF growth

CONSIDERATIONS FOR ALTERNATIVE SELECTION

- Low front end cost
- Life cycle costs
 - Dependent on number of EVAs
- Minimize dead-ended costs
- EVA productivity
 - Prebreathe time
 - Suit comfort - gloves
 - Eliminate prebreathe as soon as feasible
- 100% telerobotics use probably not possible nor cost effective

EVA SUPPLY OPTIONS

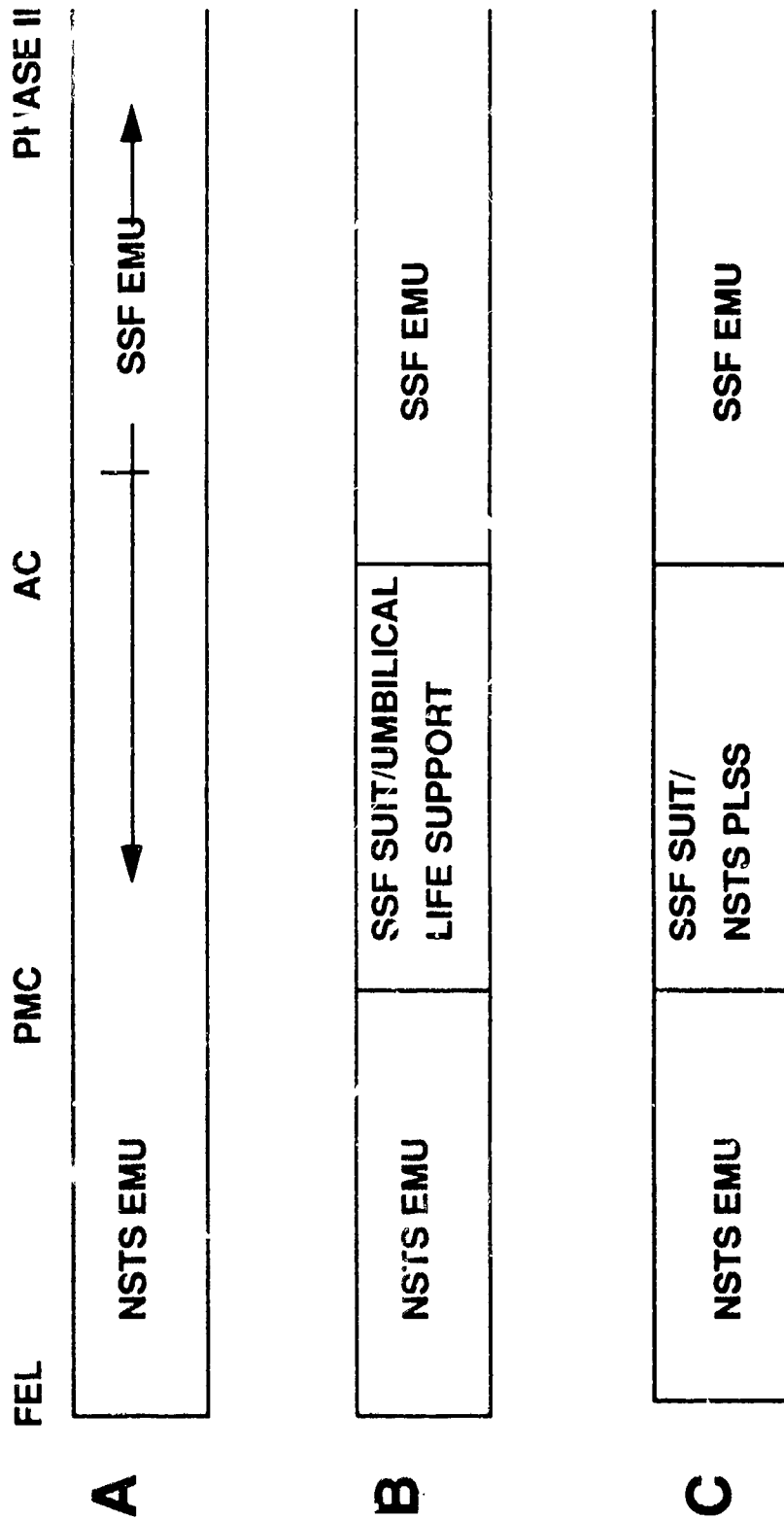

KEY TECHNOLOGIES FOR EVOLUTION OF EVA SYSTEM LIFE SUPPORT

<u>TECHNOLOGY</u>	<u>APPLICATION</u>	<u>CHARACTERISTICS</u>	<u>BENEFIT</u>
HFM	Selective removal of CO ₂ / H ₂ O from vent loop	No power, low volume No moving parts, venting	Low life cycle \$
Metal Oxides	Selective removal of CO ₂ from vent loop	Regenerable, closed loop	Low life cycle \$
Metal Hydrides	Heat rejection for EVA	Low volume, venting, Regenerable	Low life cycle \$, Less contamination
High Pressure Glove	Zero prebreathe suit	Dexterous, low torque	Low IV overhead, EVA productivity
Rotary Coupling	Fluid and electrical connections for umbilical EVA reel	Low leakage, high cycle, Low torque	Facilitate Umbilical Management
Fuel Cell	EMU power supply	Regenerable, closed loop, High current density	Low life cycle \$

— SPACE STATION FREEDOM

McDonnell Douglas • GE • Honeywell • IBM • Lockheed

EVA AND TELEROBOT INTERACTION

Kelli F. Willshire
NASA Langley Research Center

Presented to the Technology for Space Station Evolution Workshop;
Dallas, Texas; January 16-19, 1990.

56-54
163620
P-19
N93-27792

INTRODUCTION

We are about to enter into a new era - that of astronauts working hand in hand with telerobots in space. This has been done to some degree with astronauts and the Space Shuttle's Remote Manipulator Arm. However, for the Space Station Freedom, not only will astronauts be working with the RMS type system but also with smaller, more dexterous systems such as the Flight Telerobotic Servicer (FTS). Because EVA time is a premium resource, the most effective use of the astronauts and the telerobot will be required. There may be some tasks for which it is most efficient to have both the EVA astronaut and the telerobot working together. This type of close interaction has not occurred before and brings up many issues. Most of these issues are related to technology: communication must be infallible, new control systems and devices may be required, enhanced telerobot safety systems may be necessary. IVA operations may also be affected by the combined EVA telerobot tasks. There is also the issue of how the EVA astronaut and the telerobot work on separate tasks but at the same time. For both situations, research and development of at least some new technology is required: enhanced communication both by voice and data, sophisticated collision detection systems, more responsive controls and displays. These new systems or system enhancements may require knowledge base systems for their operation. This paper will review some of the important issues, types of tasks, the FTS capabilities, the technology that is needed to address those issues, and the possible impact on Space Station Freedom.

OUTLINE

- ISSUES OF EVA - TELEROBOT INTERACTION
- TYPES OF TASKS
- FTS CAPABILITIES
- TECHNOLOGY REQUIRED FOR INTERACTIONS
- POSSIBLE IMPACT ON SPACE STATION FREEDOM

When astronauts and the telerobot work together or in close proximity, many issues become important. These issues are listed on this page, not necessarily in priority order.

The first issue is that of communication. Effective communication between the astronaut and telerobot will be critical for safe and successful task completion. Communication should be extremely reliable and noninterfering with the conduct of the task. That is, methods of communication should be as natural as possible so that voice is likely to be the best method to use. This will require more capable voice recognition and command systems.

Safety is the next issue and is related to communication. The entire scenario of astronauts and the telerobot working together or in close proximity is safety critical, not only for the astronaut, but also for the integrity of the Space Station and the mission success. Many subissues are involved in safety and include physical means of preventing the telerobot from harming itself, the astronauts, or the Station; effective work practices by the astronauts; adequate visibility and communication; and escape procedures should an accident happen.

Workload is another issue when the interaction of the telerobot and the astronaut is considered. How much work and of what level of difficulty, mental or physical, is optimum for the astronauts when working with telerobots? The astronaut would not likely be exclusively an observer, which could be boring and monotonous and create a situation where a critical event may be missed. On the other hand, the astronaut should not have to continually manipulate the telerobot which would be physically fatiguing and possibly result in an unsafe situation.

Task allocation is related to workload. Which tasks are best suited for the astronaut to do and which are best for the telerobot is already being examined. This area will need to be extended to consider the IVA astronaut in the loop with the EVA astronaut and telerobot.

Control should be considered in at least two ways. The first is that of who has authority for a task and how does that authority get changed when necessary. The second, but related, way is that of control from the ground. This brings up the additional problems of time delay.

Symbiosis, a term used by the investigators at Oak Ridge National Laboratories among others, is the issue of how the astronaut works with the telerobot or separately but in close proximity. This is a broader issue which is made up of components of all the above issues.

Mobility is the last issue to be discussed. What is the best way to move both the telerobot and the astronaut when both are exterior to the Station? What are safe modes and speeds of travel? What procedures should be followed for moving about the Station?

ISSUES

- COMMUNICATION
- SAFETY
- WORKLOAD
- TASK ALLOCATION
- CONTROL
- SYMBIOSIS
- MOBILITY

Fatigue was mentioned with respect to workload. Ocean Systems Engineering has identified some possible problems for IVA astronauts based upon their experience with underwater teleoperated systems. They list several physical and environmental fatigue factors. Operational stress can be generated by task difficulty, operational time limitations, or extended durations of concentration. Eye strain can be caused by improperly sized video monitors, video flicker, distortion, or improper restraints monitoring. Body fatigue can be created by large scale masters, miniature joysticks, or the relationship between the restraint and console. Boredom is caused by repetitive work tasks, excessive time on operations, lack of sleep, or minimal time off from work. IVA lighting can create glare on video monitors which can adversely affect eyesight during operations. Background noise interferes with communication and concentration. These problems can be avoided by proper human factors design and operational procedures.

POSSIBLE PROBLEMS FOR IVA ASTRONAUTS

- O **PHYSICAL AND ENVIRONMENTAL FATIGUE FACTORS**
 - **OPERATIONAL STRESS: GENERATED BY TASK DIFFICULTY, OPERATIONAL TIME LIMITATIONS, EXTENDED DURATIONS OF CONCENTRATION**
 - **EYE STRAIN: IMPROPERLY SIZED VIDEO MONITORS, VIDEO FLICKER, DISTORTION, AND IMPROPER RESTRAINT FOR MONITORING**
 - **BODY FATIGUE: CREATED BY LARGE SCALE MASTERS, MINIATURE JOYSTICKS, AND RESTRAINT TO CONSOLE RELATIONSHIP**
 - **BOREDOM: CAUSED BY REPETITIVE WORK TASKS, EXCESSIVE TIME ON OPERATIONS, LACK OF SLEEP, MINIMAL TIME OFF SHIFT**
 - **IVA LIGHTING: GLARE ON VIDEO MONITORS, ADVERSELY AFFECT OPERATION EYESIGHT,**
 - **NOISE: BACKGROUND INTERFERES WITH COMMUNICATION, CONCENTRATION**

There will be several types of Space Station tasks that can be done by either EVA astronauts or telerobots or both. Assembly of the Station and large space structures has received quite a bit of attention since it is one of the first tasks required by the Station. Assembly by telerobot is feasible, although it may take longer with a telerobot. On the other hand, the telerobot can be operated almost 24 hours a day, whereas the EVA astronaut is limited to 6 hours per day, and no EVAs are permitted until the third day in space. Since assembly of a truss structure involves a series of repetitious steps, it is amenable to automation or robotic operations by which most steps can be done autonomously. However, it may prove optimal to have both the EVA astronaut and the telerobot working together during assembly.

Similarly, inspection and check-out tasks can be fairly routine and repetitious and so amenable to automation or at least supervised teleoperation. Making sure that utilities are in place, secure, and operational is an example of an inspection and check-out task.

Repair is a more complicated task depending upon the type and extent of repair required. There may be groups of steps which can be automated, but more than likely, supervision will be required and decisions made by astronauts.

Replacing orbital replacement units (ORUs) should be routine in most cases if the ORUs are designed properly and no extenuating circumstances exist.

Servicing implies a variety of tasks from resupplying fuel, cleaning, refurbishment, and routine replacement of worn parts. Individually, these tasks should be able to be automated or at least conducted via supervised teleoperation.

TYPES OF EVA OR TELEROBOT TASKS

- ASSEMBLY
- INSPECTION AND CHECK OUT
- REPAIR
- ORU REPLACEMENT
- SERVICING

This is the Martin Marietta Astronautics concept of the Flight Telerobotic Servicer being developed under contract with NASA Goddard Space Flight Center. Its characteristics are described on the following pages.

FLIGHT TELEROBOTIC SERVICER

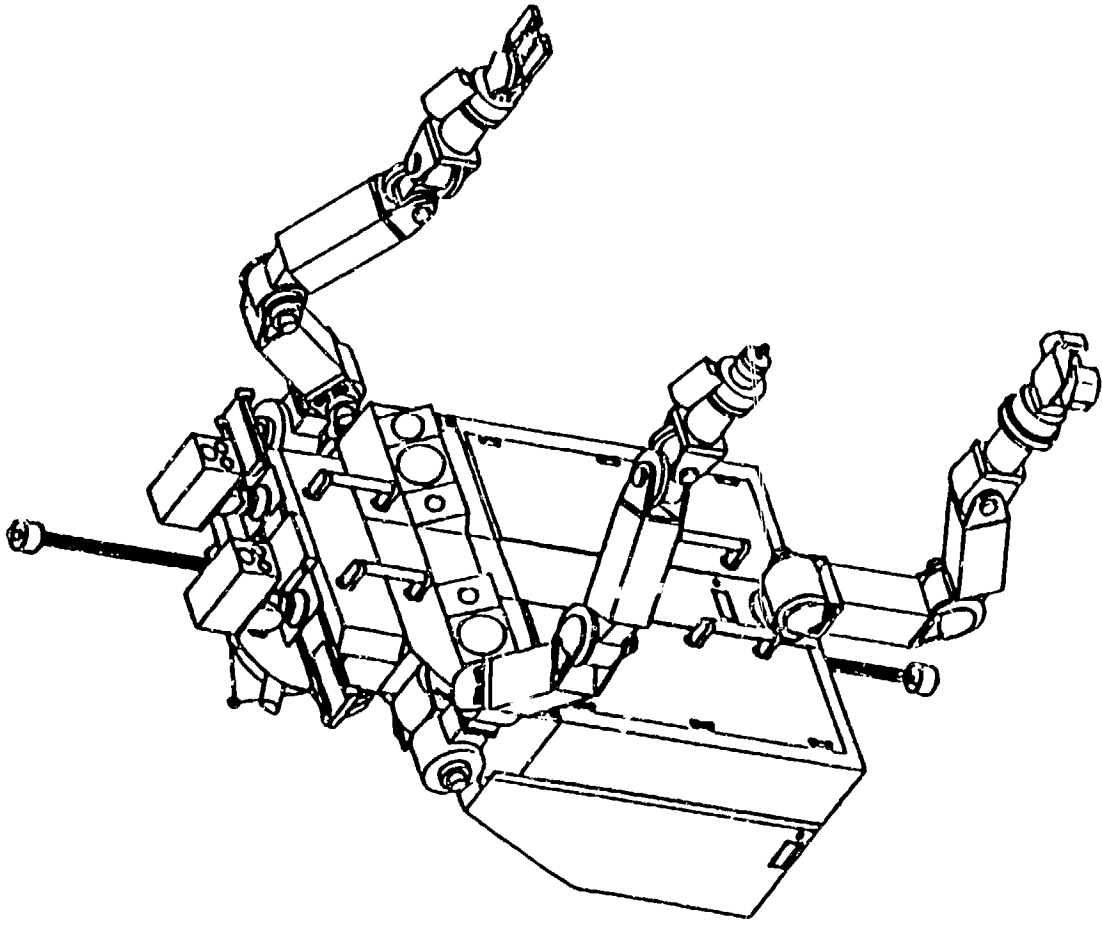

These are the Flight Telerobotic Servicer (FTS) characteristics projected by the FTS project office to be available by assembly complete. The FTS consists of three main parts: the telerobot, the workstation, and a distributed data management system. The telerobot will have two 7 degree-of-freedom manipulator arms, which are each 5 feet in length. It will also have an attachment, stabilizing, and positioning subsystem which is similar to a leg in function. There will be four cameras; one on each wrist, and two on the head, with a lighting system. End-of-arm tooling will be provided which allows switching to one of several end effector tools on a caddy.

The workstation will be an enhanced multipurpose application console or MPAC. There will be an operator restraint system inside the space vehicle. Two 6 degree-of-freedom mini-master force reflecting handcontrollers will be used for operating the manipulators. Three video images will be able to be presented simultaneously, or one can be used for computer graphics. There will be voice control of the cameras. Video and data recorders will be included.

The FTS data management processing system (DMPS) will be fault tolerant, redundant, distributed, and modular so that it can be more easily repaired and upgraded as more capability is needed.

PROJECTED FTS CHARACTERISTICS

- O TELEROBOT
 - TWO 7 DOF MANIPULATOR ARMS (5FT)
 - ATTACHMENT, STABILIZING AND POSITIONING SUBSYSTEM
 - FOUR CAMERAS: TWO ON WRISTS, TWO ON HEAD
 - LIGHTS
 - END-OF-ARM TOOLING

- O WORKSTATION
 - ENHANCED MPAC
 - OPERATOR RESTRAINT SYSTEM
 - TWO 6 DOF MINI-MASTER FORCE REFLECTING HANDCONTROLLERS
 - VIDEO DISPLAY: THREE IMAGES SIMULTANEOUSLY OR ONE FOR GRAPHICS
 - VOICE CONTROL OF CAMERAS
 - VIDEO AND DATA RECORDERS

- O DMPS
 - FAULT TOLERANT, REDUNDANT, DISTRIBUTED, MODULAR

The FTS has three modes of operation. The first listed is the fixed base dependent mode in which the FTS is attached and stabilized at the worksite by the Shuttle RMS or Station (Mobile Remote Manipulator System) MRMS. It obtains its power, data, and communication resources via an umbilical to the host, e.g., the Shuttle or Station. The second mode is that of fixed base independent. For this mode, the FTS is attached and stabilized at the worksite, but uses power from internal batteries and wireless communication. The third mode is transporter attached. The FTS stays attached to the Shuttle RMS or the Station MRMS for mobility during a task and receives its resources from the host transporter. Regardless of the operation mode, the FTS is designed and sized so that it can be taken inside the Shuttle or Station for servicing.

FTS OPERATIONS

- O FIXED BASE DEPENDENT
 - ATTACHED AND STABILIZED AT WORKSITE
 - RESOURCES VIA UMBILICAL
- O FIXED BASE INDEPENDENT
 - ATTACHED AND STABILIZED AT WORKSITE
 - POWER FROM INTERNAL BATTERIES
 - WIRELESS COMMUNICATION
- O TRANSPORTER ATTACHED
 - SHUTTLE RMS OR STATION MRMS FOR MOBILITY
 - RESOURCES FROM HOST TRANSPORTER
- O IVA SERVICED

The FTS is projected to use the following amounts of resources. The telerobot and workstation together will weigh under 1500 pounds. The stowed telerobot will require 7 ft X 3.5 ft X 3 ft volume. The power requirements will be less than 2000 watts peak, or 1000 watts average, and 350 watts for standby.

FTS RESOURCES

- O WEIGHT**
 - TELEROBOT AND WORKSTATION < 1500 LBS

- O VOLUME**
 - 7 FT x 3.5 FT x 3 FT FOR STOWED TELEROBOT

- O POWER**
 - LESS THAN 2000 WATTS PEAK
 - 1000 WATTS AVERAGE
 - 350 WATTS STANDBY

The question is not whether telerobots, such as the FTS, or astronauts should always perform certain tasks, rather the problem is to find the optimum mix of astronauts, IVA and EVA, and telerobot operations. This optimum depends upon proper human factors design of the human-machine systems, including designing for robot-friendliness. The latter usually makes things more human friendly, also. In addition, technology enhancements are necessary to reach the complete optimum. The required technologies include a more rugged EVA suit for longer, more comfortable operations; sophisticated collision detection and avoidance systems; responsive controls and displays so that time delays are not apparent to the user; automatic control delegation so that control is switched when necessary to the proper agent; enhanced communication systems which are more reliable and understandable, especially in the area of voice recognition and command; and finally, enhanced knowledge bases and knowledge base methodology to support the proper level of automation and supervision.

Supporting these technologies on the Space Station Freedom may require more data, communication, and power resources. However, the investment of these resources will be outweighed by the increased productivity of the Station overall and its mission success.

REQUIRED TECHNOLOGY

- MORE RUGGED EVA SUIT
- SOPHISTICATED COLLISION DETECTION AND AVOIDANCE
- RESPONSIVE CONTROLS AND DISPLAYS
- AUTOMATIC CONTROL DELEGATION
- COMMUNICATION ENHANCEMENTS
- ENHANCED KNOWLEDGE BASES

TECHNOLOGY FOR SS FREEDOM EVOLUTION - A WORKSHOP

EVA / MANNED SYSTEMS WORKSHOP
CHAIRMAN - BRUCE WEBBON, PHD.

SIMPLIFIED AID FOR CREW RESCUE (SAFR)

16-19 Jan. 1990

H. T. Fisher, Mgr.
Manned Systems
NASA Space Flight Programs
Aeronautics Division
Lockheed Missiles & Space Co., Inc.

N93-27453/3
163621
p 21

AGENDA

- Crew Emergency Rescue Program
- Functional Description
- Operational Description
- I/F's With Other Subsystems/Elements
- SAFR Characteristics
- Potential Resource Requirements
- Logistics, Repair & Resupply
- Potential Performance Improvements
- Automation Impact
- Summary & Conclusions

142
UNCLASSIFIED PLAN

CREW EMERGENCY RESCUE SYSTEM PROGRAM

NASA-JSC has requested a two part study be undertaken for SS Freedom Work Package 2 which will subsequently develop a point design concept(s) for a Crew Emergency Rescue System (CERS). This study is the responsibility of McDonnell Douglas (Work Package 2 prime) assisted by Lockheed (subcontractor to MDAC). This basic program has, and is addressing the potential of an EVA crewperson or equipment item becoming detached from the SS Freedom with the objective of rescuing the individual or retrieving the adrift equipment item. The currently on-going study is composed of two parts:

- Part I - Delineation of rescue/retrieval requirements, identification of alternative hardware concepts, and conduct of trades to down select the concepts to a manageable number for study in the next phase.
- Part II - Detailed definition of the concept(s) selected, subsystem delineation and trade-offs, development of a point design, preparation of a top level specification, generation of basic program costs, preparation of a candidate precursor prototype flight experiment on the Orbiter, and development of a DDT&E schedule.

Part I of the study has been completed and effort is well underway for Part II. Both existing and 'leading edge' technology is being examined as part of the effort, thus, the applicability to this workshop.

CREW EMERGENCY RESCUE SYSTEM PROGRAM

A. NASA-JSC Directed Study On EVA Crew Rescue & Equipment Item Retrieval

- Work Pkg. 2 - McDonnell Douglas & Lockheed

B. Two Part Study

- Part I Complete - Reqs., Trades, Concept Selection
- Part II Underway - Point Design Evolution

C. Two Primary Concepts Being Pursued

- Autonomous Free Fyler - MDAC
- Simplified Crew Aid For Rescue (SAFR) - Lockheed

FUNCTIONAL DESCRIPTION

As the CERS program evolved in Part I of the study, two substantially different concepts emerged for subsequent study: (1) An autonomous free flyer (MDAC); and (2) Simplified Aid For Rescue [SAFR] (Lockheed). This briefing addresses the SAFR concept (shown on the facing page). The SAFR is a modular system attached to the Extravehicular Mobility Unit (EMU) and worn during the entire EVA sortie. It utilizes multiple thrusters for propulsive capability with Nitrogen as the basic fuel. The thrusters are mounted on the sides of the Personal Life Support System (PLSS) 'backpack' while the tank and avionics suite is mounted beneath the PLSS to minimize any encumbrance to the EVA crewperson. The avionics suite provides flight control capability with a 'hand controller' as the EVA crewperson interface device for nulling out tumble and for control of yaw and pitch. A battery provides power to the avionics and heaters are provided for temperature control of the avionics suite, hand controller, and tankage assembly. The modularity of the SAFR design allows for installation on either the NSTS or SS Freedom EMU's.

FUNCTIONAL DESCRIPTION

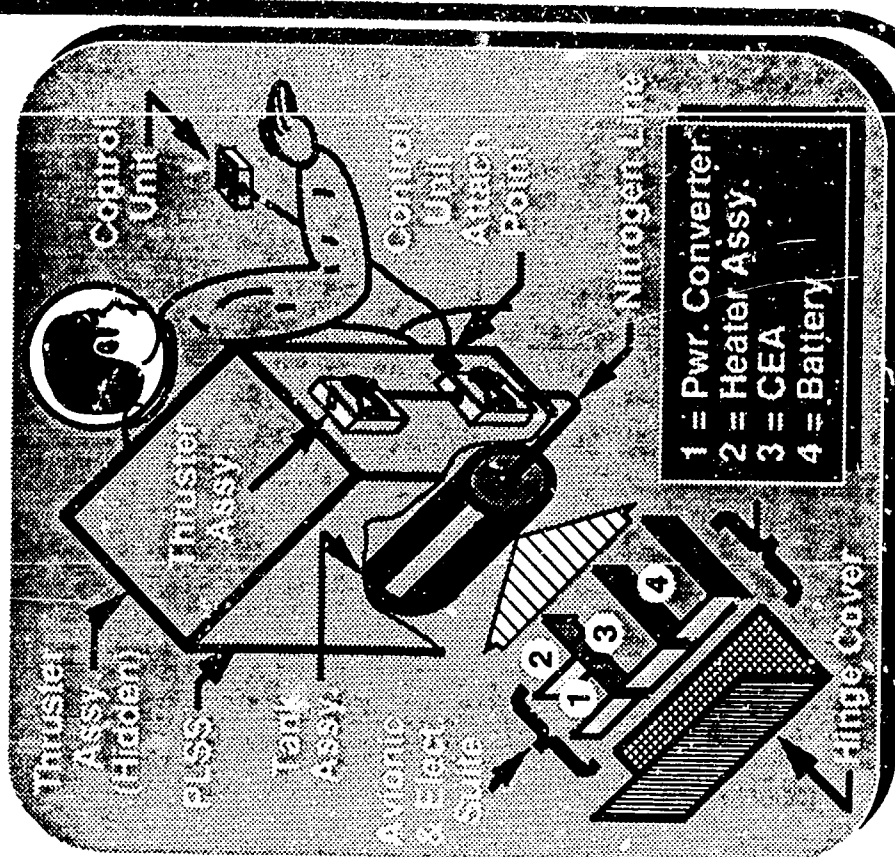
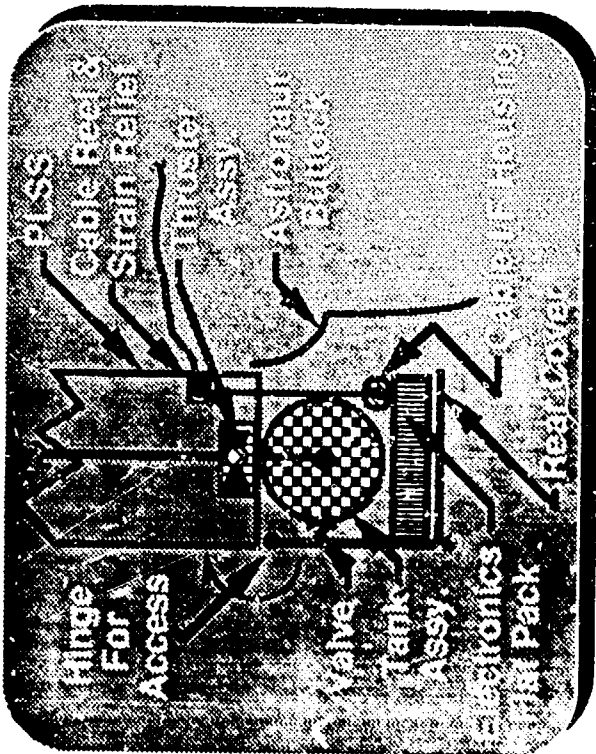

- Propulsive Approach
- Multi-Thrusters
- Min. Control System
- Min. Encumbrance
- Self Contained / Modular
- Light Wt. & Min. Volume
- Nitrogen Propellant

OPERATIONAL DESCRIPTION

The SAFR concept is, simply stated, a 'lifevest' used for the emergency return of an adrift EVA crewperson to the orbiting element from which he or she became detached. As such, it is a minimum system with no frills and is in no way intended as a replacement for the much more versatile and capable Manned Maneuvering Unit (MMU). Should the EVA crewperson become detached from an orbital element (e.g., SS Freedom) the initial task would be to null the tumble or spin via an automatic mode built into the avionics. The EVA crewperson would then use the hand-controller to slowly yaw or pitch him or herself to a position wherein the orbital element is within their view by use of nitrogen fueled propulsive capability. The individual then translates via line-of-sight (LOS) at a slow rate, e.g., less than 5"/sec., and, if necessary, makes a final adjustment burn prior to final 'soft contact' with the orbital element. The SAFR is pre-checked out in the airlock, and is serviced therein as required, including nitrogen gas resupply if needed. The thrusters are positioned and configured such that if a particular nozzle valve or regulator fails, there is only a 'graceful degradation' to the system and sufficient capability exists for a degraded mode return. This SAFR currently is being designed for a conscious and system participative EVA crewperson, although future studies may examine an autonomous return mode for a potentially disabled individual. SAFR is planned for use on either the NSTS or SS Freedom EMU's and, therefore, can be operated out of the Shuttle or SS Freedom airlocks.

OPERATIONAL DESCRIPTION

- 3 Axis Single Mode Ops
- Line-Of-Sight Pointing
- Range ~ 1000 Ft.
- Tumble Null - Auto Mode
- Laser Gyro Stabilization
- Use - NTS / SSE, EMU's
- Conscious Crewperson
- Airlock C/O & Service
- Hand Controller Ops
- Multi-Thrust Utilization

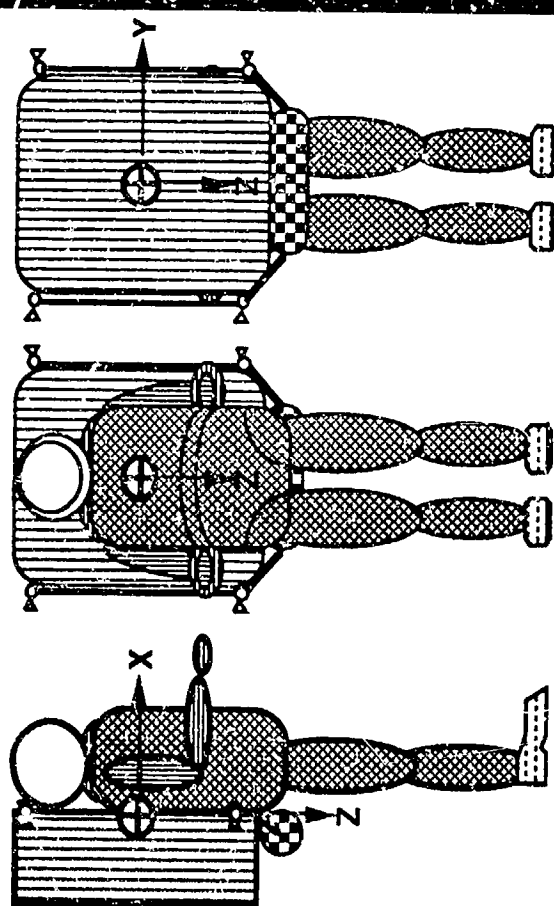

I/F'S WITH OTHER SUBSYSTEMS / ELEMENTS

The facing page indicates the major interfaces the SAFR system will have with presently defined orbiting elements, e.g., SS Freedom or the NSTS. As shown, SAFR interfaces to the EMU in 7 locations relative to attachment. An option is an I/F with the EMU comm in the event that autonomous operations might be achievable. The attachments are designed to be modularly and multi-positionable to assure flexibility in attachment to the EMU. When used with the SS Freedom over the duration of the program, it is planned to provide simple C/O and servicing of the SAFR within the airlock and to use the planned EMU checkout and servicing equipment system for that function. Nitrogen will be acquired from the indigenous SS Freedom supply for tank refill as required. The SAFR design is purposely compact to assure minimum protuberances and envelope profile to preclude any encumbrance when egressing or ingressing from or to the Airlock, or when conducting any EVA task.

I/F'S WITH OTHER SUBSYSTEMS / ELEMENTS

EXTRAVEHICULAR MOBILITY UNITS

- NSTS EMU
- SS Freedom EMU

- Personal Life Support Sys
 - Δ Structure - 7 Locations
 - Thrusters - 4 I/F's
 - Avionics - 2 I/F's
 - Hand Controller - 1 I/F
 - Δ Comm (Option)
 - EMU Radio - 1 I/F

AIRLOCKS

- NSTS - Space Shuttle
- Space Station Freedom

- Hatch Pass-Through
- Nitrogen Supply
- CASES
 - Δ Sys Checkout
 - Δ Battery Recharge
 - Δ Comm Link Check
 - Δ Gyro Initialization
 - Δ Nitrogen Pressure C/O
 - Δ Fault Isolation - Mafnt.

SAFR CHARACTERISTICS

The facing page presents a simplified list of the basic system hardware for SAFR. As evidenced by the short list, the system is, from program on-set, planned to be a minimum capability, simple approach, based on evolution of technology (MMU) already successfully flown on the Orbiter. This approach is specifically directed to minimizing any Crew skills required to operate the system and to reduce ground simulation to a bare minimum. The current design goal relative to total mass is ~ 45 lbs (dry weight). A weight of 4.5 lbs. is being carried as a management contingency reserve at this time. Where possible existing hardware and technology will be used. Areas wherein new or 'leading edge' technology may be examined include, but are not limited to: (1) Batteries; (2) Tanks, and (3) Small gyros and accelerometers. The currently identified major driver appears to be power (avionics, heater needs, and thruster operations). Thus, the desire to closely examine the current battery technology state-of-the-art.

SAFR CHARACTERISTICS

HARDWARE	QUAN.
1. Thruster Assy.	4
2. GN 2 Tank	1
3. Pressure Regulator	1
4. Toggle Valve	1
5. Isolation Valve	1
6. Quick Disconnect	1
7. Pressure Gauge	1
8. Heater Strips	6
9. Prop. Lines/Fittings	4
10. Battery	1
11. Rate Gyro Cluster	1
12. Control Electronics Assy.	1
13. Power Converter	1
14. Housing	1
15. Cables & Attach Fittings	Misc.
16. Protective Cover	1
17. Hand Controller Unit	1

MASS (Lbs.)

- Design Goal = 45
- Management Contingency = 4.5

Total 49.5

POTENTIAL RESOURCE REQUIREMENTS

The facing page presents the current approach relative to the development of SAFR. Presently, consideration is being given to the possibility of a Shuttle flown precursor experiment which would employ a SAFR protoflight unit. Such a flight would permit the evaluation of the SAFR approach, and perhaps simultaneous comparison with the GEMINI era hand-held maneuvering unit. This approach would permit early examination and assessment of the SAFR concept and associated technology. Current resource requirements are portrayed on the opposite page and indicate the very low cost profile envisioned for the program. By keeping the system very simple (no bells and whistles), such an effort as this may be feasible in the current severe economic environment, yet provide a very real need to support crew safety.

POTENTIAL RESOURCE REQUIREMENTS

CURRENT PHILOSOPHY

- Complete Part II Conceptual Design Study For NASA
- Consider Pre-Cursor Shuttle Flight Demonstration
- Implement SAFR For SS Freedom
 - △ Develop For Initial SS Freedom Build-Up (Employ On NSTS EMU)
 - △ Modularly Change Over To SS Freedom EMU For Ops

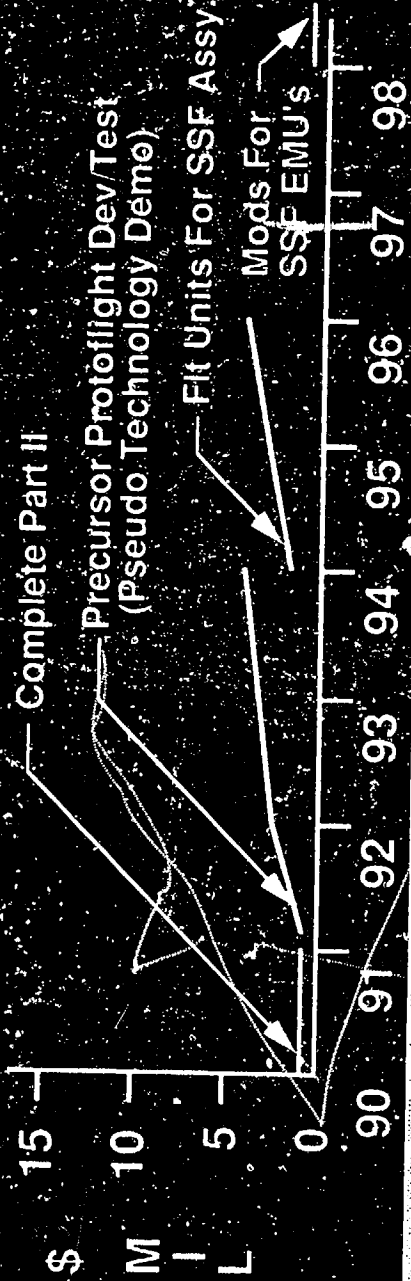

LOGISTICS, REPAIR & RESUPPLY

The SAFR system has, purposely, been designed as a very simple hardware element. As such, servicing, repair and logistics has been, from the beginning, as a minimum support need. The basic SAFR hardware (3shipsets) is planned for launch via the NSTS for initial supply to the SS Freedom. Since the avionics suite, thruster assemblies are modular, some on-orbit servicing is quite feasible using the 3rd shipset item as both a backup unit and as a 'real-time' spare. Should any subsystem element of SAFR need replacement on-orbit via logistics resupply, the weight and volume would be very low. Maintenance or repair of SAFR can be accomplished easily at the SS Freedom Maintenance Work Station once the tank had been removed or nitrogen externally vented while in the Airlock. The Airlock also serves as a SS Freedom candidate facility for nitrogen resupply although some question remains as to the final selected pressure.

LOGISTICS, REPAIR & RESUPPLY

LOGISTICS

- Initial Launch - 3 Units
- Earth Return As Req'd.

REPAIR

- C/O At Airlock CASES
- Repair At Maint. Wk. Sta.

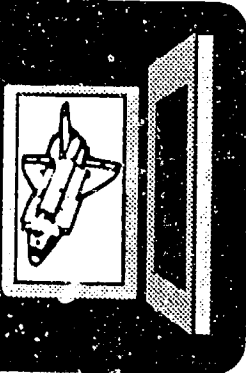

RESUPPLY

- Nitrogen - Pressure At 3000 To 5000 PSIA - TBD

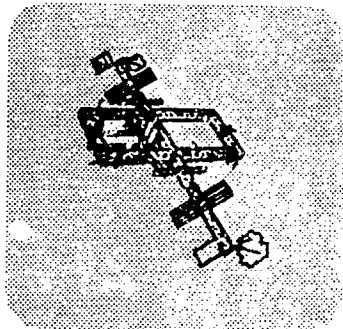

POTENTIAL PERFORMANCE IMPROVEMENTS

The facing page indicates that a crew aid such as SAFR with its explicit objective (EVA crew rescue) has not been previously developed. However, it is patently obvious that the MMU could very readily perform that function as part of its extensive capability. Historically, the Gemini era Hand-Held Maneuvering Unit comes to mind relative to an EVA device used a few times for examining man's capability for maneuvering on-orbit although the astronaut was tethered. For purposes of comparison with the HHMU, the potential enhancements brought about by the SAFR concept are indicated on the opposite page. These enhancements, therefore, could be considered technology upgrades. However, the HHMU still remains a potential candidate for the rescue function until such time that it is decided that its operation may be too complex, that consummate skill level requirements may be excessive, and/or that training/simulation investments are too great.

POTENTIAL PERFORMANCE IMPROVEMENTS

An Aid Such As SAFR Has Not Been Specifically Developed Before. However, The Manned Maneuvering Unit Certainly Could Play Such A Role, And Perhaps The Gemini Era Hand Held Maneuvering Unit(HHMU) Could Be Used For This Task. SAFR Is Not Intended To Replace The MMU. Thus, Potential Performance Enhancement Over The HHMU Would Be:

Increased Range

Simplified Operations

Much Lesser Training & Simulation

Increased Control Performance

Multi-Uses Prior To Refurbishment.

Modularity

On-Orbit Servicing

Graceful Failure Degradation.

AUTOMATION IMPACT

The current elements of the SS Freedom automation program are not yet, at least to the author, fully clear. Accordingly, to define the specific automation impacts on SAFR is difficult at this time. However, the facing page indicates typical impacts if, for example, EVA were eliminated from the program or conducted only at certain times then, obviously SAFR need not be implemented. The premise being that EVA had been eliminated or conducted only at a time when some other rescue technique were available. Also shown on the chart are alternatives to SAFR. These have been assessed resulting in the autonomous S/C (CERS) concept leading the alternatives (and other less viable candidates) based on its extensive capability for conducting both the rescue and retrieval mission, and particularly since it is berthed to the SS Freedom at all times. However, until a reasonably complete snapshot is available of the overall autonomy program, impacts on SAFR and CERS are unclear. Further, with the low DDT&E outlay, rapid implementation schedule potential for the SAFR, and its basic transparency, it remains a very viable method for EVA crew rescue. Finally, it is not envisioned that automation will totally eliminate the need for EVA particularly in SS Freedom assembly, for certain EV contingencies, nor for complex one-of-a-kind extravehicular functions.

AUTOMATION IMPACT

Rescue Alternatives

Automation Impact Implications include:

EVA Alternatives

Utilize Shuttle When Able/Avial.

No EVA Conduct For SS Freedom

Potential Employment Of OTV + Robotics

EVA Only When Shuttle Present

Possible Use Of MRMS

EVA Only When OTV + Robotics Present

Use Of Autonomous S/C - E.G. CERS

EVA Only When ACRV Present

SAFR Is 'Transparent' & Low Cost

SUMMARY & CONCLUSIONS

1. A Simplified Aid For Rescue (SAFR) Has Been Described & Operations/Functions Presented
2. SAFR's Use Is Essentially That Of A 'Life Jacket'

- A. SAFR Represents No Technology Risk
- B. 'Cutting Edge' Technology Can Be Used
- C. SAFR Is A Low Cost Technology Development Item With Future Spin-Offs.
- D. SAFR is A Multi-Program Applicable Technology
- E. SAFR Addresses A Major NASA Thrust - Crew Safety



Lyndon B. Johnson Space Center



EVOLVING TECHNOLOGIES FOR SPACE STATION
FREEDOM COMPUTER-BASED WORKSTATIONS

MAN-SYSTEMS DIVISION

J. LEWIS, Ph.D. January 16, 1990

TECHNOLOGY FOR SPACE STATION EVOLUTION - A WORKSHOP

EVOLVING TECHNOLOGIES FOR SPACE STATION FREEDOM COMPUTER-BASED WORKSTATIONS

Dean G. Jensen, Ph. D.
Marianne Rudisill, Ph. D.
NASA, Johnson Space Center

58-54
163622
93-27794
p. 15



Lyndon B. Johnson Space Center



**EVOLVING TECHNOLOGIES FOR SPACE STATION
FREEDOM COMPUTER-BASED WORKSTATIONS**

MAN-SYSTEMS DIVISION

J. LEWIS, Ph.D. January 16, 1990

CONTENTS

EVOLVING TECHNOLOGIES FOR SPACE STATION FREEDOM COMPUTER-BASED WORKSTATIONS

- **INTRODUCTION**
 - **HUMAN-COMPUTER INTERFACE**
 - **CREW COMPUTER INPUTS**
 - **COMPUTER DISPLAY FORMAT AND CONTENT WORKSTATIONS**
 - **DISTRIBUTED SYSTEM**
 - **CONTROL FOR SYSTEMS/ROBOTS/FREE FLYERS**
- **CURRENT ACTIVITIES AND EVOLVING TECHNOLOGIES**



Lyndon B. Johnson Space Center



**EVOLVING TECHNOLOGIES FOR SPACE STATION
FREEDOM COMPUTER-BASED WORKSTATIONS**

MAN-SYSTEMS DIVISION

J. LEWIS, Ph.D.

January 16, 1990

INTRODUCTION

THE HCI SOFTWARE ENVIRONMENT HAS THE FOLLOWING SEVEN MODULES

- **WINDOW MANAGER**
Provides and controls on-screen windows
- **USER INTERFACE MANAGEMENT SYSTEM**
Provides dialog, help and information, and error message management
- **CONTROL AND MONITOR DISPLAY MANAGER**
Provides the capability to define and build dynamic displays and store them in Data Definition Files (DDF), and provides the runtime environment to link dynamic displays with operational data and commands
- **USER INTERFACE LANGUAGE MANAGER**
Generates and executes User Interface Language commands and procedures
- **CAUTION AND WARNING ANNUNCIATION MANAGER**
Displays caution and warning events and messages and accepts crewmember acknowledgements
- **VIDEO DISPLAY MANAGER**
Routes and displays video images intermixed with text and graphics
- **USER SUPPORT ENVIRONMENT SESSION MANAGER**
Provides initialization, user login authorization and encryption, security logging, user profile management, and word processing



Lyndon B. Johnson Space Center



EVOLVING TECHNOLOGIES FOR SPACE STATION FREEDOM COMPUTER-BASED WORKSTATIONS

MAN-SYSTEMS DIVISION

J. LEWIS, Ph.D.

January 16, 1990

INTRODUCTION

WORKSTATION LOCATIONS

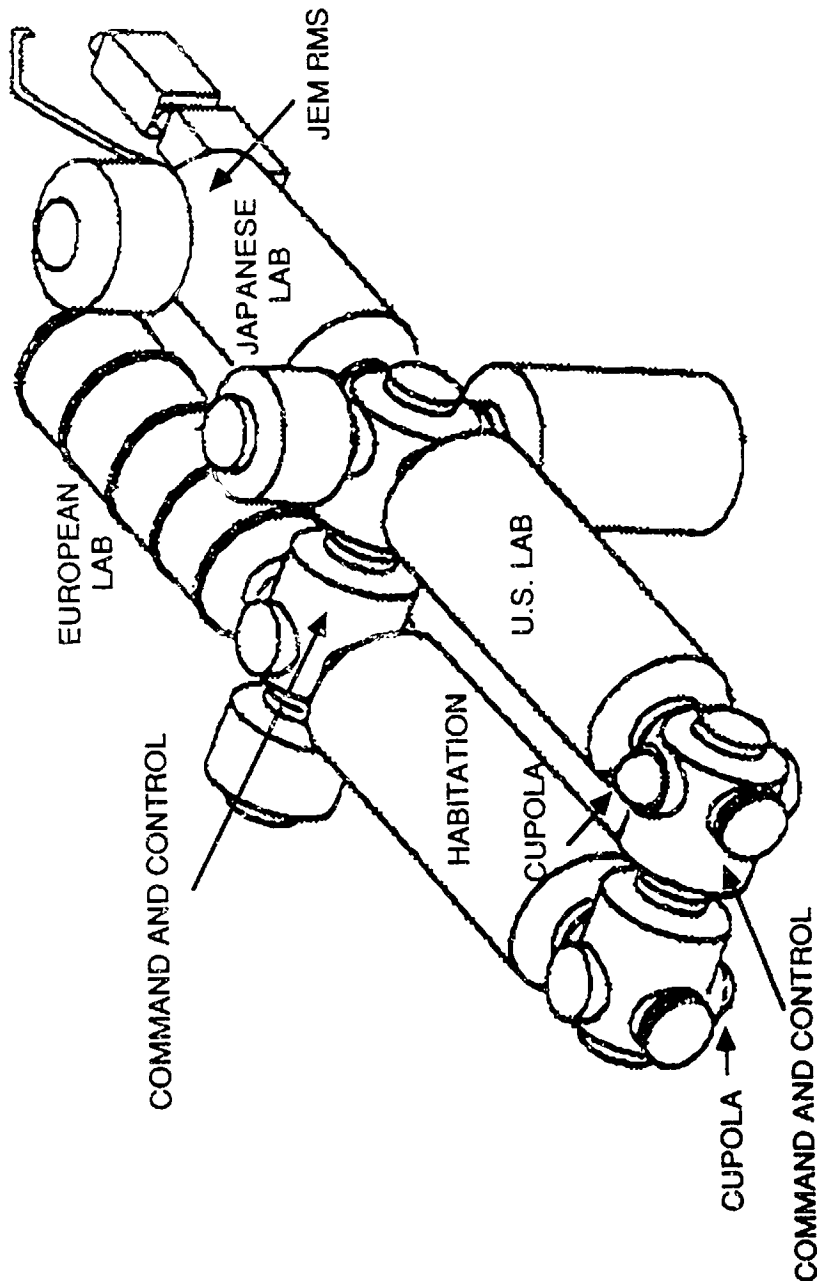



Lyrdon B. Johnson Space Center



EVOLVING TECHNOLOGIES FOR SPACE STATION
FREEDOM COMPUTER-BASED WORKSTATIONS

MAN-SYSTEMS DIVISION

J. LEWIS, Ph.D.

January 16, 1990

INTRODUCTION

COMMAND AND CONTROL WORKSTATION CONCEPT

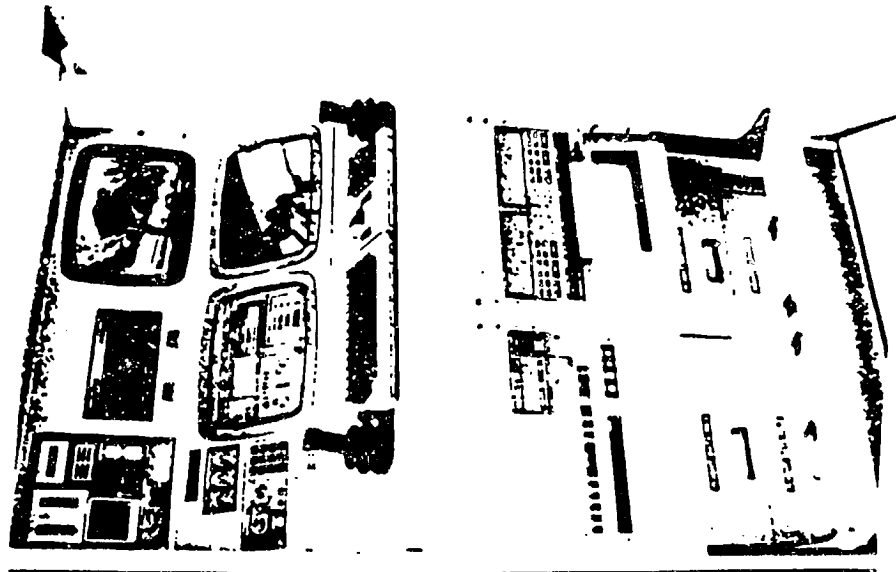

Features

- Three 15" Displays
- Full Keyboard
- Trackball
- Hand Controllers
- Audio/Video Recorders
- Hard-Copy Printer/Plotter
- Safety-Critical D&C
- Lighting
- Crew Restraints

Functions

- Systems Management
- Customer Support
- Proximity Operations
- Telerobotic (MSS,FTS) Control
- External Operations Support



Lyndon B. Johnson Space Center



EVOLVING TECHNOLOGIES FOR SPACE STATION
FREEDOM COMPUTER-BASED WORKSTATIONS

MAN-SYSTEMS DIVISION

J. LEWIS, Ph.D. January 16, 1990

INTRODUCTION

CUPOLA WORKSTATION CONCEPT

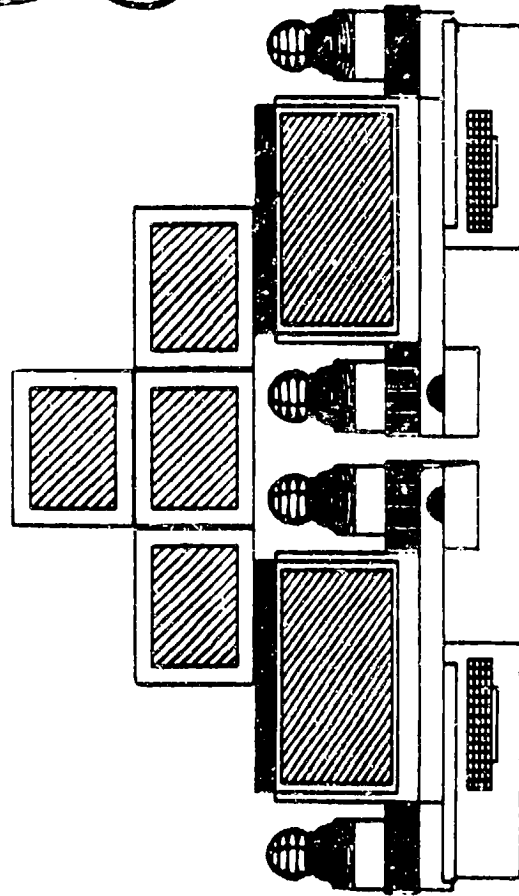
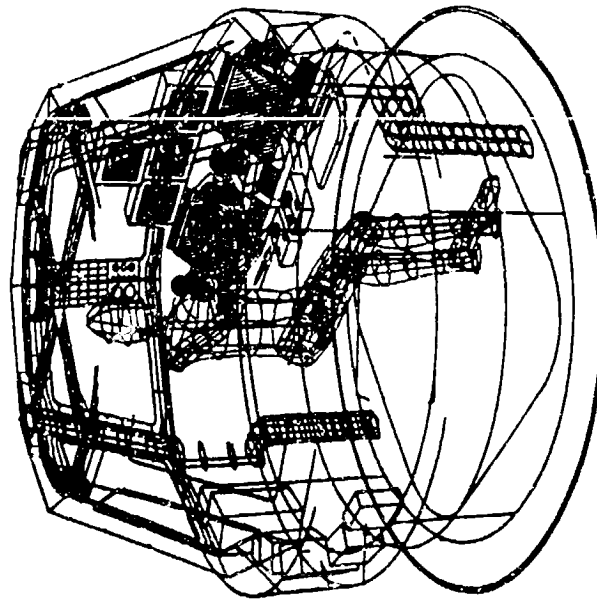



Lyndon B. Johnson Space Center

**EVOLVING TECHNOLOGIES FOR SPACE STATION
FREEDOM COMPUTER-BASED WORKSTATIONS**

MAN-SYSTEMS DIVISION

J. LEWIS, Ph.D. January 16, 1990

INTRODUCTION JAPANESE EXPERIMENT MODULE RMS WORKSTATION CONCEPT

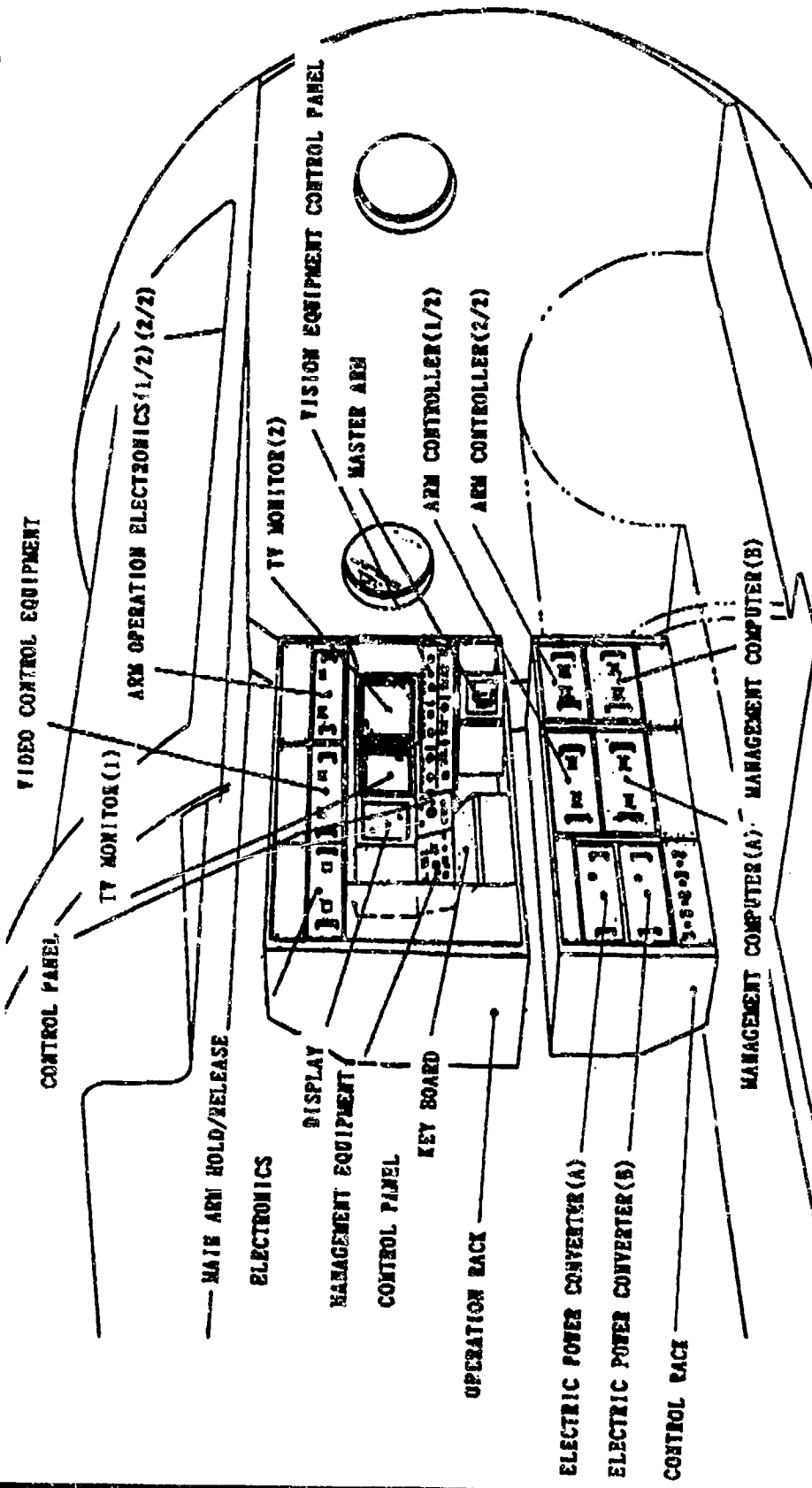



Lyndon B. Johnson Space Center



EVOLVING TECHNOLOGIES FOR SPACE STATION
FREEDOM COMPUTER-BASED WORKSTATIONS

MAN-SYSTEMS DIVISION

J. LEWIS, Ph.D.

January 16, 1990

INTRODUCTION

REMOTE DEVICES CONTROLLED FROM WORKSTATIONS

FREE FLYERS

- EUROPEAN SPACE AGENCY MAN-TENDED FREE FLYER
- CREW AND EQUIPMENT RETRIEVAL SYSTEM
- ORBITAL MANEUVERING VEHICLE

LARGE MANIPULATORS

- SPACE STATION REMOTE MANIPULATOR SYSTEM (RMS)
- JAPANESE EXPERIMENT MODULE RMS

DEXTEROUS MANIPULATORS

- JAPANESE SMALL FINE ARM
- FLIGHT TELEROBOTIC SERVICER
- SPECIAL PURPOSE DEXTEROUS MANIPULATOR



Lyndon B. Johnson Space Center



**EVOLVING TECHNOLOGIES FOR SPACE STATION
FREEDOM COMPUTER-BASED WORKSTATIONS**

MAN-SYSTEMS DIVISION

J. LEWIS, Ph.D.

January 16, 1990

INTRODUCTION

ORBITAL MANEUVERING VEHICLE FREE FLYER

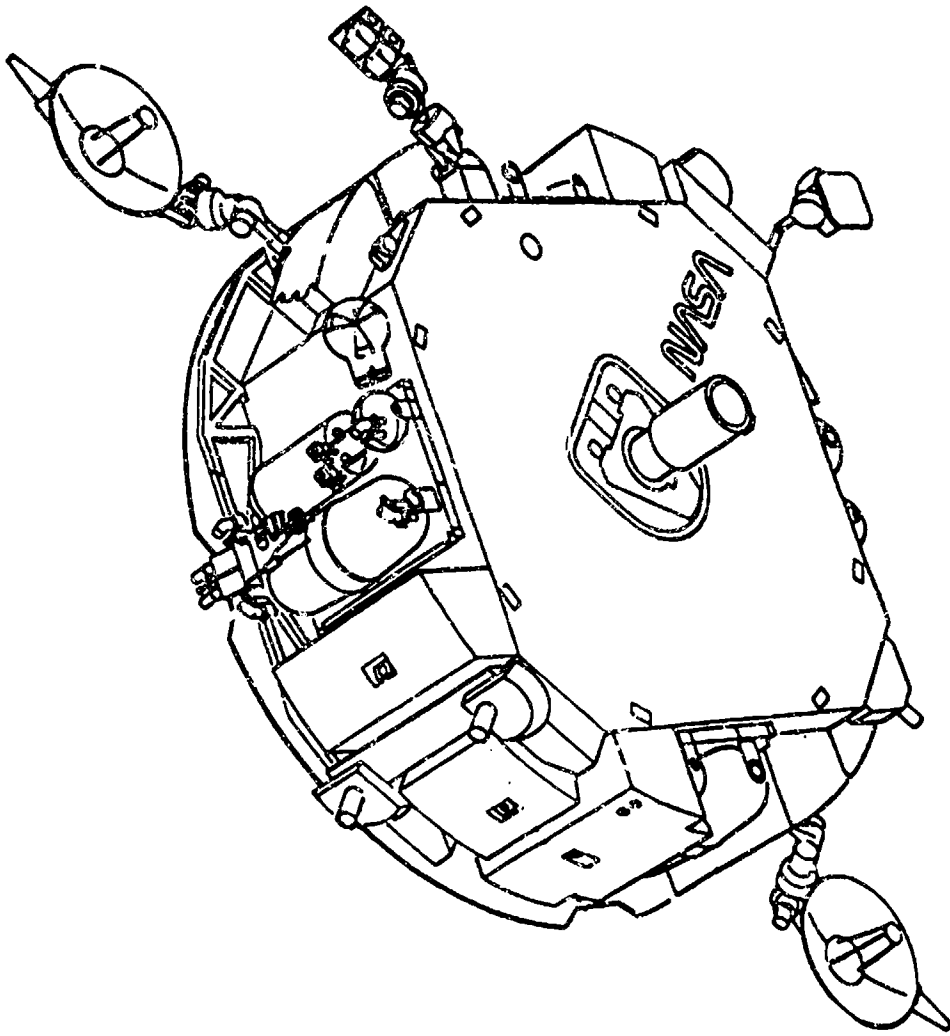



Lyndon B. Johnson Space Center



**EVOLVING TECHNOLOGIES FOR SPACE STATION
FREEDOM COMPUTER-BASED WORKSTATIONS**

MAN-SYSTEMS DIVISION

J. LEWIS, Ph.D. January 16, 1990

INTRODUCTION

REMOTE MANIPULATOR SYSTEM

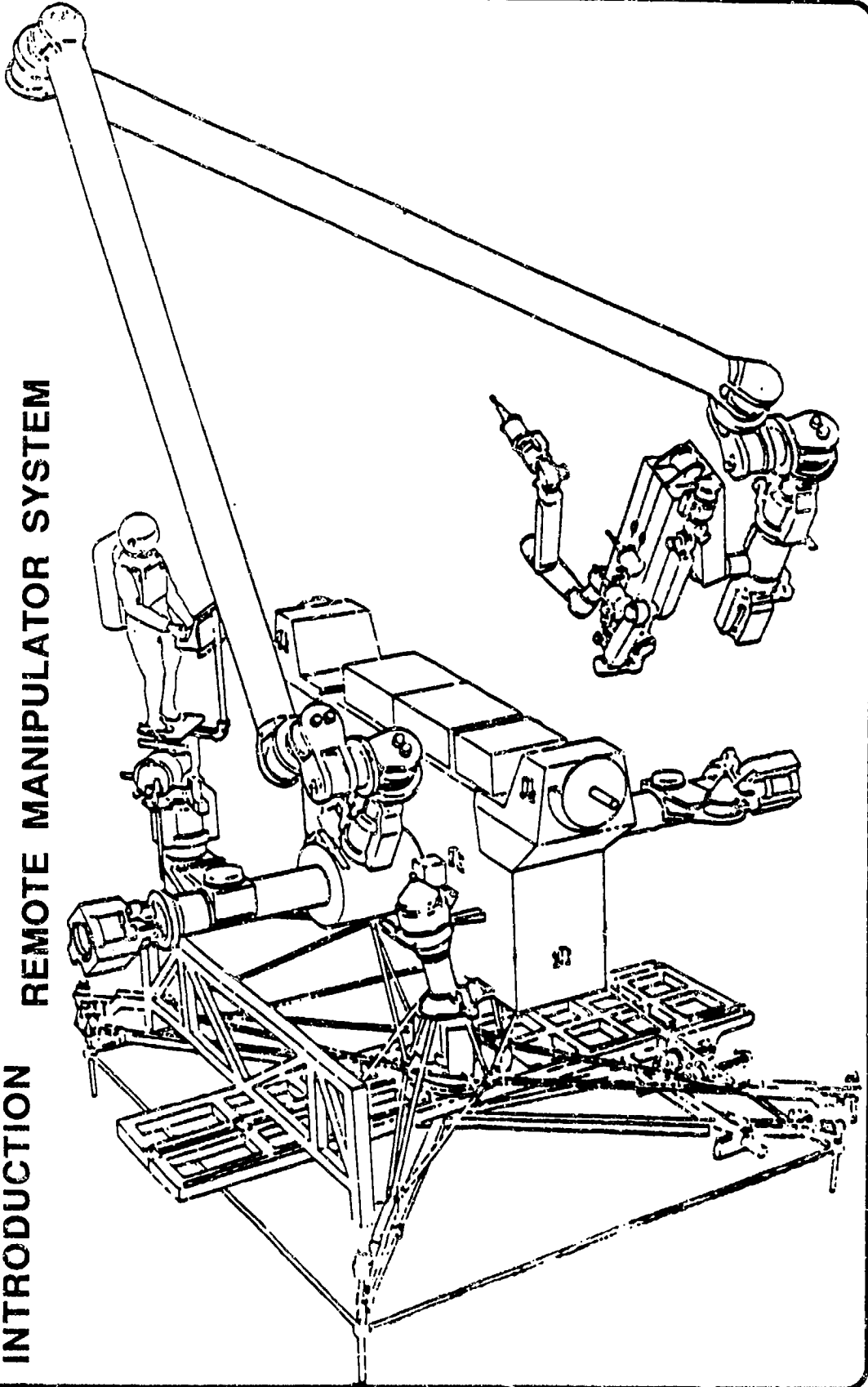



Lyndon B. Johnson Space Center



**EVOLVING TECHNOLOGIES FOR SPACE STATION
FREEDOM COMPUTER-BASED WORKSTATIONS**

MAN-SYSTEMS DIVISION

J. LEWIS, Ph.D.

January 16, 1990

INTRODUCTION JAPANESE EXPERIMENT MODULE EXPOSED FACILITY

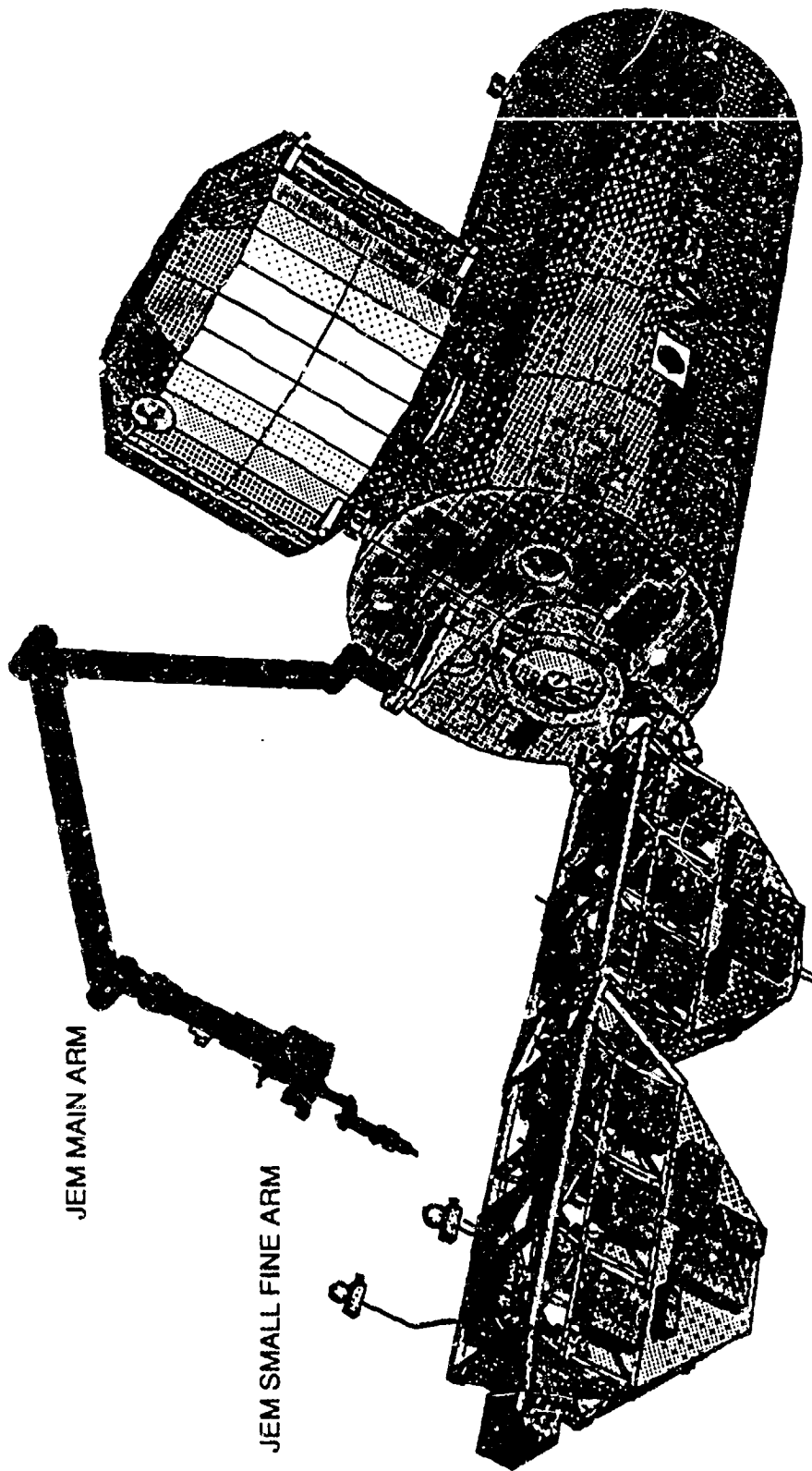

JEM MAIN ARM

JEM SMALL FINE ARM



Lynndon B. Johnson Space Center

EVOLVING TECHNOLOGIES FOR SPACE STATION
FREEDOM COMPUTER-BASED WORKSTATIONS

MAN-SYSTEMS DIVISION

J. LEWIS, Ph.D. January 16, 1990

INTRODUCTION JAPANESE EXPERIMENT MODULE SMALL FINE ARM

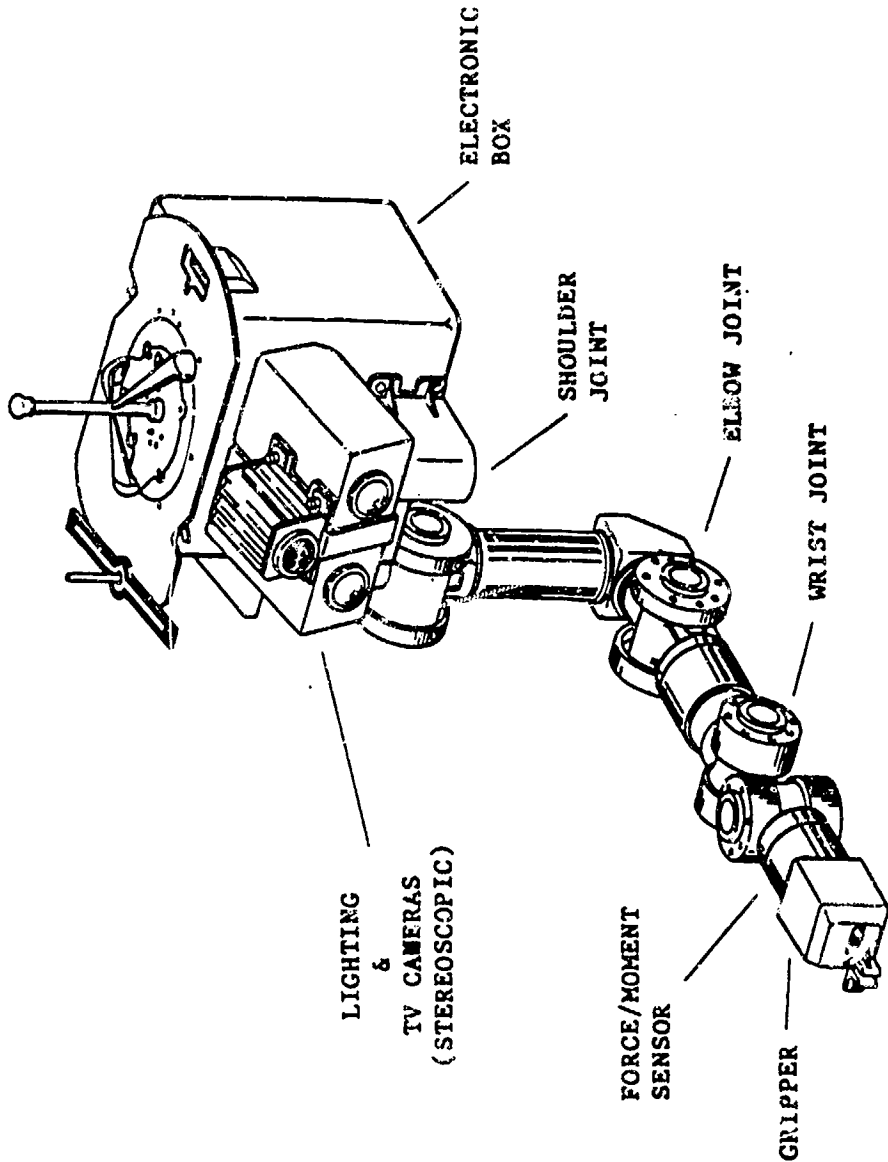



Lyndon B. Johnson Space Center

**EVOLVING TECHNOLOGIES FOR SPACE STATION
FREEDOM COMPUTER-BASED WORKSTATIONS**

MAN-SYSTEMS DIVISION

J. LEWIS, Ph.D.

January 16, 1990

INTRODUCTION

FLIGHT TELEROBOTIC SERVICER

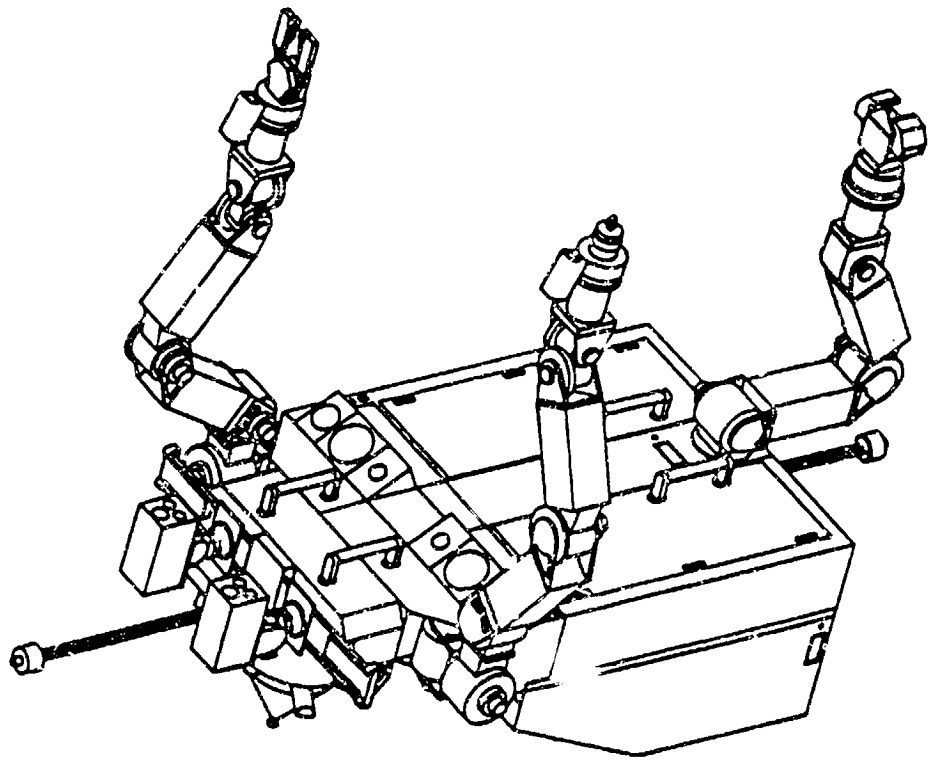



Lyndon B. Johnson Space Center



**EVOLVING TECHNOLOGIES FOR SPACE STATION
FREEDOM COMPUTER-BASED WORKSTATIONS**

MAN-SYSTEMS DIVISION

J. LEWIS, Ph.D.

January 16, 1990

EVOLVING TECHNOLOGIES

HUMAN-COMPUTER INTERACTION

VOICE RECOGNITION AND PRODUCTION

- FACILITATE "HANDS-FULL" TASKS
(CAMERA CONTROL DURING TELEROBOTIC MANIPULATIONS)

DIRECT MANIPULATION

- TOUCH SCREENS
- 3-D DISPLAY MANIPULATION
- ZERO-G CURSOR CONTROL DEVICES

ENHANCED INFORMATION DISPLAY

- 3-D COMPUTER-ENHANCED IMAGES
- VIDEO MANIPULATION (OBJECT ENHANCEMENT & TRACKING)
- VIDEO WITH TEXT AND GRAPHICS OVERLAYS
- VIDEO STEREO VIEWING TECHNIQUES
- MULTI-TASKING MANAGEMENT

SOFTWARE AUTOMATION

**KNOWLEDGE-BASED OR INTELLIGENT SYSTEMS
USER MODELING METHODS AND TOOLS
HCI PROTOTYPING TECHNOLOGY**



Lyndon B. Johnson Space Center



**EVOLVING TECHNOLOGIES FOR SPACE STATION
FREEDOM COMPUTER-BASED WORKSTATIONS**

MAN-SYSTEMS DIVISION

J. LEWIS, Ph.D.

January 16, 1990

EVOLVING TECHNOLOGIES

WORKSTATION/ROBOTICS RELATED ACTIVITIES

VIRTUAL WORKSTATIONS

MACHINE VISION SYSTEMS

- OPTICAL SYSTEMS - e.g. TRACKING - EARTH'S RAD. BUDGET SAT.
- LASER SYSTEMS - e.g. MODEL-BASED SYSTEMS FOR RECOGNITION
- SUPERVISED AND AUTONOMOUS MODES
- PROVIDING OPERATOR AIDS (e.g. RANGE / RATE)
- EDGE DETECTION

ANIMATION

- REPRESENT RANGE/RATE INFORMATION
- PRODUCE "SYNTHETIC" VIDEO VIEWS (FROM CDA DATABASE)

FORCE REFLECTION (HAND CONTROLLER)

SYNTHESIZED FORCE REFLECTION

- AUDIO
- VISUAL

TECHNOLOGY FOR SPACE STATION EVOLUTION
A WORKSHOP

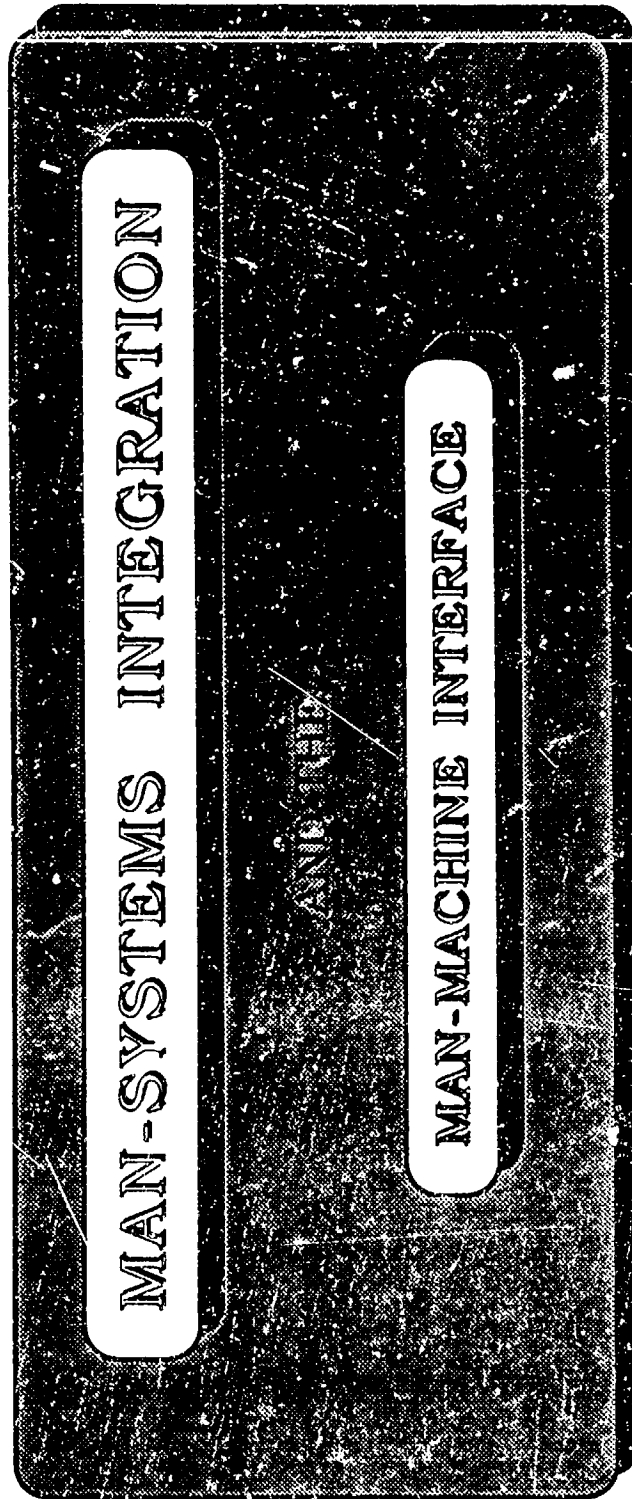

JOSEPH P. HALE
NASA
MARSHALL SPACE FLIGHT CENTER

59-54
N93-27795
163625
p-12

Man-Systems Integration applies the systems' approach to the integration of the user and the "machine" to form an effective, symbiotic Man-Machine System (MMS). A MMS is a combination of one or more human beings and one or more physical components that are integrated through the common purpose of achieving some objective. In this concept, the human is considered a component or subsystem of the larger system. These components interact within the system environment to bring about, from given inputs, some desired output. The human operator interacts with the system through the Man-Machine Interface (MMI). The operator must sense, or perceive, the state of the system and environment; then process that information, make a decision, and select a response; before inputting that response into the system. The perception and response components are accomplished through the MMI. Proper attention to the MMI can facilitate the information processing, decision-making, and response selection components, thus enhancing total system performance.

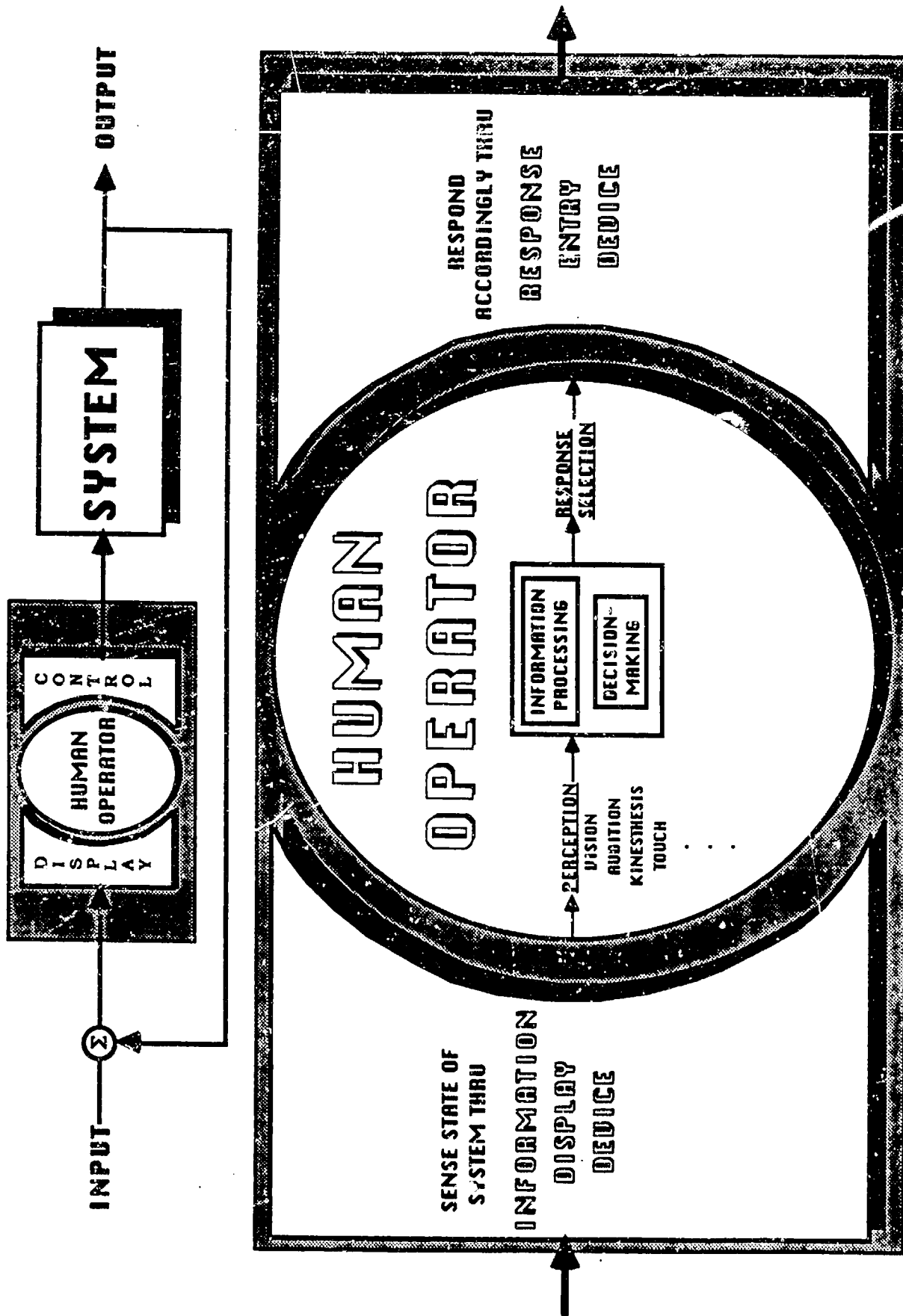

**THE
HUMAN OPERATOR**

**CONDUCTS/
EXECUTES**



DATA/INFORMATION MANAGEMENT

- ACQUISITION
- RETRIEVAL
- PROCESSING
- STORAGE
- DISPLAY

**COMMANDS AND CONTROLS
TROUBLESHOOTING/FAULT DIAGNOSIS
TELEOPERATION**

**TO PERFORM/
UNDERTAKE**



**SPACE STATION OPERATIONS
PAYLOAD OPERATIONS
CREW SUPPORT & HEALTH MAINTENANCE
PROXIMITY OPERATIONS
MAINTENANCE/SERVICING OPERATIONS
ON-BOARD PROFICIENCY/REFRESHER TRAINING**

VIA

THE MAN-MACHINE INTERFACE (MMI)



MMI INTERFACES INCLUDE

ELECTRICAL POWER SYSTEM
THERMAL CONTROL SYSTEM
DATA MANAGERMENT SYSTEM
COMMUNICATIONS & TRACKING
ECLSS
MAN/SYSTEMS

**THE REMAINDER OF THIS PRESENTATION WILL
FOCUS ON SELECTED MMI TECHNOLOGY
REQUIREMENTS FOR:**

**DATA/INFORMATION
DISPLAY**

TELEOPERATION

DATA/INFORMATION DISPLAY

EMPHASIS IS ON
ACTIVITIES AND
OPERATIONS WHERE:

-DATA/INFORMATION MUST BE
-READILY ACCESSIBLE
-FREQUENTLY CONSULTED

-OTHER FACTORS CONSTRAIN:
-WEIGHT
-VOLUME
-"PORTABILITY"
-RECONFIGURATION

EXAMPLES:

-IN SITU MAINTENANCE/SERVICING OPERATIONS
-PROXIMITY OPERATIONS (CUPOLA)

DATA/INFORMATION DISPLAY

PRESENT MONITORS

<u>FLAT PANEL</u>	<u>MASS</u>	<u>VOLUME (WxHxD)</u>	<u>POWER</u>	<u>PORTABLE(2)</u>	<u>COUNT</u>	<u>CUPOLA(2)</u>
15"	<20lbs.	13"H10"H5"	<150W	0H2	2H2	
9"	<15lbs.	7.2"H5.4"H5"	<75W	1H2	4H2	

REQUIRED PHYSICAL IMPROVEMENTS

- LIGHTER
- SMALLER
- MORE "PORTABILITY"
(PORTABLE WORKSTATION)
- MORE EASILY RECONFIGURED
(CUPOLA)

WEARABLE

DATA/INFORMATION DISPLAY

CURRENTLY UNDER EVALUATION:

"PRIVATE EYE"
 <2 OZ.
 1.1"H1.2"H3.2"
 0.5'W at 5 VOLTS
 720x280 PIXELS
 MONOCHROME
 STATIC DISPLAYS

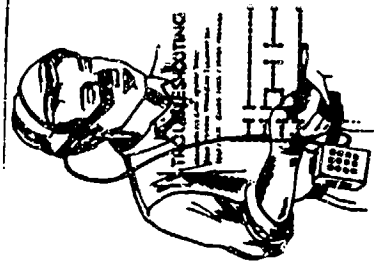
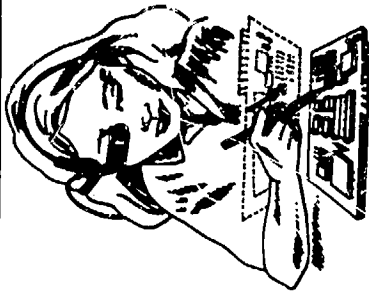

REQUIRED PERFORMANCE IMPROVEMENTS

**GREATER RESOLUTION
 COLOR
 DYNAMIC/VIDEO DISPLAYS**

TELEOPERATION

THE HUMAN OPERATOR
REMOTELY OPERATES
TELEBOTIC ARM(S) AND
END EFFECTOR(S)

OTHER FACTORS CONSTRAIN

- WEIGHT
- VOLUME
- OPERATOR'S DYNAMIC
WORK ENVELOPE

EMPHASIS IS ON
ACTIVITIES AND
OPERATIONS WHERE:

PRESENT CONTROLS STILL UNDER STUDY

TELEOPERATION

REQUIRED IMPROVEMENTS

LIGHTER

SMALLER

REDUCED DYNAMIC WORK ENVELOPE

ENHANCED PERFORMANCE

-MORE "INTUITIVE" OPERATION

-ANTHROPOMORPHIC

TELEOPERATION

CURRENTLY UNDER EVALUATION:

"DATAGLOVE"³¹

SENSES HAND

GESTURE

POSITION

ORIENTATION

5 OZ.

HANDSIZE

WEARABLE

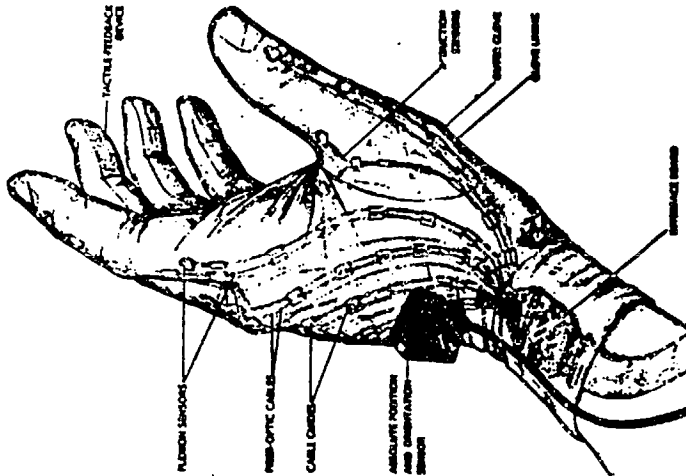

REQUIRED IMPROVEMENTS

FORCE-REFLECTIVE FEEDBACK

INCREASED RESOLUTION AND ACCURACY

**Work/Control Stations in Space Station
Weightlessness**

**Charles A. Willits
NASA/SSFPO**

**Technology for Space Station Evolution Workshop
January 16-19, 1990
Dallas, Texas**

CMIT

PAPER UNAVAILABLE AT TIME OF
PUBLICATION

**Human Interface Research to Support Evolution
Space Station**

**James O. Larimer
Ames Research Center**

**Technology for Space Station Evolution Workshop
January 16-19, 1990
Dallas, Texas**

omit

PAPER UNAVAILABLE AT TIME OF
PUBLICATION

Fluid Management System

Level III

Subsystem Presentation

omit

**FLUID MANAGEMENT SYSTEM (FMS)
FLUID SYSTEMS OVERVIEW**

**TECHNOLOGY FOR SPACE STATION
EVOLUTION - A WORKSHOP**

JANUARY 16

**R. S. BAIRD
PROPULSION AND POWER DIVISION
NASA JOHNSON SPACE CENTER**

510-18
163624
p. 23
N93-27796



AGENDA		Propulsion & Power Division
	R. S. Baird	1/16/90

FLUID MANAGEMENT SYSTEM DESCRIPTION

- SYSTEM REQUIREMENTS:
 - GENERAL REQUIREMENTS
 - INTEGRATED NITROGEN SYSTEM REQUIREMENTS
 - INTEGRATED WATER SYSTEM REQUIREMENTS
 - INTEGRATED WASTE GAS SYSTEM REQUIREMENTS
- PHYSICAL DESCRIPTION:
 - STATION OVERVIEW
 - INTERNAL TO PRESSURIZED VOLUME
 - EXTERNAL TO PRESSURIZED VOLUME
 - PRELIMINARY MASS AND POWER SUMMARY

FLUID MANAGEMENT SYSTEM EVOLUTION

- POTENTIAL EVOLUTION REQUIREMENTS
- EVOLUTION DESIGN ADAPTABILITY
- EVOLUTION TECHNOLOGY DEVELOPMENTAL NEEDS
- TECHNOLOGY WORK CURRENTLY IN PROGRAM
- EVOLUTION STUDY



FLUID MANAGEMENT SYSTEM GENERAL DESCRIPTION	Propulsion & Power Division
	R. S. Baird
	1/16/90

GENERAL REQUIREMENTS

- SUPPLY NITROGEN - INTEGRATED NITROGEN SYSTEM [INS]
- SUPPLY WATER - INTEGRATED WATER SYSTEM [IWS]
- WASTE GAS COLLECTION, STORAGE AND DISPOSAL
 - INTEGRATED WASTE GAS SYSTEM [IWGS]
- CONTROLLED VENTING COORDINATION
 - CONTROLLED VENTING SYSTEM [CVS]

ELEMENT UNIQUE HARDWARE DESIGN, DEVELOPMENT, AND CERTIFICATION

- MSFC: USL, HABITATION MODULE, AND LOGISTICS (PLUMBING AND RESUPPLY TANKER)
- JSC: TRUSS, NODES, AND DOCKING ADAPTERS (PLUMBING, PALLET, AND RACKS)



INTEGRATED NITROGEN SYSTEM DESCRIPTION	Propulsion & Power Division
	R. S. Baird 1/16/90

REQUIREMENTS:

- SUPPLY NITROGEN TO STATION USERS:
 - LAB EXPERIMENT GAS
 - SYSTEM PRESSURIZATION GAS
 - SYSTEM MAINTENANCE PURGE GAS
- PROVIDE ECLSS EMERGENCY ACCESS TO NITROGEN

IMPLEMENTATION:

- LOGISTIC TRANSPORT TO STATION IN SUPERCRITICAL FLUID STATE
- CENTRALIZED THERMAL CONDITIONING AND LOW PRESSURE (600 TO 800 PSIA) STORAGE ON THE FLUID MANAGEMENT AND DISTRIBUTION (FMAD) PALLET
- SUPPLY TO INTERNAL USERS IN "ON DEMAND", COMMON PRESSURE (200 PSIA) UTILITY BUS FORMAT
- SUPPLY TO EXTERNAL USERS IN "ON DEMAND" UTILITY FORMAT
- MANUAL INTERNAL CONNECTION TO ECLSS

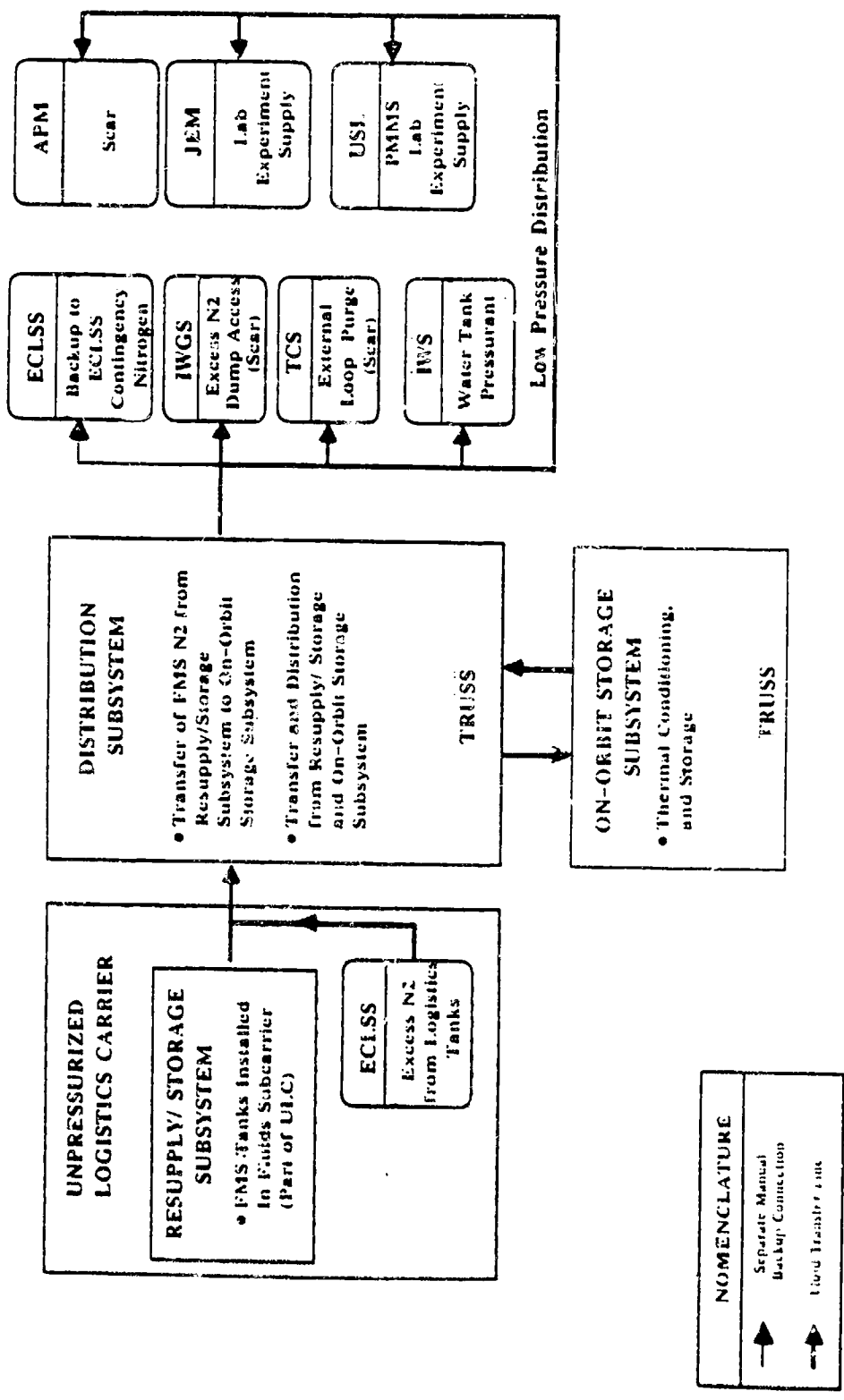

FIGURE 3-1: TOP-LEVEL PNIC/AC INS FUNCTIONAL SCHEMATIC



INTEGRATED WATER SYSTEM DESCRIPTION	Propulsion & Power Division
	R. S. Baird

1/16/90

REQUIREMENTS:

- SUPPLY WATER TO STATION LABORATORY EXPERIMENT USERS
- PROVIDE ECLSS DIRECT ACCESS TO SCAVENGED NSTS FUEL CELL WATER
- PROVIDE TEMPORARY STORAGE OF ECLSS EXCESS HYGIENE WATER TO SUPPORT SCHEDULED OVERBOARD DISPOSAL

IMPLEMENTATION:

- LABORATORY SUPPLY WATER SCAVENGED FROM NSTS FUEL CELLS
- SUPPLY TO LABORATORY USERS IN "ON-DEMAND", LOW PRESSURE (25 TO 30 PSIA) UTILITY BUS FORMAT
- SEPARATE STORAGE AND DISTRIBUTION OF FUEL CELL SOURCE AND HYGIENE SOURCE WATER
- INTERNAL STORAGE IN NODES 2 AND 3 (ONE RACK IN EACH)
- SCHEDULED OVERBOARD VENT OF HYGIENE SOURCE WATER FROM HABITATION MODULE AND USL AT PMC
- ECLSS PROVIDED PRIORITY ACCESS TO SCAVENGED NSTS FUEL CELL WATER

DISTRIBUTION SUBSYSTEM

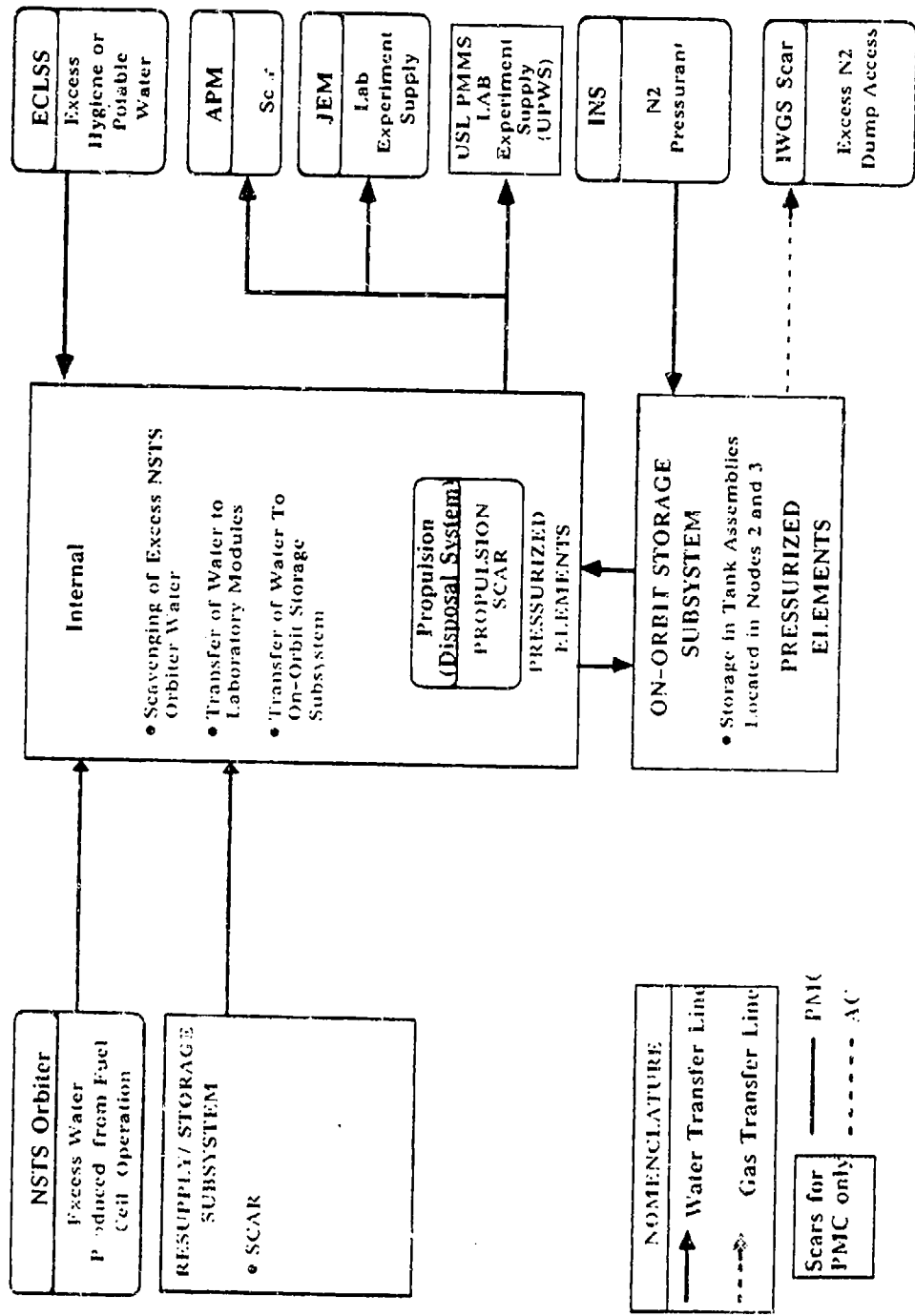

FIGURE 3-1 TOP-LEVEL PMIC/AC IWS FUNCTIONAL SCHEMATIC

CS



INTEGRATED WASTE GAS SYSTEM DESCRIPTION	Propulsion & Power Division
	R. S. Baird 1/16/90

REQUIREMENTS:

- COLLECT, STORE, AND DISPOSE OF WASTE GASES BY AC
 - LAB EXPERIMENT BULK "SAFE" WASTE GASES
 - ECLSS WASTE GASES
 - SYSTEM PRESSURIZATION VENT GASES
 - SYSTEM MAINTENANCE PURGE GASES
- COORDINATE OVERBOARD VENTING TO SUPPORT EXTERNAL CONTAMINATION ENVIRONMENT CONTROL FOR PMC AND AC

IMPLEMENTATION:

- SEPARATE COLLECTION, STORAGE, AND DISPOSAL OF:
 - LAB MIXED WASTE GASES (N2, Ar, O2, Kr, Xe, He, AND TRACE CONTAMINANTS)
 - REDUCING WASTE GASES (H2, N2, AND AMMONIA)
- CENTRALIZED COMPRESSION AND STORAGE OF EACH WASTE GAS TYPE ON FMAD PALLET
- COORDINATE NONPROPULSIVE DISPOSAL OF WASTE FLUIDS BY PMC
- SCHEDULED PROPULSIVE DISPOSAL OF BULK WASTE GASES BY AC

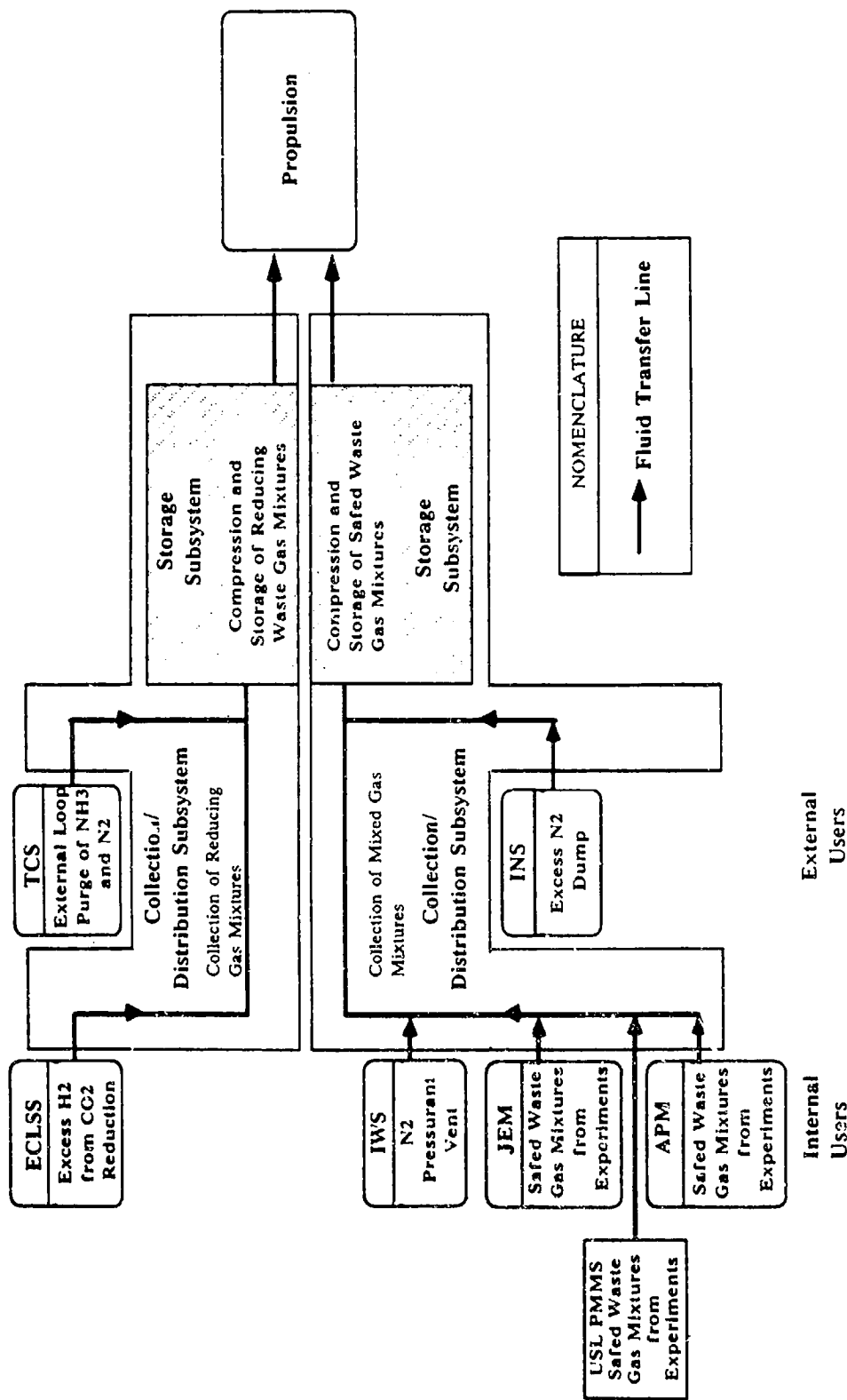
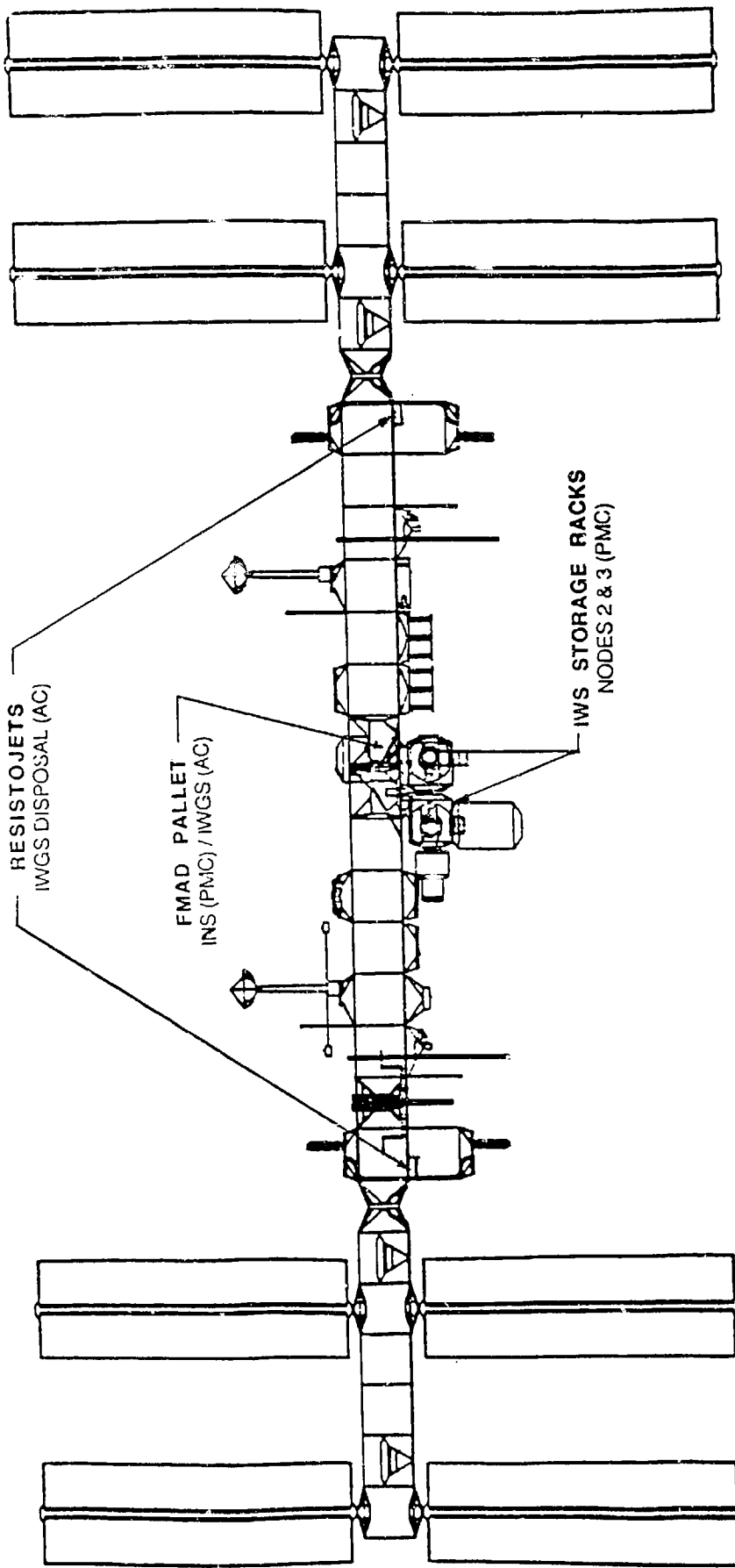
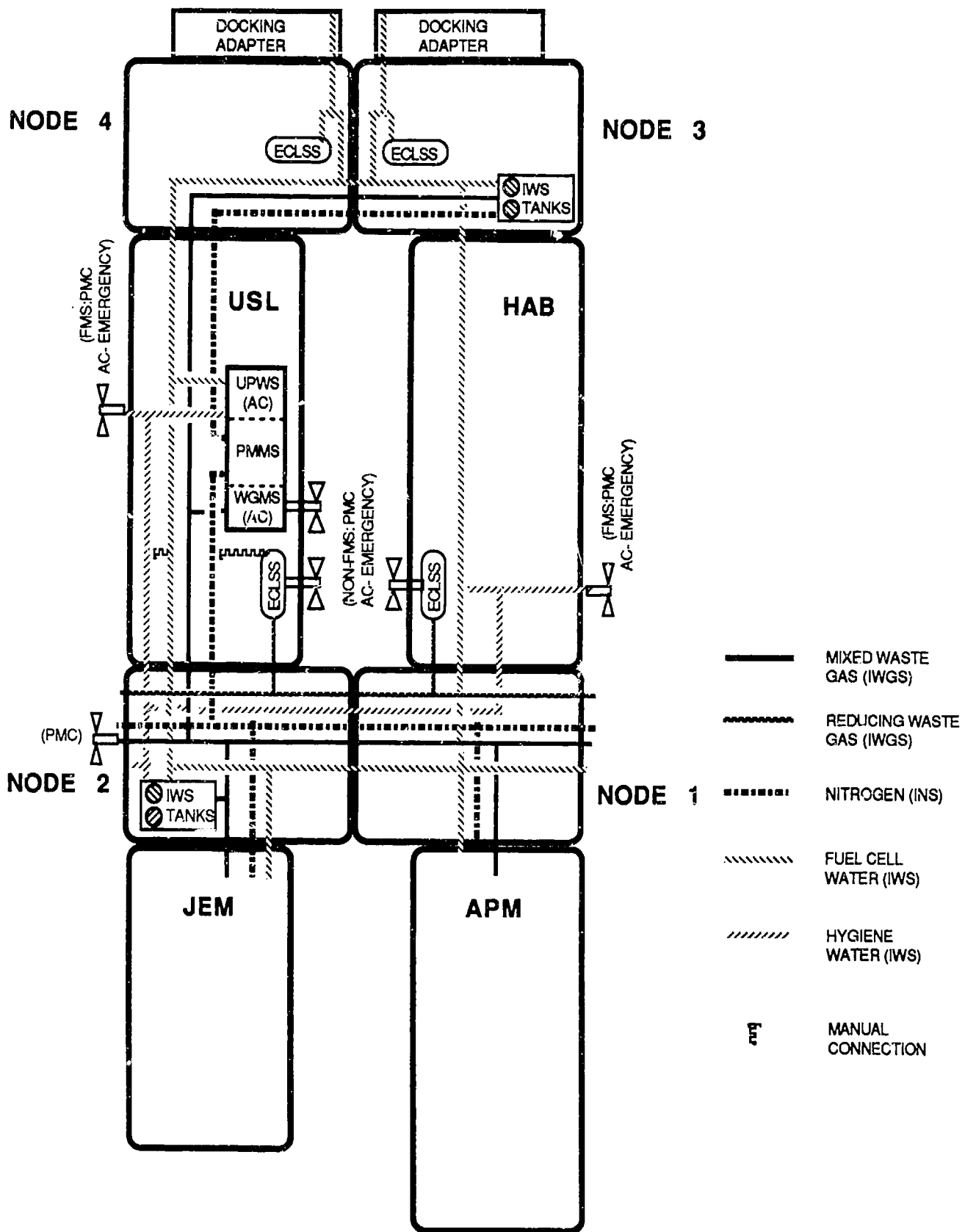

FIGURE 3-1 TOP-LEVEL PMC/AC IWGS FUNCTIONAL SCHEMATIC



FLUID SYSTEM CONFIGURATION

FMS PRESSURIZED VOLUME PMC AND AC PHASE CONFIGURATION



**FLUID MANAGEMENT SYSTEM
NODE WATER RACKS**

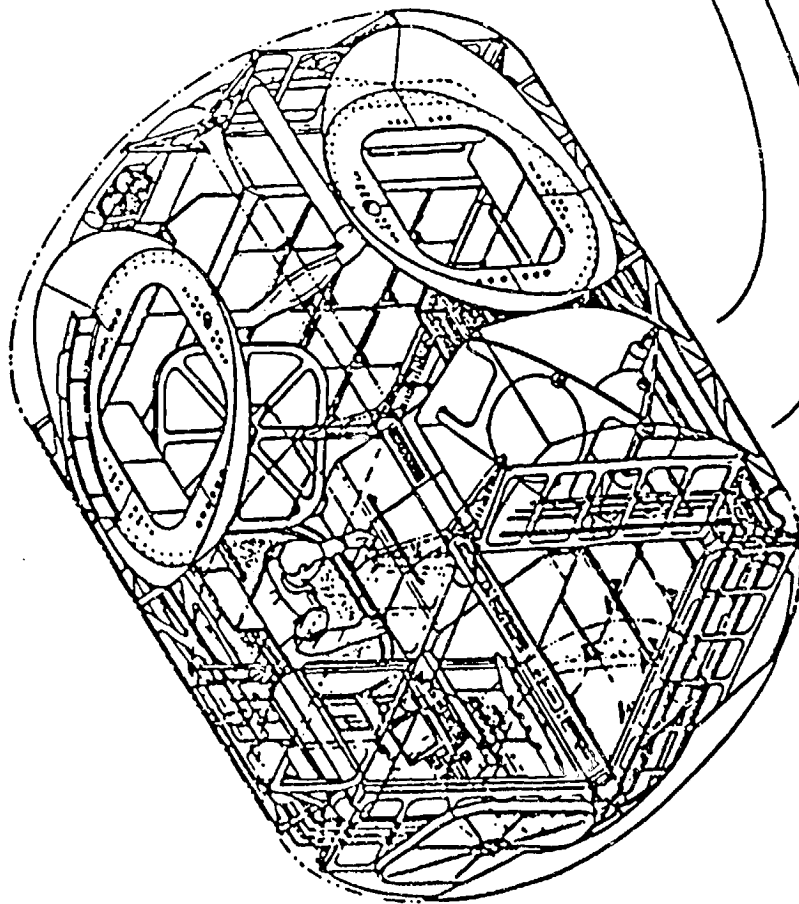
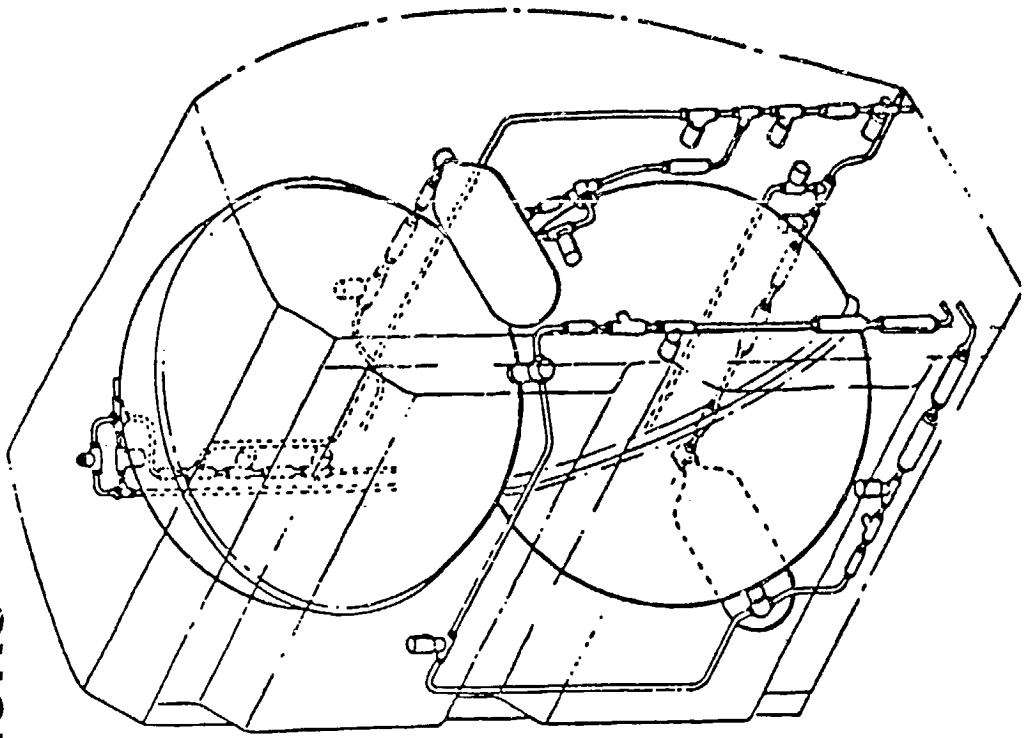

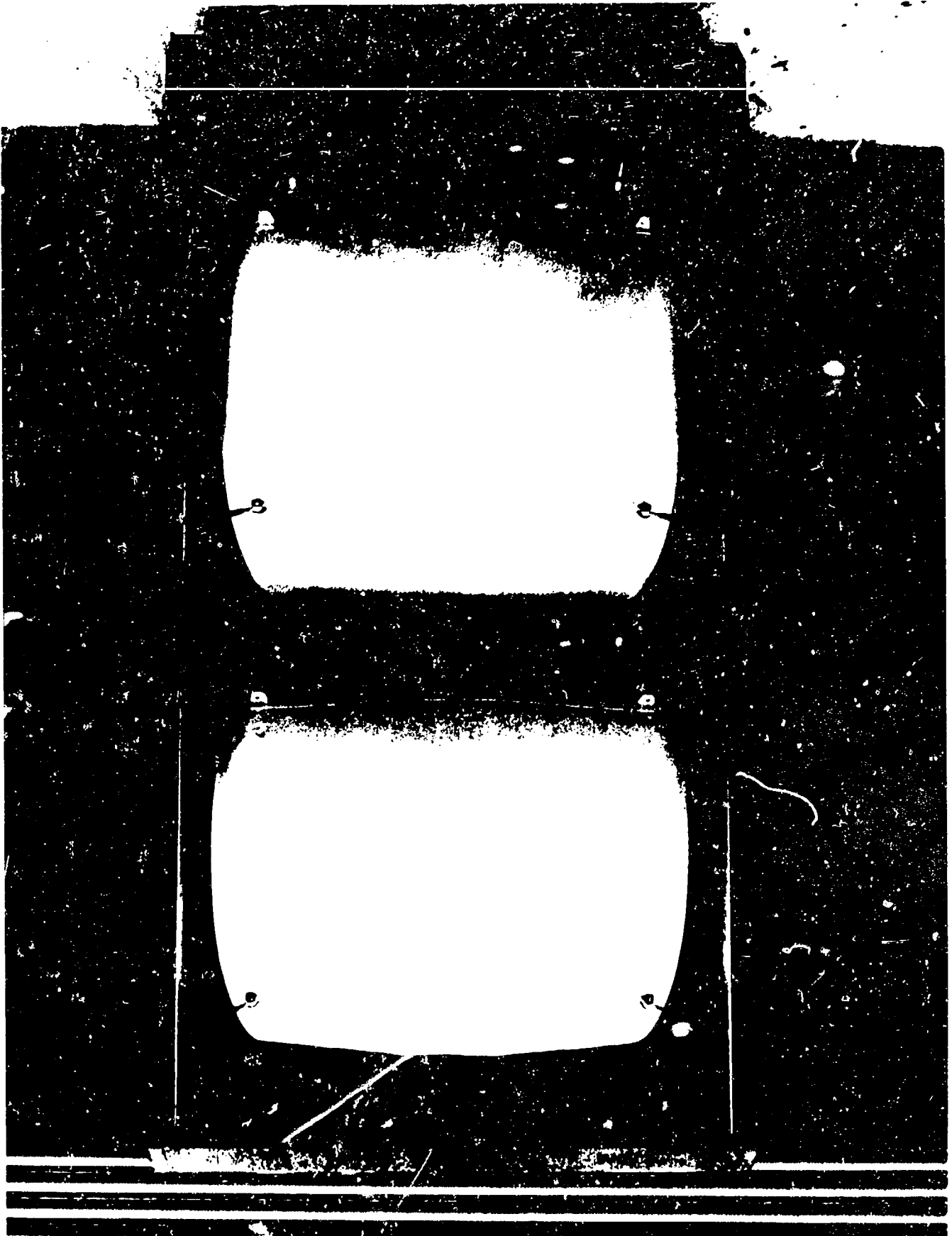

FMS EXTERNAL PMC PHASE CONFIGURATION

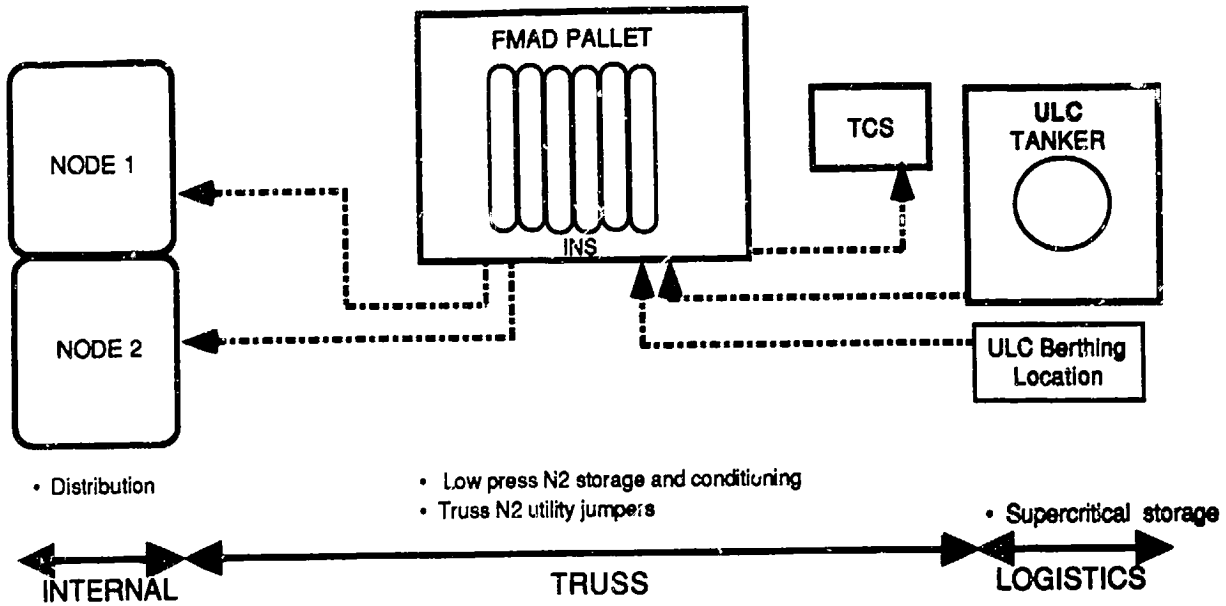

FMS EXTERNAL AC PHASE CONFIGURATION

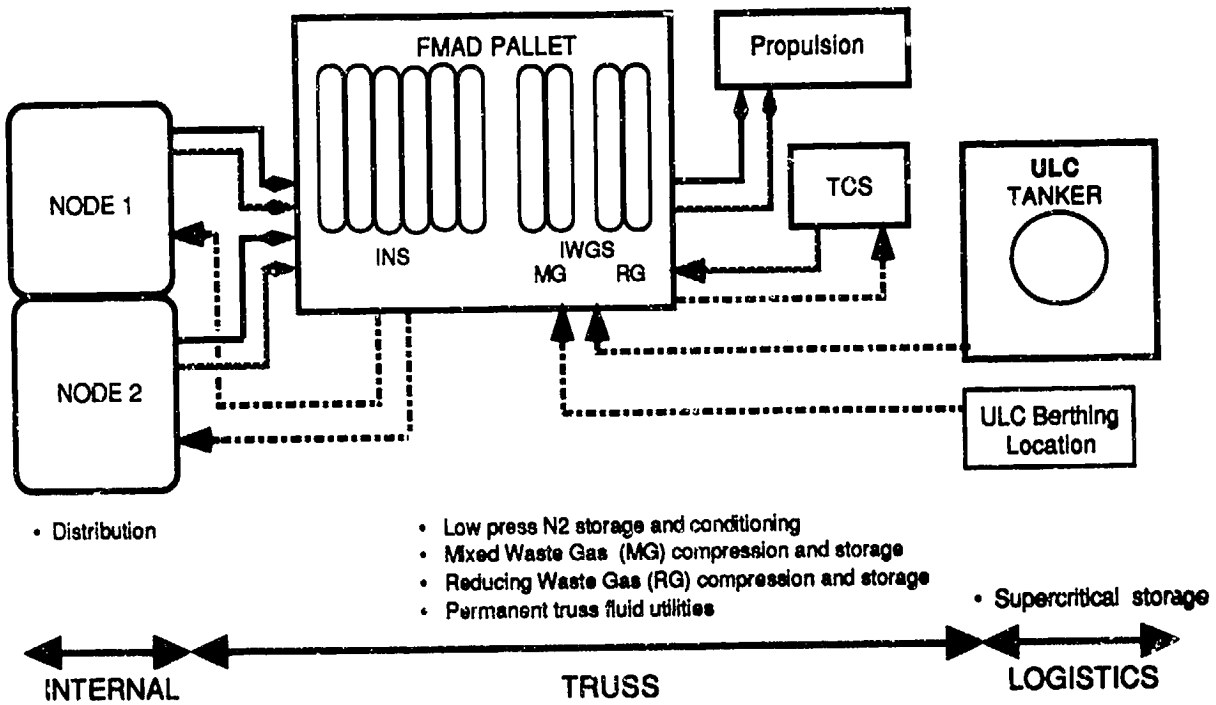

..... NITROGEN (INS) ——— MIXED WASTE GAS (IWGS) ——— REDUCING WASTE GAS (IWGS)

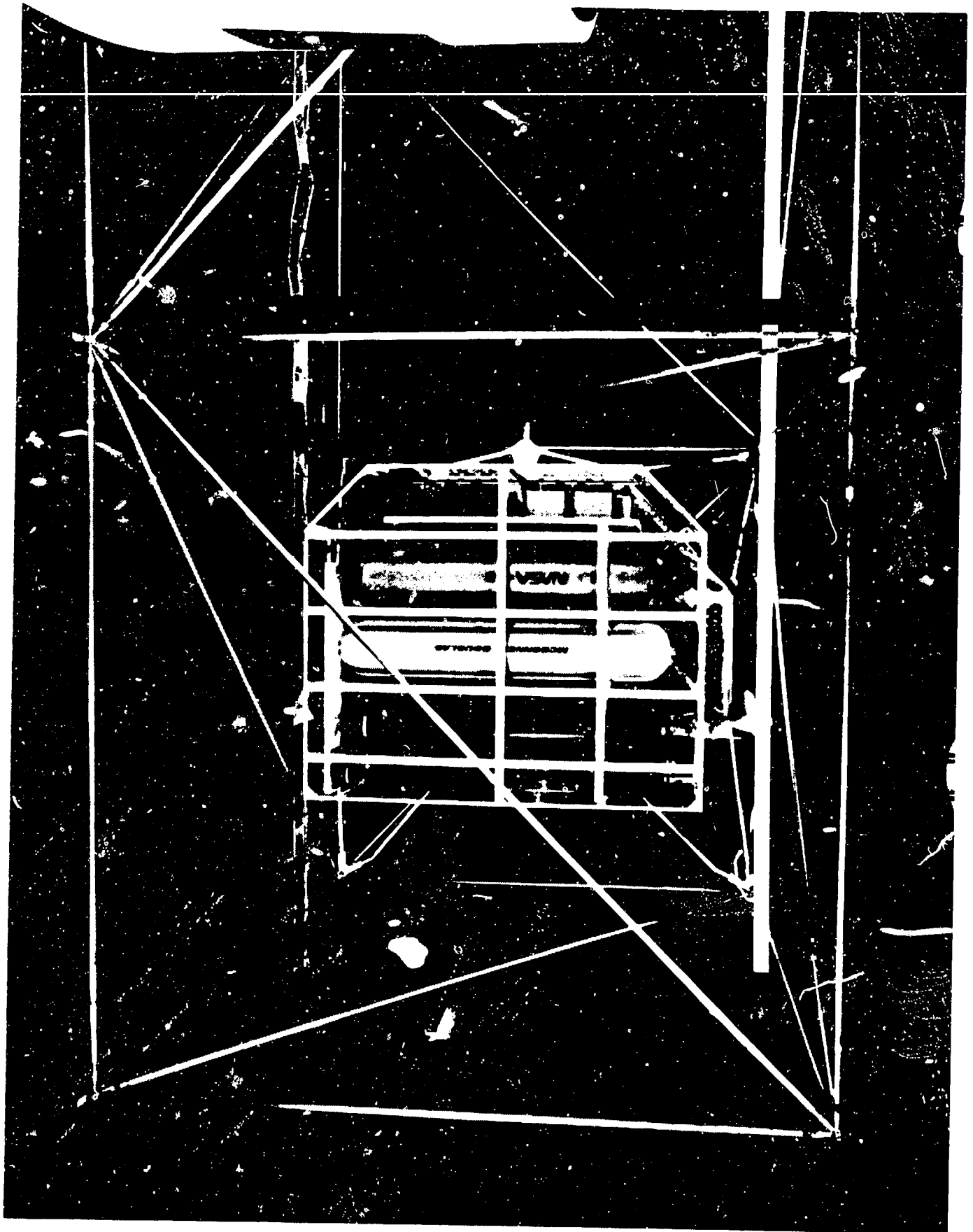

**FLUID MANAGEMENT SYSTEM
PRELIMINARY MASS AND POWER SUMMARY**

MASS & POWER SUMMARY	MASS (Lbm)	POWER (WATTS)
FLUID SYSTEMS MASS:		
INS	836.34	101.00
WGS (S12)	633.90	77.60
WGS (2X)	760.30	215.80
FLUID SYSTEM CONTROL	319.00	0.00
TWS RACK	2 EAC 140.07	31.80
STRUCTURAL/OTHER MASS:		
PALLET (GENERAL)	914.10	0.00
RACK (GENERAL)	2 EAC 168.00	0.00
TOTAL FLUIDS		
PALLET (PMG)	2066.44	101.00
PALLET (AC)	3453.64	394.40
RACK (EACH)	308.07	31.80
RACK (TOTAL)	616.14	63.60
PMGPI TOTAL	2684.28	164.80
AC TOTAL	4078.76	458.00
UTILITY DISTRIBUTION		
HAS (WPO1)	40.92	2.00
LIS (WPO1)	110.01	6.00
TRUSS (PMG)	258.96	5.20
TRUSS (AC)	638.36	5.20
NODE 1 (PMG)	81.43	11.00
NODE 1 (AC)	78.93	10.00
NODE 2 (PMG)	91.61	7.50
NODE 2 (AC)	89.11	6.00
NODE 3	57.92	2.40
NODE 4	47.76	2.40
SEM (NASDA)	0.00	0.00
APM (ESA)	0.00	0.00
FMC TOTAL	728.60	38.60
AC TOTAL	1063.26	34.80
TOTAL FMS		
PMG TOTAL	3414.18	211.20
AC TOTAL	5142.98	482.80



FLUID MANAGEMENT SYSTEM POTENTIAL EVOLUTION REQUIREMENTS	Propulsion & Power Division
	R. S. Baird

1/16/90

EXPANSION OF STATION SCIENCE ACTIVITIES

- ADDITIONAL EXPERIMENT FLUID SUPPLY SERVICES
 - GASES: Kr, Ar, He, CO2
 - CRYOGENS: He
- INCREASED CAPACITY OF EXISTING NITROGEN AND WATER SUPPLY AND WASTE GAS COLLECTION SERVICES

TRANSPORTATION NODE

- ADDITION OF SIGNIFICANT CRYOGENIC FLUID (O2, H2, AND N2) HANDLING SERVICES
 - LONG TERM STORAGE AND BOILOFF CONTROL
 - ON-ORBIT FLUID DISTRIBUTION AND TRANSFER
- EXPANSION OF EXISTING NITROGEN AND WATER SERVICES TO SUPPORT ADVANCED STATION PROPULSION
- EXPANSION OF EXISTING NITROGEN SERVICES FOR HIGH PRESSURE USERS
- ADDITION OF EARTH STORABLE PROPELLANT (HYDRAZINE AND BI-PROPS) STORAGE, DISTRIBUTION, AND TRANSFER SERVICES

FURTHER REDUCTION OF AVAILABLE EVA MAINTENANCE SUPPORT

- ENHANCED ROBOTIC MAINTENANCE COMPATIBILITY
- ENHANCED LIFE AND REDUNDANCY



FLUID MANAGEMENT SYSTEM EVOLUTION DESIGN ADAPTABILITY	Propulsion & Power Division
	R. S. Baird

1/16/90

DESIGN ADAPTABILITY IN PLACE

- ORU DESIGN TO BE COMPATIBLE WITH ROBOTIC INSTALLATION AND MAINTENANCE
- ORU DESIGN TO ACCOMMODATE INSTALLATION OF NEW TECHNOLOGY COMPONENTS WHEN AVAILABLE
- NODE PLUMBING ROUTING WILL NOT PRECLUDE THE POSSIBILITY OF LATER (BY CDR) SCARING FOR ADDITIONAL NODES

DESIGN ADAPTABILITY OPTIONS:

- ADAPTABLE TO ADDITION OF NEW FLUID SERVICES:
 - ADDITIONAL LINES AND INTERFACES IN THE UTILITY TRAYS
 - ADDITIONAL FMAD PALLETS
 - ADDITION OF LINES IN NODES:
 - FULL DISTRIBUTION TO USERS (IF INSTALLED ON GROUND)
 - NODE FLUID SERVICING STATION (SCARABLE FOR ON-ORBIT INSTALLATION)
- ADAPTABLE TO INCREASED CAPACITY OF CURRENT FLUID SERVICES WITH ADDITIONAL FMAD PALLETS AND/OR UPGRADED ORUS
- ADAPTABLE TO ADDITIONAL NODES AND MODULES WITH ADDITION OF PLUMBING IN EXISTING NODES (EARLY IN DESIGN PROCESS)



FLUID MANAGEMENT SYSTEM EVOLUTION TECHNOLOGY DEVELOPMENT NEEDS	Propulsion & Power Division
	R. S. Baird

1/13/90

COMPRESSORS: INCREASED LIFE AND PERFORMANCE

LEAK DETECTION:

- APPLICABLE TO ALL FLUID LINES
- INSENSITIVE TO BACKGROUND ENVIRONMENT

FLUID SYSTEM GAUGING: DISTRIBUTION, MONITORING, AND INVENTORY CONTROL

INSTRUMENTATION:

- WASTE GAS CONTENT
- LONG TERM, ON-ORBIT OPERATIONS CALIBRATION

FLUID LINES:

- ADVANCED LIGHT WEIGHT LINES
- MAINTENANCE INSPECTION, REPAIR, AND REPLACEMENT TECHNIQUES

QUICK DISCONNECT / FITTING: ENHANCED LIFE AND AUTOMATION/ROBOTIC COMPATIBILITY

LARGE SCALE, ON-ORBIT SLOSH CONTROL

CRYOGENIC FLUID HANDLING:

- LONG TERM BULK STORAGE
- ON-ORBIT REFRIGERATION AND INSULATION
- DISTRIBUTION AND TRANSFER TECHNIQUES

LIGHT WEIGHT TANKAGE



**FLUID SYSTEM
TECHNOLOGY DEVELOPMENT
CURRENTLY IN PROGRAM**

Propulsion & Power Division

R. S. Baird

1/16/90

COMPRESSOR

- COMPLEMENTARY JSC/MDSSC IWGS WASTE GAS PROTOTYPE DEVELOPMENT:
- SOUTHWEST RESEARCH INSTITUTE: MIXED WASTE GAS PISTON TECHNOLOGY
- AIRESEARCH/ALLIED SIGNAL: REDUCING WASTE GAS DIAPHRAGM TECHNOLOGY
- IWGS COMPRESSOR PROTOTYPE LONG TERM OPERATIONS TESTING PLANNED

LEAK DETECTION

- JSC PROOF OF CONCEPT OF CAPACITANCE FOIL TECHNOLOGY
- MDSSC DEVELOPMENT AND TESTING OF IONIZATION GAGE TECHNOLOGY

DEPLOYABLE I.LINE

- COMPLEMENTARY JSC/MDSSC PERMEATION TESTING OF NON-METALLIC LINES
- COMPLEMENTARY JSC/MDSSC EVALUATION OF DEPLOYABLE METALLIC LINE CONCEPTS

QUICK DISCONNECT AND FITTING PROTOTYPE DEVELOPMENT

- FITTING PROTOTYPE TECHNOLOGY DEVELOPMENT - (MDSSC/STANLEY AVIATION)
- QUICK DISCONNECT PROTOTYPE TECHNOLOGY DEVELOPMENT - (MDSSC/SYMETRICS)

INTEGRATED SCHEDULE - IIA (UTILITY DIST SYSTEM) (TIER 1) PROGRAM DIRECTORS MEETING AT JSC

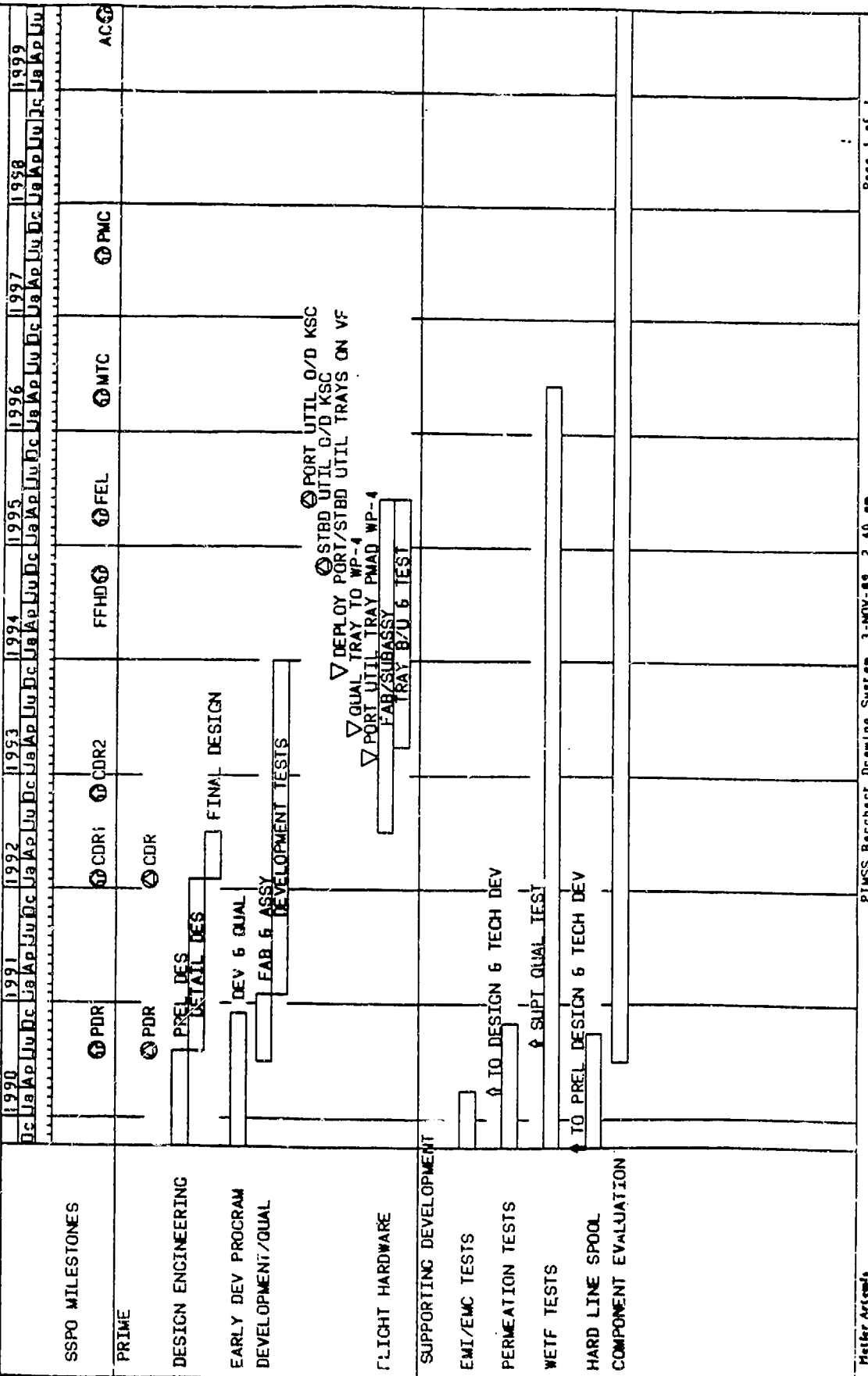

INTEGRATED SCHEDULE - FLUIDS MGMT SYSTEM (TIER 1) PROGRAM DIRECTORS MEETING AT JSC

	1990	1991	1992	1993	1994	1995	1996	1997	1998	1999	
	Dec	Jan	Feb	Mar	Apr	May	Jun	Jul	Aug	Sep	
SSPO MILESTONES											
SUPPORTING DEVELOPMENT COMPRESSOR TECHNOLOGY PROGRAM (MIXED WASTE GAS COMPRESSOR)		<ul style="list-style-type: none"> □ PDR □ PROTOTYPE FAB □ PROTOTYPE TEST ▽ HW DELIVERABLE 		<ul style="list-style-type: none"> □ CDR1 □ CDR2 		FFHD	FEL	MTC	PMC		ACC
IWCS WASTE GAS COMP IMPACT EVAL			<ul style="list-style-type: none"> □ REPORTS DEL (MONTHLY/FINAL) ↑ REPORTS TO DESIGN & TEST 								
PROTO COMPRESSOR LIFE TEST FMS HARDWARE EVALUATION			<ul style="list-style-type: none"> □ FROM DEV HW □ TO DESIGN 								



FLUID SYSTEM EVOLUTION STUDY	Propulsion & Power Division
	R. S. Baird

1/16/90

- PROPULSION/FLUID MANAGEMENT/UTILITIES EVOLUTION STUDY TASK (4767209) FY90 START
- PURPOSE TO DETERMINE:
 - SYSTEM GROWTH CONCEPT CONSISTENT WITH SSF REFERENCE GROWTH CONFIGURATIONS
 - FUTURE CAPABILITY AND DERIVED ENABLING/ENHANCING TECHNOLOGY NEEDS
 - SCAR AND HOOK CANDIDATES WHICH ENABLE/FACILITATE ON-ORBIT GROWTH AND/OR TECHNOLOGY UPGRADES
 - SYSTEM IMPACTS:
 - SCAR COST AND WEIGHT ESTIMATES
 - "FAILURE TO SCAR" ASSESSMENT
 - IMPACTS OF GROWTH ON OTHER SYSTEMS
- BASELINE PRELIMINARY DESIGN ASSESSMENT:
 - EVOLUTIONARY POTENTIAL/CAPABILITY
 - EXISTING EVOLUTIONARY DESIGN FEATURES (SCARS AND HOOKS)
 - RECOMMEND ADDITIONAL DESIGN FEATURES
- EVOLUTION DESIGN REQUIREMENTS RECOMMENDED FOR THE PDRD

**Fluid Management System
Invited Presentations**

omit

~~222~~ INTENTIONALLY BLANK



Space Station Freedom

BOEING

Space Station Fluid Resupply

Presented by:
A. Winters
BA&E
Huntsville Division 27797

511-13
163625
N93-27797
P-10



Space Station Fluid Resupply

Space Station Freedom

BOEING

Contents:

Requirements

Design Considerations

Configurations

Operations

Summary



Space Station Fluid Resupply

Space Station Freedom

BOEING

- **Requirements**

Resupply (PMC)

ECLSS Fluids

LAB Fluids

Contingency

ECLSS Fluids

{ ~ 3200 lbs N₂ per year

~ 3500 lbs O₂ per year

~ 1300 lbs N₂ per year

{ ~ 700 lbs N₂ on station

~ 900 lbs O₂ on station



Space Station Fluid Resupply

Space Station Freedom

BOEING

• Design Considerations:

Resupply

Resupply Frequency

~ 180 days

Transportation State

High pressure gas

Supercritical fluid

Contingency

Supply Frequency

On station @ PMC; as required thereafter

Transportation State

High pressure gas (3000 psi)

Supercritical fluid

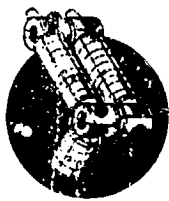

Space Station Fluid Resupply

Space Station Freedom

BOEING

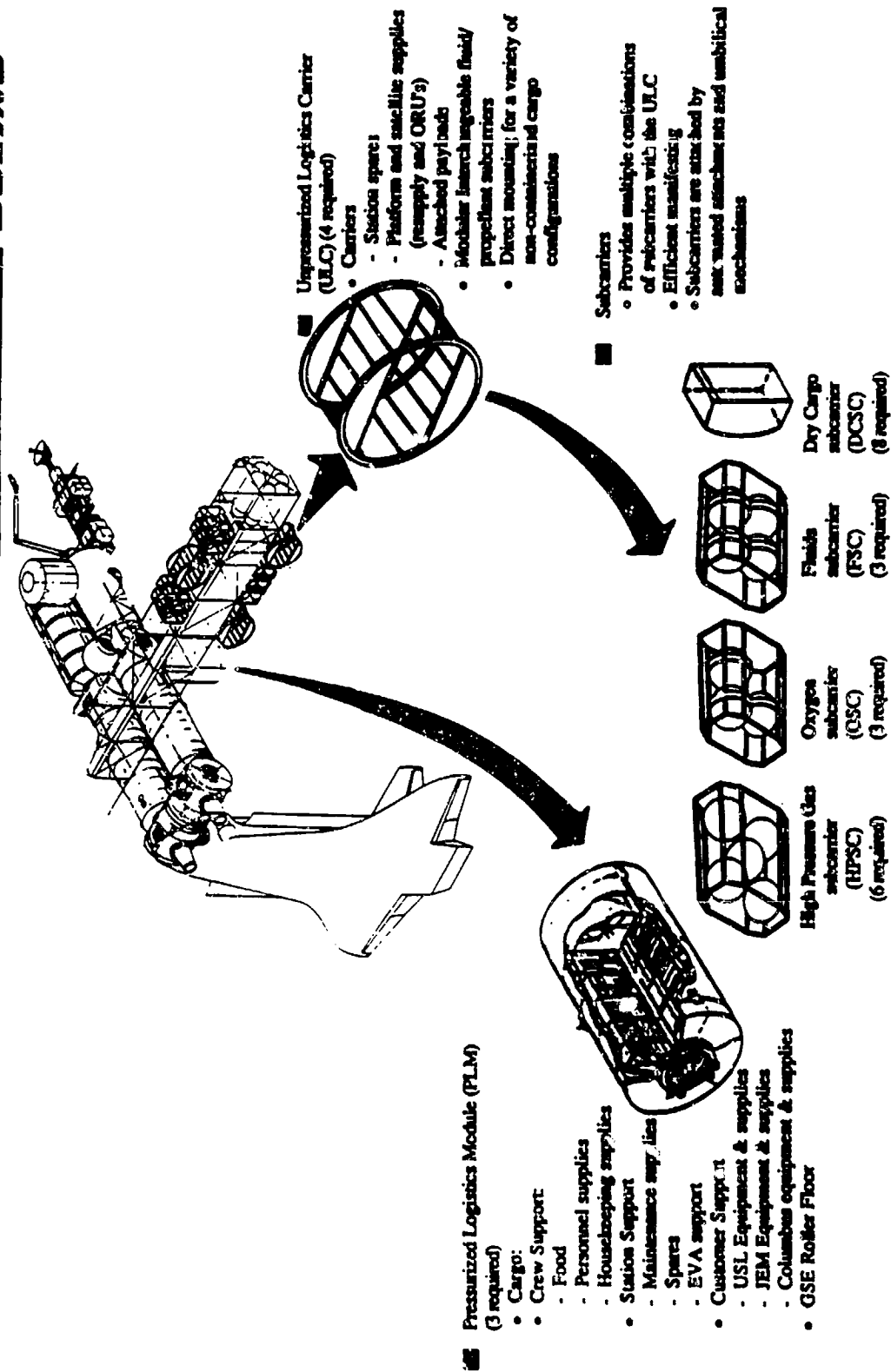



Space Station Fluid Resupply

Space Station Freedom

BOEING

• Unpressurized Logistics Carrier

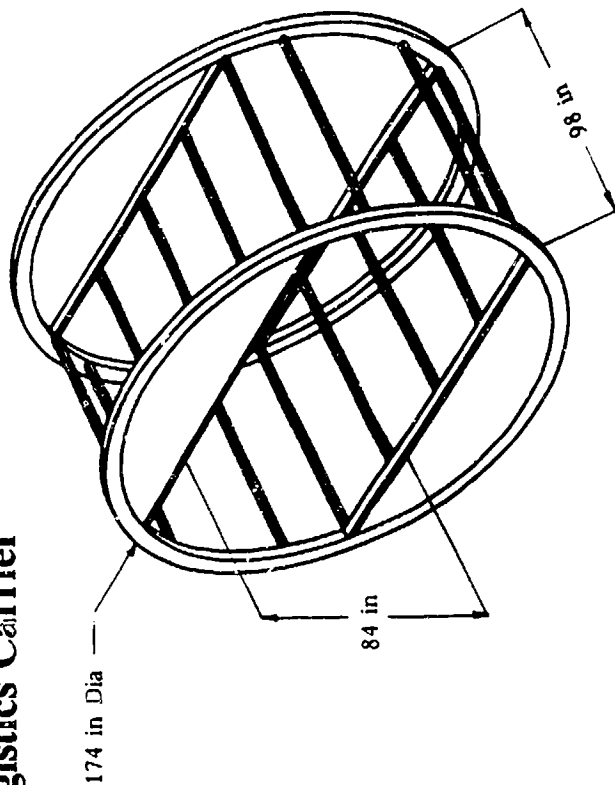

Outfitting

- Cargo Accommodations
- Subcarrier Attach Mechanisms
- Non-Containerized Cargo Attachments

• Subsystems

- EPS
- DMS
- TSS
- MS
- Passive Thermal Control System (PTCS)
- Mechanisms
 - Automated Umbilical Mechanism
 - Subcarrier Attachment Mechanisms

Characteristics

- Empty Weight: 2,251 lbs
- Cargo Accommodation capability
 - Combinations of Subcarriers (FSC, OSC, HFSC, DCSC)
 - Seat Track on Member Faces for Oversized Cargo



Space Station Fluid Resupply

Space Station Freedom

BOEING

- Fluids Subcarrier (FSC)

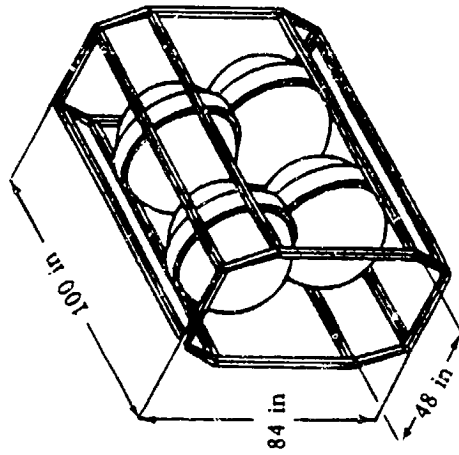

Outfitting

- Cargo accommodations
 - 3 ECLSS Supercritical N₂ (SCN₂) tanks
 - 1 Lab SCN₂ tank

• Subsystems

- MS
- FPS
- DMS
- TSS
- Passive Thermal Control System (PTCS)
- Tanks and Plumbing
- Mechanisms
 - Automated Umbilical Mechanism
 - ULC Attachment Mechanism
 - ITA Attachment Mechanism

Characteristics

- Total Dry Weight - 1940 lbs
- Cargo Accommodations Capability
 - ECLSS SCN₂ - 1434 lbs
 - Lab SCN₂ - 478 lbs

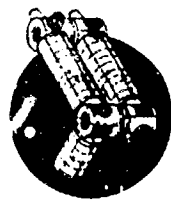

Space Station Fluid Resupply

Space Station Freedom

BOEING

- Oxygen Subcarrier (OSC)

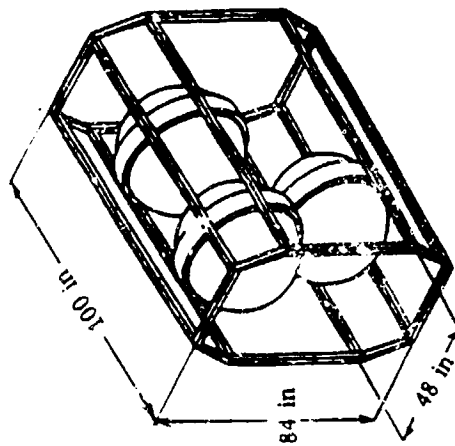

Outfitting

- Cargo accommodations
- 3 ECLSS Supercritical O₂ (SCO₂) tanks
- Subsystems
 - MS
 - EPS
 - DMS
 - TSS
 - Passive Thermal Control System (PTCS)
 - Tanks and Plumbing Mechanisms
 - Automated Umbilical Mechanism
 - ULC Attachment Mechanism
 - JTA Attachment Mechanism

Characteristics

- Total Dry Weight - 1459 lbs
- Cargo Accommodations Capability
 - ECLSS SCO₂ - 2175 lbs

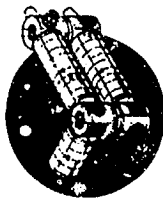

Space Station Fluid Resupply

Space Station Freedom

BOEING

- High Pressure Subcarrier (HPSC)

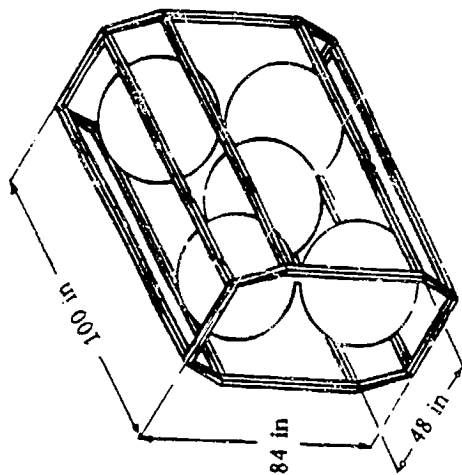

Outfitting

- Cargo accommodations
 - 3 High Pressure N₂ (HPN₂) tanks
 - 2 HP O₂ tanks

• Subsystems

- MS
- EPS
- DMS
- TSS
- Passive Thermal Control System (PTCS)
- Mechanisms
 - Automated Umbilical Mechanism
 - ULC Attachment Mechanism
 - JTA Attachment Mechanism

Characteristics

- Total Dry Weight - 3226 lbs
- Cargo Accommodations Capability
 - HPN₂ - 588 lbs
 - HPO₂ - 506 lbs



Space Station Freedom

Space Station Fluid Resupply

BOEING

- Transportation and Transfer Plan - Resupply
 - Prelaunch and post launch operations phases
 - Load fluids into supercritical tanks on the subcarriers
 - Transport fluids to the SS in a liquid state
 - On station operations phase
 - Change state of fluid from liquid to supercritical by turning on tank heaters
 - Transfer fluids from subcarriers to users
 - Complete unloading of subcarriers
 - Prelanding operations phase
 - Return subcarriers with residual gas

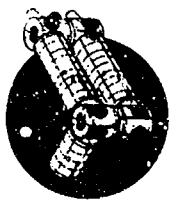

Space Station Fluid Resupply

Space Station Freedom

BEING

Operations Phase Definitions

- All LE's go through complete operations cycles consisting of 6 primary phases
- Hab and US Lab go through operations cycles 1, 2 and 3 **TOTAL CYCLE**

PHASE DEFINITIONS

- 1 Pre Launch Phase**
Begins at start of preparations and processing for launch and ends at launch.
- 2 Post Launch Phase**
Begins at launch and ends at completion of element installation on SS.
- 3 On Station Operations Phase**
Begins at completion of elements installation on SS and ends at start of transfer of returning LE from SS to the orbiter.
- 4 Prelanding Phase**
Begins at start of transfer of returning LE from SS to the orbiter and ends at landing.
- 5 Post Landing Phase**
Begins at landing and ends at completion of LE offload operations.
- 6 LE Turnaround**
Begins at completion of LE unloading operations and ends at start of LE prelaunch operations.

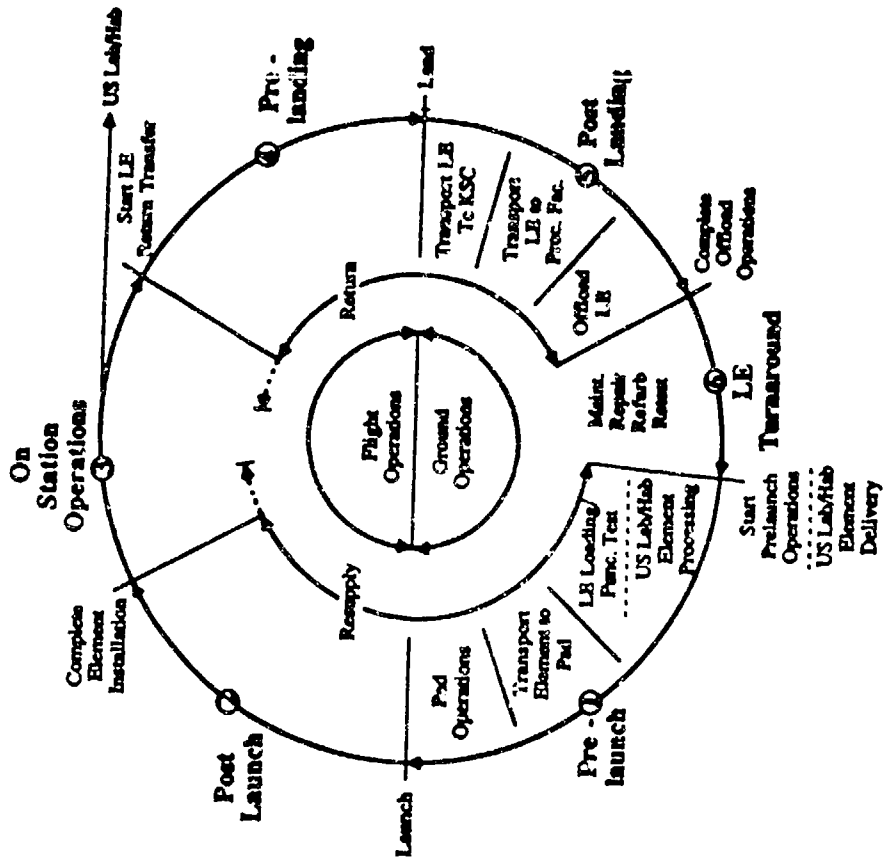



Space Station Fluid Resupply

Space Station Freedom

BOEING

- Operations Flow - FSC and OSC

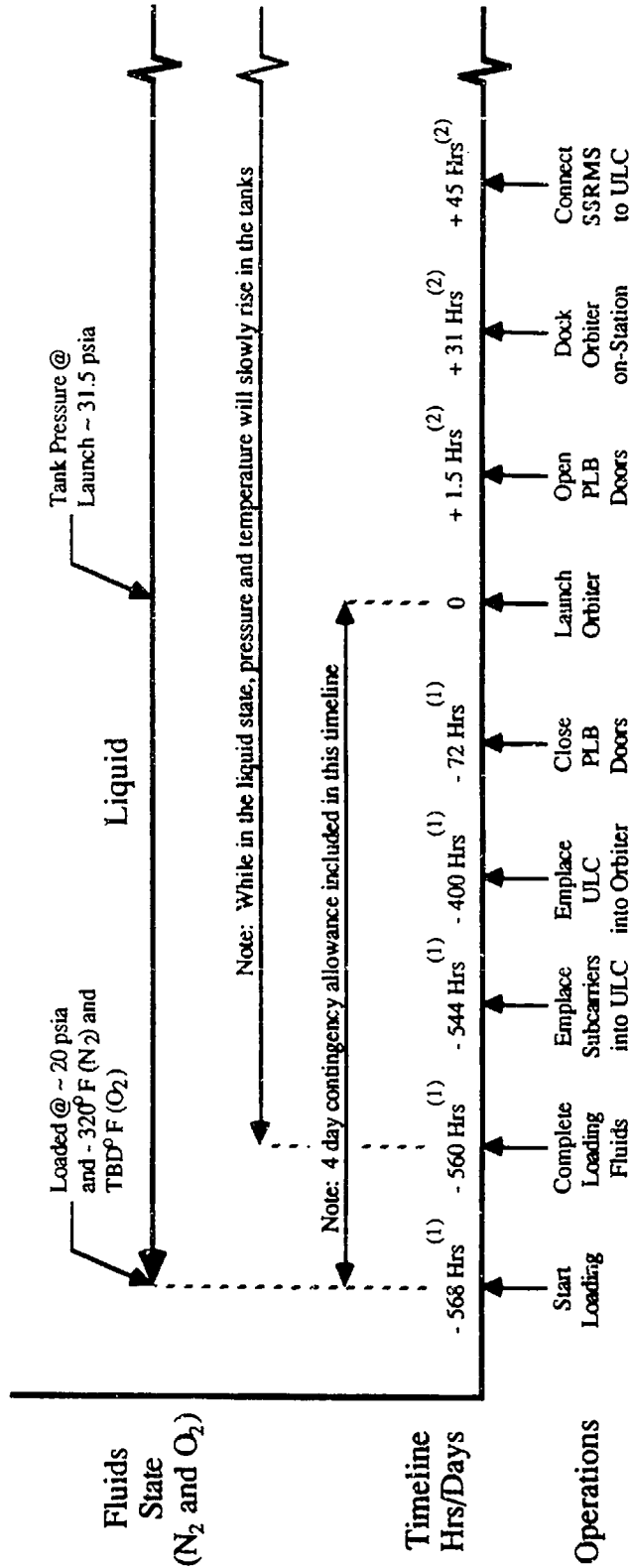

(1) Preliminary timeline estimate

(2) Pr-liminary timeline estimate from NSTS Integration and Operations Office

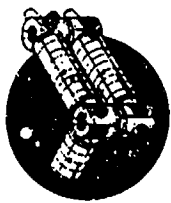

Space Station Fluid Resupply

Space Station Freedom

BOEING

• Operations Flow - FSC and OSC (continued)

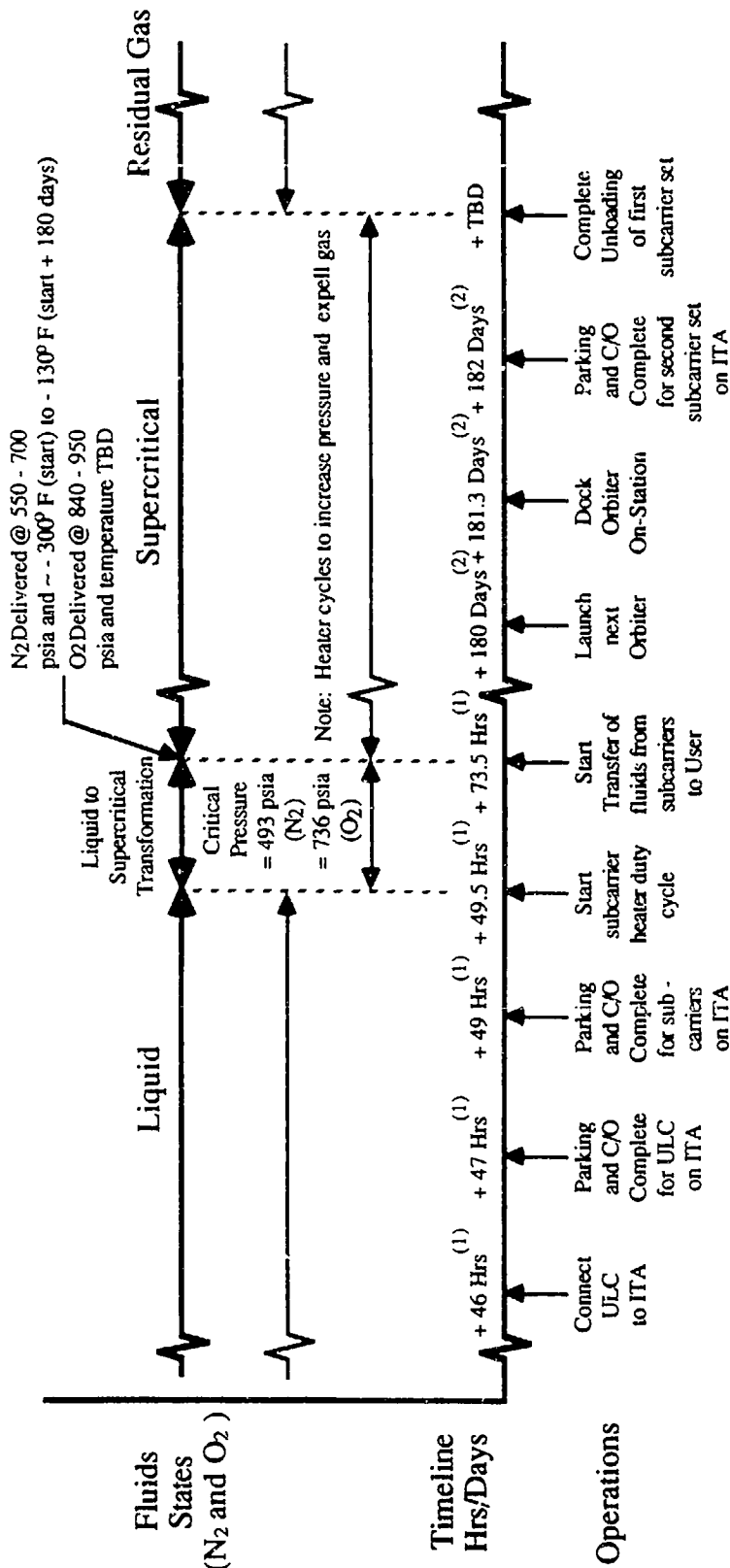

(1) Preliminary timeline estimate

(2) Preliminary timeline estimate NSTS Integration and Operations Office



Space Station Fluid Resupply

Space Station Freedom

BOEING

- Operations Flow - FSC and OSC (continued)

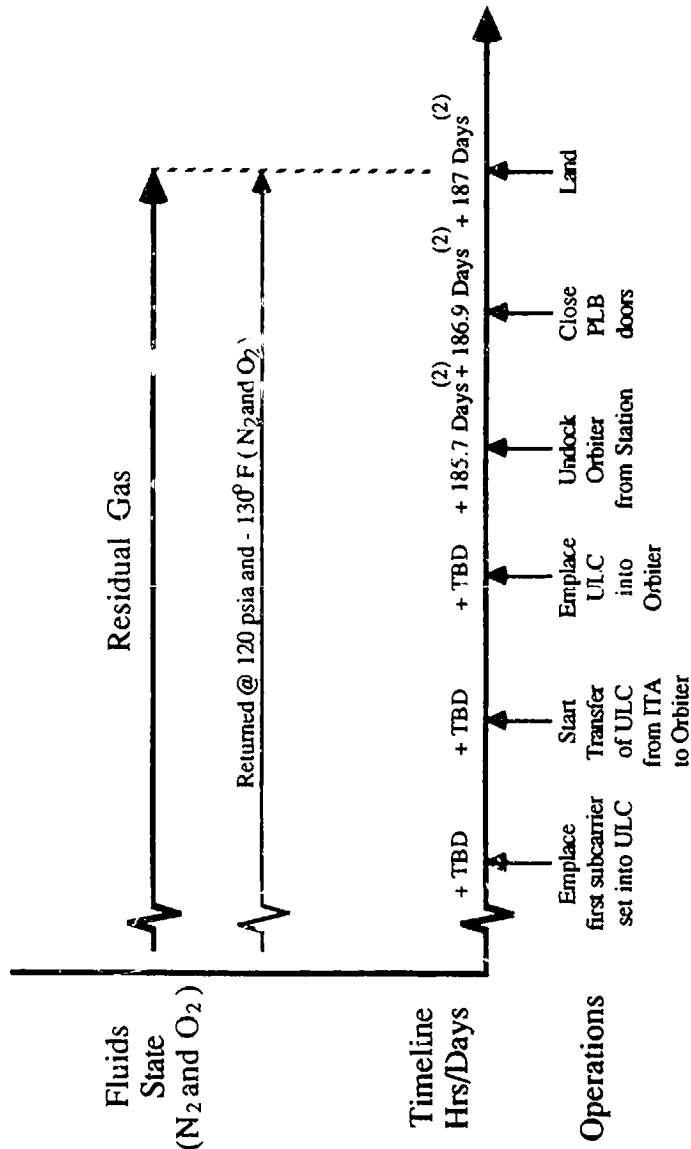

(1) Preliminary timeline estimate

(2) Preliminary timeline estimate from NSTS Integration and Operations Office

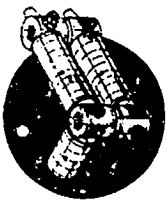

Space Station Freedom

Space Station Fluid Resupply

BOEING

- Transportation and Transfer Plan - Contingency
 - Prelaunch and post launch operations phases
 - Load fluids into high pressure tanks on the HPSC
 - Transport fluids to the SS in a gaseous state
 - On station operations phase
 - Transfer fluids as required
 - Replace HPSC as required



Space Station Freedom

Space Station Fluid Resupply

BOEING

- **Summary**
- **SSF is resupplied with supercritical O₂ and N₂ for the ECLSS and USL on a 180 day resupply cycle**
- **Resupply fluids are stored in the subcarriers on station between resupply cycles and transferred to the users as required**
- **ECLSS contingency fluids (O₂ and N₂) are supplied and stored on station in a gaseous state**
- **Efficiency and flexibility are major design considerations**
- **Subcarrier approach allows multiple manifest combinations**
- **Growth is achieved by adding modular subcarriers**

Propulsion Needs for Lunar/Mars Missions

**Presented at the
Technology for Space Station Evolution Workshop
at the D/FW Hilton Executive Conference Center
January 16, 1990**

**Gordon R. Woodcock
Boeing Aerospace and Electronics
Huntsville, Alabama**

512-20
163626
N93-27798
P-20

NASA LEVEL II

Baseline Missions Sequence

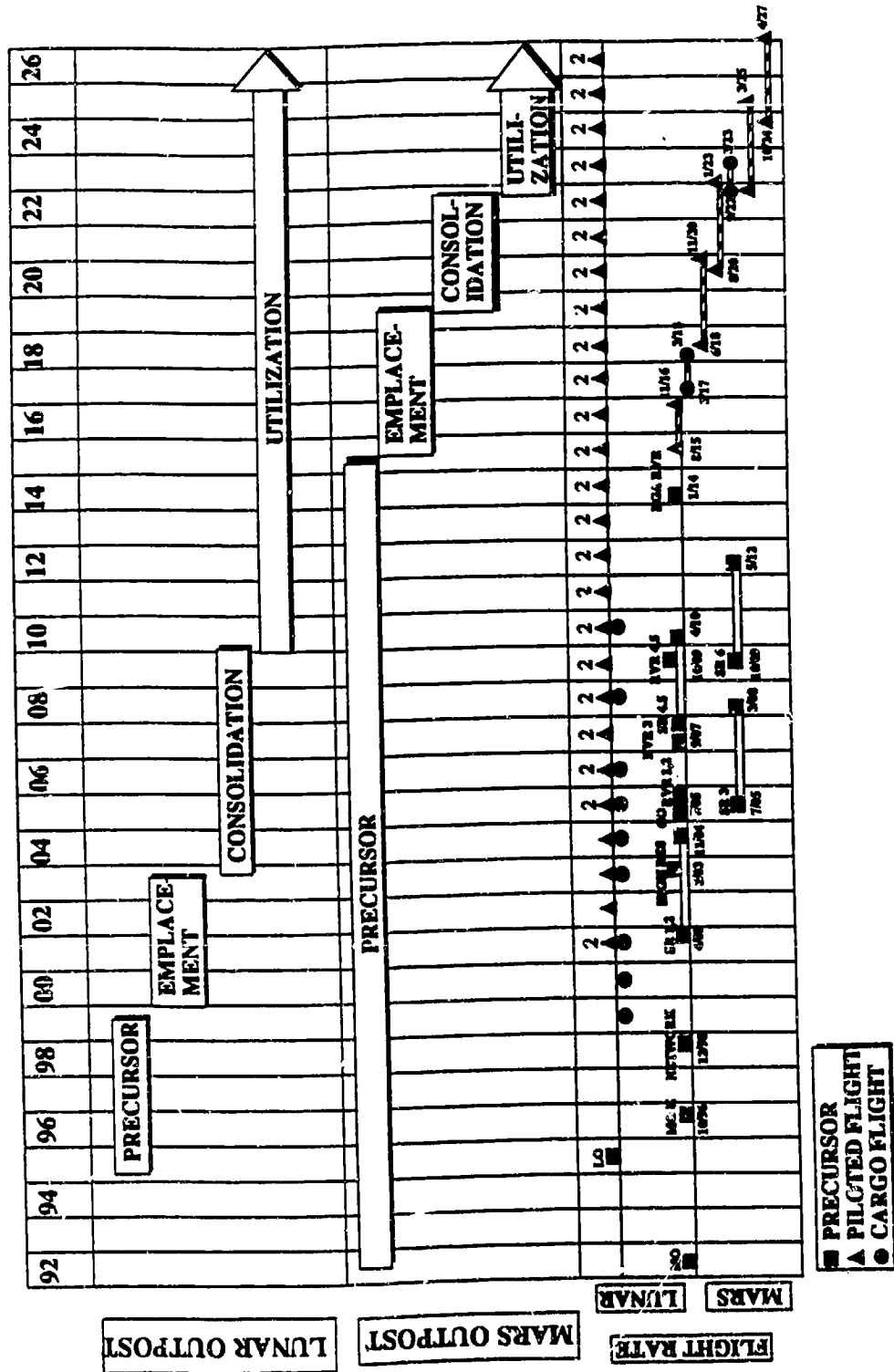

LTV/LEV LUNAR MISSION PROFILE (STEADY - STATE MODE)

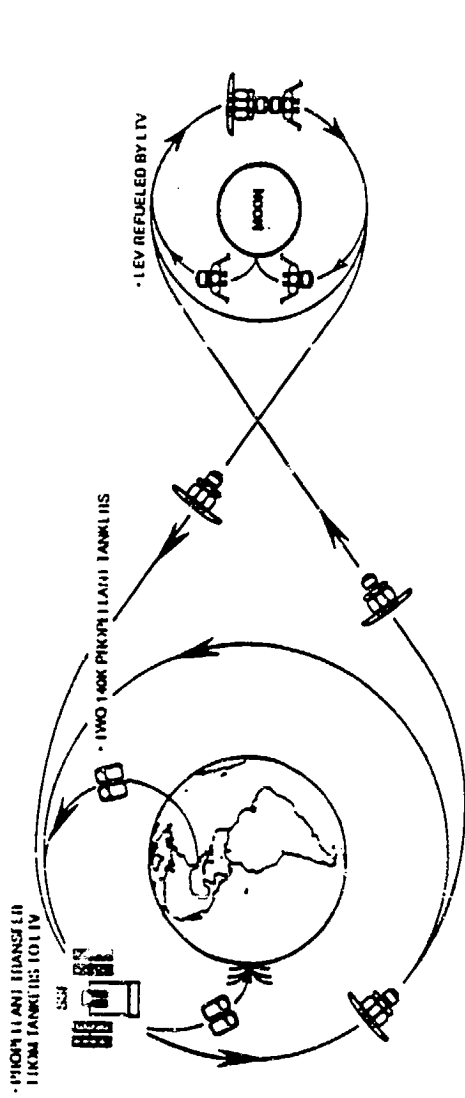

SINGLE STAGE REUSEABLE

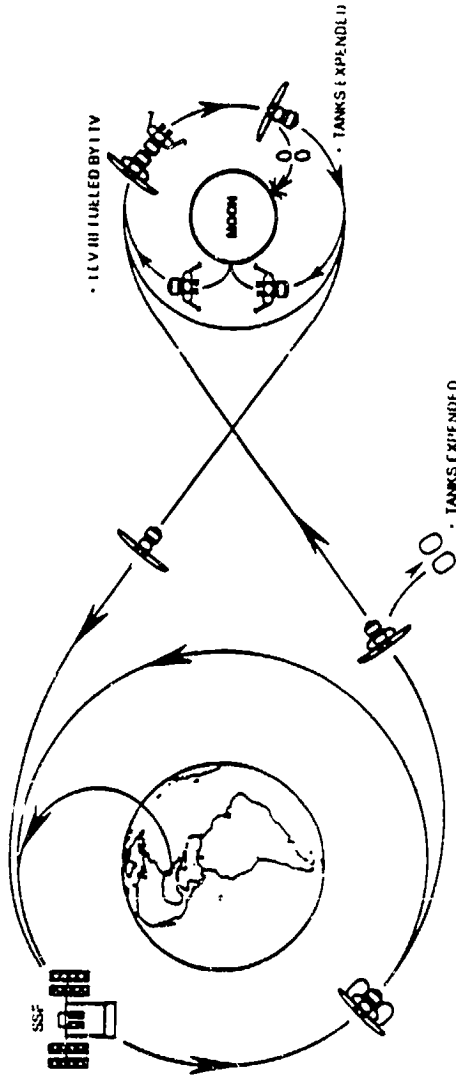

1 1/2 STAGE (REFERENCE)

- CURRENT REFERENCE IS 1 1/2 STAGE.**
- SMALLER AEROBRAKE
 - BETTER PERFORMANCE
 - CORE STORAGE
 - CORE APPLICATIONS
 - LTV SIZE/ASSEMBLY IMPROVED

Lunar Transfer Vehicle/Lunar Excursion Vehicle Option 1

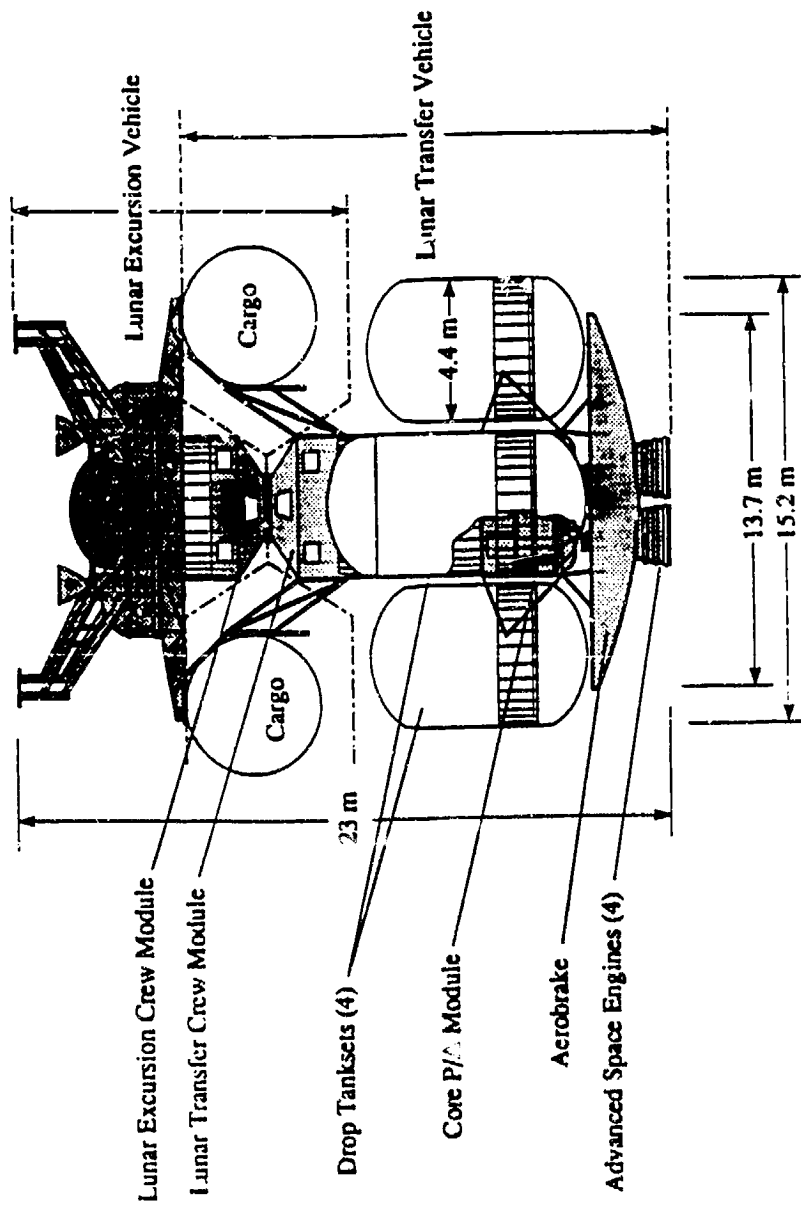

LEV	
• Mass	5.6t
• Propellant	23t
• Crew Module	3.6t *
LTV Tanksets (4)	
• Mass	5.8t
• Propellant	100t **
LTV Core	
• Mass	3.1t
• Propellant	5.4t
• Crew Module	7.6t *

* Excludes Crew, LTV Crew Module Includes 1.8t H₂O Radiation Shield
 ** Capacity 129.8t

Launch Vehicles for Lunar Missions

Requirements

- Shuttle for Manned Launches
- H.L.V for Cargo + Propellant
- 2-6 H.L.V Flights/Year
- Lunar Vehicle/Aerobrake Requires 7.6m dia x 27m Payload Envelope

Shuttle

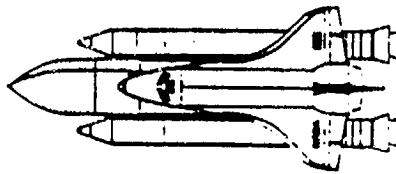

- 2 ASRMs
- Sid ET
- 3 x 104% SSMEs
- 22t P/L Capability to SSF
- 4.6m x 18.2m P/L Envelope

or

Shuttle-C

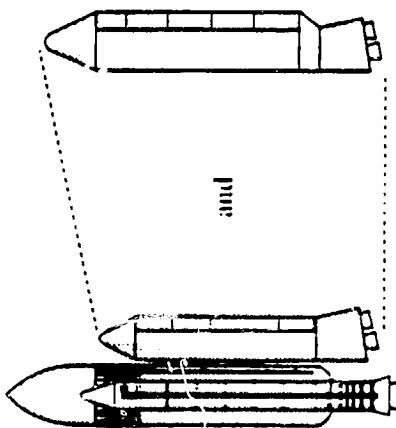

- 2 ASRMs
- Mod. ET
- 3 x 104% SSMEs
- 61t P/L Capability to SSF
- 7.6m x 27m P/L Envelope

ALS.

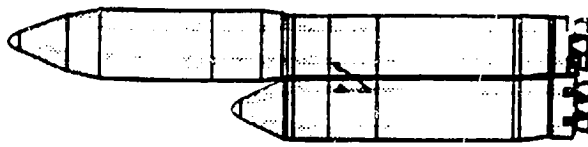

- 1 LOX/LH₂ Booster w/6 STMEs
- LOX/LH₂ Core w/3 STMEs
- 52.3t P/L Capability to SSF
- 7.6m D x 30m L P/L Envelope

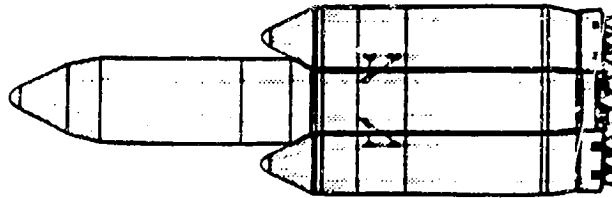

- 2 LOX/LH₂ Booster w/6 STMEs
- 1 LOX/LH₂ Core w/3 STMEs
- 98.2t P/L Capability to SSF
- 10m D x 30m L P/L Envelope

Technical Study Group

Lunar Outpost

Payload T Lunar Surface

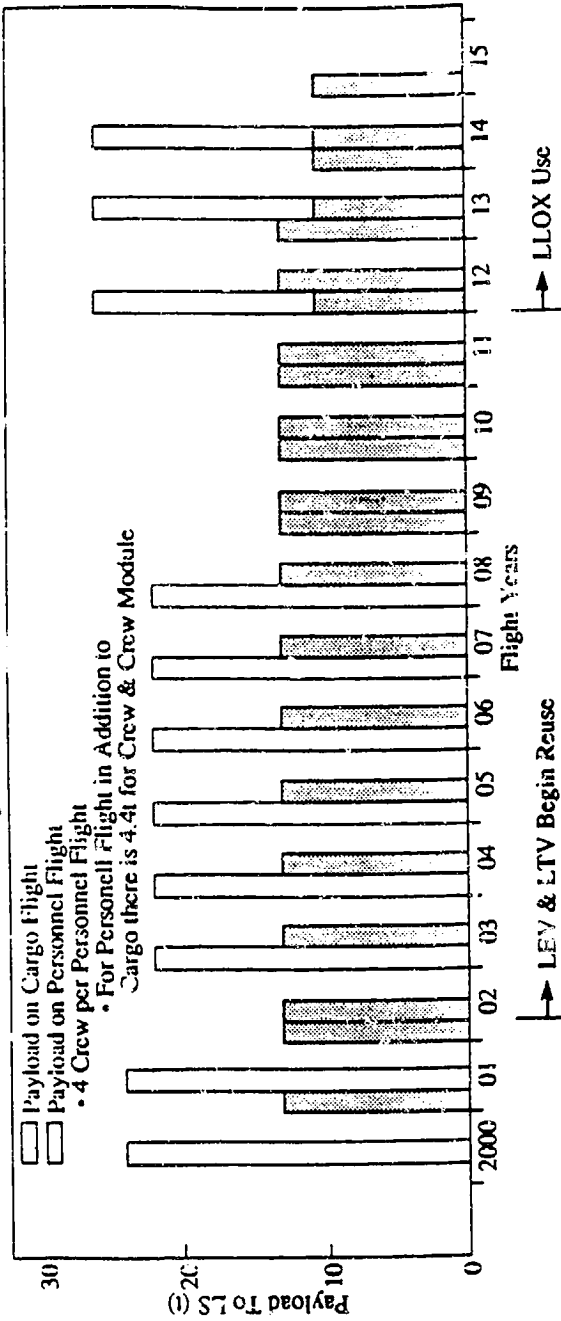

Mass Delivered To LEO

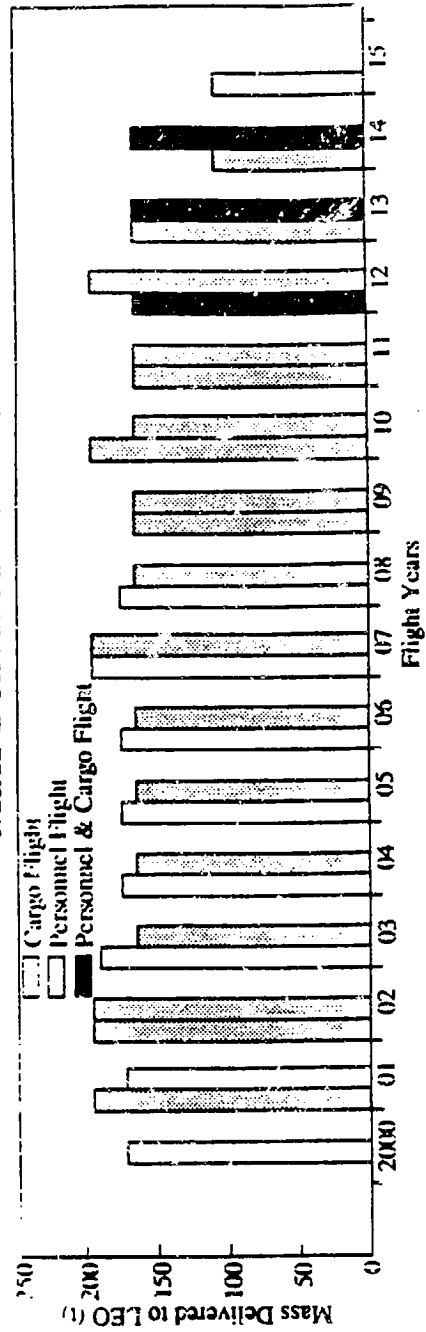

Mars Transfer Operations

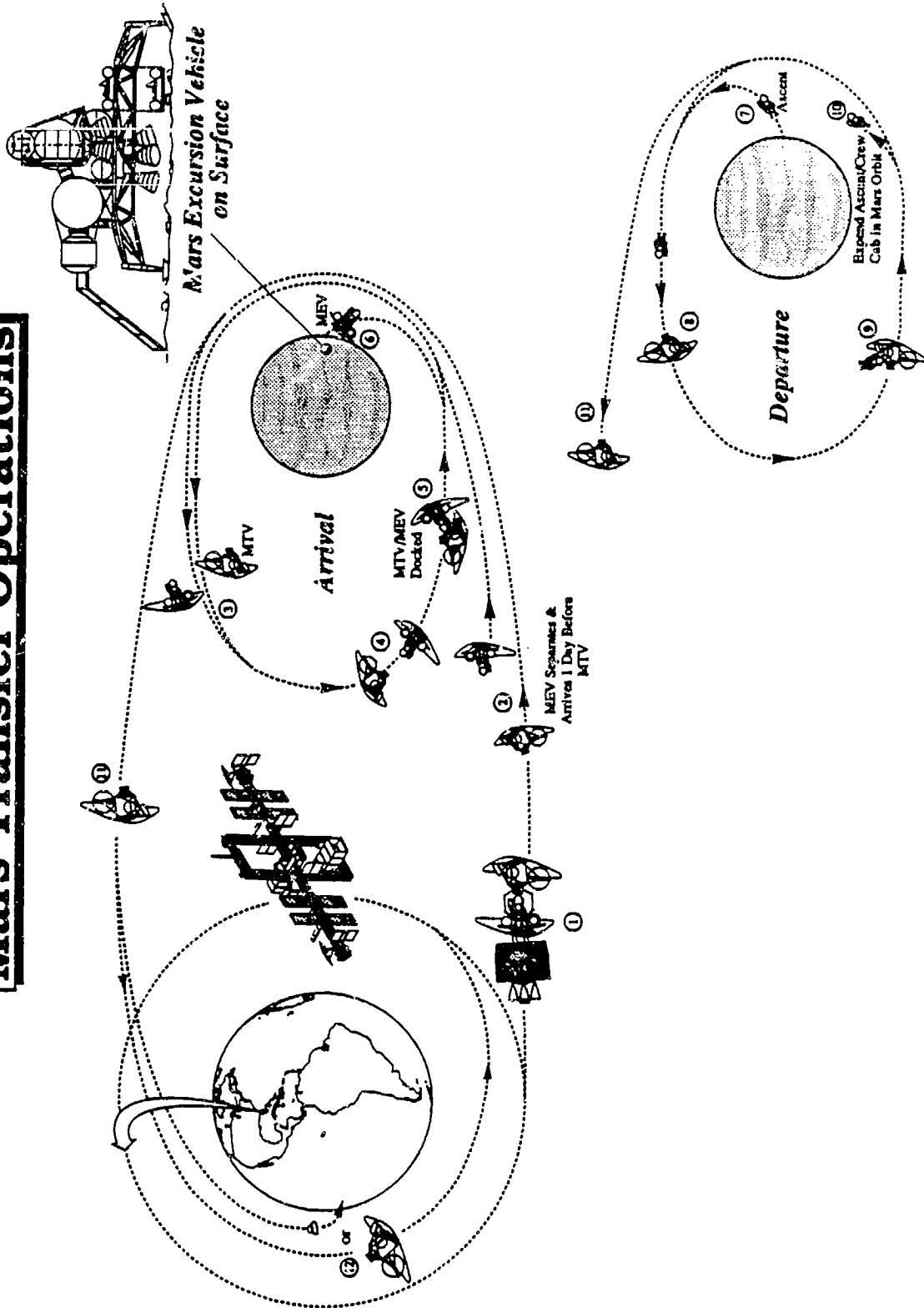



Mars Mission Vehicle in LEO

BOEING

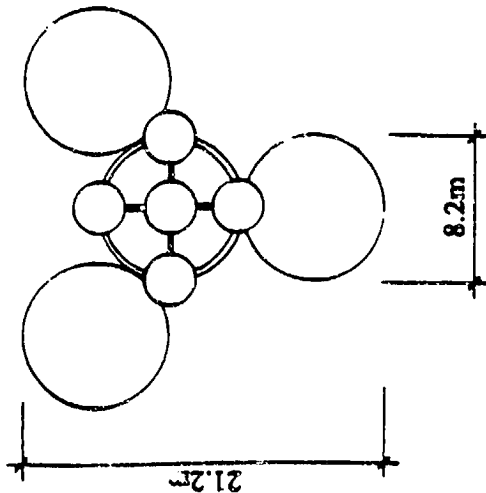
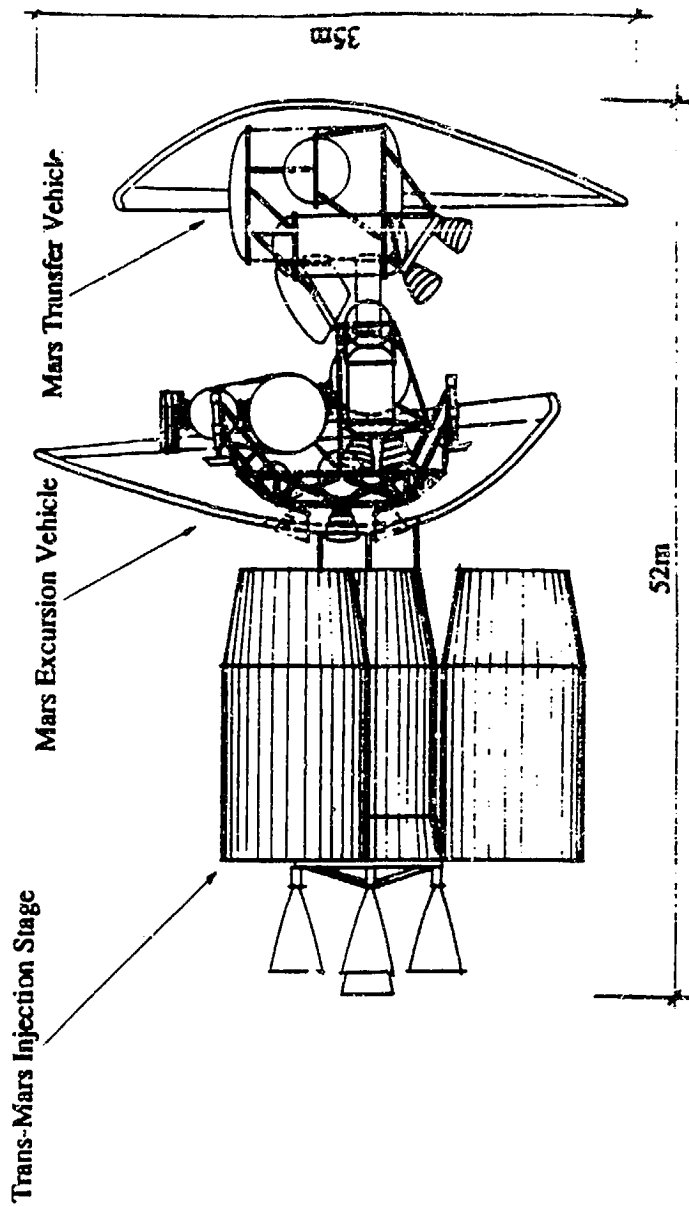

Mass for Option 2

MTV	138.7
MEV	83.6 t
TMIS	517.1 t
Total IMEO	739.4 t

Mass for Option 1

MTV	138.7 t
MEV	79.0 t
TMIS	509.8 t
Total IMEO	727.5 t



Mission Vehicle Commonality

BOEING

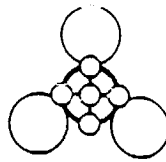
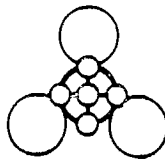
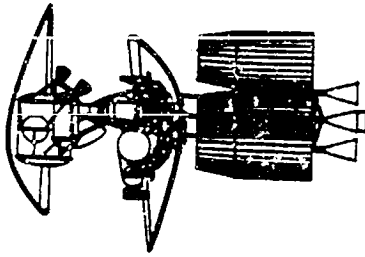
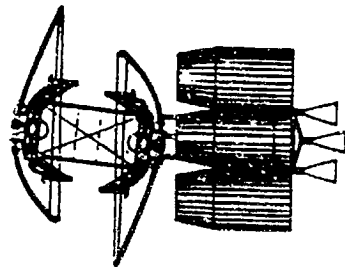
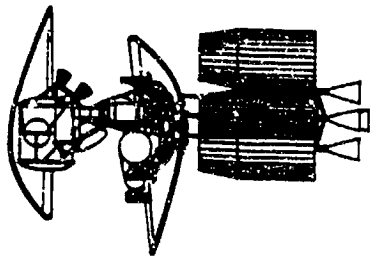

2015 Crew (Opposition)

- Reference configuration
- (4) tank sets, (5) engines

MEV	81
ECCV	7
Crew System	36
TEIS	89
MTV Acrobate	21
TMIS	490
Total IMEO	724t

2017 Cargo

- (2) 59t capacity cargo landers
- No MTV, no TEIS
- (3) tank sets, (3) engines

MEV's	163
Nav-kit	10
TMIS	360
Total IMEO	\$33t

2018 Crew (Conjunction)

- Extra provisions
- (4) tank sets (offload:d), (5) engines
- Aeroshell reused at Earth

MEV	90
ECCV	7
Crew System	48
TEIS	70
MTV Acrobate	21
(1 re-use)	
TMIS	340
Total IMEO	\$76t

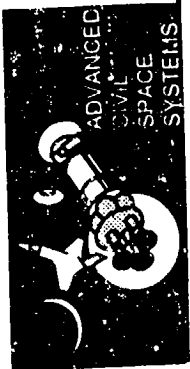

Mass Comparison for Reference Missions

BOEING

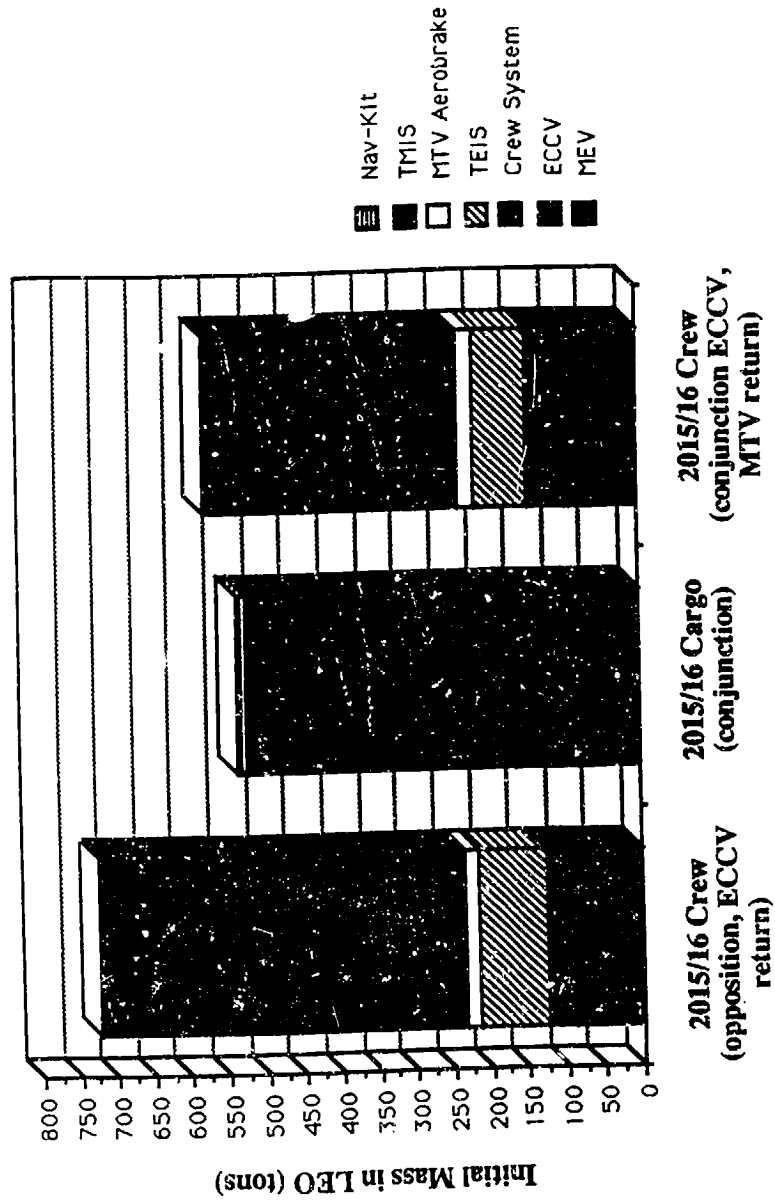



Advanced Propulsion

BOEING

Advanced propulsion options exist that could provide benefits in terms of reduced mass requirements, trip times, or both, relative to chemical propulsion.

Options considered:

Solar Electric Propulsion (SEP)
Nuclear Electric Propulsion (NEP)
Solid Core Nuclear Thermal Rockets (NTR)
Gas Core Nuclear Thermal Rockets (GCR)

The impact of these options upon a single Mars mission has been assessed; However, a fully integrated mission scenario must be developed to most effectively utilize these systems over the Lunar/Mars initiative.



Propulsion Option Size Comparison

BOEING

Space Station Freedom

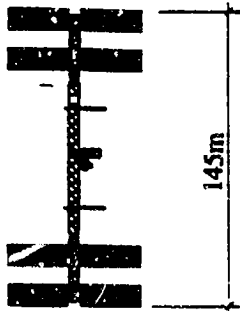

Solar Electric Power (SEP) Option

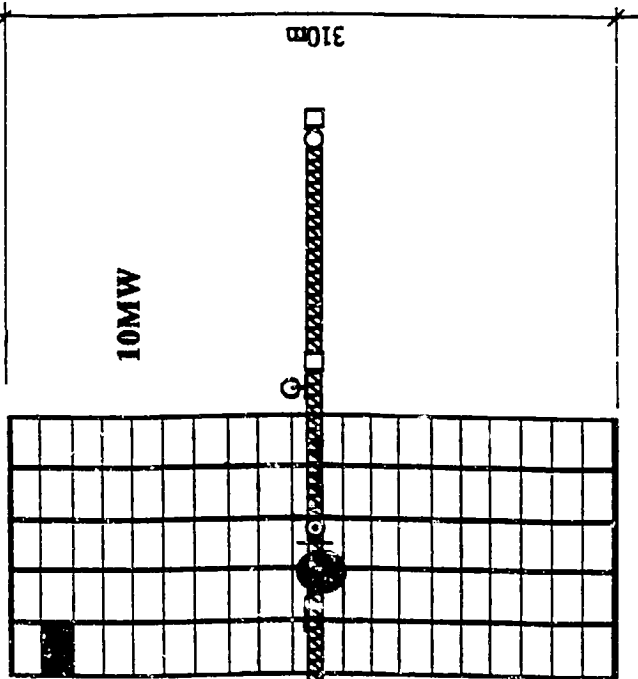

Nuclear Electric Propulsion (NEP) Option

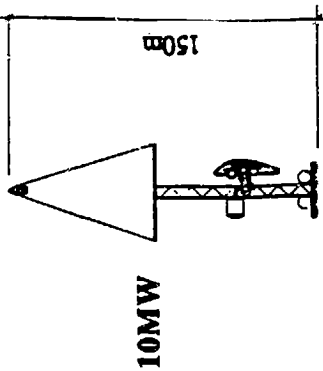

Nuclear Thermal Rocket (NTR) Option

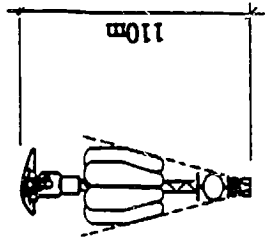

Gas Core Reactor (GCR) Option

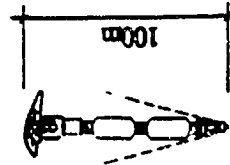

Cryogenic Reference

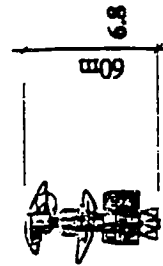



MTV Propulsion Option Weights For Mission Favorable Opportunities

BOEING

2015-16 Opposition

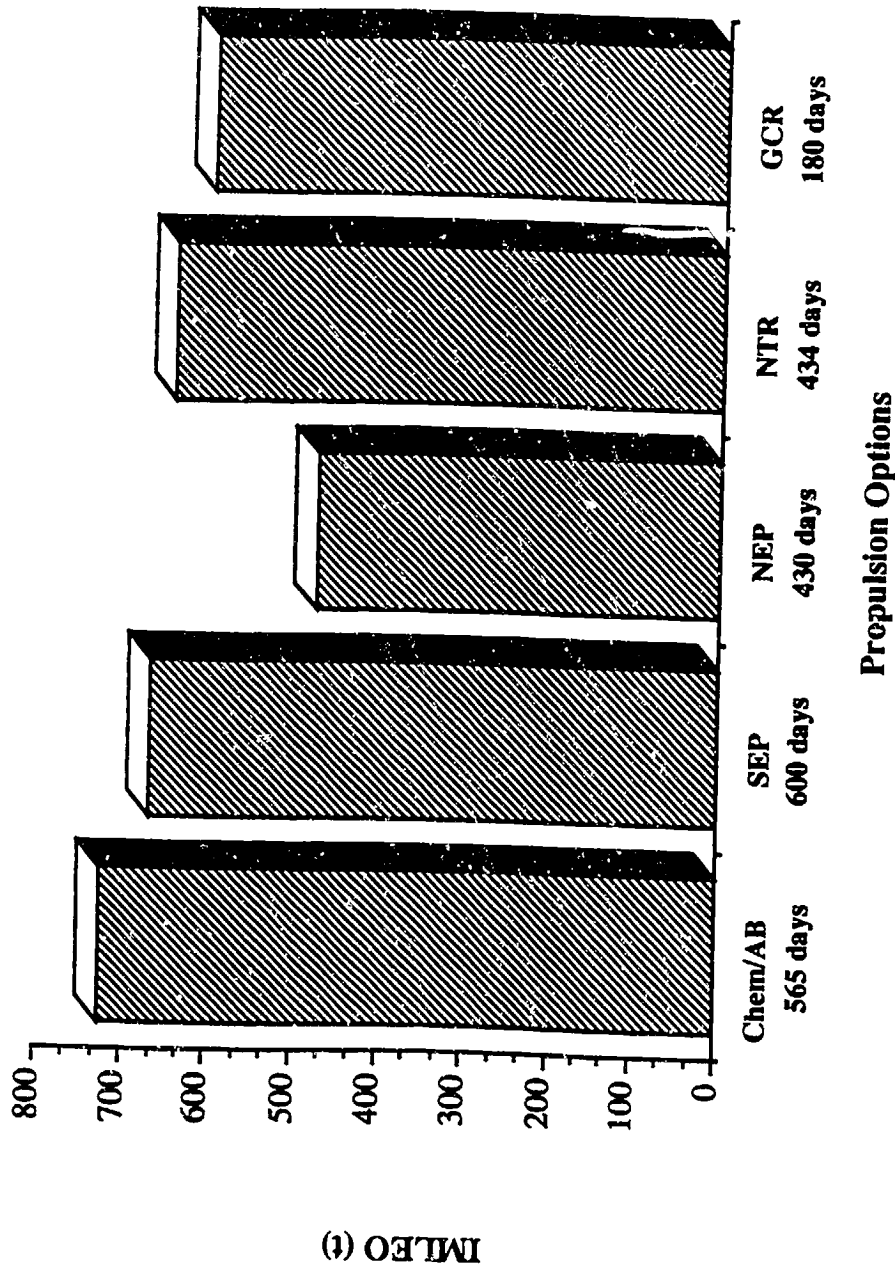



Propulsion Options Comparison - LeRC

BOEING

**Propulsion Options Mass Comparison
Reference Mission**

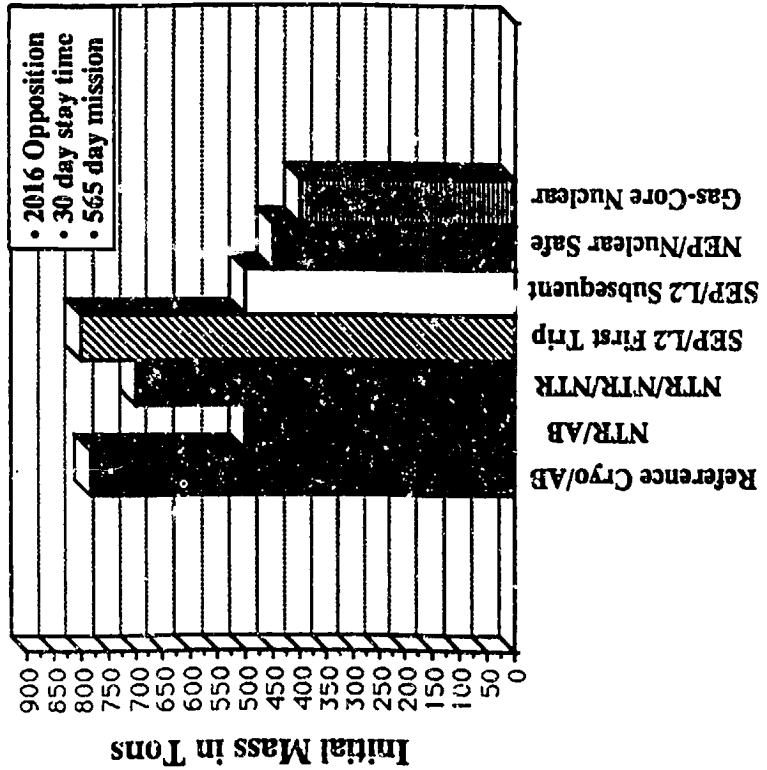

**Trip Times at Constant IMLEO
Propulsion Options Mass Comparison**

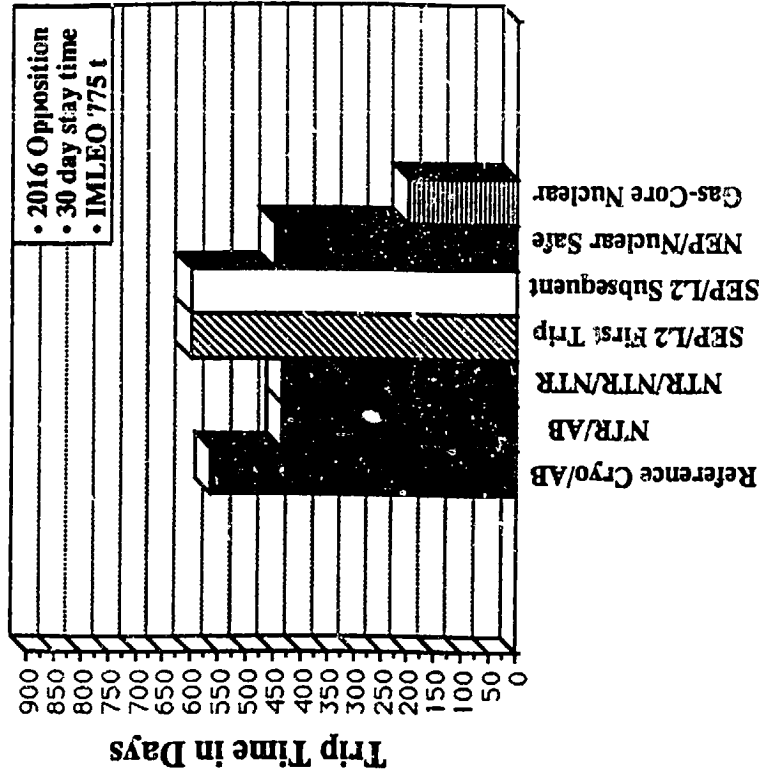

Mars Transportation Architecture Options

Propulsion/ Vehicle Type	NODE(S)		FUELING/REFUELING	
	Assy at SSF	HEO/L2 Node SSF	Launch Tankers Loaded	Tankers Direct Depot to Vehicle
Cryo/Aerobrake Partially Reusable (Reference)	(1)	(2)	(1 & 2)	
Cryo/Aerobrake Fully Reusable	(3 & 5)	(4)	(3 & 4)	(5)
NTR 900 Isp Staged Tanks & Engines	(6)		(6)	
NTR 1250 Isp Staged Tanks & Engines	(7)		(7)	
NTR 1250 Isp Fully Reusable	(8)	(8)		(8)
GCR Isp 2500 Fully Reusable	(9)	(9)		(9)
SEP Operated from L2	(10 & 12)	(11)	(12)	(10 & 11)
NEP Operated from SSF Orbit	(13)		(13)	
NEP Operated from High Orbit/L2	(14)	(15)	(14)	(15)



Tanker Options for Fully Reusable Systems

BOEING

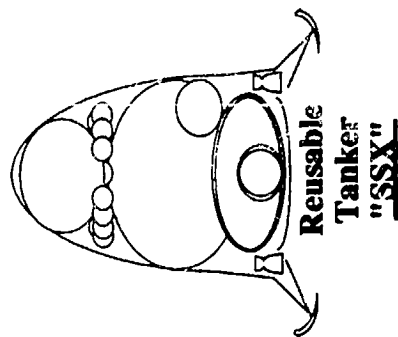
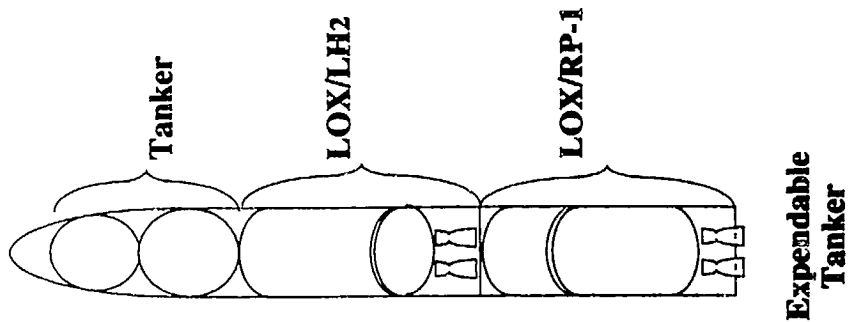
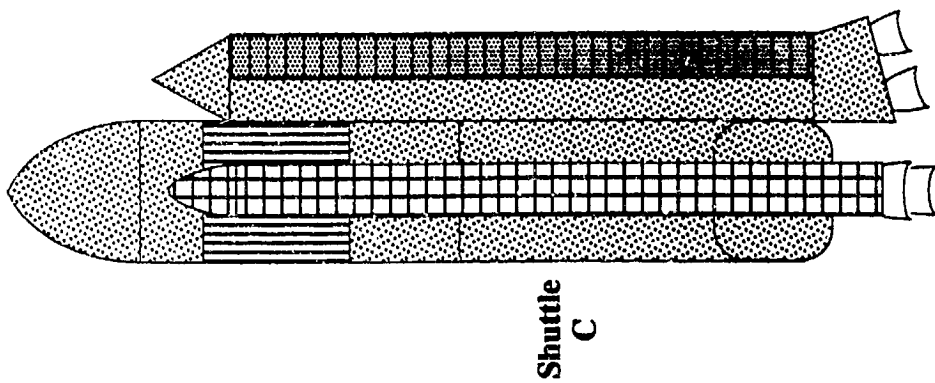



NTR 900 Isp Staged Tanks and Engines, Mode 6

BOEING

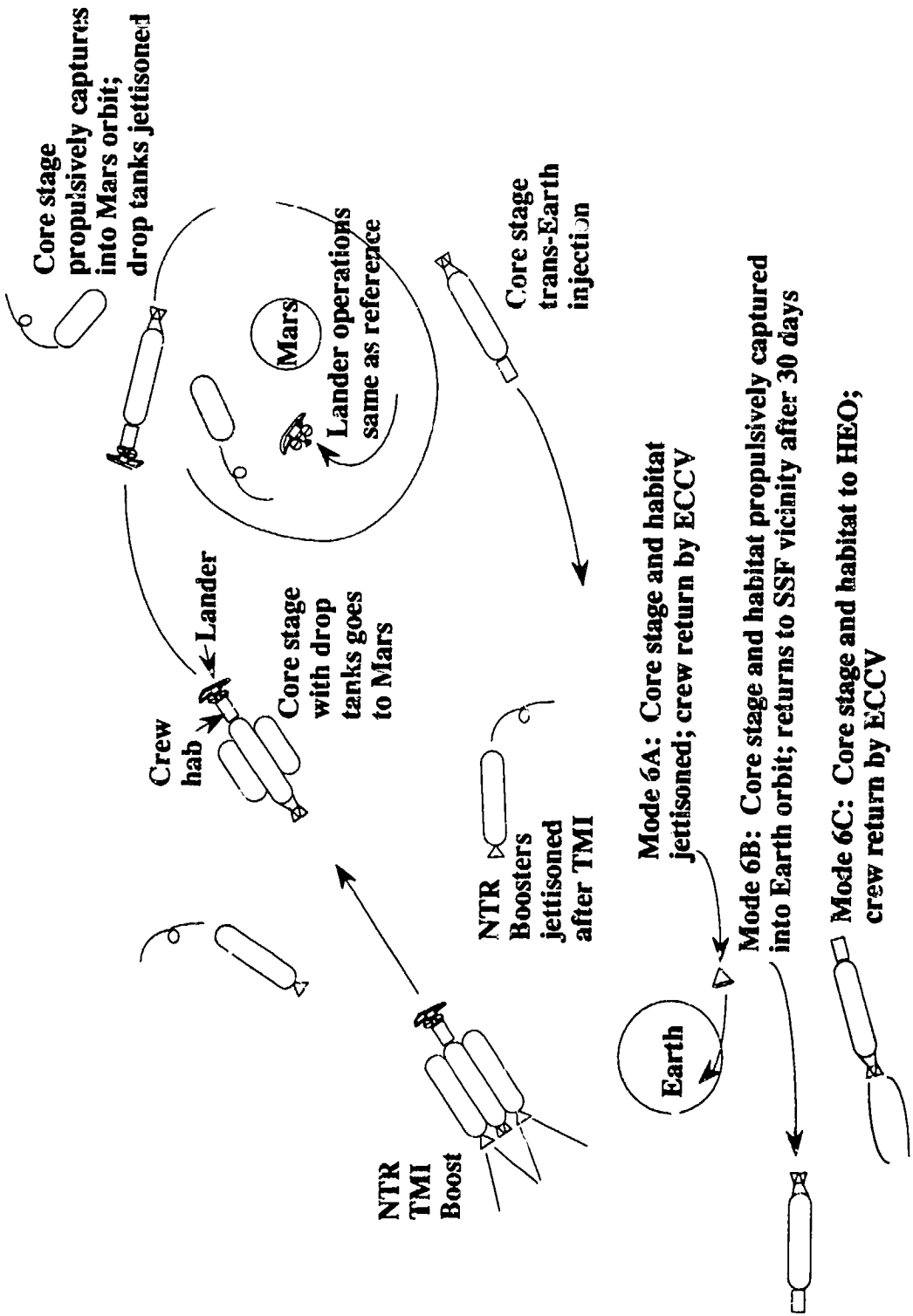



Fully Reusable Cryogenic Aerobraked System, Split TMI Burn (Modes 3 and 5)

BOEING

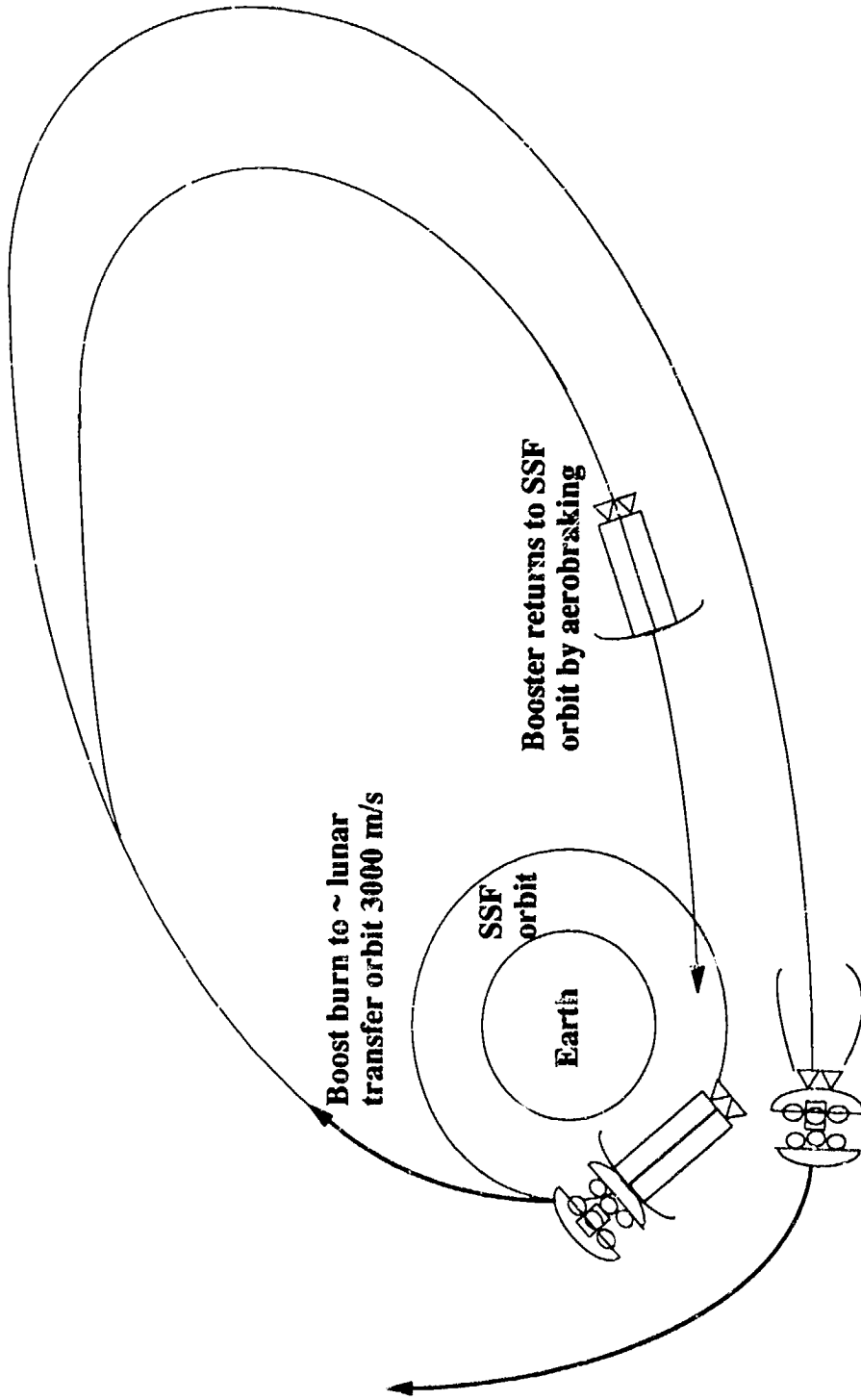

TMI burn ~ 1200 m/s, uses MTV propulsion with extra tanks.
MEV delivered to Mars and reused there; MTV returns to SSF orbit



NEP Operated from High Orbit, Modes 14 and 15

BOEING

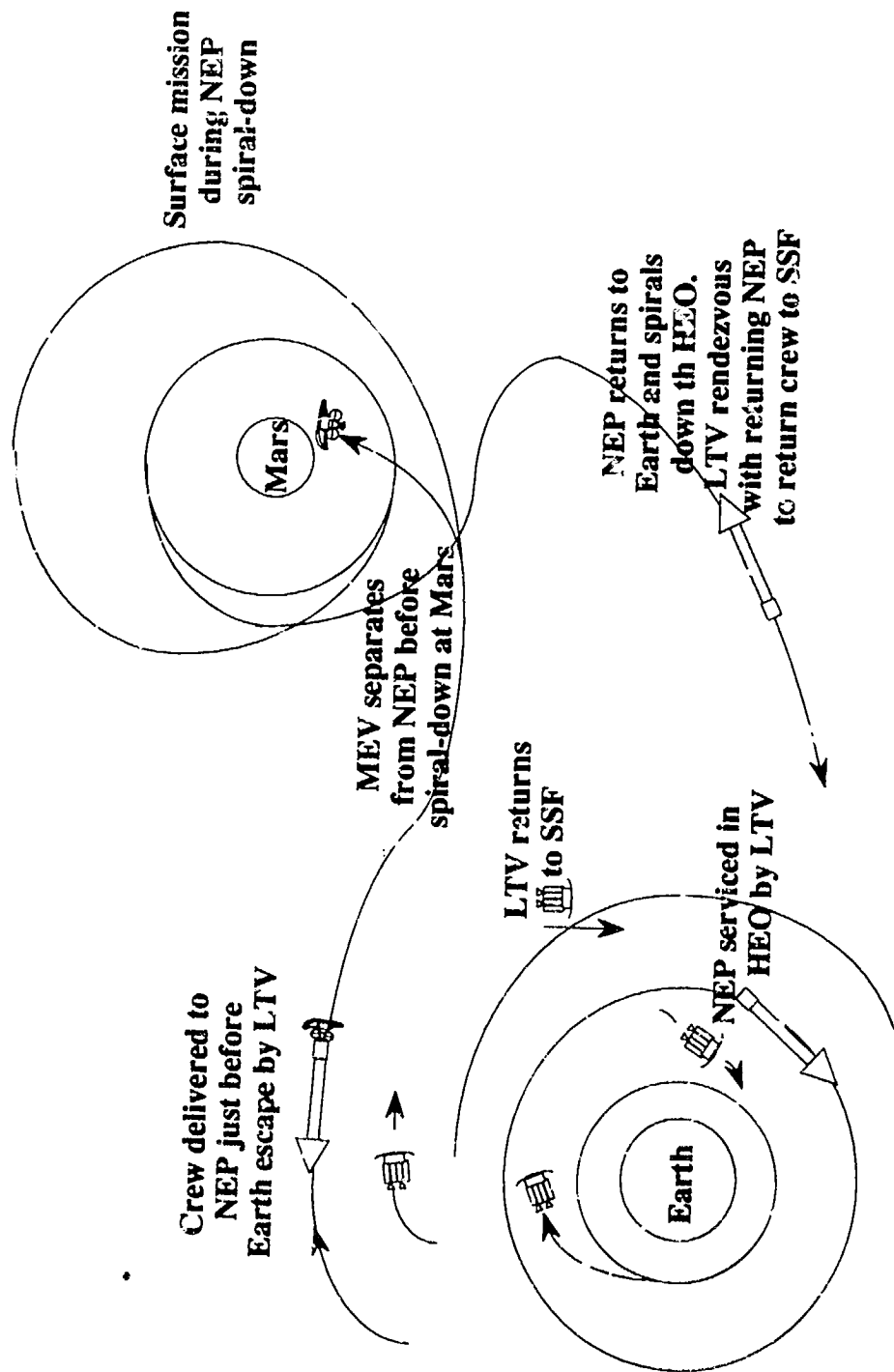

Nuclear Safe Orbit Considerations

- Nuclear safe altitude customarily set at ~ 800 km. for 300-year lifetime.
- This is close to worst possible debris altitude & therefore not acceptable.
- Options:
 - (1) Operate nuclear system from SSF orbit, or
 - (2) Operate nuclear system from a high orbit, above
 - (a) debris environment,
 - (b) High-radiation part of van Allen belt (>5000 km)
- High orbit can be at zero inclination with continuous access, or at SSF inclination, where it suffers differential nodal regression and therefore only occasional accessibility at low ΔV . ~ 1 year at 800 km; ~ 2-3 months at >5000 km.
- While this issue is not resolved, indications are that the high orbit may as well be GEO or L2.

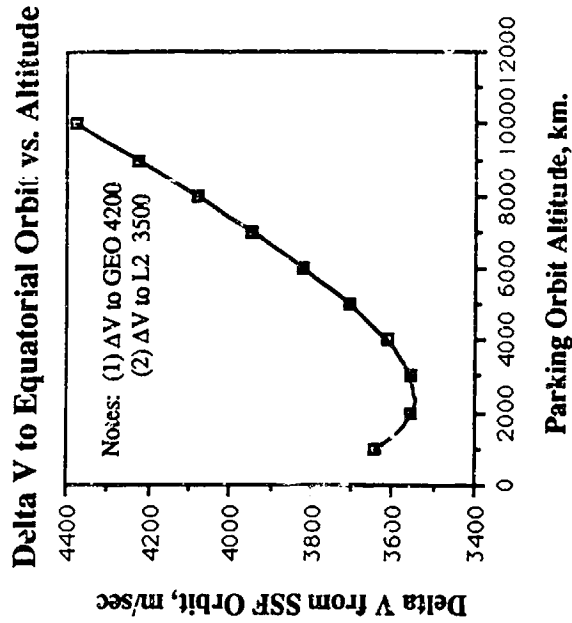

Space Station Fluid Management Logistics

Sam M. Dominick

**Martin Marietta Space Systems
Denver, Colorado**

**Technology For Space Station Evolution-
A Workshop**

January 16-19, 1990

513-18
163627
N93-27799

P-31

MARTIN MARIETTA

Fluid Management Logistics Issues For Space Station Freedom Evolution

Recent changes in the configuration of the Space Station Freedom have resulted in increased logistics requirements. Selection of hydrazine for the propulsion and reboost system, and the changes to the Environmental Control and Life Support System have resulted in increased fluid resupply requirements. Coupled with this are future increases in fluid logistics requirements to support Station growth, and propellant storage and resupply requirements to allow Freedom to serve as a transportation node for future Lunar and Mars missions. These requirements will result in fluid resupply becoming an increasingly important part of Space Station Freedom operations. Development of automated fluid transfer operations and weight efficient fluid logistics carriers, designed to be compatible with several launch vehicles, will be required.

Fluid Management Logistics: Issues For Space Station Freedom Evolution

- **Recent Design Changes Have Increased Fluid Logistics Requirements**
 - Hydrazine Propulsion System Selection
 - Open-Loop Environmental Control/Life Support System
- **Space Station Freedom Evolution Will Require Expanded Capability For Fluid Transport And Fluid Transfer Systems**
 - Station Growth
 - Use As Lunar/Mars Transportation Node
- **As Station Evolves, Fluid Resupply/Transfer Operations Will Take Larger Portion Of Crew Time And Launch Resources Requiring A System-Level Approach To Optimizing Fluid Logistics**
 - Minimization Of Operations
 - Automated Fluid Transfer Operations
 - Weight Efficient Tankers

Current Fluid Logistics Approach

The current logistics approach for resupplying fluids to the Space Station Freedom consists of an Unpressurized Logistics Carrier containing smaller subcarriers with the fluid tanks and hardware. The Unpressurized Logistics Carrier is designed for STS-launch compatibility only and for reusability. The Freedom propulsion and reboost system utilizes four propulsion modules with a capacity of 10000-12000 lbs of hydrazine each. These modules are self-contained with no capability for on-orbit fluid transfer. They are also designed for STS-launch only and are qualified for ~100 flights. All refurbishment/refueling takes place on the ground.

Current Fluid Logistics Approach

- **Unpressurized Logistics Carrier Using Sub-Carriers For Fluid Resupply; Designed For Reusability (~100 Flights) And For STS Launch Only**
- **Hydrazine Propulsion/Reboost System**
 - **Resupply Via Changeout Of Modules**
 - **No Capability For Orbital Refueling; Modules Refueled/Refurbished On Ground**
 - **Designed For STS Launch Only (15 Ft Diameter)**
 - **Module Capacity 10000-12000 lbs**

Evolution Of Space Station Freedom Fluid Resupply

To satisfy the requirements for Space Station Freedom evolution, launch vehicles other than the STS must be employed. Launch vehicles that are being considered for use in future Freedom operations include Shuttle-C, Titan III and Titan IV, and the Advanced Launch System (ALS). The current STS-based Logistics elements will not be adequate to satisfy future fluid resupply requirements. More capacity will be required as well as the ability to transport large quantities of liquid hydrogen and liquid oxygen for Lunar/Mars mission support. In addition to increased fluid resupply requirements, fluid waste disposal requirements will likely increase as well. To meet these expanding requirements, fluid logistics elements of increased capacity and with launch compatibility with a variety of future Expendable Launch Vehicles will be required. In addition, totally expendable fluid resupply carriers can offer advantages, particularly in waste fluid disposal, that should be considered.

Evolution Of Space Station Freedom Fluid Resupply

- **Launch Vehicle Options Must Necessarily Expand Beyond STS To Satisfy Future Station Evolution (e.g. Shuttle-C, ALS, Titan Family)**
- **STS-Based Fluid Transportation/Resupply Systems Not Adequate For Station Evolution**
 - **More Capacity Required**
 - **Liquid Hydrogen/Liquid Oxygen Transportation For Lunar/Mars Support**
- **Waste Fluid Disposal May Become More Critical As Station Grows**
- **Fluid Transport And Resupply Systems Compatible With Multiple Expendable Launch Vehicles Desirable For Manifesting Flexibility**
- **Design Of Expendable Fluid Transport/Resupply Systems Offer Advantages In System Complexity And Operations That Should Be Considered**

Launch Vehicle Evolution

Current and planned launch vehicles that could support Space Station Freedom evolution are shown. The Advanced Launch Vehicle (ALS) is not shown due to uncertain development status. However, the Lunar/Mars mission scenarios must have a heavy lift vehicle such as ALS or Shuttle-C.

Launch Vehicle Evolution

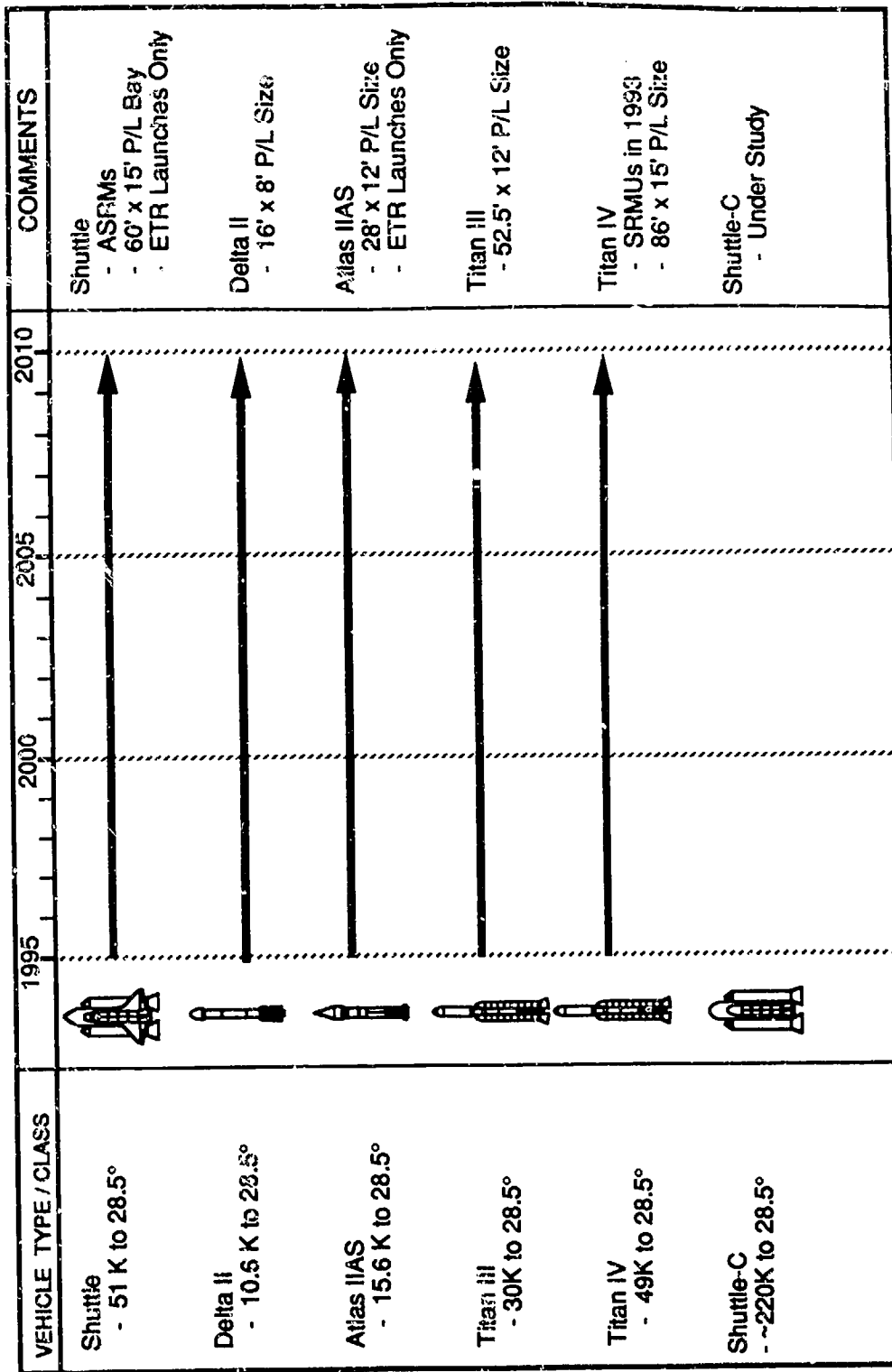

MARTIN MARETTA

ELV Logistics System Approach

The approach to the use of an expendable ELV-based logistics carrier is summarized below. The ELV-based logistics carrier would be used in addition to the STS-based logistics carriers, thus providing an independent resupply capability resulting in additional payload capability to orbit and a reduction in STS manifesting. Also, the system, designed for the outset to be expendable, could be used as a waste disposal system with the capability to de-orbit more payload than it orbits (described later). The modular design of the carrier would allow resupply missions to be tailored according to specific needs.

ELV Logistics System Approach

- Utilizes ELV Instead Of A "Shuttle Only" Logistics System
- Provides An Independent Resupply Capability For Space Station And/Or Polar Orbit Systems
- Reduces Shuttle Manifest Crowding
- Provides Additional Capability To Resupply Fluids, ORU's, Dry Goods Containers And Enhances The Capability To Dispose Of Liquid And Solid Waste
- Increases System Flexibility For Resupply Of Fluids
- Reduces Space Station Mass Buildup Problem With The Capability To Deorbit More Weight (Waste/Trash) Than It Brings Up
- Modular Design Accommodates Special Logistics Mission Requirements
- Utilizes Low Cost "Throw Away" Logistics Carrier Approach - Trades Expendable Fluid Carrier Recurring Costs Versus Return/Refurbishment Costs Of Reusable Carrier

Logistics Carrier Configuration

The overall configuration of the ELV-based expendable logistics carrier is shown below. The carrier consists of subelements for fluid/propellant resupply and dry goods resupply. The fluid module is used to resupply nitrogen, water, and high pressure gases. The propellant module contains hazardous propellants such as hydrazine for resupply of the Freedom propulsion system and the Orbital Maneuvering Vehicle (OMV). One end of the carrier contains a mounting interface with the ELV and OMV payload adapters and the opposite end a standard Space Station interface, containing all of the fluid and electrical umbilicals. The dry goods carrier can resupply both pressurized and unpressurized cargo. Pressurized cargo is accommodated in pressurized containers that are equipped with grapple fixtures to allow removal by the Space Station manipulator arm for transfer to the pressurized modules. The carrier can be flown in varying configurations such as all fluids/propellants or all dry goods or both.

Logistics Carrier Configuration

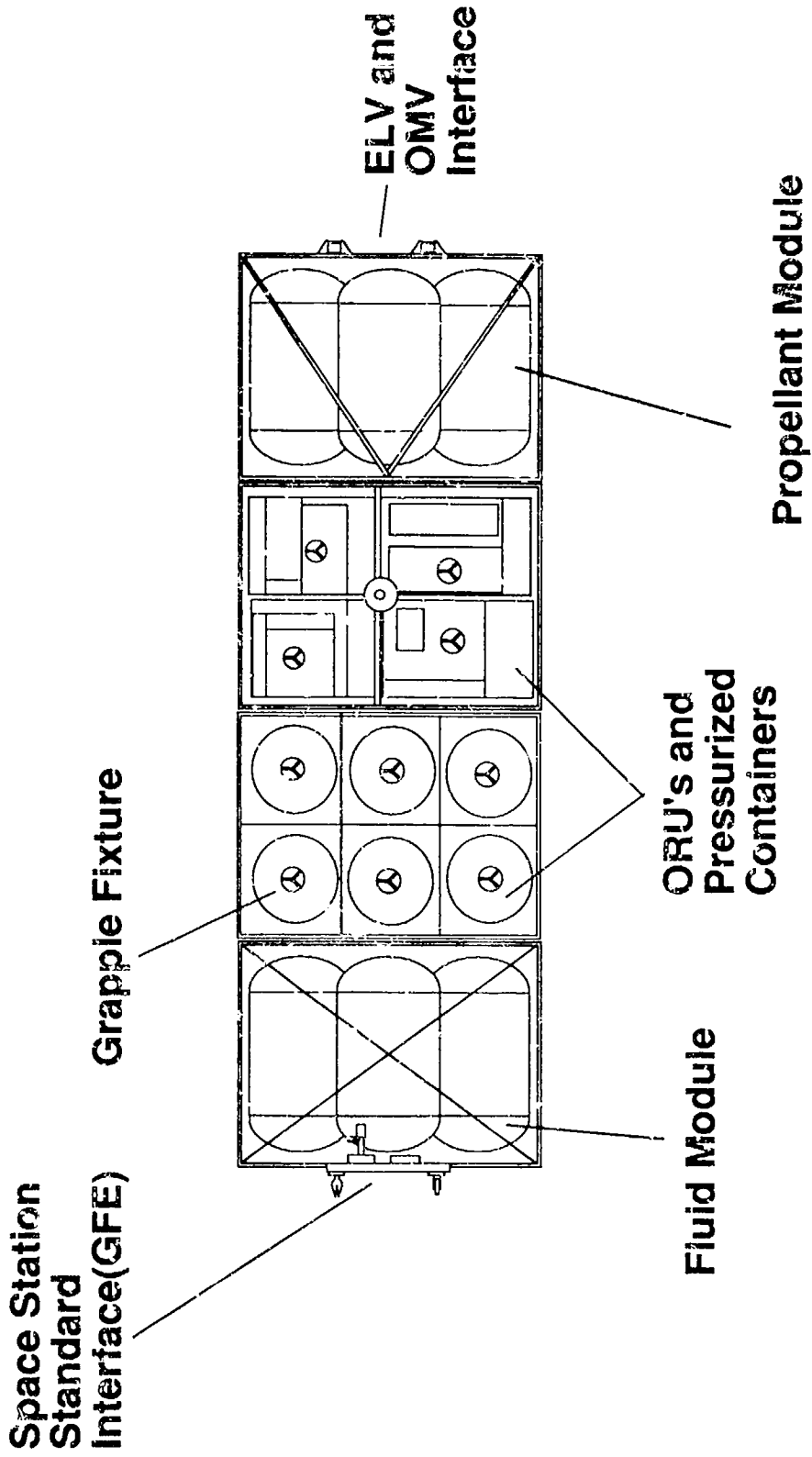

MARTIN MARIETTA

Expendable Fluid/Propellant Carrier Description

The key design features of the fluid/propellant carrier are summarized below.

Expendable Fluid/Propellant Carrier Description

- **Modular Design To Accommodate High Pressure Gas And Liquid Tanks**
- **Qualified For One Flight**
- **Utilizes Existing Tanks**
- **Welded Aluminum Truss Structure With Ample Design Margins**
- **Minimum Avionics And Power Subsystems - Uses Freedom-Provided Resources**
- **Passive Thermal Control (Blankets And Coatings)**
- **Space Station Freedom Avionics Controls All Orbital Fluid Transfer Operations**
- **Equipped With Common Interface Hardware (Umbilicals, Mechanisms, etc.)**
- **Interface Provided To Accept Waste Fluids From Stations Subsystems**
- **Man-Rating Achieved By Combination Of On-Board And Station-Based Components**

Fluid Carrier Design Concept

The configuration of the fluid/propellant carrier is shown below. The accompanying table summarizes the total carrier weight. The fluid/propellant carrier is designed to fit within a typical ELV payload fairing (≥ 12 ft. dia meter). Up to six tanks carried with a total capacity of 6000 lbs of hydrazine or water, resulting in a mass fraction of 0.77. Space is provided for high pressure gas bottles although these would not be required if Space Station-supplied nitrogen is available or if Station-based pumps are used to transfer the fluids. A minimum of electronics is carried to interface with the Station avionics system which would monitor and control the carrier.

Fluid Carrier Design Concept

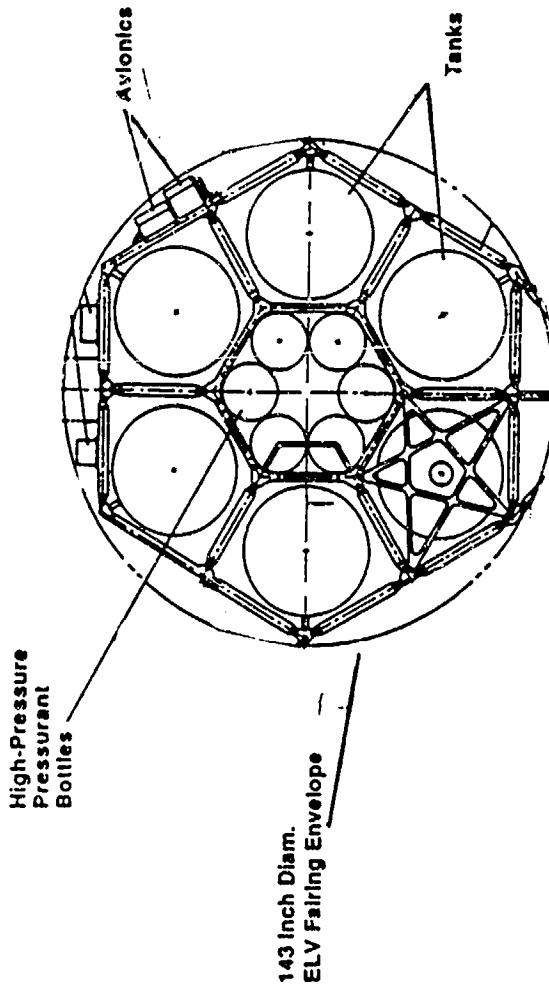

Subsystem	Weight, lbs
Fluids Carrier	81
• Thermal	350
• Truss Structure	70
• Mechanisms	25
• Avionics	500
• Tanks	50
• Fluid Components	
Propellant Capacity	6000
Total Wet Weight	7766
Mass Fraction	0.77
Dry Goods Carrier	350
• Structure	20
• Mechanisms	50
• Thermal Control	
Mass Fraction	Depends On Cargo Density

MARTIN MARETTA

Expandable Fluid Carrier Schematic

The schematic of the fluid/propellant carrier is shown on the facing page. For clarity, only two of the six tanks are shown. Since the carrier is launched on an EI V, the STS requirement of two failure tolerance to leakage in the payload bay is not required. However, once the carrier is attached to the Space Station, full man-rating will be required. This redundancy is achieved by considering that the carrier is part of an overall fluid storage and transfer system. Man rating is obtained by the use of on-board components and Station-based components. Two fluid interfaces are provided, one for fluid transfer to the Space Station Freedom, and one for transfer to the carrier of waste fluids. The waste fluid interface would be kept dry by valving on the Station side of the interface until the carrier is empty to avoid contamination of the supply fluid. Once done, the waste fluid is transferred into the carrier until full.

Expendable Fluid Carrier Schematic

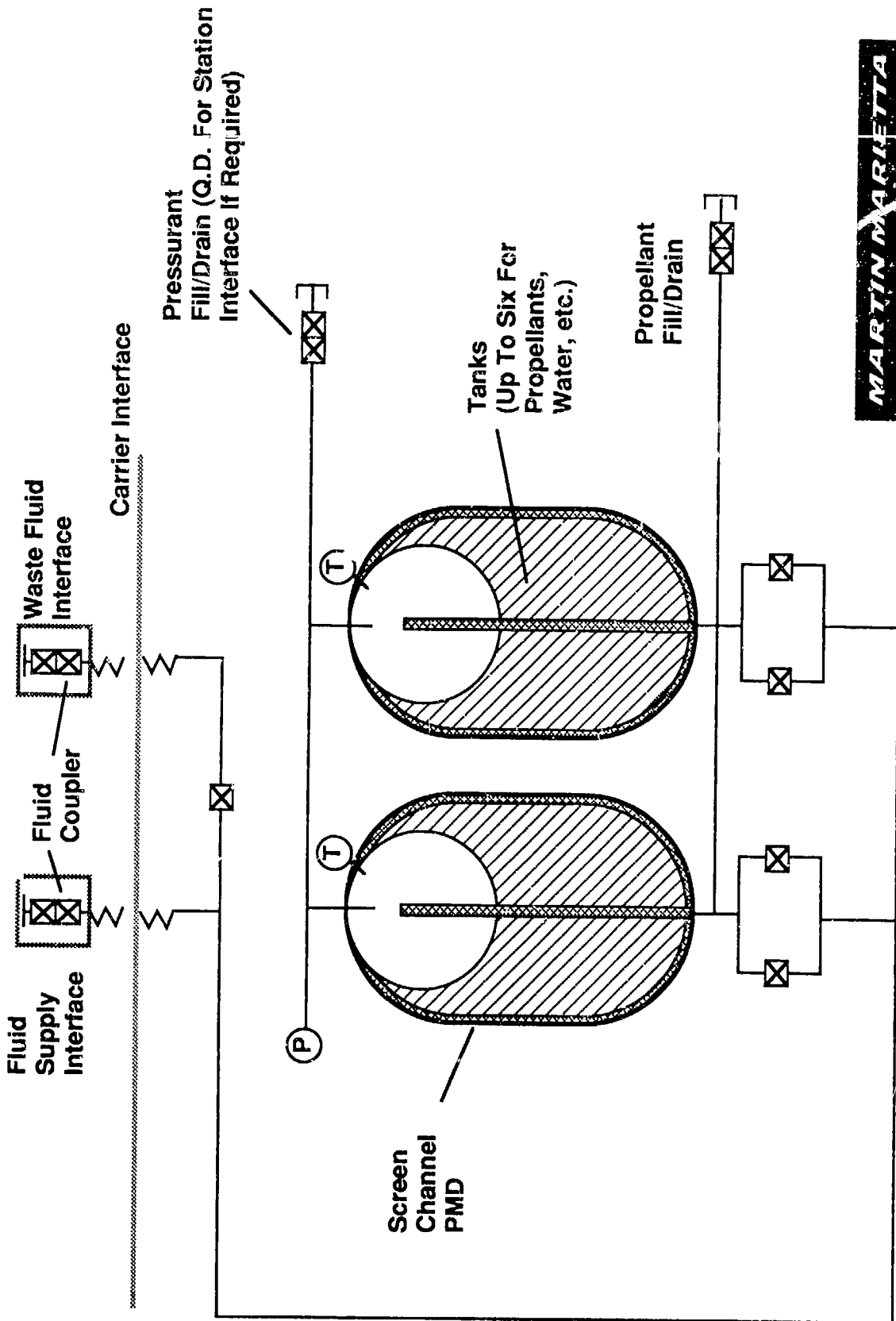

MARTIN MARIETTA

Logistics Carrier Orbital Operations

The orbital operations for the expendable logistics carrier begin by launch directly into the Space Station orbit by the ELV second stage or upper stage. The OMV, carrying a used carrier filled with waste fluids and trash would rendezvous and trade carriers with the ELV stage. The would be accomplished by deployment of the carrier from the ELV via a spring-type release mechanism and attachment of the old carrier to the ELV by the OMV. The OMV would then dock to the new carrier and transport it to the Space Station. The ELV second stage would then reignite, deorbiting itself and the old carrier for disposal in the ocean. Considering the Titan III as the launch vehicle, a carrier weighing 24000 lbs could be launched to the Station and an old carrier weighing 30000 lbs could be deorbited. Therefore, use of the expendable logistics carrier allows both consumables and waste fluids/trash to be handled on a single ELV launch.

Logistics Carrier Orbital Operations

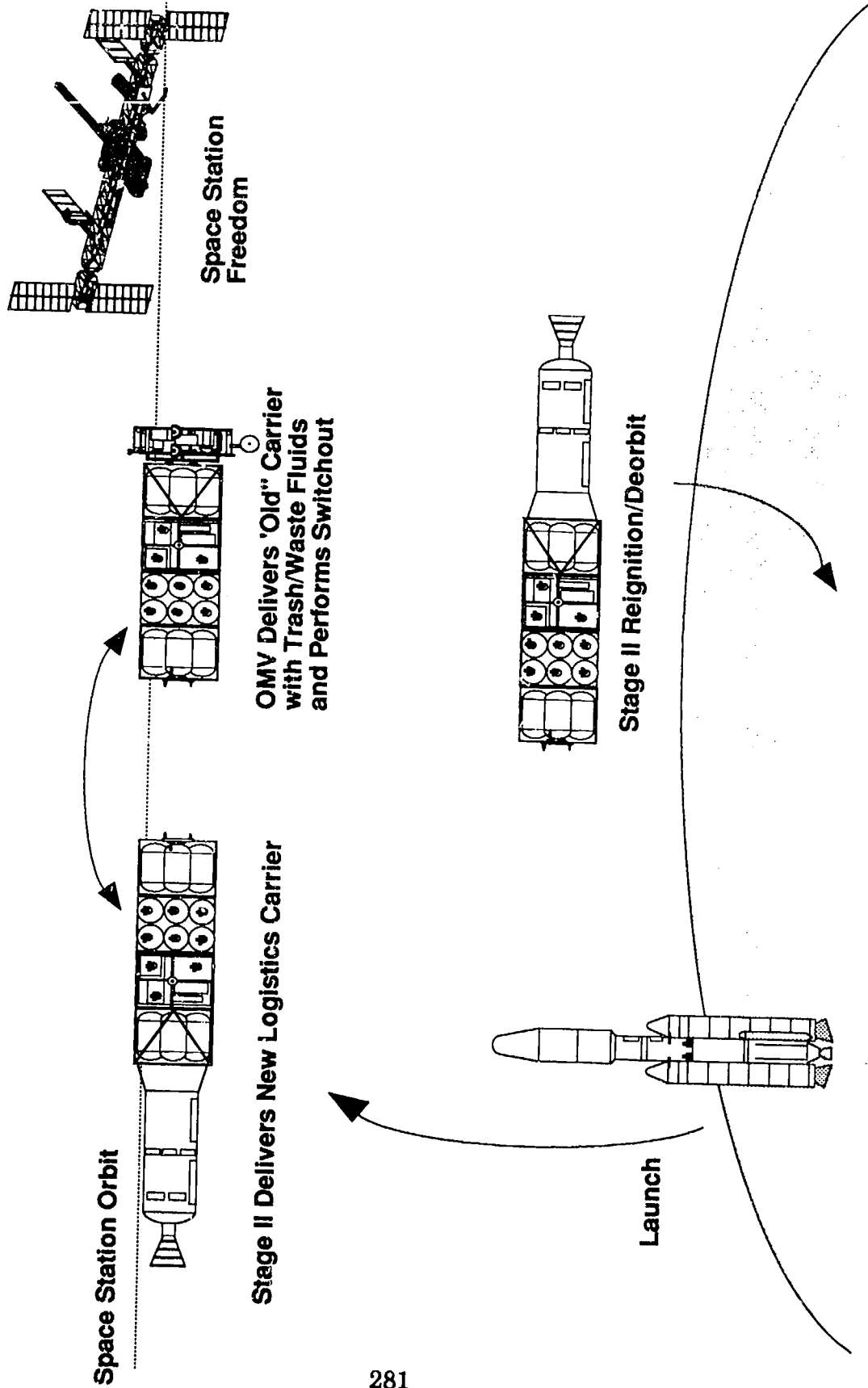

MARTIN MARIETTA

Carrier Operations At Space Station

Operations of the expendable logistics carrier begin with attachment of the carrier to the Station truss assembly by the Station Manipulator Arm or by directly by the OMV. After mating of the fluid and electrical couplings, the fluid transfer operations would occur as required using Station avionics for control and monitoring. Simultaneously, dry goods would be transferred as required into the pressurized modules or to the truss structure either by the manipulator arm or by the Flight Telerobotic Servicer. Transfer of appropriate waste fluids into the fluids/propellant carrier would be performed as required. The carrier would remain attached until the next logistics carrier is launched.

Carrier Operations At Space Station

- Carrier Docked To Station Truss Via Station Manipulator Arm
- Fluid/Electrical Umbilical Mating
- Fluid Transfer Operations As Required
- Dry Goods Transfer To Pressurized Modules Via FTS Or Manipulator Arm
- Waste Fluid Transfer Into Empty Carrier Tanks
- Transport To ELV For Disposal By OMV

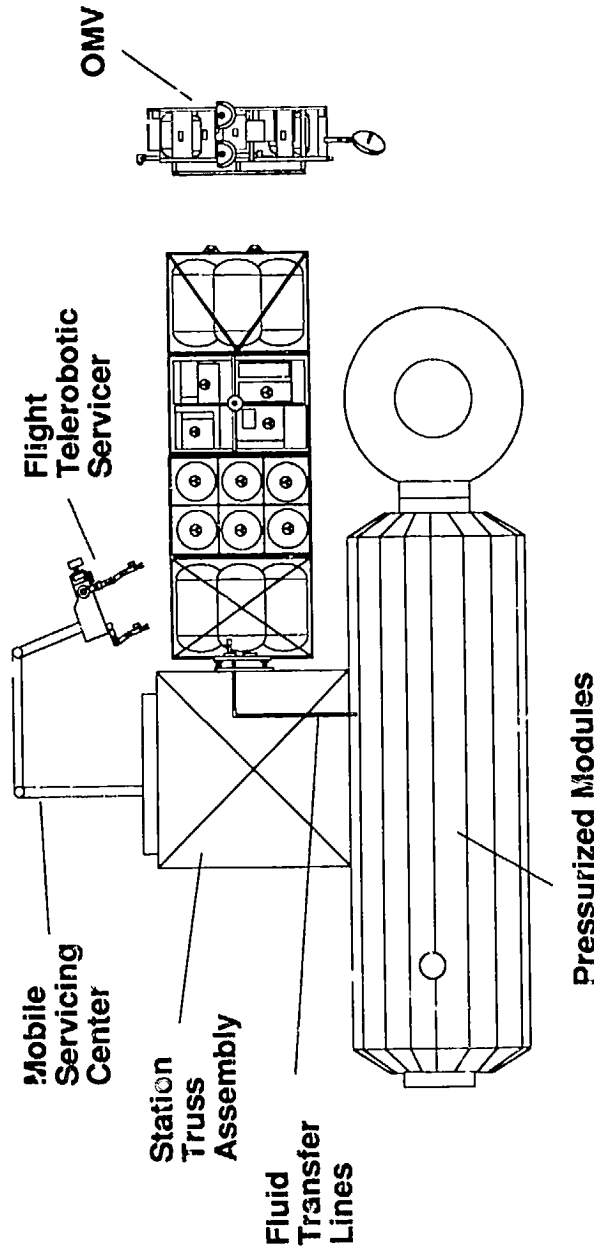

Summary/Status Of Orbital Fluid Transfer Techniques

As stated in an introductory chart, simple techniques for the transfer of fluids on-orbit must be developed that will lend themselves to automatic control due to the probability of limited crew time. The fluid transfer technique is a key driver in the configuration of the fluid resupply system, including the logistics carrier. The facing page summarizes the state-of-the-art in fluid transfer techniques, including the processes involved and the status concerning testing, analysis, etc. The three categories shown, "no-vent" fill, ullage transfer, and vented fill, are broad categories only. Specific fluid resupply systems have been proposed that use variations of these techniques, but generally they fall into one of these three categories. Of the three, only the "no-vent" fill technique has been demonstrated on-orbit (hydrazine via the NASA JSC Orbital Resupply System (ORS) flight demonstration and water via the Martin Marietta Storable Fluid Management Demonstration (SFMD) orbital experiment). More orbital testing of these techniques via a system-level demonstration is required to support fluid logistics evolution. Also, development of software to automatically control and monitor the fluid transfer process (particularly for large systems) will be required. Simplification of the fluid transfer process will be desirable to simplify the software.

Summary/Status Of Orbital Fluid Transfer Techniques

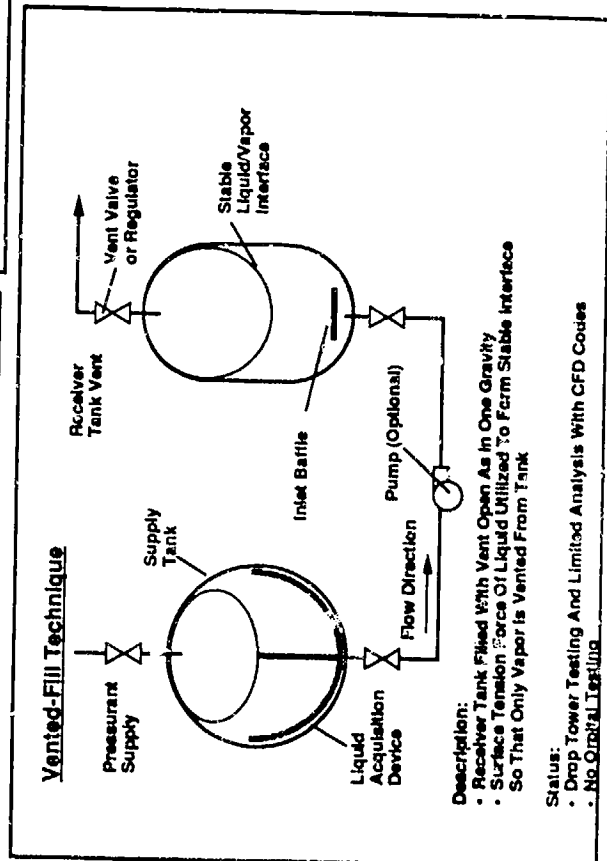
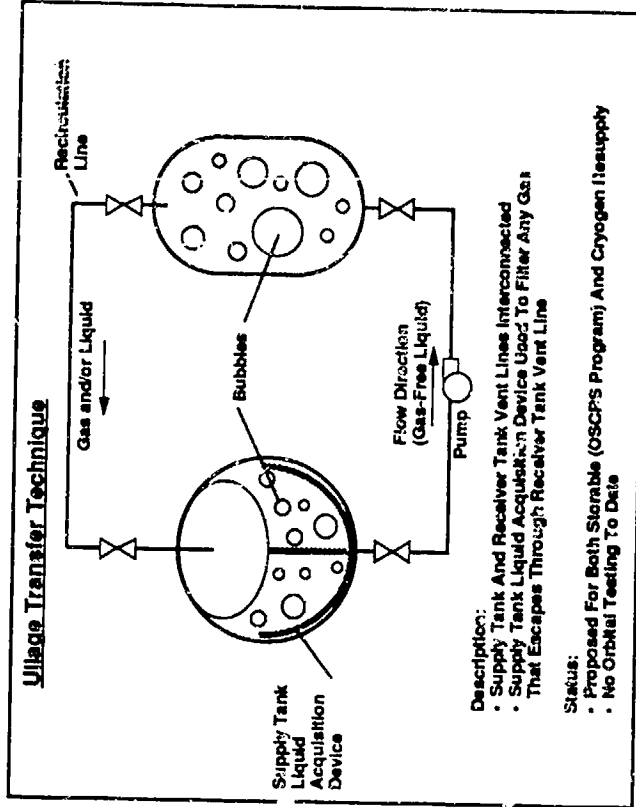
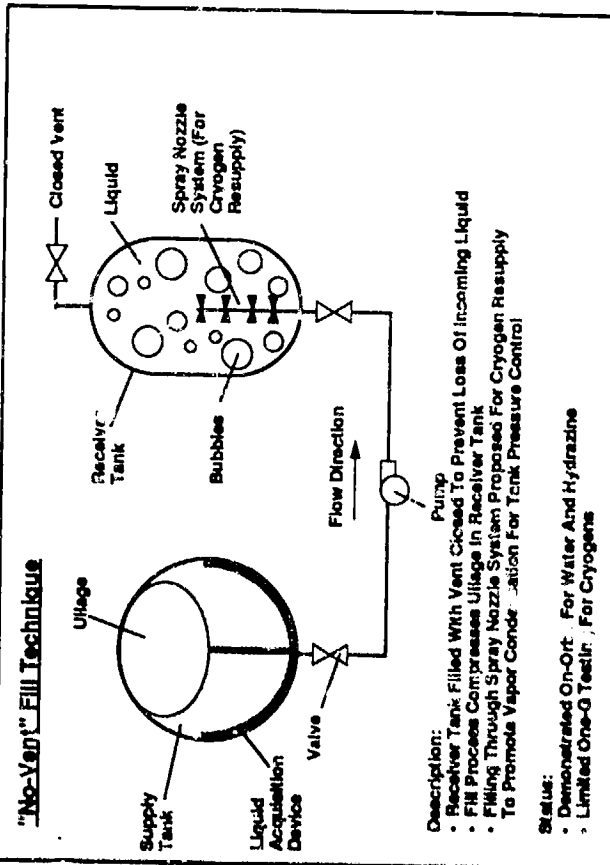

Soviet Progress Tanker System Schematic

The role of an expendable fluid/propellant carrier and operational techniques for fluid transfer can be seen in examination of the Soviet Progress tanker system. The Progress tanker system has been successfully operating for over ten years performing propellant resupply operations in a semi-automatic mode. The unmanned Progress tanker is used to resupply the earlier Soviet Salyut and the current Mir space station's regulated bipropellant propulsion systems as well as resupplying dry goods. The fluid transfer system is shown on the facing page. The Progress/Station fluid interfaces are mated upon docking and are then leak checked via high pressure gas. The fuel and oxidizer couplers are located on opposite sides of the docking ring to maximize physical separation in case of leaks. Both coupler halves are dry during the docking operation. Once the leak check has been completed, a 1 Kw compressor on the Mir is used to reduce the pressure in the station propellant tanks to about 300 psi to allow propellant to be pressure transferred from the Progress tanks. The compressor, with a 10:1 compression ratio, discharges into the station pressurant storage tanks, thereby reusing the pressurant gas. All tanks on the station side and the Progress side utilize a metal bellows (or similar device) propellant management device which prevents contamination of the nitrogen pressurant gas by the propellant, thereby making it safe to recompress. After the pressure reduction has been completed (a process that took several shifts on the Salyut space stations due to power limitations), propellant is then transferred from the Progress tanker; fuel and oxidizer being performed separately for safety. Once propellant transfer operations are complete, the fuel and oxidizer lines are purged using gaseous nitrogen by dumping a small amount of raw propellant overboard. This is done to ensure that, upon Progress undocking, the coupler halves are dry, eliminating concerns over a stuck-open disconnect.

Soviet Progress Tanker System Schematic

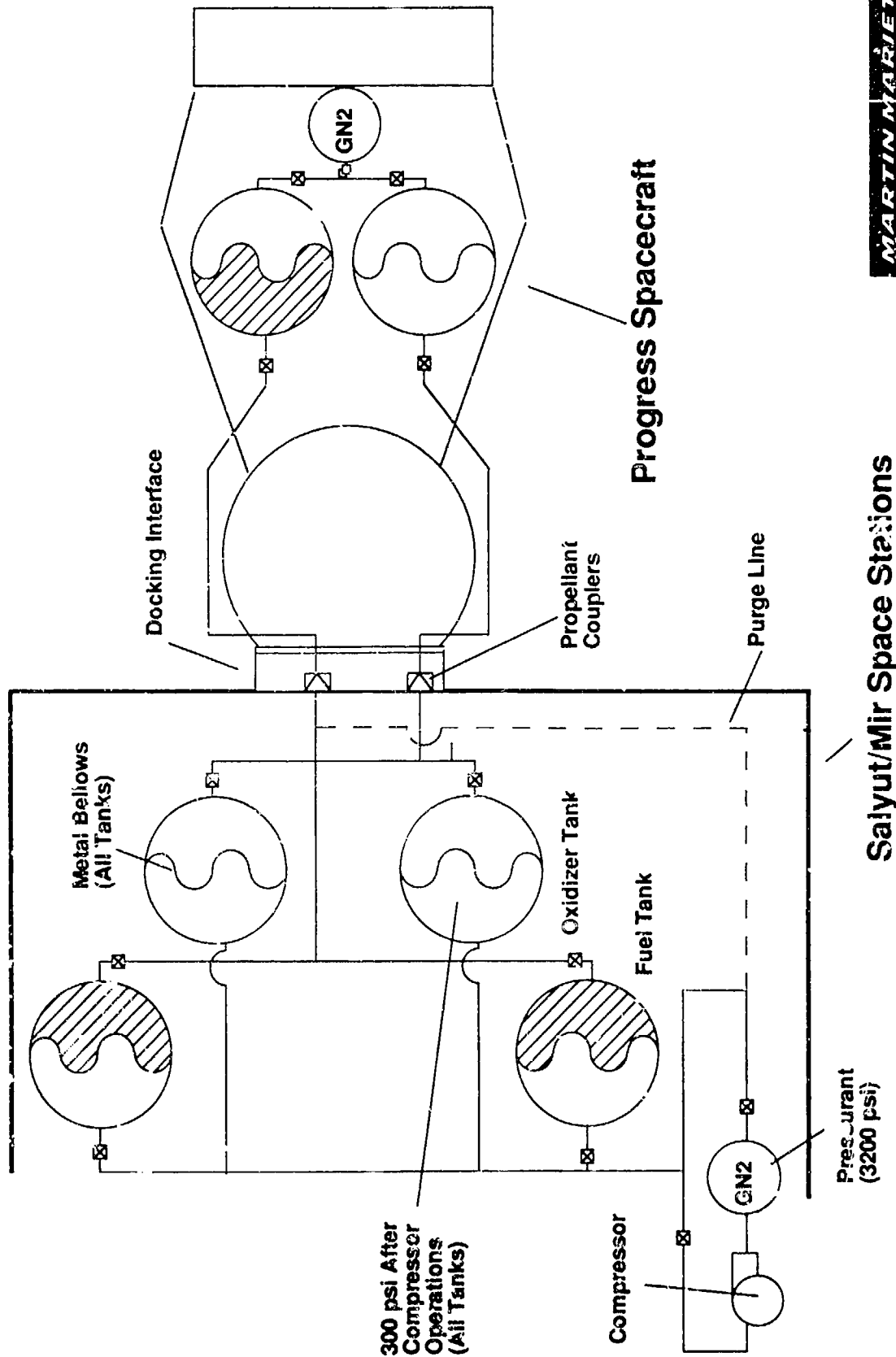

MARTIN MARIETTA

Soviet Propellant Resupply System Observations

Examination of the Soviet Progress tanker system results in several observations as to their philosophy in designing and operating an expendable fluid resupply system. First, the fluid transfer operations are performed without crew involvement unless a contingency occurs. Fluid transfer is performed automatically with the ground controllers monitoring the operations. The Soviets accept a small quantity of vented propellants to prevent mating a wet fluid coupler. This probably results in relatively simple coupler since two-fault tolerance to leaks via three seals is not required. Finally, resupply of pressurant gas has been eliminated by use of the metal bellows propellant management device and the on-board compressor, saving resupply system launch weight at the expense of extra power usage on-orbit.

Soviet Propellant Resupply System Observations

- Soviet Progress Tanker System Operational For >12 Years
- Propellant Transfer Performed Without Crew Involvement Unless Contingency Occurs
- Transfer Of Fuel And Oxidizer Done Separately ; Quick Disconnects Located On Opposite Sides Of Docking Ring For Maximum Physical Separation
- Metal Bellows Device Plus The Compressor Prevents Pressurant Contamination And Allows Reuse Eliminating Need For Pressurant Gas Resupply; Benefits Of A Regulated Propulsion System Are Retained
- Soviets Accept Small Quantity Of Raw Propellant Vented Overboard To Eliminate The Need To Demate A Wet Quick Disconnect; Possibly Results In Simpler Connector (No Triple Redundant Seals)
- Power Consumption Of Compressor (1 Kw) Deemed Preferable To Additional Weight For Pressurant Resupply

Fluid Logistics Evolution - Conclusions

The conclusions reached in this evaluation of Space Station Freedom fluid logistics evolution are summarized below. First, development of fluid logistics carriers that are both expendable and capable of launch on ELY's would provide a needed increase in capacity as well as providing a fluid/trash disposal system. This will be of increasing importance as Station evolution forces an increase in fluid resupply requirements. Launching large quantities of hazardous propellants, particularly cryogenics, on an unmanned vehicle will simply operations and safety concerns. On-orbit fluid resupply techniques and software to automatically transfer fluids are required. An increase in fluid launch capacity may simplify fluid transfer operations by allowing simpler methods to be used. Development and system-level demonstrations of fluid transfer systems including transfer techniques and automated software are needed. Finally, simplification of the fluid logistics elements can be achieved by consideration of man-rating on a system level basis, helping to avoid the need for single components to be two-fault tolerant.

Fluid Logistics Evolution - Conclusions

- Development Of Fluid Logistics Elements With ELV Launch Compatibility
- Expendable Fluid Resupply Systems Provide Attractive Mission Operations Advantages (e.g. Waste Disposal, Less Complexity)
- Use Of ELV's For Evolutionary Fluid Resupply Will Relieve STS Manifesting Concerns; Permits Large Quantities Of Hazardous Propellants To Be Launched On Unmanned Vehicle
- Operational Simplicity May Be Driver For Fluid Transfer Operations Not Minimization Of Fluid Losses During Process
- Fluid Transfer Procedures/Systems Adaptable To Automated Operations (With Manual Override) Need Development And Demonstration
- Fluid Resupply Redundancy/Reliability Should Be Worked At System Level; Avoids Placing Two-Fault Tolerance On Single Components (e.g. Couplers)



THE RESUPPLY INTERFACE MECHANISM

By

Barney F. Gorin

Presented By Stewart Jackson
Fairchild Space Company
Germantown, MD 20874

At

Technology for Space Station
Evolution Workshop

Dallas, Texas/January 16-19, 1990

514-18
163628
N93⁰⁰-231800

WHY SERVICE?



FAIRCHILD
SPACE COMPANY

Spacecraft servicing is much the same as servicing any major asset. We service our plant and equipment, our automobiles, our aircraft - all our major assets - expressly for the economic benefit. Spacecraft Servicing will be done for the same reason. Only the location - and therefore the difficulty of servicing - will change.

The major servicing activities for any major asset are:

- Normal Maintenance
- Consumable Replenishment
- Repair of failed components
- PrePlanned Product Improvement (P3I)

This will be true for spacecraft as well.

SPACECRAFT SERVICING VALUE



FAIRCHILD
SPACE COMPANY

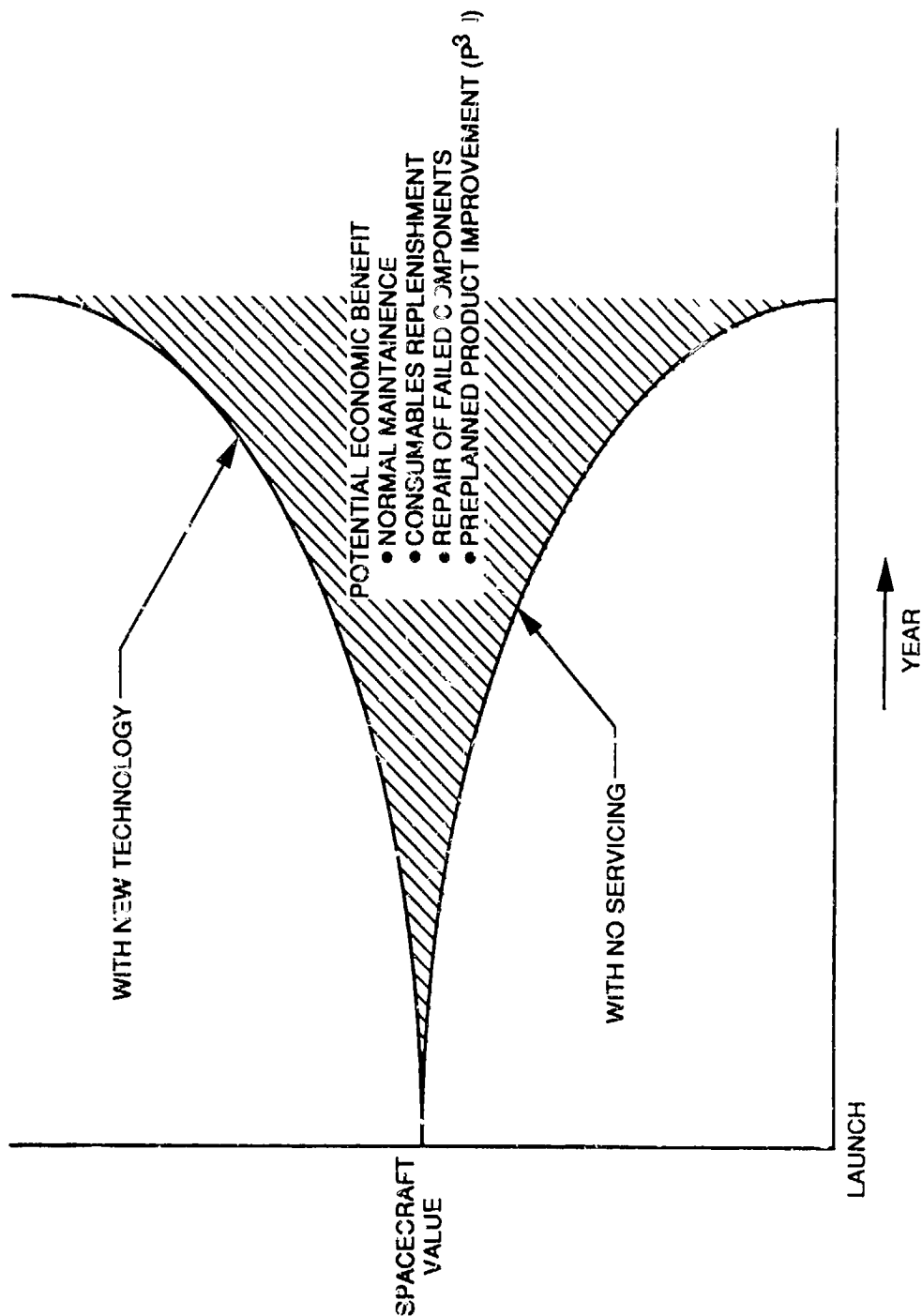



Each of the categories has its own characteristics:

Normal Maintenance

- items with reliably known wear or degradation rates
- In an automobile this includes tires, break pads, belts, hoses and windshield wiper blades.

Consumables Replenishment

- Materials - usually liquids - which are used as a natural part of a mission.
- In an automobile this is gasoline.

Repair of Failed Components

- Murphy lives
- This is why cars come with warranties and we have body shops.

PrePlanned Product Improvement

- The replacement of old technology with new on an existing platform.
- These are most of the year to year car model changes.

SERVICEABLE SPACECRAFT (CONT'D)



FAIRCHILD
SPACE COMPANY

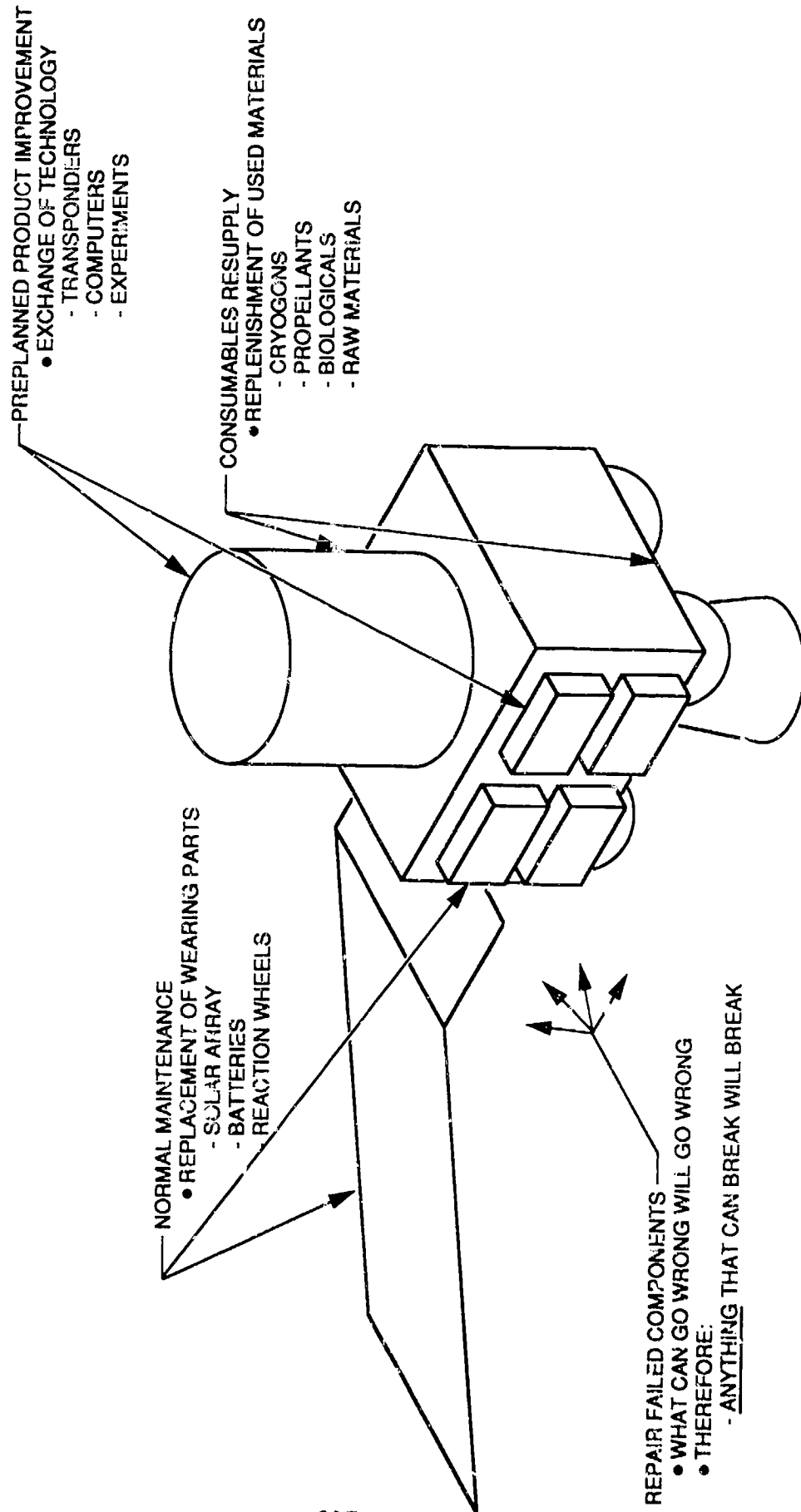

NON-SERVICEABLE SPACECRAFT



FAIRCHILD
SPACE COMPANY

What is the major servicing issue?

What came first? The chicken or the egg?

Spacecraft developers don't want to design servicable spacecraft unless a servicer is available. The potential servicer developers don't want to build servicing equipment for which there are no users.

NON-SERVICEABLE SPACECRAFT



FAIRCHILD
SPACE COMPANY

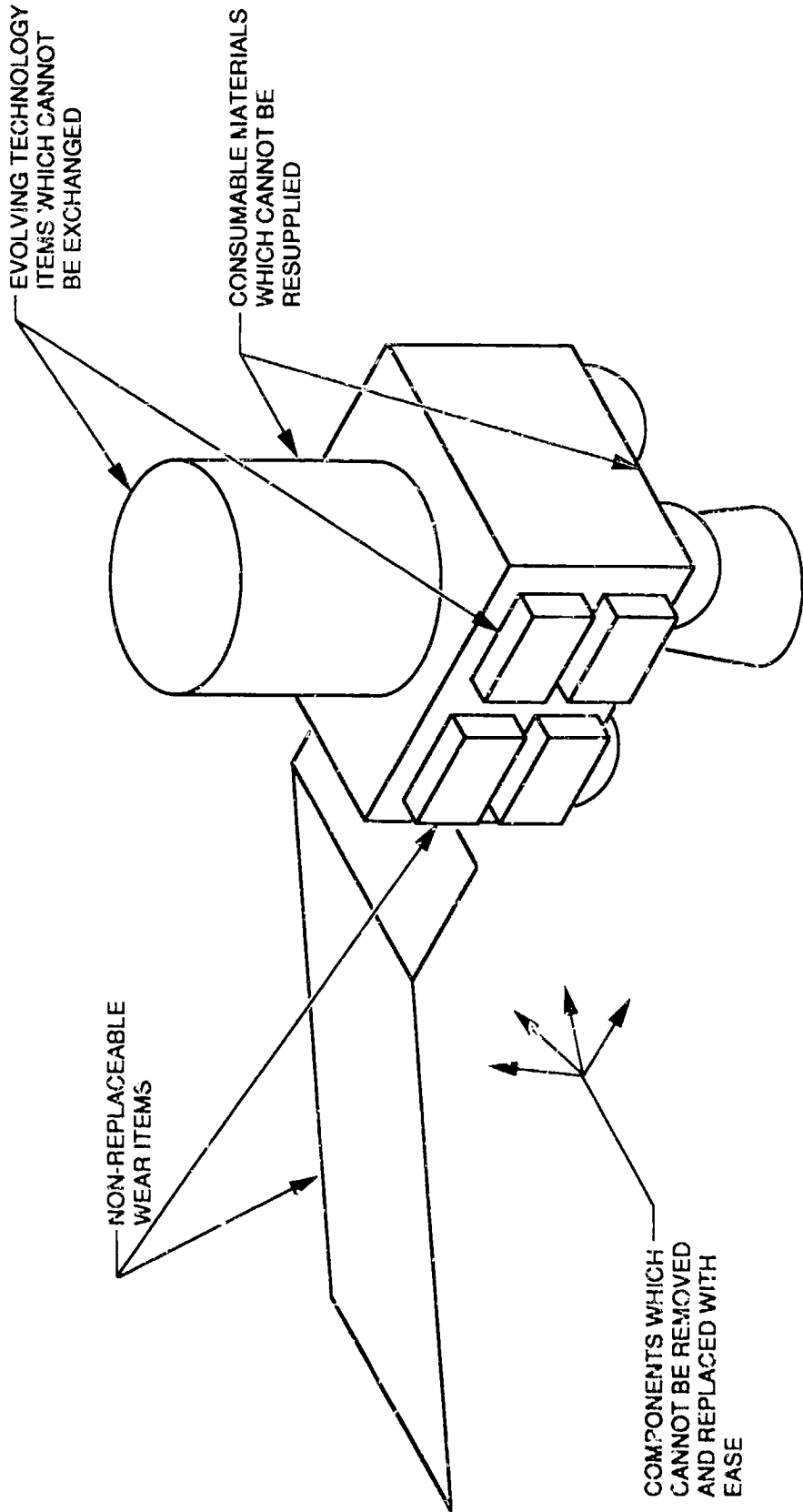



FAIRCHILD
SPACE COMPANY

Let's look at one particular issue: Propellant Resupply. We can design this to be easy or difficult. Consider a few of these steps:

- **Access propellant system - if we can simply agree on a simple, mechanized system to do this - eliminating complex operations and EVA - this step becomes trivial. Agreement, however, is difficult and the mechanism development must be funded.**
- **Condition Propellant System - This usually means venting of ullage gas to clear pressurant bubbles from screens. Venting is a problem as is ullage gas replacement. Thus if spacecraft tanks are selected which minimize the problem, its a big step forward.**
- **Provide ullage pressurant gas - If this can be avoided, the operation becomes simpler.**
- **Pressurize ullage pressurant gas - As above, if this can be avoided, the operation becomes simpler.**
- **Provide high pressure gas - and**
- **Pressurize high pressure gas - These steps refer to the resupply of cold gas propulsion systems and the high pressure gas feed for propulsion systems which utilize pressure regulation to maintain a constant propellant feed pressure. This is a very difficult step which should be "designed around" if possible.**



EXAMPLE (CONT'D)

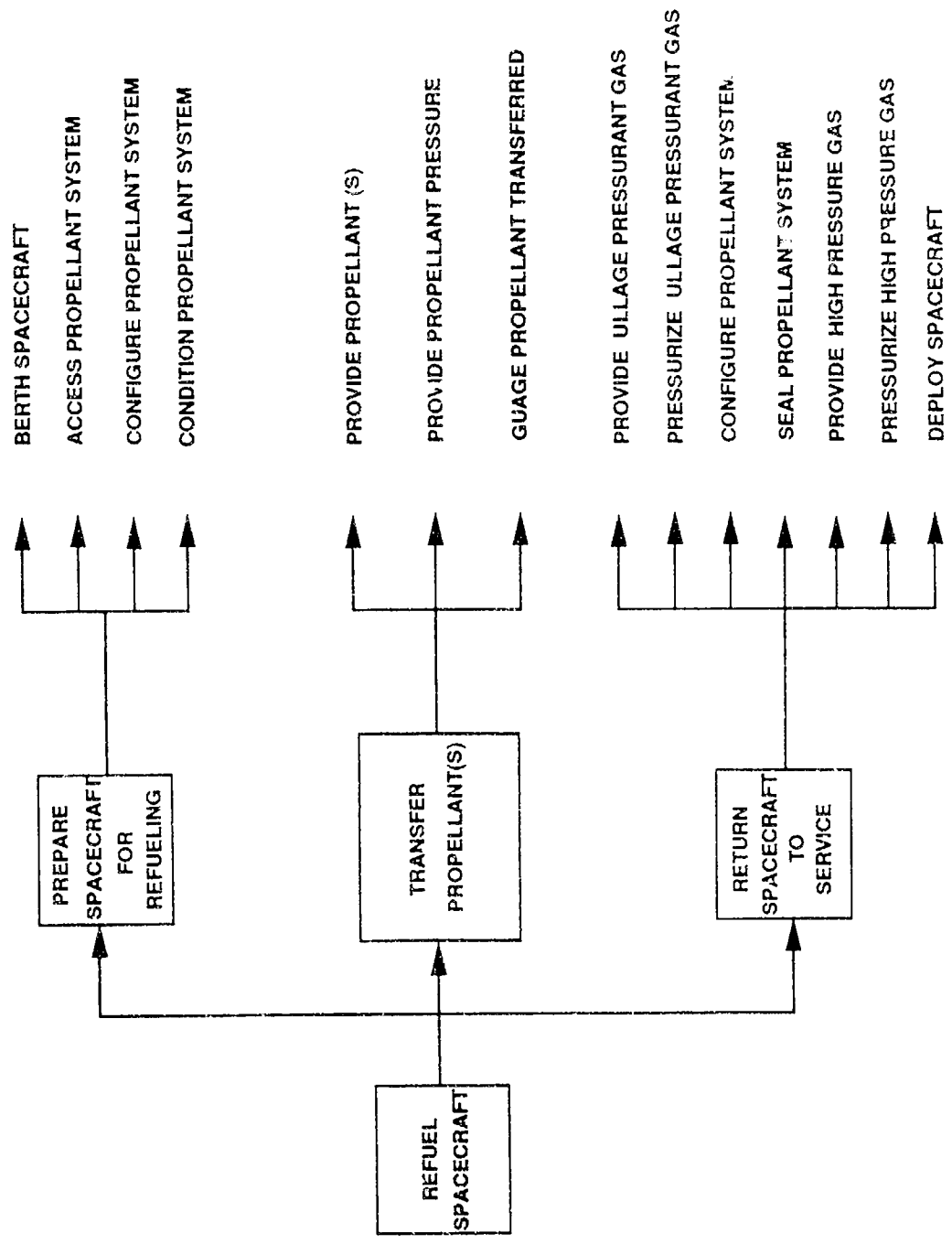

ca-1



Spacecraft propulsion system resupply then, can be divided into these major issues:

- Design for Servicing
- Servicing Technology
- Mechanization

These issues are, however, interrelated such that a choice in one area drives a selection in another.

In general, resupply will be aided by automation of the fluid transfer control system. This will probably include development of an expert system.

SERVICING CONCERN (CONT'D)



FAIRCHILD
SPACE COMPANY

SERVICING TECHNOLOGY	INTERFACE			VENTING TECHNOLOGY			COMPRESSOR FOR ON-ORBIT OPERATION
	EVA	MECHANIZATION		LIQUID VAPOR SEPARATOR	VENT PRODUCT SCRUBBER	PROPELLANT PUMP	
		GENERAL PURPOSE ROBOT	SPECIAL PURPOSE MECHANISM				
DESIGN FOR SERVICING	X	X	X				
USE OF CONSENSUS INTERFACE							
MINIMIZE VENTING				X	X	X	
MINIMIZE GAS RESUPPLY							X
"EASY VENT" PROPELLANT TANK				X	X		



So Where Does Space Station Freedom Come Into Play?

- First, the Servicing Bay - which has been deferred - can help to break the "chicken or egg" logjam. If this bay is well equipped with berthing facilities, consumables resupply tankers and mechanized servicing systems it will allow the spacecraft developers to plan for specific servicing activities.
- Second, as a major, high cost, long term asset, the space station itself will require servicing. This will help to encourage development of the technologies and creation of the hardware needed for servicing operations.
- Third, as a transportation node for the Moon or Mars missions, Space Station Freedom will be a test bed for advanced resupply issues relating to cryogenic resupply.

SPACE STATION FREEDOM



FAIRCHILD
SPACE COMPANY

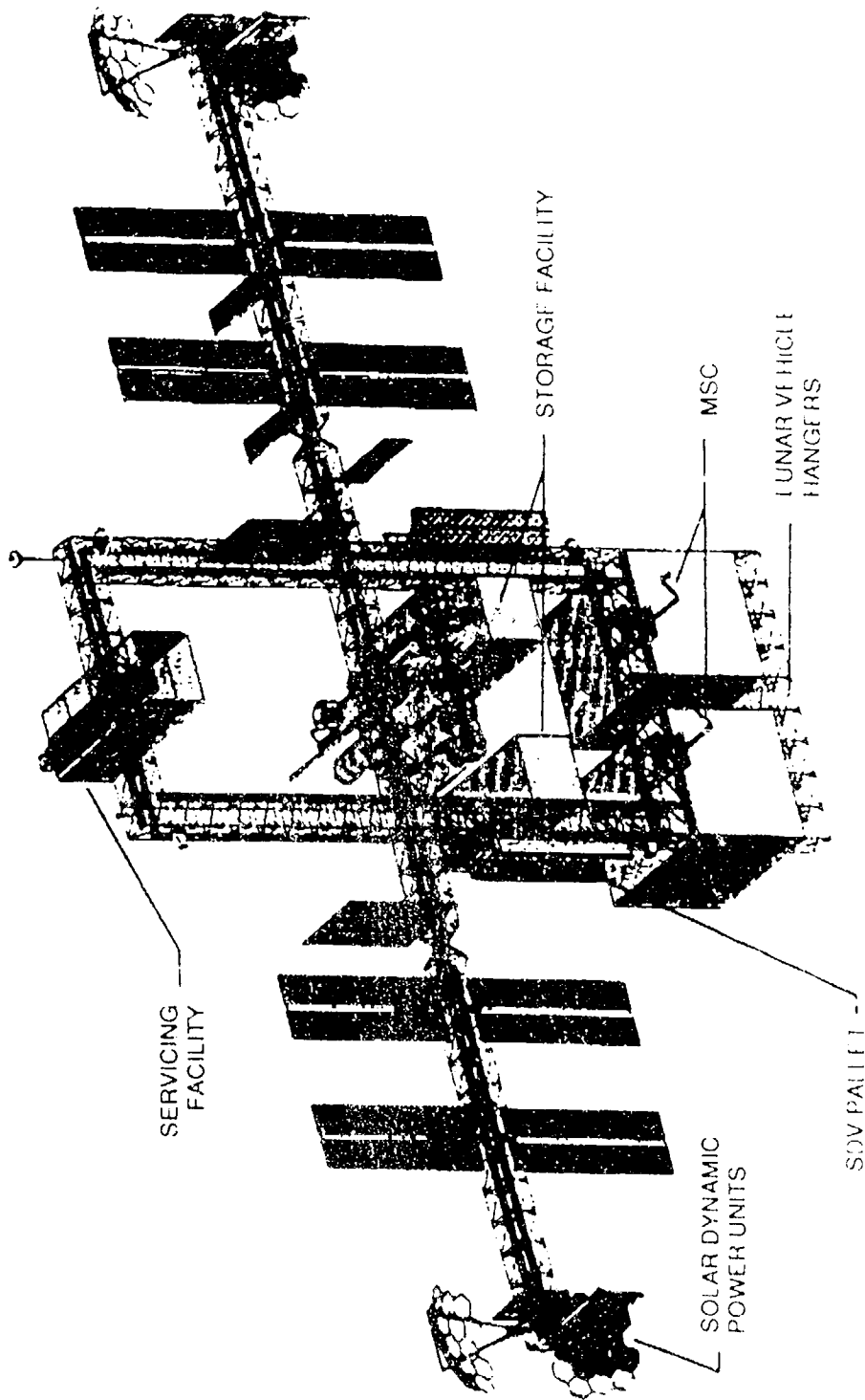

NASA

Lewis Research Center
Space Flight Systems Directorate

970

**ORBITAL STORAGE & SUPPLY
OF
SUBCRITICAL LIQUID NITROGEN**

JOHN C. AYDELOTT

**CRYOGENIC FLUIDS TECHNOLOGY OFFICE
NASA LEWIS RESEARCH CENTER
CLEVELAND, OHIO**

Cryogenic Fluids Technology Office

1-15
N93-27801

CRYOGENIC FLUID MANAGEMENT TECHNOLOGY

SUBCRITICAL CRYOGENIC FLUID MANAGEMENT HAS LONG BEEN RECOGNIZED AS AN ENABLING TECHNOLOGY FOR KEY PROPULSION APPLICATIONS, SUCH AS SPACE TRANSFER VEHICLES (STV) AND THE ON-ORBIT CRYOGENIC FUEL DEPOTS WHICH WILL PROVIDE STV SERVICING CAPABILITY. THE LERC CRYOGENIC FLUIDS TECHNOLOGY OFFICE (CFTO), UNDER THE SPONSORSHIP OF OAST, HAS THE RESPONSIBILITY OF DEVELOPING THE REQUIRED TECHNOLOGY VIA A BALANCED PROGRAM INVOLVING ANALYTICAL MODELING, GROUND-BASED TESTING AND IN-SPACE EXPERIMENTATION.

National Aeronautics and
Space Administration
Lewis Research Center

CRYOGENIC FLUIDS TECHNOLOGY OFFICE NASA

CRYOGENIC FLUID MANAGEMENT TECHNOLOGY

GOAL:
DEVELOP THE TECHNOLOGIES
ESSENTIAL FOR THE EFFICIENT
STORAGE, SUPPLY AND TRANS-
FER OF SUBCRITICAL CRYOGENIC
FLUIDS IN THE ENVIRONMENT
OF SPACE



IN SPACE
EXPERIMENTATION



GROUND BASED TESTING



ANALYTICAL MODELS



SPACE OPERATIONS



SPACE DEFENSE SYSTEMS



TRANSFER
VEHICLE

70-83-8142

CRYOGENIC MANAGEMENT TECHNOLOGIES

THE OVERALL OBJECTIVE OF THE CFTO PROGRAM IS TO DEVELOP THE TECHNOLOGY REQUIRED TO PERFORM STORAGE, SUPPLY AND TRANSFER OF SUBCRITICAL CRYOGENIC LIQUIDS IN THE LOW-GRAVITY ENVIRONMENT OF SPACE. IN ADDITION, THE PROGRAM IS ADDRESSING FLUID HANDLING ISSUES AND DEVELOPING ADVANCED CRYOGENIC SYSTEM INSTRUMENTATION.

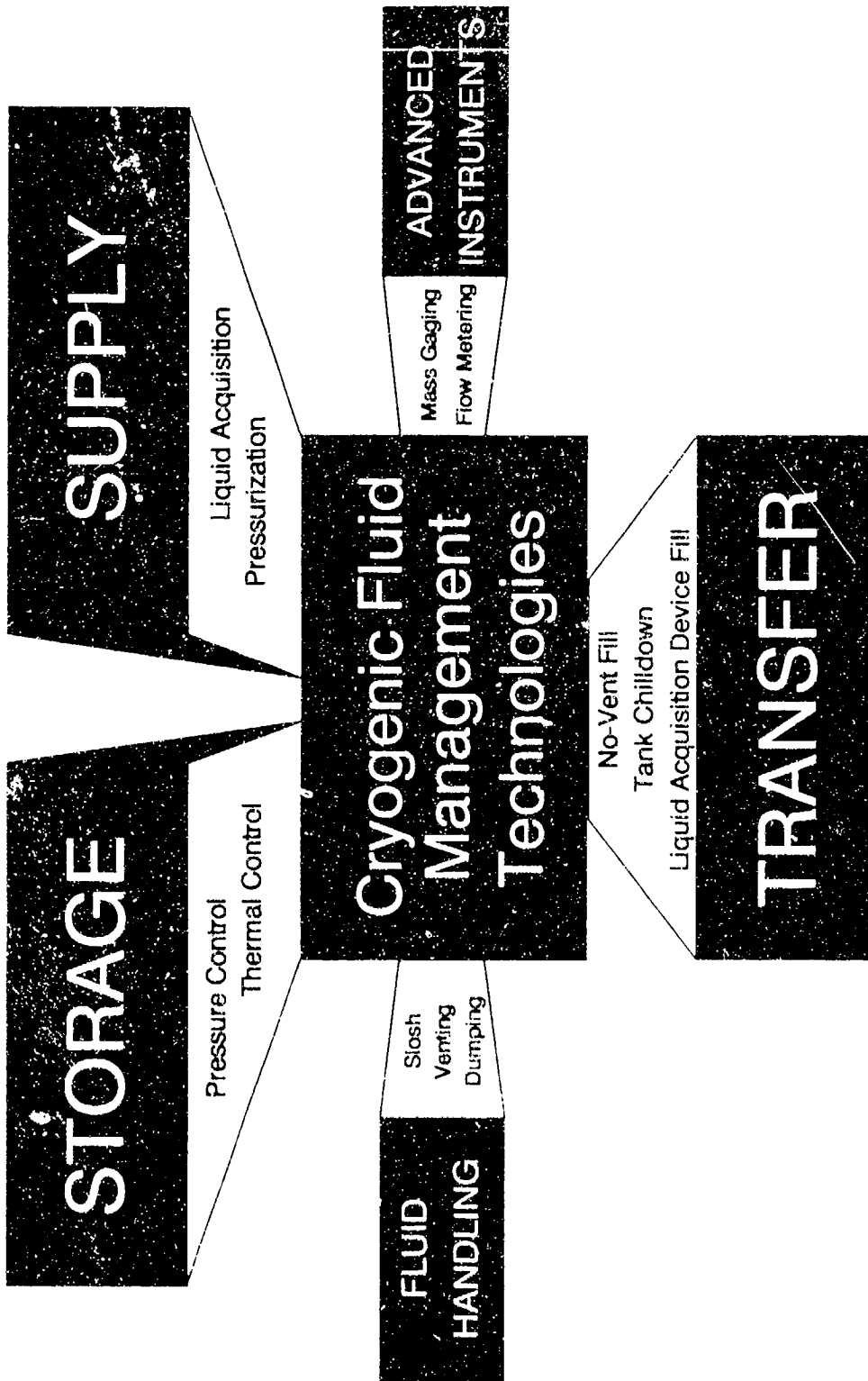

NITROGEN STORAGE AND SUPPLY

WITH THE CURRENTLY ENVISIONED DEFINITION OF THE EVOLUTIONARY SPACE STATION FREEDOM, CRYOGENIC LIQUID REQUIREMENTS FOR EXPERIMENT COOLING APPLICATIONS HAVE INCREASED THE IMPORTANCE OF DEVELOPING SUBCRITICAL FLUID MANAGEMENT TECHNOLOGY. IN ADDITION, THE REQUIREMENTS FOR GASEOUS NITROGEN TO BE USED IN THE ENVIRONMENTAL CONTROL AND LIFE SUPPORT SYSTEM, PARTICULARLY TO MEET THE ANTICIPATED GROWTH BEYOND THE INITIAL OPERATING CAPABILITY, SUGGESTS THAT SUBCRITICAL CRYOGEN RESUPPLY ALSO BE CONSIDERED AS A POTENTIALLY ENHANCING TECHNOLOGY WHICH WOULD REDUCE EARTH-TO-ORBIT HARDWARE WEIGHT AND ON-ORBIT POWER REQUIREMENTS.

NITROGEN STORAGE AND SUPPLY**SPACE STATION FREEDOM NEEDS**

- ENVIRONMENTAL CONTROL AND LIFE SUPPORT SYSTEM (GN₂)
- EXPERIMENT COOLING (LN₂)

STATE-OF-THE-ART SUPERCRITICAL CRYOGEN STORAGE SYSTEM

- HEAVY STORAGE VESSEL CONSTRUCTION (~ 25 LB/100 LB OF FLUID)
- HEATERS TO MAINTAIN PRESSURE (~ 2 KWH/100 LB OF FLUID)
- FLUID DENSITY AND COOLING ABILITY CONTINUOUSLY REDUCED AS CRYOGEN IS UTILIZED

BENEFITS OF SUBCRITICAL CRYOGEN STORAGE AND SUPPLY SYSTEM

- REDUCED WEIGHT AND ELECTRICAL POWER
- CONSTANT COOLANT THERMODYNAMIC CHARACTERISTICS

Cryogenic Fluids Technology Office

CRYOGENIC NITROGEN COOLING CAPABILITY

THE OBVIOUS DISADVANTAGE OF SUPERCRITICAL SYSTEMS IS THE HIGH PRESSURE LEVELS REQUIRED WHICH TRANSLATES DIRECTLY INTO GREATER SYSTEM WEIGHT. LESS OBVIOUS DISADVANTAGES OF SUPERCRITICAL SYSTEMS ARE ASSOCIATED WITH THE NEED TO MAINTAIN THE REQUIRED SUPERCRITICAL PRESSURE LEVEL, AS FLUID IS WITHDRAWN FROM THE SYSTEM, BY ADDING ENERGY TO THE TANKAGE, USUALLY IN THE FORM OF HEAT. FOR SOME APPLICATIONS, THERE IS ALSO A DISADVANTAGE RESULTING FROM THE FACT THAT THE FLUID IS CONTINUALLY DECREASING IN DENSITY (MASS IS BEING REMOVED FROM A CONSTANT VOLUME SYSTEM) AND INCREASING IN ENTHALPY (DUE TO THE HEAT ADDITION REQUIRED TO MAINTAIN PRESSURE) THUS REDUCING THE FLUID'S COOLING CAPABILITY.

Cryogenic Nitrogen Cooling Capability

Subcritical vs. Supercritical Storage

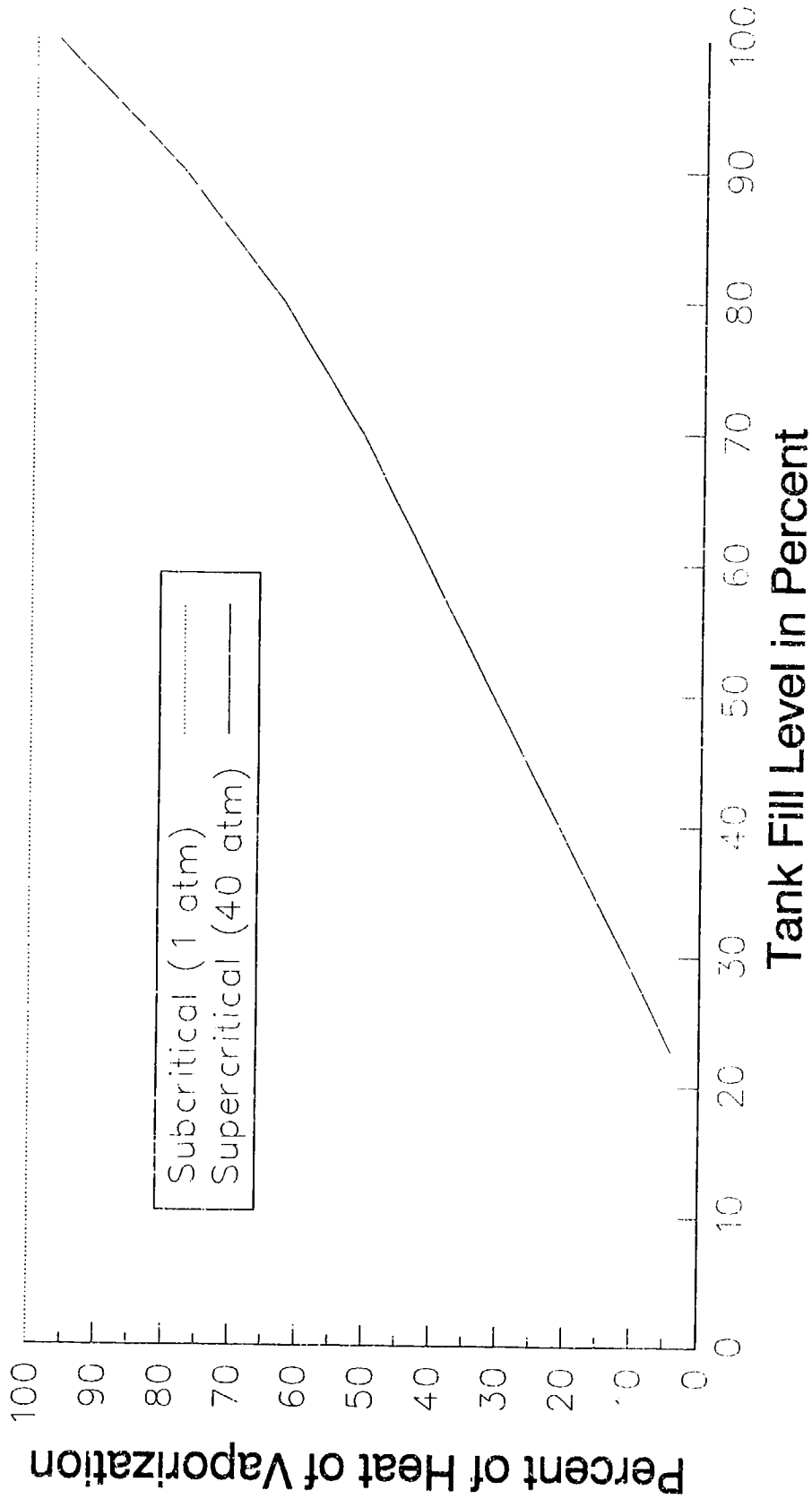

LN₂ SYSTEM DEMONSTRATION TECHNICAL OBJECTIVES

CRYOGENIC LIQUID STORAGE: THE SPECIFIC OBJECTIVE OF THIS TEST IS TO EVALUATE THE ABILITY OF PASSIVE THERMODYNAMIC VENT SYSTEMS (TVS) TO MAINTAIN NEARLY CONSTANT CRYOGENIC TANK PRESSURE. THE TVS WILL INCORPORATE A HEAT EXCHANGER EITHER MOUNTED ON THE TANK WALL OR ATTACHED TO THE LIQUID ACQUISITION DEVICE (LAD). EXPERIMENTALLY DETERMINED VENT RATES WILL BE COMPARED WITH ANALYTICAL PERFORMANCE PREDICTIONS FOR HEAT FLUXES TYPICAL OF BOTH VACUUM JACKETED AND FOAM/MLI INSULATED CRYOGEN STORAGE SYSTEMS.

LIQUID NITROGEN SUPPLY: THE SPECIFIC OBJECTIVE OF THIS TEST IS TO DEMONSTRATE THE ABILITY TO SUPPLY SUBCOOLED LIQUID NITROGEN TO A SIMULATED USER. A TOTAL COMMUNICATION CAPILLARY DEVICE FABRICATED FROM FINE MESH SCREEN SHALL BE EMPLOYED FOR LIQUID ACQUISITION. GASEOUS NITROGEN, STORED IN HIGH PRESSURE BOTTLES, SHALL BE USED FOR LIQUID EXPULSION. EXPERIMENTALLY DETERMINED RATES OF PRESSURANT CONSUMPTION WILL BE COMPARED WITH ANALYTICAL PREDICTIONS FOR SEVERAL INITIAL LIQUID FILLINGS, TWO DISCRETE VALUES OF LIQUID EXPULSION RATE, AND AT LEAST TWO VALUES OF LIQUID SUBCOOLING.

PRESSURANT BOTTLE RECHARGING: THIS TEST WILL DEMONSTRATE THE ABILITY TO RESUPPLY A GASEOUS NITROGEN PRESSURANT BOTTLE BY INJECTION OF A METERED QUANTITY OF LIQUID NITROGEN. ONE OF THE PRESSURANT BOTTLES WILL BE DEPLETED DURING THE COURSE OF THE LIQUID SUPPLY TESTS AND THEN EVACUATED TO SPACE. THE PRESSURANT BOTTLE WILL BE SEQUENTIALLY CHILLED DOWN TO AN ANALYTICALLY DETERMINED "TARGET TEMPERATURE," ONCE AGAIN EVACUATED TO SPACE AND THEN NO-VENT FILLED WITH A SMALL QUANTITY OF LIQUID NITROGEN. THE BOTTLE WILL BE ALLOWED TO SELF-PRESSURIZE DUE TO ENVIRONMENTAL HEATING AND THE FINAL TANK PRESSURE WILL BE COMPARED WITH ANALYTICAL PREDICTION.

ON-ORBIT NITROGEN STORAGE AND SUPPLY SYSTEM DEMONSTRATION**TECHNICAL OBJECTIVES**

- CRYOGENIC LIQUID STORAGE
- LIQUID NITROGEN SUPPLY
- PRESSURANT BOTTLE RECHARGING
- LIQUID ACQUISITION DEVICE PERFORMANCE
- ACTIVE PRESSURE CONTROL EXPERIMENTATION*

ANTICIPATED APPROACH

- SHUTTLE CARGO BAY PAYLOAD
- HITCHHIKER "M" CLASS CARRIER
- DESIGNED AND QUALIFIED FOR THREE FLIGHTS

MILESTONES

- PARALLEL PHASE A/B STUDY CONTRACTS AWARDED JANUARY 1990
- FY92 PHASE C/D COMPETITIVE PROCUREMENT
- LAUNCH LATE IN 1994

*INTERIM STV TECHNOLOGY NEED, NOT REQUIRED FOR SSF

LN₂ SYSTEM DEMONSTRATION TECHNICAL OBJECTIVES (CONTINUED)

LIQUID ACQUISITION DEVICE PERFORMANCE (EXPULSION EFFICIENCY):
THE SPECIFIC OBJECTIVE OF THIS EXPERIMENT IS TO DETERMINE THE
QUANTITY OF VAPOR-FREE LIQUID THAT CAN BE REMOVED FROM A
CRYOGEN STORAGE TANK WHICH EMPLOYS A TOTAL COMMUNICATION
LIQUID ACQUISITION DEVICE FABRICATED FROM FINE MESH SCREEN
MATERIAL. THE SHUTTLE OMS OR PRIMARY RCS WILL BE EMPLOYED TO
PROVIDE A RELATIVELY HIGH ACCELERATION ENVIRONMENT WHICH WILL
STRESS THE LAD RETENTION CAPABILITY DURING THE FINAL LIQUID
EXPULSION. THE EXPERIMENTALLY DETERMINED VALUE OF LIQUID
RESIDUALS WILL PROVIDE A SINGLE DATA POINT FOR PARTIAL
VERIFICATION OF THE ANALYTICAL MODELS DESCRIBING LAD
PERFORMANCE.

LIQUID SUPPLY

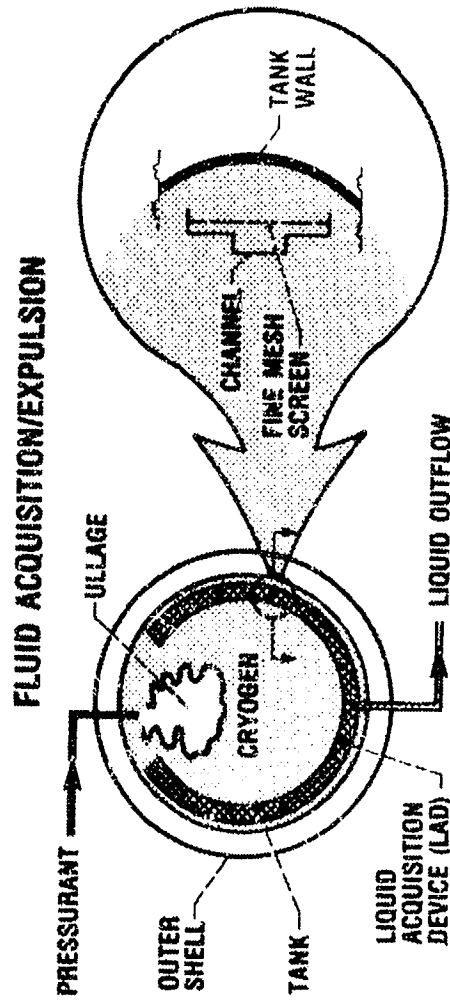

CURRENT STATUS

- LAD ONLY FLOWN WITH NON CRYOGENIC LIQUIDS
- GROUND BASED CHARACTERIZATION OF SCREEN MATERIAL

ISSUES/CONCERNS

- LAD PERFORMANCE/EXPULSION EFFICIENCY
- IMPACT OF HEAT ADDITION/SCREEN DRYOUT
- LONG TERM CONTAMINATION/DEGRADATION
- ON ORBIT REFILLING

CO-97-25040

LN₂ SYSTEM DEMONSTRATION TECHNICAL OBJECTIVES (CONTINUED)

ACTIVE PRESSURE CONTROL: THE OBJECTIVE OF THIS EXPERIMENT IS TO EVALUATE THE ABILITY OF JET-INDUCED MIXER, COUPLED WITH A COMPACT TVS HEAT EXCHANGER, TO CONTROL CRYOGENIC STORAGE TANK PRESSURE. EXPERIMENTAL DATA WILL BE ACQUIRED FOR COMPARISON WITH ANALYTICAL PREDICTIONS OF THE PERFORMANCE OF THE ACTIVE PRESSURE CONTROL SYSTEM AND TO PROVIDE PARTIAL VERIFICATION OF THE ANALYTICAL MODELS WHICH DESCRIBE THE PHYSICAL PROCESSES INVOLVED. SPECIFICALLY, THE EXPERIMENT WILL BE DESIGNED TO PARAMETRICALLY INVESTIGATE THE EFFECTS OF TANK HEAT FLUX, AXIAL-JET FLOW RATE, TVS HEAT EXCHANGER FLOW RATE, TANK LIQUID FILL LEVEL, AND THE ACCELERATION ENVIRONMENT ON: (1) THERMAL STRATIFICATION OF THE TEST FLUID, (2) THERMAL DESTRATIFICATION OF THE TEST FLUID BY AXIAL-JET INDUCED MIXING AND, (3) TANK PRESSURE DECAY DURING TVS OPERATION.

LIQUID STORAGE

PRESSURE CONTROL TECHNIQUE FOR LONG TERM CRYOGENIC LIQUID STORAGE IN SPACE

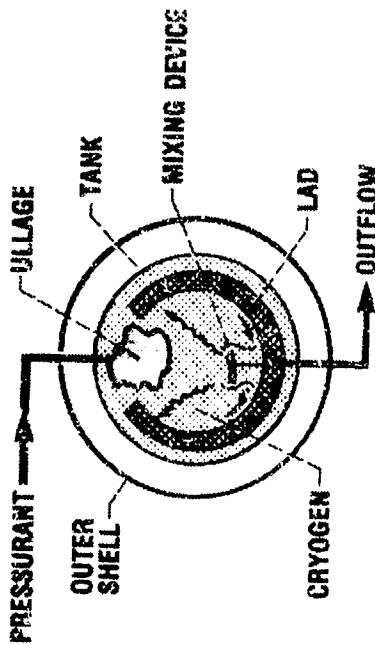

FLUID MIXING

CURRENT STATUS • NO IN SPACE DEMONSTRATION WITH SUBCRITICAL LIQUIDS

- ISSUES/CONCERNS**
- MIXING FANS REQUIRE POWER - INCREASE HEAT INPUT
 - INCREASE COST AND COMPLEXITY
 - FLUID DYNAMICS GRAVITY DEPENDENT

CD-87-25063

SUPERFLUID HELIUM NEEDS AND RESUPPLY ON SPACE STATION

DR. MICHAEL J. DIPIRRO

NASA/GODDARD SPACE FLIGHT CENTER

JANUARY 16, 1990

198-27802

323

Since its first orbital use in 1983, superfluid helium (He II) has found increasingly many uses in space. In the area of astrophysics one finds applications in the infrared, xray, gamma ray, and cosmic ray particle areas. Examples include the InfraRed Astronomical Satellite (IRAS) in 1983, the shuttle based InfraRed Telescope (IRT) in 1985, the Cosmic Background Explorer (COBE) in 1989-1990, the Infrared Space Observatory (ISO) to be launched in approx. 1992, the Space InfraRed Telescope Facility (SIRTF) in approx. 1999, and the Large Deployable Reflector (LDR). The Advanced Xray Astrophysics Facility (AXAF), scheduled for launch in 1997, has its most sensitive instrument, the X-Ray Spectrometer (XRS), cooled by He II. The space station based cosmic ray facility called Astromag (1999) uses He II to cool large superconducting magnets. Recent ground based detectors using ultra low temperature germanium detectors have been used for gamma rays. Such a system in space would use He II as the heat sink.

Earth observation projects also have baselined He II cooling for SAFIRE, an EOS instrument, and a superconducting gravity gradiometer for a gravity mapping mission.

WHAT IS SUPERFLUID HELIUM (He II) USED FOR IN SPACE?

• ASTROPHYSICS

INFRARED ASTRONOMICAL SATELLITE (IRAS)

INFRARED TELESCOPE (IRT)

COSMIC BACKGROUND EXPLORER (COBE)

INFRARED SPACE OBSERVATORY (ISO)

SPACE INFRARED TELESCOPE FACILITY (SIRTF)

ADVANCED XRAY ASTROPHYSICS FACILITY XRAY SPECTROMETER (AXAF/XRS)

COSMIC RAY DETECTOR FACILITY (ASTROMAG)

LARGE DEPLOYABLE REFLECTOR (LDR)

FUTURE GAMMA RAY DETECTORS

• EARTH OBSERVING

GRAVITY MAPPING MISSION

SAFIRE (EOS INFRARED INSTRUMENT)

The Advanced X-ray Astrophysics Facility (AXAF), to be launched in 1997, is scheduled to be serviced every 5 years, eventually from the space station.

AXAF - ADVANCED X-RAY ASTROPHYSICS FACILITY



The X-Ray Spectrometer (XRS), one of three focal plane instruments on AXAF, will have a 400 liter He II dewar. Its 4 year lifetime can be extended by He II resupply.

XRS - X-RAY SPECTROMETER

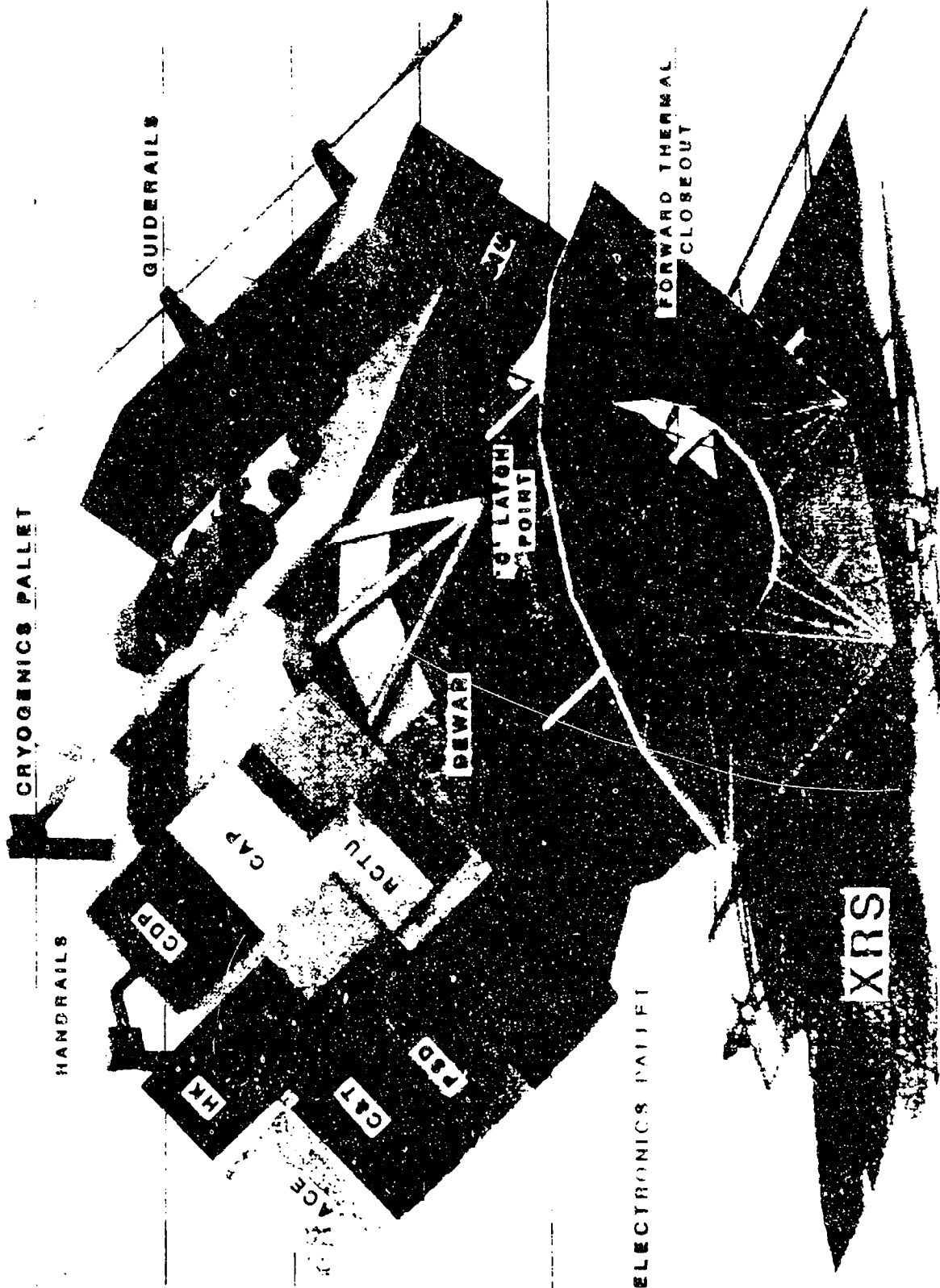

The space station attached Astromag, a cosmic ray facility, is shown here at the center near the top of the picture. It consists of a 3000 to 4000 liter dewar of He II which cools a pair of superconducting magnets. Two instruments are shown attached to the core facility.

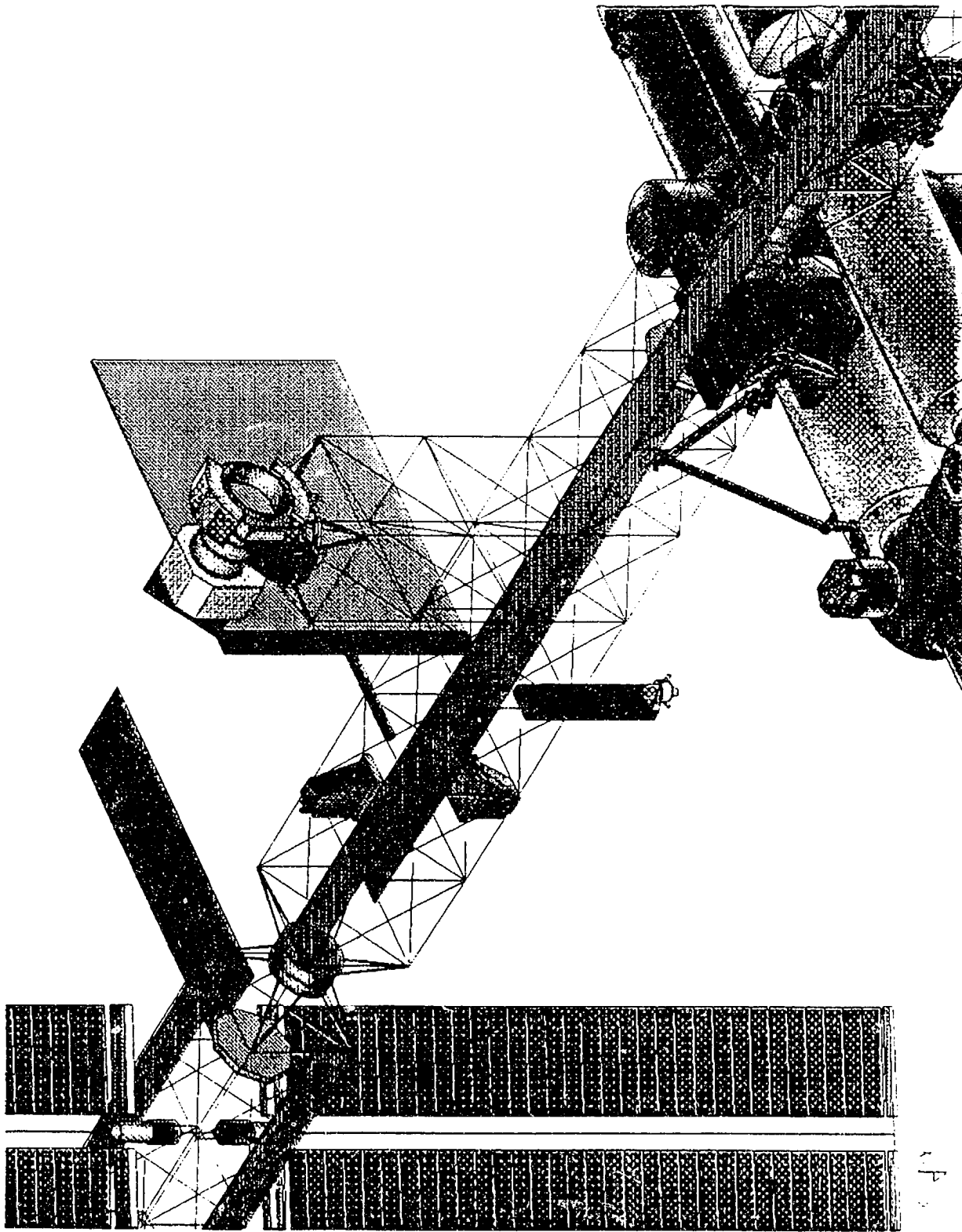

Superfluid helium will also be used in various fundamental physics experiments, such as the very sensitive test of Einstein's general relativity theory, Gravity Probe-B (GP-B) scheduled for launch in the late 1990's. Other planned experiments will test the equivalence principle between inertial and gravitational mass, superconducting gravity gradiometer tests of general relativity and the "fifth force", and critical point phenomena tests beginning with sensitive measurements of the specific heat of liquid helium at the superfluid transition (lambda point), which is scheduled to fly in 1991 as a shuttle attached payload. A critical point phenomena facility (CPPF) has been proposed for space station to support these various experiments.

In addition, a previously proposed materials processing facility (MPF) using a superconducting magnet to aid in low g alloying and crystal growth experiments, would use He II. Nuclear Magnetic Resonance (NMR) and Magnetic Resonance Imaging (MRI) machines are standard laboratory and medical tools on earth may eventually be used in space.

• FUNDAMENTAL PHYSICS

GRAVITY PROBE-B (GP-B)

EQUIVALENCE PRINCIPLE TESTS

GENERAL RELATIVITY AND "FIFTH FORCE" TESTS USING GRAVITY
GRADIOMETER

CRITICAL POINT PHENOMENA (CPPF) INCLUDING LAMBDA POINT, CRITICAL
POINT AND TRICRITICAL POINT EXPERIMENTS

• OTHER

MATERIALS PROCESSING FACILITY (MPF) (USES SUPERCONDUCTING MAGNET)
NMR DEVICES

Space station serves as the base of operation for Astromag, the CPPF, the MPF and other users of He II such as for small infrared telescopes. It also serves as the eventual servicing area for free flyers such as AXAF. For other satellites, in far different orbits such as SIRTf, the space station may serve as a transportation node - - a storage depot for liquid helium resupply missions. One possible commercial use of the moon is the mining and return to earth of He3, the rare isotope of helium. This may be used in clean fusion reactions on earth. It is most easily shipped as a liquid, requiring He II refrigeration.

HOW DOES SPACE STATION FIT IN?

• AS BASE OF OPERATION

ASTROMAG

CPPF

MPF

NMR DEVICES AND OTHER SMALL USERS (e.g. SMALL IR TELESCOPES)

• AS SERVICING AREA

AXAF

• AS TRANSPORTATION NODE

LDR

SIRTF

LUNAR USES, ETC. (e.g., RETURN OF He³ FROM THE MOON)

Several technology issues arise from superfluid helium use on the space station. One must consider long term storage of superfluid including the size and location of the tankage and boil off rate (lifetime) requirements. Venting is a concern including contamination of other space station users, emergency venting in the event of tank puncture, and pressurized lab module penetrations for liquid helium fill and vent of small experiments.

Another issue to be addressed is whether the boil off gas can be reliquefied and reused on orbit. This raises questions about power requirements, vibration, and capturing the vented gas. At this time resupply appears much more feasible.

Fluid management in low gravity is the key to He II resupply.

SPACE STATION He II TECHNOLOGY ISSUES

- LONG TERM STORAGE
 - TANK SIZE AND LOCATION
 - BOIL OFF RATE
- VENTING
 - CONTAMINATION
 - LAB MODULE PENETRATIONS FOR FILL AND VENT
 - EMERGENCY RELIEF
- RECYCLABILITY
 - POWER REQUIREMENTS, VIBRATION, CAPTURING VENT GAS
- RESUPPLY
 - FLUID MANAGEMENT

Some of the component technologies in the fluid management of He II in space are listed here. The transfer line coupler must provide a low heat input to the superfluid while maintaining a safe environment for an EVA. To produce a low heat leak a demateable cold seal must be employed. Cryogenic valves for use with superfluid helium have been developed for many programs. Cryogenic relief valves are required for potential trapped volumes. Repeatable burst pressures for emergency venting burst disks have been developed over the past few years. A superfluid helium pump capable of delivering He II to the receiver vessel at a reasonable flow rate (a few hundred liters per hour) is required. Phase separation to allow boil off while retaining liquid within the dewar is essential. Liquid acquisition within the supply tank to gather liquid and feed it to the pump at the required flow rate is needed for efficient transfer. To control the transfer accurate methods of measuring the transfer rate and amount of liquid in the supply and receiver is required.

RESUPPLY - - FLUID MANAGEMENT ISSUES

- TRANSFER LINE COUPLER
- CRYOGENIC VALVES
- RELIEF VALVES AND BURST DISKS
- PUMP
- PHASE SEPARATION
- LIQUID ACQUISITION
- QUANTITY GAUGING
- FLOW METERING

The Superfluid Helium On-Orbit Transfer (SHOOT) Flight Demonstration is shown mounted on a Hitchhiker carrier with avionics. SHOOT consists of two 210 liter superfluid helium dewars connected by a transfer line. The dewars are identical with plumbing components arranged so that either may act as a supply or receiver dewar. SHOOT is manifested for flight in July, 1992.

SUPERFLUID HELIUM ON ORBIT TRANSFER FLIGHT DEMONSTRATION

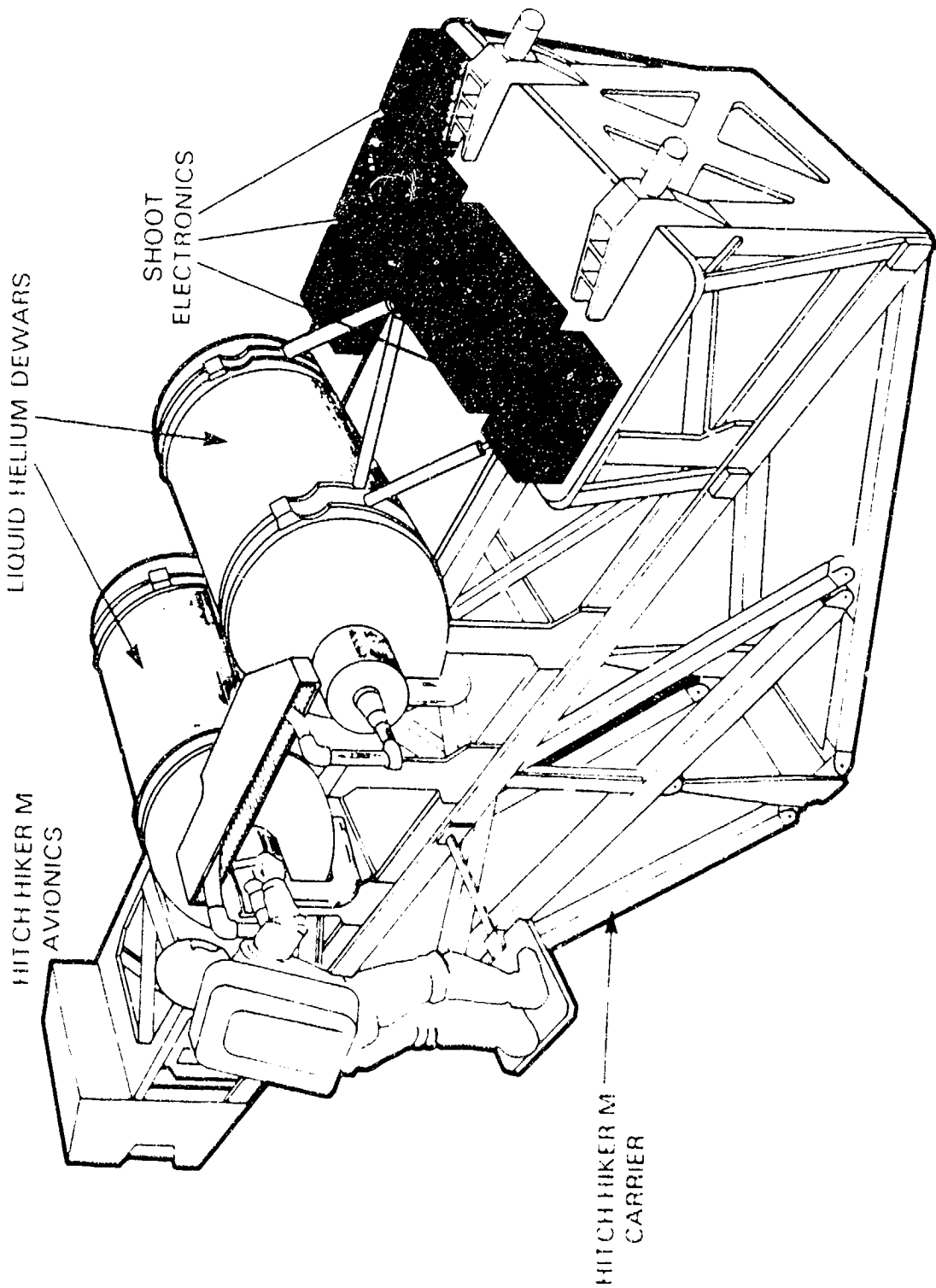

Many of the components required for successful He II resupply have been developed for SHOOT. Stepper motor driven cryogenic valves with no detectable leakage to superfluid have been developed for SHOOT by Utah State University. Repeatable, replaceable cryogenic burst disks have been developed by Katema Corp. Low throughput cryogenic relief valves for relieving trapped volumes have been developed by the Goddard Space Flight Center (GSFC). A thermomechanical (TM) effect pump capable of flow rates in excess of 900 liters per hour and pressures above one half an atmosphere has been developed at GSFC. In addition, the GSFC has developed phase separators that work at high flow rates with little pressure drop and other separators that work with He I and its vapor as well as He II. The mass gauging technique used in SHOOT will be a more sensitive version of the heat pulse method of heat capacity determination first used in space in the Superfluid Helium Experiment aboard Spacelab 2. Our sensitivity should be 1%. To measure flow rates a non-cavitating venturi will be used. Also, by measuring the heater power and outlet temperature of the thermomechanical pump the flow rate may be determined. An EYA compatible coupler has been partially developed for Johnson Space Center (JSC) by Moog and Ball Aerospace. The present design has some drawbacks in performance, weight, complexity, and cost. An improved version should be developed.

FLUID MANAGEMENT TECHNOLOGY DEVELOPED FOR SHOOT

- EVA COMPATIBLE He II COUPLER DEVELOPED FOR JSC BY MOOG AND BALL
 - - - FLIGHT UNIT MAY NOT BE COMPLETED AND HAS DRAWBACKS
- STEPPER MOTOR DRIVEN CRYOGENIC VALVES DEVELOPED BY UTAH STATE U.
- REPEATABLE, REPLACEABLE CRYO BURST DISKS DEVELOPED BY KATEMA
- CRYO RELIEF VALVES DEVELOPED AT GSFC
- TM PUMP DEVELOPED AT GSFC
- PHASE SEPARATORS FOR HIGH FLOW RATES AND He I AS WELL AS He II
- MASS GAUGING WILL BE MORE SENSITIVE VERSION OF HEAT PULSE TECHNIQUE USED IN SPACELAB 2 SUPERFLUID HELIUM EXPERIMENT
- VENTURI FLOWMETER ALONG WITH TM PUMP TEMPERATURE MEASUREMENTS WILL BE USED

Cut away view of the He II EVA compatible coupler developed for JSC by Moog Corp.

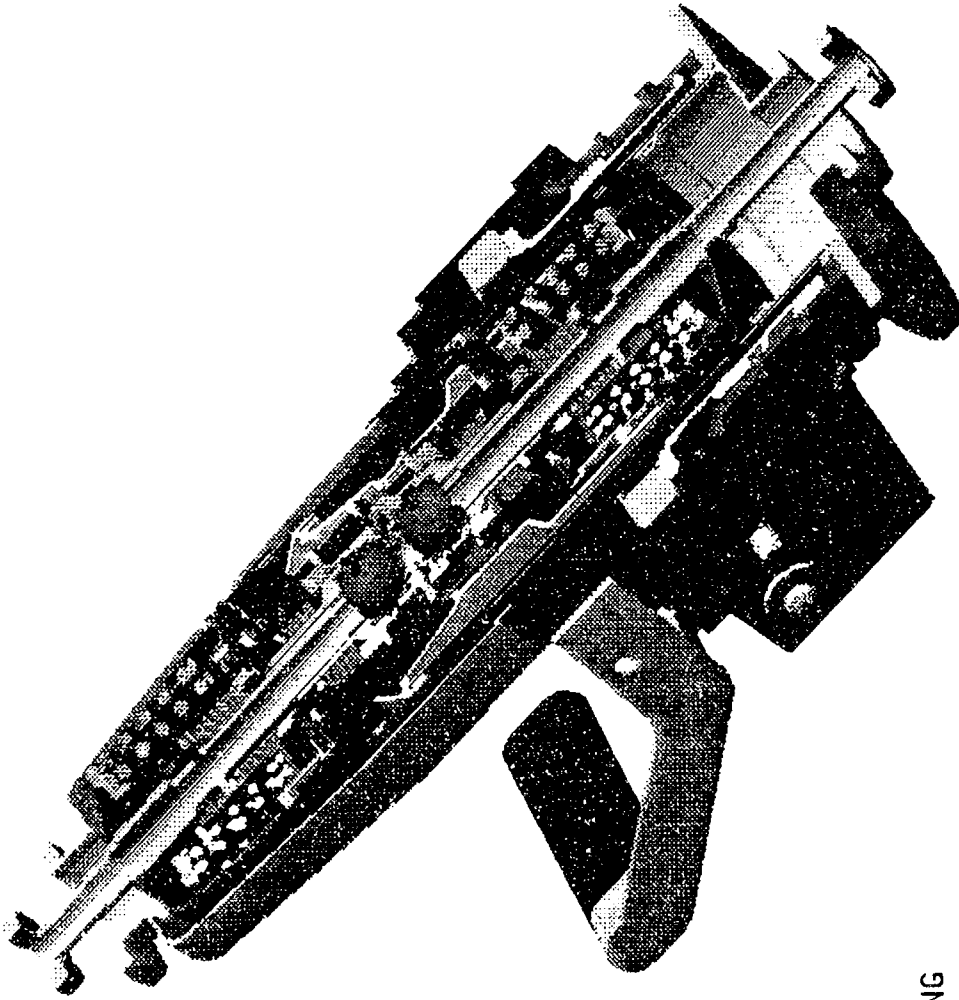

HE II COUPLING
SECTION VIEW
BOTH HALVES MATED
2/3/89
MOOG INC., SPD

The most critical components that require the low gravity environment of space to demonstrate its operation fully are the liquid acquisition devices. Simply stated, the devices must deliver liquid to the pump inlet at the required flow rates (up to say 1000 liters per hour in the low g environment. To keep operations from being frequently interrupted, adverse accelerations (accelerations which tend to settle the bulk liquid away from the pump) of up to 0.1 milli-g must be overcome by the liquid acquisition system. In the event of a larger acceleration that drives liquid away from the pump, the device must recover in a time much shorter than the total resupply time.

LIQUID ACQUISITION DEVICES FOR ON ORBIT TRANSFER

- MUST DELIVER LIQUID TO THE PUMP INLET AT THE REQUIRED FLOW RATE EVEN IN THE PRESENCE OF ADVERSE ACCELERATIONS
 - - ACCELERATIONS OF THE ORDER OF 10⁻⁴ SHOULD BE OVERCOME
- DESIGN MUST ALLOW RECOVERY IN SHORT TIME IN THE EVENT OF LARGER SUSTAINED ACCELERATION

SHOOT has selected two types of liquid acquisition devices, both of which use surface tension to keep vapor away from the pump inlet. The first type is a screened channel made of a fine mesh screen covering a stainless steel duct. The screen to be used for SHOOT is similar to that which may be applicable to liquid hydrogen as well. It is a 325 X 2300 Dutch twill weave. The other type of liquid acquisition system uses vanes feeding a sponge reservoir which surrounds the TM pump.

The screened channel device, designed and made by Martin-Marietta, operates by preventing the passage of vapor through a wetted screen by the surface tension of the He II. The relatively low value of this surface tension (about 0.34 dynes/cm) requires the use of fine mesh to keep the vapor out. Even so, a relatively small helium head of a few centimeters is enough to break through this screen in one g. Small scale tests of this device have been performed at GSFC and Martin-Marietta. Large scale tests are on-going at the University of Wisconsin. The calculated performance of the screen can be seen only for short periods of time before cavitation in the superfluid column occurs. The cause of this cavitation is as yet unexplained, although it has been observed by many experimenters over the last 30 years. At relatively low pressure heads, cavitation is infrequent, however, lending hope for the success of this device in space use.

The sponge material used in the second liquid acquisition system is made from foam silica, similar to that used in the thermal protection system on the shuttle. Wicking and pressure drop measurements have been made at the GSFC and the University of Wisconsin on this material. The sponge will act as a "high"-g reservoir for the pump. The vanes which feed the sponge are mylar sheet arranged radially in the tank. The advantage of this type of device is the predictable recovery from an adverse acceleration. Its disadvantage is that an adverse acceleration of just over 0.1 milli-g is enough to disrupt the flow to the pump.

LIQUID ACQUISITION DEVICES FOR SHOOT

- SHOOT HAS SELECTED TWO TYPES OF DEVICES USING SURFACE TENSION
 - SCREENED CHANNEL DEVICE (325 X 2300 DUTCH TWILL)
 - SPONGE / VANE COMBINATION (LOW DENSITY SILICA AND MYLAR VANES)
- TESTING OF SCREENED CHANNELS AT MARTIN-MARIETTA, GSFC AND U. OF WISCONSIN INDICATE PROBABILITY OF SUCCESS
 - INFREQUENT CAVITATION AT LOW PRESSURE HEADS
 - CALCULABLE PERFORMANCE FOR RELATIVELY SHORT TIMES
 - MORE TESTING TO BE PERFORMED
 - FINAL DATA FROM SHOOT FLIGHT
- LIQUID / VAPOR DETECTORS TO AID IN FAILURE AND RECOVERY DETECTION
 - SPONGE MATERIAL HAS BEEN INVESTIGATED BY GSFC AND U. OF WISCONSIN
 - ADVANTAGE IS PREDICTABLE RECOVERY FORM CAVITATION
 - DISADVANTAGE IS LOWER SUSTAINABLE NEGATIVE HEAD, AND MORE IMPEDANCE TO FLOW

The photograph shows a screened channel device without the screen with liquid/vapor detectors strung along its length. These low dissipation devices developed at the GSFC will aid in the measurement of the screened channel performance relative to cavitation and recovery.



To summarize, there are many applications for He II in space, some of which have already flown, or are being planned. The space station may play an important role in many of these uses as either a base of operations, for servicing or as a transportation node. Space station issues of venting and servicing connections must still be addressed. Most of the resupply technology issues for He II are being addressed by the SHOOT Flight Demonstration. However, a better design of the transfer line coupler is needed. In addition, more extensive study of liquid acquisition in low gravity will help in predicting behavior of future systems.

SUMMARY

- MANY SPACE APPLICATIONS ARE PLANNED FOR SUPERFLUID HELIUM
- SPACE STATION MAY PLAY AN IMPORTANT ROLE AS BASE OF OPERATIONS, SERVICING, OR TRANSPORTATION NODE FOR RESUPPLY FOR THESE USERS
- MOST RESUPPLY TECHNOLOGY ISSUES FOR He II ARE BEING ADDRESSED BY THE SHOOT FLIGHT DEMONSTRATION
- BETTER DESIGN OF EVA COMPATIBLE COUPLER IS REQUIRED
- MORE EXTENSIVE STUDY OF LIQUID ACQUISITION TECHNIQUES IS DESIRABLE
- SPACE STATION ISSUES OF VENTING AND SERVICING CONNECTIONS MUST STILL BE ADDRESSED