

## HIGH-TOUGHNESS GRAPHITE/EPOXY COMPOSITE MATERIAL EXPERIMENT\*

David K. Felbeck

University of Michigan

2250 G.G. Brown Laboratory

Ann Arbor, MI 48109-2125

Phone: 313-994-6662; Fax: 313-665-9370

### SUMMARY

This experiment was designed to measure the effect of near-earth space exposure on three mechanical properties of specially toughened 5208/T300 graphite/epoxy composite materials. The properties measured are elastic modulus, strength, and fracture toughness. Six toughness specimens and nine tensile specimens were mounted on an external frame during the 5.8-year orbit of the Long Duration Exposure Facility (LDEF). Three identical sets of specimens were manufactured at the outset: the flight set, a zero-time non-flight set, and a total-time non-flight set.

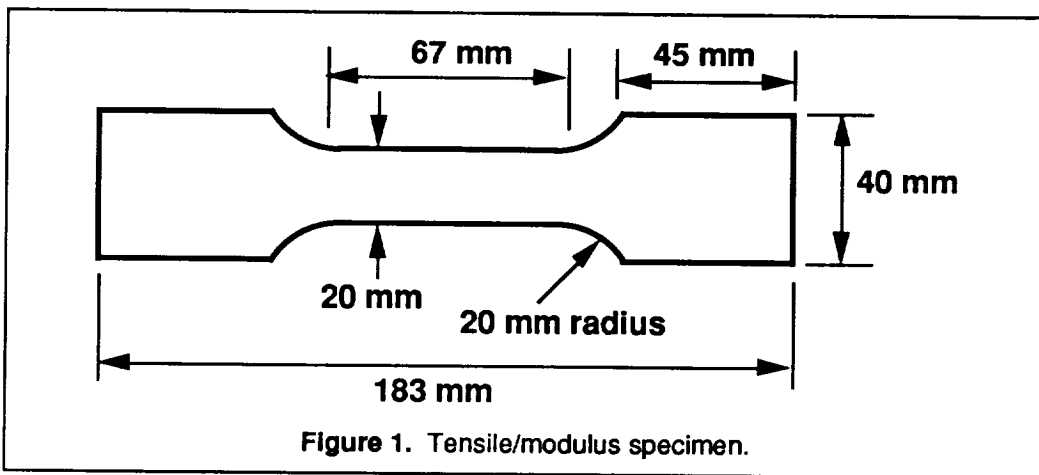
### INTRODUCTION

The then-recent development of a procedure for improving the toughness of graphite/epoxy composites<sup>1,2</sup> provided an appropriate material for near-earth space exposure testing when the Long Duration Exposure Facility was publicly proposed by NASA/Langley in the late 1970s. This toughening procedure, termed *intermittent interlaminar bonding*, consists of introduction of a thin perforated layer of Mylar film between adjacent plies of a cross-ply composite so as to limit the area of inter-ply bonding. In this way, fracture of the composite is diverted when crossing regions have no bonding between plies, with a consequent substantial increase in total area of fracture and an increase in fracture energy, usually with only minor reduction in strength and elastic modulus.

### TEST PROCEDURE

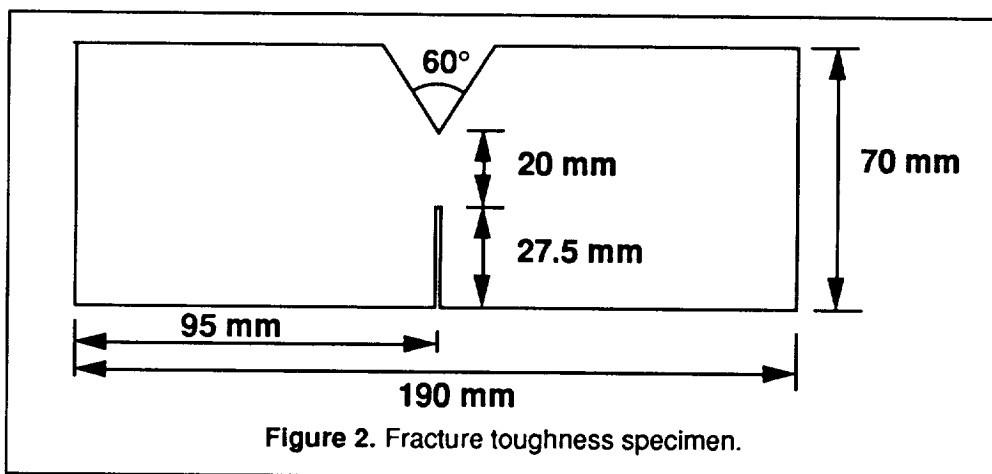
The tensile/modulus dumbbell-shaped specimens are each about 183 mm overall length with test section width about 20 mm, as shown in Fig. 1. All specimens with intermittent interlaminar control consist of eight layers of prepreg unidirectional T300 graphite tape with 5208 epoxy, plus seven layers of 7- $\mu$ m thick Mylar, and are about 1.1 mm thick. For this study, orientations of the graphite cross-ply were either  $\pm 20^\circ$  or  $\pm 45^\circ$ . The prepreg composite of T300 graphite with 5208 epoxy was Narmco Lot 50548470, batch 20, roll 20, having density of 142.2 g/m<sup>3</sup> and 32.6% resin. The Mylar used contains evenly spaced holes of 1.1-mm diameter in a matrix spaced appropriately for the per cent contact desired. For specimens with 0% contact, Teflon was sprayed on each of the contacting layers of prepreg

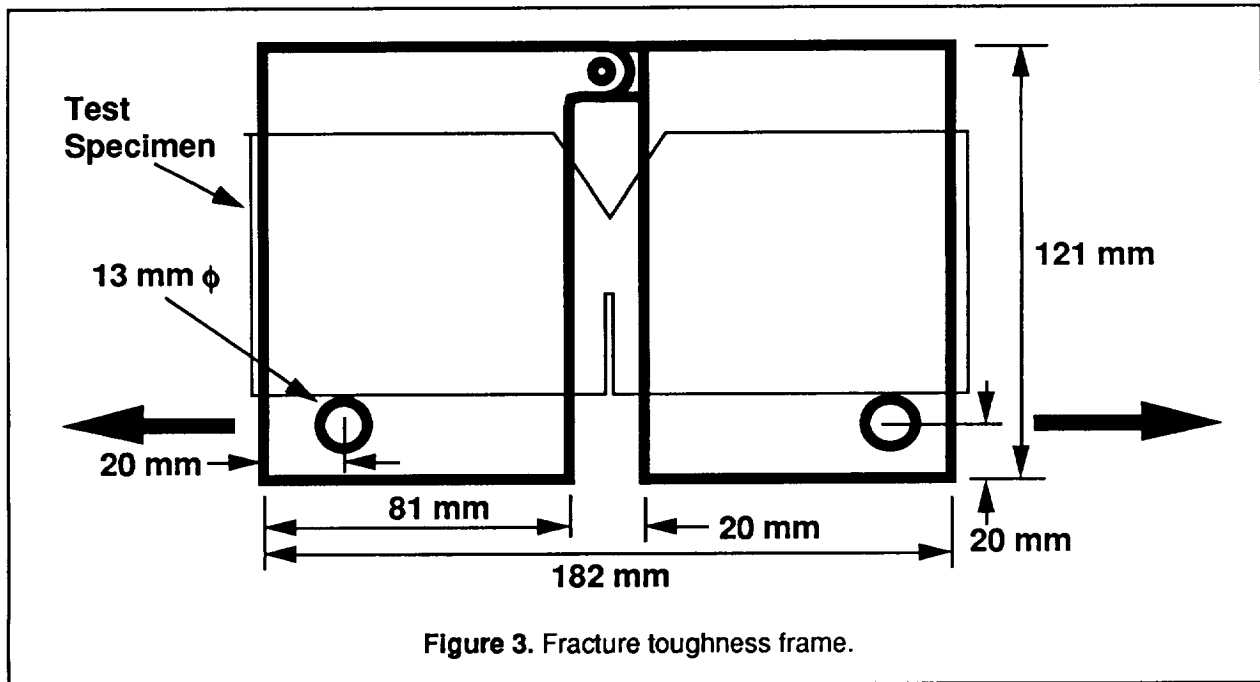
\*This work was performed under National Aeronautics and Space Administration Langley Research Center Grant NAS1-17008.



prior to curing so as to prevent interlaminar bonding. Specimens for 100% contact were cured with nothing between adjacent layers. Curing of all specimens was in accordance with the manufacturer's specifications. Using steel friction grips, each specimen was tested initially for elastic modulus at moderate loads and a crosshead speed of 0.5 mm/min, then later fractured to measure strength as the maximum stress (load/net area) during the test. (Elastic modulus is the ratio of incremental stress to incremental strain at stresses well below the fracture stress; that is, where the stress-strain curve is virtually a straight line.)

The fracture toughness compact-tension specimens are about 190 mm long and about 70 mm wide overall, as shown in Fig. 2. A narrow 27.5-mm transverse slot is machined on the initiation side, and a 22.5-mm 60° notch is cut out on the termination side to control out-of-plane buckling, with a net test section width of approximately 20 mm. Each specimen with intermittent interlaminar control consists of eight layers of prepreg plus seven layers of Mylar in the same manner as for the tensile/modulus specimens. The 100% and zero per cent contact specimens are likewise the same layup (either  $\pm 20^\circ$  or  $\pm 45^\circ$ , as listed in Table 1) as for the tensile/modulus specimens. Each specimen is mounted in a loading frame as shown in Fig. 3. Each half of the frame is made of 8-mm thick structural steel and is loaded as shown by the arrows in Fig. 3. A matrix of compression screws to secure the specimen, not shown here, was found to be necessary to prevent slippage of the specimen.



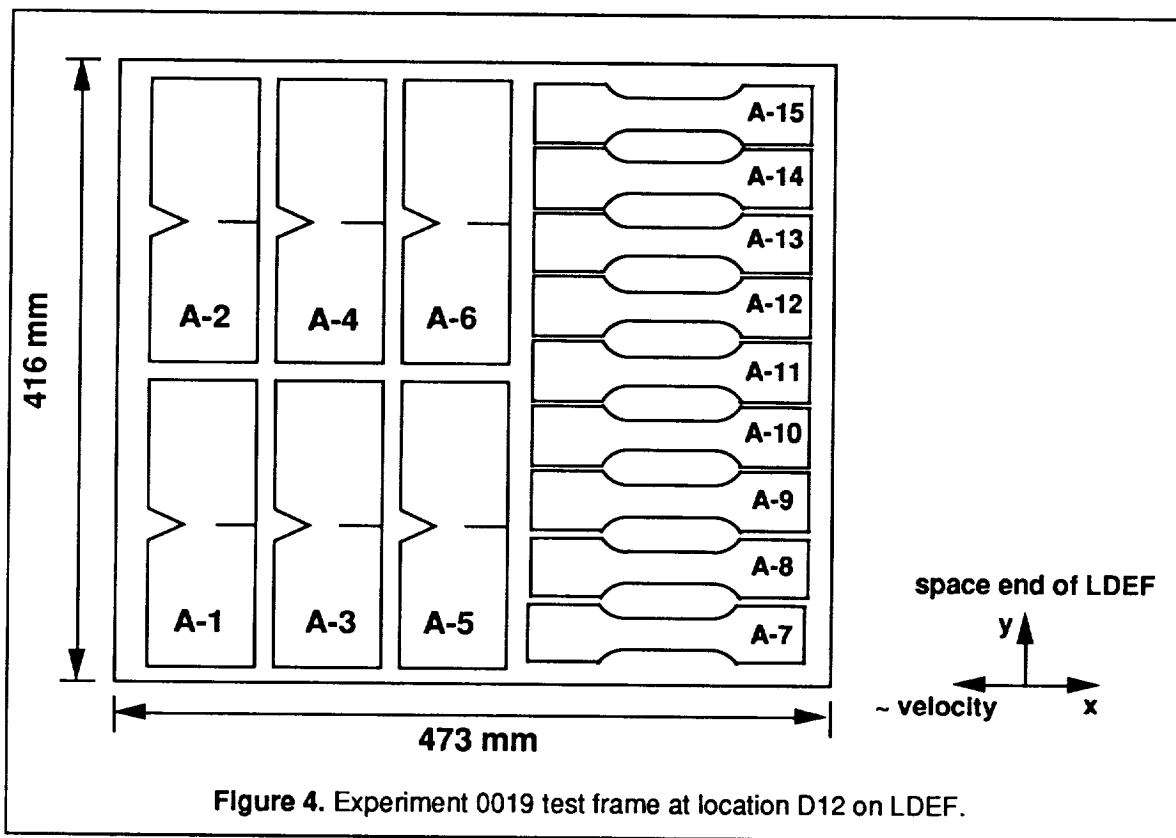


Because the compact-tension specimen permits slow stable fracture to occur, the load-displacement curve can be recorded, in accordance with the Gurney method<sup>3</sup>, at a crosshead speed of 0.5 mm/min. In this case we made the arbitrary assumption that all work done following an 80% drop from the maximum load is neglected; in fact, each specimen would continue to absorb energy until complete separation is achieved, so this assumption leads to a conservative measure of fracture energy. This additional energy would normally be expected to exceed the elastic energy that would be given up by the specimen if it could return to its initial displacement. The net work done divided by the *apparent* minimum fracture area (specimen thickness times increase in crack length) is thus the fracture toughness  $R$ , where stress intensity factor  $K_{Ic} = [ER]^{1/2}$ ;  $E$  is the elastic modulus. Note that  $K_{Ic}$  is here not plane strain stress intensity factor, but the Mode I critical stress intensity factor. With the relatively large values of toughness measured, the ratio of stress intensity factor divided by yield strength (in this case the fracture stress), upon which the radius of the plastic region depends, would mandate thicknesses one to three orders of magnitude greater than the subject specimens in order to achieve mostly plane strain conditions. Thus the results obtained here for plane stress are meaningful for the range of thickness measured, as well as foreseeable thicknesses that might be used in actual structures.

For each of the two classes of specimens, tensile/modulus and fracture toughness, the cross-ply angle and the fraction (percent) of contact between adjacent plies are varied. The interlaminar contact fraction is controlled by the spacing and thus the fraction of holes in the Mylar sheet.

### EXPERIMENT LOCATION

Our experiment was located on LDEF in tray D12, which was oriented so that the vector normal to the plane of the tray was  $82^\circ$  from the velocity vector; this panel received relatively low solar exposure. The layout of the 15 specimens, and their orientation with respect to space and the approximate



velocity vector of LDEF, are shown in Fig. 4. All specimens were held in place with thin aluminum strips bolted to the test frame, not shown in the sketch. Measurement of the extent of atomic oxygen exposure has been made by other LDEF experimenters. Of particular importance here is that atomic oxygen produced erosion only in the surface epoxy but caused no loss of graphite filaments in our experiment.

## RESULTS

All specimens were manufactured in December 1982, in preparation for delivery of the flight specimens to Langley the following spring. All specimens for each of the 15 groups were cured at the same time from the same batch. LDEF was launched in April 1984, approximately 16 months after manufacture of our specimens. The three sets of specimens were designated as:

Set A: flight specimens, to be flown on board LDEF

Set B: "zero time" specimens, to be tested at the time of the launch of LDEF

Set C: total time, ground specimens, to be tested after the flight along with Set A

Six fracture toughness specimens (group numbers 1-6) and nine tensile/modulus specimens (group numbers 7-15), of varying layup angle and per cent contact, were manufactured for each of the three sets. Complete descriptions of the characteristics of each group of specimens, date of manufacture, date of testing, and results are compiled in Table 1.

Toughness results are shown in Figs. 5 through 10. Our past experience with composite specimens of the same type had shown some modest scatter in results, but we had never tested specimens that were more than a few months old. In the present program, even the "zero time" specimens, Set B, were approximately 18 months old when tested, and the rest of the specimens were about 100 months old. The scatter in results between the zero-time specimens (Set B) and the total-time ground specimens (Set C) was therefore unanticipated. Because of these substantial changes in properties with time, we have elected to display all test results as a function of time since manufacture. We have no explanation for the observed changes; additional studies of the effects of aging in composite materials of this type are clearly warranted.

Figures 5-10 demonstrate that, in general, fractional per cent contact produces the highest values of toughness, as would be expected from the basic mechanism of partial bonding. Thus the toughness for 18% (Fig. 6) and 36% (Fig. 9) contact are higher than for 0% contact (Figs. 5 and 8), and much higher than for 100% contact (Figs. 7 and 10). In every case, toughness of the flight specimens was less than of the zero-time specimens; this suggests degradation from exposure. But as already noted above, we have no explanation for increases with toughness with time of ground specimens and, in Fig. 5, a marked decrease in toughness with time. (The datum for Set C of Group 3, Fig. 7, was lost.)

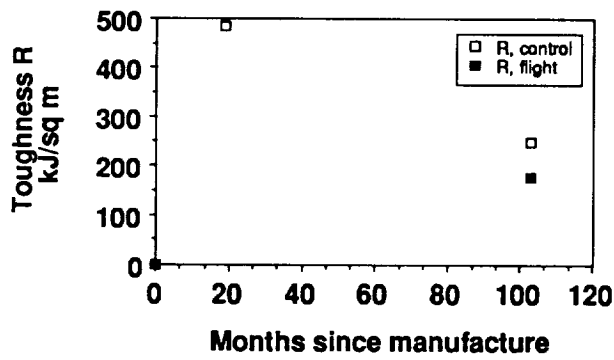
Modulus results are shown in Figs. 11 through 19. Elastic modulus of the ground specimens either remained the same or decreased. Both ground specimens having 100% contact (Figs. 14 and 18) show marked decreases in modulus. The scatter in modulus of flight specimens appears to follow no consistent pattern, and the very limited number of tests precludes further conclusions. The testing procedure for measuring modulus is rather critically dependent on control of specimen slippage, with scatter observed in repeated tests; thus we have used average values here. The widely different values of modulus in Groups 8 and 9, which are the same lay-up, demonstrate this problem.

Strength results are shown in Figs. 20 through 28. Measurement of strength of these composites is more precise than measurement of toughness or modulus, as can be noted by the closeness of values for Groups 8 and 9. Scatter of ground specimens is less for the strength specimens, and flight specimens are in every case but one (Fig. 22) lower in strength than total time control specimens. (Datum for Set B in Fig. 23 was lost.) We may conclude that flight exposure led to some degradation in strength in almost all cases.

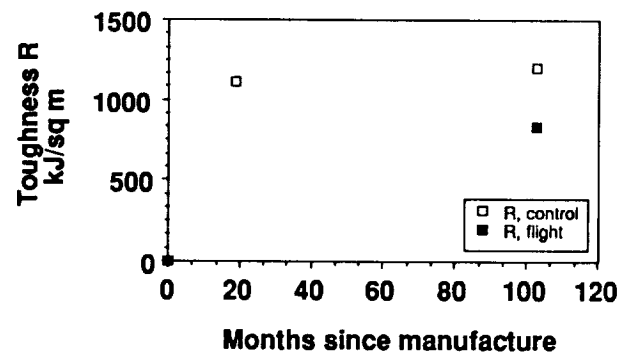
Toughness of flight specimens is given in Fig. 29, with corresponding lay-ups and per cent interlaminar contact. For each ply angle, the partial per cent contact provides the highest toughness after exposure and the 100% contact the lowest.

Figure 30 shows the elastic modulus of all flight specimens. The  $\pm 45^\circ$  specimens are all of low modulus; all of the  $\pm 20^\circ$  specimens show several times the modulus of the  $\pm 45^\circ$  specimens. That one of the  $\pm 20^\circ$  18% specimens shows much higher modulus than the corresponding 100% contact specimen suggests that the  $\pm 20^\circ$  18% datum may be the result of an inaccurate measurement. The strength of the flight specimens, Fig. 31, shows a similar difference between the  $\pm 45^\circ$  specimens and the  $\pm 20^\circ$  specimens. As expected, the 100% contact specimens for both angle layups show the highest strengths.

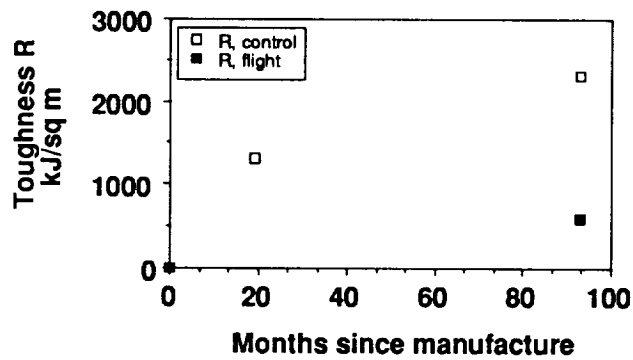
**Fig. 5. Group 1:  $\pm 20^\circ$ , 0% contact**



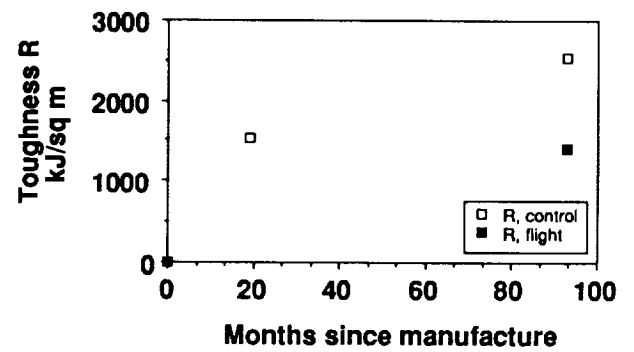
**Fig. 8. Group 4:  $\pm 45^\circ$ , 0% contact**



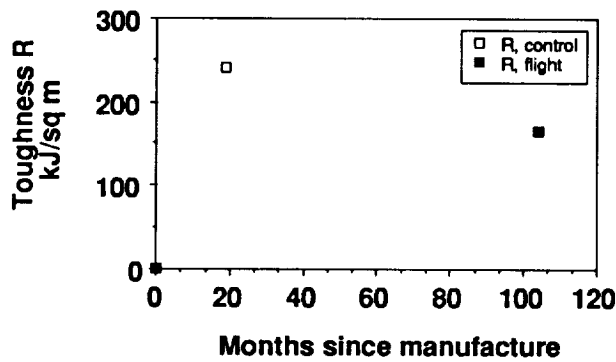
**Fig. 6. Group 2:  $\pm 20^\circ$ , 18% contact**



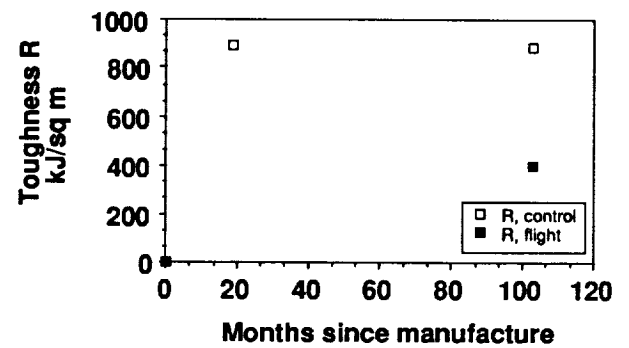
**Fig. 9. Group 5:  $\pm 45^\circ$ , 36% contact**



**Fig. 7. Group 3:  $\pm 20^\circ$ , 100% contact**

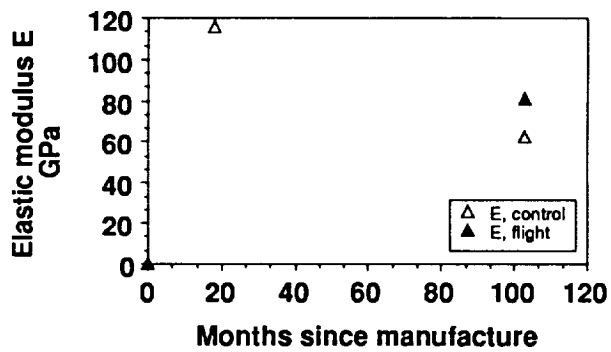


**Fig. 10. Group 6:  $\pm 45^\circ$ , 100% contact**

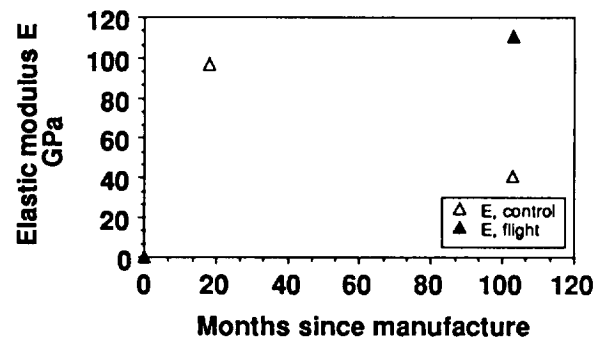


Figures 5-10. Toughness results.

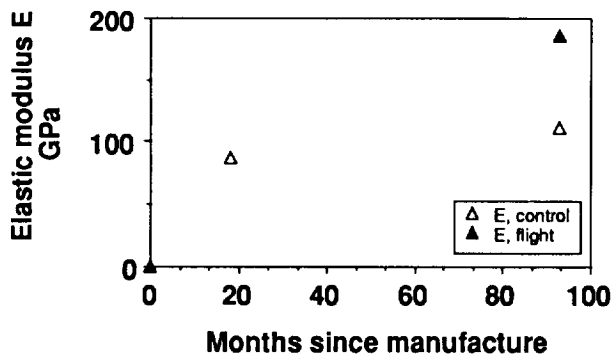
**Fig. 11. Group 7:  $\pm 20^\circ$ , 0% contact**



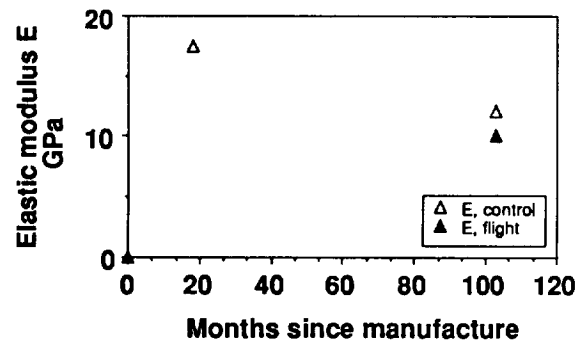
**Fig. 14. Group 10:  $\pm 20^\circ$ , 100% contact**



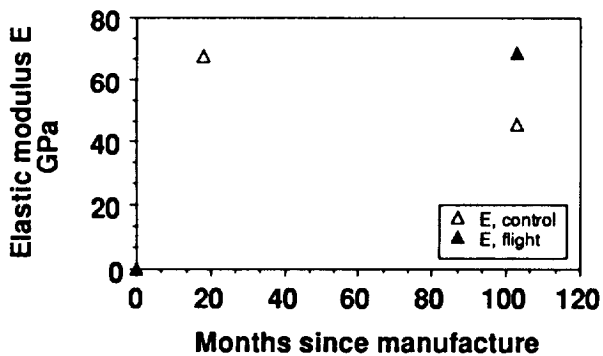
**Fig. 12. Group 8:  $\pm 20^\circ$ , 18% contact**



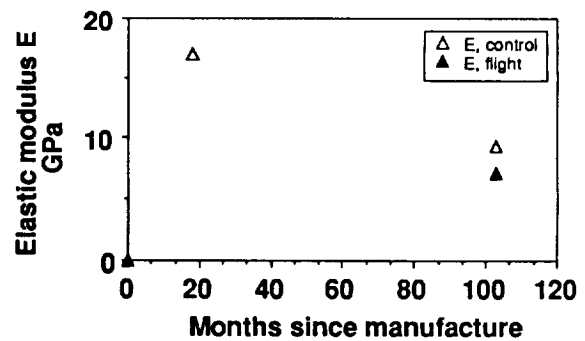
**Fig. 15. Group 11:  $\pm 45^\circ$ , 0% contact**



**Fig. 13. Group 9:  $\pm 20^\circ$ , 18% contact**

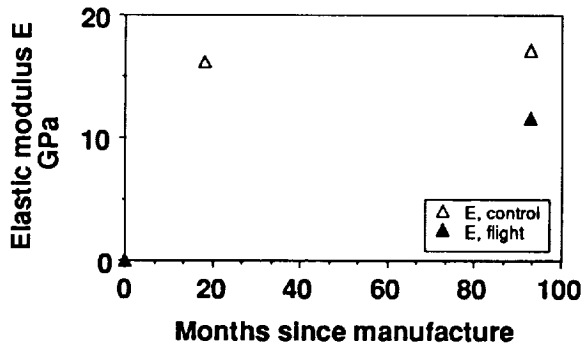


**Fig. 16. Group 12:  $\pm 45^\circ$ , 36% contact**

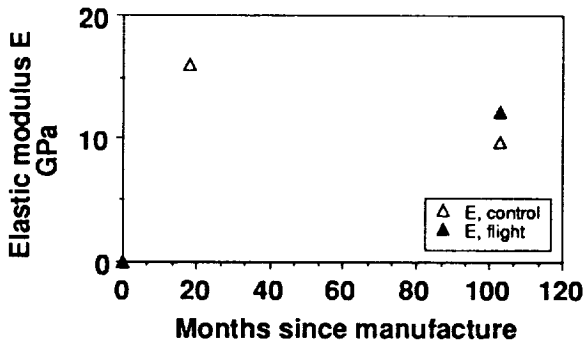


**Figures 11-16. Elastic modulus results.**

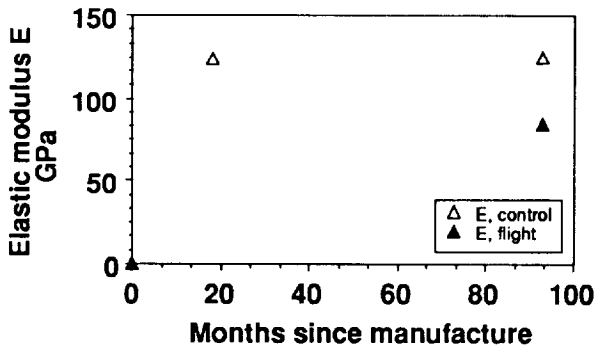
**Fig. 17. Group 13:  $\pm 45^\circ$ , 36% contact**



**Fig. 18. Group 14:  $\pm 45^\circ$ , 100% contact**

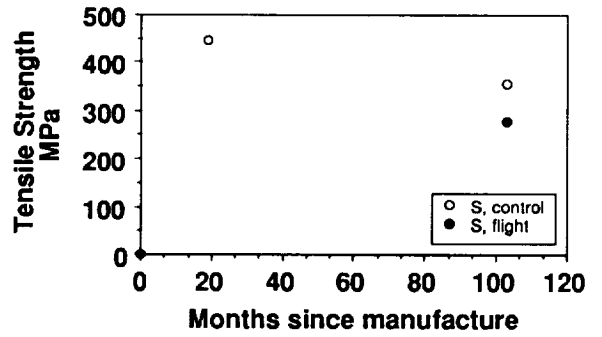


**Fig. 19. Group 15:  $\pm 20^\circ$ , 36% contact**

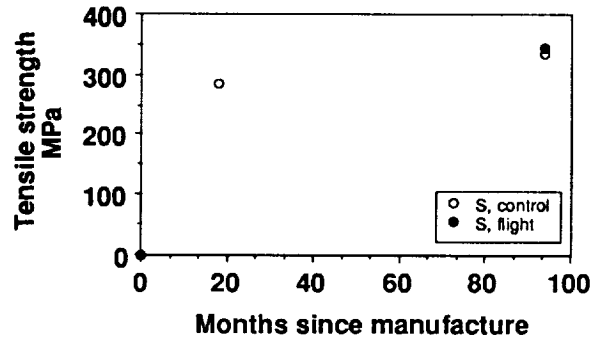


Figures 17-19. Elastic modulus results (cont.).

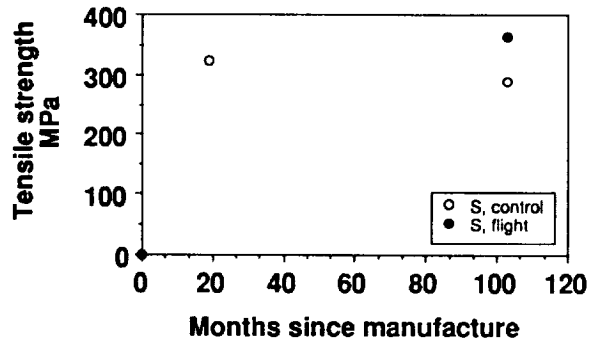
**Fig. 20. Group 7:  $\pm 20^\circ$ , 0% contact**



**Fig. 21. Group 8:  $\pm 20^\circ$ , 18% contact**



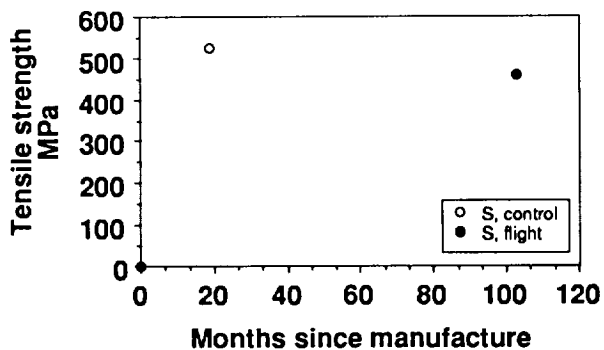
**Fig. 22. Group 9:  $\pm 20^\circ$ , 18% contact**



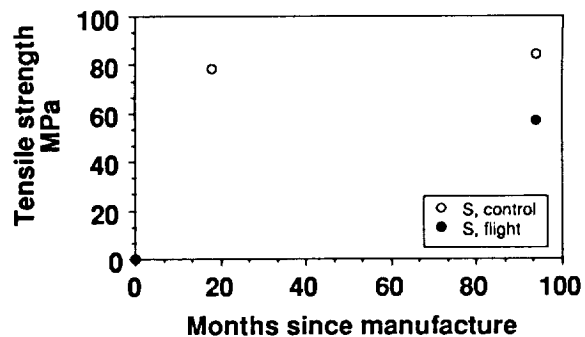
Figures 20-22. Tensile strength results.



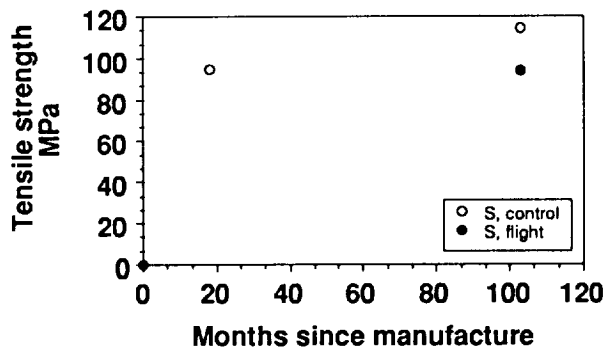
**Fig. 23. Group 10:  $\pm 20^\circ$ , 100% contact**



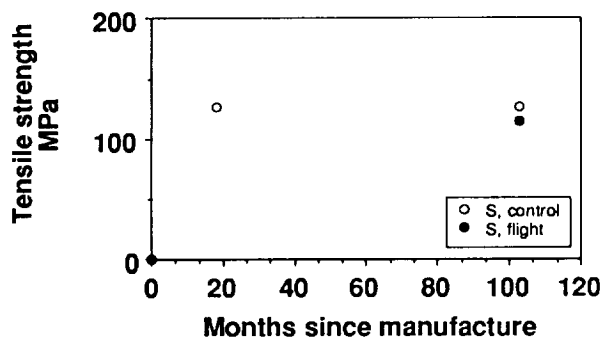
**Fig. 26. Group 13:  $\pm 45^\circ$ , 36% contact**



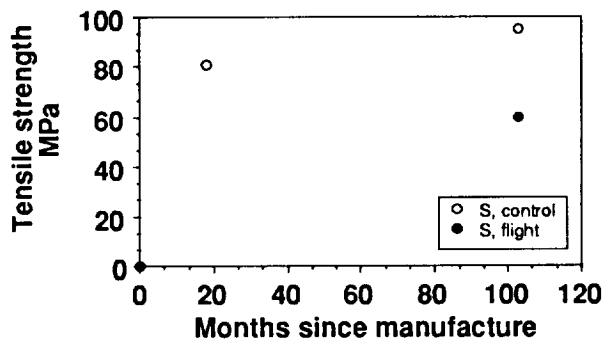
**Fig. 24. Group 11:  $\pm 45^\circ$ , 0% contact**



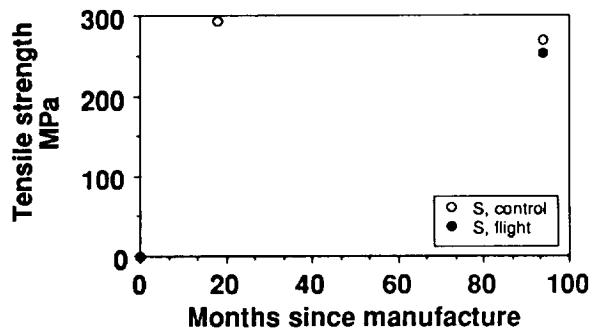
**Fig. 27. Group 14:  $\pm 45^\circ$ , 100% contact**



**Fig. 25. Group 12:  $\pm 45^\circ$ , 36% contact**

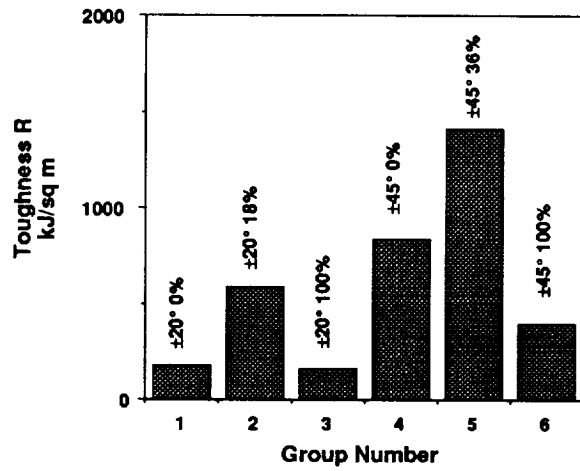


**Fig. 28. Group 15:  $\pm 20^\circ$ , 36% contact**

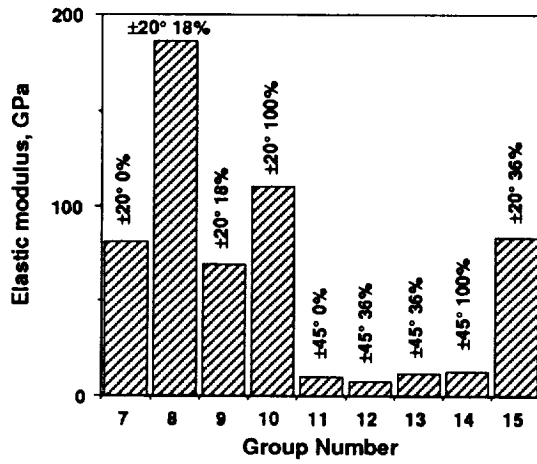


Figures 23-28. Tensile strength results (cont.).

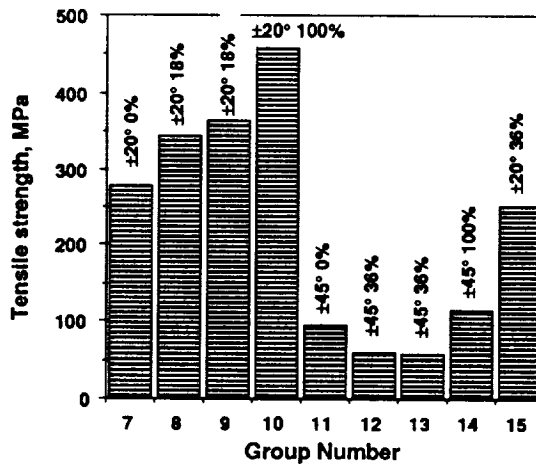
**Fig. 29. Toughness of Flight Specimens**



**Fig. 30. Modulus of Flight Specimens**



**Fig. 31. Strength of Flight Specimens**



## OTHER OBSERVATIONS

We have observed a number of micrometeoroid impact sites on the soft aluminum surface of the frame and on the composite specimens, ranging in size from 0.1 mm down to sub-micron sizes. Since this subject is being given extensive examination by other LDEF experimenters, we have not pursued it systematically and will not report on the subject here.

We also noted some apparently anomalous indentations on our aluminum frame, which we have reported elsewhere.<sup>4,5</sup> We believe now, after further systematic examination of ground control and flight tray clips, that these observations represent artifacts somehow resulting from techniques of fabrication, although we still do not know their origins.

Wahl maximum-temperature sensors were located on the outside (exposed) face of each of the specimens. These sensors indicate maximum temperature reached during ground storage, launch, flight, retrieval, and post-flight storage, in increments of 11°C. The temperatures indicated upon retrieval of the experiment are as follows:

<u>Specimen</u>	<u>Temp., °C</u>	<u>Specimen</u>	<u>Temp., °C</u>	<u>Specimen</u>	<u>Temp., °C</u>
A-1	93	A-6	82	A-11	93
A-2	93	A-7	82	A-12	93
A-3	93	A-8	93	A-13	93
A-4	82	A-9	93	A-14	93
A-5	82	A-10	93	A-15	93

From Fig. 4 it is apparent that Specimens A-4 through A-7 have no special location or orientation with respect to the experiment panel that would explain the lower observed maximum temperature, and no other LDEF experiment in the vicinity is likely to have led to the observed differences. Thus we may conclude that the maximum external temperature reached was close to 93°C, with a small variation below that actuating only the 82°C sensors.

Wahl maximum-temperature sensors were located on the under side (unexposed) surface of the test frame at nine locations. Upon retrieval, all of these sensors read 82°C.

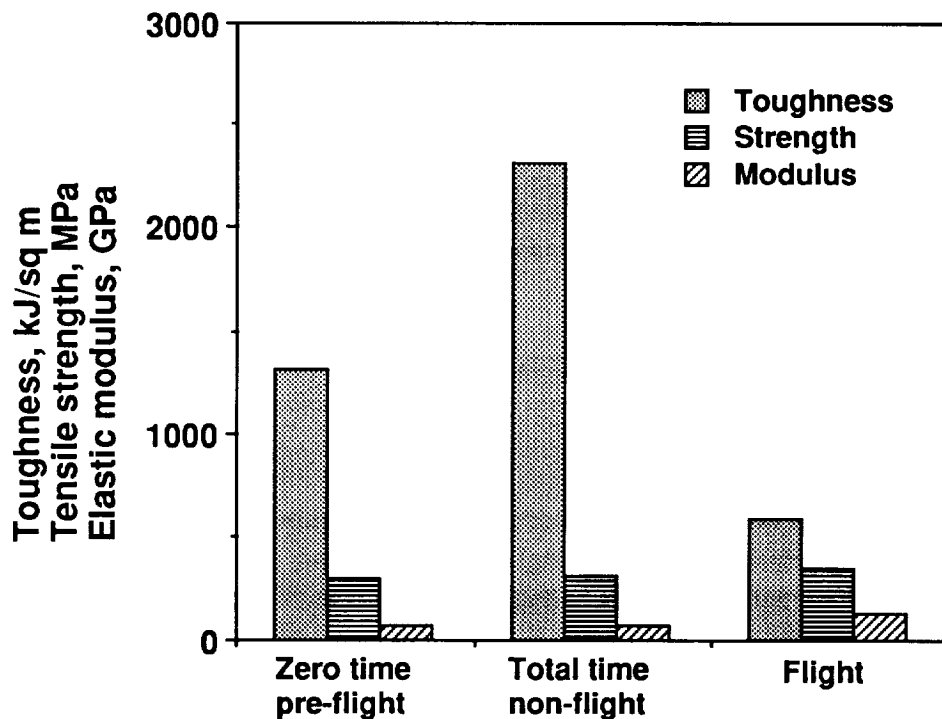
## CONCLUSIONS

We observe the following:

- Marked degradation from exposure, of the order of a factor of roughly two from the control specimens, is observed in every one of the six toughness specimens.
- Except for the Group 1 specimen ( $\pm 20^\circ$ , 0% contact), the toughness of the other four control specimens (Specimen C-3 datum was lost during the test) increased during the 100 or so months since manufacture. Although an observation that four out of five specimens increased in toughness is significant, the limited amount of this increase probably lies within the range of scatter for the test.

- The elastic modulus of the flight specimens varied rather widely from the control specimens for the same life, both higher and lower. In six of the nine specimens, flight modulus was lower than zero-time modulus; in four of the nine specimens, flight modulus was lower than total time ground specimens. Some of this variation is surely experimental scatter, but we have no way to establish its extent.
- In most cases, the elastic modulus of the control specimens either remained about the same or degraded during the duration of the experiment. In no case did it increase significantly.
- The strength of the flight specimens ranged from moderate increase to moderate decrease, except for Group 7 ( $\pm 20^\circ$ , 0% contact) which was about half of the initial strength. In every specimen except  $\pm 20^\circ$  18% contact, the strength of the flight specimens was less than that of the total time ground specimens.
- The change in strength of the control specimens ranged from moderate increase to moderate decrease. Even with the better precision of the strength results, this modest variation is probably attributable to scatter.
- Substantial differences are observed in the behavior of specimens having different cross-ply angles and fraction of interlaminar contact.
- In general, the 0% and 100% contact layups produced poorer combinations of post-flight properties than partial contact layups with the same cross-ply arrangement.

**Fig. 32.  $\pm 20^\circ$ , 18% Contact Specimens:  
Initial and Final Properties**



We conclude the following:

- With the proper selection of layup (see discussion below of  $\pm 20^\circ$ , 18% contact) , and also including choices of layups not included in this experiment, graphite/epoxy composites can be used for extended exposure, at least in near-earth orbit, for periods of the order of 5 years without degradation to intolerable levels of toughness, elastic modulus, and strength. This assumes that suitable coating or protection from solar exposure and atomic oxygen is provided, as neither of these problems was severe in our test because of the orientation of the test panel.
- The single best combination of acceptable properties of toughness, elastic modulus, and strength in uniaxial tension after flight exposure is achieved for the Groups 2, 8 and 9 layup:  $\pm 20^\circ$ , 18% contact. These results are shown in Fig. 32. While the toughness dropped to 593 kJ/m<sup>2</sup>, this is still an entirely acceptable value, and both the elastic modulus and the tensile strength remained essentially constant as a result of the 5.8-year near-earth space exposure.

## REFERENCES

1. Marston, T.U.; Atkins, A.G.; and Felbeck, D.K.: "Interfacial Fracture Energy and the Toughness of Composites," *Jour. of Materials Science*, v. 9 (1974), p. 447.
2. Jea, L.-C.; and Felbeck, D.K.: "Increased Fracture Toughness of Graphite-Epoxy Composites Through Intermittent Interlaminar Bonding," *Jour. of Composite Materials*, v. 14 (July 1980), p. 245.
3. D.K. Felbeck and A.G. Atkins, *Strength and Fracture of Engineering Solids*. (Englewood Cliffs, NJ: Prentice-Hall, Inc., 1984), p. 333-35. More detailed information on the Gurney method can be found in several papers in the *Proceedings of the Royal Society (London)*, e.g., 1974, vol. 340A, p. 213.
4. Felbeck, D.K.; and Durrant, W.H: "Repetitive Orbital Damage," *Nature*, v. 347, Sept. 27, 1990, p. 341.
5. Felbeck, D.K.: Author's Response to Scientific Correspondence, *Nature*, v. 352, July 25, 1991, p. 289.

**Table 1. All Data.**

<u>Spec.</u>	<u>Tested</u>	<u>Layup</u>	<u>%contact age.mo.</u>	<u>R. kJ/sq.m</u>	<u>E. GPa</u>	<u>Su. MPa</u>	<u>Comment</u>
<b>Group 1</b>		<b>20 deg</b>	<b>0</b>				<b>Gp 1 specs mfr 12/9/82</b>
A-1	7/23/91		103	177			Set A=Flight
B-1	7/11/84		19	484			Set B=Zero time
C-1	7/23/91		103	248			Set C=Ground, total time
<b>Group 2</b>		<b>20 deg</b>	<b>18</b>				<b>Gp 2 specs mfr 12/13/82</b>
A-2	9/20/90		93	593			
B-2	7/11/84		19	1315			
C-2	9/20/90		93	2311			
<b>Group 3</b>		<b>20 deg</b>	<b>100</b>				<b>Gp 3 specs mfr 12/7/82</b>
A-3	7/23/91		104	165			
B-3	7/11/84		19	241			
C-3	7/23/91		104	no result			
<b>Group 4</b>		<b>45 deg</b>	<b>0</b>				<b>Gp 4 specs mfr 12/15/82</b>
A-4	7/23/91		103	839			
B-4	7/11/84		19	1116			
C-4	7/23/91		103	1200			
<b>Group 5</b>		<b>45 deg</b>	<b>36</b>				<b>Gp 5 specs mfr 12/17/82</b>
A-5	9/20/90		93	1410			
B-5	7/11/84		19	1528			
C-5	9/20/90		93	2540			
<b>Group 6</b>		<b>45 deg</b>	<b>100</b>				<b>Gp 6 specs mfr 12/16/82</b>
A-6	7/23/91		103	400			
B-6	7/11/84		19	890			
C-6	7/23/91		103	886			
<b>Group 7</b>		<b>20 deg</b>	<b>0</b>				<b>Gp 7 specs mfr 12/3/82</b>
A-7	7/16/91		103		80.9		
A-7	7/18/91		103			279	
B-7	6/9/84		18		116		
B-7	6/22/84		19			447	
C-7	7/16/91		103		62.2		
C-7	7/18/91		103			355	
<b>Group 8</b>		<b>20 deg</b>	<b>18</b>				<b>Gp 8 specs mfr 12/9/82</b>
A-8	9/21/90		93		186		
A-8	10/9/90		94			344	
B-8	6/9/84		18		87.9		
B-8	6/22/84		18			285	
C-8	9/21/90		93		111		
C-8	10/9/90		94			336	
<b>Group 9</b>		<b>20 deg</b>	<b>18</b>				<b>Gp 9 specs mfr 12/4/82</b>
A-9	7/16/91		103		68.5		
A-9	7/18/91		103			365	
B-9	6/9/84		18		67.6		
B-9	6/22/84		19			324	
C-9	7/16/91		103		45.6		
C-9	7/18/91		103			290	

**Table 1. All Data (cont.).**

<u>Spec.</u>	<u>Tested</u>	<u>Layup</u>	<u>%contact age.mo.</u>	<u>R. kJ/sq.m</u>	<u>E. GPa</u>	<u>Su. MPa</u>	<u>Comment</u>
<b>Group 10</b>			<b>20 deg</b>				<b>Gp 10 specs mfr 12/5/82</b>
A-10	7/16/91		103		111		
A-10	7/18/91		103			460	
B-10	6/9/84		18		97.2		
B-10	6/22/84		19			525	
C-10	7/16/91		103		40.9		
C-10	7/18/91		103			no result	
<b>Group 11</b>			<b>45 deg</b>				<b>Gp 11 specs mfr 12/16/82</b>
A-11	7/16/91		103		10.1		
A-11	7/18/91		103			94.1	
B-11	6/9/84		18		17.5		
B-11	6/22/84		18			94.6	
C-11	7/16/91		103		12.1		
C-11	7/18/91		103			114	
<b>Group 12</b>			<b>45 deg</b>				<b>Gp 12 specs mfr 12/18/82</b>
A-12	7/16/91		103		7.07		
A-12	7/18/91		103			59.7	
B-12	6/9/84		18		17		
B-12	6/22/84		18			81	
C-12	7/16/91		103		9.3		
C-12	7/18/91		103			95	
<b>Group 13</b>			<b>45 deg</b>				<b>Gp 13 specs mfr 12/19/82</b>
A-13	9/21/90		93		11.6		
A-13	10/9/90		94			56.7	
B-13	6/9/84		18		16.2		
B-13	6/22/84		18			78.5	
C-13	9/21/90		93		17.1		
C-13	10/9/90		94			84.7	
<b>Group 14</b>			<b>45 deg</b>				<b>Gp 14 specs mfr 12/17/82</b>
A-14	7/16/91		103		12.2		
A-14	7/18/91		103			115	
B-14	6/9/84		18		16.1		
B-14	6/22/84		18			127	
C-14	7/16/91		103		9.68		
C-14	7/18/91		103			127	
<b>Group 15</b>			<b>20 deg</b>				<b>Gp 15 specs mfr 12/13/82</b>
A-15	9/21/90		93		84		
A-15	10/9/90		94			253	
B-15	6/9/84		18		124		
B-15	6/22/84		18			292	
C-15	9/21/90		93		125		
C-15	10/9/90		94			269	

All specimens of prepreg unidirectional 5208/T300 epoxy/graphite, 8 plies thick, Narmco Lot 50548470, batch 20, roll 20: 142.2 g/sq m, 32.6% resin. Interleaved with fractionally perforated 7 µm thick Mylar film having evenly spaced 1.14-mm holes. Zero percent contact specimens were made with teflon coating sprayed on all contact surfaces.

Set A: For LDEF flight

Set B: For time zero testing

Set C: For ground storage, post-flight testing

