

FABRICATION OF THE V-22 COMPOSITE AFT FUSELAGE  
USING AUTOMATED FIBER PLACEMENT

Robert L. Pinckney

Boeing Helicopters, Philadelphia, PA

SUMMARY

Boeing Helicopters and its subcontractors are working together under an Air Force Wright Research and Development Center (WRDC)-Manufacturing-Technology Large-Composite Primary Structure Fuselage program to develop and demonstrate new manufacturing techniques for producing composite fuselage skin and frame structures. Three sets of aft fuselage skins and frames have been fabricated and assembled, and substantial reductions in fabrication and assembly costs demonstrated.

INTRODUCTION

Advanced composite structures are lightweight, strong, stiff, and resistant to fatigue and corrosion. These features make composites highly attractive for major applications in military and commercial aircraft. Currently, industry is producing a number of secondary structure applications, and a significant amount of R&D effort is being expended to further develop engineering and manufacturing technology for wing primary structure. To maximize the benefits derived from using composites on aircraft, there is a need for a corresponding level of development activity on fuselage primary structure.

The Boeing Company, in a team effort with other major companies, conducted a WRDC sponsored program entitled "Manufacturing Technology for Large Aircraft Composite Primary Structure (Fuselage)." This program addressed the need to establish manufacturing capability to produce primary composite fuselage structure for large aircraft at predictable and reasonable cost. The program objective was to establish and validate low cost manufacturing methods for efficient production of such structure which could be applied to a variety of future aerospace systems.

The Boeing team effort combined the technical skills, automation technology, resources, and production experience of six companies in a concerted effort to achieve maximum cost-effectiveness in composites fuselage manufacturing. While Boeing had primary responsibility for carrying out the program, five other companies participated in Phase I and II. They were

Northrop Corporation  
Hercules, Inc.  
Teledyne-Ryan Aeronautical  
Rohr Industries, Inc.  
Xerkon, Inc. (formerly Proform, Inc.)

In order to evaluate various manufacturing methods and assure incorporation of the latest state-of-the-art technology in advanced composite manufacturing, the six-member team produced manufacturing test hardware during the first two phases of the program.

Innovative tooling and manufacturing methods were used to fabricate the test hardware. These test components were compared for manufacturing cost, quality, strength, and weight. The methods found to be superior were selected to fabricate full-size verification and test hardware in Phases III and IV.

The planned down selection at the program decision point led to the start of Phase III in September 1985 with the team narrowed to Hercules, Teledyne-Ryan, and Xerkon.

A pictorial overview of the program test and demonstration components is shown in figure 1.

## MANUFACTURING CONCEPTS

The manufacturing concepts selected for the production demonstration of the V-22 aft fuselage were those developed by the Hercules, Teledyne-Ryan and Xerkon Companies. Hercules fabricated the one-piece aft fuselage skin with its 157 cocured stiffeners on a male mandrel using their multi-axis fiber-tow placement machines.

### The Xerkon Company

The Xerkon Company fabricated the J-section stiffener preforms and two of the five fuselage frames using their dry-fiber stitching and resin infusion processes. Teledyne-Ryan fabricated the remaining three frames using their press molding (Quadrapress®) system. Design changes were made to accommodate each of the new manufacturing and material forms as required. Changes were validated by means of detail stress analysis and predicted fuselage dynamic responses.

The Xerkon Company replaced square weave fabric and unidirectional tape preimpregnated materials with dry fiber tows stitched into preformed shapes for the frames and stiffeners. The preforms were then impregnated with epoxy resin and cured in integrally heated and cooled, closed molds using their Autocomp® process. A high degree of automation in the stitching process was employed. Robotic tool loading and final part trimming was developed, figure 2.

### Teledyne-Ryan

The Teledyne-Ryan Company fabricated the three forward frames required for final aft fuselage assembly using their Press Cure Quadrapress® technique. No major design changes were required to utilize the press cure system rather than the more conventional autoclave cure technique; however, the fabric material forms, splice areas and other design details were changed to reduce layup hours. The use of 60-inch wide, 5 harness weave, 13-mil thick carbon fiber fabric significantly reduced preform layup time.

The use of graphite fiber-epoxy tooling inserts to transport, load, and unload the frame components to and from the curing press allowed the press platens to be maintained at a constant temperature of 182°C (360°F) thus appreciably reducing the cure cycle time. In addition, the frame configurations were such that the three individual frames could be nested and simultaneously cured during one press cycle. The tooling configuration is shown in figure 3 and a press load of cured frame sections in figure 4.

## PHASE I & II LARGE FUSELAGE SECTION

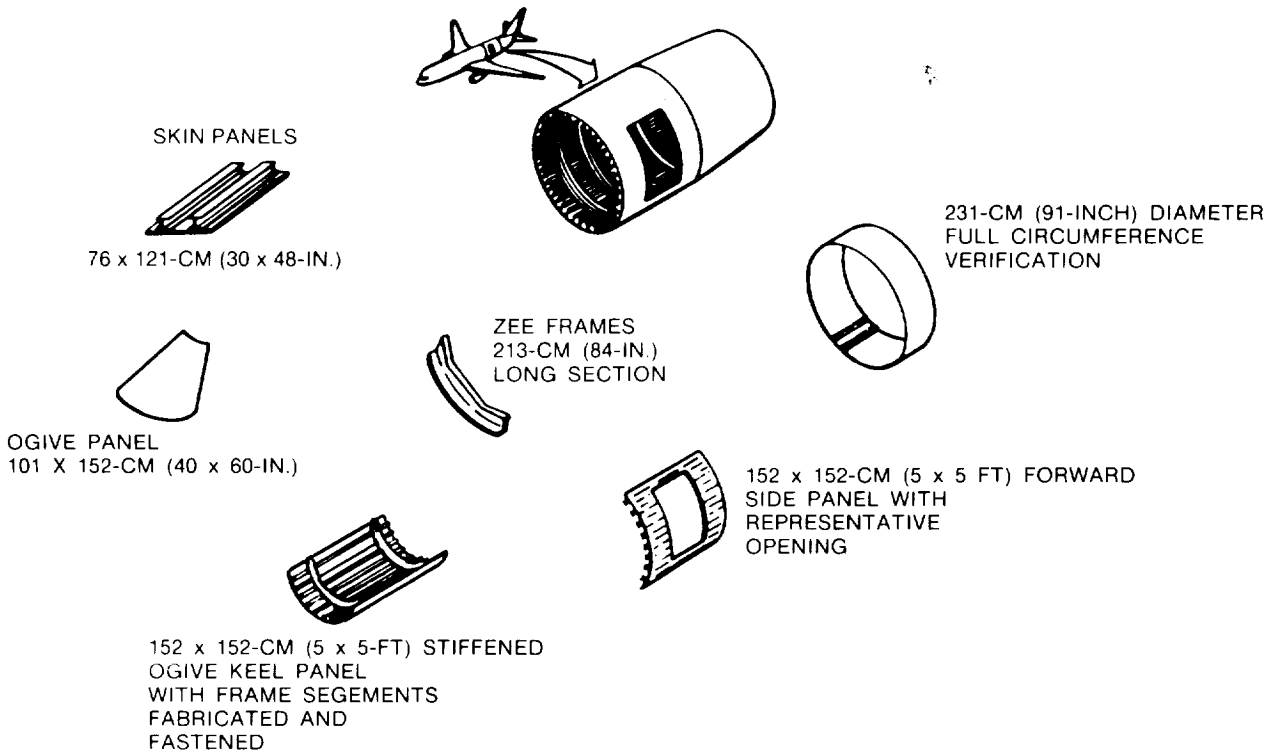

## PHASE III & IV V-22 AFT SECTION

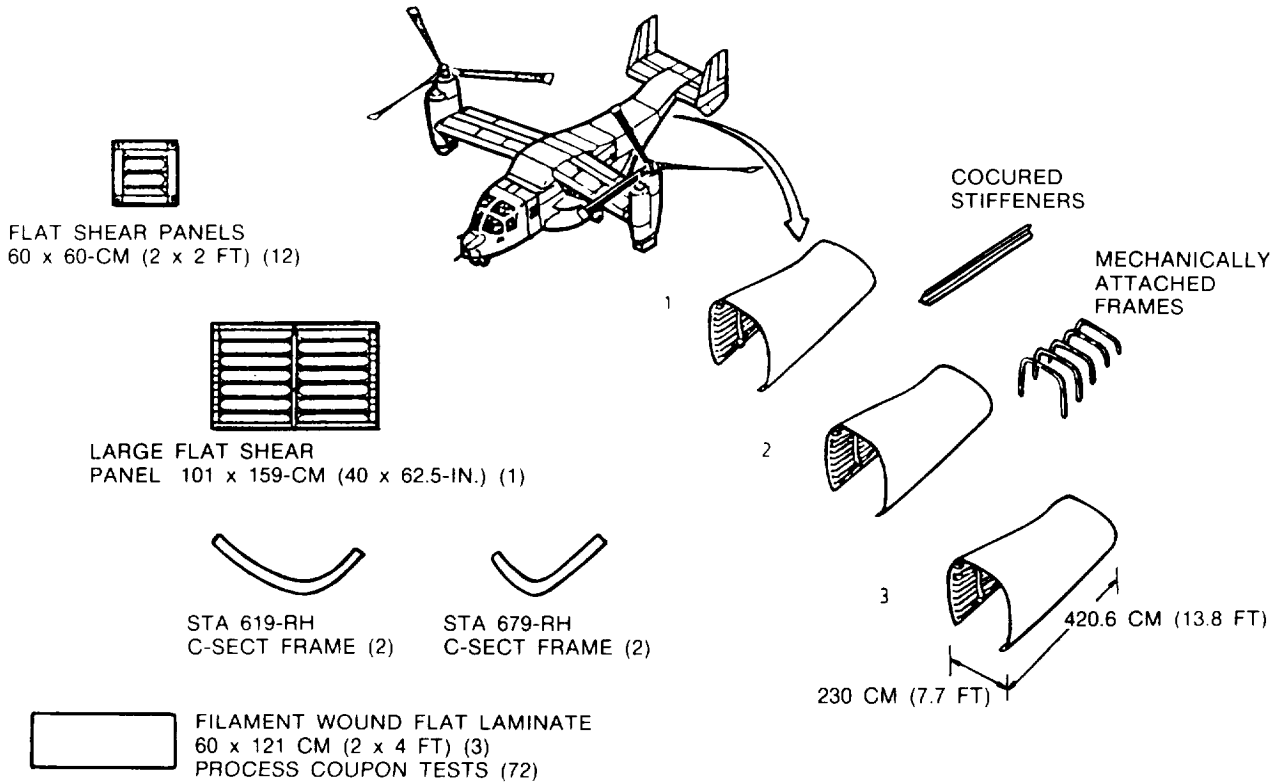

Figure 1. Program Test Components

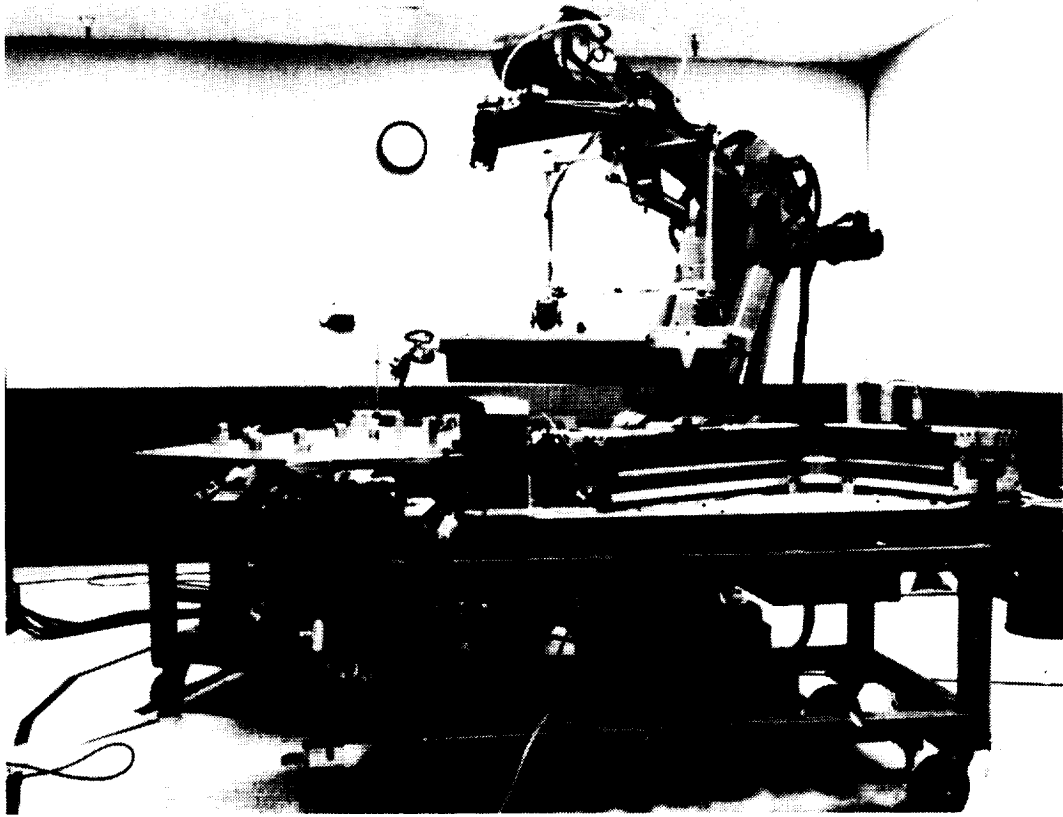

Figure 2. Robotic Handling of Center Tool Section

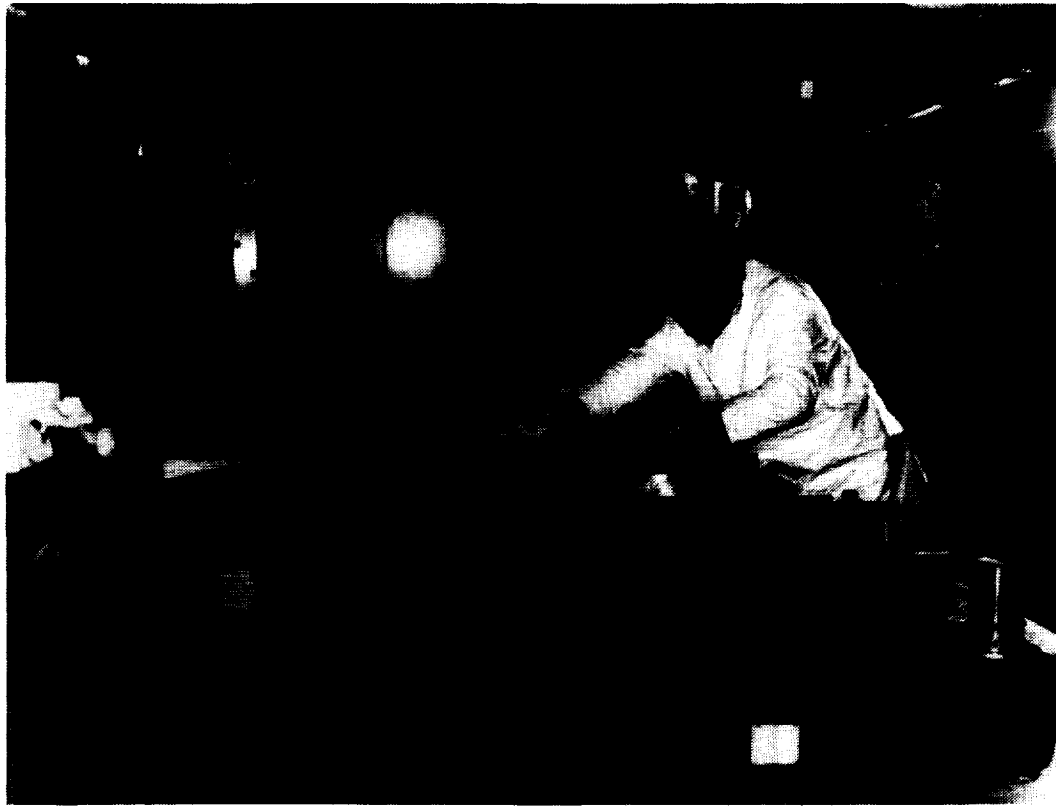

Figure 3.

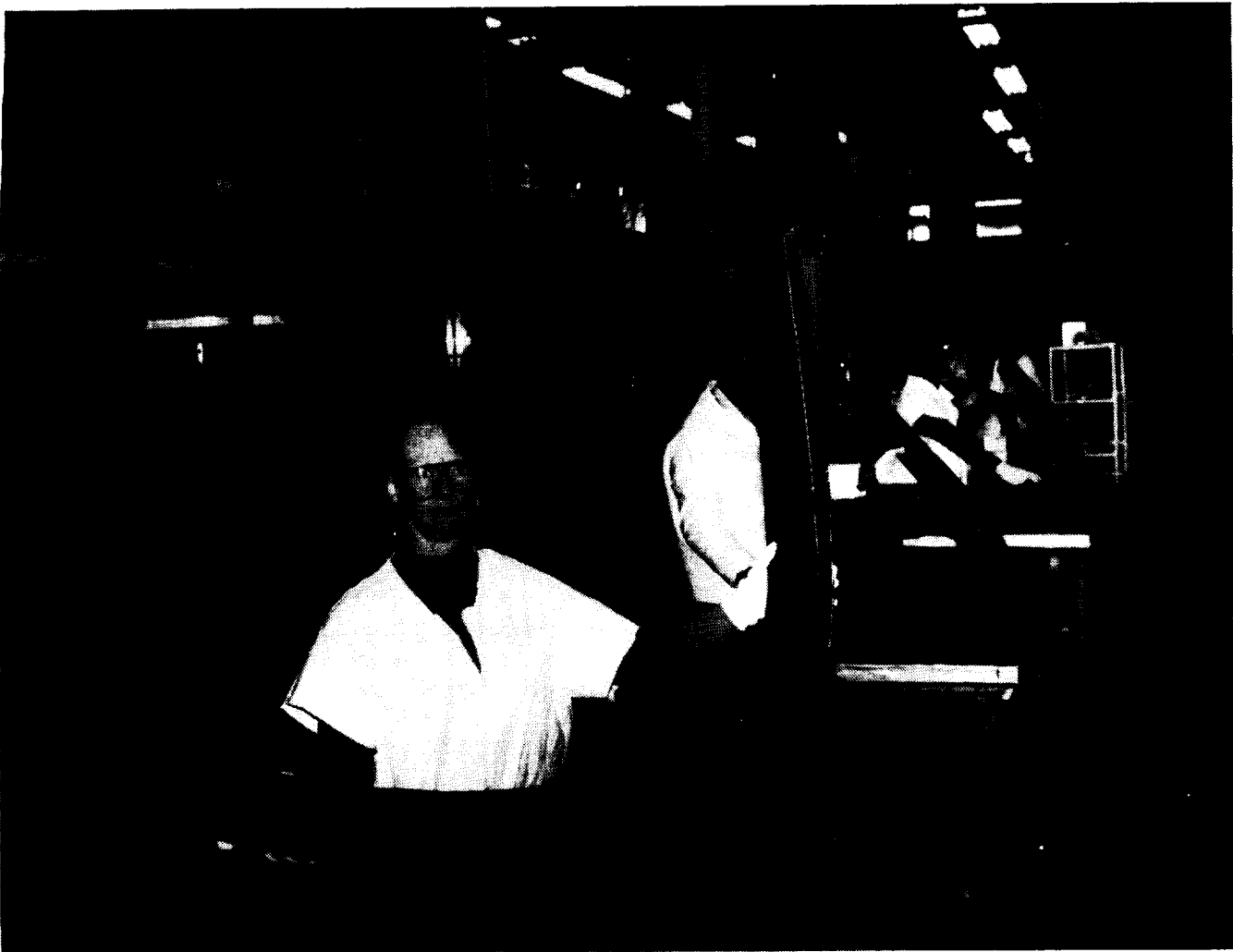

Figure 4.

### The Hercules Company

The Hercules Company; using CADAM data, tooling master models, and technical assistance supplied by Boeing; designed and fabricated the necessary tooling to produce the V-22 aft fuselage shells using their multiaxis fiber tow placement machines. Fiber tow placement offers reduced cost through automated, multitow placement (up to 32 tows of prepreg simultaneously onto a variety of tool geometries). Thickness and fiber angle control and in-process compaction, using the lowest projected cost material form, are key elements of this technology. Sectional, internal tooling provides precise detail part location, internal mold line (IML) control, and allows internal doubler pads and stiffeners to be cocured to the skin. Following autoclave curing of the part, the tooling is disassembled from within providing a single unit fuselage section. This results in the elimination of assembly joints and fasteners, and reduces the part count from eight sections to one.

The fiber placement machines utilize a computerized mathematical model of the part to generate a fiber path of a specified width, thickness, and orientation and to control cut and add functions. The software and hardware provide synchronization control and movement. The material delivery system processes, delivers, and compacts the prepreg tow material on the mandrel as demanded by part geometry.

Tooling for fiber tow placement must meet the following three requirements: It must form and apply pressure to all of the internal details of the finished part; it must have a center shaft to enable it to be rotated in the fiber placement machine; it must be able to withstand the pressure and temperature of repeated cure cycles; and it must be capable of being removed from the finished part interior.

Fiber tow placement offers many improvements over hand layup which contribute directly or indirectly to cost savings. Tow width control allows for nonstandard ply thicknesses which optimizes part design while maintaining constant band width. Gaps and overlaps are kept within a tolerance of 0.75 mm (0.030 inch). Constant ply thickness can be maintained by adding or dropping tows as the part changes cross section. Tow and band cut/add features reduce material scrap to as low as 5% by placing the material only where required. Fiber placement also utilizes prepreg tow which is projected to be the lowest cost material form available.

During the fiber tow placement process, a conformable roller rides directly on the part or tool to deliver the tow material while providing in-process compaction. This minimizes the need for intermediate compaction steps. The placement head flexibility allows fiber placement on convex and concave surfaces. The delivery head delivers individual tows as a flexible band to minimize material distortion. This flexibility provides fiber angle control which allows for fiber placement of non-geodesic shapes. There are no limits on the winding angle. Purely axial (0 degree) plies can be readily placed with this process.

Hercules currently has two fiber placement machines (FPM). FPM1 is a 6-axis, development machine which has been in use since 1982. This machine was used to manufacture the first three V-22 aft fuselage sections. FPM2 is a production rated, 7-axis, fiber placement machine to be used for production programs and to fabricate the final deliverable V-22 aft fuselage section. Figure 5 shows a typical FPM2 setup with an explanation of the various axes of motion.

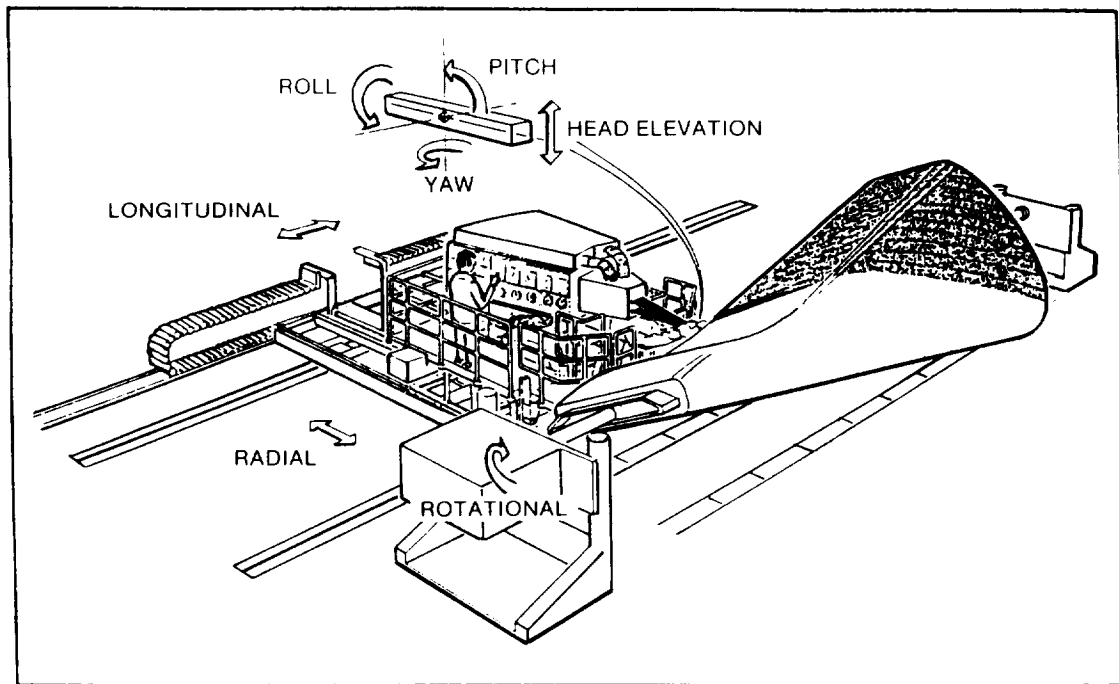

Figure 5.

The panelized design for the V-22 FSD aft fuselage consists of a basic skin of four layers of AS4 fabric for a total thickness of 0.75 mm (0.030 inch). The fiber placed design consists of a skin with five plies of IM6 prepreg tow (equivalent to grade 145 tape) for a total thickness of 0.71 mm (0.028 inch). In subscale testing, fiber placed test panels were the equivalent of the baseline test panels.

The panelized FSD design utilized outside mold line (OML) tooling, which required building the fuselage component from the outside in. Once laid up, they are bagged on the IML surface and cured. Each component is limited in size by the workers' ability to reach the middle of the tool during processing.

In contrast, the fiber placed design utilizes a knockdown, male IML mandrel. The internal stiffeners are assembled into the tooling which locates them exactly. The stiffener doublers are laid up in sections on recesses built into the surface of the full-size composite mandrel so that the resultant inner skin surface is smooth. See figure 6. The mandrel can be rotated so that workers can lay up sections of doubler material from a convenient position. The skin is then fiber placed on the mandrel surface using continuous, full-length, 9 cm (3.50 inch) wide bands of prepreg tows.

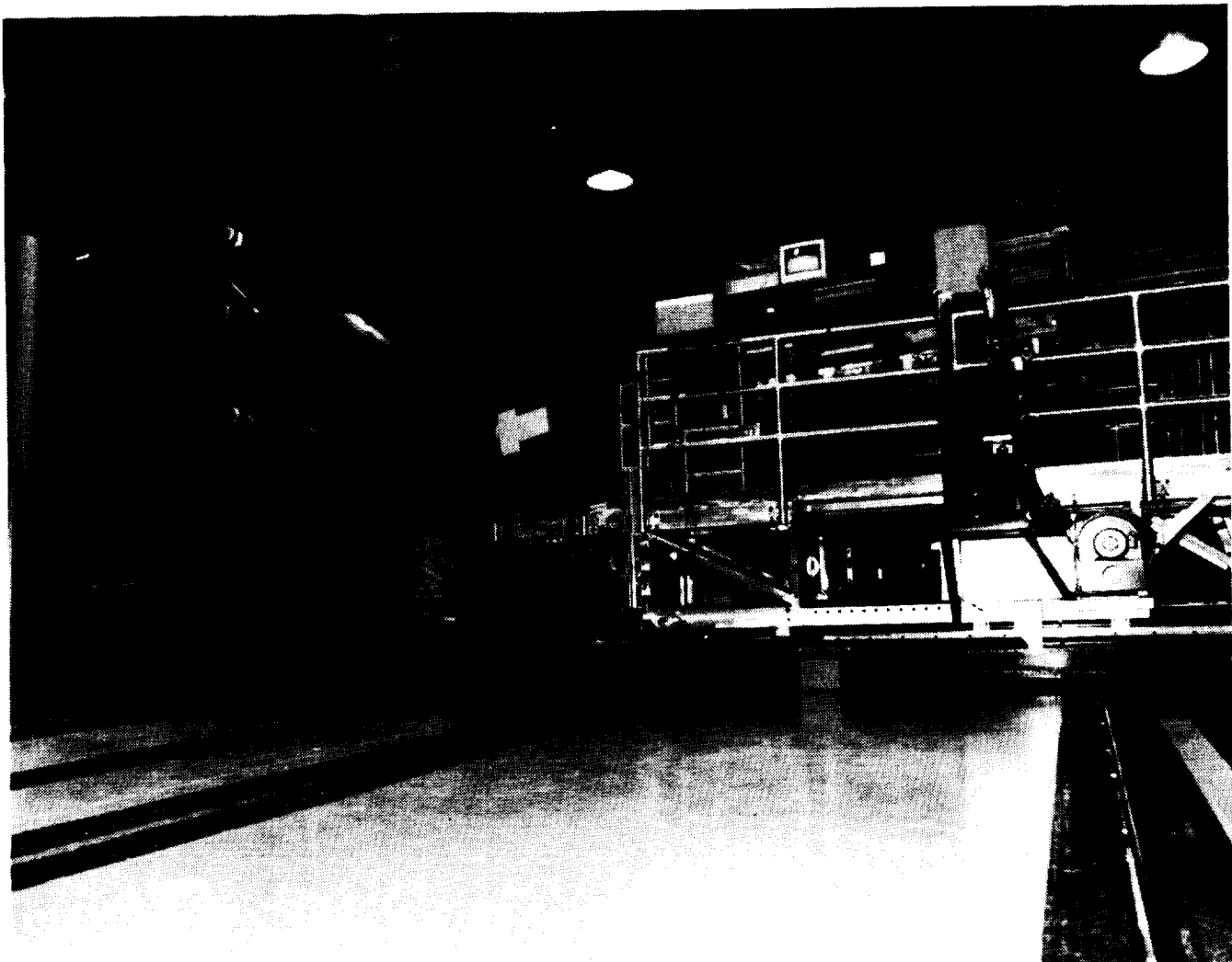

Figure 6.

The hand layup design of the V-22 aft fuselage consisted of 10 skin panels; 2 in the ramp and 8 in the upper fuselage. The fiber tow placed aft fuselage was cured in one piece, with the mandrel components being disassembled from within. For ease in manufacturing, and since the ramp is a separate assembly from the upper fuselage section, the ramp is cut before cure. Both components remain on the mandrel through the cure cycle. Manufacturing the aft fuselage in fewer pieces results in fewer subassemblies and fewer fasteners. This reduces handling, part control, and traceability costs as well as component, subassembly and inspection costs. The completed aft fuselage one-piece shell with the ramp skin and mandrel removed is shown in figure 7.

### BOEING HELICOPTERS AFT FUSELAGE ASSEMBLY

The three aft fuselage shells and frame details supplied by Hercules, Teledyne-Ryan and Xerkon were trimmed to net shape, ultrasonically and dimensionally inspected, and shipped to Boeing Helicopters for final assembly. The detail components were reinspected by Boeing and the additional components required, (frame splice plates, angles, and fasteners) were procured. A new assembly fixture was fabricated to accommodate the large one-piece shell and to locate the frames and other details.

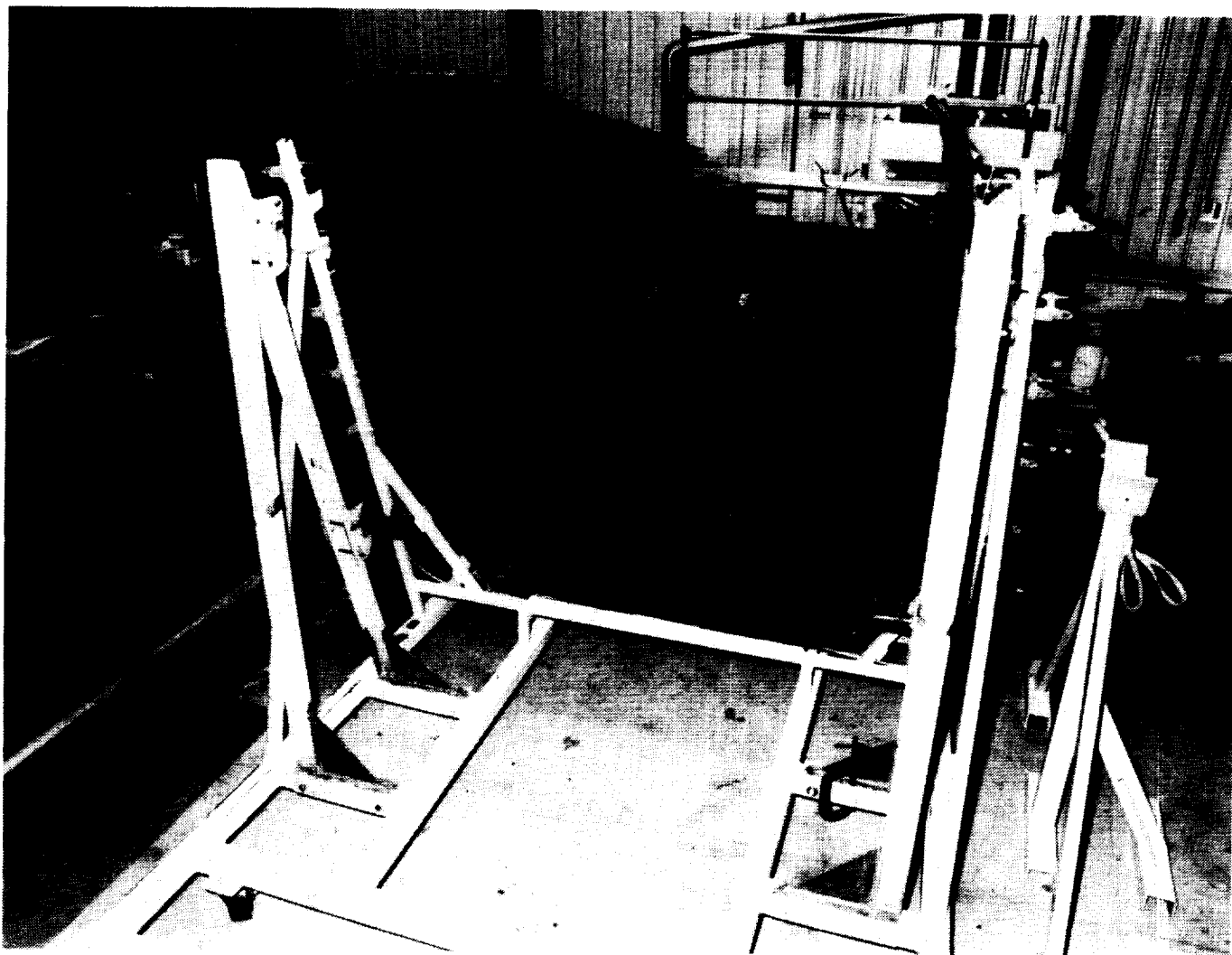

Figure 7.



Frame-fastener hole locations were pilot drilled on the bench, and the frames were located in the assembly fixture by means of tooling holes defined in the CAD data supplied to each frame contractor. The one-piece shell was positioned over the frames and pinned to the assembly fixture by means of tooling tabs located at each end of the shell. Fastener holes were located in the one-piece shell skin by back drilling through the frame pilot holes. All fastener holes were drill reamed to final size and titanium fasteners installed with wet polysulfide sealant. The one-piece shell eliminated eight individual hand layup panels and reduced from thirty-two to eight the number of trim lines required to be hand fitted, pressure sealed, and electrically connected for EMI protection.

Since the frame/skin mating surfaces were all tool controlled, no shims were needed for fit up and thus no need for fasteners of various lengths to accommodate shimming. Substantial assembly cost savings were realized. A completed aft fuselage skin/frame assembly is shown in figure 8.



Figure 8.

ORIGINAL PAGE IS  
OF POOR QUALITY

ORIGINAL PAGE  
BLACK AND WHITE PHOTOGRAPH

## COST PROJECTIONS, COMPARISONS AND SAVINGS

At the completion of design modifications in 1987, we projected a cost savings in production basic factory labor for the V-22 Aft Fuselage as a result of automating key operations. In 1988 we performed time studies for fiber tow placement of the stiffened skin to validate the earlier projections. The time study costs have been evaluated and are first broken down as cost by operation, then as production basic factory labor savings. The latter includes a direct comparison with the 1987 projections.

**1987 Cost Savings Projection.** We projected a cost savings for the V-22 production aft fuselage section of 54% in basic factory labor. This cost savings is due to automation of the frame and stiffener forming and skin fabrication (see figure 9). This projection also included material cost (converted to a labor equivalent) and assembly labor. During the program, we performed studies to validate the projection.

**1988 Time study by Operation.** Figure 10 illustrates the results of the time study performed on automated stiffened skin fabrication. This study included all fabrication operations for the stiffened skin on the first two deliverable units (SS-001 and SS-002).

In referring to figure 10 note that the mandrel assembly and fiber placement are the largest cost contributors. However, expectations for labor and material savings for this operation were not fully realized on SS-001 and SS-002. Further improvements to the fiber placement

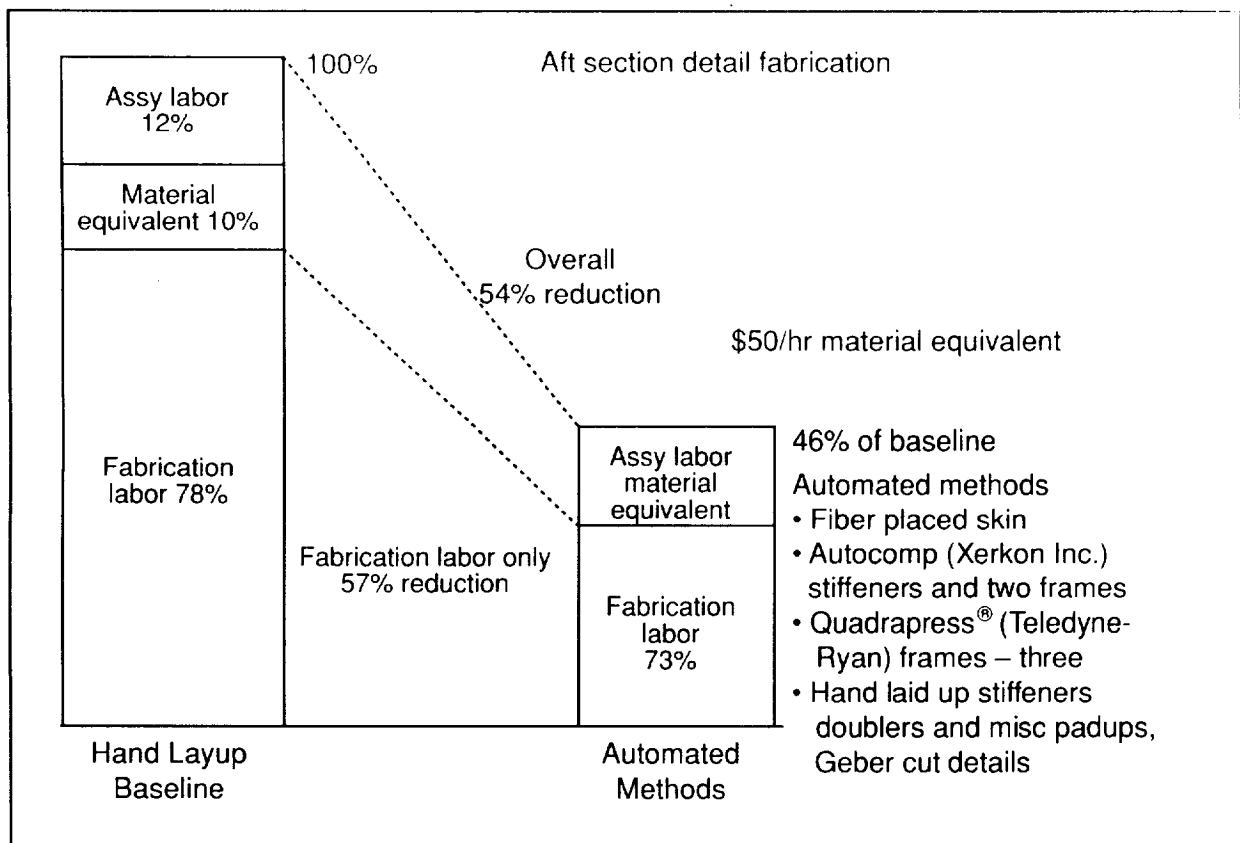

Figure 9. Automated Technology Application to V-22 Production  
Hand Lay Up Versus Automated Methods

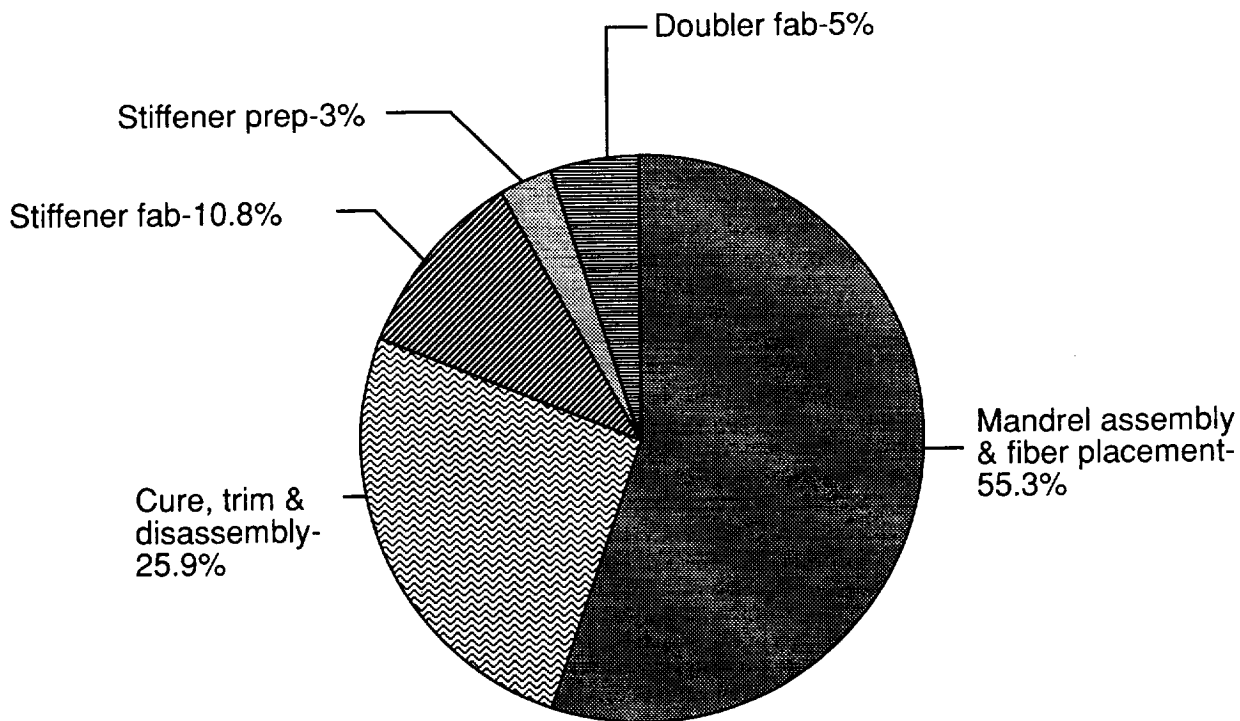

Figure 10. Automated Technology Application to V-22  
Time Study Costs by Operation

machine as well as process improvements were integrated into the production rated fiber placement machine (FPM2) and upgraded tow placement heads. These were used to fabricate the final deliverable aft fuselage SS-003. Projected lower prepreg tow costs also contribute to a lower projected production cost.

### PROGRAM RESULTS

Significant direct labor cost savings were demonstrated throughout the program. Direct labor savings, when compared to the V-22 FSD hand layup costs, were more than 50% for the detail composite component fabrication and their assembly. The demonstrated direct labor savings for the Xerkon Autocomp® and Teledyne-Ryan Quadrapress® frame processes are shown in figures 11 and 12. Figure 12 shows the Hercules Fiber tow placement process results.

A segmented learning curve based on prior composite component fabrication experience was used to calculate the average cost for the 912 production units: Units 1 through 165 follow an 83% curve, and units 166 through 912 a 90% curve for an average of approximately 84%. In an effort to more equitably compare the benefit of the fiber tow placement process in making large cocured fuselage skins, the actual data obtained in the hand layup fabrication of the first seven shipsets of V-22 components was collected and used to recompute the baseline cost, figure 13. The reduction found was due to improvement in the manufacturing process, reduction in the number of stiffener configurations, and improved adhesives and copper shielding materials. Several of these changes were also incorporated into the fiber-tow automated shell.

The final assembly operations, mechanical fastening of the five frames, frame splices, and the fiber-placed one-piece cocured skin also resulted in substantial savings in direct labor

costs, as shown in figure 14. These were due to reasons previously presented. An 80% curve was used through unit 240 and a 90% through unit 912 to calculate the savings.

Preliminary analysis of the data currently available shows that the 84 kg (185 pound) aft fuselage structure fabricated by the advanced manufacturing techniques demonstrated in this program can be produced in quantity for the equivalent direct labor cost of approximately 400 hours. This represents a 64% savings when compared to the hours required for the conventional fabrication and assembly of the multicomponent baseline structure.

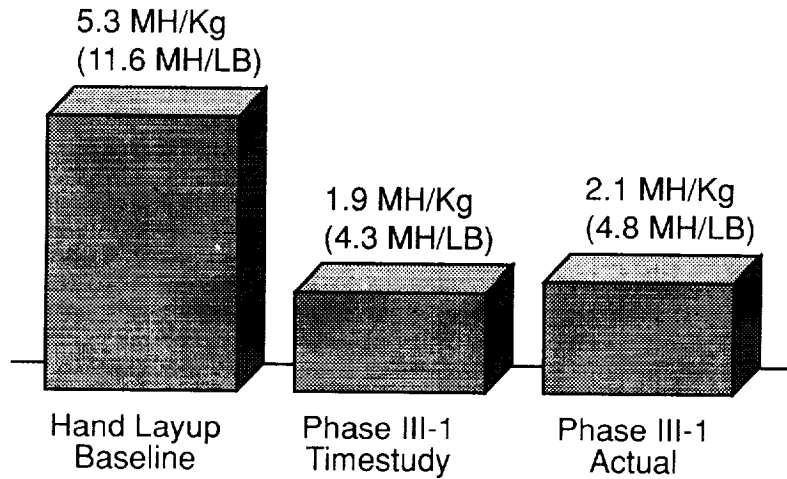

Figure 11. Manufacturing Costs —  
Frame Fabrication: Xerkon Autocomp Process  
Average for 912 Production Units

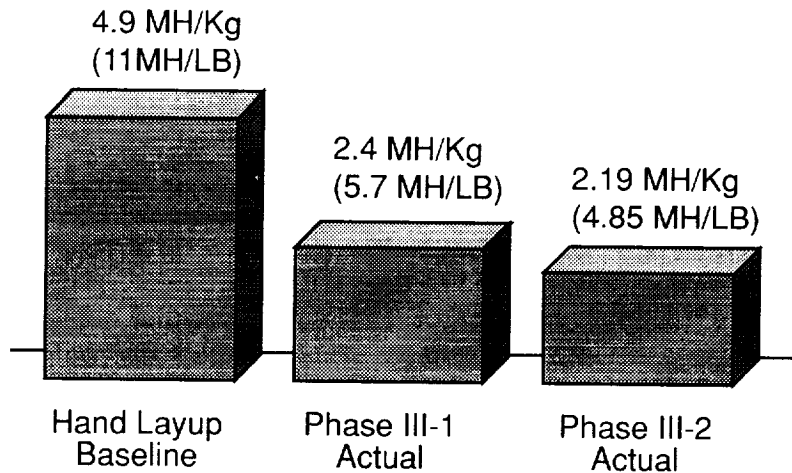

Figure 12. Manufacturing Costs —  
Frame Fabrication: Teledyne Quadrapress Process  
Average for 912 Production Units

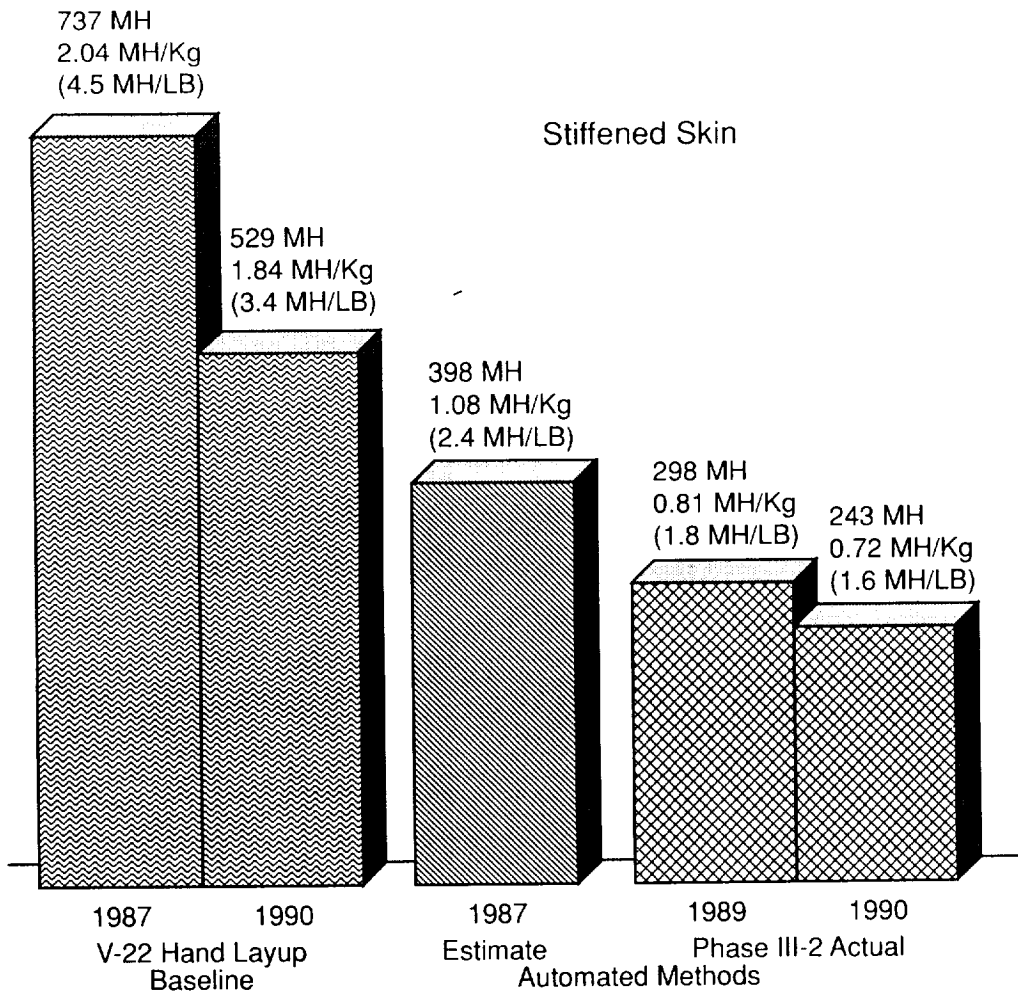

Figure 13. Manufacturing Costs — Skin Fabrication: Hercules Fiber Tow Placement Average for 912 Production Units

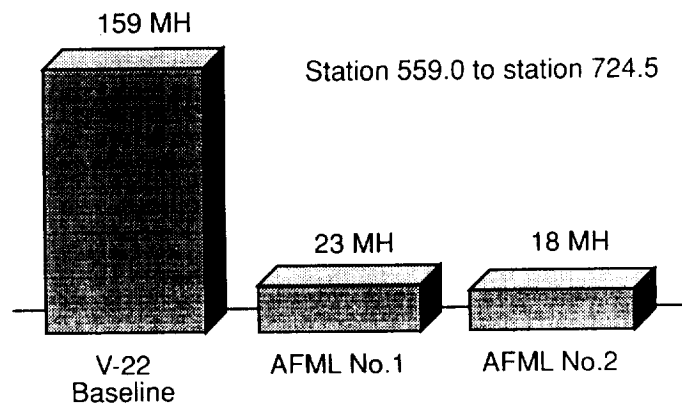

Figure 14. Costs of Aft Fuselage Assembly by Boeing Average for 912 Production Units

