

NATIONAL ADVISORY COMMITTEE  
FOR AERONAUTICS

OCT 3 1922

V1-4  
~~VI-4~~

MAILED  
*Dr. Briggs*

TECHNICAL NOTES

NATIONAL ADVISORY COMMITTEE FOR AERONAUTICS.

CASE FILE  
COPY

\_\_\_\_\_  
No. 112  
\_\_\_\_\_

THE N. A. C. A. THREE-COMPONENT ACCELEROMETER.

By H. J. E. Reid,  
Langley Memorial Aeronautical Laboratory.

\_\_\_\_\_  
October, 1922.

NATIONAL ADVISORY COMMITTEE FOR AERONAUTICS.

---

TECHNICAL NOTE NO. 113.

---

THE N.A.C.A. THREE-COMPONENT ACCELEROMETER.

By H. J. E. Reid.

Summary.

A new instrument known as the "N.A.C.A. Three-Component Accelerometer" is described in this note. This instrument was designed by the technical staff of the National Advisory Committee for Aeronautics for recording accelerations along three mutually perpendicular axes, and is of the same type as the N.A.C.A. single component accelerometer with the addition of two springs and a few minor improvements such as a pump for filling the dash-pots and a convenient method for aligning the springs. This note includes a few records as well as photographs of the instrument itself.

---

Introduction.

Previously, several instruments have been constructed for recording accelerations in an airplane along a single axis. The more important of these are described in the following reports:

- (1) N.A.C.A. Report No. 100 - Accelerometer Design. 1921.
- (2) R & M No. 376, British Advisory Committee for Aeronautics, September, 1917.

- (3) Development of an Airplane Shock Recorder.  
By A. F. Zahm, Journal of Franklin  
Institute, August, 1919.
- (4) N.A.C.A. Technical Note No. 3, Notes on Theory  
of the Accelerometer. May, 1920.

In order to measure the acceleration along the three axes of an airplane simultaneously it is necessary to have three accelerometer movements, each mounted perpendicular to one of the axes. As it is desirable in some cases to know these accelerations, three movements were incorporated for convenience, in one instrument.

#### Description of the Three-Component Accelerometer.

Photographs and diagrams of the instruments are shown in Figs. 1-4. The construction, as may be seen from Fig. 3, is similar to the other standard N.A.C.A. recording instruments; the optical system, recording drum, and driving motor being identical. There is a light source consisting of a single lamp, so that the three mirrors form separate images on a single film. The three curves are distinguished from each other by means of a revolving shutter which gives a dotted and a dash record from two of the mirrors. As in the case with the other instruments, there is a timing lamp to synchronize the records and to give time intervals.

The principal features are shown in Figs. 1 and 2. Fig. 1 shows the arrangement of the three springs and the corresponding axis along which each records the acceleration. The motion of

the end of each spring is transmitted by the stylus - a small-pointed screw - to the mirror as shown in Fig. 2. The X and Z springs register directly, but the motion of the Y spring must be transmitted through a bell crank. The moving parts are made very small and light to reduce their moment of inertia and a hair spring on each mirror spindle takes up all backlash. To adjust the sensitivity, the spring may be moved along its own axis or the weight of the screw near the free end may be changed. This screw is also used to align the axis of the spring, that is, to make the axis parallel to one of the three mutually perpendicular faces milled on the case. By moving the screw in or out or adding a small weight to either side, the effective axis of the spring is thus shifted. The zero is adjusted by means of the stylus.

The motion of the springs is damped by a small dash pot on the end of each, as shown in the photographs (Figs. 3 and 4). Three dash pots have a very close-fitting vane and the clearance around the stem is kept as small as possible in order to prevent the leakage of oil. For convenience in filling, each of the three dash pots is connected by a small hypodermic tube to a pump which fills all simultaneously. It was originally planned to have the top of each pot connected to a three-outlet cock and to force the oil through. Better results were obtained, however, by forcing the oil through the pot and out around the stem of the piston. By this method the air is all forced out and the oil remains in the pot indefinitely - even when in a horizontal position.

### Calibration.

The usual method of calibrating is to take a record with the instrument resting on the base, the side, and the end, thus rotating consecutively the plane of each spring through 90 degrees. This causes a variation in load of one g. on each spring. Assuming a straight line calibration the curve for each spring is determined by the two points thus obtained. Other points between zero and one g. have been obtained by rotating the instrument through known angles less than 90 degrees and computing the value of g. thus obtained. Points above one g. have been obtained by adding weights and the assumption of a straight-line curve verified. Another method of calibration would be to properly mount the instrument on a rotating table and compute the centrifugal force on each spring for each rotating speed.

### Precision.

The accuracy of the instrument as used in the air is determined by the accuracy with which the records can be scaled. The records can easily be measured to 0.01 inch, which corresponds to 0.12 second of time with a drum speed of 0.5 r.p.m. The acceleration normal to the wings may be measured to 0.04 g. and the lateral and longitudinal to 0.025 g. The difference is due to the sensitivity of the former spring being 0.25 inch deflection per 1 g. while that of the latter is 0.40 inch per 1 g.

It has been found that for accelerations such as those ob-

tained in maneuvers the lag is negligible but for landing shocks the instrument is over-damped and the resulting lag makes the records inaccurate. The damping can, however, be so adjusted that airplane landing shocks are accurately recorded. This may be accomplished by mounting the instrument on a table vibrated by a cam and adjusting the damping till the records show correct values as determined from the amplitude and frequency of the vibrating table.

#### Records.

The records shown in Figs. 5 and 6 were taken on the rear seat of a Ford sedan over a rough road and on the floor over a smooth road. The former shows accelerations along all three axes as the car pitched and swayed, giving fore and aft and sidewise accelerations as well as vertical. Fig. 6 shows the side or lateral accelerations when the steering wheel is turned quickly in one direction and in the other. There is very little acceleration along the other axes as the road was smooth and the speed kept constant. The lateral acceleration is approximately 0.5 g. in this case. An instrument of this type could be used to advantage in studying springs and chassis suspension in the design of automobiles.

Fig. 7 shows a record taken in the air with no timing intervals and before the damping on the Z spring was improved. The first part represents a loop and the second two wing-overs in quick succession. It will be noticed in the loop that the accel-

eration along the Z axis is about 3 g., the normal position of the zero line being 1 g. The acceleration at the top of the loop is less than normal, but never reaches zero, as there was no tendency to hang. The longitudinal acceleration is 0.75 g. or approximately 24 ft/sec<sup>2</sup> (deceleration). In these maneuvers there was very little lateral acceleration and it is thought that it may be necessary to change the sensitivity of the X spring. In any case, the sensitivity of the springs may be readily changed to suit the problem in hand.

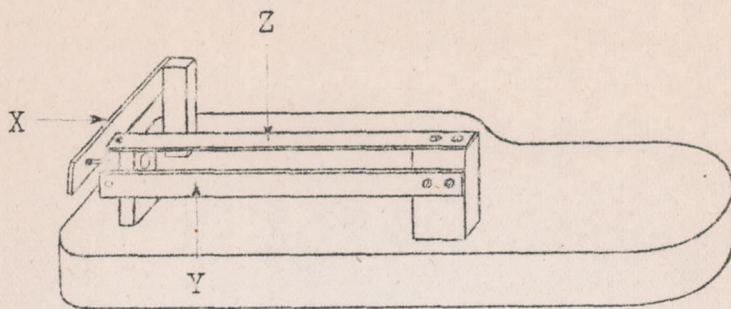

Fig. 1. Showing the arrangement of the springs and the axes of the instrument.

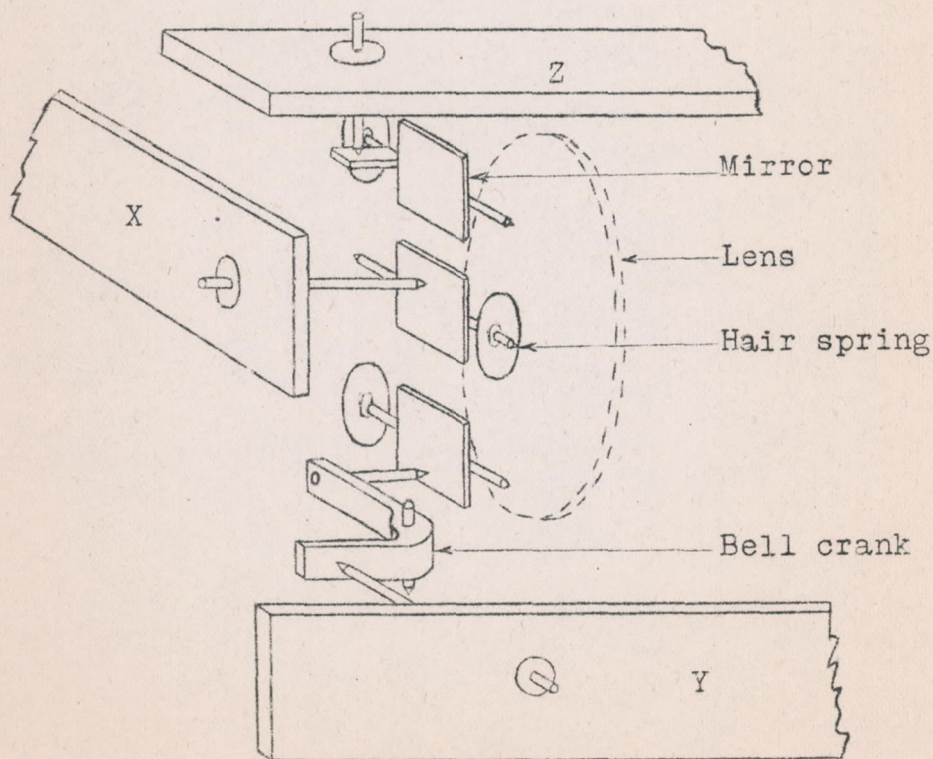

Fig. 2. Showing the means for transferring the motion of the springs to the three mirrors.  
The dash pots are omitted.



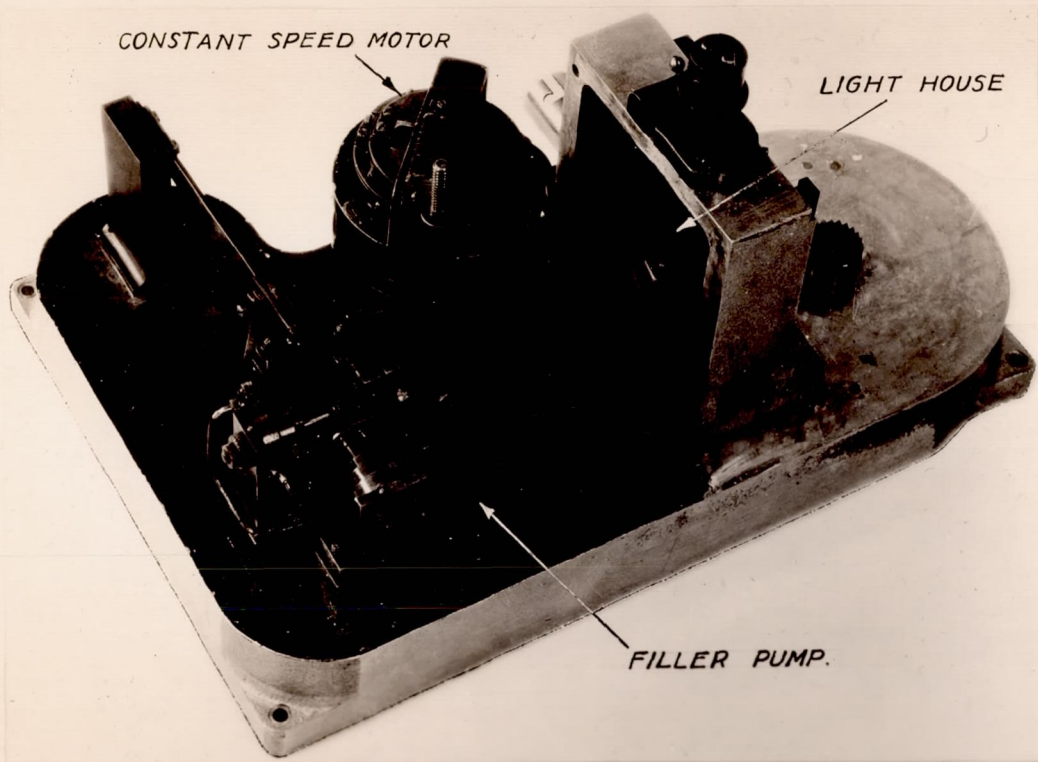

Fig.3.

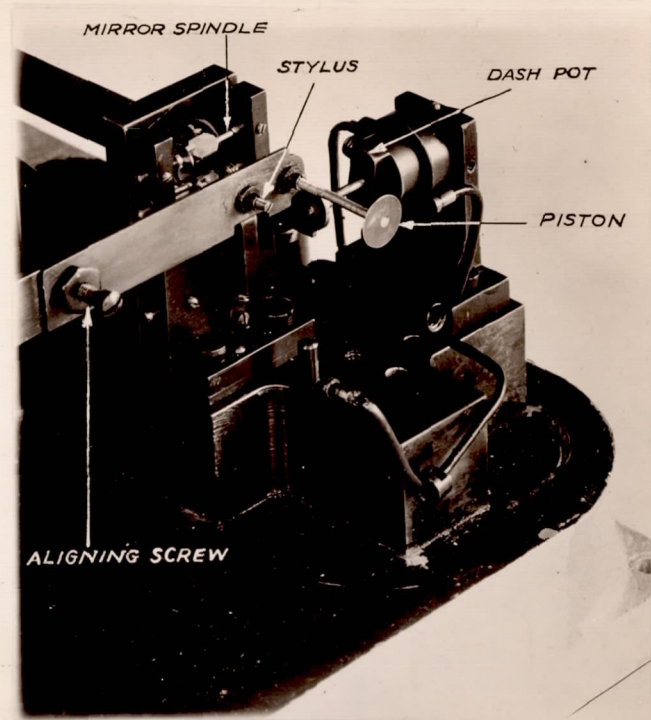

Fig.4.

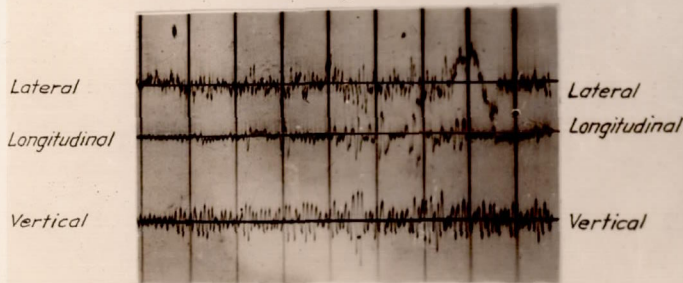

Fig.5.

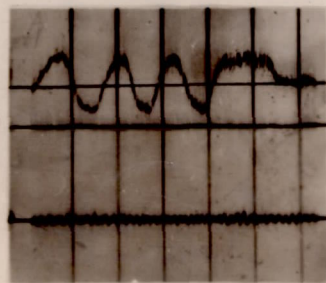

Fig.6.

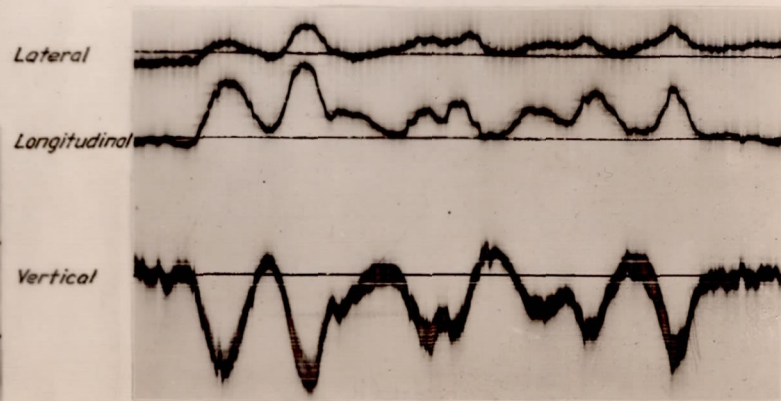

Fig.7.