

FILE COPY  
NO. I-W

FILE COPY

~~NO. 2~~

CASE FILE  
COPY

TECHNICAL NOTES

NATIONAL ADVISORY COMMITTEE FOR AERONAUTICS

-----  
No. 502  
-----

AERODYNAMIC INVESTIGATION OF A CUP ANEMOMETER

By John D. Hubbard and George P. Brescoll

FILE COPY

-----  
To be returned to  
the files of the National  
Advisory Committee  
for Aeronautics  
Washington, D. C.

Washington  
July 1934

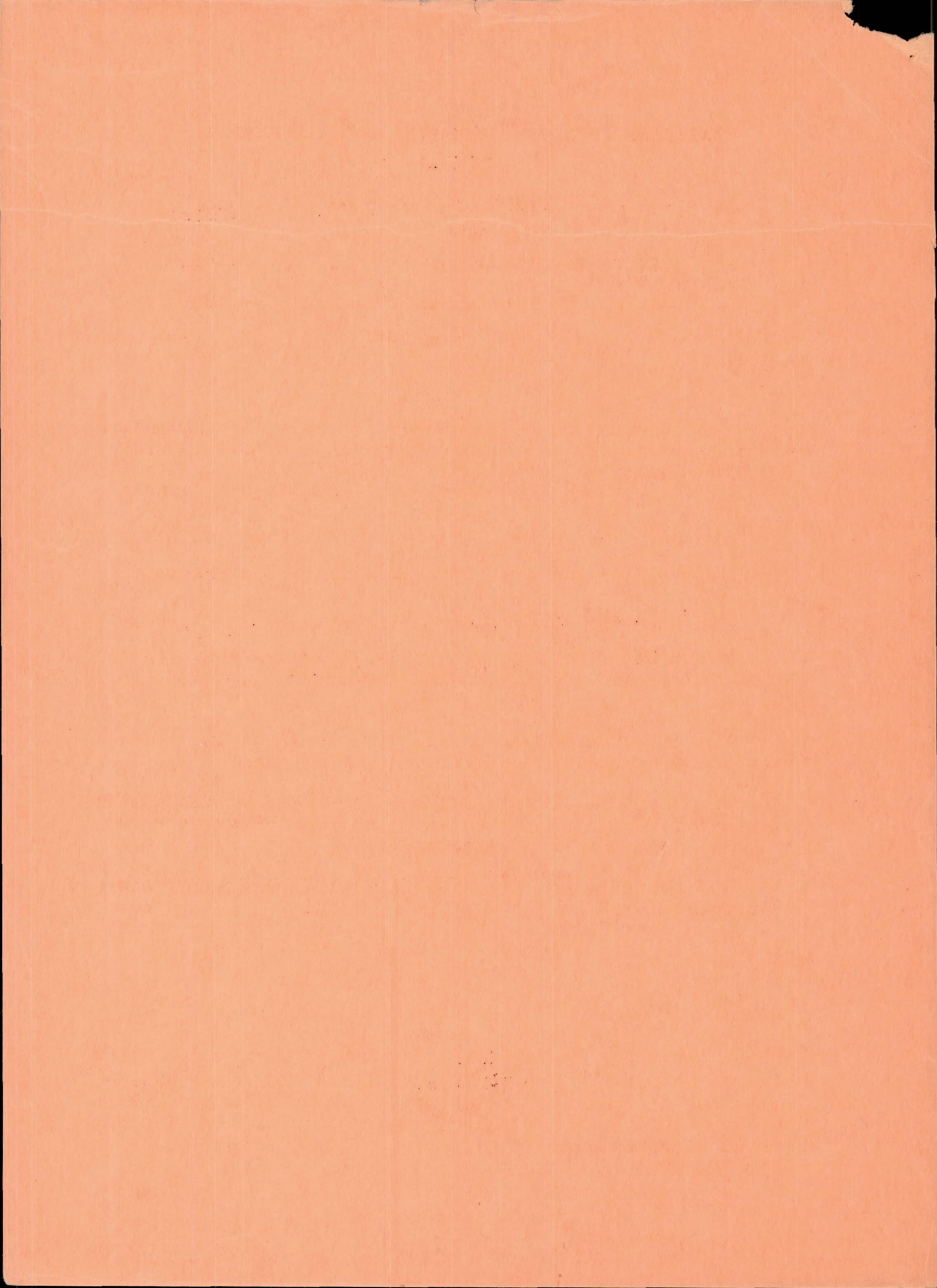

NATIONAL ADVISORY COMMITTEE FOR AERONAUTICS

TECHNICAL NOTE NO. 502

AERODYNAMIC INVESTIGATION OF A CUP ANEMOMETER\*

By John D. Hubbard and George P. Brescoll

SUMMARY

This thesis presents the results of an investigation wherein the change of the normal force coefficient with Reynolds Number was obtained statically for a 15.5-centimeter hemispherical cup under the following conditions:

- (1) Single cup with no interference
- (2) Single cup with three-cup interference
- (3) Four cups

The coefficients found in this research vary with Reynolds Number and are high as compared with those of Eiffel.

The effect of interference upon a single cup is to increase the drag and normal force coefficients.

The curve resulting from the summation of the coefficients for four cups agrees with the static torque curve of a Robinson type cup anemometer.

All tests were carried on in the University of Detroit atmospheric wind tunnel during May 1933.

---

\*Thesis submitted in partial fulfillment of the requirements for the degree of Bachelor of Science in Aeronautical Engineering in the Department of Aeronautical Engineering in the College of Engineering of the University of Detroit, June 1933.

## TABLE OF SYMBOLS:

$V$  = true air speed in ft./sec.

$D$  = measured drag in lb.

$\rho$  = mass density of air = 0.00237 ft. lb./sec.

$\nu$  = kinematic viscosity = 0.000159 ft.<sup>2</sup>/sec.

$d$  = diameter of cup in feet

$S$  = projected area of cup

$q = \frac{1}{2} \rho V^2$  = dynamic pressure

$C_D = \frac{D}{qS}$  = absolute coefficient

$E = \frac{Vd}{\nu}$  = Reynolds Number

$w$  = weight of cu.ft. of alcohol

$h$  = height in inches of alcohol

\* $C_N$  = normal force coefficient

\* $C_N = C_D$  of cup when movable cup is at 0° and 180° position

## INTRODUCTION

Quite a few tests have been run on the cup-type anemometer. Slippage, sensitivity of the instrument in gusty air and the wind force on variously shaped cups have all been investigated. Sometimes, tests were not conducted under the best of conditions. For instance, the hemispherical cup drag coefficients obtained by Eiffel in his circuit-chamber type wind tunnel are possibly subject to large experimental error due to the turbulence of the air stream. This was mentioned by Wieselsberger in his comment on the tests.

This present investigation was undertaken: first, to determine the characteristic drag coefficients for two positions of the cup (concave side and convex side normal to wind); second, to observe the interference effects of three cups upon the single remaining cup of a four-cup Robinson type anemometer; third, to check the characteristic static torque curve of a Robinson cup anemometer with a curve of the summation of theoretical coefficients for four cups based on single-cup data obtained from single cup with interference tests.

The testing of a hemispherical cup shows that there is a variation in drag coefficient as well as normal force on the cup for every position with respect to the wind as the cup is rotated through  $360^{\circ}$ . It is on this variation that the operation of the Robinson cup anemometer is based.

#### APPARATUS

The apparatus used in this experiment for the measurement of normal force on hemispherical cups was as follows:

1. A special Robinson cup type anemometer as shown in figures 1-6. This four-cup anemometer was essentially made up of a tube called the housing which contained a hollow spindle, two ball bearings, a steel torque shaft, and two base plates with an angular change wheel located between the plates. (See figs. 5 and 6 for detail views.)

The spindle was mounted on two ball-bearing units which allowed it to rotate freely. The solid torque shaft, surrounded by the hollow spindle and housing, was held in place by two adjusting seat screws having coned seats to take the pointed ends of the torque shaft. Thus the torque shaft was permitted to swing free of both housing and spindle (fig. 7).

Into the head of the spindle were threaded three steel cup rods. These rods were in a horizontal plane  $90^{\circ}$  apart. The enclosed head of the torque shaft held the fourth cup rod and a hole through the spindle allowed this cup rod about  $15^{\circ}$  free swing. The shaft, spindle, and housing were mounted vertically on the two horizontal base plates.

The base plates were separated by four brass spacers to allow the angular change wheel and lever arm sufficient clearance.

The angular change wheel was rigidly fastened to the torque shaft and pinned by a removable pin to the lever arm which in turn was joined to the drag wire. By this method the drag forces were transmitted to the drag wire. Holes drilled in the angular change wheel at a constant radius at  $15^\circ$  intervals made it unnecessary to unfasten the drag wire from the apparatus throughout the tests. The cup position could be changed simply by pinning the arm to the desired station or hole in the angular change wheel. So that the cup rods should remain at  $90^\circ$  at all times, a similar pin and hole arrangement was made on the dial of the spindle plate and housing.

By wedging the movable cup rod to the spindle, the torque shaft could be made to take the resultant drag of the four cups.

2. The University of Detroit atmospheric wind tunnel has a closed test section of 10 by 7 feet and possible air speeds to 110 miles per hour. The air is forced through the tunnel by a 14-foot, 4-blade propeller on a 200 horsepower direct current motor. Because of the need of speed variation, the Ward Leonard System of control was incorporated in the tunnel construction.

The drag balance (fig. 8) of the tunnel on which all the normal forces were measured, was a simple semiautomatic beam balance with a running weight. This running weight was moved in and out along the beam by a reversible electric motor and worm arrangement. The balance was automatically kept in equilibrium by two contact points at the end of the beam.

3. A pitot-static tube within the test section of the tunnel in conjunction with a micromanometer (fig. 9) was used as an air-speed indicator.

#### PROCEDURE

The apparatus was set up in the tunnel as shown in figure 1. The first group of runs was made for the purpose of measuring, in 24 positions, the normal force on one cup at velocities of 10, 15, 20, and 40 m.p.h. air speeds.

The cup fastened to the head of the torque shaft was set in number 1 position, i. e., the concave side of the cup perpendicular toward the relative wind. A zero reading was made to find the initial static load on the drag balance. Then a velocity of 10 miles per hour, equivalent to 0.06075 inch of alcohol, was set up in the tunnel. Readings were taken with the cup set at  $15^\circ$  intervals through a range of  $360^\circ$ .

Similar runs were made for velocities of 15, 20, and 40 miles per hour and for each test a new zero reading was obtained.

The second group of runs was taken with the apparatus set up as shown in figures 2-4. The normal force on a single cup with three-cup interference was measured in the same manner as the first group. However, care was taken to have the cup rods in a horizontal plane  $90^\circ$  apart.

The final group of runs was made with the torque shaft taking the resultant torque of four cups. The apparatus was arranged for this by removing the spindle pin and wedging the movable cup rod fast to the spindle. Thus the torque of the three cups was transmitted to the movable cup rod where it was taken by the torque shaft. Readings were taken through a range of  $180^\circ$  for velocities of 10 and 20 miles per hour.

#### RESULTS AND SAMPLE CALCULATIONS

The data, as recorded in the laboratory, had to be corrected for tare drag and for resistance of the exposed wires and reduced to a coefficient form wherein

$$C_N = \frac{\text{normal force in pounds}}{\frac{1}{2} \rho V^2 S}$$

Table I contains calculated data wherein  $q$ , the dynamic pressure, was obtained from  $q = \frac{1}{2} \rho V^2$ . The height of alcohol in inches ( $h$ ) was obtained from

$$h = \frac{q}{w} \times 12.$$

Table II, containing wire and plate data, was calculated after the discovery was made that the stirrup, to which the drag wire was attached, had slipped off the knife-edge of the bell crank and thereby gave false readings for the observed wire and plate drag. The determination of R.N. of the wires was:  $R.N. = \frac{dV}{v}$ . The  $C_D$  was obtained from a chart of  $C_D$  against R.N.

$$\text{Drag of wires} = C_D^{\frac{1}{2}} v^2 dl \quad d = \text{diameter of wire in feet}$$

$$\text{where} \quad dl = \frac{d''}{12} \times \frac{l''}{12} \quad l = \text{effective length in feet}$$

The drag of the plate was obtained:

$$D = C_D^{\frac{1}{2}} \rho v^2 S$$

where  $C_D$  was assumed to be 0.20.

Table III contains computed data for the rod obtained in similar manner as the data on wire in table II. After obtaining  $C_D$ , the drag was computed for the condition of the rod perpendicular to the wind. The change due to the angularity of the rod will be found in table IV (reference 1).

Tables V-XII contain the observed data and calculated data from which the absolute normal force coefficients were obtained. A sample calculation for position number 1 or  $0^\circ$  position for a 20 m.p.h. air speed follows:

From table VII:

|                                  |              |
|----------------------------------|--------------|
| Gross reading . . . . .          | 2.899        |
| - Zero . . . . .                 | <u>1.099</u> |
|                                  | 1.800        |
| - Drag due to wires and plate .. | <u>0.040</u> |
|                                  | 1.760        |
| - Drag due to rod . . . . .      | <u>0.016</u> |
| Total net drag . . . . .         | 1.744        |



To put this force on the cup, the following ratio was used.

$$\frac{\text{Force on balance}}{\text{force on cup}} = \frac{\text{lever arm of cup}}{\text{lever arm of balance}} = \frac{13.75}{2.48}$$

$$\text{Force on cup} = 0.1805 \text{ force on balance}$$

$$\text{Normal force on cup} = 0.1805 \times 1.744 = 0.3130$$

The normal force coefficients were calculated from the quantities expressed in units of lb. ft.-sec. system, as

$$C_N = \frac{\text{normal force}}{qS}$$

$$C_N = \frac{0.3130}{0.603 \times 0.205} = 1.485$$

In tables XIII and XIV will be found the simultaneous force of four cups. In these tables the rod drag is neglected due to the fact that the forces on the four rods neutralize each other.

Table XIV-A shows comparative four-cup data built up from observed single-cup data.

A summary of the coefficients will be found in table XV.

#### DISCUSSION OF RESULTS

The results of tables V-XIV are found plotted in figure 10 and show the computed normal force coefficient vs. cup position. It is readily seen that the curves for the single-cup tests follow each other closely as do the curves for the tests with three-cup interference. It is also noticeable that the maximum values for the three-cup interference tests occur  $15^\circ$  ahead of tests on the single cup. This indicates that the maximum static torque value of an anemometer is reached when the open cups are  $30^\circ$  and  $120^\circ$  to the relative wind. This fact is borne out in the plot of tests wherein the four cups acted simultaneously.

The minimum points for both sets of tests occur at  $105^\circ$  and  $240^\circ$ , although the curves are shown as going

through the same point at  $90^\circ$ . This is due to the effect of shielding of the cup by the mast or housing. The points are more widely spread at  $240^\circ$ , but the slope of the curves seems to indicate that the minimum occurs here.

The graph of figure 11 shows the variation of normal force coefficient vs. cup position for a single cup for various speeds. Of special interest in this graph are the  $0^\circ$  cup positions where the concave side of the cup was perpendicular to the relative wind, and the  $180^\circ$  cup positions where the convex side was presented.

The results of tables V-XIV are shown in another manner in figures 12-15 wherein the normal force coefficients were plotted as polar diagrams for each velocity for the single cup and with three-cup interference. These polar diagrams show graphically just how the coefficients of the cup vary as the cup is revolved through  $360^\circ$ .

The outstanding observation is that the coefficients for the three-cup interference runs are (at corresponding positions) nearly all of greater values than those for the single cup. This, perhaps, indicates that when there is a turbulent flow, coefficients of resistance may be expected to be of greater magnitude.

To further illustrate the effect of variation of normal force coefficients, figure 16 shows polar diagrams for a single cup at various speeds. This graph shows excellent similarity of the curves.

The polar diagrams of figure 17 are for a single cup with three-cup interference. This graph essentially shows the variation of the normal force coefficient due to change in velocity. A striking fact is the high value of normal force coefficient at 10 miles per hour.

The results of table XIV-A are shown in figure 18. This shows the agreement between the actual normal force coefficient and the so-called "theoretical normal force coefficient," computed by adding the coefficients at stations  $90^\circ$  apart on a single cup. This checks very well with the measured static force of the four cups as the curves are practically identical.

A summary of the results of table XV is found in figure 19, wherein the normal force coefficients of the concave and convex sides are plotted against Reynolds Number for the single cup and with three-cup interference.

The convex-side coefficients decrease with increase of Reynolds Number. The effect of three-cup interference increases the normal force coefficients.

The concave-side coefficient for the single-cup value at 10 miles per hour of 1.620 increasing to 1.756 at 15 miles per hour and then dropping to 1.575 at 20 miles per hour and to 1.565 at 40 miles per hour. A plot of these coefficients shows small variance in value.

There is reason to believe that with greater increase in Reynolds Number, these curves may asymptotically approach a constant value (reference 1). However, there is no theory to support this conclusion of asymptotic approach.

Eiffel found values of 0.33 for the convex side and 1.33 for the concave side. The results of this investigation indicate that these values are low. Had tests been made at higher velocities, a better curve of drag coefficient vs. Reynolds Number would have resulted, and a more definite conclusion reached.

#### CONCLUSIONS

With the completion of this research, several facts stand out.

The coefficients found in this research vary with Reynolds Number and are high compared with those of Eiffel.

The effect of interference upon a single cup is to increase the drag and normal force coefficients.

The curve resulting from the summation of coefficients for four cups agreed with the static torque curve of a Robinson type cup anemometer.

It is recommended that further static torque tests be carried out on this subject using a definite series of cup sizes with varying cup-rod lengths and for a larger velocity range. Further study might be made on the dynamic torque characteristic of an anemometer.

---

Thanks are extended at this time to George J. Higgins, Associate Professor of Aeronautics for his constructive suggestions; to Theodore O'Neil for his financial consideration on the machine work done on the model, and to Edward Du Bois for his many helpful laboratory suggestions.

## REFERENCE AND BIBLIOGRAPHY

1. Warner, Edward P.: Airplane Design, chs. X and XI. McGraw-Hill Book Co., Inc., 1927.
- Eiffel, E.: The Resistance of the Air and Aviation Experiments. H. Dunod and E. Pinat, 1910.
- Diehl, Walter S.: Engineering Aerodynamics, ch. IV. The Ronald Press Co., 1928.
- Bacon, D. L., and Reid, E. G.: The Resistance of Spheres in Wind Tunnels and in Air. T.R. No. 185, N.A.C.A., 1924.
- Warner, Edward P., and Johnston, Paul S.: Aviation Handbook. McGraw-Hill Book Co., Inc., 1931.
- Marvin, Charles F.: A Rational Theory of the Cup Anemometer. Monthly Weather Review, vol. 60, February 1932.
- Swan, Paul: Thesis on Wires, June 1931.

TABLE I  
Calculated Data

| $V_{\text{mph}}$ | $V_{\text{fps}}$ | $V_{\text{fps}}^2$ | $q$ (lb.) | $h$<br>(inches alcohol) |
|------------------|------------------|--------------------|-----------|-------------------------|
| 10               | 14.66            | 215                | 0.256     | 0.06075                 |
| 15               | 22.06            | 507                | 0.603     | .155                    |
| 20               | 29.33            | 859                | 1.021     | .243                    |
| 40               | 58.7             | 3434               | 4.090     | .973                    |

TABLE II  
Wire and Plate Data

| $V_{\text{mph}}$ | Wires |                  |       |        | Plate |        |
|------------------|-------|------------------|-------|--------|-------|--------|
|                  | R.N.  | $\log_{10}$ R.N. | $C_D$ | drag   | $C_D$ | drag   |
| 10               | 215   | 2.33             | 1.18  | 0.0030 | 0.2   | 0.0072 |
| 15               | 323   | 2.51             | 1.12  | .0069  | .2    | .0169  |
| 20               | 430   | 2.63             | 1.04  | .0109  | .2    | .0287  |
| 40               | 860   | 2.93             | .93   | .0394  | .2    | .1150  |

Wire used was 0.028 diameter.

TABLE III

## Rod Data

| $V_{\text{mph}}$ | R.N. | $\log_{10} \text{R.N.}$ | $C_D$ |
|------------------|------|-------------------------|-------|
| 10               | 1928 | 3.283                   | 0.85  |
| 15               | 2880 | 3.459                   | .85   |
| 20               | 3840 | 3.584                   | .88   |
| 40               | 7680 | 3.885                   | .95   |

Rod used was 0.250 inch diameter.

TABLE IV

## Angular Drag of Rod

| Angle with<br>relative wind<br>(degrees) | Relative resistance<br>of projected area |
|--|--|
| 90                                       | 1.0                                      |
| 75                                       | .95                                      |
| 60                                       | .80                                      |
| 45                                       | .55                                      |
| 30                                       | .35                                      |
| 15                                       | .20                                      |
| 0  |  |

TABLE V

## Force of Single Hemispherical Cup

Velocity 10 m.p.h.

| Cup position | Gross | Zero  | Due to plate and wires | Due to rod | Net (lb.) | Normal force on cup | $C_N$ |
|--------------|-------|-------|------------------------|------------|-----------|---------------------|-------|
| 1            | 1.549 | 1.128 | 0.012                  | 0.0038     | 0.407     | 0.0730              | 1.390 |
| 2            | 1.566 |       |                        | .0036      | .424      | .0760               | 1.445 |
| 3            | 1.641 |       |                        | .0030      | .500      | .0897               | 1.710 |
| 4            | 1.748 |       |                        | .0021      | .608      | .1090               | 2.080 |
| 5            | 1.585 |       |                        | .0013      | .446      | .0800               | 1.525 |
| 6            | 1.349 |       |                        | .0007      | .210      | .0377               | 0.718 |
| 7            | 1.135 |       |                        | 0          | .003      | .00054              | .0102 |
| 8            | 1.051 |       |                        | .0007      | .084      | .0015               | .0287 |
| 9            | 1.040 |       |                        | .0013      | .094      | .00167              | .0321 |
| 10           | 1.036 |       |                        | .0021      | .100      | .0179               | .342  |
| 11           | 1.018 |       |                        | .0030      | .117      | .0210               | .400  |
| 12           | 1.009 |       |                        | .0036      | .126      | .0226               | .431  |
| 13           | 0.977 |       |                        | .0038      | .158      | .9284               | .541  |
| 14           | .995  |       |                        | .0036      | .140      | .0251               | .478  |
| 15           | 1.019 |       |                        | .0030      | .116      | .0208               | .396  |
| 16           | 1.066 |       |                        | .0021      | .070      | .00125              | .0238 |
| 17           | 1.062 |       |                        | .0013      | .075      | .00168              | .032  |
| 18           | 1.057 |       |                        | .0007      | .081      | .00145              | .0276 |
| 19           | 1.082 |       |                        | 0          | .056      | .0010               | .0191 |
| 20           | 1.360 |       |                        | .0007      | .221      | .0396               | .755  |
| 21           | 1.628 |       |                        | .0013      | .489      | .0895               | 1.705 |
| 22           | 1.791 |       |                        | .0021      | .651      | .1170               | 2.230 |
| 23           | 1.624 |       |                        | .0030      | .483      | .0867               | 1.650 |
| 24           | 1.595 |       |                        | .0036      | .453      | .0815               | 1.550 |

TABLE VI

Force of Single Hemispherical Cup

Velocity 15 m.p.h.

| Cup position | Gross | Zero  | Due to plate and wires | Due to rod | Net (lb.) | Normal force on cup | C <sub>N</sub> |
|--------------|-------|-------|------------------------|------------|-----------|---------------------|----------------|
| 1            | 2.259 | 1.122 | 0.0238                 | 0.0090     | 1.104     | 0.198               | 1.602          |
| 2            | 2.315 |       |                        | .0085      | 1.160     | .208                | 1.685          |
| 3            | 2.492 |       |                        | .0072      | 1.339     | .240                | 1.942          |
| 4            | 2.725 |       |                        | .0050      | 1.574     | .283                | 2.290          |
| 5            | 2.222 |       |                        | .0031      | 1.073     | .193                | 1.562          |
| 6            | 1.665 |       |                        | .0018      | 0.517     | .0928               | 0.750          |
| 7            | 1.125 |       |                        | 0          | .020      | .00359              | .0291          |
| 8            | 0.942 |       |                        | .0018      | .202      | .0362               | .293           |
| 9            | .935  |       |                        | .0031      | .207      | .0372               | .301           |
| 10           | .957  |       |                        | .0050      | .183      | .0328               | .266           |
| 11           | .864  |       |                        | .0072      | .274      | .0492               | .398           |
| 12           | .865  |       |                        | .0085      | .272      | .0488               | .395           |
| 13           | .823  |       |                        | .0090      | .308      | .0552               | .446           |
| 14           | .827  |       |                        | .0085      | .310      | .0557               | .451           |
| 15           | .858  |       |                        | .0072      | .280      | .0503               | .407           |
| 16           | .955  |       |                        | .0050      | .185      | .0332               | .269           |
| 17           | .985  |       |                        | .0031      | .157      | .0282               | .228           |
| 18           | .958  |       |                        | .0018      | .186      | .0334               | .270           |
| 19           | 1.035 |       |                        | 0          | .110      | .01975              | .160           |
| 20           | 1.762 |       |                        | .0018      | .614      | .1105               | .895           |
| 21           | 2.420 |       |                        | .0031      | 1.271     | .2285               | 1.850          |
| 22           | 2.462 |       |                        | .0050      | 1.311     | .236                | 1.910          |
| 23           | 2.336 |       |                        | .0072      | 1.183     | .2125               | 1.720          |
| 24           | 2.260 |       |                        | .0085      | 1.105     | .1985               | 1.605          |



TABLE VII

## Force of Single Hemispherical Cup

Velocity 20 m.p.h.

| Cup position | Gross | Zero  | Due to plate and wires | Due to rod | Net (lb.) | Normal force on cup | $C_N$ |
|--------------|-------|-------|------------------------|------------|-----------|---------------------|-------|
| 1            | 2.899 | 1.099 | 0.0396                 | 0.0158     | 1.744     | 0.3130              | 1.485 |
| 2            | 2.941 |       |                        | .0150      | 1.787     | .3205               | 1.522 |
| 3            | 3.218 |       |                        | .0125      | 2.066     | .371                | 1.760 |
| 4            | 3.535 |       |                        | .0087      | 2.387     | .428                | 2.035 |
| 5            | 2.772 |       |                        | .0055      | 1.627     | .292                | 1.385 |
| 6            | 1.901 |       |                        | .0031      | .759      | .1362               | .647  |
| 7            | 1.165 |       |                        | 0          | .026      | .00467              | .0222 |
| 8            | .845  |       |                        | .0031      | .290      | .0520               | .247  |
| 9            | 1.058 |       |                        | .0055      | .075      | .0134               | .636  |
| 10           | .905  |       |                        | .0087      | .225      | .0405               | .192  |
| 11           | .752  |       |                        | .0125      | .374      | .0671               | .319  |
| 12           | .641  |       |                        | .0150      | .482      | .0865               | .410  |
| 13           | .621  |       |                        | .0158      | .502      | .0900               | .4275 |
| 14           | .633  |       |                        | .0150      | .490      | .089                | .423  |
| 15           | .700  |       |                        | .0125      | .426      | .0765               | .363  |
| 16           | .859  |       |                        | .0087      | .271      | .0487               | .231  |
| 17           | 1.098 |       |                        | .0055      | .045      | .0081               | .0384 |
| 18           | .876  |       |                        | .0031      | .259      | .0465               | .221  |
| 19           | .936  |       |                        | 0          | .202      | .0363               | .1725 |
| 20           | 2.197 |       |                        | .0031      | 1.055     | .1895               | .900  |
| 21           | 3.127 |       |                        | .0055      | 1.982     | .356                | 1.690 |
| 22           | 3.197 |       |                        | .0087      | 2.049     | .368                | 1.750 |
| 23           | 3.058 |       |                        | .0125      | 1.906     | .342                | 1.625 |
| 24           | 2.905 |       |                        | .0150      | 1.751     | .3142               | 1.495 |
| 1            | 2.852 |       |                        | .0158      | 1.697     | .3022               | 1.435 |

TABLE VIII

## Force of Single Hemispherical Cup

Velocity 40 m.p.h.

| Cup position | Gross               | Zero  | Due to plate and wires | Due to rod | Net (lb.) | Normal force on cup | C <sub>N</sub> |
|--------------|---------------------|-------|------------------------|------------|-----------|---------------------|----------------|
| 1            | 2.434* <sup>1</sup> | 1.346 | 0.1544                 | 0.068      | 7.231     | 1.295               | 1.540          |
| 2            | 2.656* <sup>1</sup> |       |                        | .065       | 7.456     | 1.34                | 1.595          |
| 3            | 2.754* <sup>1</sup> |       |                        | .055       | 7.564     | 1.36                | 1.620          |
| 4            | 2.085* <sup>3</sup> |       |                        | .038       | 10.033    | 1.810               | 2.15           |
| 5            | 2.390* <sup>1</sup> |       |                        | .024       | 7.231     | 1.295               | 1.54           |
| 6            | 2.420* <sup>3</sup> |       |                        | .014       | 4.090     | .735                | .875           |
| 7            | 1.385               | 1.017 |                        | 0          | .214      | .0384               | .0457          |
| 8            | 1.760               |       |                        | .014       | .603      | .1085               | .129           |
| 9            | 1.239               |       |                        | .024       | .092      | .0165               | .0196          |
| 10           | .418                |       |                        | .038       | .715      | .1285               | .153           |
| 11           | 2.910* <sup>4</sup> |       |                        | .055       | 1.377     | .247                | .294           |
| 12           | 2.384* <sup>4</sup> |       |                        | .065       | 1.890     | .340                | .405           |
| 13           | 2.195* <sup>4</sup> |       |                        | .068       | 2.079     | .373                | .444           |
| 14           | 2.285* <sup>4</sup> |       |                        | .065       | 1.992     | 9.358               | .425           |
| 15           | 2.727* <sup>4</sup> |       |                        | .055       | 1.660     | .298                | .355           |
| 16           | 3.534* <sup>4</sup> |       |                        | .038       | .770      | .1380               | .164           |
| 17           | 4.565* <sup>4</sup> |       |                        | .024       | .247      | .0444               | .0528          |
| 18           | 1.595               |       |                        | .014       | .410      | .0735               | .0875          |
| 19           | 2.418               |       |                        | 0          | 1.247     | 9.224               | .266           |
| 20           | 1.495* <sup>2</sup> | 1.346 |                        | .014       | 3.165     | .568                | .675           |
| 21           | 3.143* <sup>1</sup> |       |                        | .024       | 7.974     | 1.435               | 1.710          |
| 22           | 3.679* <sup>1</sup> |       |                        | .038       | 8.506     | 1.530               | 1.820          |
| 23           | 3.122* <sup>1</sup> |       |                        | .055       | 7.932     | 1.425               | 1.700          |
| 24           | 2.567* <sup>1</sup> |       |                        | .065       | 7.367     | 1.325               | 1.580          |
| 1            | 2.333* <sup>1</sup> |       |                        | .068       | 7.130     | 1.280               | 1.525          |

\*1-6.365-added \*2-3.184-added \*3-9.536-added

\*4-3.171-subtracted.

TABLE IX

Force of Single Hemispherical Cup  
with 3-cup Interference

Velocity 10 m.p.h.

| Cup position | Gross | Zero  | Due to plate and wires | Due to rod | Net (lb.) | Normal force on cup | C <sub>N</sub> |
|--------------|-------|-------|------------------------|------------|-----------|---------------------|----------------|
| 1            | 1.525 | 1.037 | 0.0102                 | 0.0038     | 0.474     | 0.0850              | 1.620          |
| 2            | 1.541 |       |                        | .0036      | .490      | .0880               | 1.675          |
| 3            | 1.615 |       |                        | .0030      | .565      | .1015               | 1.930          |
| 4            | 1.514 |       |                        | .0021      | .465      | .0835               | 1.590          |
| 5            | 1.232 |       |                        | .0013      | .184      | .0330               | .628           |
| 6            | 1.204 |       |                        | .0007      | .157      | .0282               | .537           |
| 7            | 1.022 |       |                        | 0          | .025      | .0045               | .0858          |
| 8            | .812  |       |                        | .0007      | .235      | .0422               | .805           |
| 9            | .855  |       |                        | .0013      | .191      | .0343               | .655           |
| 10           | .928  |       |                        | .0021      | .117      | .0210               | .400           |
| 11           | .790  |       |                        | .0030      | .254      | .0456               | .870           |
| 12           | .704  |       |                        | .0036      | .340      | .0610               | 1.160          |
| 13           | .710  |       |                        | .0038      | .333      | .0598               | 1.140          |
| 14           | .733  |       |                        | .0036      | .311      | .0558               | 1.065          |
| 15           | .810  |       |                        | .0030      | .234      | .0420               | .800           |
| 16           | .838  |       |                        | .0021      | .207      | .0371               | .707           |
| 17           | .853  |       |                        | .0013      | .193      | .0346               | .660           |
| 18           | .894  |       |                        | .0007      | .153      | .0274               | .522           |
| 19           | .909  |       |                        | 0          | .138      | .0248               | .473           |
| 20           | 1.307 |       |                        | .0007      | .260      | .0466               | .890           |
| 21           | 1.617 |       |                        | .0013      | .569      | .1020               | 1.940          |
| 22           | 1.832 |       |                        | .0021      | .783      | .1405               | 2.68           |
| 23           | 1.685 |       |                        | .0030      | .635      | .1140               | 2.170          |
| 24           | 1.607 |       |                        | .0036      | .556      | .1000               | 1.905          |

TABLE X

Force of Single Hemispherical Cup  
with 3-Cup Interference

| Velocity 15 m.p.h. |       |       |                        |            |           |                     |        |
|--------------------|-------|-------|------------------------|------------|-----------|---------------------|--------|
| Cup position       | Gross | Zero  | Due to plate and wires | Due to rod | Net (lb.) | Normal force on cup | $C_N$  |
| 1                  | 2.244 | 1.002 | 0.0238                 | 0.0090     | 1.209     | 0.217               | 1.756  |
| 2                  | 2.248 |       |                        | .0085      | 1.213     | .218                | 1.765  |
| 3                  | 2.461 |       |                        | .0072      | 1.428     | .256                | 2.070  |
| 4                  | 2.237 |       |                        | .0050      | 1.206     | .2165               | 1.750  |
| 5                  | 1.547 |       |                        | .0031      | .518      | .093                | .753   |
| 6                  | 1.403 |       |                        | .0018      | .375      | .0674               | .545   |
| 7                  | 1.083 |       |                        | 0          | .058      | .00104              | .0084  |
| 8                  | .888  |       |                        | .0018      | .135      | .0242               | .196   |
| 9                  | 1.011 |       |                        | .0031      | .011      | .00197              | .01595 |
| 10                 | .820  |       |                        | .0050      | .200      | .0359               | .2905  |
| 11                 | .665  |       |                        | .0072      | .353      | .0633               | .512   |
| 12                 | .585  |       |                        | .0085      | .432      | .0775               | .627   |
| 13                 | .561  |       |                        | .0090      | .455      | .0817               | .661   |
| 14                 | .576  |       |                        | .0085      | .441      | .0791               | .640   |
| 15                 | .628  |       |                        | .0072      | .390      | .0700               | .566   |
| 16                 | .736  |       |                        | .0050      | .284      | .0510               | .413   |
| 17                 | .838  |       |                        | .0031      | .134      | .0241               | .195   |
| 18                 | .763  |       |                        | .0018      | .260      | .0467               | .378   |
| 19                 | .846  |       |                        | 0          | .179      | .0321               | .260   |
| 20                 | 1.650 |       |                        | .0018      | .632      | .1135               | .920   |
| 21                 | 2.369 |       |                        | .0031      | 1.340     | .241                | 1.950  |
| 22                 | 2.495 |       |                        | .0050      | 1.464     | .263                | 2.730  |
| 23                 | 2.345 |       |                        | .0072      | 1.312     | .236                | 1.990  |
| 24                 | 2.273 |       |                        | .0085      | 1.238     | .222                | 1.795  |

TABLE XI

Force of Single Hemispherical Cup  
with 3-Cup Resistance

| Velocity 20 m.p.h. |       |       |                        |            |           |                     |       |
|--------------------|-------|-------|------------------------|------------|-----------|---------------------|-------|
| Cup position       | Gross | Zero  | Due to plate and wires | Due to rod | Net (lb.) | Normal force on cup | $C_N$ |
| 1                  | 2.871 | 0.969 | 0.0396                 | 0.0158     | 1.847     | 0.3315              | 1.575 |
| 2                  | 2.947 |       |                        | .0150      | 1.924     | .3455               | 1.640 |
| 3                  | 3.281 |       |                        | .0125      | 2.260     | .4050               | 1.925 |
| 4                  | 2.914 |       |                        | .0087      | 1.898     | .3410               | 1.620 |
| 5                  | 1.879 |       |                        | .0055      | .865      | .1552               | .738  |
| 6                  | 1.551 |       |                        | .0031      | .540      | .0970               | .460  |
| 7                  | .978  |       |                        | 0          | .030      | .00538              | .0266 |
| 8                  | .878  |       |                        | .0031      | .127      | .0228               | .1085 |
| 9                  | .945  |       |                        | .0055      | .058      | .0104               | .0495 |
| 10                 | .713  |       |                        | .0087      | .287      | .0515               | .245  |
| 11                 | .509  |       |                        | .0125      | .477      | .0856               | .407  |
| 12                 | .343  |       |                        | .0150      | .650      | .1165               | .555  |
| 13                 | .242  |       |                        | .0158      | .751      | .1350               | .641  |
| 14                 | .377  |       |                        | .0150      | .616      | .1105               | .525  |
| 15                 | .409  |       |                        | .0135      | .577      | .1035               | .492  |
| 16                 | .595  |       |                        | .0087      | .405      | .0727               | .345  |
| 17                 | .865  |       |                        | .0055      | .138      | .0248               | .118  |
| 18                 | .614  |       |                        | .0031      | .381      | .0685               | .325  |
| 19                 | .788  |       |                        | 0          | .220      | .0395               | .188  |
| 20                 | 2.187 |       |                        | .0031      | 1.176     | .2110               | 1.000 |
| 21                 | 3.151 |       |                        | .0055      | 2.137     | .3835               | 1.820 |
| 22                 | 2.945 |       |                        | .0037      | 1.929     | .3460               | 1.645 |
| 23                 | 2.924 |       |                        | .0125      | 1.903     | .3420               | 1.625 |
| 24                 | 2.805 |       |                        | .0150      | 1.782     | .3200               | 1.520 |

TABLE XII

Force of Single Hemispherical Cup  
with 3-Cup Interference

Velocity 40 m.p.h.

| Cup position | Gross   | Zero  | Due to plate and wires | Due to rod | Net (lb.) | Normal force on cup | C <sub>N</sub> |
|--------------|---------|-------|------------------------|------------|-----------|---------------------|----------------|
| 1            | 2.208*1 | 1.024 | 0.1544                 | 0.0682     | 7.327     | 1.315               | 1.565          |
| 2            | 2.492*1 | "     |                        | .0648      | 7.614     | 1.370               | 1.630          |
| 3            | 3.390*1 | "     |                        | .0545      | 8.522     | 1.530               | 1.820          |
| 4            | 1.279*1 | "     |                        | .0375      | 6.428     | 1.155               | 1.375          |
| 5            | 1.570*2 | "     |                        | .0238      | 3.552     | .6375               | .758           |
| 6            | .473*2  | "     |                        | .0136      | 2.465     | .4430               | .528           |
| 7            | 1.314   | "     |                        | 0          | .136      | .0244               | .0129          |
| 8            | 1.510   | 0.763 |                        | .0136      | .609      | .109                | .130           |
| 9            | .807    | "     |                        | .0238      | .174      | .0312               | .0371          |
| 10           | 3.225*3 | "     |                        | .0375      | .825      | .148                | .172           |
| 11           | 2.604*3 | "     |                        | .0545      | 1.429     | .267                | .318           |
| 12           | 1.998*3 | "     |                        | .0648      | 2.025     | .364                | .433           |
| 13           | 1.858*3 | "     |                        | .0682      | 2.162     | 9.389               | .463           |
| 14           | 2.119*3 | "     |                        | .0648      | 1.904     | .342                | .407           |
| 15           | 2.655*3 | "     |                        | .0545      | 1.378     | .248                | .295           |
| 16           | 3.462*3 | "     |                        | .0375      | .588      | .1055               | .1255          |
| 17           | .823    | "     |                        | .0238      | .190      | .0342               | .0307          |
| 18           | .921    | "     |                        | .0136      | .021      | .00377              | .0045          |
| 19           | 1.520   | 1.191 |                        | 0          | .175      | .0314               | .0374          |
| 20           | 2.897*2 | "     |                        | .0136      | 4.722     | .085                | .101           |
| 21           | 3.770*1 | "     |                        | .0238      | 8.766     | 1.575               | 1.875          |
| 22           | 3.002*1 | "     |                        | .0375      | 7.984     | 1.435               | 1.710          |
| 23           | 1.910*1 | "     |                        | .0545      | 6.875     | 1.235               | 1.470          |
| 24           | 1.775*1 | "     |                        | .0648      | 6.728     | 1.210               | 1.44           |
| 1            | 1.763*1 | "     |                        | .0682      | 6.615     | 1.190               | 1.415          |

\*1-6.365-added      \*2-3.184-added      \*3-3.171-subtracted

TABLE XIII

## Simultaneous Force of 4-Cup Anemometer

Velocity 20 m.p.h. ✓

| Cup position | Gross | Zero  | Due to plate and wires | Due to rod | Net (lb.) | Normal force on cup | $C_N$ |
|--------------|-------|-------|------------------------|------------|-----------|---------------------|-------|
| 1            | 2.248 | 1.068 | 0.0396                 | 0          | 1.141     | 0.205               | 0.975 |
| 2            | 3.712 |       |                        |            | 2.605     | .467                | 2.24  |
| 3            | 4.895 |       |                        |            | 3.788     | .680                | 3.26  |
| 4            | 4.012 |       |                        |            | 2.905     | .521                | 2.50  |
| 5            | 3.172 |       |                        |            | 2.064     | .371                | 1.78  |
| 6            | 2.405 |       |                        |            | 1.298     | .233                | 1.12  |
| 7            | 2.302 |       |                        |            | 1.195     | .215                | 1.035 |
| 8            | 3.538 |       |                        |            | 2.431     | .436                | 2.095 |
| 9            | 4.785 |       |                        |            | 3.768     | .676                | 3.25  |
| 10           | 4.059 |       |                        |            | 2.952     | .530                | 2.54  |
| 11           | 3.175 |       |                        |            | 2.068     | .371                | 1.78  |
| 12           | 2.322 |       |                        |            | 1.215     | .218                | 1.045 |
| 13           | 2.390 |       |                        |            | 1.283     | .230                | 1.105 |

TABLE XIV

## Simultaneous Force of 4-Cup Anemometer

Velocity 10 m.p.h.

| Cup position | Gross | Zero  | Due to plate and wires | Due to rod | Net (lb.) | Normal force on cup | C <sub>N</sub> |
|--------------|-------|-------|------------------------|------------|-----------|---------------------|----------------|
| 1            | 1.312 | 1.068 | 0.0102                 | 0          | 0.234     | 0.040               | 0.763          |
| 2            | 1.621 |       |                        |            | .543      | .0975               | 1.860          |
| 3            | 1.913 |       |                        |            | .835      | .150                | 2.86           |
| 4            | 1.782 |       |                        |            | .704      | .1265               | 2.41           |
| 5            | 1.507 |       |                        |            | .429      | .077                | 1.47           |
| 6            | 1.396 |       |                        |            | .318      | .057                | 1.085          |
| 7            | 1.291 |       |                        |            | .213      | .0383               | .730           |
| 8            | 1.567 |       |                        |            | .489      | .0878               | 1.675          |
| 9            | 1.920 |       |                        |            | .842      | .1510               | 2.88           |
| 10           | 1.848 |       |                        |            | .770      | .138                | 2.63           |
| 11           | 1.521 |       |                        |            | .443      | .0795               | 1.515          |
| 12           | 1.363 |       |                        |            | .285      | .0512               | .975           |
| 13           | 1.304 |       |                        |            | .226      | .0405               | .773           |



TABLE XIV-A

Normal Force Coefficient for Four Hemispherical Cups  
Based on Single-Cup Data with 3-Cup Interference

|              | Cup 1<br>✓ | Cup 2<br>(#1) ✓ | Cup 3<br>(#1) ✓ | Cup 4<br>(#1) ✓ | $C_N$ for<br>4 cups |                  |
|--------------|------------|-----------------|-----------------|-----------------|---------------------|------------------|
| Cup position | 1          | 7               | 13              | 19              | 1                   | Plotted position |
| $C_N$        | +1.575     | +0.0266         | -0.641          | -0.188          | +0.773              | Total $C_N$      |
| Cup position | 2          | 8               | 14              | 20              | 2                   | Plotted position |
| $C_N$        | +1.640     | -0.1085         | -0.525          | +1.000          | +2.007              | Total $C_N$      |
| Cup position | 3          | 9               | 15              | 21              | 3                   | Plotted position |
| $C_N$        | +1.925     | -0.0495         | -0.492          | +1.820          | +3.204              | Total $C_N$      |
| Cup position | 4          | 10              | 16              | 22              | 4                   | Plotted position |
| $C_N$        | +1.620     | -0.245          | -0.345          | +1.645          | +2.675              | Total $C_N$      |
| Cup position | 5          | 11              | 17              | 23              | 5                   | Plotted position |
| $C_N$        | +0.738     | -0.407          | -0.118          | +1.625          | +1.838              | Total $C_N$      |
| Cup position | 6          | 12              | 18              | 24              | 6                   | Plotted position |
| $C_N$        | +0.460     | -0.555          | -0.325          | +1.520          | +1.100              | Total $C_N$      |
| Cup position | 7          | 13              | 19              | 1               | 7                   | Plotted position |
| $C_N$        | +0.0266    | -0.641          | -0.188          | +1.575          | +0.773              | Total $C_N$      |
| Cup position | 8          | 14              | 20              | 2               | 8                   | Plotted position |
| $C_N$        | -0.1085    | -0.525          | +1.000          | +1.640          | +2.007              | Total $C_N$      |

TABLE XIV-A (continued)

Normal Force Coefficient for Four Hemispherical Cups  
Based on Single-Cup Data with 3-Cup Interference

|                 | Cup 1   | Cup 2<br>(#1) | Cup 3<br>(#1) | Cup 4<br>(#1) | $C_N$ for<br>4 cups |                     |
|-----------------|---------|---------------|---------------|---------------|---------------------|---------------------|
| Cup<br>position | 9       | 15            | 21            | 3             | 9                   | Plotted<br>position |
| $C_N$           | -0.0495 | -0.492        | +1.820        | +1.925        | +3.204              | Total $C_N$         |
| Cup<br>position | 10      | 16            | 22            | 4             | 10                  | Plotted<br>position |
| $C_N$           | -0.245  | -0.345        | +1.645        | +1.620        | +2.675              | Total $C_N$         |
| Cup<br>position | 11      | 17            | 23            | 5             | 11                  | Plotted<br>position |
| $C_N$           | -0.407  | -0.118        | +1.625        | +0.738        | +1.838              | Total $C_N$         |
| Cup<br>position | 12      | 18            | 24            | 6             | 12                  | Plotted<br>position |
| $C_N$           | -0.555  | -0.325        | +1.520        | +0.460        | +1.100              | Total $C_N$         |
| Cup<br>position | 13      | 19            | 1             | 7             | 13                  | Plotted<br>position |
| $C_N$           | -0.641  | -0.188        | +1.575        | +0.0266       | +0.773              | Total $C_N$         |

TABLE XV

Summary of Hemispherical Cup Coefficients  
at Positions of  $0^\circ$  and  $180^\circ$   
for 15.5 cm Cup

| $V_{\text{mph}}$ | R.N.   | $C_N$<br>Single cup |                | $C_N$<br>3-cup<br>interference |                | $C_N$<br>4 cups<br>simulta-<br>neously |
|------------------|--------|---------------------|----------------|--------------------------------|----------------|--|
|                  |        | concave<br>side     | convex<br>side | concave<br>side                | convex<br>side |  |
| 10               | 47100  | 1.390               | 0.541          | 1.620                          | 1.140          | 0.763                                  |
| 15               | 70700  | 1.602               | .446           | 1.756                          | .661           |  |
| 20               | 94200  | 1.485               | .4275          | 1.575                          | .641           | .975                                   |
| 40               | 188400 | 1.540               | .444           | 1.565                          | .463           |  |

At  $0^\circ$  and  $180^\circ$   $C_N = C_D$



Figure 1.- Front view of apparatus with single cup.

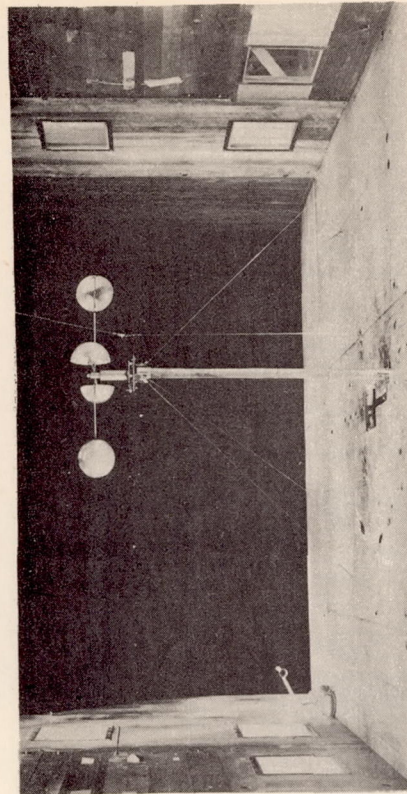

Figure 2.- Rear view of apparatus with three cup interference.

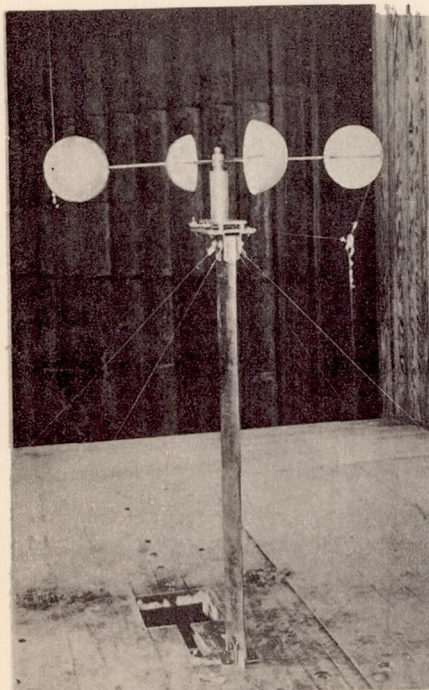

Figure 3.- Rear right view of apparatus.

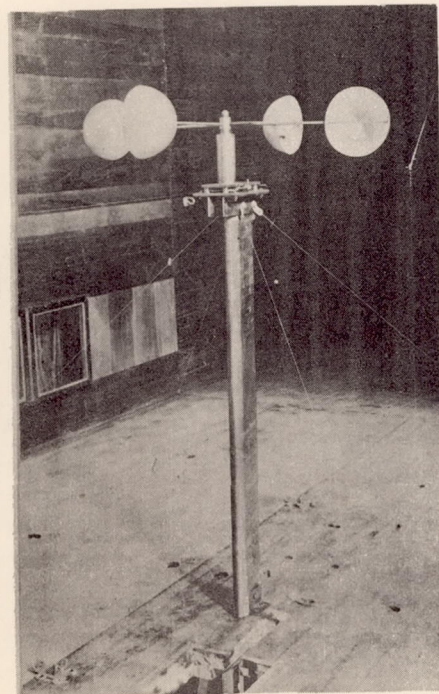
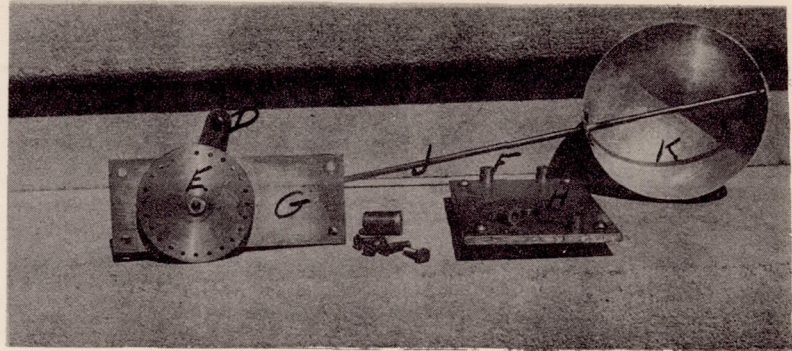
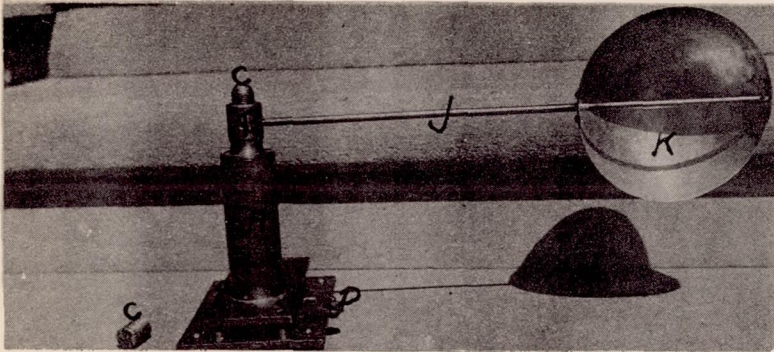

Figure 4.- Right front view of apparatus.



- A, housing
- B, spindle
- C, adjusting seat screws
- D, lever arm
- E, angular change wheel
- F, spacers
- G, top base plate
- H, bottom base plate
- J, cup rod
- K, cup

Figures 5 and 6.-Detail view of apparatus

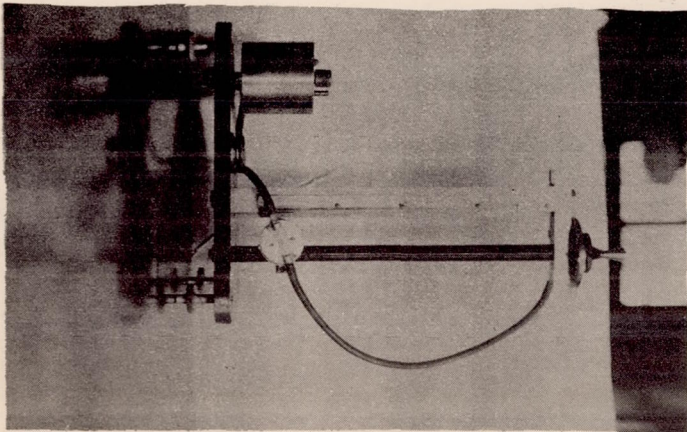

Figure 9.- View of micro-manometer.

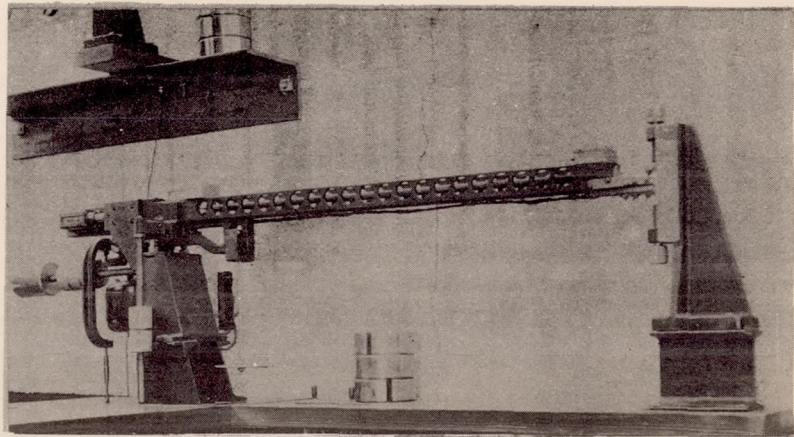
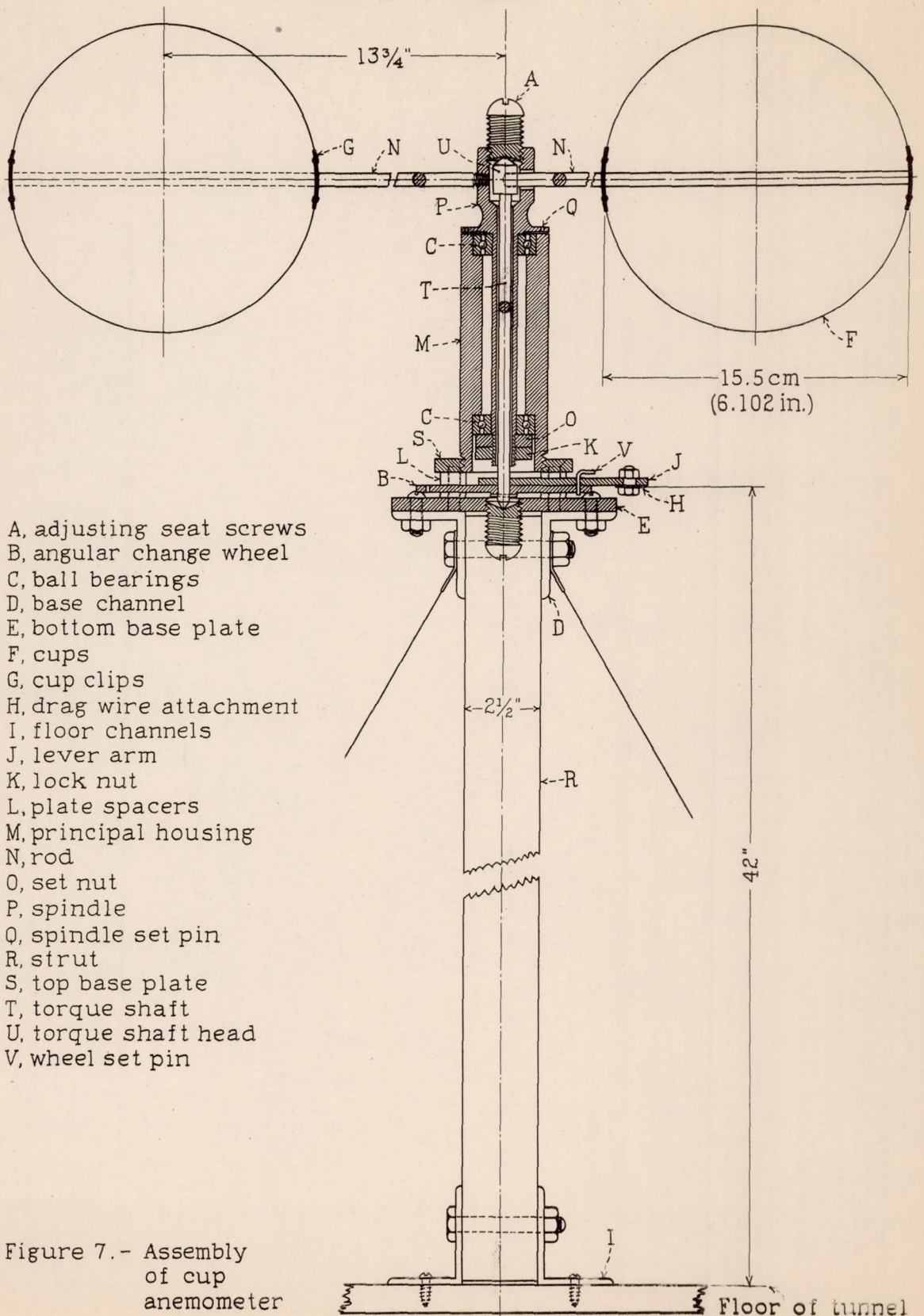

Figure 8.- View of drag balance



- A, adjusting seat screws
- B, angular change wheel
- C, ball bearings
- D, base channel
- E, bottom base plate
- F, cups
- G, cup clips
- H, drag wire attachment
- I, floor channels
- J, lever arm
- K, lock nut
- L, plate spacers
- M, principal housing
- N, rod
- O, set nut
- P, spindle
- Q, spindle set pin
- R, strut
- S, top base plate
- T, torque shaft
- U, torque shaft head
- V, wheel set pin

Figure 7.- Assembly of cup anemometer

Floor of tunnel

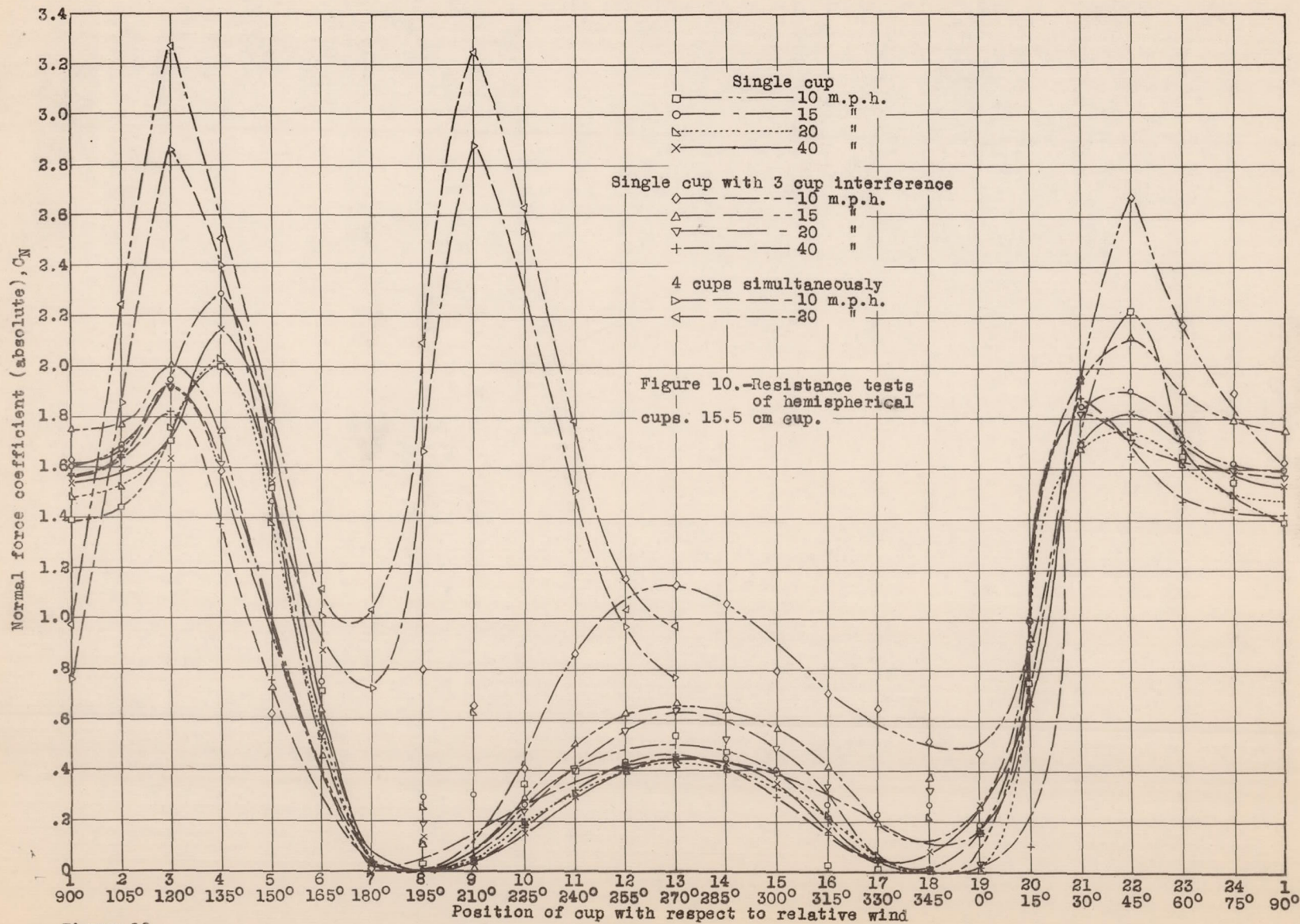

Figure 10.—Resistance tests of hemispherical cups. 15.5 cm cup.

Figure 10.

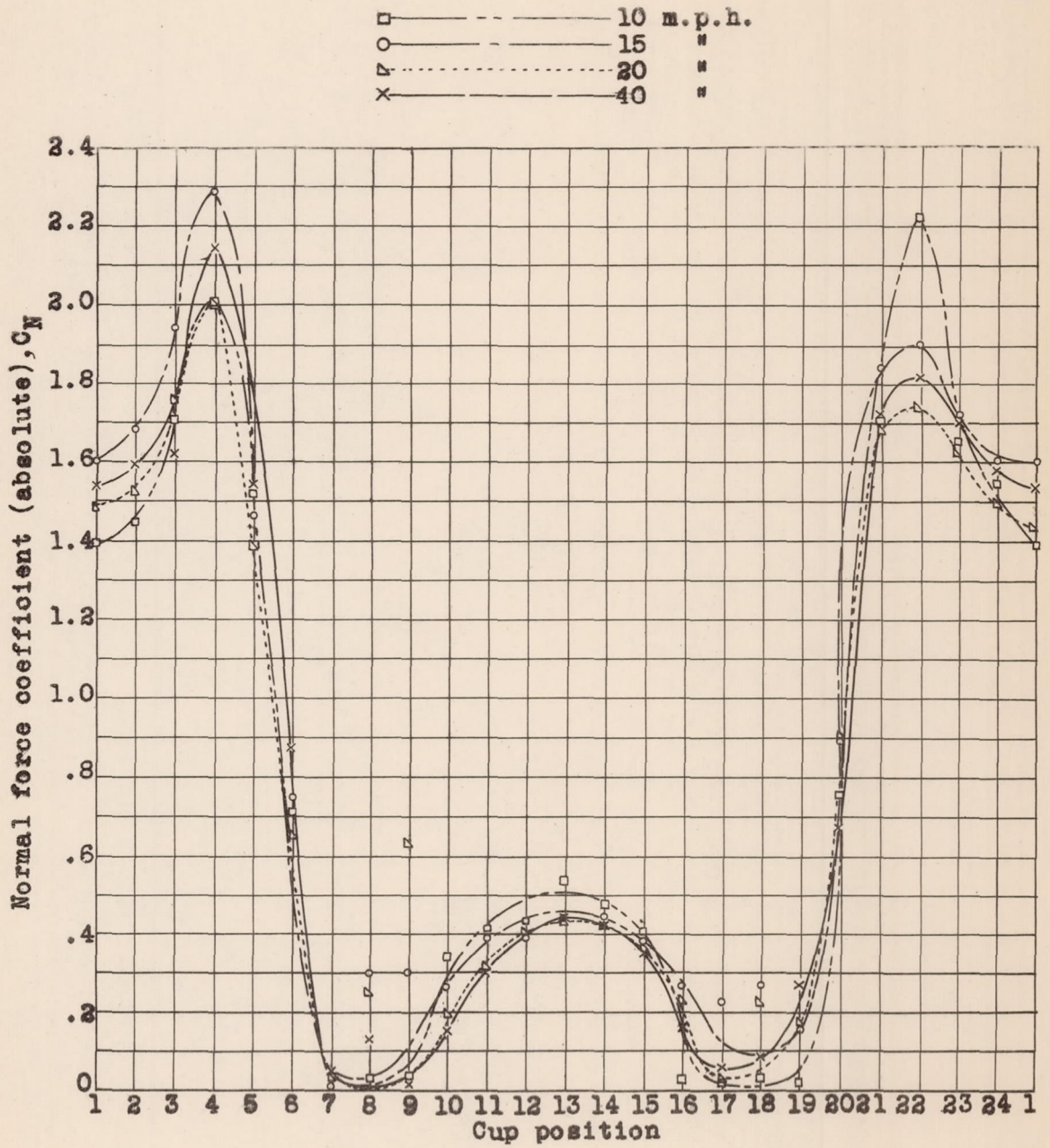

Figure 11.—Resistance of single anemometer cup. 15.5 cm cup.



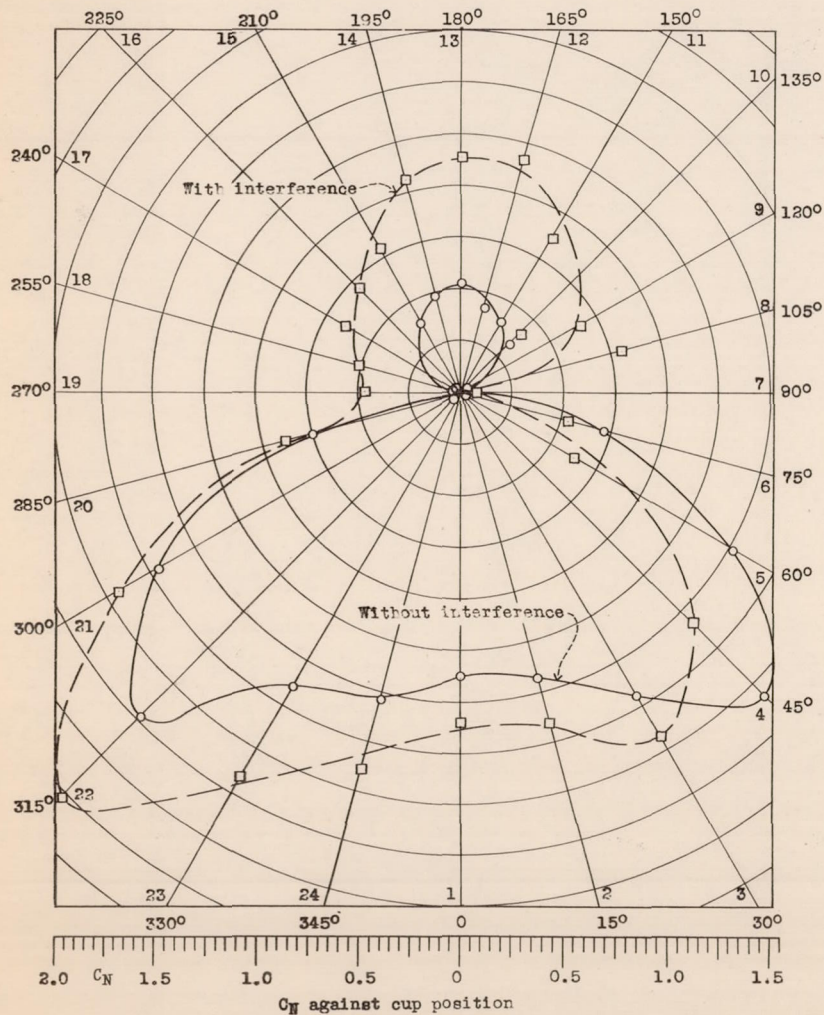

Figure 12.- Normal force coefficients for hemispherical cups. 15.5 cm (6.102") cup. Velocity = 10 m.p.h.

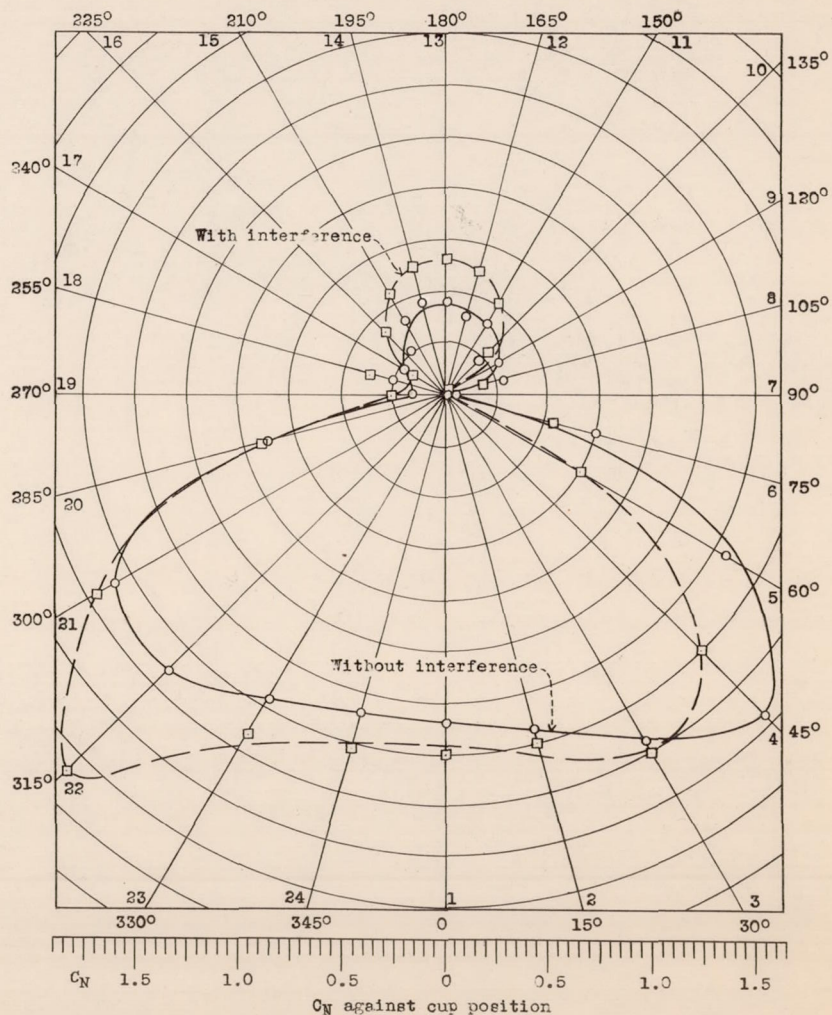

Figure 13.- Normal force coefficients for hemispherical cups. 15.5 cm (6.102") cup. Velocity = 15 m.p.h.

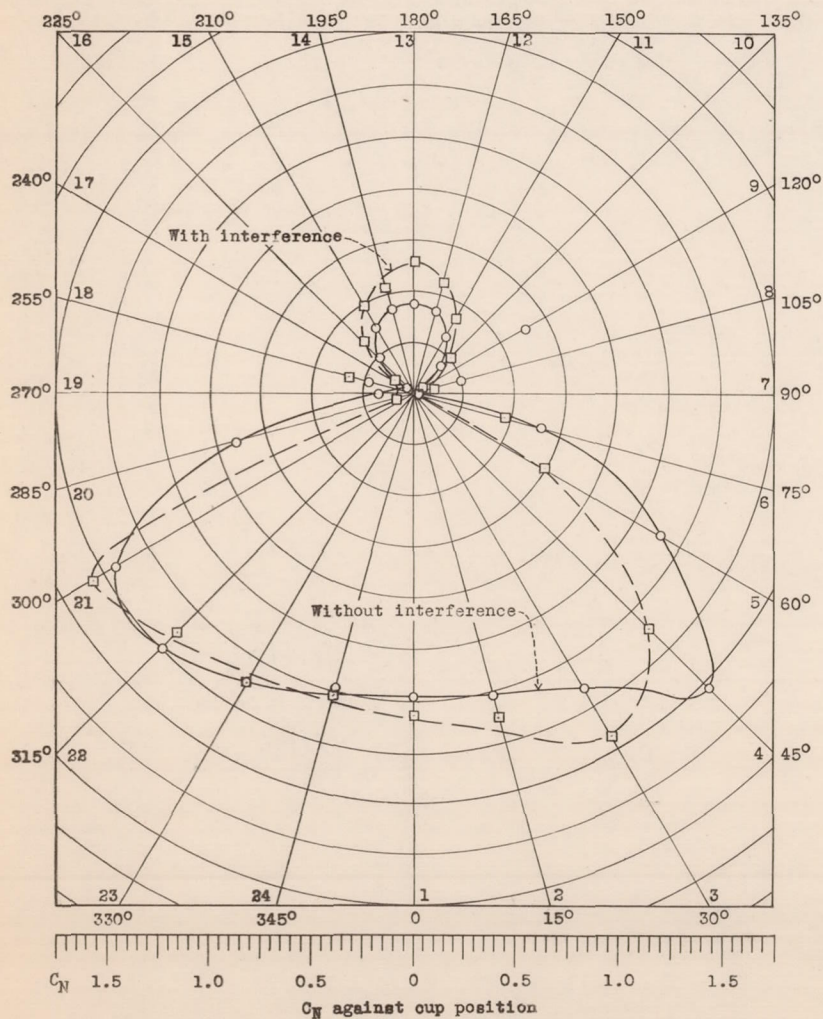

Figure 14.- Normal force coefficients for hemispherical cups. 15.5 cm (6.102") cup. Velocity = 20 m.p.h.

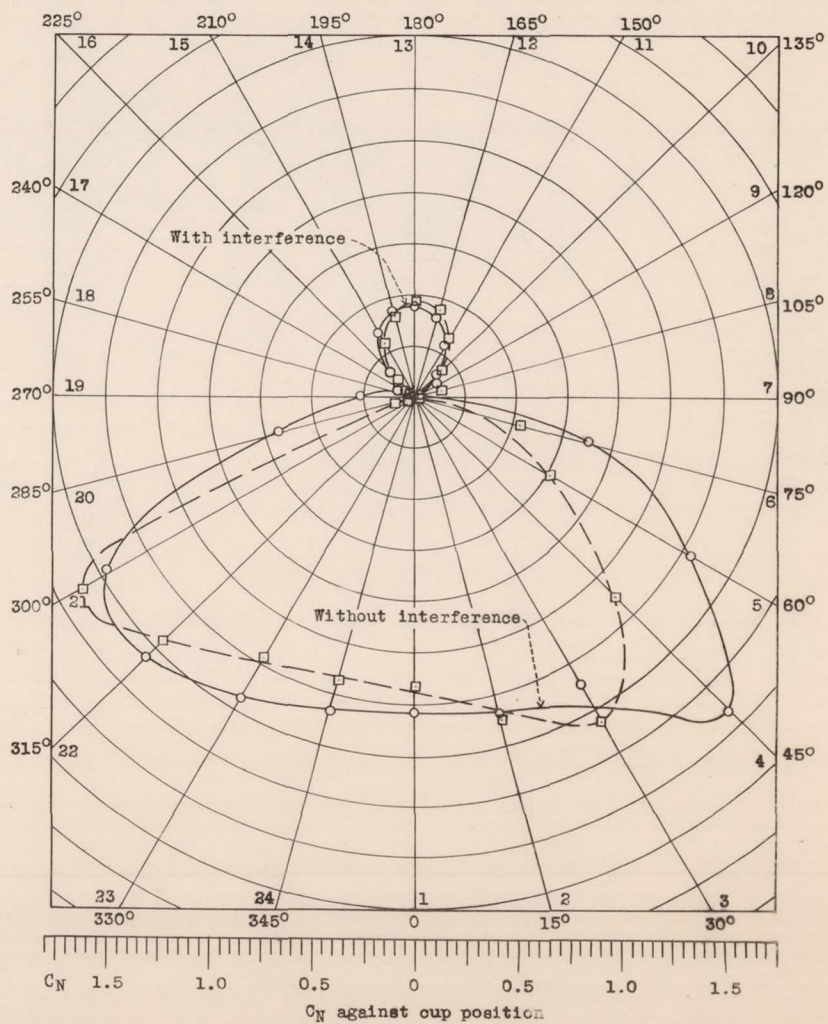

Figure 15.- Normal force coefficients for hemispherical cups. 15.5 cm (6.102") cup. Velocity = 40 m.p.h.

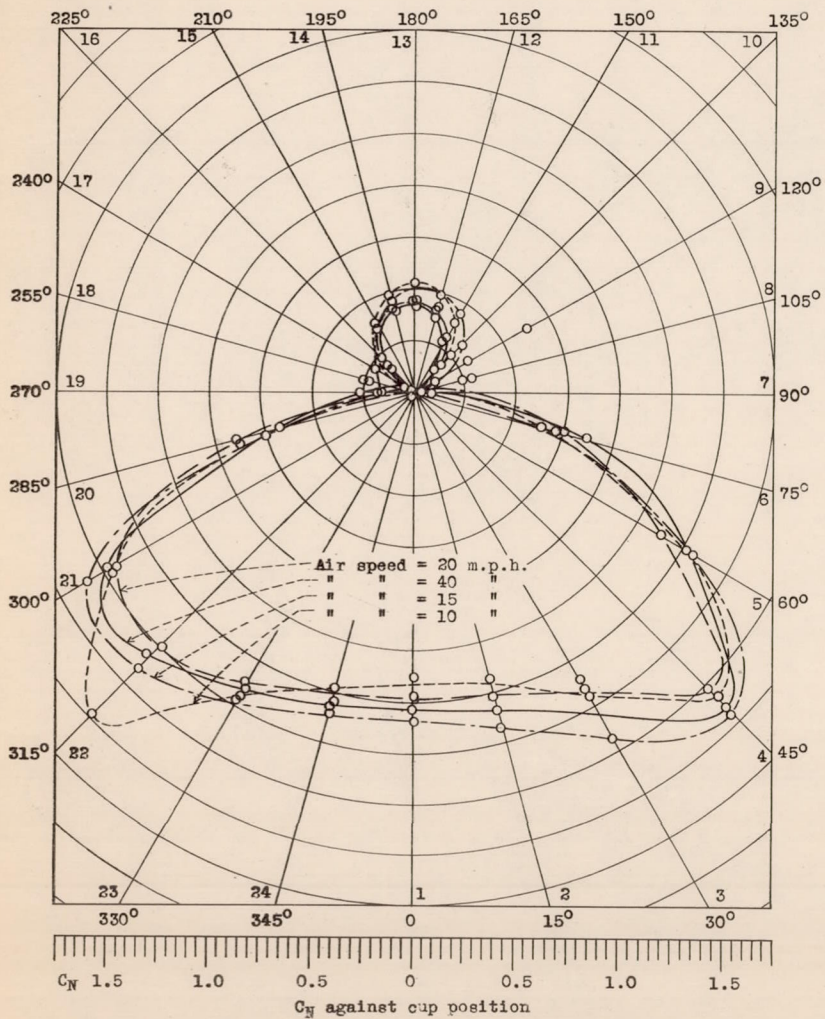

Figure 16.- Normal force coefficients for hemispherical cup without interference. 15.5 cm (6.102") cup.

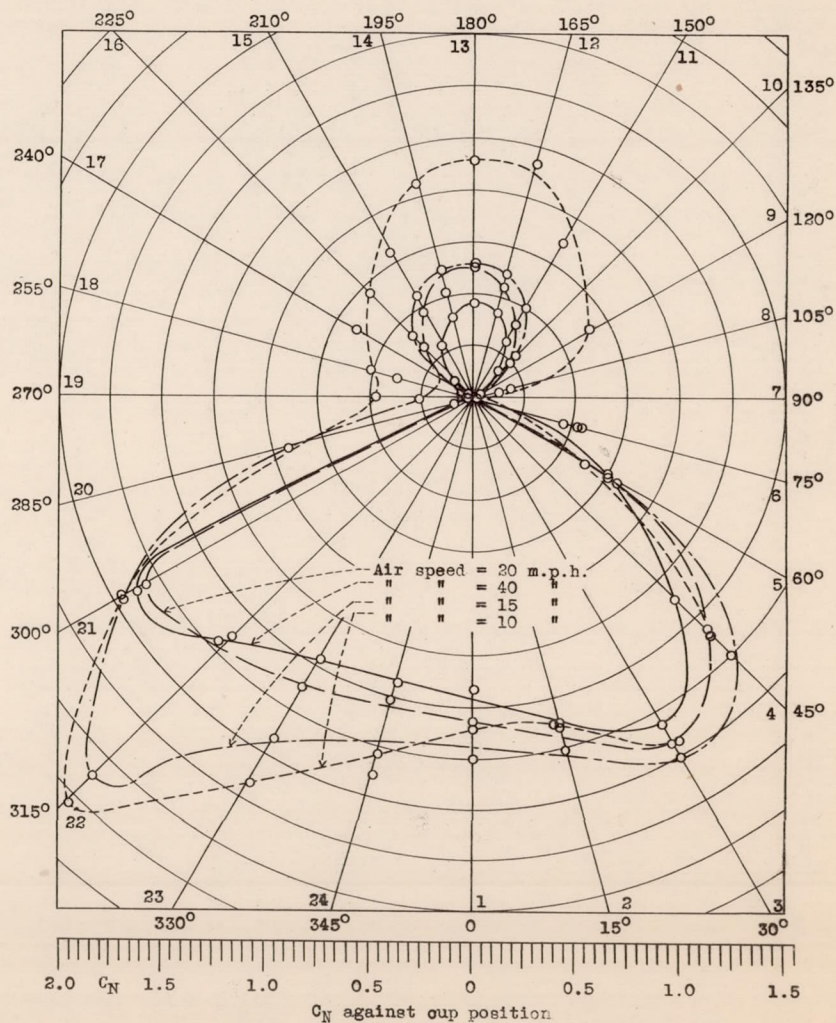

Figure 17.- Normal force coefficients for hemispherical cup with 3 cup interference. 15.5 cm (6.102") cup.

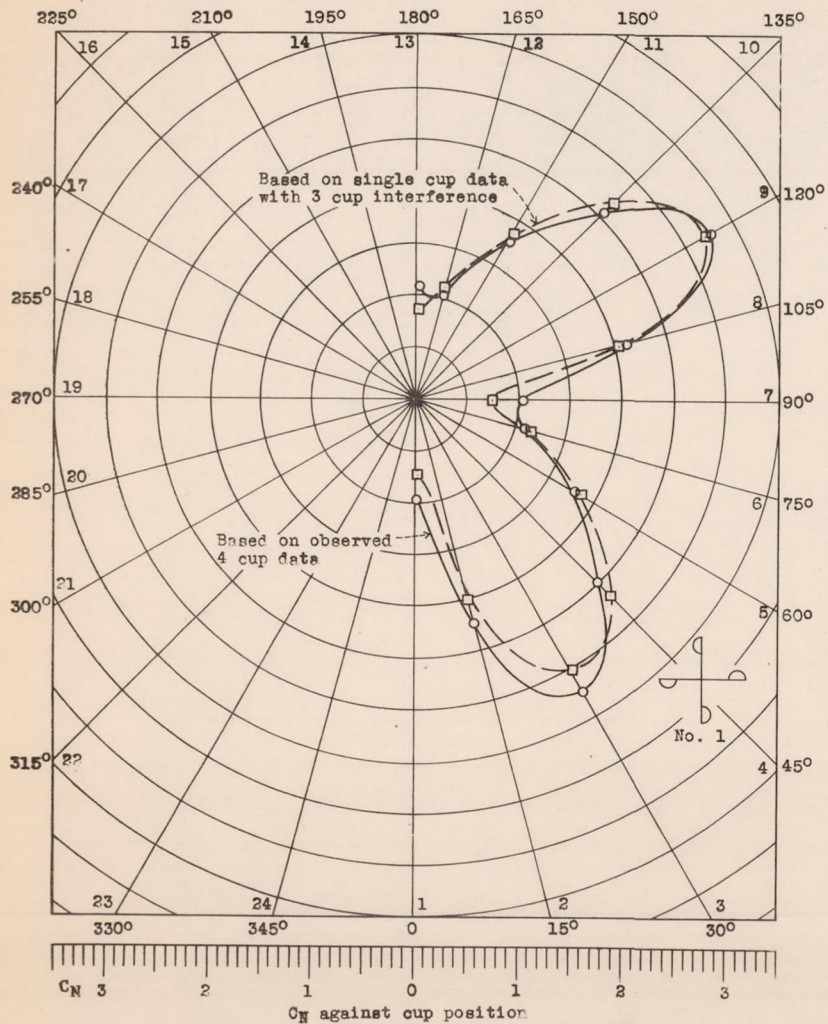

Figure 18.- Normal force coefficients for 4 hemispherical cups. 15.5 cm (6.102") cup. Velocity = 20 m.p.h.

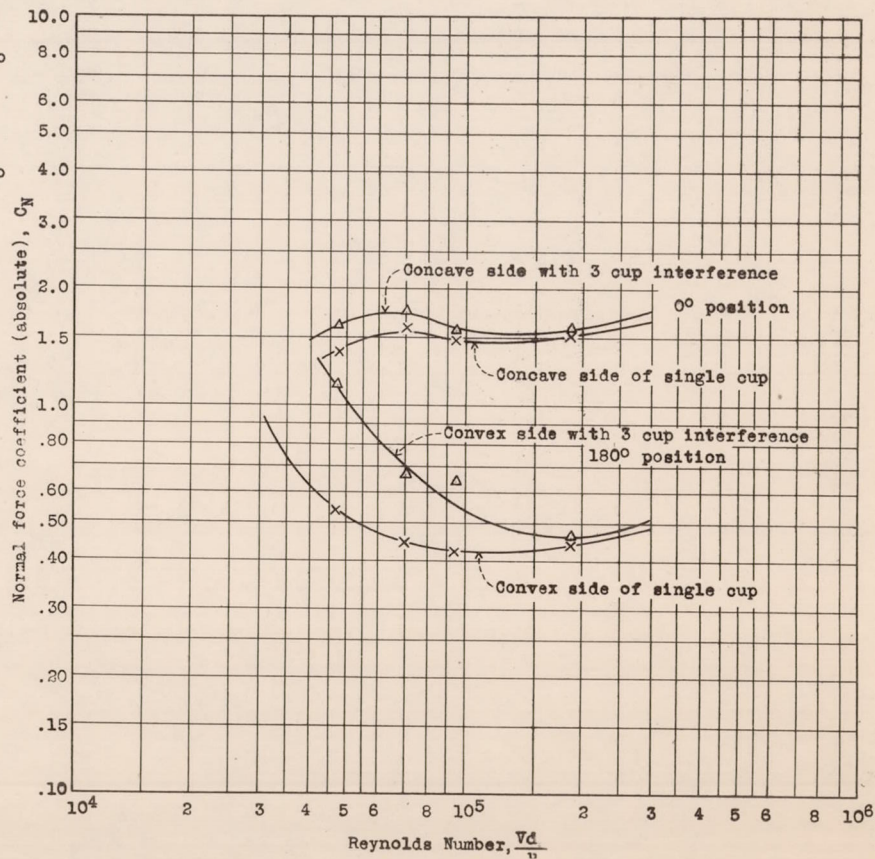

Figure 19.- Variation of normal force coefficient for hemispherical cup. 15.5 cm (6.102") cup.