

FILE COPY
NO. 2-W

CASE FILE COPY

TECHNICAL NOTES

NATIONAL ADVISORY COMMITTEE FOR AERONAUTICS

No. 547

DEVELOPMENT OF THE N.A.C.A. SLOT-LIP AILERON

By Fred E. Weick and Joseph A. Shortal
Langley Memorial Aeronautical Laboratory

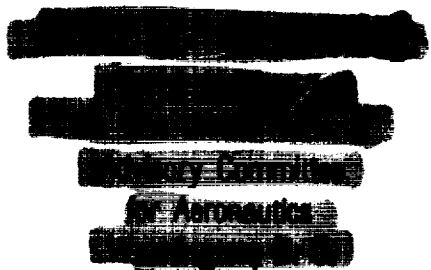

Washington
November 1935

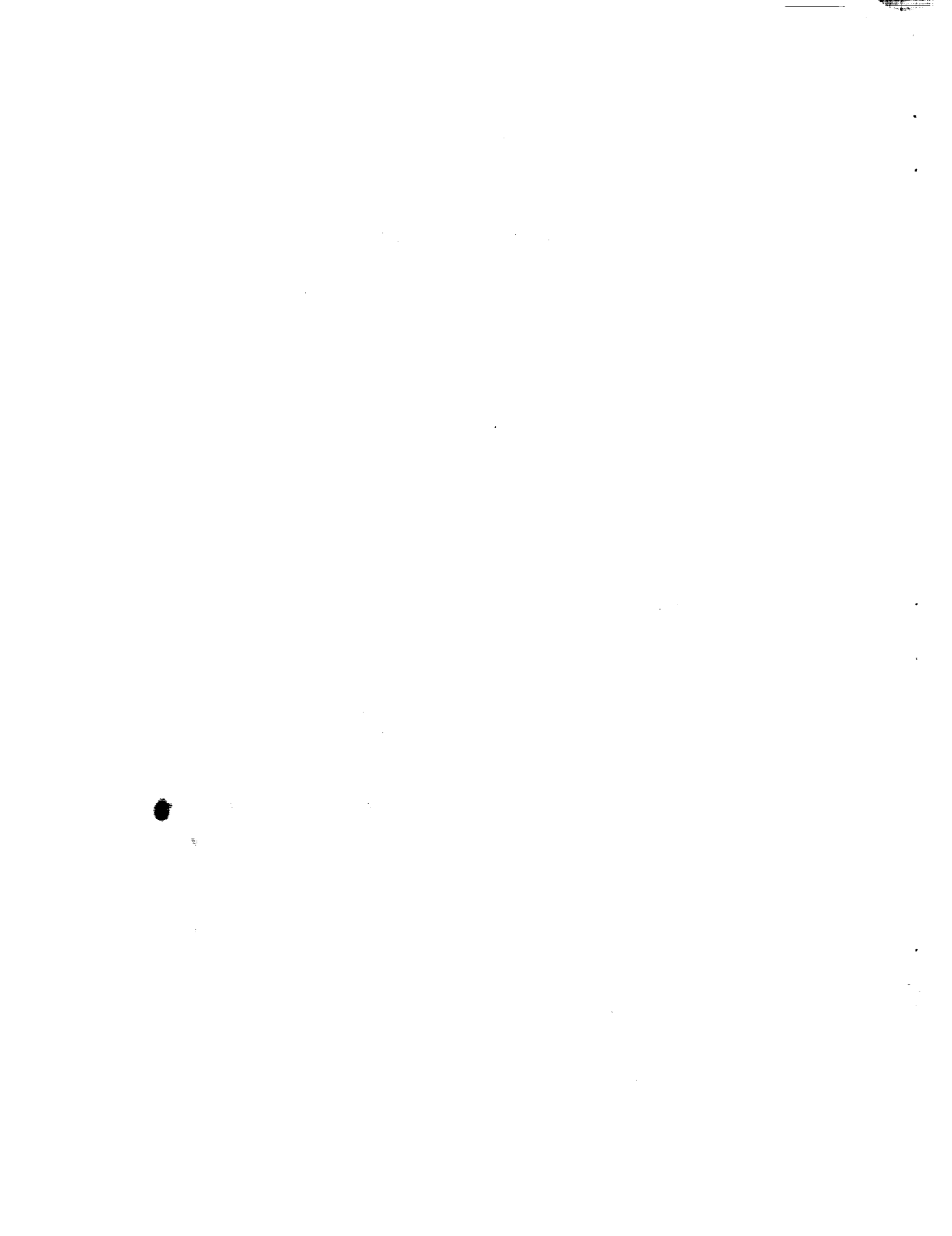

NATIONAL ADVISORY COMMITTEE FOR AERONAUTICS

TECHNICAL NOTE NO. 547

DEVELOPMENT OF THE N.A.C.A. SLOT-LIP AILERON

By Fred E. Weick and Joseph A. Shortal

SUMMARY

An investigation of the undesirable delayed action, or lag, of the spoiler-type lateral control device led to the development of the N.A.C.A. slot-lip aileron. The tests were made in the 7- by 10-foot wind tunnel with a 4- by 8-foot wing hinged at the tunnel jet boundary and restrained in roll by elastic cords. Time histories were taken of the motion of the control device under test and of the resulting wing motion.

First, the lag, as affected by the fore-and-aft location of retractable ailerons or spoilers was determined. The lag was found to increase regularly as the spoiler was moved from the rear of the wing toward the front. Then a combination of spoiler and fixed slot was developed that, with the spoiler retracting into the forward part of the slot, reduced the time lag to a negligible value. In addition, an arrangement was developed using a hinged aileron-type flap as the upper portion, or lip, of a slot through the wing. This arrangement appears to be usable as a form of lateral control device that shows promise of giving improved control and stability at the high angles of attack through the stall, with negligible lag, low control forces, and relatively simple construction.

INTRODUCTION

Owing to the fact that safety in flight can be increased by improving the lateral control and stability at high angles of attack, the National Advisory Committee for Aeronautics has undertaken an investigation with that aim (reference 1). Wind-tunnel tests have shown that spoiler-

type devices located in the forward portion of the wing should give improved rolling and yawing moments at high angles of attack (reference 2). Flight tests have revealed, however, that the spoiler control is accompanied by a delayed response, or lag, (reference 3) unless located well back on the wing (reference 4). The present work was undertaken to investigate the nature of this lag under controlled conditions in a wind tunnel and to explore the possibilities of obtaining a device having spoiler-type control without lag. For this purpose, a special large wing was fitted with the desired control devices and flexibly mounted in the N.A.C.A. 7- by 10-foot wind tunnel in such manner that the wing moved when the controls were deflected, the motions of both the control device and the wing being, in each case, photographically recorded. The final outcome of the investigation was the development of a new form of lateral control device called "slot-lip ailerons."

APPARATUS AND TESTS

The 7- by 10-foot wind tunnel is described in reference 5. A diagram of the wing arranged for the present lag tests is shown in figure 1. The wing was hinged at one end and was supported above and below by elastic cords (airplane rubber shock-absorber cords) at a point somewhat inboard from the other end. In order to hold the wing level with the tunnel in operation, the tension in the lower cord was made adjustable. The motions of the wing and the control device were transmitted by means of cords to a control-position recorder developed for flight tests. With this instrument, the motion of the control device and the motion of the wing were photographically recorded on the same film.

The lag tests were made with the wing at two different angles of attack, 0° representing the high-speed and cruising conditions of flight and 15° representing flight at low speed. With the 0° angle of attack the tunnel was operated at 30 miles per hour and with the 15° angle of attack at 40 miles per hour, these conditions giving the same lag for corresponding lift coefficients as the full-scale tests on the F-22 airplane used in the flight tests with spoilers (reference 3). In the present tests the control devices were deflected various amounts and then returned to neutral, the records being taken in each case.

RESULTS AND DISCUSSION

The present work, which is in the nature of a development, is divided into several distinct steps: First, inasmuch as it was known from flight tests (references 3 and 4) that there is a decided difference between the lag of a retractable spoiler near the leading edge of the wing and that of one near the trailing edge, tests were made to check this point in the wind tunnel and to obtain the variation of lag as the spoiler location was moved from the front to the rear. Second, with the spoiler located about one third back from the leading edge, which seemed the most promising position, attempts were made to eliminate the lag or at least to reduce it to a negligible value by combining a slot with a spoiler. Third, when an arrangement with negligible lag was obtained, modifications were made with the view of improving the practicability of the device. Finally, the most promising arrangement was tested at two other locations along the chord of the wing.

Retractable spoilers or ailerons.- The retractable spoilers or ailerons (they have been called "spoilers" when located near the leading edge of the wing and "aileron" when located near the trailing edge) were curved plates that slid in and out of the upper surface of the wing as indicated in figure 2. Finally, an aileron consisting of a hinged flat plate attached to the trailing edge of the wing was tested in this series as representative of the type of action obtained with ordinary ailerons.

Typical time history curves showing the movement of the wing following a deflection of the control surface are shown in figure 3. In these tests the control devices were suddenly deflected the full amount. The inertia of the wing carried it past the position of final balance between the tension in the elastic chord and the air forces, but the motion was damped out in a very short time. With the aileron attached to the trailing edge, the motion started in the desired direction as soon as the aileron was moved (within the limits of accuracy of the measurements, or about 0.05 second). With the retractable spoiler near the leading edge, however, the wing had a slight movement in the wrong direction at first and did not start moving in the right direction until nearly a second after the control deflection started, this time interval being termed the "lag."

The flight tests of references 3 and 4 showed that a lag of one-half second makes the control practically unusable but that a lag of one-tenth second or less was not detectable by the pilot and therefore not objectionable. The various lags of the retractable ailerons in the different positions along the chord are shown in figure 2 for the two angles of attack representing the high- and low-speed conditions of flight. The lag is substantially greater for the high-angle-of-attack and low-speed condition than it is for the low-angle-of-attack and high-speed condition. It becomes less as the spoiler is moved to the rear and reaches a usable value about 20 percent from the trailing edge. Points are plotted on figure 2 for full deflection and also for half deflection, both being made suddenly. The lag was about the same for both deflections. When the control was returned to neutral, there was also a lag in the return of the wing. (See fig. 3.) In fact, with the retractable spoiler in the forward location, a lag of about the same order was present with any amount of control deflection in either direction.

The final deflection of the wing was a rough measure of the rolling moment given by the lateral control device, and this deflection, in degrees, is given in the dashed curves of figure 2. At the high angle of attack the deflection, or the rolling moment, became greater as the spoiler was moved forward to 30 percent of the wing chord but fell off slightly for the foremost position. At the low angle of attack the deflections were about the same for all positions except for the foremost, which had a rather small value.

It was noticed in the flight tests of reference 4 that although the retractable aileron in the 0.83 c position had no lag noticeable to the pilots with the original wing a slight lag was found when a split trailing-edge flap was in use. This effect was also found in the present wind-tunnel tests and the results, which are given in figure 4, show that a slight increase in lag was obtained when the flap was used.

It was known from the flight tests of reference 3 that a combination of retractable spoilers near the leading-edge and conventional trailing-edge ailerons gave immediate response; and, in order to investigate the possibility of obtaining a lag-free control for a wing having its trailing-edge portion free to take a high-lift trailing-edge flap, wind-tunnel tests were made using two re-

tractable devices - a front retractable spoiler and a rear retractable aileron acting together. (See fig. 5.) When one device was located directly behind the other, the lag was no greater than that of the rear one and the rolling moment was the same as that of the front one, making a combination satisfactory except possibly for some increase in the mechanical complication. When the spans of the front and rear control devices were reduced to half their original lengths and the two were staggered, the lag was found to be less than that of the front one alone but still too large for satisfactory use.

Spoiler combined with slot.- The initial reversed effect resulting in the lag was thought to be intimately associated with the time required to effect a rather extreme change in the flow pattern with extreme local pressure changes. It seemed that if a slot were put through the wing permitting air to flow from the high pressure region below the wing to the region of low pressure that must tend to form just behind the spoiler as it is raised above the surface of the wing, the extreme momentary pressure change, and therefore the lag, might be eliminated or at least reduced to a negligible value. Furthermore, if the slot were left permanently open and were properly shaped, it should delay the stall over its portion of the wing and thereby improve the lateral stability at the angles of attack in the region of the stall. It would, of course, be desirable to have the shape and size of the slot such as to have as low a drag as possible. (See references 6 and 7.)

The results of the first attempt to combine a spoiler and a slot are shown in figure 6. The position of the spoiler about one third of the wing chord back from the leading edge was chosen from the results of figure 2 and also from those of reference 8 as the location probably giving the most desirable rolling moments. The spoiler was retracted entirely within the slot and curved to fit the slot shape. The size of the slot was varied by moving the rear wall; the effect of this variation on the lag is plotted in figure 6. A gap at the top of the slot (see fig. 6) of 3.5 percent of the wing chord or larger was required to reduce the lag to less than one tenth second. With a gap of 4.5 percent or larger the lag was extremely small, establishing the correctness of the reasoning on which the design was based.

With the gap at the top maintained at 3.5 percent c,

the width at the bottom was then reduced in several steps in order to provide a slot having somewhat lower drag. The shape was modified both at the front and at the rear of the slot as shown in figure 7. A width at the bottom of 5.5 percent c was found to give a lag of less than one tenth second.

The hinge moments of this device were not measured but in the operation of the device in the wind tunnel no difference could be detected with or without the air in motion, indicating that the aerodynamic hinge moments were close to zero. The hinge moments of such an arrangement could easily be changed by changing the angle of the spoiler or the location of its axis.

Slot-lip ailerons.— Although the arrangement having the spoiler retracting into the slot could apparently be used satisfactorily as a lateral control device, it seemed rather cumbersome and it was thought that using a hinged flap as the upper portion or lip of the slot as shown in figure 8 might be a decided improvement structurally and might also have less drag. The arrangement shown in figure 8, which has the flap hinge axis located 25 percent back of its leading edge for balancing, was tested with a slot gap of 4.2 percent c . The lag with this arrangement was negligible. Tests were also made with the slot shaped in such a manner that the gap was closed when the flap was neutral, in which case the lag was too great at the high-angle-of-attack condition. It therefore appears that, in order to reduce the lag to a negligible value, it is necessary to have the slot continuously open even with a device which opens the slot an increasing amount as it is deflected.

At this stage it was desired to obtain some information in regard to the control forces required to operate a slot-lip aileron of this form, and the hinge moments were measured with the aileron hinge axis moved to give various degrees of balance. For these tests, the wing was wired in a fixed position in the tunnel and the hinge moment was obtained from the measured twist of a calibrated torque rod attached to the aileron in line with its axis. The results of hinge-moment tests are given in figure 9. With all hinge-axis locations and with both angles of attack the free floating position of the aileron ($C_{h_1} = 0$) was such that its trailing edge was below the main wing contour, indicating that the pressure through the slot with

the aileron neutral was less than that over the upper surface of the wing at that point and that the velocity through the slot was therefore greater than that over the upper surface of the wing in that region. The constant slope of the curve of hinge-moment coefficient against aileron deflection usually considered desirable was not obtained in these tests, the curves having zero and even reversed slope in some cases. Moving the ailerons back to provide greater clearance at the nose, as shown by the dotted lines in figure 9, improved the conditions somewhat. A second arrangement was then tried having a straight wall at the front of the slot as shown in figure 10. Two sizes of overhanging plates to direct the air flow back over the top of the flap were tried. As shown by the curves of figure 10, this change did not appreciably improve conditions. Next, the aileron flap was moved rearward, tripling the clearance between the nose of the flap and the front wall of the slot; and this change, as shown in figure 11, resulted in a decided improvement. The distance between the nose of the aileron and the front wall of the slot was then still further increased, as shown in figure 12, and the hinge-moment curves for that arrangement have a reasonably satisfactory form.

The hinge-moment curves with a clearance of 7.8 percent of the aileron chord between the nose of the aileron and the front wall of the slot (fig. 11) were considered reasonably satisfactory with the proper length of overhanging plate ahead of the aileron, and further lag tests were then made with this arrangement in order to find how small the slot could be made without causing objectionable lag. From the results of these tests, tabulated in figure 13, it is apparent that a slot having a 2-percent-c gap at the top and a 5-percent-c width at the bottom would give a lag of less than one tenth second. The slot was then rebuilt to have a smooth shape with this size, as shown dotted in figure 14. This arrangement had a lag less than one tenth second but, as it was desired to reduce it still further, the gap was increased to 3 and the width to 6 percent. Lag tests were then made with the aileron hinged at four different axis locations and it was found, as shown in figure 14, that the lag was not appreciably affected by the hinge-axis location but that the rolling moment as indicated by the final wing deflection became, in general, less as the hinge axis was moved to the rear. The hinge moments were then measured for this arrangement with all four hinge-axis locations. The results are given in figure 15.

At this stage the lag and hinge moments of the slot-lip aileron had apparently been developed to a usable point for the location 30 percent back of the leading edge of the wing, but it was not certain that this location was necessarily the best, especially considering that the drag and yawing moments could not be measured in these tests. Both the drag due to the slots and the yawing-moment coefficients due to the ailerons should decrease as the combination is moved to the rear, but the effect of the slot in improving the lateral stability near the stall should be greater as the slot is moved forward. Tests were therefore made with the slot-lip ailerons located in two additional positions, 55 percent of the wing chord and 10 percent of the wing chord. At the 55-percent location the slot was first given a gap of 2 percent and a width of 5 percent as shown in figure 16. Lag tests were made with this size and with one modification in which the width was decreased to 4 percent and which gave a lag just under one tenth second. Hinge-moment tests were then made with four different axis locations, the results of which are given in figure 17. The hinge moments, it will be noticed, are definitely lower than those for the 30-percent location.

Similar lag and hinge-moment tests are given for the 10-percent position in figures 18 and 19. In this position it was necessary to increase the gap to 4 percent and the width to 7 percent in order to reduce the lag below one tenth second; and the drag would undoubtedly be high.

CONCLUSIONS

For the conditions of the tests, which are representative of a rather small full-scale airplane, the following conclusions may be drawn:

1. The lag of single retractable ailerons or spoilers with no slot varies with the position along the wing chord from a negligible value for a position near the trailing edge to the major part of a second for a position near the leading edge. The lag is too great for practical use (greater than one tenth second) unless the devices are located within about 20 percent of the wing chord from the trailing edge.

2. With two retractable devices covering the same

portion of the span and operating together, one located at 30 percent of the chord from the leading edge and the other directly behind it at 83 percent of the chord from the leading edge, a usable combination is obtained that gives the same rolling moment as the front one alone with no more lag than the rear one alone.

3. The lag of a retractable spoiler can be reduced to a negligible value by providing an open slot of the proper size and form through the wing directly behind the spoiler.

4. The slot-lip ailerons appear to be usable as a form of lateral control device that shows promise of giving improved lateral control and stability at the high angles of attack through the stall, with negligible lag, light control forces, and relatively simple construction. It is desirable that additional tests be made to find the yawing moments given by these ailerons and the effect of the slot on the drag.

Langley Memorial Aeronautical Laboratory,
National Advisory Committee for Aeronautics,
Langley Field, Va., April 25, 1935.

REFERENCES

1. Weick, Fred E., and Wenzinger, Carl J.: Wind-Tunnel Research Comparing Lateral Control Devices, Particularly at High Angles of Attack. I - Ordinary Ailerons on Rectangular Wings. T.R. No. 419, N.A.C.A., 1932.
2. Weick, Fred E., and Shortal, Joseph A.: Wind-Tunnel Research Comparing Lateral Control Devices, Particularly at High Angles of Attack. V - Spoilers and Ailerons on Rectangular Wings. T.R. No. 439, N.A.C.A., 1932.
3. Weick, Fred E., Soulé, Hartley A., and Gough, Melvin N.: A Flight Investigation of the Lateral Control Characteristics of Short Wide Ailerons and Various Spoilers with Different Amounts of Wing Dihedral. T.R. No. 494, N.A.C.A., 1934.
4. Soulé, H. A., and McAvoy, W. H.: Flight Investigation of Lateral Control Devices for Use with Full-Span Flaps. T.R. No. 517, N.A.C.A., 1935.
5. Harris, Thomas A.: The 7 by 10 Foot Wind Tunnel of the National Advisory Committee for Aeronautics. T.R. No. 412, N.A.C.A., 1931.
6. Weick, Fred E., and Wenzinger, Carl J.: The Characteristics of a Clark Y Wing Model Equipped with Several Forms of Low-Drag Fixed Slots. T.R. No. 407, N.A.C.A., 1932.
7. Weick, Fred E., and Shortal, Joseph A.: The Effect of Multiple Fixed Slots and a Trailing-Edge Flap on the Lift and Drag of a Clark Y Airfoil. T.R. No. 427, N.A.C.A., 1932.
8. Shortal, J. A.: Effect of Retractable-Spoiler Location on Rolling- and Yawing-Moment Coefficients. T.N. No. 499, N.A.C.A., 1934.

Fig. 1

N.A.C.A.

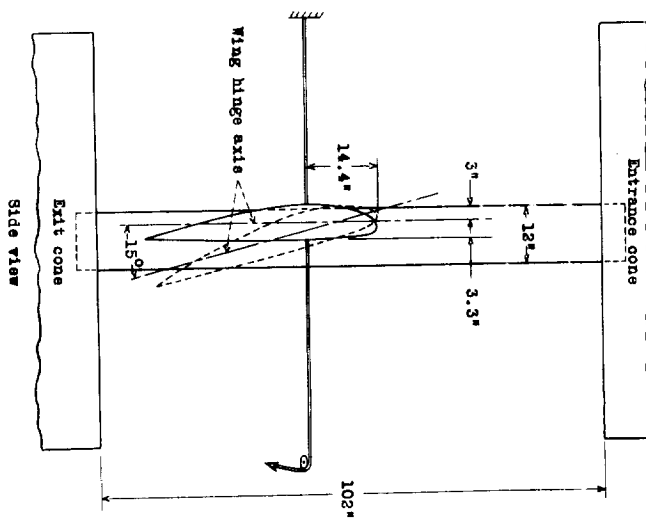
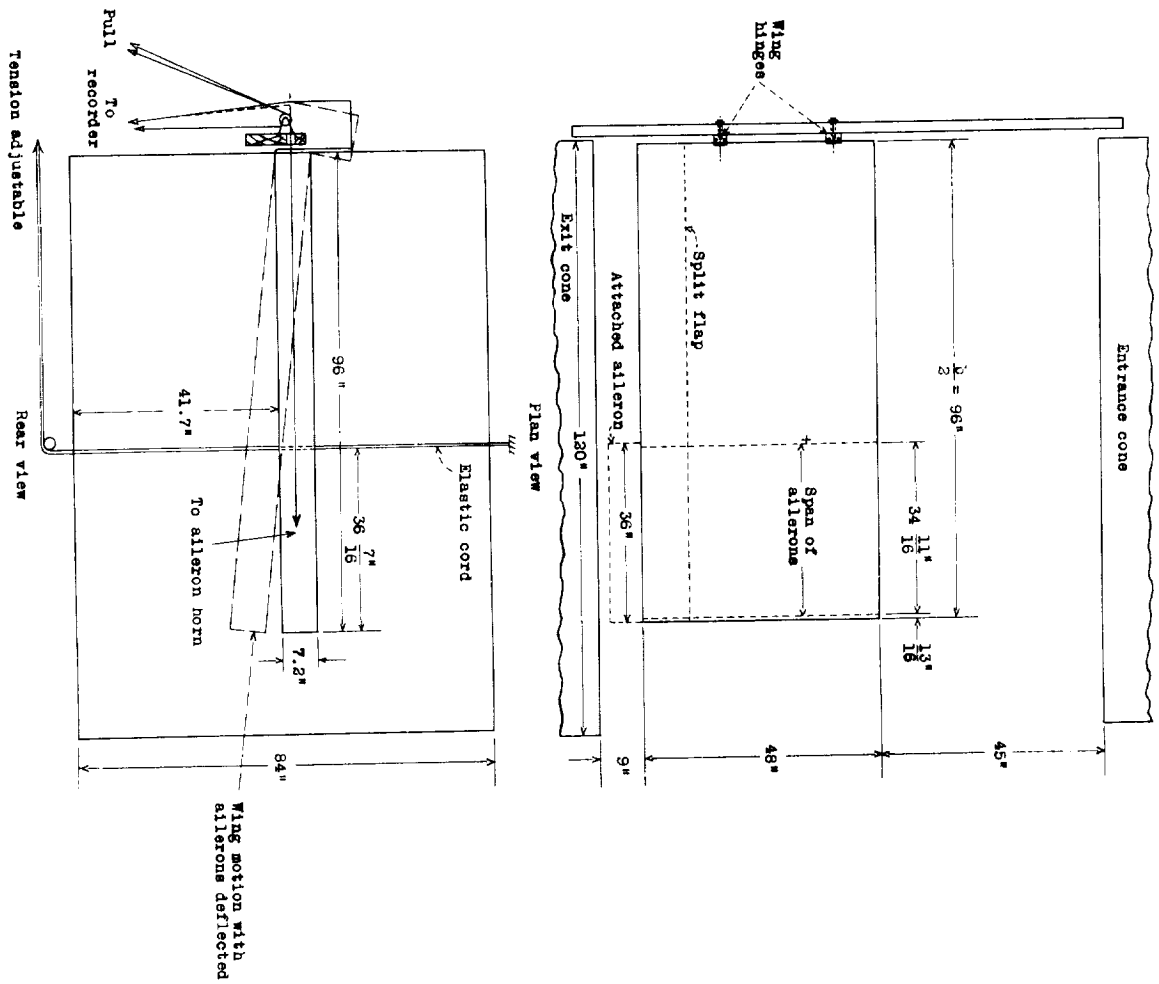

Figure 1.- Diagram of Clark Y-15 semispan wing set-up in the 7 by 10 foot tunnel for lag tests.



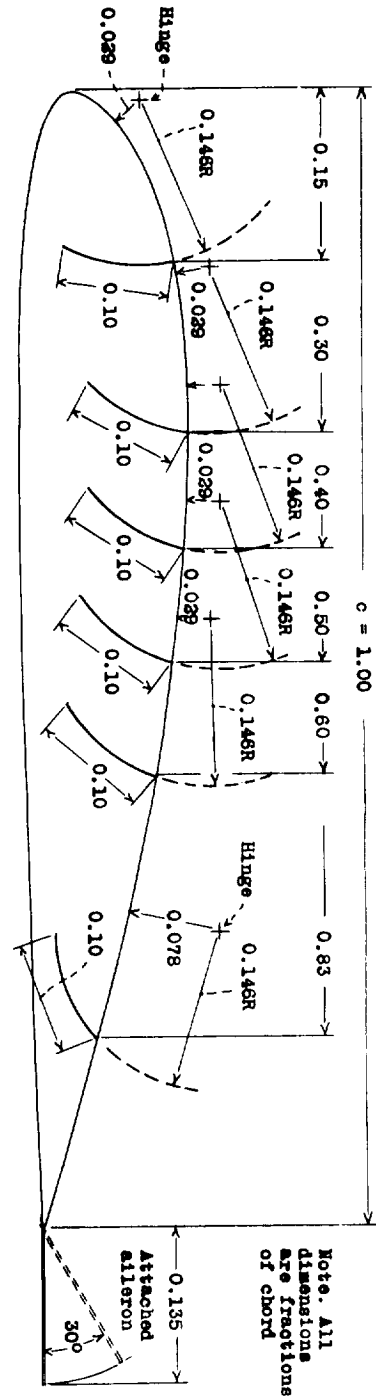
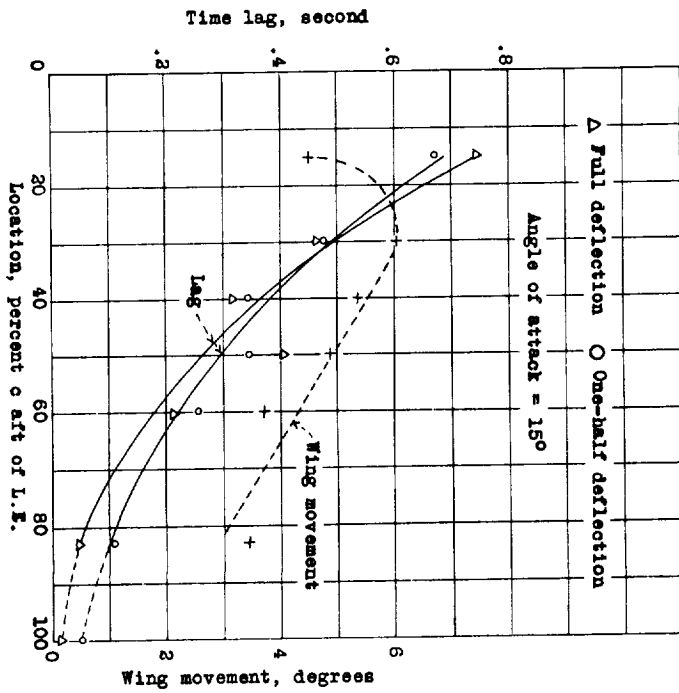
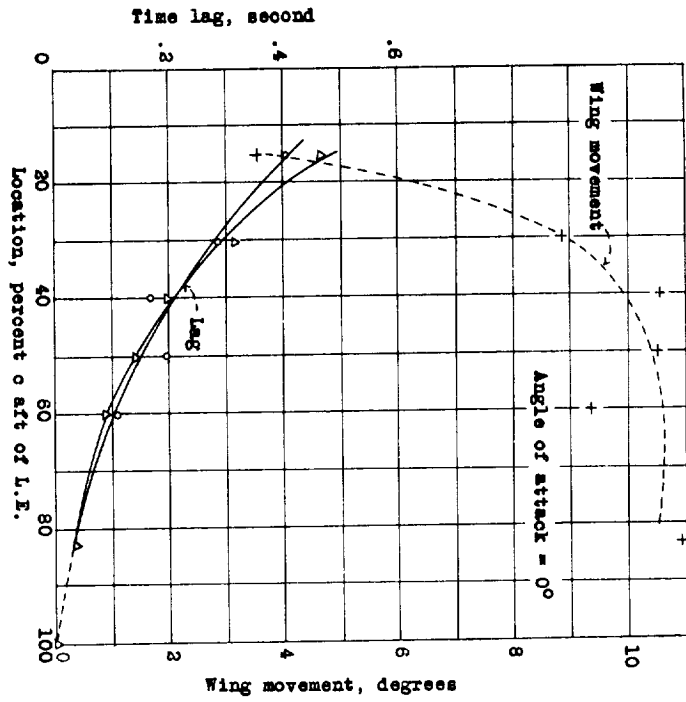

Figure 2. - Effect of retractable spoiler location on lag and rolling moment.



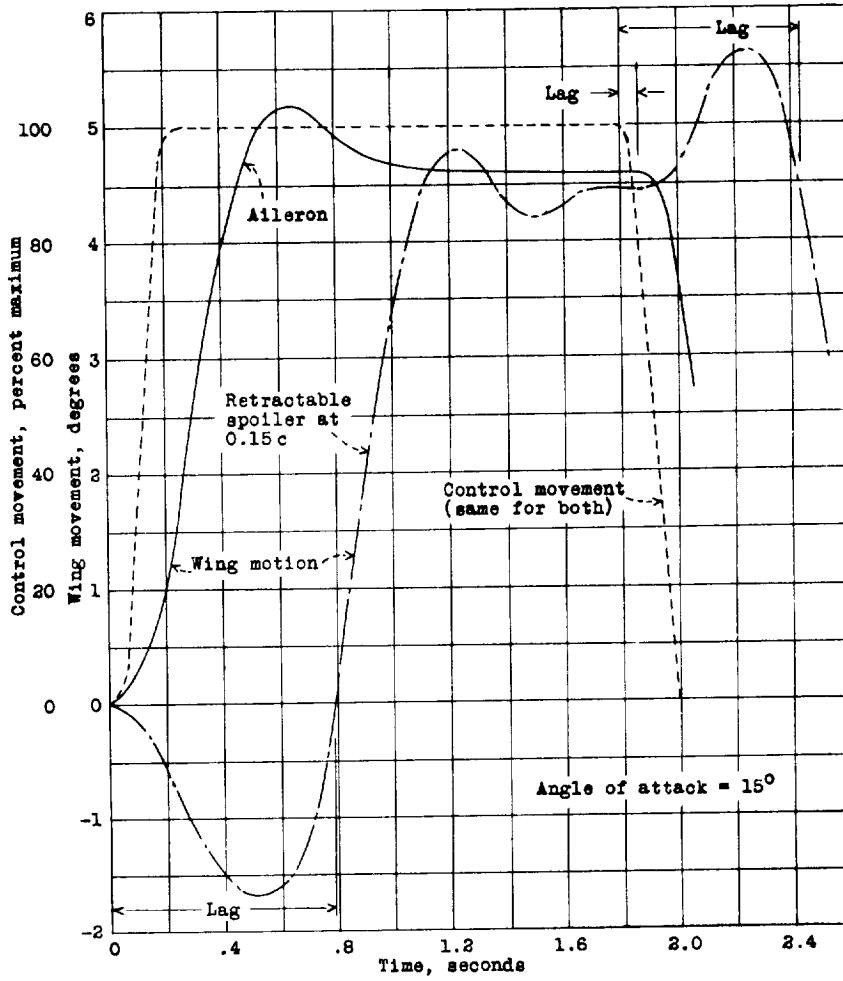

Figure 3.- Typical time history curves.

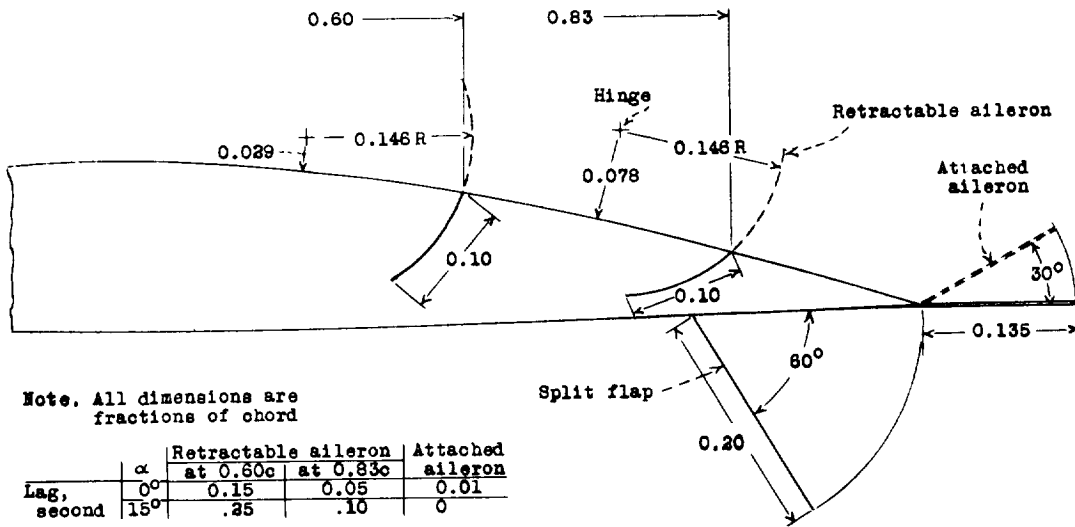

Figure 4.- Effect of a split flap on lag due to retractable spoilers near the trailing edge of the wing.



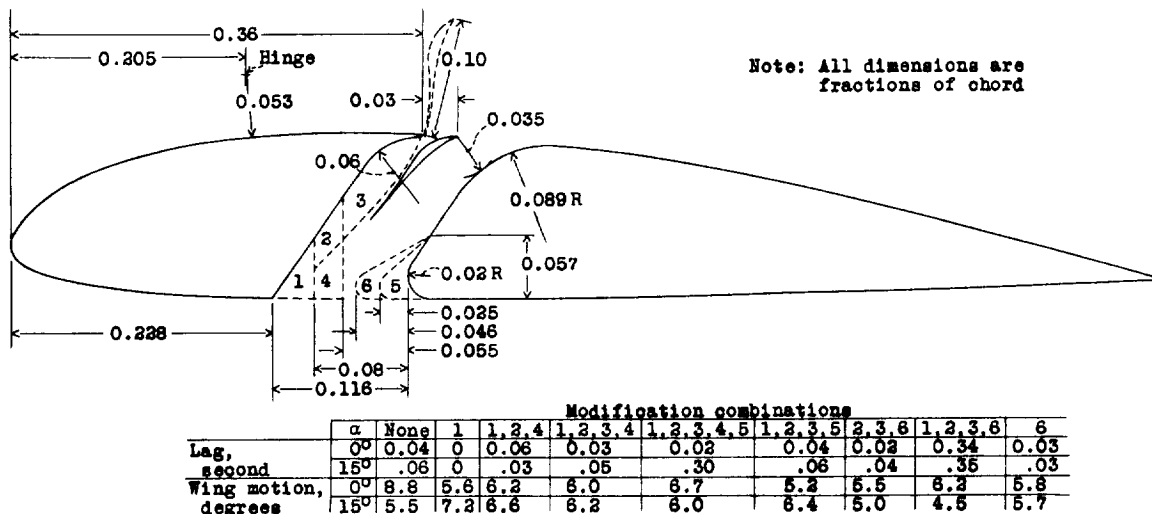
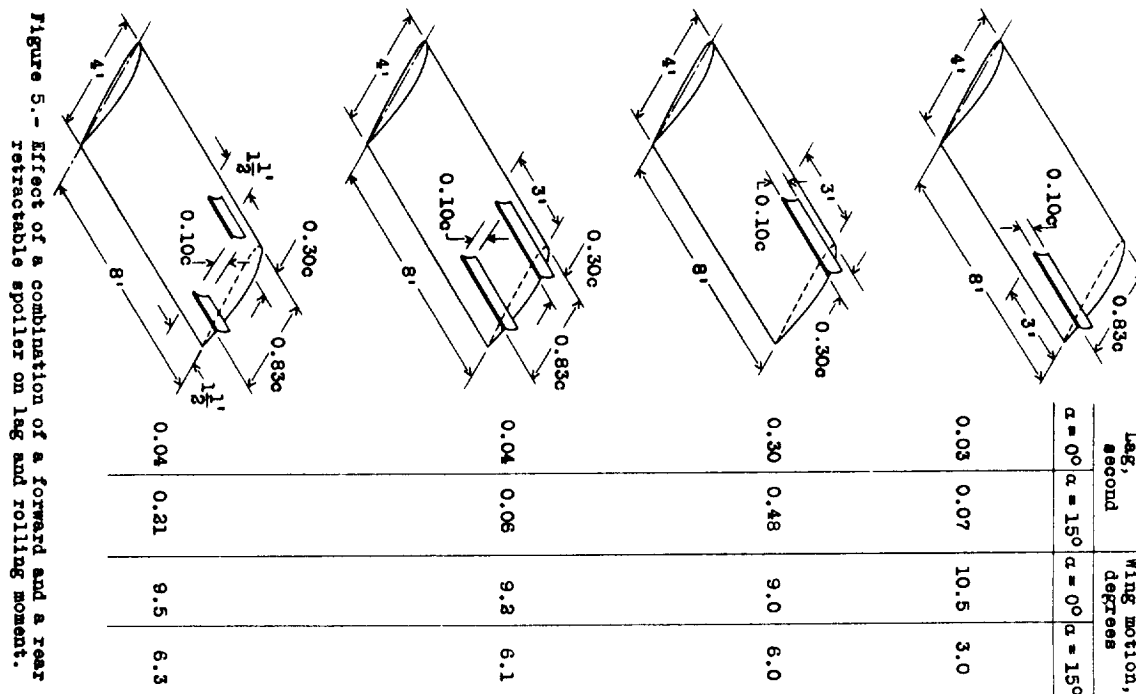

Figure 7.- Effect of various modifications of a fixed slot on the lag and rolling moment due to an adjoining retractable spoiler.

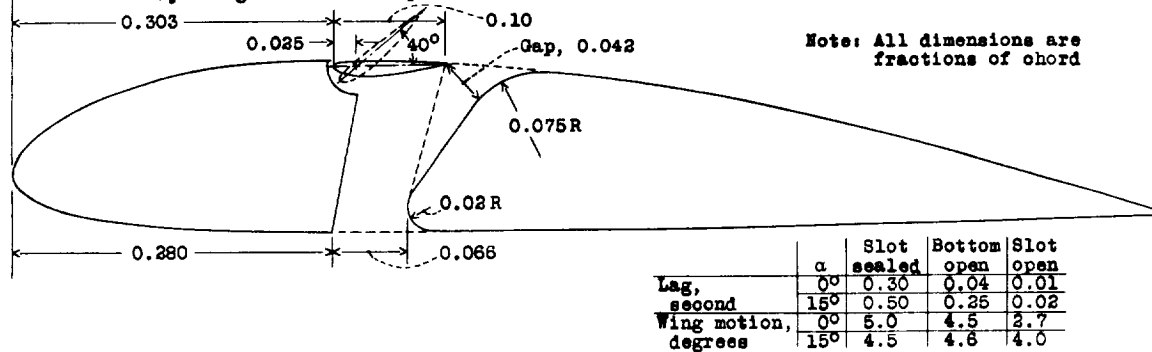

Figure 8.- Lag and rolling moment due to a slot-lip aileron at 0.30 chord with a special-shape slot of slot gap 0.042c and slot width 0.066c with the slot both open and sealed.

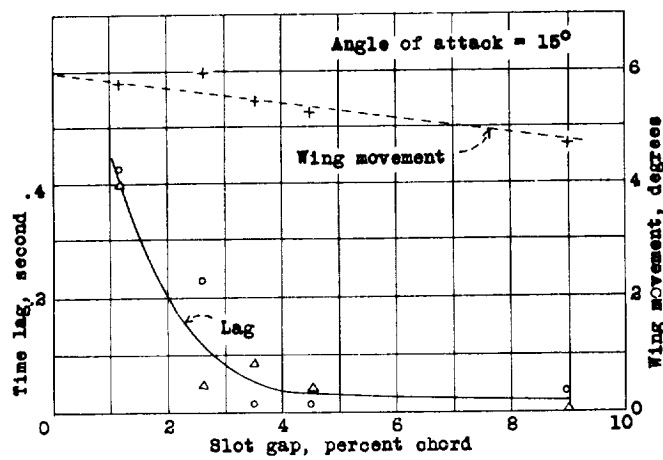
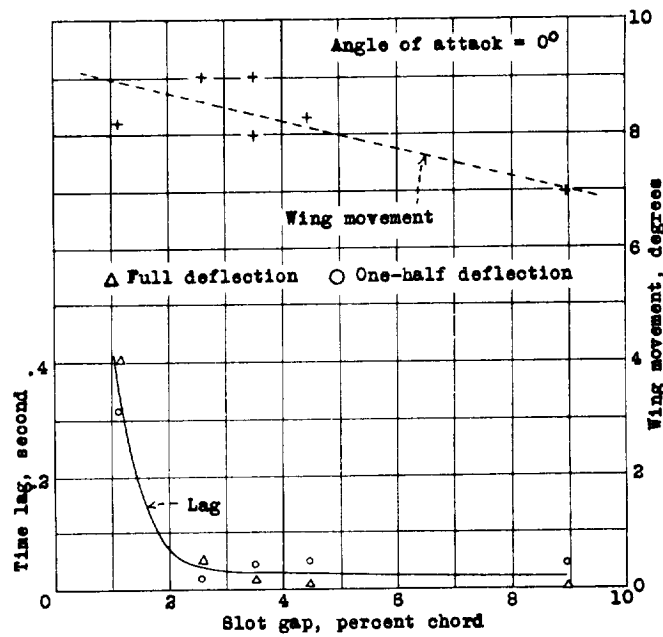
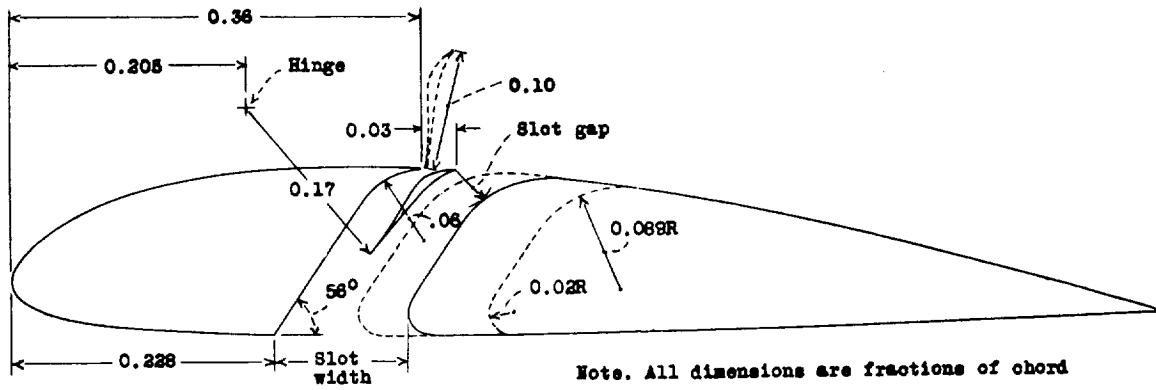
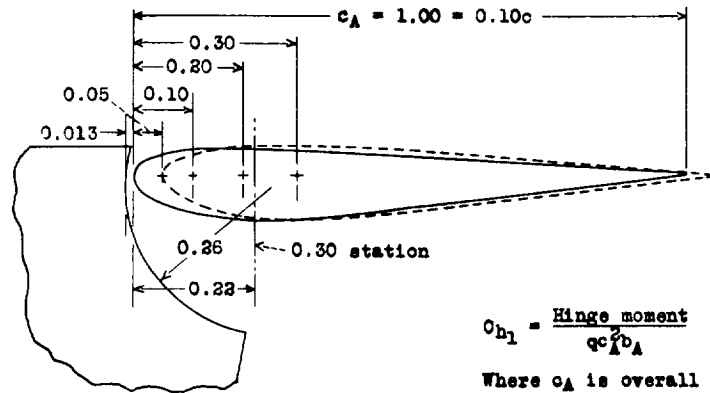

Figure 6.- Effect of slot gap on lag and rolling moment due to a forward retractable spoiler used in conjunction with a fixed slot adjoining the aileron.





$$C_{h1} = \frac{\text{Hinge moment}}{qc_A^2 b_A}$$

Where c_A is overall aileron chord,
 b_A is aileron span

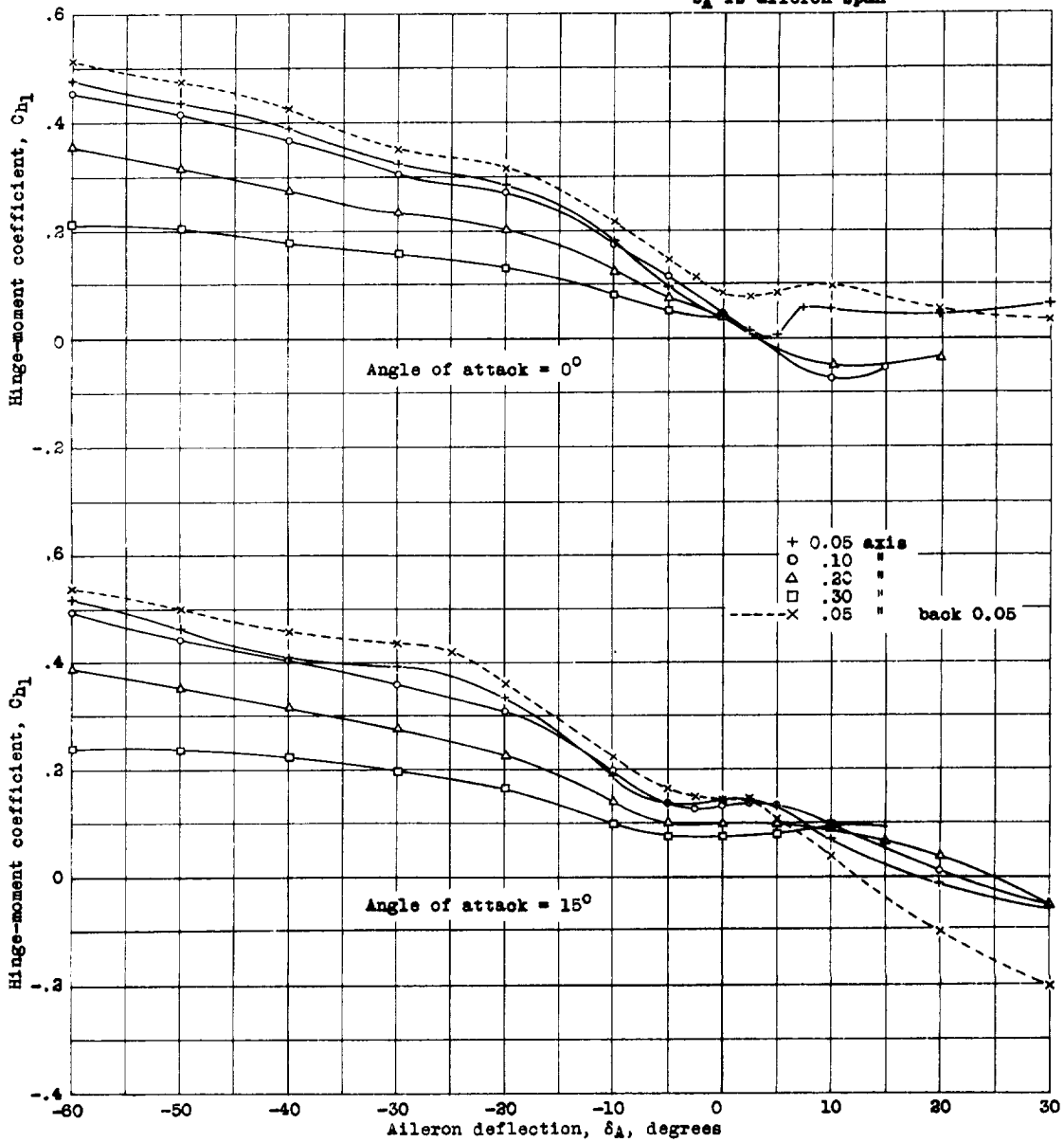

Figure 9.- Hinge-moment coefficients of a slot-lip aileron at 0.30 chord with a special-shape slot of slot gap 0.042c and slot width 0.068c with various aileron hinge-axis positions.

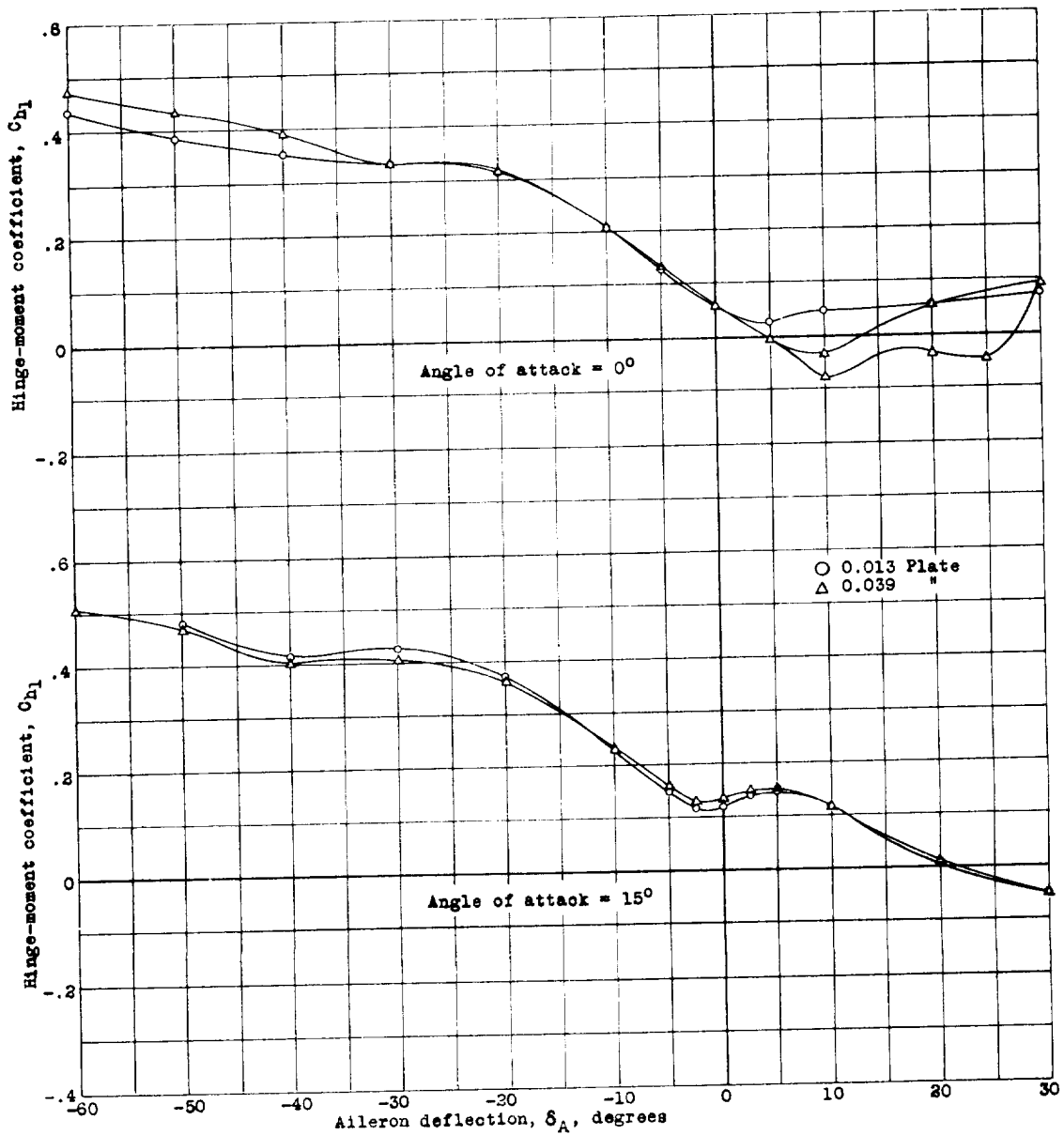
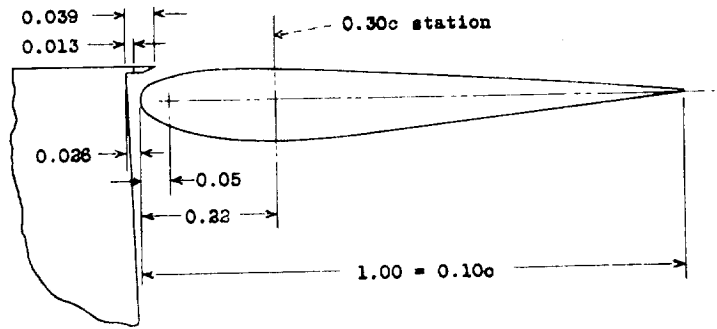

Figure 10.- Hinge-moment coefficients of a slot-lip aileron at 0.30 chord with a slot with a straight front wall with a clearance of 0.026 aileron chord and a slot gap 0.042c and slot width 0.066c.

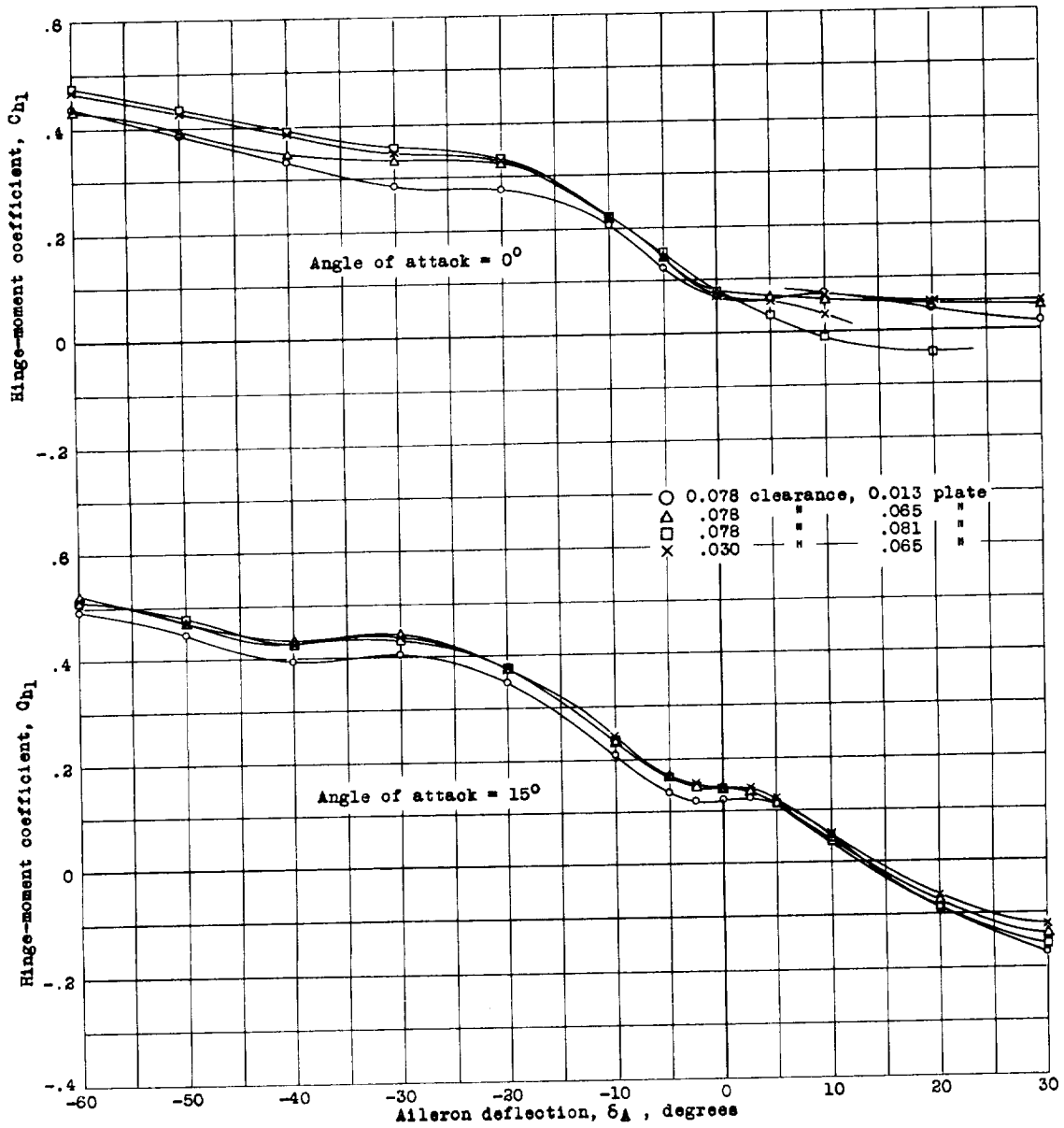
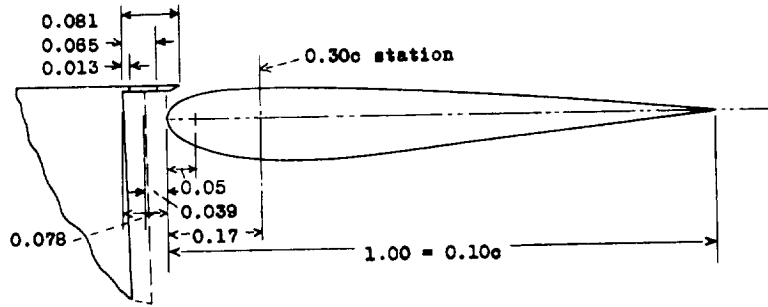

Figure 11.- Hinge-moment coefficients of a slot-lip aileron at 0.30 chord with a slot with a straight-front wall with a clearance of 0.078 and 0.039 aileron chord and a slot gap 0.042c and slot width 0.066c.

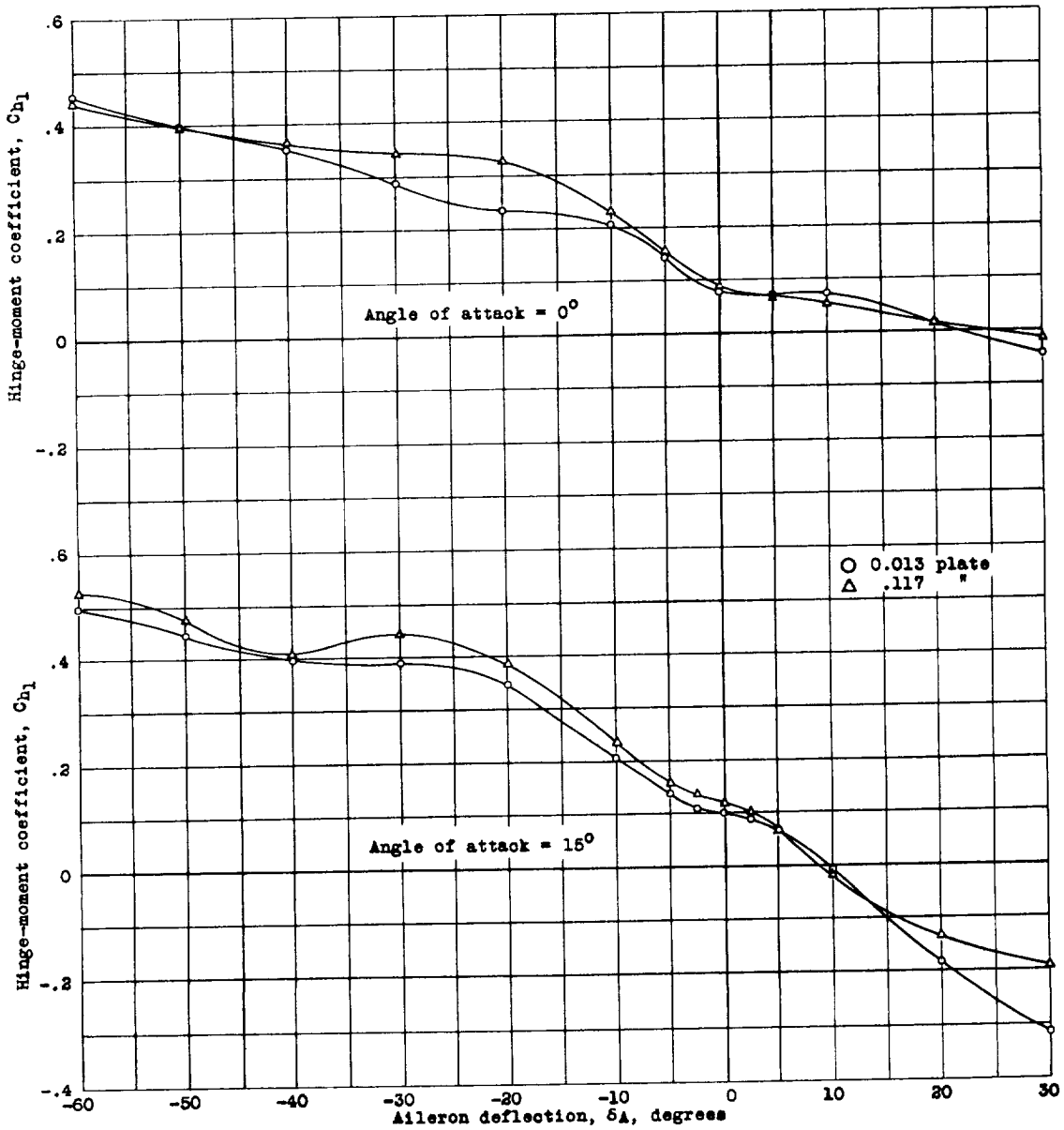
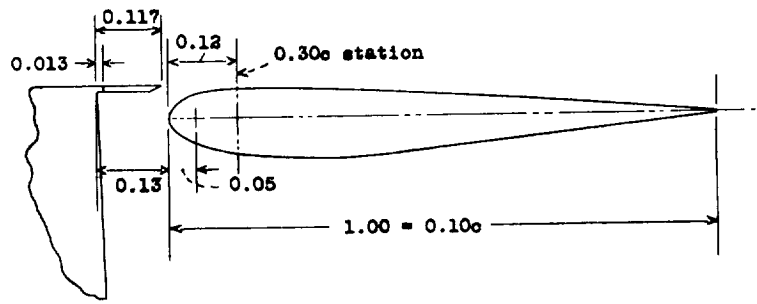

Figure 12.-- Hinge-moment coefficients of a slot-lip aileron at 0.30 chord with a slot with a straight front wall with a clearance of 0.13 aileron chord and a slot gap 0.042c and slot width 0.086c.



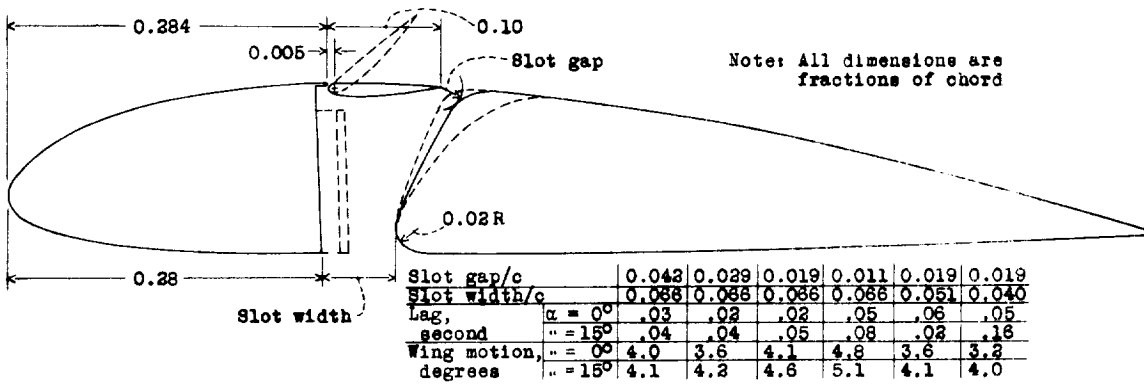

Figure 13.- Lag and rolling moment due to a slot-lip aileron at 0.30 chord with a straight front wall with a clearance of 0.078 aileron chord with several slot gaps and widths.

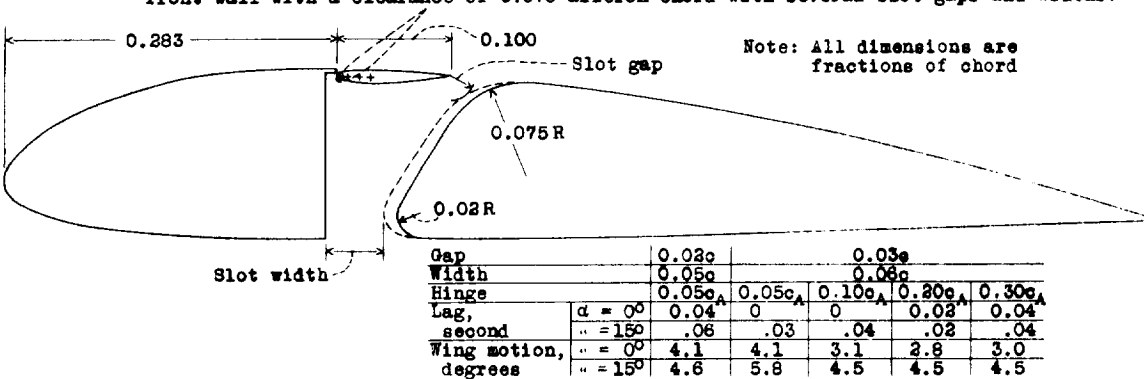

Figure 14.- Lag and rolling moment due to a slot-lip aileron at 0.30 chord with two slot gaps and widths and various hinge axes.

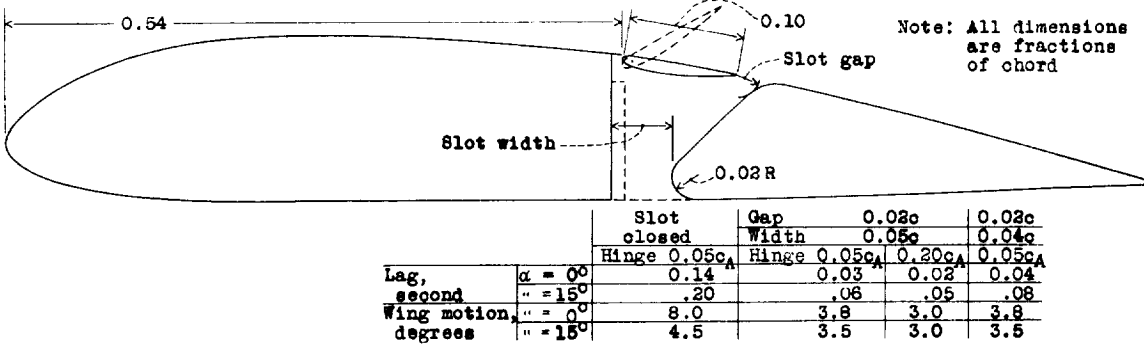

Figure 16.- Lag and rolling moment due to a slot-lip aileron of 0.55 chord with 0.061 aileron chord clearance with slot gap 0.02c and width 0.04c and 0.05c with two different aileron-hinge axes.

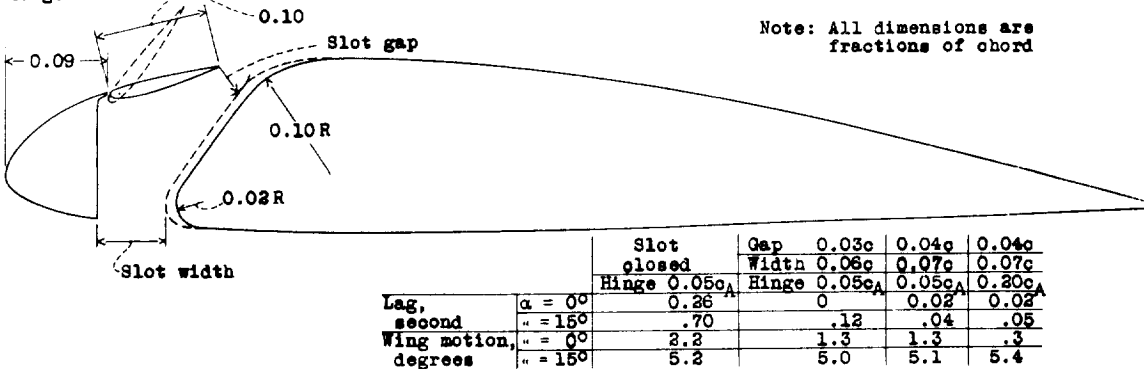

Figure 18.- Lag and rolling moment due to a slot-lip aileron at 0.10c with 0.078 aileron chord clearance and various slot gaps and widths.

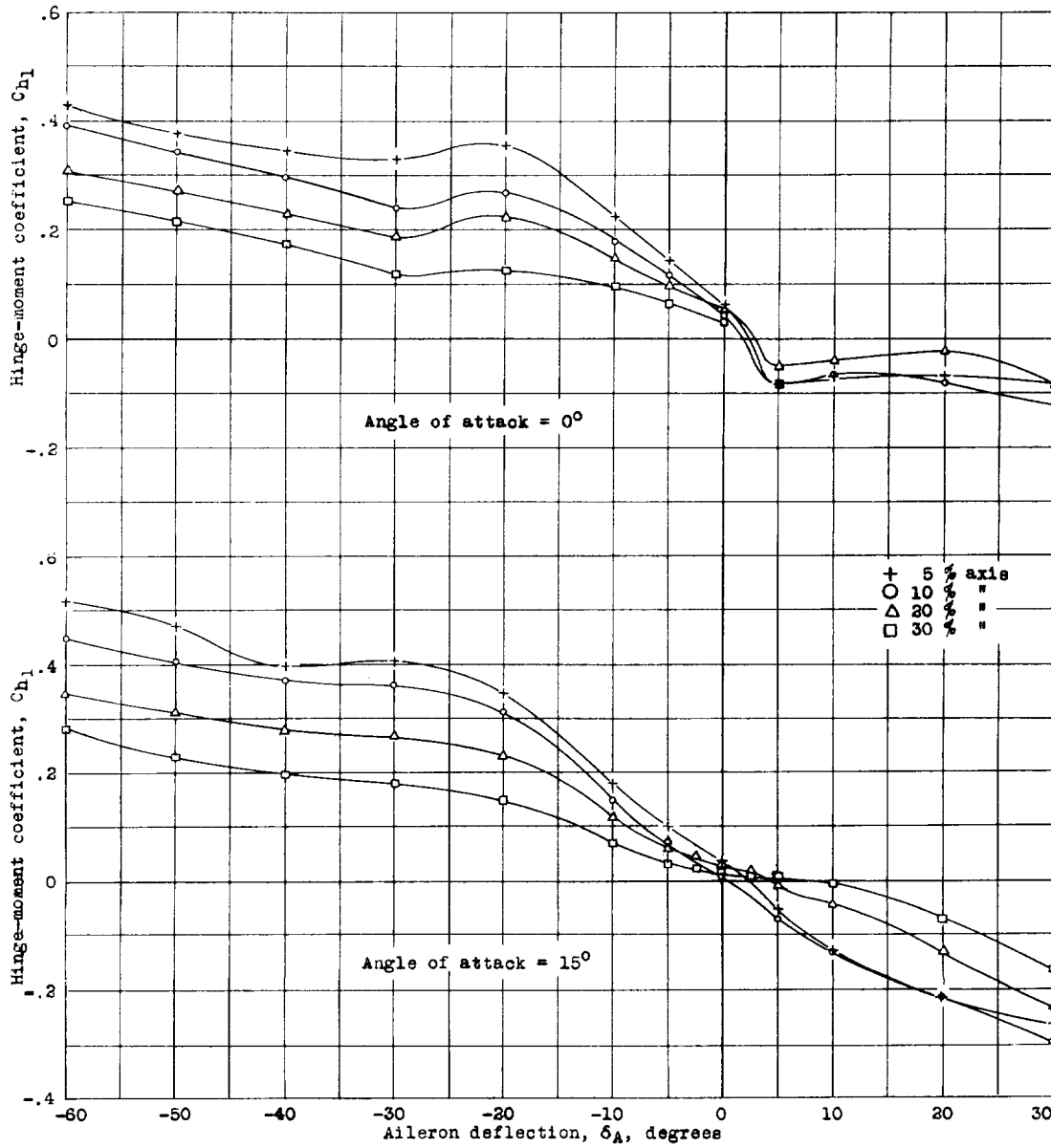
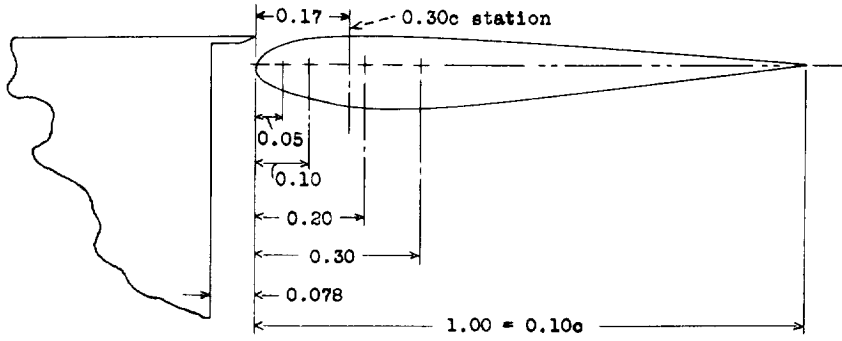

Figure 15.- Hinge-moment coefficients of a slot-lip aileron at 0.30 chord with 0.078 aileron chord clearance with slot gap 0.03c and width 0.06c with various aileron-hinge axes.



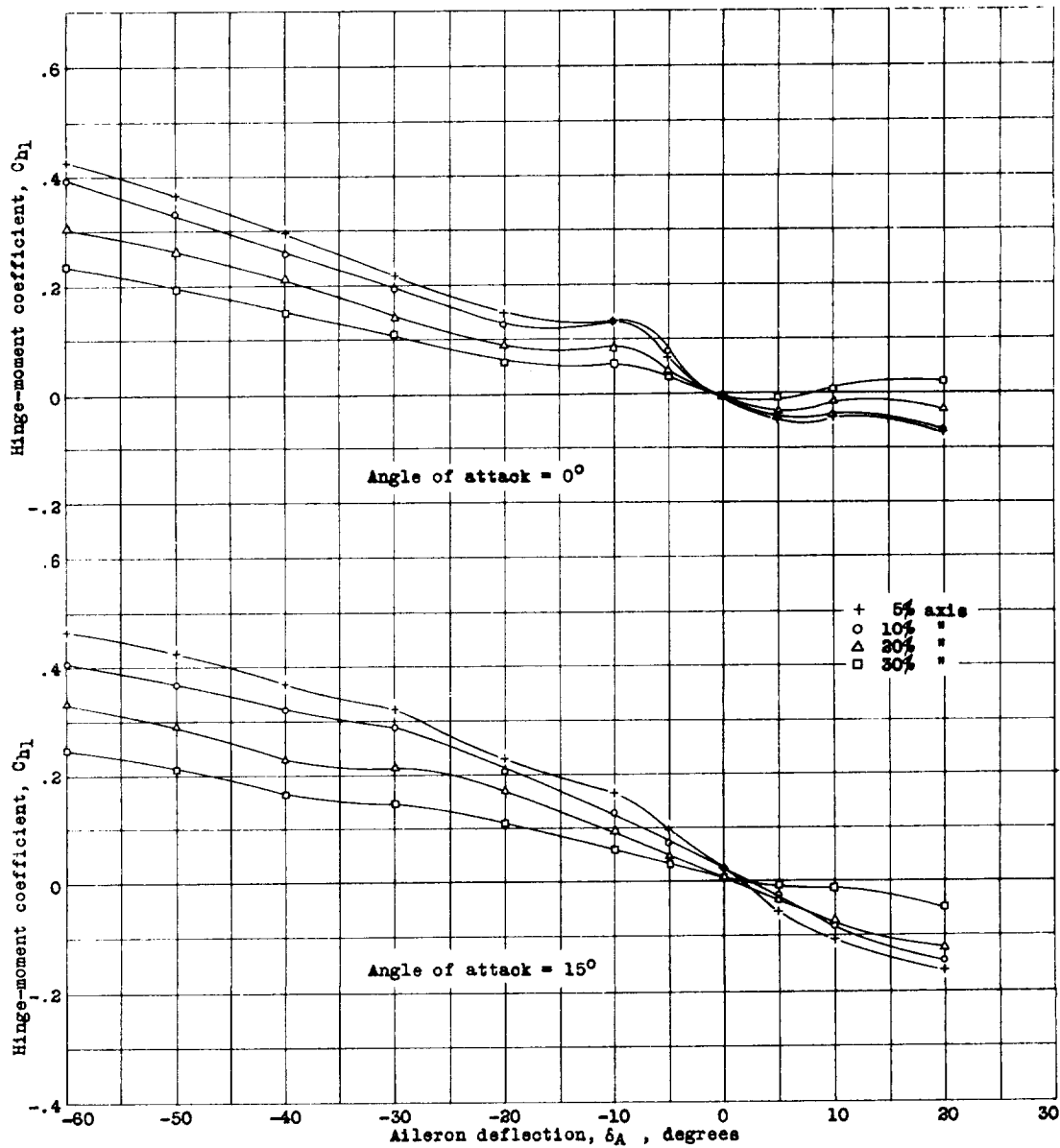
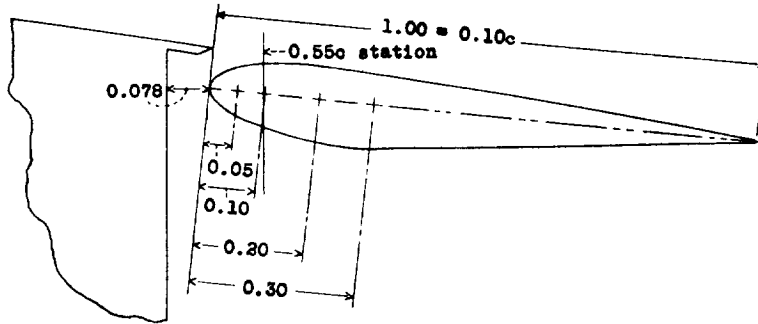

Figure 17.- Hinge-moment coefficients of a slot-lip aileron at 0.55 chord with 0.078 aileron chord clearance with slot gap 0.02c and width 0.05c and various aileron-hinge axes.

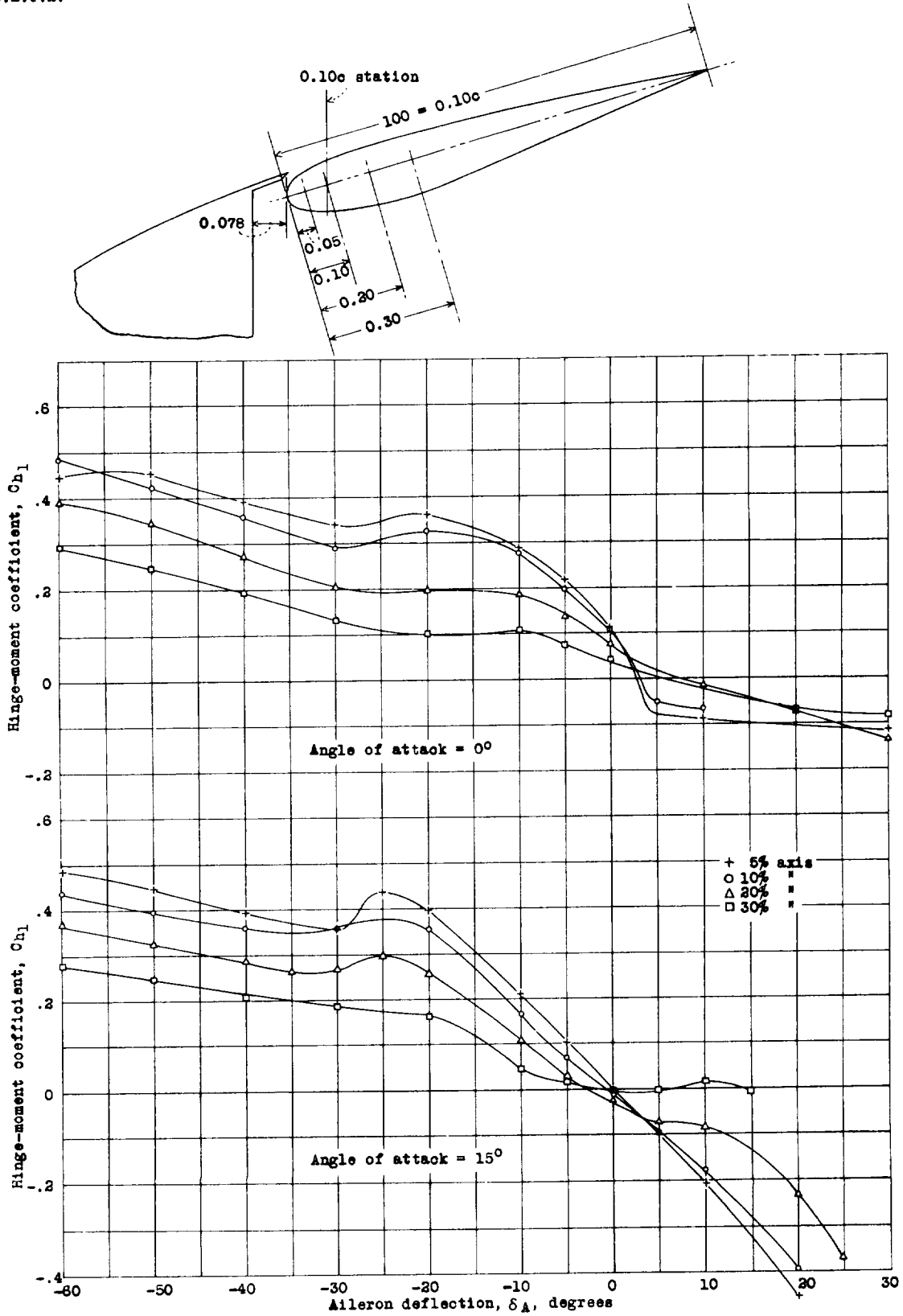

Figure 19.- Hinge-moment coefficients of a slot-lip aileron at 0.10c with 0.078 aileron chord clearance with 0.04c gap and 0.07c width and various aileron-hinge axes.

