

FILE COPY
NO. 6

FILE COPY
NO. 2

TECHNICAL NOTES
NATIONAL ADVISORY COMMITTEE FOR AERONAUTICS

No. 604

FULL-SCALE WIND-TUNNEL AND FLIGHT TESTS OF A FAIRCHILD 22
AIRPLANE EQUIPPED WITH EXTERNAL-AIRFOIL FLAPS

By Warren D. Reed and William C. Clay
Langley Memorial Aeronautical Laboratory

THIS DOCUMENT ON LOAN FROM THE FILES OF

NATIONAL ADVISORY COMMITTEE FOR AERONAUTICS
LANGLEY AERONAUTICAL LABORATORY
LANGLEY FIELD, HAMPTON, VIRGINIA

RETURN TO THE ABOVE ADDRESS.

REQUESTS FOR PUBLICATIONS SHOULD BE ADDRESSED
AS FOLLOWS:

Washington
July 1937

NATIONAL ADVISORY COMMITTEE FOR AERONAUTICS
1724 F STREET, N.W.,
WASHINGTON 25, D.C.

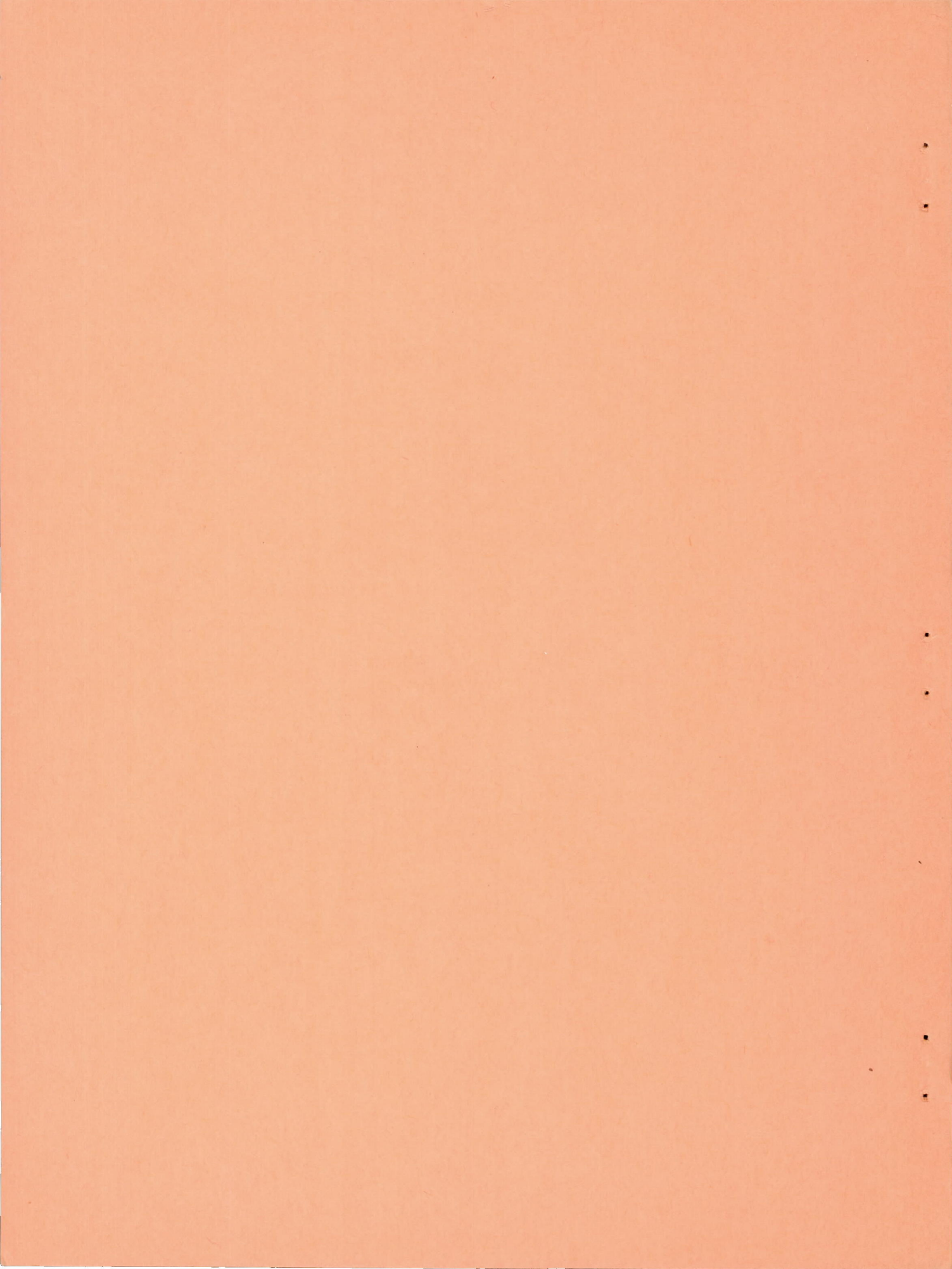

NATIONAL ADVISORY COMMITTEE FOR AERONAUTICS

TECHNICAL NOTE NO. 604

FULL-SCALE WIND-TUNNEL AND FLIGHT TESTS OF A FAIRCHILD 22
AIRPLANE EQUIPPED WITH EXTERNAL-AIRFOIL FLAPS

By Warren D. Reed and William C. Clay

SUMMARY

Wind-tunnel and flight tests have been made of a Fairchild 22 airplane equipped with a wing having external-airfoil flaps that also perform the function of ailerons. Lift, drag, and pitching-moment coefficients of the airplane with several flap settings and the rolling- and yawing-moment coefficients with the flaps deflected as ailerons were measured in the full-scale tunnel with the horizontal tail surfaces and propeller removed. The effect of the flaps on the low speed and on the take-off and landing characteristics, the effectiveness of flaps when used as ailerons, and the forces required to operate them as ailerons were determined in flight.

The wind-tunnel tests showed that the flaps increased the maximum lift coefficient of the airplane from 1.51 with the flap in the minimum drag position to 2.12 with the flap deflected 30° . In the flight tests the minimum speed decreased from 46.8 miles per hour with the flaps up to 41.3 miles per hour with the flaps deflected. The required take-off run to attain a height of 50 feet was reduced from 820 to 750 feet and the landing run from a height of 50 feet was reduced from 930 to 480 feet. The flaps for this installation gave lateral control that was not entirely satisfactory. Their rolling action was good but the adverse yaw resulting from their use was greater than is considered desirable, and the stick forces required to operate them increased too rapidly with speed.

INTRODUCTION

At the request of the Bureau of Aeronautics, Navy Department, the N.A.C.A. is conducting a series of tests of different types of flapped wings on a Fairchild 22 airplane.

The tests consist of the measurement in the full-scale wind tunnel of the primary aerodynamic characteristics of the airplane with each type of flap and the determination in flight of the take-off, landing, and other characteristics not readily obtained in the wind tunnel. Results from tests of a Fowler wing and a wing equipped with a Zap flap are given in references 1 and 2, respectively. The present paper deals with results of the tests of external-airfoil flaps that combined the functions of ailerons and flaps.

AIRPLANE AND WING

The Fairchild 22 airplane used in the investigation is a small, externally braced, parasol monoplane. It is normally equipped with a rectangular wing with rounded tips having a span of 32 feet 10 inches, a chord of 5 feet 6 inches, and an N-22 airfoil section. The area of the wing is 171 square feet and its weight is approximately 200 pounds. The lateral control is provided by means of conventional ailerons of 12-inch chord extending across practically the entire trailing edge of the wing.

The special wing (designed for these tests) is equipped with external-airfoil flaps (figs. 1, 2, 3, and table I), has the same over-all plan form and total area as the standard wing, and weighs 65 pounds more. It was installed on the airplane with an angle of wing setting of 3.2° so that with the flap in the "up" position (-3.2°) the fuselage would be at the same attitude at zero wing lift as when equipped with the standard wing. The main wing has a chord of 83.3 percent of the over-all chord, is of N.A.C.A. 23015 section, and has an area of 146 square feet. The external-airfoil flaps, which are mounted behind and below the trailing edge of the main wing, as shown in figure 2, comprise the remaining 16.7 percent of the over-all chord (20 percent of the main wing chord) and extend over the complete span except for a 3-foot cut-out in the center section. These flaps, which are of the Clark Y airfoil section, have an area of 25 square feet.

Apart from a crank mechanism that deflects both the flaps together to increase the lift, an additional linkage controlled by the stick provides movement of the two sections as ailerons. The position of the flap hinge axis (fig. 2) limits the total downward flap deflection to 40° from the main wing chord. At this angle the gap between

the flap and the wing is closed; thus, the maximum usable deflection of the external airfoils as flaps is 40° less the downward deflection required for aileron control.

In order to reduce the yawing moments and not to restrict the aileron control for large angles of the flaps, the aileron linkage was first adjusted to give extreme differential movement. With this arrangement, full movement of the stick provided an aileron deflection of 7° down and 23° up from neutral, which allowed a maximum flap deflection of 33° . Preliminary tests showed, however, that at high flap angles this differential linkage resulted in an unstable control force, which caused the stick to overbalance and to assume either an extreme right or left position. An analysis of the problem indicated that the overbalance resulted from the unequal mechanical advantages associated with differential operation between the two ailerons, in combination with the relatively high hinge moments at large flap angles resulting from the tendency of the surfaces to float upward. As it was not desired to employ a spring device to regulate the control reactions, stable conditions were obtained by readjusting the linkage to give the ailerons practically no differential. (See fig. 4.) This linkage permitted full movement ($\pm 20^\circ$) of the aileron control at a flap angle of but 20° and was employed for all the wind-tunnel tests of aileron control. For the flight tests the aileron movement was reduced to $\pm 10^\circ$ and the maximum flap movement was increased to 27.4° .

Recent wind-tunnel tests (reference 3) indicate that the stick forces could be improved if a 23012 airfoil section were used in place of the Clark Y section. With either airfoil section, though, adverse yaw of an objectionable magnitude would probably be encountered at large flap angles.

WIND TUNNEL

Tests

All full-scale wind-tunnel tests (see reference 4 for a description of the tunnel) were made with the horizontal tail surfaces and propeller removed. Tests were made to determine the following:

- (1) The optimum setting of the flap for minimum drag.

(2) The aerodynamic characteristics for five flap angles, including those for minimum drag and maximum possible deflection, over an angle-of-attack range from -12° to 23° .

(3) The effect of the slot between the external-airfoil flaps and the wing. (At two flap angles the gap was covered with tape.)

(4) The effectiveness of the flaps as ailerons at several angles of attack for each of three flap deflections.

(5) The scale effect on the minimum drag coefficient of the airplane with the flaps set at the minimum drag angle. (The speed range covered was from 30 to 120 miles per hour.)

The tests, except for scale effect, were made at an air speed of about 58 miles per hour.

Results and Discussion

The results are presented in terms of absolute coefficients based on the over-all wing area and have been corrected for wind-tunnel effects.

The optimum angle of the flaps for the minimum drag condition was found in previous wind-tunnel tests to be -3.2° with the wing chord. This angular setting was checked in the full-scale wind tunnel and was not critical, as a change in the angle to -8.2° increased the minimum drag of the airplane only 1.5 percent.

The characteristics of the external-airfoil flaps are shown in figure 5. With increase in flap deflection the angle of zero lift occurs at a larger negative angle, the slope of the lift curve remains essentially the same, and the angle for maximum lift is practically constant. Figure 6 shows that the slot between the main wing and flap appreciably increases the slope of the lift curve, the maximum lift coefficient, and the maximum ratio of lift to drag.

The maximum lift coefficient (fig. 7) increases with flap deflection from 1.51 with the flap up to 2.12 with a flap angle of 30° . The coefficient at larger flap angles

is less, owing to a gradual closing of the slot as is indicated from the curves of figures 6 and 7.

Figure 8 shows the scale effect on the minimum drag coefficient. The coefficient decreases normally with increasing Reynolds Number.

A comparison of the rolling-moment coefficients (fig. 9) shows very little change in rolling moment with either flap angle or angle of attack. The adverse yawing moments become greater as the angle of attack or flap angle is increased except at the high angle of attack, 15.2° , where the flap angle has little effect on the yawing moments.

Performance Computations

The effect of the external-airfoil flaps on the performance of the Fairchild 22 airplane was computed from the data obtained in the full-scale tunnel in order to reduce the amount of flight testing required. It should be appreciated that comparisons made on the basis of these computations show the manner in which the performance is affected but do not represent the true performance of the airplane because, in particular, the tail surfaces were not in place when the tunnel tests were made and the horsepower-available curve used was only approximate.

Gliding performance.— The results of the computations for gliding flight are presented in figure 10. The principal items of interest regarding the performance shown by the figure are given in the following table. The table also contains data for the airplane fitted with an N.A.C.A. CYH wing, which has been used as the basis for comparison with wings of the series previously tested. Under "Equal disposable load," allowance has been made for the increased weight of the wing with the external-airfoil flaps.

Power-on performance.— Results of computations of the power-on performance are presented in figure 11. The complete power-required curves for different deflections of the flap are based on wind-tunnel data obtained at an air speed of 58 miles per hour. Because of the scale effect on the aerodynamic characteristics, a portion of the power-required curve for the flap-up (-3.2°) condition at test speeds corresponding to maximum flight speed is also given.

Wing	Weight (lb.)	Minimum speed		Minimum gliding angle (deg.)	Gliding angle at minimum speed		Horizontal distance traveled during 100-foot descent	
		Flap up (-3.2°) (m.p.h.)	Flap down (29.8°) (m.p.h.)		Flap up (-3.2°) (deg.)	Flap down (29.8°) (deg.)	Maximum flap -3.2° (ft.)	Minimum flap 29.8° (ft.)
0.20c _w external- airfoil flap	1,600	48.9	41.1	5.9	7.5	9.9	968	573
N.A.C.A. CYH equal gross weight	1,600	50.6	5.4	7.4	...	1,058	770
N.A.C.A. CYH equal disposable load	1,535	49.8	5.4	7.4	...	1,058	770

The principal performance characteristics shown by the figure and comparative data for the airplane fitted with the N.A.C.A. CYH wing are given in the following table.

Wing	Weight (lb.)	Maximum rate of climb (ft. per min.)	Maximum angle of climb (deg.)	High speed (corrected for scale effect) (m.p.h.)
O.20c _w external- airfoil flap	1,600	535	5.5	109.6
N.A.C.A. CYH equal gross weight	1,600	594	5.8	110.6
N.A.C.A. CYH equal disposable load	1,535	624	6.4	110.7

The preceding tables show the effect of the external-airfoil flap on the performance of the airplane and may be briefly summarized as follows: The gliding performance is improved by use of the flaps; the climb is decreased, primarily because of the greater wing weight; the high speed is 1 mile per hour less than with the CYH wing.

FLIGHT

Tests

The flight tests were made to determine the effect of the flaps on the low speed and on the take-off and landing characteristics. Flight measurements were also made to determine the effectiveness of the flaps when used as ailerons and the stick forces required to operate them. The test procedure, except where noted in the text, was the

same as that used in previous tests of this series (references 1 and 2).

For the flight tests a $\pm 10^\circ$ angular displacement of the external airfoils was found to be sufficient for lateral control, thus permitting a maximum flap deflection of 27.4° from the main wing chord. The deflection of the flaps, when used for lateral control, is plotted against stick position in figure 12.

Results and Discussion

Maximum lift coefficients.— Inasmuch as the wind-tunnel tests were made of the airplane with the horizontal tail surfaces removed, measurements of the maximum lift coefficients were made in flight. The results of these measurements are given in the following table. For comparison the lift coefficients obtained from the tunnel tests are also given.

	Flap deflection (deg.)	V_{\min} (m.p.h.)	$C_{L_{\max}}$
Flight:			
Power off	-3.2	46.8	1.60
	27.4	41.3	2.06
Power on	-3.2	41.3	2.06
	27.4	35.2	2.84
Full-scale tunnel:			
No horizontal tail	-3.2	--	1.51
	27.4	--	2.12
Tail correction applied	-3.2	--	1.47
	27.4	--	2.02

In accordance with the previous tests of this series, the lift coefficients obtained in flight are somewhat higher than those obtained in the full-scale wind tunnel. With the flap up the maximum lift coefficient obtained in

flight exceeds that obtained in the tunnel by 8.8 percent. With the flap down the lift coefficient in flight is 2.0 percent higher than in the tunnel. An investigation being conducted at the present time indicates that the discrepancy is due partly to the fact that in flight the maximum lift coefficients were obtained by slowly increasing the angle of attack; whereas in the tunnel, measurements were made with the wing stationary.

Take-off characteristics.— Figure 13 shows the effect of flap position on the ground run and on the distance required to attain a height of 50 feet in a take-off. The values given for the take-off distances apply to still-air conditions, in which the airplane leaves the ground at 5 miles per hour in excess of the full-throttle stalling speed for the given flap setting and in which this speed is maintained constant throughout the climb.

The method used in previous take-off tests was revised to some extent for the present tests in order to improve the precision of the results. One of the chief difficulties previously experienced was that comparative take-off runs are difficult to obtain because it is practically impossible for the pilot to make a take-off at exactly the specified speed in each run and to hold that speed during the initial climb. Both of these items are important, the air speed at the instant of take-off being particularly so because it critically affects the ground run and also influences the distance required to climb to an altitude of 50 feet. The principal change in procedure was that, in the present investigation, the ground run corresponding to a given take-off speed was determined from data obtained in a series of tests separate from those in which the air runs were measured. A description of the procedure for the take-off tests follows.

In the determination of the ground run the airplane was held by the brakes until steady full-throttle engine speed was obtained. The brakes were then released and the tail was raised as soon as possible. The fuselage was held horizontal until the airplane had reached a speed 10 to 15 miles per hour above the full-throttle stalling speed for the given flap setting. The motion of the airplane during the run was recorded with a phototheodolite and, from the records, curves of speed against ground run were determined. These results were corrected to zero wind. Check runs gave consistent results. The ground runs corresponding to speeds 5 miles per hour in excess of the

full-throttle stalling speed for any given flap setting were taken directly from these curves.

The air runs were made in a manner similar to that of previous investigations. The separation of the air runs from the ground runs eliminated the need for considering the ground surface from which the take-offs were made, a practical advantage that was due to the fact that the concrete ramp used for the ground runs is available only for limited periods of time. A large number of runs were made so that it was possible to select only those in which the take-off speed was that specified and in which the variation of speed during the climb was small.

The results of the measurements as given on figure 13 show that the flaps were effective only in reducing the ground run. The minimum ground run was 285 feet ($\delta_f = 27.4^\circ$) as compared with 355 feet with the flap up. This decrease of 85 feet in the ground run represented a decrease of 8.5 percent in the total run required to attain a height of 50 feet.

Landing characteristics.— Figure 14 shows the effect of the external-airfoil flaps on the distance required to land from a height of 50 feet in still air and also on the ground run required after landing when a normal amount of braking is applied. The flaps reduced the air run from 600 to 250 feet, or approximately 60 percent. Even with the flaps up, however, the air run was about 20 percent less than with the standard wing. With the flaps down, the air run was about the same as those obtained with this airplane equipped with the previously tested flapped wings. The ground run was reduced from 335 feet to 280 feet, or 15 percent, owing primarily to the decrease in landing speed from 48 to 43 miles per hour. The flaps, therefore, are responsible for a decrease in the total landing run from 927 to 480 feet, or 48 percent.

Lateral-control characteristics.— The results of the tests to determine the lateral-control characteristics of the external-airfoil flaps when they were deflected as ailerons are presented in figures 15 and 16. Maximum angular velocity and acceleration are plotted against aileron deflection for the two extreme flap positions (fig. 15), and show that the rolling action due to the external-airfoil flap increases uniformly with aileron displacement. In figure 16 the maximum angular velocity and acceleration in roll obtained with abrupt full-right displacement of

the control stick are plotted as functions of air speed. The maximum rate of roll and the maximum acceleration in roll obtained with the flap either up or down are considerably greater than with the standard ailerons for this airplane (reference 5).

It will be observed from figure 16 that at any given speed the maximum rate of roll is less with the flap down than it is with the flap up, whereas the maximum angular acceleration is larger with the flap down. A possible explanation of this apparent inconsistency is the effect of the adverse or negative yaw with the flap down. In figure 17, which shows rates of roll and yaw against time for the two extreme flap positions, the difference in the character of the yawing action can be noted. (Magnitudes are not strictly comparable owing to the difference in speed.) With the flap up the yawing velocity is slightly positive at first and does not become negative until after the attainment of maximum rolling velocity. With the flap down, however, the yawing velocity is negative from the start and is of an appreciable magnitude before the attainment of maximum rate of roll. It seems possible that the rolling moment due to this negative yawing velocity may be of sufficient magnitude to account for the apparent discrepancy between the relative magnitudes of angular velocities and accelerations for the two flap positions.

Another characteristic of the functioning of the controls shown by figure 17 is that the rolling motion starts almost immediately after the controls are deflected or, in other words, these ailerons have no appreciable lag.

The yawing action as observed by the pilot was adverse for all flap positions. With the flaps up, it was small and not objectionable. As the flaps were deflected, however, the adverse yaw increased and was considered to be of objectionable magnitude with the flaps full down. The stick forces required to operate the external-airfoil flaps as ailerons were considered by the pilots to be too high for an airplane of this size. The forces for full aileron deflection were shown by measurement to be 12 and 20 pounds with the flaps up at 60 and 90 miles per hour, respectively. With the flap down at speeds of 50 and 70 miles per hour, stick forces for full deflection were 11 and 15 pounds.

These stick forces could have been reduced by increasing the stick travel but they would still be undesirable

in that they increase more rapidly with speed than do the stick forces for normal ailerons.

CONCLUSIONS

1. The aerodynamic characteristics of the external-airfoil flap differ from those of split or plain flaps principally in that the maximum lift is attained with less deflection of the flap (30°) and, in general, the L/D ratio is greater for a given lift increment.
2. The maximum value of the lift coefficient obtained from the wind-tunnel tests is 1.51 with the flap in the minimum-drag position and 2.12 with the flap deflected 30° .
3. From flight tests it was found that the use of flaps decreased the minimum speed from 46.8 to 41.3 miles per hour, reduced the take-off run required to attain a height of 50 feet from 820 to 750 feet, and reduced the landing run from a height of 50 feet from 930 to 480 feet.
4. For a given aileron deflection there is very little change in rolling moment with either flap angle or angle of attack, and the rolling action found in flight was satisfactory.
5. The use of external-airfoil flaps as ailerons is considered unsatisfactory because the stick forces required to operate them as ailerons increase too rapidly with speed and because the adverse yaw with the flaps down is too large.

Langley Memorial Aeronautical Laboratory,
National Advisory Committee for Aeronautics,
Langley Field, Va., July 8, 1937.

REFERENCES

1. Dearborn, C. H., and Soulé, H. A.: Full-Scale Wind-Tunnel and Flight Tests of a Fairchild 22 Airplane Equipped with a Fowler Flap. T.N. No. 578, N.A.C.A., 1936.
2. Dearborn, C. H., and Soulé, H. A.: Full-Scale Wind-Tunnel and Flight Tests of a Fairchild 22 Airplane Equipped with a Zap Flap and Zap Ailerons. T.N. No. 596, N.A.C.A., 1937.
3. Platt, Robert C., and Abbott, Ira H.: Aerodynamic Characteristics of N.A.C.A. 23012 and 23021 Airfoils with 20-Percent-Chord External-Airfoil Flaps of N.A.C.A. 23012 Section. T.R. No. 573, N.A.C.A., 1936.
4. DeFrance, Smith J.: The N.A.C.A. Full-Scale Wind Tunnel. T.R. No. 459, N.A.C.A., 1933.
5. Soulé, H. A., and McAvoy, W. H.: Flight Investigation of Lateral Control Devices for Use with Full-Span Flaps. T.R. No. 517, N.A.C.A., 1935.

TABLE I

FAIRCHILD 22 AIRPLANE WITH EXTERNAL-AIRFOIL FLAP
(Flight Condition)

Wing:

Area (wing + flaps)	171 sq. ft.
Span (b)	32 ft. 10 in.
Chord (c_w)	5 ft. 6 in.
Aspect ratio	6.31
Airfoil section	N.A.C.A. 23015
Angle of wing setting	3.2°
Dihedral	0

Flap:

Area	25 sq. ft.
Span (3-foot cut-out at center)	31 ft. 4 in.
Chord (c_f)	11 in.
Airfoil section	Clark Y
Flap deflection relative to wing chord	Up -3.2° Down 27.4°
Aileron deflection for all flap positions	Up 10° Down 10°

Stabilizer:

Area	27 sq. ft.
Span	10 ft.
Deflection (relative to thrust axis)	Up 4.1° Down 2.5°

Elevator:

Area	10.4 sq. ft.
Deflection (relative to thrust axis)	Up 28° Down 27°
Distance from leading edge of wing to elevator hinge	15 ft. 9 in.

Fin:

Area	4.1 sq. ft.
----------------	-------------

TABLE I (Cont.)

Rudder:

Area	6.0 sq. ft.
Deflection	Right 20° Left 20°

Weight data:

Weight	1,525 to 1,575 lb.
c.g. position: back of leading edge of wing	1 ft. 2½ in. or 22 percent c_w
below thrust axis	0 ft. 5/8 in.

Engine: 4-cylinder inverted air-cooled Cirrus.

Rated horsepower	95 at 2,100 r.p.m.
----------------------------	--------------------

TABLE I (Cont.)

Notes:

1. All values are based on the dry weight of the sample.

2. The values are given in percent.

3. The values are given in percent of the dry weight of the sample.

4. The values are given in percent of the dry weight of the sample.

5. The values are given in percent of the dry weight of the sample.

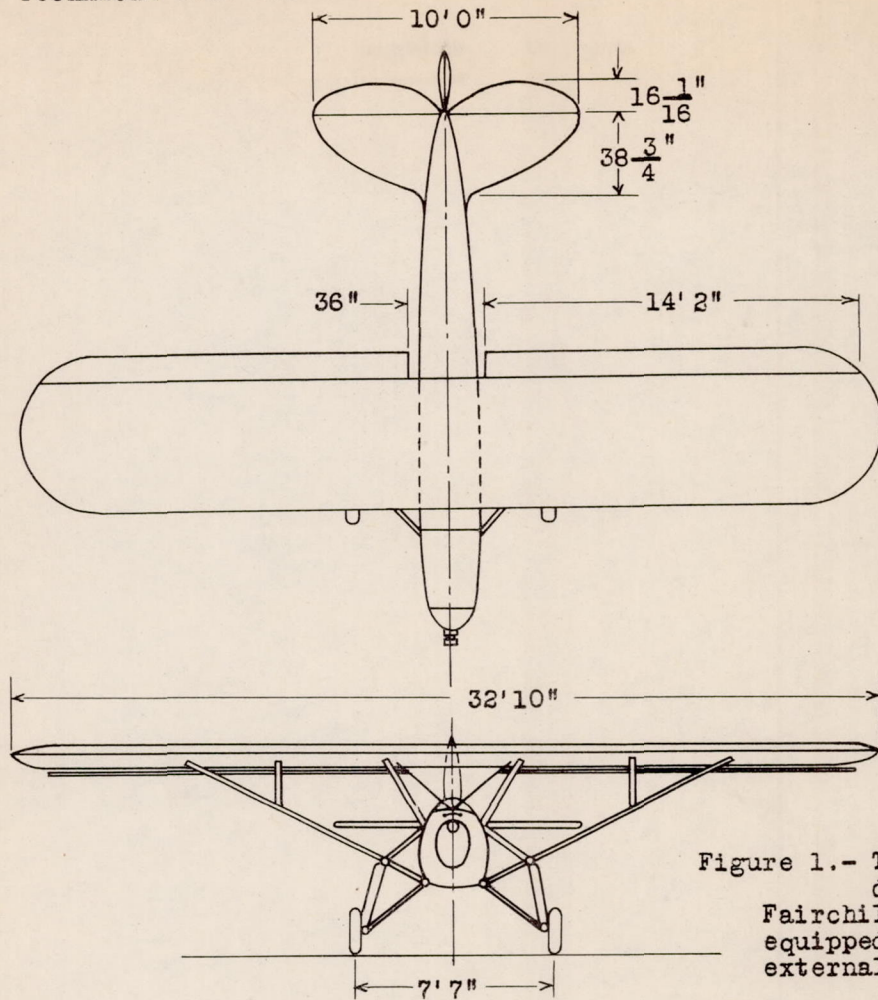

Figure 1.- Three-view drawing of Fairchild airplane equipped with an external-airfoil flap.

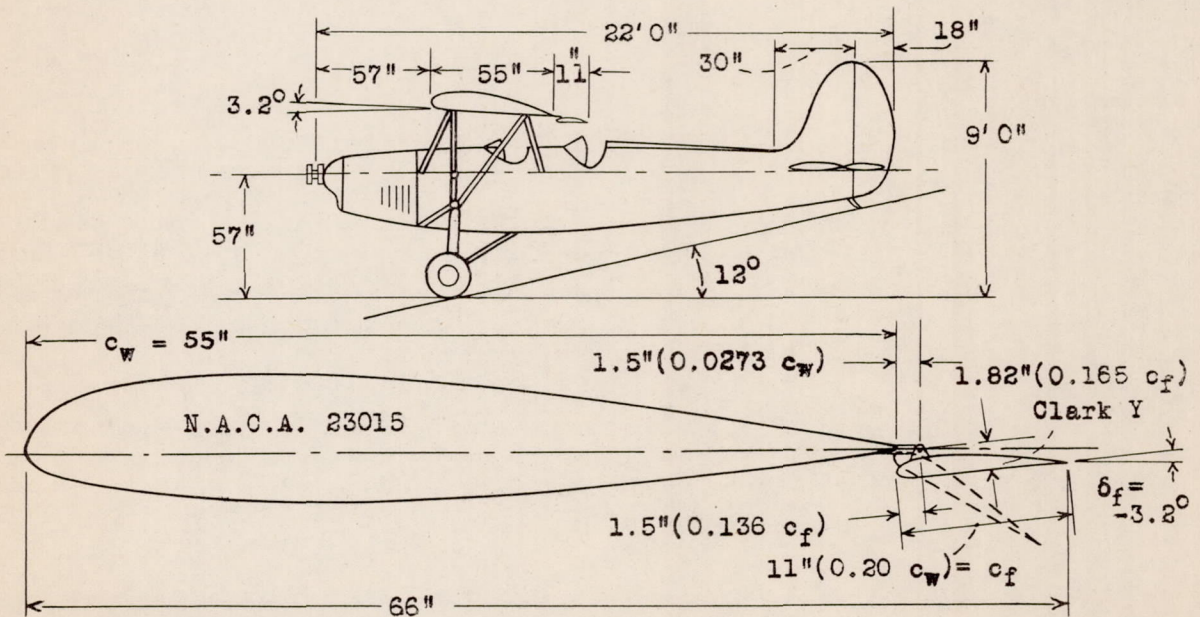
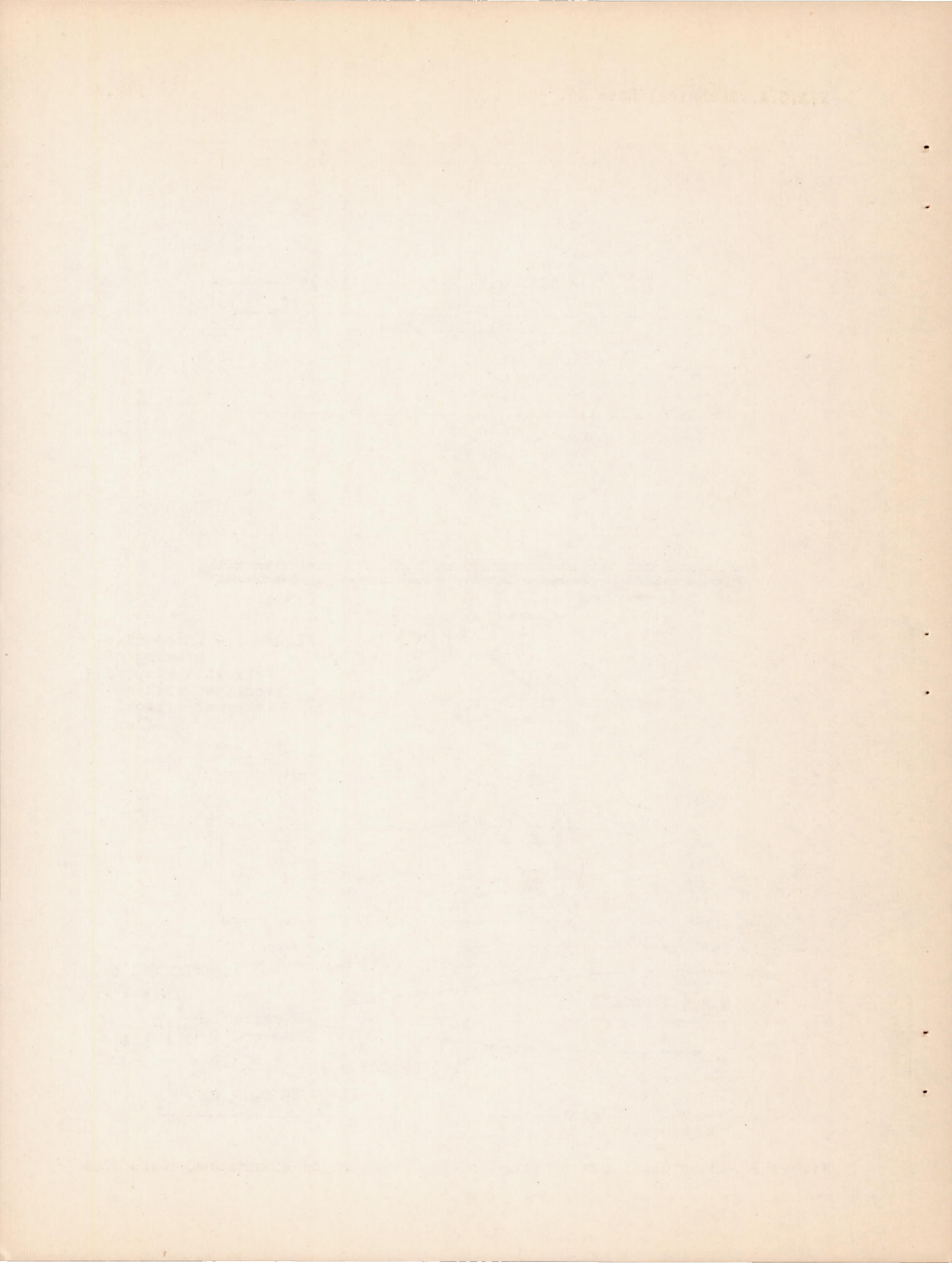

Figure 2.- Sectional view of wing showing location of external-airfoil flap



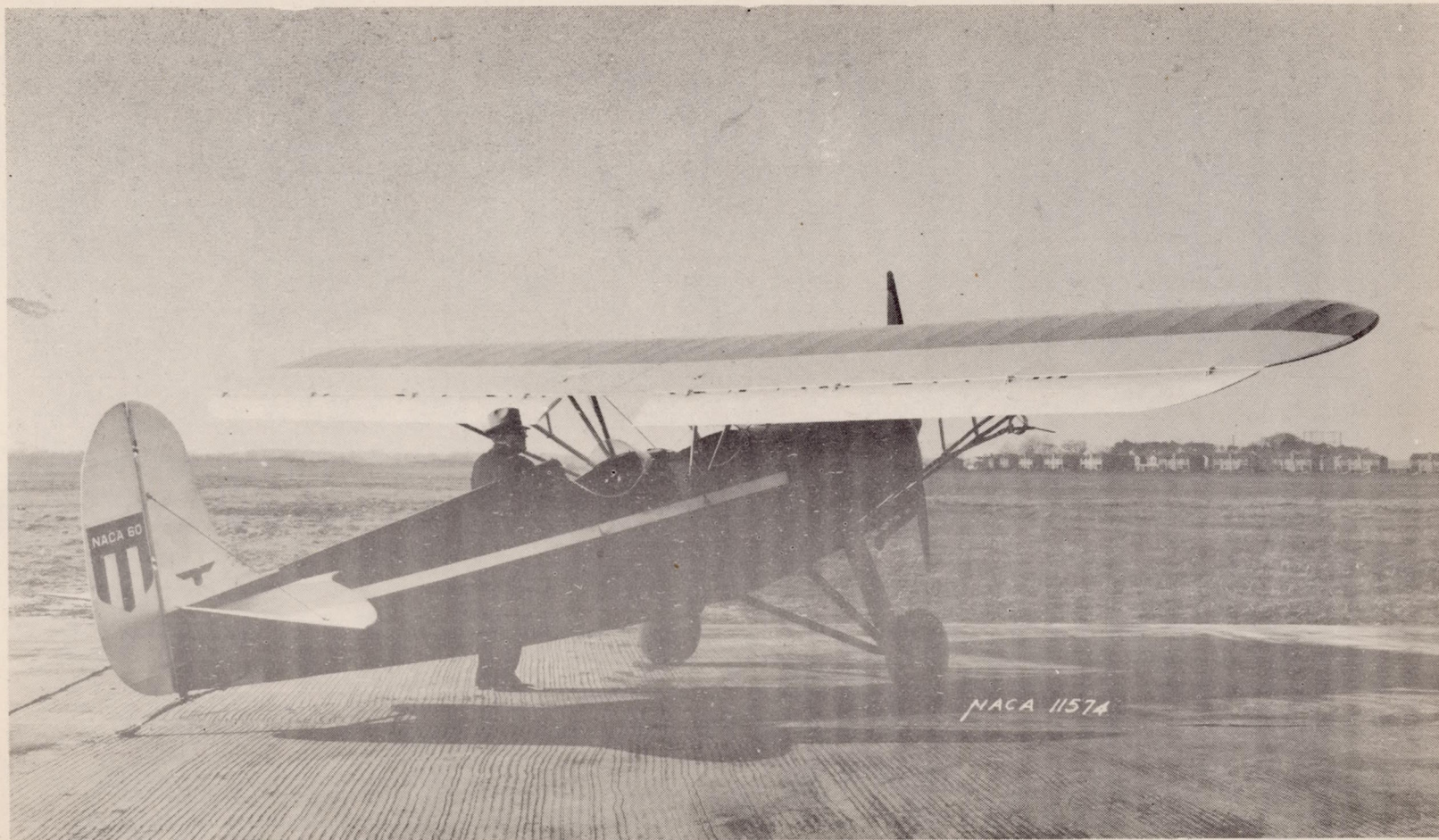

Figure 3.- Fairchild 22 airplane with external-airfoil flap.

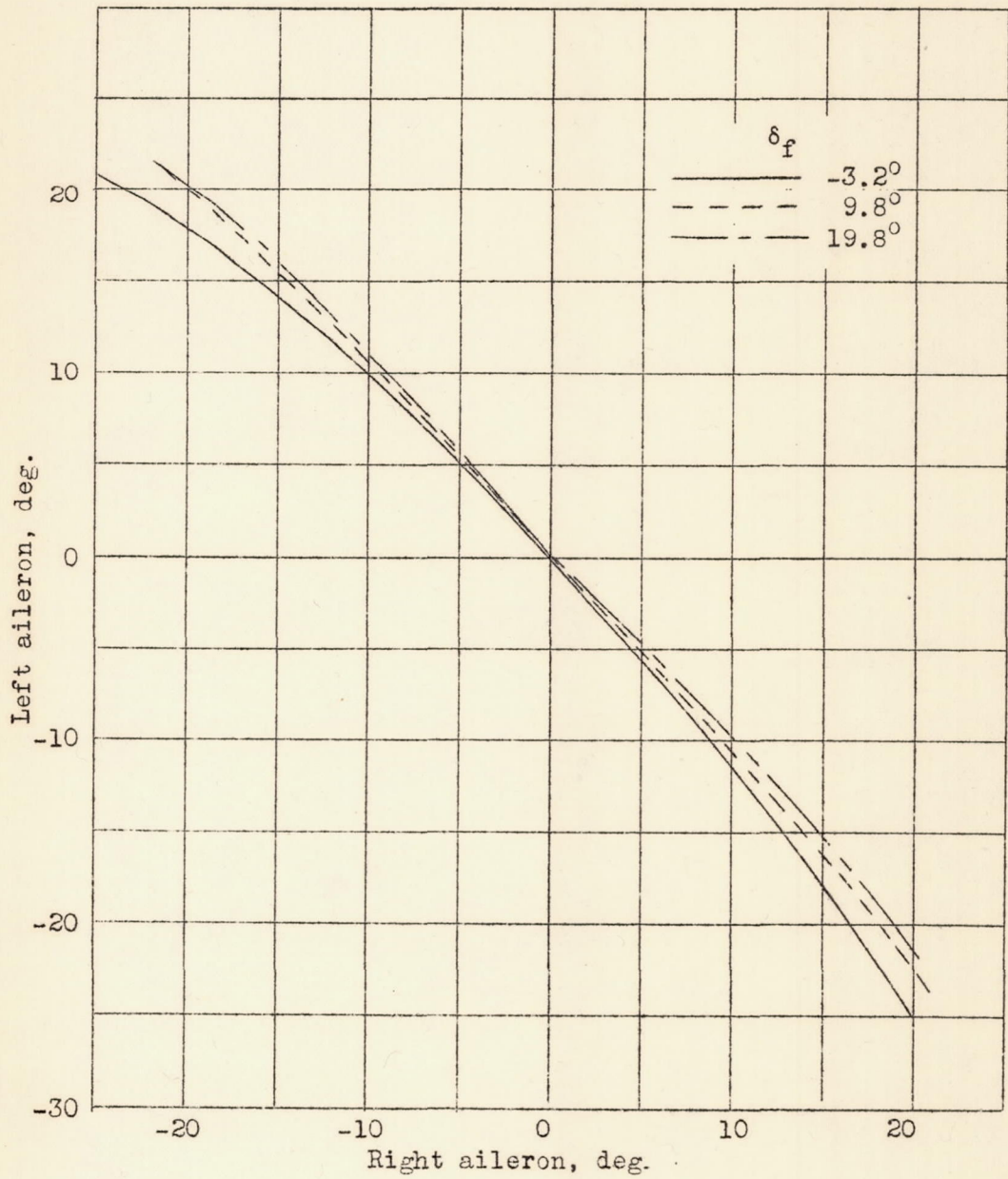

Figure 4.- Aileron deflection relative to flap setting for three settings of the flap.

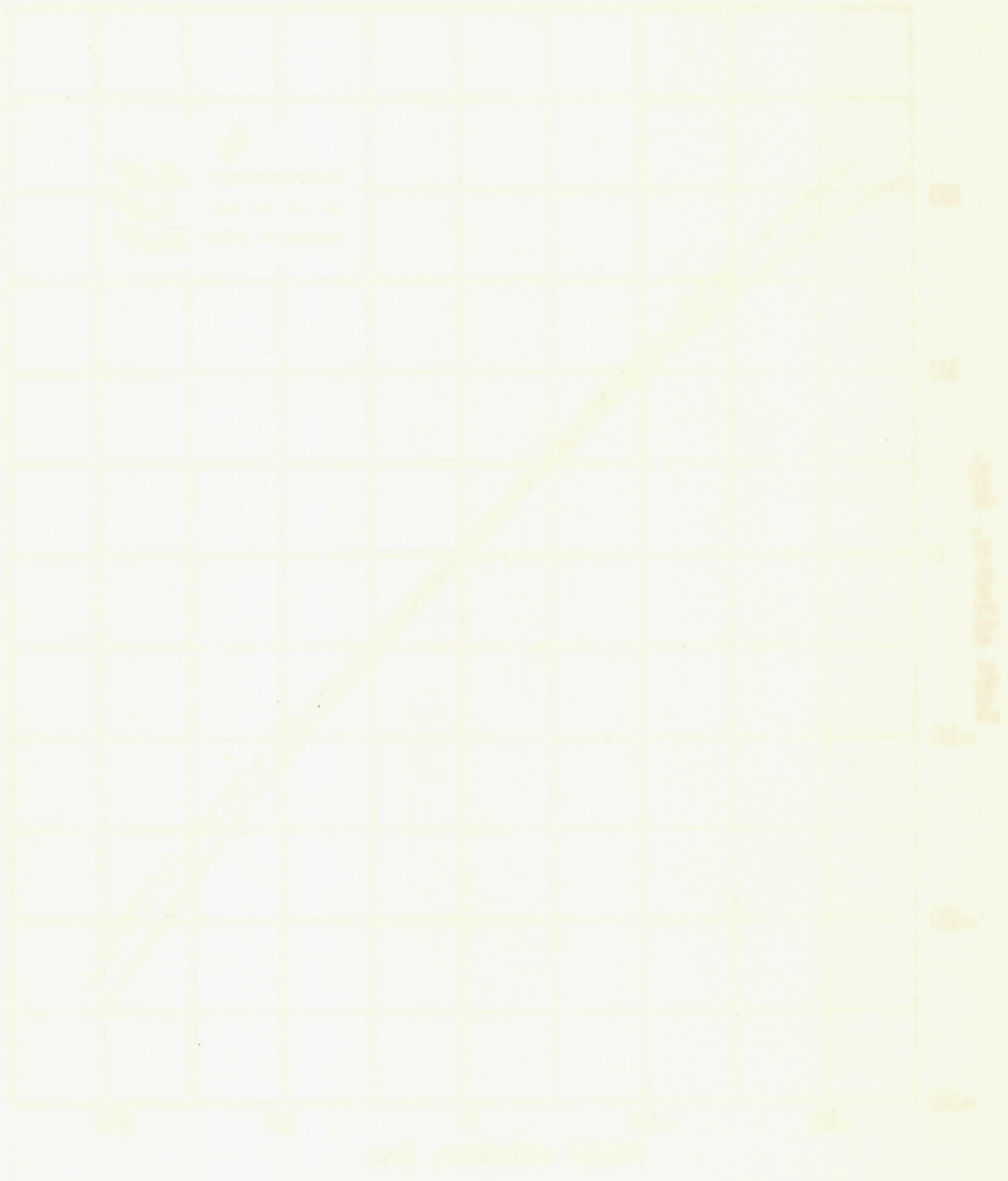
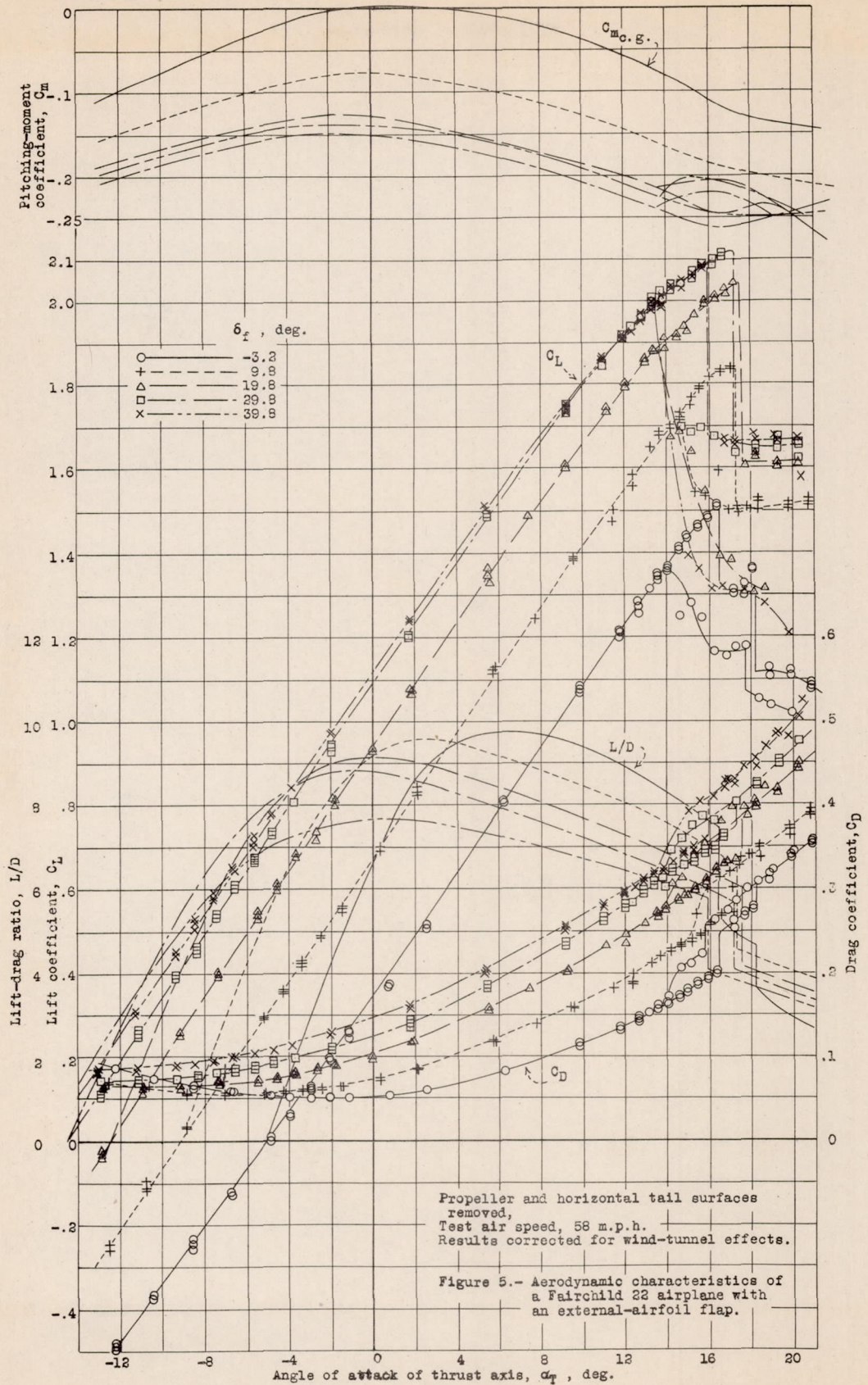
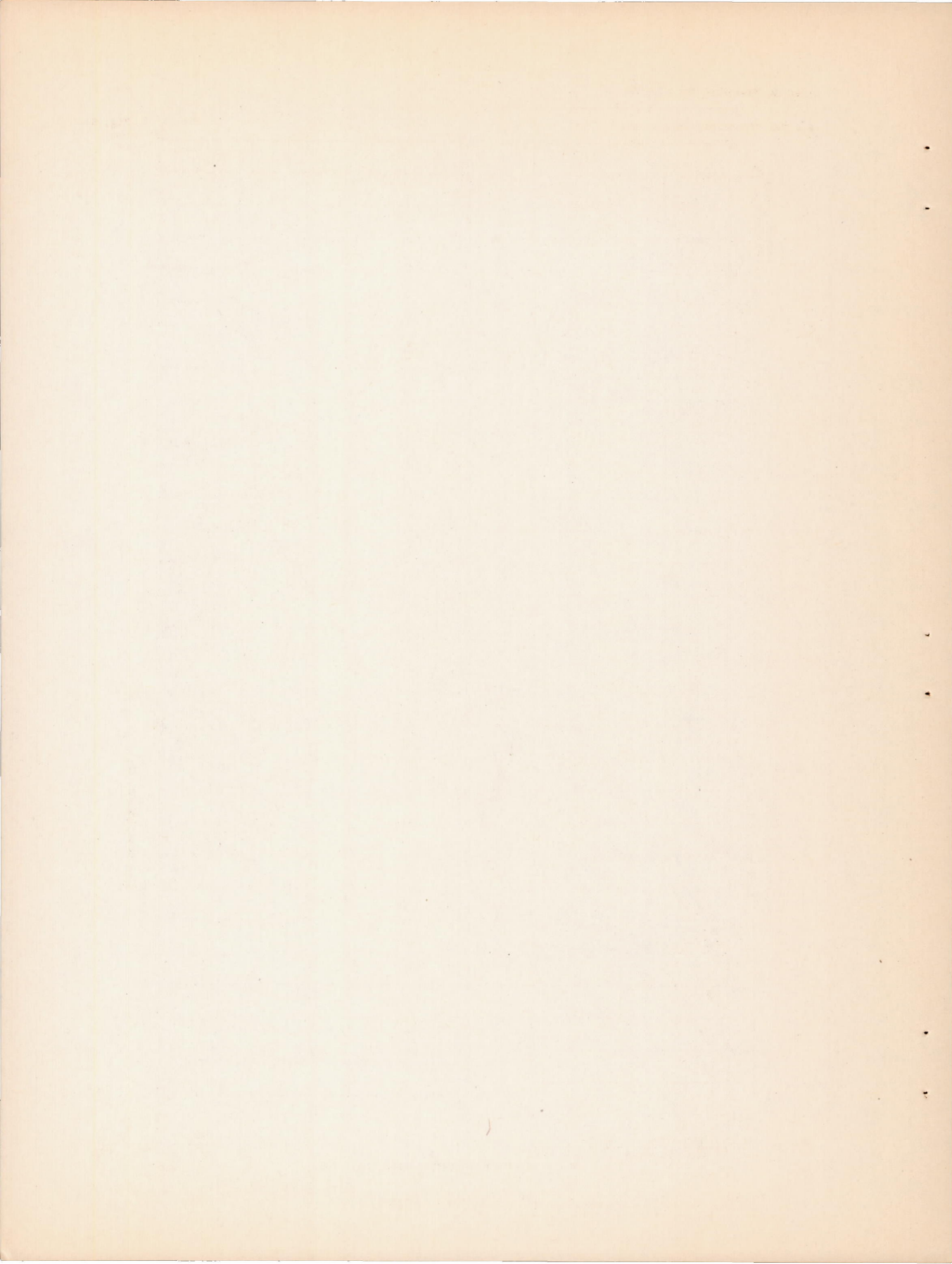
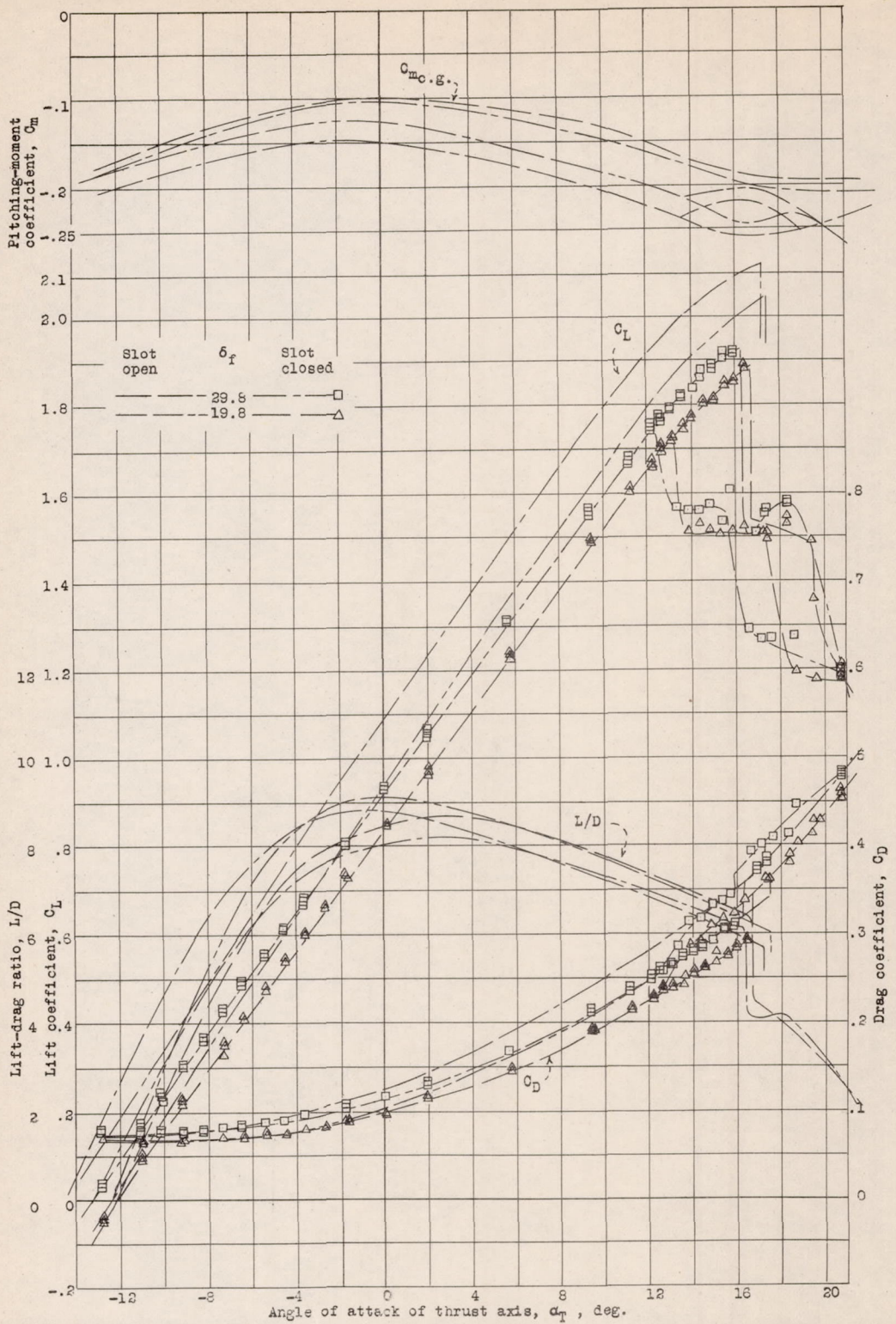

Figure 1. Temperature vs. Time for three different reactions.







Propeller and horizontal tail surfaces removed, Test air speed, 58 m.p.h., Results corrected for wind-tunnel effects

Figure 6.- Effect of closing slot between wing and flap on the aerodynamic characteristics of a Fairchild 22 airplane with an external-airfoil flap

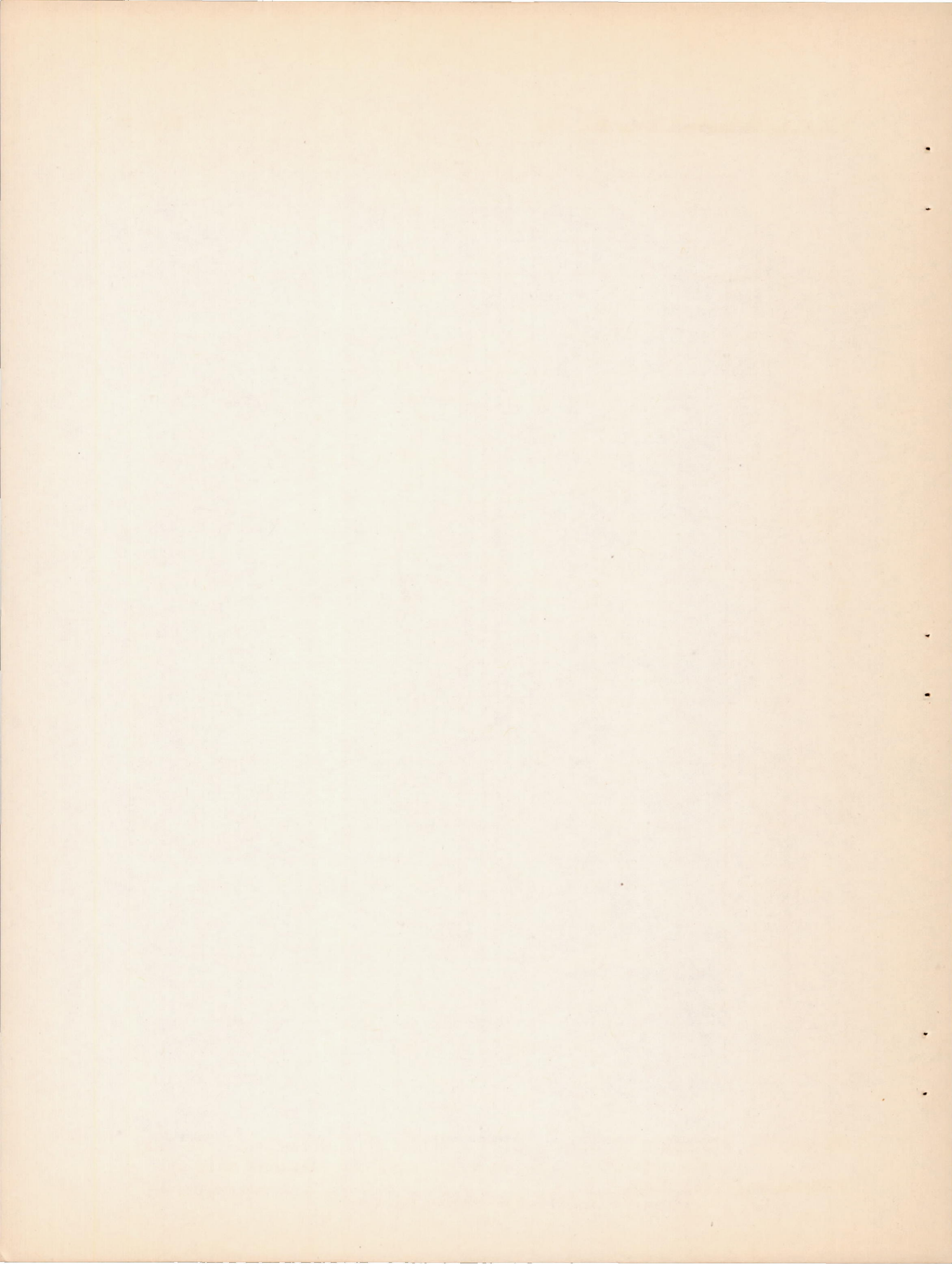

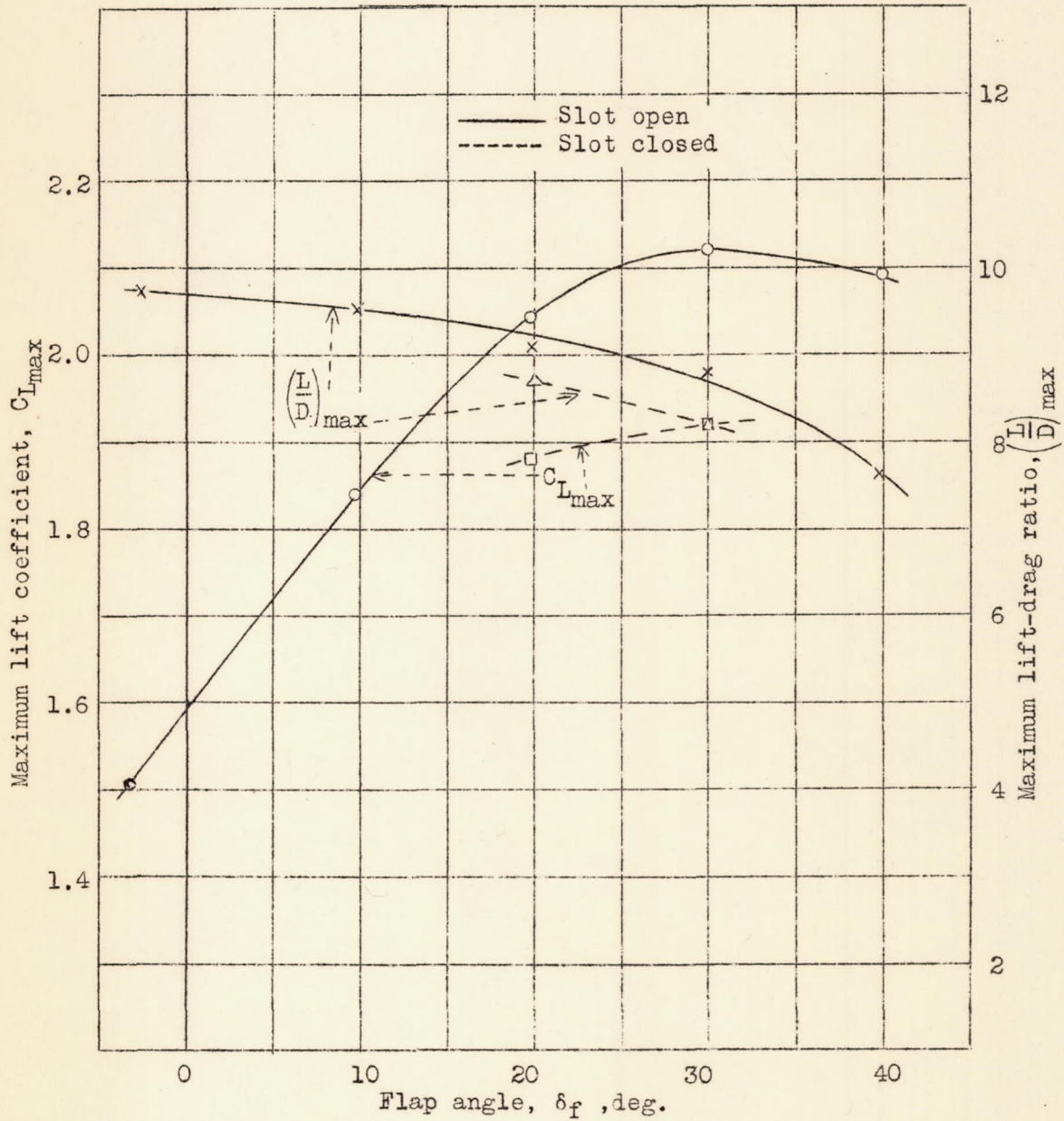

Figure 7.- Variation of maximum lift coefficient and maximum lift-drag ratio with flap angle on a Fairchild 22 airplane with an external-airfoil flap.



Figure 7 - Relation of amount of water and rate of flow. The amount of water is shown in the upper part of the graph and the rate of flow is shown in the lower part of the graph.

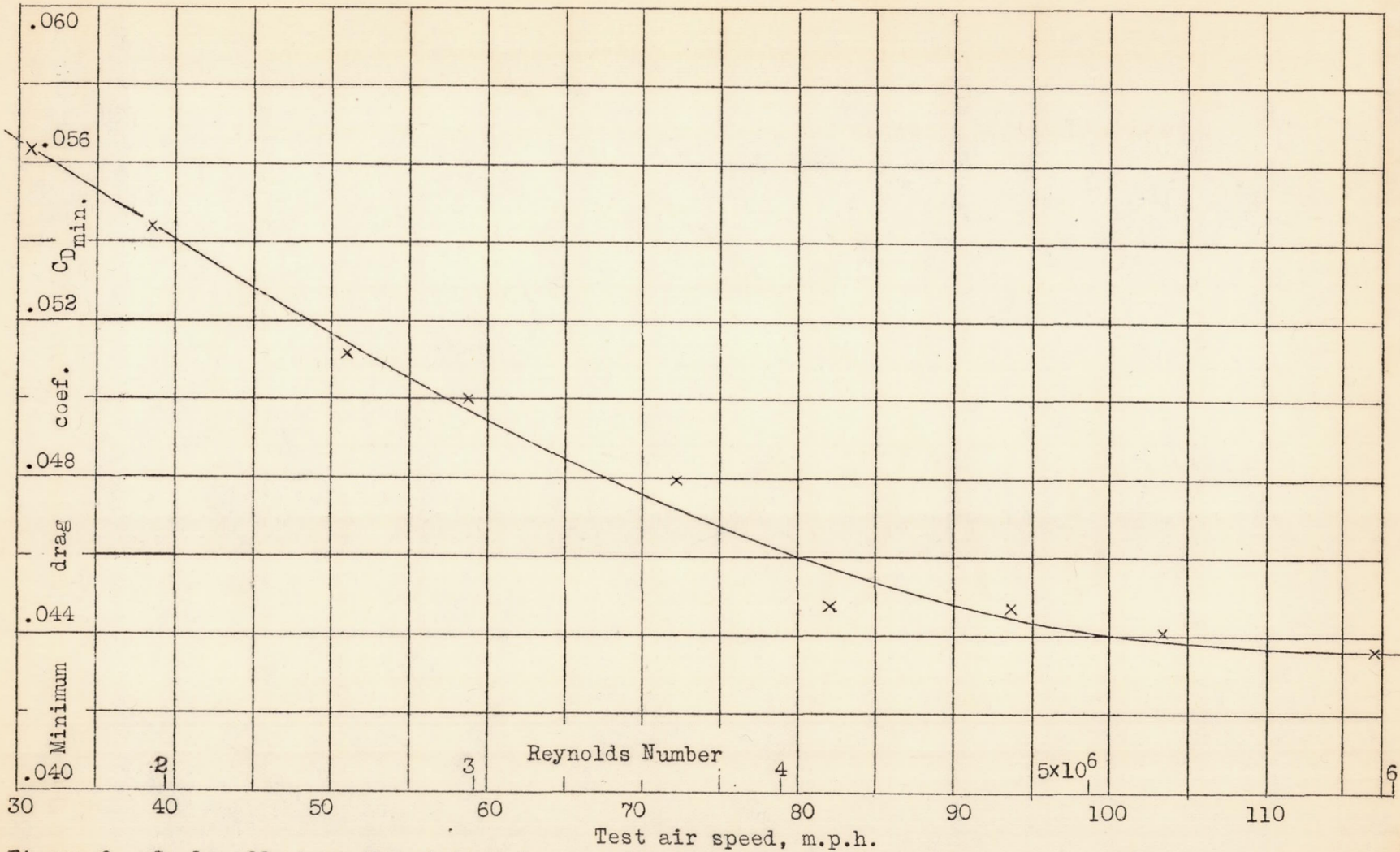

Figure 8.- Scale effect on the minimum drag coefficient of a Fairchild 22 airplane with an external-airfoil flap. $\delta_f = -3.2^\circ$.

Vertical axis: ...
Horizontal axis: ...



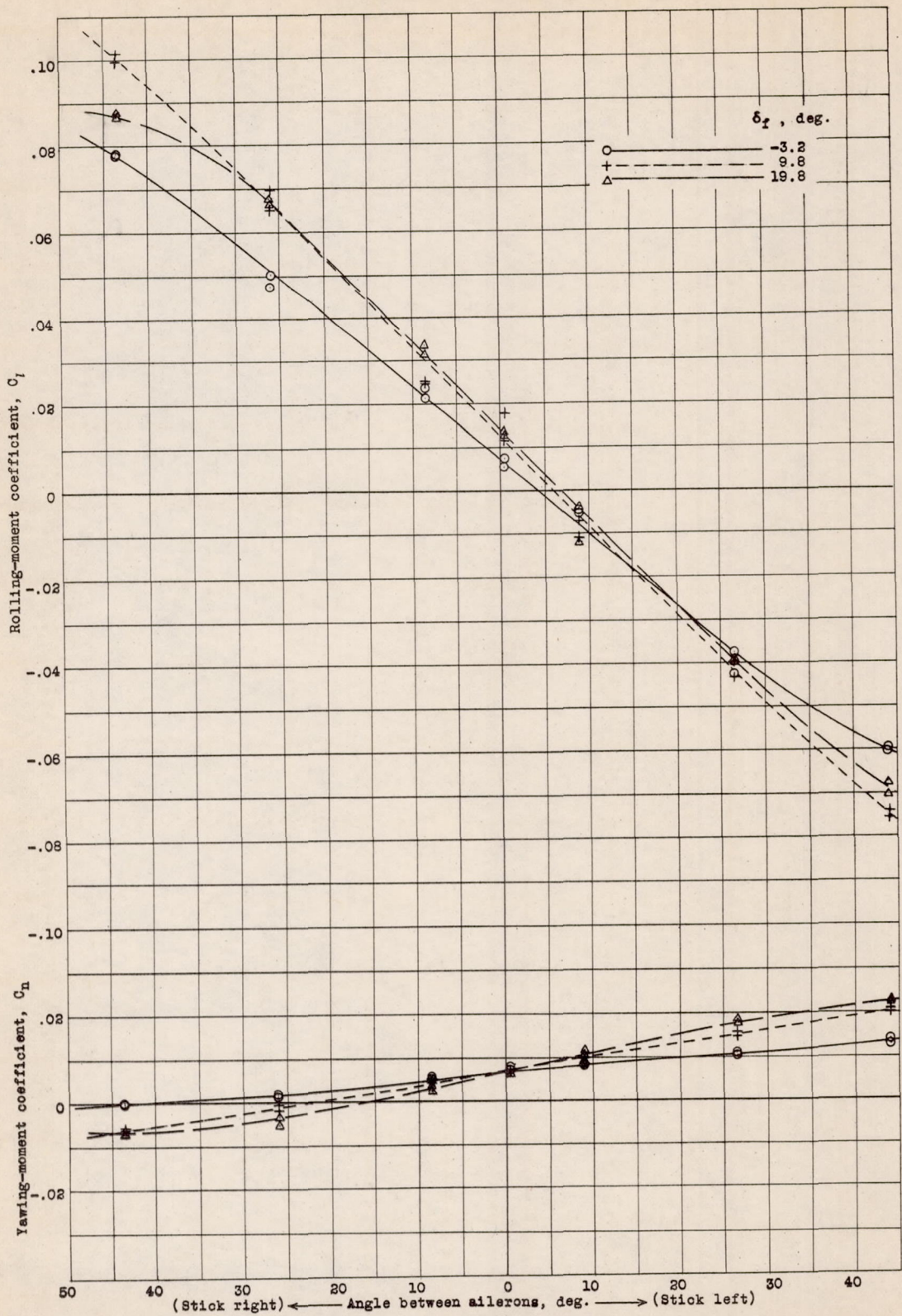

Figure 9(a).- The effect of the flap used as ailerons on the rolling- and yawing-moment coefficients of Fairchild 22 airplane with an external-airfoil flap. $\alpha_T = -1.8^\circ$.



The graph shows the temperature of a substance as it cools over time. The temperature starts at 100 degrees at time 0 and decreases to approximately 60 degrees at time 10. The rate of cooling appears to be constant.

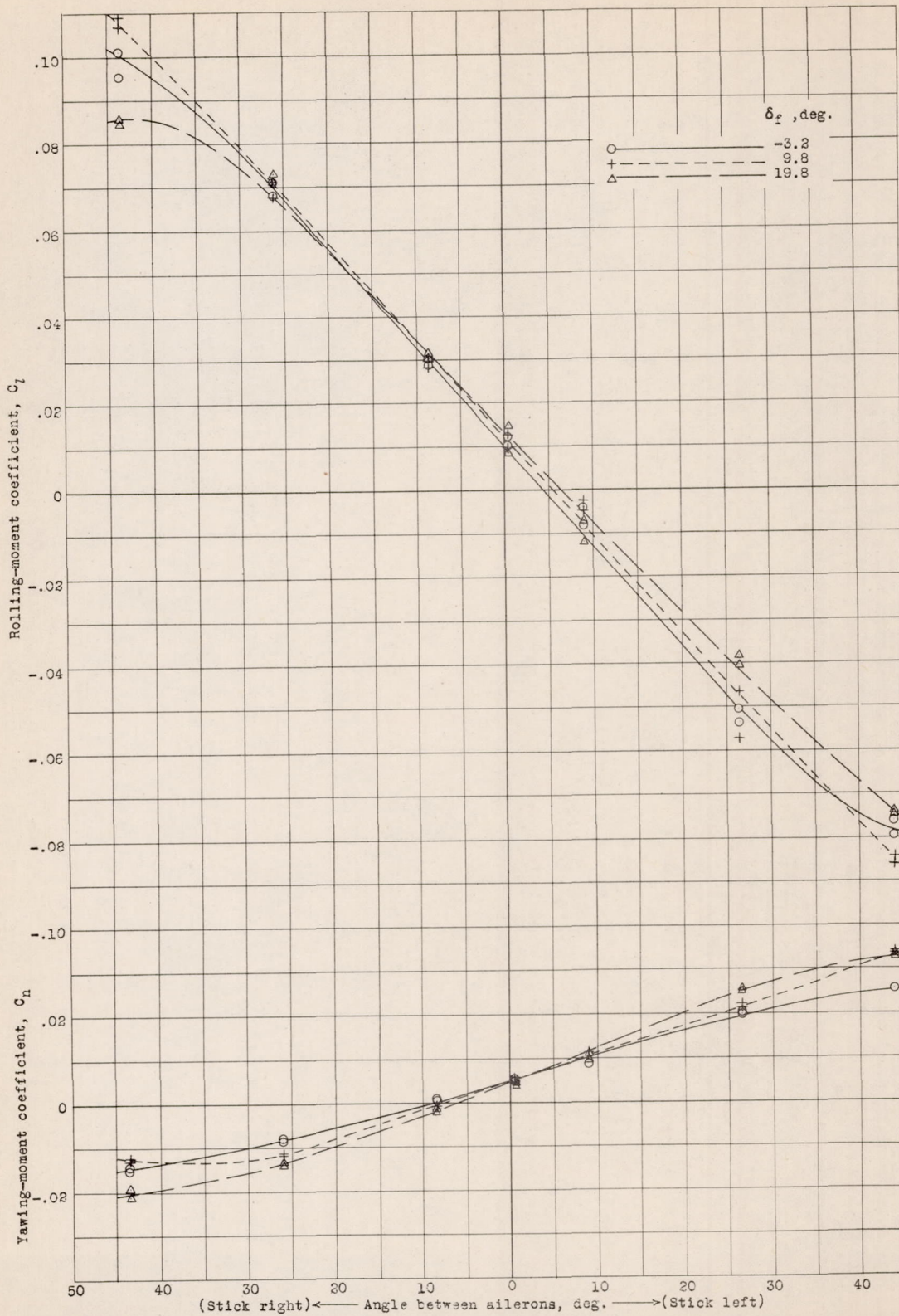
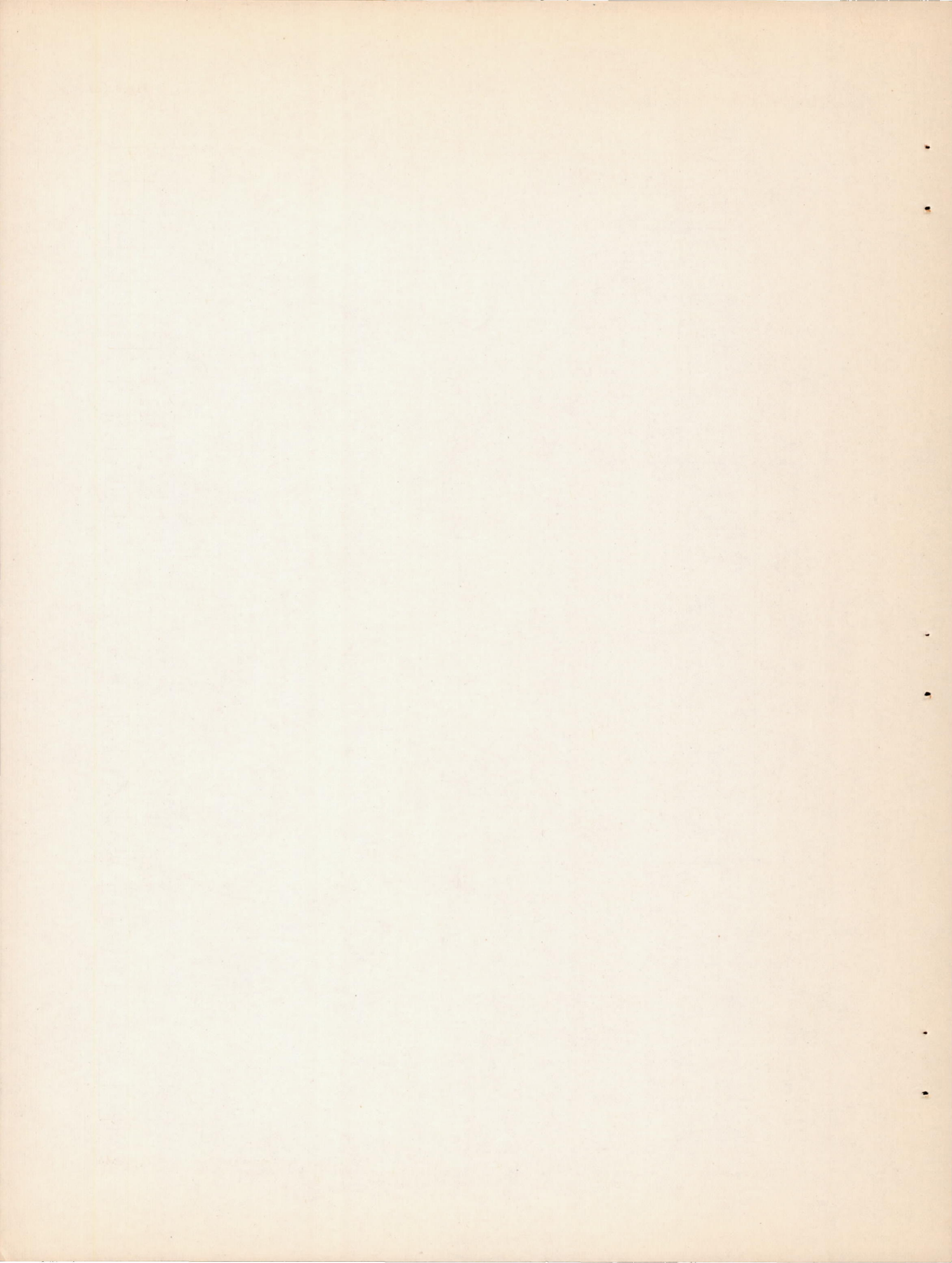

Figure 9(b).- The effect of the flap used as ailerons on the rolling- and yawing- moment coefficients of a Fairchild 22 airplane with an external-airfoil flap. $\alpha_T = 7.7^\circ$



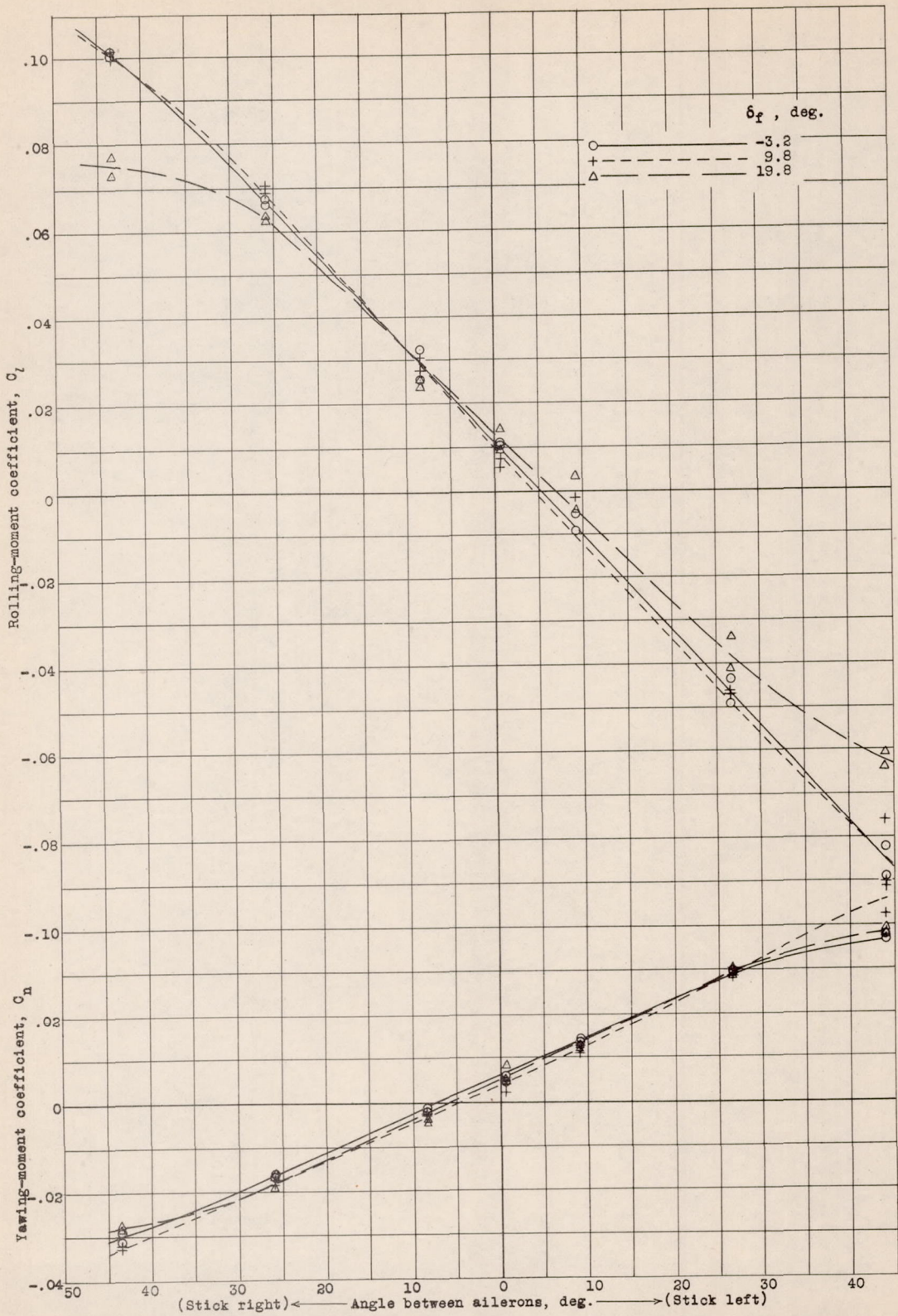

Figure 9(c).- The effect of the flap used as ailerons on the rolling- and yawing-moment coefficients of a Fairchild 22 airplane with an external-airfoil flap. $\alpha_T = -15.2^\circ$



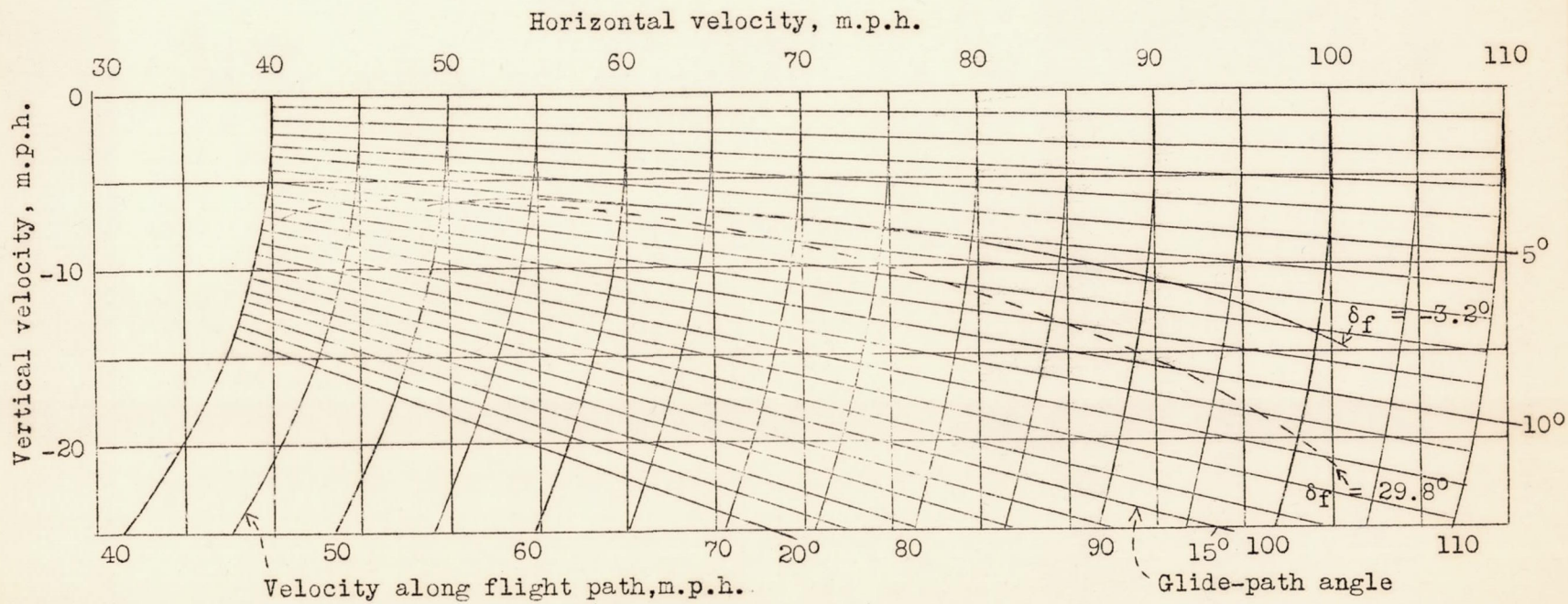

Figure 10.- Velocity diagram of a Fairchild 22 airplane with an external-airfoil flap.



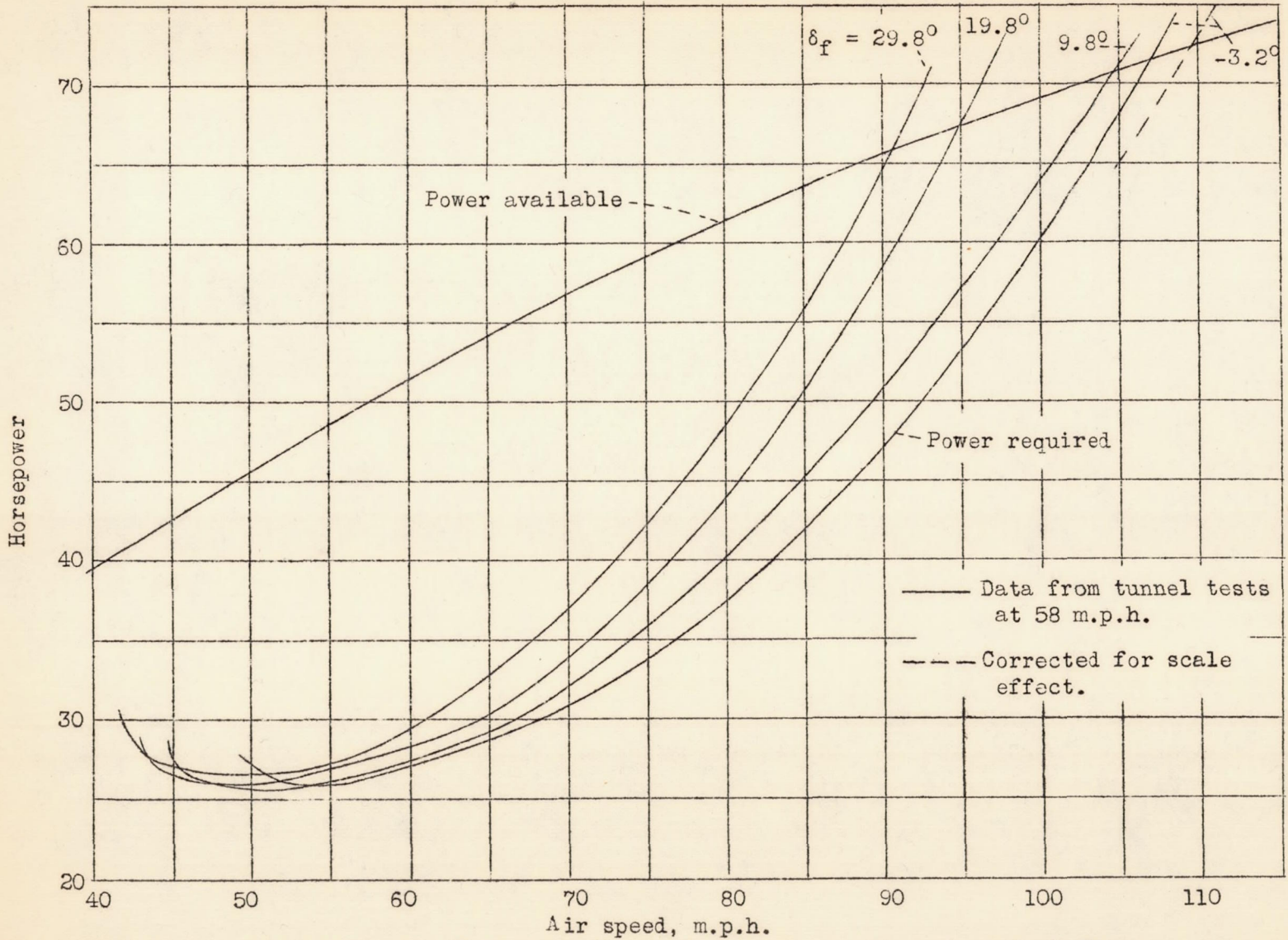
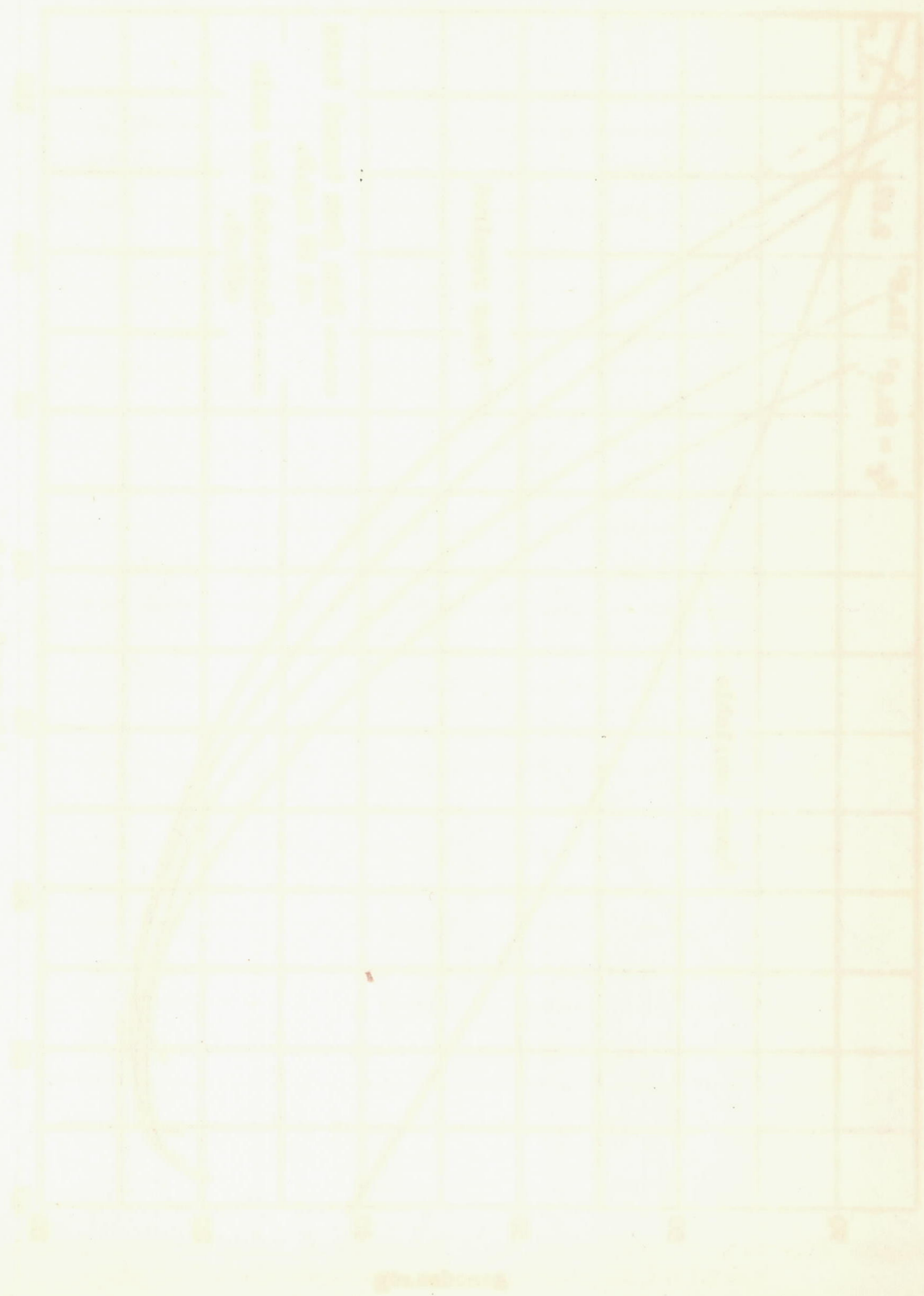

Figure 11.- Horsepower curves of a Fairchild 22 airplane with an external-airfoil flap.

Figure 1. Relationship between the amount of water and the amount of sediment carried by the water.



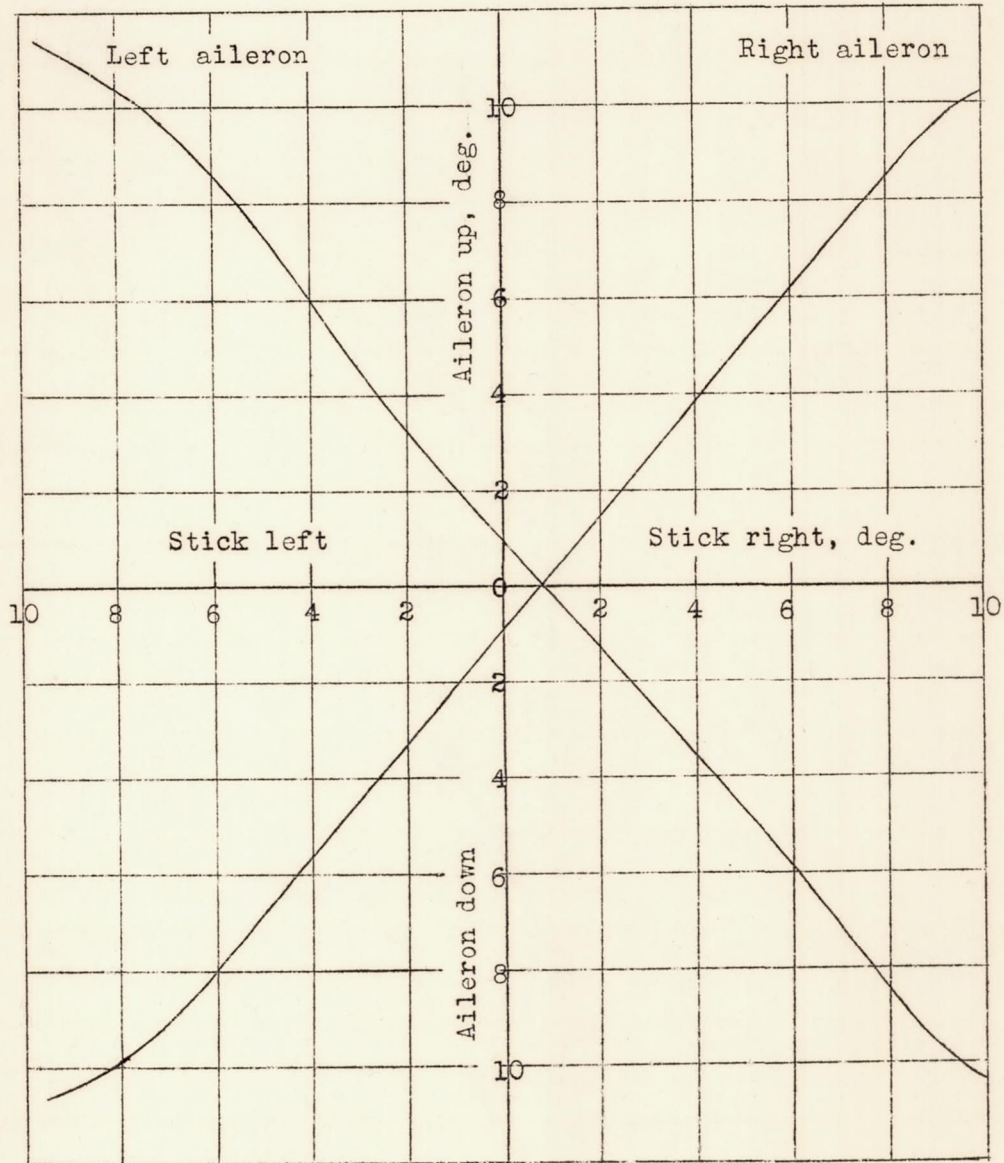

Figure 12.- Aileron deflection as a function of stick deflection on a Fairchild 22 airplane with an external-airfoil flap.



Figure 10. - A graph showing the relationship between two variables. The x-axis represents one variable and the y-axis represents another. The lines intersect at the point (5, 5).

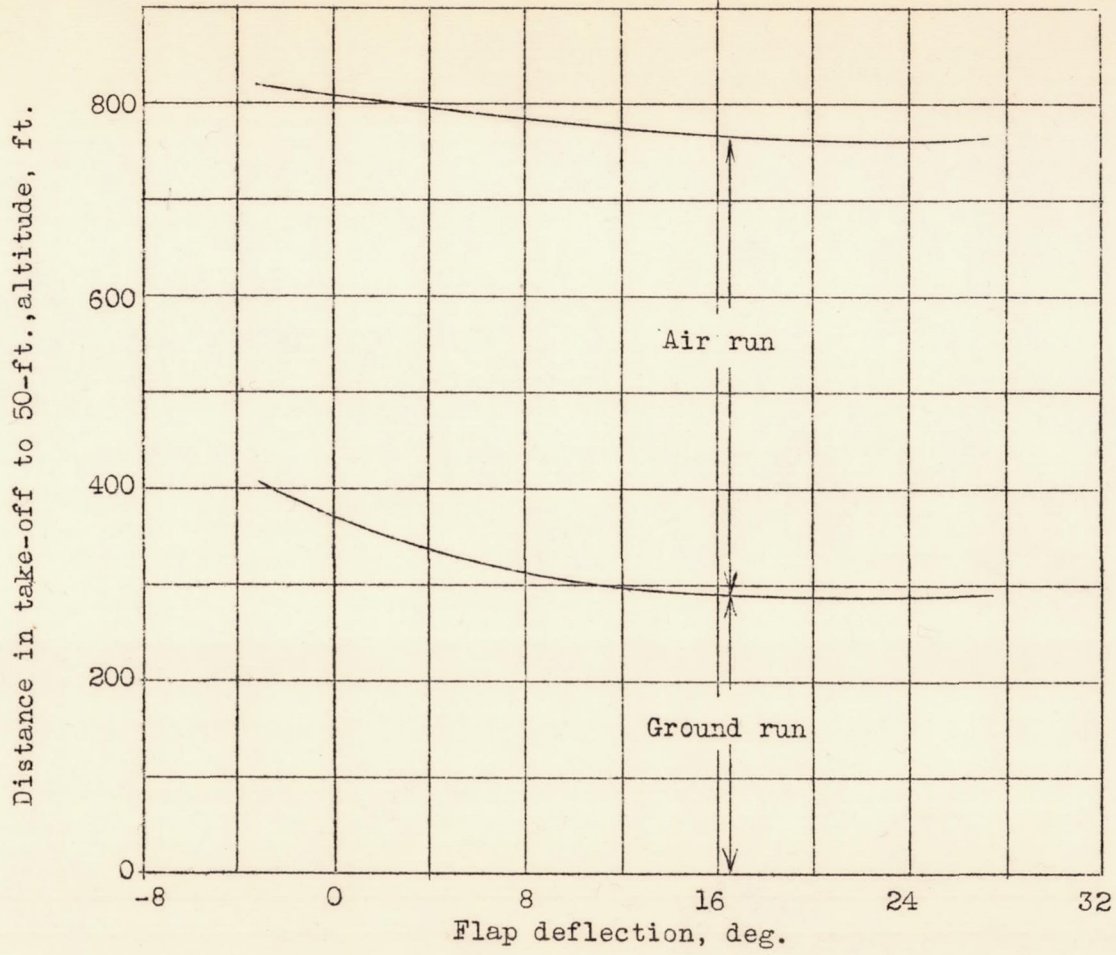

Figure 13.- Take-off curves for a Fairchild 22 airplane with an external-airfoil flap.

Diagram illustrating the relationship between the amount of water in the soil and the amount of water in the atmosphere.



Diagram illustrating the relationship between the amount of water in the soil and the amount of water in the atmosphere.

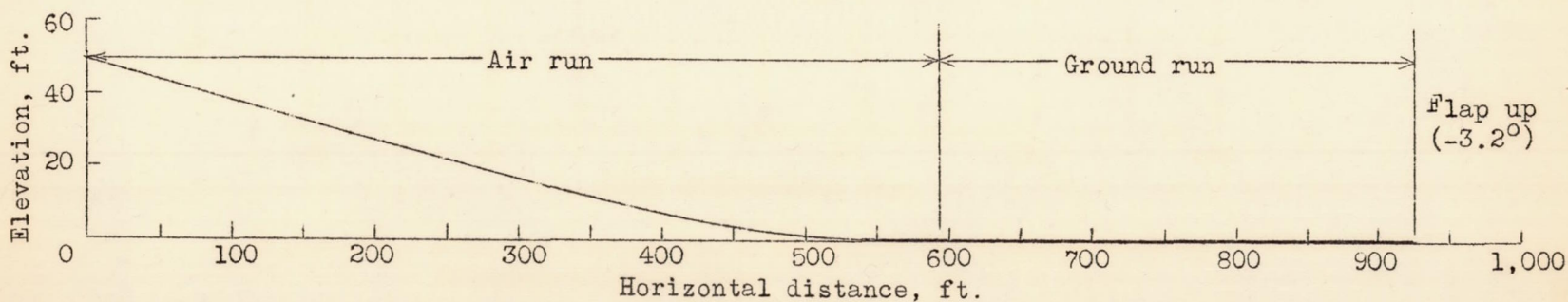
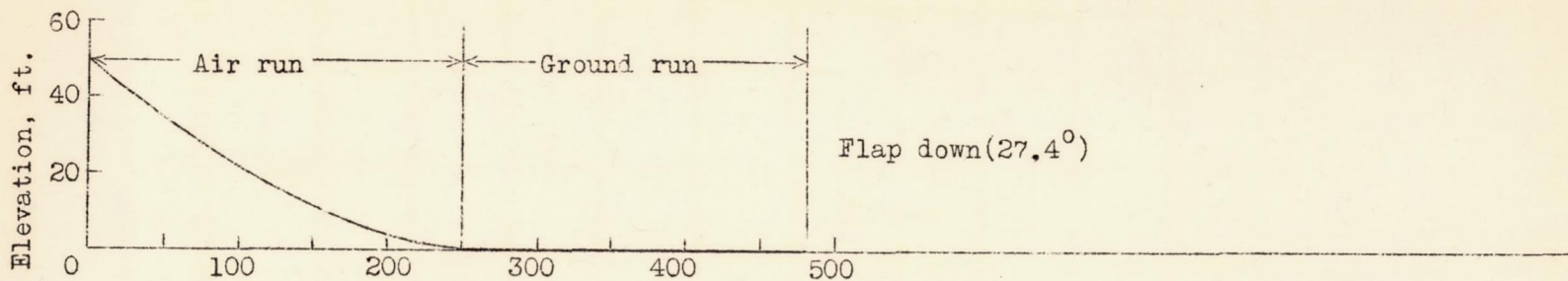

Figure 14.- Landing curves of a Fairchild 22 airplane with an external-airfoil flap.

Fig. 1. Distribution of water in the aquifer system at the time of the earthquake of 1906.



Fig. 2. Distribution of water in the aquifer system at the time of the earthquake of 1906.



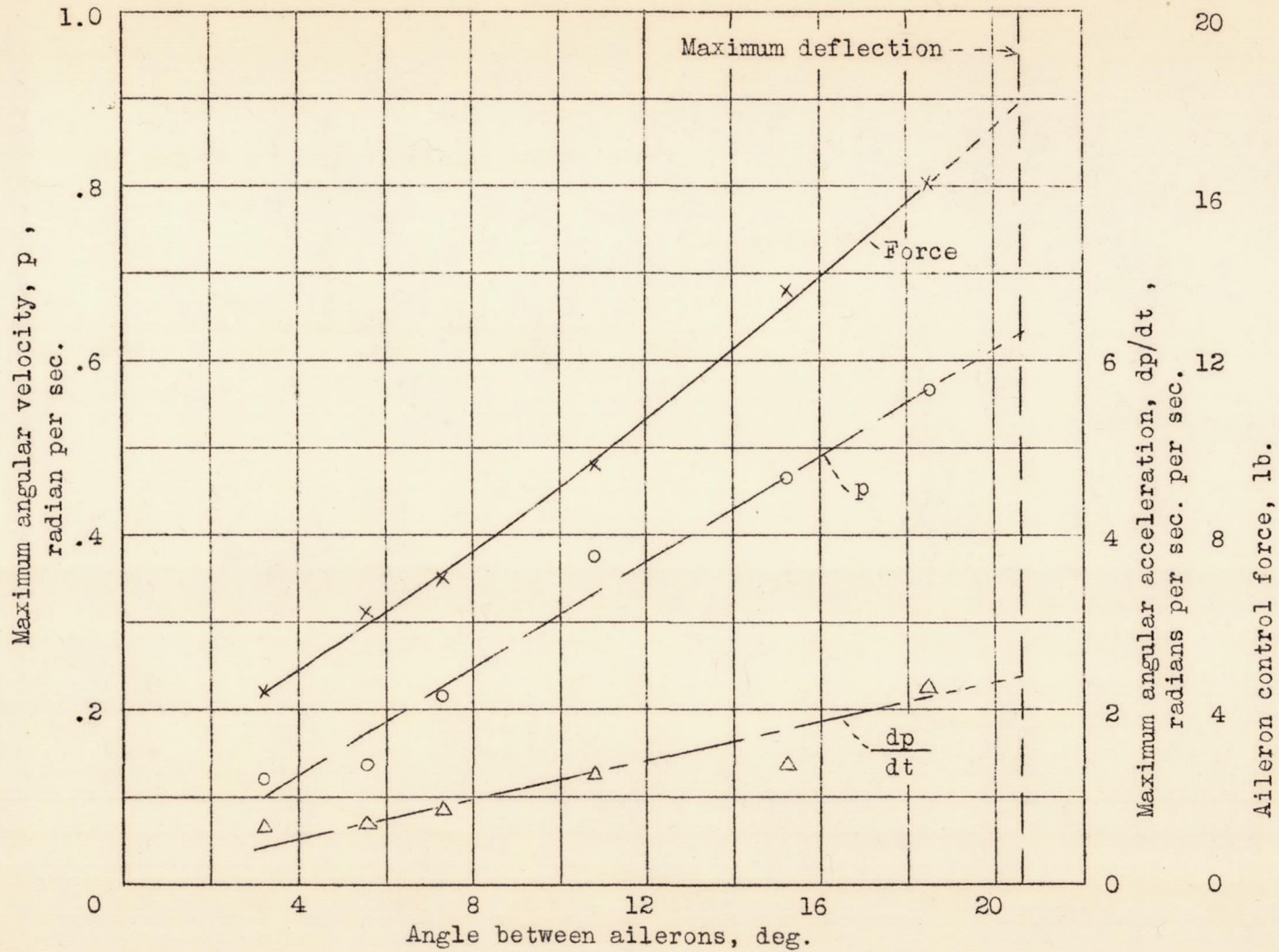

Figure 15(a).- Variation of control characteristics with aileron deflection of a Fairchild 22 airplane with an external-airfoil flap. Flap up(-3.2°); test air speed, 69 m.p.h.

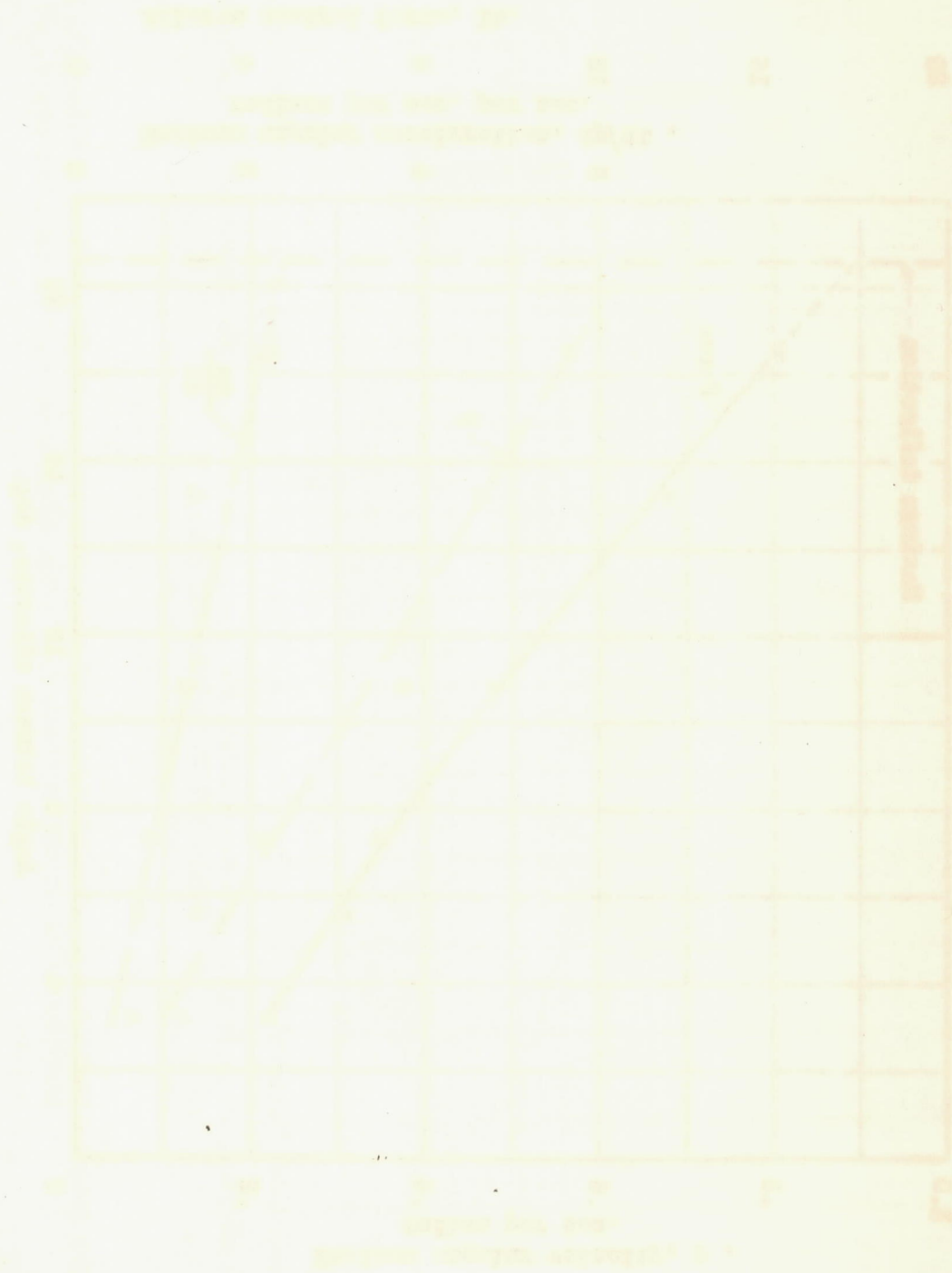

Figure 1. Relationship between the number of correct responses and the number of items presented. The vertical bar on the right indicates the range of values for the number of correct responses.

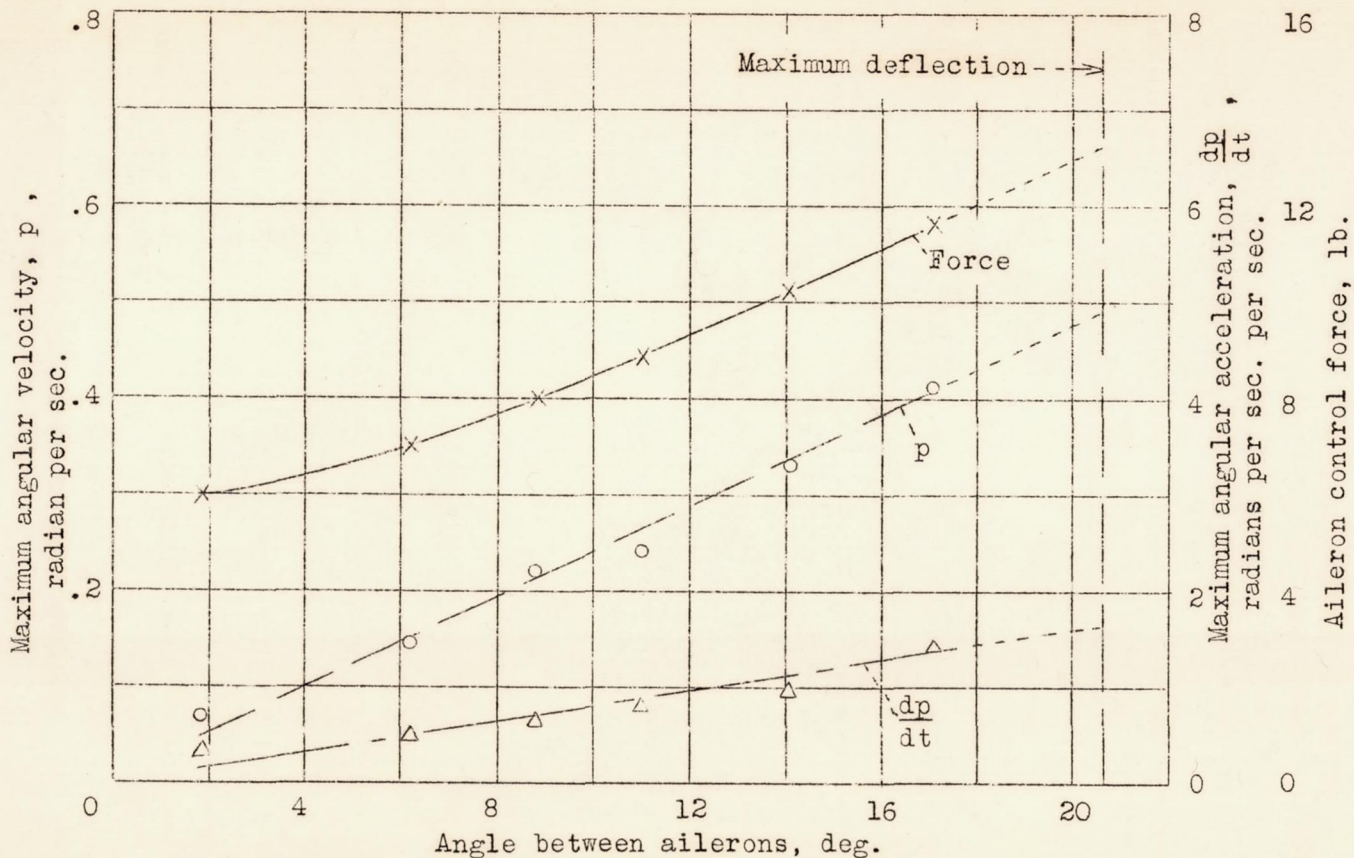

Figure 15(b).- Variation of control characteristics with aileron deflection of a Fairchild 22 airplane with an external-airfoil flap. Flap down (27.4°); test air speed, 57.5 m.p.h.

Fig. 15(b)

Page 10

U.S. Department of the Interior
Bureau of Land Management



U.S. Department of the Interior
Bureau of Land Management

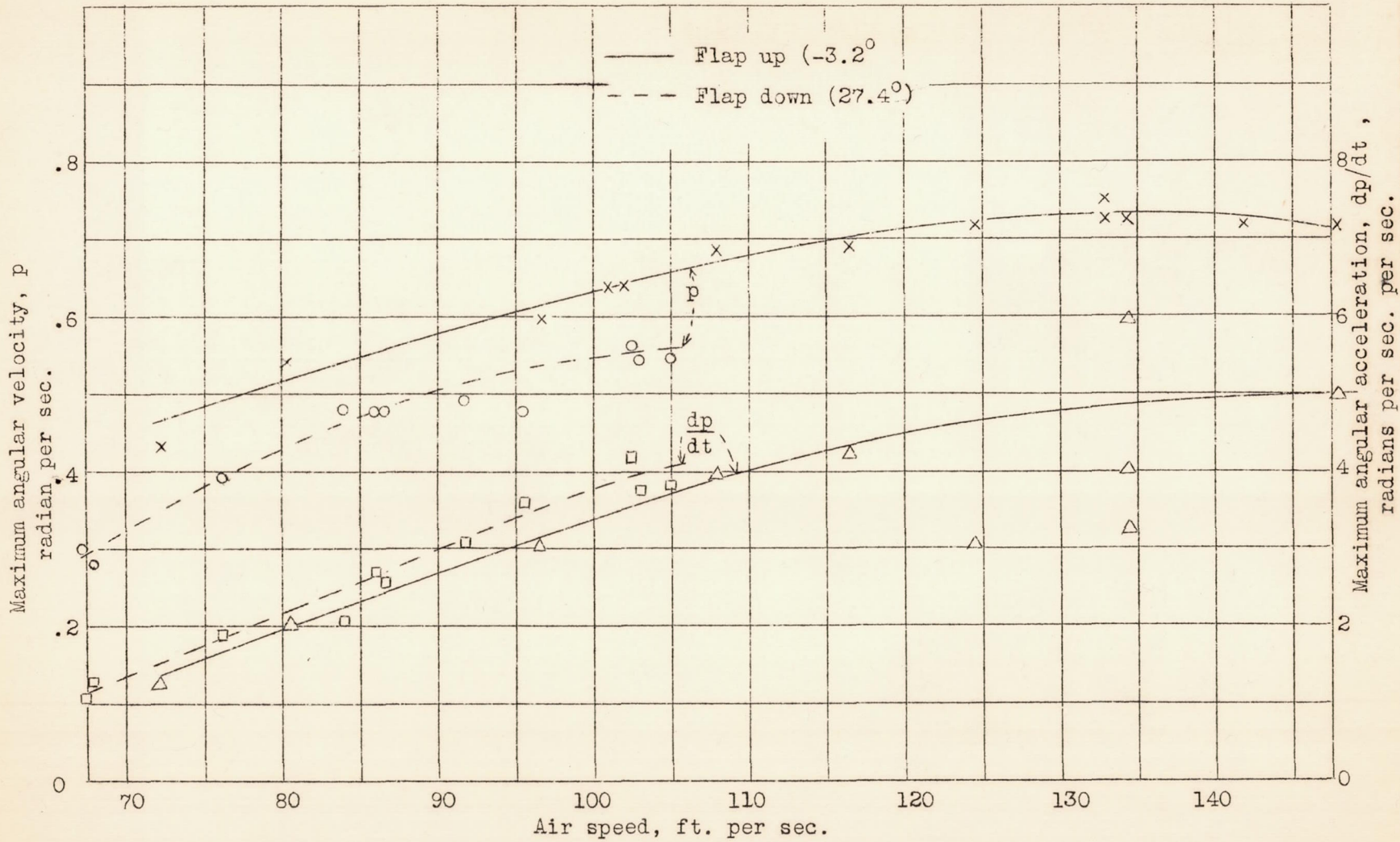

Figure 16.- Variation of rate of roll and angular acceleration in roll with air speed of a Fairchild 22 airplane with an external-airfoil flap.

THE UNIVERSITY OF CHICAGO
DEPARTMENT OF CHEMISTRY
LABORATORY OF PHYSICAL CHEMISTRY



