

8509

NACA TN 2083

0065253



TECH LIBRARY KAFB, NM

NATIONAL ADVISORY COMMITTEE FOR AERONAUTICS

TECHNICAL NOTE 2083

THEORETICAL ANALYSIS OF VARIOUS THRUST-AUGMENTATION
CYCLES FOR TURBOJET ENGINES

By Bruce T. Lundin

Lewis Flight Propulsion Laboratory
Cleveland, Ohio



Washington
May 1950

AFMTC
TECHNICAL LIBRARY
MAY 20 1950

317.98/41



NATIONAL ADVISORY COMMITTEE FOR AERONAUTICS

TECHNICAL NOTE 2083

THEORETICAL ANALYSIS OF VARIOUS THRUST-AUGMENTATION CYCLES

FOR TURBOJET ENGINES

By Bruce T. Lundin

SUMMARY

The results of analytical studies of tail-pipe-burning, water-injection, and bleedoff methods of thrust augmentation are presented that provide an insight into the operating characteristics and summarize the performance that may be obtained when applied to a typical turbojet engine. The necessity of designing tail-pipe burners with a low burner-inlet velocity, a low burner drag, and a high diffuser efficiency in order to obtain both a high thrust augmentation and to minimize the loss in normal-engine performance during nonburning operation is illustrated.

The ratio of augmented to normal thrust produced by a typical tail-pipe burner at sea-level altitude increased with flight Mach number from a value of nearly 1.5 at a Mach number of 0 to over 3.0 at a Mach number of 2.0 and decreased with increasing altitude for supersonic flight Mach numbers. Water injection is considered for both injection into the compressor inlet and for injection into the engine combustion chambers. With sufficient water injection into the compressor inlet to saturate the air at the compressor outlet, the ratio of augmented to normal thrust at sea level increased from 1.4 at a Mach number of 0 to nearly 2.6 at a Mach number of 2.0. The injection of water into the combustion chambers of an engine having compressor characteristics typical of an axial-flow compressor provided slightly less thrust augmentation than the compressor-inlet-injection method and the specific liquid consumption was about 2 times as great.

The thrust augmentation provided by the bleedoff method was the highest of the three methods studied for engines with compressor characteristics typical of either centrifugal- or axial-flow compressors. The maximum augmented thrust at a flight Mach number of 0 and sea-level altitude for the centrifugal-flow engine, which was somewhat higher than for the axial-flow engine, was about 2.3 times the normal thrust of the engine.

This thrust augmentation was, however, obtained at the expense of a high rate of liquid consumption and required that stoichiometric combustion be maintained in the engine combustion chambers.

INTRODUCTION

Methods of increasing the thrust of turbojet engines for short periods of time are of importance in increasing the effectiveness of this type of aircraft power plant. Thrust-augmentation methods find principal application in improving both the take-off and climb characteristics of jet-propelled aircraft, as well as the combat and high-speed performance of many military aircraft. Three different methods of thrust augmentation that are of current interest and that have been the subject of recent analytical and experimental investigations are tail-pipe burning, water or water-alcohol injection, and bleedoff. In order to obtain an insight into the operating characteristics of these three thrust-augmentation methods, an analytical study of the performance of each method has been made at the NACA Lewis laboratory and the results are presented herein.

The three methods of thrust augmentation are treated separately and are applied to turbojet engines having a fixed set of component efficiencies and operating conditions that are representative of those in current use. A brief description of the principles of operation of each augmentation method is given, together with curves that illustrate the effects of the principal design and operating variables of the augmentation system on the thrust and liquid consumption of the engine. For the tail-pipe-burning method of thrust augmentation, particular attention is given to the effect of the burner-design parameters on both the augmented and normal engine performance. The variation of engine performance with flight conditions is presented for a representative burner design. Two methods of water injection are considered: injection into the compressor inlet and injection into the combustion chambers of the engine. For each method, the augmented engine performance is presented for a range of injected water-air ratios and for several typical flight conditions. The performance of the bleedoff cycle of thrust augmentation is investigated for a wide range of bleedoff flow rates for zero-ram, sea-level flight conditions; results are presented for engines having both constant- and variable-area exhaust nozzles and with compressor characteristics typical of both axial- and centrifugal-flow compressors.

SYMBOLS

The following symbols are used in the analysis and in the presentation of the results:

C_d	tail-pipe-burner drag coefficient, defined as drop in total pressure across burner due to friction divided by burner-inlet dynamic head
C_v	exhaust-nozzle velocity coefficient, defined as ratio of actual to theoretical jet velocity
F	net thrust, (lb)
f	over-all fuel-air ratio
g	acceleration of gravity, (ft/sec ²)
M	flight Mach number
N	compressor speed, (rpm)
P	total pressure, (lb/sq ft)
p	static pressure, (lb/sq ft)
R	gas constant, (ft-lb/(lb)(°R))
T	total temperature, (°R)
t	static temperature, (°R)
V	velocity, (ft/sec)
W	engine air flow, (lb/sec)
γ	ratio of specific heats

η_b adiabatic tail-pipe-burner-inlet diffuser efficiency,

$$\frac{\frac{\gamma}{\gamma-1} gRt_5 \left[\left(\frac{p_6}{p_5} \right)^{\frac{\gamma-1}{\gamma}} - 1 \right]}{\frac{1}{2} (v_5^2 - v_6^2)}$$

η_c adiabatic compressor efficiency, $\frac{\left(\frac{p_2}{p_1} \right)^{\frac{\gamma-1}{\gamma}} - 1}{\left(\frac{T_2}{T_1} \right) - 1}$

η_e adiabatic engine-inlet diffuser efficiency, $\frac{\left(\frac{p_1}{p_0} \right)^{\frac{\gamma-1}{\gamma}} - 1}{\frac{\gamma-1}{2} M^2}$

η_t adiabatic turbine efficiency, $\frac{1 - \left(\frac{T_5}{T_4} \right)}{1 - \left(\frac{p_5}{p_4} \right)^{\frac{\gamma-1}{\gamma}}}$

θ $\frac{\text{compressor-inlet total temperature, } T_1}{\text{standard NACA temperature at sea level, } 518.4^\circ \text{ R}}$

θ'_{eff} effective temperature of fluid passing through compressor

Subscripts:

- 0 free stream
- 1 compressor inlet
- 2 compressor outlet
- 4 turbine inlet
- 5 turbine outlet
- 6 tail-pipe-burner inlet

- 7 tail-pipe-burner outlet
- 8 exhaust-nozzle outlet
- a augmented engine
- j exhaust jet expanded to atmosphere
- n normal, or unaugmented, engine

The engine stations to which the numerical subscripts refer are shown in figure 1.

TAIL-PIPE BURNING

Analysis

The tail-pipe-burning method of thrust augmentation or afterburning as it is sometimes designated, consists in introducing and burning fuel between the turbine and the exhaust nozzle of the engine. The increased temperature of the exhaust gases thus produced results in an increase in the jet velocity and hence an increase in the thrust. A schematic diagram of a turbojet engine equipped for tail-pipe burning is shown in figure 1. Because the velocity of the gases in the tail-pipe burner must be sufficiently low to avoid excessive pressure losses and to insure satisfactory combustion, a diffuser is provided between the turbine outlet and the tail-pipe-burner inlet. Fuel is injected into the tail-pipe burner upstream of flame holders that provide the stagnation regions and the turbulence necessary for combustion. A suitable length of tail pipe is provided downstream of the flame holders to permit completion of combustion before reaching the exhaust nozzle. The exhaust nozzle must be of the variable-area type, either two-position or continuously variable, in order to provide for operation under both nonburning and augmented conditions. A more detailed discussion of the tail-pipe-burning method of thrust augmentation, together with a generalized method of the analysis of the cycle, is presented in reference 1.

The net thrust of the engine, F , which is equal to the change in momentum of the gases passing through the engine, may be expressed as

$$F = \frac{W}{g} \left[V_j (1+f) - V_0 \right] \quad (1)$$

The ratio of the augmented net thrust to the normal net thrust, which is herein designated the augmented thrust ratio, may be written as

$$\frac{F_a}{F_n} = \frac{V_{j,a} (1+f_a) - V_0}{V_{j,n} (1+f_n) - V_0} \quad (2)$$

The values of the effective jet velocity V_j for both the augmented and the normal engine were determined by conventional step-by-step calculations through each of the engine components. An engine-inlet diffuser efficiency η_e of 0.91 was assumed for subsonic flight speeds; for supersonic speeds, total-pressure-ratio recovery factors P_1/P_0 of 0.95, 0.93, and 0.88 were assumed for flight Mach numbers of 1.0, 1.5, and 2.0, respectively. The compressor pressure ratio was taken as 4.0 at sea-level altitude and a flight Mach number of 0. For other flight conditions, the pressure ratio was varied to meet the condition of constant work input per pound of air. The compressor efficiency η_c was assumed to be 0.80 and the turbine efficiency η_t was assumed to be 0.85. A pressure loss in the primary-engine combustion chambers of 0.03 of the total pressure at the compressor outlet was used in all the calculations. Both the augmented and normal engines were considered to be operating at a constant turbine-inlet temperature T_4 of 2000° R. Because a constant turbine-inlet temperature is assumed, it is implied that the exhaust-nozzle area is adjusted to the proper value at all operating conditions. The normal engine was assumed to have no tail-pipe pressure losses; that is, the exhaust-nozzle-inlet total pressure was assumed equal to the turbine-outlet total pressure. The tail-pipe burner is considered as a constant-area duct in which the over-all pressure drop is the sum of the friction and momentum pressure drop; the friction pressure drop was determined from the burner-inlet diffuser efficiency and the burner drag coefficient, as previously defined, and the momentum pressure drop was calculated from considerations of the change in momentum of the gases due to combustion. The exhaust-nozzle velocity coefficient C_v was assumed to be 0.975 for both the augmented and normal engines. A combustion efficiency of 0.95 was used in the calculations of fuel flow to both the primary combustion chambers and the tail-pipe burner. Dissociation was also considered in the calculations of fuel flow to the tail-pipe burner.

Calculations were made to determine the effect of tail-pipe-burner-outlet gas temperature T_7 , turbine-outlet velocity V_5 , burner-inlet velocity V_6 , burner-inlet diffuser efficiency η_b , and burner drag coefficient C_d on the performance of the engine under both augmented and unaugmented conditions. For each set of calculations, one of these variables was systematically varied while all the others were held constant at the following reference values:

Tail-pipe-burner-outlet gas temperature, T_7 , °R	3800
Turbine-outlet velocity, V_5 , ft/sec	750
Tail-pipe-burner-inlet velocity, V_6 , ft/sec	400
Tail-pipe-burner-inlet diffuser efficiency, η_b	0.80
Tail-pipe-burner drag coefficient, C_d	1.0

Results and Discussion

Tail-pipe-burner-outlet temperature. - The effect of the tail-pipe-burner-outlet temperature on the augmented thrust ratio is shown in figure 2 for a range of burner-inlet velocities from 200 to 750 feet per second. These results are for sea-level altitude and a flight Mach number of 0. The turbine-outlet temperature associated with the 2000° R inlet temperature and the assumed values of compressor pressure ratio and efficiency (that is, compressor work) is 1730° R and is indicated in figure 2 by the vertical dashed boundary line at this value of burner-outlet temperature.

The augmented thrust ratio increases with increase in burner-outlet temperature as a result of the accompanying increase in jet velocity and decreases with increase in burner-inlet velocity because of increased friction and momentum pressure drop across the burner. The performance with neither friction nor momentum pressure losses in the tail-pipe burner, which is an idealized case of a burner-inlet velocity of 0, is included as the upper dashed curve for comparison. For burner-inlet velocities below about 700 feet per second, a maximum burner-outlet temperature of slightly less than 4000° R is reached when the over-all engine fuel-air ratio is stoichiometric. At high burner-inlet velocities, the maximum burner-outlet temperatures that can be reached without affecting the engine operating conditions are limited by thermal choking. At a burner-outlet temperature of 3800° R and a burner-inlet velocity of 400 feet per second, the augmented thrust ratio is 1.47. The values of augmented thrust ratio of less than 1.0 at a gas temperature of 1730° R represent a loss in unaugmented engine performance

due to the pressure losses in both the tail-pipe-burner-inlet diffuser and in the tail-pipe-burner itself. The effect of the various burner-design parameters on this loss in unaugmented performance, as well as on the augmented engine performance, will be illustrated in greater detail in subsequent figures.

Turbine-outlet velocity and diffuser efficiency. - The augmented thrust ratio is plotted against the turbine-outlet velocity in figure 3 for a burner-outlet temperature of 3800° R and diffuser efficiencies of 1.0, 0.8, and 0.6. A similar set of curves is included for a gas temperature of 1730° R in order to illustrate the performance at nonburning conditions.

For a diffuser efficiency of 1.0, both the augmented and normal thrust remain constant with change in turbine-outlet velocity; for the more realistic values of diffuser efficiency, however, the performance progressively decreases with increased turbine-outlet velocity and decreased diffuser efficiency. For example, with a diffuser efficiency of 0.8, an increase in the turbine-outlet velocity from 750 to 1200 feet per second results in about a 3-percent decrease in thrust for augmented operation and about a 2-percent decrease in unaugmented thrust. With a diffuser efficiency of 0.6, the adverse effects of increased turbine-outlet velocity are even greater.

These results illustrate the desirability of designing the turbojet engine with a low turbine-outlet velocity in order to obtain high thrust augmentation and to minimize penalties arising from pressure losses in the tail-pipe burner during nonburning operation. Alternatively, if the engine has a high turbine-outlet velocity, every effort should be made to obtain a high diffuser efficiency.

Burner-inlet velocity and drag coefficient. - In figure 4, the augmented thrust ratio is plotted against the burner-inlet velocity for a range of burner drag coefficients and for burner-outlet gas temperatures of 3800° and 1730° R. An increase in the burner-inlet velocity results in a considerable decrease in the augmented thrust ratio for all values of burner drag coefficient for augmented operation and for the higher values of drag coefficients for nonburning operation. The greater effect of burner-inlet velocity on augmented operation than on normal operation is due to the fact that for augmented operation, the pressure losses in the burner are the result of both the burner friction and the momentum change of the gases, whereas for nonburning or normal operation, only the friction pressure

drop occurs. As might be expected, the augmented thrust ratio is comparatively unaffected by an increase in the burner drag coefficient at low burner-inlet velocities but, at the higher velocities, the adverse effects of a high drag coefficient are of significant magnitude. For example, at an inlet velocity of 600 feet per second, an increase in the drag coefficient from 1.0 to 3.0 reduces the augmented thrust ratio from 1.33 to 1.09 for augmented operation and from 0.95 to 0.82 for the nonburning condition. At 400 feet per second, which may be considered a desirable design value for the burner-inlet velocity, the loss in performance is only about 40 percent of that at 600 feet per second and, for a drag coefficient of 1.0, provides an augmented thrust ratio of 1.47 for augmented operation and 0.97 for the nonburning condition.

Although a low drag coefficient is advantageous for maximum thrust, some drag is necessary for satisfactory combustion, particularly for altitude operation. A low burner-inlet velocity may therefore be desirable to compensate for a high burner drag coefficient and to obtain both a high thrust augmentation and to minimize the loss of unaugmented or nonburning thrust. In addition, a low inlet velocity may also be required for satisfactory combustion efficiency and stability. A reduction in the burner-inlet velocity, however, requires an increase in the diameter of the burner that may often be limited by aircraft-installation considerations.

Effect of flight conditions. - The effect of flight Mach number on the augmented thrust ratio is shown in figure 5 for altitudes of both sea level and 35,000 feet. Included for reference are curves of the normal thrust ratio, where this thrust ratio is equal to the thrust of the normal-engine configuration divided by the thrust obtained at sea-level altitude and a flight Mach number of 0. The augmented-thrust curves of this figure are based on the performance of a tail-pipe burner having the same design and operating variables as were used for the reference values in the previous figures. Additional calculations for other than these values of tail-pipe-burner parameters at several flight speeds indicated that, in general, the effect of the various burner-design parameters on the augmented-thrust ratio is slightly greater at low flight speeds and somewhat less at supersonic speeds than they are at a flight speed of 0.

For both altitudes considered, the thrust of the normal engine decreases slightly as the flight Mach number is first increased and then increases as the flight speed is increased above a flight Mach number of about 0.5. This variation of

of thrust with flight Mach number is the result of the combined effects of changing air flow, pressure ratio, propulsive efficiency, and inlet diffuser efficiency that accompany the changes in flight Mach number. The thrust at an altitude of 35,000 feet is from 55 to 60 percent lower than at sea level, principally because of the decreased air density at altitude.

The augmented thrust ratio, shown by the upper curves of figure 5, increases considerably with increase in flight Mach number but is not greatly affected by altitude for subsonic Mach numbers. For sea-level altitude, the augmented thrust ratio increases from nearly 1.5 at a Mach number of 0 to 2.0 at a Mach number of 1.0 and to over 3.0 at a Mach number of 2.0. At a flight Mach number of 2.0, increasing the altitude to 35,000 feet decreases the augmented thrust ratio to about 2.5.

The corresponding specific fuel consumptions for both the normal and augmented engines are shown plotted against the flight Mach number in figure 6 for altitudes of sea level and 35,000 feet. The specific fuel consumption of the augmented engine increases with an increase in flight speed up to a Mach number of about 0.8 and then decreases with further increase in flight speed. For the normal engine, however, the specific fuel consumption increases continuously with increased flight speed throughout the range of speeds presented. The increase in specific fuel consumption due to operation of the tail-pipe burner above that of the normal engine therefore becomes reduced as the flight speed is increased. For example, at sea-level altitude, the augmented specific fuel consumption varies from 2.2 times the corresponding normal fuel consumption at a Mach number of 0 to about 1.4 times the normal consumption at a Mach number of 2.0. At an altitude of 35,000 feet, the augmented specific fuel consumption is about 17 percent lower than at sea level at subsonic flight speeds and about 12 percent lower at high supersonic flight speeds.

Unaugmented performance at cruise engine operation. - The results presented in figures 2 to 6 are, as previously indicated, for a turbine-inlet temperature of 2000° R and thus may be considered representative of engine operation at maximum rated conditions. In order to determine the effect of the tail-pipe-burner installation on the unaugmented engine performance at cruise conditions, additional calculations were made based on engine conditions typical of reduced-speed operation at a thrust of about 70 percent of the rated value. These calculations indicated that the thrust losses caused by the tail-pipe burner at cruise conditions for flight Mach numbers in the range of 0.5 to 1.0 are within 1 percent of those illustrated in figures 2 to 4 for

rated-engine conditions. This small change in the effect of burner pressure losses with change in engine operating conditions is a result of the counteracting effects of a decreased burner pressure drop at cruise conditions because of the reduced burner-inlet velocity and an increased influence of a given burner pressure drop on the jet velocity when the exhaust-nozzle pressure ratio is small (as exists for reduced-thrust engine operation).

WATER INJECTION AT COMPRESSOR INLET

Analysis

The effect of water injection at the compressor inlet of an engine may be illustrated by a schematic plot of typical compressor characteristics, as shown in figure 7. In figure 7, the compressor pressure ratio is plotted against the compressor air flow for two values of the corrected compressor speed $N/\sqrt{\theta_{eff}}$ where N is the actual rotor speed and θ_{eff} is an effective temperature of the fluid passing through the compressor. The evaporation of the injected liquid extracts heat from the air and thus reduces the temperature of the fluid passing through the compressor below that of the dry-compression process. For constant compressor speed N , the decrease in the fluid temperature θ_{eff} caused by this evaporation of the injected liquid results in an increase in the corrected compressor speed $N/\sqrt{\theta_{eff}}$. As indicated in figure 7, this increase in corrected compressor speed tends to increase the compressor air flow, which, together with the injected water, increases the total mass flow. In order to pass this increased mass flow through the turbine nozzles, the turbine-inlet pressure must be increased with the result that the equilibrium running condition between the turbine and compressor is obtained at a higher pressure ratio. The change from normal to augmented operation of the engine may thus be represented in figure 7 as a shift from point 1 to point 2. This increase in both the compressor pressure ratio and air flow is reflected throughout the engine as an increase in both the total mass flow and exhaust-nozzle pressure ratio, both of which increase the thrust produced.

As for the analysis of the tail-pipe-burning method of thrust augmentation, the compressor efficiency was assumed to be 0.80, the turbine efficiency was assumed to be 0.85, and the turbine-inlet temperature was maintained constant at 2000° R. A compressor pressure ratio of 4.0 was also assumed for the normal engine at sea-level altitude and a flight Mach number of 0. For all augmented conditions, as well as for the normal engine at other flight speeds

and altitudes, the compressor work input was maintained constant at the value corresponding to that of the normal engine at the condition of sea-level altitude and a flight Mach number of 0. Other necessary assumptions of inlet-diffuser efficiency, combustion-chamber pressure drop, and exhaust-nozzle velocity coefficient were also the same as for the tail-pipe-burning analysis. In addition, an ambient relative humidity of 50 percent was assumed for all cases considered.

The determination of the compressor performance for the wet-compression process involved first the evaluation of the temperature and the water content of the saturated mixture at the compressor inlet. This evaluation was accomplished by means of a psychrometric chart that was developed for wide ranges of pressure and temperature conditions. The performance of the mechanical part of the wet-compression process was then determined from a Mollier diagram for saturated air that was specifically prepared for this application and that is similar in principal to the familiar Mollier diagram for steam. By using initial conditions corresponding to the saturation temperature and water content at the compressor inlet, the compression process was traced on this diagram for the assumed values of compressor work and adiabatic efficiency; the pressure and the temperature at the end of the wet-compression process were read directly from the diagram. For conditions where the injected water was completely evaporated before the end of the compression process, the compressor performance was calculated by assuming the process consisted of two steps: (1) compression of the wet mixture as previously discussed; and (2) adiabatic compression of the gas mixture calculated according to the usual thermodynamic relations. This procedure for determining the compressor performance with injection is, in effect, equivalent to the evaluation of a new effective fluid temperature θ_{eff} for the compressor and hence the determination of the pressure ratio associated with the increased compressor corrected speed, as illustrated by point 2 of figure 7. The increase in total mass flow for the augmented condition was then calculated from consideration of the flow through the constant-area turbine nozzles for the assumed turbine-inlet temperature and the turbine-inlet pressures corresponding to the various compressor-outlet pressures. With the compressor-outlet conditions and the mass flow through the engine thus determined, the performance of the complete engine was calculated by conventional analysis of the performance of the other engine components.

1235

The fuel flow for all augmented conditions was considered to be the same as for normal-engine operation. Although an increased quantity of fuel is required to provide the additional energy for vaporization of the injected water, a practical means of providing this extra fuel has been found to be the addition of alcohol to the injected water. By using the proper mixture of water and alcohol, augmented operation may therefore be obtained with the same primary fuel flow as used in normal operation with resulting simplification of operational procedures. Insofar as the thrust augmentation is concerned, the thrust produced has also been found to be materially unaffected by the amount of alcohol in the injected mixture. The values of thrust augmentation presented herein for water injection are therefore considered applicable to either water injection alone or to the mixtures of water and alcohol that are of practical interest; values of total liquid consumption are, however, applicable only to the mixtures of water and alcohol that permit operation with the same fuel flow as normal operation.

Results and Discussion

The variation in the compressor pressure ratio, the air flow, and the augmented thrust ratio with injected water-air ratio are shown in figure 8. These results are all for conditions of sea-level altitude and a flight Mach number of 0; to illustrate the effect of inlet-air temperature, curves are shown for NACA standard air by the solid lines and for Army summer air (40° F higher than NACA standard air) by the dashed lines. As the water-air ratio is increased from 0, the condition of saturation of the air at the compressor inlet is first reached, which is indicated by the triangles on the curves. Further increases in the water-air ratio result in saturation of the air at some point during the mechanical-compression process until saturation occurs at the compressor outlet; which is indicated by the circles on the curves.

As previously discussed, the cooling effect of the evaporating water results in a continuous increase in both the compressor pressure ratio and the compressor air flow up to the point of saturation at the compressor outlet. At the point of saturation of the compressor-inlet air, the changes in compressor performance, and hence the thrust augmentation produced, are very small because the inlet air can evaporate only a small amount of water at these flight conditions. For saturation at the compressor outlet, however, the water-air ratio for NACA standard air is about 0.048, which produces an increase in pressure ratio from the normal value of 4.0 up to 4.9

and an associated increase in air flow of about 15 percent. Although the actual magnitude of both the pressure ratio and the air flow is lower at the higher air temperature, the percentage increase in both these variables with increasing water-air ratio is greater than for NACA standard air and the condition of saturation at the compressor outlet occurs at a higher water-air ratio. The augmented-thrust ratio, shown in the upper part of the figure, increases continuously with increased water-air ratio and, for saturation at the compressor outlet, reaches a value of slightly over 1.40 for NACA standard air and a value of 1.50 for Army summer air. Although the augmented-thrust ratio is greater for the higher air temperature, the actual augmented thrust produced is lower because of the lower normal thrust for this condition.

These water-air ratios are the ideal ratios for thermodynamic equilibrium between the air and the water throughout the compression process. The water-air ratios required in actual operation have been found to be somewhat higher than these ideal values and, unlike the other thrust-augmentation methods considered herein, the computed values of thrust augmentation are somewhat optimistic compared with actual experience. Although the cause of this departure of the actual process from the ideal one is not completely understood, a lack of equilibrium between the air and the water and increased losses in the compressor due to the presence of the water are probably contributing factors.

The effect of injected water-air ratio on the augmented thrust ratio is further illustrated in figure 9 for several flight Mach numbers and for altitudes of sea level and 35,000 feet. For these calculations, ambient conditions corresponding to NACA standard air were used. The salient characteristic of these curves is the large increase in both the augmented thrust ratio for a given water-air ratio and in the water-air ratio at which saturation at the compressor outlet is reached with an increase in flight Mach number. For example, at sea-level altitude, the augmented thrust ratio for compressor-outlet saturation increases from a value of 1.4 at a flight Mach number of 0 up to nearly 2.6 at a flight Mach number of 2.0 with an attendant increase in the water-air ratio from 0.048 to 0.115. For saturation at the compressor outlet, the thrust augmentation at an altitude of 35,000 feet is slightly over 0.5 times as great as at sea level and the required water-air ratios are about 0.75 times as large. Although the thrust augmentation provided by saturation of the inlet air is insignificant at a flight Mach number of 0, an appreciable amount of water may be evaporated ahead of the compressor at high Mach numbers and large increases in thrust may be thus obtained.

The specific liquid consumption (including both injected water and fuel flow) is plotted in figure 10 as a function of the injected water-air ratio for the same range of flight conditions as in figure 9. For all flight conditions, the specific liquid consumption increases almost linearly with injected water-air ratio, increases with flight Mach number, and decreases as the altitude is increased. For sea-level altitude, the specific liquid consumption for conditions of saturation at the compressor outlet increases from 3.2 to 8.8 pounds per hour per pound of thrust as the flight Mach number is increased from 0 to 2.0. At these limiting water-air ratios, increasing the altitude to 35,000 feet decreases the specific liquid consumption about 30 percent for the range of flight speeds presented. These values of specific liquid consumption at sea-level altitude are 2.9 and 5.2 times the specific fuel consumption of the normal engine for flight Mach numbers of 0 and 2.0, respectively.

WATER INJECTION INTO COMBUSTION CHAMBERS

Analysis

The effect of water injection into the combustion chambers on the engine operating conditions may also be illustrated by reference to a typical compressor-characteristic curve, as shown in figure 11. In this figure, the relation between the compressor pressure ratio and the compressor air flow is shown for one compressor speed and the surge limit of the compressor is represented by the dashed line. Point 1 is considered as the normal-engine operating point.

For conditions of choked flow through the turbine nozzles with a constant turbine-inlet temperature, the total mass flow through the engine is dependent only on the turbine-inlet pressure (neglecting the less-important effects of the thermodynamic properties of the fluid). Because of this limitation on the total mass flow, the injection of liquids into the combustion chambers tends to decrease the air flow through the compressor. This decrease in air flow, however, is accompanied by a simultaneous increase in the compressor pressure ratio, as illustrated by the compressor-characteristic curve of figure 11. Because the compressor rotor speed is constant, the new compressor operating condition may be represented by point 2 on the curve. This increase in pressure ratio, in turn, permits an increase in the total mass flow through the turbine with the result that a new equilibrium running point of the engine having a lower compressor air flow, a higher compressor pressure ratio, and a higher total mass flow is obtained. The thrust

augmentation produced therefore depends on the operating characteristics of the compressor and is a result of both the increased total mass flow and higher jet velocity provided by the increased pressure ratio. In addition to these effects, the increased gas constant and specific heat of the water-air mixtures also contribute, to a smaller degree, to an increase in the turbine-outlet pressure and hence in the jet velocity. From the diagram of figure 11, it is obvious that the amount of water that may be injected will be limited by compressor surge.

The analysis of the combustion-chamber injection method of thrust augmentation is based on a compressor having the characteristics illustrated in figure 12. These characteristics were established in a somewhat arbitrary manner from the test results of a full-scale compressor but are considered typical of current axial-flow compressors. The use of combustion-chamber injection with a compressor having an essentially flat characteristic, such as current centrifugal-flow compressors, is not considered of practical interest because of the very limited obtainable increase in pressure ratio, and hence in engine thrust. Because all engine operation is considered to be at a constant compressor speed N , the corrected speed $N/\sqrt{\theta}$ for various flight conditions is inversely proportional to the square root of the compressor-inlet temperature. The five constant-speed curves of figure 12, varying in the value of $N/\sqrt{\theta}$ from 100 percent to 74.6 percent of the rated value, thus represent the compressor operating line for flight Mach numbers of 0, 0.5, 1.0, 1.5, and 2.0 at sea level, respectively. The pressure ratio of this compressor was set at a value of 4.0 for normal operation at sea-level altitude and a flight Mach number of 0 to be consistent with the other thrust-augmentation methods considered. The normal-engine operating line for a constant turbine-inlet temperature and for flight at various Mach numbers was established from considerations of equilibrium-flow conditions between the compressor and the turbine. This operation at constant turbine-inlet temperature for a range of flight speeds (or corrected compressor speeds) may, of course, require the use of a variable-area exhaust nozzle.

In addition to the assumption of this compressor characteristic, a compressor efficiency of 0.80, a turbine efficiency of 0.85, and a turbine-inlet temperature of 2000° R were assumed. This assumption of constant compressor efficiency requires that the compressor work per pound of air, and hence the compressor slip factor, be varied as the operating point of the compressor is varied along a constant corrected-speed line. Based on a study of the actual characteristics of several axial-flow compressors, this assumption of constant efficiency is considered to be a fairly accurate idealization of

actual performance for the range of operating conditions involved in the analysis. Conversely, a slight reduction in efficiency is normally encountered when the corrected compressor speed is reduced from the design value; the error introduced in the computed thrust augmentation at the various flight speeds considered by the assumption of a constant efficiency is, however, small because both the augmented and normal thrust are affected by the compressor efficiency in about the same manner. Other assumptions of inlet-diffuser efficiency, combustion-chamber pressure drop, and exhaust-nozzle velocity coefficient were also the same as for the other thrust-augmentation cycles previously presented. For each flight condition and hence each compressor operating line of interest, the equilibrium running point between the compressor and the turbine was determined for various injection rates by graphically superimposing the compressor and the turbine flow characteristics. By using the compressor pressure ratio and air flow thus determined, the performance of the complete cycle was computed using conventional thermodynamic methods of analysis.

Results and Discussion

The variation of the compressor pressure ratio, the air flow, the total mass flow, and the augmented thrust ratio with injected water-air ratio are shown in figure 13. The simultaneous increase in the pressure ratio and the decrease in the air flow resulting from the assumed compressor characteristics is shown by the two lower curves. The assumed compressor surge line limits the injection rate to a water-air ratio of about 0.16, at which point the pressure ratio has increased to 4.65 and the air flow has decreased to about 95 percent of the normal value. The total mass flow through the engine, which is equal to the sum of the air flow, the fuel flow, and the injected water, increases from a normal value of about 1.018 times the air flow to a maximum value of 1.12 times the normal air flow, or an increase of 10 percent. The augmented thrust ratio resulting from these changes in pressure ratio and mass flow increases almost linearly with increased water-air ratio and reaches a value of 1.32 at the assumed compressor surge point.

The thrust augmentation provided by combustion-chamber injection is shown in figure 14 for a range of flight Mach numbers at sea-level altitude; performance of the compressor-inlet injection method is included for comparison. The water-air ratios and the specific liquid consumption associated with each of these two methods of injection are shown in the upper part of the figure. For each flight Mach number, the injection at the compressor inlet was assumed sufficient to saturate the air at the compressor outlet and the injection into the combustion chambers was taken as the limiting value at the compressor surge point. Although engine operation at the compressor surge point is recognized as being an impractical mode of operation, the results are presented on this basis in order to illustrate, for the assumed compressor, the limiting or maximum values of thrust augmentation obtainable.

The augmented thrust ratio obtained by combustion-chamber injection rapidly increases with flight Mach number and reaches a value of about 2.40 at a flight Mach number of 2.0. For the range of flight speeds considered, these values of augmented thrust ratio are from 6 to 12 percent lower than those obtained by injection at the compressor inlet. The water-air ratios for combustion-chamber injection also increase with increased flight speed and reach a value of about 0.28 at a Mach number of 2.0. These water-air ratios are about 3 times as great as for compressor-inlet injection at low flight speeds and about 2.5 times as great at high flight speeds. Because of the difference in augmented air flows for the two methods, however, the actual water-injection rates are roughly 2 times as great for the combustion-chamber-injection method as for the compressor-inlet-injection method.

The specific liquid consumption for combustion-chamber injection increases from a value of about 8 pounds per hour per pound of thrust at a Mach number of 0 to about 15 pounds per hour per pound of thrust at a flight Mach number of 2.0. These values of specific liquid consumption are 2.4 and 1.7 times as great as for compressor-inlet injection and about 7.0 and 8.9 times the specific fuel consumption of the normal engine for flight Mach numbers of 0 and 2.0, respectively.

BLEEDOFF

Analysis

In the bleedoff cycle of thrust augmentation, the secondary combustion or dilution air, which is normally required to prevent the turbine-inlet temperature from exceeding permissible values, is bled off from the combustion chambers (or compressor outlet) and ducted to an auxiliary combustion chamber where it is burned to a high temperature and discharged through an auxiliary exhaust nozzle. This air that is bled off is replaced with water that vaporizes in the combustion chamber and passes through the turbine as steam. Thus, in essence, the dilution air is replaced with steam and at the same time a high-pressure air supply for an auxiliary jet is made available. The injection of water into the compressor inlet, as previously discussed, is also considered as a part of the bleedoff cycle of operation in order to take advantage of the increased compressor pressure ratio and air flow obtained by this method. A schematic diagram of a turbojet engine equipped for thrust augmentation by the bleedoff method is presented in figure 15. This bleedoff engine may be considered as consisting of two main components, the normal (primary) turbojet engine, which is fitted with a bleedoff manifold and the necessary water-injection nozzles, and an auxiliary (or secondary) engine that consists essentially of the auxiliary combustion chamber and exhaust nozzle. A shut-off valve is provided in the ducting connecting these two engines, which is maintained in the open position for bleedoff operation and may be closed to return the engine to normal operating conditions.

The analysis of the bleedoff cycle of thrust augmentation was made for two different types of compressor characteristic. One of these characteristics was similar to that of the typical axial-flow compressor assumed for the combustion-chamber-injection analysis and the other was typical of current centrifugal-flow compressors. These two characteristics, together with the assumed surge limits, are illustrated in figure 16. The particular values of pressure ratio and air flow shown in this figure will be discussed in a subsequent paragraph. For convenience in terminology, engines having these two types of compressor shall be denoted as the axial-flow-type and centrifugal-flow-type engines.

For each type of engine, several modes of operation are possible depending on the manner in which the area of the exhaust nozzle on the primary engine is permitted to vary. For the present analysis, the performance of both the axial- and centrifugal-flow engines was determined for both a constant- and a variable-area exhaust nozzle. For the case of the variable-area nozzle, the area was selected as the value that provided the largest combined thrust of the primary and secondary engine for a given total liquid consumption or, conversely, the minimum liquid consumption for a given total thrust. This mode of operation shall be considered as occurring with an optimum-area exhaust nozzle. In addition to the preceding four cases, results are also presented for a variation of the exhaust-nozzle area that provides a constant compressor air flow, and hence constant pressure ratio, for all conditions of bleedoff operation. This operation at a single compressor operating point, which shall be designated the constant air-flow case, is considered of interest because the results will be applicable to engines having any type of compressor characteristic.

For the axial-flow engine, the compressor efficiency was assumed to be constant at a value of 0.80, which, as previously discussed in connection with the combustion-chamber-injection analysis, results in a variation of the compressor slip factor, and hence in the compressor work, as the operating point of the compressor is varied. For the centrifugal-flow engine, however, the compressor efficiency was assumed to be 0.80 only at the point of zero bleed-off and for all other conditions was varied to satisfy conditions of constant slip factor. This assumption of constant efficiency for the axial-flow compressor and constant slip factor for the centrifugal-flow compressor was based on a study of the actual characteristics of several typical compressors and is considered to be a fairly accurate idealization of the characteristics of each type of compressor over the range of operating conditions involved in the present analysis. For all calculations, the turbine efficiency was assumed to be 0.85 and the turbine-inlet temperature was maintained constant at 2000° R. The injection rate at the compressor inlet was assumed to be sufficient to maintain a constant water-air ratio of 0.03, except for one example in which it was increased sufficiently to obtain saturated air at the compressor outlet. The fuel flow to the primary engine was obtained for the various combustion-chamber water-air ratios and temperature rises from the charts of reference 2. The secondary-engine fuel-air ratio was assumed to be stoichiometric for all conditions presented and the effects of dissociation were considered in the determination of the outlet gas temperature. The combustion efficiency of both the primary and secondary engines was assumed to be 0.95. The pressure

1235

loss in the bleedoff ducting was taken the same as the pressure drop in the primary combustion chambers; that is, the total pressure at the secondary-engine inlet was the same as the turbine-inlet pressure. The velocity coefficient of both the constant- and variable-area exhaust nozzles on the primary engine, as well as the exhaust nozzle of the secondary engine, was assumed to be 0.975. The maintainance of these assumed operating conditions implies that the proper size of exhaust nozzle is provided on the secondary engine for the specified flow conditions at every operating point. All calculations were made for a flight Mach number of 0 and sea-level altitude.

The compressor pressure ratio and compressor mass flow for injection at the compressor inlet were first determined by the compressor-inlet-injection analysis previously presented; by using these values as the normal operating point of the compressor, the desired compressor-characteristic line to be used for various bleed-off and combustion-chamber-injection rates was drawn through this point. For an inlet injection of a water-air ratio of 0.03, the pressure ratio is 4.65 and the compressor mass flow (air flow plus inlet water injection) is about 1.15 times the normal air flow. As illustrated in figure 16, this operating point is common to both compressor characteristics. The range of air flow and pressure ratio illustrated by the extent of the lines in figure 16 represents the range of compressor operating conditions accompanying the range of bleedoff and injection conditions covered by the analysis.

Various values of bleedoff flow and combustion-chamber-injection rates were then assumed (requiring variations in the exhaust-nozzle area) and, for each pair of values, the relation between turbine-inlet pressure (also compressor-outlet pressure) and compressor mass flow was established from the flow conditions through the choked turbine nozzles. This relation between compressor-outlet pressure and mass flow based on the turbine characteristics was superimposed on the desired compressor characteristics; the equilibrium engine operating condition for the assumed bleedoff and water-injection flows was determined by the intersection of the two curves. The compressor work, the turbine work, and hence the turbine-outlet conditions and the primary-engine thrust, as well as the secondary-engine thrust, were computed by conventional thermodynamic methods of analysis.

The preceding method was repeated for wide ranges of both bleedoff flow and combustion-chamber-injection rate and, for each case, both the various parameters of engine performance and the primary-engine exhaust-nozzle size were determined. Plots of the engine-performance variables against exhaust-nozzle size were then made from which cross plots for either the constant-area nozzle or the desired type of area variation could be made. The constant-area exhaust nozzle was, of course, of the same area as for normal or unaugmented engine operation. A check calculation was also made, which indicated that the exhaust-nozzle area for inlet injection alone at a water-air ratio of 0.03 was also the same as for normal operation. The results of the present bleedoff analysis at the point of zero bleedoff therefore correspond with the results of the inlet-injection analysis previously presented at a water-air ratio of 0.03.

Results and Discussion

Bleedoff and water-injection rates. - The relation between the bleedoff flow rate and the water-injection rate into the primary-engine combustion chambers for both the axial- and centrifugal-flow-type engine is shown in figure 17. Both the bleedoff flow and the injection rate are presented as a ratio of the flow rate to the air flow of the normal, or unaugmented engine, and shall be designated the water-injection ratio and bleedoff-flow ratio, respectively. For the constant-area exhaust nozzle, presented in figure 17(a), the required water-injection rate increases almost linearly with an increase in bleedoff flow for both the axial- and centrifugal-flow-type engines. The amount of water injection required, however, is considerably greater for the centrifugal-flow engine than for the axial-flow engine with about 0.6 pound of water required to replace each pound of bleedoff air for the centrifugal-flow engine as compared to only 0.4 pound of water per pound of air for the axial-flow engine. For both engines, the maximum operable bleedoff flow is reached when the fuel-air ratio in the primary-engine combustion chamber becomes stoichiometric. These maximum bleedoff flow ratios, shown by the end points of the curves, are about 0.48 and 0.65 for the centrifugal- and axial-flow engines, respectively.

The performance with the optimum-area exhaust nozzle for each type of engine, as well as the condition of constant air flow, is presented in figure 17(b). The variation in the exhaust-nozzle area for each case is also included in the upper part of the figure. With the optimum-area exhaust nozzle, the relation between the bleedoff-flow rate and the water-injection rate is similar for

both types of engine, with somewhat lower bleedoff flows being obtained with the centrifugal-flow engine than with the axial-flow engine. With both types of engine, a considerable amount of air can be bled off without injection into the combustion chambers (with increases in the exhaust-nozzle area), representing the optimum conditions of minimum liquid consumption. A further increase in thrust, however, requires water injection with the amount increasing in approximately direct proportion to the bleedoff flow, as illustrated by the rising portion of the curves. At the maximum bleedoff-flow ratios of 0.5 for the centrifugal-flow engine and 0.57 for the axial-flow engine, the fuel-air ratio in the primary-engine combustion chamber becomes stoichiometric. Further increases in thrust are, however, possible by reducing the bleedoff flow to provide the primary engine with more air and making up the resulting decrease in secondary-engine thrust by increasing the water injection in the primary engine, as illustrated by the uppermost portion of the curves. This decrease in bleedoff flow and increased injection rate shifts the compressor operating point to higher pressure ratios until the limiting condition of compressor surge is reached at a bleedoff-flow ratio of 0.39 for the centrifugal-flow engine and 0.23 for the axial-flow engine. At this limiting condition, approximately 0.85 pound of water is required for each pound of air that is bled off for the centrifugal-flow engine and about 1.60 pounds of water per pound of air are required for the axial-flow engine. The apparent anomaly of the optimum-area nozzle requiring greater water-injection rates than the constant-area nozzle (see fig. 17(a)) for a given bleedoff-flow ratio in the region of high bleedoff flows is explained by the correspondingly greater thrust provided by the primary engine under these conditions, as will be illustrated later.

For the case of constant compressor air flow, about 0.75 pound of water is required to replace each pound of bleedoff air. Because both the compressor air flow and the turbine-inlet pressure and temperature are constant for this condition, the replacement of water for air in the primary combustion chambers differs from a direct 1:1 ratio only because of the changing thermodynamic properties of the mixture passing through the turbine. The maximum bleedoff-flow ratio for these conditions, which occurs at stoichiometric fuel-air ratio, is about 0.415.

The variation in size of the optimum-area exhaust nozzle, shown in the upper part of the figure, is within about 10 percent of either side of the normal area for both types of engine over the range of operable bleedoff flows. During the phase of bleedoff without water injection, an increase in the nozzle size is necessary to prevent an increase in the turbine-inlet temperature. With an increase in

water injection accompanying the increased bleedoff, however, the nozzle size is decreased because both the turbine-inlet pressure is increased and the pressure drop across the turbine is decreased by the water injection. For the constant-air-flow condition, the exhaust-nozzle area decreases almost linearly with increased bleedoff flow and reaches a value of about 0.95 times the normal area at the maximum operable bleedoff flow. This variation in nozzle area is a result of the decrease in both exhaust mass flow and turbine pressure ratio caused by the changing thermodynamic properties of the working fluid.

Performance of primary engine. - The variation of both the total liquid flow and the thrust of the primary engine with bleedoff flow is presented in figure 18(a) and 18(b) for the constant- and variable-area exhaust nozzles, respectively. For all operating conditions presented, the total liquid flow exhibits characteristics very similar to those of the combustion-chamber-injection flow illustrated in figure 17 because the other liquid flows involved (fuel flow and inlet-injection flow) are approximately constant and of relatively smaller magnitude. At zero bleedoff flow, the liquid flow is about 5.8 percent of the normal engine air flow, which consists of the engine fuel flow and the compressor-inlet injection. For the constant-area exhaust nozzles (fig. 18(a)), the liquid flow increases almost linearly with increased bleedoff flow and reaches values of approximately 39.0 and 30.0 percent of the normal air flow at the maximum bleedoff conditions for the centrifugal- and axial-flow engines, respectively. The maximum liquid flows for the optimum-area exhaust nozzles (fig. 18(b)) are 41 and 46 percent of the normal air flow for the centrifugal- and axial-flow engines, respectively, at which condition the primary-engine combustion chambers are operating stoichiometrically and the compressors are operating at the surge limit.

The primary-engine thrust with the constant-area exhaust nozzle (upper part of fig. 18(a)) decreases approximately linearly as the bleedoff flow is increased for the axial-flow engine and is nearly constant for the centrifugal-flow engine. For the axial-flow engine, the thrust varies from 1.28 times the normal thrust at zero bleedoff (effect of inlet injection alone) to about 0.75 times the normal thrust at the maximum bleedoff-flow ratio of 0.65. In spite of this decrease in primary-engine thrust, the utilization of the bled air in the secondary engine results in an increasing total thrust output, as will be illustrated later. The much larger reduction in thrust with bleedoff flow for the axial-flow engine than for the centrifugal-flow engine is a direct result of a shift in the operating point of the axial-flow compressor to lower pressure ratios as the bleedoff flow is increased, as compared with the approximately

constant pressure-ratio characteristics of the centrifugal-flow compressor. The resulting reduction in turbine-inlet pressure tends to reduce the engine thrust by the combined effects of the reduced pressure itself, a lower mass flow through the turbine, and an increase in the work per pound of fluid that must be extracted by the turbine.

For the optimum-area exhaust nozzle (fig. 18(b)), the thrust of both the centrifugal- and axial-flow engine decreases very rapidly with increased bleedoff flow in the region of low bleedoff and zero water injection because of the attendant decrease in mass flow and turbine-outlet pressure, as previously discussed. Although these values of thrust with the optimum-area exhaust nozzle are lower than with the constant-area nozzle (fig. 18(a)) in the region of low bleedoff flows, they will be subsequently shown to be superior operating conditions. For bleedoff-flow ratios greater than about 0.3 (fig. 18(b)), the thrust of both engines increases slightly with increased bleedoff flow because the air that is bled off is almost exactly replaced by the water injection and the higher values of the gas constant and specific heat of the water-air mixture passing through the turbine results in a slight increase in the turbine-outlet pressure. After stoichiometric combustion is reached in the primary combustion chamber (at the maximum bleedoff-flow ratios), the thrust increases very rapidly because the bleedoff flow is decreasing and the injection flow is increasing, both of which increase the total mass flow through the engine.

For the constant-air-flow condition, the thrust increases slightly with increased bleedoff flow because of the decrease in the turbine pressure ratio, and hence the increase in the turbine-outlet pressure and jet velocity, as previously discussed.

Performance of secondary engine. - The thrust and total liquid (fuel) flow of the secondary engine is shown for the same range of bleedoff flows in figure 19 for the axial- and centrifugal-flow engines and for the constant- and variable-area exhaust nozzles. Because the secondary engine was assumed to be operating at stoichiometric fuel-air ratio, the liquid-flow curve is simply a straight line with a slope of about 0.068. The thrust increases approximately linearly with bleedoff flow at about the same rate for all the various engine and exhaust-nozzle types considered and varies from 0 at zero bleedoff to a maximum value of 1.3 times the thrust of the normal engine at the maximum bleedoff-flow ratio of 0.65 (axial-flow engine with constant-area exhaust nozzle). For bleedoff-flow ratios of slightly less than 0.5, the secondary-engine thrust is the same as the normal-engine thrust. The somewhat smaller thrust

per pound of bleedoff flow for the axial-flow engine as compared with the centrifugal-flow engine is a result of the lower compressor-outlet pressure of the axial-flow engine at high bleed-off flows and hence lower inlet pressure to the secondary engine.

Performance of complete engine. - The performance of the complete engine is shown in figure 20 as a plot of the augmented thrust ratio against the augmented liquid ratio (ratio of total liquid flow to normal fuel flow). An auxiliary abscissa scale of the ratio of total liquid flow to normal air flow is included for reference. Five curves are shown in this figure, which represent the performance of both the centrifugal- and axial-flow engines, each with constant- and optimum-area exhaust nozzles, and the case of constant compressor air flow. The specific liquid consumption, which is equal to the augmented liquid ratio divided by the augmented thrust ratio times the normal specific fuel consumption of the engine, is shown by the straight lines superimposed on the thrust curves. The occurrence of stoichiometric fuel-air ratio in the primary-engine combustion chamber and of compressor surge are also noted wherever applicable by the circle and triangle symbols, respectively. The square symbol represents the condition of sufficient injection at the compressor inlet to saturate the air at the compressor outlet for the constant-air-flow case. The condition of zero bleedoff is represented by the point where all five curves became coincident at an augmented thrust ratio of 1.28 and an augmented liquid ratio of 3.30

For all five cases considered, the augmented thrust ratios at a given augmented liquid ratio are of about the same magnitude and, except in the region of maximum liquid ratios with optimum-area exhaust nozzles, increase in an approximately linear manner with an increase in the augmented liquid ratio above the point of zero bleed-off. For augmented liquid ratios greater than about 1.2, the augmented thrust ratio is slightly higher for the centrifugal-flow engine than for the axial-flow engine for both types of exhaust nozzle. This superior performance of the centrifugal-flow engine, which is in opposition to the results obtained by combustion-chamber injection alone, is, as previously discussed, a result of the approximately constant-pressure-ratio characteristics of this compressor over the operable range of bleedoff flows as compared with the decreased pressure ratio of the axial-flow compressor with increased bleedoff flow. For both the centrifugal- and axial-flow engines, the augmented thrust ratios are about the same with both the constant- and optimum-area exhaust nozzles for most of the operating range but, for the axial-flow engine, operation at higher augmented liquid ratios are possible with the optimum-area exhaust nozzle. Thus, for all operating conditions for the centrifugal-flow engine and for augmented thrust ratios below about 2.0 for the

axial-flow engine, using a variable-area exhaust nozzle is of little advantage; the principal advantage of the variable-area nozzle is that, for the axial-flow engine, a higher maximum value of thrust augmentation may be reached.

For the axial-flow engine with the constant-area exhaust nozzle, the maximum augmented thrust ratio is slightly over 2.0 and the associated augmented liquid ratio is about 19. With the optimum-area exhaust nozzle on this engine, the maximum augmented thrust ratio is slightly over 2.2 when the augmented liquid ratio is about 25. For the centrifugal-flow engine, the maximum augmented thrust ratio is about 2.3 at an augmented liquid ratio of nearly 24 for both the constant- and optimum-area exhaust nozzles.

The condition of constant air flow, which requires a variable-area exhaust nozzle, results in engine performance that is very nearly the same as that of the optimum-area nozzle on the axial-flow engine. The maximum augmented thrust ratio for this condition of operation, which can be obtained with any type of compressor characteristic, is slightly over 2.2. A comparison of this curve with the square symbol indicates that, at a given augmented liquid ratio, an increase in the water injection at the compressor inlet from a water-air ratio of 0.03 to that required for saturation at the compressor outlet (0.0481) resulted in an increase of only slightly over 1 percent in the augmented thrust ratio. At the maximum operating condition, the specific liquid consumption varies from 10.5 pounds per hour per pound of thrust for the axial-flow engine with the constant-area exhaust nozzle up to about 13 pounds per hour per pound of thrust for this engine with the optimum-area exhaust nozzle. The specific liquid consumption of this method of thrust augmentation at the maximum operating condition is thus from 9.5 to 12 times the specific fuel consumption of the normal engine.

These maximum values of augmented thrust ratio, which are for a flight Mach number of 0 and sea-level altitude, are considerably higher than are possible by any of the other thrust-augmentation methods presented. Thus, the method of air bleedoff provides very large take-off thrust augmentation but at the expense of high rates of liquid consumption. The practical attainment of these high values of thrust augmentation requires, however, that combustion be maintained in the engine combustion chambers at high fuel-air ratios and for relatively high rates of water injection.

SUMMARY OF RESULTS

The following results were obtained from a theoretical investigation of the application of tail-pipe-burning, water-injection, and bleedoff methods of thrust augmentation for turbojet engines representative of current design practices and operating conditions:

1. Tail-pipe burning. - In order to obtain high thrust augmentation and to minimize the loss in normal-engine performance during nonburning operation arising from pressure losses in the burner, the tail-pipe burner should have a low burner-inlet velocity, a low burner drag, and a high diffuser efficiency (especially for engines having a high turbine-outlet velocity). For a typical tail-pipe-burner design, the ratio of augmented to normal thrust for sea-level operation increased with flight Mach number from a value of nearly 1.5 at a flight Mach number of 0 to over 3.0 at a Mach number of 2.0. The thrust augmentation was comparatively unaffected by altitude at subsonic flight speeds but decreased appreciably as the altitude was increased from sea level to 35,000 feet at high supersonic speeds. The total specific fuel consumption during tail-pipe-burning operation at sea-level altitude was 2.2 times the normal consumption at a flight Mach number of 0 and about 1.4 times the normal consumption at a Mach number of 2.0.

2. Water injection. - With water injection into the compressor inlets, the evaporative cooling of the air resulted in an increase in the corrected compressor speed and an associated increase in both the compressor pressure ratio and air flow. The thrust augmentation produced increased considerably with increased flight Mach number and decreased with increasing altitude. With sufficient water injection to saturate the air at the compressor outlet, the ratio of augmented to normal thrust at sea level increased from 1.4 at a flight Mach number of 0 to nearly 2.6 at a Mach number of 2.0 with an attendant increase in the water-air ratio from 0.048 to 0.115. The total specific liquid consumption for these conditions of operation was 2.9 and 5.2 times the specific fuel consumption of the normal engine for flight Mach numbers of 0 and 2.0, respectively. The injection of water into the combustion chamber was shown to cause a shift in the compressor operating point to a higher pressure ratio, which in turn increased the total mass flow through the turbine. The maximum thrust augmentation produced by combustion-chamber injection for an engine having compressor characteristics typical of an axial-flow compressor was slightly less than that obtained by compressor-inlet injection; specific liquid consumption was about 2 times as great.

1235

3. Bleedoff. - The ratio of augmented to normal thrust obtained by the bleedoff method increased almost linearly with total liquid flow for both axial- and centrifugal-flow-type engines and was the highest of the three systems studied. For the centrifugal-flow-type engine, which had a relatively flat compressor characteristic, the maximum augmented thrust at a flight Mach number of 0 and sea-level altitude was about 2.3 times the normal thrust with either a constant-area exhaust nozzle or a variable-area exhaust nozzle set at the optimum area. For the axial-flow engine, which had a steep compressor-characteristic curve, the maximum augmented thrust at these flight conditions was slightly over 2.0 times the normal thrust with a constant-area exhaust nozzle and about 2.2 times the normal thrust with a variable-area exhaust nozzle (at optimum area). The total specific liquid consumption at these maximum operating conditions was from 9.5 to 12 times the specific fuel consumption of the normal engine. These high values of thrust augmentation were thus obtained at the expense of very high rates of liquid consumption and require that stoichiometric combustion be maintained in the engine combustion chambers.

Lewis Flight Propulsion Laboratory,
National Advisory Committee for Aeronautics,
Cleveland, Ohio, September 2, 1949.

REFERENCES

1. Bohanon, H. R., and Wilcox, E. C.: Theoretical Investigation of Thrust Augmentation of Turbojet Engines by Tail-Pipe Burning. NACA RM E6102, 1947.
2. Turner, L. Richard, and Bogart, Donald: Constant-pressure Combustion Charts Including Effects of Diluent Addition. NACA Rep. 937, 1949.

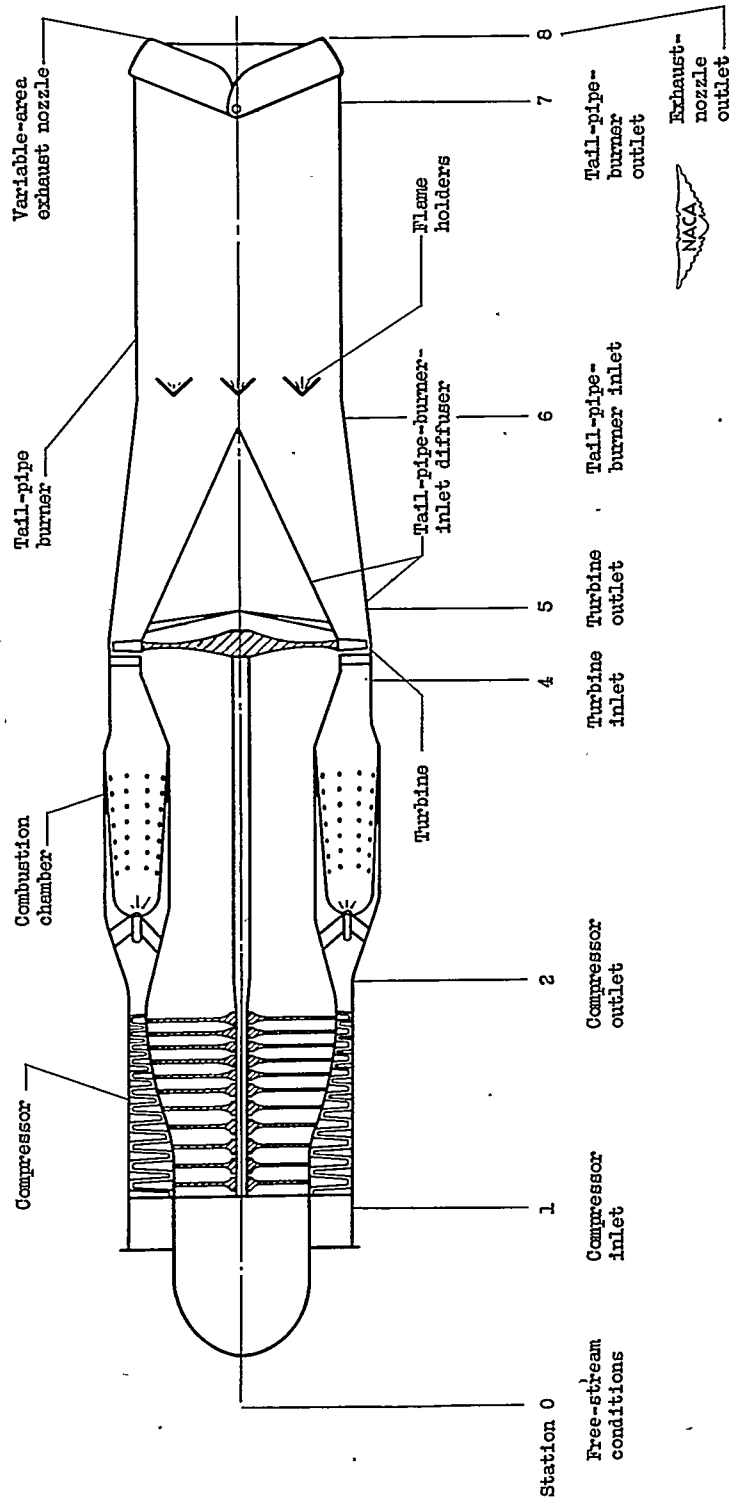

Figure 1. Schematic diagram of turbojet engine equipped for tail-pipe burning.

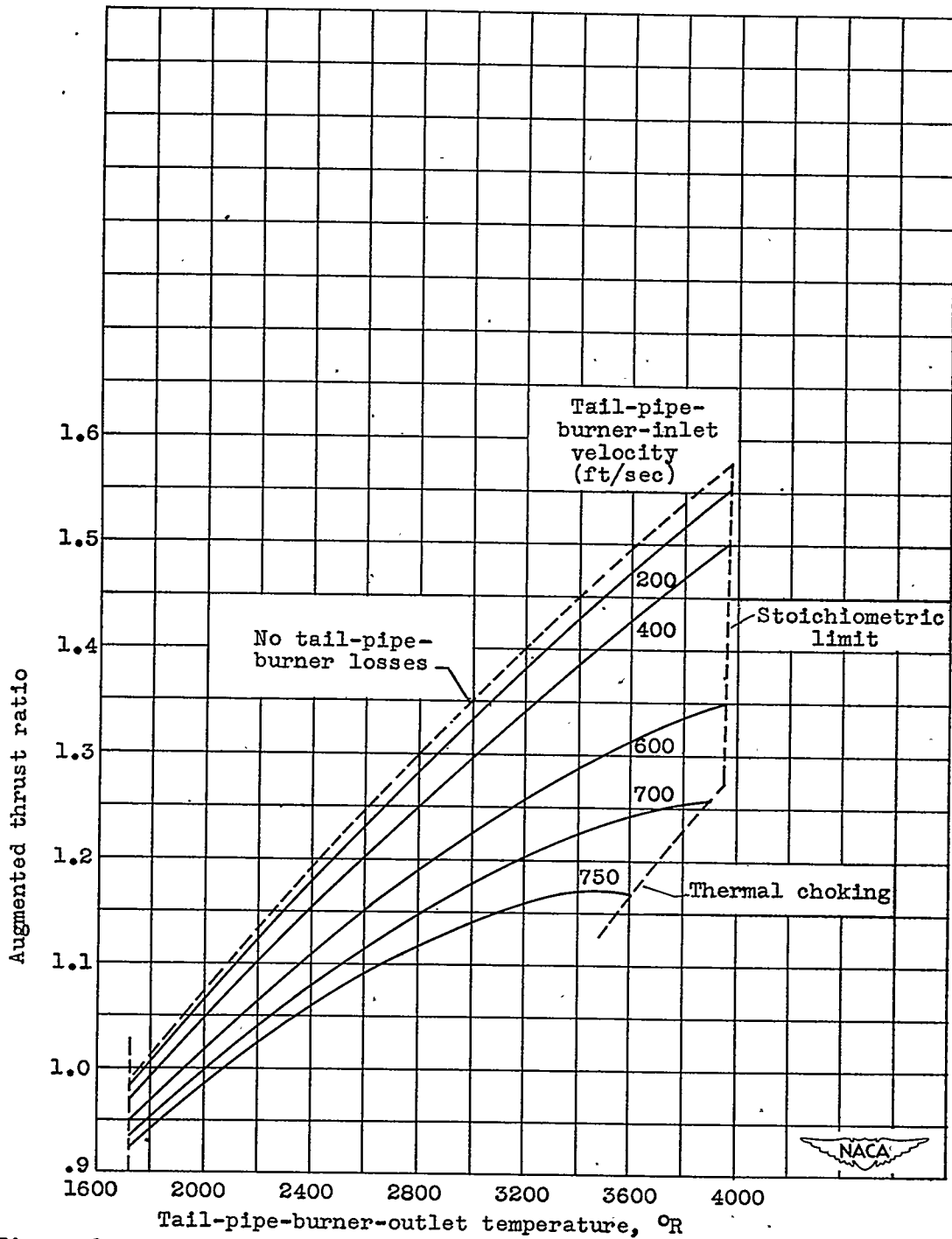

Figure 2. - Variation of augmented thrust ratio obtained by tail-pipe burning with tail-pipe-burner-outlet temperature for various tail-pipe-burner-inlet velocities. Turbine-outlet velocity, 750 feet per second; tail-pipe-burner-inlet diffuser efficiency, 0.80; tail-pipe-burner drag coefficient, 1.0; flight Mach number, 0; altitude, sea level.

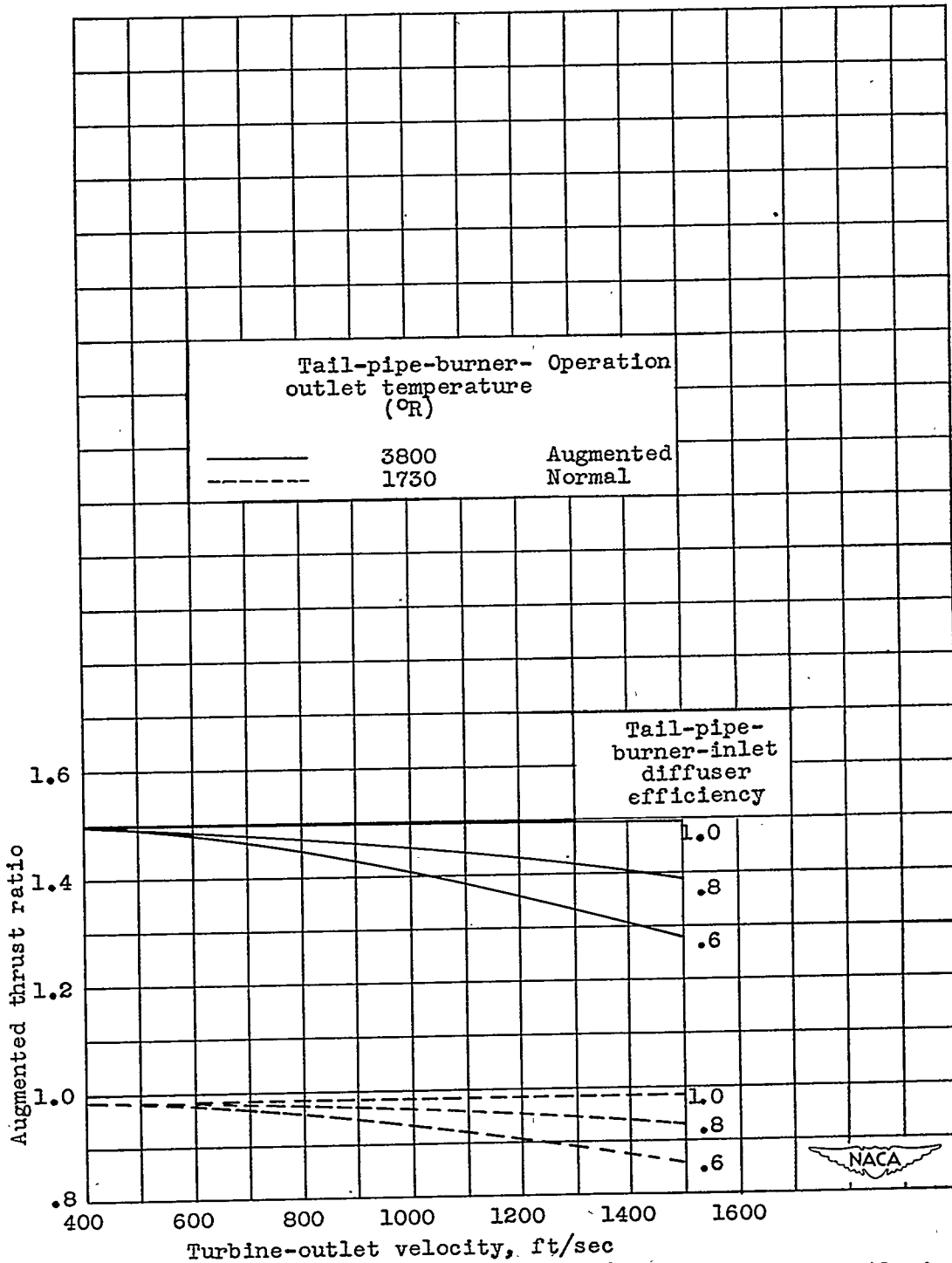

Figure 3. - Variation of augmented thrust ratio obtained by tail-pipe burning with turbine-outlet velocity for various tail-pipe-burner-inlet diffuser efficiencies for normal and augmented operation. Tail-pipe-burner-inlet velocity, 400 feet per second; tail-pipe-burner drag coefficient, 1.0; flight Mach number, 0; altitude, sea level.

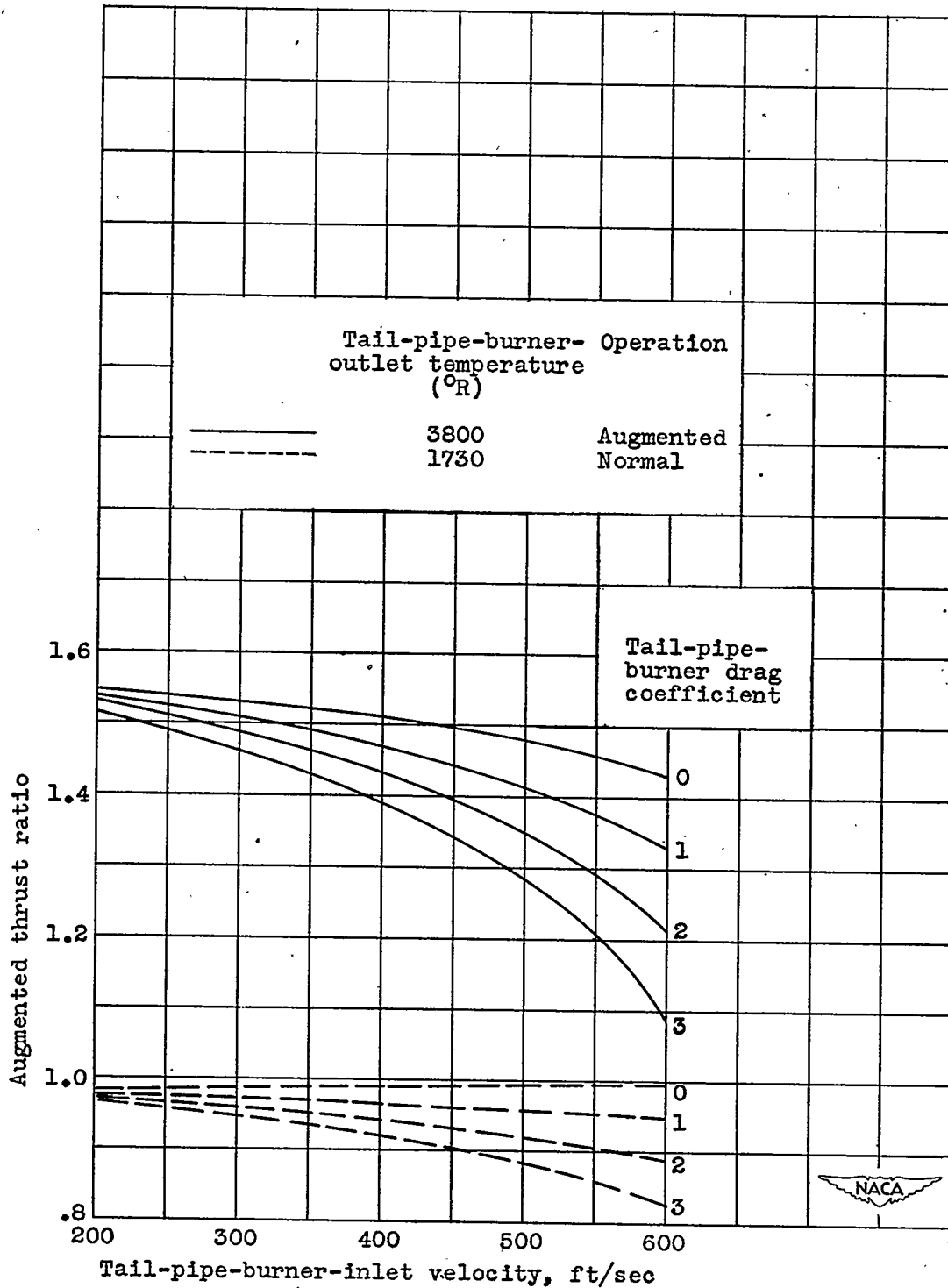

Figure 4. - Variation of augmented thrust ratio obtained by tail-pipe burning with tail-pipe-burner-inlet velocity for various tail-pipe-burner drag coefficients for normal and augmented operation. Turbine-outlet velocity, 750 feet per second; tail-pipe-burner-inlet diffuser efficiency, 0.80; flight Mach number, 0; altitude, sea level.

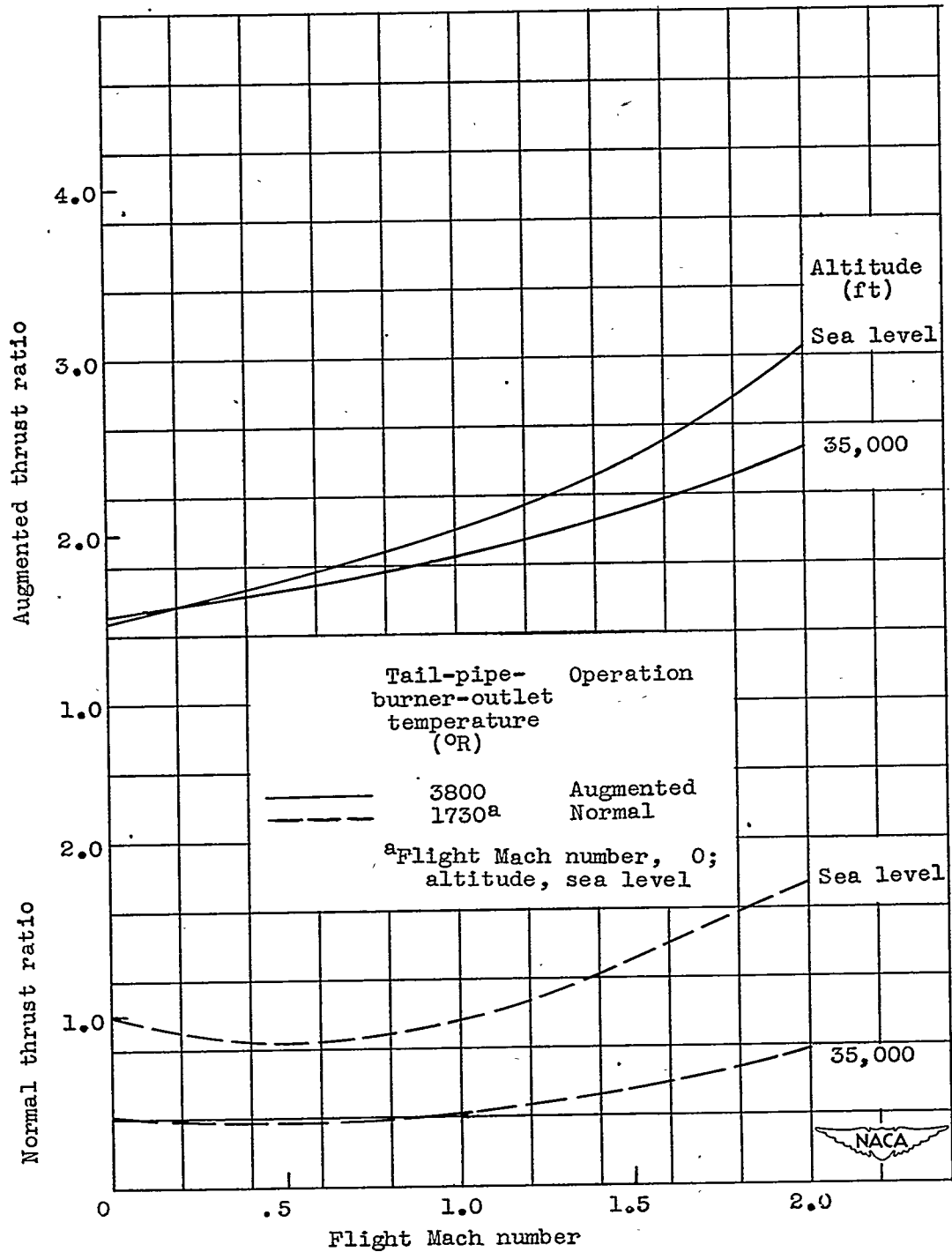

Figure 5. - Variation of normal thrust ratio and augmented thrust ratio obtained by tail-pipe burning with flight Mach number. Turbine-outlet velocity, 750 feet per second; tail-pipe-burner-inlet velocity, 400 feet per second; tail-pipe-burner-inlet diffuser efficiency, 0.80; tail-pipe-burner drag coefficient, 1.0.

1235

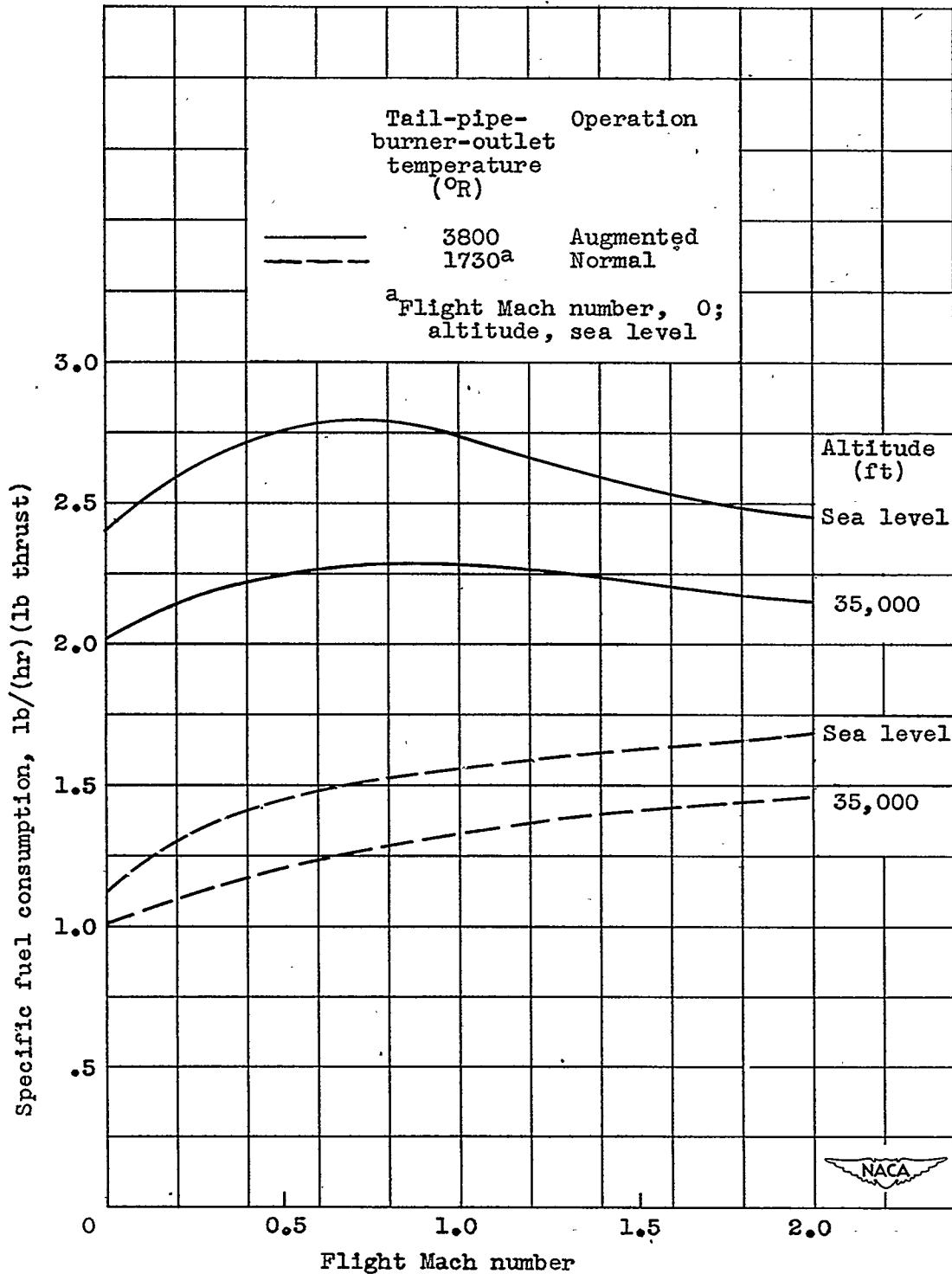

Figure 6. - Variation of specific fuel consumption with flight Mach number for normal and augmented operation with tail-pipe burning. Turbine-outlet velocity, 750 feet per second; tail-pipe-burner-inlet velocity, 400 feet per second; tail-pipe-burner-inlet diffuser efficiency, 0.80; tail-pipe-burner drag coefficient, 1.0.

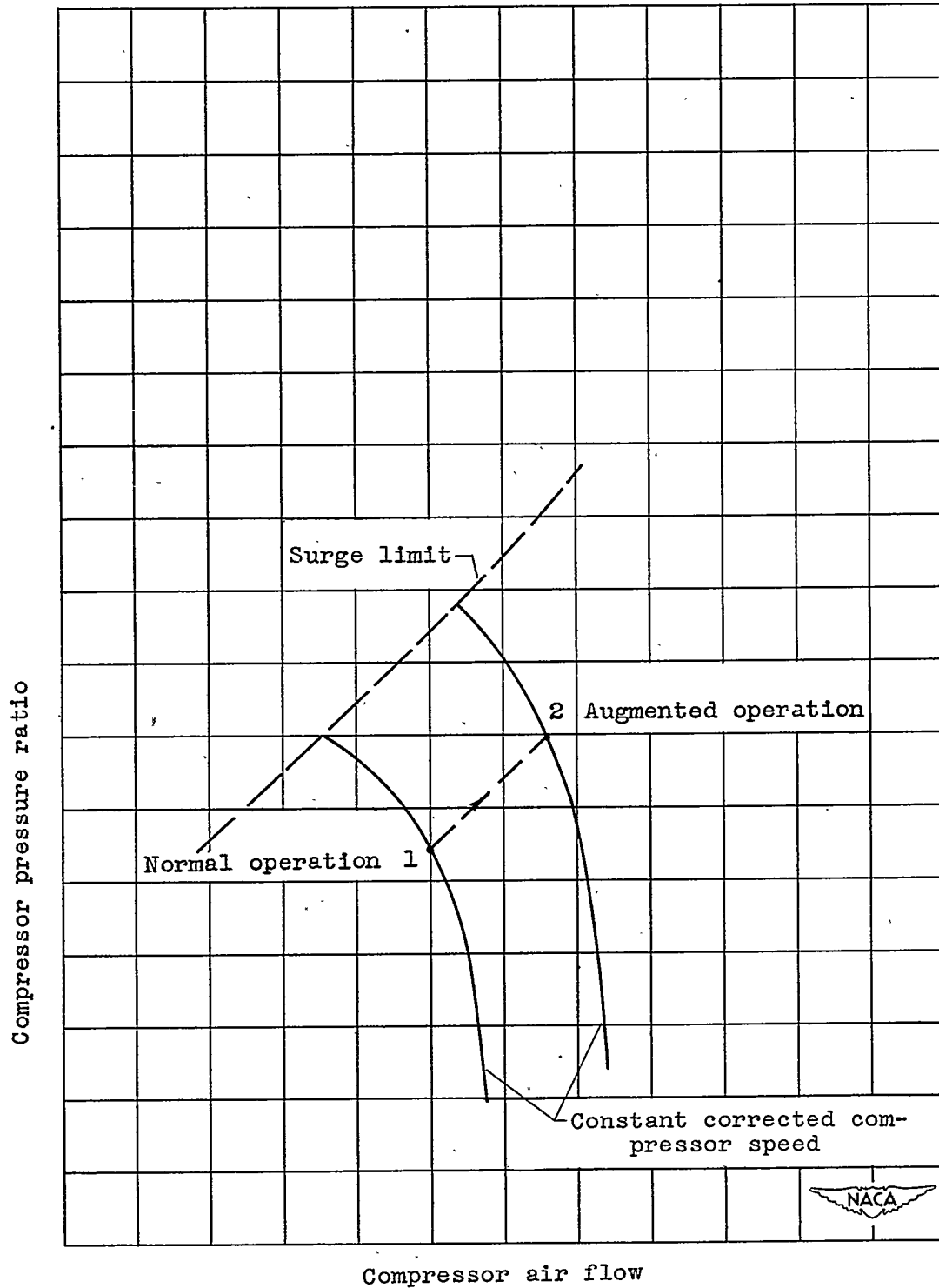

Figure 7. - Typical compressor characteristics illustrating effect of water injection at compressor inlet on compressor operating point.

1235

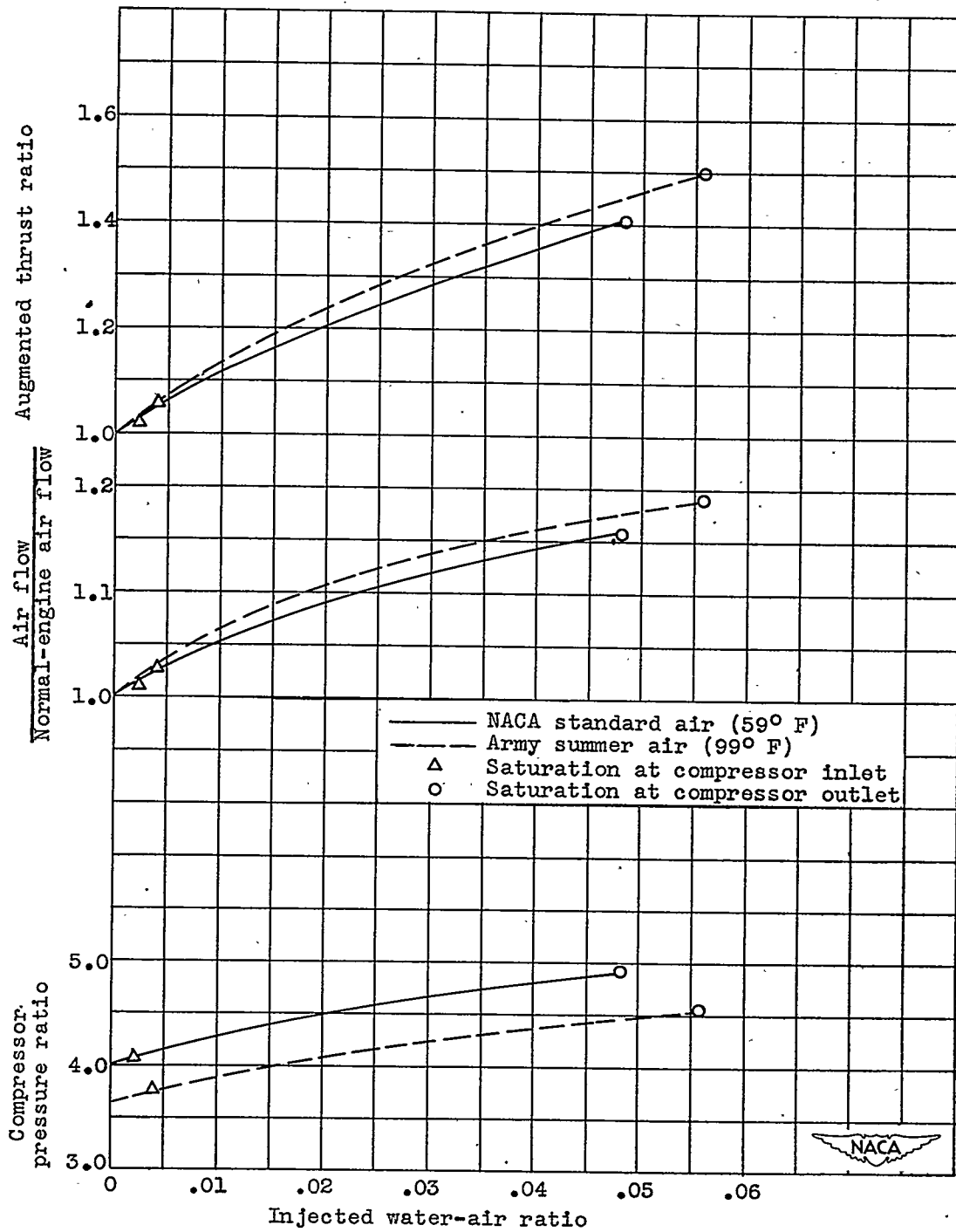

Figure 8. - Variation of compressor pressure ratio, air flow, and augmented thrust ratio with water-air ratio for injection at the compressor inlet for NACA standard air and Army summer air. Flight Mach number, 0; altitude, sea level.

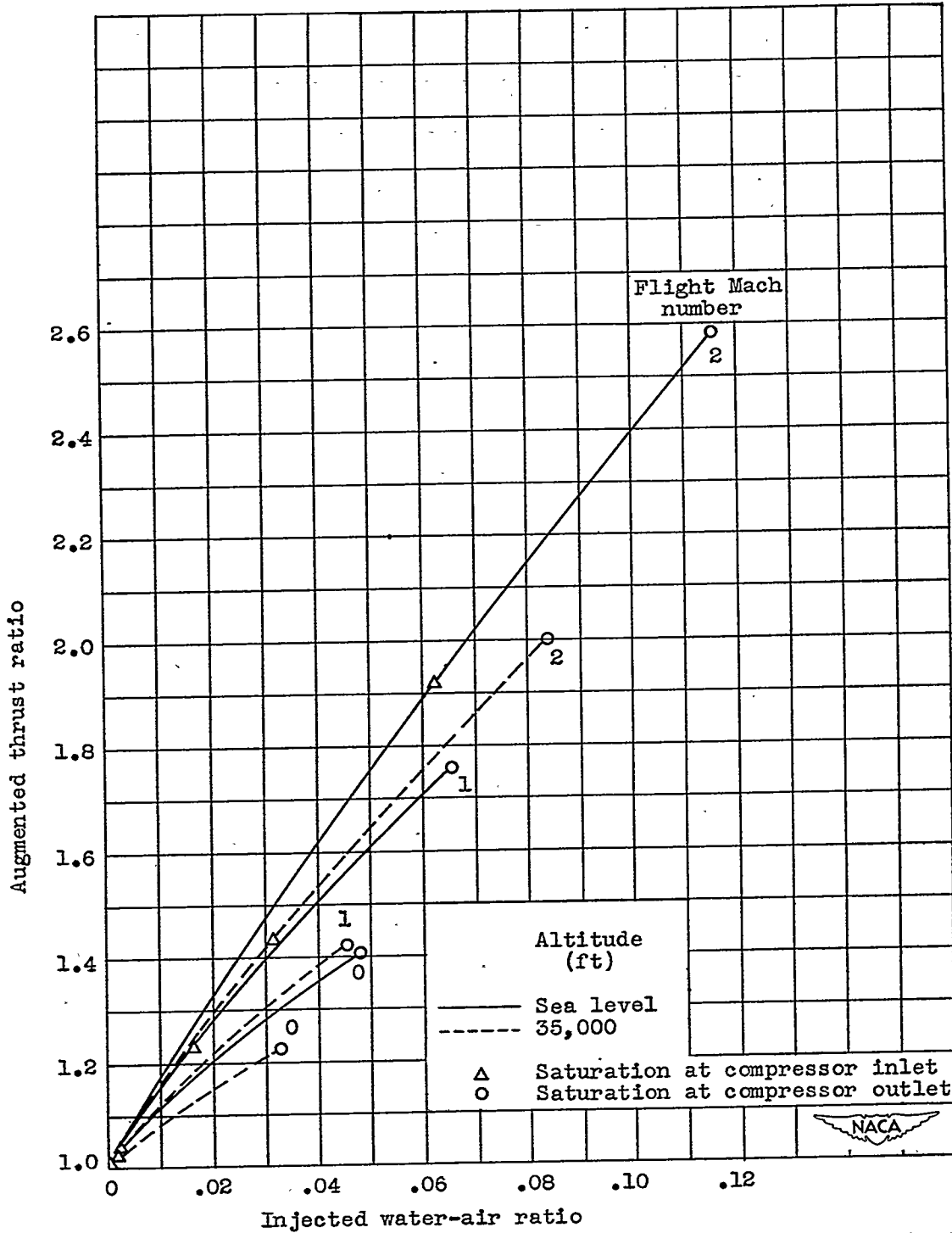

Figure 9. - Variation of augmented thrust ratio with water-air ratio for injection at the compressor inlet at various flight Mach numbers and altitudes with NACA standard air.

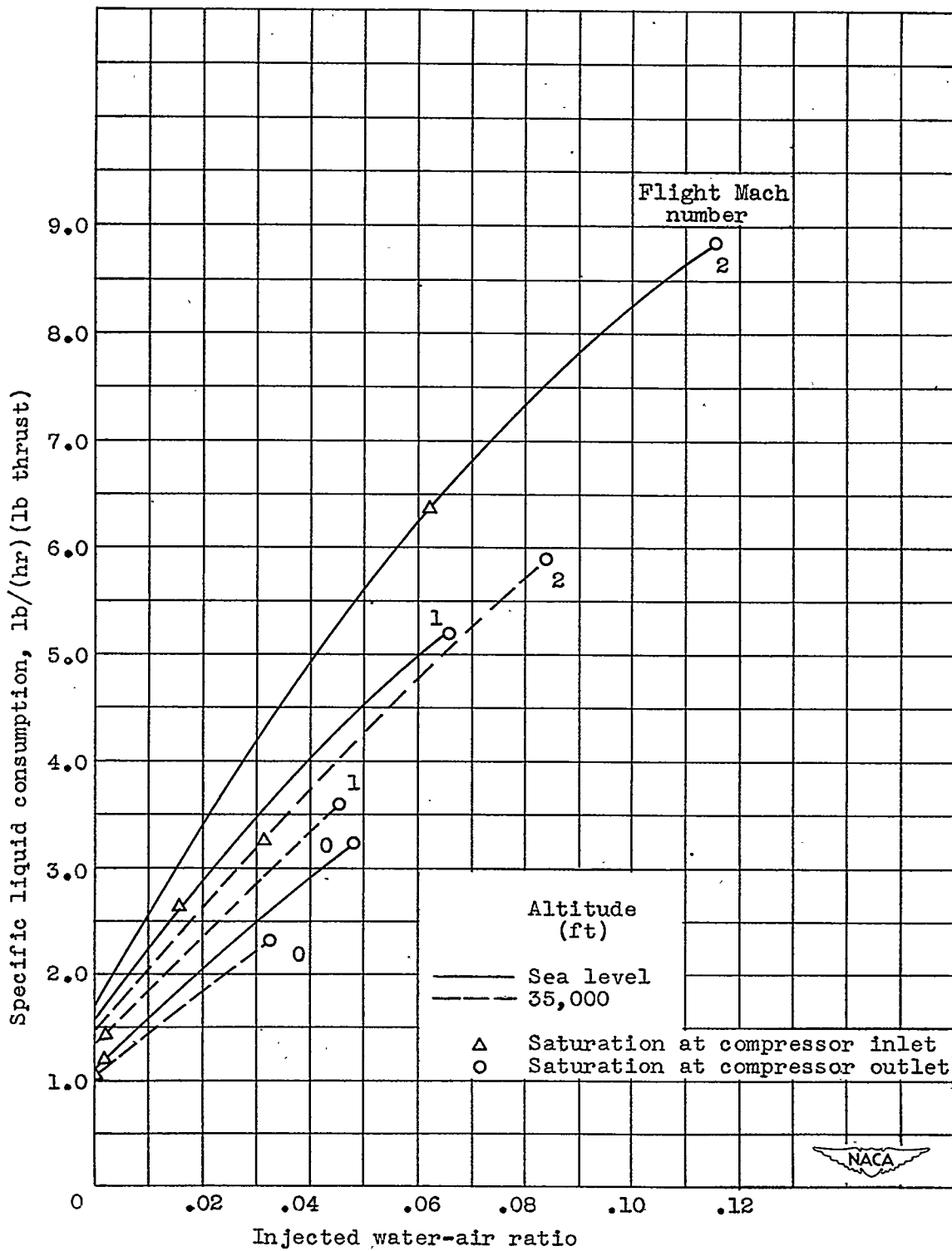

Figure 10. - Variation of specific liquid consumption with water-air ratio for injection at the compressor inlet for various flight Mach numbers and altitudes with NACA standard air.

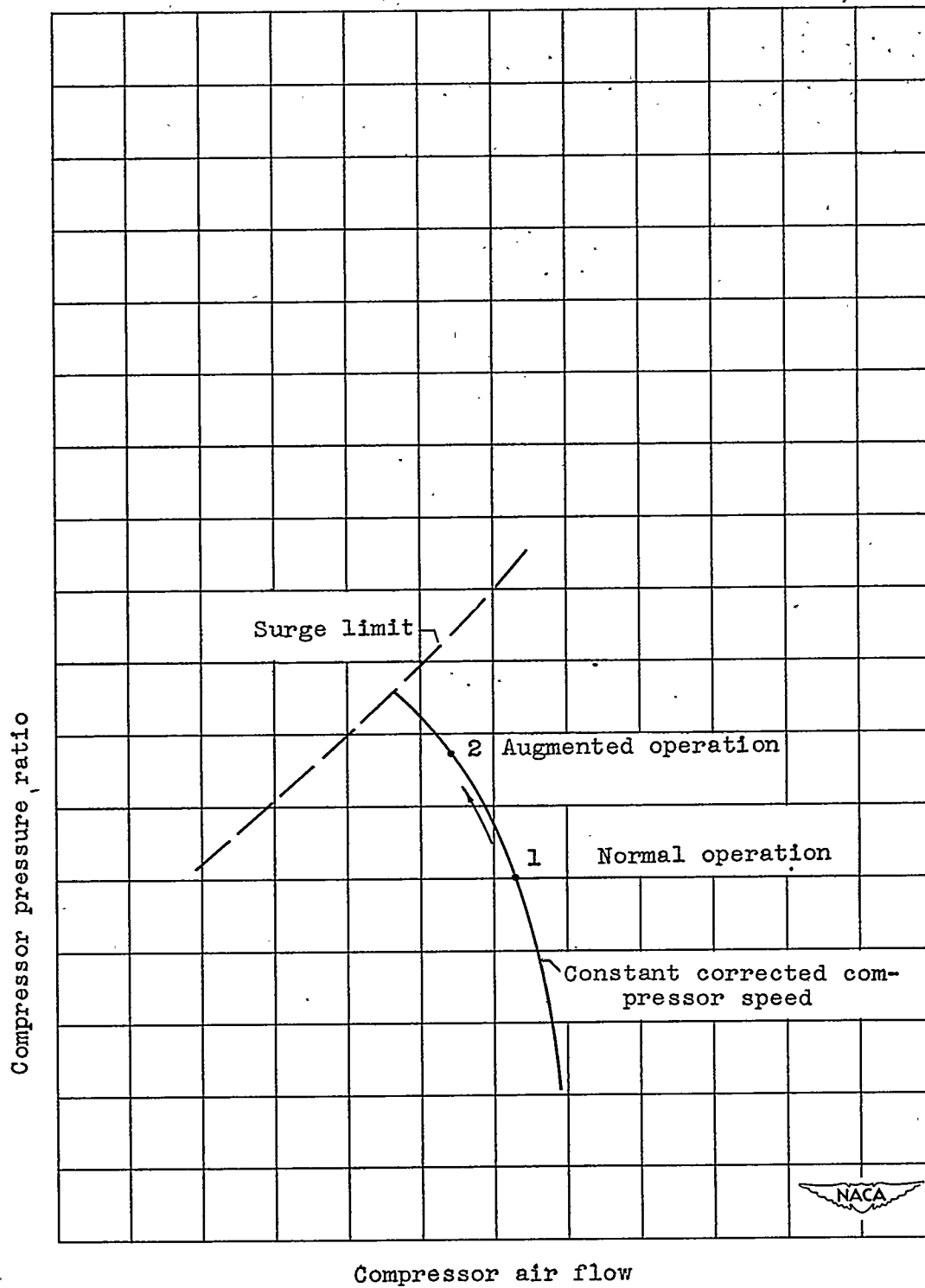

Figure 11. - Typical compressor characteristics illustrating effect of water injection into engine combustion chambers on compressor operating point.

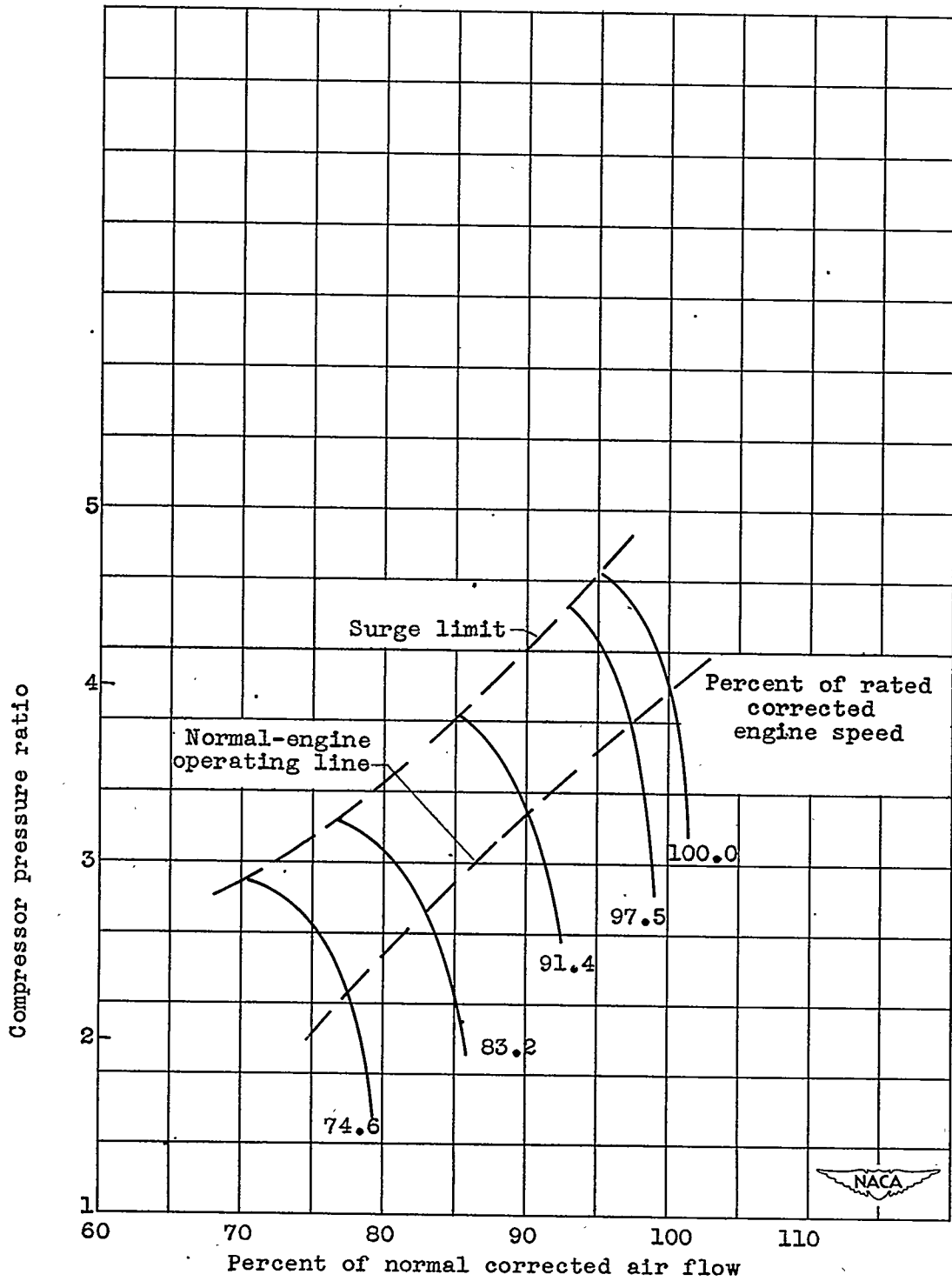

Figure 12. - Compressor characteristics assumed for analysis of thrust augmentation by water injection into engine combustion chambers.

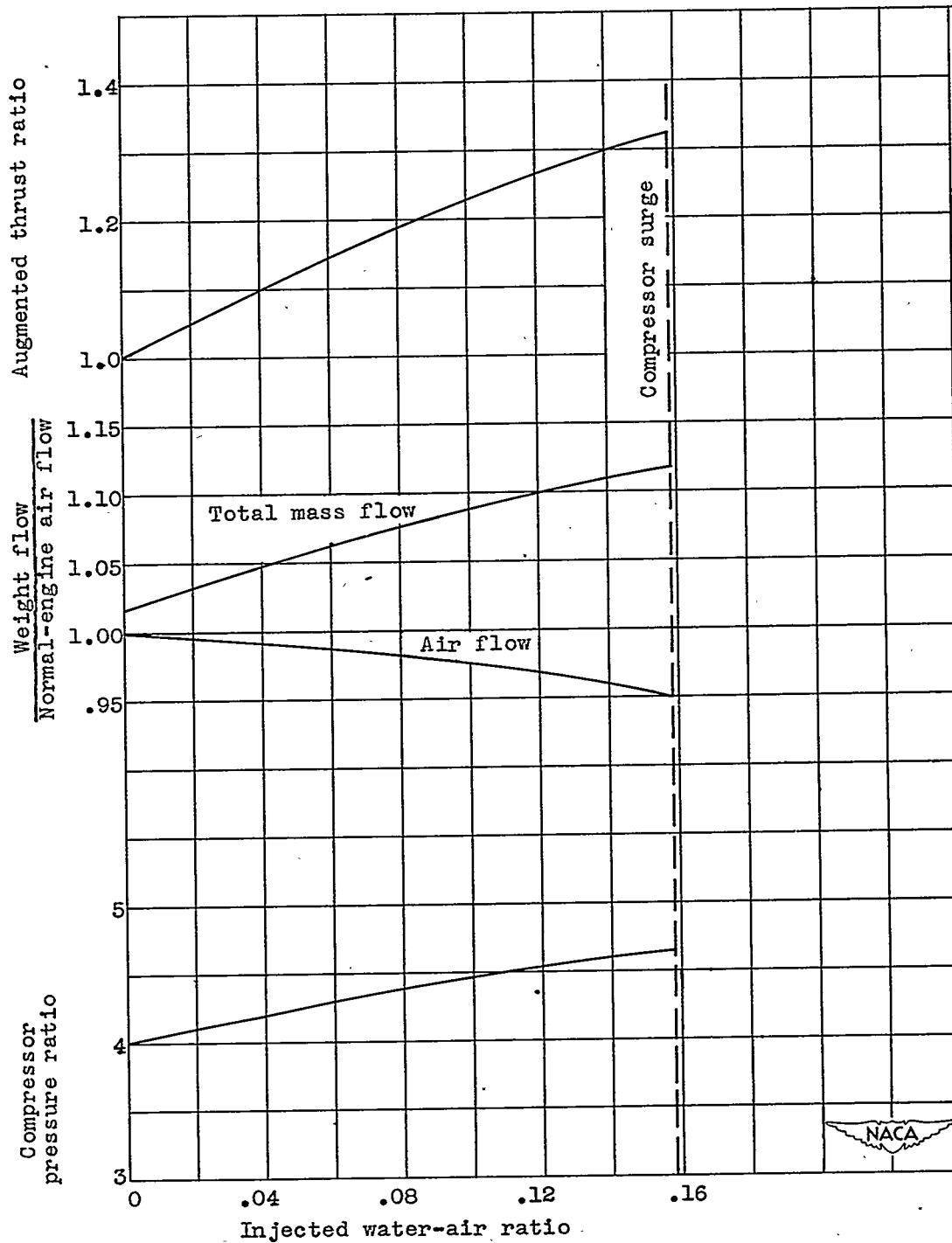

Figure 13. - Variation of compressor pressure ratio, air flow, total mass flow, and augmented thrust ratio with water-air ratio for injection into the engine combustion chambers. Flight Mach number, 0; altitude, sea level.

1235

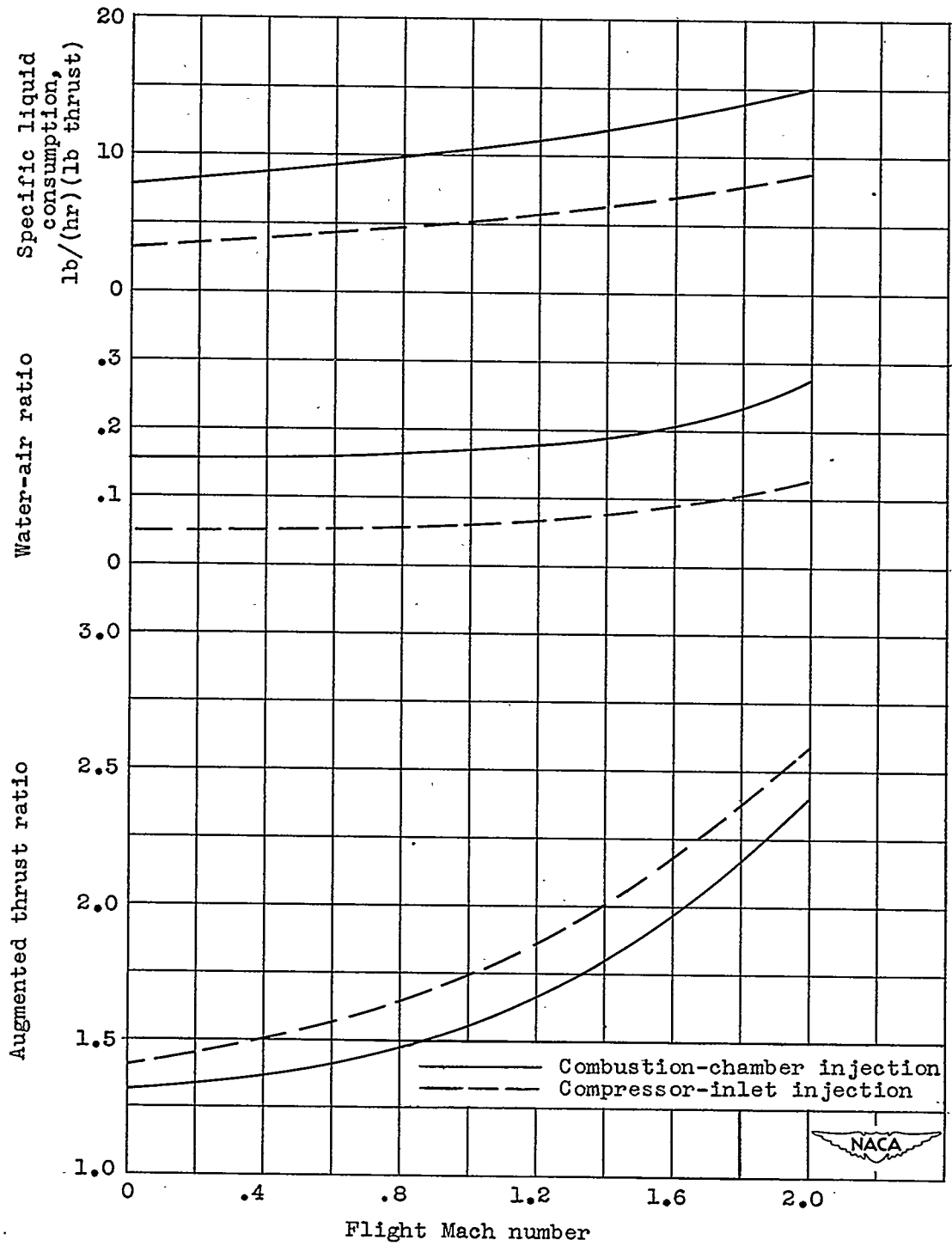

Figure 14. - Variation of augmented thrust ratio, water-air ratio, and specific liquid consumption with flight Mach number for combustion-chamber and compressor-inlet injection at sea-level altitude. Combustion-chamber injection for surge-limited compressor operation and compressor-inlet injection for saturation at the compressor outlet.

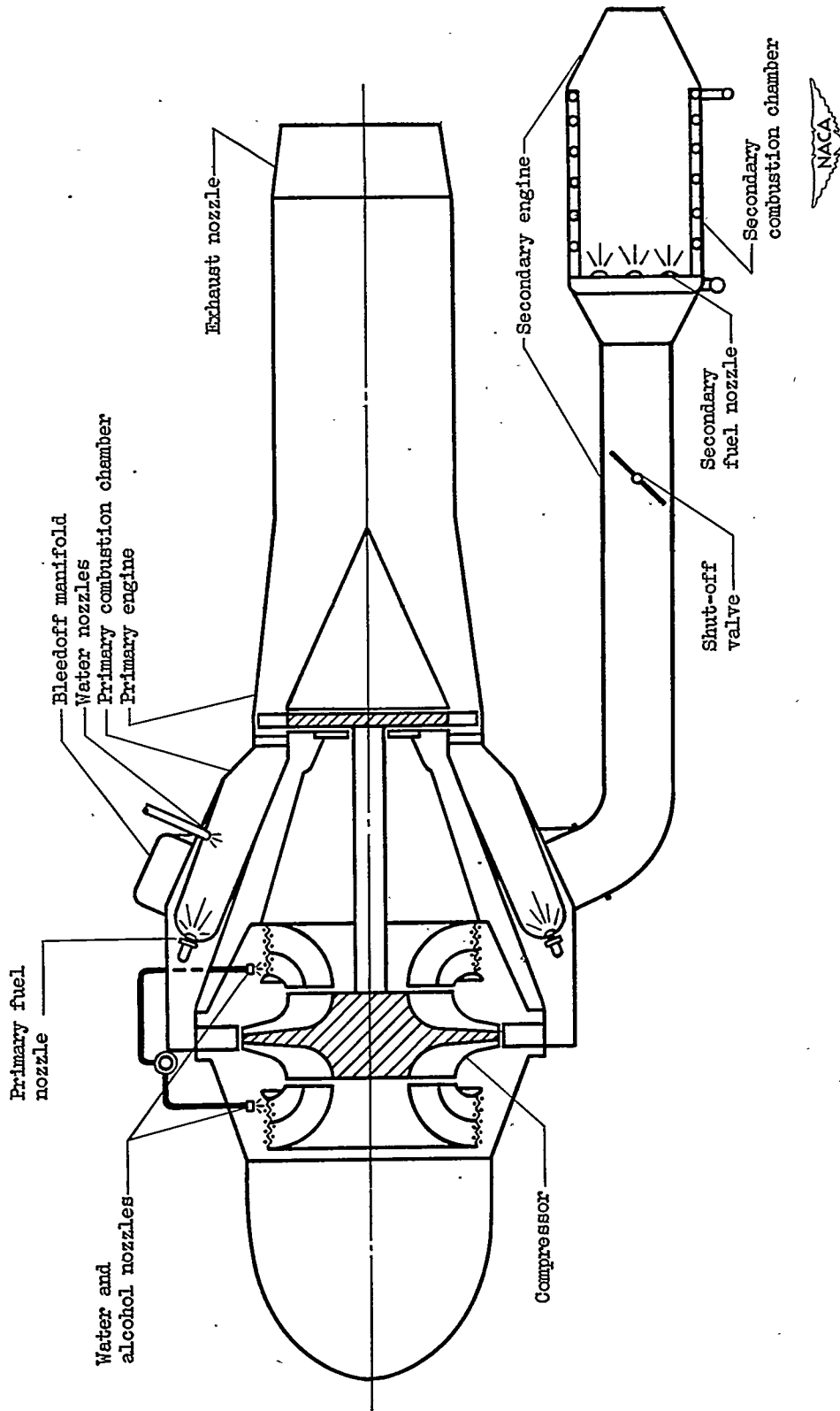

Figure 15. - Schematic diagram of turbojet engine equipped for bleedoff.

1235

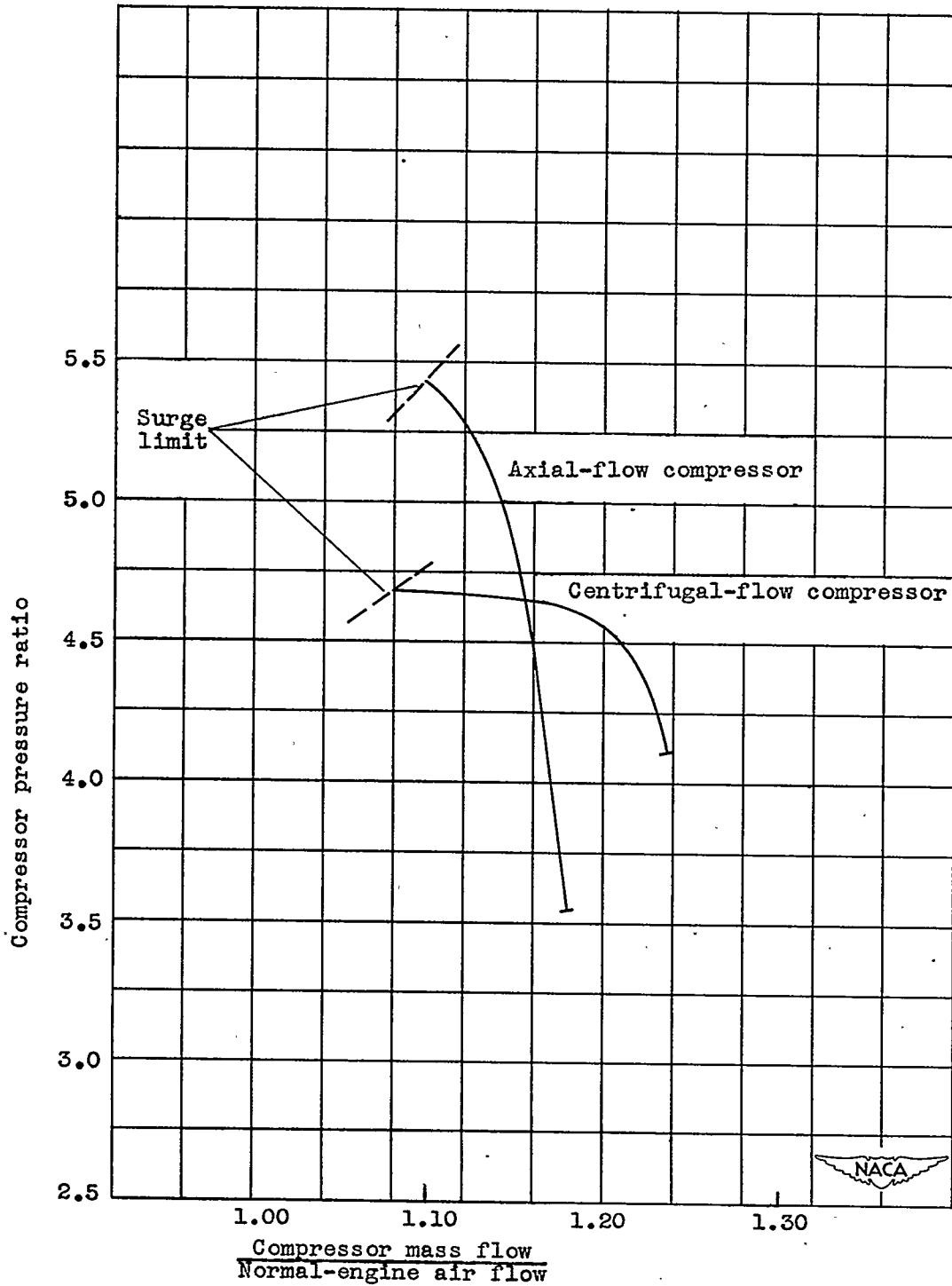
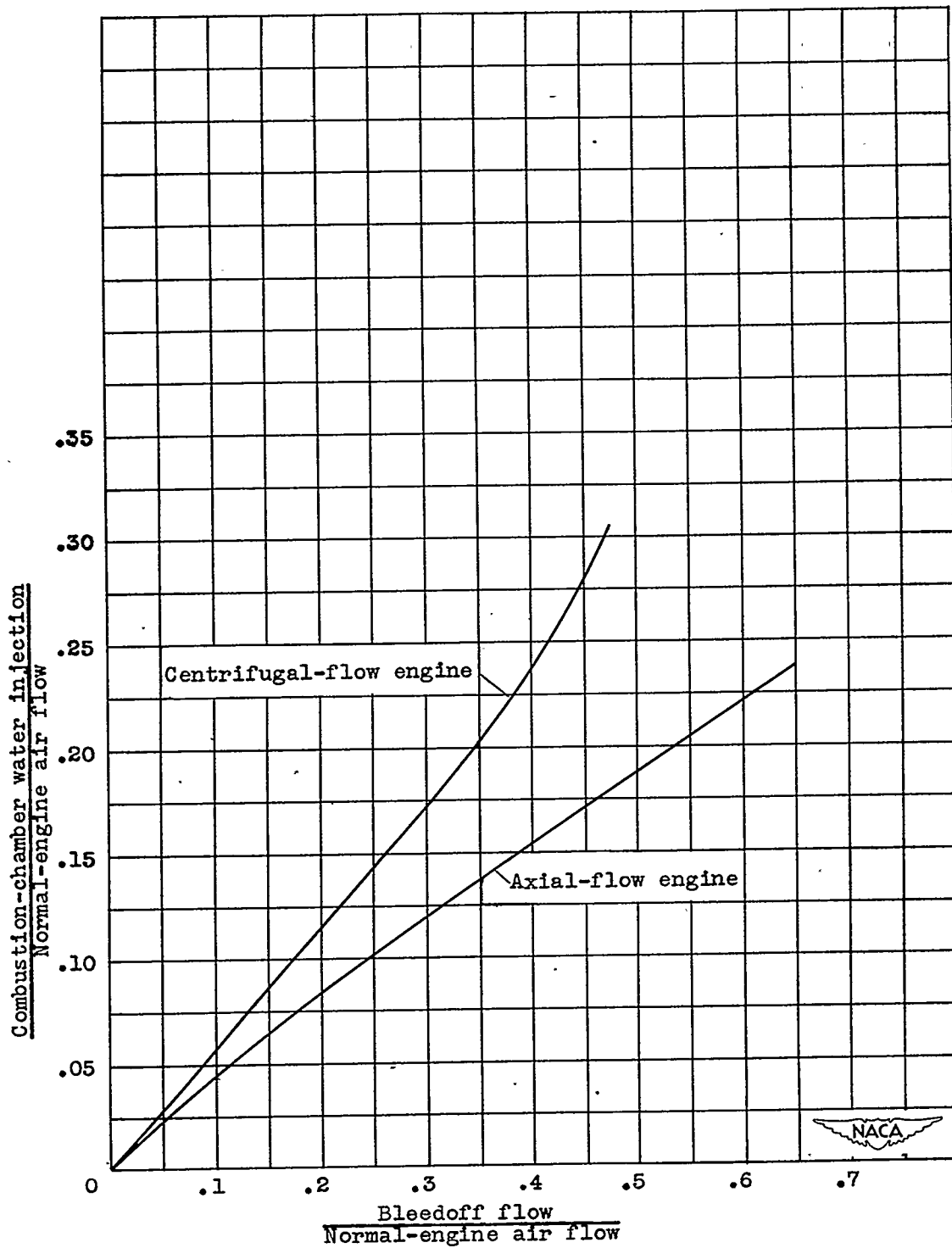
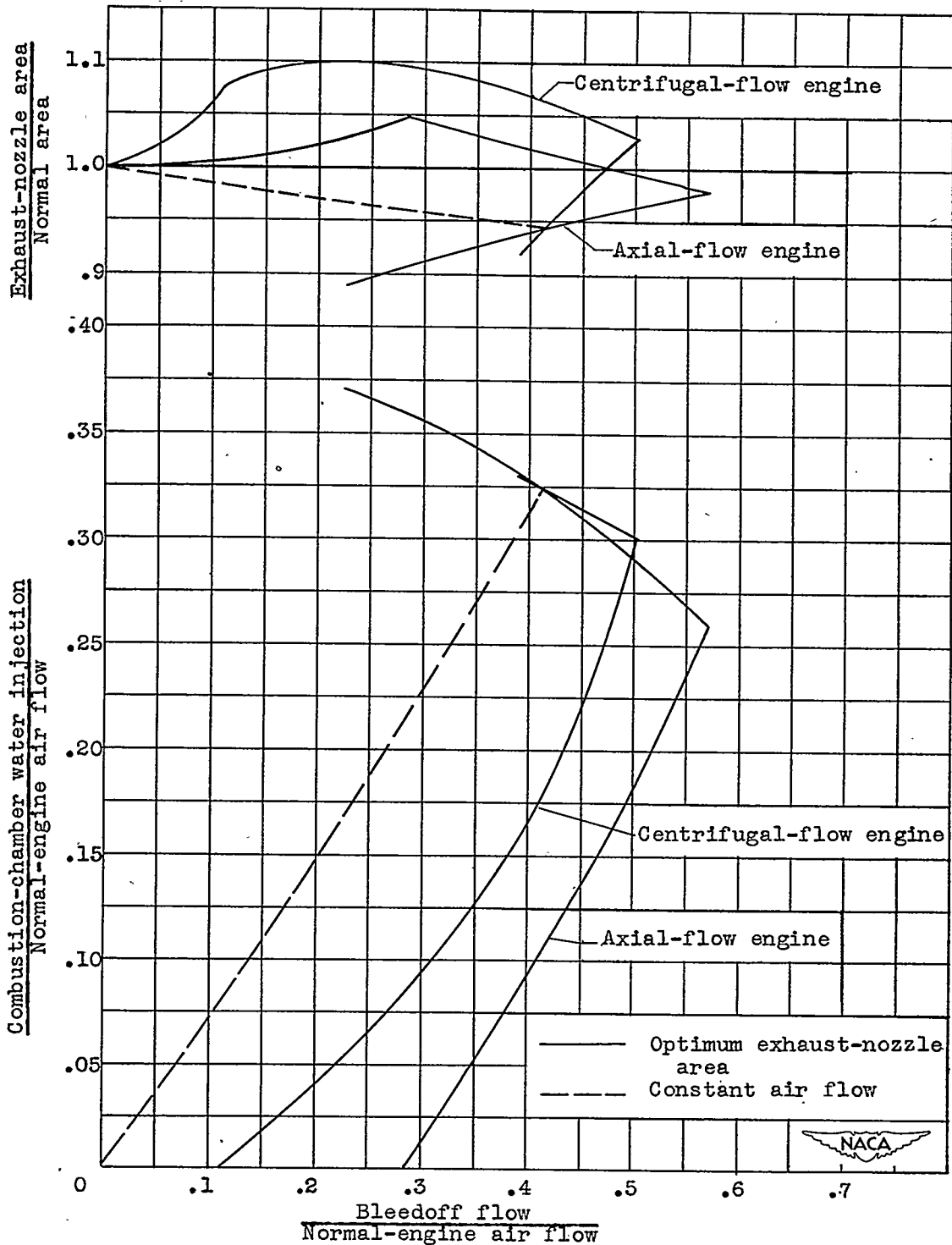

Figure 16. - Compressor characteristics assumed for analysis of thrust augmentation by bleedoff. Water-air ratio of compressor-inlet injection, 0.03; rated engine speed; flight Mach number, 0; altitude, sea level.



(a) Constant-area exhaust nozzle.

Figure 17. - Variation of water-injection rate into primary-engine combustion chambers with bleedoff flow. Flight Mach number, 0; altitude, sea level.



(b) Variable-area exhaust nozzle.

Figure 17. - Concluded. Variation of water-injection rate into primary-engine combustion chambers with bleedoff flow. Flight Mach number, 0; altitude, sea level.

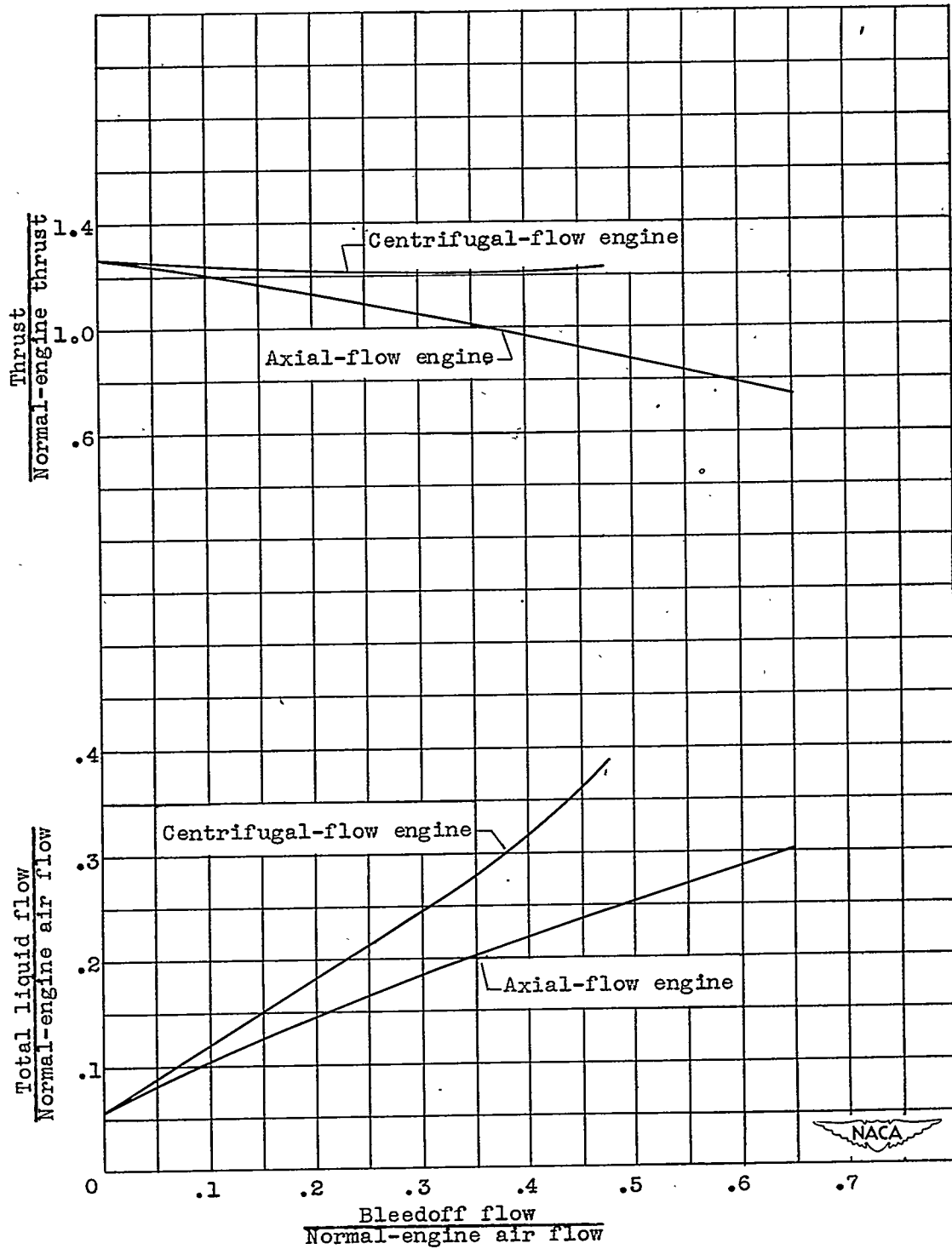

(a) Constant-area exhaust nozzle.

Figure 18. - Variation of total liquid flow and thrust of primary engine with bleedoff flow. Flight Mach number, 0; altitude, sea level.

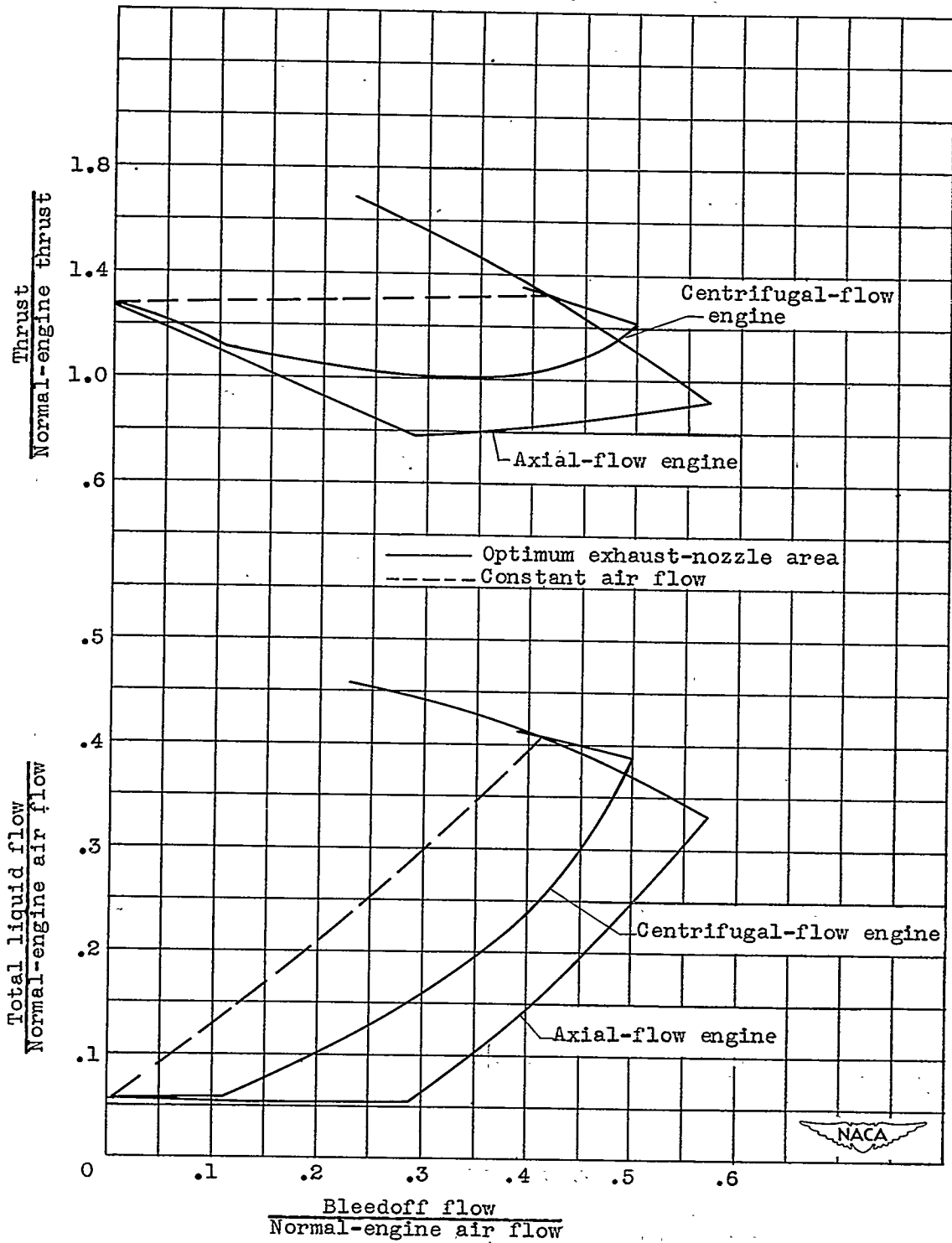

(b) Variable-area exhaust nozzle.

Figure 18. - Concluded. Variation of total liquid flow and thrust of primary engine with bleedoff flow. Flight Mach number, 0; altitude, sea level.

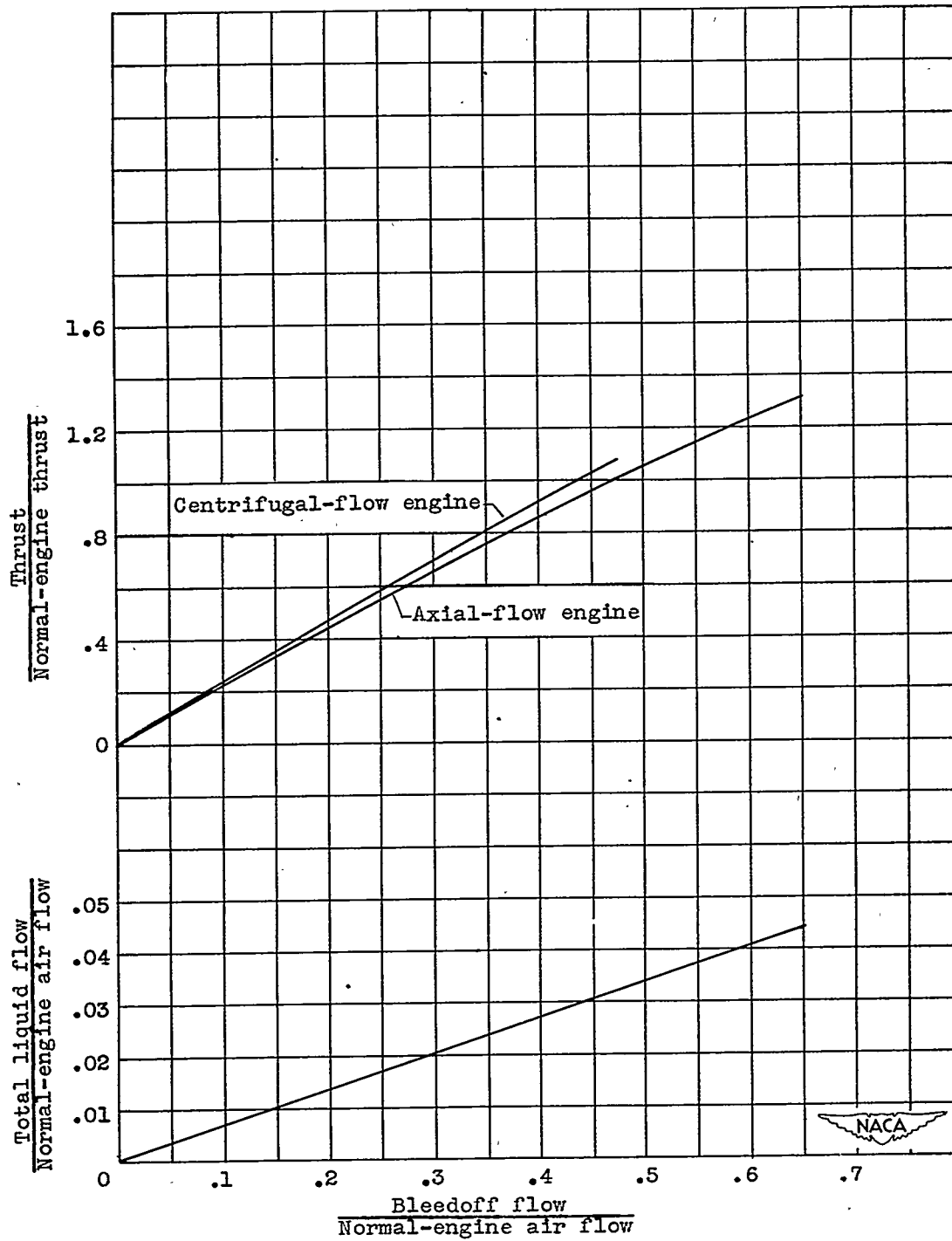

(a) Constant-area exhaust nozzle.

Figure 19. - Variation of fuel flow and thrust of secondary engine with bleedoff flow. Flight Mach number, 0; altitude, sea level.

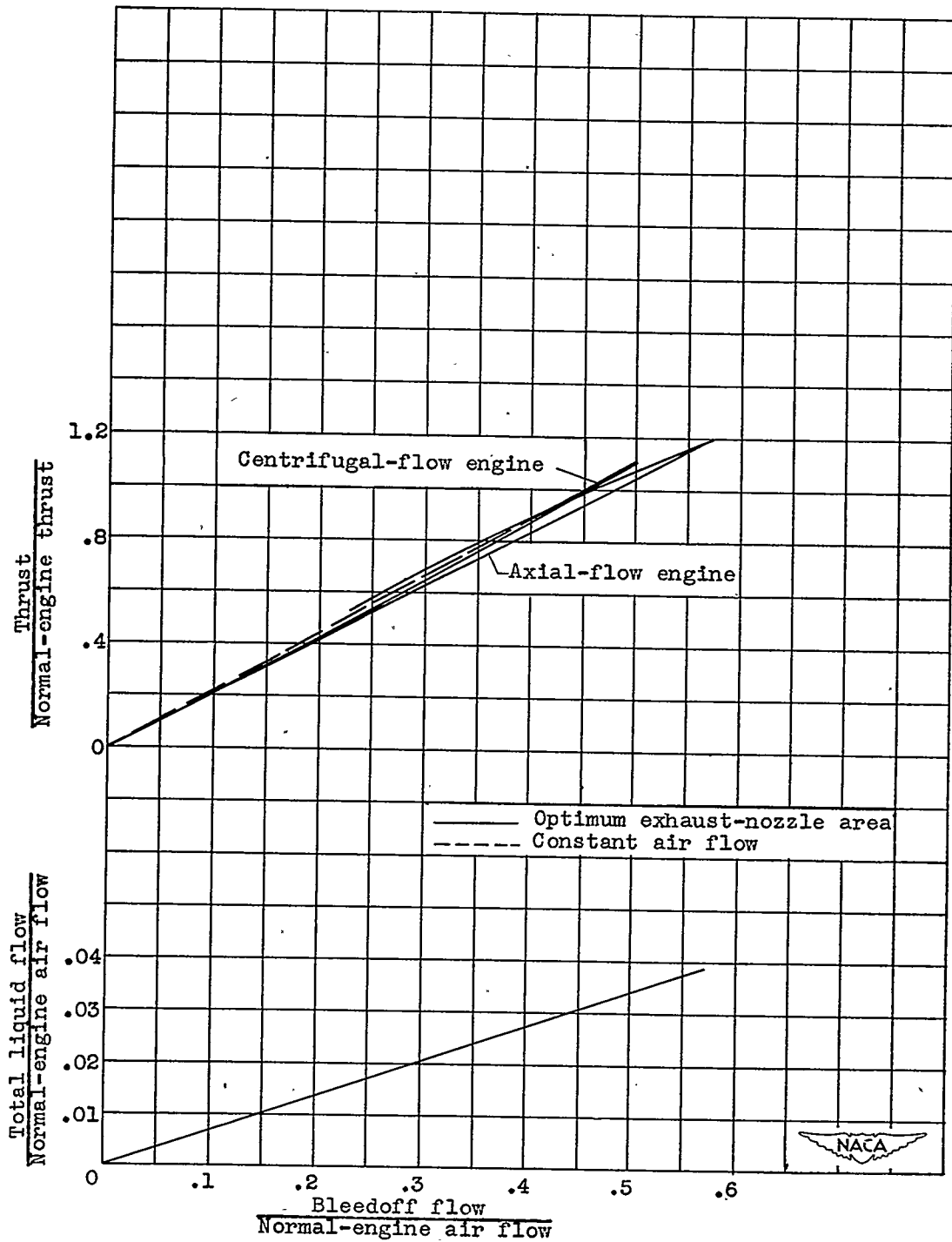

(b) Variable-area exhaust nozzle.

Figure 19. - Concluded. Variation of fuel flow and thrust of secondary engine with bleedoff flow. Flight Mach number, 0; altitude, sea level.

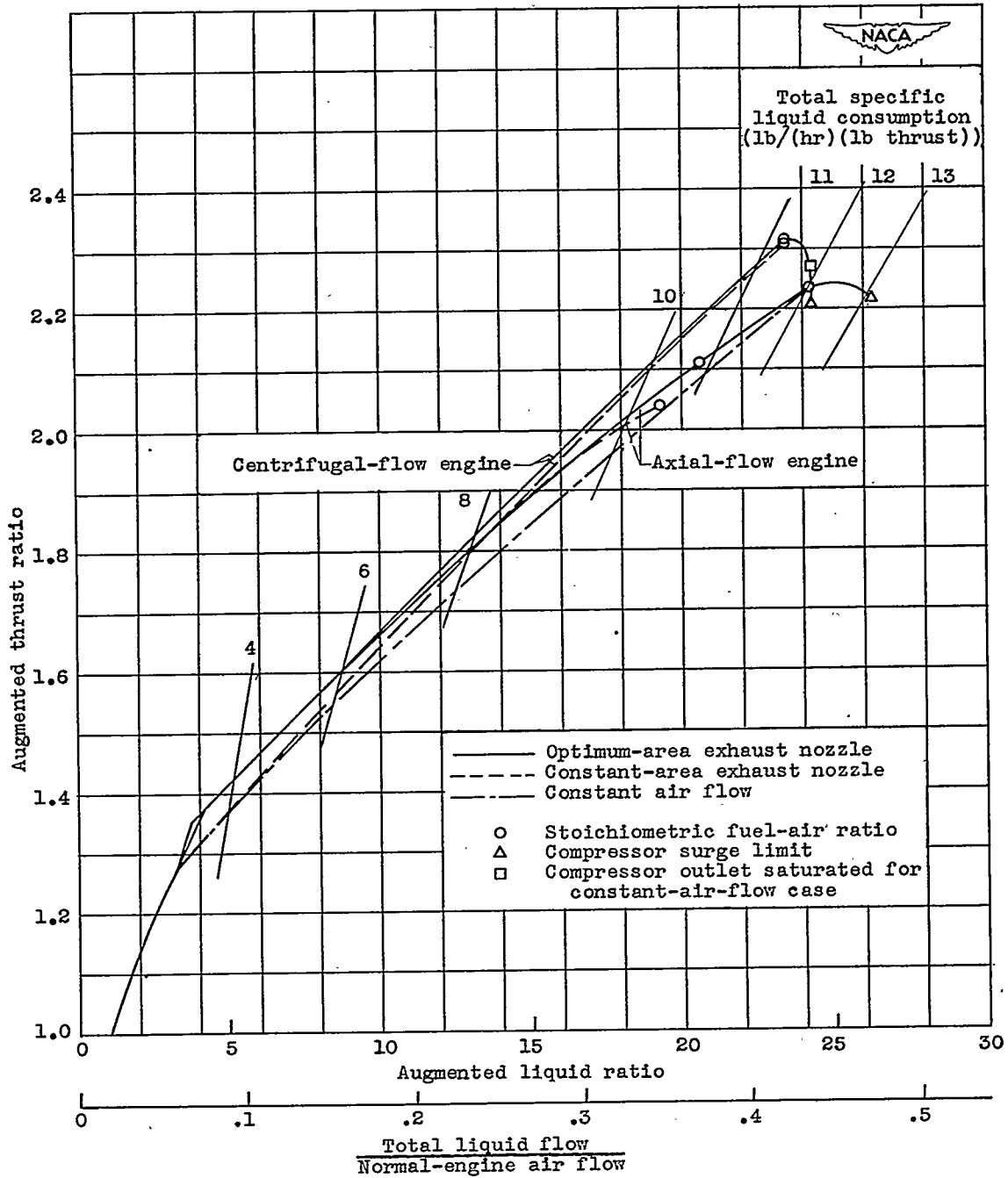

Figure 20. - Variation of augmented thrust ratio with ratio of total liquid flow to normal-engine fuel flow (augmented liquid ratio) and normal-engine air flow for bleedoff method of thrust augmentation for complete engine. Flight Mach number, 0; altitude, sea level.