

TN 2960

NACA TN 2960

# NATIONAL ADVISORY COMMITTEE FOR AERONAUTICS

TECHNICAL NOTE 2960

DRAG OF CIRCULAR CYLINDERS FOR A WIDE RANGE  
OF REYNOLDS NUMBERS AND MACH NUMBERS

By Forrest E. Gowen and Edward W. Perkins

Ames Aeronautical Laboratory  
Moffett Field, Calif.

TECHNICAL LIBRARY  
AIRESEARCH MANUFACTURING CO.  
9851-9951 SEPULVEDA BLVD.  
INGLEWOOD,  
CALIFORNIA

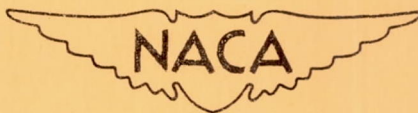

Washington

June 1953

---

TECHNICAL NOTE 2960

---

DRAG OF CIRCULAR CYLINDERS FOR A WIDE RANGE  
OF REYNOLDS NUMBERS AND MACH NUMBERS

By Forrest E. Gowen and Edward W. Perkins

## SUMMARY

Pressure distributions around circular cylinders placed perpendicular to the stream for subsonic and supersonic flow conditions have been obtained. Drag coefficients calculated from these wind-tunnel tests and from transonic free-flight tests are presented.

Drag data are presented for the Mach number range of 0.3 to 2.9. The Reynolds numbers for the subsonic and supersonic Mach numbers were within the ranges of approximately 50,000 to 160,000 and 100,000 to 1,000,000, respectively. No effects of Reynolds number were found for flow in the supersonic Mach number range of the tests. The drag coefficient increased with increasing Mach number to a maximum of approximately 2.1 at a Mach number of unity. In the supersonic Mach number range, the drag coefficient decreased with increasing Mach number to a value of about 1.34 at a Mach number of 2.9. Drag data from other investigations have been included for comparison.

The effects of fineness ratio on drag at supersonic Mach numbers were also investigated and found to be small.

## INTRODUCTION

Recent developments in the study of forces and moments on inclined bodies of revolution have led to a renewed interest in the drag characteristics of circular cylinders. R. T. Jones (reference 1) has shown theoretically that the flow perpendicular to an inclined, infinitely long circular cylinder with a laminar boundary layer may be considered independent of the axial flow. In a recent paper by Allen and Perkins (reference 2) the local normal force on an inclined body of revolution was related to the drag of a circular cylinder at a Mach number and Reynolds number based on the component of flow perpendicular

to the inclined axis of the body. The calculation of aerodynamic characteristics of inclined bodies of revolution by this method depends upon a knowledge of the drag characteristics of circular cylinders over a wide range of Reynolds numbers and Mach numbers. A survey of the data available on the drag of circular cylinders indicates that most of the data are restricted to Mach numbers less than about 0.5. At these low Mach numbers, many investigators have obtained circular-cylinder drag coefficients for a considerable range of Reynolds numbers. (See, for example, references 3 through 10, inclusive.) The results from most of these and from other investigations have been conveniently summarized in reference 11. For Mach numbers above 0.5, there are little available data and within these data there is considerable scatter.

The purposes of the present investigation were to extend the range of available data on circular cylinders to a Mach number of about 3.0 and to investigate the effects of Reynolds number on circular-cylinder drag for supersonic Mach numbers.

#### SYMBOLS

- $C_D$  drag coefficient  $\left(\frac{\text{drag per unit length}}{q_0 d}\right)$
- $d$  diameter of cylinder, inches
- $M_0$  free-stream Mach number
- $P$  pressure coefficient  $\left(\frac{p-p_0}{q_0}\right)$
- $p$  local static pressure on cylinder, pounds per square inch
- $p_0$  free-stream static pressure, pounds per square inch
- $q_0$  free-stream dynamic pressure, pounds per square inch
- $R$  Reynolds number based on free-stream conditions and cylinder diameter
- $\theta$  circumferential angle measured from the upstream stagnation point
- $\eta$  ratio of the drag coefficient of a circular cylinder of finite length to that of a circular cylinder of infinite length

## APPARATUS AND TESTS

The investigation at high subsonic Mach numbers was performed in the Ames 1- by 3-1/2-foot high-speed wind tunnel, which is a single-return closed-throat tunnel vented to the atmosphere in the settling chamber. The two cylinders tested were mounted directly in the window glass as shown in part (a) of figure 1. Two diametrically opposed orifices were located in each model at the tunnel center line. Circumferential pressure distributions for the Mach numbers and Reynolds numbers shown in figure 2 were then obtained by rotating the whole window assembly through an angle of 90°.

The experimental data presented for the transonic speed range were obtained from a current investigation performed by the Langley Pilotless Aircraft Research Division, and the details of this investigation are given in reference 12.

The supersonic tests were conducted in the Ames 1- by 3-foot supersonic wind tunnels Nos. 1 and 2. The nozzles of these tunnels are similar and both are equipped with flexible top and bottom plates. Tunnel No. 1 is a single-return, continuous-operation, variable-pressure wind tunnel with a maximum Mach number of 2.2. Tunnel No. 2 is an intermittent-operation, nonreturn, variable-pressure wind tunnel with a maximum Mach number of 3.8. The model installation shown in figure 1(b) was used in both tunnels. Circumferential pressure distributions were obtained at nine longitudinal stations on the model.

To investigate the end effects on the circular cylinder, tests were performed with and without the end plate shown in figure 1(b) for the Mach numbers and Reynolds numbers given in the following table. Data were taken at only one Reynolds number for a Mach number of 2.9.

Mach number	Reynolds number (millions)
1.49	0.16
	.38
	.58
1.98	.13
	.26
	.42
	.54
	.74
2.9	1.30
	.72

## RESULTS AND DISCUSSION

General Characteristics of Flow  
About a Circular Cylinder

Subsonic Mach numbers.- Characteristics of the flow around circular cylinders at speeds below the critical Mach number ( $M_0 < 0.4$ ) are well known and have been discussed in considerable detail by Goldstein in reference 11. In general, for Reynolds numbers below the critical Reynolds number range,<sup>1</sup> the flow is characterized by a laminar boundary layer on the cylinder accompanied by a periodic discharge of vortices in the wake. As the Reynolds number is increased through the critical range, the boundary-layer flow on the cylinder becomes turbulent, the separation point moves downstream, and the pressure recovery in the separated-flow region increases. For these latter conditions there is apparently no periodic discharge of vortices from the cylinder although measurements of the wake fluctuations have indicated some predominate frequencies. (Page 421 of reference 11.) At velocities above the critical Mach number compression waves form on the cylinder. This shock formation, which occurs alternately first on one side of the cylinder and then on the other, is accompanied by a forward movement of the boundary-layer separation point and violent oscillations of the wake. (See fig. 3.) These oscillations may be periodic although this has not been confirmed since no measurements in the wake at supercritical Mach numbers are available. Schlieren pictures taken during the present investigation and the data of reference 13 indicate that for certain test conditions a periodic discharge of vortices occurs. However, even though a number of schlieren pictures taken at one tunnel setting (i.e., one Mach number and Reynolds number) in the Ames 1- by 3-1/2-foot wind tunnel indicated a periodic flow in the wake, others for apparently the same test conditions indicated completely turbulent wake flow.

In the supercritical Mach number range no effect of Reynolds number on the flow about the models was found for the limited Reynolds number range of the present investigation.

Supersonic Mach numbers.- At supersonic speeds, for the cylinder tested in the Ames 1- by 3-foot supersonic wind tunnels, no significant changes in the flow field occurred with increasing Mach number or Reynolds number. A typical shadowgraph picture of the supersonic flow

---

<sup>1</sup>The range of Reynolds numbers through which the drag coefficient decreases from 1.2 to about 0.3 is usually defined as the critical Reynolds number range.

---

field about the test cylinder is shown in figure 4. The streaks that appear on the boundary-layer plate ahead of the bow shock wave are oil streaks left by a minute amount of oil on the plate. The detached bow wave shows a double shadow on the boundary-layer plate. It was found that the second shadow resulted from the intersection of the bow shock wave with the tunnel-wall boundary layer at the window near the free end of the cylinder. The bow wave curved around the free end of the cylinder so that the intersection with the tunnel-wall boundary layer was displaced slightly downstream from the position of the wave ahead of the cylinder. This picture and those taken for Mach numbers of 1.98 and 2.9 indicated a small disturbance in the flow which appears to originate at  $\theta = 100^\circ$  to  $120^\circ$ . The origin of this disturbance appears to coincide with the line of boundary-layer separation. The sharply converging wake between the cylinder and the trailing shock wave, shown for a Mach number of 1.49, is typical for all the test Mach numbers. With increasing Mach number the width of the minimum section of the wake decreased.

### Pressure Distribution

Subsonic Mach numbers.- Typical pressure distributions for subsonic Mach numbers are presented in figures 5(a) and 5(b).<sup>2</sup> At Mach numbers less than the critical, the experimental pressure distributions are in fair agreement with the theory over most of the upstream half of the cylinder. Over the remainder of the cylinder there is considerable divergence between experimental and theoretical pressure distributions with the experimental curves showing the typical large region of separated flow over the downstream half of the cylinder. The effects of Reynolds number are shown by the curves for Reynolds numbers of 314,000 and 426,000. These curves are typical of the distributions of pressure coefficient for Reynolds numbers below and above the critical range of Reynolds numbers, and indicate the increase in pressure recovery in the separated-flow region which occurs as the critical Reynolds number is exceeded.

At subsonic Mach numbers above the critical Mach number (fig.5(b)), the effects of compressibility are evidenced in the increase of the pressure coefficients on the windward side of the cylinder with increasing Mach number. The pressures over the downstream surface of the cylinder are, in general, less than those measured at subcritical Mach numbers. The adverse pressure gradient, which is usually

---

<sup>2</sup>The data of figure 5(a) were obtained from unpublished results of recent tests made in the Ames 7- by 10-foot wind tunnel.

---

associated with boundary-layer separation, is evident in the data for Mach numbers of 0.3, 0.5, and 0.6. The pressure distribution for a Mach number of 0.7, which is similar to those obtained in the range of Mach numbers above 0.625, shows little, if any, adverse pressure gradient. Since the flow in the wake of the cylinder at subsonic Mach numbers above the critical was of an oscillatory character (see fig. 3), it would be expected that the pressures in the region of separation and over the aft part of the cylinder would not be steady; hence, the pressures recorded by the manometer system in this region would be only the average static pressures. The effects of Reynolds number on the pressure distribution were found to be negligible at Mach numbers above the critical for the limited Reynolds numbers of this investigation.

Supersonic Mach numbers.- Typical pressure distributions about a circular cylinder at supersonic Mach numbers are shown in figures 5(c) and 5(d). The distributions for all three supersonic Mach numbers are somewhat similar to the pressure distributions at subsonic supercritical Mach numbers. However, the variation with Mach number is different in that there is a general increase in pressure coefficient over the entire body with increasing Mach number (fig. 5(c)). For the supersonic Mach numbers investigated, the separation point was located in the  $100^{\circ}$  to  $120^{\circ}$  region and the pressures on the cylinder in the separated-flow region were more uniform than for subsonic flow. Although the shadowgraph of figure 4 indicated a small disturbance in the external flow field near the position of separation and the flow in this vicinity appeared to be steady, detailed pressure distributions failed to reveal the expected pressure rise (or local adverse pressure gradient) at the position of the disturbance. As shown in figure 5(c), the pressures in the separated-flow region approach a vacuum as the Mach number is increased. The pressure coefficient at the forward stagnation point ( $\theta = 0$ ) was, for all supersonic Mach numbers, in close agreement with the pitot-pressure coefficient calculated with the aid of Rayleigh's equation.

The pressure distributions of figure 5(d) are typical of the data for Mach numbers of 1.49 and 1.98. These data show that for the Reynolds number range of this investigation, which included the critical Reynolds number range for subsonic flow, there is no effect of Reynolds number on the pressure distribution at supersonic Mach numbers.

Figure 5(e) shows experimental distributions of pressure coefficient for various Mach numbers. Included in the figure are the theoretical distributions for the limiting cases of Mach numbers near zero (incompressible potential theory) and a Mach number of infinity (Newtonian theory, reference 14). Over most of the cylinder the pressures calculated from the theory for infinite Mach number were higher than those measured for the highest Mach number of the present investigation. Nevertheless, the experimental distribution of pressure

coefficient approached the theoretical distribution as the Mach number was increased. The theoretical curve shown does not take into consideration the effects of centrifugal forces which would be expected to result in a reduction of the local pressure coefficient on the cylinder at points other than the forward stagnation point. An approximate method for the estimation of the centrifugal force effects has been suggested in reference 14. However, pressure coefficients calculated by this method were much lower than the experimental values for a Mach number of 2.9 and therefore have not been included in figure 5(e).

### Drag

Reynolds number effects.- The variation of drag coefficient with increasing Reynolds number is shown in figure 6. One of the most significant changes in the drag coefficient occurs at Mach numbers less than 0.4 where the boundary-layer flow on the cylinder changes from laminar to turbulent (previously discussed) as the Reynolds number is increased in the critical Reynolds number range. This change in flow is accompanied by a decrease in drag coefficient from about 1.2 to about 0.3. The range of Reynolds numbers designated as the critical range and the value of drag coefficient above this Reynolds number range have been found to be influenced by such factors as surface roughness and stream turbulence (reference 5). The limits of the critical range of Reynolds numbers obtained by a number of investigators are about 200,000 to about 500,000 (fig. 6). The results of tests at supersonic Mach numbers of 1.49 and 1.98 indicate that although the Reynolds number range of these tests included the subsonic critical Reynolds number range, any effects of Reynolds number were small. This result might have been anticipated from a consideration of the effects of Reynolds number on the pressure distribution and resulting drag at subsonic speeds. In subsonic flow, in the subcritical Reynolds number range, the suction pressures acting on the downstream surface of the cylinder contribute a large part of the total drag. The principal effect of increasing the Reynolds number through the critical range is a sizable increase in the pressure recovery on the downstream side of the cylinder with a resulting large decrease in drag. (See, for example, fig. 5(a) and pp. 422 and 424 of reference 11.) In supersonic flow, the percentage of the total drag due to the suction pressures in the separated-flow region is small and decreases with increasing Mach number, being only 10 percent at a Mach number of 2.9. (Even if a full vacuum were developed over the rear half of the cylinder, the resulting drag contribution would be only 20 percent of the total.) Hence, if there were any effects of Reynolds number on the total drag coefficient at supersonic Mach numbers, the magnitude of the effects would be expected to be small and to decrease with increasing Mach number.



Mach number effects.- The data presented in figure 7 show the variation of drag coefficient with Mach number for the Mach number range from 0.1 to 2.9. At Mach numbers below 0.4, drag coefficients for Reynolds numbers above and below the critical Reynolds number are included to indicate that the Reynolds number effects predominate in this region. All of the data available for Mach numbers less than about 0.6 show the characteristic rise in drag coefficient with increasing Mach number above the critical, and the drag-coefficient variation is well defined within this range.

For Mach numbers in the range of about 0.6 to 1.0, there are little available data and the scatter is large. The data from the 1- by 3-1/2-foot wind tunnel show an abrupt decrease in the rate of increase of drag coefficient with Mach number at a Mach number of 0.65. A similar variation is shown by the flight results (reference 12) and the data of Knowler and Pruden (reference 13). These references show a significant decrease in drag coefficient between Mach numbers of 0.65 and 0.8. Since no other data are available in the Mach number range of about 0.8 to 1.4, the free-flight results (reference 12) for a fineness-ratio-60 cylinder are included to indicate trends even though it appears that the magnitudes at Mach numbers less than unity are not the same as would be obtained for two-dimensional flow.

The data of figure 7 indicate that, for the Mach number range shown, the major effect of Mach number on drag coefficient occurs in the range of Mach numbers from about 0.4 to 1.4 with a maximum drag coefficient of about 2.1 near sonic velocity. At Mach numbers greater than 1.4 the drag coefficient decreases slowly with increase in Mach number. At a Mach number of about 1.5 the drag coefficients obtained from the present investigation and reference 15 are in good agreement.

The data of the present report indicate that for supersonic Mach numbers the drag coefficient may approach a constant value of the order of 1.3 at high Mach numbers. Since the experimental pressure distribution at a Mach number of 2.9 approached that for infinite Mach number (Newtonian theory), the theoretical drag coefficient was calculated from Newtonian theory. The resulting drag coefficient of 1.333 agreed with the experimental drag coefficient at a Mach number of 2.9. This agreement may be considered fortuitous since the pressure distribution predicted by Newtonian theory is not correct at this Mach number. However, it can be seen from the trends of the pressure-distribution curves (fig. 5(e)) and the drag-coefficient curve (fig. 7) that for Mach numbers of the order of 3.0 or greater the drag of circular cylinders may be predicted within approximately 5 percent by Newtonian theory.

Effects of fineness ratio on drag.- The curve shown in figure 8 for low subsonic Mach numbers was obtained from data in reference 11 (p. 439) and shows the variation of  $\eta$ , the ratio of the drag of a circular cylinder of finite length to the drag of a circular cylinder of infinite length, as a function of fineness ratio. These data were obtained for a very low Mach number and only one Reynolds number (88,000). Some indication of the influence of Mach number and Reynolds number on the fineness-ratio effect is shown by the free-flight results presented in figure 9. From these data it appears that in the subsonic speed range, the fineness-ratio effect is dependent on both Mach number and Reynolds number. Values of  $\eta$  based upon the two-dimensional values of the drag coefficients from the 1- by 3-1/2-foot tunnel data have been calculated for fineness ratios of 15, 30, and 60 and are presented in figure 8; however, no consistent trend with Mach number or Reynolds number is evident from this limited amount of data.

In the low supersonic speed range the free-flight data of figure 9 indicate that the fineness-ratio effects are negligible. For supersonic Mach numbers of 1.49, 1.98, and 2.90, the variation of  $\eta$  with fineness ratio was determined from the pressure-distribution results obtained in the Ames 1- by 3-foot supersonic wind tunnels for the model shown in figure 1. Typical longitudinal distributions of drag coefficient are shown in figure 10 for a Mach number of 1.98 for tests with and without the end plate. Data for Mach numbers of 1.49 and 2.90 were similar and are not presented. These data show that the effects of the end plate and boundary-layer plate were to increase the local drag coefficient above the two-dimensional value in regions near the ends of the model. The drag coefficients over the center portion of the model were unaffected by the removal of the end plate and were therefore considered to be the values for two-dimensional flow. Values of  $\eta$  were calculated from the distribution of drag coefficient from the free end of the cylinder for various length cylinders and are presented in figure 8. It can be seen from this figure that the end effects for supersonic Mach numbers are negligible ( $\eta$  is approximately 1.0) for fineness ratios in excess of about 6.

## CONCLUSIONS

Drag coefficients have been obtained from pressure-distribution measurements on circular cylinders at high subsonic speeds in the Ames 1- by 3-1/2-foot wind tunnel and for supersonic Mach numbers of 1.49, 1.98, and 2.9 in the Ames 1- by 3-foot supersonic wind tunnel. Data for supersonic Mach numbers were obtained for a range of Reynolds numbers which included the subsonic critical Reynolds number range. The results of these tests lead to the following conclusions:

1. Effects of Reynolds number on drag coefficient and pressure distribution are negligible at supersonic speeds.
2. The major effects of Mach number on the drag coefficient of circular cylinders are confined to a range of Mach numbers from 0.4 to 1.4. Above 1.4 the drag coefficient decreases slowly with increasing Mach number and may be approximated by Newtonian theory for Mach numbers of the order of 3 or greater.
3. The effects of fineness ratio on the drag coefficient appear to be negligible for fineness ratios in excess of approximately 6 at supersonic Mach numbers.

Ames Aeronautical Laboratory  
National Advisory Committee for Aeronautics  
Moffett Field, Calif., Mar. 20, 1952

#### REFERENCES

1. Jones, Robert T.: Effects of Sweepback on Boundary Layer and Separation. NACA Rep. 884, 1947. (Formerly NACA TN 1402)
2. Allen, H. Julian, and Perkins, Edward W.: A Study of Effects of Viscosity on Flow Over Slender Inclined Bodies of Revolution. NACA Rep. 1048, 1951.
3. Wieselsberger, C.: New Data on the Laws of Fluid Resistance. NACA TN 84, 1922.
4. Relf, E. F.: Discussion of the Results of Measurements of the Resistance of Wires, with Some Additional Tests on the Resistance of Wires of Small Diameter. R. & M. No. 102, British A.C.A., 1914.
5. Fage, A., and Warsap, J. H.: The Effects of Turbulence and Surface Roughness on the Drag of a Circular Cylinder. R. & M. No. 1283, British A.R.C., 1929.
6. Fage, A.: The Drag of Circular Cylinders and Spheres at High Values of Reynolds Number. R. & M. No. 1370, British A.R.C., 1930.
7. Fage, A., and Falkner, V. M.: Further Experiments on the Flow Around a Circular Cylinder. R. & M. No. 1369, British A.R.C., 1931.
8. Lindsey, W. F.: Drag of Cylinders of Simple Shapes. NACA Rep. 619, 1938.

9. Stack, John: Compressibility Effects in Aeronautical Engineering. NACA ACR, 1941.
10. Bursnall, William J., and Loftin, Laurence K., Jr.: Experimental Investigation of the Pressure Distribution About a Yawed Circular Cylinder in the Critical Reynolds Number Range. NACA TN 2463, 1951.
11. Goldstein, S.: Modern Developments in Fluid Dynamics. Oxford, The Clarendon Press, Vols. I and II, 1938.
12. Welsh, Clement J.: The Drag of Finite Length Cylinders Determined From Flight Tests at High Reynolds Numbers, for a Mach Number Range From 0.5 to 1.3. NACA TN 2941, 1953.
13. Knowler, A. E., and Pruden, F. W.: On the Drag of Circular Cylinders at High Speeds. R.&M. No. 1933, British A.R.C., 1944.
14. Griminger, G., Williams, E. P., and Young, G. B. W.: Lift on Inclined Bodies of Revolution in Hypersonic Flow. Jour. Aero. Sci., vol. 17, no. 11, Nov. 1950, pp. 675-690.
15. von Kármán, Th.: The Problem of Resistance in Compressible Fluids. Roma, Real Accademia D'Italia, 1935 - XIV. (GALCIT Pub. 75)



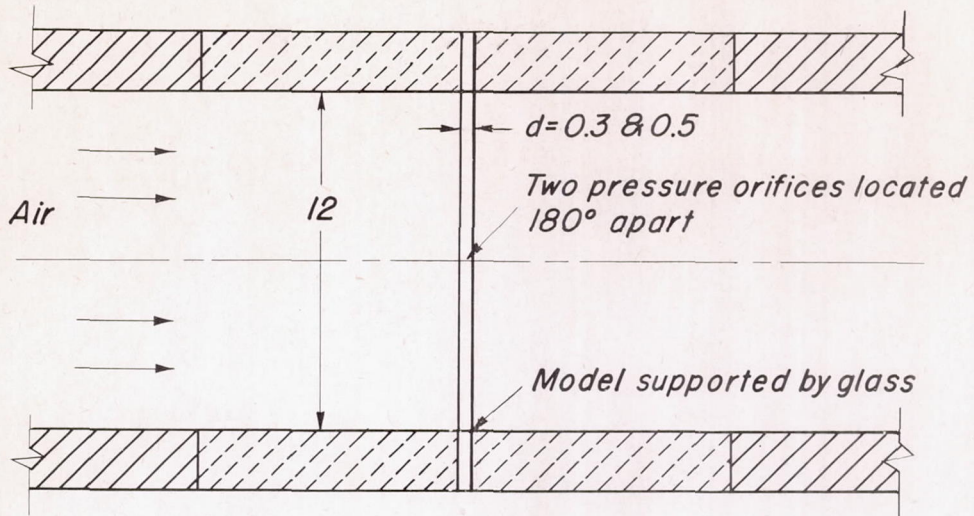

(a) 1-by  $3\frac{1}{2}$ -foot wind-tunnel installation.

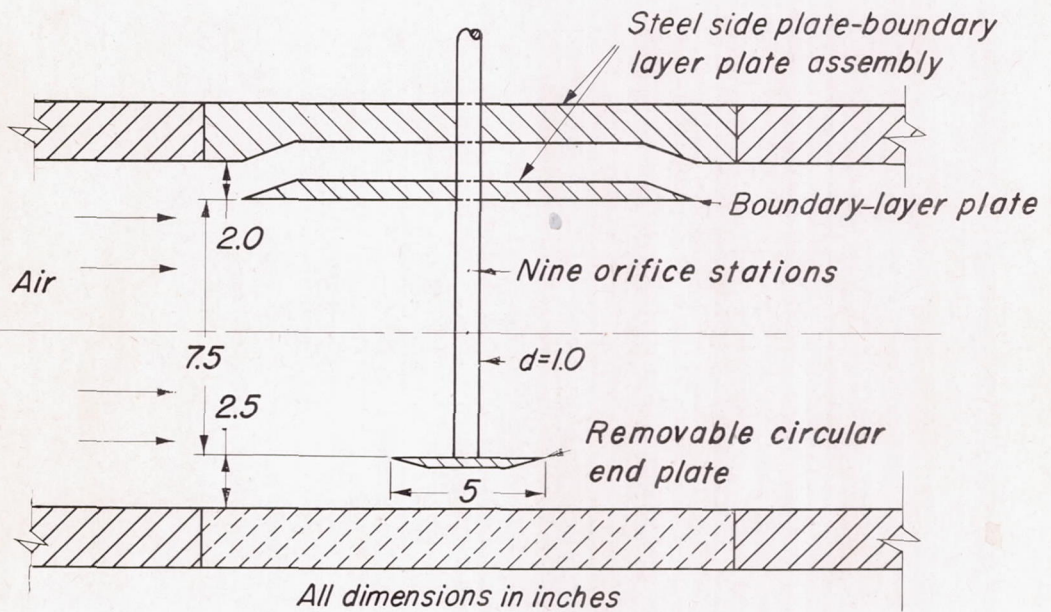

(b) 1-by 3-foot supersonic-wind-tunnel installation.

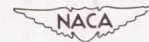

Figure 1.- Sketches of model installations for pressure-distribution tests.

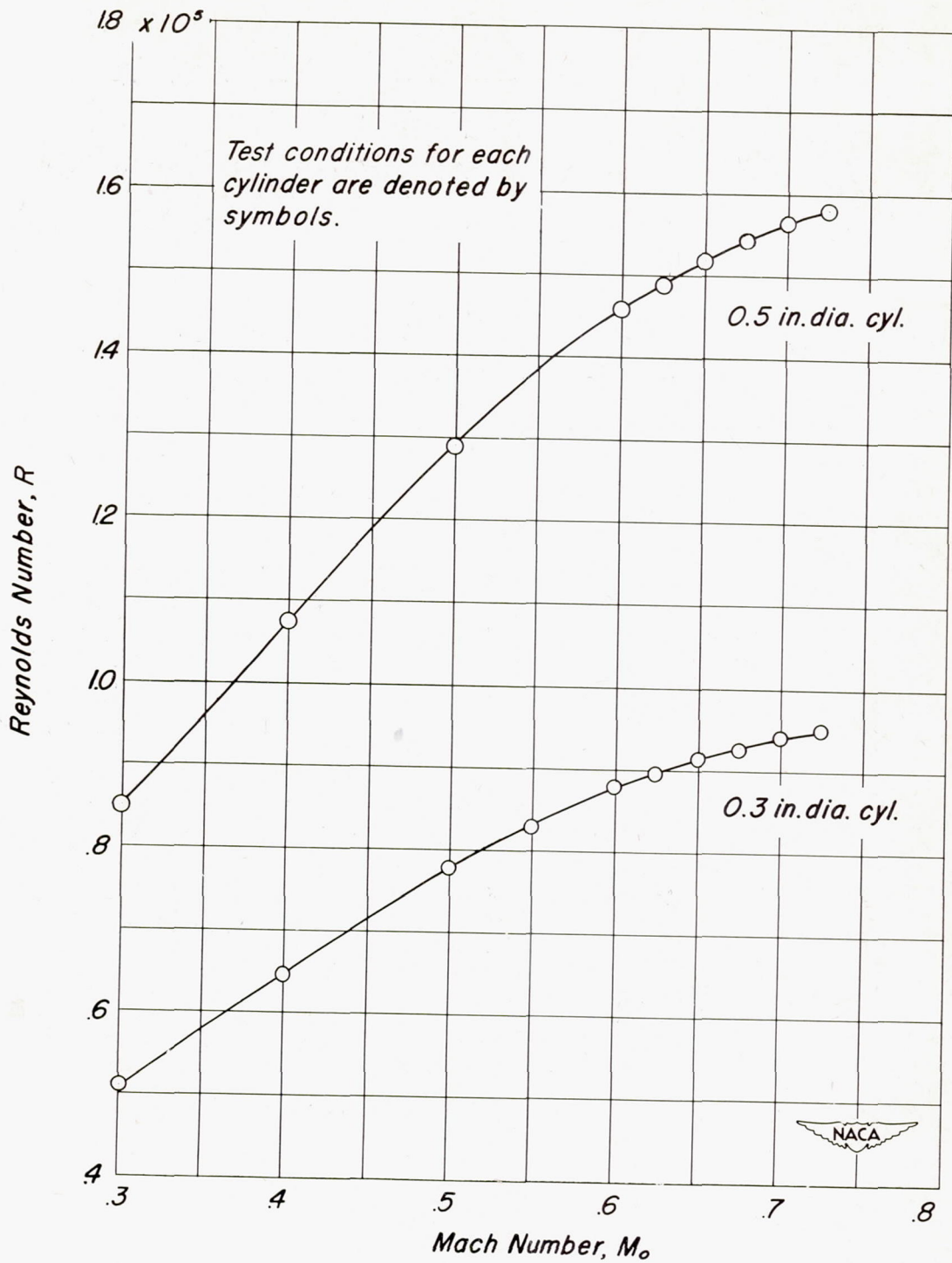

Figure 2.-Variation of Reynolds number with Mach number for the cylinder drag tests in the 1-by  $3\frac{1}{2}$ -foot wind tunnel.

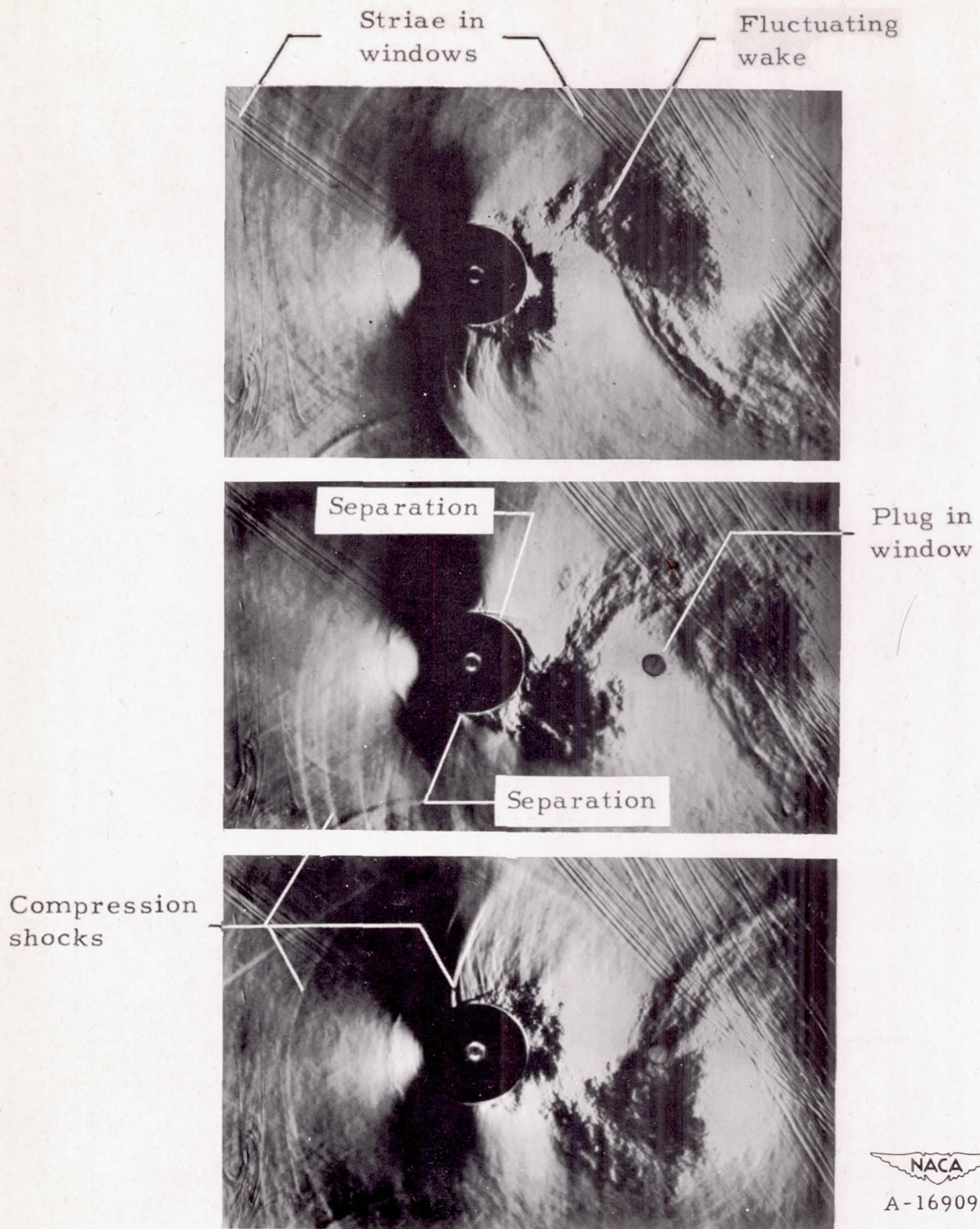

Figure 3. - Schlieren pictures of the flow about a 1.97-inch cylinder in the Ames 1- by 3<sup>1</sup>/<sub>2</sub>-foot wind tunnel at a Mach number of 0.51.



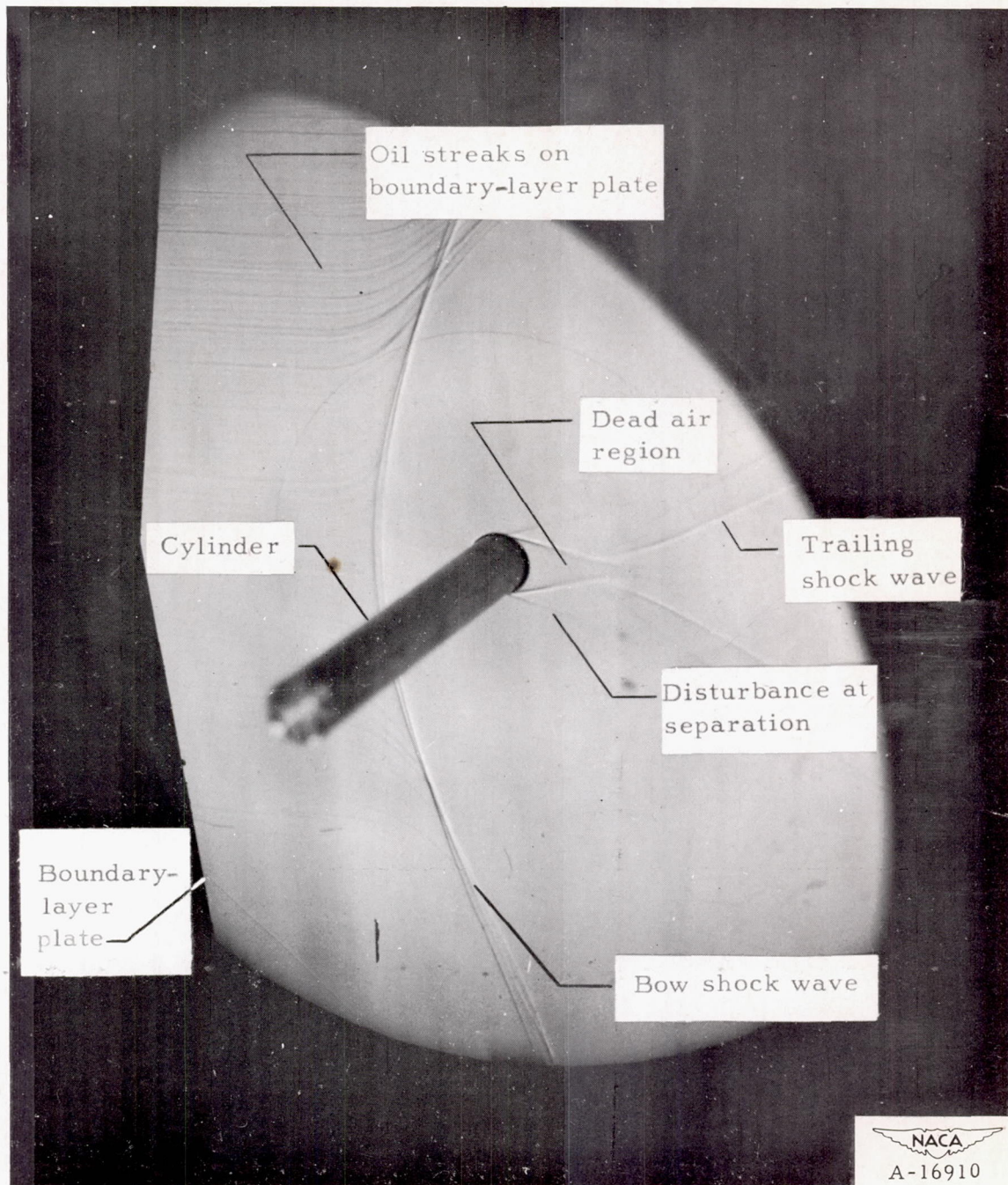
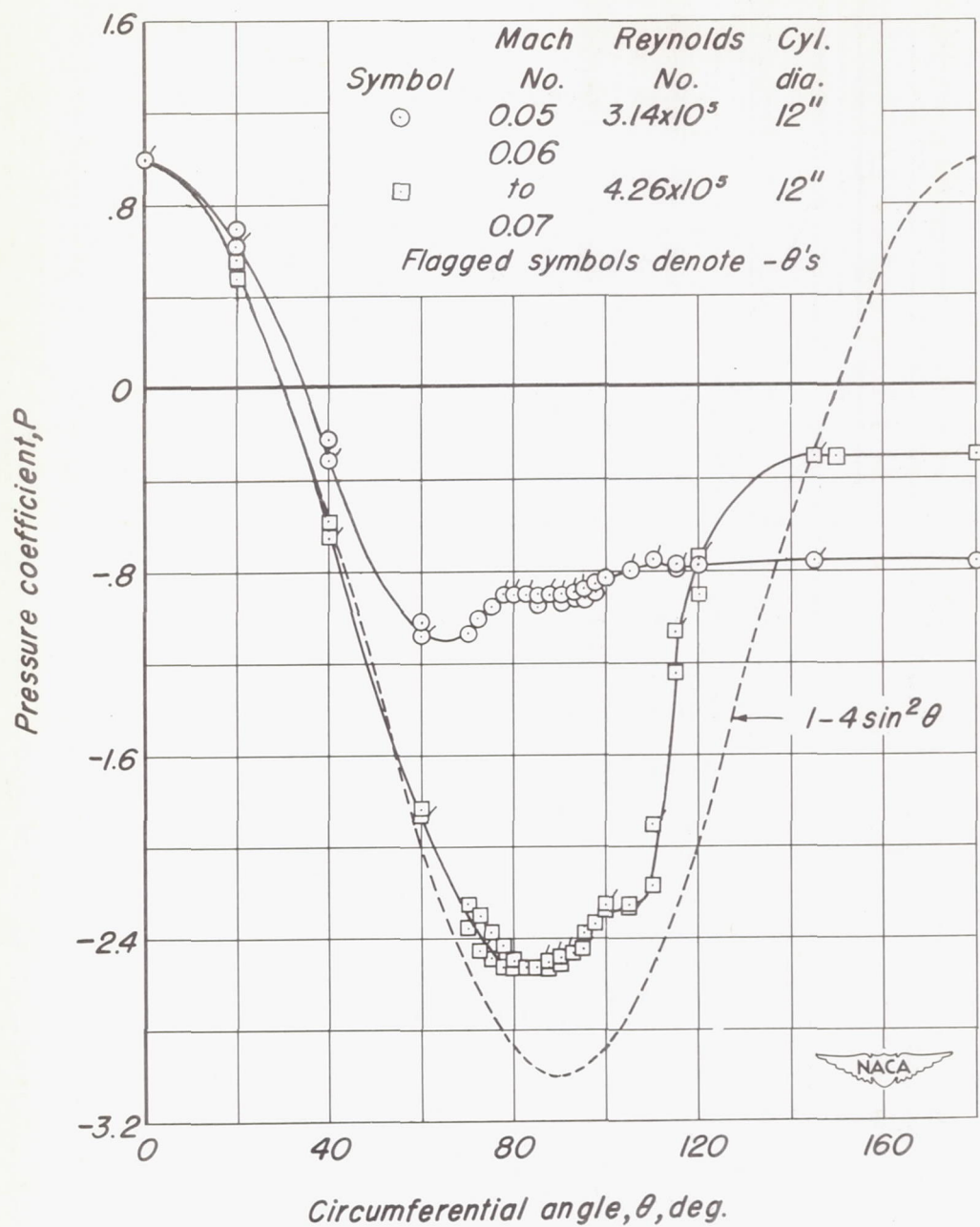
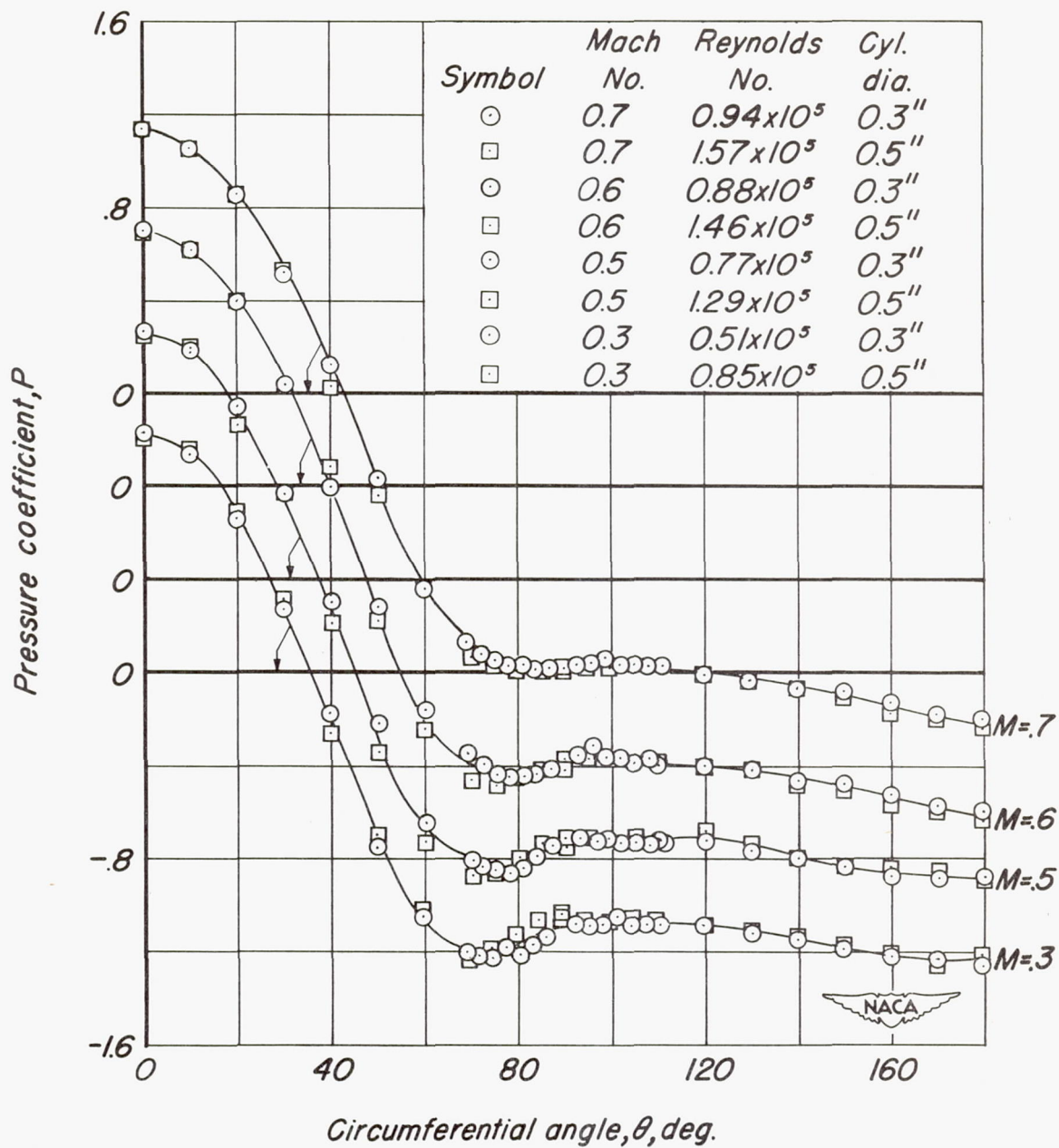

Figure 4. - Shadowgraph of the flow about a circular cylinder for a Mach number of 1.49.



(a) Low subsonic Mach numbers.

Figure 5.- Circumferential distributions of pressure coefficient for circular cylinders at various Reynolds numbers and Mach numbers.



(b) High subsonic Mach numbers.

Figure 5.- Continued.

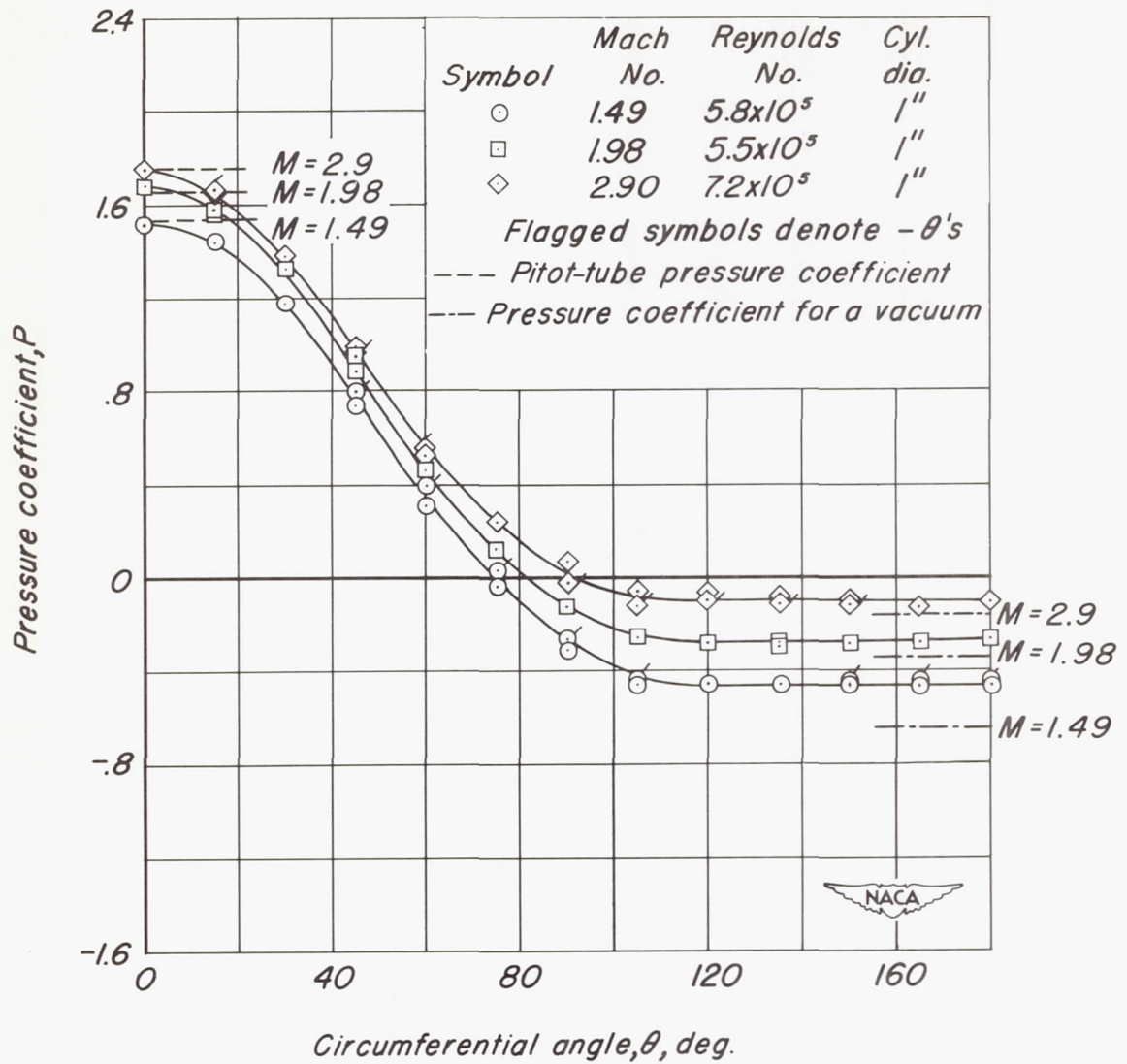

(c) Supersonic Mach numbers

Figure 5.-Continued.

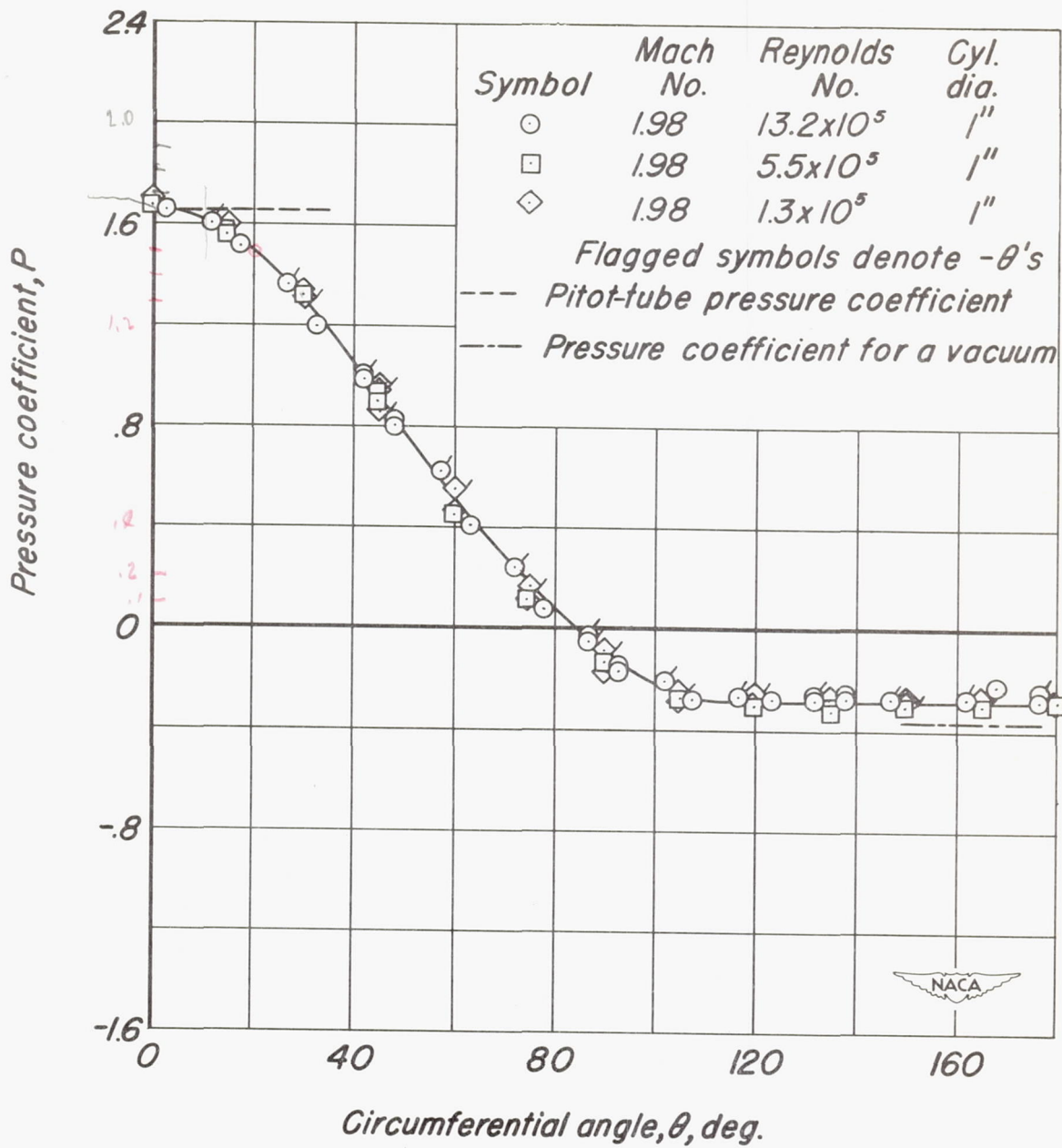

(d) Effects of Reynolds number at a Mach number of 1.98.

Figure 5.—Continued.

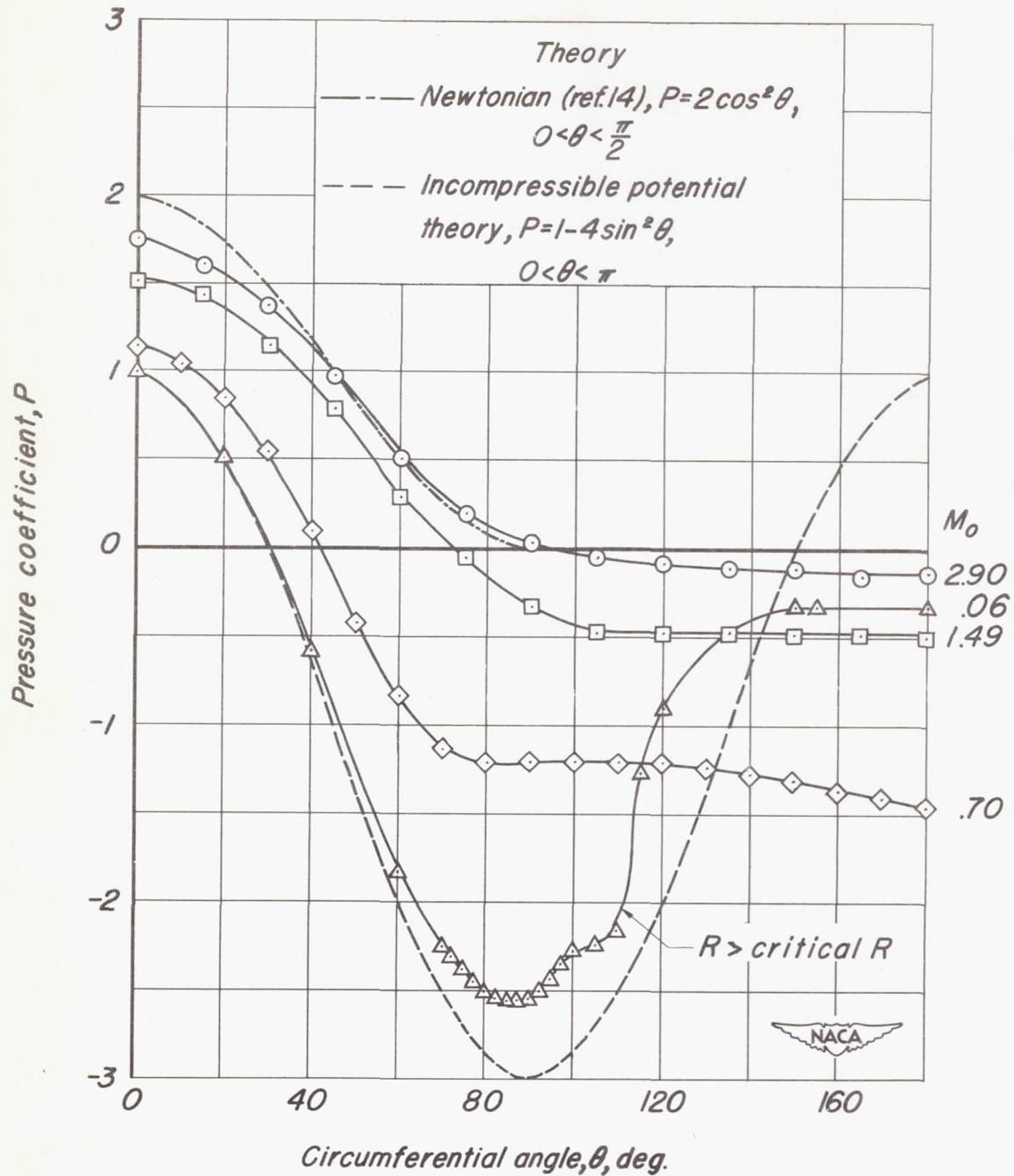

(e) Comparison between experiment and theory.

Figure 5.-Concluded.

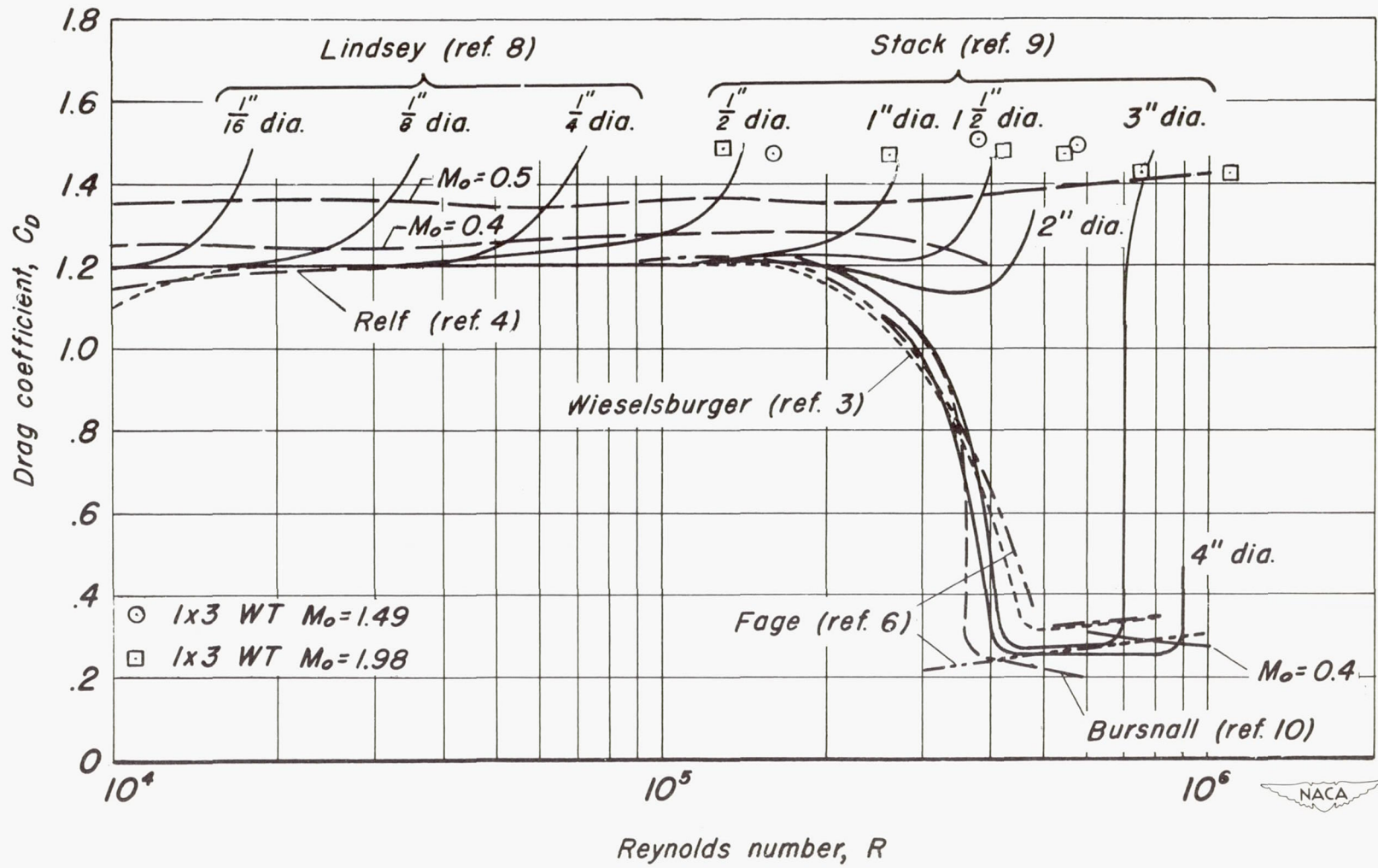

Figure 6.—The effect of Reynolds number on circular-cylinder drag coefficients.



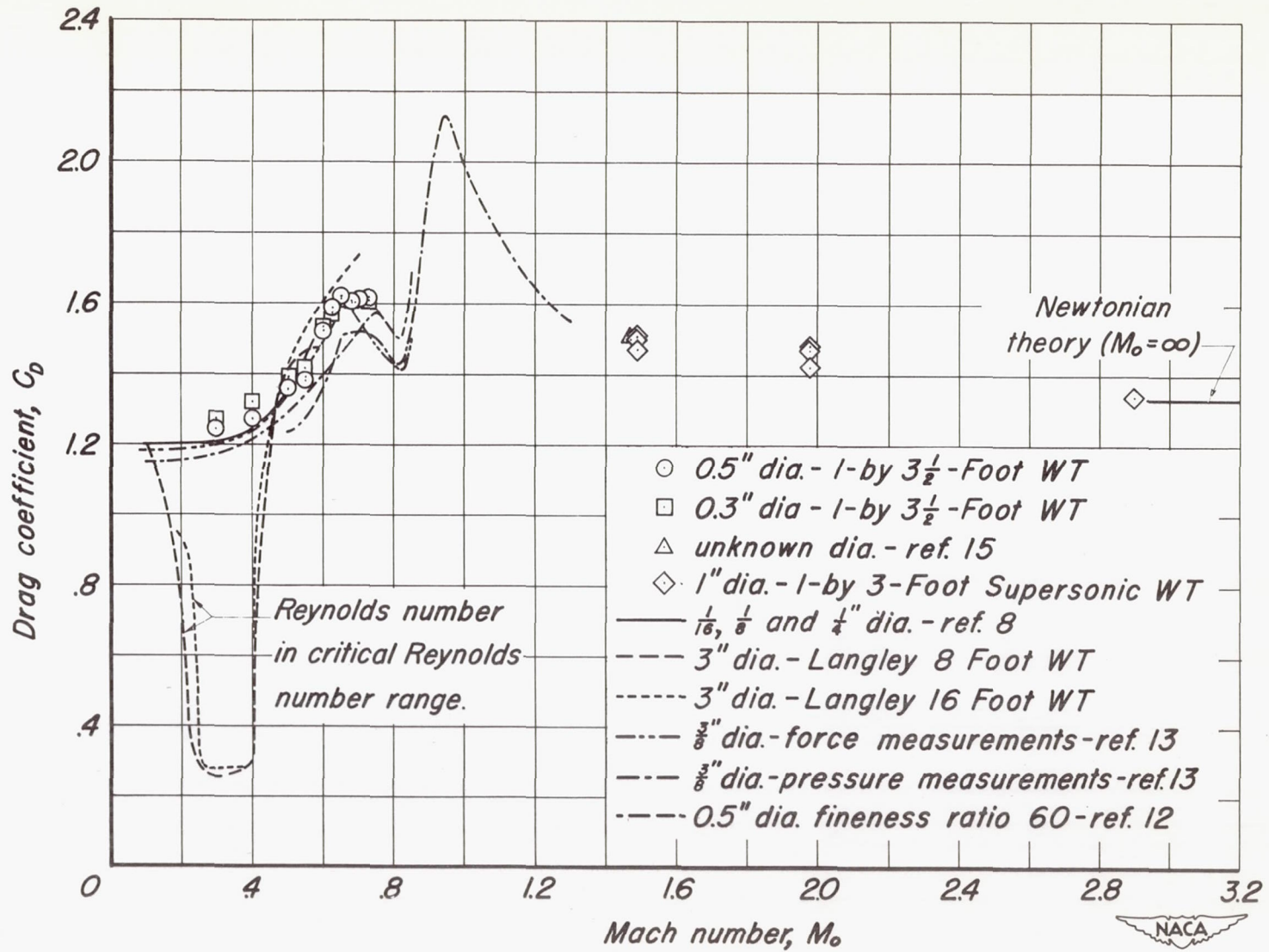

Figure 7.- The effect of Mach number on circular-cylinder drag coefficients.



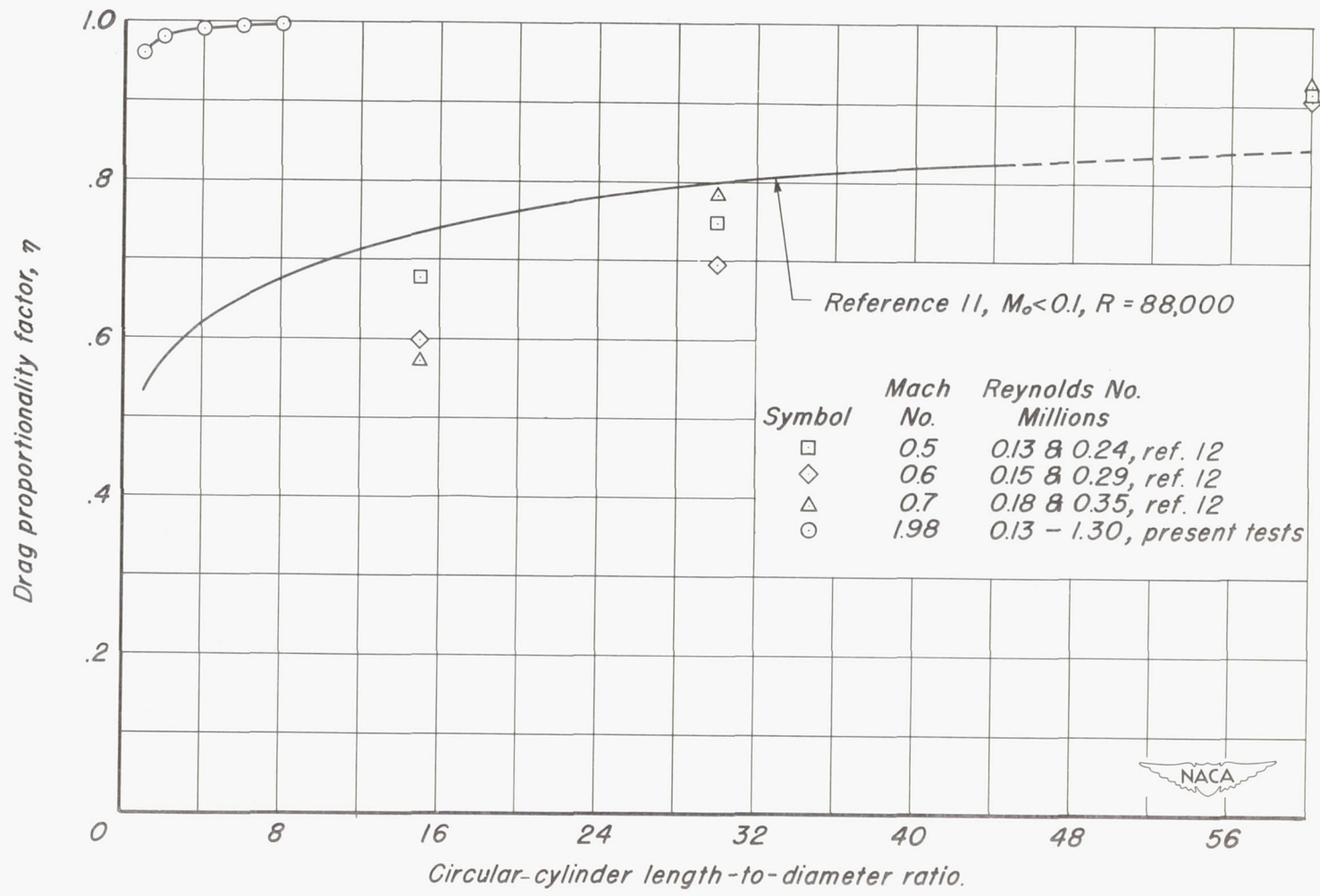

Figure 8.-Ratio of the drag coefficient of a circular cylinder of finite length to that of a cylinder of infinite length,  $\eta$ , as a function of length-to-diameter ratio.

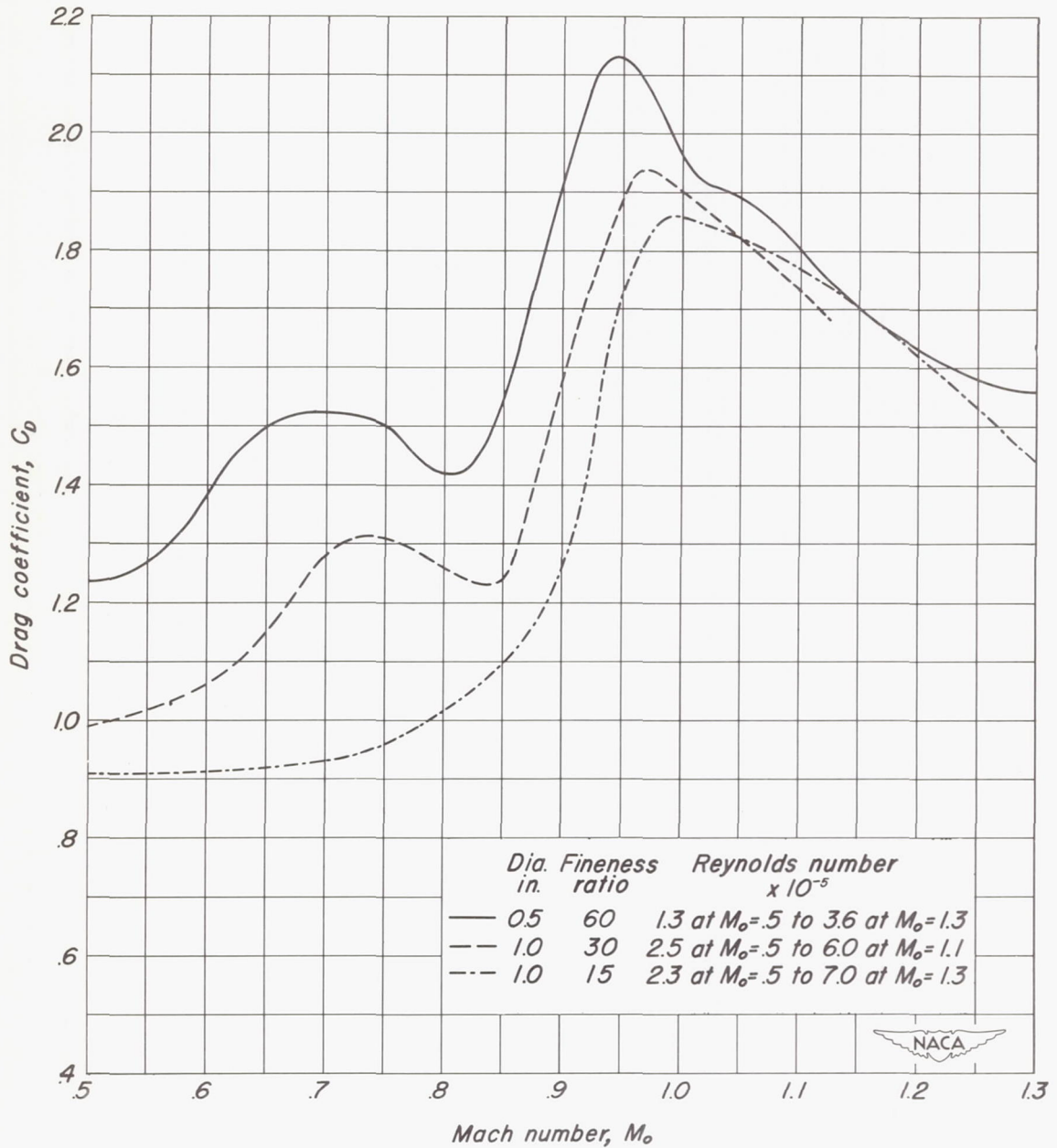

Figure 9.- Variation of drag coefficient with Mach number for a circular cylinder with varying fineness ratio from rocket firing tests.

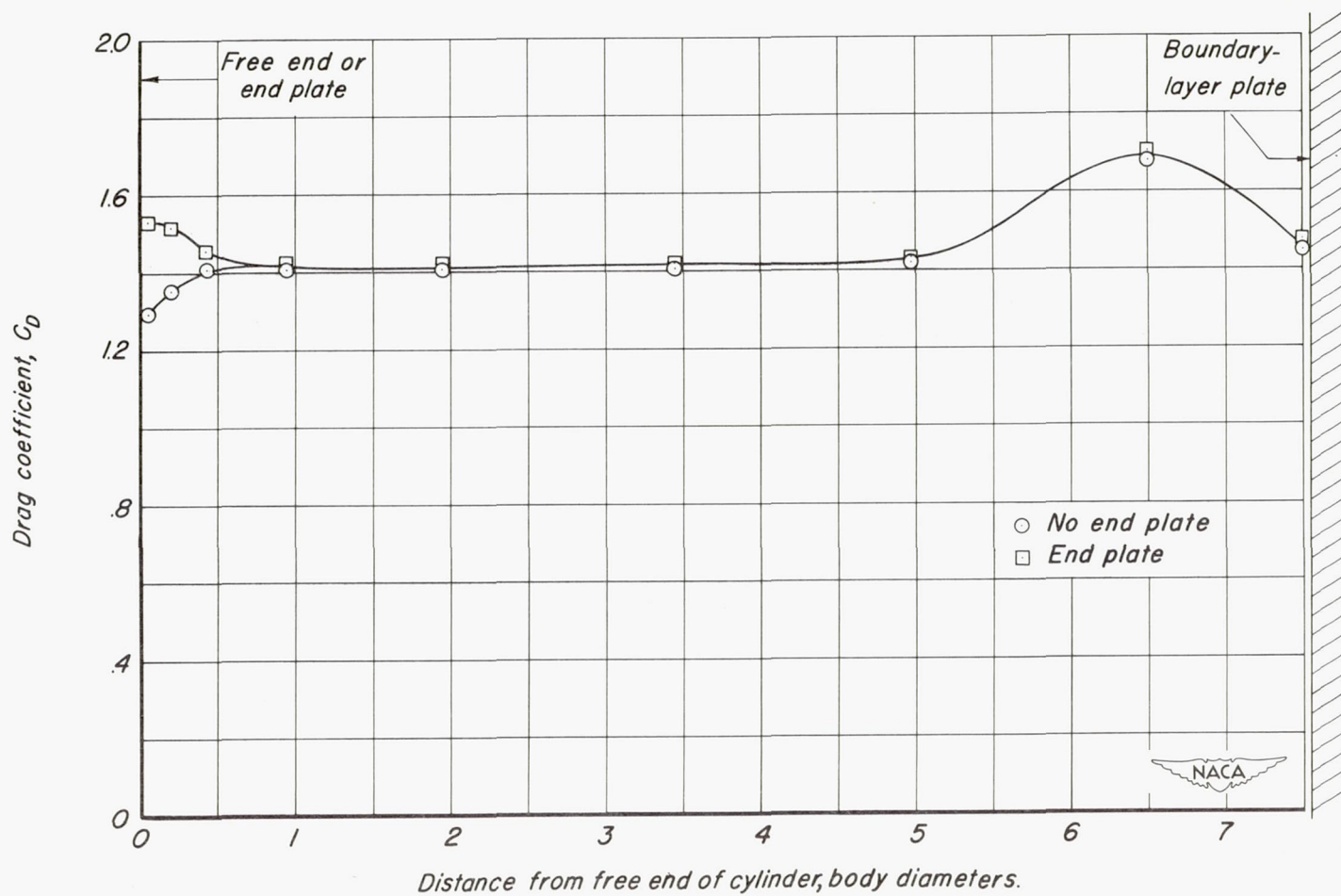

Figure 10.— Comparison of longitudinal distributions of drag coefficient for a circular cylinder with and without an end plate for a Reynolds number of  $7.4 \times 10^5$  and a Mach number of 1.98.