

~~CONFIDENTIAL~~

COPY NO.

RM No. E7K14

32

NACA
CASE FILE
COPY
RESEARCH MEMORANDUM
CASE FILE
COPY

EXPERIMENTAL INVESTIGATION OF THRUST AUGMENTATION OF
 AXIAL-FLOW-TYPE 4000-POUND-THRUST TURBOJET ENGINE
 BY WATER AND ALCOHOL INJECTION AT COMPRESSOR INLET

By Burnett Baron, Harry W. Dowman
 and William C. Dackis

Flight Propulsion Research Laboratory
 Cleveland, Ohio

JPL LIBRARY
CALIFORNIA INSTITUTE OF TECHNOLOGY

Classification Changed to	
UNCLASSIFIED	
Authority <i>NACA Research Abstracts #57</i>	
Date	By (ew)
MAR 3 1954	<i>D. E. Newlan</i>

This document contains classified information affecting the National Defense of the United States within the meaning of the Espionage Act, Title 18, U.S.C. Sec. 793 and 794. The transmission or the revelation of its contents in any manner to an unauthorized person is prohibited by law. Information so classified may be imparted only to persons in the military and naval services of the United States, appropriate civilian officers and employees of the Federal Government who have a legitimate interest therein, and to United States citizens of known loyalty and discretion who of necessity must be informed thereof.

**NATIONAL ADVISORY COMMITTEE
 FOR AERONAUTICS**

WASHINGTON

July 8, 1948

JUL 13 1948

CONFIDENTIAL
~~UNCLASSIFIED~~

NACA RM No. E7K14

UNCLASSIFIED
CONFIDENTIAL

Classification Changed to UNCLASSIFIED	
Authority <i>NACA Research Abstracts #57</i>	
<i>2/29 Jan 54</i>	
Date MAR 3 1954	By <i>(6W)</i> <i>L E Newlan</i>

NATIONAL ADVISORY COMMITTEE FOR AERONAUTICS

RESEARCH MEMORANDUM

EXPERIMENTAL INVESTIGATION OF THRUST AUGMENTATION

OF AXIAL-FLOW-TYPE 4000-POUND-THRUST TURBOJET

ENGINE BY WATER AND ALCOHOL INJECTION

AT COMPRESSOR INLET

By Burnett Baron, Harry W. Dowman
and William C. Dackis

SUMMARY

An experimental investigation of thrust augmentation of an axial-flow-type turbojet engine with a 4000-pound-thrust rating by means of water-alcohol injection at the compressor inlet has been conducted at sea-level conditions and zero ram. Three injection systems were investigated in an effort to obtain satisfactory atomization and distribution of the injected liquids. The engine was equipped with an adjustable-area exhaust nozzle during these investigations in order to provide control of the exhaust-gas temperature independent of injection rate and rotor speed. The engine performance was determined at constant rotor speed and exhaust-gas temperature for various mixtures and flow rates of injected water and alcohol up to 4.5 pounds per second of water and 2.25 pounds per second of alcohol.

The thrust augmentation by injection of water and alcohol at the compressor inlet was limited by centrifugal separation of the injected liquid and air in the compressor. A thrust augmentation of 15.4 percent was obtained by injecting 3.0 pounds per second of water at a rotor speed of 7635 rpm, an exhaust-gas temperature of 1665° R, and an inlet-air temperature of 548° R. Small reductions of inlet-air temperature (8° to 25° F) appeared to cause large decreases in the thrust augmentation produced. Although three different injection systems were used, differences in the inlet-air temperature for each system prevented any determination of the importance of form of injection on the thrust augmentation produced.

UNCLASSIFIED
CONFIDENTIAL

CONFIDENTIAL
UNCLASSIFIED

INTRODUCTION

The limited thrust output of turbojet engines at take-off and during climb has instigated considerable study and experimentation on the thrust augmentation of these engines. Several methods of providing additional thrust have been investigated at the NACA Cleveland laboratory. One simple method of thrust augmentation is the injection of refrigerants at the compressor inlet, and the results of an experimental investigation of this method for centrifugal-flow-type turbojet engines with 1600- and 4000-pound thrust ratings are presented in references 1 and 2, respectively. Investigations have also been conducted to determine the application of this method of augmentation to axial-flow-type turbojet engines. Reference 3 presents the results of a brief investigation of the performance of an axial-flow-type turbojet engine with a 4000-pound-thrust rating with water injection at the compressor inlet under altitude conditions.

The performance of this same type of engine investigated at the NACA Cleveland laboratory with injection of water and alcohol mixtures at sea-level conditions and zero ram is presented herein. In an effort to attain optimum atomization and distribution of the injected liquids, the investigation was conducted with three systems varying in the direction of injection and the type and location of injection nozzles. The engine was equipped with an adjustable-area exhaust nozzle to provide control of the exhaust-gas temperature independent of injection rate and rotor speed.

The engine performance was determined at approximately rated rotor speed and maximum permissible exhaust-gas temperature over a range of flows for several injected mixtures of water and alcohol. In order to indicate the distribution of the injected liquids at the compressor discharge, temperature surveys at this location were taken for several injected-liquid flows.

APPARATUS

Engines. - The investigation was conducted on two TG-180 engines. This engine has an 11-stage axial-flow compressor, eight cylindrical combustion chambers, and a single-stage turbine. The nominal military rating of the engine is 4000 pounds thrust at a rotor speed of 7700 rpm and zero-ram, sea-level conditions.

Engine and component installation. - The general arrangement of the installation of the engine in the test chamber is shown in figure 1. The engine was mounted on a swinging framework suspended from the ceiling of the test chamber; the engine thrust was balanced

CONFIDENTIAL
UNCLASSIFIED

and measured with an air-pressure diaphragm. Air entered the nearly airtight chamber through two 18-inch-throat-diameter A.S.M.E. nozzles, which were used to determine the flow. The engine speed and the fuel flow were measured with standard instrumentation.

A spherical clamshell-type adjustable-area exhaust nozzle having a projected discharge-area range from 224 to 283 square inches was installed at the end of a tail pipe 30 inches in length. This tail pipe, which had an inside diameter of 21 inches, was installed to provide for discharge of the exhaust gas outside the test chamber. An inlet cowling facilitated measurement of the engine inlet-air temperature and also provided a support for the injection equipment.

Liquids. - For these investigations, AN-F-32 (Amendment-3) fuel was used. A mixture containing 50-percent methyl alcohol and 50-percent ethyl alcohol (by volume) was used for injection with water. The water was obtained from the city water supply.

Water-alcohol-injection systems. - Three different arrangements of water-alcohol-injection equipment, designated injection systems A, B, and C, were used and are shown in figures 2(a), 2(b), and 2(c), respectively.

In system A, the spray nozzles were embedded in the wooden inlet cowling and the injection manifolds were located circumferentially around the outside of the cowling to prevent inlet-pressure losses. Twenty water-spray nozzles and twenty alcohol-spray nozzles were installed at distances of 14 and $8\frac{1}{2}$ inches, respectively, from the peak of the compressor-inlet screen. The nozzles were directed upstream (with respect to the air flow) and inward toward the nose-piece over the accessories.

System B was designed with the injection manifolds on the nose-piece in an effort to avoid an excess of liquid at the compressor-blade tips. Ten water-spray nozzles and eight alcohol-spray nozzles at distances of 22 and 24 inches, respectively, from the peak of the compressor-inlet screen were directed upstream and outward toward the wooden inlet cowling.

The injection manifolds for system C were installed at the entrance of the inlet cowling, which placed both the water and alcohol spray nozzles at a distance of $40\frac{1}{4}$ inches from the peak of the compressor-inlet screen. The increased length of path of the liquids before entering the compressor provided additional time for vaporization before compression. Twenty-six water nozzles and twenty-six alcohol nozzles sprayed directly downstream (with respect to the air

UNCLASSIFIED

flow). The greater number of smaller spray nozzles used in system C than in systems A and B served to achieve better atomization and distribution of the injected liquids.

The principal dimensions of the three injection systems and the characteristics of the spray nozzles of each system are summarized in the following table:

Injection system	Angle of injection with respect to air flow (deg)	Type of spray	Distance from peak of inlet screen (in.)	Radius of nozzle circle (in.)	Number of nozzles	Rated capacity (gal/min)	Rated spray angle (deg)
Water nozzles							
A	150	Flat	14	$15\frac{1}{2}$	20	1.87	54
B	120	Flat	22	10	10	1.87	54
C	0	Conical	$40\frac{1}{4}$	$12\frac{1}{4}$	26	1.00	60
Alcohol nozzles							
A	150	Flat	$8\frac{1}{2}$	$15\frac{1}{2}$	15 5	0.81 1.87	58 54
B	120	Flat	24	$9\frac{1}{4}$	8	1.87	54
C	0	Conical	$40\frac{1}{4}$	$12\frac{1}{4}$	26	.66	60

Instrumentation. - The location of temperature and pressure instruments on the engine are shown in figure 3.

The temperatures taken and number, type, and location of thermocouples were as follows:

(a) Total temperature at engine inlet (station 0 for injection systems A and B, station O_c for injection system C) T_0 : average of 20 thermocouples, five in each of four rakes 90° apart in the inlet cowling

(b) Total temperature at compressor discharge (station 2) T_2 : four rakes of five thermocouples located ahead of combustion chambers 2, 4, 6, and 8: (1) average T_2 , average of all 20 thermocouples; (2) T_2 surveys, average of four thermocouples for each of five radial locations across compressor discharge

UNCLASSIFIED

(c) Exhaust-gas temperature at tail-pipe inlet (station 6), T_6 : average of eight strut-type thermocouples equally spaced circumferentially and 4 inches from tail-pipe wall

The pressures taken and number, type, and location of pressure tubes were as follows:

(a) Total pressure at engine inlet (station 0) P_0 : one open-end tube in quiescent zone of test chamber

(b) Total pressure at compressor discharge (station 2) P_2 : average of 12 total-pressure tubes, three in each of four rakes ahead of combustion chambers 1, 3, 5, and 7

PROCEDURE

The investigation of engine performance with water and alcohol injection at the compressor inlet was conducted under the following conditions:

Injec- tion system	Injected water flow W_w (lb/sec)	Injected alcohol flow W_{a1} (lb/sec)	Approx- imate rotor speed N (rpm)	Approx- imate exhaust- gas tem- perature T_6 (°R)	Engine inlet- air tem- perature T_0 (°R)	Engine inlet pressure P_0 (lb/sq in. abs.)
A	0, 1.5, 3.0, 4.5 3.0, 4.5	0 1.5	7634	1677	548	14.30
B	0, 1.5, 3.0 1.5, 3.0 1.5, 3.0	0 .75 1.5	7590	1648	540	14.24
C	0, 0.75, 1.5, 2.25, 3.0 0.75, 1.5, 2.25, 3.0 0.75, 1.5, 2.25, 3.0 2.25, 2.5, 3.0	0 .75 1.5 2.25	7635	1665	523	14.27

652

UNCLASSIFIED
CONFIDENTIAL

The maximum injected water flow for systems B and C was lower than that used for system A because at the highest injected water flow for system A (4.5 lb/sec) localized overheating of the turbine wheel and diaphragm was encountered, as indicated by hot spots in the turbine-exhaust outer cone. The investigation of all three injection systems was conducted at substantially constant rotor speed and exhaust-gas temperature. The exhaust-gas temperature was adjusted to the values indicated in the table by varying the area of the adjustable exhaust nozzle.

Operation of the engine to establish the normal performance with each injection system is indicated in the preceding table by zero injected water and alcohol flows. Separate determination of normal performance for each injection system was necessary because two different engines were used and because each injection system was investigated at slightly different engine-inlet conditions of temperature and pressure.

ADJUSTMENT OF DATA

The correction factors used in references 1 and 2 to correct the engine performance data to standard inlet conditions are believed to be applicable over only a small temperature range and when conditions of equilibrium between the air and the injected liquid exist during compression. Whereas conditions of equilibrium may be expected in a centrifugal-flow compressor, centrifugal separation of the liquid and the air in an axial-flow compressor prevents equilibrium between the liquid and the air from being obtained. Even though the temperature differences for these investigations may be considered small, no attempt was made to correct the engine performance data presented to standard sea-level conditions of temperature and pressure. The data were, however, adjusted to a rotor speed of 7635 rpm and an exhaust-gas temperature of 1665° R for comparison. These adjustments of the data were based on curves of engine performance against rotor speed for various positions of the adjustable nozzle (various exhaust-nozzle areas) similar to those presented in reference 4. Use of these curves for adjustment of the data imposes the assumption that curves of performance against rotor speed with injection of water and alcohol are parallel to curves of performance without injection. Because the range of adjustment is small, any error in the engine performance variables introduced by this assumption is believed to be negligible.

UNCLASSIFIED
CONFIDENTIAL

RESULTS AND DISCUSSION

The effects of water-alcohol injection at the compressor inlet, for three injection systems, on the performance and operation of an axial-flow 4000-pound-thrust turbojet engine are discussed.

Engine Performance

Thrust and thrust augmentation for three injection systems. - The static thrust F of the engine and the percentage thrust augmentation $(\Delta F)/F$ obtained are plotted as functions of injected water flow W_w for the several injected alcohol flows in figures 4, 5, and 6 for injection systems A, B, and C, respectively. The differences in normal thrust of the engine (without injection) for investigations of the various injection systems is attributed to the fact that one engine was used for systems A and B and a second engine for system C; variation in inlet temperatures and pressure for the different systems also contributed to differences in normal thrust.

The thrust augmentation obtained with injection system A (fig. 4(b)) increased with injected water flow over the range of flows investigated and decreased with the addition of alcohol to the injected mixture. Although the maximum thrust augmentation was obtained at the highest water flow (4.5 lb/sec), this injection rate was considered injurious to the engine (as will be discussed later). An injected-water flow of 3.0 pounds per second appeared to have no detrimental effects, however, and at this injected flow rate (water alone) a thrust augmentation of 15.4 percent was obtained at a rotor speed of 7635 rpm, an exhaust-gas temperature of 1665° R, and an inlet-air temperature of 548° R.

The thrust augmentation provided by injection system B (fig. 5(b)) increased with injected water flow over the range of flows investigated and the addition of alcohol to the injected mixture further increased the available augmentation. The maximum thrust augmentation was 12.7 percent for injection of 3.0 pounds per second of water and 1.5 pounds per second of alcohol (inlet-air temperature, 540° R).

For injection of water alone and for injection of water with 0.75 pound per second of alcohol, the thrust augmentation obtained with injection system C (fig. 6(b)) increased to a maximum at approximately 2.25 pounds per second of water and decreased with further injection of water. With injection of water-alcohol

mixtures containing 1.5 and 2.25 pounds per second of alcohol, the augmentation increased with increased water injection over the range of flows investigated. At any fixed injected water flow, the addition of alcohol up to 1.5 pounds per second also increased the available augmentation; further increase in the injected alcohol flow decreased the augmentation. The maximum thrust augmentation obtained in the investigation of injection system C (inlet-air temperature, 523° R) was 7.6 percent for injection of 3.0 pounds per second of water and 1.5 pounds per second of alcohol.

Operation of injection systems. - A photograph of injection system A in operation is presented in figure 7(a). It is apparent that excellent atomization of the injected liquid was obtained. The penetration of the spray into the air stream was inadequate, however, and the injected liquid concentrated near the wall of the compressor casing. Injection system B in operation (fig. 7(b)) shows poor distribution of the injected liquid. The photograph of injection system C in operation (fig. 7(c)) indicates that this injection system was more effective than systems A and B in atomization and distribution of the injected liquid. The atomized liquid is seen to be more heavily concentrated around the nosepiece than near the inner surface of the inlet cowling. This concentration of injected liquid in the region of the compressor rotor-blade roots was considered desirable because it would be expected to offset partly the centrifugal separation of injected liquid and air in the compressor.

Comparison of systems. - A comparison of the thrust augmentations of the different injection systems would indicate that injection system A is more effective than systems B and C although system C provided the most desirable atomization and distribution of injected liquid. This discrepancy between thrust augmentation and characteristics of the injection spray is believed to be caused by the higher inlet-air temperature for the investigation of system A (548° R) as compared with that for the investigation of system C (523° R). Any improvement that the atomization and the distribution of injected liquid on the thrust augmentations produced thus was believed to be obscured by the effect of inlet-air temperature. Humidity of the inlet air, which was much higher during the investigation of system C than of system A, is thought to have also had some effect on the augmentation.

Effect of engine inlet-air temperature on thrust augmentation. - The thrust-augmentation data in figures 4 to 6 are replotted in figure 8 as a function of engine inlet-air temperature. These curves admittedly do not indicate a true effect of inlet-air temperature

because of the different injection systems used and possibly because of variations in the humidity of the inlet air. The curves may, however, indicate at least a minimum effect of inlet-air temperature because the data for the lowest inlet-air temperature (and lowest thrust augmentation) were obtained with the injection system (system C) providing the best form of injection. These data indicate that an increase in inlet-air temperature of 30° F results in an increase of approximately 8 percentage points in the thrust augmentation for all injection rates investigated.

Effect of water and alcohol injection on engine performance other than thrust and thrust augmentation. - Fuel flow W_f , total liquid consumption W_t , specific liquid consumption W_t/F , compressor-discharge pressure P_2 , air flow W_a , and average compressor-discharge temperature T_2 for injection system C are presented as functions of injected water flow for various alcohol flows in figure 9. The engine performance data from all three injection systems showed similar results for variables other than thrust; hence the data for system C, which required the least adjustment, were selected for presentation. The large changes in engine performance resulting from the injection of water were the increases in the fuel flow and the total and specific liquid consumption and the decrease in the compressor-discharge temperature. Changes in performance of smaller magnitude were the increase in compressor-discharge pressure and the decrease in the air flow. The injection of alcohol, at a constant water injection rate, resulted in a marked decrease in fuel flow and an increase in the total and specific liquid consumption. The changes in the compressor-discharge pressure, the air flow, and the compressor-discharge temperature were of much smaller magnitude.

A water-alcohol mixture with which the engine may be operated at the normal fuel flow during injection is shown in figure 9(a) for injection of 2.2 pounds per second of water and 0.75 pound per second of alcohol. Insufficient data are available to determine whether this mixture, which contains 25.4-percent alcohol by weight, would permit operation of the engine at normal fuel flow for other rates of injection.

Further inspection of figure 9(a) shows that the injected alcohol does not replace the fuel in the ratio of the respective heating values. For an increase in injected alcohol flow from 0 to 2.25 pounds per second, the fuel flow decreases approximately 0.62 pound per second. Calculations based on heating values of 18,700 and 10,900 Btu per pound for kerosene and alcohol, respectively, and a kerosene combustion efficiency of 95 percent indicate that approximately 45 percent of the alcohol burned.

Examination of the curves of total liquid consumption and air flow (figs. 9(b) and 9(e), respectively) shows that approximately 3.0 percent of the maximum augmentation of 7.6 percent (fig. 6(b), injection of 3.0 lb/sec of water and 1.5 lb/sec of alcohol) is the result of the increase in the mass flow through the engine. The remaining 4.6-percent augmentation may be attributed to the increased jet velocity provided by the higher compressor-discharge pressure. Figure 9(c) shows that the 7.6-percent augmentation was realized at the expense of an increase in specific liquid consumption of 357 percent. It is shown in reference 2 that, for similar rates of injection into a centrifugal-flow-type turbojet engine with a 4000-pound-thrust rating, a 23.8-percent thrust augmentation was obtained with an increase in specific liquid consumption of 254 percent.

Compressor-discharge temperature surveys. - Compressor-discharge temperature surveys are presented for system C in figure 10, in which the temperature is plotted against the radial distance D across the compressor-discharge annulus from the outside wall for all injected water flows (separate curves for each injected alcohol flow). For all injected flows the temperature is lowest near the outside wall and highest near the inside wall of the compressor discharge. The large magnitude of this temperature difference indicates that considerable centrifugal separation of the injected liquid and air occurred in the compressor. This concentration of liquid near the compressor casing at the discharge occurred even though this injection system provided the greatest distance for vaporization and mixing before compression as well as concentration of the injected liquid at the root of the compressor blades (fig. 7(c)).

The compressor-discharge temperature surveys for injection of 3.0 pounds per second of water (at all alcohol flows) show low-temperature areas extending at least halfway across the compressor discharge from the outside wall. These extensive low-temperature areas indicate greater mixing of the injected liquids at high injected water flows possibly through turbulence caused by stalling of the compressor or flow separation in the compressor diffusers. Similar results were observed in the investigation presented in reference 3.

It is apparent from the results of these investigations that thrust augmentation by injection of water and alcohol at the compressor inlet of an axial-flow-type engine is limited by centrifugal separation of the liquid and air during compression. It is likely that water-alcohol injection at the compressor inlet can be used to

the best advantage only when the engine inlet-air temperature is high enough and the initial relative humidity low enough to provide for considerable evaporation of the injected liquid before compression.

Engine Operation

The injection of water and alcohol had some detrimental effects on the engine, most of which occurred during the high water flow of 4.5 pounds per second injected with system A. At this water-injection rate, afterburning through the turbine was evidenced by hot spots in the turbine exhaust cone. The addition of alcohol to this water flow, however, decreased the hot spots, indicating an improvement in the combustion characteristics. Figure 11 shows the cracked and warped blades of the turbine nozzle box at the conclusion of the investigations of injection systems A and B. No damage was observed on the nozzle box of the engine on which the investigation of system C was conducted; the injected water rate for this system, however, was limited to 3.0 pounds per second.

Examination of the compressor after the first two injection systems had been investigated showed definite evidence of blade rubbing on both the compressor casing and rotor drum in the fourth to the ninth stages, whereas there was very little evidence of rubbing in the compressor used for the investigation of system C. The greater amount of rubbing was probably caused by greater temperature differences between rotor and casing for injection systems A and B, either as a result of the high rate of injected water for system A or the poor distribution and mixing provided by these systems, or both. The radial blade clearance also may have been less for the engine used with injection systems A and B than for the engine of system C.

SUMMARY OF RESULTS

The investigation of the performance of an axial-flow-type turbojet engine with a 4000-pound-thrust rating at zero-ram, sea-level conditions showed that thrust augmentation by injection of water and alcohol at the compressor inlet was limited by centrifugal separation of the injected liquid and air in the compressor. A thrust augmentation of 15.4 percent was obtained by injecting 3.0 pounds per second of water at a rotor speed of 7635 rpm, an exhaust-gas temperature of 1665° R, and an inlet-air temperature of 548° R. Small reductions of inlet-air temperature (8° to 25° F) appeared to cause large decreases in the thrust augmentation

UNCLASSIFIED
CONFIDENTIAL

produced. Although three different injection systems were used, differences in the inlet-air temperature for each system prevented any determination of the importance of form of injection on the thrust augmentation produced.

Injected water flows of 4.5 pounds per second produced localized hot spots in the turbine, which were apparently caused by impaired combustion and afterburning through the turbine. Large radial temperature differences were obtained at the compressor discharge for all injected flows; rubbing of the compressor blades on the casing and rotor drum occurred during some of the runs.

Flight Propulsion Research Laboratory,
National Advisory Committee for Aeronautics,
Cleveland, Ohio.

REFERENCES

1. Jones, William L., and Dowman, Harry W.: Experimental Investigation of Thrust Augmentation of a 1600-Pound Thrust Centrifugal Flow-Type Turbojet Engine by Injection of Refrigerants at the Compressor Inlets. NACA RM No. E7G23, 1947.
2. Jones, William L., and Engelman, Helmuth W.: Experimental Investigation of Thrust Augmentation of 4000-Pound-Thrust Centrifugal-Flow-Type Turbojet Engine by Injection of Water and Alcohol at Compressor Inlets. NACA RM No. E7J19, 1948.
3. Dietz, Robert O., Jr., and Fleming, William A.: Altitude-Wind-Tunnel Investigation of Thrust Augmentation of a Turbojet Engine. II - Performance with Water Injection at Compressor Inlet. NACA RM No. E7C12, 1947.
4. Lundin, Bruce T., Dowman, Harry W., and Gabriel, David S.: Experimental Investigation of Thrust Augmentation of a Turbojet Engine at Zero Ram by Means of Tail-Pipe Burning. NACA RM No. E6J21, 1946.

UNCLASSIFIED
CONFIDENTIAL

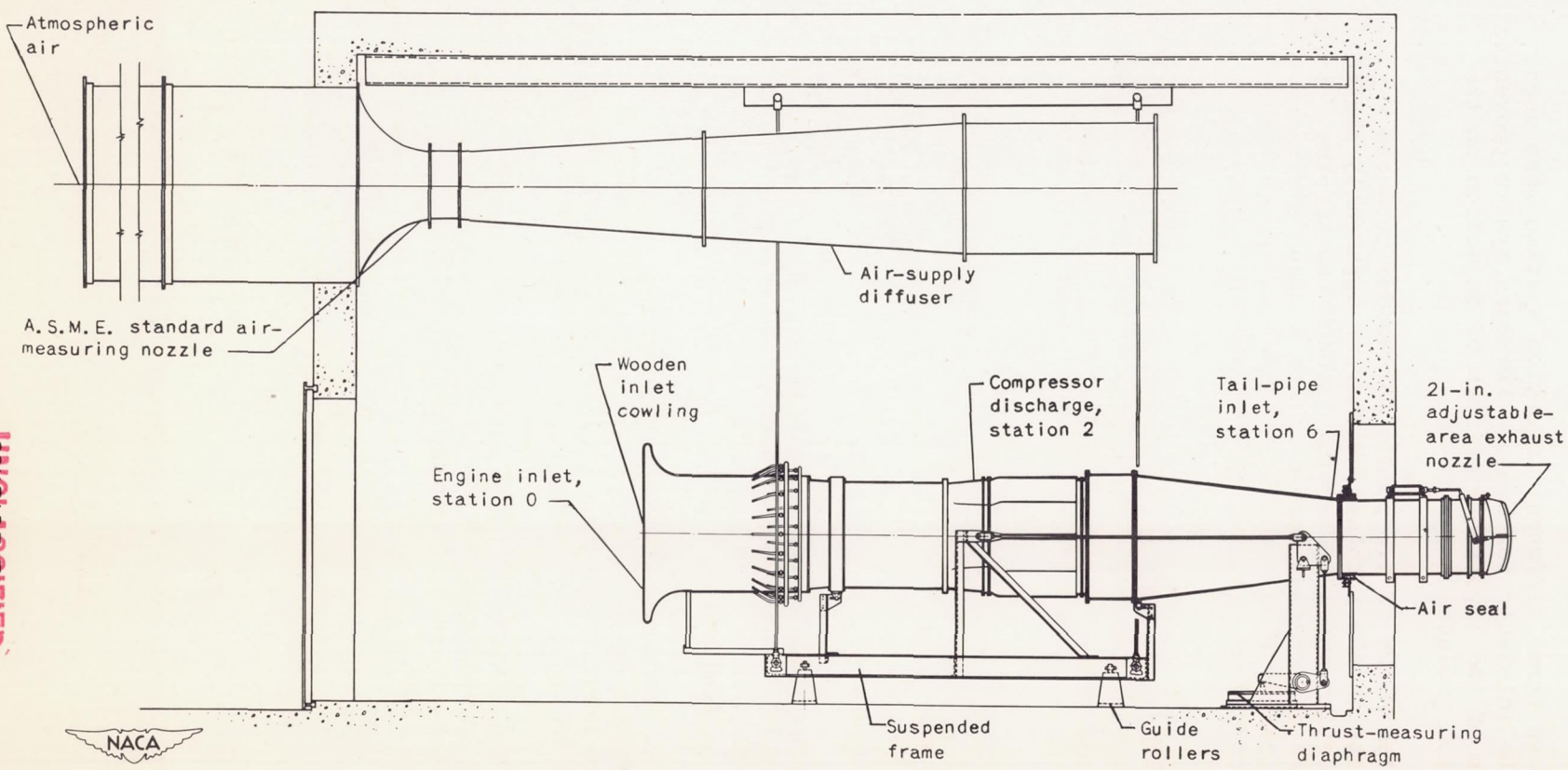

Figure 1. - Schematic diagram of engine installation.

UNCONFIDENTIAL

UNCONFIDENTIAL



853

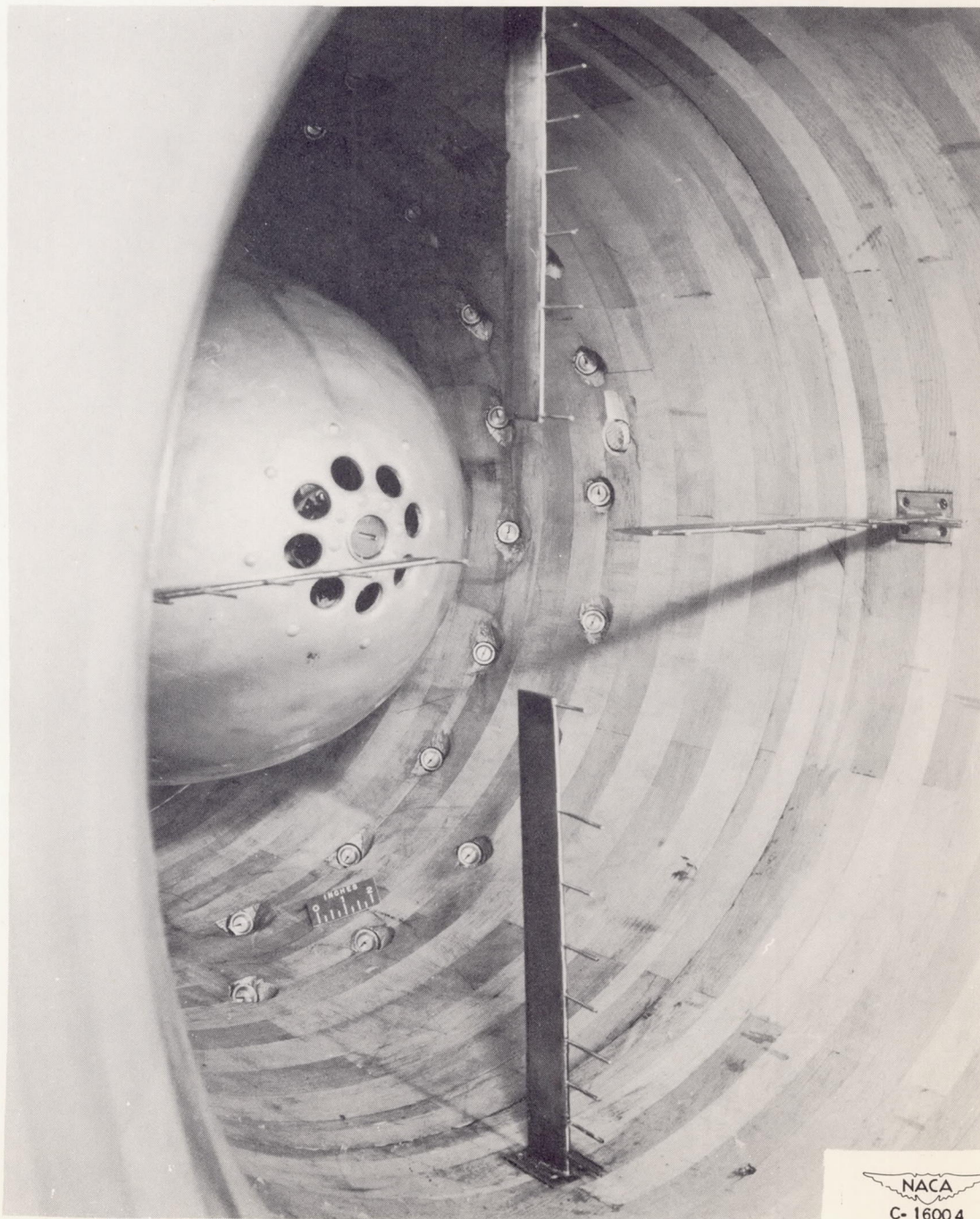

NACA
C-16004
10-10-46

(a) Injection system A: nozzles installed in wooden inlet cowling.

Figure 2. - Systems for water and alcohol injection.

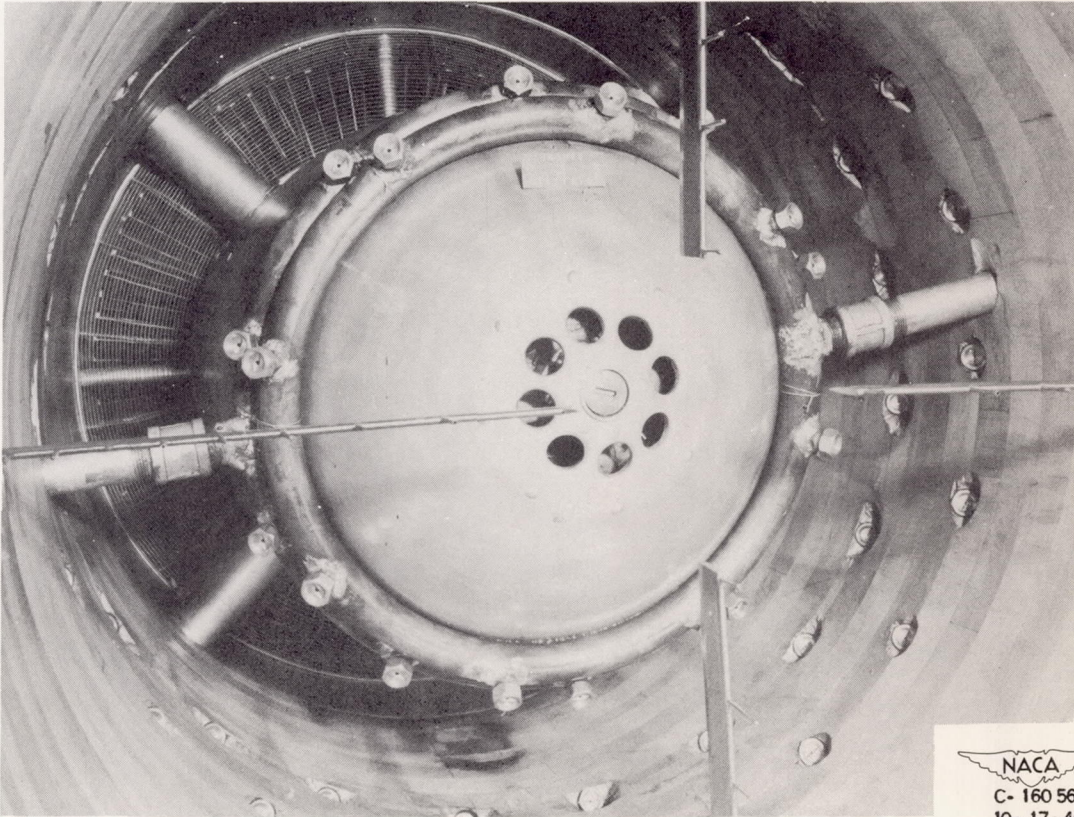

NACA
C-16056
10-17-46

(b) Injection system B: nozzles installed on nosepiece inside wooden inlet cowling.

Figure 2. - Continued. Systems for water and alcohol injection.

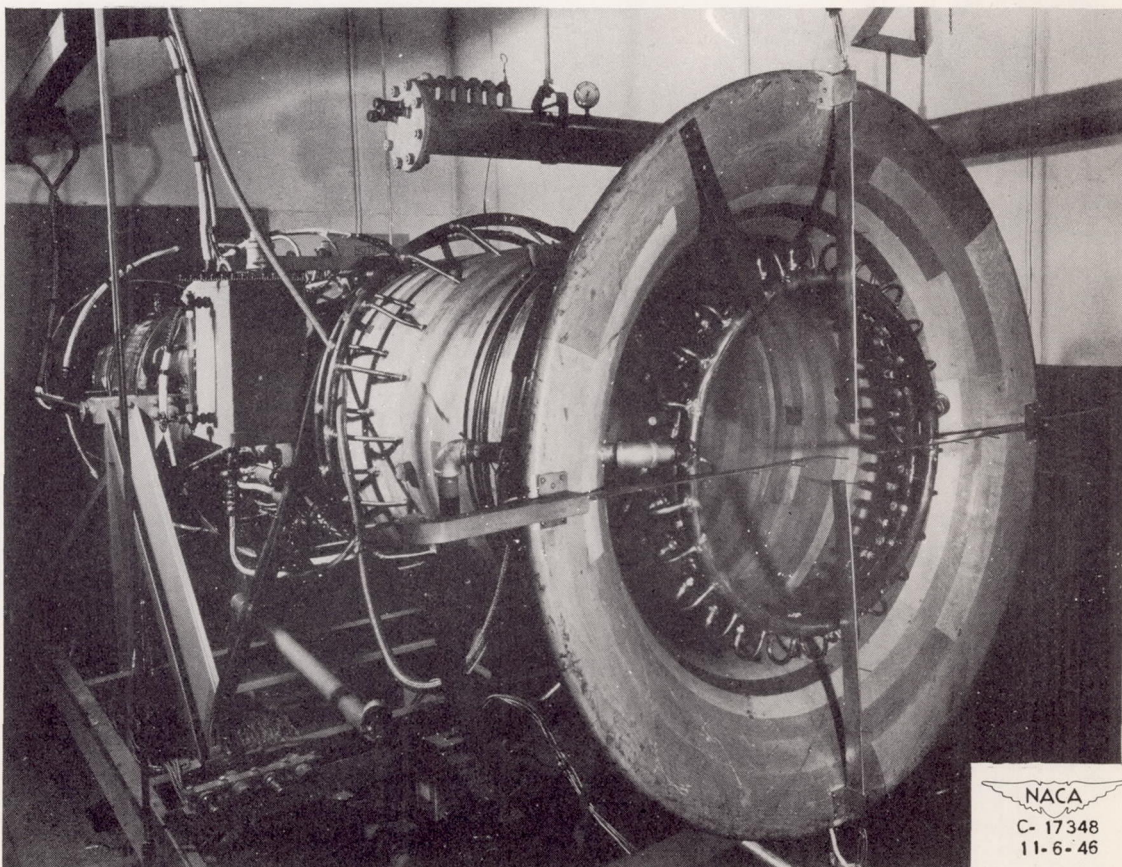

(c) Injection system C: nozzles at entrance to wooden inlet cowling.

Figure 2. - Concluded. Systems for water and alcohol injection.

853

Engine inlet:

Station O_c , Station O ,
system C, systems A and BCompressor discharge,
station 2Tail-pipe inlet,
station 6

Figure 3. - Engine instrumentation.

CONFIDENTIAL
UNCLASSIFIED

Figure 4. - Turbojet-engine performance with injection of water and alcohol for injection system A. Engine inlet-air temperature, 548° R. Data adjusted to rotor speed of 7635 rpm and exhaust-gas-temperature of 1665° R.

CONFIDENTIAL
UNCLASSIFIED

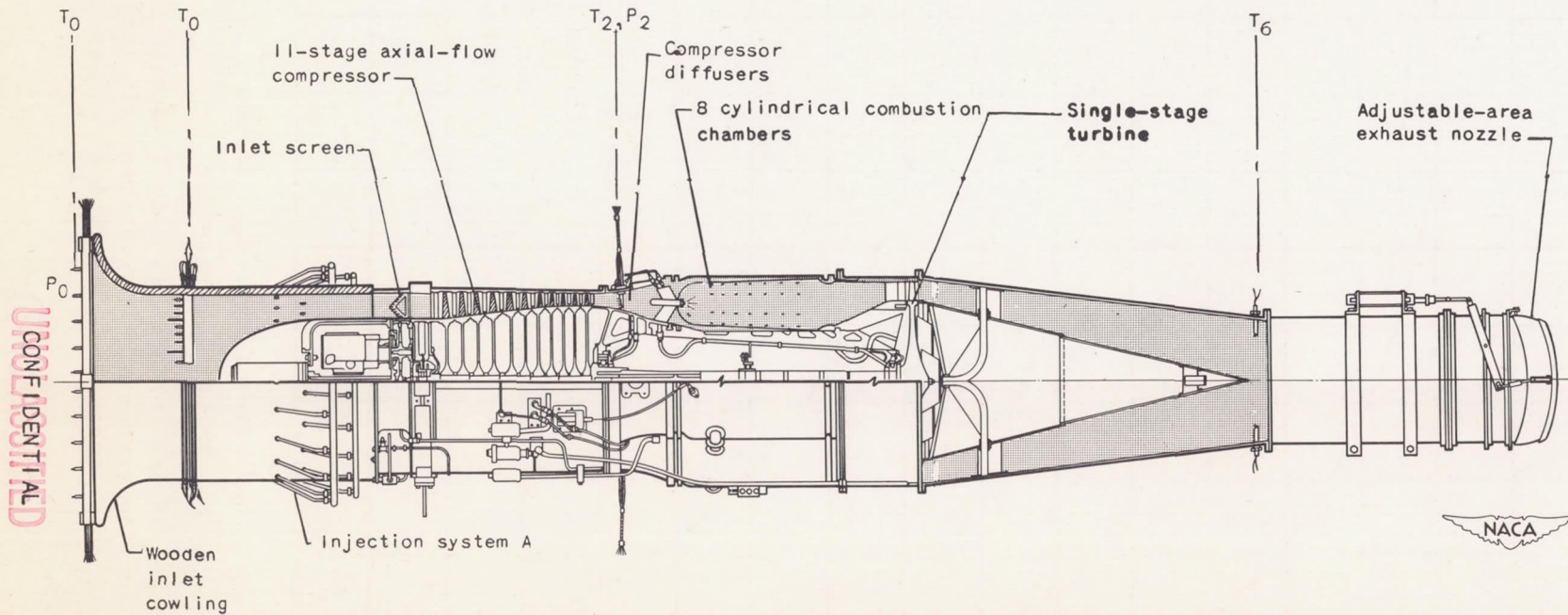

(a) Thrust.

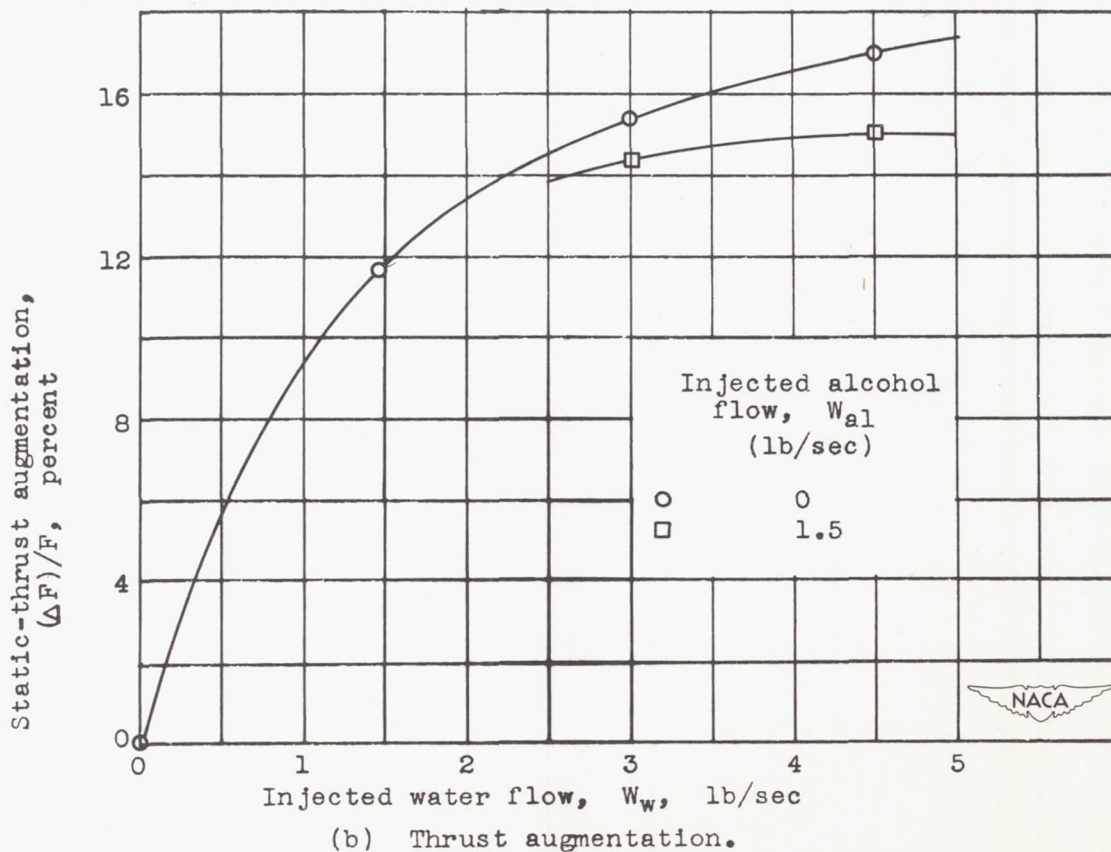
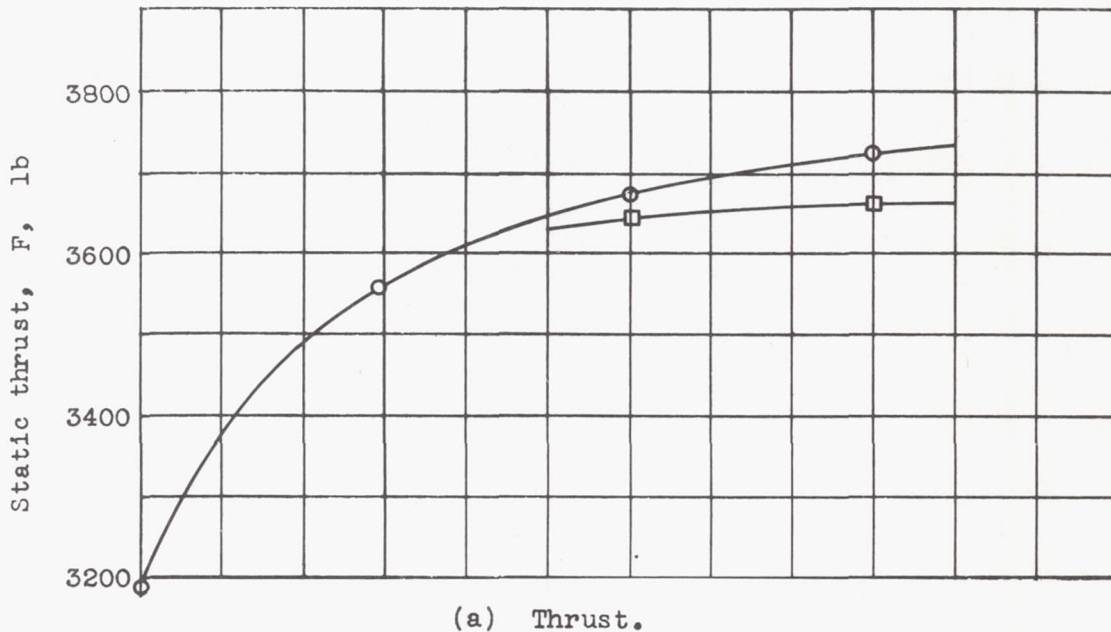
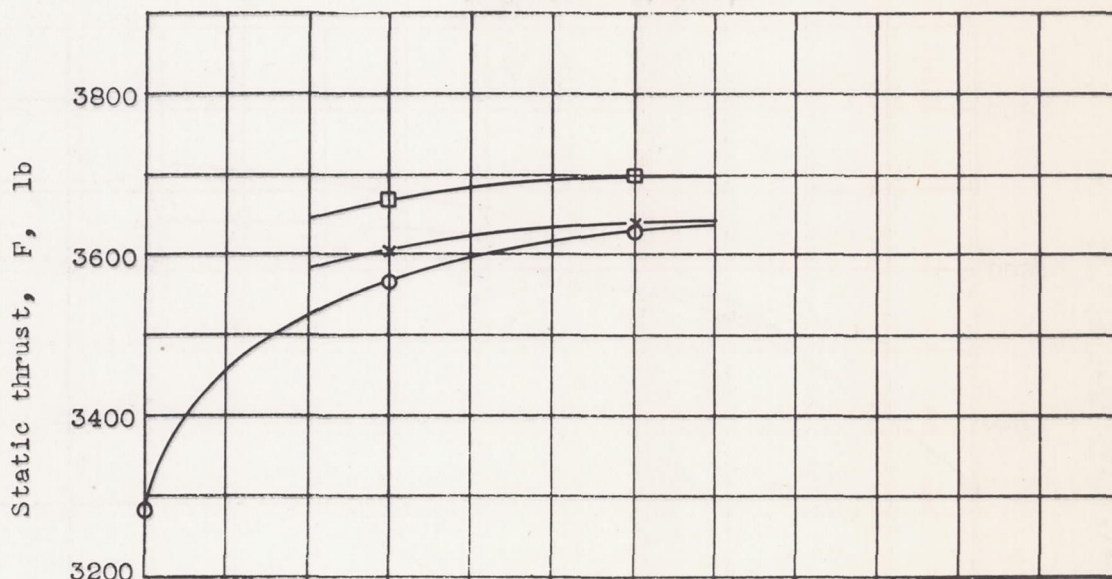
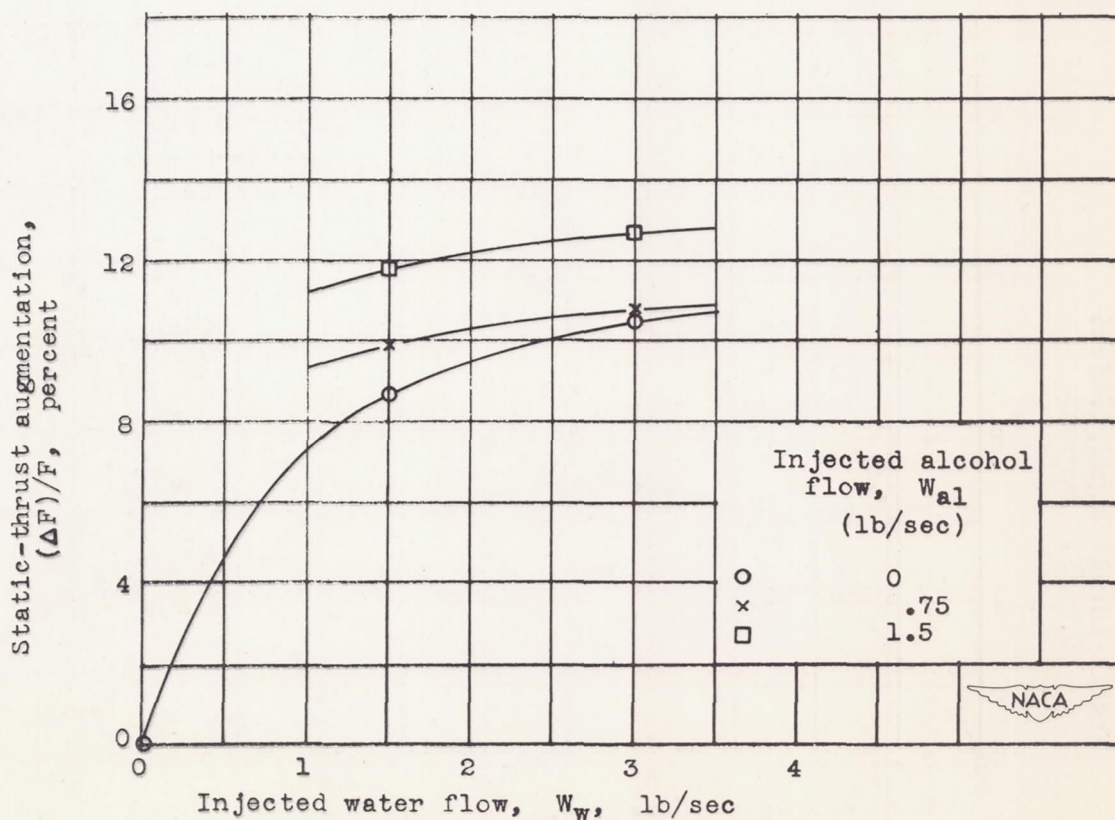

(b) Thrust augmentation.

Figure 5. - Turbojet-engine performance with injection of water and alcohol for injection system B. Engine inlet-air temperature, 540° R. Data adjusted to rotor speed of 7635 rpm and exhaust-gas temperature of 1665° R.

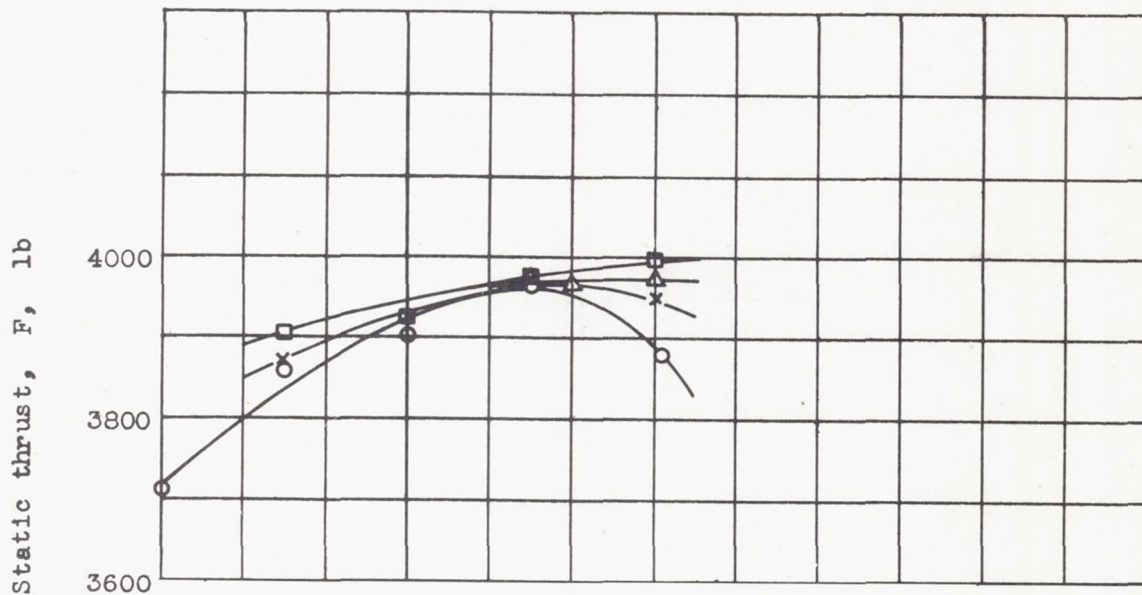
UNCLASSIFIED
CONFIDENTIAL

(a) Thrust.

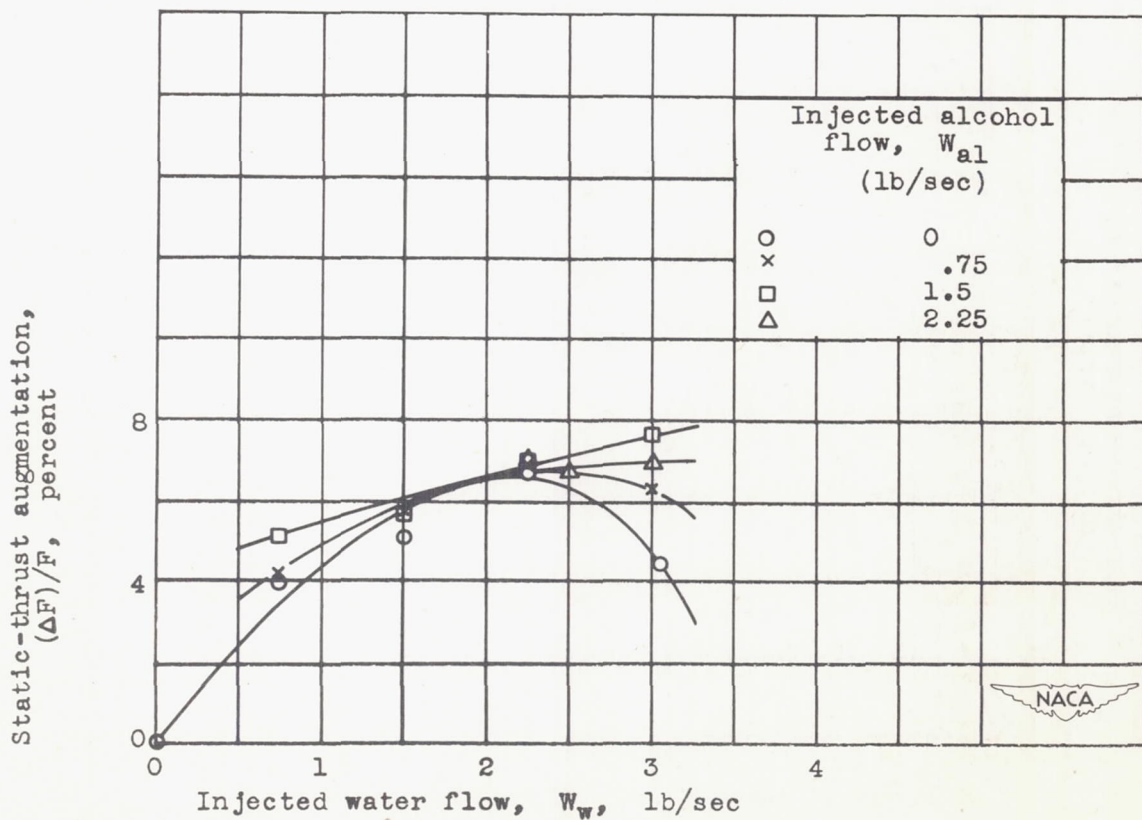

(b) Thrust augmentation.

Figure 6. - Turbojet-engine performance with injection of water and alcohol for injection system C. Engine inlet-air temperature, 523° R. Data adjusted to rotor speed of 7635 rpm and exhaust-gas temperature of 1665° R.

UNCLASSIFIED
CONFIDENTIAL

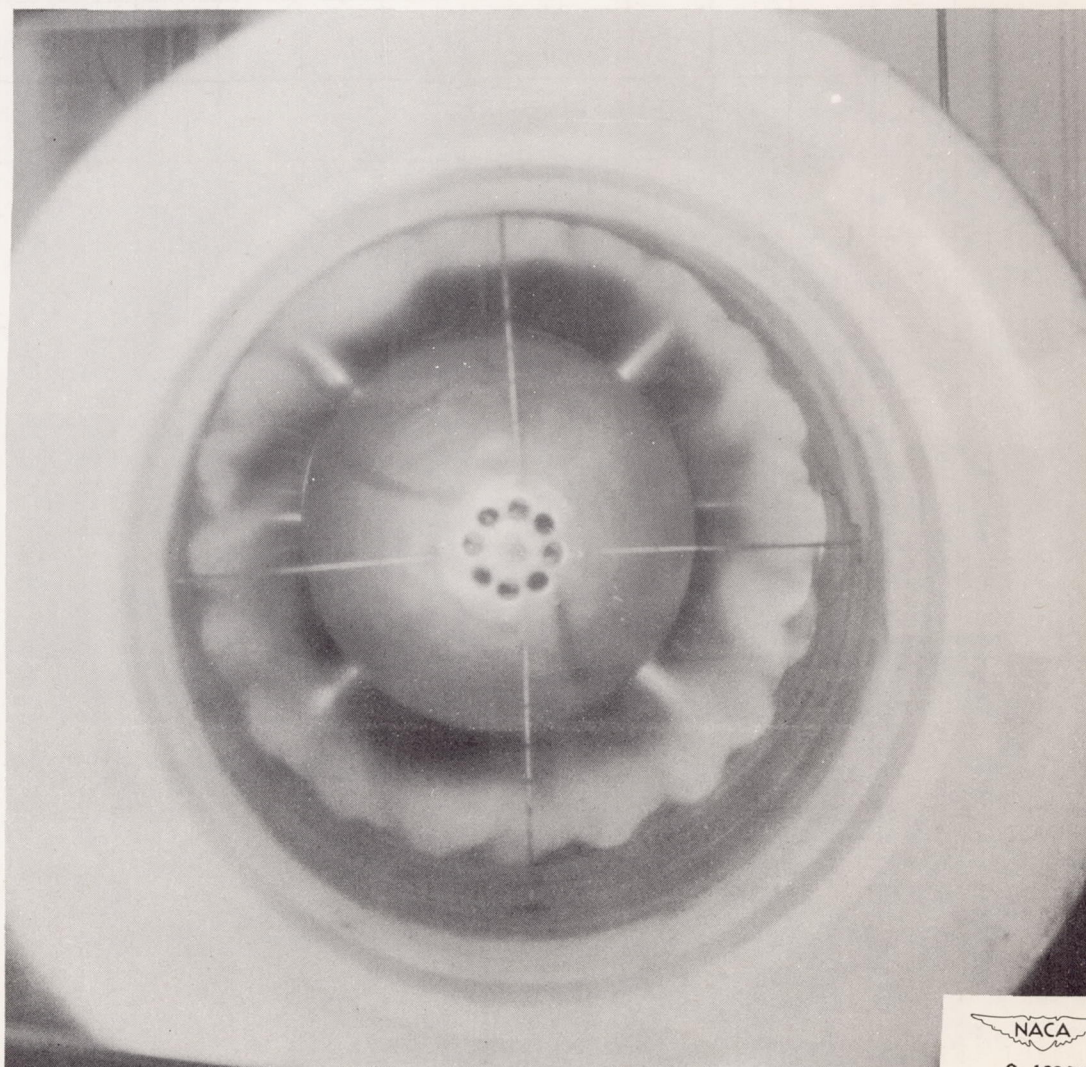

NACA
C-16005
10-10-46

(a) System A: injected water flow W_w , 3.0 pounds per second; injected alcohol flow W_{al} , 2.0 pounds per second.

Figure 7. - Injection systems in operation.

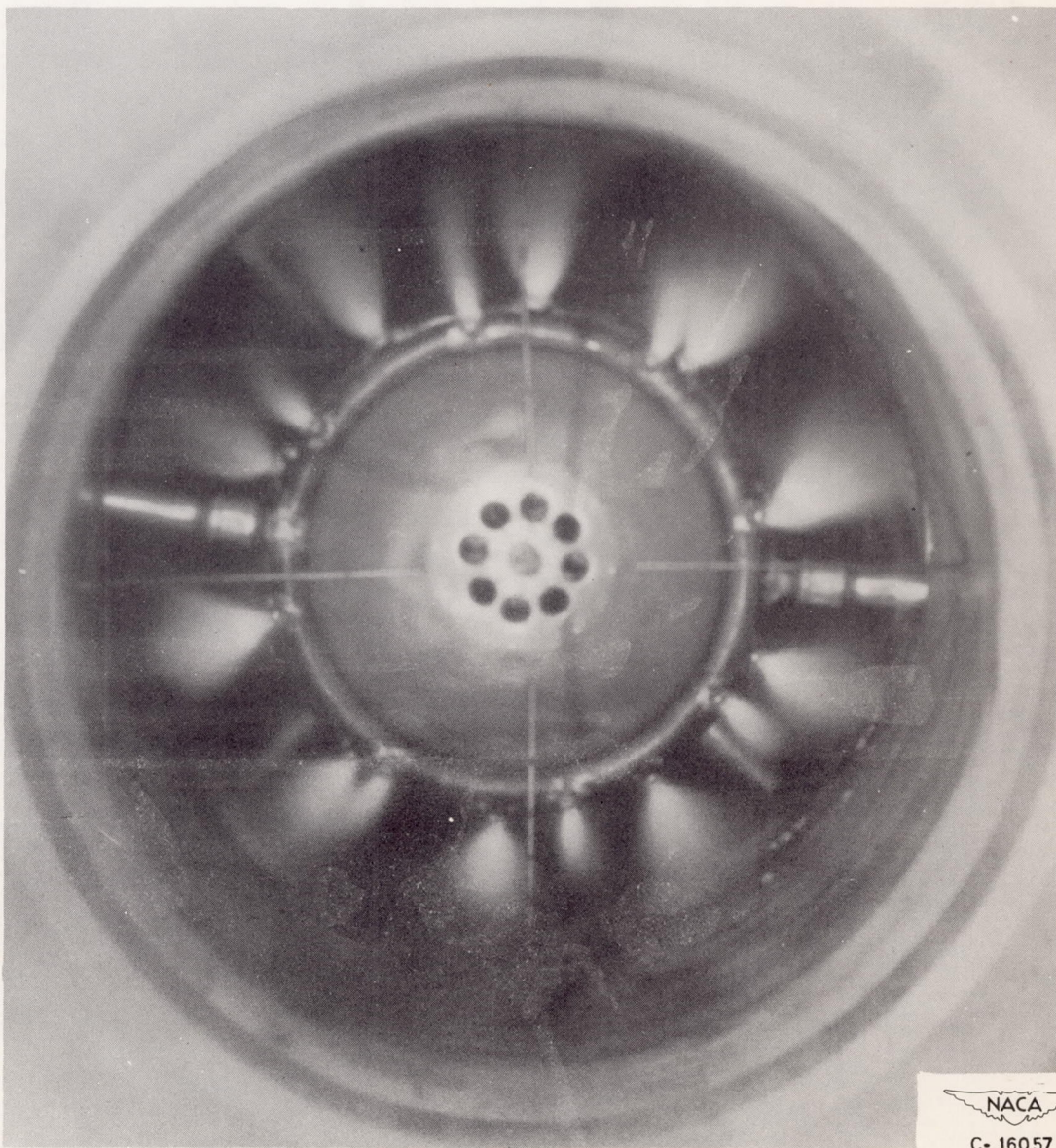

NACA

C-16057
10-17-46

(b) System B: injected water flow W_w , 3.0 pounds per second; injected alcohol flow W_{al} , 0.75 pound per second.

Figure 7. - Continued. Injection systems in operation.

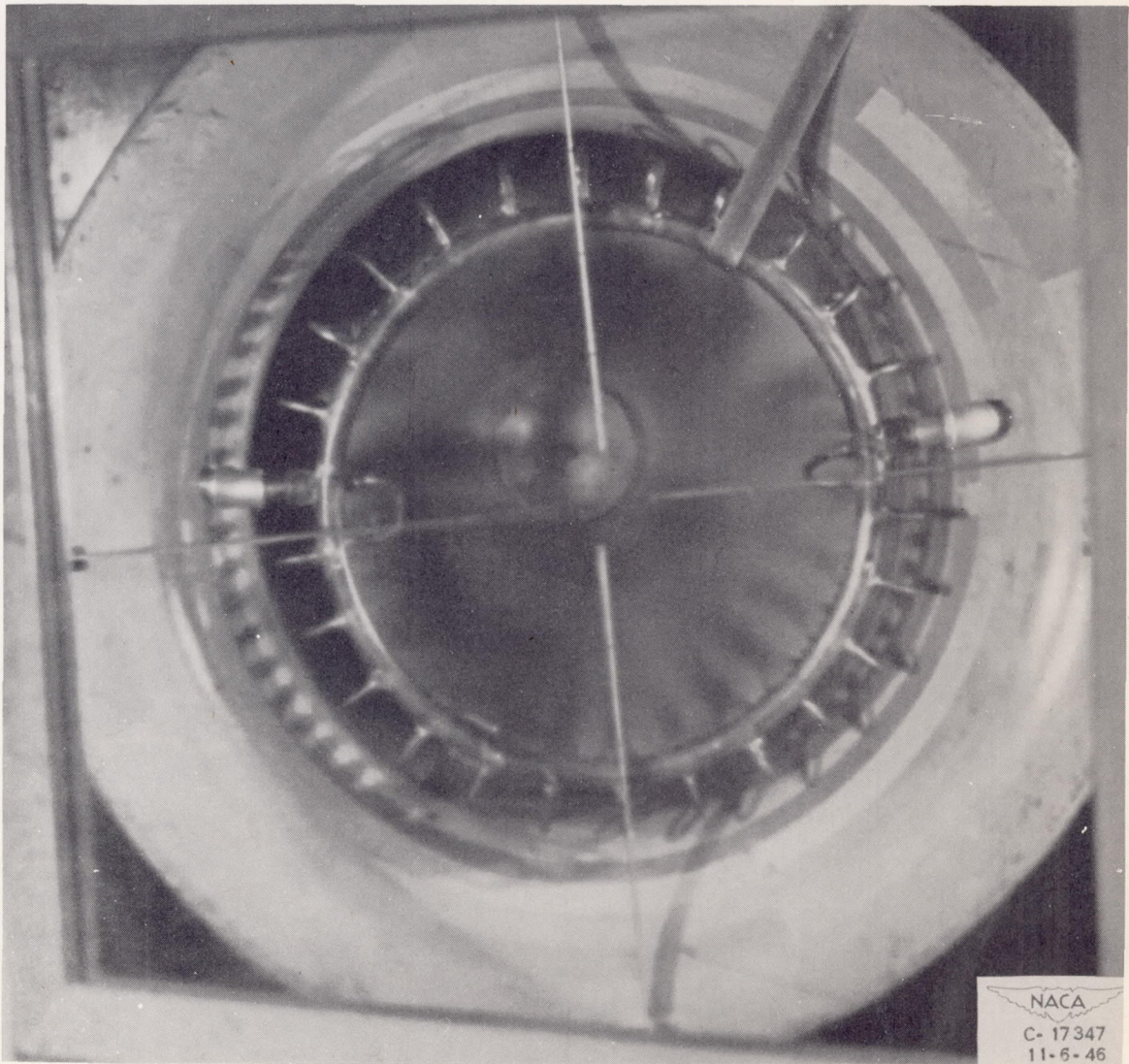

(c) System C: injected water flow W_w , 1.5 pounds per second; injected alcohol flow W_{al} , 0.75 pound per second.

Figure 7. - Concluded. Injection systems in operation.

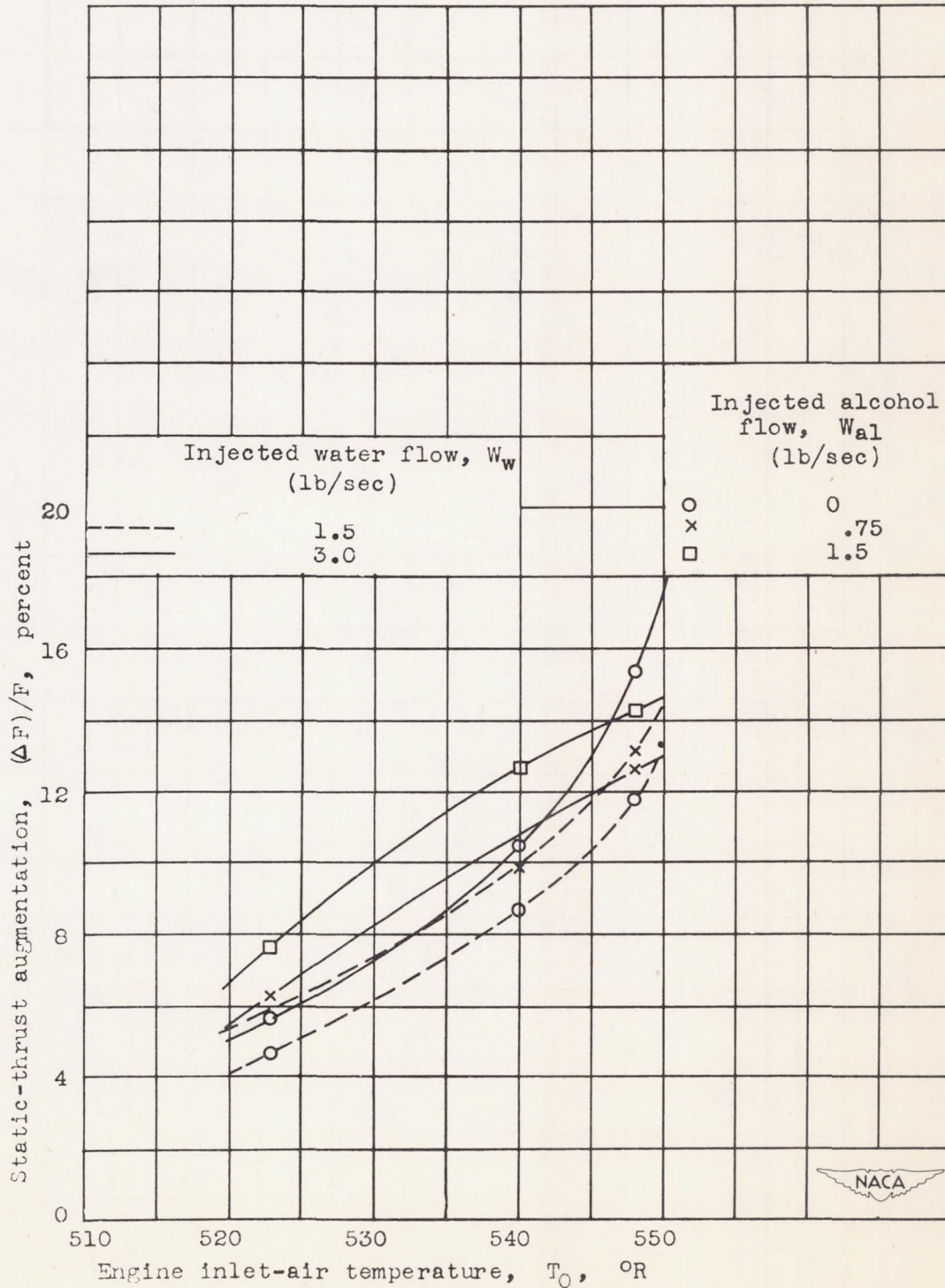
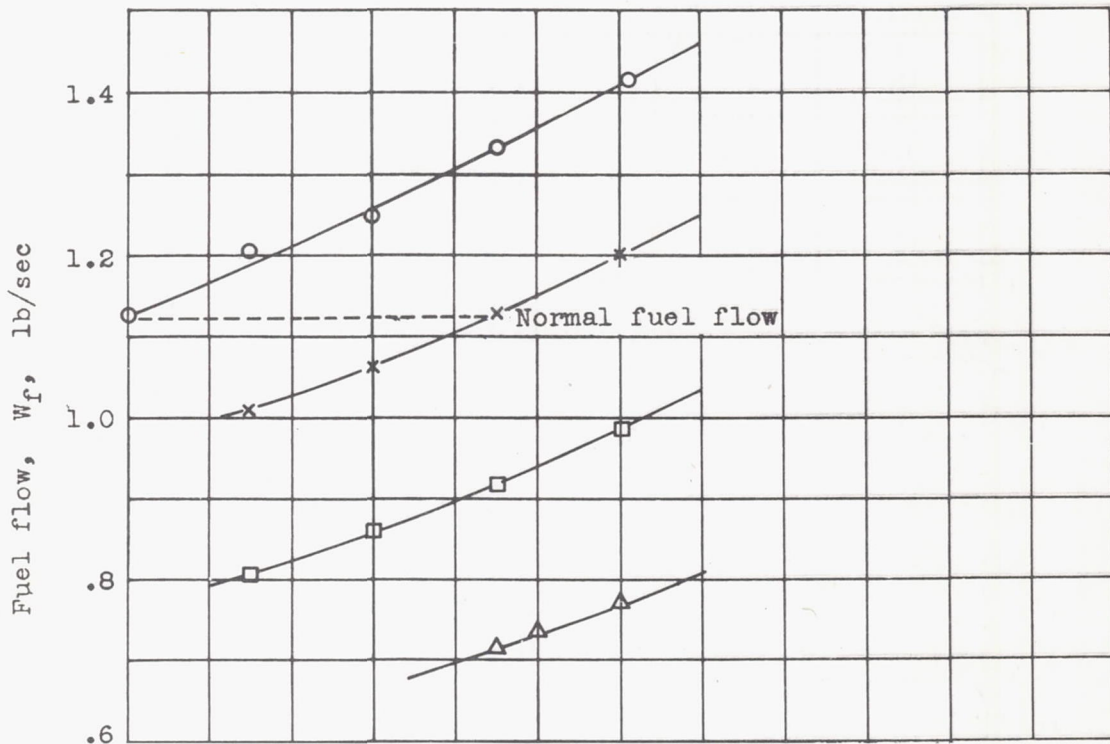
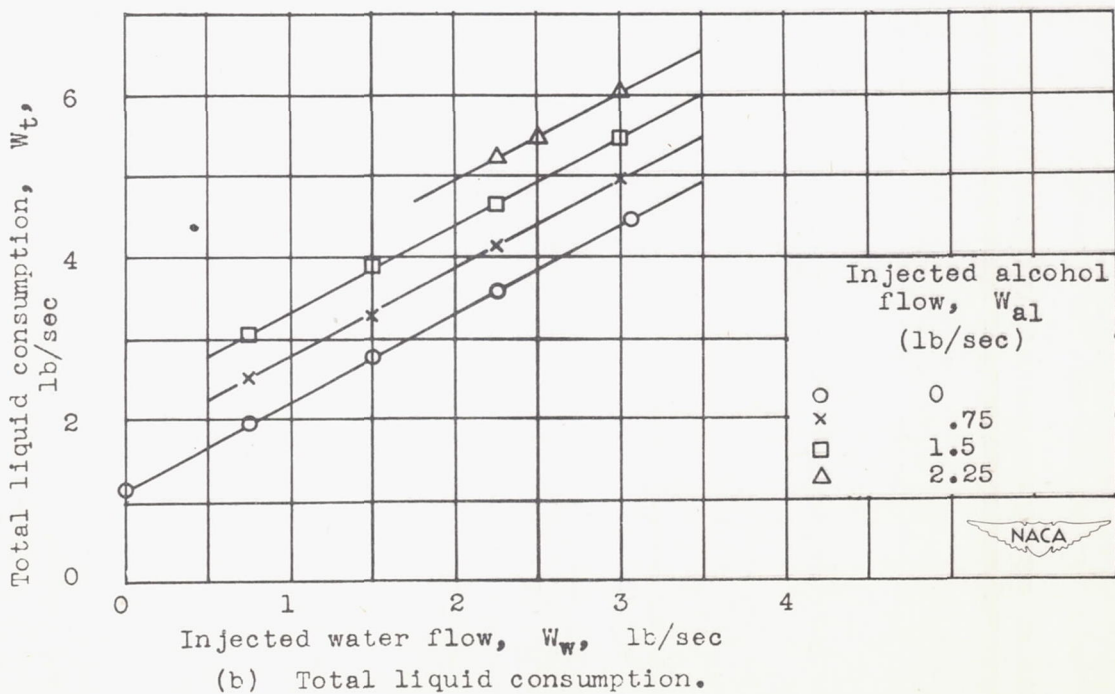

Figure 8. - Variation in static-thrust augmentation of turbojet engine for injection of water and alcohol with engine inlet-air temperature.

UNCLASSIFIED
CONFIDENTIAL

(a) Fuel flow.



(b) Total liquid consumption.

Figure 9. - Turbojet engine performance with injection of water and alcohol for injection system C. Engine inlet-air temperature, 523° R; rotor speed, 7635 rpm; exhaust-gas temperature, 1665° R.

UNCLASSIFIED
CONFIDENTIAL

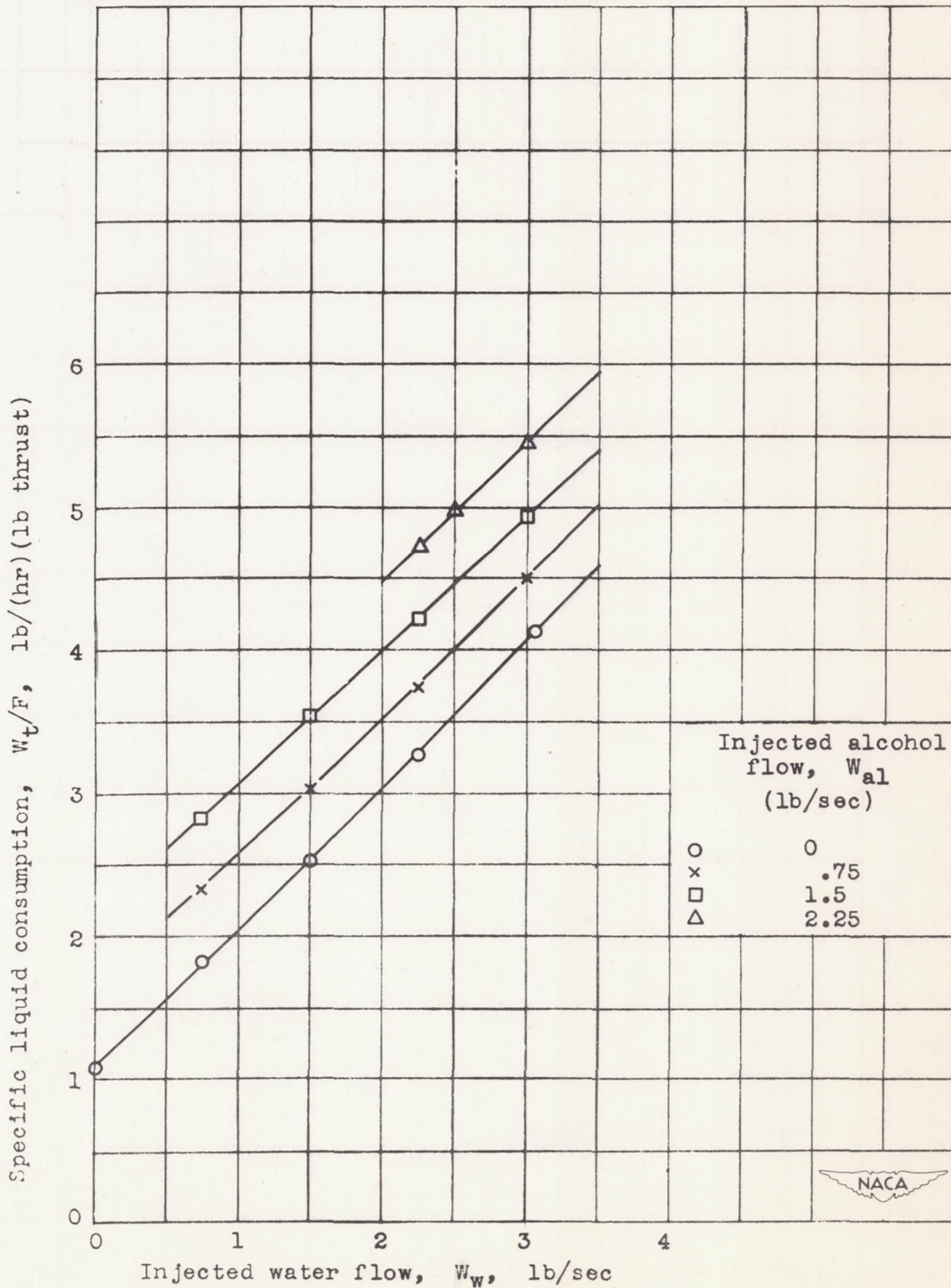

(c) Specific liquid consumption.

Figure 9. - Continued. Turbojet engine performance with injection of water and alcohol for injection system C. Engine inlet-air temperature, 523° R; rotor speed, 7635 rpm; exhaust-gas temperature, 1665° R.

853

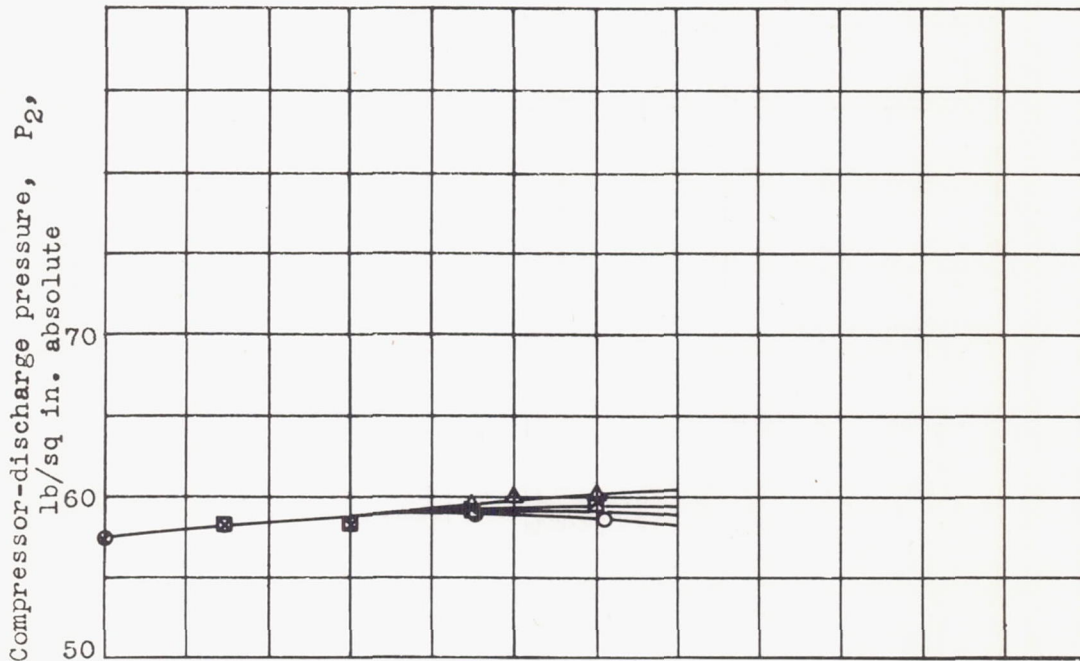

(d) Compressor-discharge pressure.

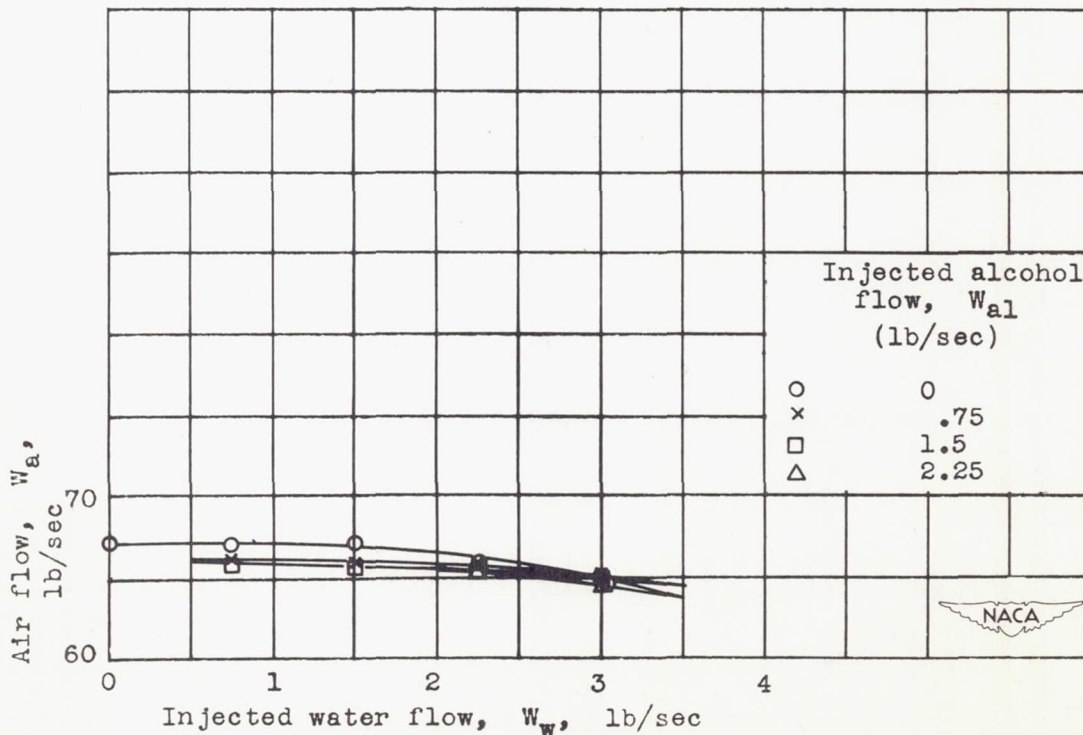

(e) Air flow.

Figure 9. - Concluded. Turbojet engine performance with injection of water and alcohol for injection system C. Engine inlet-air temperature, 523° R; rotor speed, 7635 rpm; exhaust-gas temperature, 1665° R.

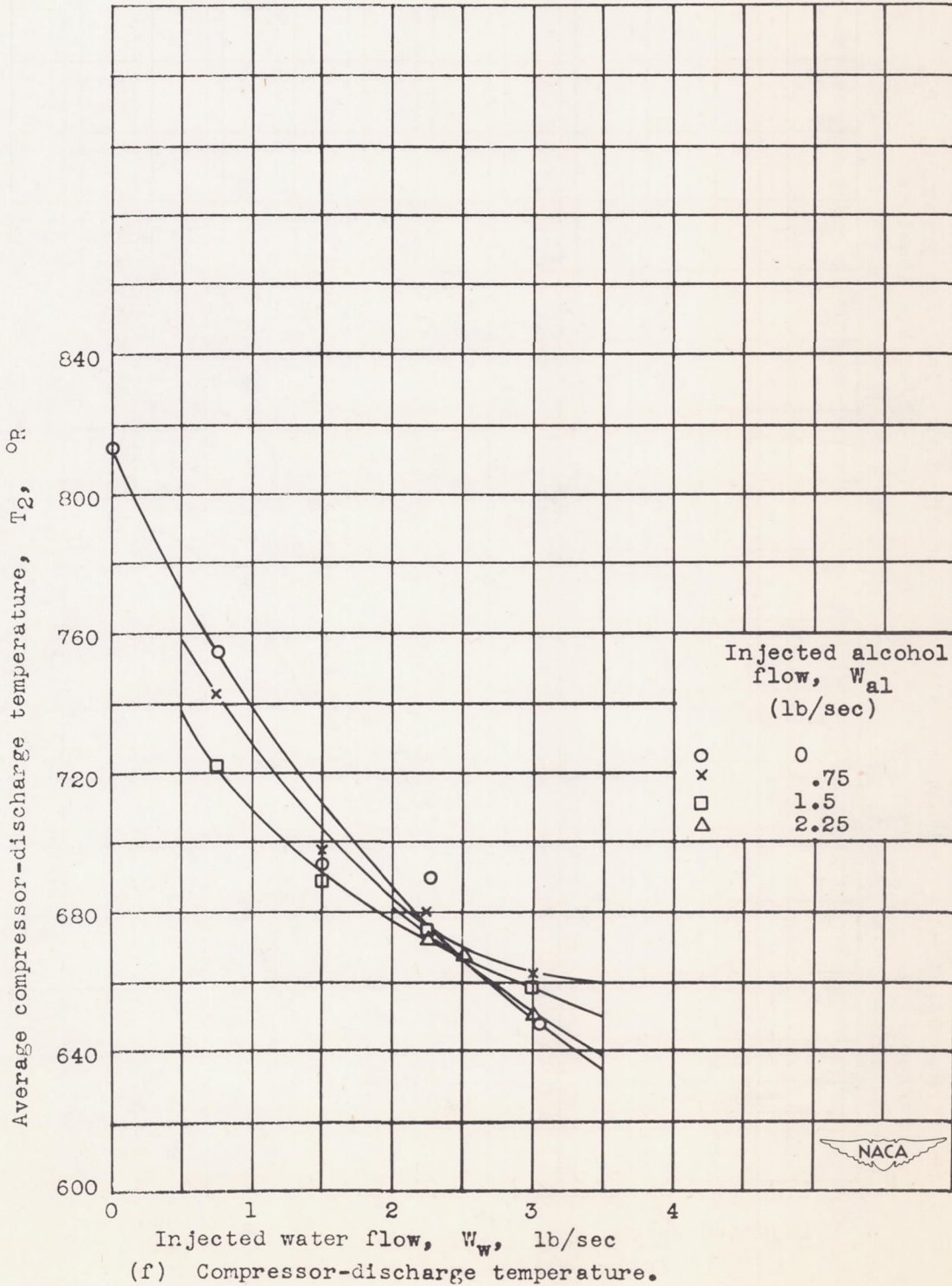

Figure 9. - Continued. Turbojet engine performance with injection of water and alcohol for injection system C. Engine inlet-air temperature, 523° R; rotor speed, 7635 rpm; exhaust-gas temperature, 1665° R.

853

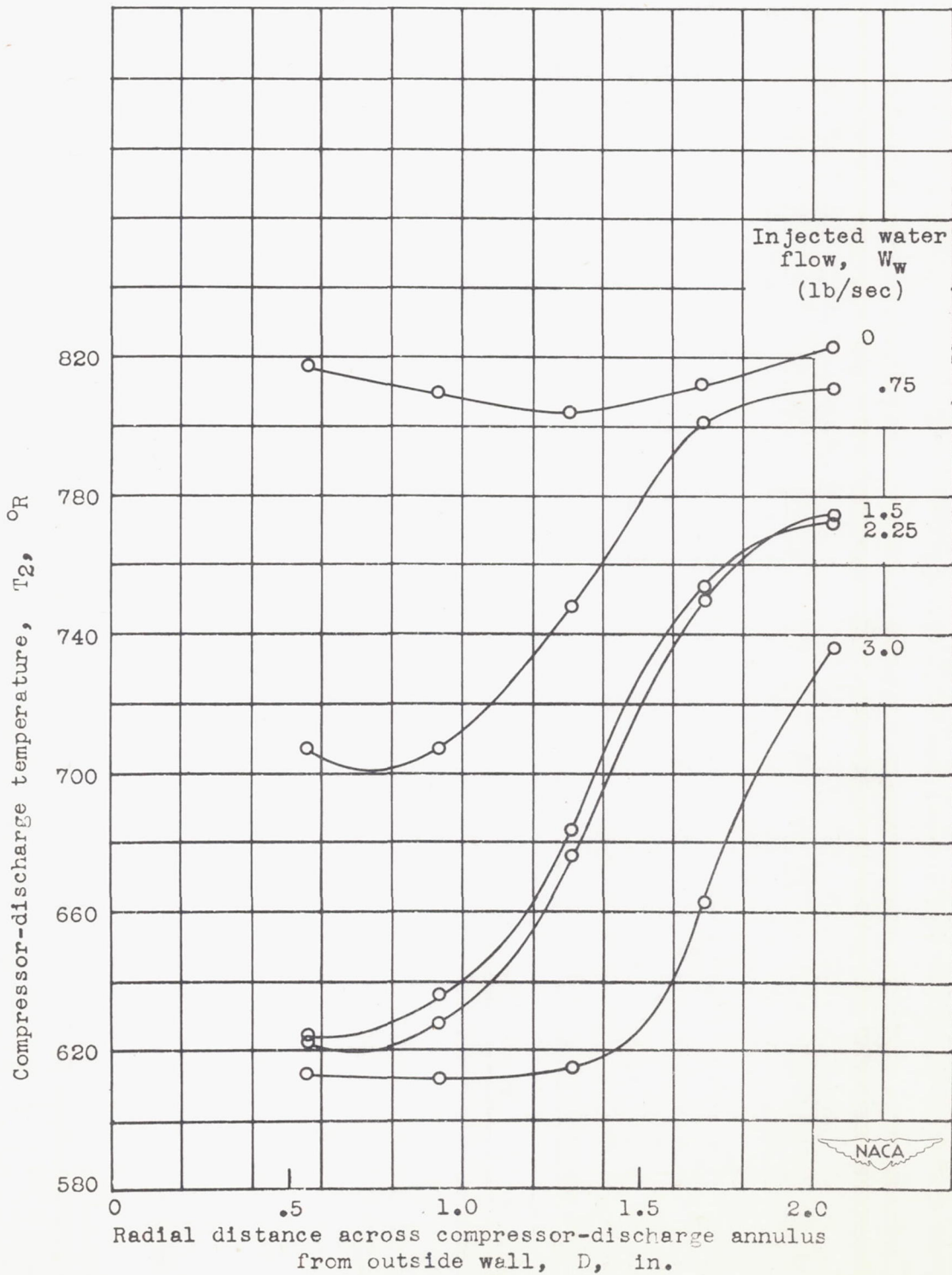
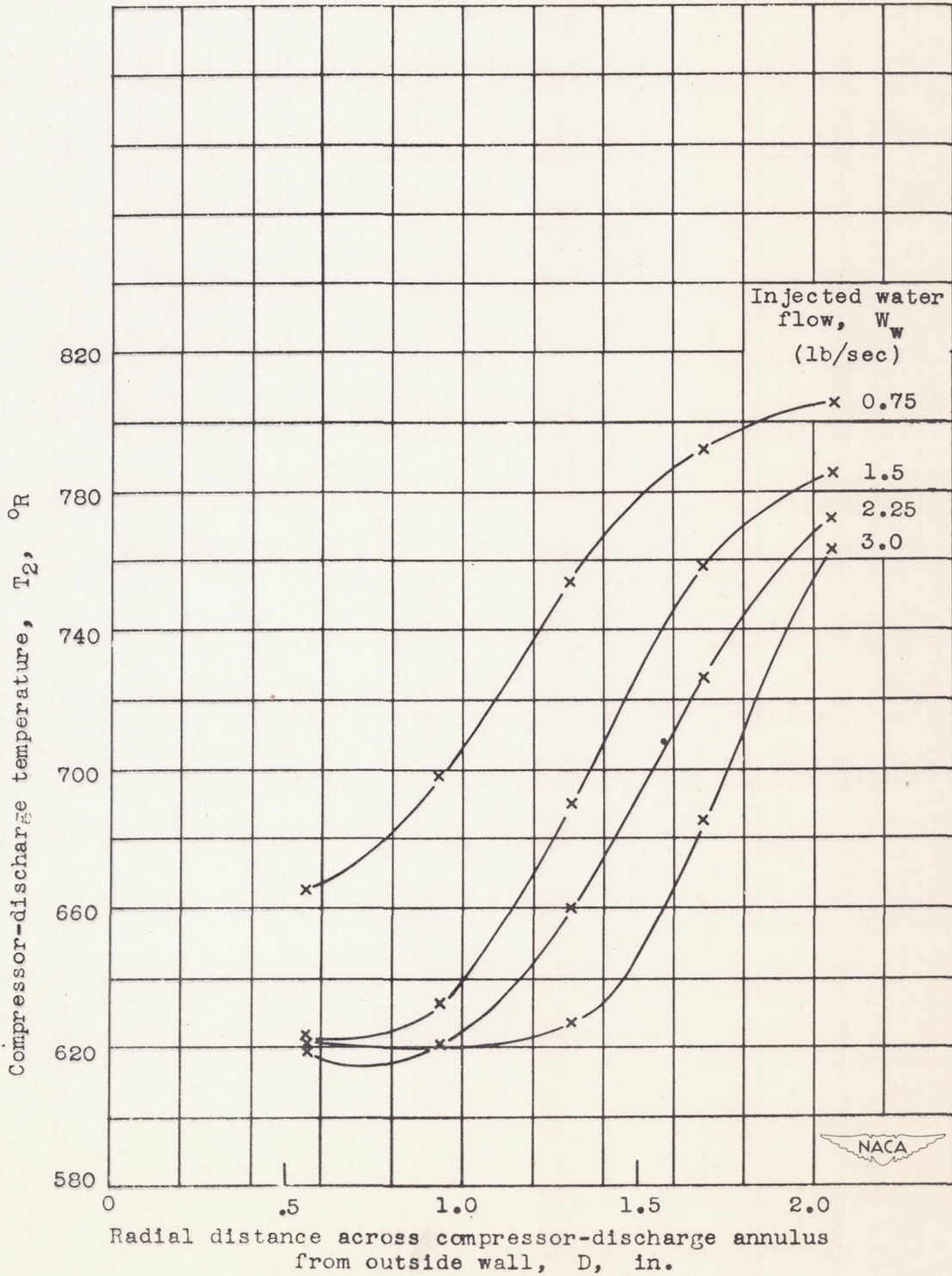

Figure 10. - Compressor-discharge temperature surveys of turbojet engine with injection of water and alcohol for injection system C.



(b) Injected alcohol flow, 0.75 pound per second.

Figure 10. - Continued. Compressor-discharge temperature surveys of turbojet engine with injection of water and alcohol for injection system C.

UNCLASSIFIED

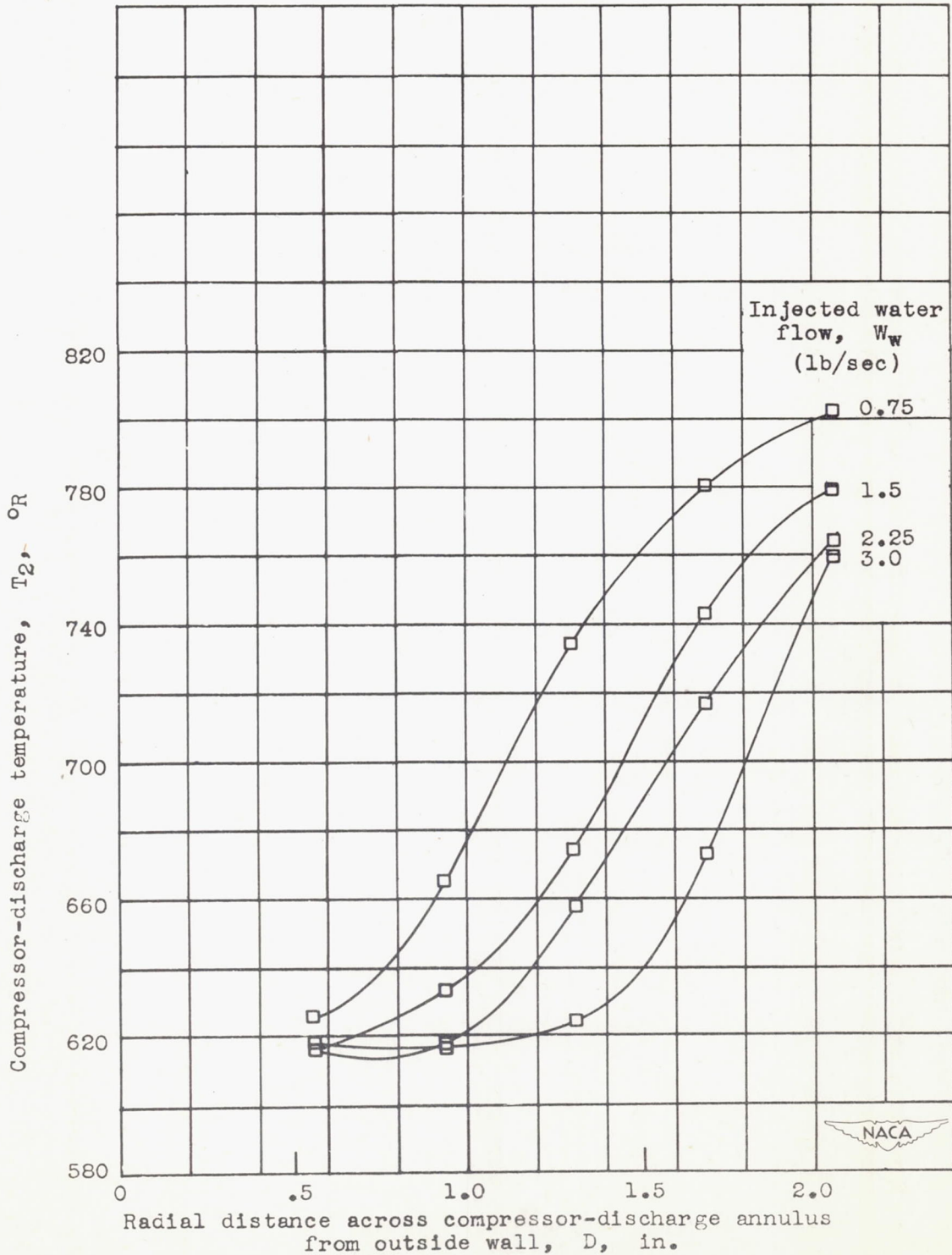

(c) Injected alcohol flow, 1.5 pounds per second.

Figure 10. - Continued. Compressor-discharge temperature surveys of turbojet engine with injection of water and alcohol for injection system C.

UNCLASSIFIED

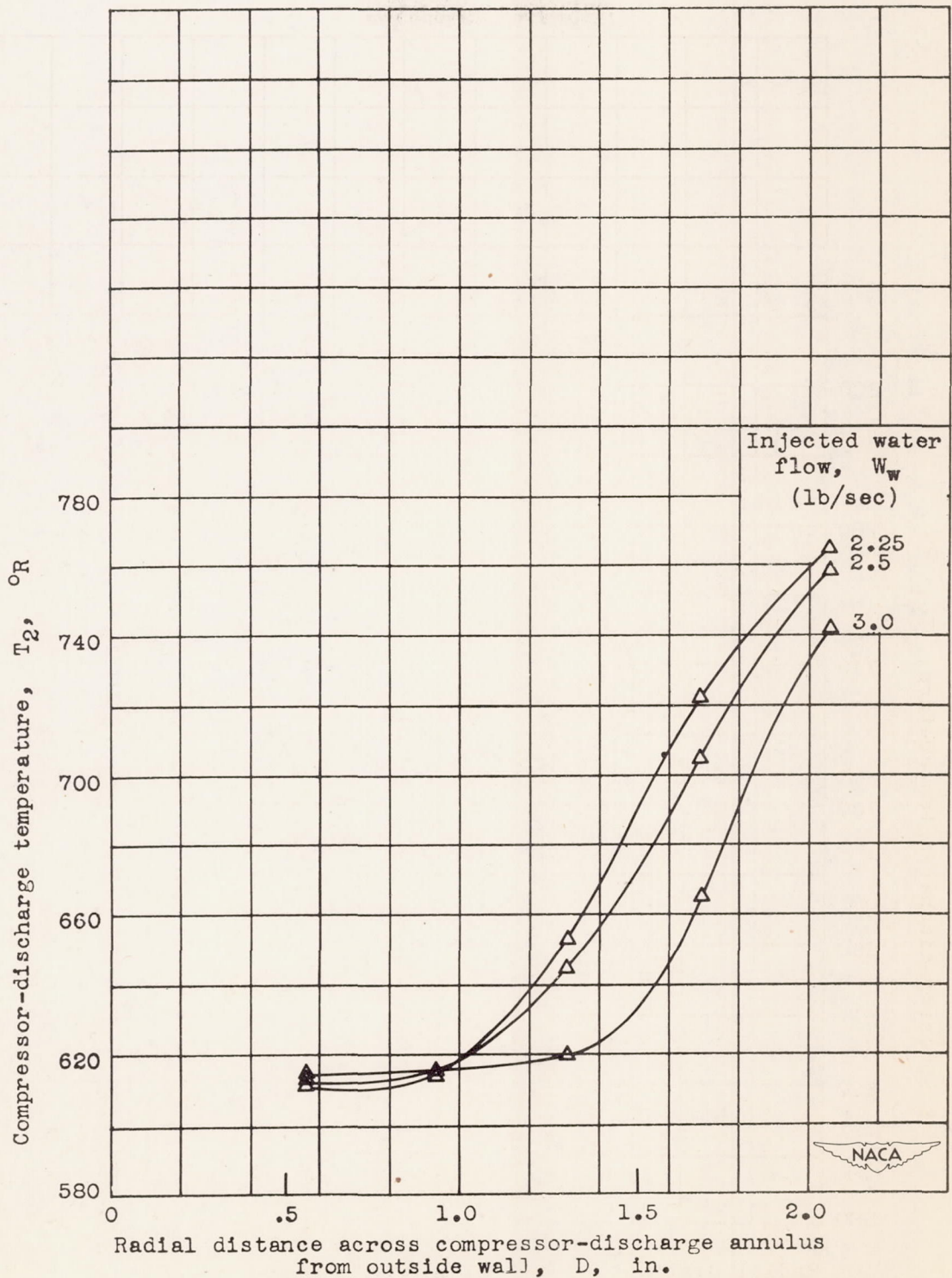

(d) Injected alcohol flow, 2.25 pounds per second.

Figure 10. - Concluded. Compressor-discharge temperature surveys of turbojet engine with injection of water and alcohol for injection system C.

853

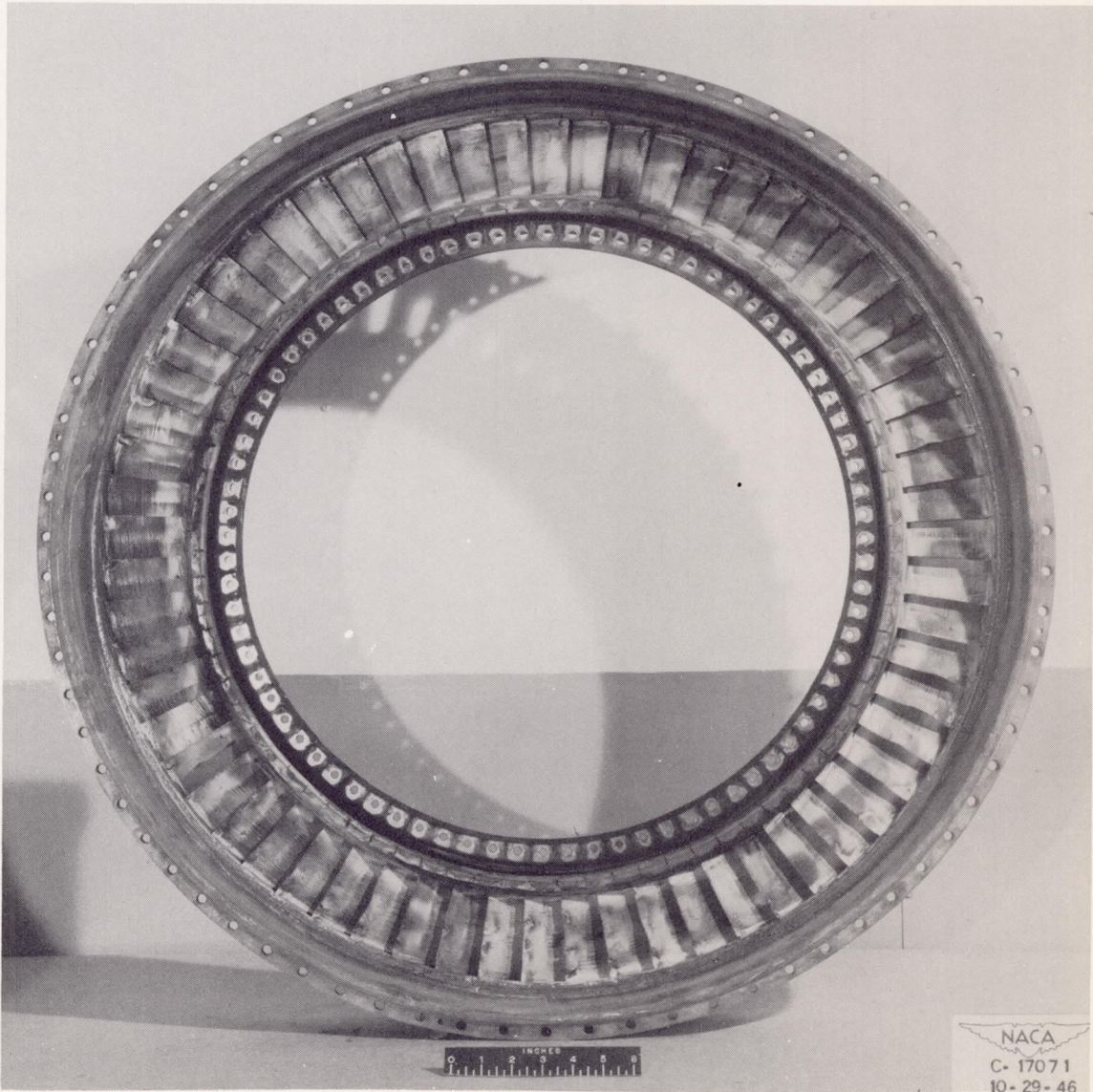

Figure 11. - View of turbine nozzle box at completion of investigations with water-alcohol injection systems A and B.