

NACA RM No. A9B09

UNCLASSIFIED
CONFIDENTIAL

Copy No. 24

RM No. A9B09

NACA
RM-A9B09

NACA CASE FILE COPY RESEARCH MEMORANDUM

EFFECTS OF WING-TIP TURRETS ON THE AERODYNAMIC
CHARACTERISTICS OF A TYPICAL
BOMBER-WING MODEL

By Lee E. Boddy and Fred B. Sutton

Ames Aeronautical Laboratory
Moffett Field, Calif.

Classification Changed to UNCLASSIFIED	
WST/6 Release Form #2 d/12 Mar. 154. Rep: NACA research lab. 50, 4/23 Dec 53.	By J.E. Newland (RM)
MAY 5 1954	Date

CLASSIFIED DOCUMENT

This document contains classified information affecting the National Defense of the United States within the meaning of the Espionage Act, USC 5031 and 32. Its transmission or the revelation of its contents in any manner to an unauthorized person is prohibited by law. Information so classified may be imparted only to persons in the military and naval services of the United States, appropriate civilian officers and employees of the Federal Government who have a legitimate interest therein, and to United States citizens of known loyalty and discretion who of necessity must be informed thereof.

JPL LIBRARY
CALIFORNIA INSTITUTE OF TECHNOLOGY

NATIONAL ADVISORY COMMITTEE
FOR AERONAUTICS
WASHINGTON
March 28, 1949

CONFIDENTIAL
UNCLASSIFIED

APR 5 1949

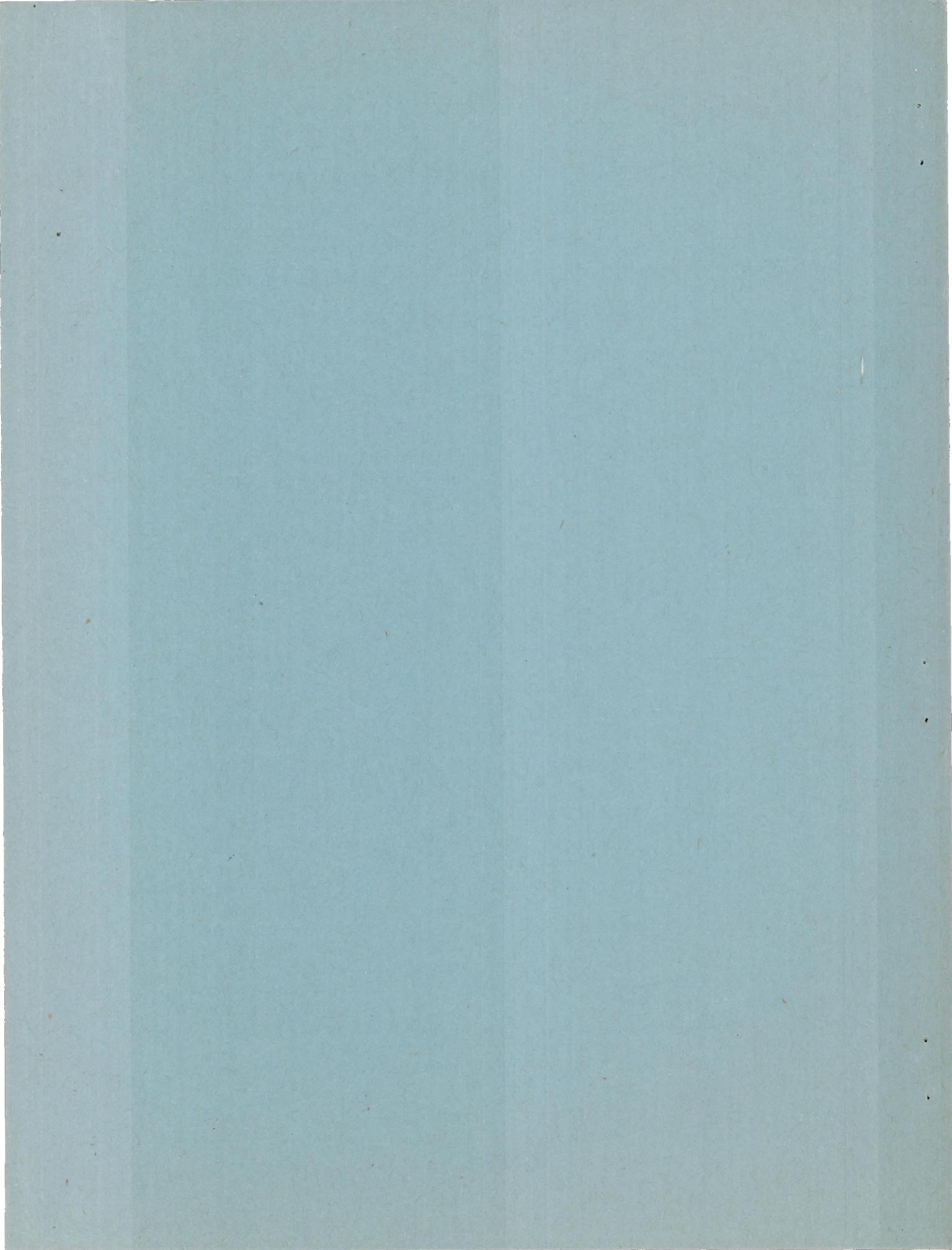

~~CONFIDENTIAL~~
UNCLASSIFIED

NATIONAL ADVISORY COMMITTEE FOR AERONAUTICS

RESEARCH MEMORANDUMEFFECTS OF WING-TIP TURRETS ON THE AERODYNAMIC CHARACTERISTICS
OF A TYPICAL BOMBER-WING MODEL

By Lee E. Boddy and Fred B. Sutton

SUMMARY

Wind-tunnel tests up to a Mach number of 0.85 were made to determine the effects of wing-tip gun turrets on the aerodynamic characteristics of a typical bomber-wing model.

Lift, drag, and pitching-moment data are presented for the wing alone; for the wing with the turrets in the clean condition; and for the wing and the turrets with guns and sighting equipment. Also presented are data which show the effects of refairing the turret nose.

The turrets had negligible effect upon the lift and pitching-moment characteristics of the wing. The addition of the turrets increased the drag coefficient of the wing by approximately 0.005 up to a Mach number of 0.70, and decreased the drag-divergence Mach number of the wing by approximately 0.05.

INTRODUCTION

One of the problems encountered in the design of long-range bombardment airplanes intended to operate beyond the range of fighter escort is providing adequate armament for defense against interceptor attack. The combination of radar gun-sighting equipment and power-operated gun turrets allows utilization of a small number of guns to greatest advantage. The wing-tip location of the gun turrets offers a field of fire with comparative freedom from blanketed areas. Properly designed tip turrets should produce end-plate effects resulting in a reduction of induced drag for the wing-turret combination. (See reference 1.)

The purpose of the tests reported herein was to determine the

~~CONFIDENTIAL~~
UNCLASSIFIED

Classification Changed to UNCLASSIFIED	
Authority	
Date MAY 5 1954	By

effect of typical wing-tip gun turrets, including various modifications, on the aerodynamic characteristics of a typical bomber wing. The tests were conducted in the Ames 16-foot high-speed wind tunnel at the request of the U.S. Air Force.

COEFFICIENTS AND SYMBOLS

C_D	drag coefficient $\left(\frac{\text{drag}}{qS} \right)$
C_L	lift coefficient $\left(\frac{\text{lift}}{qS} \right)$
C_m	pitching-moment coefficient about the quarter chord $\left(\frac{\text{pitching moment}}{qS\bar{c}} \right)$
b	wing span, feet
c	wing chord, feet
\bar{c}	wing mean aerodynamic chord $\left(\frac{\int_0^{b/2} c^2 dy}{\int_0^{b/2} c dy} \right)$, feet
M	free-stream Mach number
P	pressure coefficient $\left(\frac{P - P_0}{q} \right)$
P_{cr}	critical pressure coefficient (P at which the local velocity equals the local velocity of sound)
p	local static pressure, pounds per square foot
P_0	free-stream static pressure, pounds per square foot

q	free-stream dynamic pressure $(\frac{1}{2} \rho V^2)$, pounds per square foot
S	wing area, square feet
V	free-stream velocity, feet per second
α	angle of attack, degrees
ρ	mass density of air, slugs per cubic foot

MODEL AND APPARATUS

The 10-foot-span wing model used in these tests had a taper ratio of 0.4, an aspect ratio of 9, and the NACA 63₁-210 section. A 6-inch portion of each wing tip was detachable to permit the mounting of the model gun turrets without increasing the 10-foot span. A drawing of the wing and turrets is shown in figure 1, and the model is shown mounted in the tunnel in figure 2.

The turret contour was based on the NACA fuselage form 332 modified to accommodate gun turrets and sighting equipment. A rearward-firing turret was mounted on the left wing tip (fig. 3(a)) and a forward-firing turret (fig. 3(b)) was mounted on the right tip. One end of each turret was made spherical to simulate a ball-type gun turret. Inboard of each spherical end was a blunt face to house sighting equipment. The unmodified turrets were tested in the clean condition with all protuberances removed except the sighting equipment on the blunt inboard faces. Modifications shown in figure 3(c), were made to the forward-firing turret, which included refairing the blunt sighting face, and removing forward-firing guns to allow covering the ball turret with a nose cap which conformed to the nose profile of the NACA fuselage form 332. Turret dimensions and the alternate positions of the guns are shown in figure 4.

Longitudinal rows of pressure orifices were installed along the top and bottom of the forward-firing turret (fig. 4).

TESTS

Force tests were made of the wing alone and the wing with

various turret modifications. The tests covered a Mach number range from 0.30 to 0.85 (equivalent to a Reynolds number range from 2.5×10^6 to 4.5×10^6 based on the mean aerodynamic chord) and an angle-of-attack range which varied because of the limited structural strength of the model wing. Pressure distributions over the turrets at angles of attack of -2° and 0° were measured. For structural reasons, these were the only angles of attack at which tests could be made at 0.85 Mach number.

Wind-tunnel-wall corrections, as computed by the method of reference 2, were applied to the measured angles of attack and drag coefficients. All data were corrected for constriction and blockage effects which were calculated by the method of reference 3. No tare corrections were applied to the data as they are very small for the sting-type model support used in these tests.

RESULTS AND DISCUSSION

The basic aerodynamic characteristics of the wing and of the wing with the various turret modifications are presented in figure 5. Figures 6 and 7 show the variation of drag coefficient and static longitudinal stability, respectively, with Mach number. Pressure distributions over the upper and lower surfaces of the forward-firing turret are shown in figures 8 and 9.

It is apparent in figure 5(a) that the turrets caused no measurable end-plate effects as evidenced by the negligible changes in lift-curve slope.

Drag polars for all the configurations tested are shown in figure 5(b). Because of the small forces involved, some of the drag data at 0.30 Mach number are somewhat erratic. Consequently, the fairing of these data was based on cross plots of drag coefficient as a function of Mach number.

Figure 6 shows the effect of the turrets and principal turret modifications on the drag of the wing at zero lift. Data shown therein and in figure 7 were obtained at Mach numbers of 0.30, 0.50, 0.60, 0.70, 0.75, 0.80, 0.825, and 0.85. Up to a Mach number of 0.70 the addition of the turrets to the wing increased the drag coefficient by approximately 0.005. Modifying the forward-firing turret by revising the nose contour and removing the nose guns to facilitate addition of the nose cap reduced the low-speed drag coefficient of the wing-turret combination. Since preliminary tests indicated that the nose guns did not appreciably change the drag

coefficient at low lift coefficients, it is believed that this reduction of drag was due largely to the revised nose contour of the turret. For the basic wing the Mach number for drag divergence (defined as the Mach number above which the drag coefficient abruptly changes from its low-speed value) was approximately 0.74; when the turrets were installed it decreased to about 0.69. Modifications to the nose of the forward-firing turret changed the Mach number for drag divergence very little.

In figure 5(c) are presented the pitching-moment data. The effect of the turrets on the pitching-moment coefficients was small. Changes in static longitudinal stability with Mach number are shown for zero lift in figure 7 for several of the modifications tested. The addition of the turrets to the wing was slightly destabilizing below 0.75 Mach number and slightly stabilizing between 0.75 and 0.83 Mach number.

No measurable effects on the aerodynamic characteristics of the wing-turret combination resulted from moving the guns to the alternate positions shown in figure 4.

Figures 8 and 9 show the pressure distribution over the forward-firing turret. In general, both the nose cap and the revised nose contour gave smaller negative peak pressures over the nose of the turret and consequently increased the critical Mach number of the turret. At an angle of attack of 0° , the unmodified turret had a critical Mach number of approximately 0.78. There was only a small change in this value with the addition of the nose cap, but by refairing the inboard nose surface the critical Mach number was increased to approximately 0.81.

CONCLUDING REMARKS

Results of tests of a model of a typical bomber wing with wing-tip gun turrets indicated that the turrets had only a negligible effect upon the lift and pitching-moment characteristics of the wing. The turrets increased the drag coefficient by approximately 0.005 up to a Mach number of 0.70 and decreased the drag-divergence Mach number of the wing by approximately 0.05. Revising the nose contour of the forward-firing turret reduced the low-speed drag coefficient, but the drag-divergence Mach number changed very little.

Ames Aeronautical Laboratory,
National Advisory Committee for Aeronautics,
Moffett Field, Calif.

REFERENCES

1. Hansen, Frederick H., Jr.: The Effect of a Wing-Tip-Mounted Fuel Tank on the Aerodynamic Characteristics of a High-Speed Bomber Wing. NACA ARR No. 5H06, 1945.
2. Silverstein, Abe, and White, James A.: Wind-Tunnel Interference with Particular Reference to Off-Center Positions of the Wing and to Downwash at the Tail. NACA Rep. No. 547, 1935.
2. Herriot, John G: Blockage Corrections for Three-Dimensional-Flow Closed-Throat Wind Tunnels, with Consideration of the Effect of Compressibility. NACA RM No. A7B28, 1947.

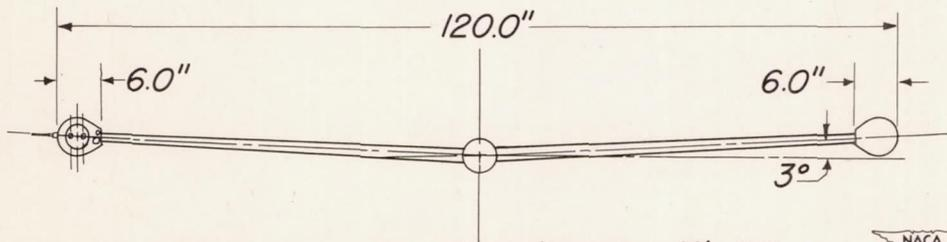
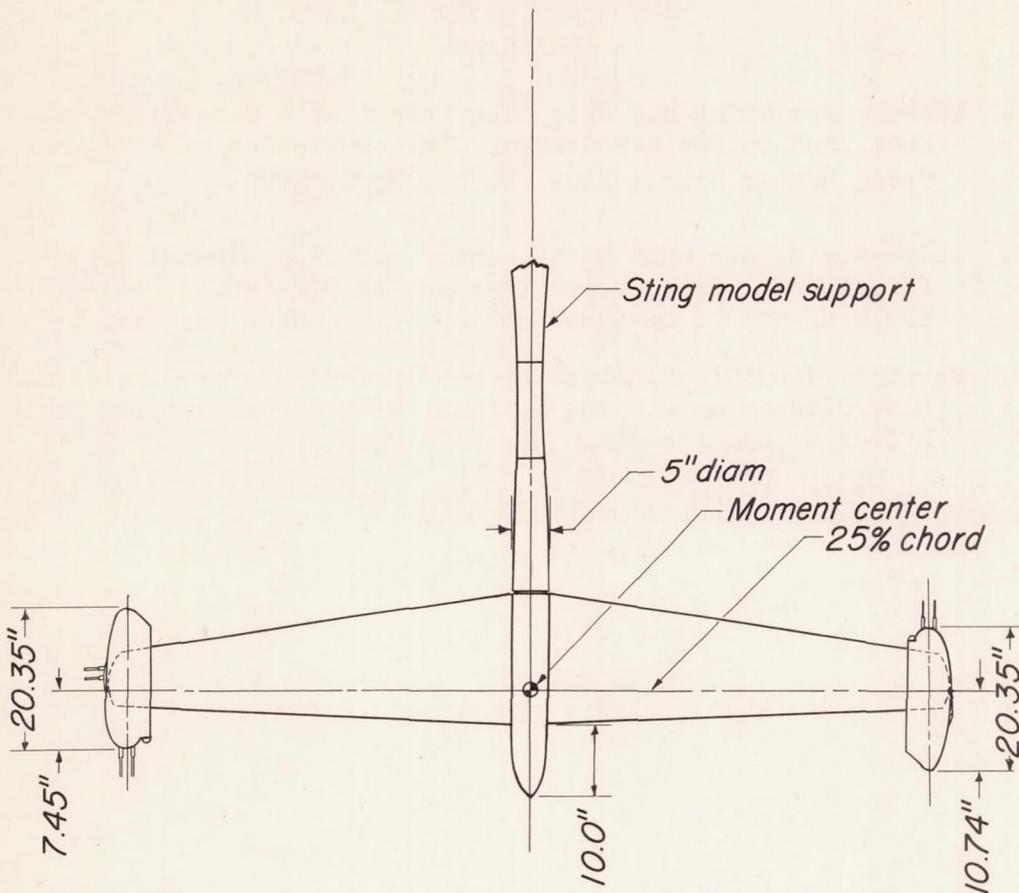

Wing area, square feet, (turrets off) 11.11
 Aspect ratio 9.00
 MAC, feet 1.178
 Taper ratio 0.4

Wing section, NACA 63,-210

Figure 1.- Plan and front views of gun turrets mounted on a typical bomber-wing model.

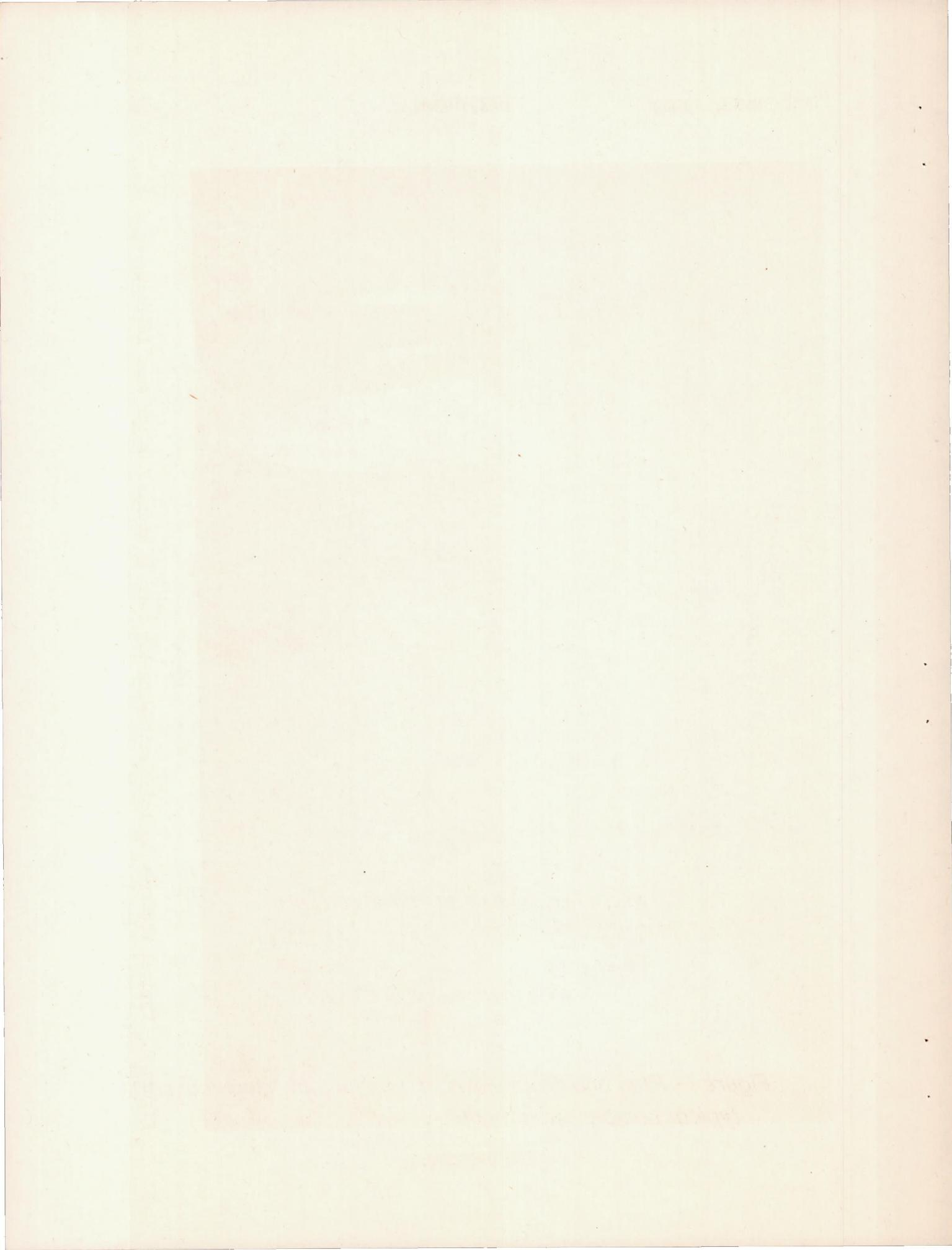

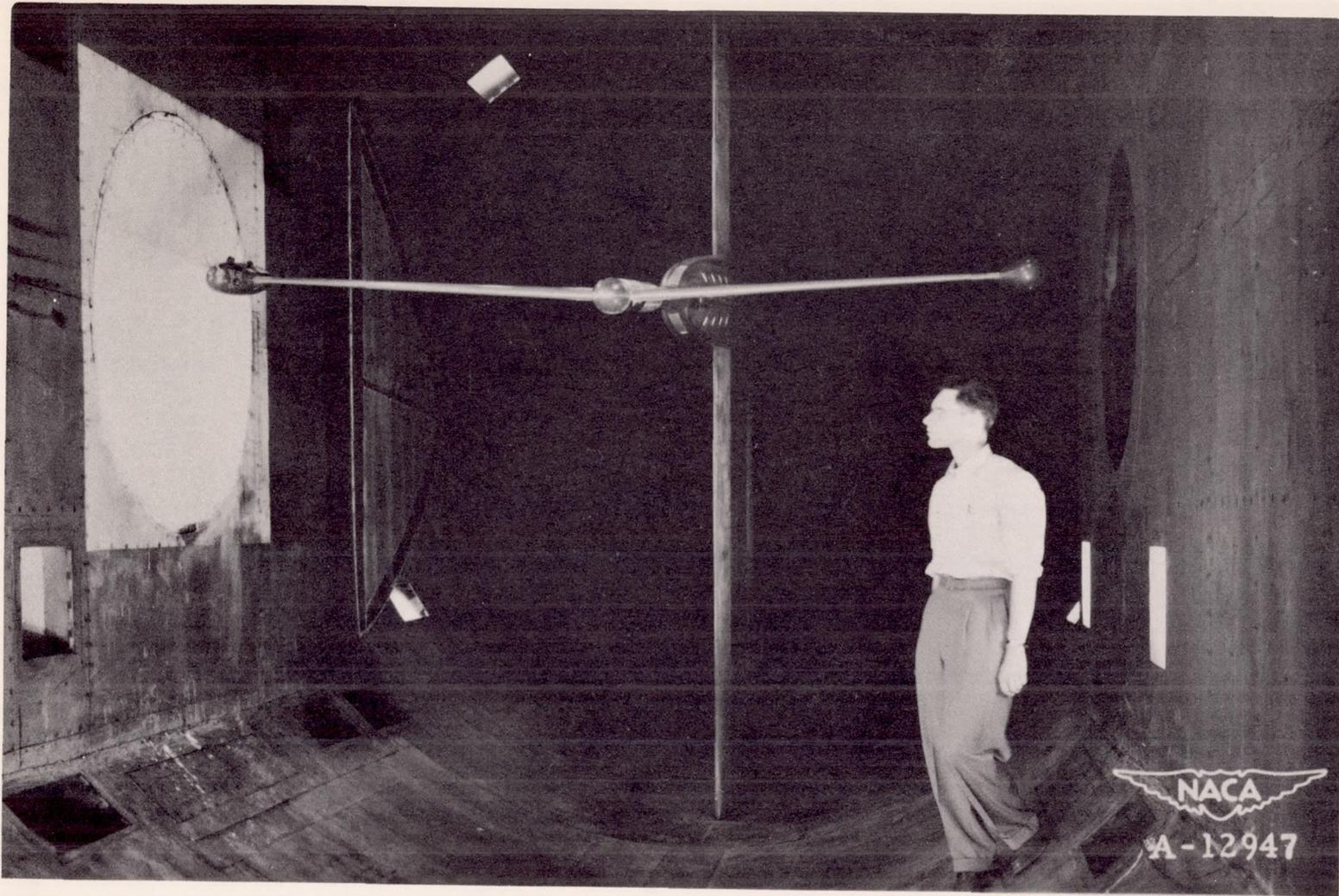

CONFIDENTIAL

Figure 2.- Typical bomber-wing model with wing-tip turrets mounted in the Ames 16-foot high-speed wind tunnel.

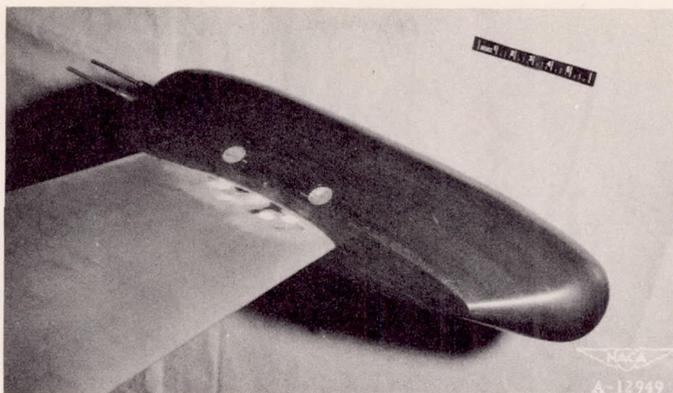

(a) Rearward-firing turret installation.

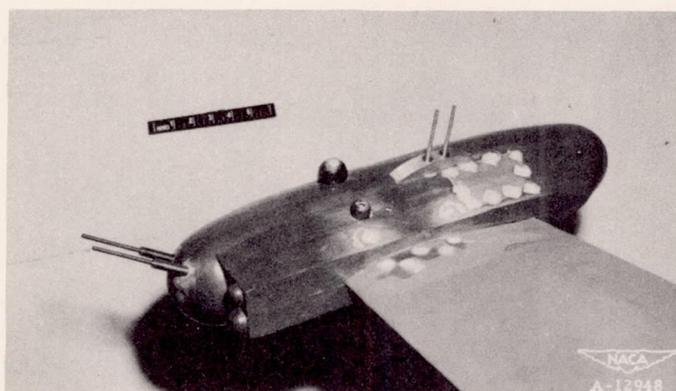

(b) Forward-firing turret installation, unmodified nose.

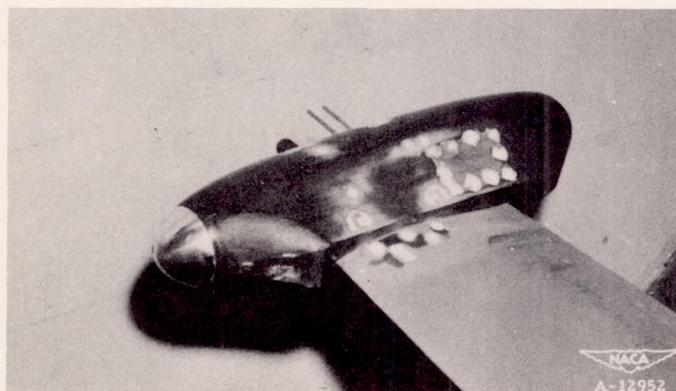

(c) Forward-firing turret installation, modified nose.

Figure 3.- Wing-tip gun turrets mounted on a typical bomber-wing model.

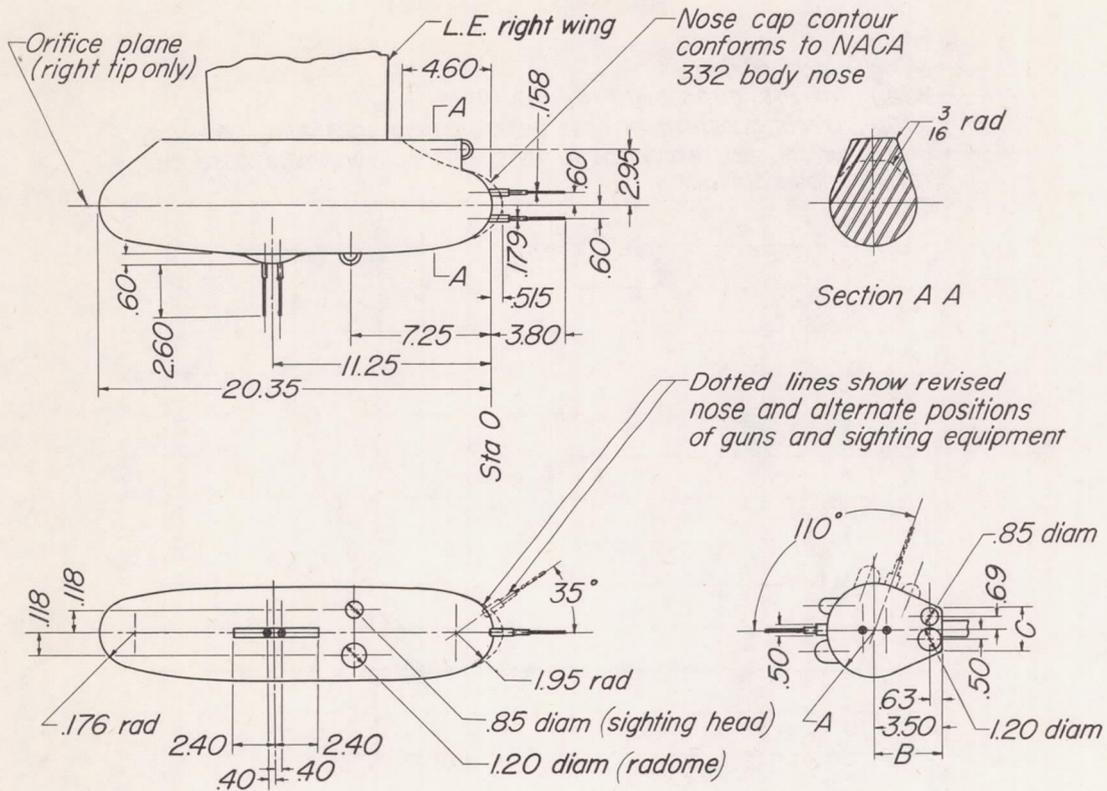

Station	A	B	C
0.0	—	—	—
.75	1.540	—	—
1.50	1.920	3.50	2.20
2.25	2.120	3.50	2.20
3.00	2.260	3.50	2.20
3.75	2.350	3.50	2.20
4.50	2.410	3.50	2.20
5.25	2.450	3.50	2.20
6.00	2.475	3.50	2.20
6.75	2.485	3.50	2.20
7.50	2.495	3.50	2.20
8.25	2.500	3.50	2.20
9.00	2.500	3.50	2.20
9.75	2.500	3.50	2.20
10.50	2.495	3.50	2.20
11.25	2.485	3.50	2.17
12.00	2.470	3.50	2.12
12.75	2.450	3.50	2.04
13.50	2.430	3.50	1.92
14.25	2.390	3.50	1.77
15.00	2.340	3.50	1.58
15.75	2.275	3.50	1.28
16.50	2.190	3.50	.82
17.25	2.080	3.34	.35
18.00	1.940	2.73	.28
18.75	1.775	2.13	.20
19.50	1.500	1.56	.13
20.35	—	—	—

Station	A	B	C
1.50	1.920	—	—
2.10	2.075	2.15	.44
2.60	2.185	2.36	.80
3.10	2.270	2.61	1.14
3.60	2.330	2.89	1.50
4.10	2.385	3.18	1.85
4.60	2.420	3.50	2.20

Note: Left and right wing-tip turrets are identical except for mounting position, refer to figure 1

All dimensions in inches

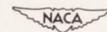
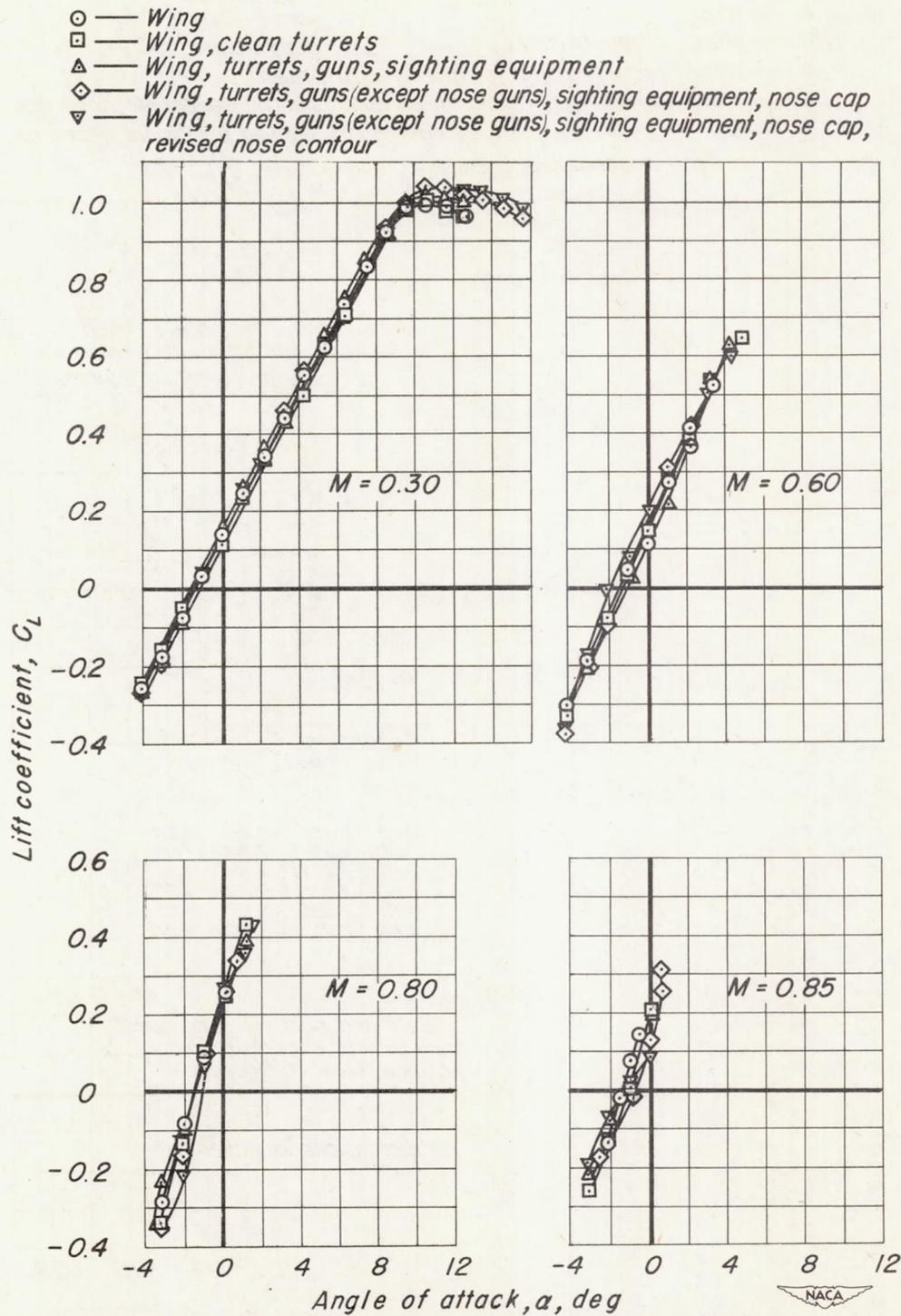
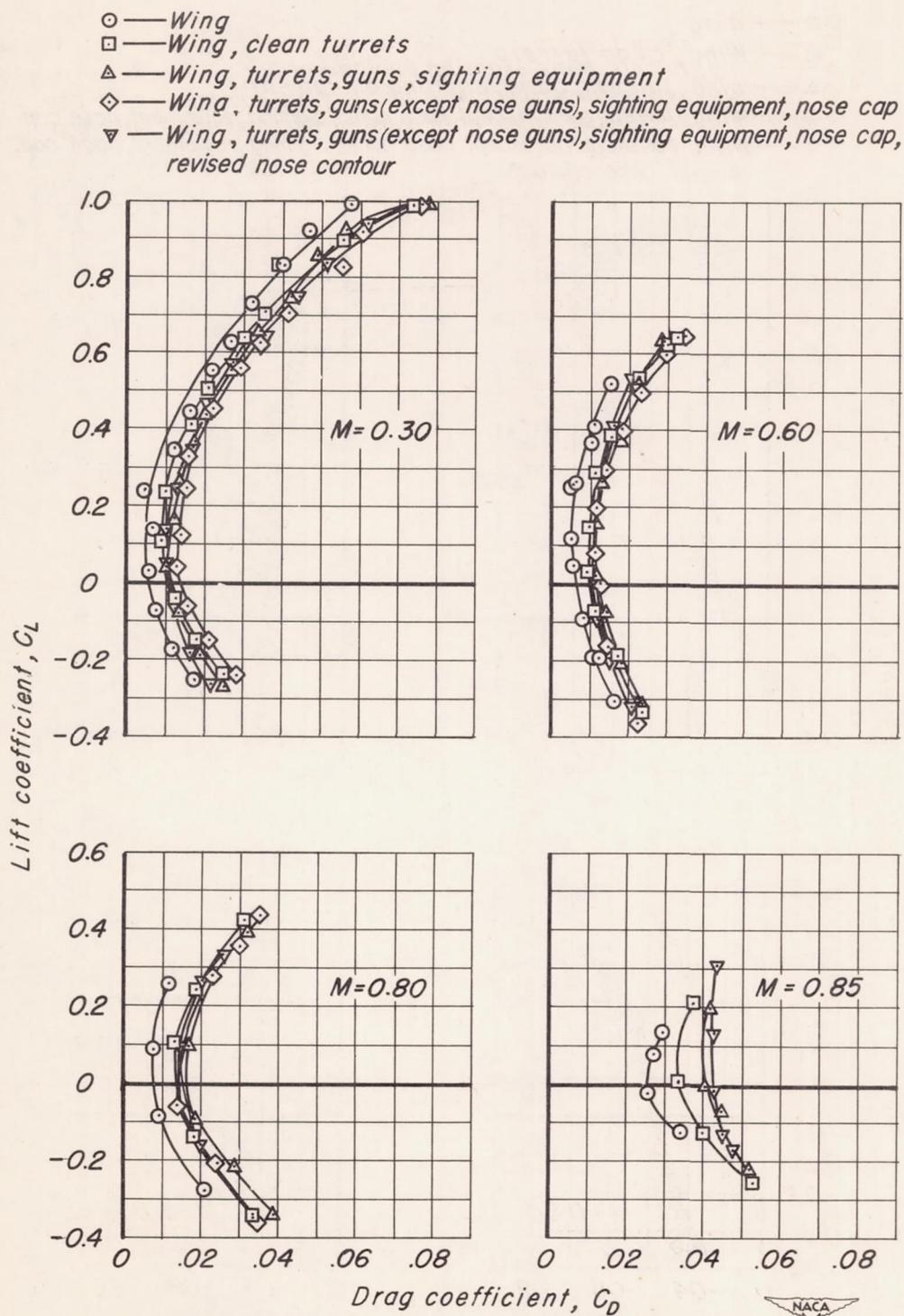

Figure 4.—Three-view drawing and tables of coordinates for the model wing-tip gun turret.



(a) Variation of lift coefficient with angle of attack.

Figure 5.— Effect of wing-tip gun turrets and turret modifications on the aerodynamic characteristics of a typical bomber-wing model.



(b) Variation of lift coefficient with drag coefficient.

Figure 5.—Continued.

- — Wing
- — Wing, clean turrets
- △ — Wing, turrets, guns, sighting equipment
- ◇ — Wing, turrets, guns (except nose guns), sighting equipment, nose cap
- ▽ — Wing, turrets, guns (except nose guns), sighting equipment, nose cap, revised nose contour

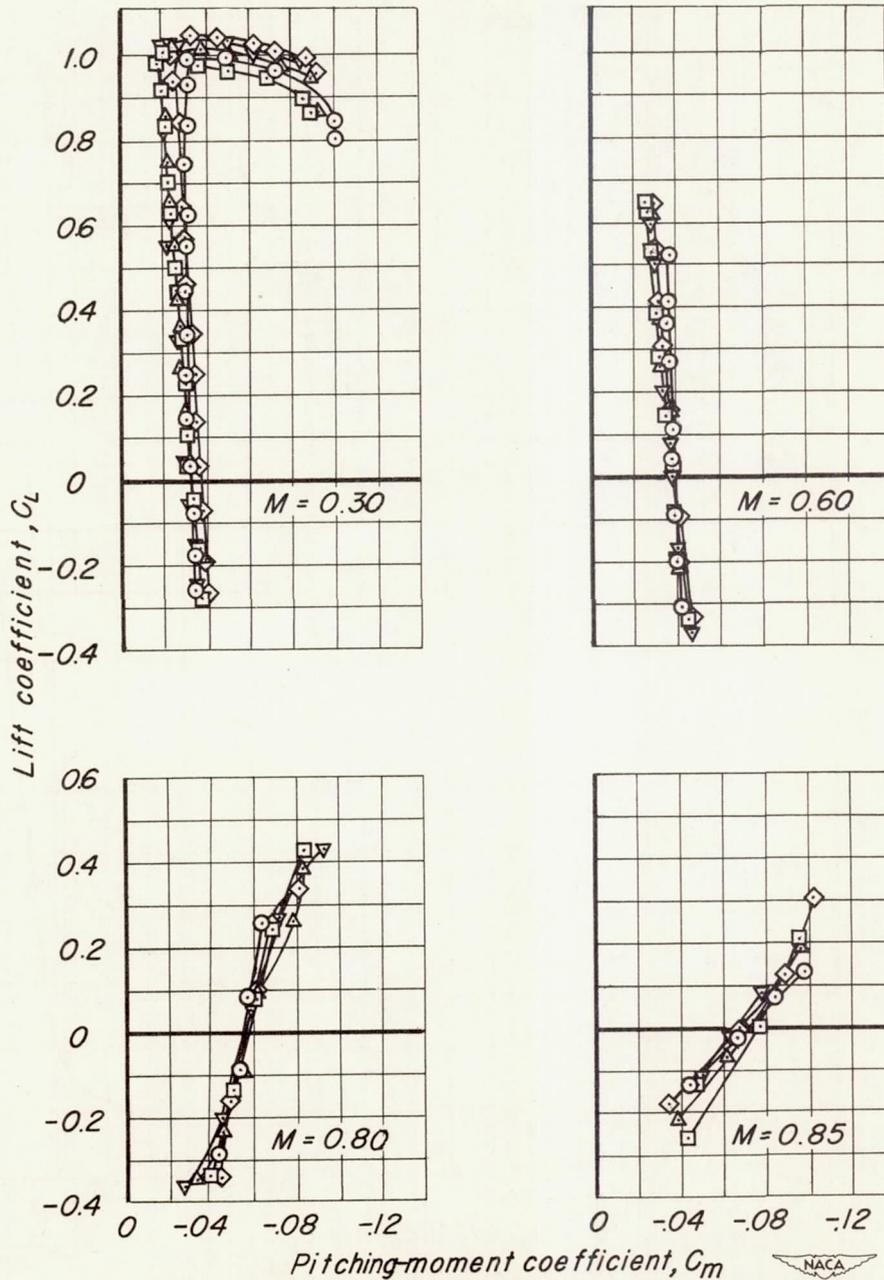

(c) Variation of lift coefficient with pitching-moment coefficient.

Figure 5.-Concluded.

- Wing
- Wing, turrets, guns, sighting equipment
- - - - Wing, turrets, guns (except nose guns),
sighting equipment, nose cap, revised nose
contour

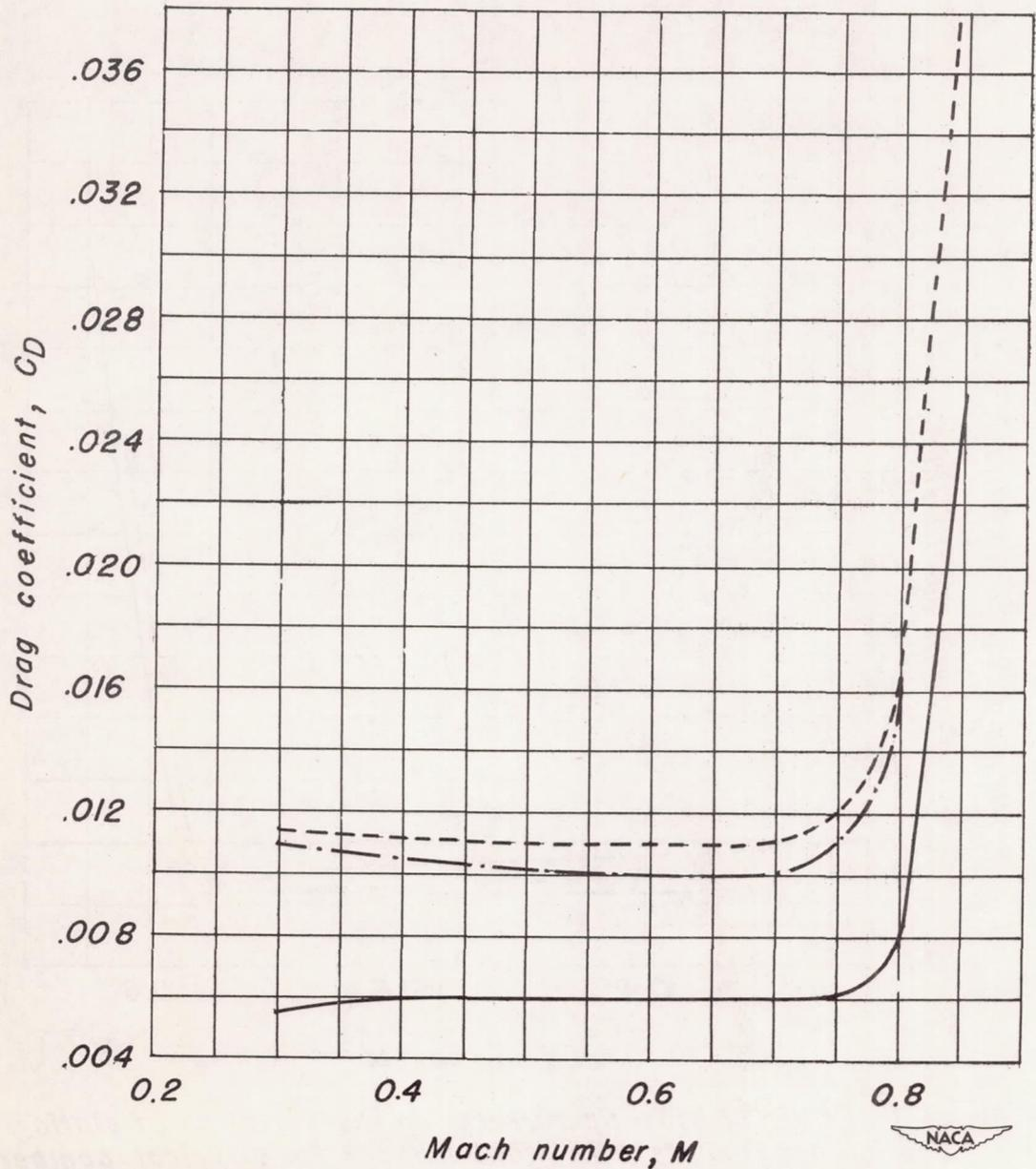

Figure 6.— Effect of wing-tip turrets on the variation of drag coefficient with Mach number for a typical bomber-wing model. $C_L, 0$.

- Wing
 - - - - Wing, turrets, guns, sighting equipment
 - - - - Wing, turrets, guns, (except nose guns), sighting equipment, nose cap, revised nose contour

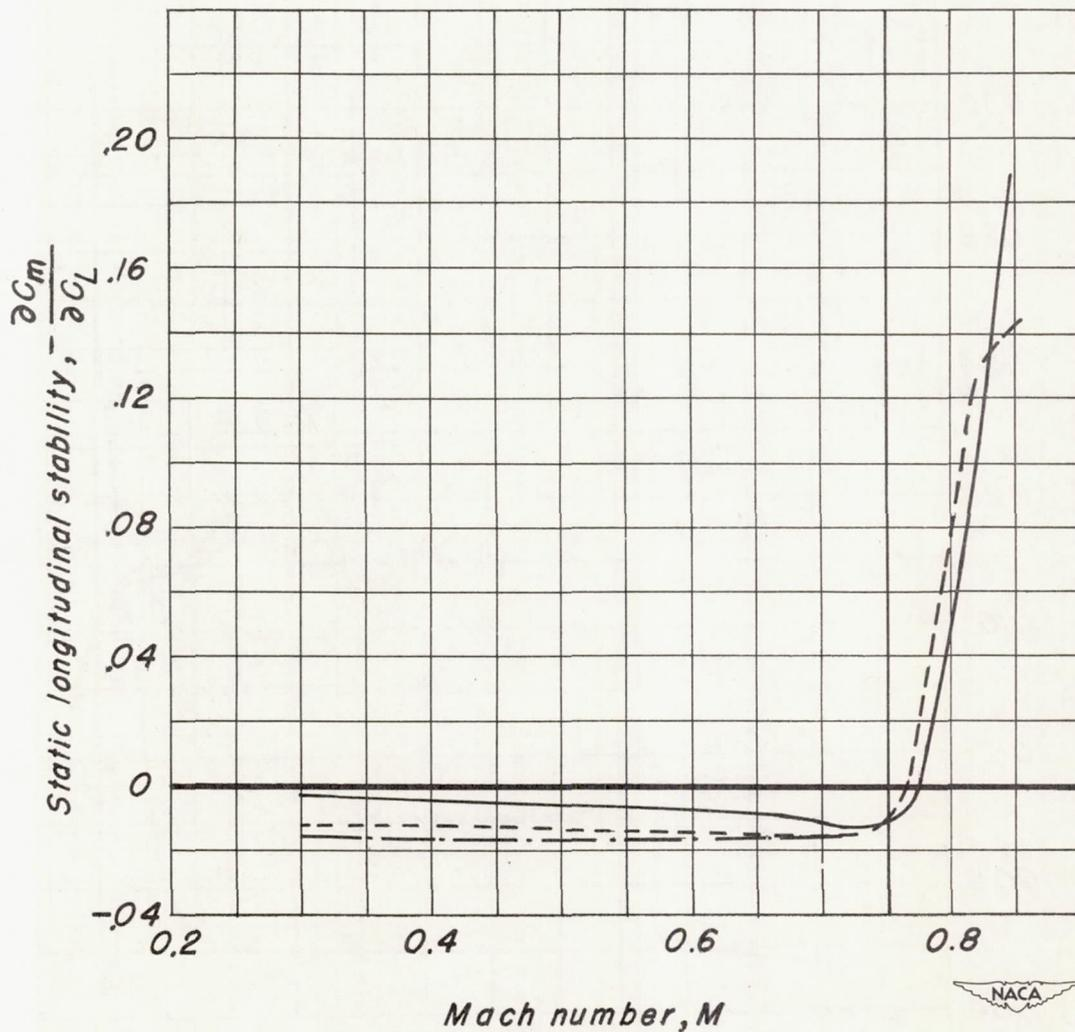
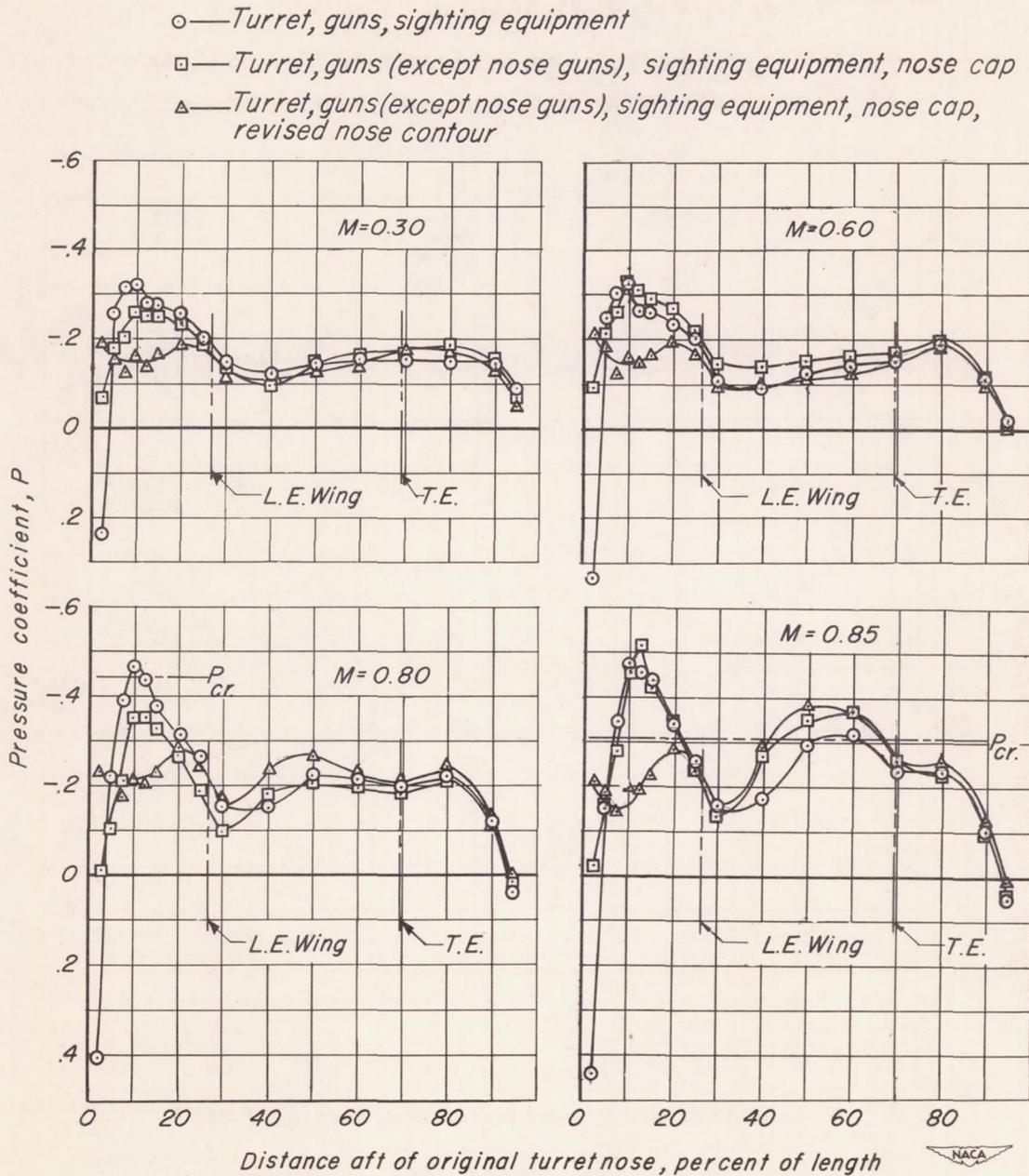

Figure 7.— Effect of wing-tip turrets on the variation of static longitudinal stability with Mach number for a typical bomber-wing model. $C_L, 0$.



(a) Upper surface.

Figure 8.— Pressure distribution along the surface of a wing-tip gun turret. α , -2° .

- — Turret, guns, sighting equipment
- — Turret, guns (except nose guns) sighting equipment, nose cap
- △ — Turret, guns (except nose guns), sighting equipment, nose cap, revised nose contour

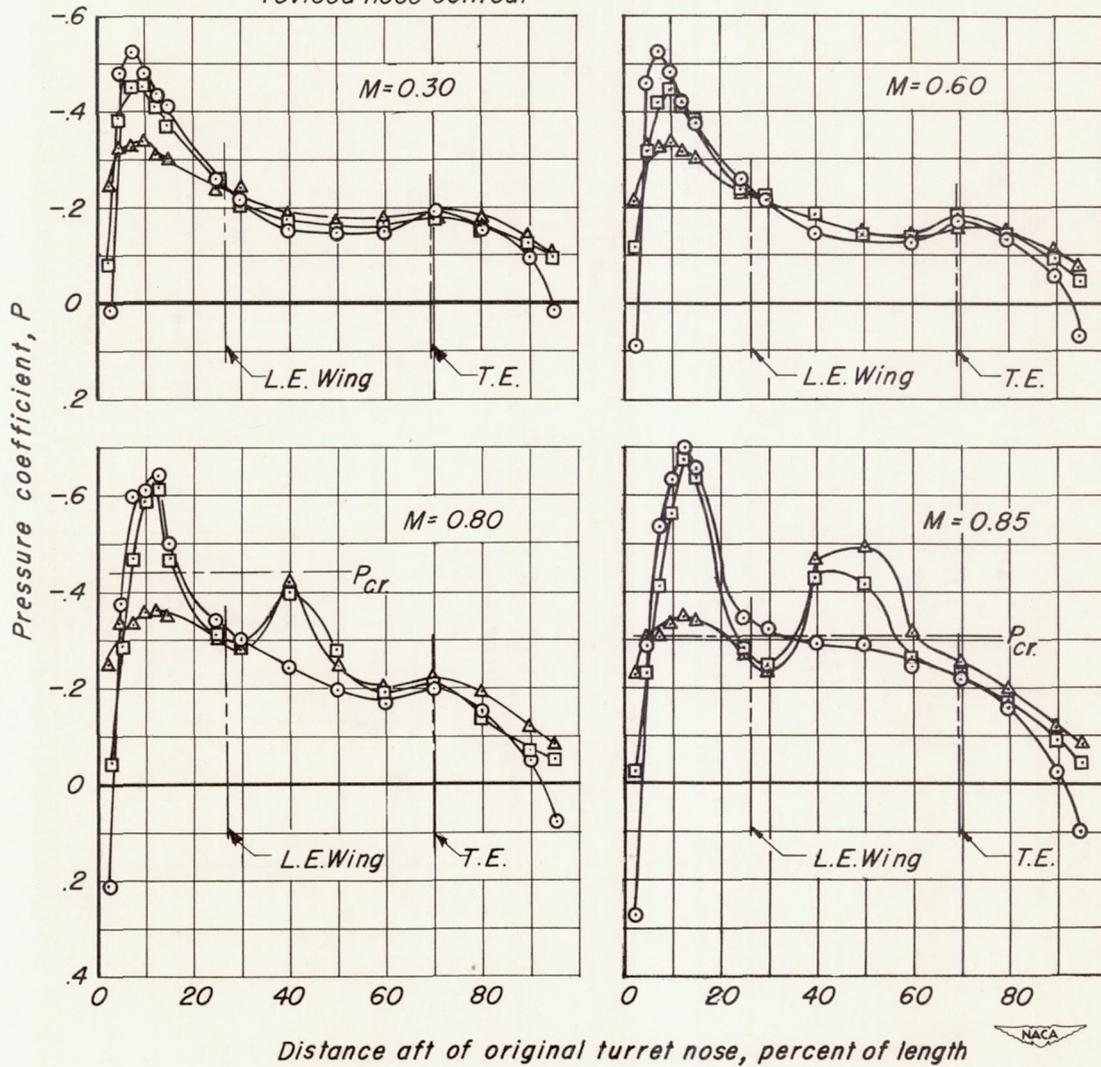

(b) Lower surface.

Figure 8.-Concluded.

- — Turret, guns, sighting equipment
- — Turret, guns (except nose guns), sighting equipment, nose cap
- △ — Turret, guns (except nose guns), sighting equipment, nose cap, revised nose contour

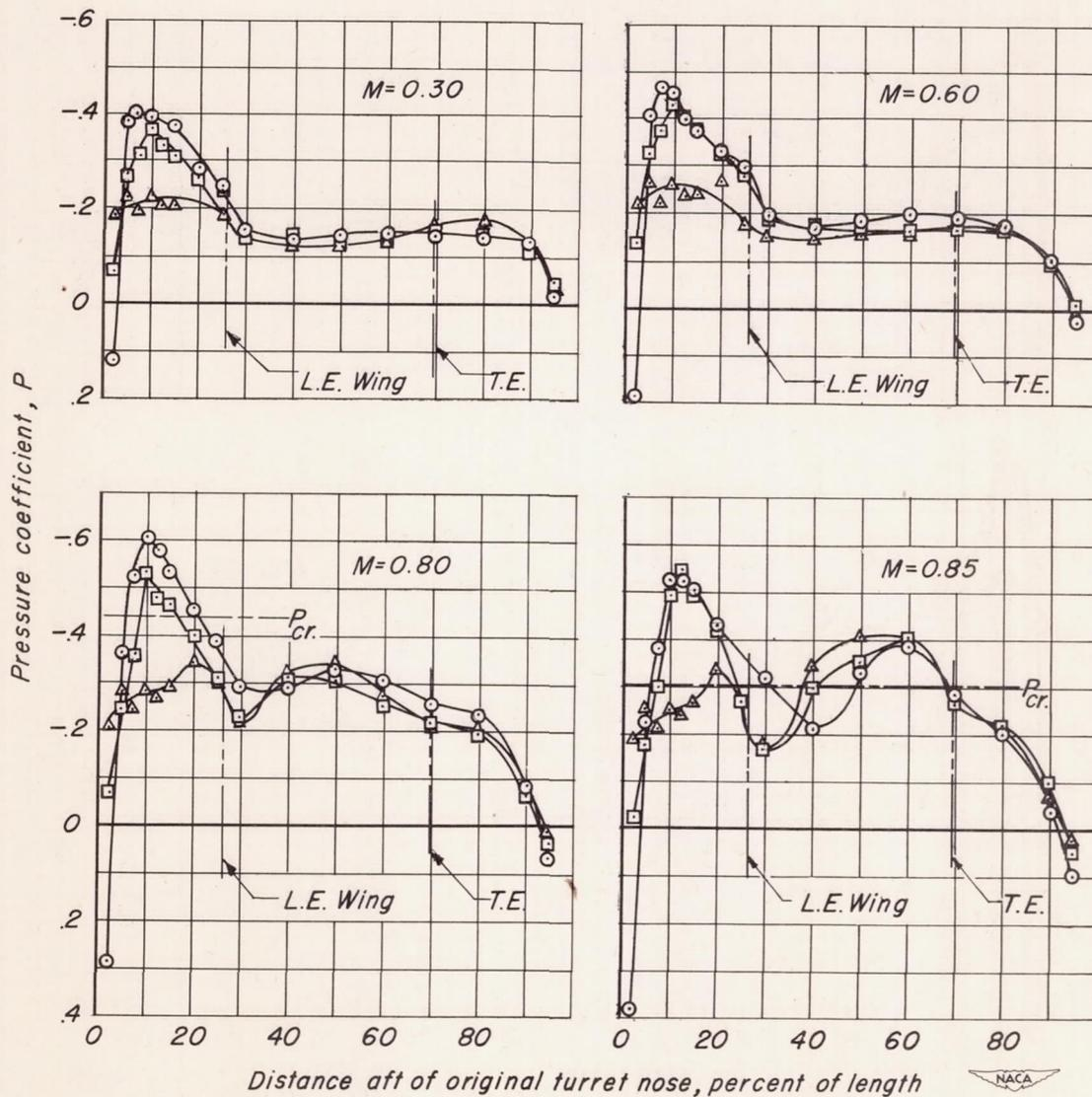

(a) Upper surface.

Figure 9.- Pressure distribution along the surface of a wing-tip gun turret.
 α , 0° .

- — Turret, guns, sighting equipment
- — Turret, guns(except nose guns), sighting equipment, nose cap
- ▲ — Turret, guns(except nose guns) sighting equipment, nose cap, revised nose contour

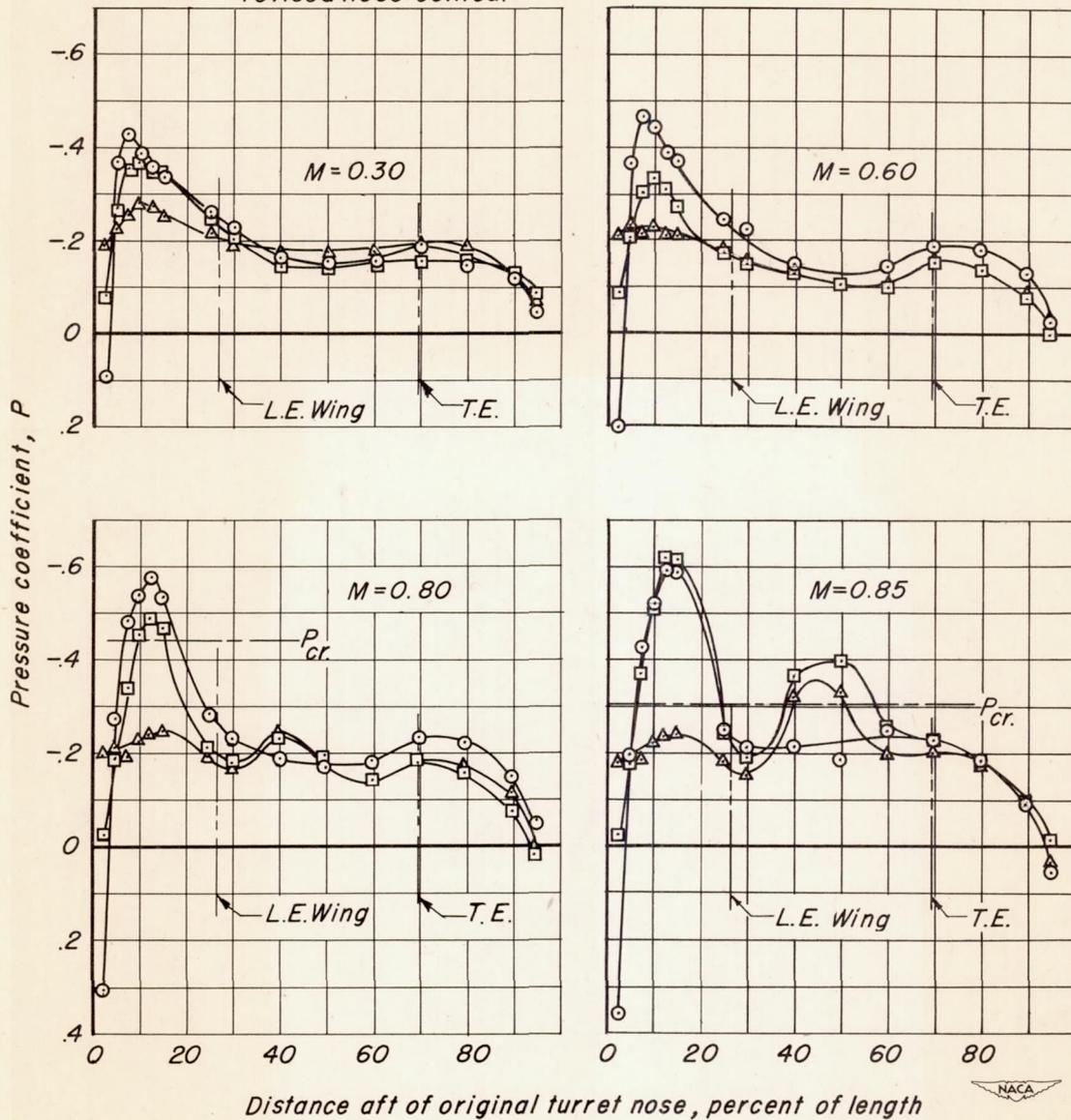

Distance aft of original turret nose, percent of length

(b) Lower surface.

Figure 9.-Concluded.