

NACA RM L50K01a

CLASSIFICATION CHANGED TO

FILE COPY
NO. 1



Copy 136
RM L50K01a

~~SECRET~~

Authorized by *Dr. Drake* Date *5-15-51*
By *James H. ...*
1-12-51

NACA

CASE FILE
COPY

RESEARCH MEMORANDUM

EFFECTS ON THE SNAKING OSCILLATION OF THE
BELL X-1 AIRPLANE OF A TRAILING-EDGE
BULB ON THE RUDDER

By Hubert M. Drake and Harry P. Clagett

THIS DOCUMENT ON LOAN FROM THE FILES OF Langley Aeronautical Laboratory
Langley Field, Va.

NATIONAL ADVISORY COMMITTEE FOR AERONAUTICS
LANGLEY AERONAUTICAL LABORATORY
LANGLEY FIELD, HAMPTON, VIRGINIA

CLASSIFICATION CHANGED TO UNCLASSIFIED

AUTHORITY J.W. CROWLEY DATE 8-31-54

CHANGE #2587

WHL

RETURN TO THE ADDRESS

REQUESTS FOR PUBLICATIONS SHOULD BE ADDRESSED
AS FOLLOWS:

CLASSIFIED DOCUMENT

This document contains classified information affecting the National Defense of the United States within the meaning of the Espionage Act, U.S.C. 50:31 and 32. Its transmission or the revelation of its contents in any manner to an unauthorized person is prohibited by law.
Information so classified may be imparted only to persons in the military and naval services of the United States, appropriate civilian officers and employees of the Federal Government who have a legitimate interest therein, and to United States citizens of known loyalty and discretion who of necessity must be informed thereof.

NATIONAL ADVISORY COMMITTEE FOR AERONAUTICS
1512 H STREET, N. W.
WASHINGTON 25, D. C.

NATIONAL ADVISORY COMMITTEE FOR AERONAUTICS

WASHINGTON
January 16, 1951

~~SECRET~~

NATIONAL ADVISORY COMMITTEE FOR AERONAUTICS

RESEARCH MEMORANDUM

EFFECTS ON THE SNAKING OSCILLATION OF THE
BELL X-1 AIRPLANE OF A TRAILING-EDGE
BULB ON THE RUDDER

By Hubert M. Drake and Harry P. Clagett

SUMMARY

A rudder bulb was installed on the trailing edge of the rudder of the Bell X-1 airplane having the 8-percent-thick wing and 6-percent-thick tail. Several flights were made to investigate the effects of the bulb on the snaking oscillation at Mach numbers between 0.75 and 1.0.

It was found that the rudder bulb had no noticeable effect on the snaking oscillation over the Mach number range tested.

INTRODUCTION

The NACA is cooperating with the U. S. Air Force in a program of flight research in the transonic speed range utilizing the Bell X-1 airplane having an 8-percent-thick wing and a 6-percent-thick tail. The airplane is maintained by the Air Force and flown by an Air Force pilot. NACA recording instruments are installed and the data reduction and analysis is performed by NACA personnel.

In the course of this program, a bulb was placed on the rudder trailing edge to increase the tendency of the rudder to float with the relative wind and, thus, increase the damping of the snaking oscillation which is experienced with the X-1. Such a bulb was installed for several flights and the results of these tests are presented in this paper.

SYMBOLS

C_{N_A}	normal-force coefficient $\left(\frac{n^w}{q}\right)$
M	Mach number
β	sideslip angle
p	rolling velocity, radians per second
\dot{p}	rolling acceleration, radians per second squared
W	airplane weight, pounds
S	wing area, square feet
q	dynamic pressure, pounds per square foot

AIRPLANE AND INSTRUMENTATION

The Bell X-1 airplane is a single-place rocket-propelled monoplane designed for flight research in the transonic speed range. A detailed description of the airplane has been presented in reference 1 and a three-view sketch is shown as figure 1.

Synchronized NACA instruments were used to record normal, transverse, and longitudinal acceleration, rolling velocity and acceleration, sideslip angle, altitude, airspeed, and rudder, aileron, elevator, and stabilizer positions. The rudder-position transmitter was sufficiently sensitive to indicate rudder movements as small as $\frac{1^\circ}{20}$ and was fastened directly to the rudder. Because of lack of space, no pedal-force recorder could be installed.

A rudder bulb consisting of half-round strips, 1/2 inch in diameter, was fastened along the entire trailing edge of the rudder except in the region of the trim tab. A photograph of the installation is shown in figure 2.

TESTS, RESULTS, AND DISCUSSION

In flight tests of the X-1 airplanes a small-amplitude, lightly damped lateral oscillation has been encountered over very nearly the

entire range of Mach numbers at which the airplane has been flown. Examples of the oscillation and calculation of the lateral stability of the X-1 are given in reference 2. A number of possible causes were suspected and investigated. It was thought that fuel sloshing might be a contributing cause until flights with propellant tanks empty showed that the snaking also occurred in this condition. It was suspected that small motions of the rudder might cause the snaking at subsonic Mach numbers so flights were made with the rudder fixed. The results of these flights are given in reference 3 and one of the figures from this reference presenting a rudder-fixed lateral oscillation of the X-1 airplane having the 10-percent-thick wing and 8-percent-thick tail is shown as figure 3. It was concluded that small rudder motions and fuel sloshing were not the primary causes of the oscillation although they might be contributing causes. In order to further investigate the effects of the rudder on the snaking, the U. S. Air Force requested that tests be made on a rudder trailing-edge bulb. The purpose of the bulb was to modify the rudder hinge moments to increase the tendency of the rudder to float with the relative wind. Several flights were made with the bulb installed on the X-1 having an 8-percent-thick wing and a 6-percent-thick tail. Records were obtained of lateral oscillations occurring in steady flight and as a result of rudder disturbances.

Time histories of lateral oscillations occurring in climbs are presented in figure 4 at Mach numbers of about 0.8 and 0.9 and in level flight in figure 5 at a Mach number of 0.99. These records were obtained with rockets operating and with varying amounts of fuel aboard as detailed in the figure legends. Time histories of oscillations resulting from rudder disturbances are presented in figure 6 for power-on flight at a Mach number of about 0.98 and in figure 7 for power-off flight at a Mach number of about 0.79. Although a roll turn-meter record was obtained for all of these time histories, a defective timer prevented synchronization of all but the time history shown in figure 7.

The rudder traces of figures 4(a) and 4(b) and the first part of the trace of figure 7 indicate that the rudder is moving as the airplane oscillates. No pedal forces were obtained so it is not possible to say whether the pilot was moving the rudder as a result of the oscillation. The rudder traces in figures 5, 6, and the last part of the trace of figure 7 do not show any rudder movements that would be expected to materially affect the oscillation. In particular, the time history of figure 7 is of interest. The rudder initiates the oscillation and continues to move as the oscillation damps to time 14 seconds when the rudder motion stops. The lateral oscillation of the airplane, however, continues with nearly constant amplitude. This agrees with the data of reference 3 in which it was shown that fixing the rudder had little effect.

CONCLUSIONS

As a result of several flights of the Bell X-1 airplane with a rudder bulb installed, it was found that the rudder bulb had little effect on the snaking oscillation of the airplane at Mach numbers between 0.75 and 1.0.

Langley Aeronautical Laboratory
National Advisory Committee for Aeronautics
Langley Field, Va.

REFERENCES

1. Williams, Walter C., Forsyth, Charles M., and Brown, Beverly P.: General Handling-Qualities Results Obtained during Acceptance Flight Tests of the Bell XS-1 Airplane. NACA RM L8A09, 1948.
2. Drake, Hubert M., and Wall, Helen L.: Preliminary Theoretical and Flight Investigation of the Lateral Oscillation of the X-1 Airplane. NACA RM L9F07, 1949.
3. Drake, Hubert M.: Effects on the Lateral Oscillation of Fixing the Rudder and Reflexing the Flaps on the Bell X-1 Airplane. NACA RM L50I05, 1950.

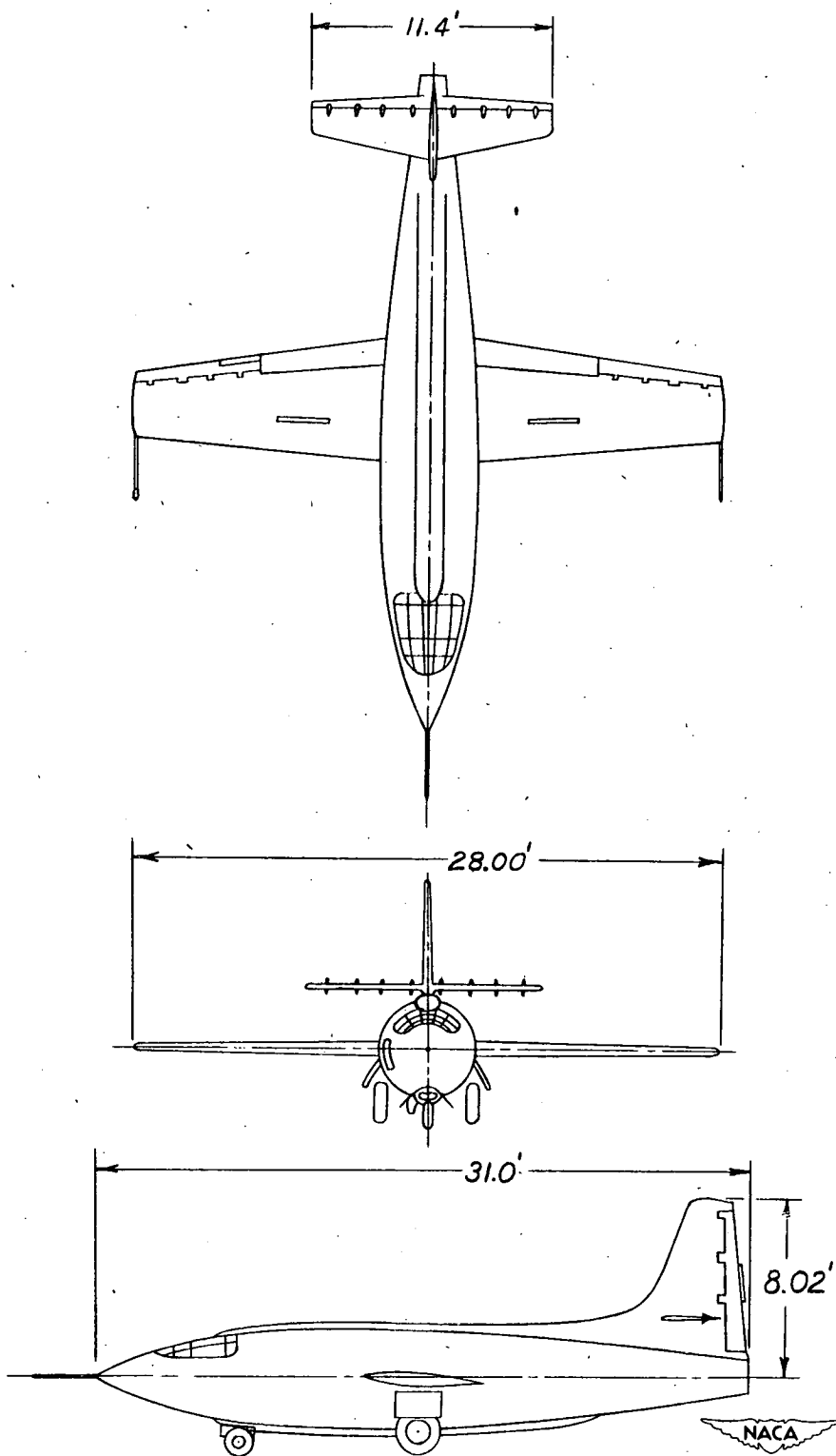

Figure 1.- A three-view sketch of the Bell X-1 airplane.

Page intentionally left blank

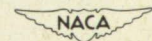
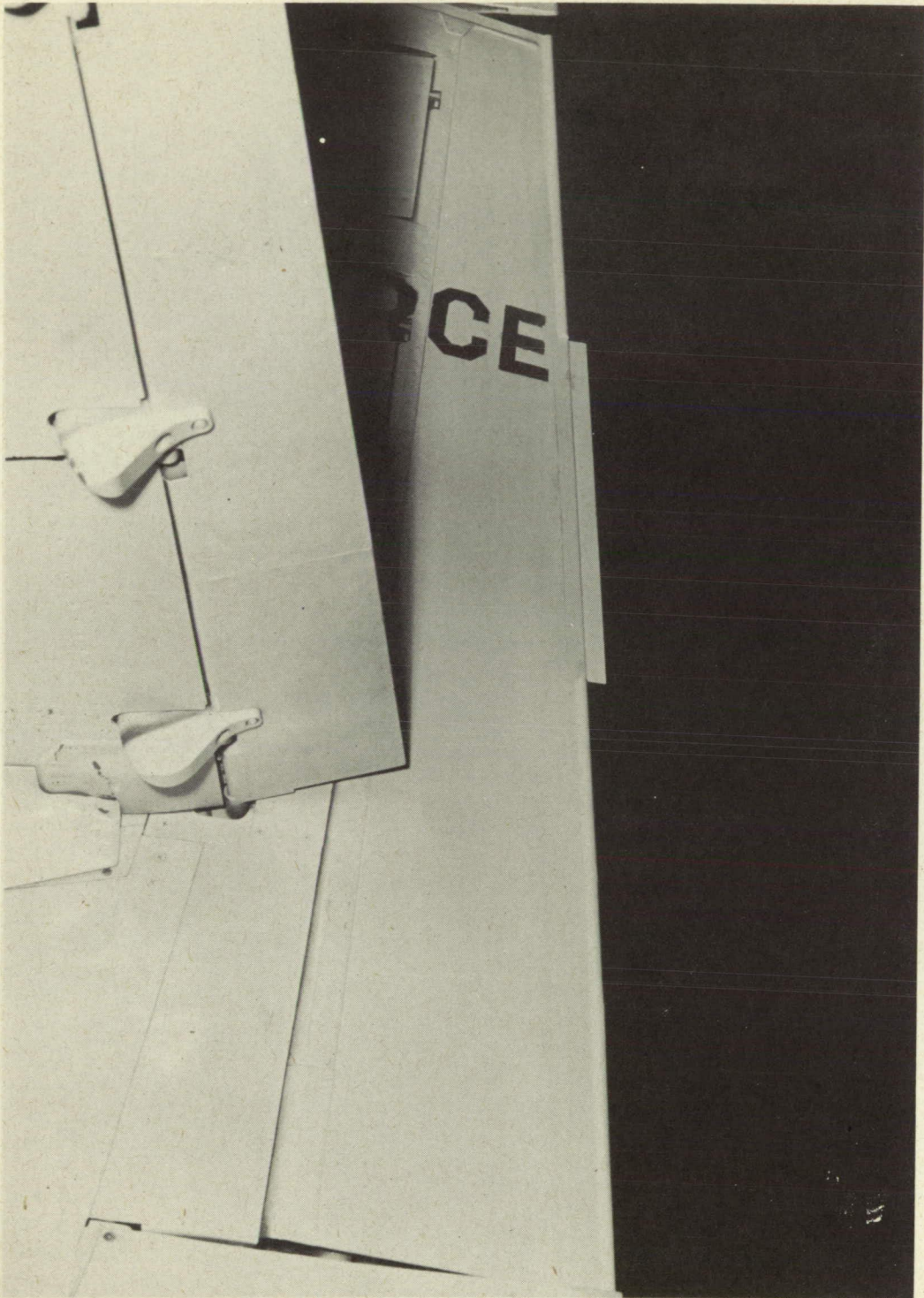

Figure 2.- Photograph of the installation of a rudder bulb fastened along the trailing edge of the rudder.

Page intentionally left blank

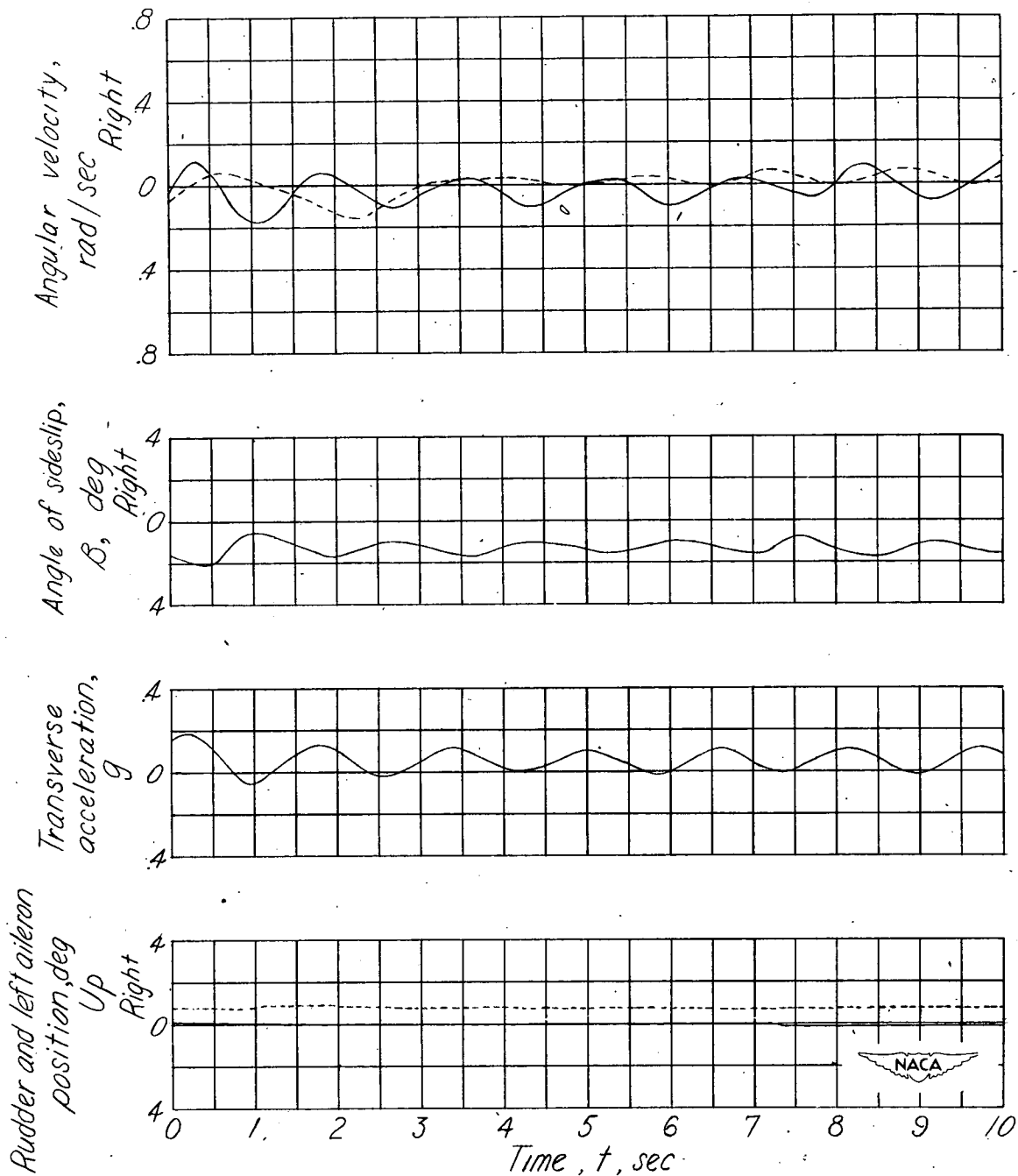
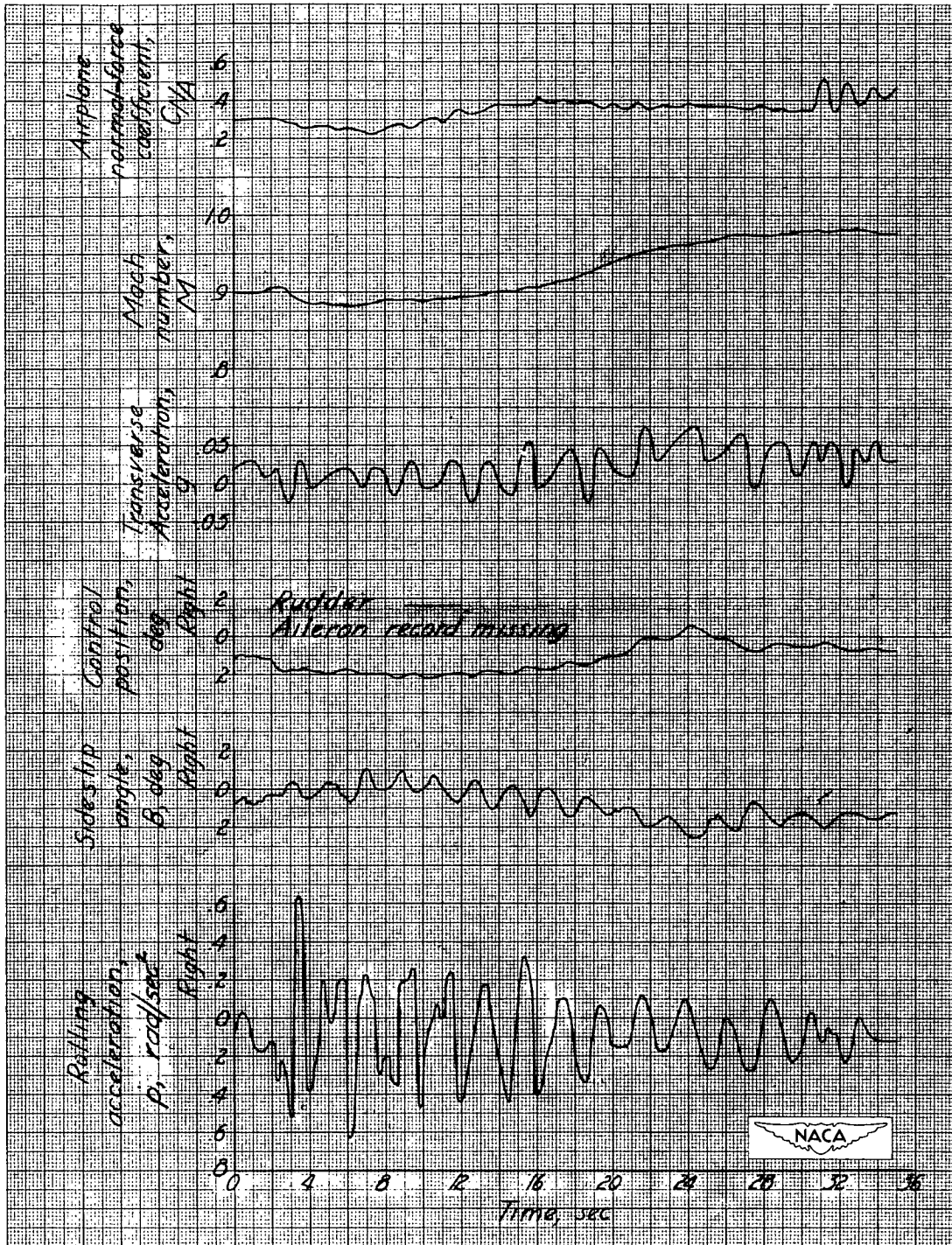
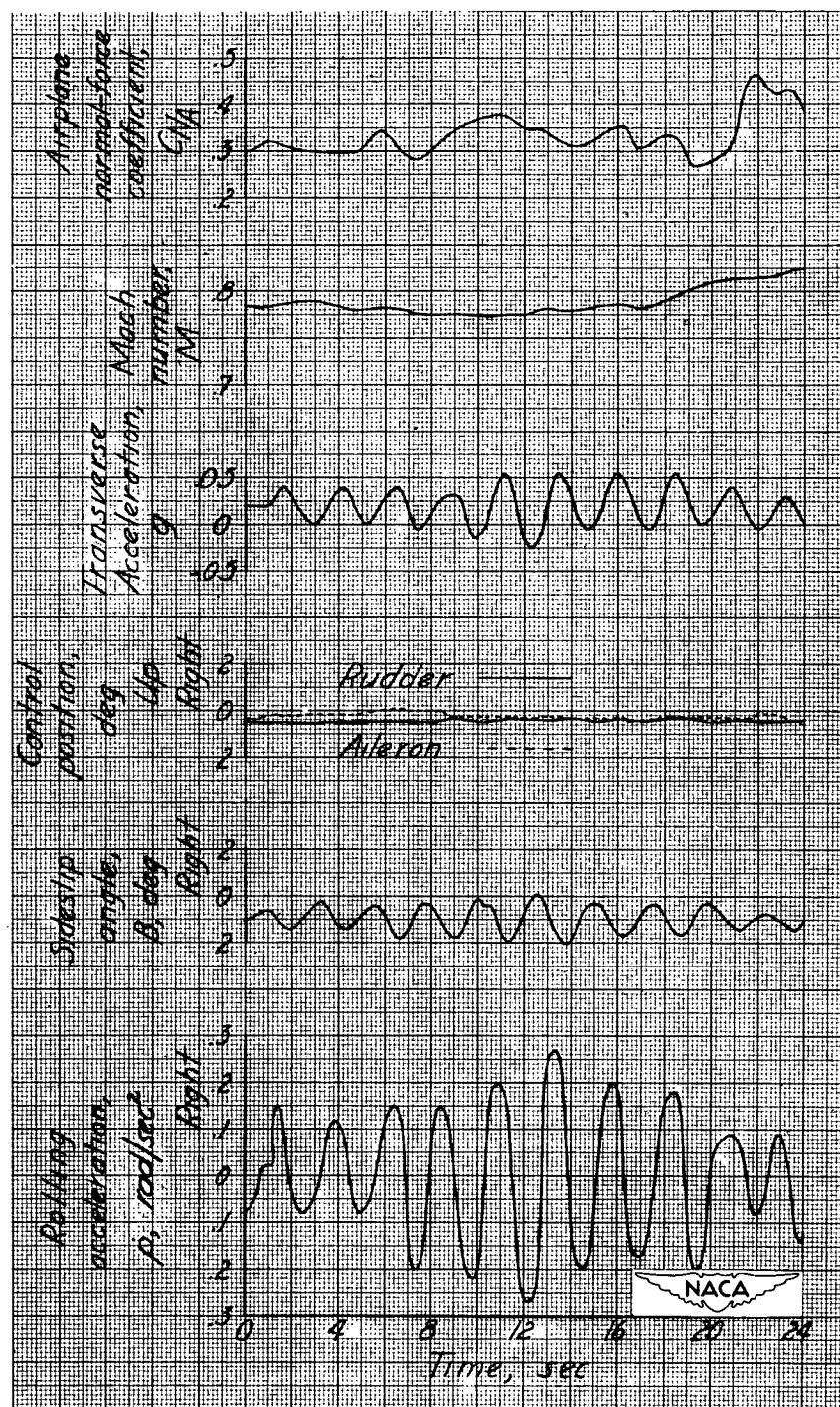

Figure 3.- Snaking oscillation of X-1 airplane with rudder fixed; 10-percent-thick wing and 8-percent-thick tail; $M = 0.84$; $C_{NA} = 0.19$; altitude, 28,000 feet to 25,000 feet. (From reference 3.)



(a) Altitude, 38,600 to 44,400 feet; three rockets on; initial weight, 9,750 pounds (48-percent propellants); final weight, 8,900 pounds (31-percent propellants).

Figure 4.- Time histories of lateral oscillations in climb.



(b) Altitude, 36,700 to 43,400 feet; three rockets on; initial weight, 10,600 pounds (65-percent propellants); final weight, 9,600 pounds (44-percent propellants).

Figure 4.- Concluded.



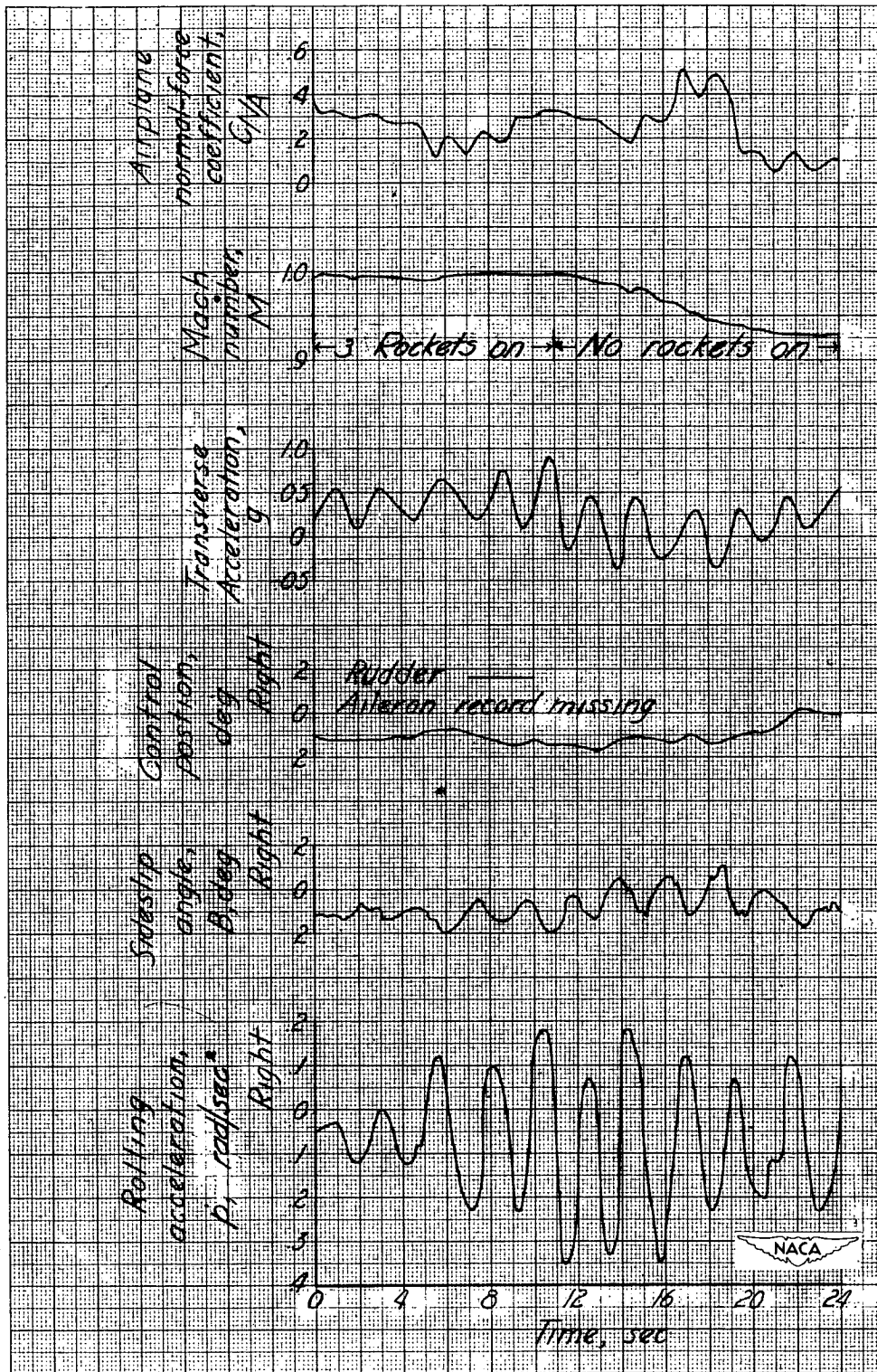

Figure 5.- Time history of lateral oscillation in level flight. Altitude, 48,000 feet; initial weight, 8,550 pounds (24-percent propellants); final weight, 8,300 pounds (19-percent propellants).

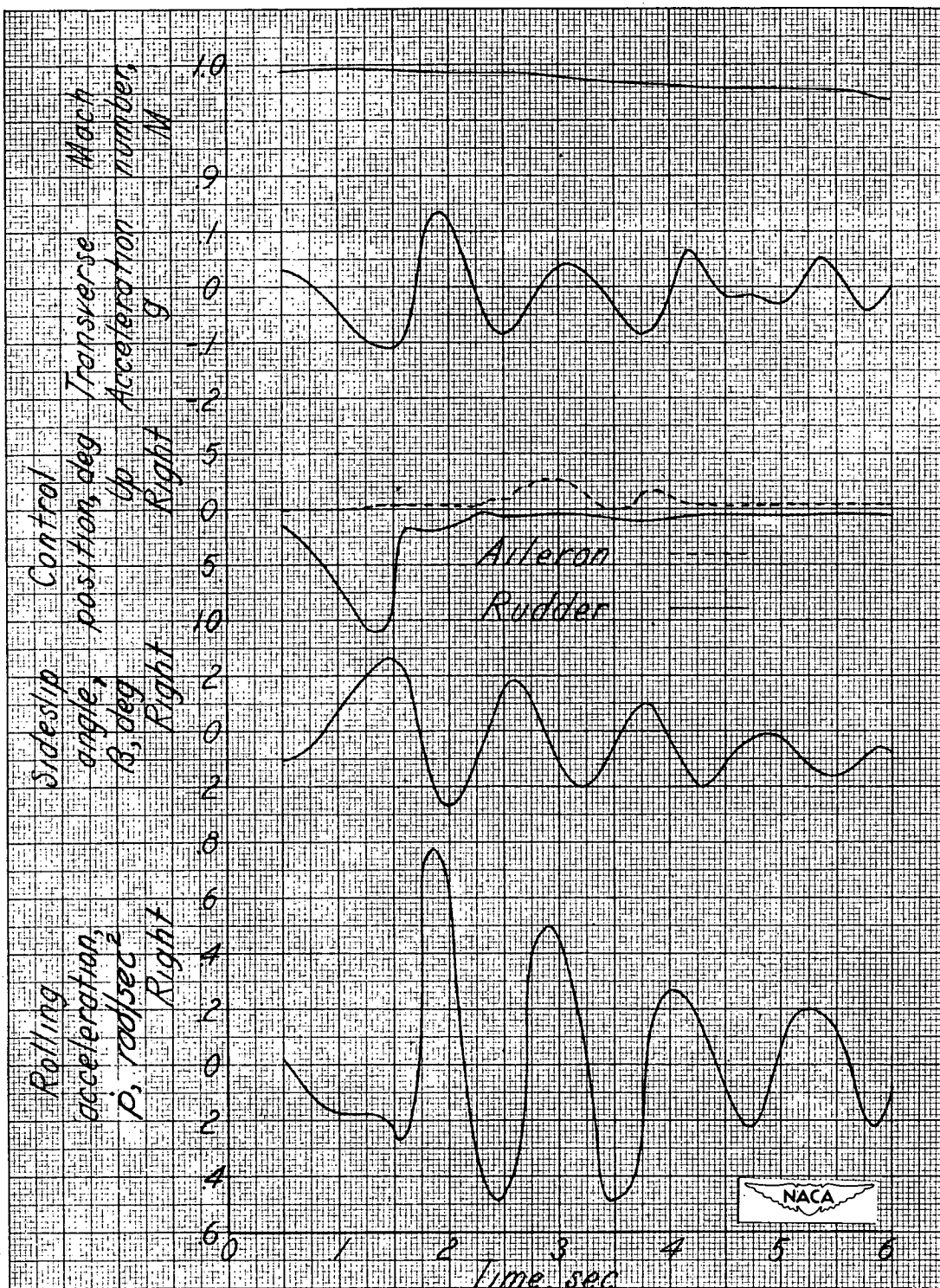

Figure 6.- Time history of rudder kick with power on. Altitude, 45,200 feet; $C_{NA} \approx 0.3$; one rocket on; initial weight, 9,235 pounds (38-percent propellants); final weight, 9,145 pounds (36-percent propellants).

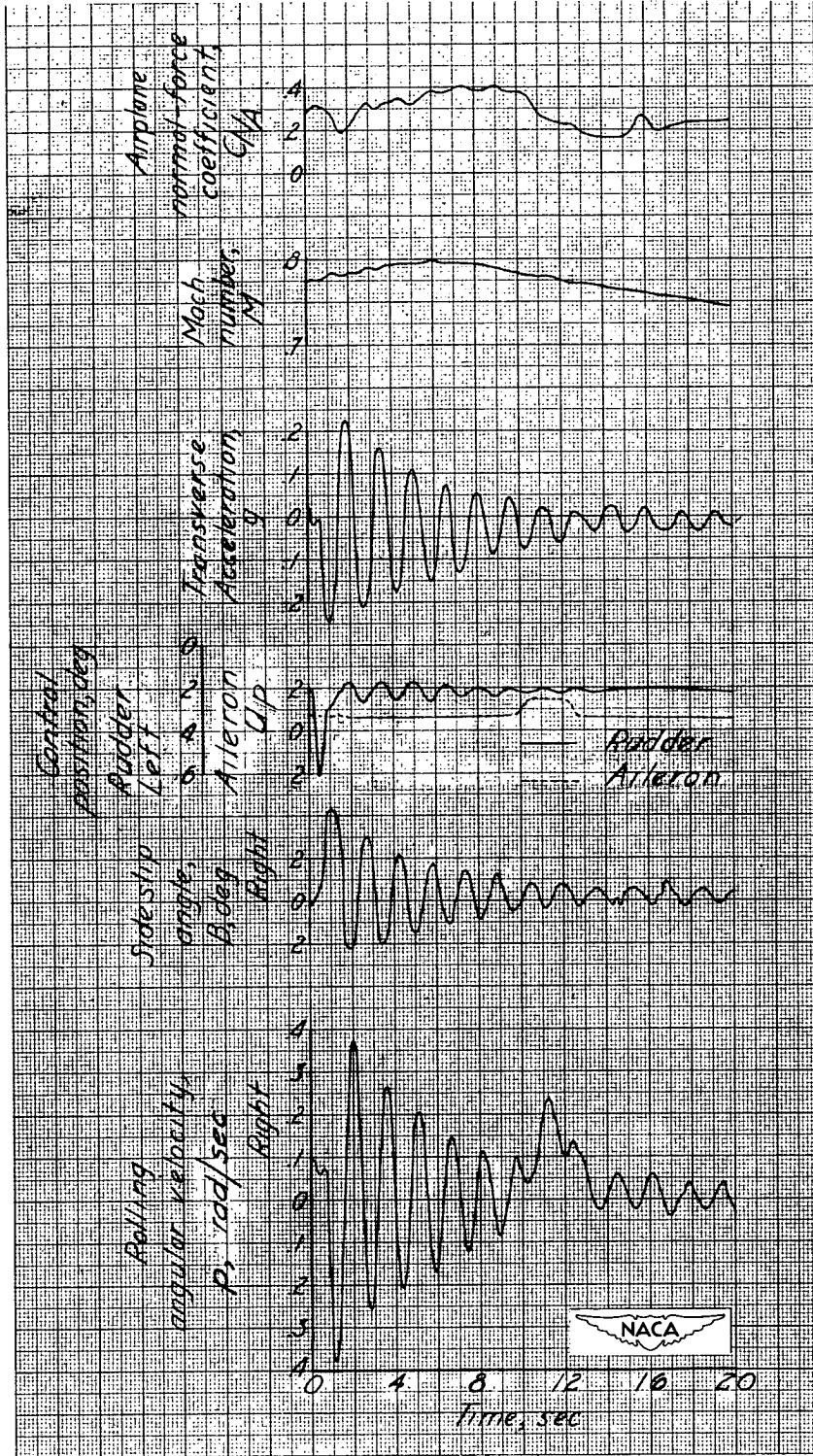

Figure 7.- Time history of rudder kick with power off. Altitude, 29,400 feet to 27,900 feet; weight, 7,340 pounds; no propellants aboard.

41080001 000000

RECORDED

RECORDED
INDEXED

RECORDED
INDEXED

RECORDED

RECORDED

RECORDED
INDEXED

RECORDED

RECORDED