

# RESEARCH MEMORANDUM

LOW-SPEED STATIC LONGITUDINAL STABILITY AND CONTROL

CHARACTERISTICS OF A 60° TRIANGULAR-WING MODEL

HAVING HALF-DELTA TIP CONTROLS

By Byron M. Jaquet, M. J. Queijo,  
and Jacob H. Lichtenstein

Langley Aeronautical Laboratory  
Langley Field, Va.

**NATIONAL ADVISORY COMMITTEE  
FOR AERONAUTICS**

**WASHINGTON**

June 27, 1951

NATIONAL ADVISORY COMMITTEE FOR AERONAUTICS

---

RESEARCH MEMORANDUM

---

LOW-SPEED STATIC LONGITUDINAL STABILITY AND CONTROL

CHARACTERISTICS OF A 60° TRIANGULAR-WING MODEL

HAVING HALF-DELTA TIP CONTROLS

By Byron M. Jaquet, M. J. Queijo,  
and Jacob H. Lichtenstein

SUMMARY

An investigation was conducted in the Langley stability tunnel to determine the low-speed static longitudinal stability and control characteristics of a 60° triangular-wing model having half-delta tip controls of 5, 10, and 15 percent (sum of left and right control areas) of the wing area.

The effectiveness of a 15-percent-area half-delta tip control was about half that of a constant-chord flap of approximately the same area, although both types of controls maintained about two-thirds of the initial effectiveness (measured near zero lift) at high lift coefficients. Tip controls of smaller areas had less control effectiveness than the 15-percent-area controls. The lift effectiveness (change in lift with control deflection) per unit area appeared to be a maximum with 10-percent-area tip controls. The pitching-moment effectiveness per unit control area decreased rapidly with an increase in control area, this behavior indicating that as the control area increased the center of pressure of the incremental load associated with control deflection moved forward.

The maximum trim lift coefficients available with the wing equipped with tip controls increased with an increase in control area or a reduction in static margin. For a 15-percent-area tip control, the maximum trim lift coefficients were about 64 percent and 93 percent of the untrimmed maximum lift coefficient for static margins of 9 percent and 5 percent, respectively, of the mean aerodynamic chord. The trim-lift-curve slope decreased with an increase in control area or static margin. The trim-lift-curve slope of the 15-percent-area tip controls

varied from 83 percent to 69 percent of the untrimmed-lift-curve slope as the static margin was changed from 5 percent to 13.5 percent of the mean aerodynamic chord.

Addition of the fuselage or circular end plates (adjacent to the inboard end of the tip controls) had insignificant effects on the control effectiveness of the 10-percent-area controls at low and moderate lift coefficients but had adverse effects on both the wing characteristics and control effectiveness at high lift coefficients.

## INTRODUCTION

Triangular wings of low aspect ratio combine certain aerodynamic and structural characteristics which are advantageous for high-speed flight. Many experimental investigations have been made to determine the aerodynamic characteristics of triangular wings over a large speed range (see references 1, 2, and 3, for example); however, the problem of providing adequate longitudinal control for triangular wings has not been investigated extensively. Trailing-edge flaps generally have good control effectiveness at moderate speeds (references 4 and 5), but the inherently high hinge moments of this type of control and the rapid loss of effectiveness at transonic speeds (references 6 and 7) make its suitability somewhat uncertain at transonic and supersonic speeds.

The results of some free-flight rocket tests (references 7 and 8) have indicated that half-delta-wing tip controls provide reasonable lateral control effectiveness at high subsonic, transonic, and low supersonic speeds. This type of control also permits a wide choice of control hinge location and hence provides opportunity for aerodynamic balance of hinge moments. The feasibility of using such controls to provide longitudinal trim and control through the speed range has not been established.

In order to provide a more complete understanding of the low-speed characteristics of half-delta tip controls, a research program is being conducted in the Langley stability tunnel. As a part of this program, the effects of symmetrical deflection of tip controls on the rolling characteristics of a  $60^\circ$  triangular wing were investigated and are reported in reference 9. The present investigation is concerned with the static longitudinal stability and control-effectiveness characteristics of a  $60^\circ$  triangular wing and fuselage combination having half-delta tip controls, the areas of which were 5, 10, and 15 percent (sum of left and right controls) of the total wing area. In addition, the effects of a fuselage and circular end plates, adjacent to the inboard end of the 10-percent-area tip controls, on the static longitudinal stability and control-effectiveness characteristics of the model were determined.

Theoretical control-effectiveness characteristics for tip controls are lacking; however, the theory for wings and control surfaces of low aspect ratio presented in reference 10 is compared with the experimental results where applicable.

### SYMBOLS

The data presented herein are in the form of standard NACA symbols and coefficients of forces and moments which are referred to the stability system of axes with the origin at the assumed center of gravity which corresponds to the quarter chord of the mean aerodynamic chord. The positive direction of the forces, moments, and angular displacements are shown in figure 1. The coefficients and symbols used herein are defined as follows:

$C_L$	lift coefficient ( $L/qS_W$ )
$C_{L_{max}}$	maximum lift coefficient
$C_D$	drag coefficient ( $D/qS_W$ )
$C_m$	pitching-moment coefficient ( $M/qS_W\bar{c}$ )
$L$	lift, pounds
$D$	drag, pounds
$M$	pitching moment, foot-pounds
$A$	aspect ratio ( $b^2/S_W$ )
$b$	wing span, feet
$c$	local wing chord parallel to plane of symmetry, feet
$\bar{c}$	wing mean aerodynamic chord, feet $\left( \frac{2}{S_W} \int_0^{b/2} c^2 dy \right)$
$S_C$	control area, square feet
$S_W$	wing area (including control area), square feet

- $\bar{x}$  distance rearward from assumed center of gravity to aerodynamic center, feet
- $x_{cp}$  distance from assumed center of gravity to center of pressure of load due to control deflection (negative when center of pressure is rearward of the center of gravity), feet
- $y$  spanwise distance from plane of symmetry, feet
- $\rho$  density of air, slugs per cubic foot
- $V$  free-stream velocity, feet per second
- $q$  dynamic pressure, pounds per square foot ( $\rho V^2/2$ )
- $\alpha$  angle of attack in plane of symmetry, degrees
- $\delta$  symmetrical deflection of left and right controls from wing-chord plane (positive when trailing edge is down), degrees
- $\Lambda$  angle of sweepback of leading edge, degrees

$$C_{L\alpha} = \frac{\partial C_L}{\partial \alpha}$$

$$C_{L\delta} = \frac{\partial C_L}{\partial \delta}$$

$$\frac{C_m}{C_L} = \frac{\partial C_m}{\partial C_L}$$

$$C_{m\delta} = \frac{\partial C_m}{\partial \delta}$$

Subscript:

t trim

#### APPARATUS, MODEL, AND TESTS

The present investigation was conducted in the 6- by 6-foot test section of the Langley stability tunnel with the model mounted on a single-strut support at the quarter-chord point of the mean aerodynamic chord.

The component parts of the model were constructed primarily of laminated mahogany and consisted of a triangular wing with  $60^\circ$  sweepback of the leading edge and a fuselage of circular cross section. The wing had an aspect ratio of 2.31 and NACA 65(06)-006.5 airfoil sections parallel to the plane of symmetry. The wing with tip controls was previously used in the investigation reported in reference 9 and the wing-fuselage combination was used in the investigations of references 11 and 12 (before modifications were made to include tip controls on the wing). Three sizes of tip controls having total areas of 5, 10, and 15 percent (sum of left and right control areas) of the total wing area (fig. 2) were used with the wing-fuselage combination, but only the 10-percent-area tip controls were used on the wing-alone configuration. For some tests, end plates in the form of 10-inch-diameter disks of  $\frac{1}{16}$ -inch brass were attached to the wing adjacent to the inboard end of the 10-percent-area control surfaces. The gap between the control surfaces and end plates was sealed for all tests. Pertinent model details are given in figure 2 and photographs of the model are presented as figure 3.

The tests consisted of measurements of lift, drag, and pitching moment through an angle-of-attack range of  $-4^\circ$  to  $36^\circ$  for control deflections of  $10^\circ$ ,  $0^\circ$ ,  $-10^\circ$ ,  $-20^\circ$ ,  $-30^\circ$ , and  $-40^\circ$  for each model configuration.

All tests were made at a dynamic pressure of 39.7 pounds per square foot. The test Mach number and Reynolds number were 0.17 and  $2.06 \times 10^6$ , respectively.

## CORRECTIONS

Approximate jet-boundary corrections based on unswept-wing concepts were applied to the drag coefficient and angle of attack. The dynamic pressure and drag coefficient were corrected for the effects of blocking by the methods of reference 13. The data have not been corrected for the effects of the support-strut tares which, with the exception of the drag tare, are believed to be small.

## RESULTS AND DISCUSSION

### Presentation of Results

The basic data (variation of  $\alpha$ ,  $C_m$ , and  $C_D$  with  $C_L$  for control deflections of  $10^\circ$  to  $-40^\circ$ ) are presented in figures 4 to 8. The lift- and pitching-moment-effectiveness parameters ( $C_{L\delta}$  and  $C_{m\delta}$ ) through the

lift-coefficient range are presented in figure 9. These parameters were determined from slopes of faired curves measured near  $\delta = 0^\circ$  which, however, were generally linear between  $\delta = 10^\circ$  and  $\delta = -20^\circ$ . The effects of control area on the control effectiveness and control center of pressure measured at zero lift and zero control deflection are presented in figure 10. The effect of control size on the control effectiveness per unit area is shown in figure 11. The effects of varying static margin on the trim lift coefficient available with various control deflections for each of the control sizes investigated are shown in figure 12 and the effects of static margin and control area on the trim-lift-curve slope ( $\alpha = 0^\circ$ ,  $\delta = 0^\circ$ ) are shown in figure 13.

### Preliminary Remarks

Inasmuch as the analysis of the present paper deals mainly with figures 9 to 13, only brief consideration is given to the basic data (figs. 4 to 8).

Since the wing was modified to be equipped with tip controls, the characteristics of the modified model with controls neutral are included to enable a comparison with previous investigations made before the modifications (references 11 and 12).

The present values of  $C_{L\alpha}$  and  $C_m/C_L$  (0.042 and -0.132, respectively) for the wing (fig. 4) are in good agreement with the previously obtained data reported in reference 11 and the lift-curve slope obtained in reference 12. The maximum lift coefficient obtained in the present tests (1.185 with  $\delta = 0$ ) was about 6 percent lower than that obtained in references 11 and 12. Generally, the longitudinal stability of each configuration increased slightly as the trim lift coefficient was increased (figs. 4 to 8).

Since tares have not been applied to the drag-coefficient data, absolute values are not considered representative of free-air conditions. However, incremental values (for example, the drag coefficient due to control deflection) should be reliable.

### Effect of Control Area

An increase in control area caused an increase in the value of  $C_{L\delta}$  and  $C_{m\delta}$  through the lift-coefficient range; the largest values of these parameters generally occurred near zero lift coefficient (fig. 9(a)). The values of  $C_{L\delta}$  and  $C_{m\delta}$  for each of the control sizes investigated

generally decreased with an increase in lift coefficient. However, with the exception of  $C_{L\delta}$  for the 10-percent-area tip controls, two-thirds of the initial effectiveness at  $C_L = 0$  was retained up to about  $C_L = 0.9$  by each of the controls.

The dotted curves of figure 9(a) represent the variation of  $C_{L\delta}$  and  $C_{m\delta}$  with  $C_L$  for a  $60^\circ$  triangular-wing model having constant-chord plain-flap controls which were 16.3 percent of the wing area and were obtained from reference 4. Half-delta tip controls appear to be about half as effective as the constant-chord flaps of approximately the same area in producing lift and pitching moment per degree of control deflection, but both types of controls showed about the same variation in control effectiveness with lift coefficient.

The control-effectiveness parameters (measured at  $C_L = 0$ ) are shown as functions of the area ratio  $S_c/S_w$  in figure 10. Values shown at  $\frac{S_c}{S_w} = 1.0$  represent the condition of the control being identical to the wing. The dashed lines extending between the test values at  $\frac{S_c}{S_w} = 0.15$  and  $\frac{S_c}{S_w} = 1.0$  were merely faired in to indicate probable variations over the entire range of  $S_c/S_w$ . The lift-effectiveness parameter  $C_{L\delta}/C_{L\alpha}$  is compared with theoretical results for tip controls as indicated by the low-aspect-ratio theory of reference 10. For the range of control sizes investigated, the experimental lift effectiveness is only about two-thirds of that indicated by the low-aspect-ratio theory. The constant-chord plain flaps of references 4 and 5 had about twice the lift effectiveness and pitching-moment effectiveness as the tip controls; whereas the constant-chord split flaps of reference 1 had about the same lift effectiveness and pitching-moment effectiveness as the tip controls.

The center of pressure of the load caused by control deflection was calculated from  $C_{m\delta}/C_{L\delta}$  (fig. 10). A rapid forward movement of the center of pressure is indicated as the tip control area is increased. The center of pressure moved forward about 20 percent of the mean aerodynamic chord as the control area was increased from 5 to 15 percent of the wing area. The curve indicates a much slower forward movement of the center of pressure as the control area was increased above 15 percent of the wing area, and this is believed to be largely responsible for the slower rate of decrease of  $C_{m\delta}$  with  $S_c/S_w$  at large values of  $S_c/S_w$  than at small values of  $S_c/S_w$ .

The centers of pressure of the load due to control deflection for the 5-, 10-, and 15-percent-area tip controls were fairly close to the



hinge line. The centers of pressure were about 0.60c, 0.50c, and 0.40c rearward from the assumed center of gravity ( $\bar{c}/4$ ); whereas the hinge lines were 0.58c, 0.51c, and 0.46c rearward from the assumed center of gravity for the 5-, 10-, and 15-percent-area controls, respectively.

The effect of control size on the control effectiveness per unit area is shown in figure 11 by the curves of  $C_{L\delta} \frac{S_W}{S_c}$  and  $C_{m\delta} \frac{S_W}{S_c}$  plotted against  $S_c/S_W$ . On the basis of equal areas, the constant-chord plain flaps of references 4 and 5 had about twice the lift effectiveness and pitching-moment effectiveness as the tip controls; whereas the constant-chord split flaps of reference 1 had about the same lift effectiveness as the tip controls but less pitching-moment effectiveness.

The greatest change in lift with control deflection ( $C_{L\delta}$ ) appears to be at  $\frac{S_c}{S_W} = 0.10$ ; however, the change in pitching moment with control deflection ( $C_{m\delta}$ ) decreases rapidly with an increase in control area, probably as a result of the rapid forward movement of the center of pressure due to the deflection of the controls.

The basic data (figs. 4 to 8) were used to calculate the trim lift coefficients available over the control-deflection range investigated for several static margins for the control sizes investigated (fig. 12). The test static margin was 13.5-percent mean aerodynamic chord, and additional data were calculated from the test data for static margins of 9.0-percent and 5.0-percent mean aerodynamic chord.

The available maximum trim lift coefficient (fig. 12) increased with an increase in control area and a decrease in static margin. For example, for the 15-percent-area tip control the maximum trim lift coefficient increased from 64 to 93 percent of the untrimmed  $C_{L_{max}}$  as the static margin decreased from 0.09c to 0.05c. By comparison, the constant-chord plain flap appeared more effective than the tip control inasmuch as a constant-chord flap of about 15 percent of the wing area was capable of trimming at 73 percent of the untrimmed  $C_{L_{max}}$  at a static margin 0.127c.

The curves of figure 13 indicate a decrease in trim-lift-curve slope with an increase in control area or static margin. For a 0.10c static margin, for example, the trim-lift-curve slope decreases from 83 percent to 74 percent of the untrimmed-lift-curve slope as the control area is increased from 5 percent to 15 percent of the wing area.

For the 15-percent-area tip controls, the trim-lift-curve slope varied from 83 percent to 69 percent of the untrimmed-lift-curve slope as the static margin was increased from 0.05 $\bar{c}$  to 0.135 $\bar{c}$ . The constant-chord flaps of reference 4 produced a slightly higher trim-lift-curve slope than tip controls of approximately the same area.

### Effects of Fuselage

The effects of the fuselage on the variation of  $\alpha$ ,  $C_m$ , and  $C_D$  with  $C_L$  with the controls neutral are similar to those noted in reference 11. (Compare figs. 4 and 6.) The addition of the fuselage to the wing with 10-percent-area tip controls caused a small increase in the value of  $C_{L\delta}$  and  $C_{m\delta}$  at low and moderate lift coefficients. At high lift coefficients (above about  $C_L = 0.7$ ) the addition of the fuselage caused a large decrease in the value of  $C_{L\delta}$  (fig. 9(b)).

### Effect of End Plates

A comparison of figures 6 and 8 indicates that the addition of circular end plates, adjacent to the inboard end of the 10-percent-area tip controls, increased the lift-curve slope and  $C_m/C_L$  at  $C_L = 0$  and  $\delta = 0^\circ$  but decreased the maximum lift coefficient by about 0.10.

The end plates had only a small effect on  $C_{L\delta}$  and  $C_{m\delta}$  at low and moderate lift coefficients but caused a rather large decrease in  $C_{L\delta}$  and  $C_{m\delta}$  at high lift coefficients (above about  $C_L = 0.7$ ).

### CONCLUSIONS

An investigation made to determine the low-speed static longitudinal stability and control characteristics of a  $60^\circ$  triangular-wing model having half-delta tip controls has indicated the following conclusions:

1. The effectiveness of a 15-percent-area half-delta tip control was about half that of a constant-chord flap of approximately the same area, although both types of controls maintained about two-thirds of the effectiveness near zero lift coefficient at high lift coefficients. Tip controls of smaller area had less control effectiveness than the 15-percent-area controls.

2. The lift effectiveness (change in lift with control deflection) per unit control area appeared to be a maximum with the tip controls having 10 percent of the wing area. The pitching-moment effectiveness per unit control area decreased rapidly with an increase in control area, this behavior indicating that, as the control area increased, the center of pressure of the incremental load associated with control deflection moved forward.

3. The maximum trim lift coefficient available with the wing equipped with tip controls increased with an increase in control area or a reduction in static margin. For a 15-percent-area tip control, the maximum trim lift coefficients were about 64 percent and 93 percent of the untrimmed maximum lift coefficient for static margins of 9 percent and 5 percent, respectively, of the mean aerodynamic chord. The trim-lift-curve slope decreased with an increase in control area or static margin. The trim-lift-curve slope of the 15-percent-area tip controls varied from 83 percent to 69 percent of the untrimmed-lift-curve slope as the static margin was changed from 5 percent to 13.5 percent of the mean aerodynamic chord.

4. Addition of the fuselage or circular end plates (adjacent to the inboard end of the tip controls) had insignificant effects on the control effectiveness of the 10-percent-area tip controls at low and moderate lift coefficients but had adverse effects on both the wing characteristics and control effectiveness at high lift coefficients.

Langley Aeronautical Laboratory  
National Advisory Committee for Aeronautics  
Langley Field, Va.

## REFERENCES

1. Anderson, Adrien E.: An Investigation at Low Speed of a Large-Scale Triangular Wing of Aspect Ratio Two. - I. Characteristics of a Wing Having a Double-Wedge Airfoil Section with Maximum Thickness at 20-Percent Chord. NACA RM A7F06, 1947.
2. Jaquet, Byron M., and Brewer, Jack D.: Low-Speed Static-Stability and Rolling Characteristics of Low-Aspect-Ratio Wings of Triangular and Modified Triangular Plan Forms. NACA RM L8L29, 1949.
3. Brown, Clinton E., and Heinke, Harry S., Jr.: Preliminary Wind-Tunnel Tests of Triangular and Rectangular Wings in Steady Roll at Mach Numbers of 1.62 and 1.92. NACA RM L8L30, 1949.
4. Wolhart, Walter D., and Michael, William H., Jr.: Wind-Tunnel Investigation of the Low-Speed Longitudinal and Lateral Control Characteristics of a Triangular-Wing Model of Aspect Ratio 2.31 Having Constant-Chord Control Surfaces. NACA RM L50G17, 1950.
5. Stephenson, Jack D., and Ameudo, Arthur R.: Tests of a Triangular Wing of Aspect Ratio 2 in the Ames 12-Foot Pressure Wind Tunnel. II - The Effectiveness and Hinge Moments of a Constant-Chord Plain Flap. NACA RM A8E03, 1948.
6. Sandahl, Carl A.: Free-Flight Investigation of the Rolling Effectiveness of Several Delta Wing-Aileron Configurations at Transonic and Supersonic Speeds. NACA RM L8D16, 1948.
7. Sandahl, Carl A., and Strass, H. Kurt: Comparative Tests of the Rolling Effectiveness of Constant-Chord, Full-Delta, and Half-Delta Ailerons on Delta Wings at Transonic and Supersonic Speeds. NACA RM L9J26, 1949.
8. Martz, C. William, and Church, James D.: Flight Investigation at Subsonic, Transonic, and Supersonic Velocities of the Hinge-Moment Characteristics, Lateral-Control Effectiveness, and Wing Damping in Roll of a 60° Sweptback Delta Wing with Half-Delta Tip Ailerons. NACA RM L9L14, 1950.
9. Wolhart, Walter D.: Wind-Tunnel Investigation at Low Speed of the Effects of Symmetrical Deflection of Half-Delta Tip Controls on the Damping in Roll and Yawing Moment Due to Rolling of a Triangular-Wing Model. NACA RM L51B09, 1951.

10. DeYoung, John: Spanwise Loading for Wings and Control Surfaces of Low Aspect Ratio. NACA TN 2011, 1950.
11. Jaquet, Byron M., and Brewer, Jack D.: Effects of Various Outboard and Central Fins on Low-Speed Static-Stability and Rolling Characteristics of a Triangular-Wing Model. NACA RM L9E18, 1949.
12. Goodman, Alex: Effect of Various Outboard and Central Fins on Low-Speed Yawing Stability Derivatives of a 60° Delta-Wing Model. NACA RM L50E12a, 1950.
13. Herriot, John G.: Blockage Corrections for Three-Dimensional-Flow Closed-Throat Wind Tunnels, with Consideration of the Effect of Compressibility. NACA Rep. 995, 1950.

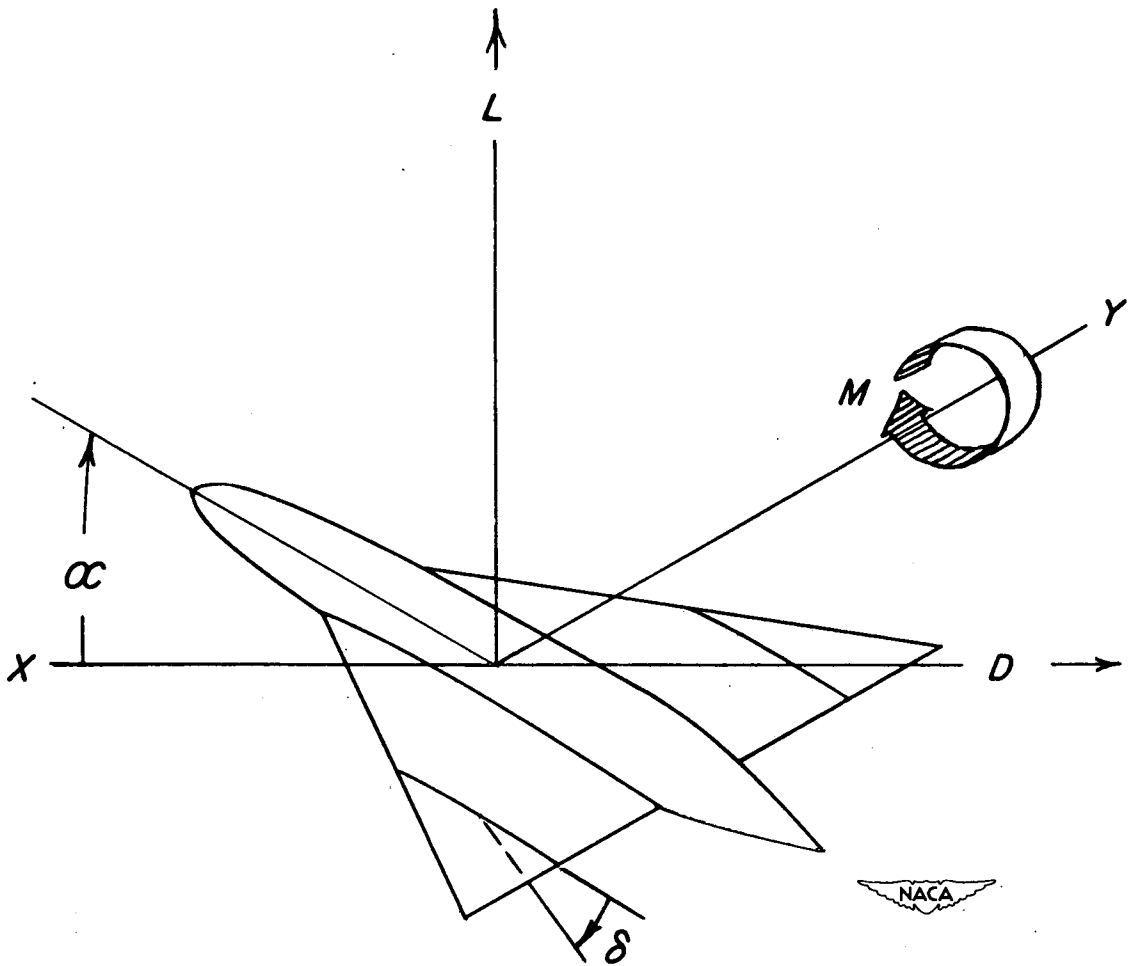

Figure 1.- Stability system of axes. Arrows indicate positive direction of forces, moments, and angular displacements.

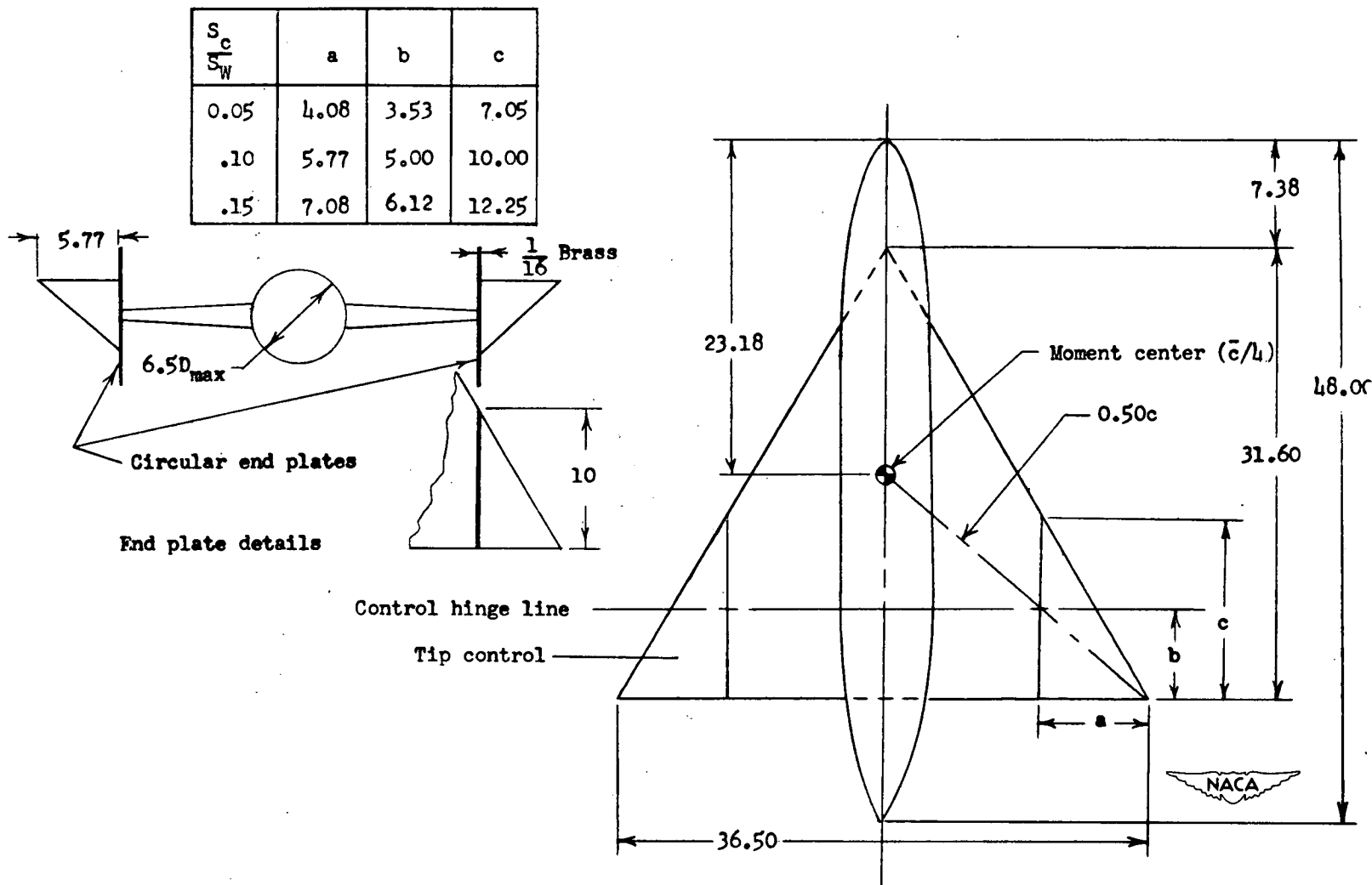
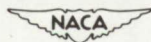
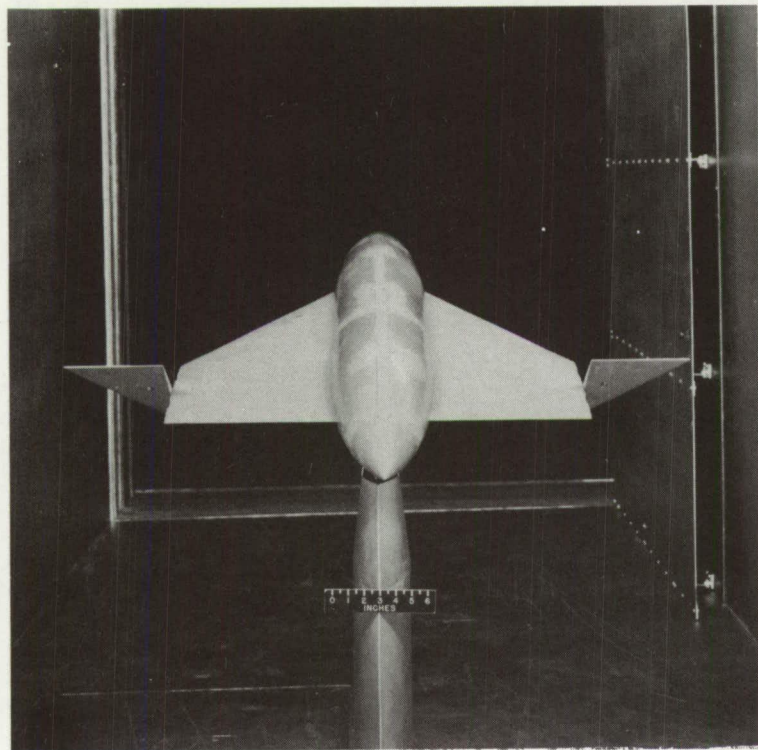
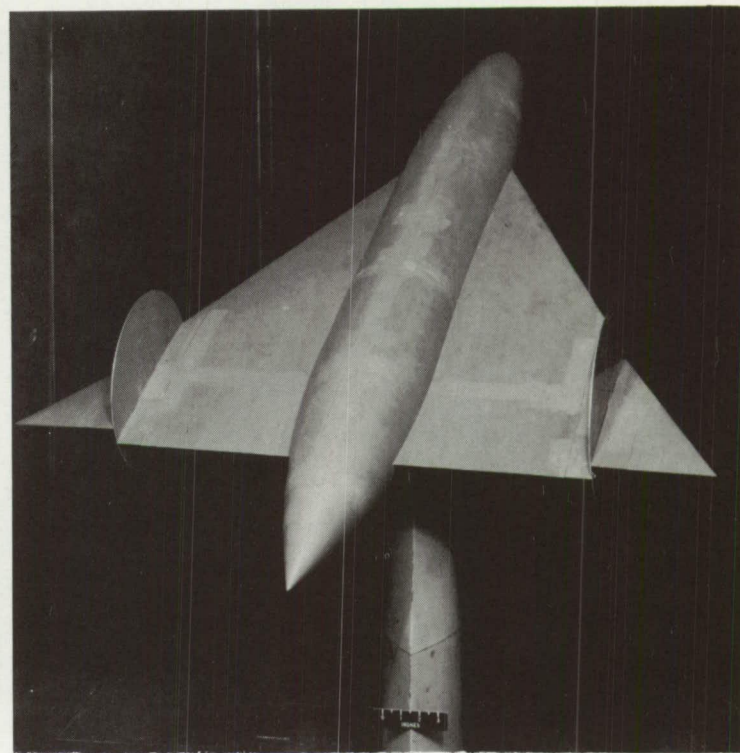

Figure 2.- Sketch of the model used in the investigation. (All dimensions are in inches.)



L-68796



L-67430

Figure 3.- Photographs of the wing-fuselage combination with the 10-percent-area half-delta tip controls alone and in combination with end plates as mounted in the Langley stability tunnel.



**Page intentionally left blank**

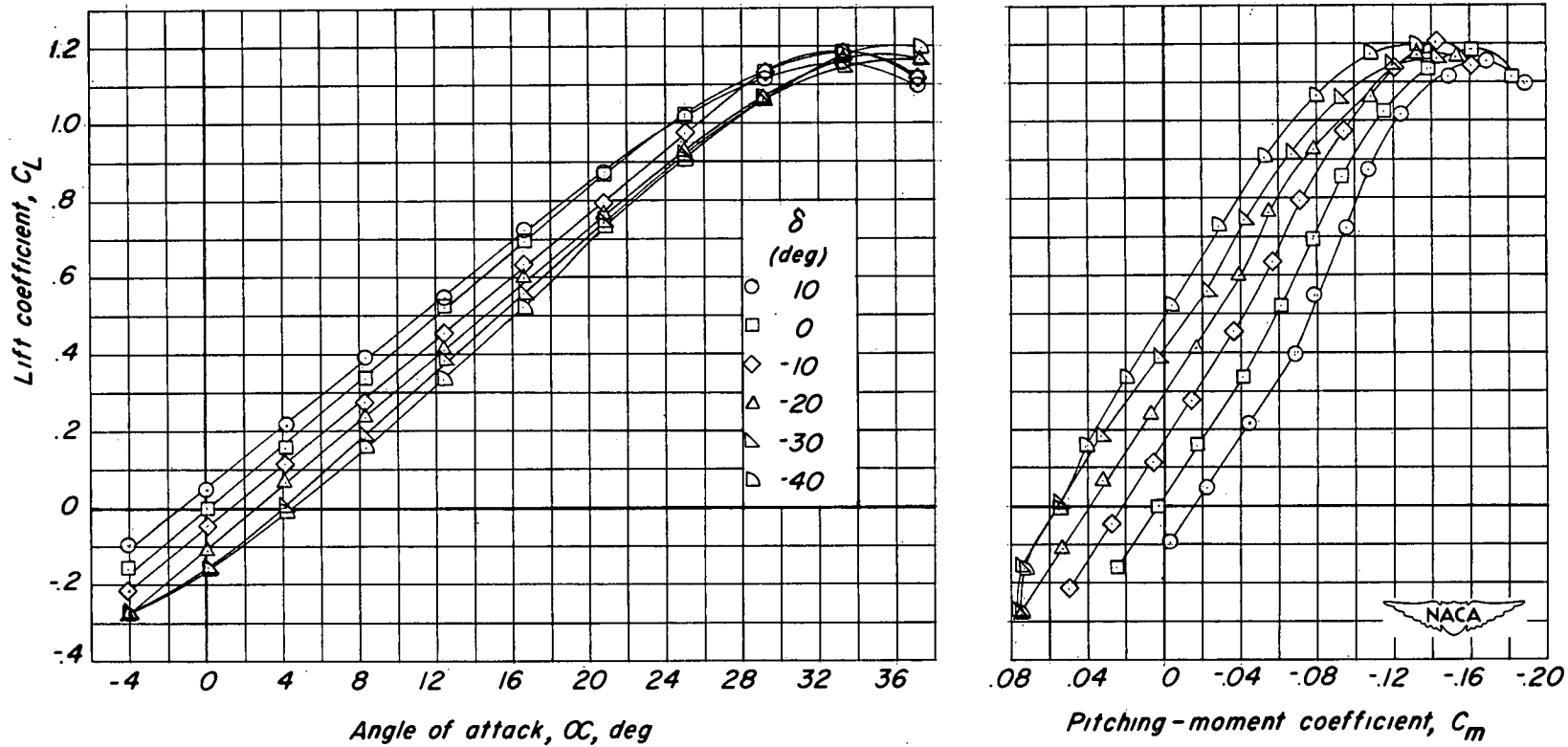

Figure 4.- Longitudinal stability and control characteristics of a  $60^\circ$  triangular wing with 10-percent-area half-delta tip controls.

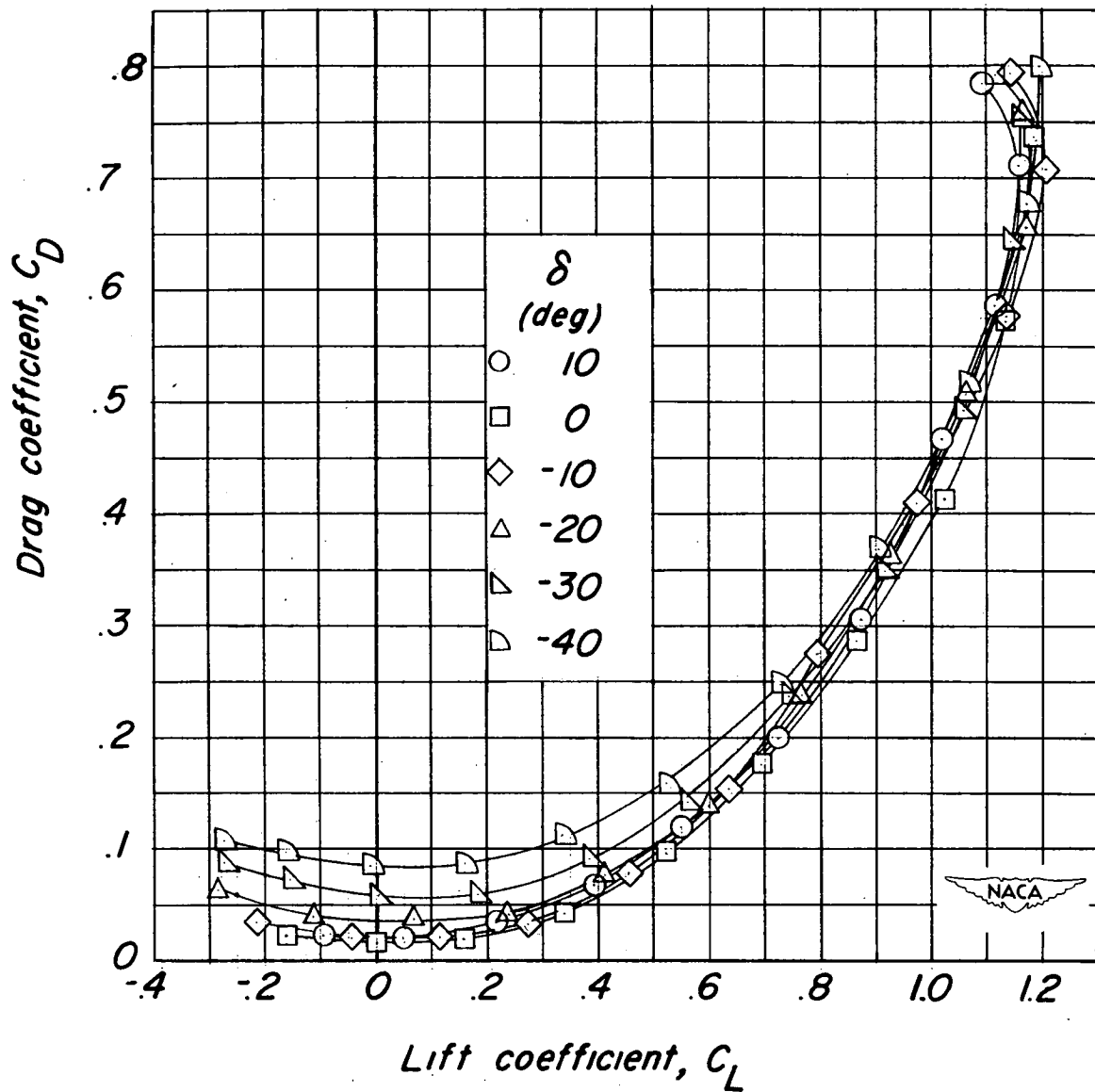

Figure 4.- Concluded.

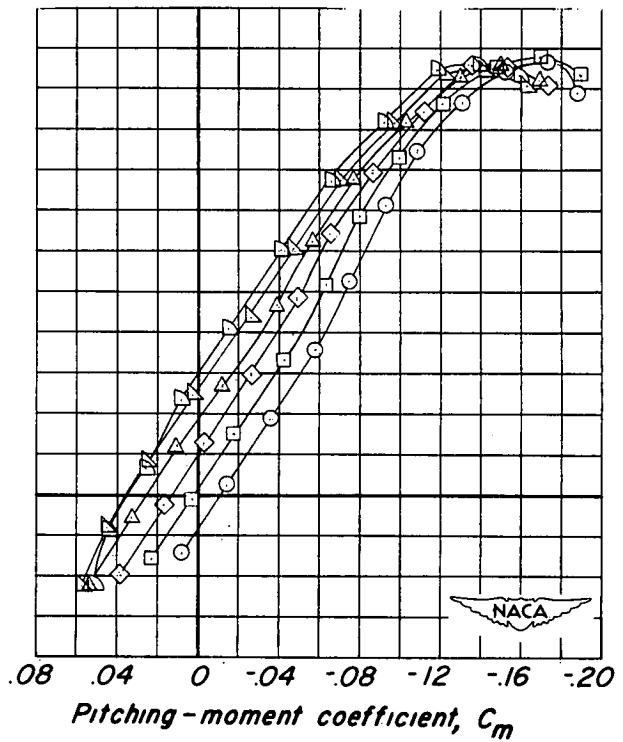
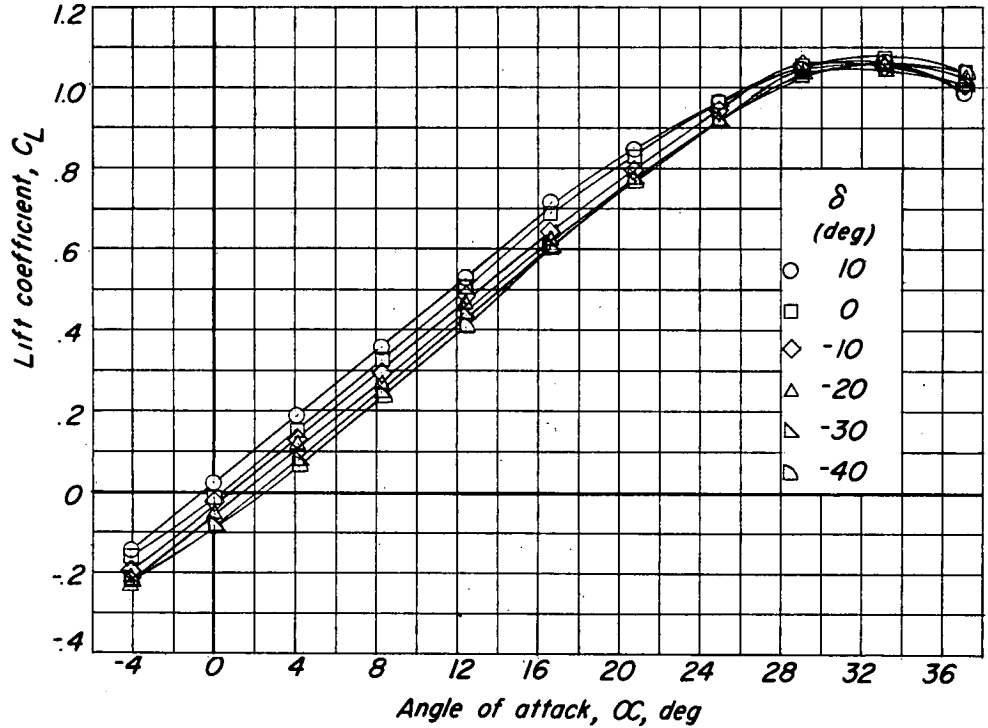

Figure 5.- Longitudinal stability and control characteristics of a 60° triangular wing and fuselage combination with 5-percent-area half-delta tip controls.

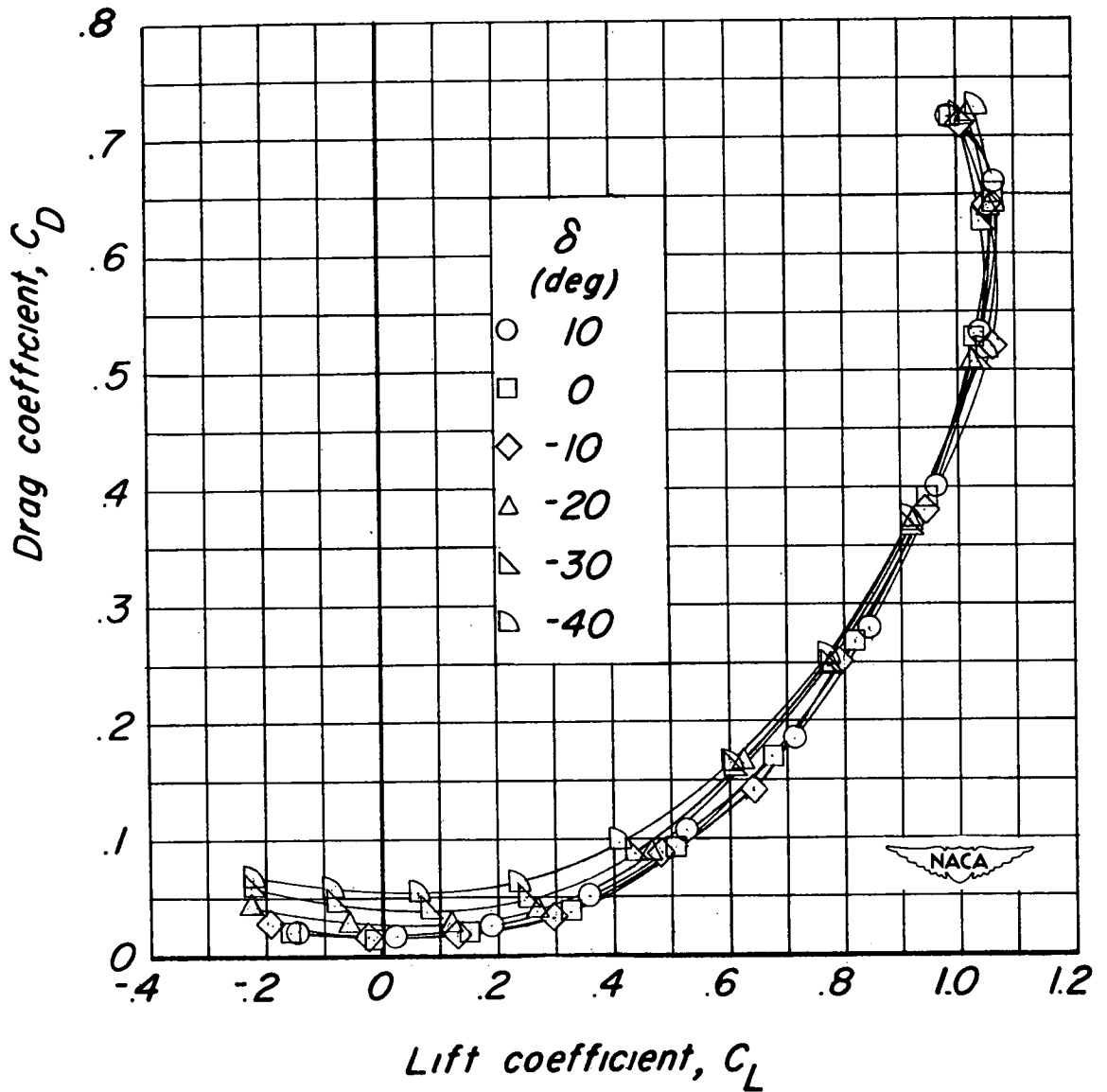

Figure 5.- Concluded.

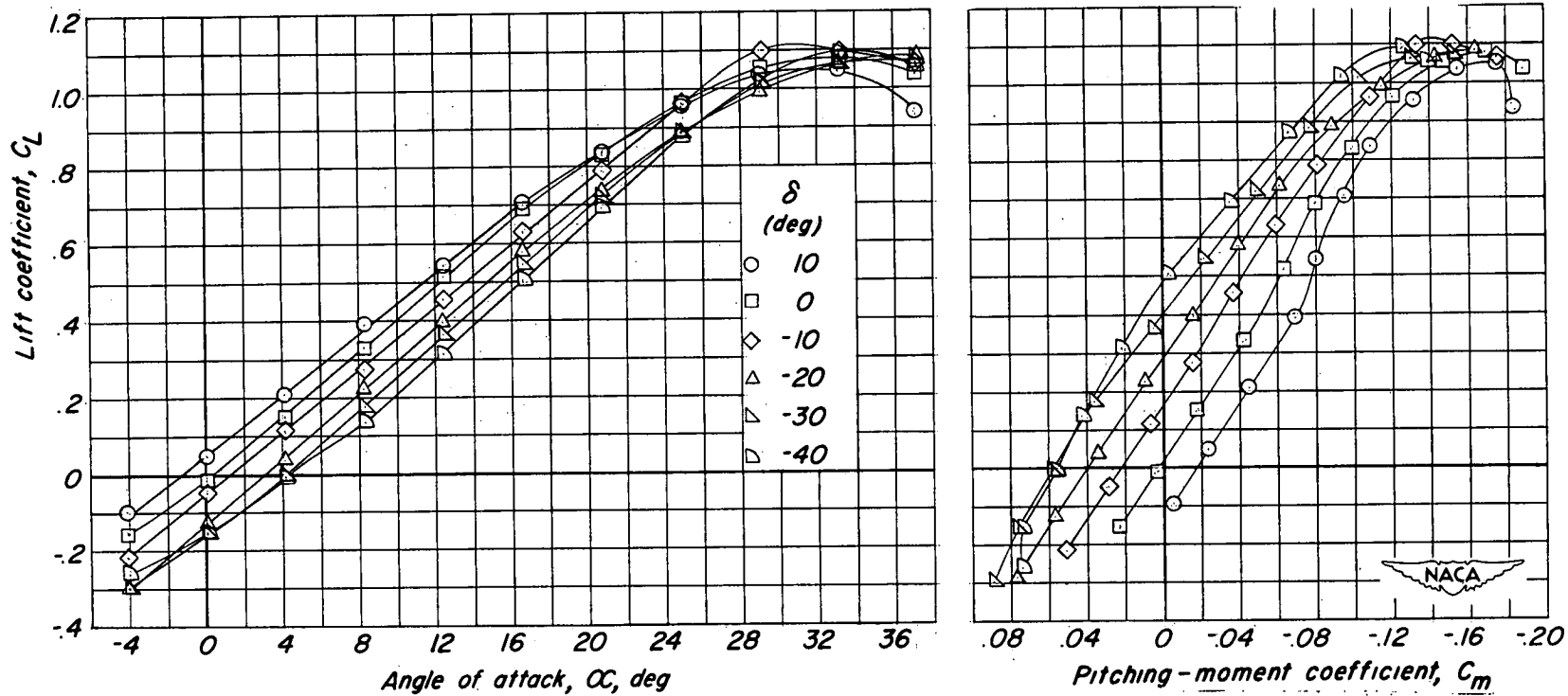

Figure 6.- Longitudinal stability and control characteristics of a 60° triangular wing and fuselage combination with 10-percent-area half-delta tip controls.

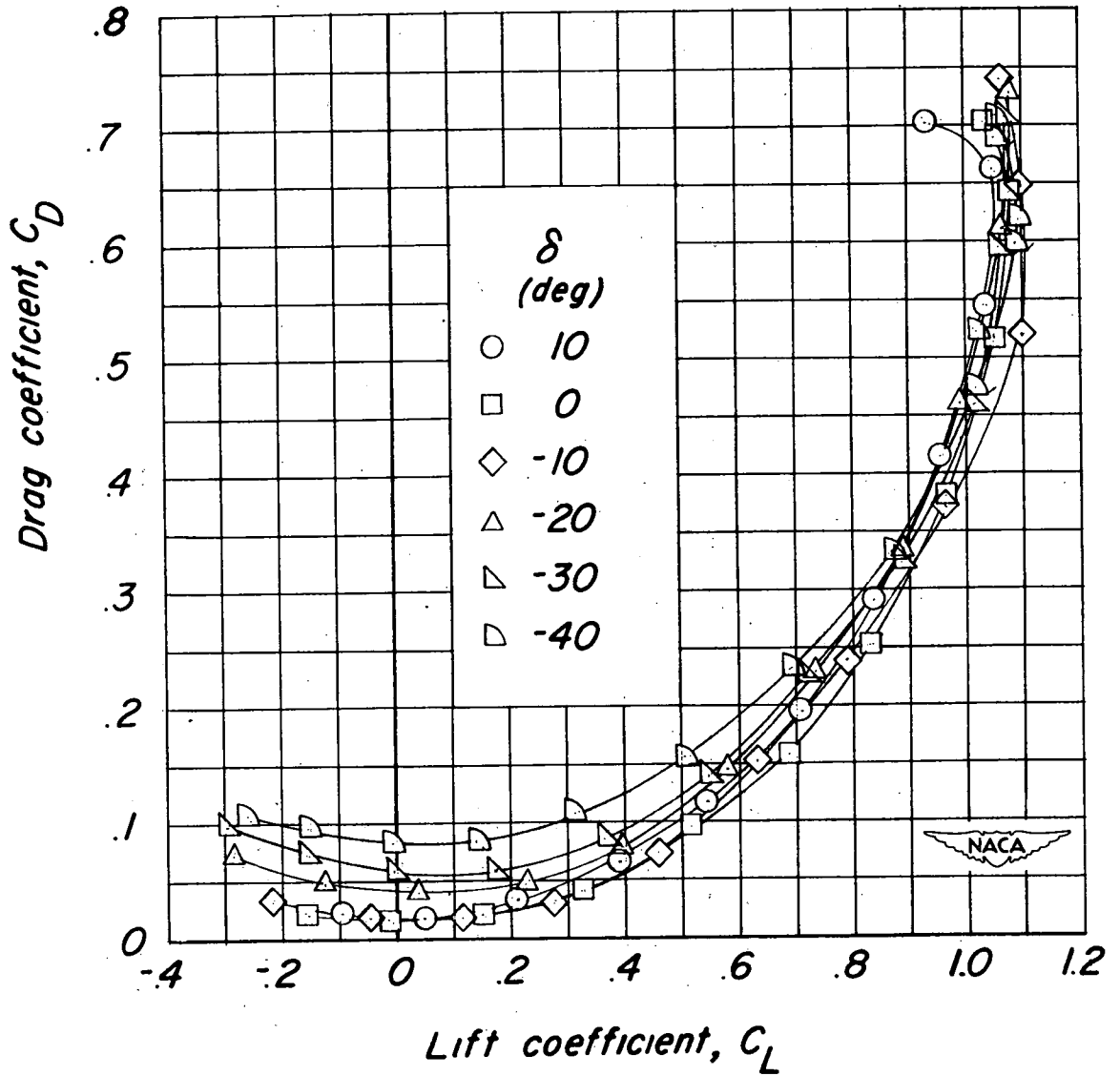

Figure 6.- Concluded.

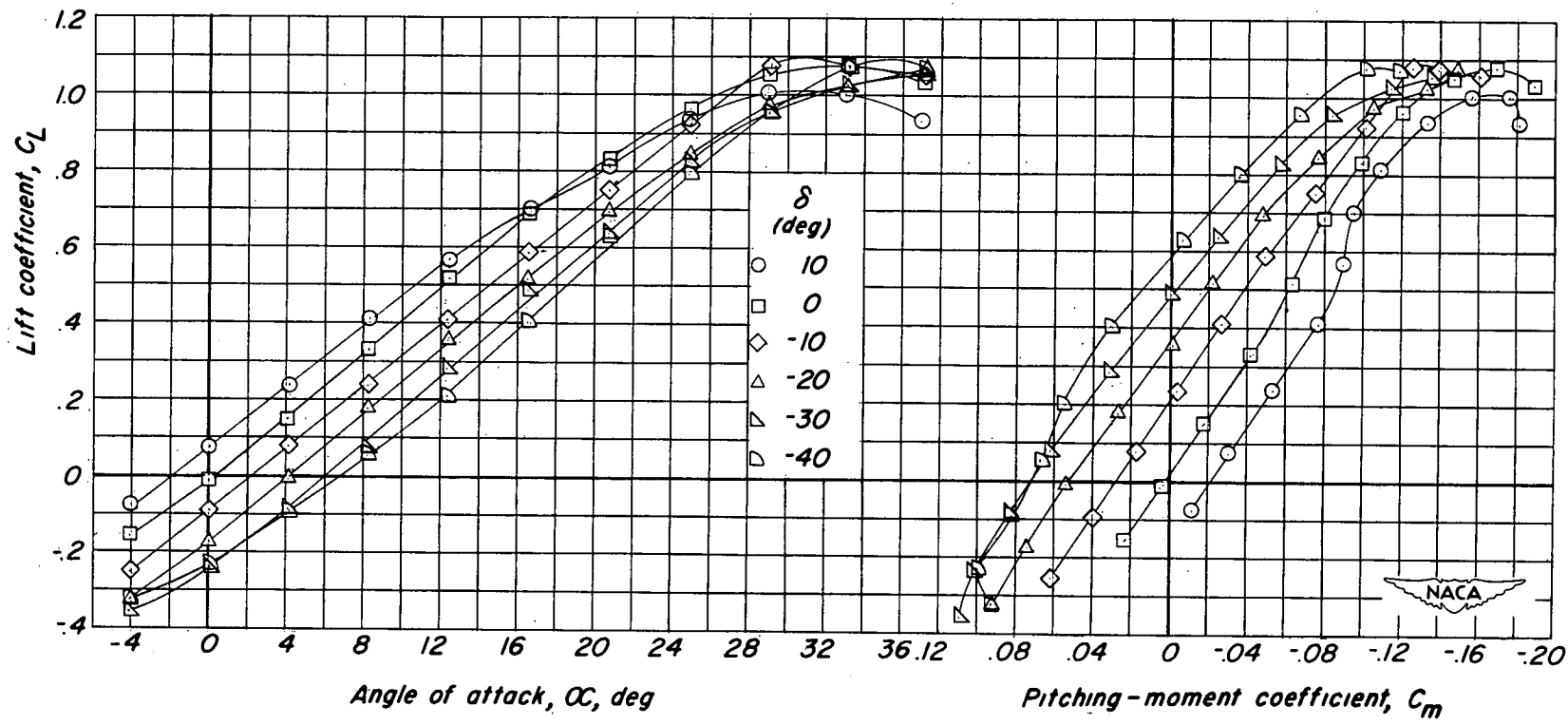

Figure 7.- Longitudinal stability and control characteristics of a 60° triangular wing and fuselage combination with 15-percent-area half-delta tip controls.



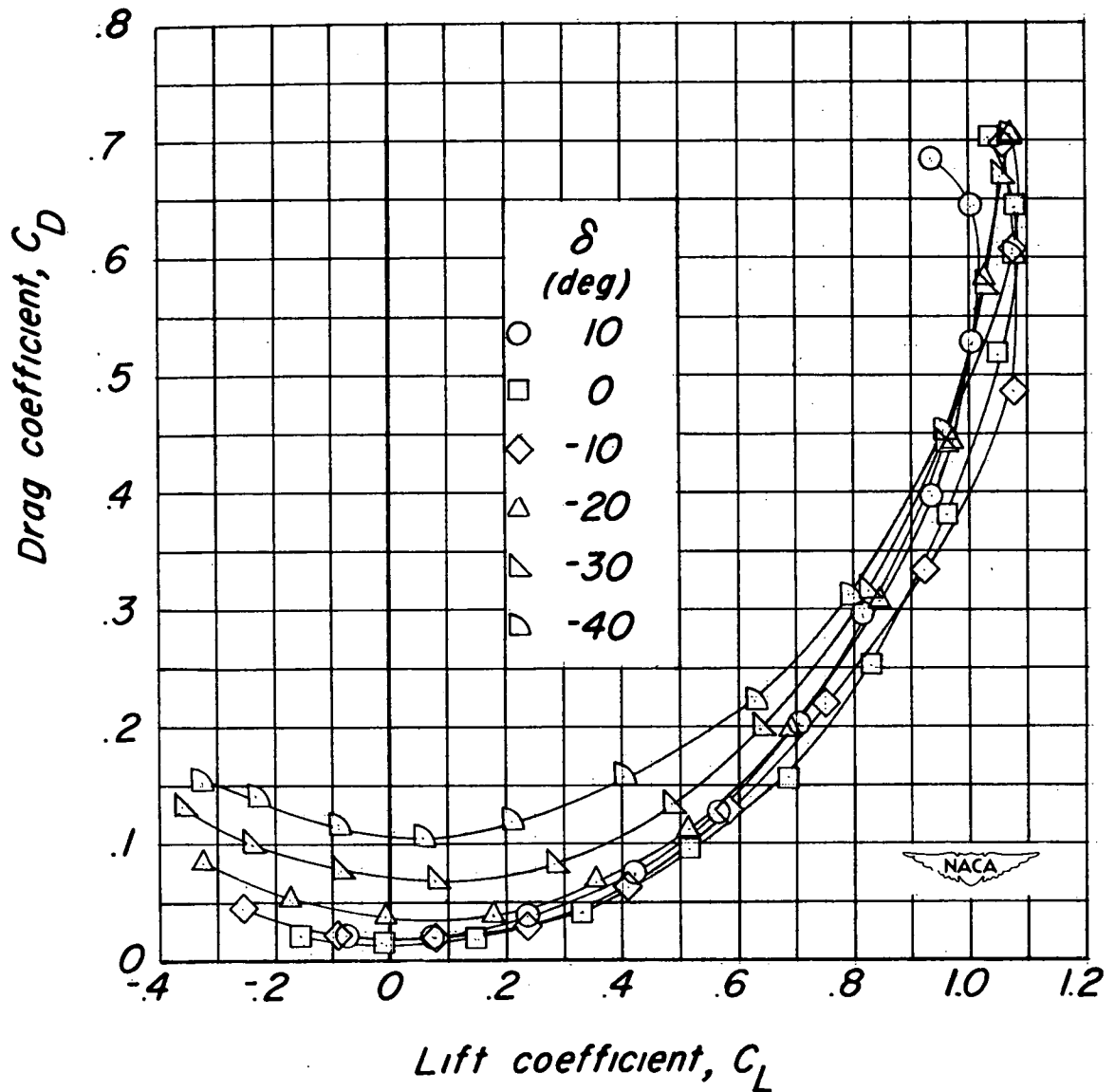

Figure 7.- Concluded.

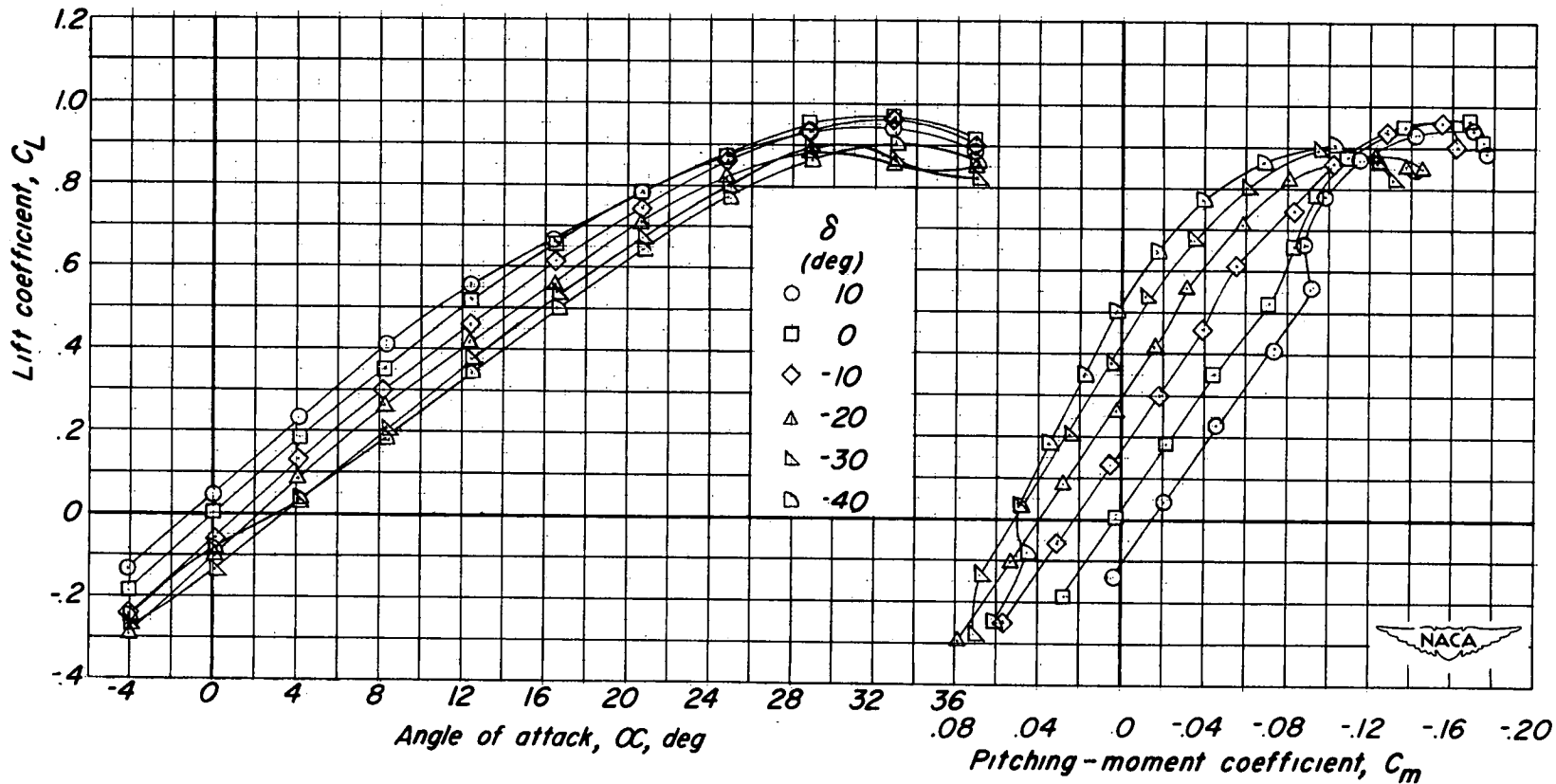

Figure 8.- Longitudinal stability and control characteristics of a 60° triangular wing and fuselage combination with 10-percent-area half-delta tip controls and end plates.

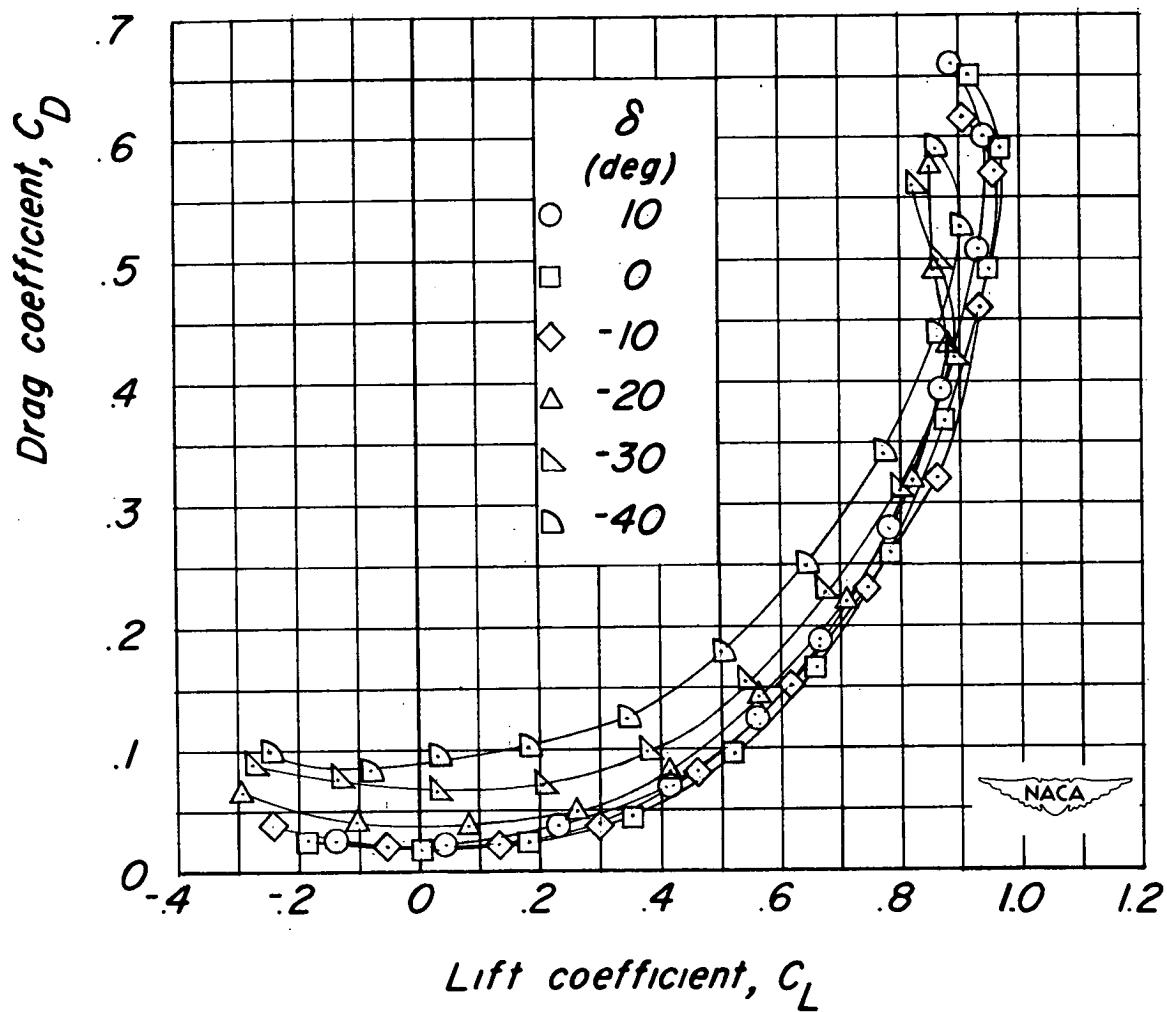
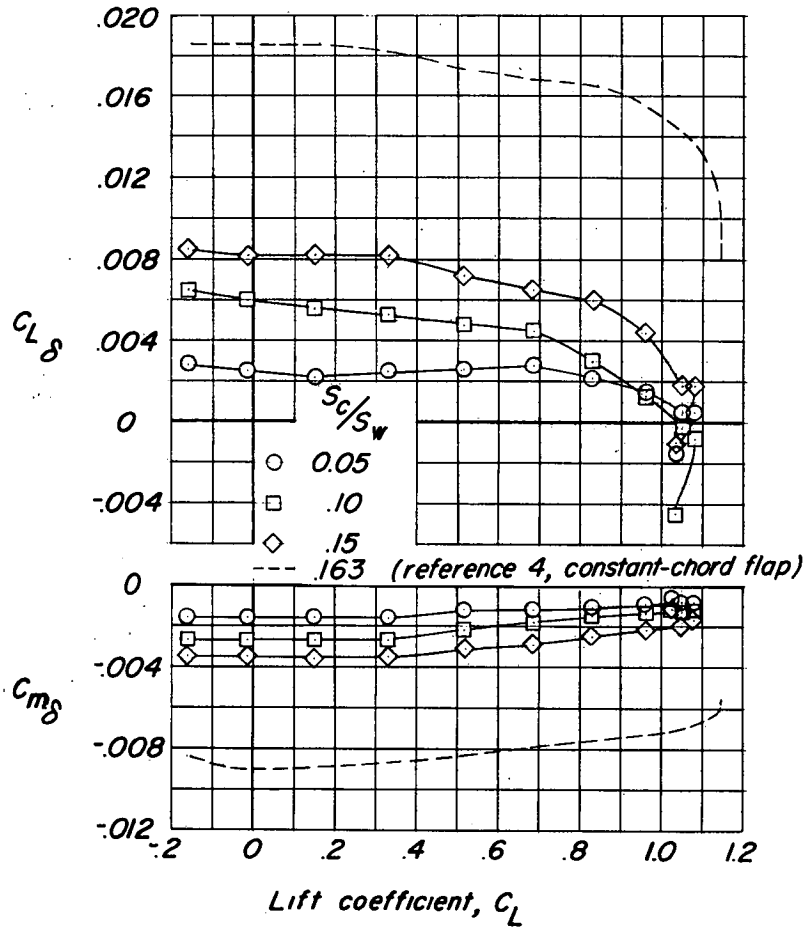
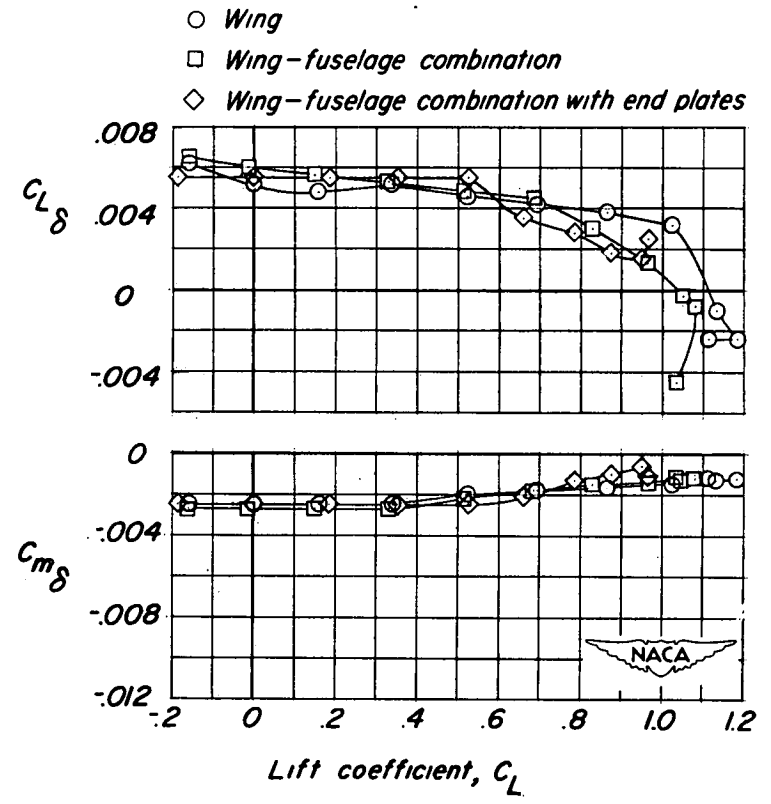

Figure 8.- Concluded.



(a) Effect of control area and comparison with constant-chord flap controls. Wing-fuselage combination.



(b) Effect of fuselage and end plates

$$\frac{S_c}{S_w} = 0.10.$$

Figure 9.- Variation of  $C_{L\delta}$  and  $C_{m\delta}$  with  $C_L$ .

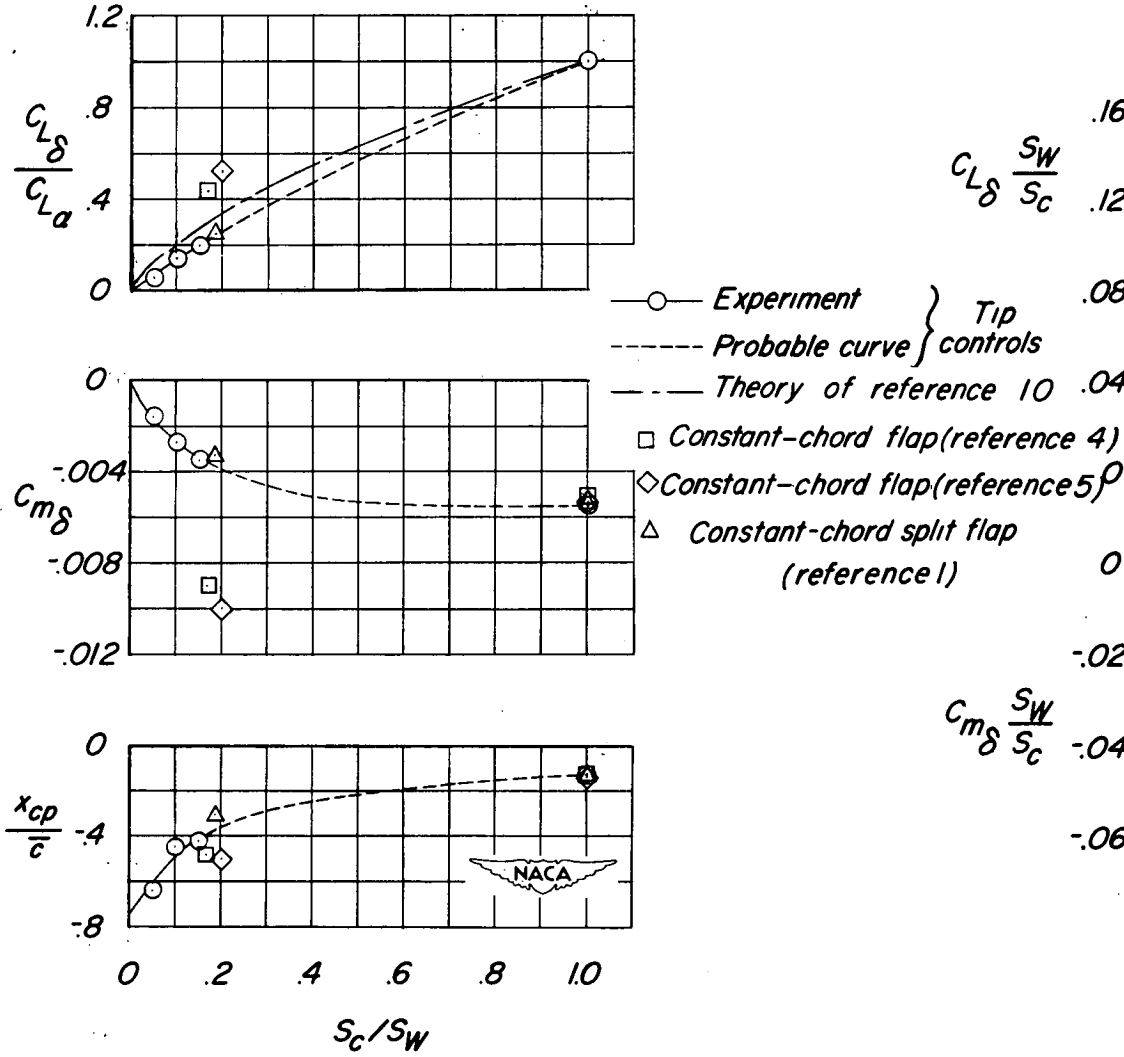

Figure 10.- Effect of control area on control-effectiveness and center-of-pressure characteristics. Wing-fuselage combination;  $\alpha = 0^\circ$ ;  $\delta = 0^\circ$ .

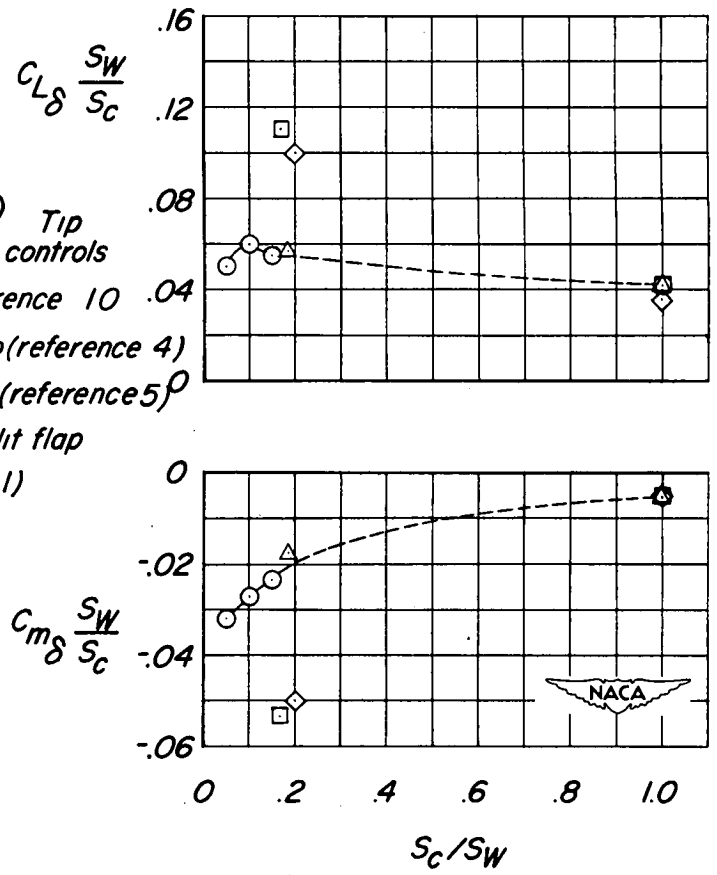

Figure 11.- Effect of control area on control-effectiveness per unit area of control. Wing-fuselage combination;  $\alpha = 0^\circ$ ;  $\delta = 0^\circ$ .

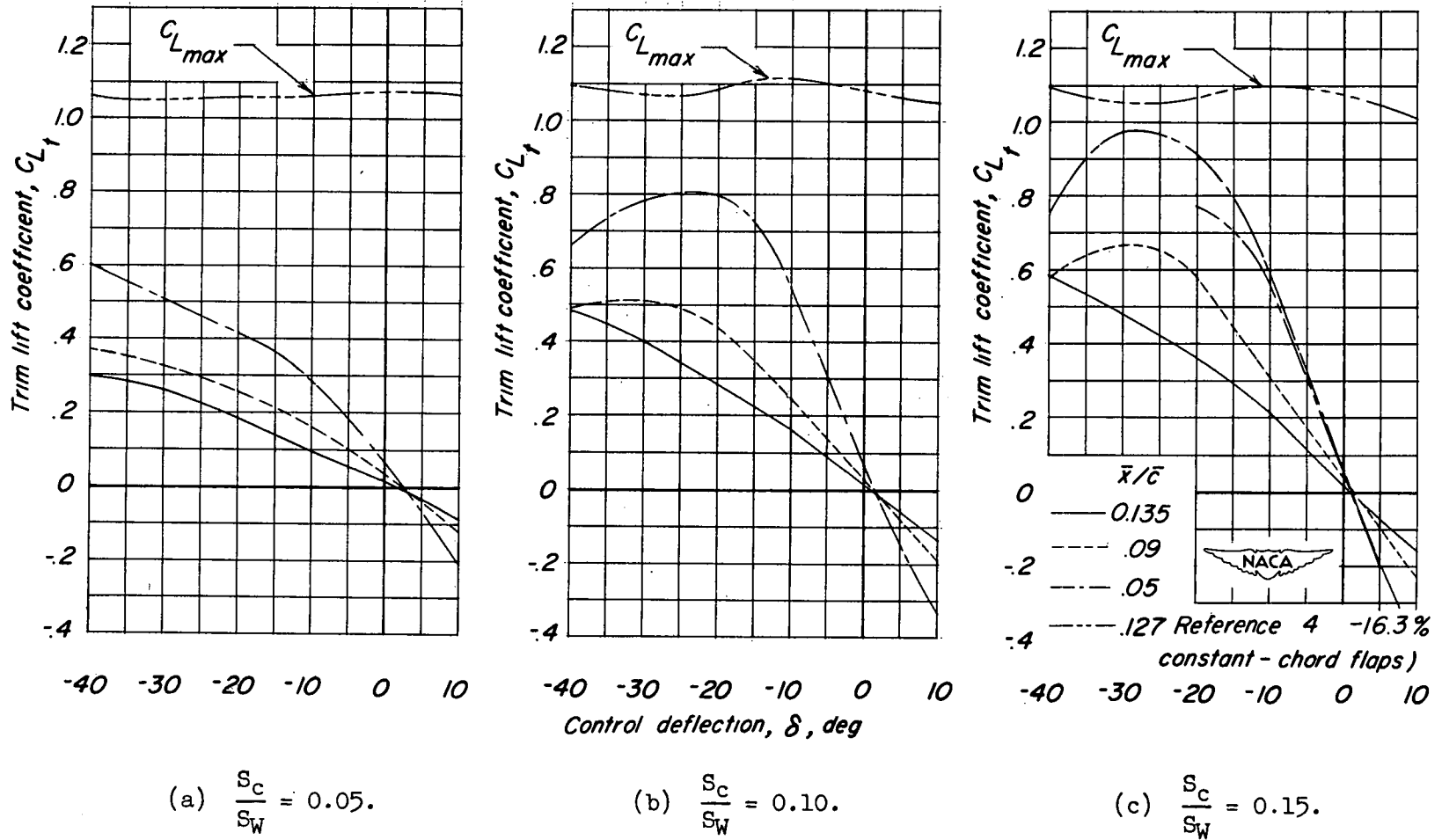

Figure 12.- Effect of static margin on variation of trim lift coefficient with control deflection for the three half-delta tip-control configurations. Wing-fuselage combination.

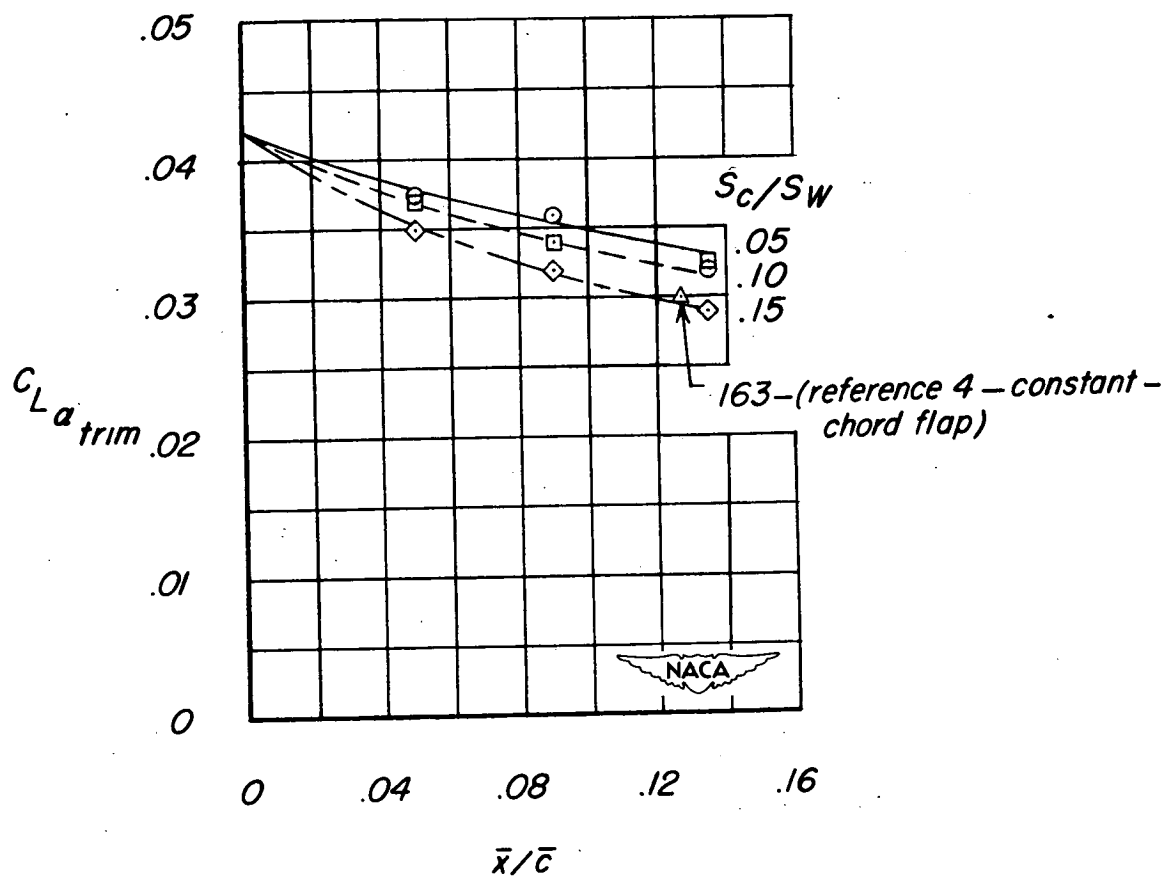

Figure 13.- Effect of control area and static margin on trim-lift-curve slope. Wing-fuselage combination;  $\alpha = 0^\circ$ ;  $\delta = 0^\circ$ .