

RM E53B18

CONFIDENTIAL

290

Copy
RM E53B18

NACA RM E53B18

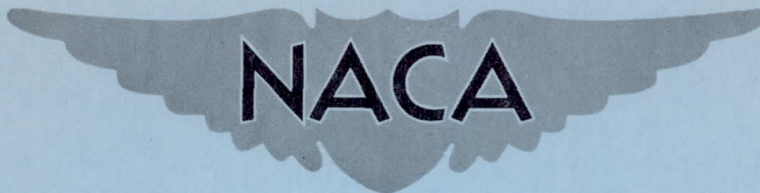

RESEARCH MEMORANDUM

PRELIMINARY INVESTIGATION OF THE COMBUSTION
OF PENTABORANE AND DIBORANE IN A TURBOJET
COMBUSTOR AT SIMULATED ALTITUDE
CONDITIONS

By J. B. Gibbs, W. B. Kaufman, and J. R. Branstetter

Lewis Flight Propulsion Laboratory
Cleveland, Ohio

TECHNICAL LIBRARY
AIRESEARCH MANUFACTURING CO.
9851-9951 SEPULVEDA BLVD.
LOS ANGELES 45, CALIF.
CALIFORNIA

CLASSIFIED DOCUMENT

This material contains information affecting the National Defense of the United States within the meaning of the espionage laws, Title 18, U.S.C., Secs. 793 and 794, the transmission or revelation of which in any manner to an unauthorized person is prohibited by law.

NATIONAL ADVISORY COMMITTEE
FOR AERONAUTICS

WASHINGTON

February 27, 1957

UNCLASSIFIED
CONFIDENTIAL

CANCELLED

Classification

CHANGED TO *Unclass.*

By authority of *NASA TRA #45 (5-11-61) eff. 4/12/61*

Changed by *ARX* Date *JUN 14 1961*

NATIONAL ADVISORY COMMITTEE FOR AERONAUTICS

RESEARCH MEMORANDUM

PRELIMINARY INVESTIGATION OF THE COMBUSTION OF PENTABORANE
 AND DIBORANE IN A TURBOJET COMBUSTOR AT SIMULATED
 ALTITUDE CONDITIONS

By J. B. Gibbs, W. B. Kaufman, and J. R. Branstetter

SUMMARY

A preliminary investigation was conducted to determine the combustion characteristics of pentaborane and diborane in a turbojet combustor. The investigation with pentaborane included the following four test conditions:

Test condition	Combustor - inlet total pressure, in. Hg abs	Combustor temperature rise, °F	Simulated flight conditions ^a	
			Altitude, ft	Percent of rated rpm
A	34	680	40,000	85
B	34	1182	44,000	100
C	15	680	57,000	85
D	15	1182	61,000	100

^aSimulating a flight Mach number of 0.6 in a typical turbojet having a 5.2 compressor pressure ratio at sea level and rated rpm.

When pentaborane was burned in the combustor configuration previously developed for diborane, severe oxide deposits formed on the fuel nozzle. An experimental combustor was developed which gave satisfactory performance with pentaborane at three of the four test conditions investigated and for short test durations. Two promising techniques were demonstrated for alleviating oxide deposition on turbine blades and other metal surfaces; namely, heating the surfaces, and filming the surfaces with air.

INTRODUCTION

Special fuels are being investigated at the NACA Lewis laboratory in an effort to extend the range, thrust, and operational limits of jet-propelled aircraft. Currently, emphasis is being placed upon the application of these special fuels to extend the range of turbojet-powered aircraft. Fuels of interest include pentaborane and diborane, which possess desirable heating values and chemical reactivity. However, the combustion products of these fuels contain boron oxides, which exist in the solid and liquid states at current turbojet-engine exhaust temperatures. Because of the anticipated deposit problem, diborane and pentaborane have previously been considered for use in engines where there are no rotating parts immersed in the combustor exhaust.

The flight range with refrigerated, liquid diborane has been estimated to be 30 to 50 percent greater than the range attainable with aviation gasoline for a long-range, 50,000-pound ram-jet-powered missile (ref. 1). Reference 1 also reports spatial flame speeds for diborane-air mixtures as high as 169.5 feet per second, which is roughly 50 times the flame speed of paraffinic hydrocarbons. Therefore, diborane would be expected to burn efficiently under conditions where ordinary hydrocarbon fuels are inadequate.

Pentaborane, like diborane, possesses high heats of combustion (ref. 2). Since pentaborane is a liquid at sea-level pressure and normal temperatures, flight type fuel-system weight penalties and handling problems should not be as severe as those expected for diborane; hence, even greater flight ranges should be possible. A few percent of pentaborane in ethane increased the flame speed approximately 16-fold over that of ethane alone (ref. 3). Therefore, on the basis of flame speeds, wide engine operational limits are anticipated as in the case of diborane.

An experimental investigation of the combustion characteristics of diborane and pentaborane in a turbojet combustor was initiated at the request of the Bureau of Aeronautics, Department of the Navy, as part of Project Zip. The preliminary results of an evaluation of diborane are reported in reference 4 and are summarized as follows: Diborane was tested at a combustor-inlet pressure of 1 atmosphere in a single tubular combustor mounted in a direct-connect duct. An experimental combustor was developed which gave satisfactory performance at the limited test conditions and short durations investigated. Three promising techniques were demonstrated for alleviating oxide deposits on turbine blades and other metal surfaces; namely, extreme cooling, heating, and filming the surfaces with air.

The results reported herein were obtained during January and February of 1953 as a continuation of the research reported in reference 4.

During the investigation of pentaborane, six fuel-injector modifications and an additional modification to the combustor were tested to reduce combustor deposits. Engine conditions were simulated for a range of altitudes from 40,000 to 61,000 feet, engine speeds of 85 and 100 percent rated engine rpm, and a flight Mach number of 0.6. In addition, a brief investigation of diborane was conducted at a higher altitude than presented in reference 4. The engine condition corresponded to an altitude of 57,000 feet, an engine speed of 85 percent rated engine rpm, and a flight Mach number of 0.6. Data for both fuels are presented on combustion efficiencies, outlet temperature profiles, pressure losses, and oxide deposits. Deposition studies at the combustor-exit station were made using the three techniques and the apparatus of reference 4.

2873

FUELS

Source. - The fuels used in this investigation were obtained through the cooperation of the Bureau of Aeronautics, Department of the Navy. The purity of the fuels was approximately 95 percent for diborane and 99 percent for pentaborane.

Properties. - Values for several of the physical properties of the pure fuels are as follows:

	Diborane	Pentaborane
Formula weight	27.7	63.17
Melting point, °F	-265	-52
Boiling point, °F at 760 mm Hg	-134.5	136
Heat of combustion, Btu/lb	33,513	^a 30,717
Heat of combustion, Btu/cu ft	^b 935,220	^c 1,169,000
Stoichiometric fuel-air ratio	0.0669	0.07635

^aValue used herein. Most recent value is 29,100.

^bSpecific gravity of liquid diborane taken as 0.4470, the specific gravity at sea-level boiling temperature.

^cSpecific gravity of liquid pentaborane taken as 0.61 at 0° C.

The melting points of the two forms of boron oxide, B₂O₃, are as follows:

Crystalline, °F 842
 Vitreous, °F 1070

FUEL SYSTEM AND OPERATING PROCEDURE

The refrigerated fuel system is shown in figure 1. Methyl cello-solve was used as the coolant and was cooled in chamber A to -96° F for the diborane runs and -10° F for the early pentaborane runs. Dry ice

was used to cool the methyl cellosolve. The coolant was circulated through chamber B and the jacketed fuel line and nozzle housing if used. In later runs with pentaborane the coolant to chamber B was shut off and the fuel tank was maintained at room temperature. The fuel-line coolant temperatures of about -90° F for diborane and -10° F for pentaborane were maintained to prevent vapor lock and thermal decomposition of the fuel. No attempt was made to determine a fuel-system temperature limit, and probably the maintained temperatures were excessively low.

The refrigeration system was started several hours before test time. When the temperature in chamber B was correct, one of the shipping tanks was transferred from the storage depot to chamber B. Diborane was stored at dry-ice temperatures and pentaborane at approximately 50° F. The fuel tank was suspended in the coolant by a cantilever arm connected to a strain gage. Each tank was fitted with a siphon extending to the bottom of the cylinder and a gas inlet located at the top of the cylinder. Fuel was forced from the tank by helium pressure which was controlled by a remotely operated regulator. The helium pressure was preset and the fuel flow was started and stopped by a remotely controlled, pressure-operated piston valve. The fuel-flow rate was governed by the applied helium pressure and by the size of the injection nozzle. A sleeve, extending from the coolant level to the bottom of chamber B, protected the fuel tank and strain gage from the flow forces of the circulating coolant. Coolant-bath density changes were insignificant during any run. Fuel lines were purged with helium before and after each run.

Figure 2 shows the details of the injection systems tested. Two types of injectors were used, a swirl-type nozzle (I) and variations of a simple discharge orifice (II, III, IV, V, VI).

APPARATUS

Combustor installation. - A diagram of the combustor installation is presented in figure 3. Combustion air from the central laboratory supply was regulated by a remote-control valve. The combustor-inlet temperature was regulated by a heat exchanger. The exhaust products from the test combustor were discharged into an exhaust plenum where they were cooled by water sprays and discharged through an exhaust header. The header was valved to provide either atmospheric or altitude exhaust. The lowest exhaust plenum operating pressure attainable with the altitude exhaust system was 0.45 atmosphere absolute.

Combustors. - Two combustors were tested. The initial configuration, model 6, was developed in the preliminary investigation (ref. 4) and is shown in figure 4(a). Model 6 fits the housing of a standard single tubular combustor from a J33-A-23 turbojet engine. The model 7 combustor is shown in figure 4(b). The dome was fabricated of porous

2873

screen which was silver-soldered to the liner. The screen material was untreated, 28X500-mesh stainless-steel wire cloth. The airflow passing through the screen was estimated to be one-fourth of the total airflow. The standard fuel-injector support strut was cut off at the wall of the adapter piece leading to the combustor housing. The model 7 combustor was used with fuel injectors V and VI (figs. 2(e) and (f)). The fuel tube was supported at the adapter wall. A standard sparkplug was installed through one of the flame-propagation ports in the combustor so that the spark was located 1/4 inch inside the liner wall.

Apparatus for oxide-deposit studies. - The deposition study apparatus consisted of a bank of 1/2-inch-diameter tubes extending across the combustor exhaust duct. Each of the tubes was designed differently to evaluate techniques for reducing turbine blade deposits. One tube was sealed on both ends so that its surface temperature would approach the temperature of the gas stream. The second tube was water-cooled. The third tube was heated above the gas-stream temperature by passing current from an electric-arc welder through the tube. The fourth tube was formed from porous wire cloth through which 80° F air was passed to provide a cool-air film surrounding the tube.

Instrumentation. - Airflow was metered by an ASME orifice. The pressure upstream of the orifice, the fuel-tank pressure, and the exit plenum pressure were indicated by calibrated gages. The orifice pressure differential and the total-pressure drop across the combustor $P_A - P_C$ were indicated by water-filled manometers. The combustor-inlet and -exit total pressures and the total-pressure drop across the combustor and exit ducting $P_A - P_E$ were indicated by mercury-filled manometers. The combustor-inlet total and the exit plenum pressures also were recorded continuously by means of pressure pickups and a four-channel oscillograph. The combustor-exit total-pressure tube was kept free of solid deposits by bleeding air through the tube when data were not being recorded.

The fuel weight was recorded continuously by means of a strain gage and an oscillograph. The fuel-weighting system was calibrated immediately before each run. The fuel-flow rate was computed from the slope of the fuel weight-time curve. An independent check of the flow rate was provided by weighing the fuel tank on a beam-balance scale before and after each run. The loss of fuel during the purging process was deducted from the scale difference weights. This loss was computed from the fuel-line volume.

Figure 5 shows the general construction and the location of the 16 thermocouples at the combustor outlet. Single thermocouples were used to indicate combustor-inlet air temperature, fuel temperature near

the injection nozzle, fuel coolant temperature, and the temperature of tubes used to simulate the turbine blades. The more important temperatures were recorded at regular intervals during each test by self-balancing strip-chart potentiometers. Additional temperatures were manually recorded from the readings of indicating, self-balancing potentiometers.

PROCEDURE

Test conditions. - Four test conditions were investigated, as follows:

Test condition	Combustor-inlet total pressure, in. Hg abs	Combustor-inlet temperature, °F	Airflow ^a , lb/(sec)(sq ft)	Combustor temperature rise, °F	Simulated flight conditions ^b	
					Altitude, ft	Percent of rated rpm
A	34	268	6.32	680	40,000	85
B	34	368	5.35	1182	44,000	100
C	15	268	2.83	680	57,000	85
D	15	368	2.38	1182	61,000	100

^aAirflow per unit of maximum cross-sectional area of combustor housing.

^bSimulating a flight Mach number of 0.6 in a typical turbojet having a 5.2 compressor pressure ratio at sea level and rated rpm.

Calculations. - On each run, one or more points were chosen for analysis from the temperature strip charts. These points represent the midpoint of an interval of exit temperature equilibrium.

Combustion efficiencies were computed from the following approximate relation:

$$\eta_b = \frac{\text{Equivalence ratio theoretically required for measured temperature rise}}{\text{Actual equivalence ratio}}$$

The data of reference 5 were used for the diborane calculations and unpublished results for the pentaborane calculations. The latter results were obtained by the method and the assumptions described in reference 6. Reference 6 also presents theoretical data for pentaborane at only one inlet temperature, 100° F.

The average combustor-outlet temperature was computed as the arithmetic mean of the 16 outlet thermocouple indications. No correction was made for radiation or velocity effects on the thermocouples.

2873

The two methods of fuel-flow-rate measurement for the diborane tests conducted in the present investigation agreed within 5 percent. In the pentaborane runs, however, the continuously recorded fuel weight-time trace indicated very low flow rates and impossibly high combustion efficiencies. This error probably was caused by changing buoyant forces on the fuel tank, since the pentaborane containers could not be completely submerged in the coolant without incorporating a redesign of chamber B. Therefore, the fuel-flow rates reported for the pentaborane tests were computed from the fuel-tank beam-balance weight method. The constancy of flow rate during each test was checked by examining the average exit temperature, the slope of the fuel weight-time trace, and the fuel-tank pressure throughout the test. When deviations from constant fuel flow occurred, the minor corrections incurred were ascertained by accounting for the time interval and change in flow rate. The change in flow rate was determined by assuming the fuel flow to be a function of the pressure drop across the discharge orifice.

The total-pressure loss through the combustor and obstructions in the outlet duct was computed as the dimensionless ratio of the measured total-pressure drop $P_A - P_E$ to the calculated reference dynamic pressure q_r . The value of q_r was computed from the combustor-inlet density, the airflow rate, and the maximum cross-sectional area of the combustor housing, 0.267 square foot. The pressure loss through the combustor was similarly computed as the dimensionless ratio of the measured total-pressure drop $P_A - P_C$ to the same reference dynamic pressure q_r .

Some of the deposits formed during the tests were analyzed for boron content in the following manner. A representative, weighed sample of the deposit was washed with water. The insoluble residue was filtered, dried, and weighed. The residue was checked for the presence of boron nitride and insoluble boron hydrides by adding a warm caustic solution and testing for hydrogen and ammonia. Since neither of the latter were present, the residue was assumed to be free boron.

RESULTS AND DISCUSSION

The results of all tests are presented in chronological order in table I. The experimental test conditions are also listed in table I; these values did not meet the target test conditions in all cases. Some of the significant results are discussed in the following paragraphs.

Combustor for Pentaborane Fuel

Development of fuel injector and combustor. - The initial tests were made with the combustor and fuel-injection system developed in the preliminary diborane investigation (ref. 4), which is shown in figures 4(a) and 2(a), respectively. A shroud was placed over the fuel-nozzle adapter to reduce the slight nozzle deposits reported in reference 4. After 9 minutes operation at test condition C (run 13, table I) with pentaborane, a large deposit was formed on the fuel nozzle (fig. 6). The nozzle deposit contained 33 percent boron, which indicated considerable fuel decomposition and a low combustion efficiency. The measured combustion efficiency was 78 percent. Once formed, the porous deposit presented hot, flow-restricting surfaces to the fuel-rich gases passing through the deposit region. These conditions were conducive to thermal decomposition of the fuel and therefore may have caused the low combustion efficiency. It was noted that the nozzle deposit had bridged the annulus between the shroud and the fuel-nozzle adapter (fig. 6).

The shroud was removed for the next test, and a 5-minute run was made at test condition A (run 14). Again, a large deposit formed on the nozzle. The combustion efficiency was 85 percent. Thus, the combustor configuration developed for use with diborane was unsatisfactory for use with pentaborane.

In an effort to retain the good combustion characteristics of the model 6 liner and dome and eliminate nozzle deposits, initial modifications were limited to the fuel nozzle. Diborane was used for the initial development tests to conserve pentaborane. These combustion results will be described in greater detail in the diborane section of this report.

Fuel nozzle II (fig. 2(b)) incorporated a longer, more streamlined nozzle adapter than did nozzle I. A 1/4-inch tube was extended downstream of the flow-restricting orifice in the fuel nozzle to provide a high-velocity fuel-vapor stream before exposure to the air. The orifice plugged immediately after the fuel valve was turned on (run 15). An inspection of the fuel system after the run revealed the presence of considerable solid boron hydrides in the fuel nozzle and in the nozzle entry tube.

The fuel injector was then altered as shown in figure 2(c). The fuel nozzle (III) was fitted with a fine mesh screen immediately upstream of the orifice. An 8.3-minute diborane run was conducted at condition C (run 16). Again an appreciable deposit was formed on the injector tip (fig. 7).

The fuel injector was changed to reduce the burning near the tip. This was attempted by locating the orifice at the tip of the nozzle to establish a high-velocity liquid stream. This design, which was

designated fuel nozzle IV (fig. 2(d)), was used with pentaborane fuel, since vapor lock was anticipated with the use of diborane. After 9.0 minutes operation at test condition C (run 17), a large deposit formed on the nozzle tip (fig. 8). The combustion efficiency was 85 percent. The attempts to eliminate fuel-nozzle deposits by fuel-nozzle modifications alone were unsuccessful. These attempts did indicate that major combustor design changes were necessary.

The design of the model 7 combustor (fig. 4(b)) and fuel nozzle V (fig. 2(e)) for use with pentaborane was based on the following assumptions:

(1) Recirculation and turbulence of the combustion air upstream and for several inches downstream of the point of fuel injection should be minimized.

(2) A high-velocity jet of liquid fuel should be injected into the airstream.

(3) The spark-ignition electrodes should not be placed near the fuel-injection zone, since the electrodes introduce surfaces where deposits could form and thereafter bridge to the injection nozzle.

Two runs were attempted with nozzle V, and in each case the orifice was plugged by a very small amount of orange-colored solid (runs 18 and 19). Prior to the second attempt, a fine mesh screen was placed in a fuel-line fitting immediately outside the combustor adapter piece. These tests indicated that the pentaborane had decomposed in the fuel tube within the time required to fill the tube and formed solid products in sufficient quantity to plug the 0.0135-inch-diameter orifice. In each case, the fuel-tube temperature was about 270° F at the time the propellant valve was turned on. These results led to the design of fuel nozzle VI (fig. 2(f)), in which 70° F nitrogen was passed around the fuel tube for cooling before fuel-flow initiation.

Results with the model 7 combustor and fuel-injection nozzle VI. - The five tests with pentaborane on combustor model 7 and fuel-injection nozzle VI included one run at each test condition and a check run (run 24) at test condition B (runs 20 to 24, table I).

The deposits in the liner for runs 20 to 23 are shown in figure 9. Fuel-nozzle deposits were less than 1 gram for all tests. The pressure drop through the combustor is plotted against time in figure 10. The exit total-pressure tube plugged in the early part of run 20. Of the others, only test condition A, run 21, showed any appreciable increase of pressure drop with time. The irregular variation in the curves indicates spalling of the liner deposits. The solid symbols in figure 10 indicate the combustor pressure drop before and after fuel

flow. These points were taken under steady-state conditions and are more dependable than those taken during the test. The test durations were not sufficiently long to predict whether the deposits would continue to grow or reach a maximum.

The combustion efficiencies ranged from 86 to 102 percent, the lower values occurring at the higher altitude conditions. Combustion was smooth and stable for all tests. In runs 20 and 21, test conditions C and A, respectively, ignition was achieved by raising the fuel pressure. After ignition, the fuel pressure was reduced to the desired value. The sparkplug probably was not effective because of its location. Ignition was rapid and smooth for all other tests.

The outlet temperature profiles for the four test conditions are presented in figure 11. Except for test condition B, (fig. 11(b)) the temperature profiles are similar to those obtained with production-model combustors. Both tests at condition B, runs 22 and 24, indicated a high-temperature zone in the upper left corner when viewing downstream. The fuel pressure was much higher for the tests at condition B than for the other tests. The fuel jet, therefore, had greater momentum, and this effect could be the cause of the local high-temperature zone.

Techniques for eliminating deposits. - The tubes installed at station D-D to evaluate various techniques for alleviating turbine deposits are shown in figure 12. The tube on the left in figure 12 is the tube designed to operate at gas-stream temperature. This tube burned away during both tests at condition B. At the high temperature of condition D (fig. 12(d)), a thin, hard deposit formed on the tube. At the temperature encountered during run 20, which was slightly above the melting point of boron oxide, a larger amount of hard deposit was found on the tube (fig. 12(c)). The low temperature of condition A (run 21) resulted in a large, spongy deposit on the tube (fig. 12(a)).

The tube second from the left is the water-cooled tube. Deposits on this tube were similar to those on the tube designed to operate at the gas-stream temperature (fig. 12). The technique of alleviating turbine oxide deposits by cooling does not appear promising for use with pentaborane.

The third tube from the left in figure 12 was electrically heated above the gas-stream temperature and above the melting point of the vitreous boron oxide (1070° F). When tube and gases were above the oxide melting point, the tube remained clean (figs. 12(b) and (d)). With the gas-stream temperature below and the tube temperature above the oxide melting point, a hard glassy deposit formed on the tube (figs. 12(a) and (c)). The downstream side of the tube indicated that the deposit resulted from a quick freeze of a viscous liquid.

Surfaces operating at temperatures above the oxide melting point would not collect deposits during operation.

The tube on the extreme right in figure 12 was formed of porous wire cloth through which 80° F air was passed. The pressure drop across the tube wall was about 3 inches of mercury. The tube wall temperature was well below the oxide melting point. For all tests, the tube was partially clear. Deposits probably formed on the tube and then spalled. If the solid particles resulting from this spalling are not so large as to damage the rotor blades, then filming surfaces with air may be a feasible method for eliminating oxide deposits. The thickness of the spalled deposit probably could be reduced by increasing the pressure drop across the tube wall.

These data indicate two promising techniques for alleviating oxide deposits on turbine blades and other metal parts. The methods are heating and filming the surfaces with air.

The over-all pressure drop through the combustor and the thermocouples and tubes in the downstream duct is plotted against time in figure 13. The oxide deposits were accumulating throughout each of the four tests.

Performance of Diborane Fuel at High Altitude

Two runs were made with diborane at test condition C (runs 12 and 16, table I). Run 12 was made on the model 6 combustor and fuel-injection nozzle I (figs. 4(a) and 2(a)). This configuration was developed in reference 4, where the combustor-inlet pressure was about 1 atmosphere. At the 1/2-atmosphere combustor-inlet pressure and the required low fuel-flow rates of run 12, vapor lock occurred in the fuel nozzle, which resulted in a very low flow rate. The fuel weight instruments could not detect such flow rates. Based on 100-percent combustion efficiency, the equivalence ratio was 0.018. At these lean, low-pressure conditions, ignition was rapid and combustion smooth and stable. Relatively minor deposits were found in the upstream end of the liner. The deposits in the downstream portion of the liner and those on the special rods were destroyed by water when a pump failure after the test caused flooding of the exit plenum and part of the ducting. The pressure drop through the combustor and through the combustor and exit duct obstructions remained nearly constant throughout the run. The model 6 combustor and fuel nozzle I apparently are satisfactory for use with diborane except at the low fuel-flow rates encountered in altitude operation. The fuel nozzle and housing should be redesigned to improve the nozzle cooling system.

Diborane was tested during the pentaborane combustor development program with the model 6 combustor and fuel nozzle III (run 16). After 8.3 minutes of operation, a small deposit containing 36 percent boron had formed on the nozzle (fig. 7), and appreciable deposits were found in the liner and dome. However, combustion was smooth and stable at a combustor-inlet total pressure of 16 inches of mercury absolute, and the combustion efficiency was 95 percent.

SUMMARY OF RESULTS

The results obtained in the investigation of pentaborane and diborane fuel in a 7-inch-diameter turbojet combustor are summarized as follows:

1. Severe oxide deposits formed on the fuel-injection nozzle when pentaborane was burned in a combustor that had been previously developed to give satisfactory performance with diborane. Low combustion efficiencies were associated with these deposits.
2. A new experimental combustor was developed which eliminated the fuel-nozzle deposits and gave satisfactory performance with pentaborane, except for a nonuniform outlet temperature pattern at one of the test conditions.
3. Smooth and stable combustion was obtained with diborane at 1/2-atmosphere combustor-inlet total pressure and an equivalence ratio estimated at 0.018.
4. Two promising techniques were demonstrated for alleviating oxide deposits on turbine stator blades and other metal surfaces; namely, heating the surfaces, and filming the surfaces with air.

Lewis Flight Propulsion Laboratory
National Advisory Committee for Aeronautics
Cleveland, Ohio, February 17, 1953

REFERENCES

1. Gammon, Benson E., Genco, Russell S., and Gerstein, Melvin: A Preliminary Experimental and Analytical Evaluation of Diborane as a Ram-Jet Fuel. NACA RM E50J04, 1950.
2. Liebhafsky, H., and Schad, J. L.: The Heat of Combustion of Pentaborane. A Direct Determination. Rep. No. R50A0502, Apparatus Dept., General Electric Co., Mar. 1950. (Proj. HERMES (TUL-2000A) U.S. Army Ord. Dept.)
3. Price, Fraser P.: Burning and Detonation of Mixtures of Boron Hydrides with Air and Oxygen. Rep. No. R50A0504, Res. Lab., Apparatus Dept., General Electric Co., Mar. 1950. (Proj. HERMES (TUL-2000A) U.S. Army Ord. Dept.)
4. Kaufman, W. B., Gibbs, J. B., and Branstetter, J. R.: Preliminary Investigation of Combustion of Diborane in a Turbojet Combustor. NACA RM E52L15, 1957.
5. Gammon, Benson E.: Preliminary Evaluation of the Air and Fuel Specific-Impulse Characteristics of Several Potential Ram-Jet Fuels. III - Diborane, Pentaborane, Boron, and Boron - Octene-1 Slurries. NACA RM E51D25, 1951.
6. Breitwieser, Roland, Gordon, Sanford, and Gammon, Benson: Summary Report on Analytical Evaluation of Air and Fuel Specific-Impulse Characteristics of Several Nonhydrocarbon Jet-Engine Fuels. NACA RM E52L08, 1953.

TABLE I. - OPERATING CONDITIONS AND RESULTS

Run	Fuel	Combus- tor model	Fuel nozzle	Test con- dition	Dura- tion of opera- tion, min	Combus- tor- inlet temper- ature, T ₁ , °F	Combus- tor- inlet total pres- sure, P ₁ , in. Hg abs	Air- flow, lb/ sec- sq ft	Fuel flow, lb sec	Equiv- alence ratio	Combus- tor temper- ature rise, °F	Combus- tor effi- ciency, percent	Fuel- injec- tor pres- sure differ- ential, lb sq in.	Combus- tor veloc- ity, ft/sec	Aver- age com- bustor- outlet temper- ature, °F	Maxi- mum indi- vidual outlet temper- ature, °F	Mini- mum indi- vidual outlet temper- ature, °F	Time data recorded, min	Deposit (liner plus dome), g	Nozzle deposit, g	Boron in nozzle deposit, weight percent
12	D1- borane	6	I	C	8.8	260	13.4	2.74	0.0013 ^a	0.018 ^a	165	---	397	111	425	470	365	4.0	< 50	0	0
13	Penta- borane	6	I	C	9.0	265	18.1	2.77	0.0031	0.055	404	78	315	84	669	865	562	4.0	297	192	33
14	Penta- borane	6	I	A	5.0	272	37.2	6.41	0.0113	0.086	676	85	240	95	948	1240	695	2.0	262	135	45
15	D1- borane	6	II	A	0	← Fuel nozzle (orifice) plugged →															
16	D1- borane	6	III	C	8.3	263	16.0	2.88	0.0037	0.131	959	95	297	98	1222	1615	900	5.0	142	17	36
17	Penta- borane	6	IV	C	9.0	280	16.1	2.81	0.0047	0.082	617	85	112	97	897	1300	580	4.0	399	246	--
18	Penta- borane	7	V	C	0	← Nozzle orifice plugged by very small deposit formed on tip (<0.1 g) →															
19	Penta- borane	7	V	C	0	← Nozzle orifice plugged by very small deposit formed on tip (<0.1 g) →															
20	Penta- borane	7	VI	C	7.5	288	16.5	2.79	0.0060	0.105	830	92	125	95	1118	1470	910	2.0	84	---	--
21	Penta- borane	7	VI	A	7.0	277	38.9	6.53	0.0095	0.071	566	94	100	93	843	1110	600	2.0	210	0	--
22	Penta- borane	7	VI	B	2.7	372	34.7	5.28	0.0170	0.158	1198	95	310	96	1560	2400	1000	2.0	90	<1.0	--
23	Penta- borane	7	VI	D	9.9	382	15.4	2.44	0.0087	0.175	1178	86	75	100	1560	1770	1370	1.0	90	C	--
24	Penta- borane	7	VI	B	3.8	368	35.4	5.39	0.0166	0.151	1202	102	315	95	1570	2400	1160	1.5	69	<1.0	--

^aBased on 100-percent combustion efficiency.

CONFIDENTIAL

CONFIDENTIAL

NACA RM E53B18

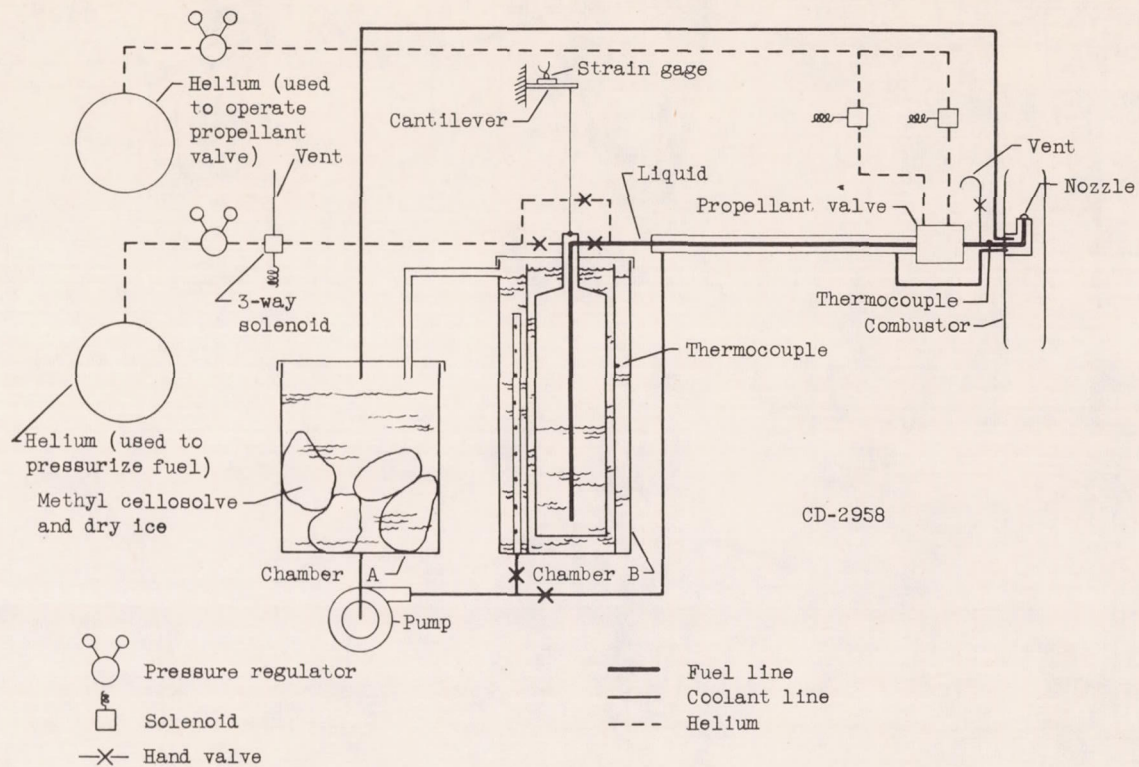

Figure 1. - Fuel system.

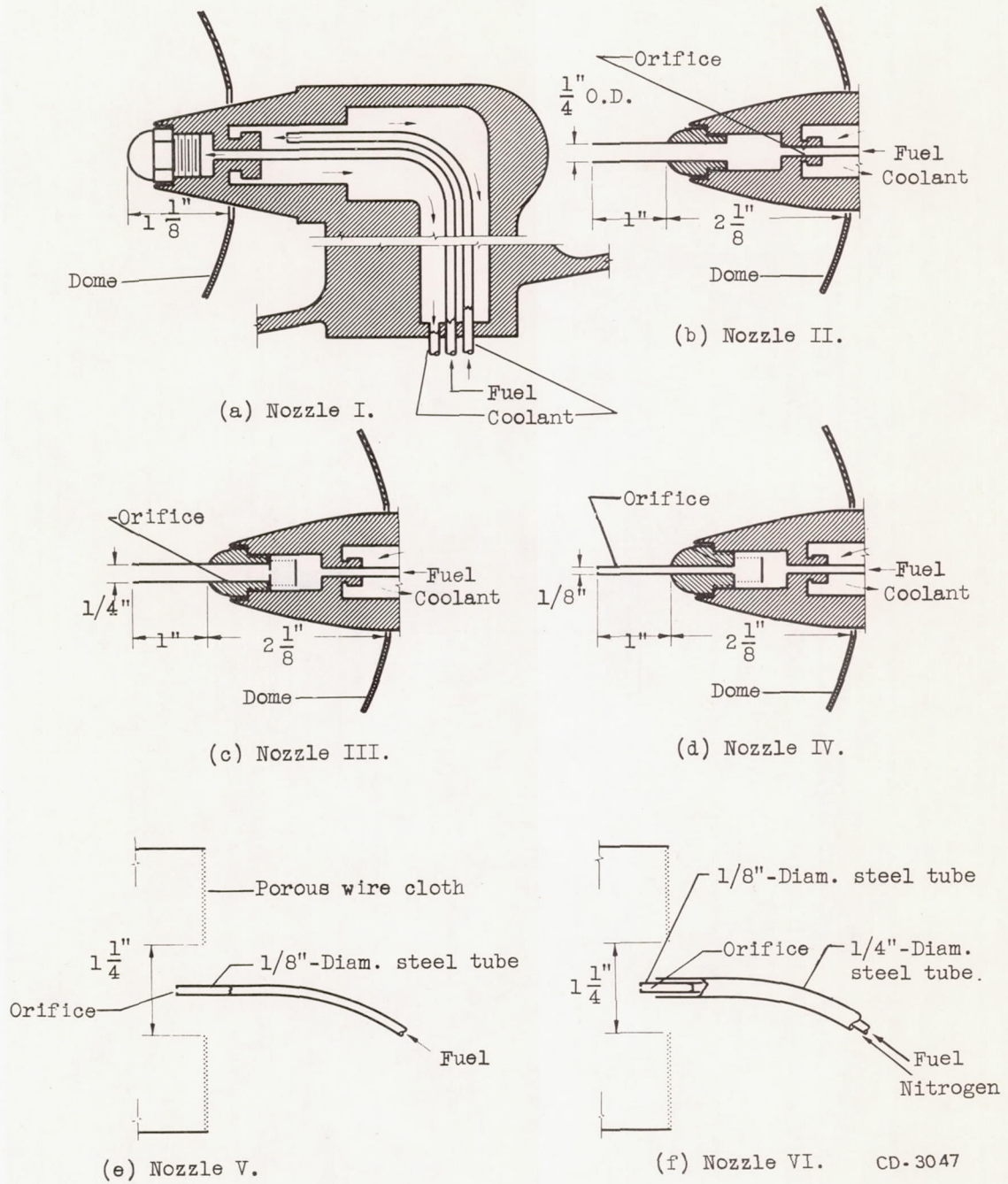

Figure 2. - Fuel-injection nozzles.

2873

CD-3047

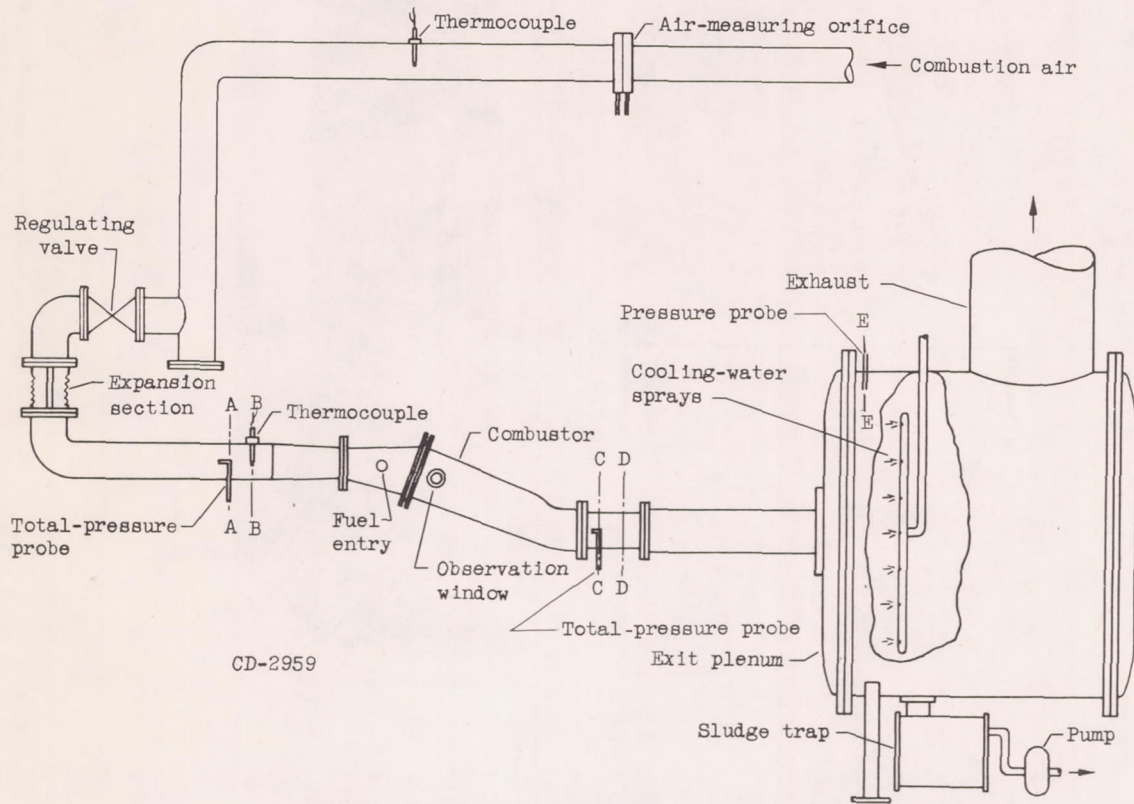
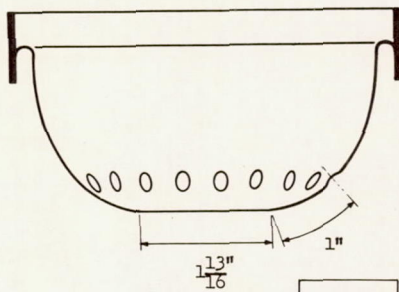
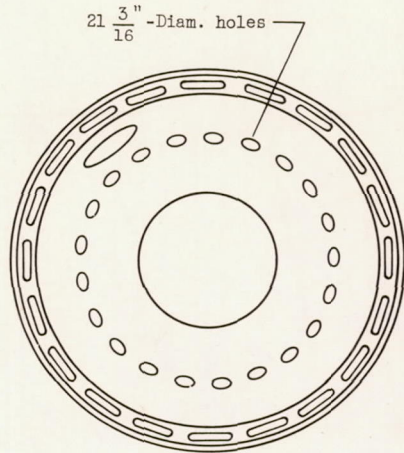

Figure 3. - Combustor installation.

2873

2873



C-31470
CD-2962

Dome

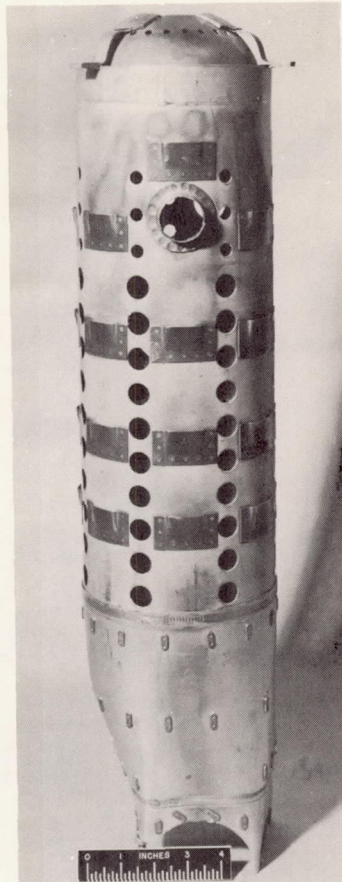

Dome and liner assembly

(a) Model 6.

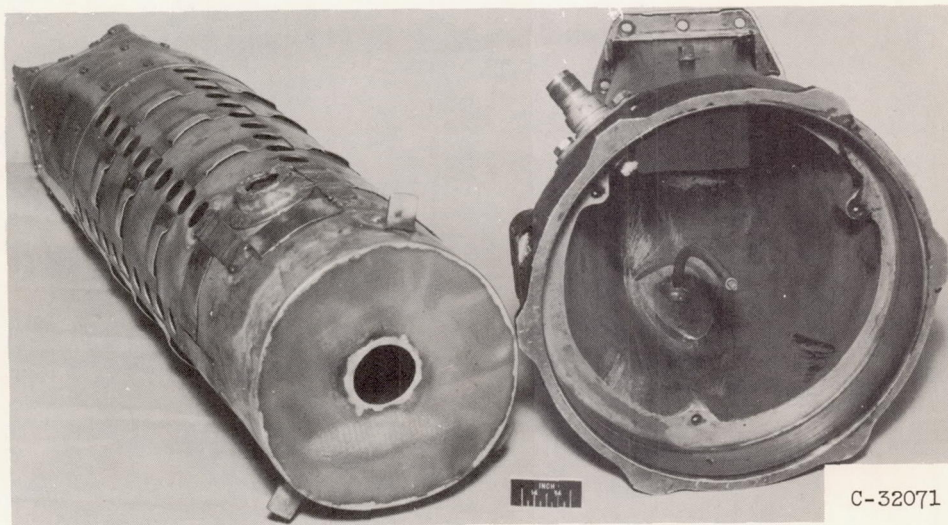

C-32071

(b) Model 7.

Figure 4. - Combustors.

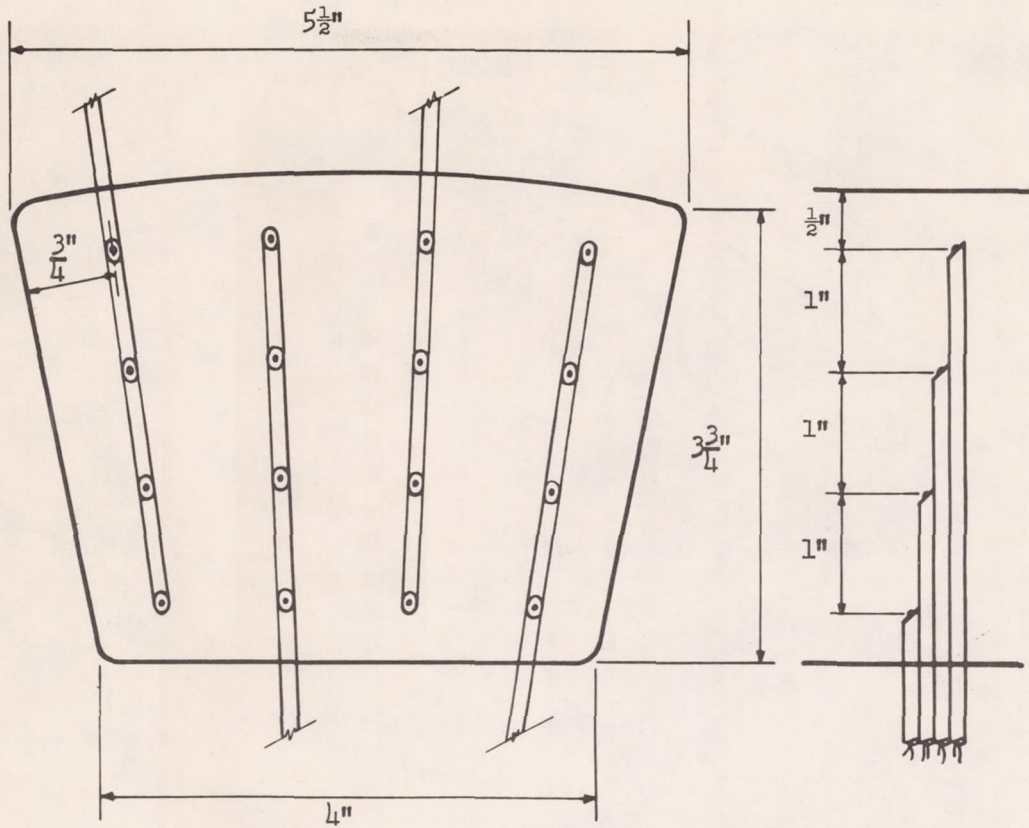

CD-2963

Figure 5. - Combustor-outlet instrumentation.

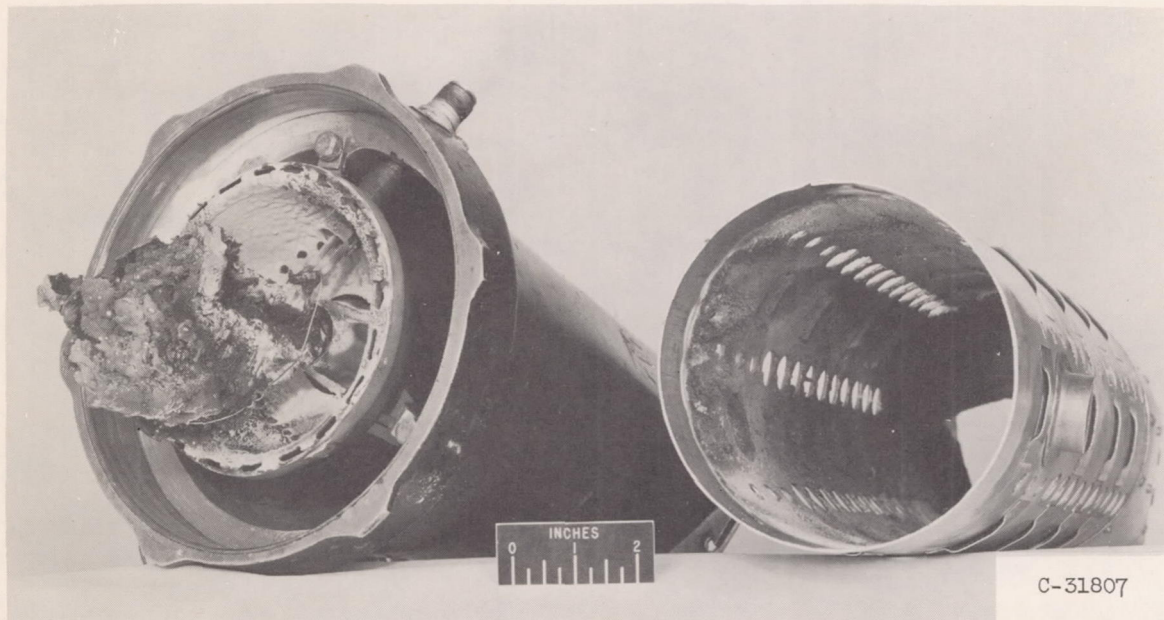

C-31807

Figure 6. - Deposits with model 6 combustor and fuel-injection nozzle I. Fuel, pentaborane; run duration, 9 minutes at test condition C.

2873

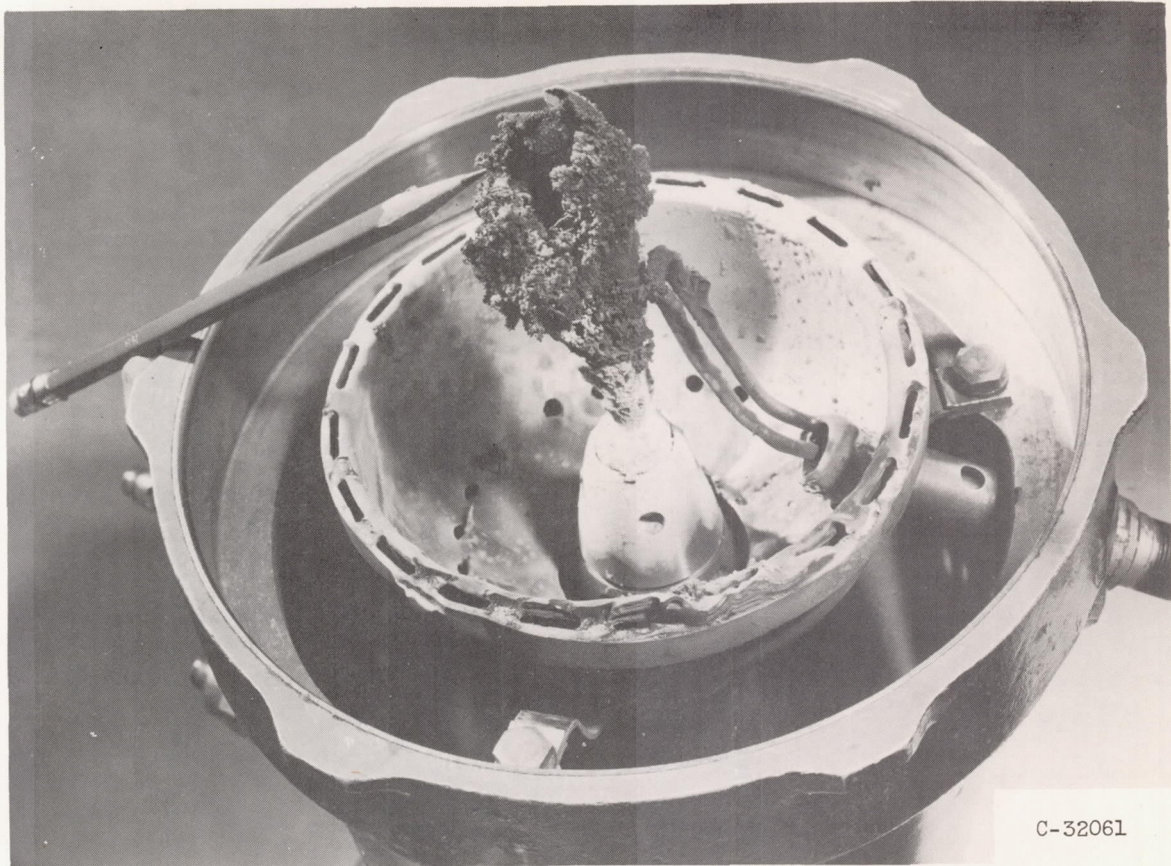

Figure 7. - Deposits with model 6 combustor and fuel-injection nozzle III. Fuel, diborane; run duration, 8.3 minutes at test condition C.

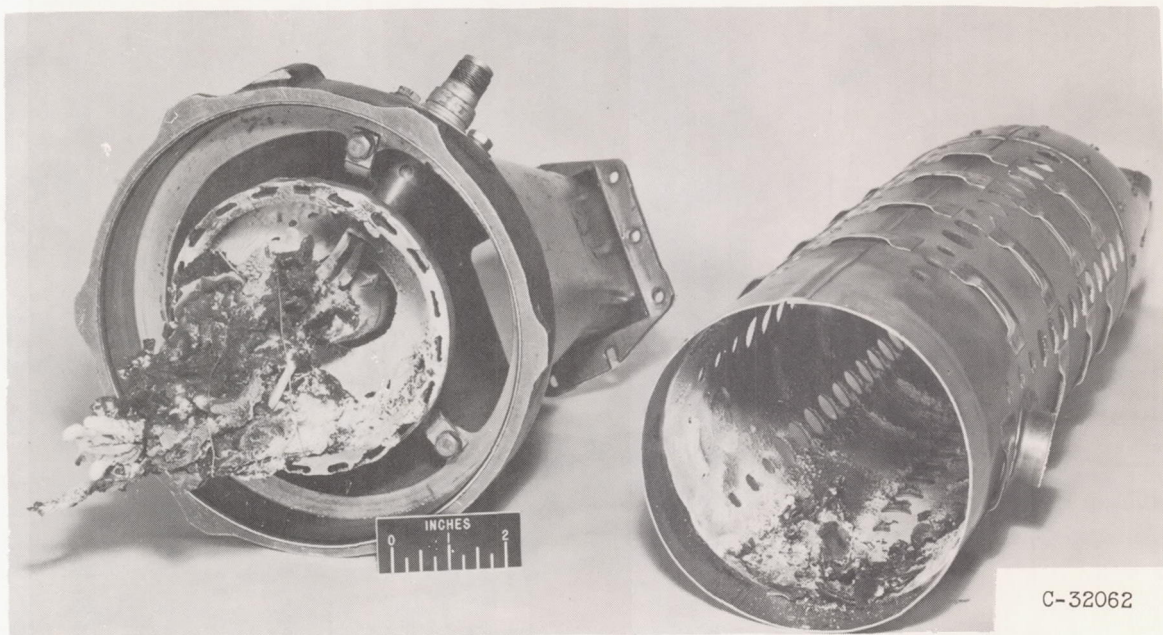
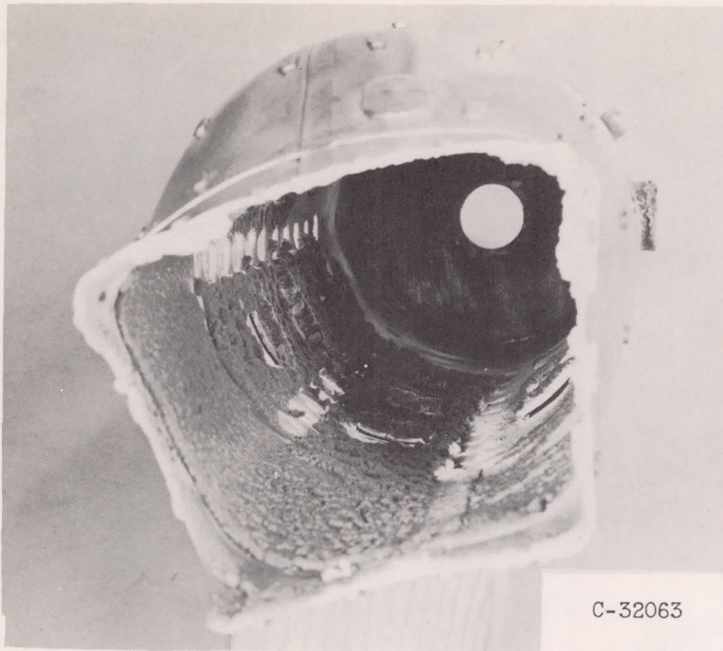
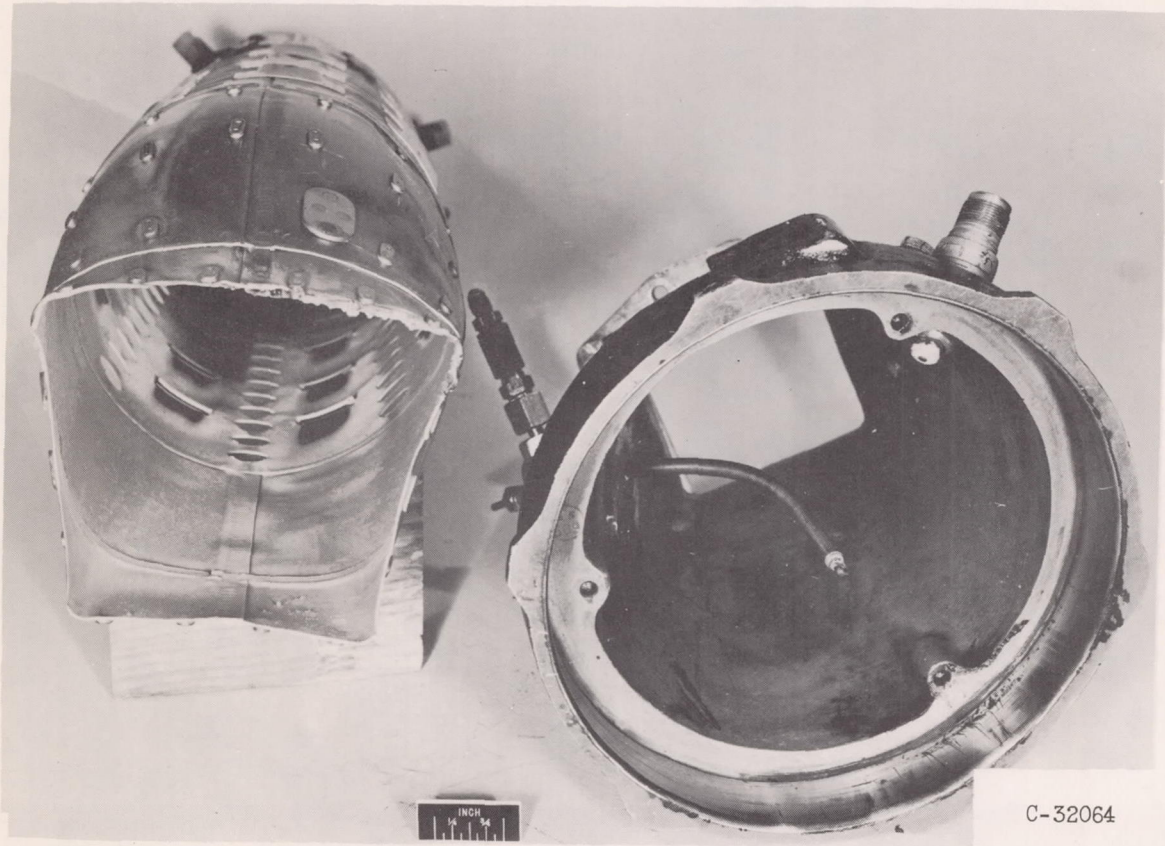

Figure 8. - Deposits with model 6 combustor and fuel-injection nozzle IV. Fuel, pentaborane; run duration, 9.0 minutes at test condition C.



(a) After 7.0 minutes at test condition A.



(b) After 2.7 minutes at test condition B.

Figure 9. - Deposits with model 7 combustor and fuel-injection nozzle VI from combustion of pentaborane.

2873

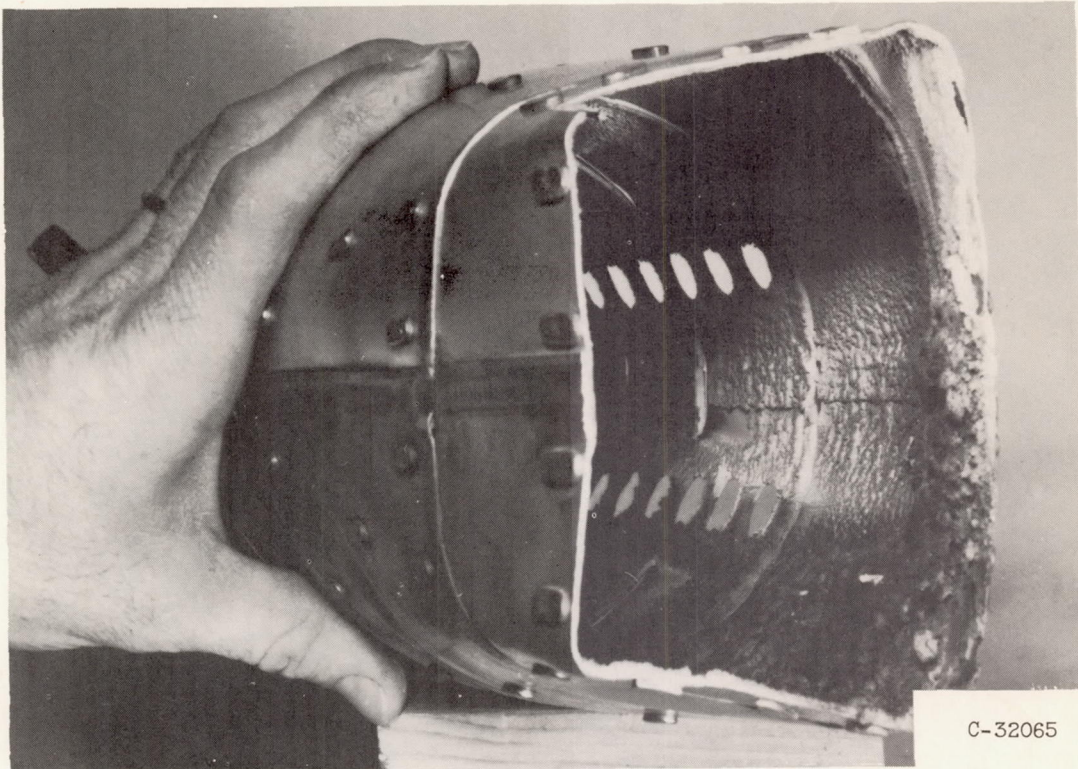

(c) After 7.5 minutes at test condition C.

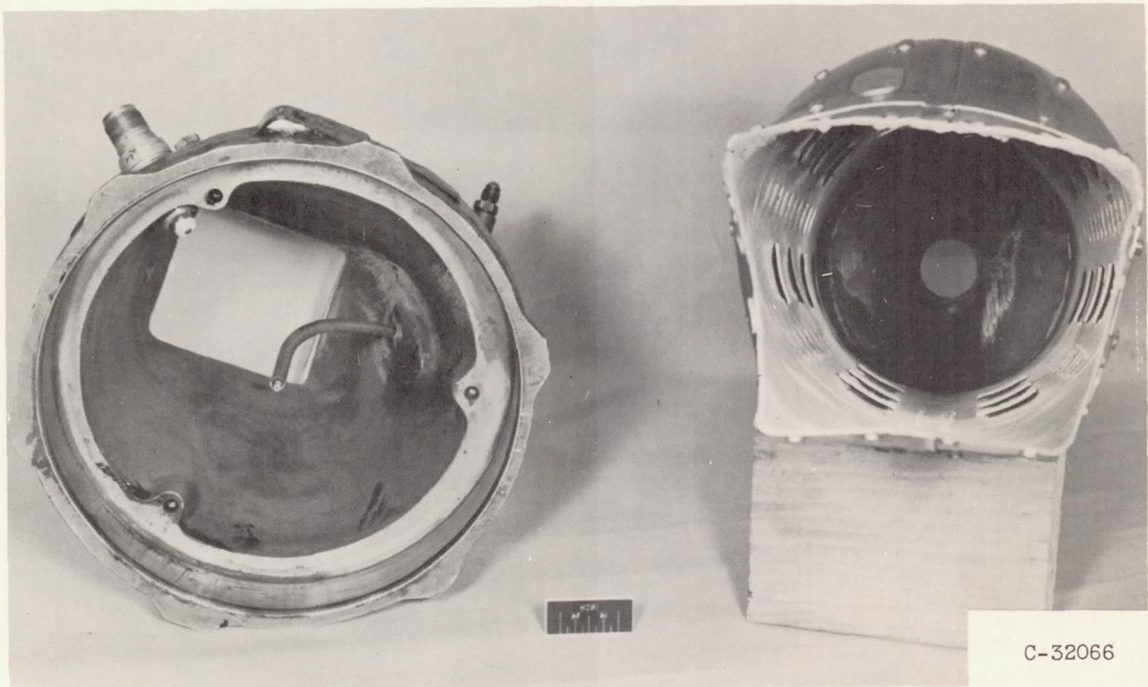

(d) After 9.9 minutes at test condition D.

Figure 9. - Concluded. Deposits with model 7 combustor and fuel-injection nozzle VI from combustion of pentaborane.

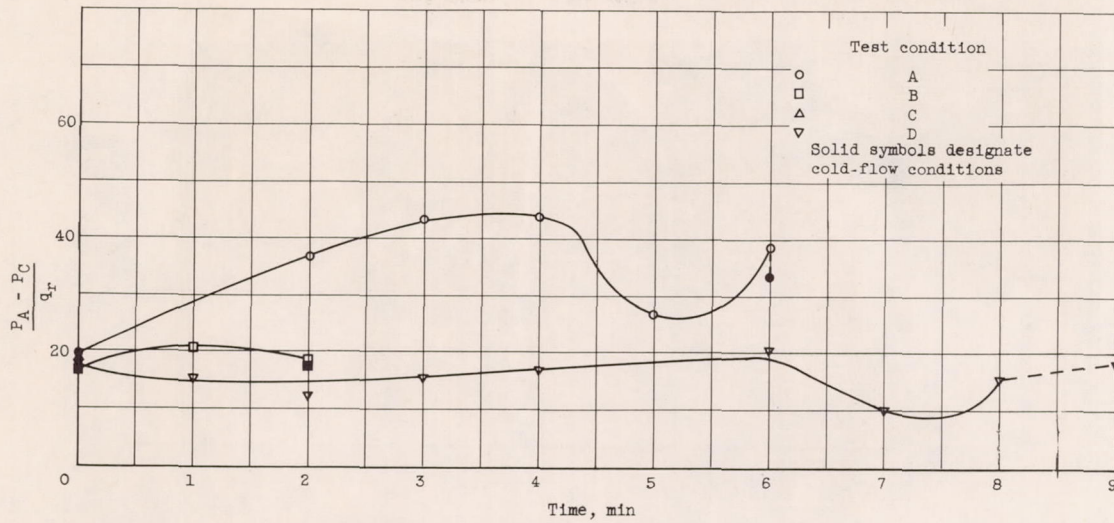
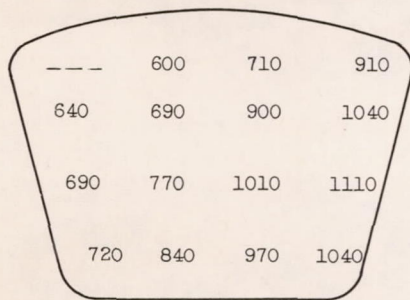
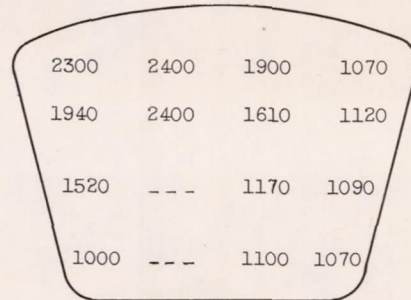

Figure 10. - Variation with time of total-pressure drop through combustor model 7. Fuel nozzle, VI; fuel, pentaborane.



(a) Test condition A.



(b) Test condition B.

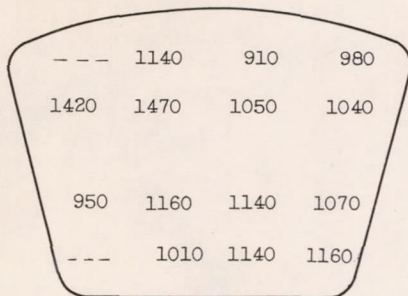

(c) Test condition C.

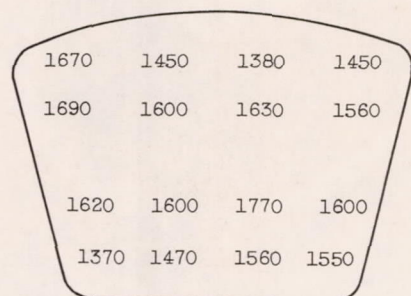

(d) Test condition D.

Figure 11. - Outlet temperatures of combustor model 7. Fuel nozzle, VI; fuel, pentaborane. (Temperatures in °F.)

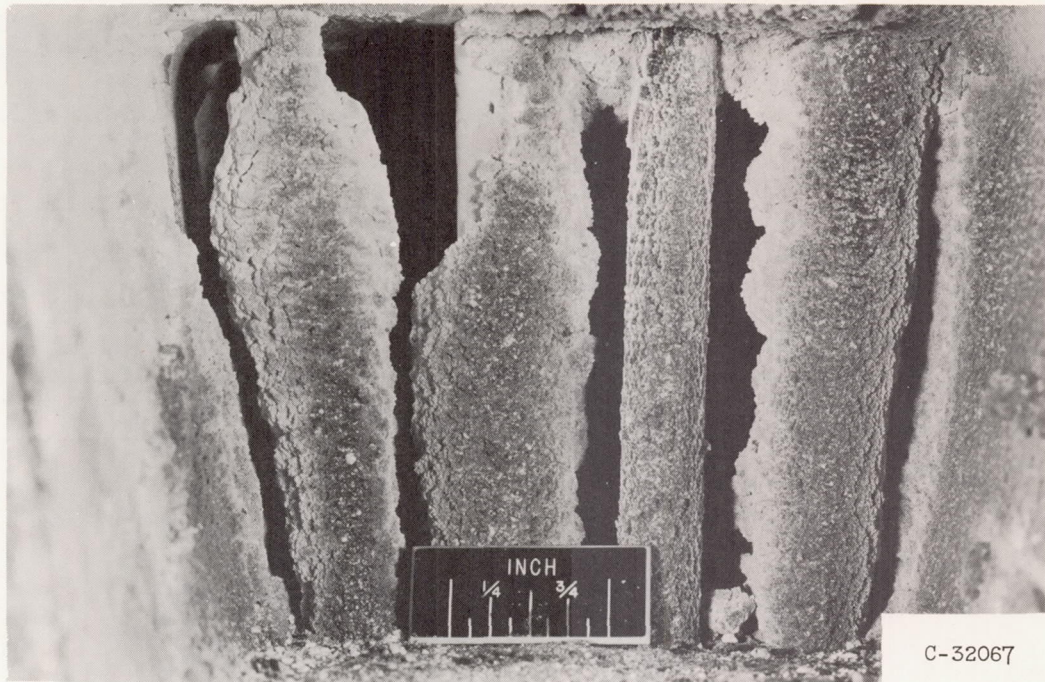

C-32067

(a) Test condition A; run duration, 7.0 minutes. Combustor-outlet temperature, 843° F.



C-32068

(b) Test condition B; run duration, 2.7 minutes. Combustor-outlet temperature, 1560° F.

Figure 12. - Deposits from combustion of pentaborane on special tubes at outlet of model 7 combustor with fuel-injection nozzle VI.

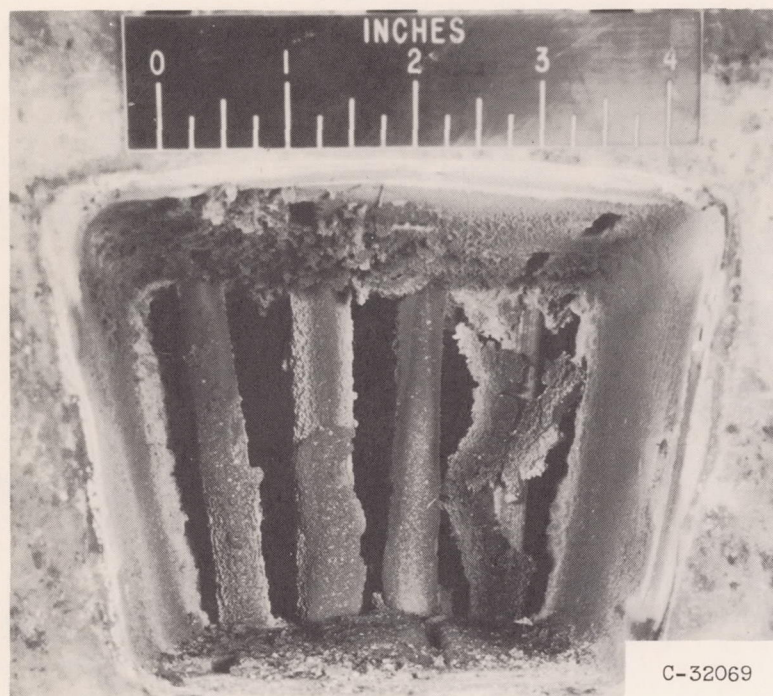

(c) Test condition C; run duration, 7.5 minutes.
Combustor-outlet temperature, 1118° F.

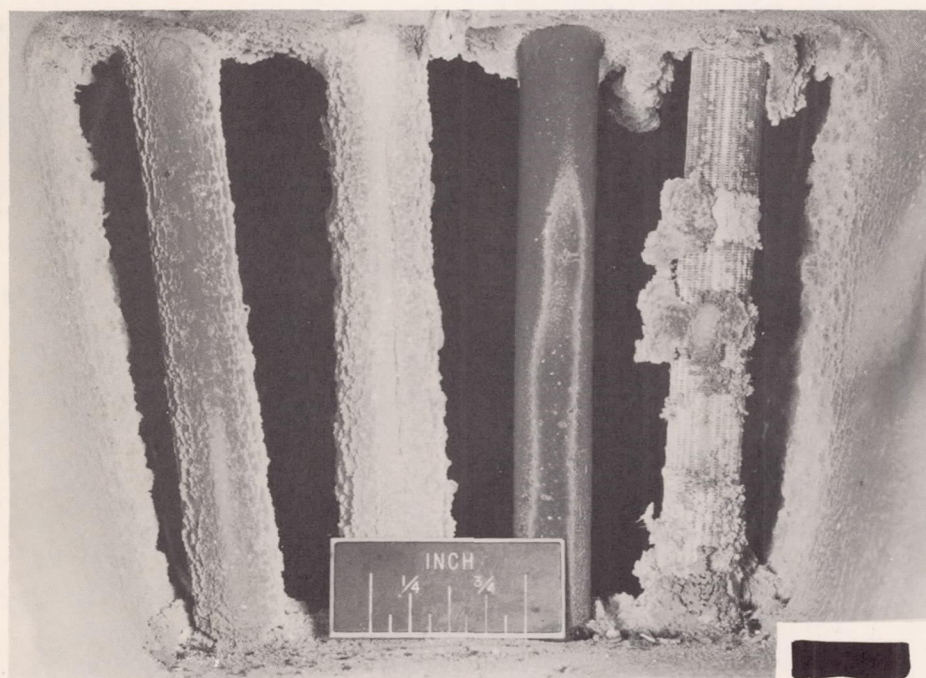

(d) Test condition D; run duration, 9.9 minutes. Combustor-outlet temperature, 1560° F.

Figure 12. - Concluded. Deposits from combustion of pentaborane on special tubes at outlet of model 7 combustor with fuel-injection nozzle VI.

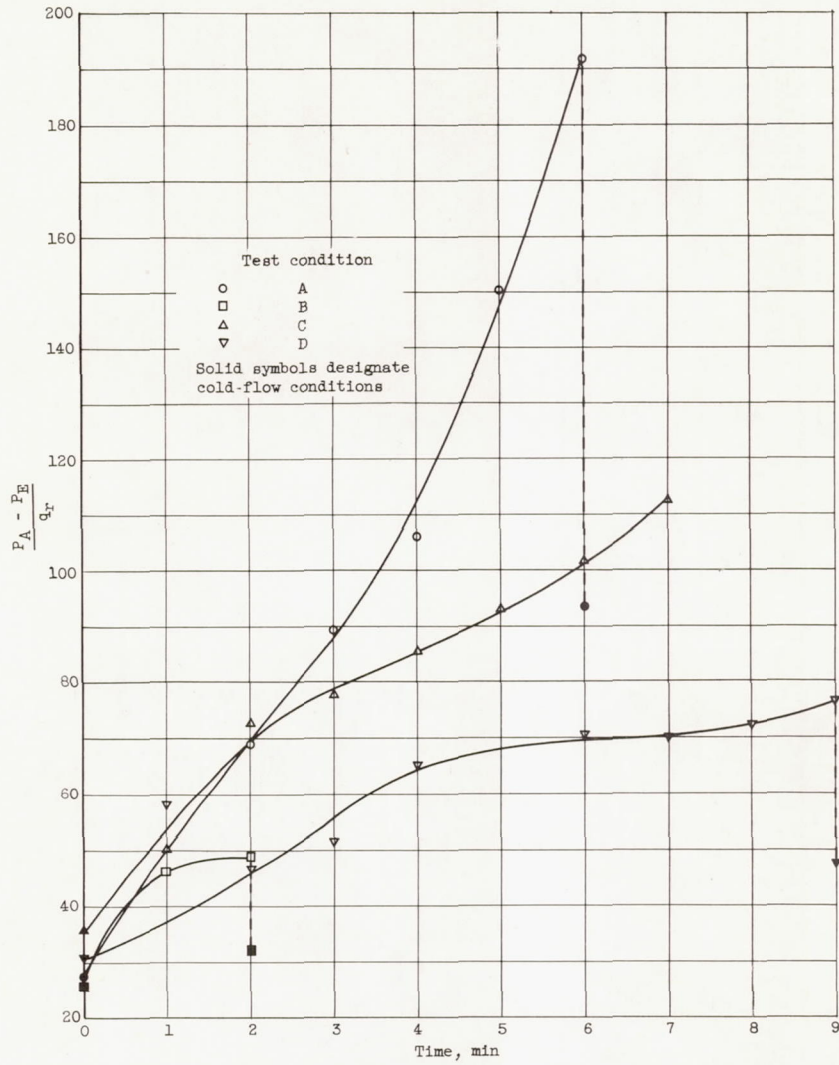

Figure 13. - Variation with time of total-pressure drop through combustor model 7 plus obstructions in exit duct. Fuel nozzle, VI; fuel, pentaborane.

CONFIDENTIAL
UNCLASSIFIED

UNCLASSIFIED
CONFIDENTIAL