

~~CONFIDENTIAL~~  
RESTRICTED

RM A53G22

NACA RM A53G22

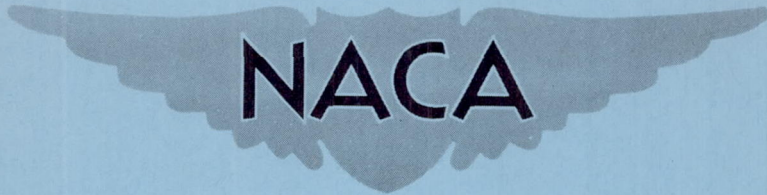

# RESEARCH MEMORANDUM

CORRELATION OF FLIGHT AND WIND-TUNNEL MEASUREMENTS OF  
ROLL-OFF IN LOW-SPEED STALLS ON A 35°  
SWEPT-WING AIRCRAFT

By Seth B. Anderson

Ames Aeronautical Laboratory  
Moffett Field, Calif.

CLASSIFICATION CHANGED TO  
CONFIDENTIAL  
BY AUTHORITY J. W. CROWLEY  
CHANGE #1633 DATE 12-1-53 T.C.F.

CLASSIFIED DOCUMENT

This material contains information affecting the National Defense of the United States within the meaning of the espionage laws, Title 18, U.S.C., Secs. 793 and 794, the transmission or revelation of which in any manner to an unauthorized person is prohibited by law.

## NATIONAL ADVISORY COMMITTEE FOR AERONAUTICS

WASHINGTON

September 24, 1953

CLASSIFICATION CHANGED TO UNCLASSIFIED  
AUTHORITY: NACA RESEARCH ABSTRACT NO. 129  
EFFECTIVE DATE: JULY 17, 1958  
WHI

~~CONFIDENTIAL~~  
RESTRICTED

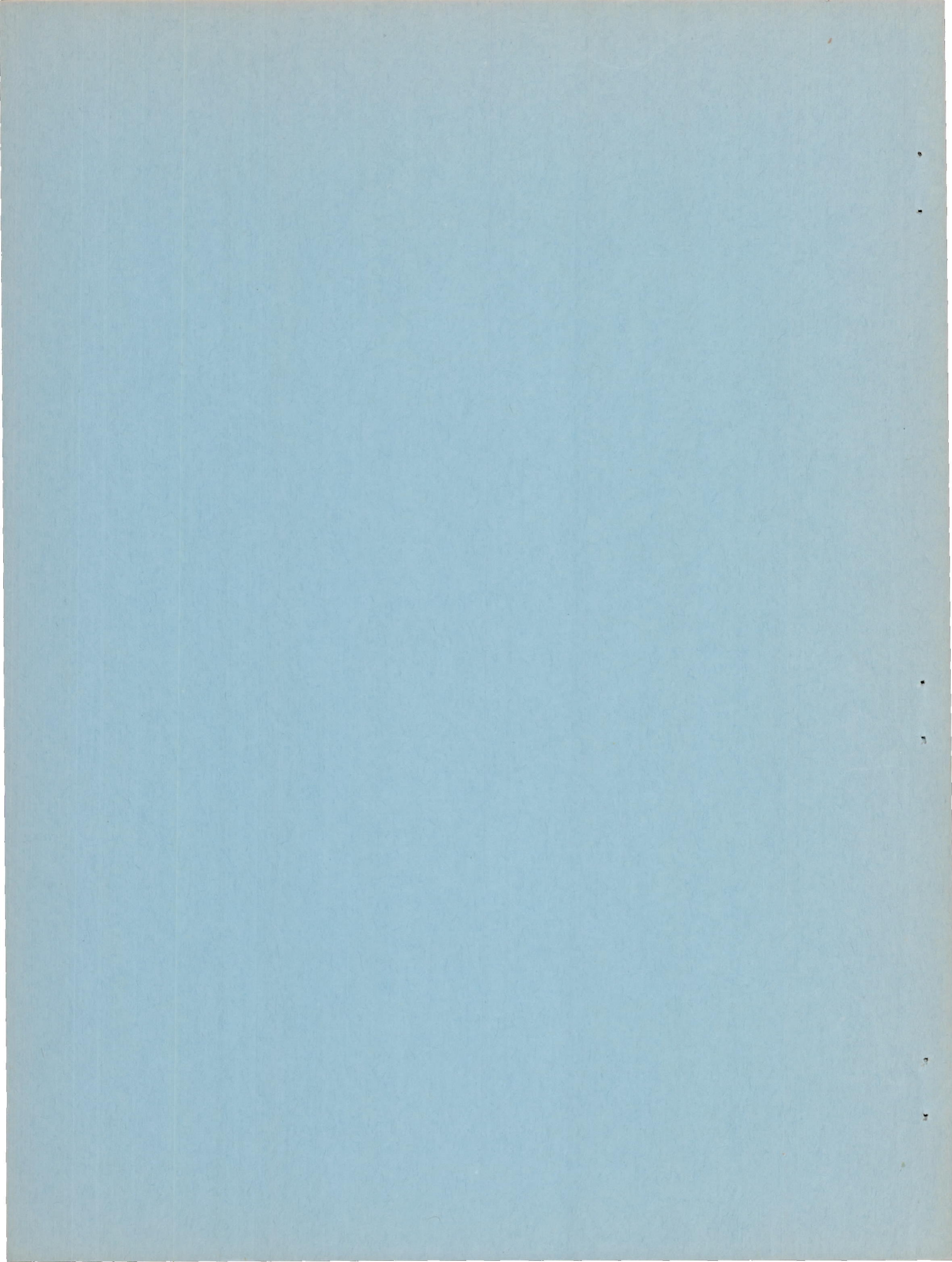

## NATIONAL ADVISORY COMMITTEE FOR AERONAUTICS

RESEARCH MEMORANDUM

## CORRELATION OF FLIGHT AND WIND-TUNNEL MEASUREMENTS OF

ROLL-OFF IN LOW-SPEED STALLS ON A  $35^\circ$ 

## SWEPT-WING AIRCRAFT

By Seth B. Anderson

## SUMMARY

Flight and wind-tunnel measurements were made of the low-speed stalling characteristics on a swept-wing jet aircraft. Included in this study are the effects on the stalling characteristics of a number of wing modifications.

The results showed a correlation between pilot opinion of the severity of the roll-off at the stall and the magnitude of the rolling moment obtained from static wind-tunnel force measurements. Values of rolling-moment coefficient of 0.01 or less at the stall (measured in the wind tunnel) resulted in a satisfactory stall in flight, while values greater than 0.03 represented unsatisfactory stalling behavior. For the test airplane initial inadvertent bank angles of  $10^\circ$  or less resulted in a satisfactory stall and greater than  $30^\circ$  in an unsatisfactory stall.

A series of fences were added to the wing to decrease the magnitude of the roll-off at the stall. To make a stall unanimously satisfactory for a number of pilots from the roll-off standpoint, considerable rounding of the lift-curve peak was necessary. This resulted in a moderate reduction in maximum lift.

## INTRODUCTION

An important problem in the design of high-speed aircraft is that of obtaining satisfactory low-speed stalling characteristics. Swept wings, in particular, tend to stall initially at the tips, resulting in longitudinal instability near maximum lift. In addition, for wings of moderate sweep, stall progression is usually not symmetrical and the stall in flight may be characterized by unacceptable rolling behavior. It has not been possible to anticipate stalling characteristics in

flight from wind-tunnel tests alone, except in a most qualitative manner (from the shape of the lift-curve peak and from tuft studies of stall progression). It is the purpose of this study to investigate the possibility of correlating quantitative factors involved in the stalling behavior from both flight and wind-tunnel measurements with pilot opinion.

The airplane used in this study was a swept-wing jet aircraft. The wind-tunnel results of reference 1 for one configuration showed longitudinal instability at the stall and a sharp lift-curve peak. A number of modifications tested in the wind tunnel produced a stable pitching-moment break at the stall and flattened the lift-curve top. The significance of some of these modifications in terms of the actual flying qualities of the airplane was evaluated by flight tests of a similar type aircraft.

The initial flight tests showed, however, that longitudinal instability at the stall for this airplane was not a problem, the stall being dominated by severe rolling behavior. In order to investigate the possibility of predicting the severity of roll-off at the stall from wind-tunnel force tests, the rolling-moment data were examined for the airplane of reference 1. The rolling-moment values, as measured on the static balance of the Ames 40- by 80-foot wind tunnel, were compared with pilots' opinions of the roll-off at the stall. The modifications made in the tunnel to the wing of the test airplane varied the rolling moments sufficiently to cover a wide range of stall behavior.

Additional information obtained in flight is included herein regarding the relationship between the shape of the lift-curve peak, maximum lift, and opinion of the roll-off at the stall as judged by a number of pilots.

#### NOTATION

$C_L$	lift coefficient, $\frac{\text{lift}}{qS}$
$C_l$	rolling-moment coefficient, $\frac{\text{rolling moment}}{qSb}$
$q$	dynamic pressure, lb/sq ft
$S$	wing area, sq ft
$\alpha$	airplane angle of attack, deg
$b$	wing span, ft

- $\varphi$  angle of bank, deg  
 $\dot{\varphi}$  rolling velocity, deg/sec

#### EQUIPMENT AND TESTS

The tests were conducted on a jet-powered fighter aircraft having sweptback wing and tail surfaces. Photographs of similar test airplanes as prepared for flight and wind-tunnel tests are presented in figures 1(a) and 1(b), respectively. Figure 2 is a two-view drawing of the airplane. A description of the geometric details of the airplane is given in table I.

Tests were conducted with the normal wing with slats operating, slats locked closed (sealed and unsealed), and a modified wing leading edge for flaps both up and down. The modified leading edge consisted of forward camber and an increased leading-edge radius as described in reference 1 (listed as modification 1). A list of configuration changes made to the wing is given in table II. A list of fence configurations is given in table III. These fences were approximately 5 inches high.

Standard NACA instruments were used to record the various flight quantities. Flight values of airspeed and angle of attack were measured 8 feet ahead of the fuselage nose.

For all tests the stalls were approached by reducing airspeed at the rate of 1 knot per second. Flight tests were performed at 10,000 feet altitude with an average gross weight of 13,000 pounds at a center-of-gravity location of approximately 0.225 mean aerodynamic chord. The flight Reynolds number was approximately  $8.0 \times 10^6$  near maximum lift. The wind-tunnel tests of the full-scale airplane were run at a dynamic pressure of about 35 pounds per square foot and a Reynolds number of the order of  $8.4 \times 10^6$ .

#### RESULTS AND DISCUSSION

##### Roll-Off Characteristics

During the initial flight tests of the test airplane it was found that in judging the suitability of the stall the pilots were chiefly concerned with the magnitude of the roll-off at the stall. In the study of the roll-off the stalls were made from wings-level flight and when any tendency for roll-off occurred, the pilot would apply corrective action by use of the rudder and aileron. An examination was made of the flight time histories in an attempt to determine which quantities had the most influence on the pilots' evaluation of the lateral behavior at

the stall. This correlation of pilots' opinions with behavior in the complete stall is similar to a study previously made (ref. 2) for stall warning in which pilots' opinions of stall warning were correlated with quantitative factors producing the warning. It appeared that the primary factors which could influence the pilots' opinions in the complete stall were the initial bank angle inadvertently attained and the maximum rolling velocity during the initial roll-off. The initial values of these quantities were examined since it was known that the wind-tunnel balance system would not give representative rolling-moment measurements in the dynamic phase of roll behavior occurring later in the stall. A correlation of these quantities with pilots' opinions is shown in figure 3. These results show that a bank angle of the order of  $10^\circ$  or less and a rolling velocity of  $10^\circ$  per second or less represented a satisfactory stall, while values of angle of bank of  $30^\circ$  or more and rolling velocities of  $30^\circ$  per second or more represented unsatisfactory stall behavior. These values are in accordance with those presented in the German flying-qualities requirements of reference 3 and those proposed for military aircraft in reference 4. The German requirements specify, however, a time duration of 10 seconds of stalled flight for which  $\pm 30^\circ$  bank angle should not be exceeded, while the results in figure 3 are presented only for the initial angle of bank at the start of the stall.

The significance of the initial departure from wings-level flight and the effect of time duration in the stall are illustrated by comparing time-history data (fig. 4) of angle of bank for the airplane with a cambered leading edge (judged unsatisfactory by the pilots) and for the normal airplane with slats open (judged satisfactory). These data show that although each configuration reached an angle of bank slightly greater than  $50^\circ$ , the initial departure from wings-level flight was more gradual for the airplane with slats. The build-up of rolling motions with time for the airplane with slats is felt by the pilot to be due to the inability to operate the controls with the proper phase relationship in the stalled region where control effectiveness is reduced and the rolling moments due to sideslip and yawing velocity may be large.

Examination of the wind-tunnel force data showed that both of the afore-mentioned configurations were characterized by a rolling-moment increment at maximum lift. An example of the relationship between the lift-curve peak and the rolling moment as measured in the wind tunnel is shown in figure 5. These results show for the cambered leading edge a sharp lift-curve peak and an abrupt rolling-moment break of large magnitude at maximum lift. In contrast, the slats-open case showed a rounded lift-curve peak and relatively small variations in rolling moment in the region above maximum lift. It is also shown in figure 5 that the large magnitude of rolling-moment increment for the cambered leading-edge configuration existed only over a relatively small angle-of-attack range. It should be pointed out that to obtain wind-tunnel data of this type, the stall must be approached at angle-of-attack increments no greater

than the order of  $0.5^\circ$ , lest the large change in rolling moment at the stall be missed entirely. The effect of this critical angle-of-attack range was noticeable in flight in that abrupt stalls had less severe roll-off than stalls approached more slowly.

The results of all wing configurations tested in flight and in the wind tunnel (see table II) are correlated in figure 6 on the basis of maximum increment in rolling-moment coefficient at the stall measured in the wind tunnel at zero sideslip. Wind-tunnel results were available for a limited number of configurations at other than zero sideslip. These results showed that the magnitude of the change in rolling-moment coefficient at the stall was approximately the same when the stall was approached at various constant values of sideslip (up to  $8^\circ$ ) as for the zero sideslip case. Judging from the results presented in figure 6, changes in  $C_l$  of 0.01 or less at the stall were satisfactory in flight; changes between 0.01 and 0.03 were marginal; and changes greater than 0.03 were unsatisfactory. Presumably, the maximum rolling-moment break tolerable is related in some manner to the rolling moments producible by manipulation of the rudder and aileron; however, the effects of this variable are difficult to evaluate in a quantitative manner and were not considered in this report.

It should be noted that the rolling-moment criteria shown in figure 6 are limited to the type and size of the aircraft tested and are intended to be used as a preliminary indication of satisfactory stalling characteristics. A discussion of the effect of airplane size and sideslip angle at the stall may be found in reference 5.

#### Maximum Lift and Stalling Characteristics

As previously pointed out, the shape of the lift-curve peak is tied in with the roll-off behavior at the stall. A flat-top lift curve is generally indicative of low rolling moments at the stall by virtue of a gradual stall progression on the wing. The question of how much a sharp lift-curve peak must be rounded to produce a satisfactory stall and how much decrement in maximum lift this causes has not been answered.

The lift curves of the airplane with the cambered leading edge and a series of fence modifications designed to improve the stalling characteristics are presented in figure 7 for the flaps-down case and the results are tabulated in table III. These fence modifications were tested in flight only. It will be noted that the lift-curve peak for the cambered leading edge was sharp and, as noted previously, the stall was reported as unsatisfactory by the pilot because of a severe roll-off. Tuft studies indicated that separation was a combined leading-edge and trailing-edge type, initiating outboard near the wing tip and spreading inboard rapidly. The addition of a fence at 46-percent semispan

(2- to 75-percent chord extent) improved the lateral characteristics at the stall slightly to a rating of "marginally satisfactory" by pilot A. As shown in figure 7, this configuration resulted in rounding the lift-curve peak somewhat and reducing maximum lift about 5.5 percent. The addition of a leading-edge "wrap" to this fence further improved the stalling characteristics to a rating of "satisfactory" by pilot A; however, the other pilots graded the stall from marginally satisfactory to unsatisfactory. Observation of tufts indicated that although this fence installation produced areas of separation inboard and to the rear of the fence, separation still occurred abruptly over a large area outboard of the fence. By moving the fence outboard to 63-percent semi-span it was possible to reduce the chordwise extent of the fence to 25 percent and still retain lateral characteristics at the stall which were acceptable to all four pilots with a decrement in maximum lift of about 11 percent. Extending this fence to 75-percent chord or using large chord fences (to 75-percent chord) at both 46- and 63-percent semispan resulted in further improvements in stalling characteristics beyond that felt necessary, with pronounced rounding of the lift-curve peaks and large reductions in maximum lift (19.5 percent). It will be noted that the pilots tended toward agreement on a satisfactory stall as the lift-curve peak was rounded more and more.

#### CONCLUSIONS

Measurements of the low-speed stalling characteristics of a swept-wing jet aircraft showed a correlation of the rolling moment at the stall between static wind-tunnel force measurements and pilot opinion of the stall. Values of rolling-moment coefficient of 0.01 or less at the stall resulted in a satisfactory stall in flight, while values greater than 0.03 were unsatisfactory. For the test airplane initial inadvertent bank angles of 10° or less at the stall resulted in a satisfactory stall and greater than 30° as unsatisfactory. To make a stall unanimously satisfactory for a number of pilots from the roll-off standpoint, considerable rounding of the lift-curve peak was necessary. This resulted in a moderate reduction in maximum lift.

Ames Aeronautical Laboratory  
National Advisory Committee for Aeronautics  
Moffett Field, Calif., July 22, 1953



## REFERENCES

1. Maki, Ralph L.: Full-Scale Wind-Tunnel Investigation of the Effects of Wing Modifications and Horizontal-Tail Location on the Low-Speed Static Longitudinal Characteristics of a  $35^{\circ}$  Swept-Wing Airplane. NACA RM A52B05, 1952.
2. Anderson, Seth B.: Correlation of Pilot Opinion of Stall Warning with Flight Measurements of Various Factors Which Produce the Warning. NACA TN 1868, 1949.
3. Doetsch, Karl Heinrich, et al.: New Standards for Desirable Handling Qualities of Aircraft. R.A.E. Trans. No. 66 (Aero. No. 7) 1946.
4. Abzug, Malcolm J.: Flying Qualities Requirements for Military Aircraft. Aeronautical Engineering Review, vol. 5, no. 10, Oct. 1946, pp. 16-22.
5. Solf, Karl.: The Lateral Motion of the Aeroplane. Tip Stalling. Ministry of Aircraft Production, Völkenröde, VG 268, 1947.

TABLE I.- DESCRIPTION OF TEST AIRPLANE

Wing	
Total wing area (including flaps, slats, and 49.92 sq ft covered by fuselage) . . . . .	287.90 sq ft
Span . . . . .	37.12 ft
Aspect ratio . . . . .	4.79
Taper ratio . . . . .	0.51
Mean aerodynamic chord (wing station 98.7 in.) . . . . .	8.08 ft
Dihedral angle . . . . .	3.0°
Sweepback of 0.25-chord line . . . . .	35°14'
Sweepback of leading edge . . . . .	37°44'
Aerodynamic and geometric twist . . . . .	2.0°
Root airfoil section (normal to 0.25-chord line) . . . . .	NACA 0012-64 (modified)
Tip airfoil section (normal to 0.25-chord line) . . . . .	NACA 0011-64 (modified)
Horizontal tail	
Total area (including 1.20 sq ft covered by vertical tail) . . . . .	34.99 sq ft
Span . . . . .	12.75 ft
Aspect ratio . . . . .	4.65
Taper ratio . . . . .	0.45
Dihedral angle . . . . .	10.0°
Root chord (horizontal-tail station 0) . . . . .	3.79 ft
Tip chord, equivalent (horizontal-tail station 76.68 in.) . . . . .	1.74 ft
Mean aerodynamic chord (horizontal-tail station 33.54 in.) . . . . .	2.89 ft
Sweepback of 0.25-chord line . . . . .	34°35'
Airfoil section (parallel to center line) . . . . .	NACA 0010-64
Maximum stabilizer deflection . . . . .	+1°, -10°
Elevator	
Area (including tabs and excluding balance area forward of hinge line) . . . . .	10.13 sq ft
Span, each . . . . .	5.77 ft
Chord, inboard (equivalent horizontal-tail station 6.92 in.) . . . . .	1.19 ft
Chord, outboard (theoretical, horizontal-tail station 76.18 in.) . . . . .	0.57 ft
Maximum elevator deflection . . . . .	+35°, -17.5°
Boost . . . . .	hydraulic



TABLE II.- WING CONFIGURATIONS TESTED IN FLIGHT AND WIND TUNNEL

Configuration	Flap position, deg	$C_{L_{max}}$		$\Delta C_l$ at $C_{L_{max}}$ Wind tunnel	Pilots' comments on	
		Flight	Wind tunnel		Stall <sup>1</sup>	Stall warning <sup>1</sup>
Basic wing - slats closed - (slits in slats sealed)	0	1.16	1.20	0.042	U	U
Basic wing - slats closed	0	1.12	1.10	.016	S	S
	38	1.27	1.37	.012	S	U
Basic wing - out-board two slat segments open	0	-	1.10	.013	S	S
	38	-	1.39	.022	M	M to U
Basic wing - all slats open	0	1.17	1.33	.006	S	M
	38	1.36	1.64	.008	S to M	U
Cambered leading edge (listed as Mod. 1 in ref. 1)	0	1.39	1.42	.055	U	U
	38	1.58	1.73	.085	U	U
Cambered leading edge with wing-root modification (listed as Mod. 2 in ref. 1)	0	1.17	1.22	.020	M to U	U
	38	1.44	1.57	.018	M to U	U
Cambered leading edge with wing-root modification (Mod. 2 of ref. 1 plus cone at out-board end of modification)	0	1.24	1.22	.011	S to M	M
	38	1.48	1.56	.058	M to U	U
Cambered leading edge with wing-root modification (listed as Mod. 3 in ref. 1)	0	1.10	1.13	.004	S	S
	38	1.42	1.48	.015	M to U	U

<sup>1</sup>U, unsatisfactory; S, satisfactory; M, marginal.

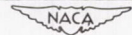
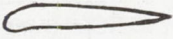

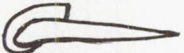
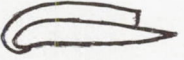

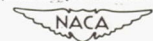

TABLE III.- FENCE CONFIGURATIONS TESTED IN FLIGHT

Configuration	Flap position, deg	$C_{L_{max}}$	Pilot	Pilots' comments on		
				Stall, straight flight <sup>1</sup>	Stall, approach turn <sup>1</sup>	Stall warning <sup>1</sup>
Mod. leading edge 	0	1.40	B	U	---	U
			A	U	---	U
	38	1.56	B	U	S	U
			A	U	U	U
Mod. L.E. - Single inboard fence at 46 per- cent b/2 	0	1.24	A	M	---	M
	38	1.50	A	M	M	U
Mod. L.E. - Single inboard fence and L.E. wrap at 46 per- cent b/2 	0	1.18	A	S	---	S
			B	S	---	S
			C	S	---	S
	38	1.44	A	S	S	U
			B	M	M	U
			C	U	S to M	M to U
Mod. L.E. ONE outboard fence with reduced chord at 63 per- cent b/2 	0	1.24	C	S	---	S
			B	S	---	S
			D	S	---	S
	38	1.40	C	S to M	S to M	S to M
			B	S	S	U
			D	S	---	M to U
Mod. L.E. ONE outboard fence at 63 percent 	0	1.18	C	S	---	S
	38	1.32	C	S	S	S
Mod. L.E. TWO fences at 46 per- cent and 63 per- cent b/2 	0	1.16	C	S	---	S
	38	1.27	C	S	S	S

<sup>1</sup>U, unsatisfactory; S, satisfactory; M, marginal



(a) Airplane tested in flight.

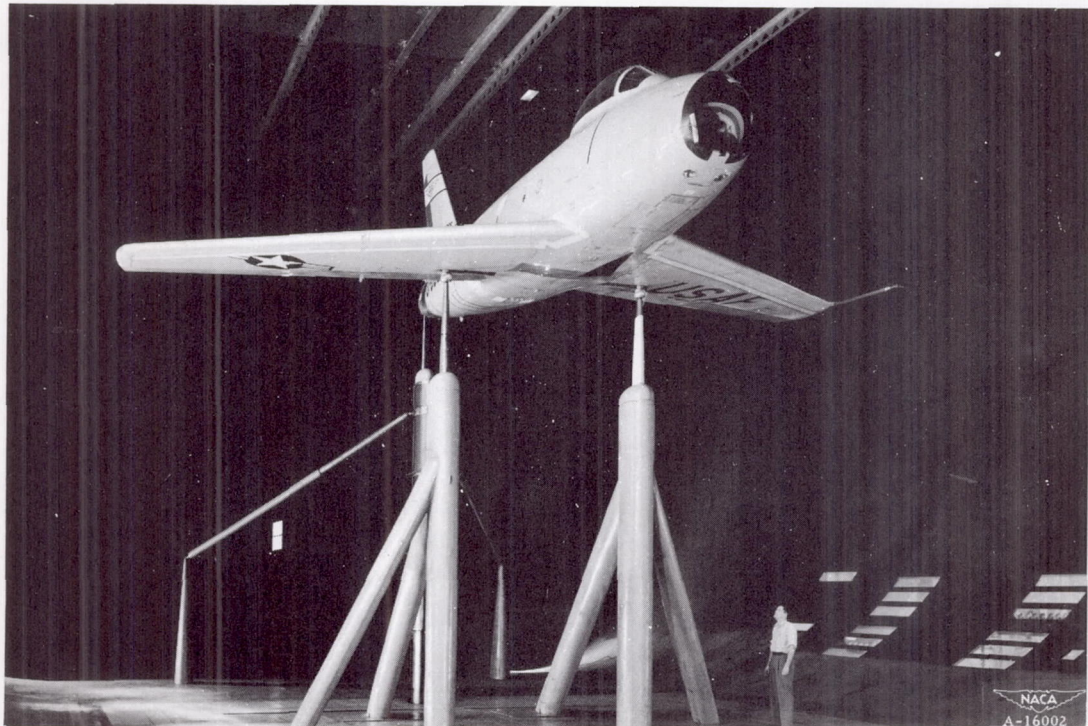

(b) Airplane tested in the 40- by 80-foot wind tunnel.

Figure 1.- Photographs of test airplane.

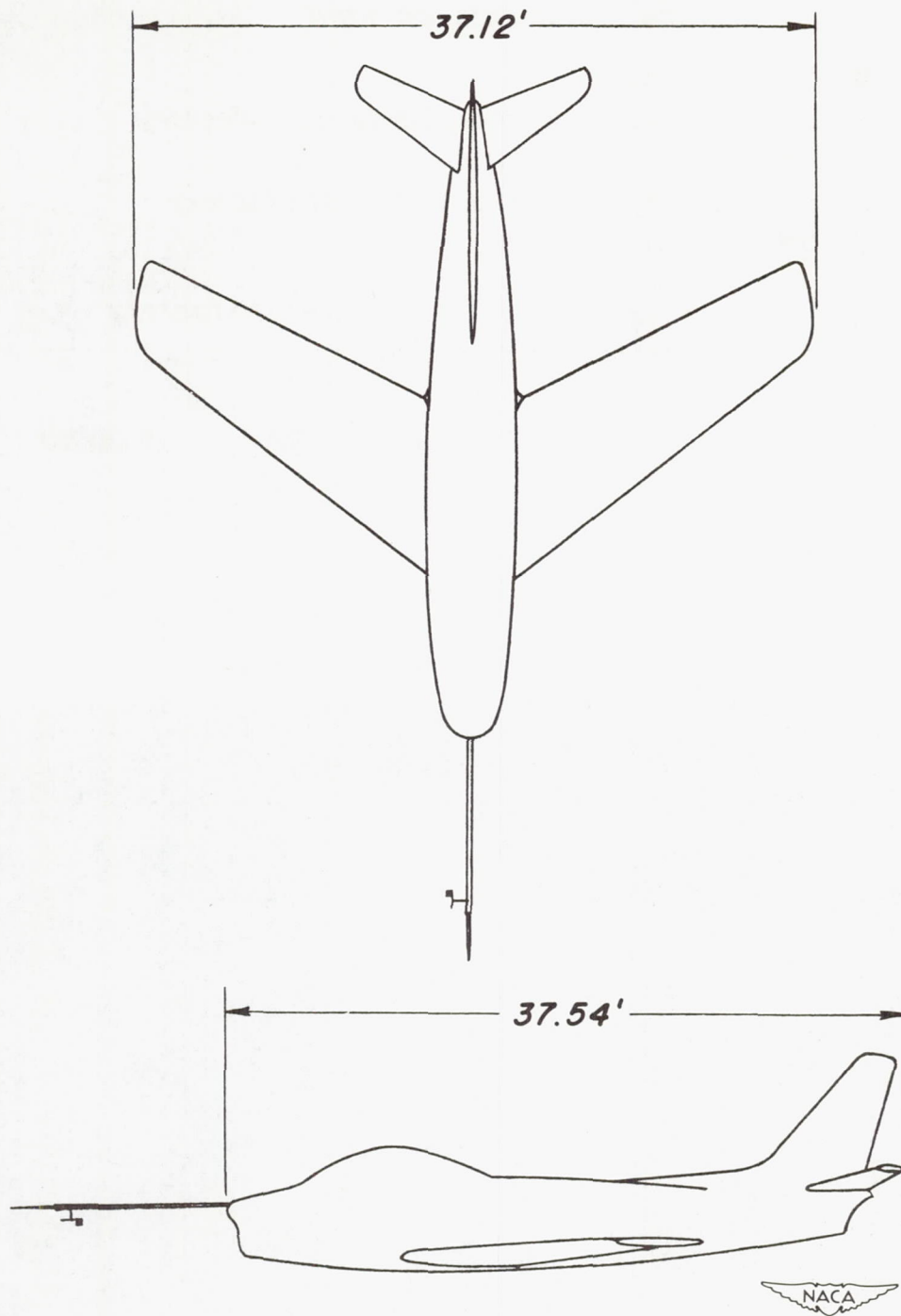
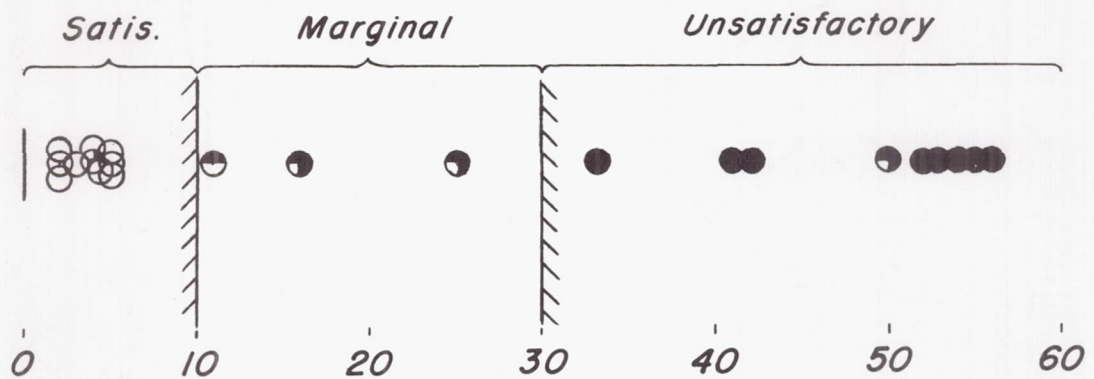

Figure 2.- Two-view drawing of the test airplane.

*Pilots' comments on stall*

- *Unsatisfactory*
- ◐ *Unsatisfactory to marginally satisfactory*
- ◑ *Marginally satisfactory*
- ◒ *Satisfactory to marginally satisfactory*
- *Satisfactory*



(a) Maximum bank angle resulting from initial roll-off,  $\phi$ , deg.

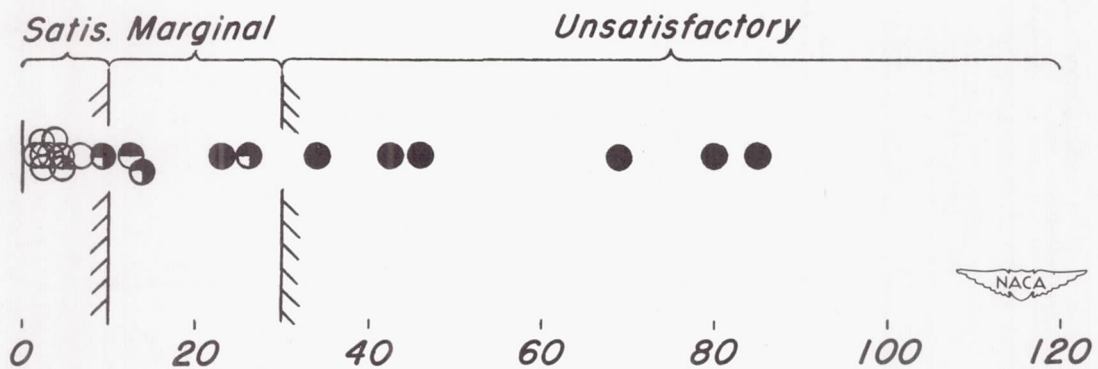

(b) Maximum rolling velocity resulting from initial roll-off,  $\dot{\phi}$ , deg/sec.

Figure 3.- Correlation of pilots' opinions of stall with various parameters.

RESTRICTED

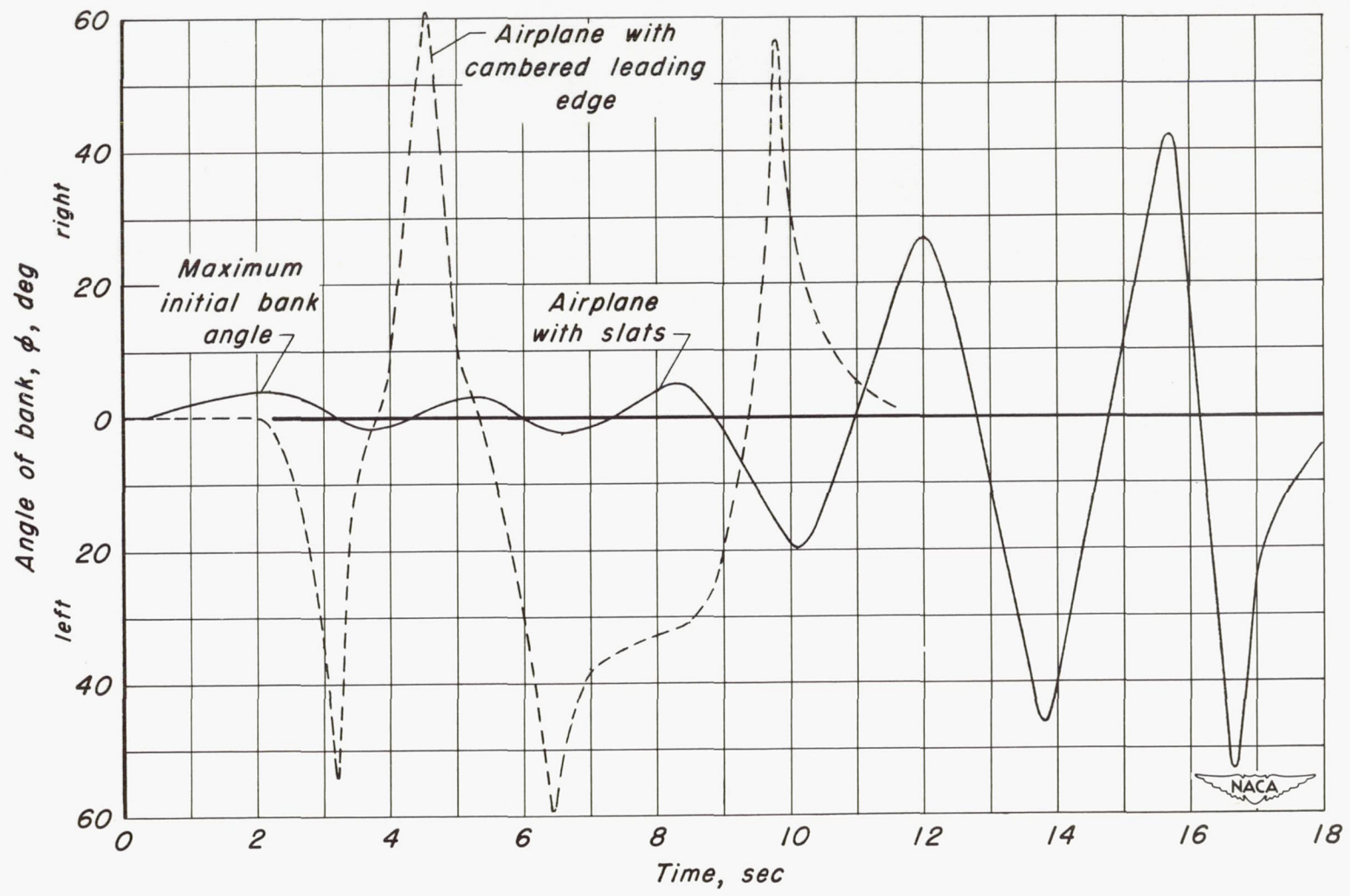

Figure 4.- Time histories of stalls for various configurations in which the pilot attempted to maintain wings level flight by use of the controls. Flaps down.



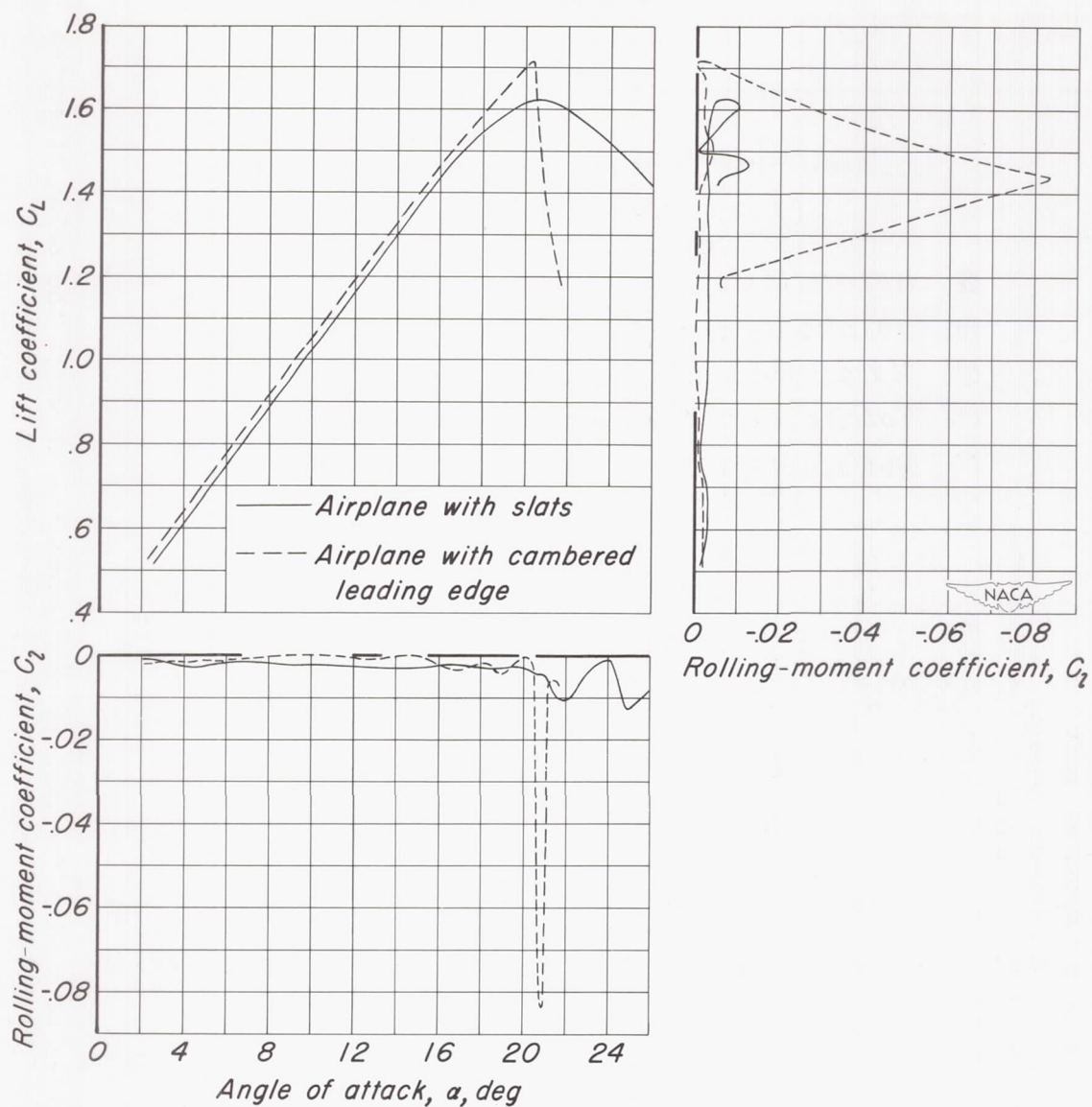

Figure 5.- Lift and rolling-moment characteristics for various configurations.

*Pilots' comments on stall*

- *Unsatisfactory*
- ◐ *Unsatisfactory to marginally satisfactory*
- ◑ *Marginally satisfactory*
- ◒ *Satisfactory to marginally satisfactory*
- *Satisfactory*

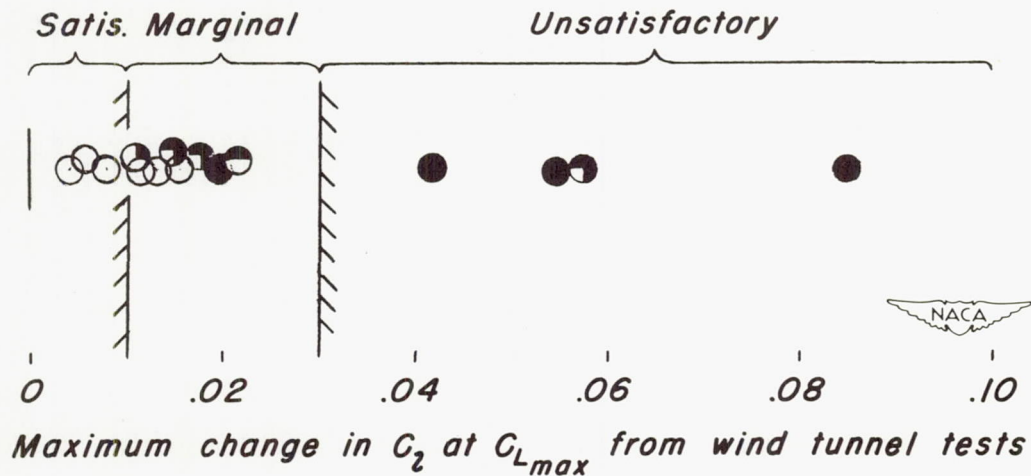

Figure 6.- Correlation of pilots' opinions of stall with changes in  $C_2$  at  $C_{L_{max}}$ .

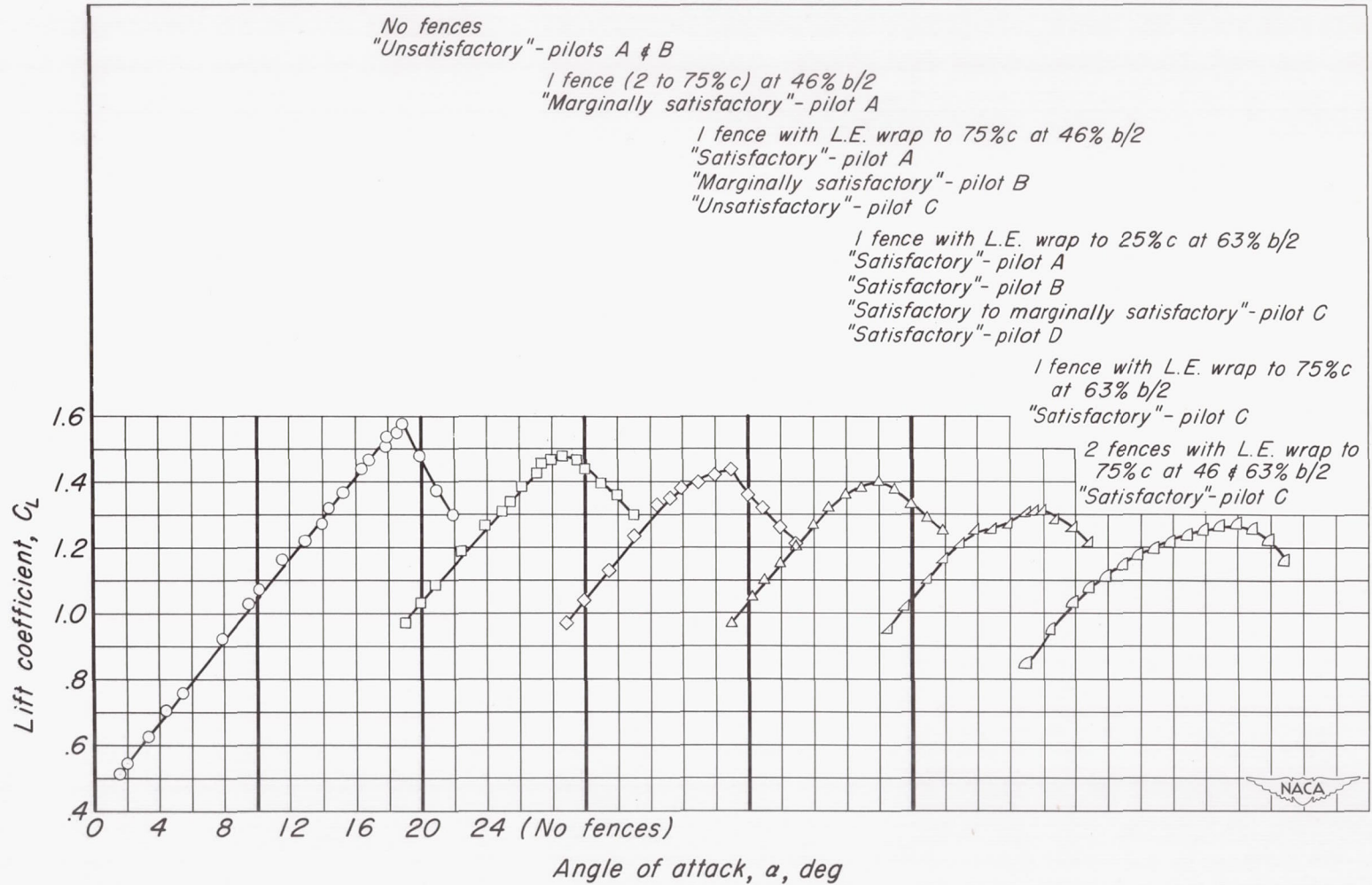
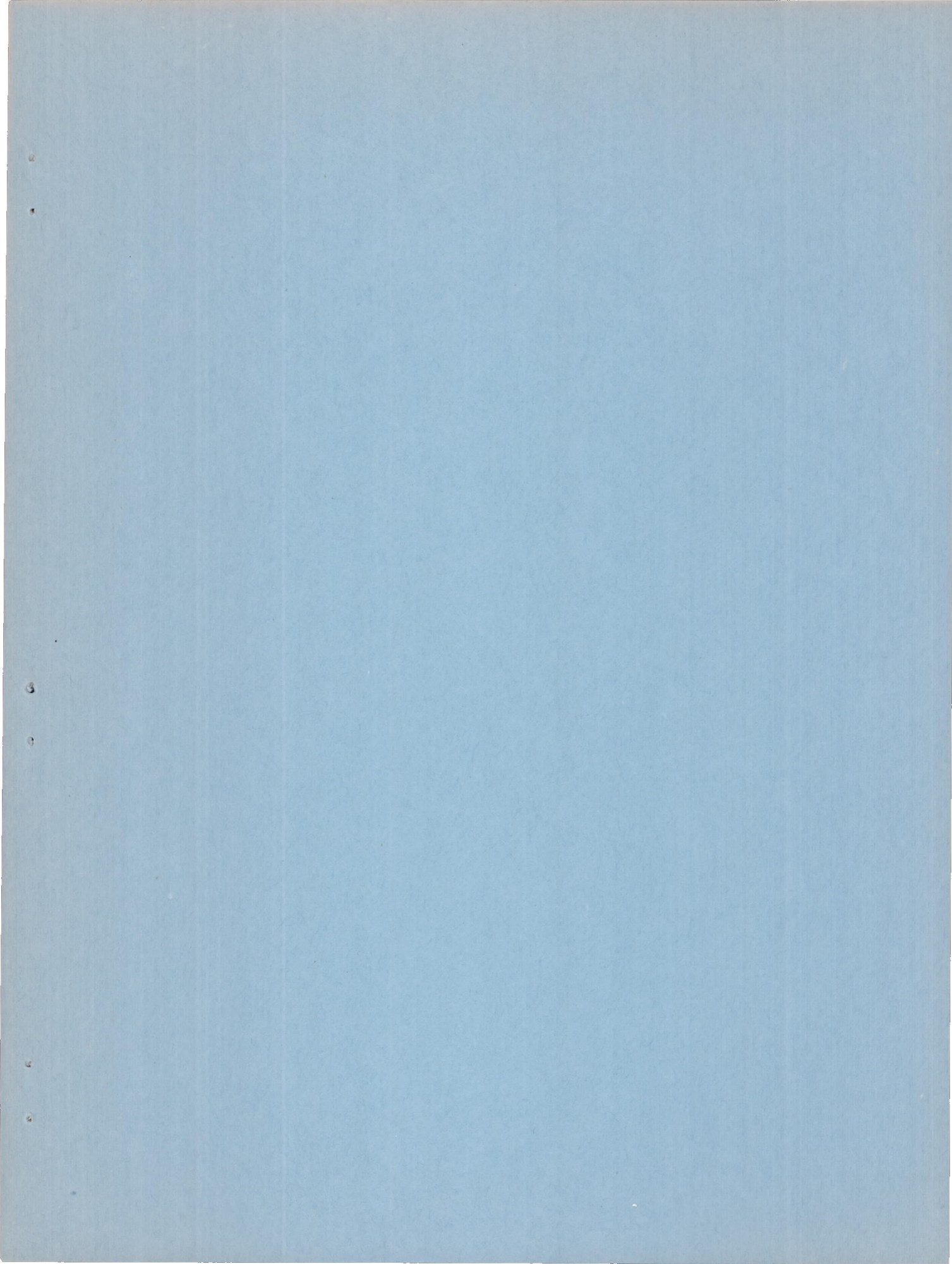

Figure 7.- Lift curves for various configurations measured in flight with cambered leading edge. Flaps down.





SECURITY INFORMATION

RESTRICTED

RESTRICTED