

RESEARCH MEMORANDUM

FACILITIES AND METHODS USED IN FULL-SCALE
AIRPLANE CRASH-FIRE INVESTIGATION

By Dugald O. Black

Lewis Flight Propulsion Laboratory
Cleveland, Ohio

NATIONAL ADVISORY COMMITTEE
FOR AERONAUTICS

WASHINGTON

March 10, 1952
Declassified April 3, 1953

NATIONAL ADVISORY COMMITTEE FOR AERONAUTICS

RESEARCH MEMORANDUM

FACILITIES AND METHODS USED IN FULL-SCALE

AIRPLANE CRASH-FIRE INVESTIGATION

By Dugald O. Black

SUMMARY

The facilities and the techniques employed in the conduct of full-scale airplane crash-fire studies currently being conducted at the NACA Lewis laboratory are discussed herein. This investigation is part of a comprehensive study of the airplane crash-fire problem.

The crash configuration chosen, the general physical layout of the crash site, the test methods, the instrumentation, the data-recording systems, and the post-crash examination procedure are described.

INTRODUCTION

A comprehensive study of the airplane crash-fire problem has been undertaken at the NACA Lewis laboratory. Research of this type was necessary because a detailed study of civilian records of crash fires (reference 1) failed to provide a clear picture of the mechanism of the crash fire and, in addition, the complexity of the problem did not lend itself to an analytical approach. Military records of airplane crash-fire accidents were scanned but the information was inconclusive.

Described herein are the crash configuration chosen, the general physical layout of the crash site, the test methods, the instrumentation, the data-recording systems, and the post-crash examination procedure.

TYPE OF CRASH SIMULATED

The crashes were designed to simulate a take-off accident in which the airplane fails to become air borne; strikes an embankment, shearing off the propellers and the landing gear; strikes trees or poles, rupturing the fuel tanks; then slides along the ground to a standstill. In this type of crash, fuel and oil lines within the engine nacelles of the test airplanes are often disrupted causing extensive exposure of

the inflammable materials; that is, gasoline, oil, and hydraulic fluids. The airplanes were caused to strike a barricade at take-off power with all airplane systems functioning; therefore, the maximum array of potential ignition sources was present. The type of test selected thus contained the elements of a very severe fire hazard although the test was considered to be survivable for a majority of the occupants from the standpoint of impact.

The NACA full-scale crash-fire investigation was conducted on C-46 and C-82 airplanes of the type shown in figure 1. The United States Air Force provided valuable assistance in conducting the investigation by supplying the war-weary and obsolete test airplanes.

The diagrams presented in figure 2 show how the barriers on the crash site produced the type of crash desired. The airplane as it approaches the crash barrier is shown in figure 2(a). First, the propellers of the airplane contact the crash barrier (fig. 2(b)); second, the main landing-gear wheels come in contact with the crash barrier (fig. 2(c)); and third, the leading edge of the wings come in contact with the pole barrier (fig. 2(d)).

CRASH SITE AND TEST METHODS

The crash tests were conducted on a portion of the United States Army Ravenna Arsenal. A plan view of the test site is shown in figure 3. The preparation or launching area includes operations building, airplane parking strips, and storage area. A runway for guiding the unmanned airplanes is located between the launching area and the crash area. The crash area includes the crash barrier, the pole barrier, the fire-protection system and the camera platforms. Electric and telephone lines connected each platform with the operations building. Located on the southern edge of the test site is an unpaved strip for landing the airplanes that were used in the crash-fire investigation. The airplanes were towed from the landing strip over the connecting roads to the airplane-storage area.

Plan and profile views of the crash area in which the crash-fire investigation was conducted are shown in figure 4. Photographs showing the side and front views of a C-82 airplane being prepared for a crash test are presented in figures 5(a) and 5(b), respectively.

The specially prepared runway and the center rail used to guide the test airplanes to the crash barrier are shown in figure 6. The rail and the runway were 1700 feet long. The runway was constructed of two concrete strips 10 feet wide separated by 15 feet. Between these two concrete strips one 80-pound rail was installed.

Two methods were used for guiding the unmanned test airplanes down the runway to the crash barrier. The C-46 airplanes, which have a conventional landing gear, were guided by a truss attached to the axles of the main landing gear and a slipper attached to the center rail (fig. 7). The 2-foot-long guide slipper was designed to fit around the top flange of the rail in such a manner that it would be impossible for the slipper to leave the rail in either a vertical or lateral direction.

In order to support the C-46 airplane in flight attitude as it proceeded down the runway, a tail truss was bolted to the lugs on the tail-wheel bulkhead (fig. 8), the tail-wheel assembly having been removed. Welded to the bottom of the tail truss was a 4-inch I-beam which was attached to a 1/2-inch-thick steel plate that slid along the top of the center rail (fig. 8).

For tricycle-type landing-gear airplanes, such as the C-82, the guide slipper was attached to the axle of the nose gear as shown in figure 9. The guide slipper on the C-82 airplanes was the same as those used on the C-46 airplanes.

An anchor pier (fig. 10) was erected at the end of the guide rail in the preparation area to retain the airplane under take-off power without brakes just before release. It was constructed of four separate concrete piers set in the ground with heavy iron framework connecting them. The restraining cable attached between the anchor pier and the glider tow mechanism of the C-82 airplane is shown in figure 5(a).

The crash barrier used to disrupt the engine propeller and to remove the main landing gear of the C-46 airplane is shown in figure 11(a). It was constructed of 8-foot-long wooden railroad ties interlocked and spiked together to form a hollow cube approximately the height of the main landing-gear wheels. This hollow cube was then filled and packed with dirt. Dirt was removed from between the abutments when tests were made with the C-82 airplanes to allow the low fuselage of the airplane to slide between the abutments as shown in figure 11(b).

The poles installed behind the crash barrier simulated trees which ruptured the wings and fuel tanks of the airplanes. These poles, which had a minimum diameter of 10 inches, were buried 5 feet below the surface of the ground at a 45° angle. Each pole had seven 1-inch-diameter steel spikes 9 inches long protruding 4 inches above the upper surface and spaced 12 inches apart as shown in figure 12. The location of the two poles used in the tests with the C-46 airplane are shown in the sketch on figure 13. The location of the four poles used in the tests with the C-82 airplane are shown in figure 14. Because of differences in construction of the fuel tanks in these airplanes, four poles were required in the C-82 crash tests to duplicate the rate of fuel spillage obtained with two poles in the C-46 crash tests. A photograph showing the damage to the left wing and the fuel tanks of a C-82 airplane produced by the pole barriers is presented in figure 15.

Before the airplane was released for its run to the crash barrier it was necessary to have the engines operating at full take-off power.

Operation of the engines from outside the airplane was accomplished by installing a hydraulic remote-control mechanism that was attached to the throttles in the cockpit and actuated by a control installed on the outside of the fuselage at the rear. The control for operating throttles, instrument-box light, airplane release cable, engine speed, and manifold-pressure indicators were located on the left side of the fuselage at the rear door (fig. 16). The instrument box cable was attached to a switch which provided power to the instruments inside the fireproof box and the light indicated that all instruments were energized.

The engines were started and checked out by operators in the cockpit of the airplane prior to release. After the engines were checked out and engine speed was reduced to approximately 1100 rpm, the remote-control mechanism in the cockpit (fig. 17) was attached to the throttles and personnel cleared from the airplane. Upon notification to release the airplane, the engines were accelerated to take-off power from the remote-control position and the cable of the glider-tow mechanism, which released the cable attached to the airplane, was pulled.

Camera platforms, from which motion pictures of the crash were recorded, were located at seven places around the crash area (fig. 3). Each platform was constructed of steel framework and armour plate for protection against flying debris (fig. 18). The height above the ground varied with each platform according to the requirements imposed by the terrain of the crash area.

A fire-protection system was constructed in the crash area to confine the fire to the crash zone. This system consisted of a water well, reservoir, pumper, underground lines, outlets, and ditches. A gasoline driven pump with a 500-gallon-per-minute capacity supplied water through underground pipes to two outlets located one on each side of the crash area as shown in figure 3. Two valves were contained in each outlet to which 300 feet of flexible hose was attached (fig. 19). A small ditch was excavated around the crash area to confine the spilled gasoline to the area.

INSTRUMENTATION AND DATA RECORDING

Special instruments were required to measure temperature, combustible vapors, and decelerations; and to detect fuel-line failures and short circuits or arcs. Instrumentation was also included to take samples of the cabin-air during the course of the fire after crash. Additional measurements, obtained in the insulated instrument box by photographing the instrument panel, included:

- (1) Instrument-box temperature
- (2) Engine speed
- (3) Engine-manifold pressure
- (4) Airplane air speed
- (5) Time

Data were recorded by photographing indicating gages mounted on a panel. The instrument panel and the cameras were mounted in a fireproof box. The fireproof box was designed to hold the instrument recorders required in the crash-fire tests and to protect such instruments during crash impact and subsequent fire. The details of the various pieces of equipment and instruments are described in the following paragraphs.

Fireproof instrument box. - It was necessary that the temperature inside the instrument box remain below 200° F in order to protect the motion-picture film in the cameras. A sketch of the fireproof instrument box showing the general dimensions and type of construction is presented in figure 20. The inside dimensions were: length, 8 feet; width, 5 feet; and height, 4 feet. The box was constructed of three 1/16-inch-thick black-iron boxes nested together with 3 inches of insulation between the inner and center boxes; 3 inches of water between the center and outer box walls with 1 inch and 5 inches of water on the bottom and the top, respectively. The inner box was shock mounted to the center box by rubber mounts to help absorb the shock of the crash. Figure 21 shows the construction of the instrument box before the top was installed. This view shows the space for insulation, water jacket, and rubber mounts. The instrument panel was mounted at one end of the box as shown in figure 22. Batteries for power, potentiometer, cameras, junction box, cabin-air sampling containers, and timer were located at the opposite end of the box as shown in figure 23; figure 24 is a close-up view showing the installation of the cameras, junction box, and timer for cabin-air sampling system.

Installation of fireproof box. - The fireproof instrument box was installed in the fuselage of the C-82 airplane as shown in figure 25. The box was so mounted that it could slide forward on the floor of the fuselage yet it was restrained from lateral or downward motion by wire cables attached between the sides of the box, near the bottom, and the front and rear spars of the airplane. Six loops of 5/8-inch-diameter rubber shock-absorber cords and wire cables were fastened between the rear of the box and an I-beam reinforcing the rear of the fuselage as shown in figure 25. Stretching of the shock-absorber cord allowed the box to move forward thus helping to absorb part of the impact shock.

The installation of the restraining system employed in front of the instrument box to prevent the recoil of the shock absorber cord is shown in figure 26. Two rods were attached to the front of the box and extended forward to the pawls located on a universal joint circled in figure 26. The pawls retained the notched rods in the extended position as the box moved forward.

The fireproof instrument box used in the C-46 airplanes and the mechanical principle of restraining the box was the same as for the C-82 airplane. In figure 27, the box installed in the C-46 airplane is shown.

Data recorded outside instrument box. - Prior to the release of the airplane down the runway, fuel, oil, and ground temperatures were recorded. The fuel was heated prior to fueling the test airplane. The final temperature of the fuel in the airplane was the same (within $\pm 5^\circ \text{F}$) for all tests. The oil temperature was indicated by an oil-temperature gage in the cockpit and recorded by the operator just prior to leaving the airplane before release. The ground temperature was taken by an immersion-type thermometer which took temperatures on the surface, 1 inch, and 6 inches below the surface just prior to the crash test.

Camera timing lights. - Timing lights were installed on the airplane for the purpose of synchronizing the cameras located around the crash area with the cameras located in the insulated instrument box.

The lights were so located on the airplane that each of the cameras around the crash area would photograph at least one set of lights regardless of the position of the airplane in the crash area. One set of lights was installed on top of the fuselage above the cockpit as shown in figure 28(a); one set was installed on each wing tip as shown in figure 28(b); and another set was installed on the outboard side of each vertical stabilizer (fig. 28(c)). All the lights were connected to a clock-timer mechanism located in the insulated instrument box. This timer also controlled an indicating light so installed on the instrument panel in the fireproof instrument box that synchronization of the external light with the instrument panel light was obtained. In this way, the panel instrument readings could be related to the motion-picture records obtained by the cameras stationed around the crash area.

Fire detectors. - Thermocouples were used to detect the origin and spread of flame throughout the aircraft structure. A typical thermocouple installation of a completely instrumented airplane is shown schematically in figure 29; coverage of the nacelles, wings, and fuselage was obtained by use of 102 thermocouples. The greatest number of thermocouples were located in the nacelles near the exhaust-disposal system where the fire was likely to originate. Each thermocouple was connected to a meter on the instrument-box panel.

The thermocouples used in the first two tests were fabricated by twisting and welding the ends of number 14-gage asbestos-covered iron-constantan lead wire. This construction was selected primarily for ruggedness and ability to withstand what was expected to be severe usage. The lines from the thermocouple fed to insulated junction boxes. These boxes were fastened rigidly to the floor of the fuselage ahead of the instrument box. A lead covered telephone cable containing 51 pairs of number 22-gage wires connected these junction boxes to the instrument box where the lines terminated at standard A.C. U.S. Army type B-11 cylinder head temperature indicators installed on the instrument panel. The indicators read to 350° C.

Analysis of the data of the first two tests indicated that it would be desirable to increase the sensitivity of the flame-detecting thermocouples to be certain that the passage of single flame fronts would be indicated. A multiple thermocouple, or thermopile, was developed. The thermopiles were shaped like a W as shown in figure 30 with two of the thermocouples exposed and one shielded by taping with glass cloth. The thermocouples were made of 28-gage iron-constantan wire. This arrangement proved to have a sensitivity comparable to a 32-gage wire thermocouple. In addition, the original ruggedness was not seriously reduced.

Backfire indication. - Backfires often follow the sudden stoppage of engines in a crash. The importance of backfires as potential ignition sources was therefore evaluated. A reliable method of detecting backfires was required; this was accomplished with a single thermocouple suspended in the number 14-cylinder intake duct of each engine. The thermocouple was fabricated of 32-gage iron-constantan wire and soft-soldered to number 14-gage iron-constantan asbestos-covered thermocouple lead wire connected to an army B-11 dual-cylinder-head temperature indicator modified to read 350° F full-scale. Passage of the flame of the backfire produced a momentary deflection of the temperature indicator amounting to approximately 70 percent of full-scale.

Cabin temperatures. - Radiant- and ambient-temperature measurements were taken at various locations in the pilot and passenger compartments of the airplane to obtain a time-history of these cabin temperatures during the fire following the crash.

The radiant temperatures were measured by a 24-gage iron-constantan thermocouple located at the center of an 8-inch diameter hollow copper sphere (fig. 31) having a 1/64-inch wall thickness. The outsides of the spheres were painted a flat black. The thermocouple was connected to the instrument box in the manner previously described. The army B-11 dual-cylinder-head temperature gages used to indicate the temperature were modified to read to 350° F full-scale.

Ambient temperatures were measured by a shielded, number 20-gage iron-constantan thermocouple located adjacent to the black copper sphere as shown in figure 31. These thermocouples were wired in the same manner as the radiant-temperature thermocouples.

All cabin-air thermocouples were located 3 feet above the floor in the pilot and passenger compartments of the airplane.

Cabin-air analysis. - In order to determine the concentration of carbon monoxide, carbon dioxide, oxygen, and hydrocarbons in the cabin atmospheres during a crash fire; samples of air were taken from the pilot and passenger compartments by an air-sampling unit installed in the instrument box. This unit consisted of aluminum bottles, vacuum pump, timer, and solenoid valves as shown in figure 32.

The air samples were conducted to the aluminum bottles by two 1/2-inch-diameter copper lines, one terminating in the pilot compartment and the other in the passenger compartment. These bottles were equipped with two electrically actuated solenoid valves and two manually operated valves. An electrical timer actuated the solenoid valves at a predetermined time.

In the operation of the air-sampling unit, the electric timer and vacuum pump were turned on just prior to release of the airplane down the runway. The vacuum pump purged the lines and sampling bottles while the timer controlled the position of the solenoid valves. The first air samples were taken simultaneously from the pilot and passenger compartments 1 minute after impact. Additional air samples were taken at 1-minute intervals until all bottles were filled. Lights on the instrument panel indicated when the solenoid valves closed on each bottle. Small needle valves on each end of the sampling bottles were closed manually immediately upon opening the instrument box after crash to minimize possible contamination of the air sample by a leaky solenoid valve.

The apparatus used in analyzing the cabin-air samples in the aluminum bottles was a five-gallon bottle of exhaust-gas-saturated water, an Orsat apparatus, and a copper oxide combustion furnace. The composition of the cabin-air sampling bottles precluded the use of mercury as a displacing solution and as exhaust gas saturated water was found to be satisfactory, it was used throughout. National Bureau of Standards colorimetric tubes were used to determine the carbon monoxide content, the Orsat apparatus to determine the carbon dioxide and oxygen content, and the copper oxide furnace to determine the concentration of combustibles present.

Combustible-vapor detector. - Combustible vapor was detected with a vapor detector as shown in figure 33.

The locations of the vapor detectors (fig. 29) were chosen as the most likely paths that combustible vapors may follow throughout the structure of the aircraft. Each detector consisted of a 24-volt army-type C-1 booster coil sealed in a black iron body, a copper mesh screen, and two thermocouples. The booster coil supplied a spark which was totally enclosed in the copper screen that acted as a Davy safety shield. As a combustible vapor passes through this screen and comes in contact with the spark, burning occurs inside the screen. A thermocouple installed inside the screen was used to indicate when ignition of the combustible mixture within the screen occurred. An additional thermocouple, located outside the screen, was connected in series with the thermocouple inside the screen and indicated passage of a flame front. With this arrangement, a positive reading would indicate a combustible vapor; a negative reading, fire; and an ambient-temperature rise would not change the reading.

The power line from the batteries to the booster coil was a number 14-gage solid-nickel wire, covered with 0.035-inch felted and braided asbestos to protect it from the fire. The 32-gage thermocouple wire was connected to a number 14-gage-asbestos covered thermocouple lead wire, which ran directly to the instrument box and was connected to the thermocouple indicators which read to 250° F full-scale.

Exhaust-stack temperatures. - Because the hot metal of the exhaust-disposal system is recognized as a potent source of ignition, a temperature-history of this system in a crash was obtained by welding number 14-gage chromel-alumel thermocouples to the exhaust system at various locations. These locations were chosen as the hottest zones on the basis of ground tests made with similar nacelle installations. The eight locations chosen are shown on figure 34. Instrument panel gages capable of reading up to 2000° F were used to indicate these temperatures.

Detection of electric-system failures. - In order to detect electric-system failures that could provide ignition sources, shunted ammeters were installed in the electric system of the test airplanes. All ammeters registered from 0 to 300 amperes. Shunts used in this installation provided a 50-millivolt voltage drop, which corresponded to a short circuit when 300-amperes flowed. These shunts were placed in the electric lines at various locations throughout the airplane (fig. 35) and connected to ammeters installed on the panel in the instrument box by asbestos covered number 14-gage solid-nickel wire. Abnormally high currents caused by arcing of a broken power line were measured by the shunts and the ammeters.

A voltmeter was connected across the airplane-battery terminals to indicate whether current variations measured in the electric circuits could be attributed to battery voltage variations.

Detection of fuel-system failures. - The fuel-system pressure was recorded to provide an indication of a fuel-line break and the time at which it occurred. Fuel-line pressure was transmitted electrically by means of a pressure switch, which was installed in the fuel line between the carburetor and the engine, to a light on the panel in the instrument box. When the fuel pressure at the point of measurement fell below 10 pounds per square inch gage, a break in the fuel line or fuel shutoff was indicated and the pressure switch opened the electric circuit thus extinguishing the indicating light on the instrument panel.

Acceleration of airplane components. - Several systems were tried in the various crash airplanes to determine the best possible means of recording accelerations to which the airplane components are subjected. In addition to measuring component accelerations, forces were measured on the shoulder and seat harnesses of dummies strapped in seats.

Three systems installed in the C-46 airplane for the third crash were as follows:

- (1) NACA telemetering
- (2) Vacuum tubes
- (3) Pilot-seat-ejection recorder

Variable-inductance accelerometer-pickups that recorded through a telemetering system were installed in the aircraft because investigations at the NACA Langley laboratory have indicated that this system was one having low zero shift and high accuracy. Two telemetering transmitters, operating on 134 and 150 megacycle frequencies, were installed on the passenger compartment floor forward of the instrument box. The transmitting antennas were mounted at about 45° angles on the sides of the fuselage 2 feet below the top. Two pickups for measuring structural accelerations were installed in each of four locations in the aircraft as shown in figure 36. These pickups were mounted on angle brackets and aligned in the horizontal and vertical planes with the aircraft in flight attitude. Two pickups were mounted on brackets on the left- and right-wing lifting attachment points for rigidity (fig. 36). These pickups indicated wing accelerations, which could be correlated with accelerations determined with the vacuum tubes. The other two pair were located close to the dummies in the fuselage of the aircraft (fig. 36) so that harness strain-gage data could be related to the telemetered accelerometer data.

The vacuum tubes employed in the third crash were an improved version over the vacuum tubes previously used. The improved version provided overload stops on both plates, an additional cup to remove more of the gases from within the tube and the plate support rods decreased

from 0.015-0.010-inch diameter. This vacuum tube, used as a transducer, was a dual diode tube which is essentially a pair of rectifiers connected in series and having a common cathode. As accelerating forces acted on the tube, the plates moved a distance proportional to the acceleration force. One plate moved toward the cathode and the other away from it thus the effective resistance of one-half of the tube increased and the other decreased as acceleration was applied. This tube was so connected that the two halves were two adjacent legs of a Wheatstone bridge. The electric output was applied directly to a rotating-mirror-type recording galvanometer. The data were obtained on photographic film. The tubes were located in the fuselage and wings of the airplane as shown in figure 36. The boxes in which the pickup tubes were mounted were made of 1/32-inch steel and secured with 1/16-inch by 1/2-inch steel straps to the bracket shown in figure 36.

In the third system, unbonded strain-gage accelerometers were used in conjunction with two 6-channel pilot-seat-ejection recorders. The unbonded strain-gage accelerometers consisted of a thin metal cantilever beam attached to an aluminum frame which was bolted to the point at which accelerations were to be measured. Attached to this cantilever were insulated posts between which thin resistance wires were stretched. As an accelerating force was applied to the system the cantilever beam bent and the wires on one side were stretched, whereas those on the other side were relaxed. Resistance increased in the stretched wire and decreased in the relaxed wire. Both changes were proportional to the amount of bending in the cantilever beam which was proportional to the accelerating force. The wires were connected in a bridge circuit and energized by a constant voltage from the pilot-seat-ejection recorder. The bridge output voltage was proportional to the bridge unbalance voltage which was proportional to the resistance changes previously mentioned. Thus, a voltage proportional to the accelerating force was obtained. The bridge unbalance voltage was detected and used to shift the frequency of a 3500-cycle-per-second oscillator the output of which was recorded on magnetic iron-oxide-coated paper tape. The locations of the recorders and accelerometers are shown in figure 36.

Personnel-seat-harness strain measurement. - In addition to measuring the accelerations in the structure of the airplane, forces were measured in the shoulder and seat harnesses of dummies strapped in the seats. A typical installation of a dummy and the seat located in the pilot compartment is shown in figure 37. The forces applied on the dummy during a crash were measured by strain-gage links threaded through each shoulder and seat harness in such a manner that the strain gages indicated tension in the harness. As tension was applied to the harness by the dummy moving forward during a crash, bending of the side members of the strain-gage links was indicated by the strain gages. The strain-gage links installed on the shoulder and seat harness of a dummy are shown in figure 38. The location of these dummies in the airplane is shown in figure 36. Standard United States Air Force type dummies, each weighing 200 pounds, were used.

Airplane velocity. - The ground speed of the airplane as it approached the crash barrier was determined by timing the passage of the airplane over two microswitches set 10 feet apart, immediately before the crash barrier. As the guide slipper of the airplane passed over each microswitch a voltage was applied to an electronic timer. In the electronic timer one switch started a counter having 0.0001 second increments and the other switch stopped it.

The microswitches described in the preceding paragraph were connected to an oscilloscope. Two pips were put on the oscilloscope by an intensity modulated beam. The oscilloscope was photographed by a camera, which fed film at a uniform rate. The modulation frequency was determined by a 400-cycle-per-second tuning fork whose oscillations were converted to an alternating current voltage that was applied to the oscilloscope intensity grid. The resulting trace was a series of dashed lines, one period representing 1/400 second. The time required to traverse a known distance could therefore be determined and the average velocity computed.

The velocity of the airplane through the crash and subsequent slide was determined photographically. This system was based on poles located between the airplane and the motion picture cameras and 1-foot black marks painted on each side of fuselage and tail boom of the airplane at 1-foot intervals. A black mark painted on the side of the airplane lined up with one of the poles in the crash area as shown in figure 39. It was thus possible to obtain an approximate measure of the airplane speed from the motion pictures by making a frame by frame study of the position of the index marks on the airplane relative to the stationary poles.

Motion-picture data. - Motion-picture cameras located on the various camera platforms around the crash area recorded the airplane approach to the crash barrier, its destruction at the barrier, the slide, and the start and progress of the fire.

Mitchell, Ciné, Fastax, and K-24 cameras, all operated electrically, were used in this investigation. Three Mitchell motion-picture cameras were located on the camera platforms at stations 2, 5, and 7 (see fig. 3). They operated without interruption throughout the crash and were loaded with a 1200-foot reel of 16 millimeter color film. These cameras operated at 128 frames per second as the airplane approached the crash barrier, through the subsequent crash, and slide to rest. The speed was then reduced to 48 frames per second for the remainder of the time. Only the Mitchell cameras were capable of taking motion pictures continuously throughout the crash and ensuing fire.

Two Ciné cameras were installed on camera platforms at stations 3 and 6 (see fig. 3). They were equipped with a 200-foot roll of 16 millimeter color film and operated at 24 frames per second. These two cameras were installed primarily as a precautionary measure in case of failure of the Mitchell cameras.

The Fastax high-speed motion-picture cameras were installed on the camera platforms at stations 1, 4, and 8 (see fig. 3). The camera installed at station 4 was remotely controlled by the operator in station 5. These cameras operated at speeds of from 100 to 1000 frames per second with either 16 millimeter black and white or high-speed color film. The speed and type of film used depended upon light conditions during the test. The film from Fastax cameras was studied to obtain information concerning the actual breakup of the airplane.

On each side of the crash barrier at stations 1 and 8, K-24 cameras, which took 4 by 5 inch pictures in color at three frames per second, were installed. Much detail could be obtained of the breakup of the airplane and subsequent fire because of the size of the picture obtained.

In some tests, a Ciné hand-held movie camera equipped with telescopic lens was used to obtain pictures of the crash from a helicopter at an altitude of approximately 1500 feet. This camera was operated at 24 frames per second by a 24-volt direct-current motor. The photographs thus obtained revealed the area of fuel spillage and flame spread.

STUDY OF AIRPLANE WRECKAGE

The wreckage resulting from the test was carefully studied and photographed to provide a permanent documentation of the findings. The general method followed in taking the photographs was: (1) general over-all views of the airplane, (2) close-up of general areas or major parts, and (3) detail photographs showing specific details of breakage, etc. Each general airplane system that could provide either combustibles or ignition sources was inspected for damage and relevant items were photographed. Additional photographs were taken of the structural damage to the engine, airplane structure, and instrumentation.

The distribution of wreckage was plotted with a plane table and alidade. The following portions of the airplane wreckage and the terrain were identified, recorded, and photographed such as: (1) main landing gear, (2) engine and propellers, (3) sections of the wings, and (4) sliding path, location, and burned-out portion of the airplane. The information obtained by plotting and photographing the distribution of wreckage was transferred to a composite photograph an example of which is shown in figure 40.

Lewis Flight Propulsion Laboratory
National Advisory Committee for Aeronautics
Cleveland, Ohio

REFERENCE

1. Pesman, Gerard J.: Analysis of Multiengine Transport Fire Records.
NACA RM E9J19, 1950.



(a) C-46.

Figure 1. - Airplanes used in full-scale crash-fire investigation.

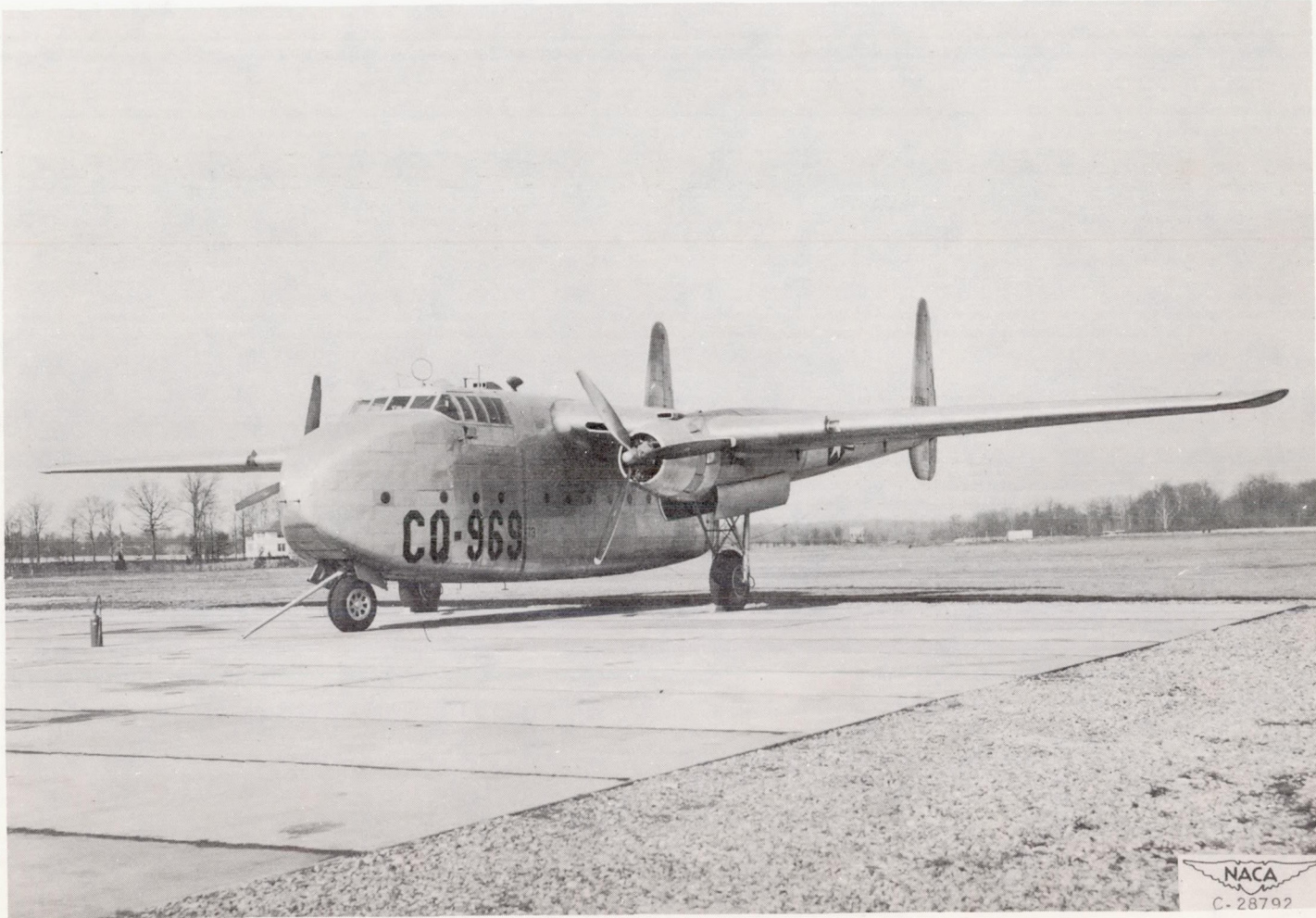

(b) C-82.

Figure 1. - Concluded. Airplanes used in full-scale crash-fire investigation.

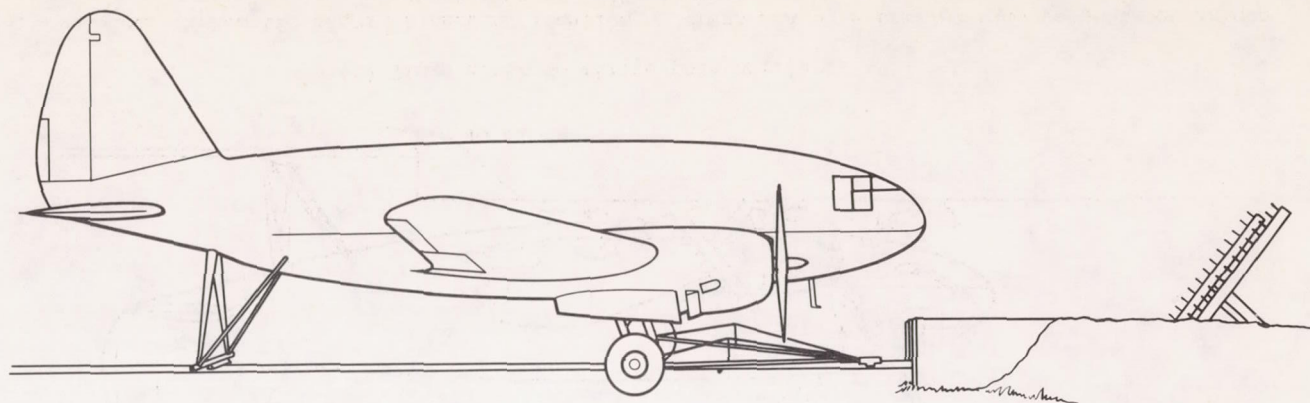

(a) Airplane approaching crash barrier.

Figure 2. - Schematic diagrams showing location of crash and pole barrier with respect to various components of C-46 airplane.

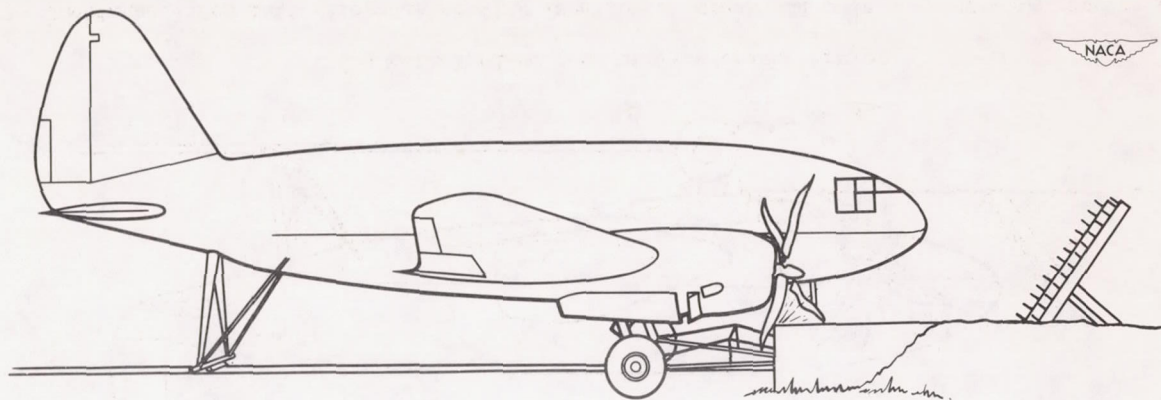

(b) Propeller strikes crash barrier.

Figure 2. - Continued. Schematic diagrams showing location of crash and pole barrier with respect to various components of C-46 airplane.

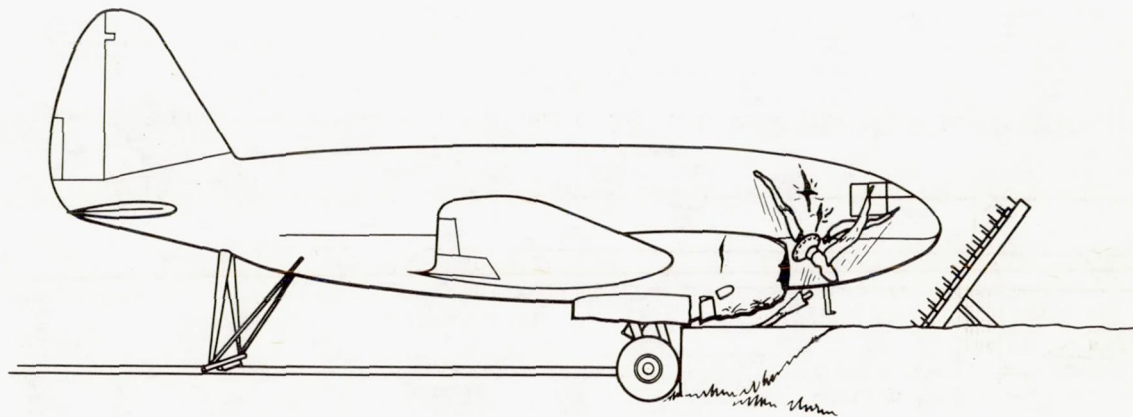

(c) Main landing gear strikes crash barrier.

Figure 2. - Continued. Schematic diagrams showing location of crash and pole barrier with respect to various components of C-46 airplane.

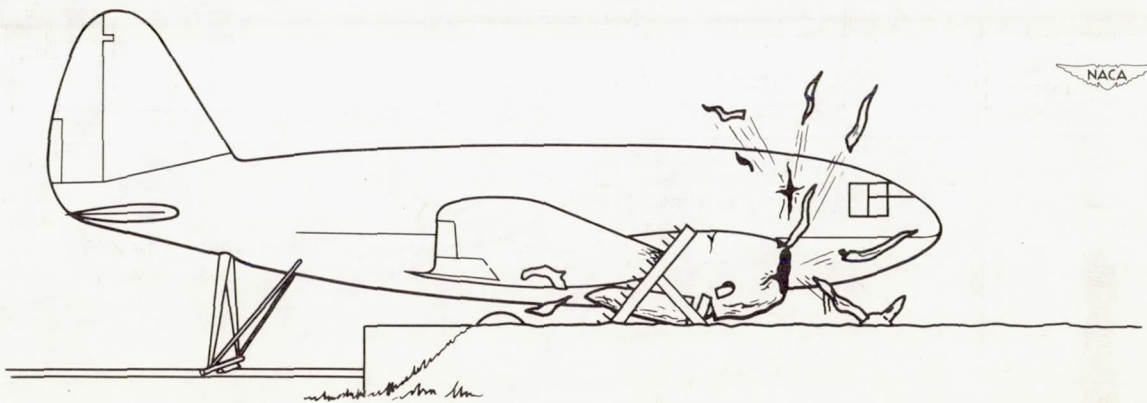

(d) Wings about to strike pole barrier.

Figure 2. - Concluded. Schematic diagrams showing location of crash and pole barrier with respect to various components of C-46 airplane.

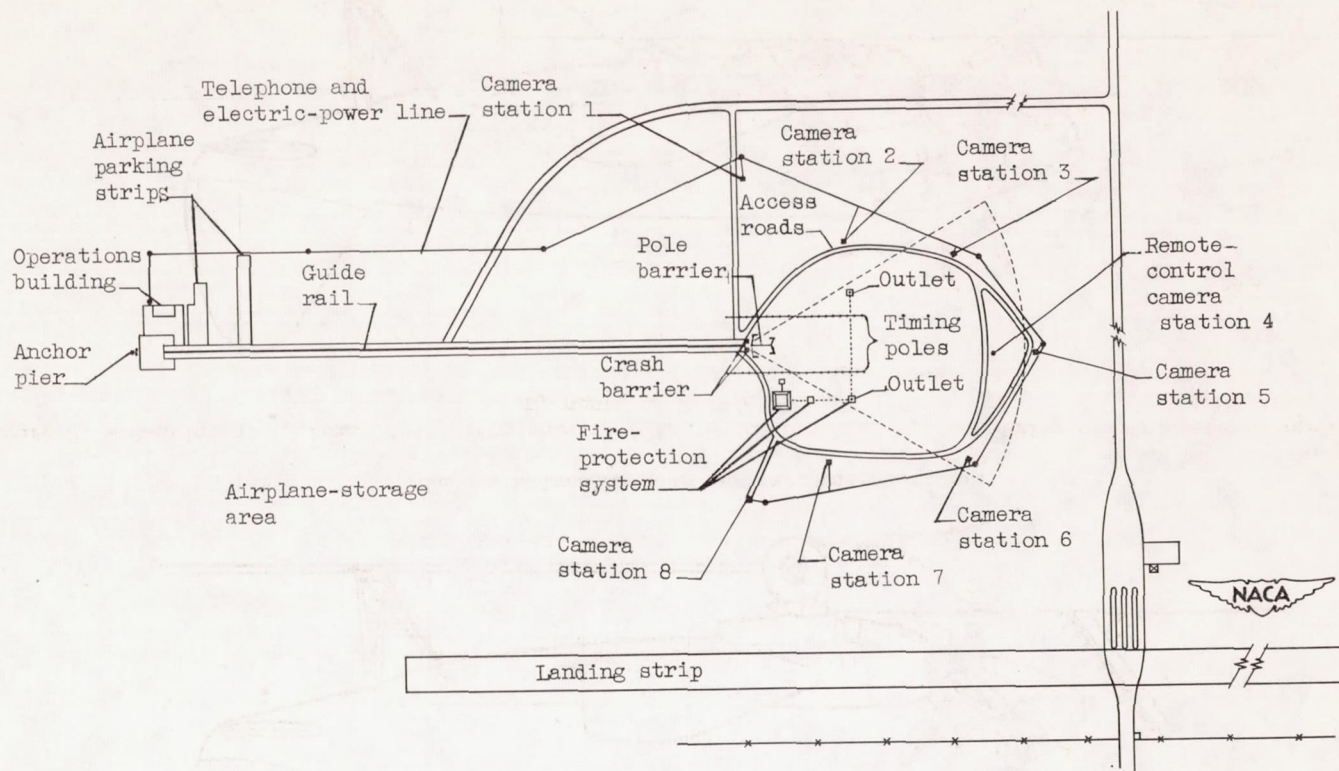
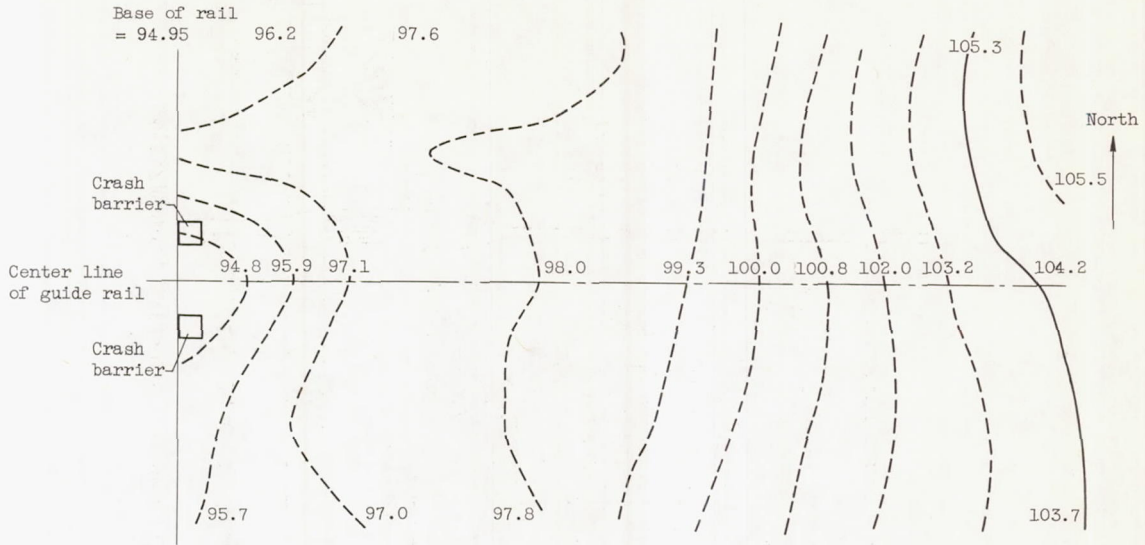
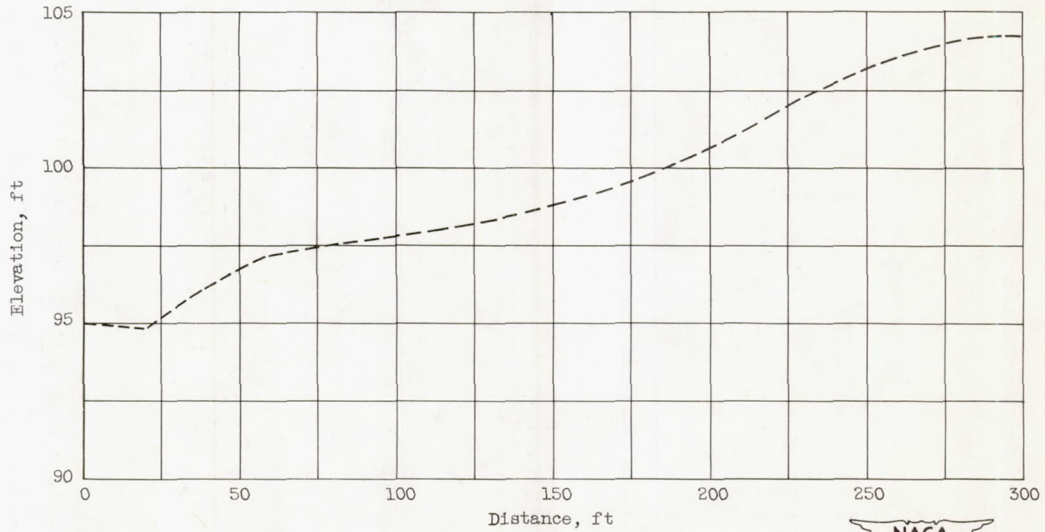

Figure 3. - Plan view of test site for conducting full-scale crash-fire investigation.



(a) Plan view.



(b) Profile view.

Figure 4. - Crash area in which the crash-fire investigation was conducted.



(a) Side view.

Figure 5. - C-82 Airplane being readied in preparation area for test.



(b) Front view.

Figure 5. - Concluded. C-82 airplane being readied in preparation area for test.



Figure 6. - Runway and center rail for guiding airplane to crash barrier.

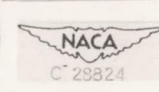
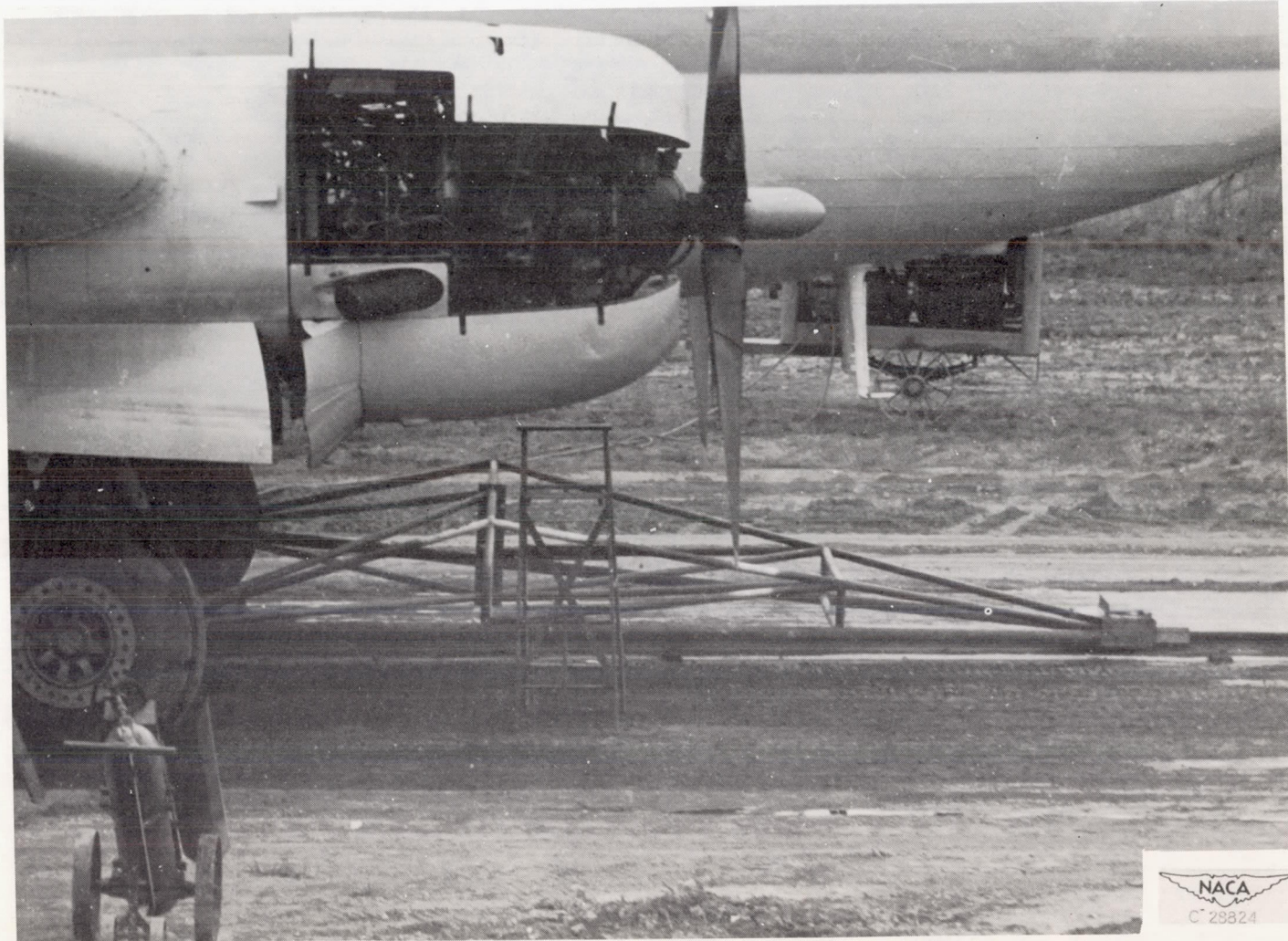

Figure 7. - Guiding truss attached to main landing wheel of C-46 airplane.



Figure 8. - Extended tail-truss support for holding C-46 airplane in flight attitude.

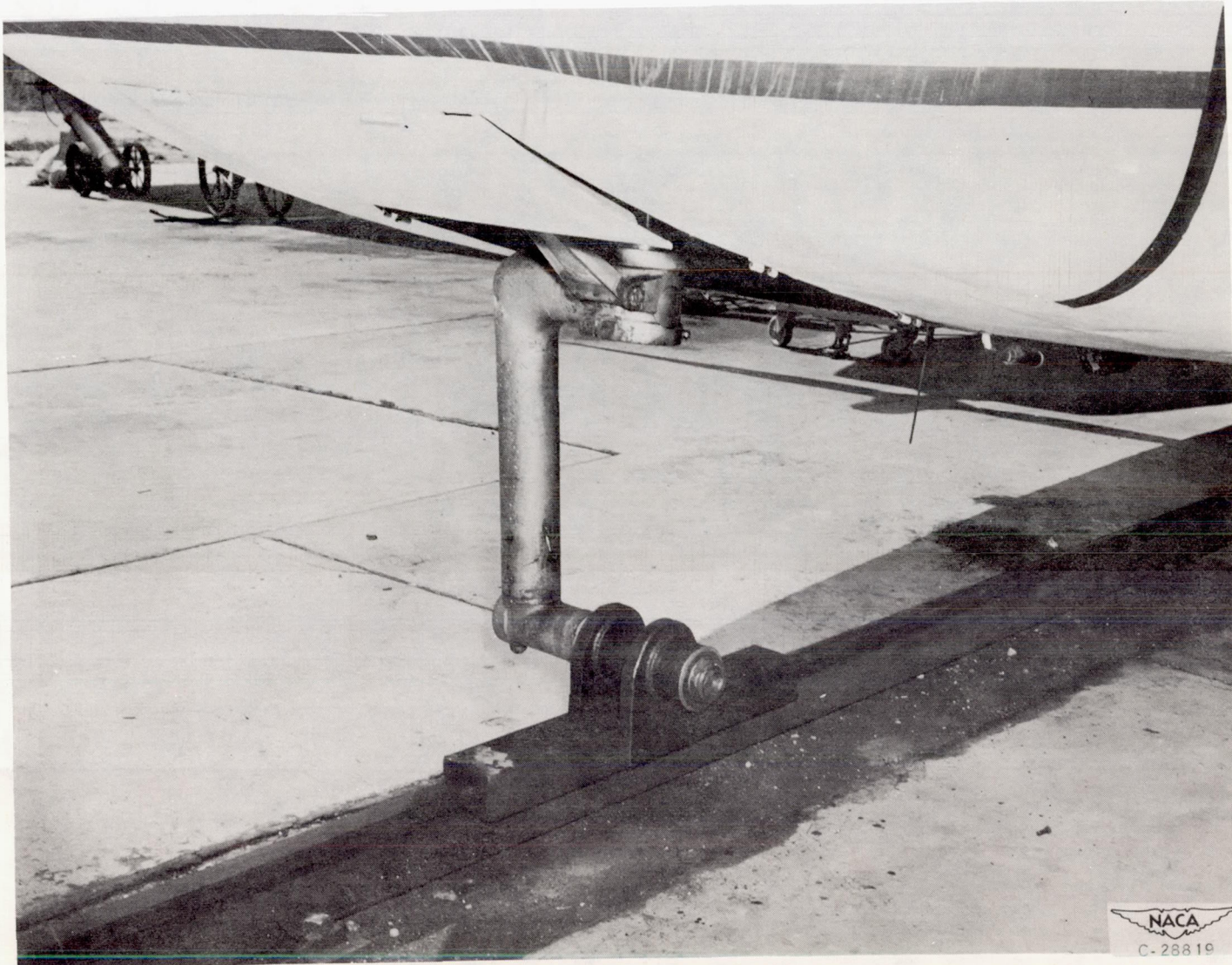

Figure 9. - Guide slipper attached to nose-gear axle of C-82 airplane.

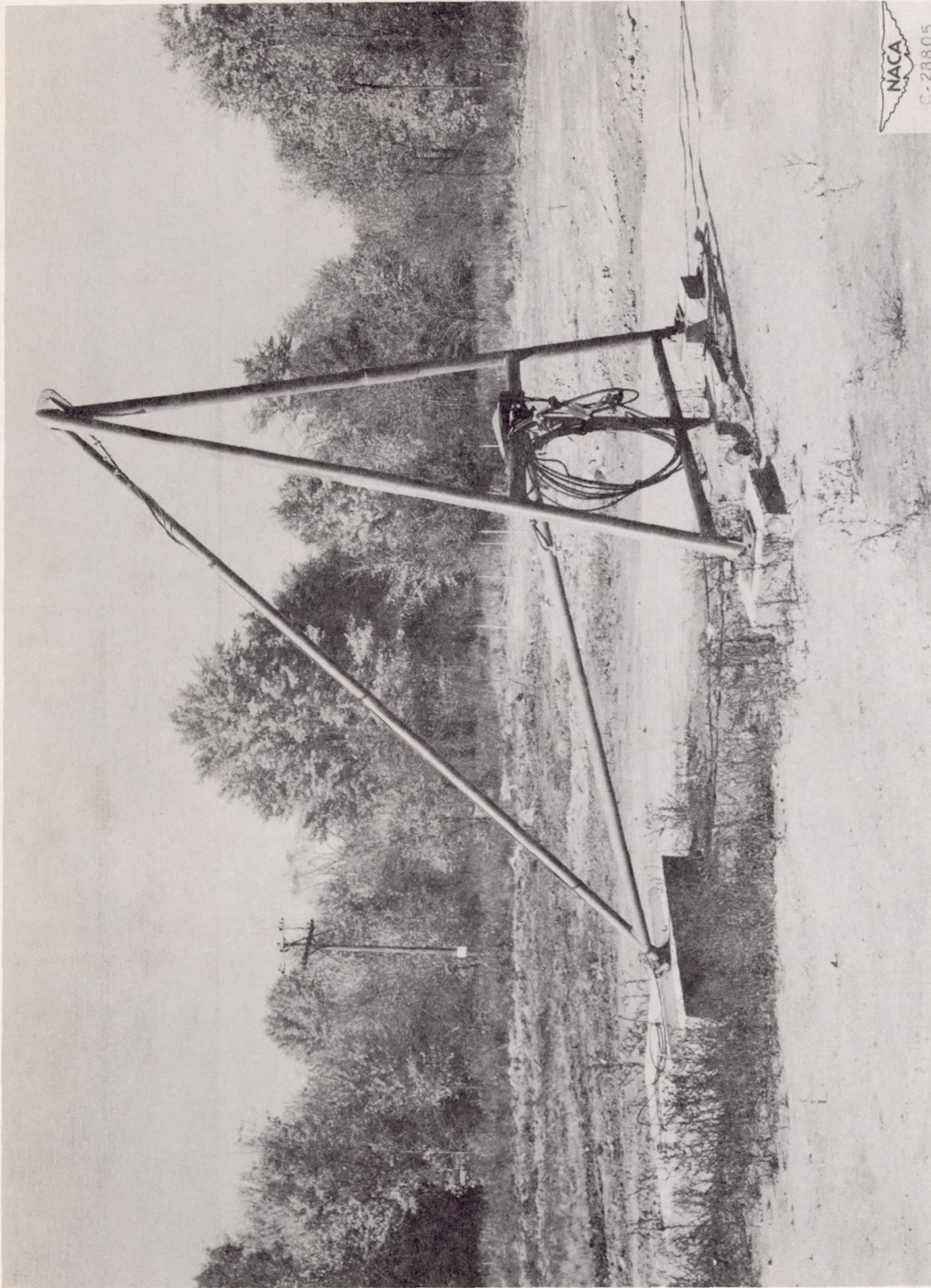
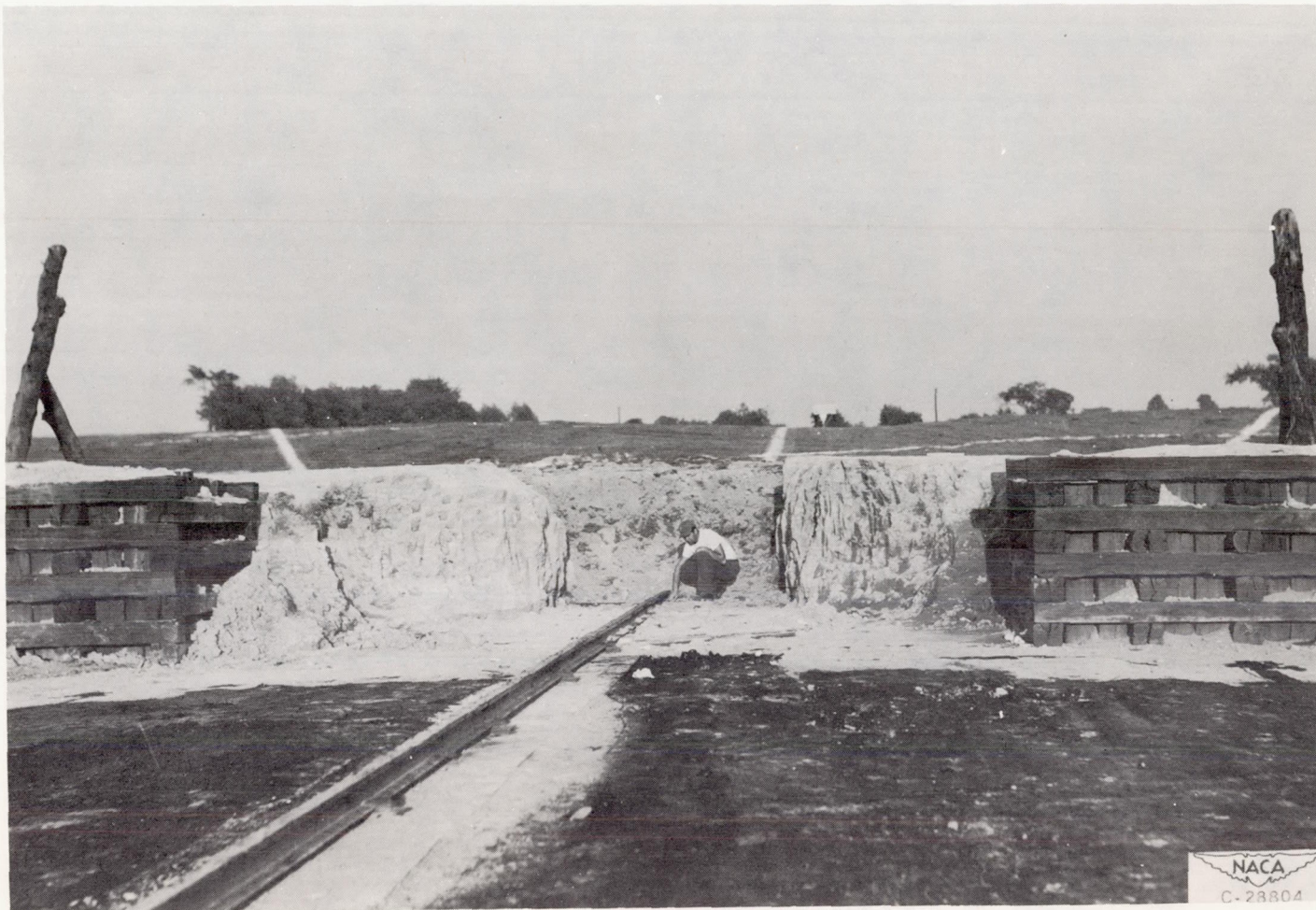
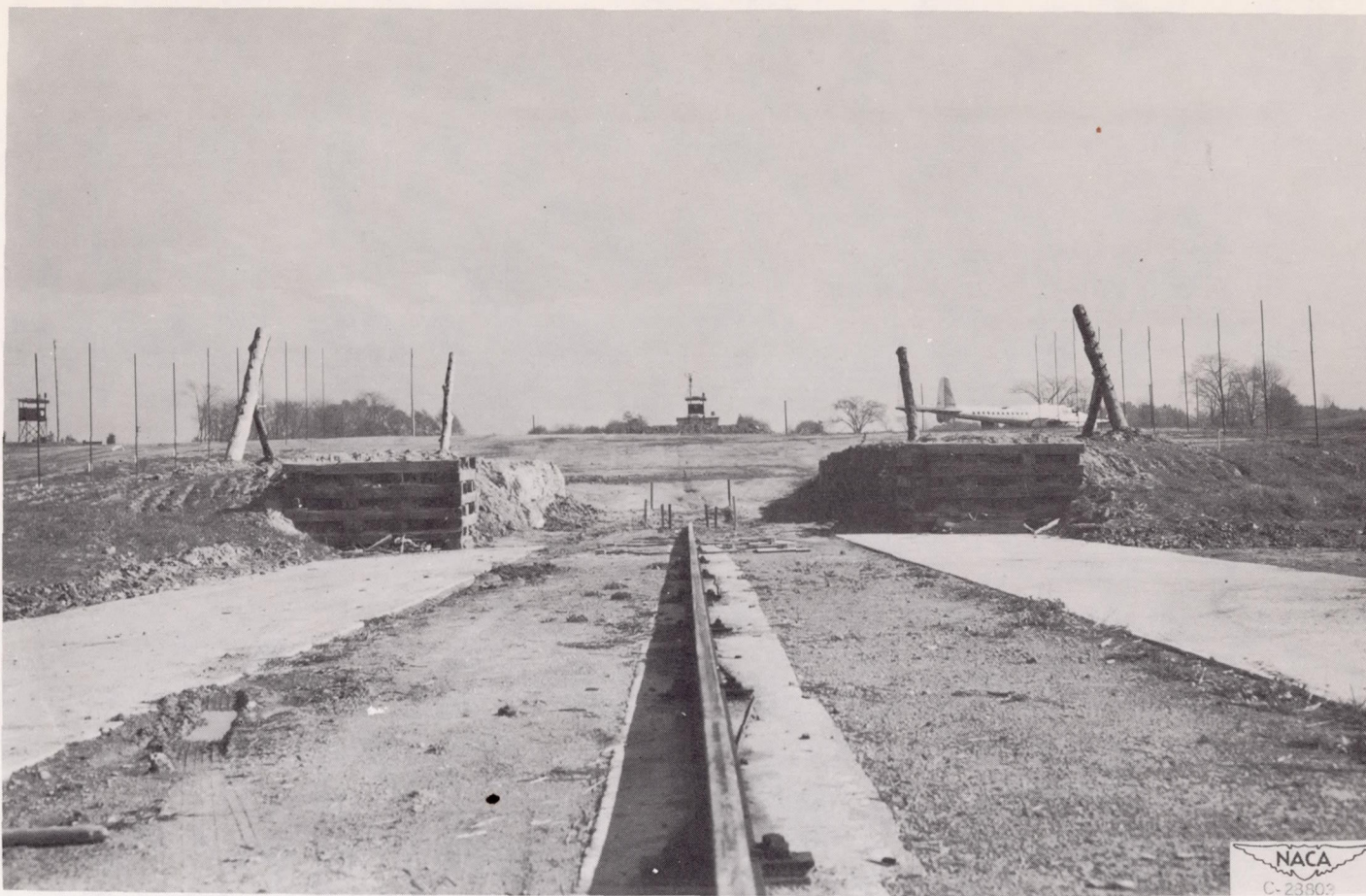

Figure 10. - Anchor pier for retaining airplane before release.



(a) For C-46 airplanes.

Figure 11. - Crash and pole barriers.



(b) For C-82 airplanes.

Figure 11. - Concluded. Crash and pole barriers.



Figure 12. - Close-up of pole barrier showing steel spikes.

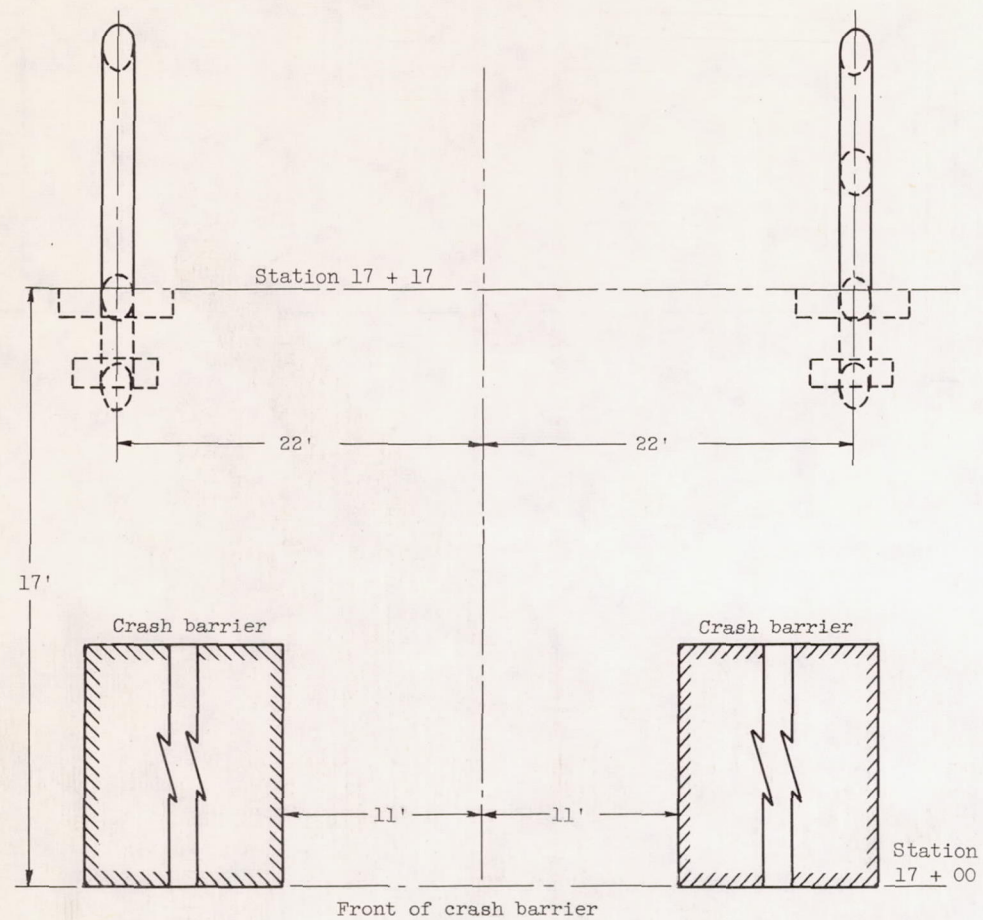

(a) Plan view of crash barrier.

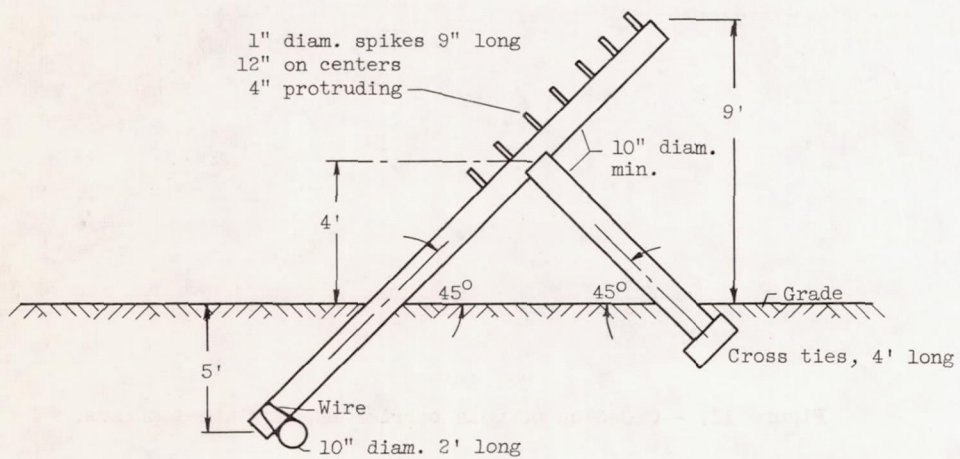
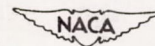

(b) Side view of pole barrier.

Figure 13. - Sketch showing location of pole barrier for C-46 airplane crash tests.

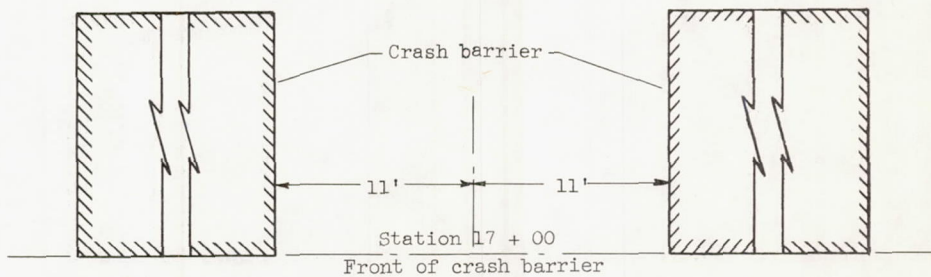
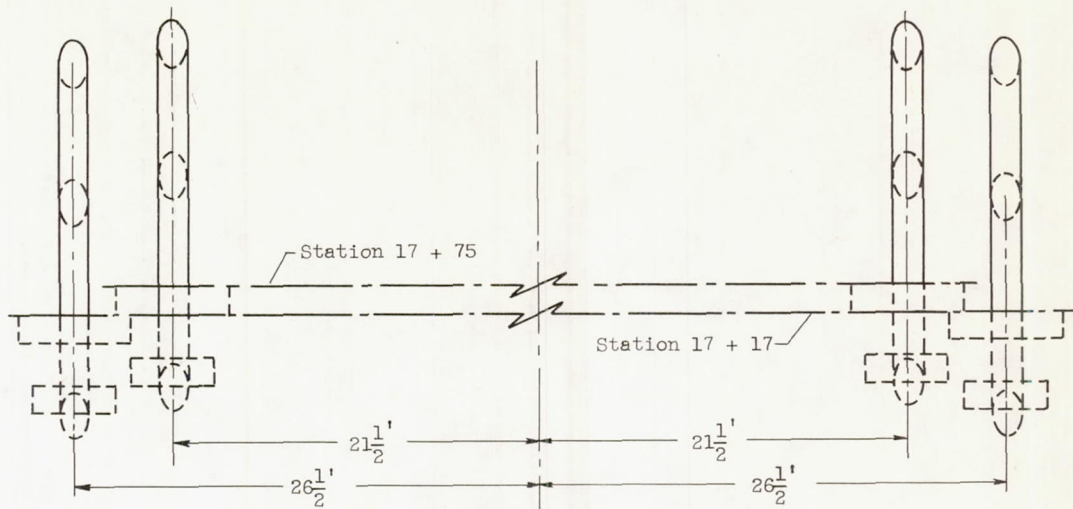

(a) Plan view of crash barrier.

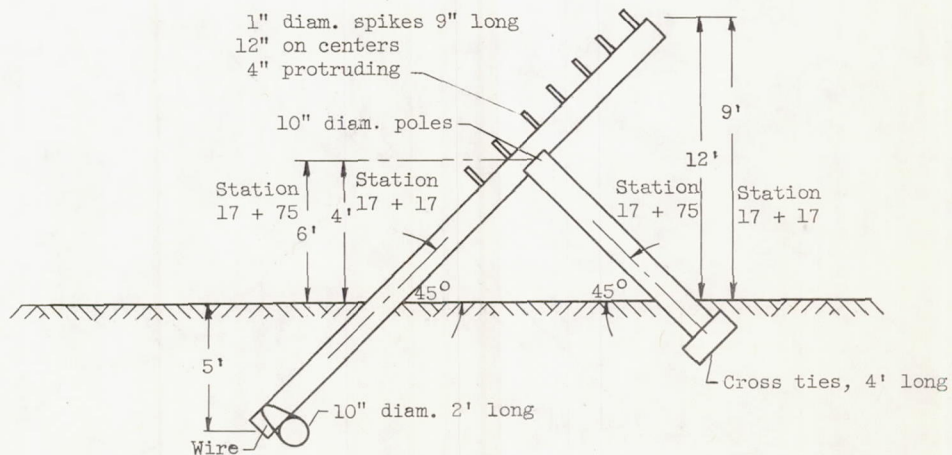

(b) Side view of pole barrier.

Figure 14. - Sketch showing location of pole barrier for C-32 airplane crash tests.

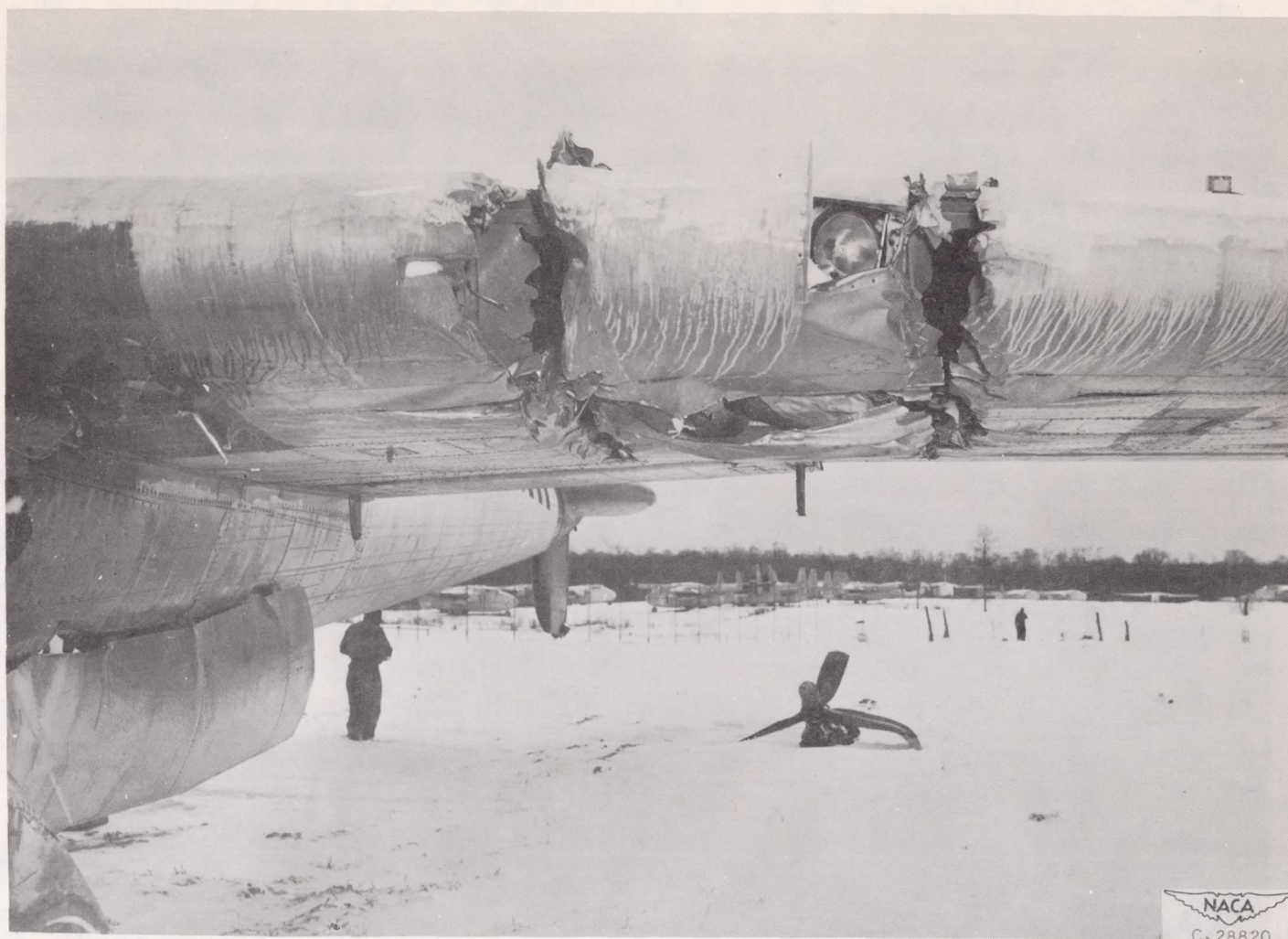

Figure 15. - Damage to left wing and fuel tanks of C-82 airplane produced by pole barriers.

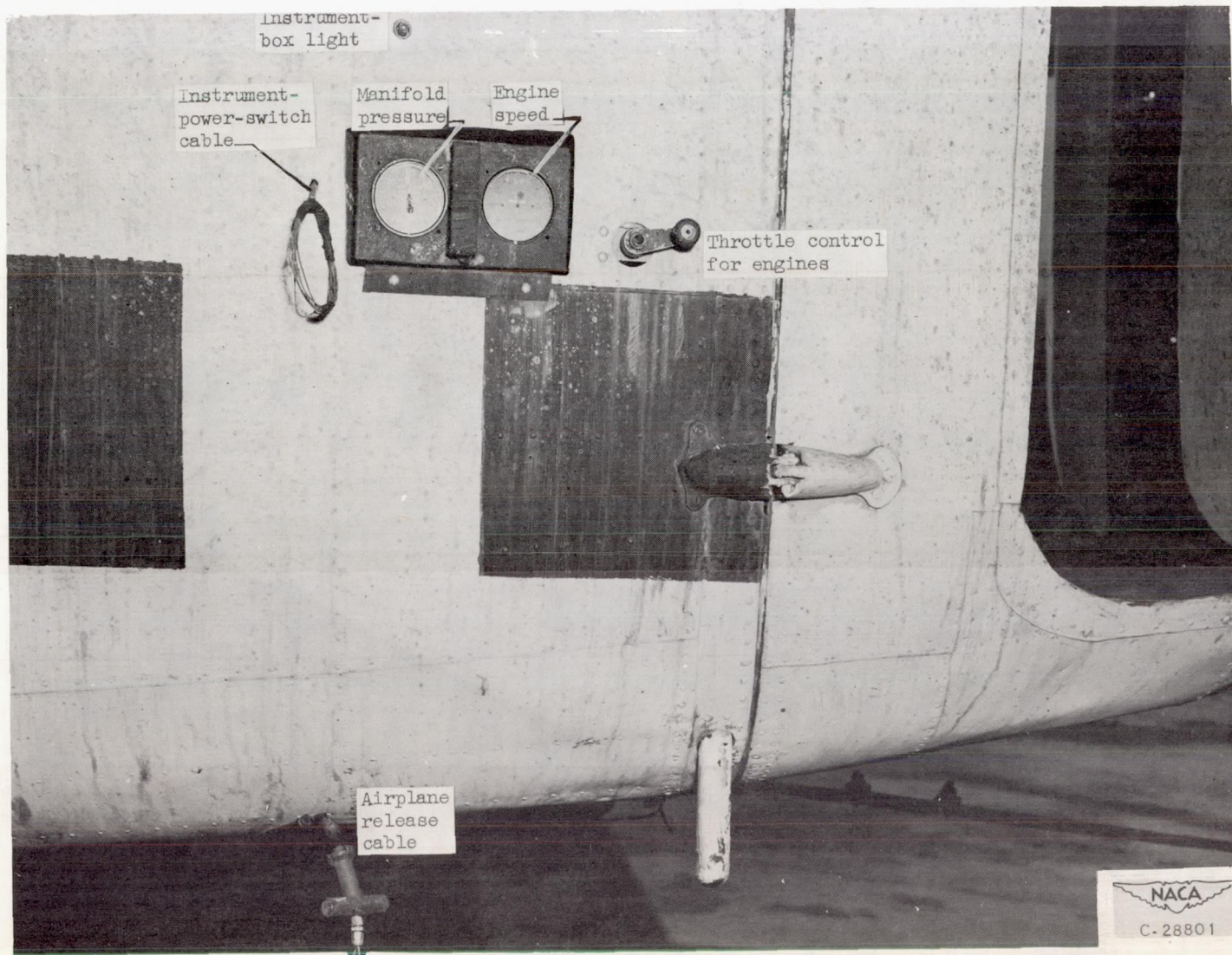

Figure 16. - Controls for operating engines, instrument box power, and airplane release located at rear of fuselage in C-82 airplane.

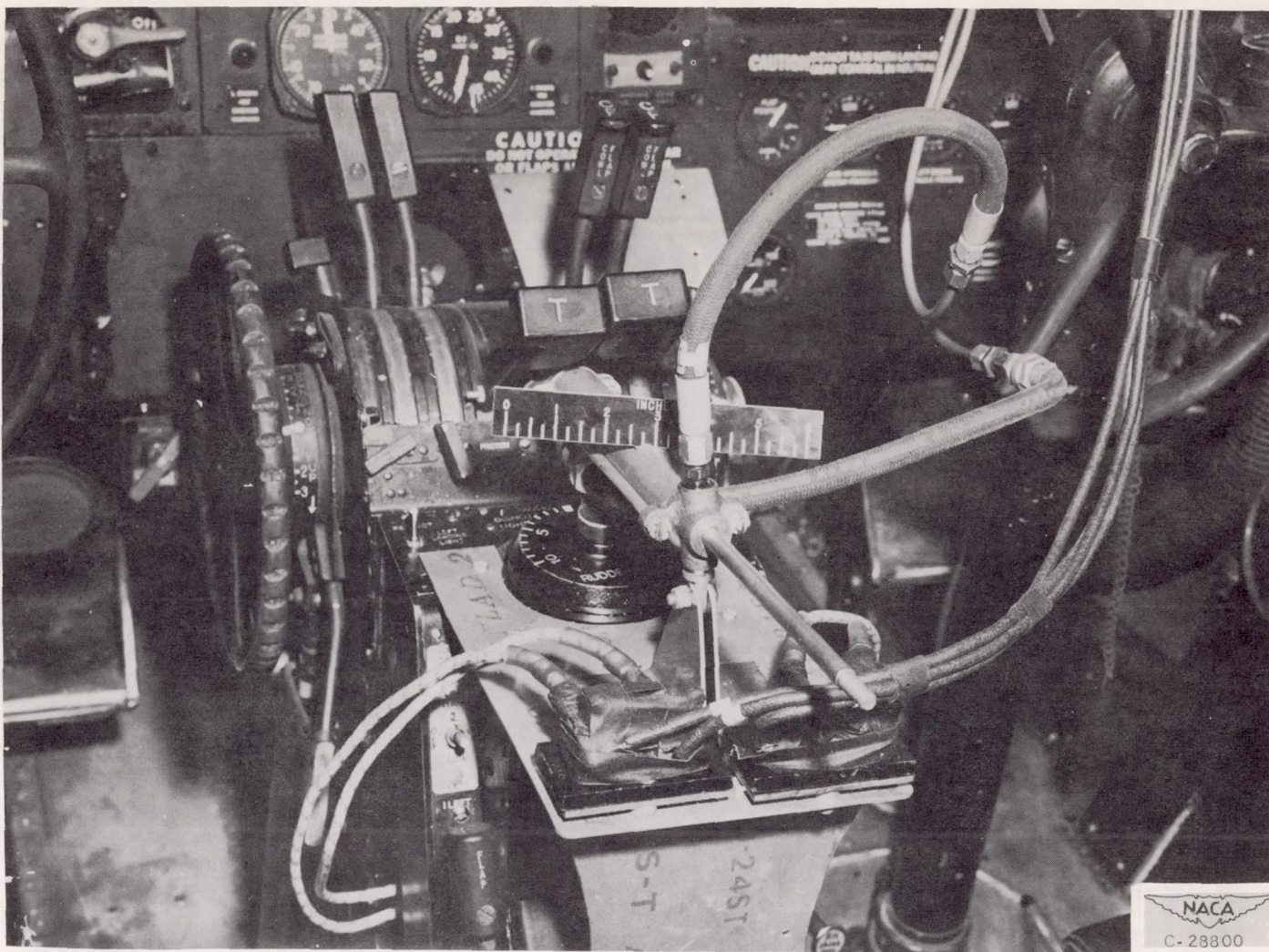

Figure 17. - Remote-control throttle mechanism located in cockpit of C-82 airplane.



Figure 18. - Typical camera platform installation in crash area.



Figure 19. - Fire protection outlet located on each side of crash area.

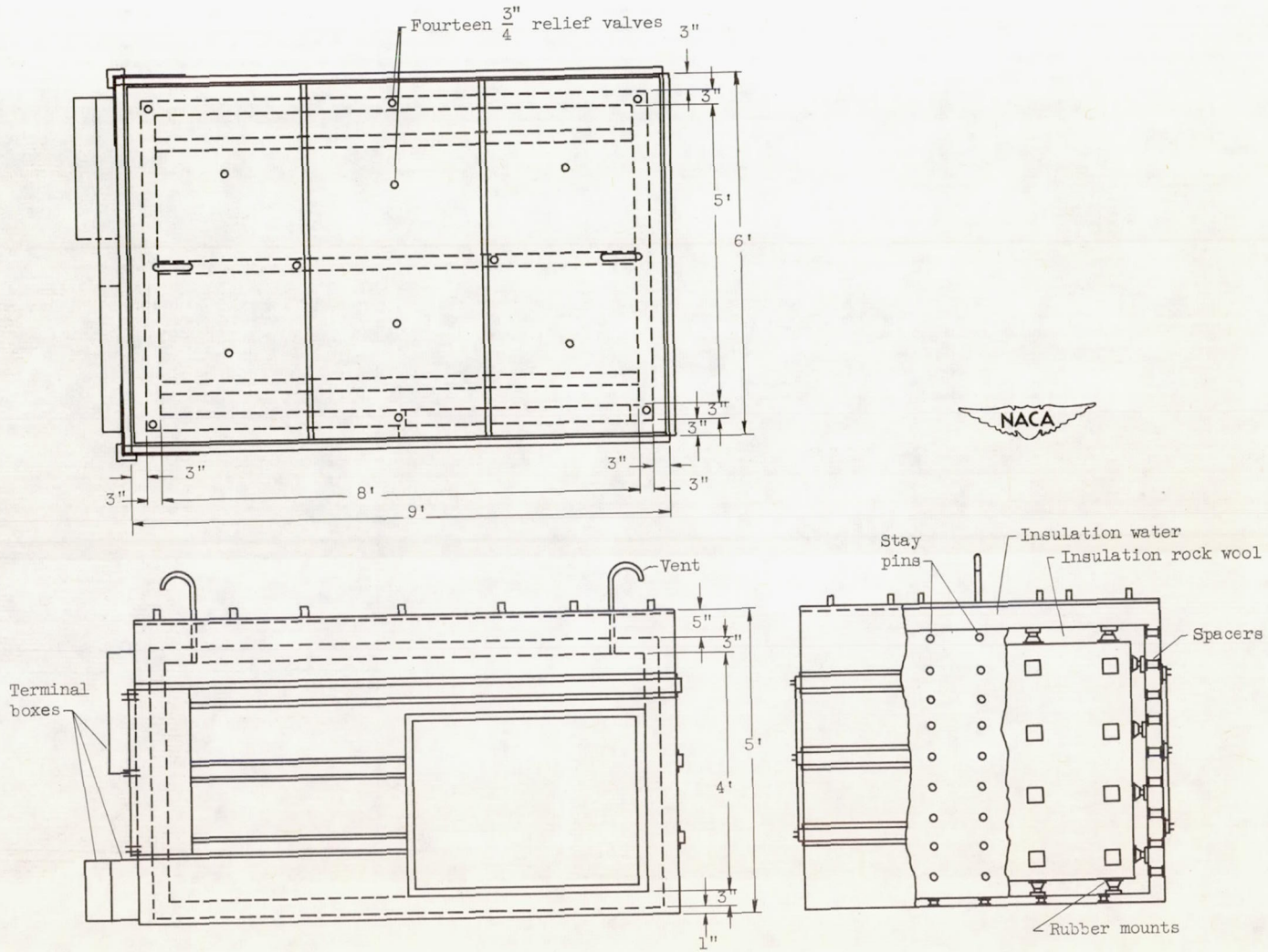

Figure 20. - Sketch showing construction of fireproof instrument box. Material, 1/16-inch black iron; water capacity, 310 gallons; total weight, 6575 pounds.



Figure 21. - Three-quarter top view showing construction of fireproof instrument box before top was installed.

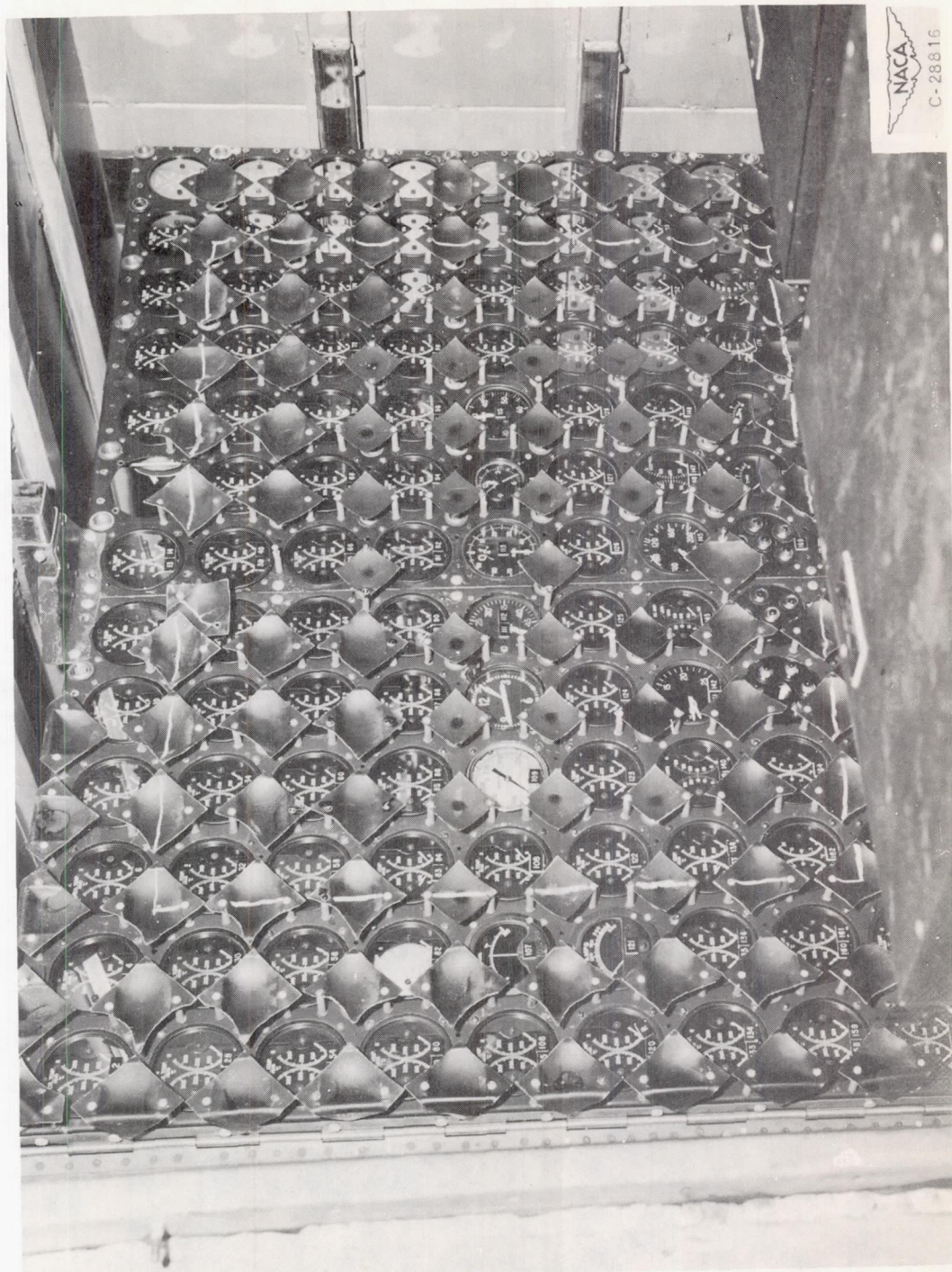

Figure 22. - Instrument panel located at one end of fireproof instrument box.

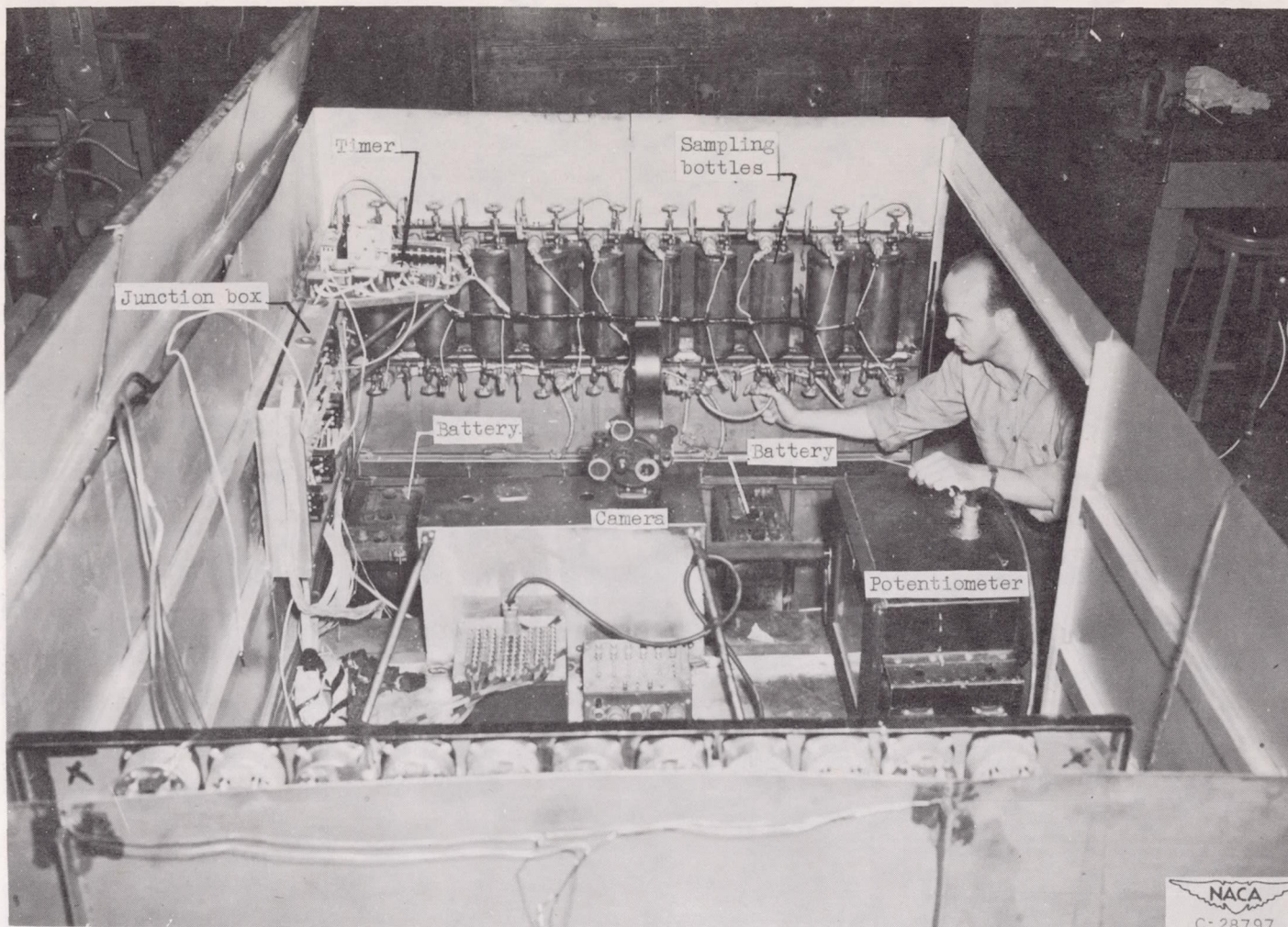

Figure 23. - Installation of cabin-air sampling bottles, camera, junction box, batteries, potentiometer, and timer in fireproof instrument box.

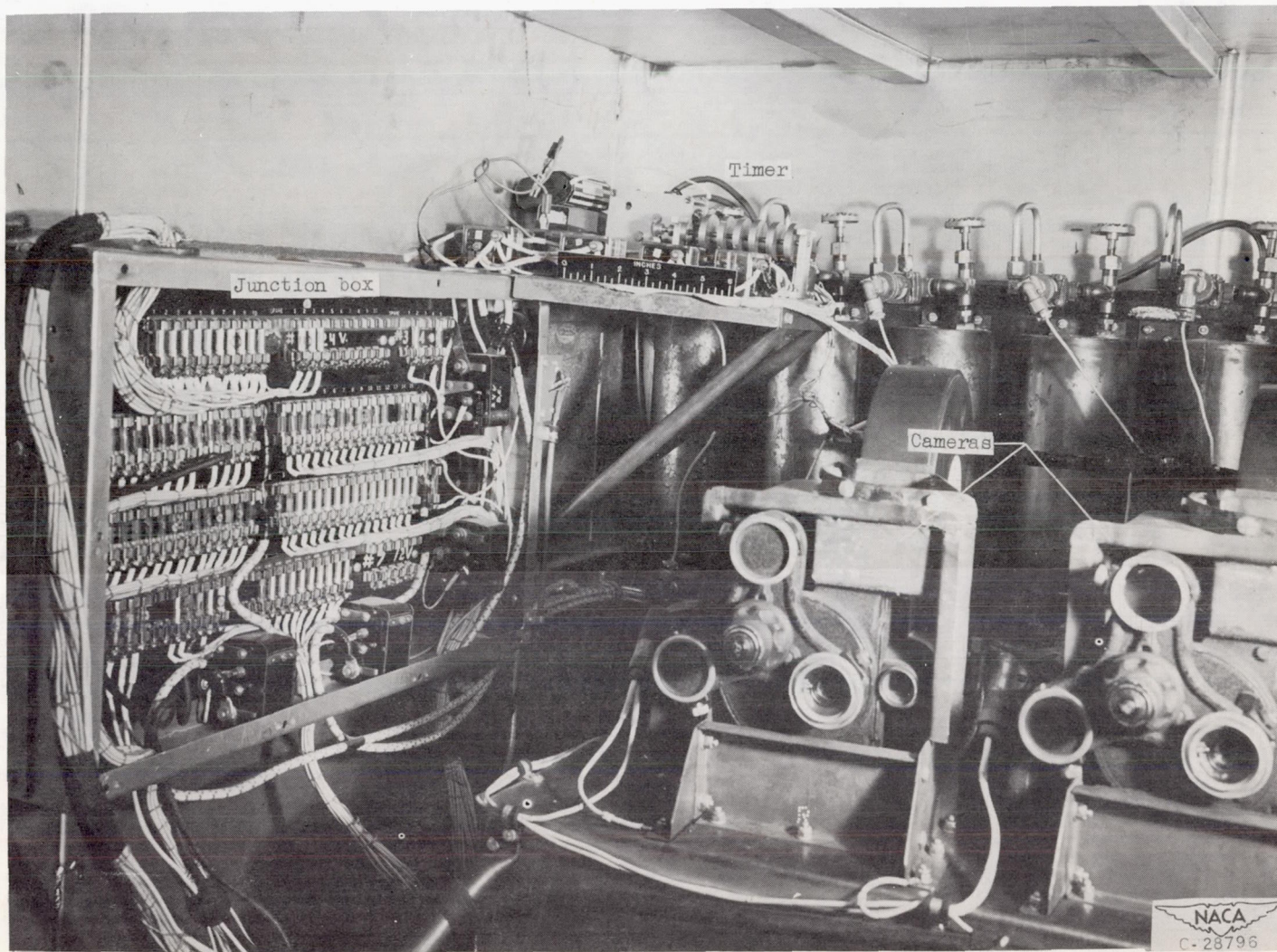

Figure 24. - Closeup view of installation of cameras, junction box, and timer in fireproof instrument box.

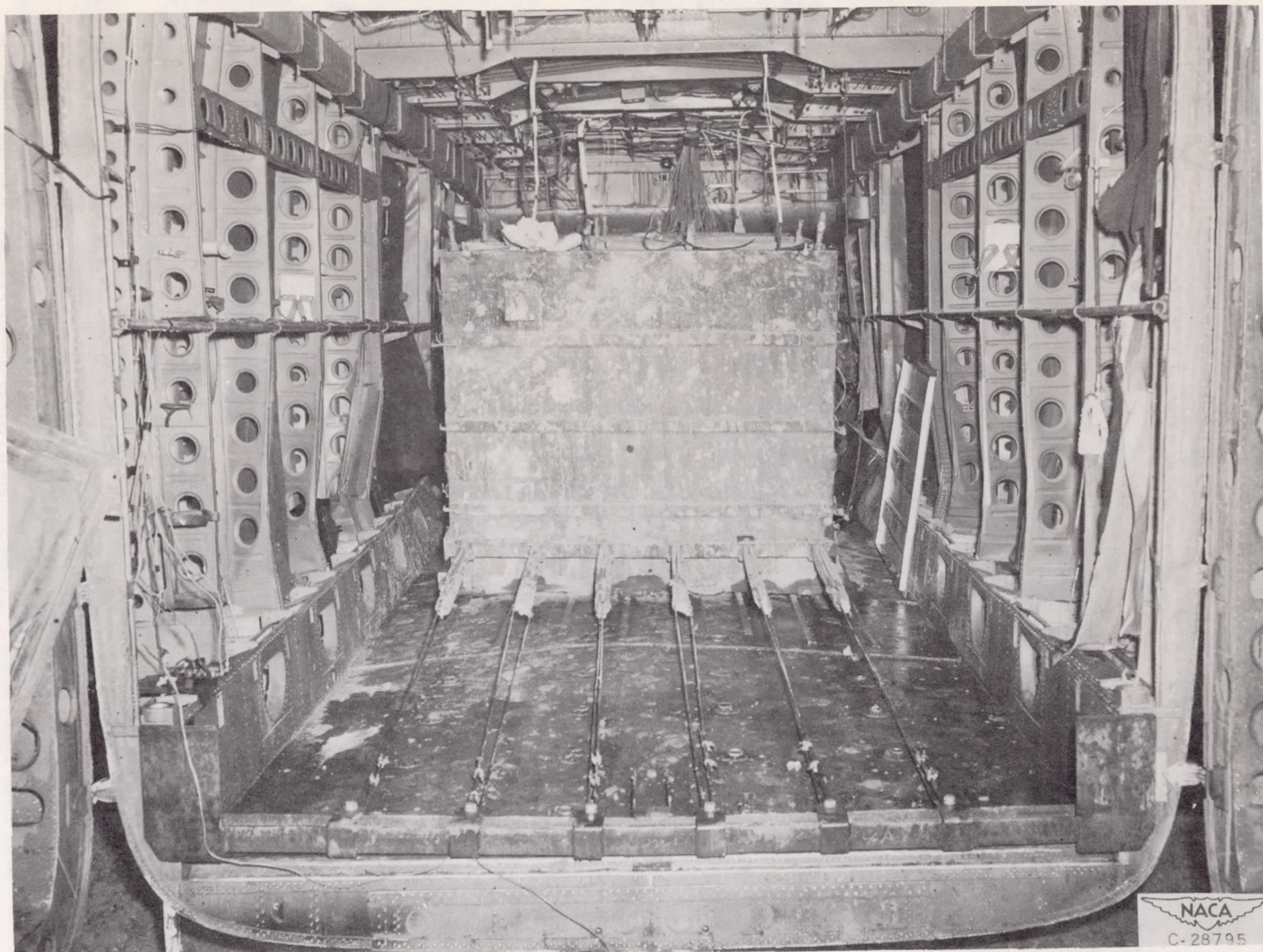

Figure 25. - Rear view of instrument box and shock absorbing system installed in rear of fuselage of a C-82 airplane

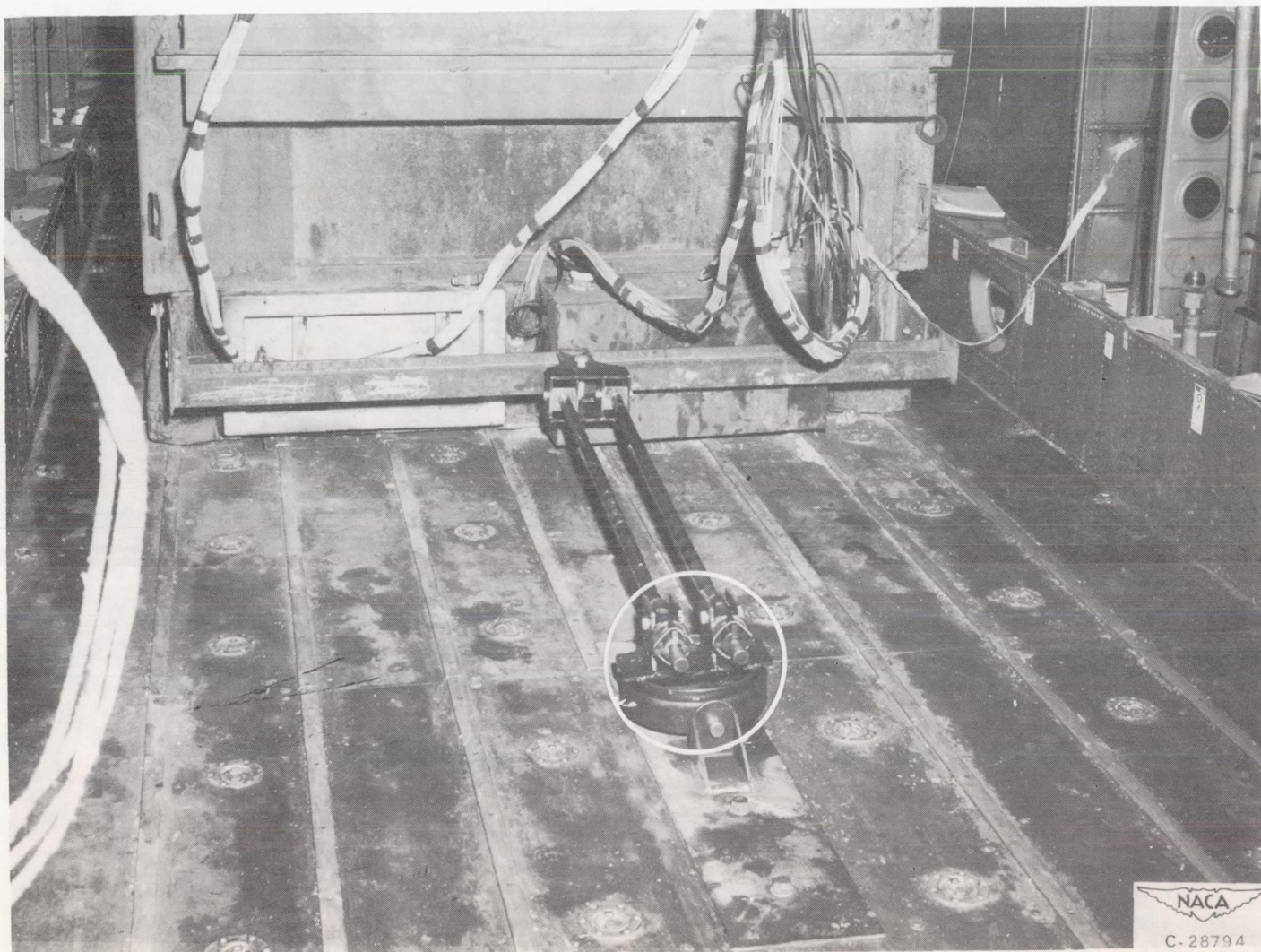

Figure 26. - Installation of restraining mechanism in front of fireproof instrument box in C-82 airplane.

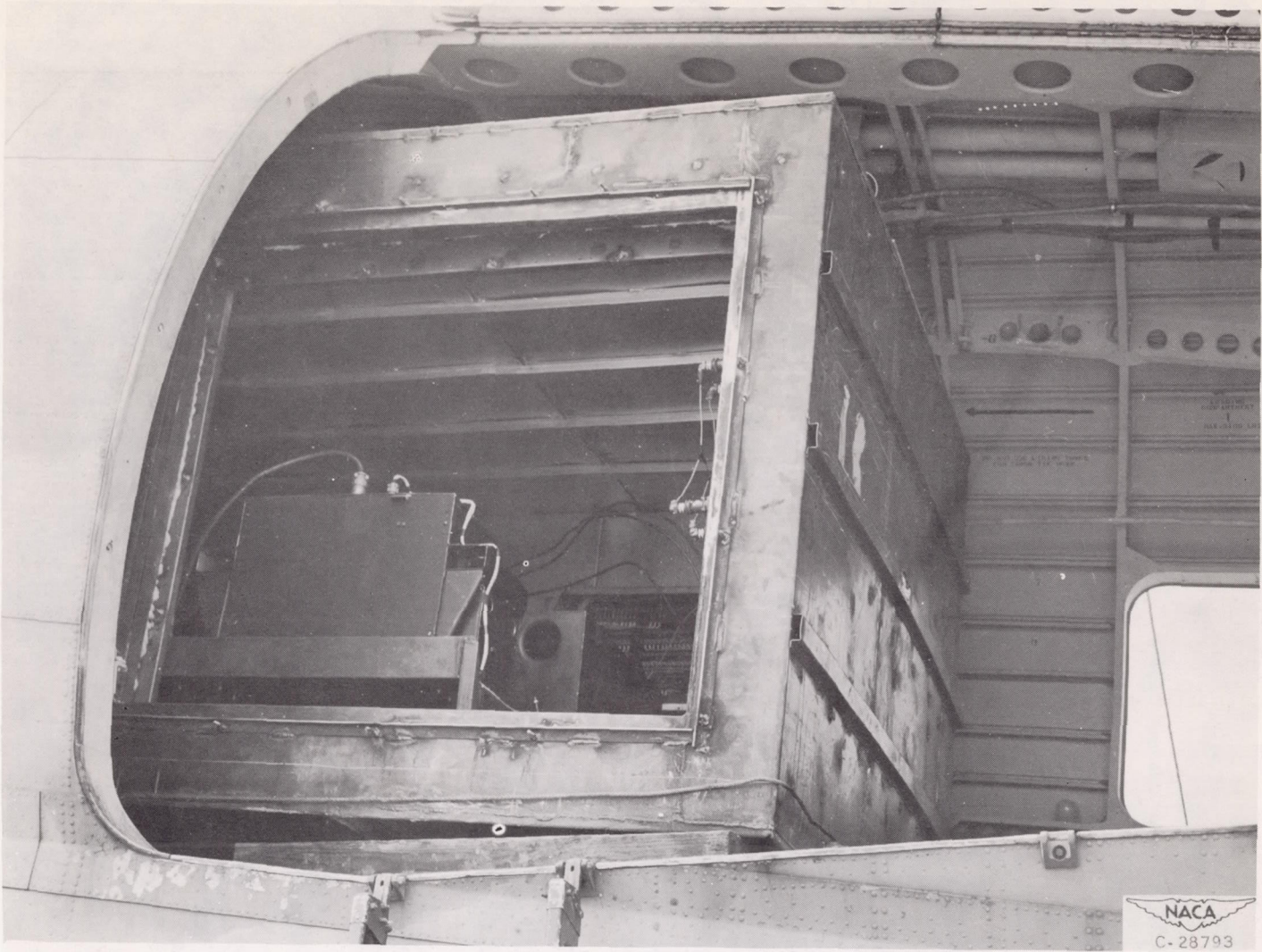
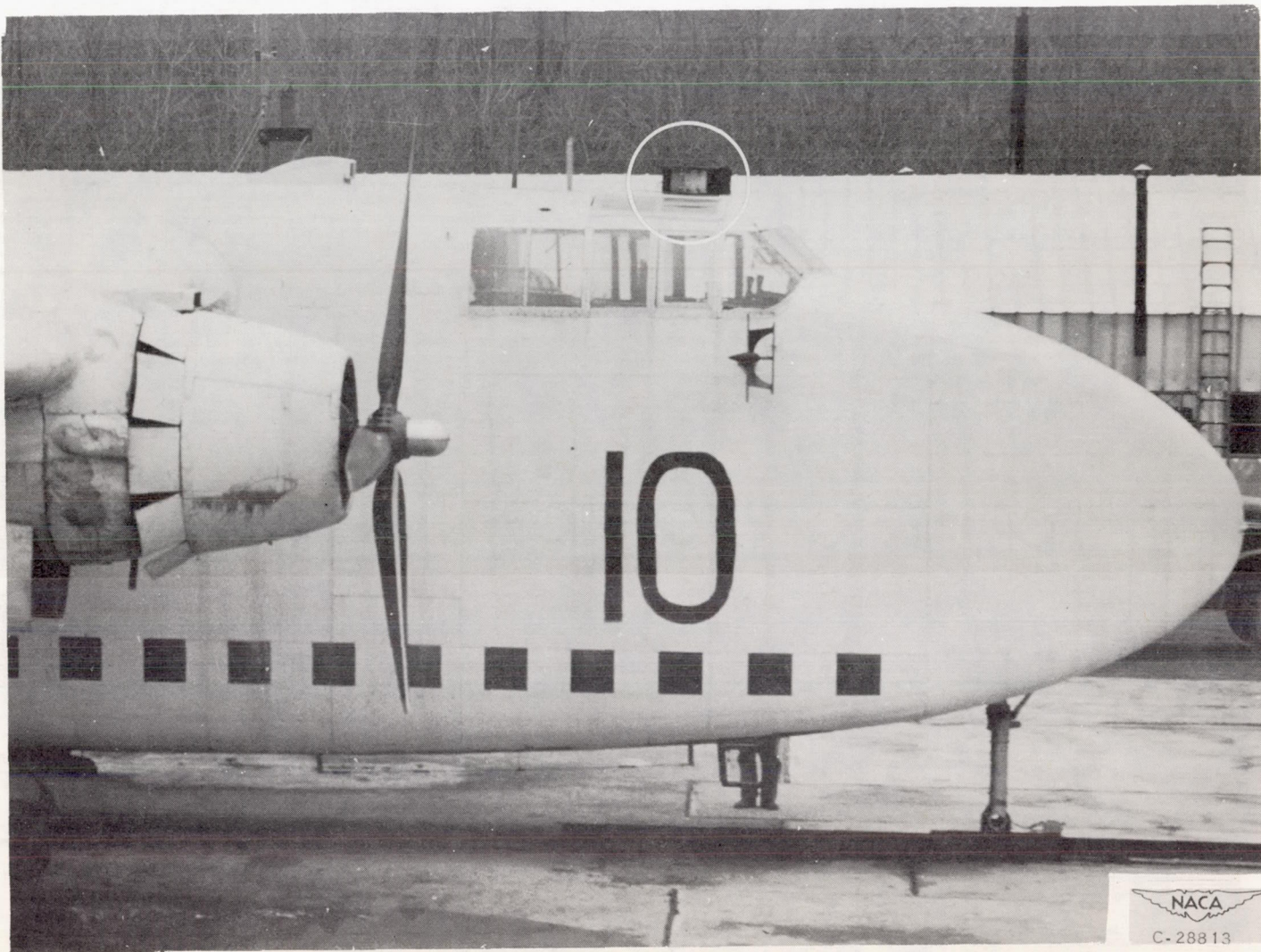
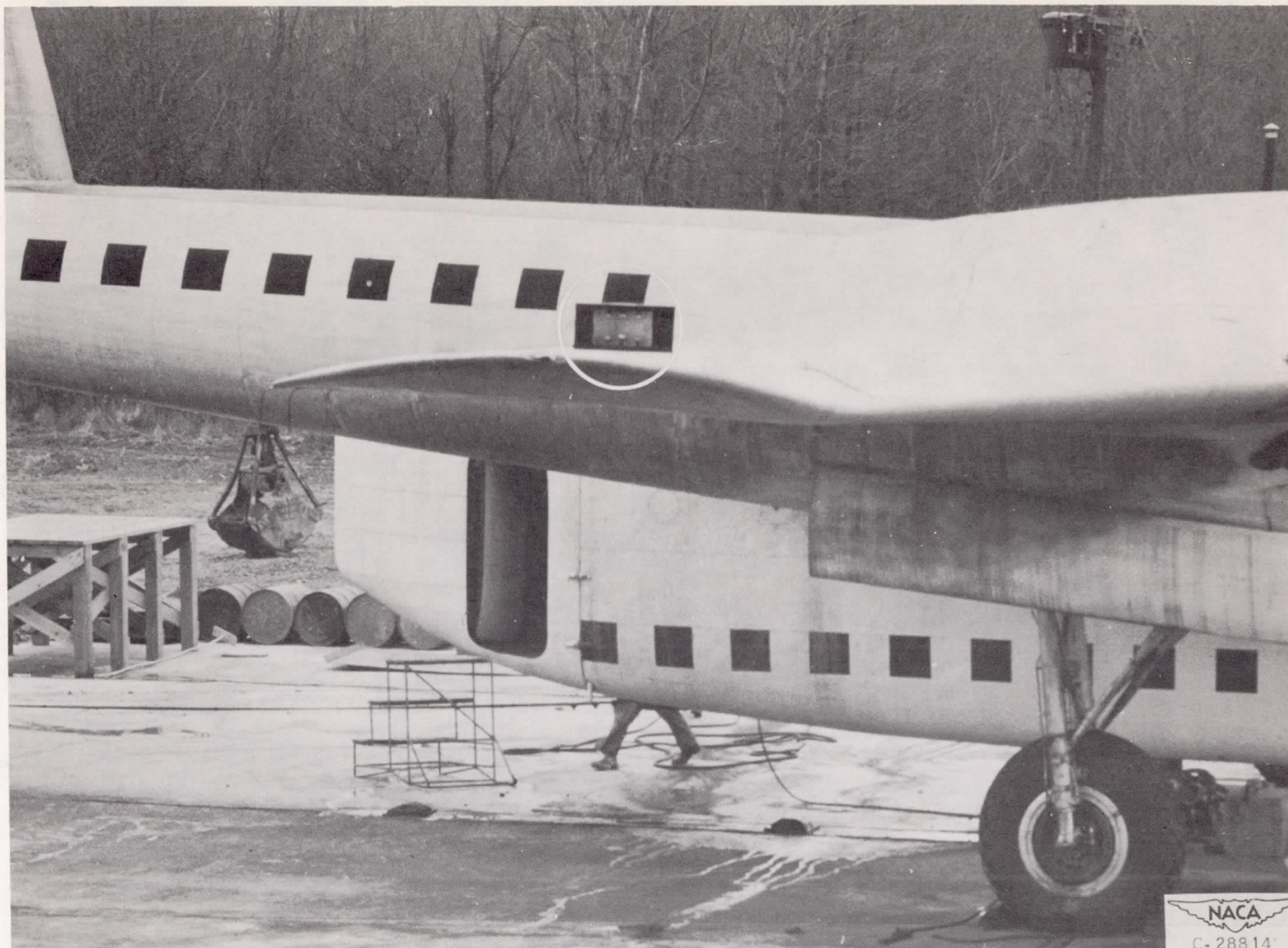

Figure 27. - Fireproof instrument box installation in C-46 airplane; side view.



(a) On top of fuselage.

Figure 28. - Timing lights installed on C-82 airplane.



(b) On right wing tip.

Figure 28 - Continued. Timing lights installed on C-82 airplane.



(c) On right vertical wing tip.

Figure 28. - Concluded. Timing lights installed on C-82 airplane.

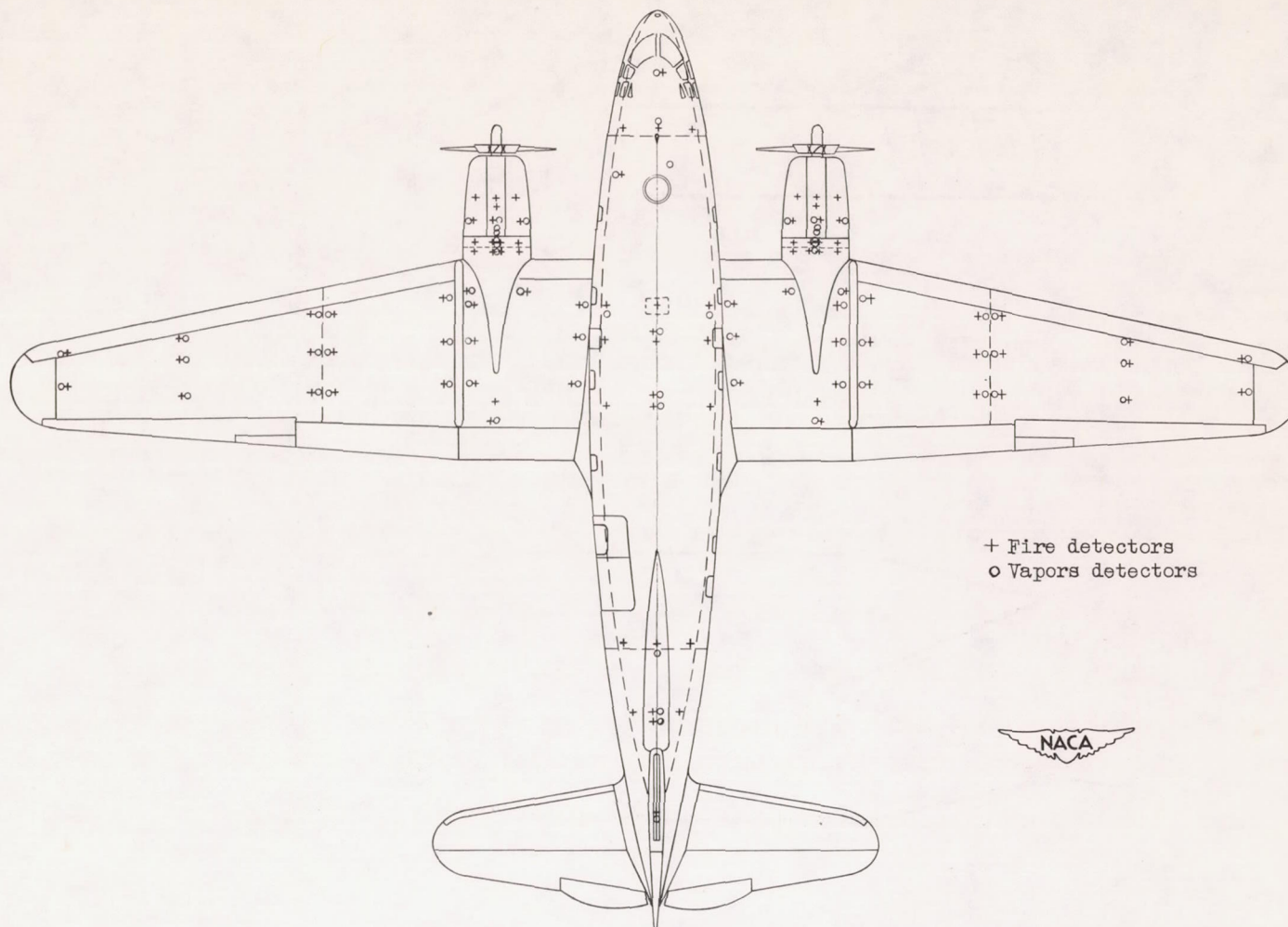

Figure 29. - Location of fire and vapor detectors installed in C-46 airplane.

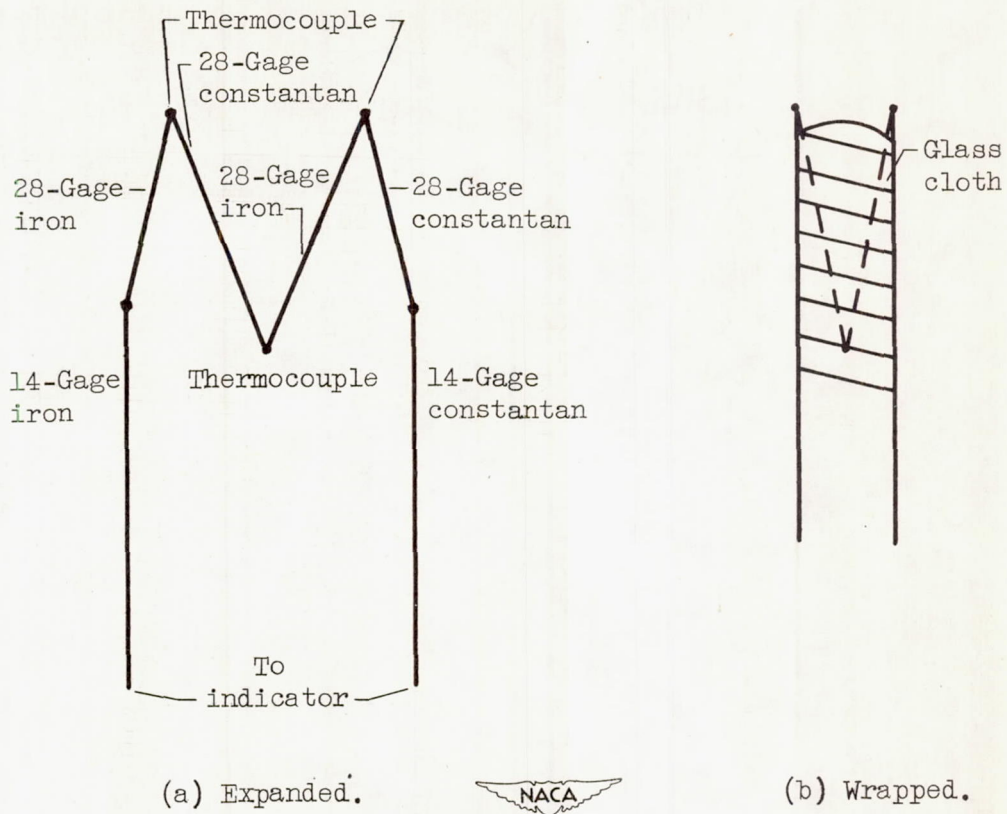

Figure 30. - Construction of thermopiles.

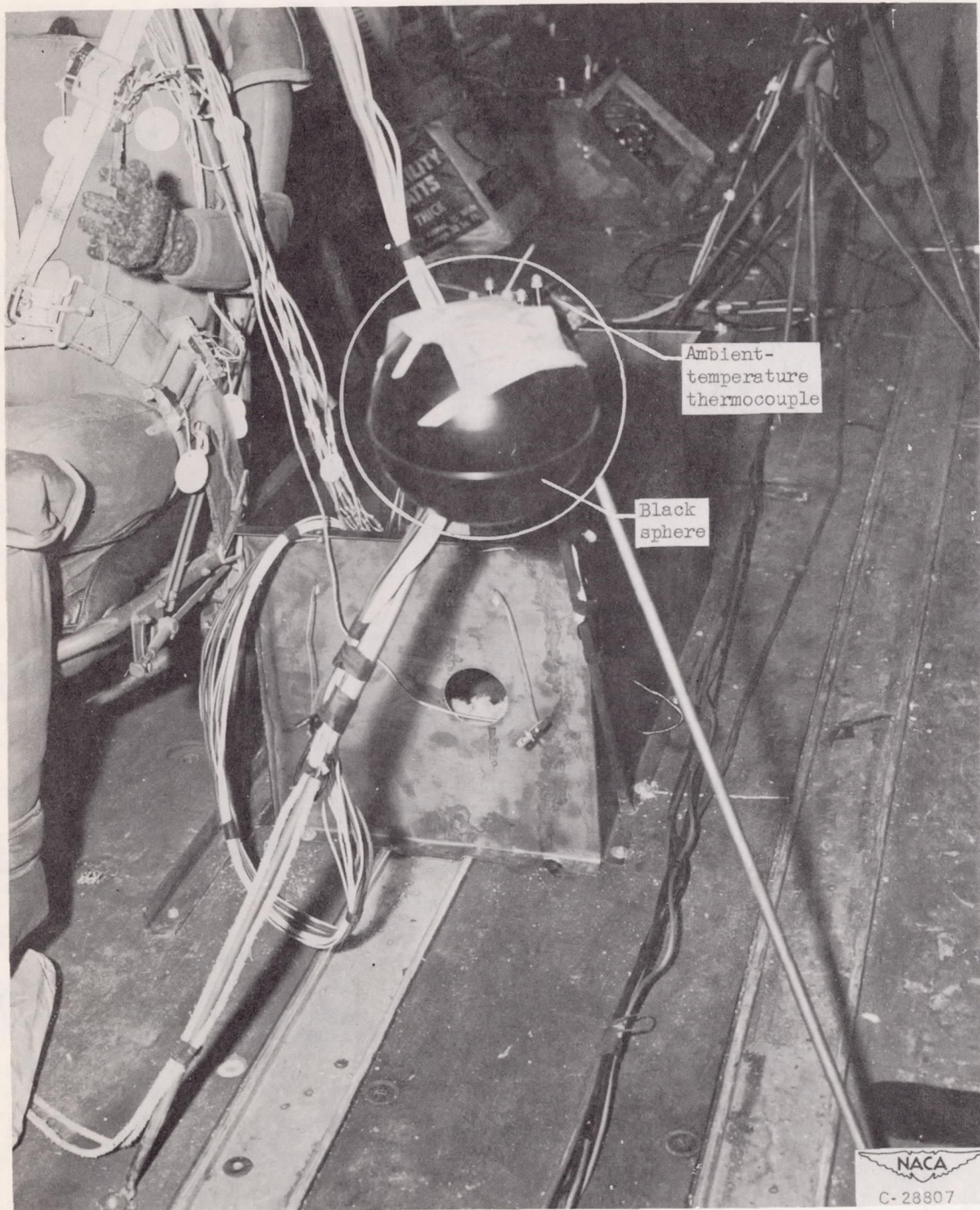

Figure 31. - Installation of radiant and ambient temperature thermocouples in fuselage of C-46 airplane.

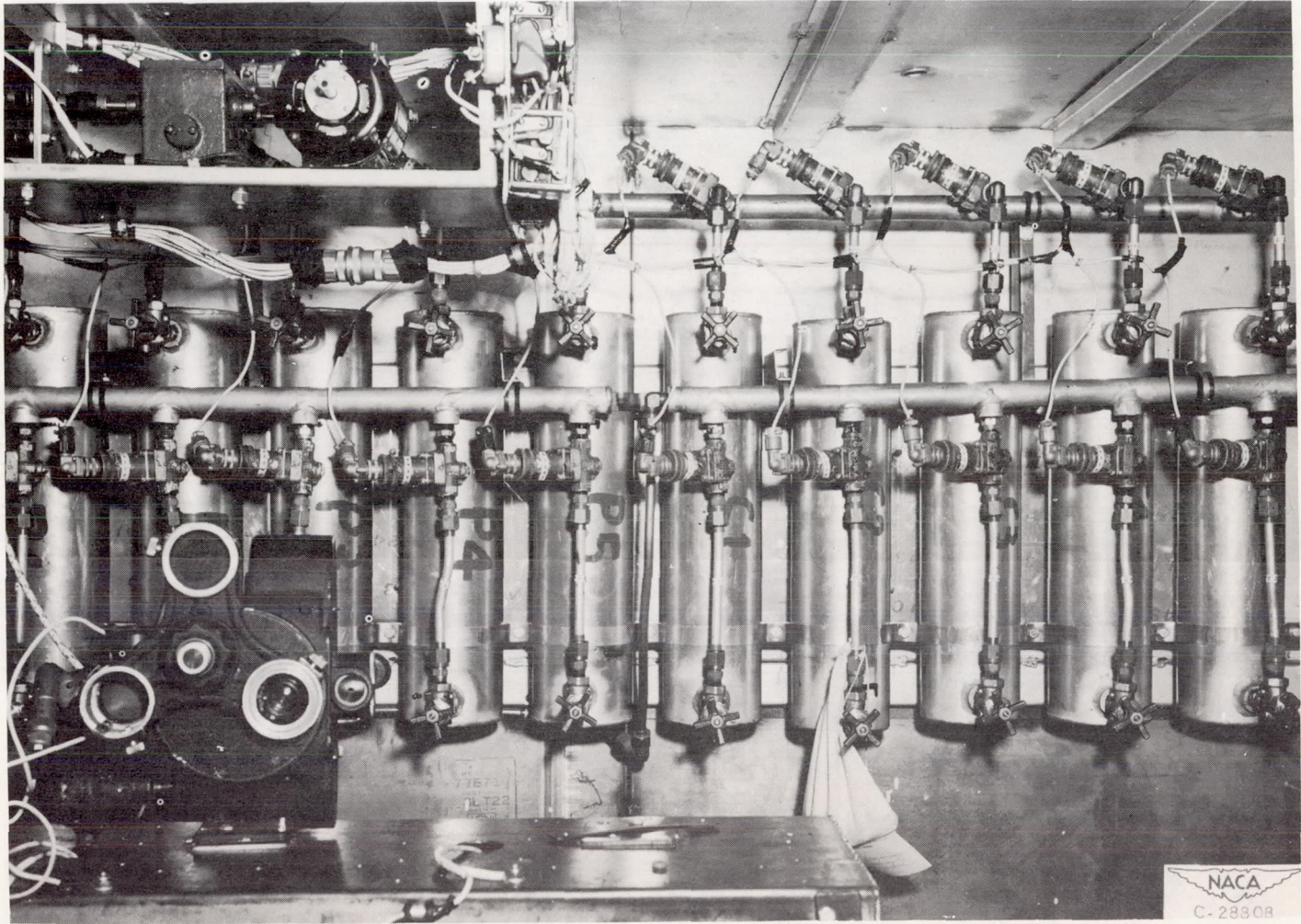

Figure 32. - Cabin-air sampling system installed in fireproof instrument box.

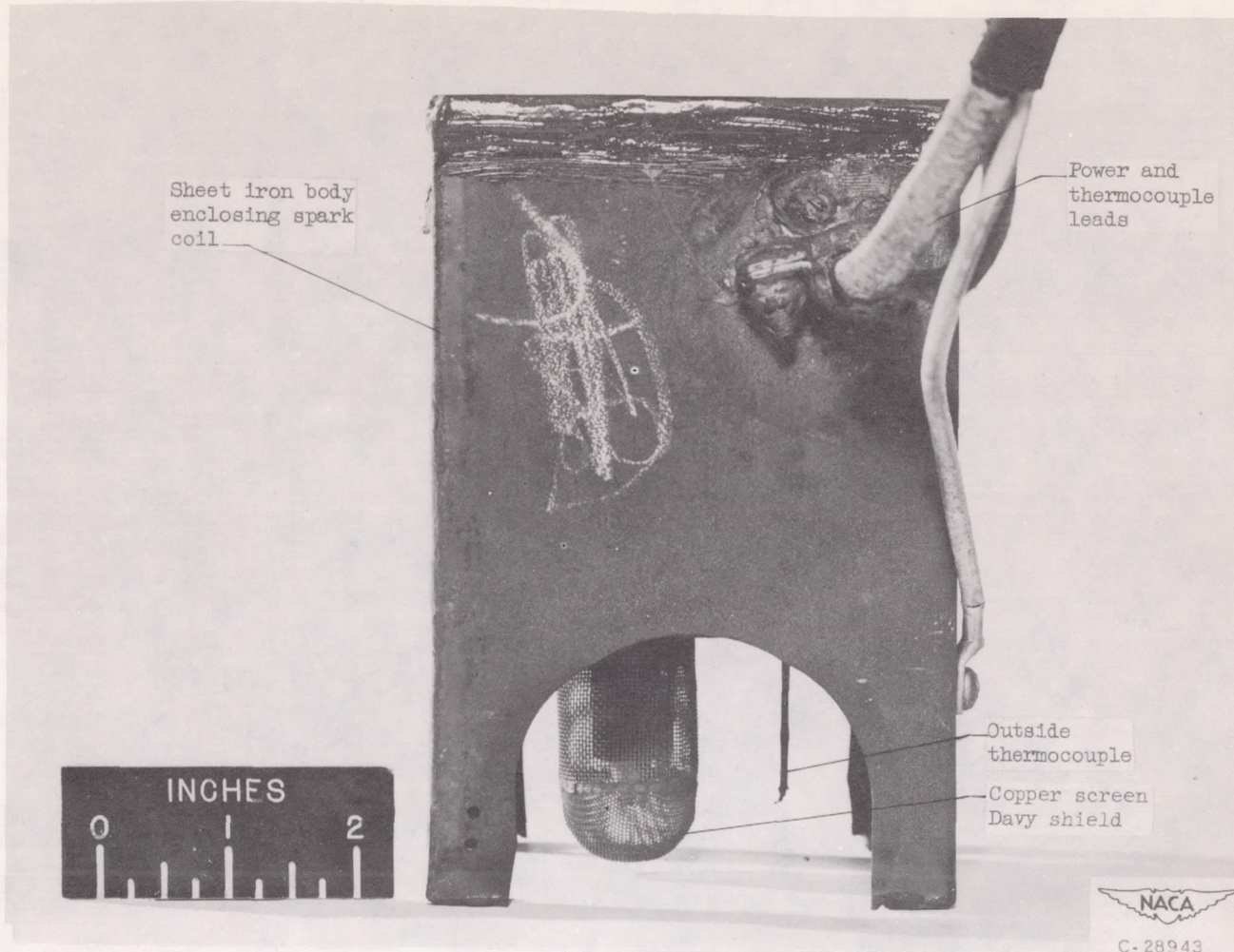
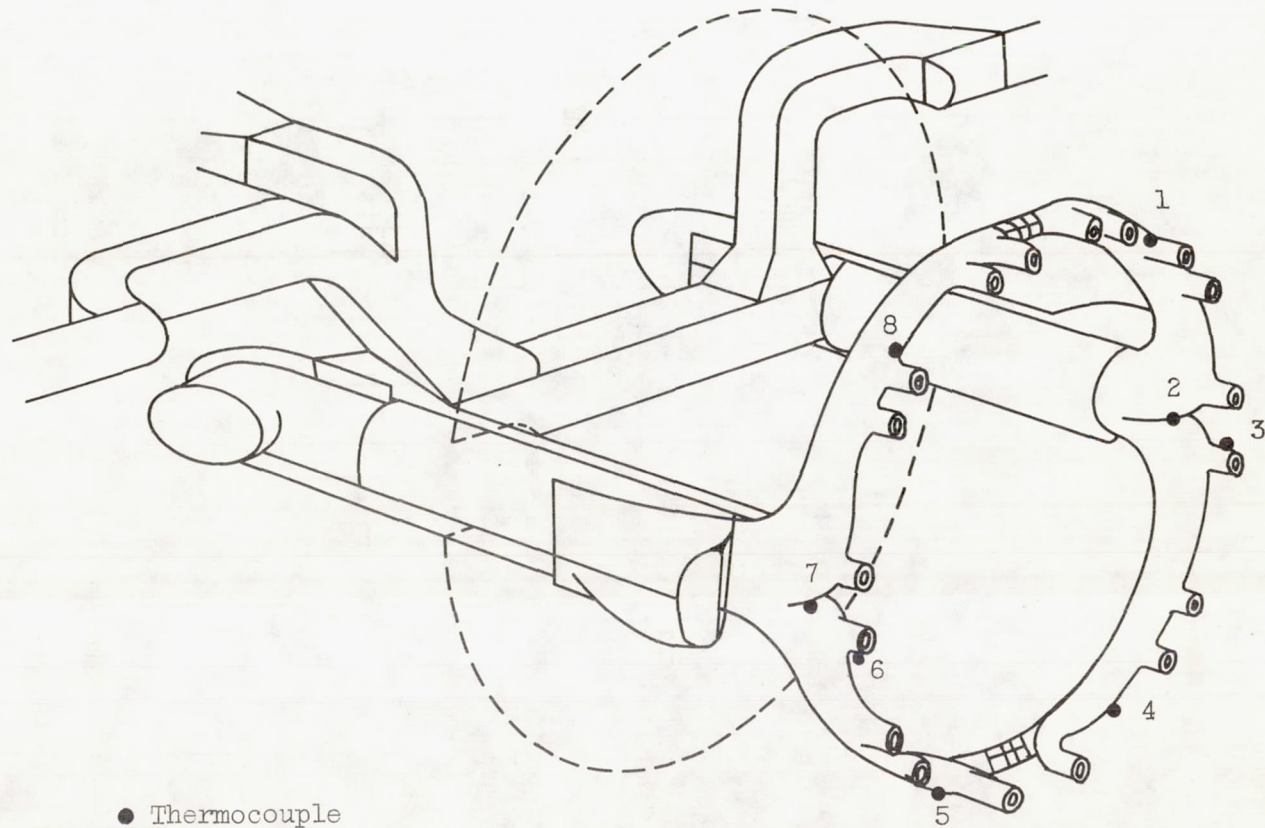

Figure 33. - Vapor Detector.



● Thermocouple
location

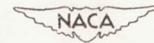

Figure 34. - Left-engine exhaust-stack thermocouple locations on C-82 airplane.

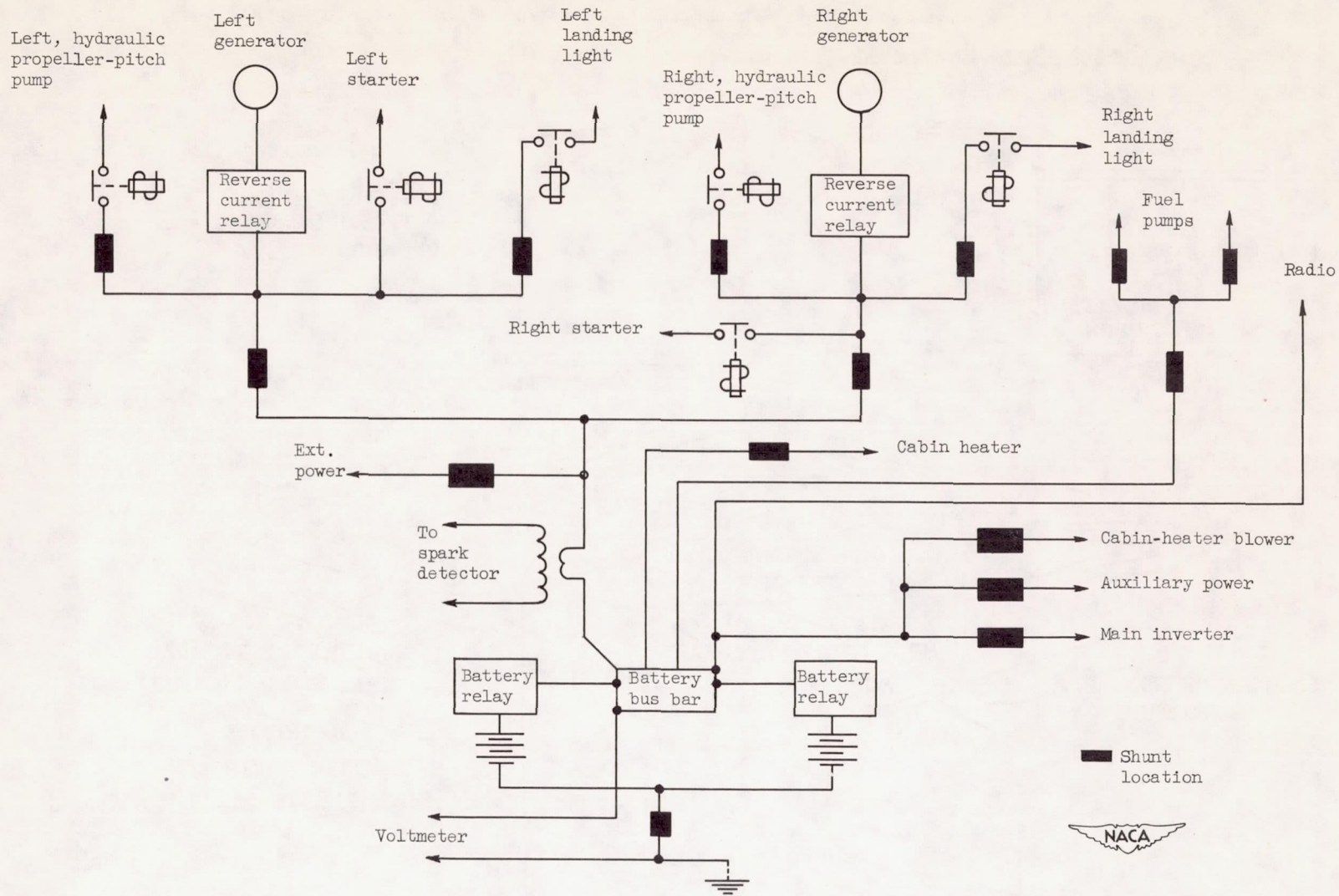

Figure 35. - Shunt locations in electric system of C-46 airplane for third crash.

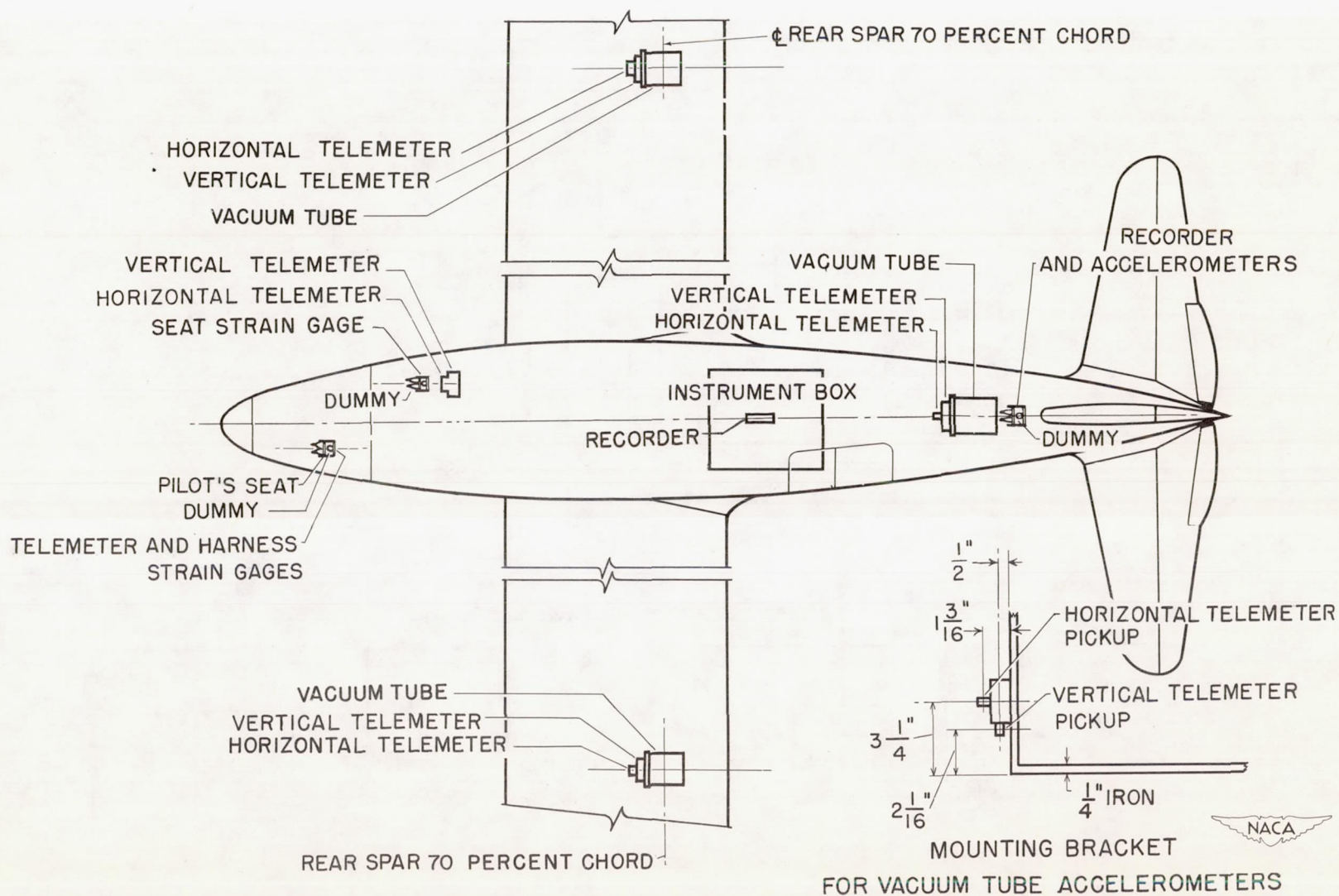

Figure 36. - Recorder, accelerometer-pickup, and strain-gage locations in C-46 airplane.

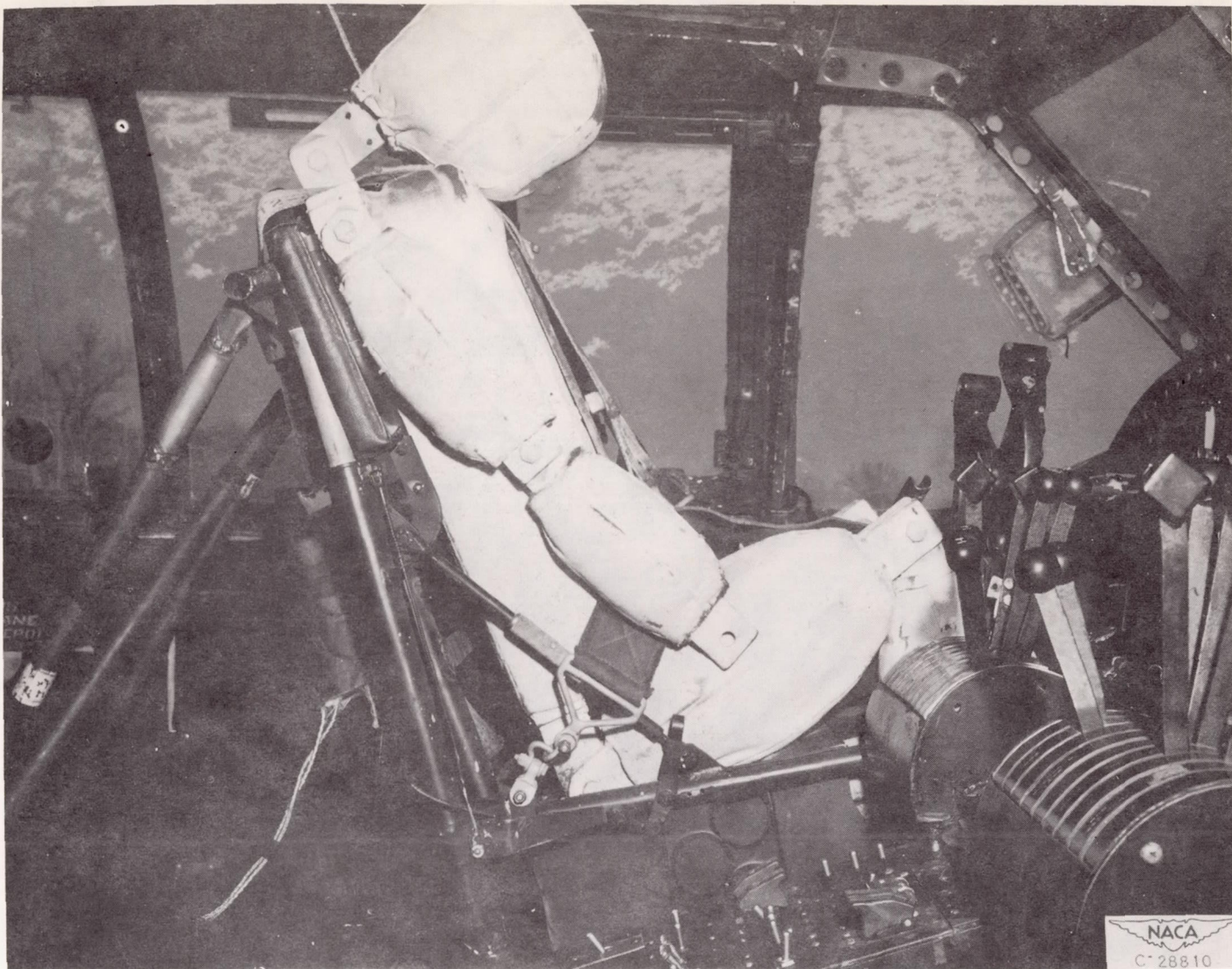

Figure 37. - Typical seat and dummy installation in pilot compartment of C-82 airplane.

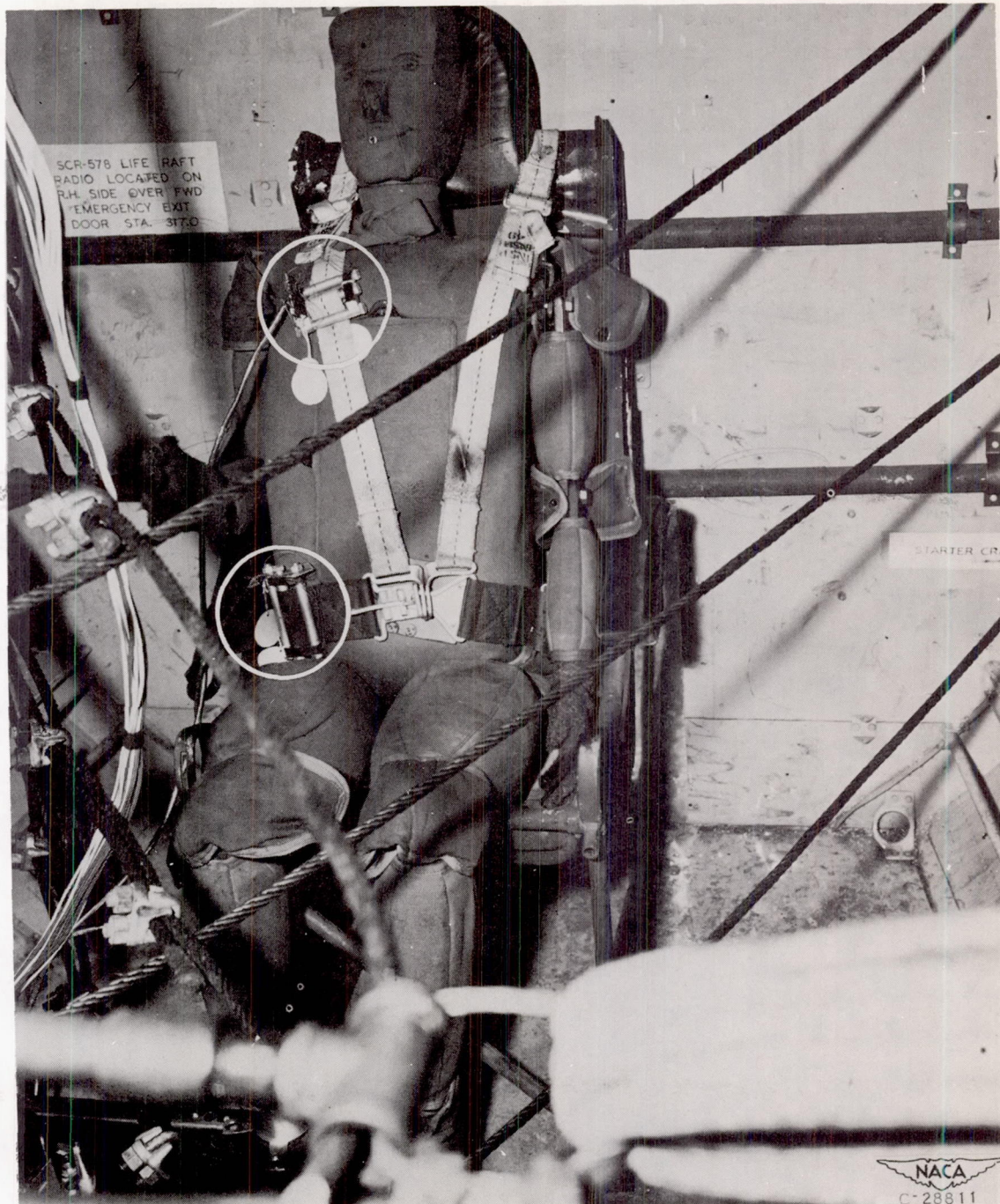

Figure 38. - Strain-gage links installed on shoulder and seat harness of dummy at rear of fuselage in C-46 airplane.



Figure 39. - Black squares painted on side of C-82 airplane and stationary poles in crash area for determining velocity.

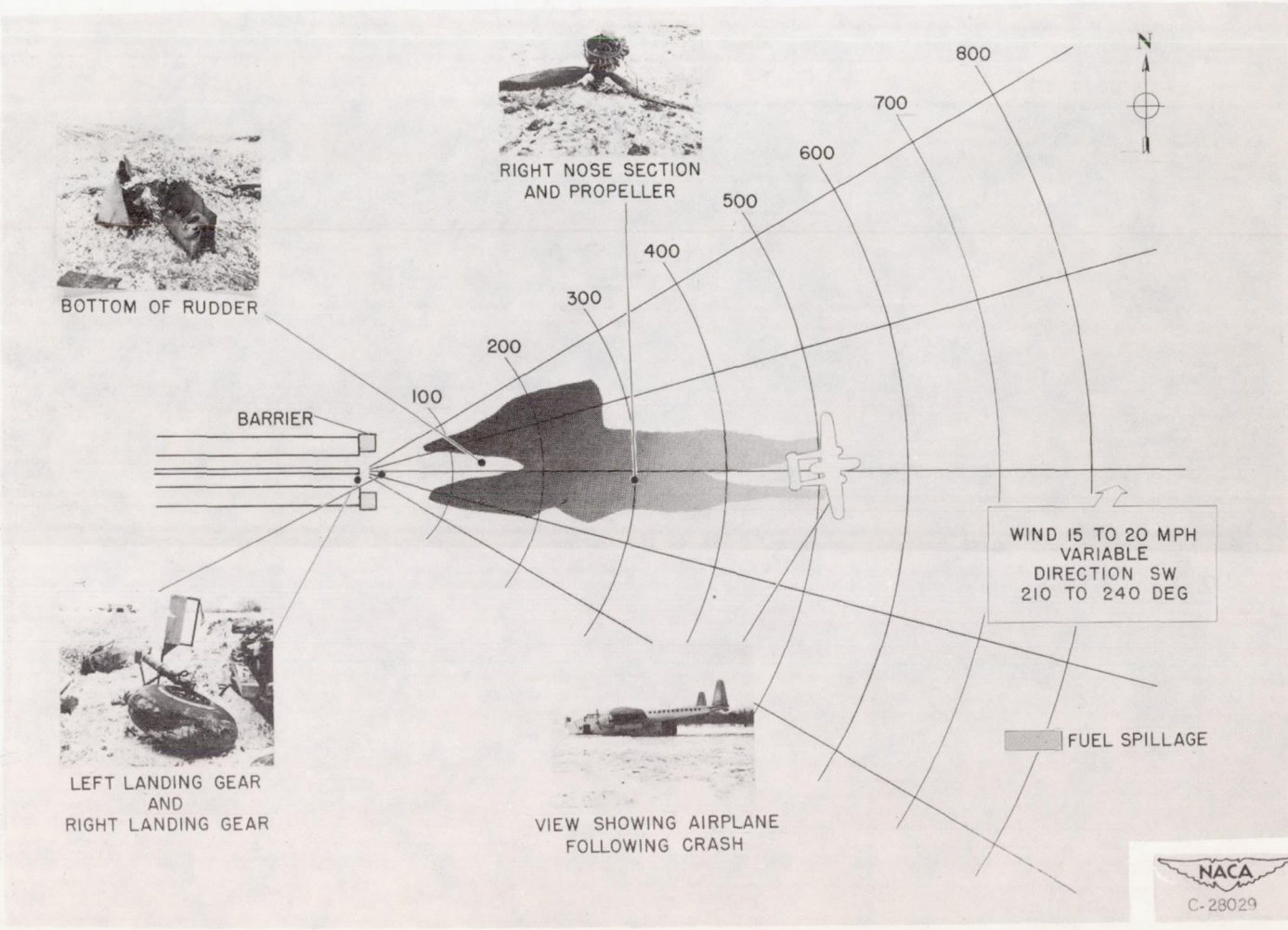

Figure 40. - Distribution of wreckage of C-82 airplane following simulated take-off accident. Test No. Y-4.