

NACA RM L53J07

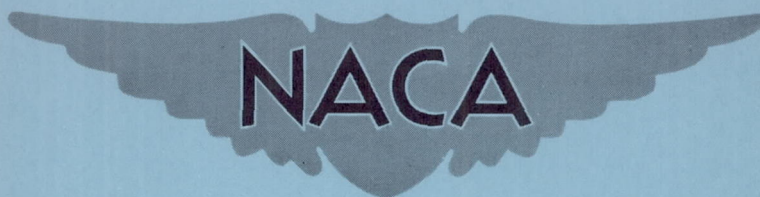

# RESEARCH MEMORANDUM

GUST-TUNNEL INVESTIGATION OF THE EFFECT OF LEADING-EDGE  
SEPARATION ON THE NORMAL ACCELERATIONS EXPERIENCED  
BY A 45° SWEEPBACK-WING MODEL IN GUSTS

By George L. Cahen

Langley Aeronautical Laboratory  
Langley Field, Va.

CLASSIFICATION CANCELLED  
BY AUTHORITY J. W. CROWLEY  
CHANGE #1673 DATE 12-7-53 T.C.F.

CLASSIFIED DOCUMENT

This material contains information affecting the National Defense of the United States within the meaning of the espionage laws, Title 18, U.S.C., Secs. 793 and 794, the transmission or revelation of which in any manner to an unauthorized person is prohibited by law.

## NATIONAL ADVISORY COMMITTEE FOR AERONAUTICS

WASHINGTON

November 24, 1953

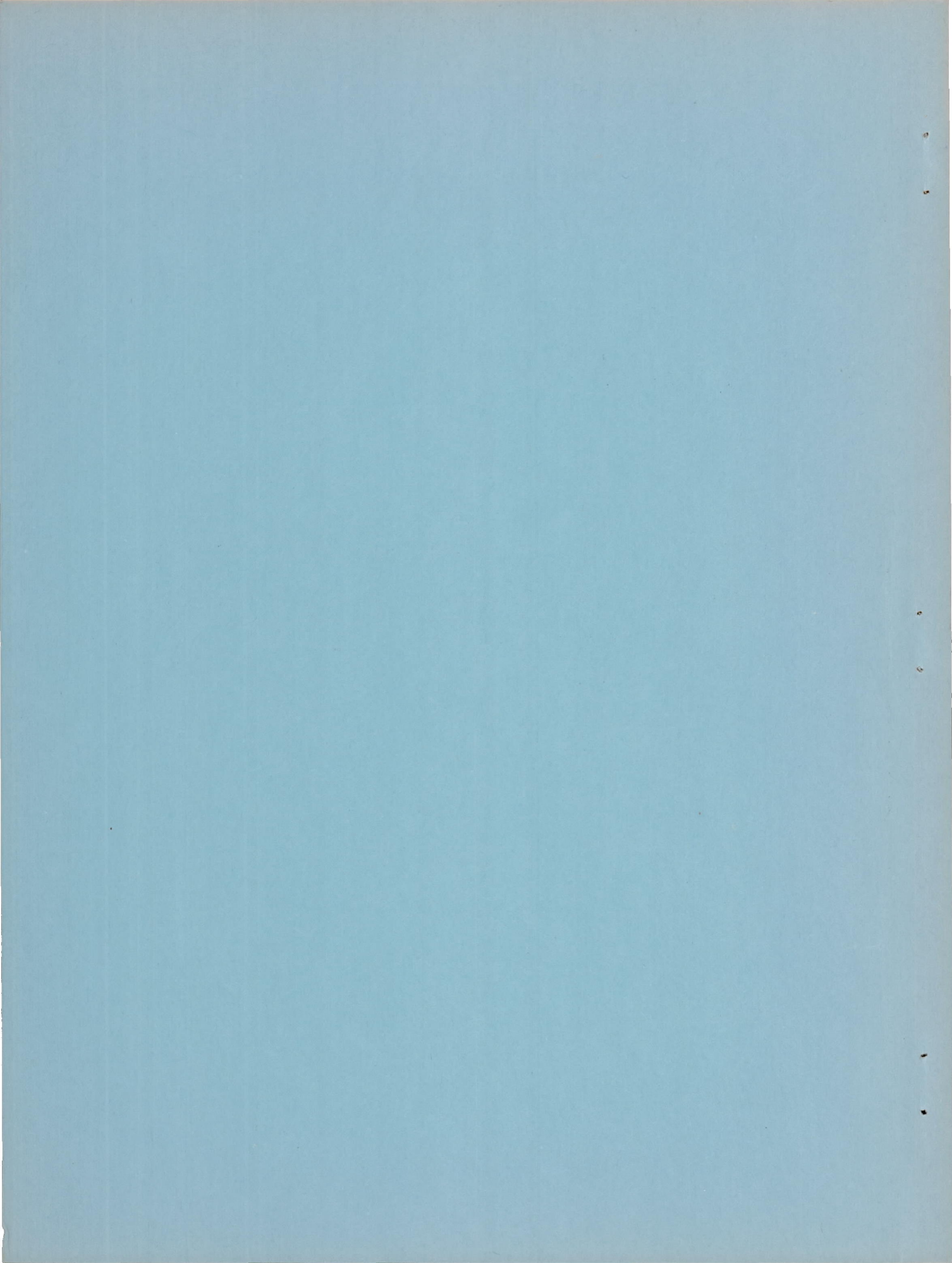

## NATIONAL ADVISORY COMMITTEE FOR AERONAUTICS

## RESEARCH MEMORANDUM

GUST-TUNNEL INVESTIGATION OF THE EFFECT OF LEADING-EDGE  
SEPARATION ON THE NORMAL ACCELERATIONS EXPERIENCED  
BY A  $45^\circ$  SWEEPBACK-WING MODEL IN GUSTS

By George L. Cahen

## SUMMARY

An investigation was conducted in the Langley gust tunnel with a  $45^\circ$  sweptback-wing model having interchangeable round and sharp leading edges in order to determine the effect of leading-edge separation on the loads experienced by the model in gusts.

Leading-edge separation served to increase the gust load. The amount of increase apparently depends upon the gust-gradient distance and velocity but cannot be predicted from the results of these few tests. Attempts at correlating the increased load values with the lift curve obtained in steady flow yielded no consistent results. Thus, it appears that the load increase is due to participation of the leading-edge vortex in the unsteady-lift phenomena associated with the gust and is not directly related to the lift curve obtained in steady flow.

The results of the tuft studies showed a hysteresis effect under unsteady conditions in the flow change between the "no vortex" and "vortex" regimes and further indicated that the rate of change in angle of attack due to the gust and the extent of penetration into the gust are both important in determining whether separation occurs.

## INTRODUCTION

Leading-edge separation resulting in a leading-edge vortex has been observed on sweptback wings in various wind-tunnel studies. In steady flow the total lift, as well as the other aerodynamic characteristics of a sweptback wing, is affected by leading-edge separation, as has been shown in references 1 and 2, for example. These studies showed also that the angle of attack at which separation first occurs depends on various

aerodynamic and geometric parameters of the wing; for example, a sharp leading edge is conducive to separation.

A preliminary investigation conducted in the Langley gust tunnel with tufts on three sweptback-wing configurations (ref. 3) indicated that a leading-edge vortex was present on a  $60^\circ$  sweptback wing but not on a  $30^\circ$  and a  $45^\circ$  sweptback wing during flights through gusts. Inasmuch as a leading-edge vortex occurred on the  $45^\circ$  sweptback wing in wind-tunnel tests, its absence in the gust flights was ascribed to lag in flow development under unsteady conditions.

In order to determine the effect of leading-edge separation on the loads experienced by a wing in gusts, the  $45^\circ$  sweptback wing was fitted with interchangeable leading edges, one pair conforming to the original airfoil section and the other being wedge shaped in order to induce separation at a lower angle of attack. This paper presents the results of load studies in the Langley gust tunnel and tuft studies in both the Langley stability tunnel and gust tunnel for the model with the two types of leading edges.

#### APPARATUS AND TESTS

The  $45^\circ$  sweptback-wing model of reference 3 was used for these tests. Pertinent characteristics of the model are given in table I. The wing was modified in that interchangeable leading edges were fitted to it. One set of the leading edges conformed to the original airfoil section (NACA 0012 section perpendicular to the 50-percent-chord line), and the other set was wedge shaped. Line drawings of the model and the leading edges are given in figure 1.

The upper surface of the left semispan of the wing was fitted with cotton-yarn tufts at intervals of 2 inches. Photographs were made of the tufts at each test angle of attack during force tests in the 6- by 6-foot test section of the Langley stability tunnel. These tests were made at a tunnel dynamic pressure of 9 pounds per square foot through an angle-of-attack range from  $0^\circ$  to  $30^\circ$ .

The Langley gust tunnel and its standard apparatus are described in reference 4. The gust-tunnel tests consisted of flights of the model at a forward speed of 60 mph with the sharp and round leading edges through sharp-edge and 12-foot gradient gusts of 5, 10, and 15 ft/sec. The sharp-edge and gradient gust profiles are shown in figure 2. Time histories of the normal acceleration at the center of gravity of the model and of the pitch angle of the model were made for eight flights under each of the twelve conditions. Photographs of the tufts were made from above

during the gust-tunnel flights by means of high-speed sequence-flash photography so that five views of the model were obtained for each flight.

### PRECISION

The quantities measured in the gust-tunnel tests are estimated to be accurate within the following limits:

Acceleration increment, g units . . . . .	±0.05
Forward speed, ft/sec . . . . .	±0.5
Gust velocity, ft/sec . . . . .	±0.1
Pitch-angle increment, deg . . . . .	±0.1
Angle of attack, deg . . . . .	±0.5

Small variations in launching speed and attitude are apt to occur in the gust-tunnel flights and produce variations in the model acceleration increment. Inasmuch as these effects cannot be eliminated by corrections to the data, the average acceleration increment for eight flights is presented for each test condition.

The values of angle of attack measured in the wind tunnel are estimated to be accurate within  $\pm 0.25^\circ$ .

### RESULTS

The records from the gust-tunnel flights were evaluated to obtain time histories of normal-acceleration increment and pitch-angle increment as functions of penetration into the gust measured in mean chords. These histories were utilized in the preparation of figures 3 and 4.

In figure 3, the values of maximum normal-acceleration increment are presented as functions of maximum gust velocity. Each of the values represents the average of eight flights which were corrected to "no pitch" conditions by multiplying by  $\left(1 - \frac{\Delta\theta}{U/V}\right)$ , where the pitch-angle increment  $\Delta\theta$  and the gust velocity  $U$  are both taken at the point of maximum acceleration increment and  $V$  is the forward speed.

Representative histories of normal-acceleration increment and angle of attack for the twelve test conditions are shown in figure 4. The instantaneous gust velocity, pitch angle, and vertical velocity were used in determining the angles of attack so that the values given represent the instantaneous angle between the wing chord and the resultant relative-wind vector.

Tuft photographs similar to those presented in figure 5 were used to determine whether separation occurred for the various flight conditions. The lift curves obtained in the wind-tunnel tests for the wing with the two types of leading edges are shown in figure 6.

#### DISCUSSION

The results of the load studies (fig. 3) indicate that, for all gust conditions, the maximum acceleration increments for the sharp-leading-edge wing were greater than for the round-leading-edge wing. The values of normal-acceleration increment obtained for the round-leading-edge wing are in good agreement with the curves calculated according to the usual method of computation (ref. 5). For the sharp-leading-edge wing, the normal-acceleration increment was computed by using several different lift-curve slopes corresponding to different points along the lift curve (fig. 6), but no consistent correlation with the experimental values could be obtained. Thus, it appears that the higher maximum acceleration increments experienced by the sharp-leading-edge wing were due to participation of the leading-edge separation vortex in the unsteady-lift phenomena associated with the gust and were not directly related to the lift curve obtained in steady flow. Since the method and the lift-curve slope generally used to calculate gust loads for swept wings (ref. 5) are both dependent upon potential-flow concepts, they should not be expected to apply for the sharp-leading-edge wing with leading-edge separation present. The results of these load studies can only be taken to indicate, therefore, that when leading-edge separation occurs in a gust, the gust load will be increased. The amount of increase apparently depends upon the gust-gradient distance and velocity, as shown in figure 3, but cannot be predicted from the results of these few tests.

The indication by the tufts in figure 5(b) of boundary-layer flow parallel to the leading edge of the wing illustrates the presence of leading-edge separation. This characteristic tuft behavior along with the sudden increase in lift-curve slope (fig. 6 at  $\alpha = 5.5^\circ$  for sharp-leading-edge wing and  $\alpha = 9.5^\circ$  for round-leading-edge wing) have been defined as signs of leading-edge separation in various wind-tunnel studies, for example, references 1 and 2. For the purposes of these tests, it is assumed that the tufts respond almost instantaneously and thus indicate a given flow pattern equally well in steady and unsteady flow.

The solid data points for angle of attack shown in figure 4 indicate that separation was present. The conditions of separation or no separation were obtained from photographs such as those presented in figure 5. The positions of the symbols for angle of attack in figure 4, in fact, indicate the values of penetration into the gust at which the tuft photographs were obtained. The normal-acceleration-increment histories in

figure 4 are sample curves, the peak values of which do not necessarily agree with those given in figure 3, which are average values for eight flights. These curves are presented so that the relative locations of acceleration increment and angle of attack may be compared.

Examination of figure 4 indicates that separation occurred at lower angles of attack for the sharp-leading-edge wing than for the round-leading-edge wing in both the wind-tunnel and gust-tunnel tests and at higher angles of attack in the gust tunnel than in the wind tunnel for both wings, except for the round-leading-edge wing in the 15 ft/sec gradient gust. (For the round-leading-edge wing in the gradient-gust condition of 15 ft/sec (fig. 4(a)), the angle of attack increased to about  $9.6^\circ$ , which was the angle at which separation occurred in steady flow, and remained there for a relatively long period of time; thus, it appears reasonable for separation to have occurred in this borderline region.) It appears from figure 4 that, for unsteady motion, the angle of attack at which separation begins is greater than that for steady flow when the angle of attack is increasing and that the angle of attack at which separation stops is less than that for steady flow when the angle of attack is decreasing. It seems then, as might be expected, that the rate of change of angle of attack due to the gust and the degree of penetration into the gust (or time) are both important in determining whether separation occurs. The present study was not conducted in a manner which would permit an analysis of these effects, however.

Reference 3 indicated that leading-edge separation occurred on the  $60^\circ$  sweptback wing in the sharp-edge gust of 10 ft/sec and reference 6 gave an experimental value of maximum acceleration increment for the  $60^\circ$  sweptback wing which was somewhat higher than that calculated using the "cosine law" lift-curve slope. Most of the discrepancy in the result of reference 6 was attributed to horizontal-tail effect, but in view of the results of the present investigation, it would seem that at least part of the discrepancy might have been due to leading-edge separation. Consequently, the statements made in references 5 and 6 that the cosine law applies for swept wings in gusts do not appear to apply when leading-edge separation is well-developed, the effect of leading-edge separation being to increase the load. The amount of the increase in load apparently depends upon the degree of leading-edge-vortex development which, as mentioned previously, depends upon the gust shape and velocity in addition to the parameters which affect leading-edge separation in steady flow.

#### CONCLUSIONS

The results of an investigation to determine the effect of leading-edge separation on the loads experienced by a  $45^\circ$  sweptback-wing model in gusts indicated the following conclusions:

1. Leading-edge separation increases the gust load to a value higher than indicated by the usual method of calculation.
2. The amount of increase in load apparently depends upon the gust-gradient distance and velocity.
3. The increase of the gust load is apparently due to participation of the leading-edge separation vortex in the unsteady-lift phenomena associated with the gust and is not directly related to the steady-flow lift curve.
4. There is a hysteresis effect under unsteady conditions in the flow change between the "no vortex" and "vortex" regimes.
5. The rate of change in angle of attack and the extent of penetration into the gust are both important in determining whether leading-edge separation occurs.

Langley Aeronautical Laboratory,  
National Advisory Committee for Aeronautics,  
Langley Field, Va., September 21, 1953.

#### REFERENCES

1. Cahill, Jones F., and Gottlieb, Stanley M.: Low-Speed Aerodynamic Characteristics of a Series of Swept Wings Having NACA 65A006 Airfoil Sections (Revised). NACA RM L50F16, 1950.
2. Fitzpatrick, James E., and Foster, Gerald V.: Static Longitudinal Aerodynamic Characteristics of a  $52^\circ$  Sweptback Wing of Aspect Ratio 2.88 at Reynolds Numbers From 2,000,000 to 11,000,000. NACA RM L8H25, 1948.
3. Cahen, George L.: A Preliminary Gust-Tunnel Investigation of Leading-Edge Separation on Swept Wings. NACA RM L52C20, 1952.
4. Donely, Philip: Summary of Information Relating to Gust Loads on Airplanes. NACA Rep. 997, 1950. (Supersedes NACA TN 1976.)
5. Pierce, Harold B.: Tests of a  $45^\circ$  Sweptback-Wing Model in the Langley Gust Tunnel. NACA TN 1528, 1948.
6. Pierce, Harold B.: Gust-Tunnel Investigation of a Wing Model With Semichord Line Swept Back  $60^\circ$ . NACA TN 2204, 1950.



TABLE I.- CHARACTERISTICS OF THE MODEL

Weight, lb . . . . .	9.75
Wing area, sq ft . . . . .	6.05
Span, ft . . . . .	4.25
Mean chord, parallel to plane of symmetry, ft . . . . .	1.475
Aspect ratio . . . . .	2.99
Root chord, ft . . . . .	1.90
Tip chord, ft . . . . .	0.95
Sweep angle at 50-percent-chord line, deg . . . . .	45



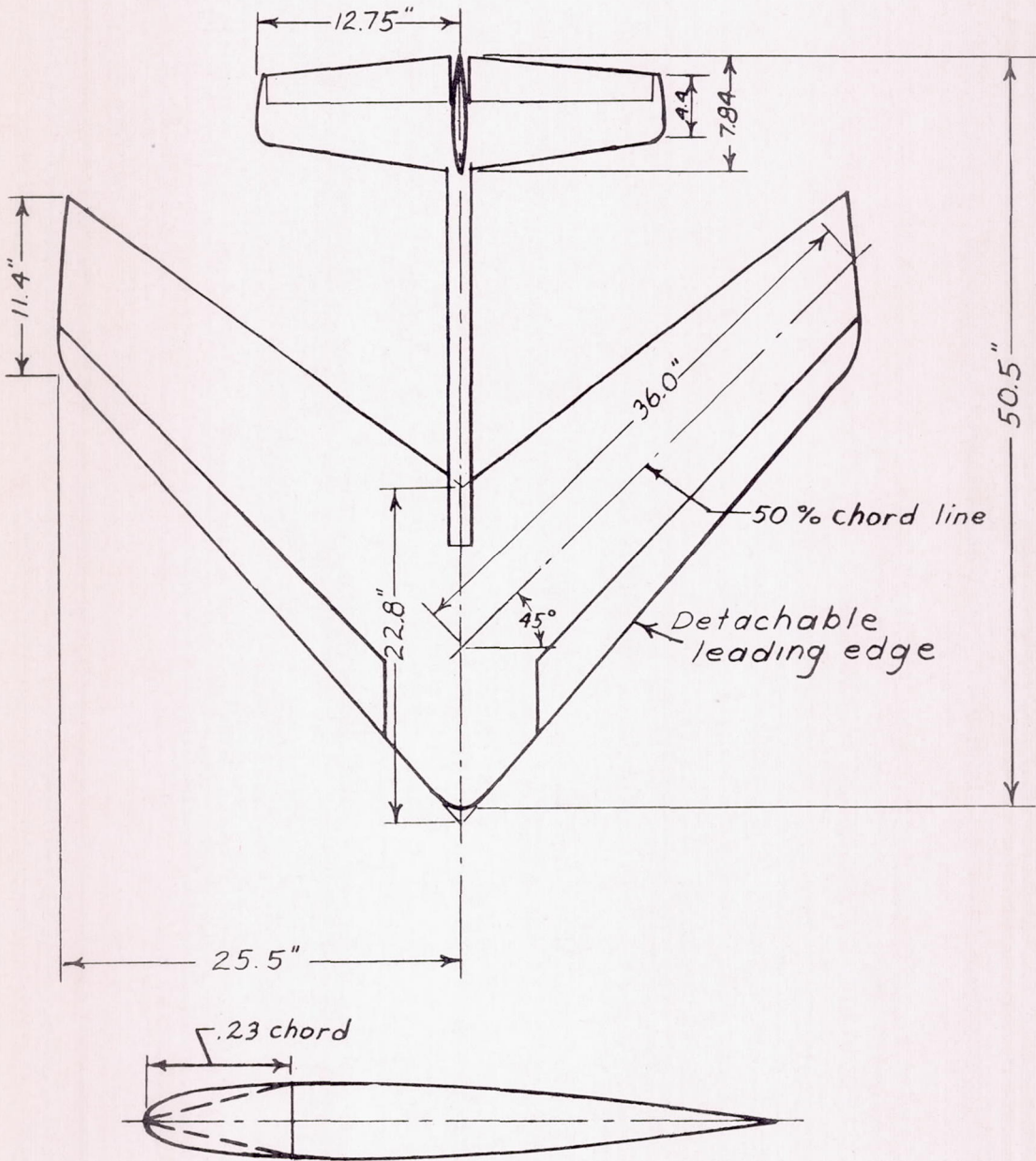

NACA 0012 airfoil with standard and wedge-shaped leading edges

Figure 1.- Plan view of model and airfoil section.

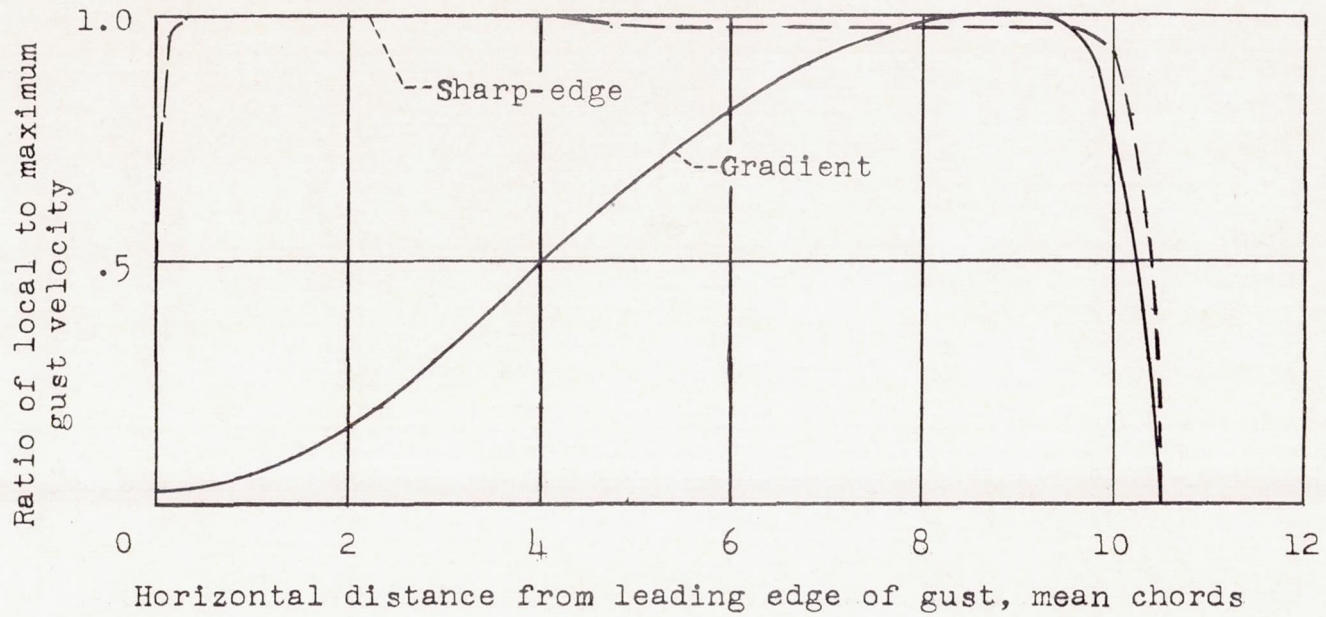

Figure 2.- Sharp-edge and gradient gust profiles.

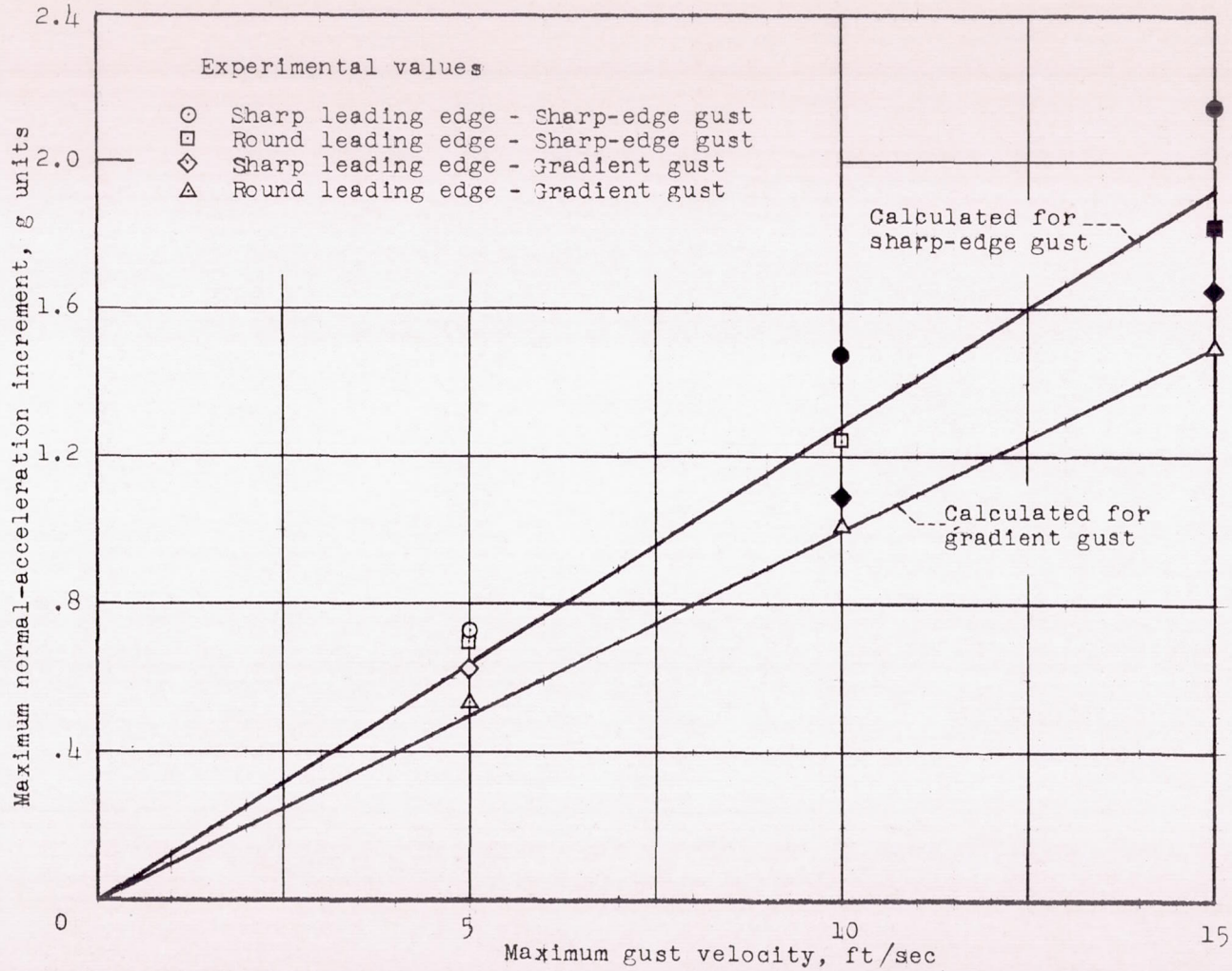
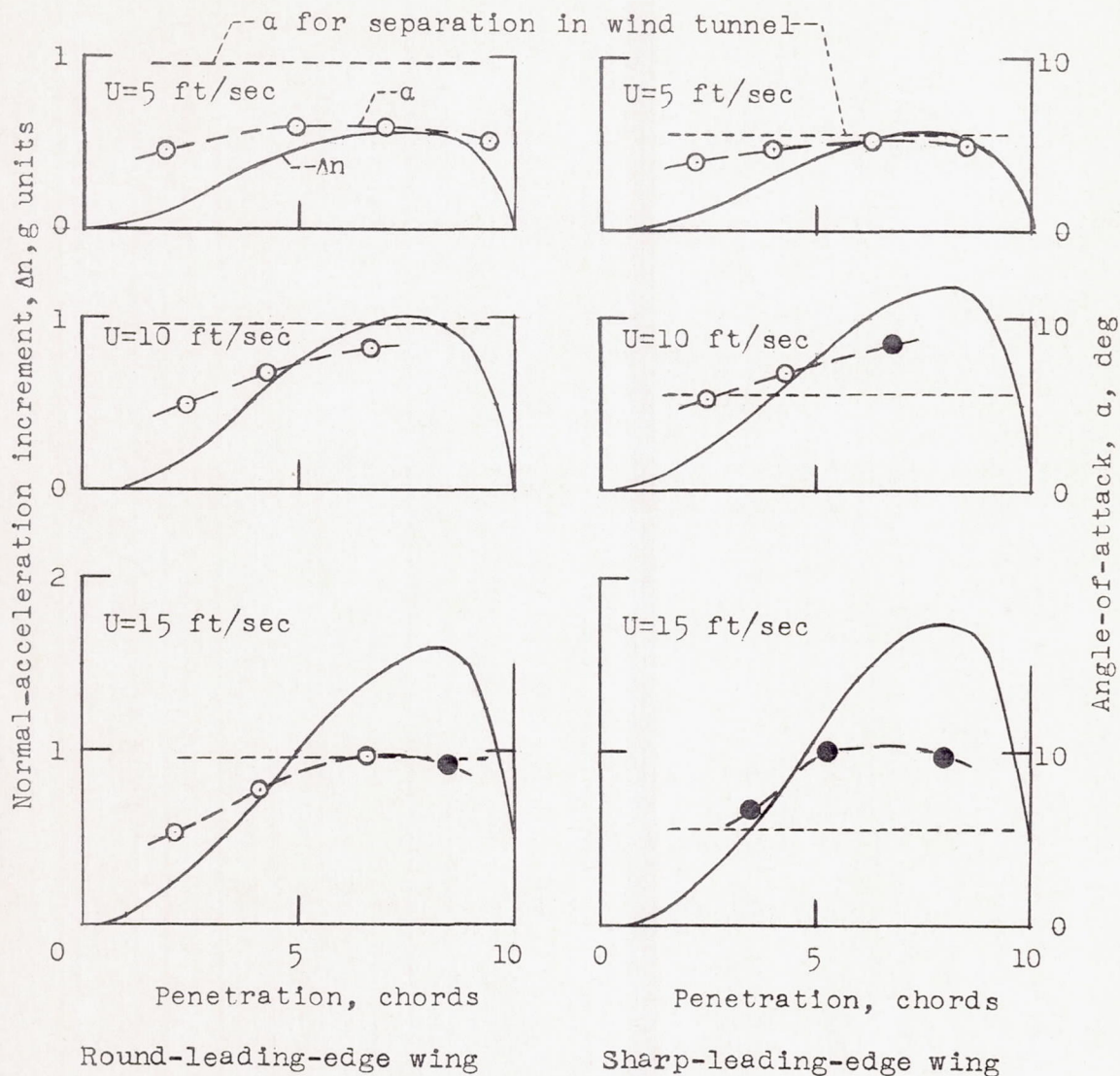
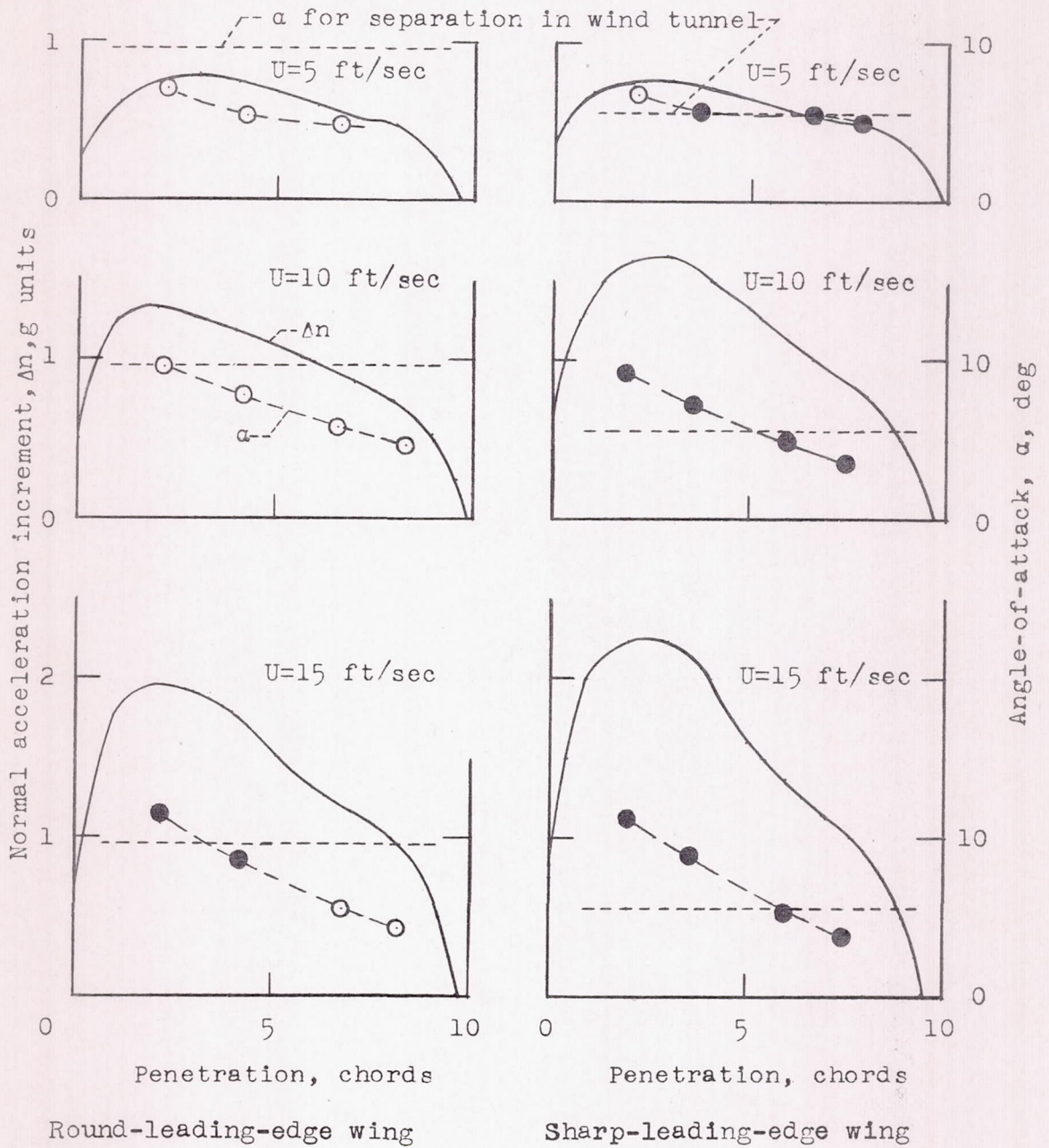

Figure 3.- Comparison of calculated and experimental maximum acceleration increments. Solid symbols denote that separation was indicated at time of peak load.



(a) Gradient gusts.

Figure 4.- Sample histories of normal-acceleration increment and angle of attack for the gust-tunnel tests. (Solid symbols denote that separation was indicated by the tufts.)



(b) Sharp-edge gusts.

Figure 4.- Concluded.

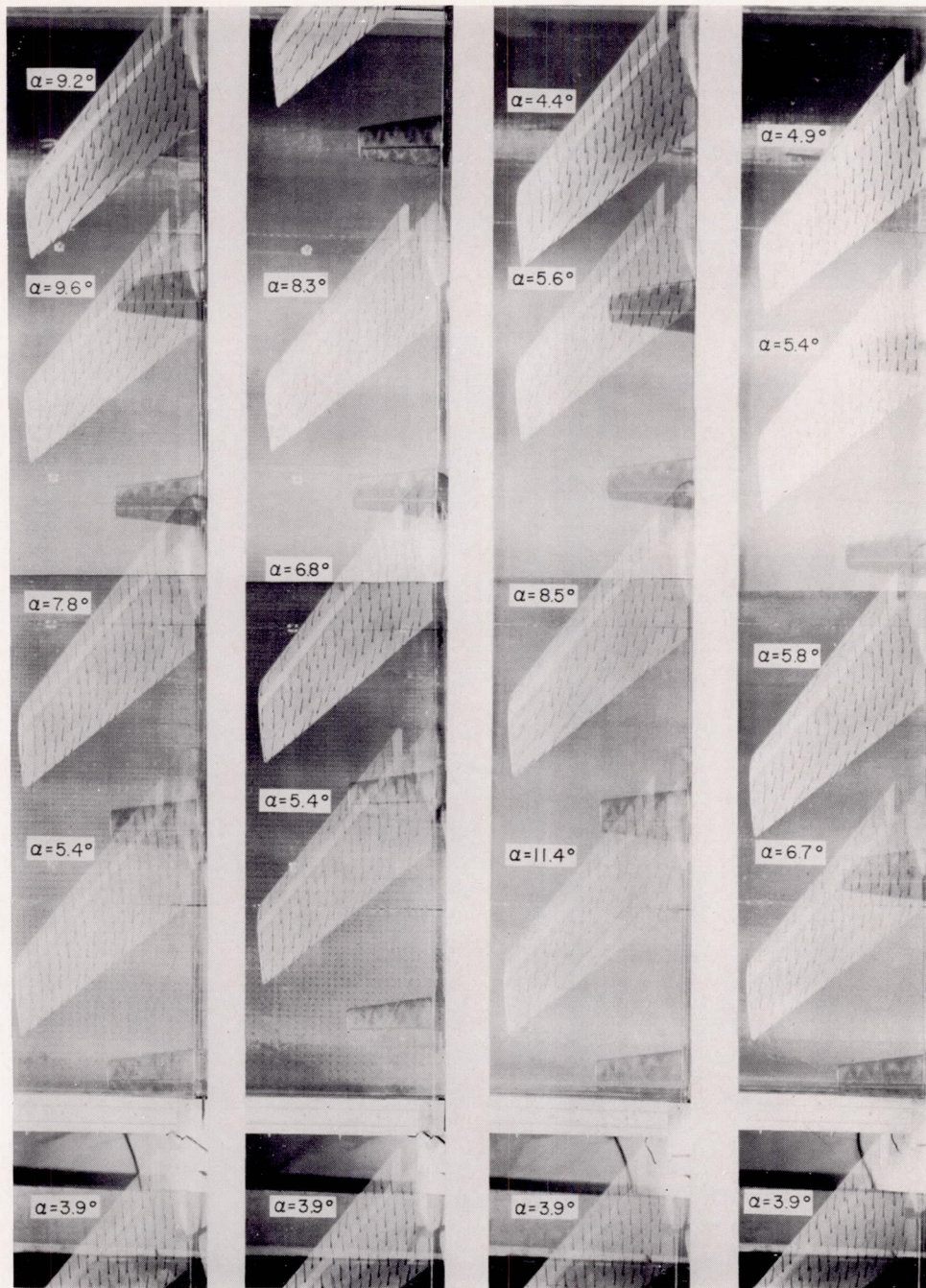

Round leading edge    Sharp leading edge    Round leading edge    Sharp leading edge  
 15 ft/sec    Gradient gust    10 ft/sec    15 ft/sec    Sharp-edge gust    5 ft/sec

L-77962.1

(a) Gust tunnel.

Figure 5.- Photographs showing first indication of leading-edge separation for each test condition.



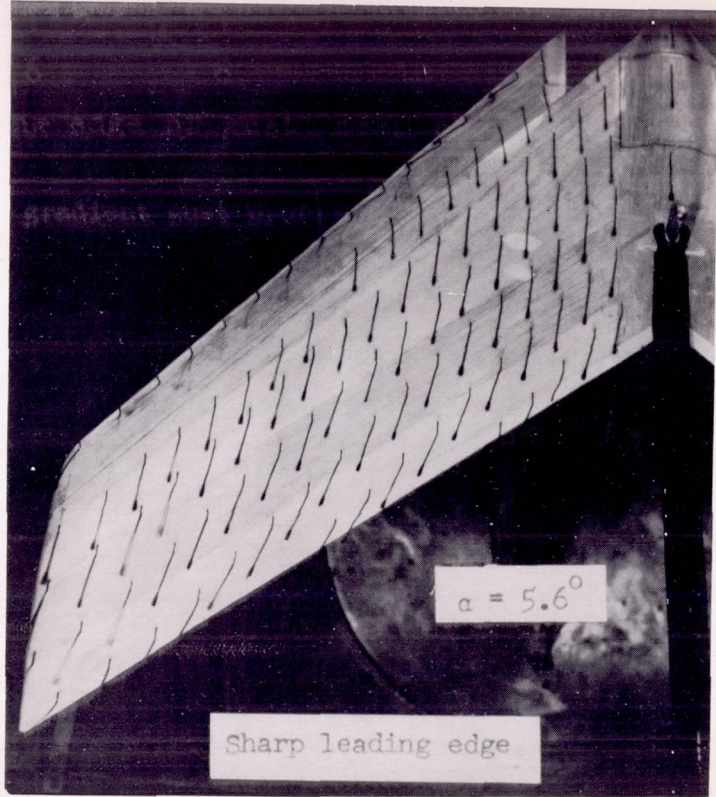
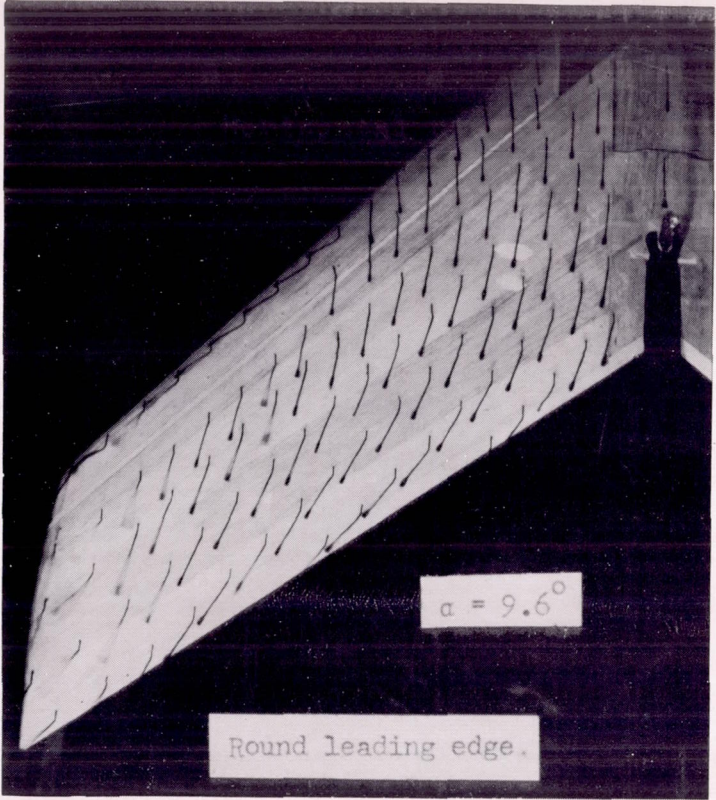

L-81237

(b) Wind tunnel.

Figure 5.- Concluded.

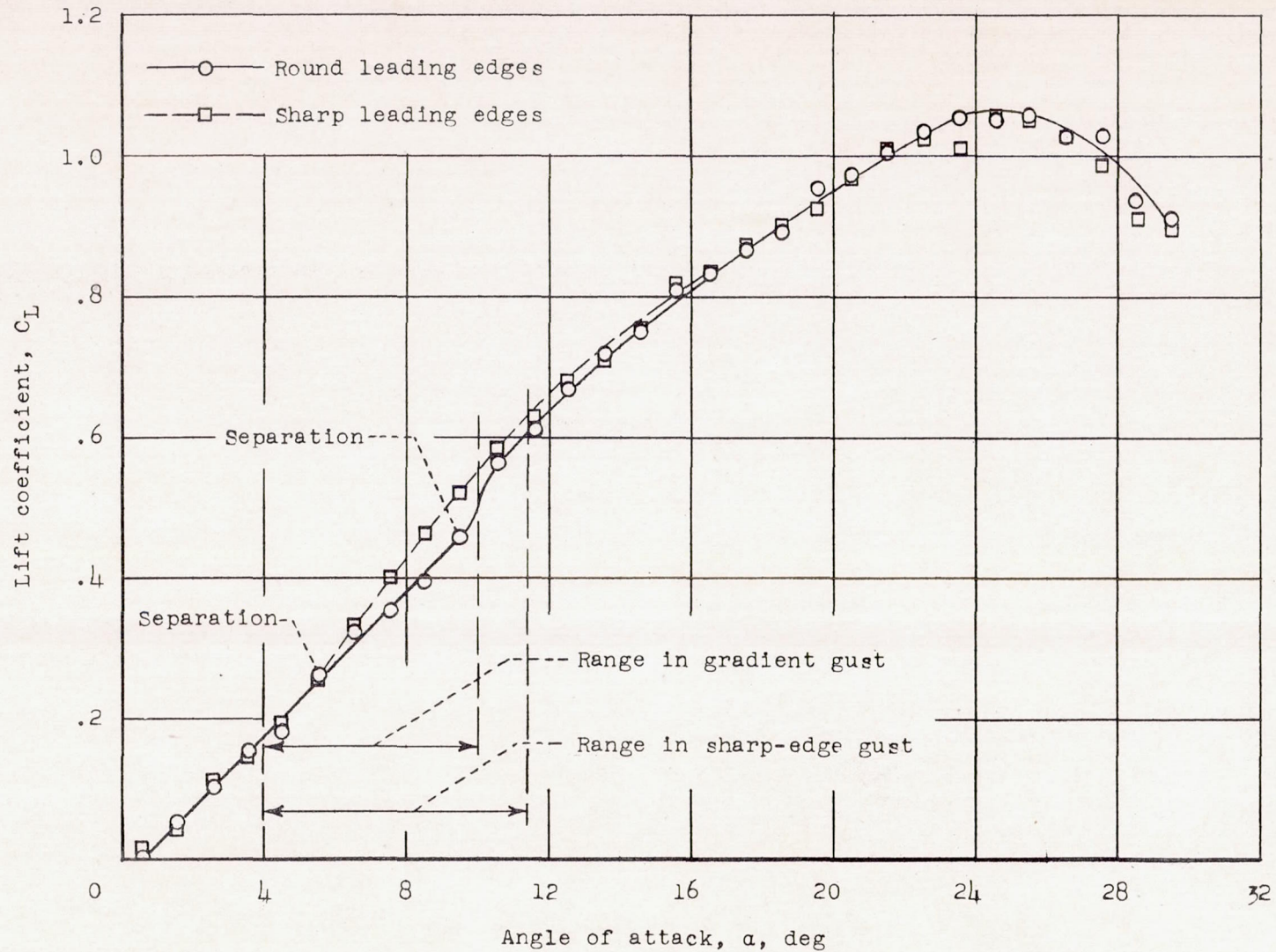
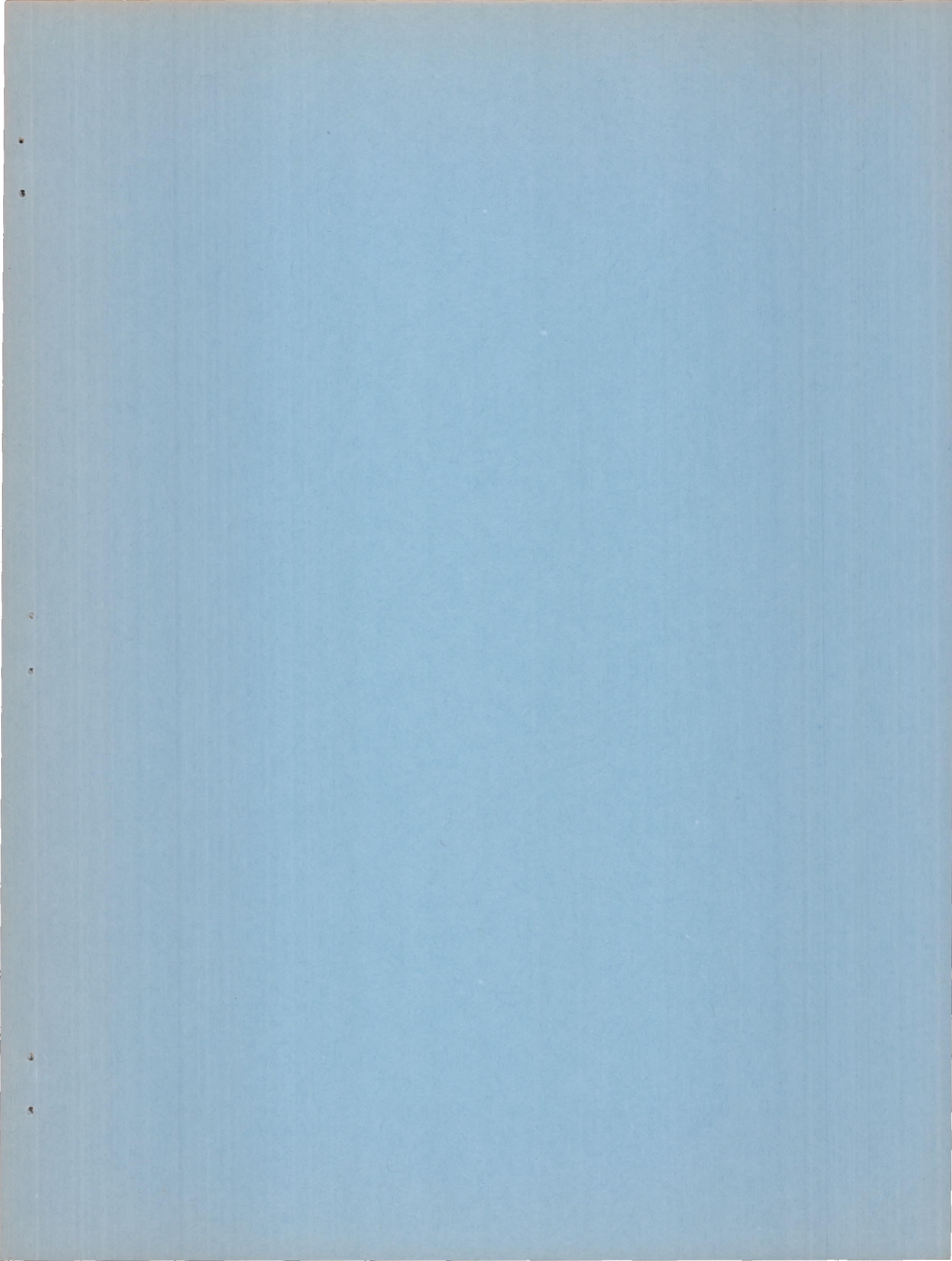

Figure 6.- Lift curves for wing with round and sharp leading edges.



SECURITY INFORMATION

RESTRICTED

RESTRICTED