

AIRCRAFT CIRCULARS
NATIONAL ADVISORY COMMITTEE FOR AERONAUTICS

No. 25

THE SUPERMARINE "SOUTHAMPTON" SEAPLANE
(Observation or Bomber)

From "Flight," November 18, and 25, 1926

Washington
December, 1926

NATIONAL ADVISORY COMMITTEE FOR AERONAUTICS.

AIRCRAFT CIRCULAR NO. 25.

THE SUPERMARINE "SOUTHAMPTON" SEAPLANE.*

(Observation or Bomber)

Having specialized for thirteen years on the design and construction of flying boats, it is not to be wondered at that the Supermarine Aviation Works have secured a leading position in this branch of aircraft work, and within the last year or so the firm has produced a seaplane which proved an instant success and large orders for which have been placed by the British Air Ministry. This type has become known as the "Southampton," and the seaplane having gone into quantity production it has now become possible to give a detailed description of it, unfettered by the rules of secrecy which surround all aircraft built for the British Air Ministry until the restrictions are raised upon the seaplane being ordered in quantities. The Supermarine "Southampton," among its many other excellent features, incorporates the somewhat unusual one of being able definitely to fly and maneuver with one of its two Napier "Lion" engines stopped. There are probably very few types of twin-engined aircraft in the world able to do this, and the fact that the "Southampton" will do it with comparative ease, speaks well for the design of this seaplane.

* From "Flight," November 18, and November 25, 1926.

This seaplane was found to provide one of those somewhat rare instances in which a seaplane is absolutely "right" straight away. No modifications of any kind were found to be necessary, and the seaplane was delivered by air to the Experimental Air Station. This feat of designing and constructing a large twin-engined seaplane in a period of only 7½ months, must be regarded as a remarkable achievement. The seaplane then went through its type tests "without a hitch," with the result that the trials were completed in record time. The "Southampton" was then adopted as the standard twin-engine reconnaissance seaplane of the R.A.F., and by now a large number of "Southamptons" have been delivered, while many more are still on order.

Hardly had a flight of these seaplanes been handed over to the Service, than it was announced that they would undertake an extended cruise in conjunction with the Fleet, around the British Isles. This cruise was accomplished without incident, and the success, from the Service point of view, was such that, the Air Ministry issued a special communique, praising the seaplanes, recalling that the cruise was one of some 10,000 miles in very bad weather.

Other long-distance flights have been made successfully. No trouble whatsoever was experienced, either with the seaplane or with its Napier "Lion" engines, and a special feature of the cruise was that constant wireless communication was maintained throughout, with R.A.F. and other wireless stations.

To appreciate to the full these cruises, it should be kept in mind that they were in no way stunt flights with an elaborate detail organization, but ordinary Service exercises with standard seaplanes, carrying throughout a crew of four and full service load.

The Supermarine "Southampton" has been designed as a Naval Patrol and Reconnaissance seaplane, possessing very low range, being very effectively armed, and capable of carrying out bombing operations.

The "Southampton" is a twin-engined seaplane or flying boat with a two-stepped circular-section hull of the flexible "Linton Hope" type, the steps being built on as a separate structure. Apart from the generally "clean" lines of the hull, the seaplane is mainly remarkable on account of its somewhat unusual wing structure.

The whole seaplane has been designed with a view to eliminate "blind spots," i.e., areas blanketing the gunners' view and field of fire. As a result the "Southampton" is well able to defend itself, and the manner in which the usual "blind spot" behind the tail has been avoided, is extremely interesting. To begin with, the tail has been designed as a semicantilever, the supporting struts projecting but a very short way out from the tail root. Secondly, the cockpits for the aft guns are placed as far out as possible laterally, and staggered in relation to one another, so that from one or other of the two cock-

pits there is no blind area beyond a distance of about 50 feet from the tail.

The hull has been given plenty of freeboard and buoyancy, so that the cockpits and propellers are well clear of the water, and the lines of the hull and planing bottom are such that the seaplane is exceptionally "clean" when maneuvering on the sea. Very complete marine gear is provided, such as towing bollards, mooring slings, boat-hooks, sea anchor, etc., so that the seaplane can be very efficiently handled while on the sea. The forward cockpit is well situated for the purpose of picking up moorings and generally attending to the various operations on the water.

Another feature of the "Southampton" is that no gasoline is carried inside the hull, the main gasoline tanks being supported under the top wing. In consequence, the hull itself is particularly free of obstructions, and in fact, it is possible for members of the crew to walk about freely anywhere from bow to stern. There is even ample space in which to sling hammocks for the crew, who can, and do, thus sleep on board. In fact, except for refueling, the seaplane is independent altogether, and is a self-contained unit.

The accommodation for the crew is as follows: In the bows is the forward gunner's cockpit, fitted with mounting for Lewis gun. A comfortable hinged seat is provided, which can be swung out of the way and stowed when the gun is being operated. Aft

of this is the pilot's cockpit, while behind that again is the cockpit for the navigator. Inside the hull, aft of the navigator's cockpit, is a roomy compartment with chair and table for the navigator, the wireless compartment being still farther aft. Finally, the two rear gunners' cockpits are situated quite a long way aft of the wings, where the field of fire is exceptionally clear.

The total loaded weight of the "Southampton" is 14,300 lb. (6,500 kg), and clearly the disposable load can be arranged in any way suitable to the purpose of the seaplane. When used as a bomber, the "Southampton" carries the following load:

Crew of four,	720 lb.	(327 kg)
Armament and military equipment,	2130 "	(968 "
300 gallons of gasoline,	2220 "	(1000 "
22 gallons of oil,	220 "	(100 "
Total load,	5290 "	(2405 "

When the seaplane is used for reconnaissance, the load is composed as follows:

Crew of five,	900 lb.	(410 kg)
Armament, etc.,	1130 "	(514 "
400 gallons of gasoline,	2960 "	(1345 "
30 gallons of oil,	300 "	(136 "
Total load,	5290 "	(2405 "

For bombing, the range has been reduced to enable 1000 lb. (455 kg) of bombs to be carried. Fitted with two Napier "Lion" engines, using 0.65 pints of gasoline per horsepower per hour, the

"Southampton" has the following officially observed performance:

Maximum speed at sea level,	107.7 M.P.H.	(173 km/hr)
Rate of climb at sea level,	610.0 ft./min.	
Ceiling,	14,000.0 ft.	(4260 m)
Minimum speed,	56 M.P.H.	(90 km/hr)
Optimum cruising speed,	85 "	(137 ")
Range at cruising speed, (400 gallons of gasoline),	680 miles	(1100 km)

The Supermarine "Southampton" could, of course, be converted into a commercial seaplane when, by allowing for a crew of two, wireless instruments, marine gear, seating, etc., 800 lb. (364 kg), there would be a disposable load of 4490 lb. (2040 kg) that could be arranged in any combination desired; as, for instance:

400 gallons of gasoline, range 680 miles, (1100 km);

Duration, 8 hours;

Number of passengers with luggage, 6; or,

300 gallons of gasoline, range 510 miles, (820 km);

Duration, 6 hours;

Number of passengers, 10; or,

200 gallons of gasoline, range 340 miles, (550 km);

Duration, 4 hours;

Number of passengers, 14.

These figures are all based upon a cruising speed of 85 M.P.H. (137 km/hr). This is for a total loaded weight of 14,300 lb. (6,500 kg). For long-range work it would be permissible to

"overload" the seaplane up to a total loaded weight of 15,700 lb. (7,140 kg) when, by reducing the weight of crew, armament, etc., the range would be greatly extended.

The Superstructure

The wings of the "Southampton" are of normal form as regards their biplane arrangement, but the wing bracing is somewhat unusual in that the center section of both wings is built up in the form of a Warren girder. Apart from the advantages arising owing to the comparatively small number of struts employed, this arrangement is convenient both for the engine installation and for the clear space which it gives across the middle portion of the lower wing. Constructionally the wings follow normal practice as regards the standard type of "Southampton" but it may be pointed out that the seaplane is now also being produced as an all-metal flying boat, the all-metal feature extending to the wings as well as to the hull. About this, however, nothing may be stated at the moment.

Interplane struts of somewhat unusual construction are employed on the "Southampton." These consist, as regards the stress-carrying member, of circular section steel tubes, tapered to the ends. These tubes have attached to them light wooden formers and stringers, the skeleton thus produced being covered with doped fabric. The details of the construction are illustrated in Fig. 5.

Reference was made to the somewhat unusual type of tail used on the "Southamptons." This consists of a monoplane stabilizer, which is arranged in the form of a semicantilever beam, the three vertical fins and rudders being mounted on top of the stabilizer, and moving with it when the tail is trimmed. The elevator is a one-piece structure and runs right across below the rudders. The stabilizer is supported on the center line of the hull, and by short struts from the hull attached to the stabilizer spars a short distance out from the center line of the seaplane. It will be realized that it has been no easy task to design a stabilizer of this area which would be sufficiently rigid with the large overhangs which the semicantilever arrangement produced (Fig. 3). The Supermarine Aviation Works have, however, evolved a special type of planked spars, which give great rigidity and have been found to provide all the stiffness required in the tail (Figs. 4 and 5). The spars taper from the center of the seaplane outwards, so that the section of the stabilizer varies gradually from center to tips. The vertical fins are pure cantilevers supported direct on the stabilizer spars. Needless to say, the stabilizer is provided with a trimming gear, so as to balance the seaplane in the engine-on and engine-off condition, and also, of course, to allow for any differences in trim due to variations in load.

The Power Plant

The Napier "Lion" engines are mounted on substantial bearers carried on pin-jointed tubular struts. The engine mountings are separate units mounted on the lower center section, and can be easily removed without interfering with the wing structure, by removing five pins in the strut ends, and by disconnecting the engine controls and gasoline leads. Each engine has its radiator mounted in front of it, and an oil tank behind it, which are removed with the engines and mountings. As all the engine instruments are mounted on the engine bearers the complete engine unit can be lifted out of the seaplane with a sling from directly overhead, the position of the engines forward of the wings rendering this possible.

The gasoline system is by gravity feed only, no gasoline being carried inside the hull. The two main gasoline tanks are slung underneath the top center section, and are of very large capacity. One of our photographs shows the internal arrangement of baffle plates in a tank.

Hand starting gear is fitted to each engine, suitably geared to make the handles easy to turn. Standard priming pumps are fitted which feed from the filters, and the starting magnetos are geared in with the starting handles. Owing to the absence of wire bracing over the center portion, it is very easy for mechanics to climb down into the rear cockpits after starting up the engines.

The Boat Hull

The hulls of the standard "Southampton" flying boats are of all-wood construction, although, as previously mentioned, an all-metal hull is now being produced. Both hulls are of the circular section flexible type. The standard hull embodies all the latest developments in Supermarine wooden hull design, including raised and flared bow, double bottom with air space from bow to rear step, brass running strakes and transom protecting strips. The double bottom is divided into ten water-tight compartments, each fitted with draining plugs and vents. The two steps are built in such a way that they can be easily repaired, or completely replaced in case of extensive damage. The main hull is double planked with an inner skin of cedar and an outer skin of mahogany, a layer of fabric being varnished on in between the skins.

The planing bottom is double planked with a diagonal skin of cedar and a fore and aft skin of mahogany, with a layer of fabric in between ironed on with marine glue. It is treated outside with a special black varnish preparation which acts as a very efficient anti-fouling agent, and gives a surface of very small frictional resistance. All timbers, hoops and saddles are of best quality American elm, while the keel and keelson are of American elm and mahogany. The springers are of grade A spruce. The entire construction of the hull utilizes the through-fastening principle, and all fixings are of copper and brass.

As mentioned previously, the circular type of construction gives a hull entirely free of obstruction inside from bow to stern.

The wing tip floats of the Supermarine "Southampton" are of somewhat unusual design, and are chiefly remarkable on account of their very pronounced V-bottom. The floats are of large buoyancy, and are designed to use their full buoyancy with a very small lateral angular movement of the seaplane. This feature is obtained by making the floats long and shallow, and of comparatively small maximum cross section. Both from an aerodynamic and hydrodynamic standpoint the floats are of very low drag, which, apart from the beneficial effect on performance, also prevents the seaplane from being yawed by the floats while taking off or landing. Each float is divided into eight water-tight compartments fitted with drain plugs.

Controls

The dual controls of the "Southampton" are arranged in the form of a complete unit, a photograph of such a control unit being given in Fig. 10. The complete control unit is mounted on a separate braced base, carried on tubular steel members from points of attachment in the hull. This base carries the control columns, adjustable rudder bars and seats, and the arrangement is such as to make the whole control unit very accessible. The Unit can be taken from the hull and replaced very easily. The two control columns are connected below their fulcrum by a tubu-

lar shaft, and a second shaft runs from the rear column to a cross lever at the rear end of the control frame.

The elevator is operated by forward and backward movements of the shafts, which carry large "bloater" levers on the port side of the control frame. From this there is a clear cable run along the inside of the hull to a lever on a torque shaft running across the hull a few feet from the stern. The rudders are operated by a similar torque shaft in the stern of the hull, and again there is a clear run for the cables up to the control frame. The rudder bars have pedals, so arranged as to make adjustment easy to suit the comfort of pilots of varying heights.

The ailerons are operated through the torque shaft on the under side of the control frame. The rear shaft carries operating levers on its aft end, from which aileron control cables run out to the wings. In this way control pulleys and leads are reduced to a minimum.

The engine controls are mounted on the port side of the pilots' cockpits, and are so arranged that the engines can be controlled either together or independently. Push and pull rods and bell crank levers are used to take the controls into the lower center section wings, in the leading edge of which torque rods run to points immediately in front of the engines, whence there is a straight run up to the engine levers themselves.

The cockpits are roomy and comfortable, and allow complete freedom of action, and the occupants are adequately protected

from winds and spray. Hinged map boards and cases and writing pads with pencil clips, etc., are provided for both pilot and navigator.

Adequate provision is made for rapid and easy movement of the crew between all cockpits and cabins. An unobstructed passage is provided, running from the forward gun ring right through to the stern of the hull. Any member of the crew can leave his seat and walk to any other member of the crew without disturbing in the least degree those he has to pass. In the pilot's and navigator's cockpits there is room for another member of the crew to stand alongside and converse.

The Beaching Gear

The old-fashioned launching cradle has been superseded in the "Southampton" by a new type of easily detachable launching gear, which enables the seaplane to be man-handled with ease. Each side of the gear forms one unit, and is attached on the three-point principle, and can be removed by the withdrawal of three pins on each side of the seaplane. The gear can also be fitted to the seaplane when in the water before drawing up the slipway. One advantage of this type of beach launching gear, apart from the ease with which the seaplane can be handled by its use, is that it supports the seaplane from the wings and does not impose any strain on the hull. A tail trolley is also provided for fitting just ahead of the rear step.

The Supermarine "Southampton" can also be fitted with two

Bristol "Jupiter," Series VI, engines, in which case the loads carried when the seaplane is used for bombing and reconnaissance, respectively, are 6110 lb., the figure in the former including 400 gallons of gasoline, and in the latter 500 gallons of gasoline. The figures for weight, empty, load carried and total loaded weight are 8190 lb., 6110 lb., and 14300 lb., respectively.

The estimated performance is as follows: top speed at

Top speed at sea level,	109 M.P.H.	(175.5 km/hr);
Rate of climb at sea level,	643 ft./min.;	
Ceiling,	14,700 ft.	(4,500 m);
Minimum flying speed,	56 M.P.H.	(90 km/hr);
Optimum cruising speed,	85 "	(137 ");
Range at cruising speed on 500 gallons of gasoline,	850 miles	(1,370 km).

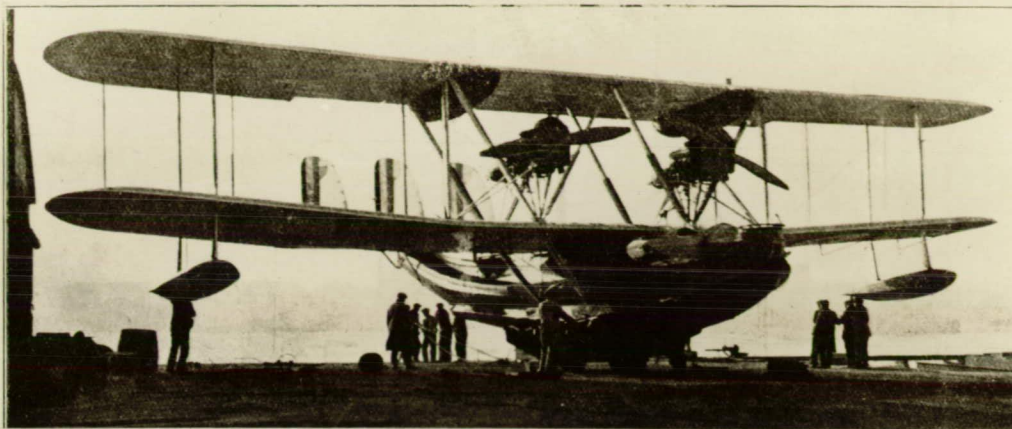

Fig.1 Three-quarter view of "Southampton" seaplane on the slipway, giving a good idea of the somewhat unusual arrangement of the interplane struts. The Napier "Lion" engines are mounted on struts independent of the wing structure and can be removed without interfering with the wing bracing.

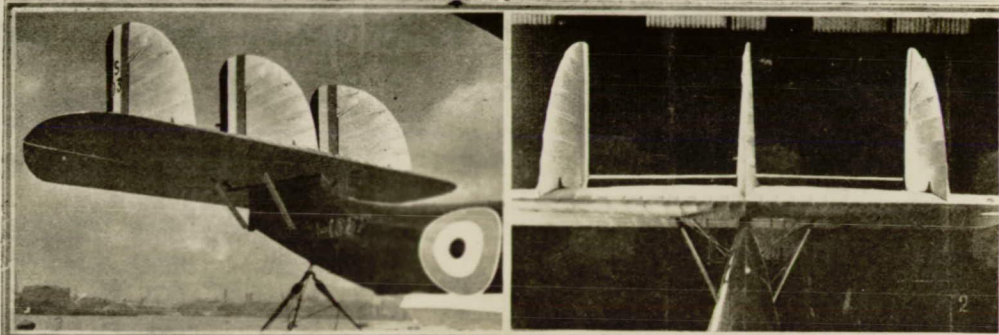

Fig.3 Two views of the cantilever tail, illustrating how little the field of fire is interfered with by the tail.

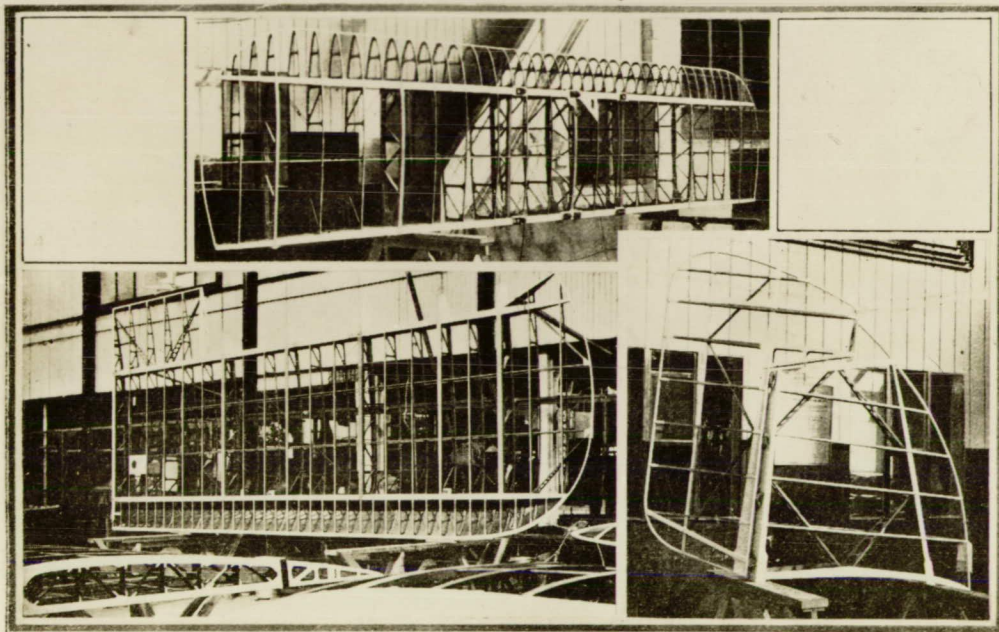

Fig.4 Skeleton of stabilizer, wing, and rudder.

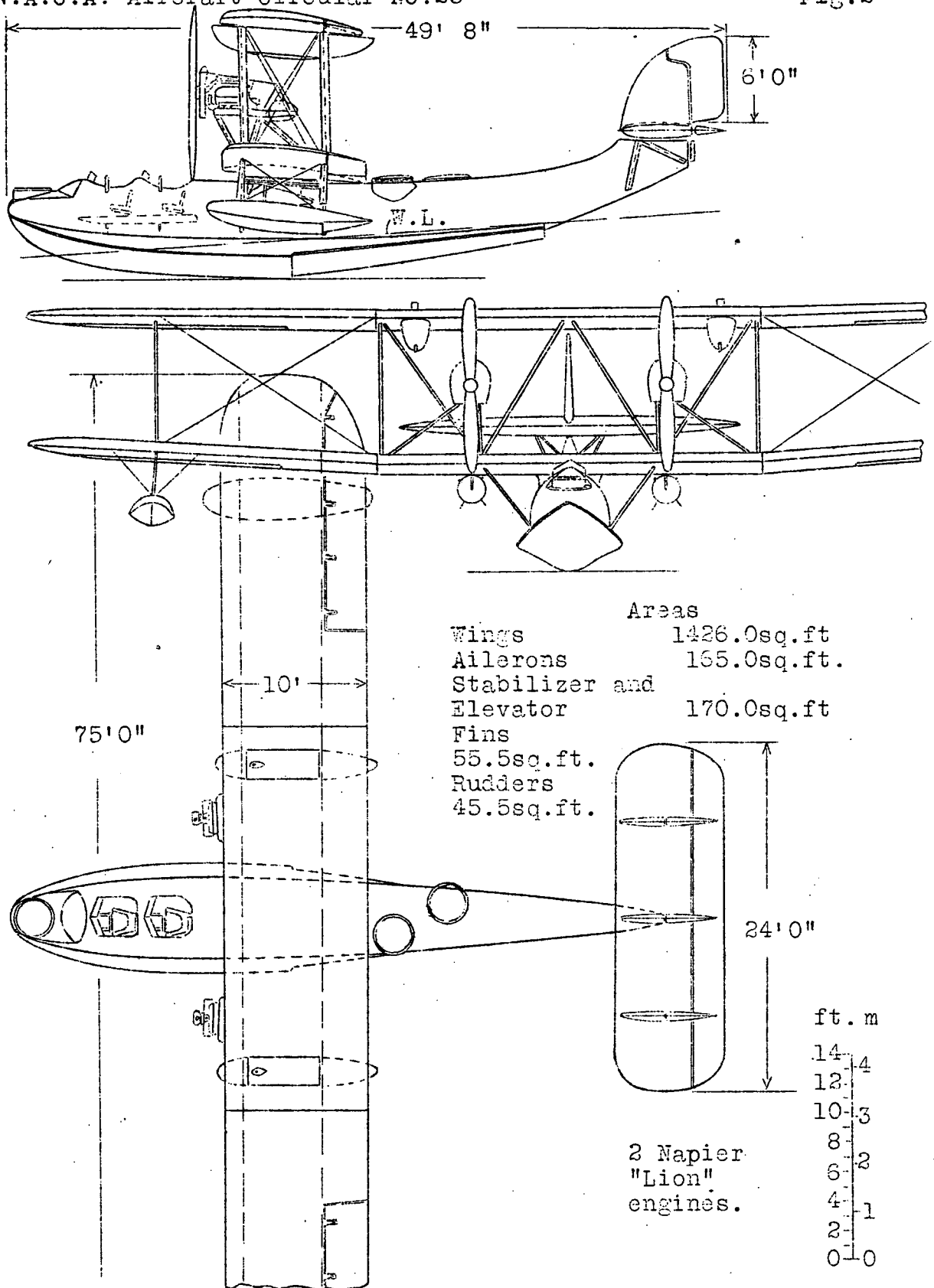

Fig.2 Supermarine "Southampton" seaplane.

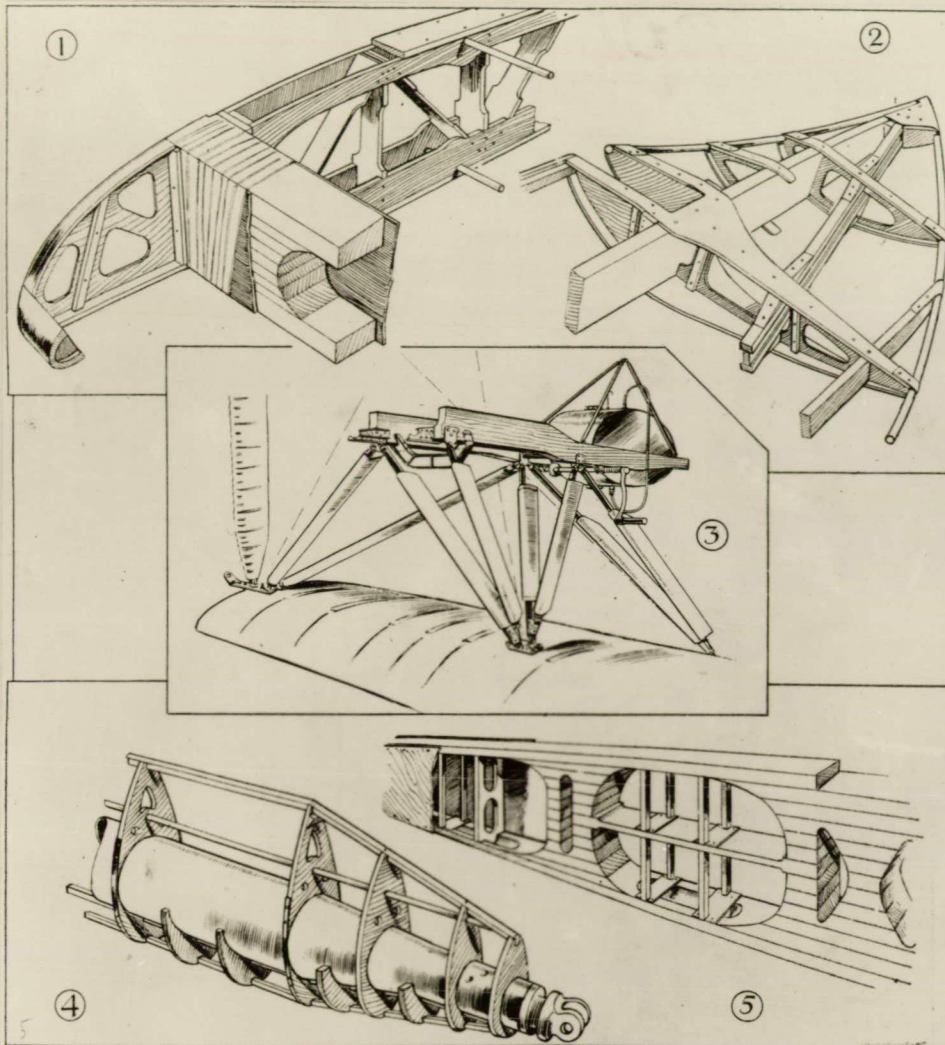

Fig. 5
Some constructional details.

1 shows details of the bottom center-section wing, the rib illustrated being the outer rib on the starboard side. The circular section stringers are of wood. In 2 is shown the construction of an aileron, while 3 illustrates the mounting of the starboard engine. The engine-bearer structure is independent of the wing structure. The interplane struts are of somewhat unusual construction, being steel tubes with wood skeleton fairings and fabric covering. Details are shown in 4. A stabilizer spar is illustrated in view 5.

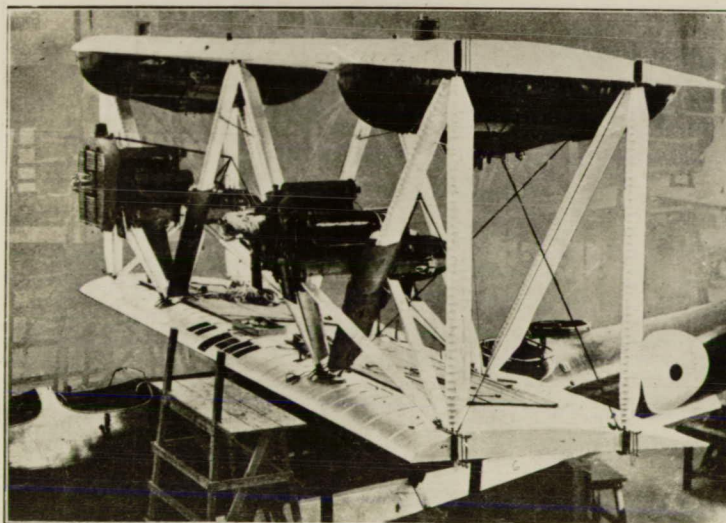

Fig.6

The center section showing the mounting of the two Napier "Lion" engine.

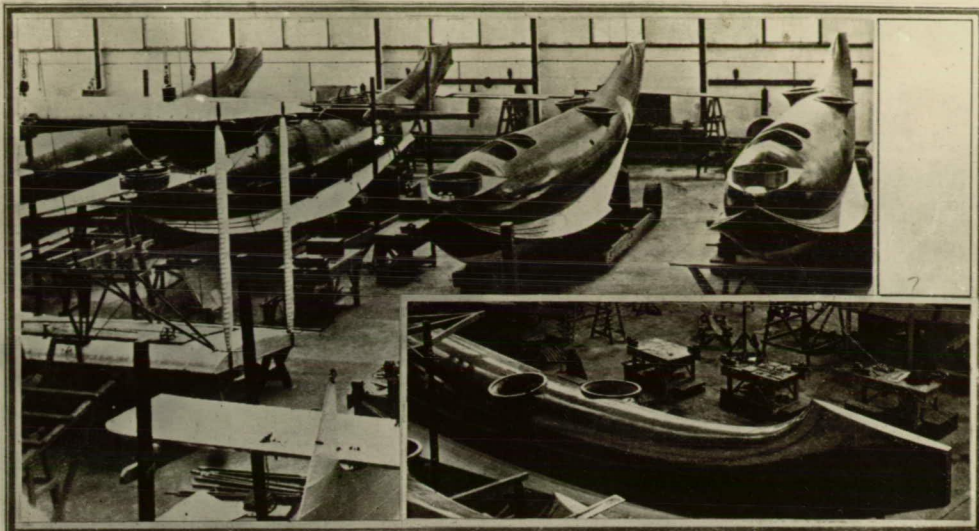

Fig.7 Hulls of the Supermarine "Southampton". Note the staggered cockpits for the rear gunners.



Fig.8 One of the wing-tip floats. Note the pronounced Vee bottom.



Fig.9 View inside a main gasoline tank showing baffle plates.

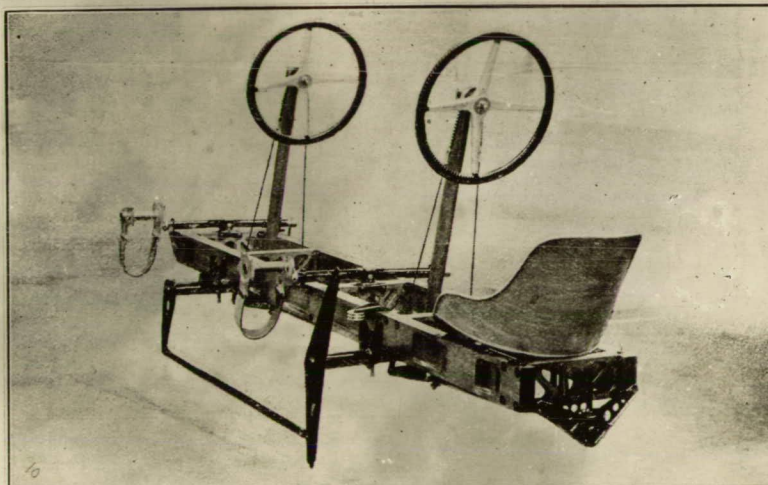

Fig.10 The controls are built up in the form of complete units, one of which is shown.