

FILE COPY
NO. 8

AIRCRAFT CIRCULARS
NATIONAL ADVISORY COMMITTEE FOR AERONAUTICS

No. 203

THE VICKERS-SUPERMARINE "SCAPA" (BRITISH)
A Military Flying Boat

FILE COPY
To be returned to
the files of the National
Advisory Committee
for Aeronautics
Washington, D. C.

Washington
May 1936

NATIONAL ADVISORY COMMITTEE FOR AERONAUTICS

AIRCRAFT CIRCULAR NO. 203

THE VICKERS-SUPERMARINE "SCAPA" (BRITISH)*

A Military Flying Boat

The "Scapa" has been designed to be used for observation, bombing, torpedo transport, and training and navigational instruction. The character of the military load carried will, of course, depend upon which of these functions the flying boat is fulfilling, but the arrangement of the crew's stations remains the same. In the extreme bows there is a special machine-gun mounting which can be removed and stowed farther aft, leaving the front cockpit free for mooring operations, etc. This cockpit has, in the extreme nose of the hull, a hinged watertight door which is used for bomb sighting.

AERODYNAMIC DESIGN

Quite remarkable care has been taken in the design of the "Scapa" to reduce head resistance. The hull itself has very clean lines, and on it is mounted a wing structure in which the number of parts has been reduced to a minimum. Apart from the slanting struts which carry the two Rolls-Royce Kestrel engines, there is but a single pair of interplane struts on each side. The engine nacelles themselves are of streamline form (fig. 4), and by placing the water radiators at the rear end of the nacelle, the usual unsightly and drag-producing excrescences are avoided. Lateral stability on the water is insured by two wing-tip floats, also of low-drag form and mounted each on a single pair of struts.

A monoplane tail is carried on the rising stern portion of the hull, to which it is braced by two struts on each side. Above the stabilizer are mounted two vertical fins carrying horn-balanced rudders. The "blind" area caused by the tail is not, therefore, large, and the rear guns have a wide field of fire.

*"From Flight, April 26, 1934, Flight, February 27, 1936, and The Aeroplane, February 26, 1936.

Between the forward cockpit and the wings is the pilots' compartment which, in the "Scapa", is provided with a sliding roof and side windows. The navigator and engineer are housed aft of the pilots' cabin, between it and the hull frame which carries the front lower wing spar, while slightly farther aft, between the two spar frames, is the W/T operator's station. Behind the wings are the two rear gun positions which, as already mentioned, afford very good tail protection owing to the shape and location of the tail surfaces (fig. 5).

If the "Scapa" is being used for extended cruises, provision is made for sleeping accommodation, food and water stowage, cooking table, and other special equipment. Stowage is also arranged for a collapsible dingey, an engine ladder, an engine maintenance platform, and a spare propeller.

STRUCTURAL FEATURES

Light alloys and stainless steel are the chief structural materials of the "Scapa". The stainless steel is used mainly for highly stressed fittings, and the light alloy for planking, frames, wing spars, and wing ribs. Doped fabric is used for covering the wings and tail surfaces.

Extensive tank tests on models resulted in a hull form which combines low air drag with clean running on the water and good seaworthiness.

For some years it was customary for British flying boats to have flaring chines, with the underwater body showing a flat vee curving sharply from keel to chine in order to keep down spray when the seaplane was taxiing and taking off. Modern tendency is toward flat sides and nearly straight-line vees in the hull bottom. The "Scapa" in this respect may be regarded as an intermediate type in that the curves of earlier seaplanes are retained, but have become very much flattened out. This is, of course, an advantage from a manufacturing point of view, as it avoids a great deal of panel beating. If a sheet of material, metal in this case, is bent simply, it will be found that a straight edge can be laid along it in such a way as to make continuous contact. If, however, one tries to bend the sheet in two directions, it is found that this cannot be done except by working on the sheet in such a way as to

cause it to stretch in some places and contract in others. It is this process which is known as panel beating. Differently explained, one can bend a sheet of metal around a cylinder but not around a barrel.

The sections of the "Scapa" have been so chosen that panel beating is almost entirely avoided, the main exception being the region around the extreme bows. For the rest, the sheet-metal covering of the "Scapa" hull is put on in fairly large panels (roughly, 4 ft. 6 in. long by 20 in. wide); so that the number of joints which have to be made watertight is reduced to a minimum.

In building the "Scapa" hulls, the keel is first secured on the stocks. The keel is built up to form an I section, and consists of a flat strip cut to the contour which the keel is desired to have, stiffened at top and bottom by flanges. These consist of extruded T sections, the vertical limbs of the T's being riveted to the edges of the keel web.

When the keel has been finished, the frames are erected on it in their proper positions and temporarily held in place while some of the fore-and-aft stringers are attached. The main stringers are of two general types: plain channel sections formed by bending the sheet itself to form the flanges, and T sections in which the edge farthest from the planking is formed by two L-section strips riveted through the web of the stringer. The stringer edge in contact with the planking is usually bent over to lie flat against the planking being riveted to it. Apart from I-section stringers, use is also made of the so-called Z section, in which the two angles are riveted on in opposite directions. The Z section has the advantage that it leaves the member very accessible for riveting. Intermediate light stringers in the "Scapa" are of what one might call £ section. That is to say, the edge in contact with the hull planking is bent over at right angles for riveting, while the free edge is curled over to give extra stiffness. The stringers are attached to the frames by small gussets, flanged over to provide the necessary riveting area, as shown in figure 6.

Several types of frame are used. The simplest is a plain channel section, having outer and inner flanges formed by simply bending over the edges of the fresh material itself. Others have the flanges formed by riveted-on angles. The spar frames are of slightly more substan-

tial construction, having two angles riveted on at the planking, two at the free edge, the latter being further reinforced by a cap-strip having its edges curled over for stiffness.

These spar frames have their webs extended upward to form the webs of the main wing spars, so that the roots of the lower wing are actually integral with the hull. The details will be understood from a reference to figures 6, 7, and 8. It should be noted that the stringers of the "Scapa" are continuous from bow to stern, and that they are notched into the frames, as shown in the sketches. In another form of hull construction, the frames are continuous, and the stringers interrupted at the frames, being attached to them by gussets. At present it does not seem decided which form of construction is the most satisfactory.

When the frames and most of the stringers are in place on the hull, the planking begins. The chine is formed by an L-section strip. This is temporarily held in place by screws to the frames, small pieces of metal of the same thickness as the actual planking being inserted to leave the necessary gap. The sheets of the planking are then "offered up" to the job, marked out, cut to size, and fitted. When a perfect fit has been attained, the piece of sheet is taken to the anodizing plant for treatment, and when that is finished it is brought back to the job, inserted in its proper place and finally secured by rivets to frames, stringers, and chine. Where the plates overlap, the edge of the outer is "stepped" over the edge of the inner before they are riveted together, so that except at the seams the two adjacent plates are perfectly in line. Marine glue is brushed on the edges before the plates are riveted together to insure watertightness.

At the two steps a transverse covering strip is used to insure a watertight joint. This strip is of Z-section, and conforms to the transverse shape of the hull at the steps. An interior view of the hull fore and aft is given in figures 9 and 10.

In the wing construction of the "Scapa" fairly normal practice is followed. An exception is, however, found in the wing spars, which are of very unusual section. Perhaps this section may be described as a Σ -section, resembling roughly, the Greek capital letter sigma. It consists

of a single corrugated web to which are riveted the two flanges.

Several advantages are gained by this very ingenious spar construction. As the spar is "open" from both sides, the riveting, holding-up, etc., becomes very easy. The sections are simple to form on rolling mill and drawbench, the web by pressing, and finally the attachment of ribs and drag bracing can be very simply carried out.

It is obvious that the type of spar web used is not by itself able to resist any very considerable vertical loads without collapsing. On the side of the spar where the spar flanges are attached to the web, the necessary strength in a vertical direction is obtained by the angle strips used to attach and reinforce the ribs. On the "open" side, similar stiffening is introduced, and where local loads demand stiffeners in between rib locations, these take the form of simple channel section struts, riveted to the spar flange.

The wing ribs are mostly of duralumin tube construction, but some of the heavier ribs, such as those which form compression ribs, or which carry bomb loads, tanks, etc., have channel section flanges with channel section ties.

The wings are of equal-span biplane form, and the ailerons, fitted to all four wings, have Frise balances. The one-piece elevator has a horn balance at each end, arranged in a somewhat unusual way. Instead of the horn balance of approximately triangular shape, those of the "Scapa" elevator are of rectangular form, and are inset in the tail surfaces, not at the extreme end but a short way from the tips. The trailing edge of the elevator has been cut away at an angle, probably in order to render the inset balances more effective.

ENGINE INSTALLATION

Two objects were achieved by placing the Kestrel engines immediately under the upper wing in the "Scapa". The position should give low air drag, and at the same time the propellers are kept well clear of spray. The exhaust tail pipes are pointed outward so as to keep the hot exhaust gases from striking the radiators which, as previ-

ously mentioned, are placed at the tail ends of the nacelles, under the trailing edge of the top wing.

Two gasoline tanks are housed in the top center section. Each tank has a capacity of 230 gallons, and supply to the engines is normally by direct gravity feed from the tanks. Pumps are, however, provided to insure an adequate supply of fuel at abnormal attitudes (such as very steep climb) when the tanks are nearly empty. Should the pumps fail, the fuel is bypassed and the gravity head is sufficient for normal attitudes. Oil is carried in two tanks which form the leading edge of the top center section and incorporate oil coolers.

Special attention has been given to ease of maintenance, and although the high placing of the engines has rendered them slightly inaccessible, the use of engine ladders and platforms facilitates the work, while large manholes enable the accessories at the back of the engines to be reached.

For launching the "Scapa" from a slipway or from the beach, and for bringing it ashore again under its own power, a launching trolley is provided. This consists of two separate units, each comprising a wheel and three struts. Each unit is attached at three points by quick-release pins: two points on the hull and one point on the lower wing. A tail trolley is also supplied.

For emergency, provision has been made for carrying a spare engine on the lower center section. The absence of central struts leaves an open space on the center line of the seaplane, in the angle between the center bay wing bracing wires and internal supports are provided so that a spare engine can, if necessary, be carried here.

DIMENSIONS

Span	75 ft.	22.85 m
Length, over-all	53 ft.	16.2 m
Height (on beaching chassis)	21 ft.	6.4 m
Wing area	1,300 sq.ft.	121.0 m ²

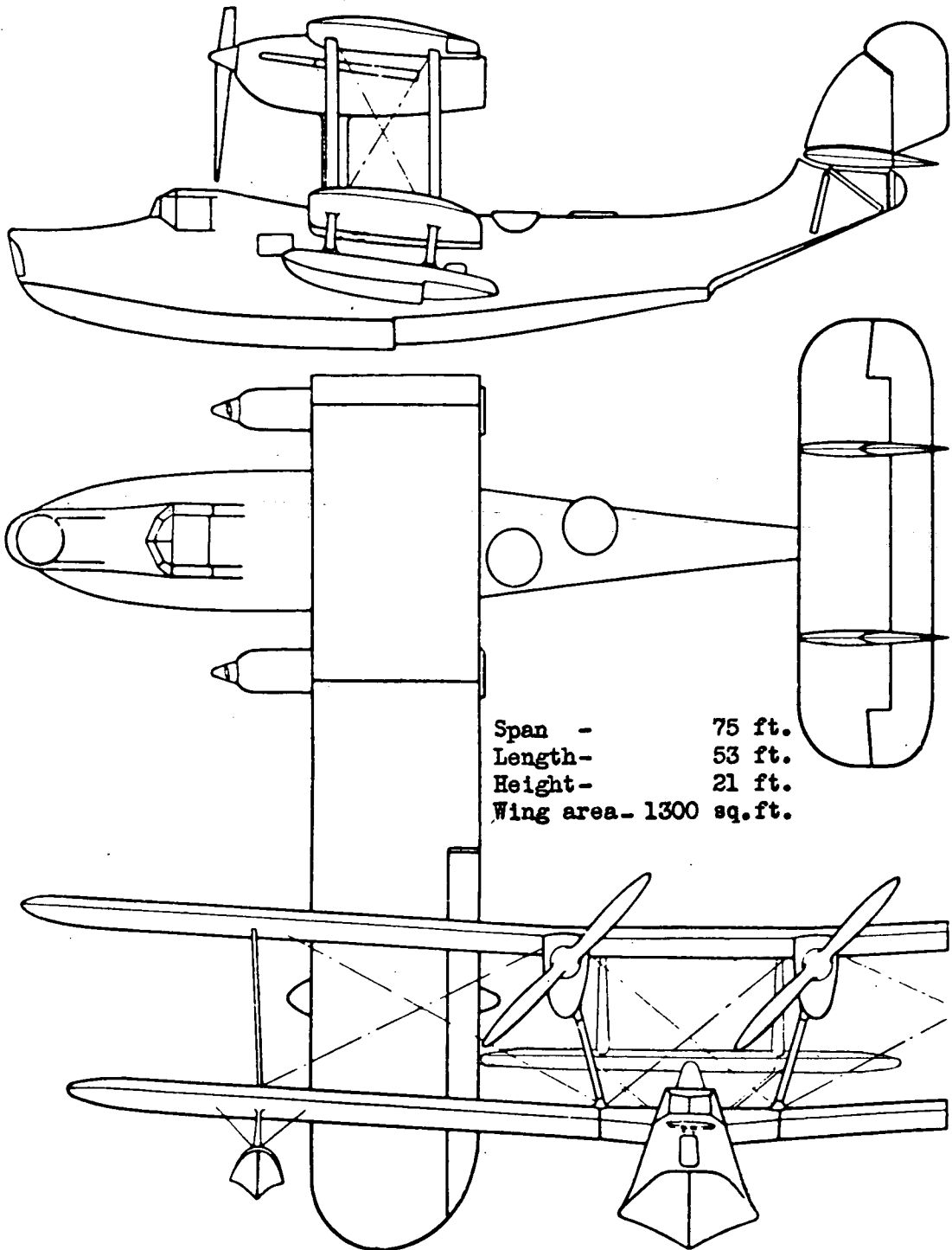
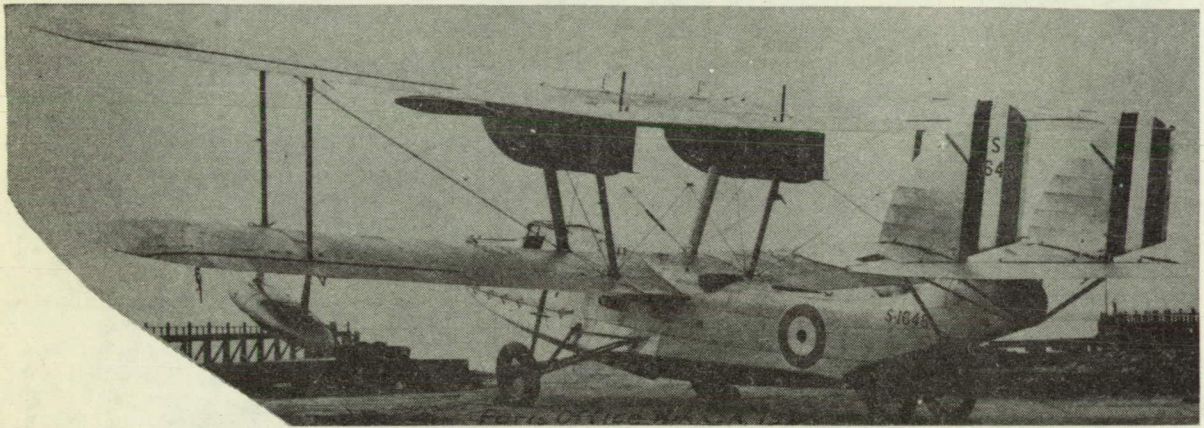
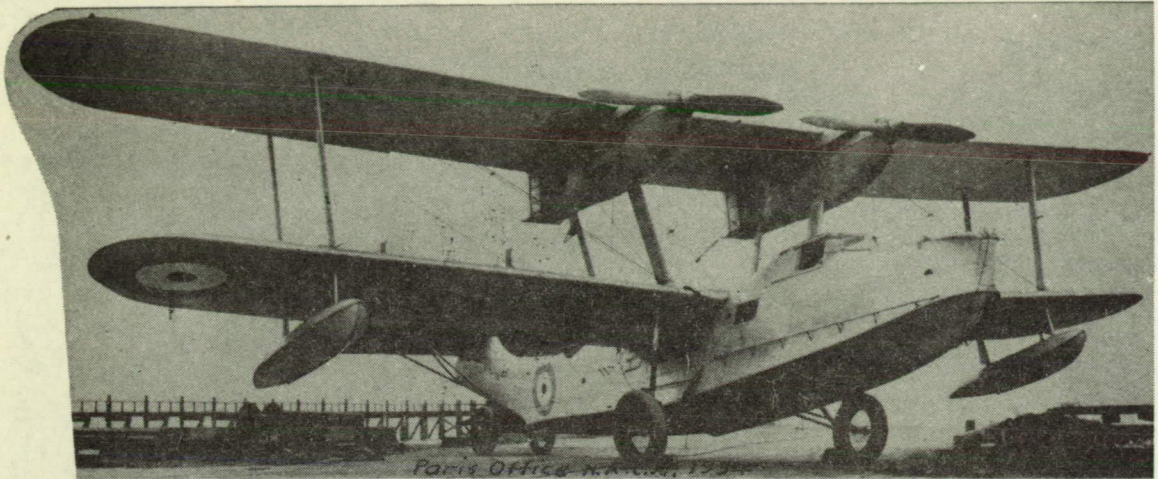

Figure 1.- General arrangement drawings of the Vickers-Supermarine Scapa seaplane. *Bridgman's "Aircraft of the British Empire"*



Figures 2,3.- Three-quarter views of the Supermarine Scapa observation seaplane. (2 Rolls-Royce Kestrel engines). *Paris Office N.A.C.A.*

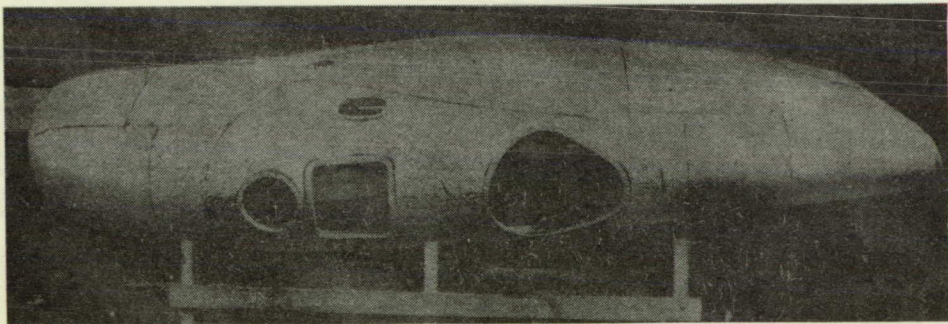
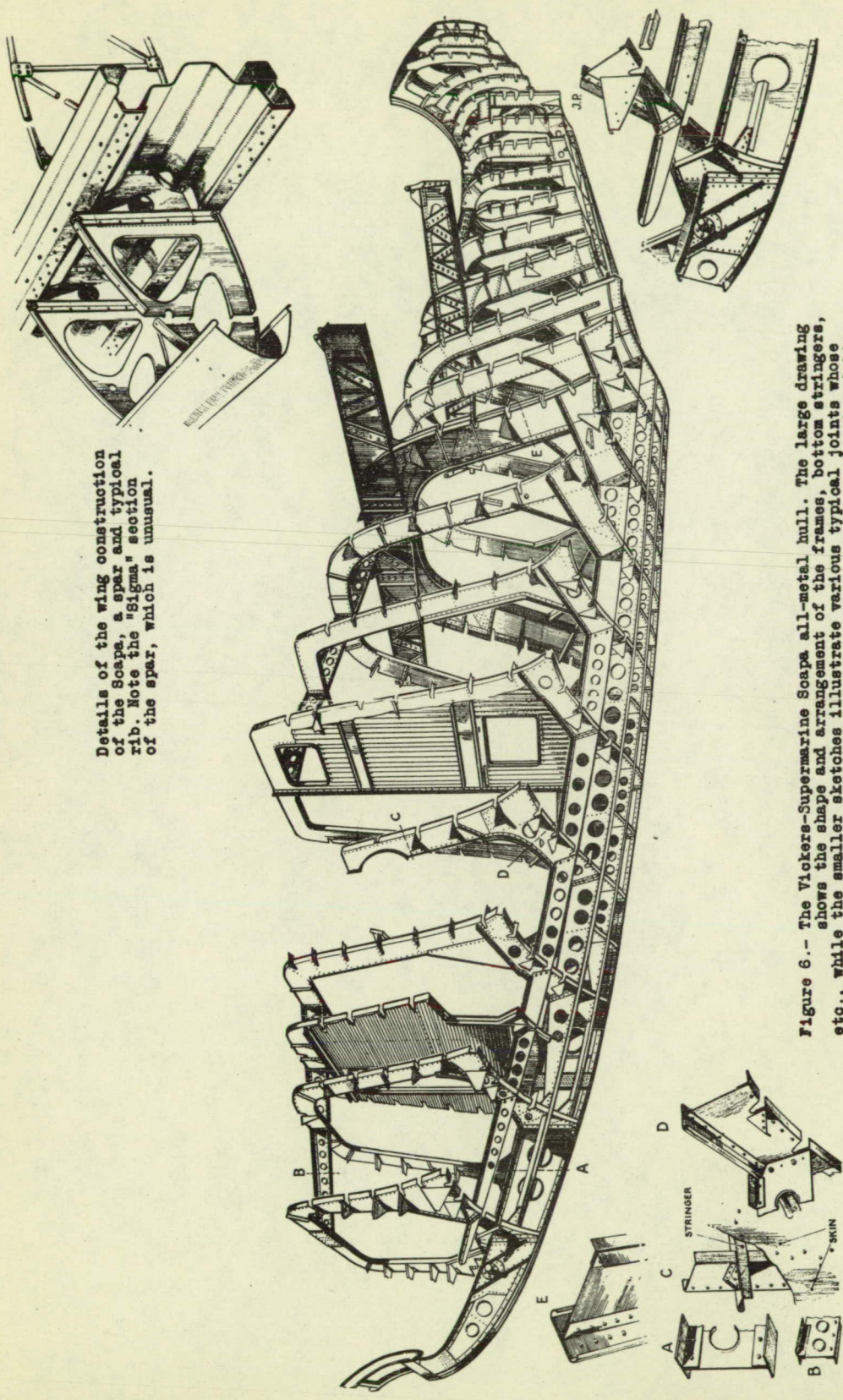

Figure 4.- View of the Scapa engine nacelle, which has been placed on its side in order to show the inspection doors in the floor by which engineers reach the engines. The nacelle is of all-metal construction. "*Flight*"



Details of the wing construction of the Scapa, a spar and typical rib. Note the "Sigma" section of the spar, which is unusual.

Figure 6.- The Vickers-Supermarine Scapa all-metal hull. The large drawing shows the shape and arrangement of the frames, bottom stringers, etc., while the smaller sketches illustrate various typical joints whose location in the hull is indicated by the reference letters. On the right is an enlarged view of a portion of the bow frame and its attachment to the keel.

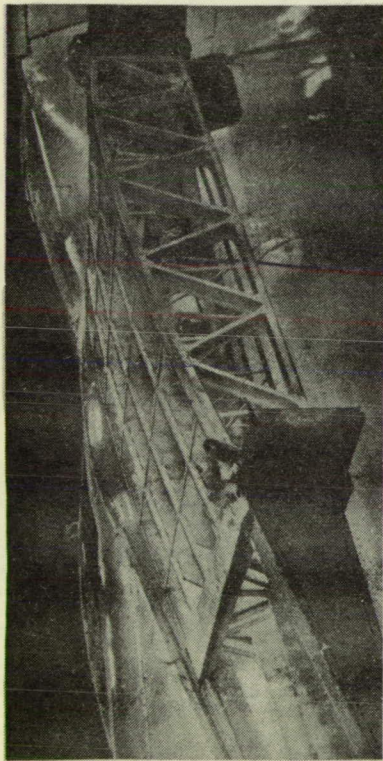

Figure 7.- View showing special ribs in the wing root.

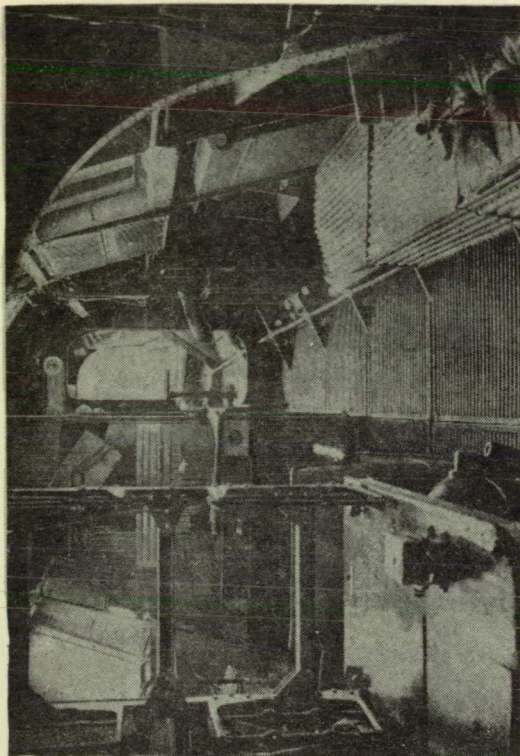

Figure 9.- Interior view of hull looking toward bow.

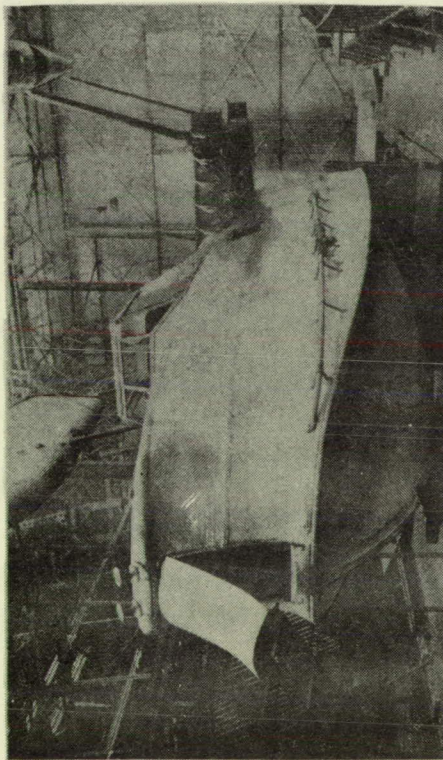

Figure 8.- View of hull with wing root in place.

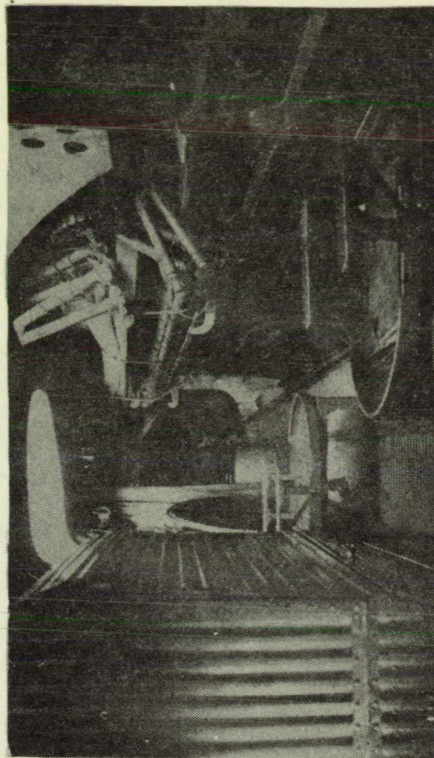

Figure 10.- Interior view of hull looking toward stern.