

4

AIRCRAFT CIRCULARS  
NATIONAL ADVISORY COMMITTEE FOR AERONAUTICS

---

No. 163

---

THE BREGUET 410 AND 411 MILITARY AIRPLANES (FRENCH)

Multiplace Sesquiplane Fighters

By Pierre Léglise

---

Washington  
May, 1932

NATIONAL ADVISORY COMMITTEE FOR AERONAUTICS

AIRCRAFT CIRCULAR NO. 163

THE BREGUET 410 AND 411 MILITARY AIRPLANES (FRENCH)\*

Multiplace Sesquiplane Fighters

By Pierre L eglise

In describing the Breguet 27 (L'A eronautique, No. 139), we indicated that the series, of which this airplane was the first, would include a multiplace fighter, the 410 M3. This is now completed and is undergoing tests.

We shall not return to the technical principles underlying the all-metal construction (high-tensile steel and duralumin) of the 410 M. Certain elements of its structure are so similar to the corresponding elements of the Breguet 27 (or 270 - N.A.C.A. Aircraft Circular No. 127) that a detailed description would duplicate the article in our salon number of 1930. We will recall the similarity of construction by referring to the Br 27 and by describing, in the legends, the carefully planned details.

THE WINGS

Upper wing (Br 27).— The two identical steel spars are attached to the top of the fuselage. Each half-wing comprises, as on the Br 27, an elastic aileron or flap near the fuselage and a differentially controlled aileron at the tip. These devices have already been found very efficacious. The former increases the speed range and the automatic stabilization of the center of pressure, while the latter renders constant the force to be applied to the control stick for obtaining a predetermined moment at different flight speeds. Moreover, it increases the efficacy of the ailerons at low speed. The span is 20.2 m (66.27 ft.) and the chord 2.51 m (8.23 ft.), corresponding to an aspect ratio of nearly 9, which is remarkable for a thin semicantilever wing. The tips are elliptical.

---

\*L'A eronautique, No. 154, March, 1932, pp. 85-92. (See also F.A.C.A. Aircraft Circular No. 127: The Breguet 270 General-Purpose Military Airplane.)

Lower wing.— The lower wing of the Breguet 27 had a single steel box spar with two parallel corrugated webs, similar to the tail boom. Here the duralumin leading edge, closed by a steel web with vertical corrugations, forms the single box spar. On the inside, the leading edges of the ribs consist of stamped frames of duralumin or steel, singly or in pairs. The web is joined to the covering by reinforcing strips forming flanges of variable thickness. Lastly, a continuous reinforcing strip of duralumin follows the leading edge inside the girder.

The after part of each half-wing has a framework of duralumin ribs: six plain ribs, with circular lightening holes, and six lattice ribs. The trailing edge is attached by small pins to this rear girder, closed by an auxiliary spar, along which run the pipes connecting the tanks and the dumping controls.

The spar of the lower wing is continuous and forms the main support of the whole structure. To it are attached, from the center toward the tips, the triangular steel fuselage supports, the tubular steel landing-gear fittings (Br 27), the duralumin engine bearers and the strut fittings. The lower wing also supports two cylindrical fuel tanks of 300 liters (79.25 gallons) each. The ribs, the landing-gear tubes and the engine bearers are attached to the spar by steel brackets. The thick lower wing has a span of 12.5 m (41.01 ft.) and a chord of 2 m (6.56 ft.).

Struts (Br 27).— The rotation of the eccentric varies the incidence of the upper wing by raising or lowering its rear spar.

## THE FUSELAGE

A word should be said regarding the uses for which the Breguet 410 was designed. The program for multiplace fighters, adopted in 1928, provided for four uses: combat, day bombing, observation and night missions. The crew generally consists of three (one pilot and two gunners) for the combat mission, but may be increased to five.

Design of the combat forms.— The search for good firing fields behind the wing led, in all recent multiplace fighters, to the adoption of novel forms or devices. For example, in the Amiot S.E.C.M. 140, the rear armament

consists of two twin machine guns: one above the fuselage and the other in a "balcony" under the fuselage. On the Elériot 137, the two rear gun rings are mounted on two lateral shoulders near the trailing edge of the wing. In the S.P.C.A. 30, each fuselage has a gun ring on top.

In the Breguet 411 M3 (with two 500 hp Hispano-Suiza 12 Hb engines), following the example of the Breguet 27, there is a discontinuity in the shape of the fuselage, as seen in plan and also in profile. This discontinuity, which corresponds to a constriction just behind the after gun ring, considerably increases the field of fire, especially downward. In a variant of the latter, the 412 M4, equipped with two 650 hp Hispano-Suiza engines, a gun ring is provided for firing under the fuselage. This ring is served by a third gunner.

Thus, in the Breguet 411 M3, the conception of the rear defense, which prevailed in the Bureau d'Etudes, led to a distinction between the fuselage proper, reserved for the crew and made as high as possible for convenient circulation, and a rear girder of small cross section for supporting the tail group.

The fuselage proper consists of transverse frames connected by four longerons and diagonal brace wires. All these parts are built up from channel members assembled by gussets and closed by the duralumin covering. The tail boom is a box composed of four longerons riveted to the transverse frames and to the covering.

The trapezoidal tail surfaces have no struts. The stabilizer can be adjusted on the ground. Small balancing flaps on the elevator and rudder are adjustable during flight.

## CHARACTERISTICS

Height	5.06 m	16.60 ft.
Length	11.49 "	37.70 "
Wing area	67.10 m <sup>2</sup>	722.26 sq.ft.
Upper wing:		
Span	20.20 m	67.27 ft.
Chord	2.51 "	8.23 "
Area	47.70 m <sup>2</sup>	514.00 sq.ft.
Lower wing:		
*Span	12.50 m	41.01 ft.
*Chord	2.00 "	6.56 "
Area	19.4 m <sup>2</sup>	208.82 sq.ft.
Maximum width of fuselage	2.56 m	8.40 ft.
Landing gear track	3.76 "	12.34 "
Weight empty with 500 hp Hispano-Suiza 12 Hb engine	2890 kg	6371 lb.
Total weight as fighter	3834 "	8452 "
Total weight as night bomber	4517 "	9958 "

## \*PERFORMANCE

Speed at 4000 m (13120 ft.)	240 km/h	149 mi./hr.
Climb to 4000 " " "	12.5 min.	
Service ceiling	7700 m	25250 ft.
Range	650 km	404 mi.

\*From Aircraft Engineering, May, 1932.

## LEGENDS

FIGURE 1.- The Bréguet 410 and 411 M3 airplanes.

FIGURE 2.- Three-quarter front view of the Bréguet 411 M3 multiplace fighter.

FIGURE 3.- Side view of the Bréguet 411 M3 multiplace fighter.

FIGURE 4.- Rear view of the Bréguet 411 M3 multiplace fighter (two 500 hp Hispano-Suiza engines).

FIGURE 5.- Rear part of lower wing of Br 410. The opening is made between two steel frames supporting, on top, two strips of channeled sheet metal.

FIGURE 6.- Same part covered with sheet duralumin. Above the hexagonal opening there is mounted a dropable cylindrical fuel tank holding 300 liters (79.25 gallons). A removable trailing edge, adapted to the rear auxiliary spar, is shown partly in position.

FIGURE 7.- Duralumin leading edge of lower wing. The structure is closed by the spar shown in Figure 8.

FIGURE 8.- Steel spar of lower wing, as seen from the rear. The web has vertical corrugations.

FIGURE 9.- Transmission of oil pressure from control station to brake. Stroke, 120 mm (4.72 in.). C, sliding tube; W, expansion tank; P, hand control; T, steel pipe forming elastic hairpin. Dotted line shows position of pipe when shock absorber is at end of stroke.

FIGURE 10.- Vertical cuts of shock absorber and brake on Bréguet wheel.

FIGURE 11.- Attachment of main strut to end of lower wing spar.

FIGURE 12.- Union of lower wing spar to fuselage by triangular steel brackets.

FIGURE 13.- Interior view of fuselage near 10 x 50 cm (3.94 x 19.69 in.) vertical bomb rack and second pilot's seat.

FIGURE 14.- Rear end of fuselage of Br 410. Two hinge pins for the stabilizer are shown and, in the panel, two components of the locking mechanism.

FIGURE 15.- Enlarged photographs of the locking components, the upper one being assembled.

FIGURE 16.- Rear end of fuselage with duralumin covering. The fin is mounted on four sockets with flush pins.

FIGURE 17 - General scheme of the controls.- The two posts  $P_1$  and  $P_2$  are of the wheel and pedal type. All the controls are rigid, consisting of duralumin tubes and stamped duralumin or steel levers mounted on ball bearings.  $P_1$  and  $P_2$  are conjugated by a control box B, whose location is indicated by the dotted parallelepiped. This box houses the elevator, rudder and aileron controls, which are operated at  $C_1$  and  $C_2$ , and enables their simultaneous connection or disconnection. A is the vertical shaft of the box B; D, the differential control of the ailerons (shown in detail at the upper left); V, the balancing flap of the elevator. V can also be controlled in flight by a separate wire which is not shown. There is also a balancing flap on the rudder.

FIGURE 18.- Differential aileron control.- The aileron lever L has, at its end, a pinion p, engaged with two racks  $c_g$  and  $c_d$  on the aileron rods  $B_g$  and  $B_d$ ; l, slots through which the axis p passes; R, return spring. In rectilinear flight, L is vertical and  $c_g$  and  $c_d$  roll symmetrically on p (whose axis is fixed) following variation in speed, gusts, etc. Hence the ailerons operate, in this case, like elastic flaps. When the pilot turns L toward the left, for example, there is, at first, a displacement of the whole system, p being locked between the two racks. B and  $B_d$  tend to communicate motions of the same amplitude to the ailerons, but the aerodynamic reactions thus developed are not equal, and the aileron undergoing the greater thrust (the right one, e.g., which is lowered) brakes  $B_d$ . p, in continuing its motion toward the left, must then roll on  $c_d$ , which increases the motion of  $B_g$  toward the left.

FIGURE 19.- Clutch control.- The lower diagram represents one of the elements of the control box B, A being the vertical shaft operated by  $C_1$  or  $C_2$ . To A is keyed the fork f, which activates the rod T. The latter

controls elastically the socket D (integral with the control lever G) by means of two springs r and r', which rest on each side of a shoulder e of this socket. The pilots' controls P<sub>1</sub> and P<sub>2</sub> turn in collars c and c' fixed laterally. In the figure, G is engaged with P<sub>2</sub>. By pushing on C<sub>2</sub>, e is driven toward the left and G engages with P<sub>1</sub>.

FIGURE 20.- Lower wing of Br 410, as seen from below in the vicinity of the fuel tank. The large flexible tube is a part of the water-cooling system.

FIGURE 21.- Fuel and oil systems on the Br 410. On the right-hand engine group is shown the very simple oil circulation. The oil tank R' is behind the fuel tank R<sub>d</sub>. t is the tube of the oil thermometer. The plate radiator is on the side of the cowling, toward the outside. Fgh is the general shut-off cock.

The fuel circulation is shown on the left-hand engine. The pumps draw the fuel from the tank R<sub>g</sub> through the strainer f. The fuel flows into the small tank C with two cocks r and r'. The former (r), controlled by the pilot at E, regulates the emptying of R<sub>g</sub>, while the latter (r'), operated by the cable c which connects at G with the corresponding cable c' from the other engine, is located at the outlet of the pipe T connecting the two tanks. A pull on G opens simultaneously the cocks r' of the small left and right tanks, and establishes the communication between R<sub>g</sub> and R<sub>d</sub>. In case of injury to one of the tanks, R<sub>g</sub> for example, it is therefore possible, by the combined action of r and r', to supply both engines from R<sub>d</sub> and vice versa. J is the joint of the dropping device; m, manometer connection; Fge, general fuel shut-off. Fge and Fgh are controlled simultaneously for both groups by one of the pilots' levers Fg. Near the middle of the connecting pipe T is the branch pipe for the Viet starter, common to both engines, as is also the starting magneto.

FIGURE 22.- Disposition of the rear defense in the new French multiplace fighters.

FIGURE 23.- Hooded gun rings of the Breguet 410. The protection of the gunners from the wind is very difficult, because the search for a free firing field generally leads



to the choice of machine-gun emplacements where the wind is violent. The need of this protection becomes all the more imperative, as the speed of the airplanes is increased, first because the fineness is affected by the firing impediments, and second, because the operation of the guns, despite all the balancing devices, becomes difficult and inaccurate. On the Br 410, the fuselage being high, it has been possible to lower the gun rings and to provide them with hoods revolving with them. The hood fits the wall of the fuselage and is located in a recess of the latter. T is the gun ring; R, the curtain sliding in the grooves r; H, loopholes; f, windows. In reality, as shown in Figures 22-25, the hoods are almost all glass. In Figure 21, it is seen that the hood does not project laterally much beyond the fuselage. OV is the line of sight and XY the longitudinal axis of the fuselage. (Tir vers l'avant = forward firing. Tir lateral = lateral firing.)

FIGURE 24.- Rear gun mount of Br 411 multiplace fighter airplane.

FIGURE 25.- Rear gun wing.

FIGURE 26.- Bow of Br 411 multiplace fighter airplane.

FIGURE 27.- Interior of Br 411, looking forward.

FIGURE 28.- Interior of Br 411, looking aft.

FIGURE 29.- Plan view, showing interior arrangements. In order to facilitate communication, the pilots' posts  $P_1$  and  $P_2$  were both located in left-hand side of fuselage. It was thus possible to reserve a passageway C  $1.8 \times 0.5$  m ( $5.9 \times 1.64$  ft.) between the two posts. These can accommodate five persons: a forward gunner  $M_1$ ; chief pilot  $P_1$ ; a navigator-bomber on the folding seat S with a trapdoor in front of him, through which he can sight or use a parachute (D, map holder); an auxiliary pilot  $P_2$  (with parachute at  $p_2$ ) or a mechanic; a rear gunner  $M_2$ . F, box of flares; B, rack for bombs  $10 \times 50$  cm ( $3.94 \times 19.69$  in.) Labrély and Duchatellier cameras under  $P_2$ . Radio under  $P_1$ . The Br 410 M3 is equipped for night flying.

FIGURE 30.- Forward gun mount with pivoting hood. This hood, which prolongs the lines of the fuselage, has large glass windows.

FIGURE 31.- Each duralumin engine bearer is mounted by means of six bolts on the box spar of the lower wing, whose leading edge is of steel at this point. A fuel tank is mounted in a prolongation of the engine bearer. The fitting for an oleopneumatic shock absorber is shown under the spar.

FIGURE 32.- An engine bearer.

FIGURE 33. Assembly of fuselage and tail girder by four bolts.

FIGURE 34.- Installation of Hispano-Suiza engine.

FIGURE 35.- Tail wheel.

FIGURE 36.- Details of lower assembly bolt. The rigid controls visible under Figures 33 and 36 are the elevator and rudder controls.

FIGURE 37.- Assembly of fore part of fuselage, engine mounting and landing gear.

FIGURE 38.- The Bréguet plate radiator.

Translation by Dwight M. Miner,  
National Advisory Committee  
for Aeronautics.

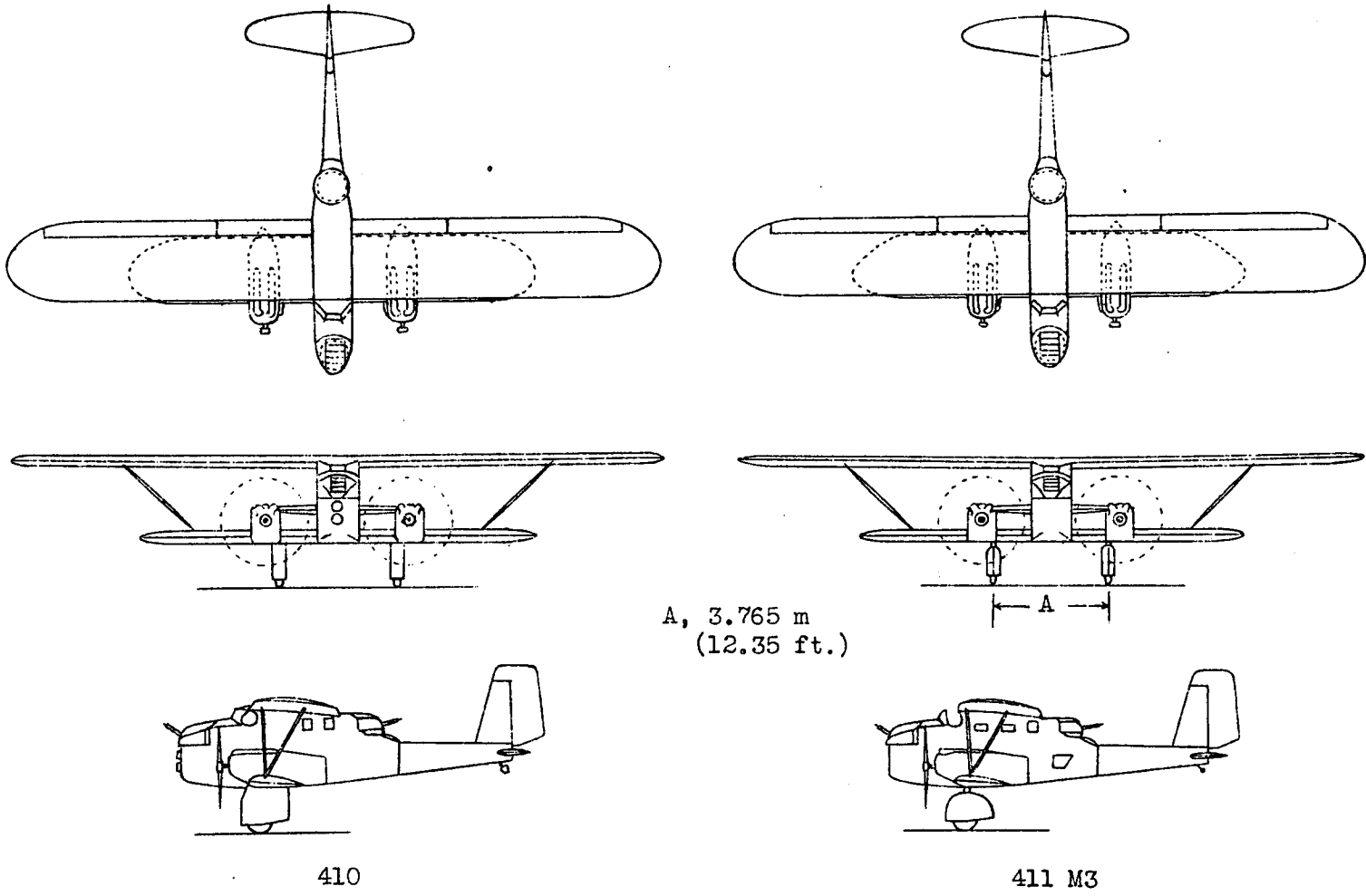

A, 3.765 m  
(12.35 ft.)

Fig. 1 General arrangement drawings of the Bréguet fighter airplanes.

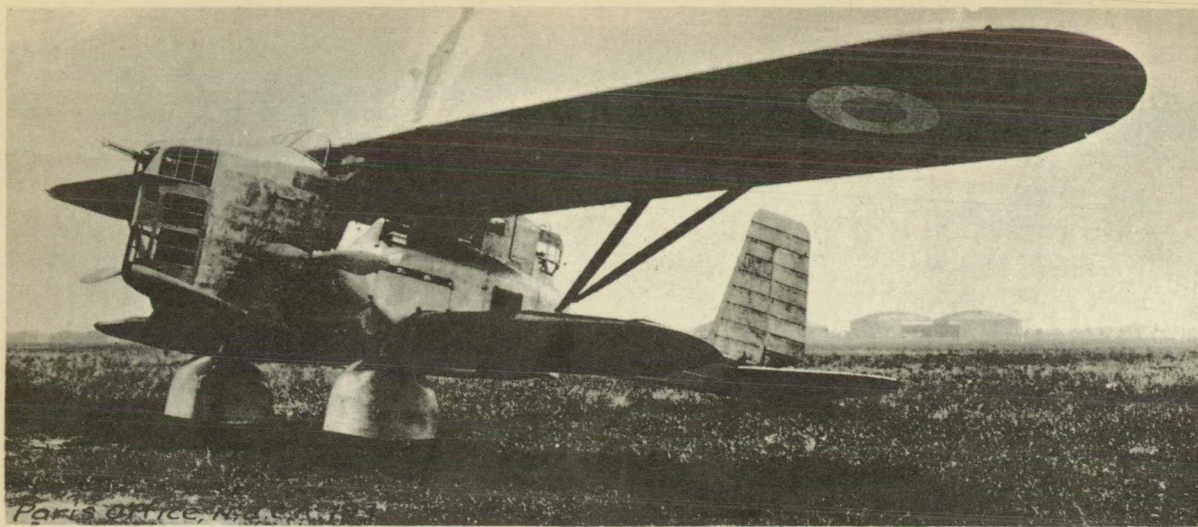

Fig.2

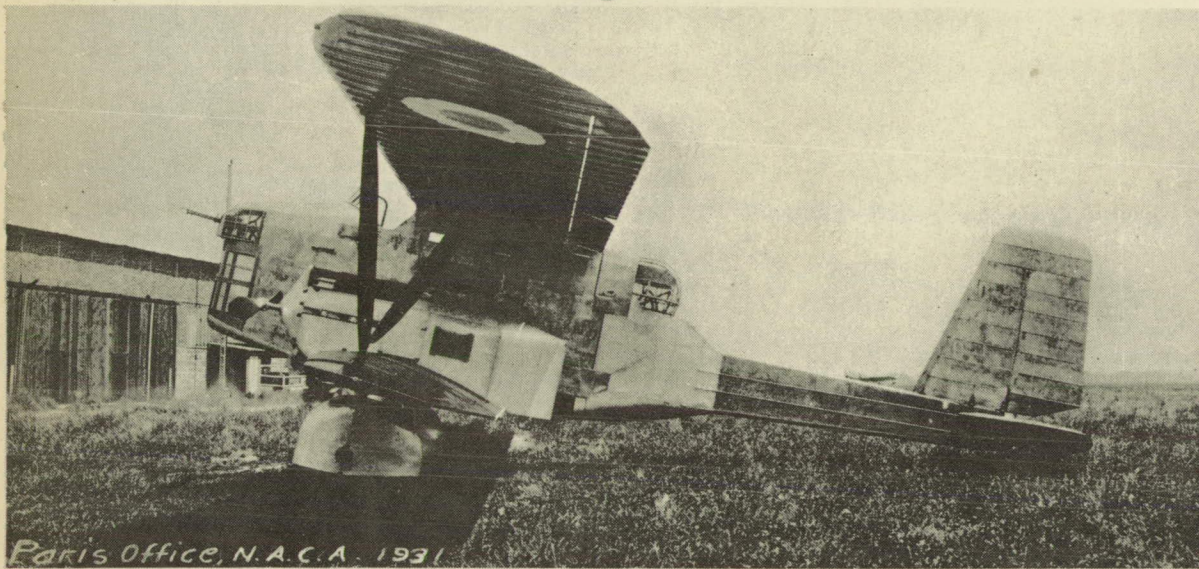

Fig.3

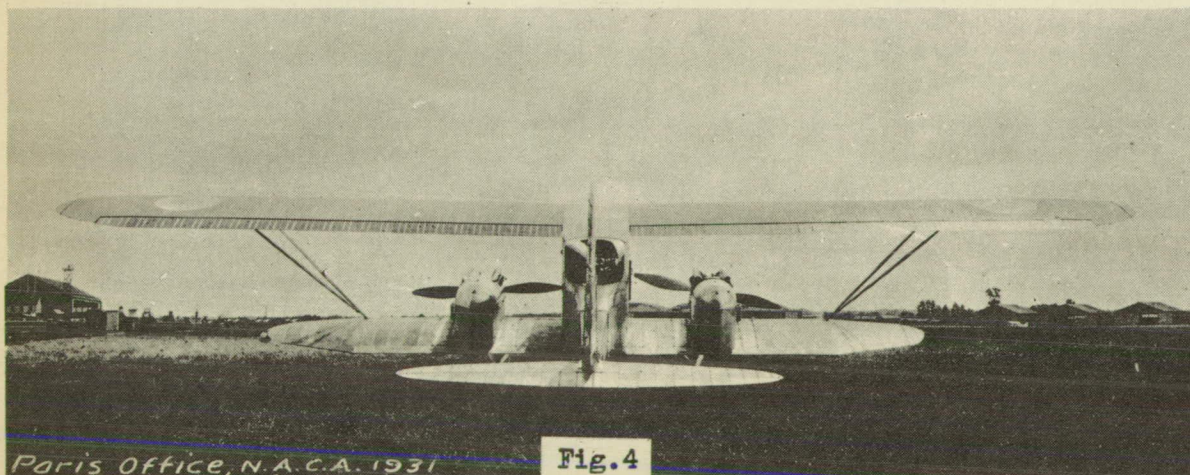

Fig.4

Bréguet 411 M3 multiplace fighter. (Two 500 hp Hispano-Suiza engines.)

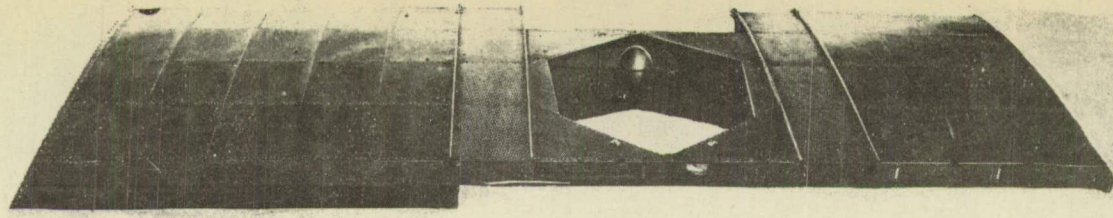

Fig. 6

Figs. from L'Aeronautique

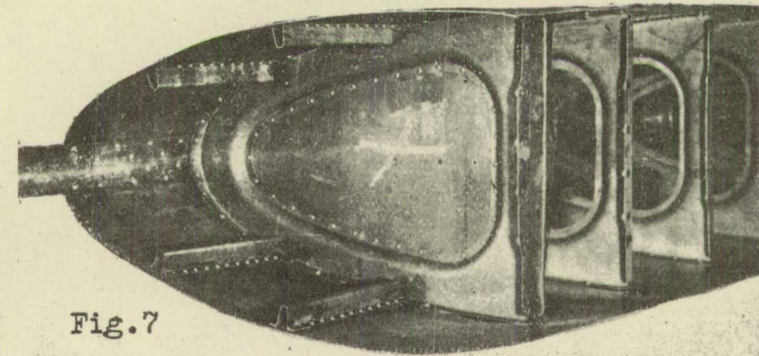

Fig. 7

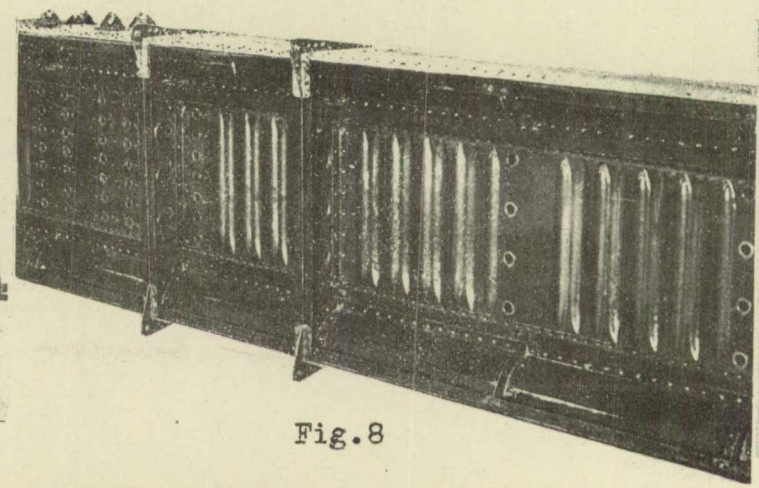

Fig. 8

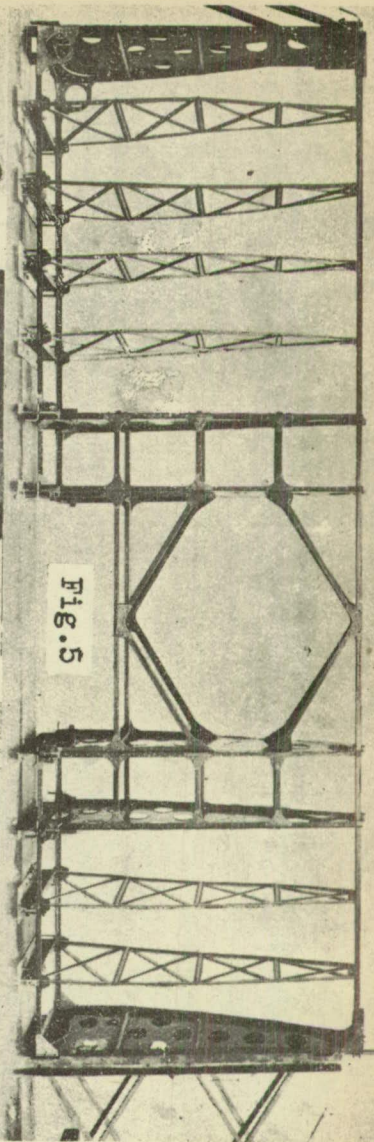

Fig. 5

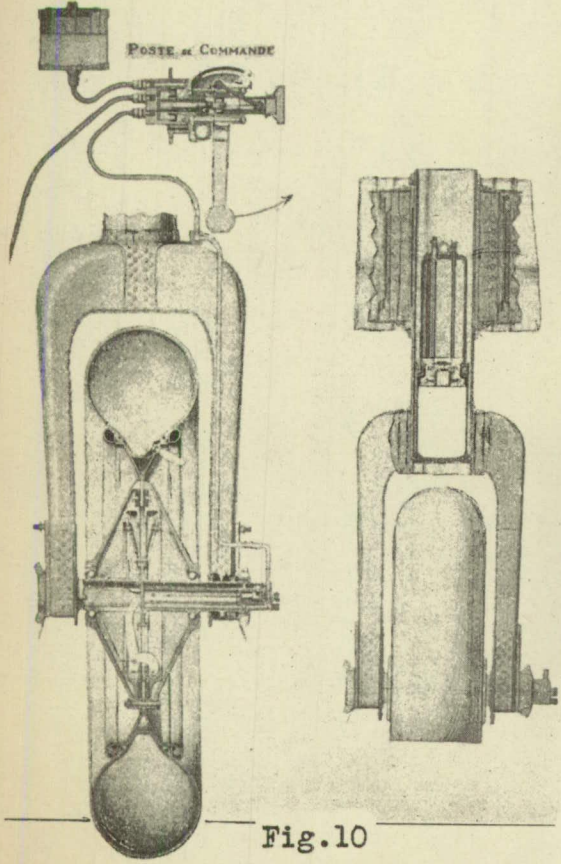

Fig. 10

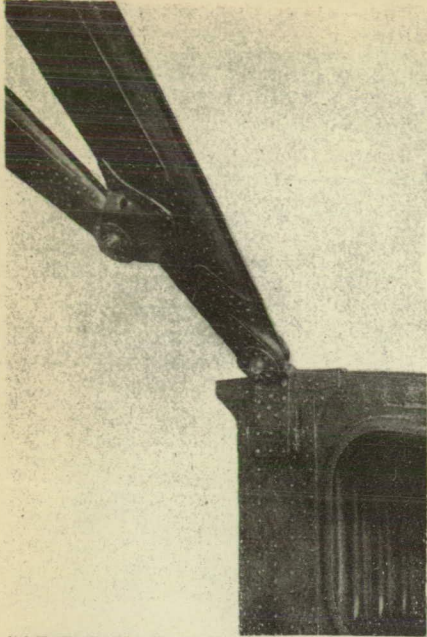

Fig.11

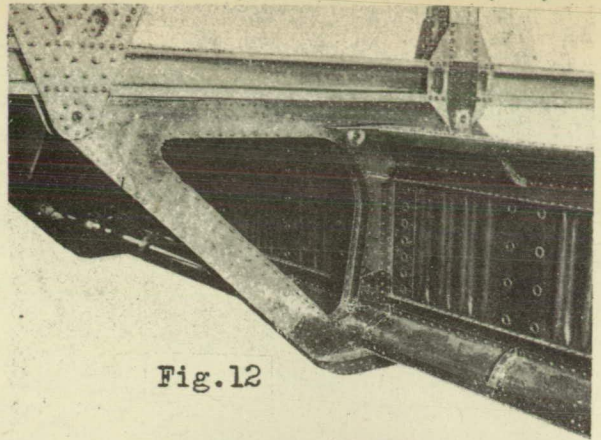

Fig.12

Figs from  
L'Aeronautique

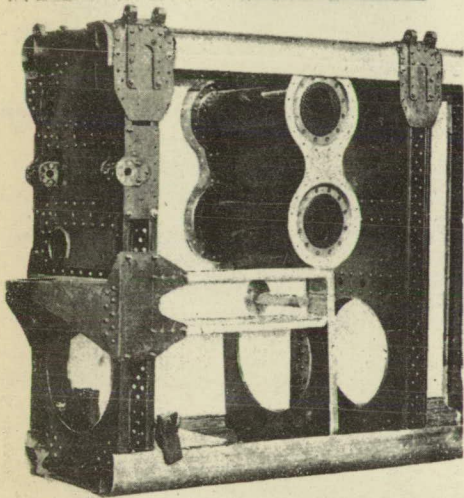

Fig.14

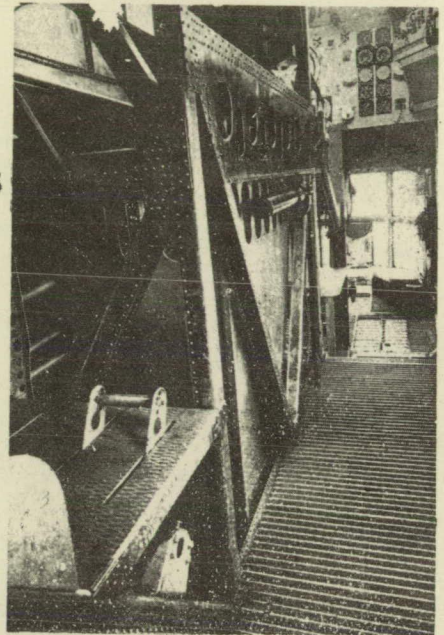

Fig.13

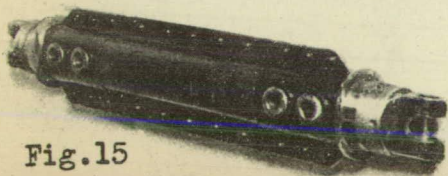
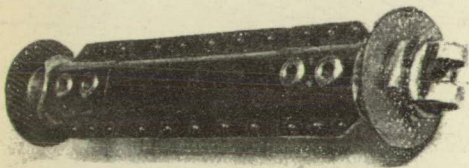
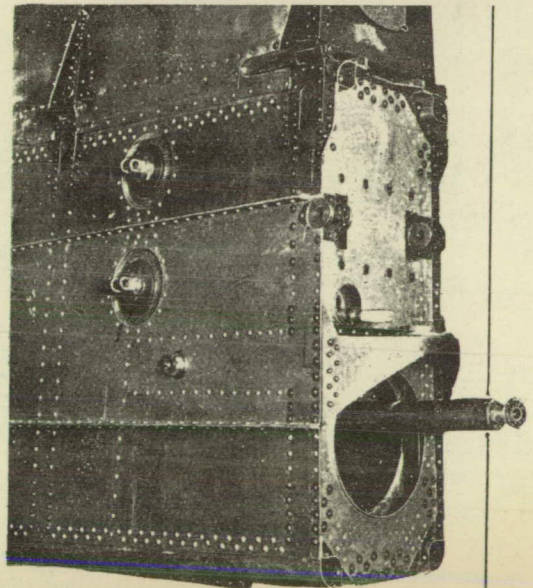

Fig.15

Fig.16



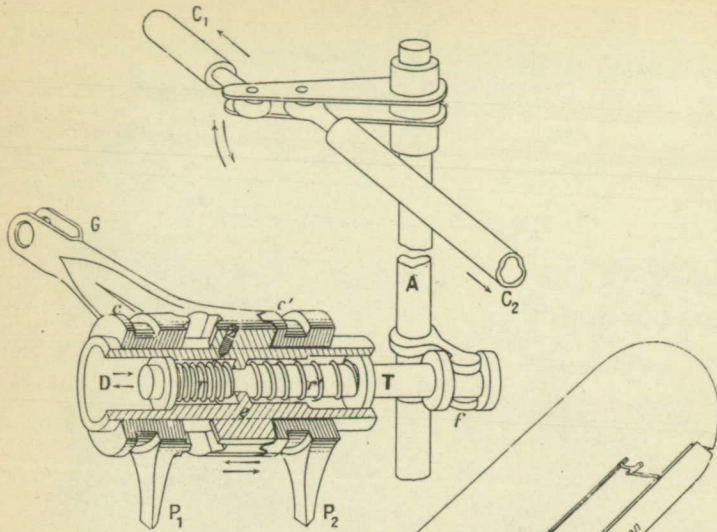

Fig.19

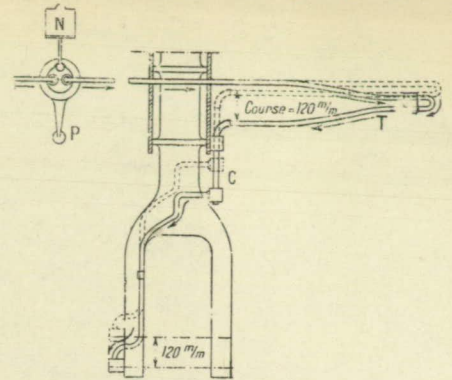

Fig.9

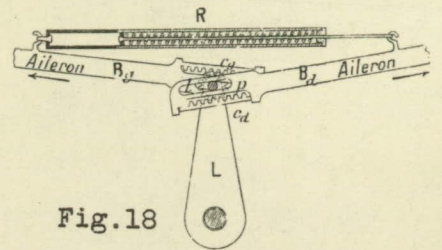

Fig.18

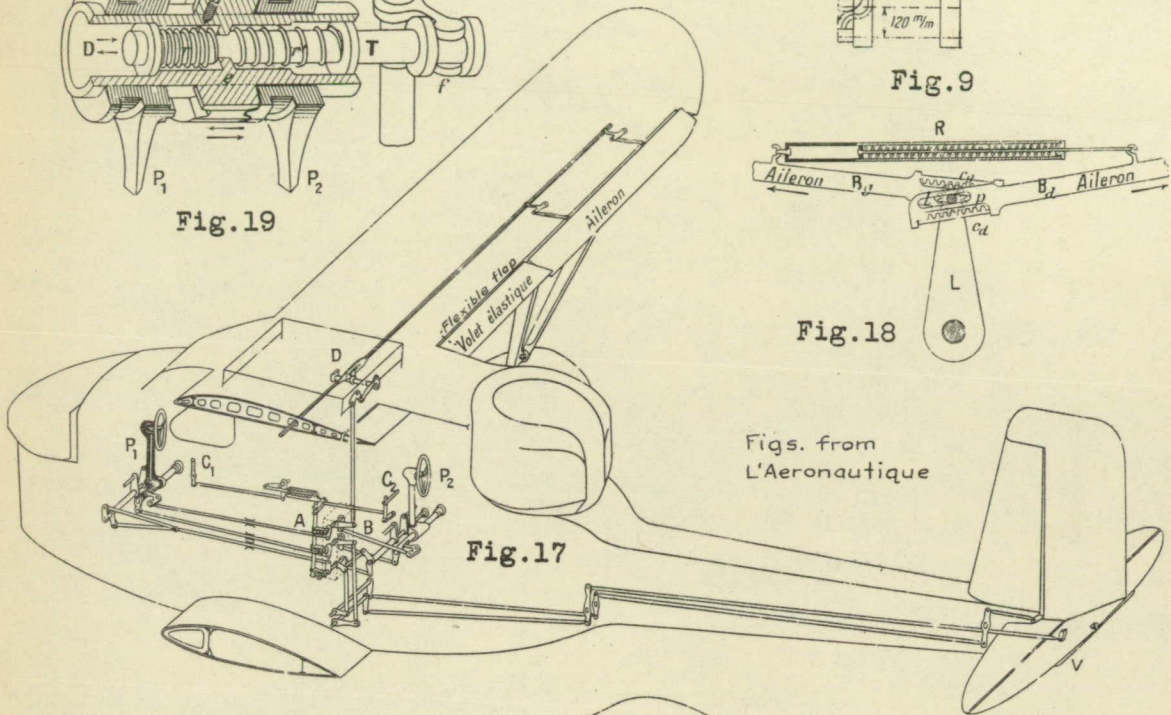

Fig.17

Figs. from  
L'Aeronautique

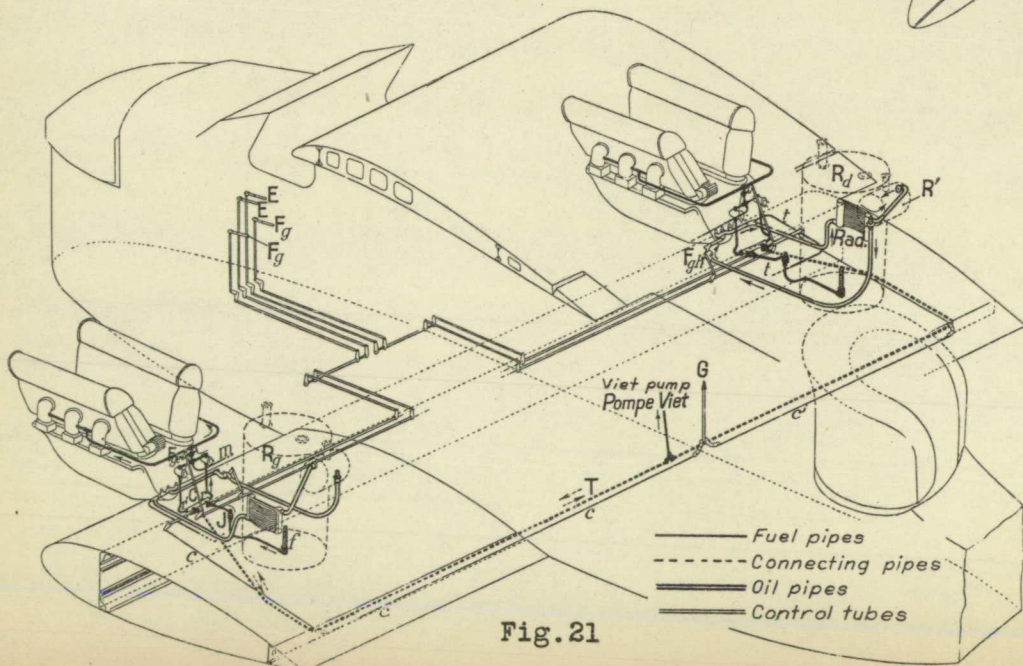

Fig.21

- Fuel pipes
- - - Connecting pipes
- Oil pipes
- Control tubes

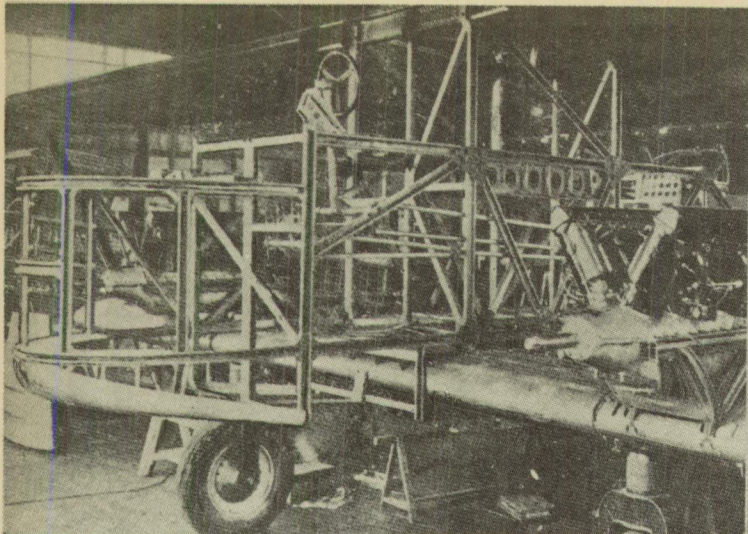

Fig.37 from  
Aircraft Engineering

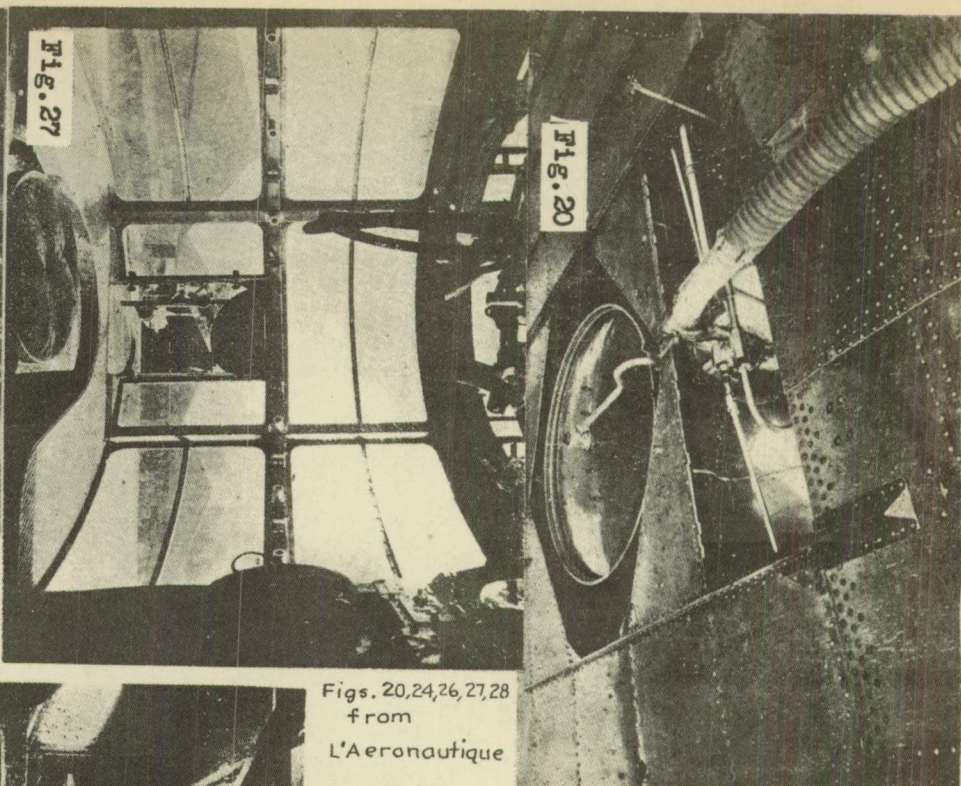

Fig.20

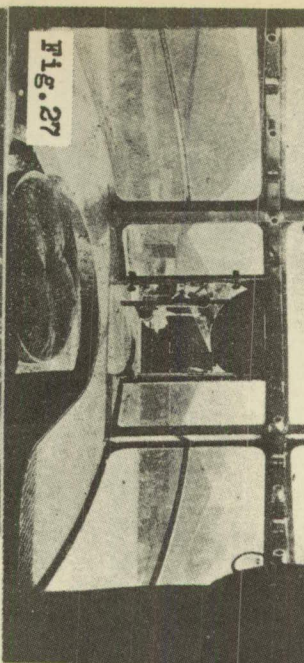

Fig.27

Figs. 20,24,26,27,28  
from  
L'Aeronautique

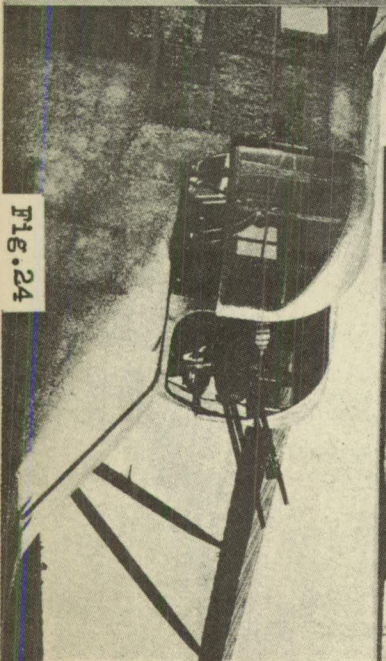

Fig.24

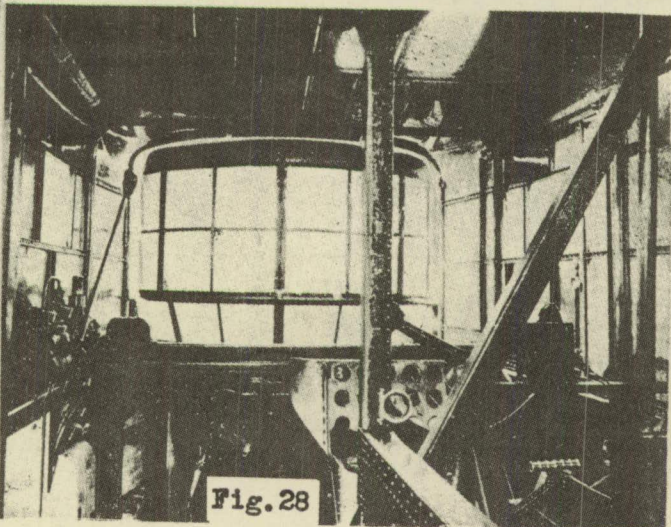

Fig.28

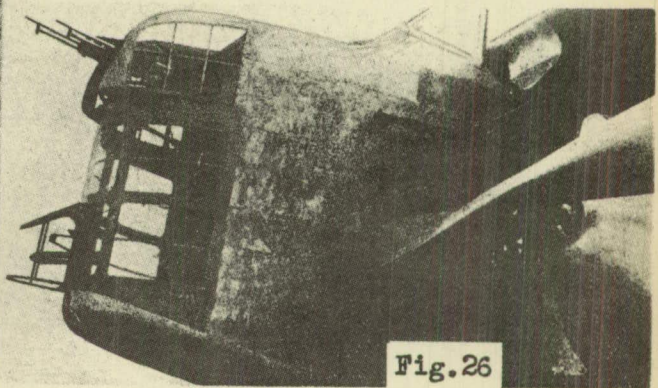

Fig.26



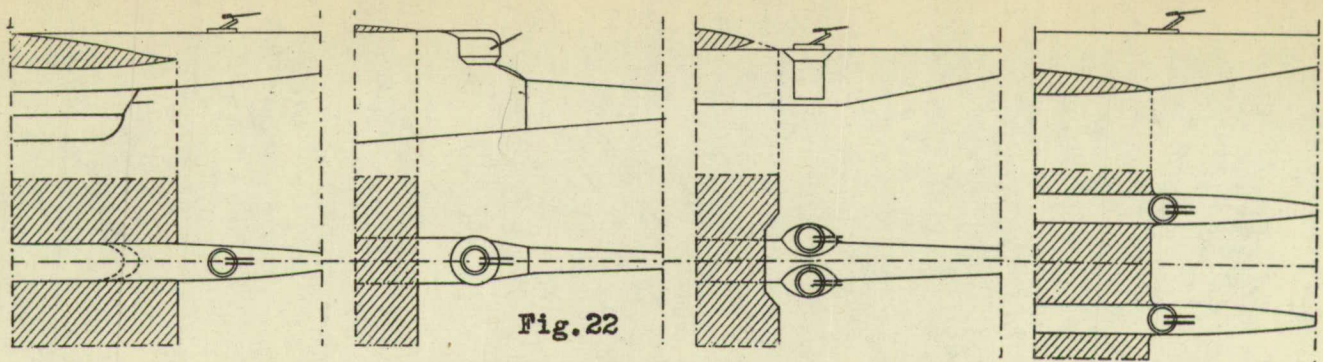

Fig. 22

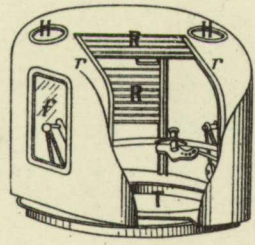
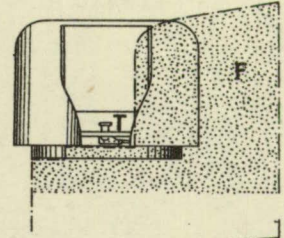
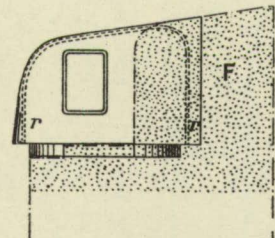

Fig. 23



Figs from L'Aeronautique

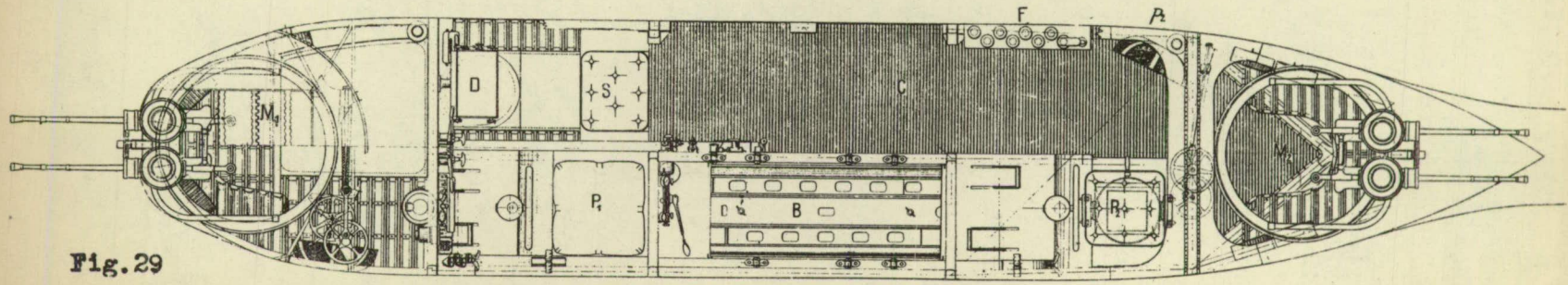
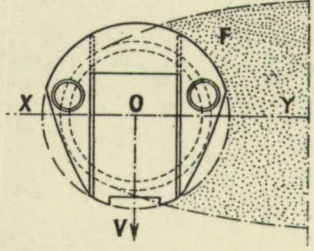
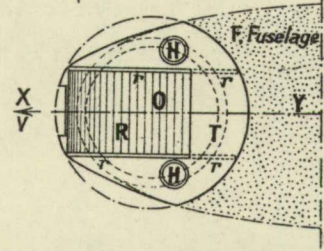

Fig. 29

Figs. 22, 23, 29

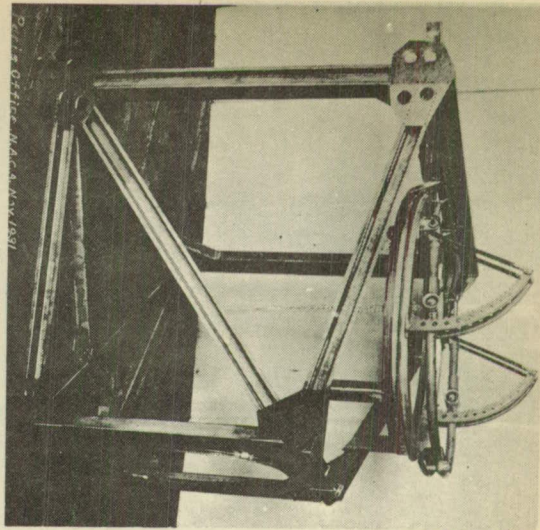

Fig. 25

Paris Office, N.A.C.A., Nov. 1931

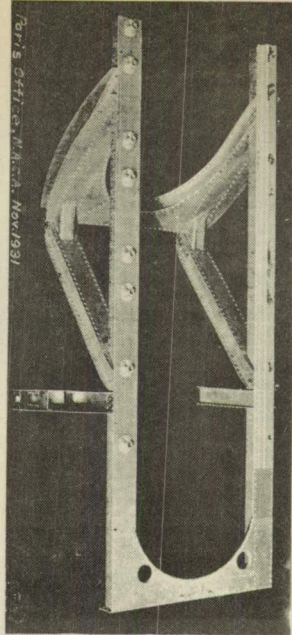
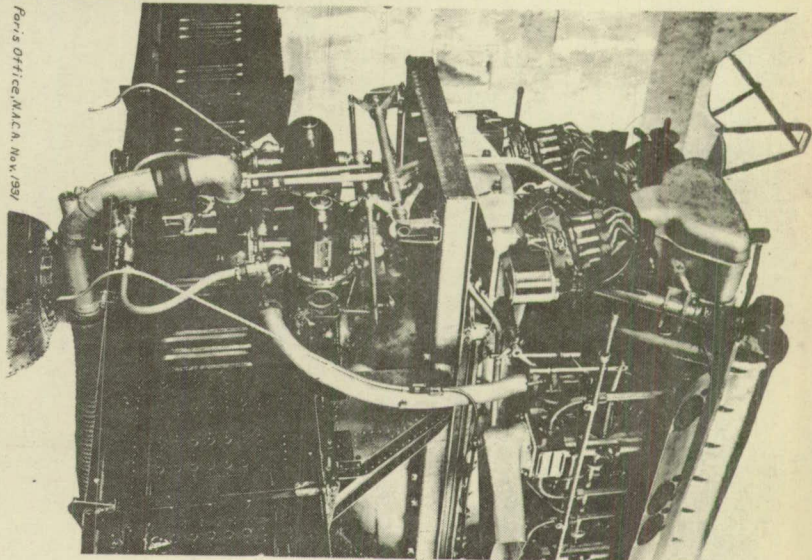

Fig. 26

Paris Office, N.A.C.A., Nov. 1931



Figs. 25, 32, 34, 35, 38

Paris Office, N.A.C.A., Nov. 1931

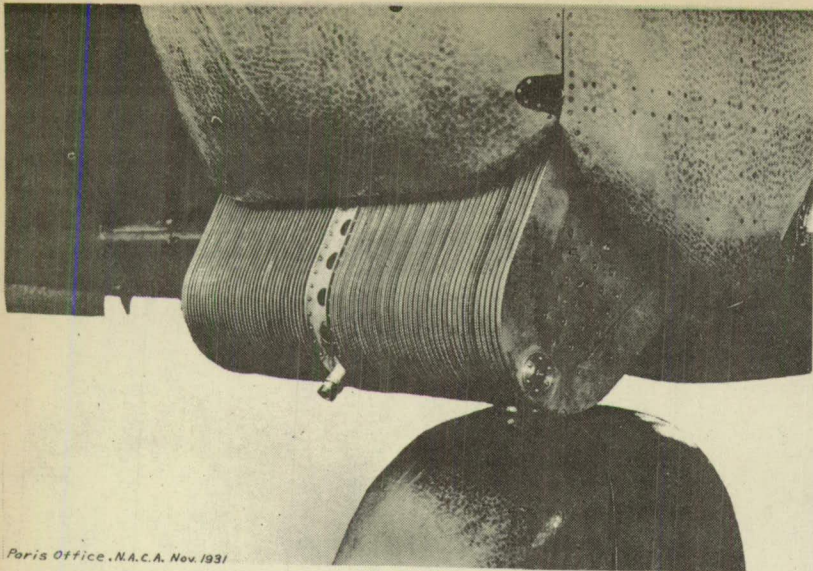

Fig. 32

Paris Office, N.A.C.A., Nov. 1931

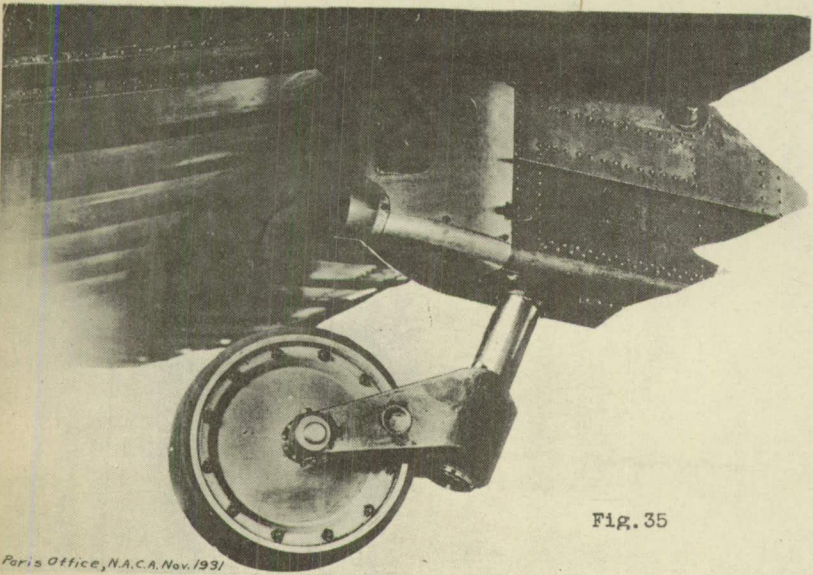

Fig. 35

Paris Office, N.A.C.A., Nov. 1931

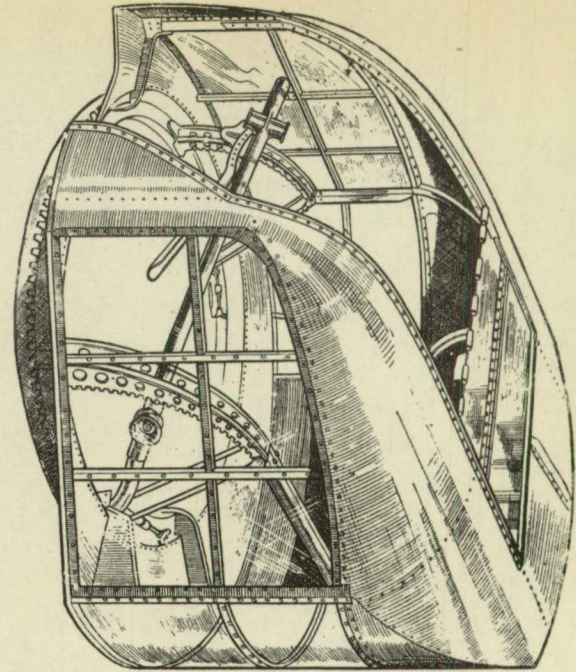

Fig. 30

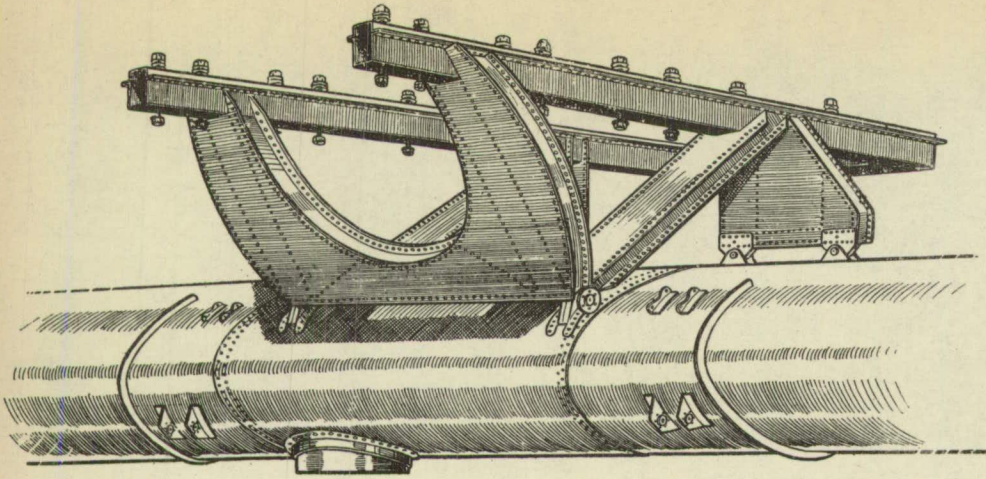

Fig. 31

Figs. from  
L'Aeronautique

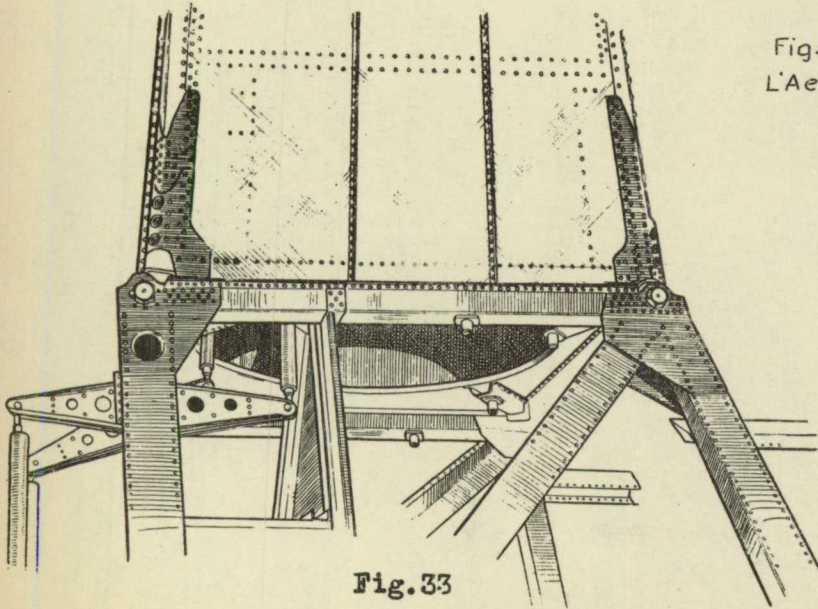

Fig. 33

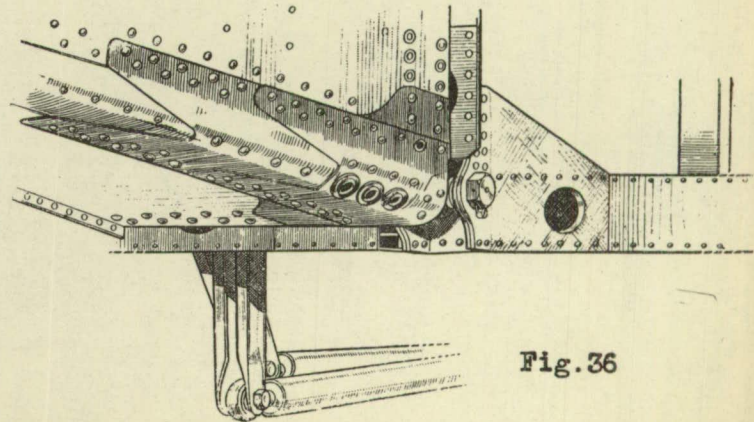

Fig. 36