

#4

★

NATIONAL ADVISORY COMMITTEE FOR AERONAUTICS

REPORT No. 290

WATER-PRESSURE DISTRIBUTION ON A SEAPLANE FLOAT

By F. L. THOMPSON

THIS DOCUMENT ON LOAN FROM THE FILES OF
NATIONAL ADVISORY COMMITTEE FOR AERONAUTICS
LANGLEY MEMORIAL AERONAUTICAL LABORATORY
LANGLEY FIELD, HAMPTON, VIRGINIA

RETURN TO THE ABOVE ADDRESS.

REQUESTS FOR PUBLICATIONS SHOULD BE ADDRESSED
AS FOLLOWS:

NATIONAL ADVISORY COMMITTEE FOR AERONAUTICS
1724 F STREET, N.W.,
WASHINGTON 25, D.C.



UNITED STATES
GOVERNMENT PRINTING OFFICE
WASHINGTON
1928

AERONAUTICAL SYMBOLS

1. FUNDAMENTAL AND DERIVED UNITS

| | Symbol | Metric | | English | |
|-------------|--------|-----------------------------|--------|-----------------------|---------------|
| | | Unit | Symbol | Unit | Symbol |
| Length..... | l | meter..... | m | foot (or mile)..... | ft. (or mi.) |
| Time..... | t | second..... | sec | second (or hour)..... | sec. (or hr.) |
| Force..... | F | weight of one kilogram..... | kg | weight of one pound | lb. |
| Power..... | P | kg/m/sec..... | | horsepower..... | HP. |
| Speed..... | | km/hr..... | | mi./hr..... | M. P. H. |
| | | m/sec..... | | ft./sec..... | f. p. s. |

2. GENERAL SYMBOLS, ETC.

- | | |
|---|--|
| <p>W, Weight, $= mg$</p> <p>g, Standard acceleration of gravity $= 9.80665$ m/sec.² $= 32.1740$ ft./sec.²</p> <p>m, Mass, $= \frac{W}{g}$</p> <p>ρ, Density (mass per unit volume). Standard density of dry air, 0.12497 (kg-m⁻⁴ sec.²) at 15° C and 760 mm $= 0.002378$ (lb.- ft.⁻⁴ sec.²).</p> <p>Specific weight of "standard" air, 1.2255 kg/m³ $= 0.07651$ lb./ft.³</p> | <p>mk^2, Moment of inertia (indicate axis of the radius of gyration, k, by proper sub- script).</p> <p>S, Area.</p> <p>S_w, Wing area, etc.</p> <p>G, Gap.</p> <p>b, Span.</p> <p>c, Chord length.</p> <p>b/c, Aspect ratio.</p> <p>f, Distance from $c. g.$ to elevator hinge.</p> <p>μ, Coefficient of viscosity.</p> |
|---|--|

3. AERODYNAMICAL SYMBOLS

- | | |
|---|--|
| <p>V, True air speed.</p> <p>q, Dynamic (or impact) pressure $= \frac{1}{2} \rho V^2$</p> <p>L, Lift, absolute coefficient $C_L = \frac{L}{qS}$</p> <p>D, Drag, absolute coefficient $C_D = \frac{D}{qS}$</p> <p>C, Cross-wind force, absolute coefficient $C_C = \frac{C}{qS}$</p> <p>R, Resultant force. (Note that these coeffi- cients are twice as large as the old co- efficients L_C, D_C.)</p> <p>i_w, Angle of setting of wings (relative to thrust line).</p> <p>i_t, Angle of stabilizer setting with reference to thrust line.</p> | <p>γ, Dihedral angle.</p> <p>$\frac{Vl}{\mu}$, Reynolds Number, where l is a linear dimension. e. g., for a model airfoil 3 in. chord, 100 mi./hr. normal pressure, 0° C: 255,000 and at 15° C., 230,000; or for a model of 10 cm chord 40 m/sec, corresponding numbers are 299,000 and 270,000.</p> <p>C_p, Center of pressure coefficient (ratio of distance of $C. P.$ from leading edge to chord length).</p> <p>β, Angle of stabilizer setting with reference to lower wing, $= (i_t - i_w)$.</p> <p>α, Angle of attack.</p> <p>ϵ, Angle of downwash.</p> |
|---|--|

REPORT No. 290

**WATER-PRESSURE DISTRIBUTION ON A
SEAPLANE FLOAT**

**By F. L. THOMPSON
Langley Memorial Aeronautical Laboratory**

NATIONAL ADVISORY COMMITTEE FOR AERONAUTICS

NAVY BUILDING, WASHINGTON, D. C.

[An independent Government establishment, created by act of Congress approved March 3, 1915, for the supervision and direction of the scientific study of the problems of flight. It consists of 12 members who are appointed by the President, all of whom serve as such without compensation.]

JOSEPH S. AMES, Ph. D., *Chairman*.
Provost, Johns Hopkins University, Baltimore, Md.
DAVID W. TAYLOR, D. Eng., *Vice Chairman*.
Washington, D. C.
GEORGE K. BURGESS, Sc. D.,
Director, Bureau of Standards, Washington, D. C.
WILLIAM F. DURAND, Ph. D.,
Professor Emeritus of Mechanical Engineering, Stanford University, Calif.
JAMES E. FECHET, Major General, United States Army,
Chief of Air Corps, War Department, Washington, D. C.
WILLIAM E. GILLMORE, Brigadier General, United States Army,
Chief, Matériel Division, Air Corps, Wright Field, Dayton, Ohio.
EMORY S. LAND, Captain, United States Navy,
Assistant Chief, Bureau of Aeronautics, Navy Department, Washington, D. C.
CHARLES F. MARVIN, M. E.,
Chief, United States Weather Bureau, Washington, D. C.
WILLIAM A. MOFFETT, Rear Admiral, United States Navy,
Chief, Bureau of Aeronautics, Navy Department, Washington, D. C.
S. W. STRATTON, Sc. D.,
President, Massachusetts Institute of Technology, Cambridge, Mass.
ORVILLE WRIGHT, B. S.,
Dayton, Ohio.

Smithsonian Institution, Washington, D. C.

GEORGE W. LEWIS, *Director of Aeronautical Research*.
JOHN F. VICTORY, *Secretary*.
HENRY J. E. REID, *Engineer in Charge, Langley Memorial Aeronautical Laboratory,*
Langley Field, Va.
JOHN J. IDE, *Technical Assistant in Europe, Paris, France.*

EXECUTIVE COMMITTEE

JOSEPH S. AMES, *Chairman*.
DAVID W. TAYLOR, *Vice Chairman*.

| | |
|----------------------|---------------------|
| GEORGE K. BURGESS. | CHARLES F. MARVIN. |
| JAMES E. FECHET. | WILLIAM A. MOFFETT. |
| WILLIAM E. GILLMORE. | S. W. STRATTON. |
| EMORY S. LAND. | ORVILLE WRIGHT. |

JOHN F. VICTORY, *Secretary*.

REPORT No. 290

WATER-PRESSURE DISTRIBUTION ON A SEAPLANE FLOAT

By F. L. THOMPSON

SUMMARY

The investigation reported herein was conducted by the National Advisory Committee for Aeronautics at the request of the Bureau of Aeronautics, Navy Department, for the purpose of determining the distribution and magnitude of water pressures likely to be experienced on seaplane hulls in service. It consisted of the development and construction of apparatus for recording water pressures lasting one one-hundredth second or longer and of flight tests to determine the water pressures on a UO-1 seaplane float under various conditions of taxiing, taking off, and landing.

The apparatus developed was found to operate with satisfactory accuracy and is suitable for flight tests on other seaplanes.

The tests on the UO-1 showed that maximum pressures of about 6.5 pounds per square inch occur at the step for the full width of the float bottom. Proceeding forward from the step the maximum pressures decrease in magnitude uniformly toward the bow, and the region of highest pressures narrows toward the keel. Immediately abaft the step the maximum pressures are very small, but increase in magnitude toward the stern and there once reached a value of about 5 pounds per square inch.

INTRODUCTION

The design of seaplane floats and hulls for strength has in the past been largely determined by experience because of the lack of data regarding the loads to which they are subjected. A float that suffers no damage under the conditions it is expected to withstand is satisfactorily strong, but, on the other hand, it may have excess strength and therefore excess weight, which is objectionable. In safely reducing float and hull weights to a minimum it is necessary to know the magnitude and distribution of water pressures to which they are subjected.

To supply data for application in the design of lighter float gear, the Bureau of Aeronautics, Navy Department, requested this investigation of the water-pressure distribution on a seaplane float. It is intended that it will later be extended to include both the twin-float and boat type seaplanes.

The major portion of a two-year period over which this investigation extended was devoted to the development and construction of apparatus. After numerous trials and laboratory tests an instrument was developed to satisfactorily record water-pressure impulses of one one-hundredth second or longer duration.

A UO-1 single float seaplane was used for the tests, it being particularly suitable for an initial trial of the apparatus and method, as it is easily handled, is of proven ruggedness, and has a float of modern design. The test work was made to include taxiing, taking off, and landing runs under various conditions, with particular emphasis on bad conditions. On each run records were obtained of the water pressures at 15 stations on one side of the float bottom, of the longitudinal float angle, and of the air speed. The average wind velocity was also determined for use in finding the water speed of the seaplane.

This report includes a full description of the instrument developed to record water pressures, a description of the apparatus and methods used in the tests, a table of the water pressures found at all stations on each run, a graphical and tabular representation of the maximum pressures

at each station regardless of the run; and the conclusions arrived at as a result of the investigation. In the complete table of results each maneuver is described as to air speed, water speed, longitudinal float angle, and condition of the water surface. The pressures recorded are maximum pressures that occurred during each run and are not necessarily simultaneous values since the runs had an average duration of two to three seconds.

APPARATUS AND METHOD

APPARATUS

A Vought UO-1 seaplane (fig. 1) was used for these tests. It was equipped with a Wright J4-A engine and a wooden float. The specified stalling speed of this seaplane is 55.5 M. P. H.

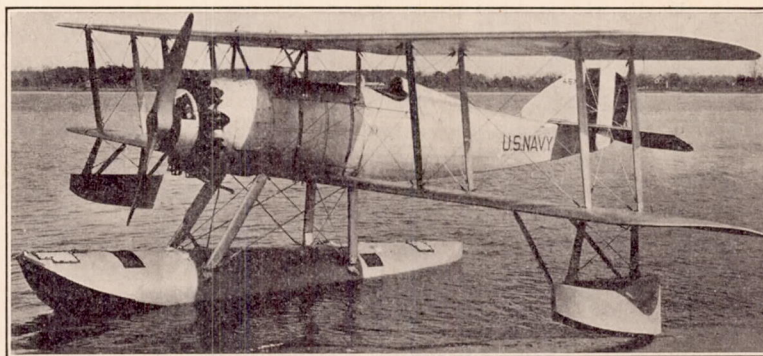

FIG. 1.—UO-1 seaplane

The gross weight with instruments installed was 2,764 pounds, which is but 19 pounds less than the maximum specified gross weight for service conditions.

The lines of the UO-1 float are shown in Figure 2. It has an angle of V of 20° at the step and aft. Forward of the step the angle of V gradually increases toward the bow. The step is $2\frac{1}{2}$ inches high, and the angle of the after keel is 5° . This combination is such that an inclina-

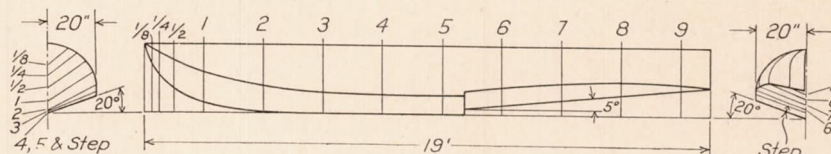

FIG. 2.—UO-1 float

tion of $6\frac{1}{2}^\circ$ or more in landing causes the stern of the float to make first contact with the water. The float deck line is rigged parallel to the thrust axis of the seaplane, thereby making angles of $1\frac{3}{4}^\circ$ and $2\frac{1}{4}^\circ$, respectively, with the upper and lower wing chords.

The instrument installation included the following:

1. Float-angle observer.
2. Two recording manometers—two pressure cells each.
3. Air-speed swiveling Pitot-static head.
4. Motor-type timer.
5. Water-pressure apparatus.

1. A small motion-picture camera driven by a constant-speed electric motor was used to photograph the shore line parallel to the path of the seaplane, thereby recording the longitudinal angle of the float. The camera was driven at a speed of five pictures per second.

2. The two recording manometers were of the type described in Reference 1 as the N. A. C. A. recording air-speed meter with the exception of having two pressure cells each instead of one. One of the four pressure cells thus provided was used to record air speed. The other three had heavy diaphragms and were used to record pneumatic pressures in connection with the water-pressure apparatus described later.

3. The swiveling Pitot-static head was located on the right front outboard wing strut and connected to the air-speed recording pressure cell.

4. An N. A. C. A. motor-type timer was used to synchronize records by means of timing lines at one-second intervals. In reference 2 the N. A. C. A. chronometric timer and the method of synchronizing records are described. The motor-type timer is used in exactly the same manner as the chronometric timer, but it depends for its periodic electrical contacts on a rotating

switch driven by a constant-speed electric motor. The two manometer records and the float-angle record were synchronized by this means.

5. The water-pressure apparatus was used for the first time in this investigation and is therefore described in detail.

WATER-PRESSURE APPARATUS

For the determination of water pressures, 15 water-pressure units of the type shown in Figures 3 and 4 were used. Each unit has four brass pistons fitted in a brass case with 0.001 inch clearance. The water pressures on the external ends of these pistons are balanced by a hand-controlled internal pneumatic pressure. The external areas of the four pistons are unequal, thereby causing unequal forces to be imposed on the pistons at any given intensity of water pressure. The internal areas are equal, and the pneumatic load resisting the water pressure load is therefore the same for each piston. The external piston areas range from 0.196 square inch for the smallest to 0.276 square inch for the largest piston; thus the range of water pressure necessary to operate the four pistons at a given pneumatic pressure is proportionately the same.

In test work the pneumatic pressure is adjusted to such a value that the expected range of water pressures as determined by preliminary trials will operate at least the largest piston but not the smallest. This determines the magnitude of the water pressure between limits. If none of the pistons operate, only a pressure not exceeded is known, and if all operate only a pressure exceeded is known.

Figure 4 is a cross-section drawing of a water-pressure unit. The pistons are hollowed for lightness. Their inner ends are secured to an air-tight fabric diaphragm, and a similar diaphragm over the external ends excludes water from the instrument. These diaphragms are sufficiently flexible to permit the longitudinal piston displacement of about 0.002 inch that is required to bring each piston against its respective contact screw. The contact screws of the three largest pistons are connected to the fourth screw through parallel resistances. Figure 5 shows a diagram of the resulting circuit. Successive operation of the pistons results in step-by-step increase of the current to the recorder until a maximum is reached when the smallest piston operates.

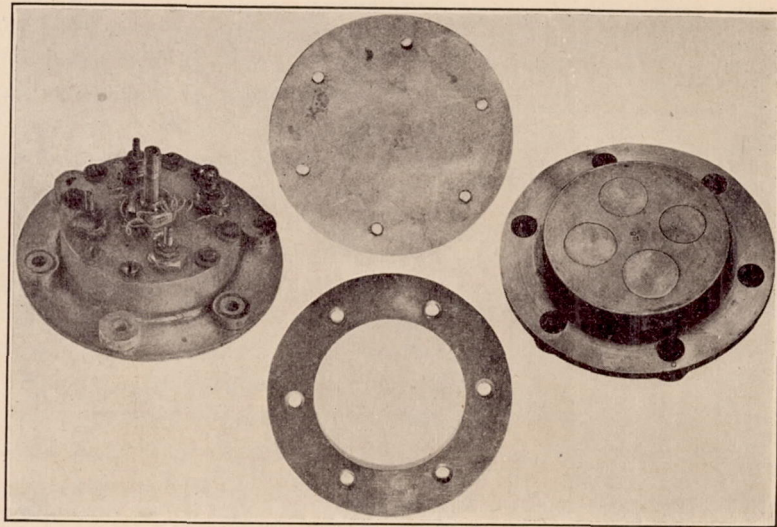

FIG. 3.—Water-pressure unit top and bottom views and its external diaphragm and retainer ring

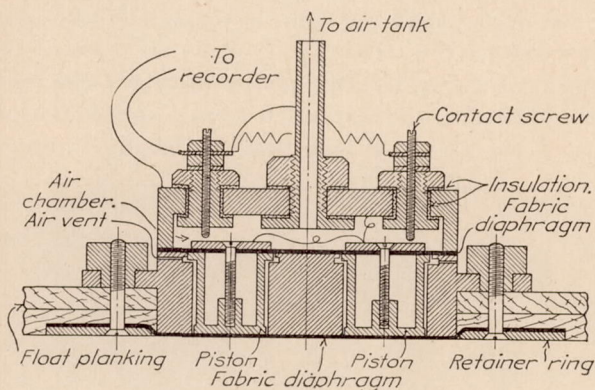

FIG. 4.—Cross section of water-pressure unit

Figure 5 shows a diagram of the resulting circuit. Successive operation of the pistons results in step-by-step increase of the current to the recorder until a maximum is reached when the smallest piston operates.

When installed in the float bottom, the pressure units present a smooth surface flush with the float-bottom planking. Figure 6 shows the float bottom with the pressure units in place. Twenty-two units were installed, but the recorder could accommodate only 15 at a time. It was intended that a series of runs would be made with 15 units connected and the runs repeated with 7 of the units replaced by the remaining 7. The first 15 units connected included representative points well distributed over the float bottom, and in order to shorten the program the remaining 7 units were not connected.

Referring again to Figure 5, the essential parts of the recording unit are shown to be a plunger-type solenoid, a mirror, a light source, and a revolving film drum. The light beam remains in a zero position until one or more pistons in the pressure unit operate, when it is deflected in steps. The measured deflection then indicates the number of pistons operating. A multiple recording instrument with 15 such units was used. It was a modification of an N. A. C. A. recording manometer with a centrally located, electrically driven, film drum (Reference 3). The original diaphragms of the recording units were actuated by the solenoid plungers. Laboratory tests with this mechanism showed that it would record satisfactorily in less than one one-hundredth of a second. The film was driven at an approximate speed of 2 inches per second, thereby obtaining records showing even the very short pressure impulses.

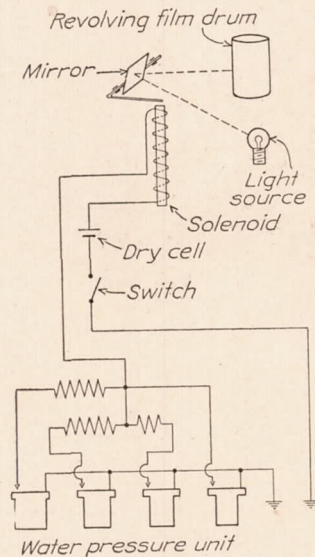

FIG. 5.—Diagram of the electrical circuit of a water-pressure unit and a recording unit.

The pneumatic system used in applying internal pressure to the water-pressure units consisted of a hand pump, three 125 cubic inch capacity air tanks, a sight gauge and a pressure-recording manometer for each tank, and aluminum tubing connections. Air was supplied to the three air tanks by the hand pump at pressures that could be controlled individually. Each tank supplied a particular group of water-pressure units. Group 1 included all units abaft the step; group 2, those units immediately forward of the step; and group 3, the remainder. By this arrangement it was

possible to record a different range of water pressures simultaneously in each of the three portions of the float bottom.

Calibrations of the water-pressure units, either in or out of the float, were made at frequent intervals by applying pneumatic pressures externally on the units. With external pressure as ordinate and internal pressure abscissa the calibration curve for each piston of a pressure unit was found to be a straight line; and the slopes of the four curves varied from a minimum for the largest piston to a maximum for the smallest piston. Due to the effect of the two diaphragms, one at each end of the pistons, the calibrations were dependent to some extent on the piston displacement necessary to make contact. To obtain suitable calibrations, it was therefore necessary to make very careful adjustments of the contact screws.

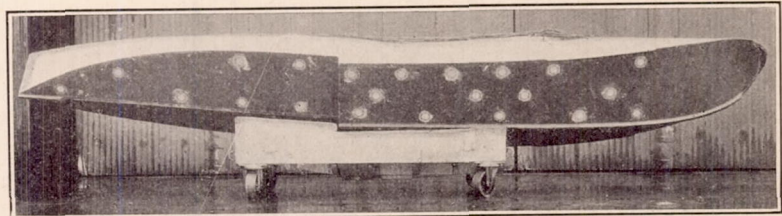

FIG. 6.—UO-1 float bottom with pressure units installed

Figure 7 is a photograph of the observer's cockpit. In the immediate foreground is the control board on which all switches and gauges were mounted. In the lower right corner is the water-pressure recorder with the film drum removed. The three shut-off cocks in the upper right corner were used for individual control of the three tank pressures of the pneumatic system, and the three gauges on the control board indicated the pressures on the tanks. The 15 knife switches were in circuits connecting the water-pressure and recording units and could be closed at any convenient time before a run. The small toggle switch marked "Motors" controlled the recording of all instruments except the water-pressure recorder, in which it only controlled

movement of the film drum. The source light in the water-pressure recorder was in the circuit of another toggle switch marked "Timing lights." Closing and opening of that switch also caused start and stop timing lines to appear on the other records.

With the above instruments and apparatus on each run, continuous records of about five or six seconds' duration were obtained of the air speed, the float angle, and the three tank pressures; and shorter records about two to three seconds in duration were obtained simultaneously of the water pressures at 15 stations on one side of the float bottom. Air-speed, float-angle, and tank-pressure records were synchronized by timing lines at one-second intervals, and by the arrangement described above two additional timing lines on these records

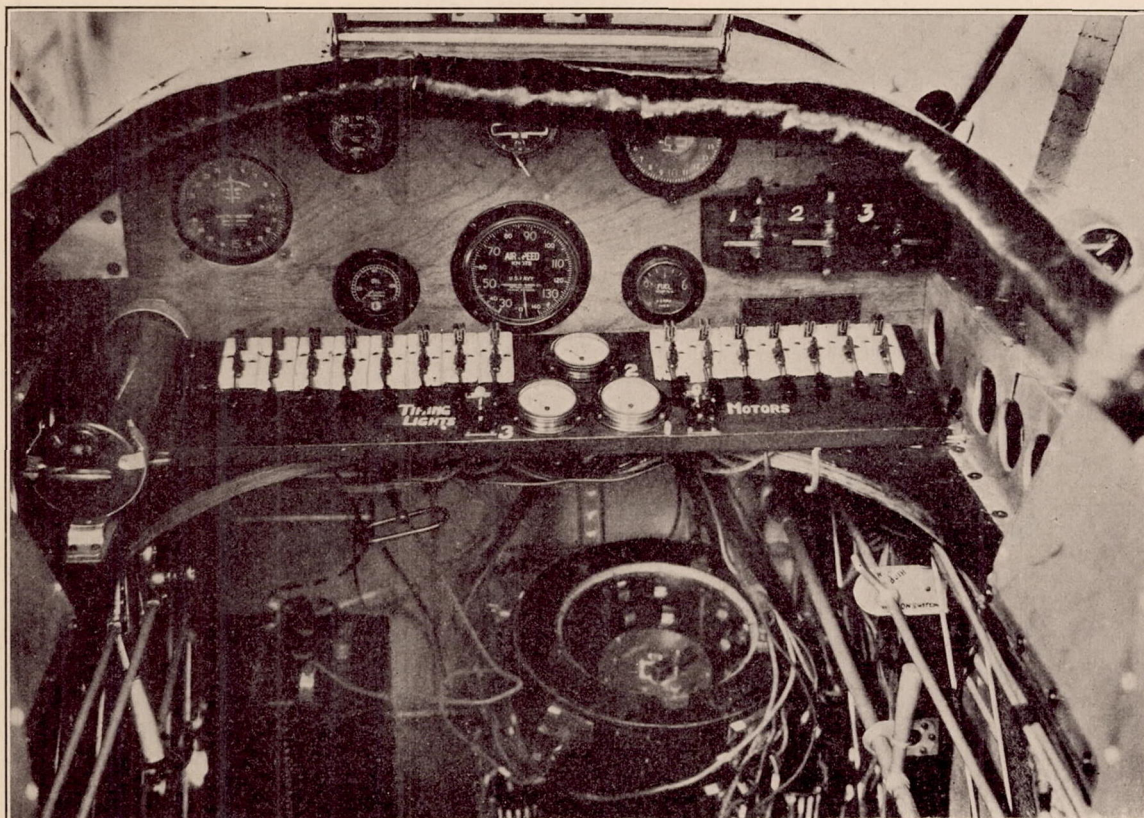

FIG 7.—Interior of the observer's cockpit

indicated the start and stop times of the water-pressure record. The shortness of the runs made it necessary for the observer to time the operation of the switches very carefully, particularly in landing runs.

METHOD OF TESTS

The program of test work was made to include the following maneuvers:

- Taking off in smooth and rough water.
- Taxying in smooth and rough water.
- Landing—power off.
- Landing—power on.
- Landing—pancake.
- Landing—fast.
- Landing—cross wind; wind on right.
- Landing—cross wind; wind on left.

This program was planned to include every type of water run likely to be encountered in safe operation of a seaplane, and more particularly the maneuvers causing highest pressures on the float. With the latter point in mind, the pilot often made maneuvers as roughly as possible with discretion.

Taxying maneuvers are further divided to distinguish between the two taxying stages mentioned in References 4 and 5, and named "plowing" and "planing" in Reference 5. The same classification is used here. "Plowing" is taxying in the low-speed range before rising to the step, in which condition the float angle is largely independent of the controls. "Planing" is taxying on the step and follows naturally after "plowing" in accelerated taxying. In this condition the longitudinal angle is much more controllable in a widening range as take-off speed is approached.

The test work was done on the sheltered waters bounding Langley Field, with the exception of four rough-water take-offs made in choppy tide-disturbed water in Chesapeake Bay at the mouth of Back River at a time when the wind was not of sufficient velocity to roughen the more sheltered water.

Each time that runs were made an observer determined the average wind velocity in the vicinity of the test with a vane-type anemometer. The average velocity computed from three two-minute readings was used in determining the approximate water speed of the seaplane from the air-speed record.

Two maneuvers—low-angle plowing and low-angle planing—were attempts to bring high-water pressures to their maximum forward position. In the low-angle plowing maneuver the seaplane was rocked and a record was taken to include a nose-down attitude, but this did not give the small angles desired. Low-angle planing was more successful and float angles of 0° were obtained. It was accomplished by a "trick" maneuver invented by the pilot for the purpose and is described briefly in the following paragraph. Of special interest in this connection is run 85, in which both the low-angle planing and the subsequent pancake landing were recorded. The description follows:

Immediately following a fast landing, with the float at an angle of from 3° to 6° , and without much loss in speed, the control column was given a sharp push forward. The seaplane immediately went to an approximate horizontal attitude for an instant (not more than one-fifth of a second) and then bounced several feet into the air. Skillful maneuvering was then required to make the subsequent pancake landing safely.

The above maneuver is interesting as an example of what can happen when making water runs at speeds above the stalling speed. With a float less deep at the bow it would be a dangerous maneuver, and with a pilot not sufficiently skillful it might be disastrous in any case.

The seaplane was subjected to some very severe conditions, but suffered no more serious damage than the knocking loose of the copper seam covering on one wing-tip float. The two cross-wind landings made in a 16 M. P. H. wind were too severe for repetition. The rough-water take-offs and some of the pancake landings were also very severe. A seaplane could not reasonably be expected to withstand without damage conditions more severe than some of those imposed.

PRECISION OF RESULTS

There are four sources of error that affect the accuracy of the results obtained with the water pressure unit. They are (1) accelerated motion of the float bottom at the instant that pressures are recorded; (2) displacement of the pistons finite distances in very short time intervals; (3) changes in calibration; (4) the method of recording pressures indirectly by "bracketing" them between high and low limits.

1. EFFECT OF ACCELERATIONS

When calibrated, the external pressure required to operate each piston against any internal pressure includes the weight per unit area of the piston. Under operating conditions when the float is decelerated by contact with the water or given an upward acceleration by a wave the pressure required to move the piston is increased by the amount, $w \left(\frac{a}{g} - 1 \right)$, where w is the weight per unit area of the piston and a is the acceleration. If the weight per unit area of the piston were the same as the float planking, the value recorded by the pressure unit would be the resultant pressure imposing stresses upon the float structure. This is the pressure that it

is desired to measure for use in the design of float structures. Actually the pistons are 13 to 17 times heavier than the float planking and a correction to the measured pressures is necessary. With due consideration for flexibility of the structure it is believed that $8g$ represents an acceleration seldom, if ever, exceeded in these tests, while $4g$ represents a probable average condition. The corrections necessary for $4g$ and $8g$ are tabulated below.

| Piston No. | Piston weight (lb./sq. in.) | Planking weight (lb./sq. in.) | Correction (lb./sq. in.) | |
|--------------|--------------------------------|----------------------------------|--------------------------|--------|
| | | | $a=4g$ | $a=8g$ |
| 1..... | 0.078 | 0.006 | 0.216 | 0.504 |
| 2..... | .084 | .006 | .234 | .546 |
| 3..... | .094 | .006 | .264 | .616 |
| 4..... | .105 | .006 | .297 | .693 |
| Average..... | ----- | ----- | .25 | .59 |

2. PISTON DISPLACEMENT

Because each piston must move a finite distance to make electric contact, some of the external force on the piston is expended in producing this movement. This additional force represents an error that may be computed providing the time required to move the piston and its weight and travel are known. The period of the water-pressure impulses which are to be measured is something greater than $1/100$ second. Therefore pistons will not be required to operate in less time than that. The piston travel is 0.002 inch and the weight of the heaviest piston is 0.105 pound per square inch. By making the pistons light and the travel small the error has been made negligible even for the assumed minimum time of $1/100$ second. The magnitude of the error is shown in the following computations:

We have

$$s = \frac{1}{2} at^2 \text{ or } a = \frac{2s}{t^2}$$

and

$$f = ma.$$

Then

$$f = m \frac{2s}{t^2}$$

where

$$s = \text{displacement.}$$

$$a = \text{acceleration.}$$

$$t = \text{time.}$$

$$m = \text{mass.}$$

and

$$f = \text{force.}$$

Using the values of weight, displacement, and time given above

$$f = \frac{.105 \times 2 \times .002 \times 10000}{32.2 \times 12} = .011 \text{ lb./sq. in.}$$

3. CALIBRATION CHANGES

Changes in calibration were found to occur probably because of changes in the piston-wall friction and changes of flexibility of the diaphragms. Errors from this cause were minimized by frequent calibrations.

4. "BRACKETING" METHOD

The accuracy with which exact values may be determined is limited by the method of "bracketing" between limits of a pressure exceeded and one not exceeded. If the differences in piston areas were made very small, the limits would be correspondingly close, but the range of pressures that could be included would also be small when the number of pistons is limited. A compromise must be made between the closeness of limits and the included pressure range so that both will be satisfactory. When limiting pressures are found by this method, an assumed true value which is the mean of the limits has the least probable error.

Due to differences in the calibration curves of the various pressure units, the range between limits varies somewhat for different pressure units, as may be noted from the results given in Table I. The following table, however, was taken from a typical calibration and shows the pressure range at two values of the internal pressure and the maximum errors, assuming the true pressure to be the mean of the limits. The probable error is, of course, less than these maxima.

| Internal pressure (lb./sq. in.) | Piston number | Water pressure (lb./sq. in.) | Mean (lb./sq. in.) | Maximum error | |
|------------------------------------|---------------|---------------------------------|-----------------------|---------------|----------|
| | | | | Lb./sq. in. | Per cent |
| 3.0 | 1 | 4.8 | 5.2 | ±0.4 | ±7.7 |
| 3.0 | 2 | 5.6 | 6.05 | .45 | 7.4 |
| 3.0 | 3 | 6.5 | 7.05 | .55 | 7.8 |
| 3.0 | 4 | 7.6 | | | |
| 1.5 | 1 | 2.6 | 3.0 | .2 | 6.7 |
| 1.5 | 2 | 3.0 | 3.25 | .25 | 7.7 |
| 1.5 | 3 | 3.5 | 3.9 | .4 | 10.2 |
| 1.5 | 4 | 4.3 | | | |

From the above discussion of errors it is concluded that the accuracy of the limiting pressures is affected considerably by acceleration, and the limits probably should be corrected to read 0.25 pound per square inch higher than the recorded values. This is the average correction for an acceleration of $4g$ and should therefore be correct within a small plus or minus error. It is further brought to attention that when definite values are desired they should be taken as the mean of the limits. When this is done the maximum error may be computed, and the probable error is something less than the maximum.

Errors in the pneumatic pressure records would affect the accuracy with which records could be interpreted. Such errors, however, were so small that they may be entirely neglected.

Air-speed records have an estimated precision of ± 1 per cent.

Float-angle check readings indicated a possible error in reading of $\pm \frac{1^\circ}{2}$.

For wind velocities up to 20 M. P. H. the velocity of unsteady air is not likely to change more than 5 M. P. H. in a short time. Average wind velocity as determined with the anemometer would then be correct within ± 2.5 M. P. H.

Water speed is the difference between air speed and wind velocity for a head wind, and is therefore subject to the same error as the wind velocity—i. e., ± 2.5 M. P. H.

RESULTS

The magnitudes of the maximum pressures occurring at all pressure stations during each run are recorded in Table I, and the locations of the stations are shown in Figure 8. These values are not necessarily simultaneous values, but are the maximum pressures that occurred during each run, which was usually two to three seconds in duration. Table II is a summary of the complete data of Table I giving the five highest pressures at all points. Curves showing the distribution of maximum pressures are given in Figure 9. Figure 10 represents graphically the distribution of maximum pressures on the float bottom. The values for Figures 9 and 10 are the highest pressures of Table II. In plotting, pressures exceeded are assumed to be exceeded by the average value of 0.5 pound per square inch.

Referring again to Figure 8 and Table II, it is seen that the highest pressures occurred immediately forward of the step for the full width of the float bottom. Going forward from the step the region of high pressures gradually narrows toward the keel and the magnitudes of the maximum pressures decrease. Pressure units (1), (2), and (3) located near the step recorded maximum pressures in excess of 6 pounds per square inch, while the maximum pressure exceeded at (15), which was farthest forward along the keel, was 2.5 pounds per square inch. Pressures at (15) were seldom of sufficient magnitude to be recorded by the pressure unit, and when they were they were obviously caused by waves. At (12), (8), and (5) there occurred pressures of increasing magnitude and of more and more frequent occurrence in the order named. Station (14), which was as far forward as (15), but near the chine, never operated; (11) operated but four times, the maximum pressure exceeded being 2.3 pounds per square inch; (10) operated more frequently than (11) and recorded higher pressures; and (6) operated frequently, often recording pressures as great as those at (1), (2), and (3). The highest pressure recorded at (6) was between 5 and 6.8 pounds per square inch.

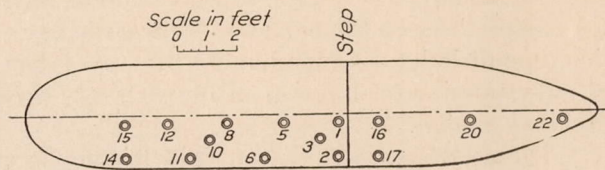

FIG. 8.—Water-pressure unit locations in the UO-1 float bottom

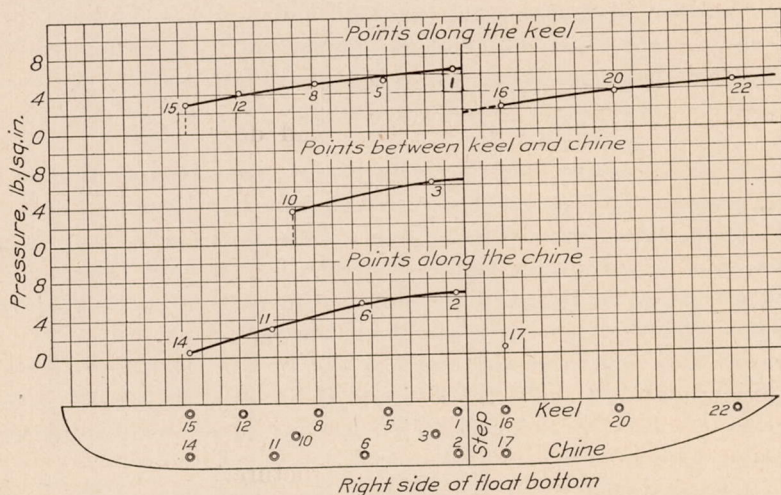

FIG. 9.—Distribution of maximum water pressures on the UO-1 seaplane float bottom

square inch; (20) operated five times during the entire series of runs and once recorded a pressure in excess of 3.4 pounds per square inch; (22) operated frequently and once in a very severe pancake landing on glassy water it recorded a pressure of between 4.5 and 5.5 pounds per square inch.

The time interval of water-pressure impulses and the frequency with which they occur are not shown in the table of results. In general, it may be said that high pressures were of longer duration and more frequent occurrence at stations (1), (2), (3), (5), and (8) than elsewhere. The high maximum pressures that occurred were not more than one-twentieth second in duration and often were much less, but the pressures were likely to be maintained near the maximum values for longer periods ranging approximately from one-tenth to one-half second. Maximum pressures at these stations were likely to recur several times during a run.

It has been mentioned that high pressures as great as those at (1), (2), and (3) often occurred at (6), but such pressures at (6) were of shorter duration (about one-fortieth second) and seldom appeared more than two or three times during a run. Between these maxima the pressure invariably dropped back to small values, usually within about one-tenth second.

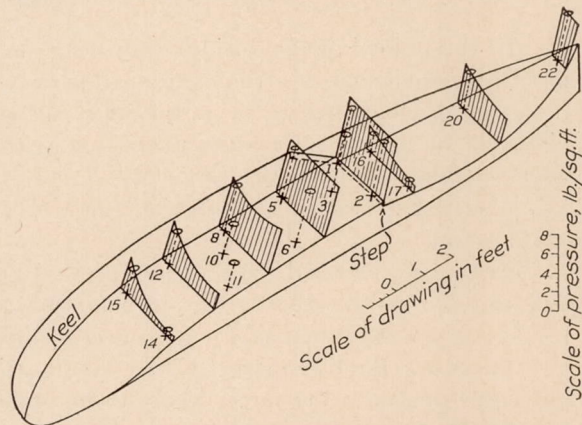

FIG. 10.—UO-1 seaplane float bottom showing the distribution of maximum water pressures over one side of the bottom

The other units forward of the step—viz, (10), (11), (12), and (15)—also recorded maximum pressures of short duration (one-thirtieth to one-fiftieth second or less). At (12) there was sometimes evidence of pressures maintained near the maximum values for much longer periods, but (10) and (11) gave records quite similar to those obtained at (6).

Abaft the step the one pressure recorded at (16) and those at (20) were of very short duration (one-fiftieth to one one-hundredth second approximately). At (22) maximum pressures were of an approximate duration of one-fortieth second and were likely to recur several times in rapid succession.

The results suggest that a right triangular area bounded by the step, the keel, and a line drawn from the outermost part of the step to the point on the keel nearest (15) as the hypotenuse would include an area of high and more or less sustained pressures decreasing in magnitude toward the bow. Along the hypotenuse and outside the triangle would lie stations (6), (10), and (15), at which occurred pressures of shorter duration and decreasing magnitude toward the bow.

The highest pressures were obtained in rough-water take-offs and pancake landings, although the maxima for some points were obtained in other maneuvers. The rough-water take-offs were very severe, due to their being made in choppy tide-disturbed water with little wind. All other rough-water maneuvers were made in a much stronger wind on more sheltered water.

The results indicate that high pressures are most likely to occur generally over the float bottom in rough water, but that pressures just as great may result from bad handling in perfectly smooth water. The truth of the latter part of the above statement is borne out in run 85 (b). In that run the pressures were not only very high at the step, but the high pressure of 4.5 to 5.5 pounds per square inch was recorded at (22) in the stern. Such a pressure so far from the center of gravity must impose very severe stresses in the float structure.

The only available comparative data are those contained in the British reports of Reference 6, which were obtained on flying-boat hulls. On the F. 3 and H. 16 hulls (R. and M. 683) the highest pressures exceeded were, respectively, 8.2 and 8.7 pounds per square inch, and pressures greater than 6 pounds per square inch were exceeded several times. These pressures are roughly 2 pounds per square inch greater than those recorded on the UO-1 float. The F. 3 and H. 16 hulls have approximately the same bottom V angle as the UO-1 float. It is of interest to note that these seaplanes are heavier per beam length in approximately the same ratio as the difference in maximum pressures.

CONCLUSIONS

In the following conclusions regarding the method and results those concerning the results should be construed as strictly applicable only to the UO-1 float as used in these tests:

The method employed is feasible, although subject to mechanical difficulties that are indicated by a lack of pressure records at various stations on different runs, but which may be largely eliminated in future test work.

The highest water pressures on the UO-1 float occur at the step for the full width of the float bottom.

Extending forward from the step the region of high water pressures narrows toward the keel and the magnitudes of the pressures decrease gradually toward the bow.

Local water pressures of considerable magnitude are likely to occur at the stern of the float.

There are large portions of the float bottom, both aft and forward of the step, on which the water pressures are never likely to be greater than 2 to 3 pounds per square inch.

REFERENCES AND BIBLIOGRAPHY

- REFERENCE 1. Norton, F. H.: N. A. C. A. Recording Air-Speed Meter; N. A. C. A. Technical Note No. 64. (1921.)
- REFERENCE 2. Brown, W. G.: The Synchronization of N. A. C. A. Flight Records. N. A. C. A. Technical Note No. 117. (1922.)
- REFERENCE 3. Norton, F. H., and Brown, W. G.: The Pressure Distribution Over the Horizontal Tail Surfaces of an Airplane, III. N. A. C. A. Technical Report No. 148. (1922.)
- REFERENCE 4. Crowley, jr., J. W., and Ronan, K. M.: Characteristics of a Single Float Seaplane During Take-Off. N. A. C. A. Technical Report No. 209. (1925.)
- REFERENCE 5. Crowley, jr., J. W., and Ronan, K. M.: Characteristics of a Twin-Float Seaplane During Take-Off. N. A. C. A. Technical Report No. 242. (1926.)
- REFERENCE 6. Baker, G. S., and Keary, E. M.:
Experiments with Full-Sized Machines. (Second Series.) Local Water Pressures on Flying-Boat Hulls. British Aeronautical Research Committee Reports and Memoranda No. 683. (September, 1920.)
P. 5 Flying Boat N. 86, Impact Tests (Experiments with Full-Sized Machines, Third Series). British Aeronautical Research Committee Reports and Memoranda No. 926. (April, 1924.)
- Bottomley, G. H.: The Impact of a Model Seaplane Float on Water. British Advisory Committee for Aeronautics Reports and Memoranda No. 583. (March, 1919.)
- Herrmann, H.: Seaplane Floats and Hulls. Part I. N. A. C. A. Technical Memorandum No. 426. (1927.) Part II. N. A. C. A. Technical Memorandum No. 427. (1927.)
- Richardson, H. C.: Airplane and Seaplane Engineering. Bureau of Aeronautics, Navy Department Technical Note No. 59. (1923.)

TABLE II.—SUMMARY OF FIVE HIGHEST WATER PRESSURES AT ALL STATIONS

| Station number | | | | | | | | | | | | | | | | | | | | | | | |
|----------------|------------------------|-------|---------|------------------------|-----|---------|------------------------|-------|---------|------------------------|-------|---------|------------------------|-------|---------|------------------------|-------|----|-----|-------|-------|-------|-------|
| 1 | | 2 | | 3 | | 5 | | 6 | | 8 | | 10 | | 11 | | | | | | | | | |
| Run No. | Pressure (lb./sq. in.) | | Run No. | Pressure (lb./sq. in.) | | Run No. | Pressure (lb./sq. in.) | | Run No. | Pressure (lb./sq. in.) | | Run No. | Pressure (lb./sq. in.) | | Run No. | Pressure (lb./sq. in.) | | | | | | | |
| | a | b | | a | b | | a | b | | a | b | | a | b | | a | b | | | | | | |
| 79 | 5.9 | ----- | 79 | 6.0 | 7.0 | 79 | 6.3 | ----- | 61 | 5.0 | ----- | 79 | 5.0 | 6.8 | 79 | 4.8 | 5.9 | 64 | 3.0 | ----- | 27 | 2.3 | ----- |
| 77 | 5.4 | ----- | 77 | 5.5 | 6.2 | 85b | 6.1 | ----- | 52 | 4.5 | ----- | 28 | 4.3 | ----- | 80 | 3.5 | ----- | 45 | 2.7 | ----- | 64 | 2.1 | ----- |
| 82 | 5.3 | 5.6 | 82 | 5.5 | 6.3 | 87 | 5.5 | 6.5 | 82 | 4.5 | 6.0 | 85a | 4.2 | 5.2 | 64 | 3.3 | 3.7 | 44 | 2.3 | ----- | 20 | 1.3 | ----- |
| 85a | 5.2 | 5.5 | 67 | 4.5 | 4.9 | 67 | 4.1 | 4.7 | 59 | 4.4 | 4.7 | 26 | 3.9 | ----- | 65 | 3.3 | 3.6 | 68 | 2.3 | ----- | 17 | 1.0 | ----- |
| 85b | 5.0 | ----- | 61 | 4.1 | 4.4 | 82 | 4.1 | 4.9 | 79 | 4.3 | ----- | 46 | 3.8 | ----- | 77 | 2.8 | 3.5 | 27 | 2.2 | ----- | ----- | ----- | ----- |

| Station number | | | | | | | | | | | | | | | | | |
|----------------|------------------------|-------|---------|------------------------|----|---------|------------------------|-------|---------|------------------------|-------|---------|------------------------|-------|-----|-----|-------|
| 12 | | 14 | | 15 | | 16 | | 17 | | 20 | | 22 | | | | | |
| Run No. | Pressure (lb./sq. in.) | | Run No. | Pressure (lb./sq. in.) | | Run No. | Pressure (lb./sq. in.) | | Run No. | Pressure (lb./sq. in.) | | Run No. | Pressure (lb./sq. in.) | | | | |
| | a | b | | a | b | | a | b | | a | b | | a | b | a | b | |
| 79 | 3.8 | 4.5 | ----- | ----- | 27 | 2.5 | ----- | 20 | 1.8 | ----- | ----- | 25 | 3.4 | ----- | 85b | 4.5 | 5.5 |
| 27 | 3.0 | ----- | ----- | ----- | 26 | 2.4 | ----- | ----- | ----- | ----- | ----- | 20 | 3.3 | ----- | 71 | 3.5 | ----- |
| 77 | 2.8 | 3.3 | ----- | ----- | 14 | 1.8 | ----- | ----- | ----- | ----- | ----- | 80 | 2.8 | ----- | 80 | 3.1 | ----- |
| 26 | 2.8 | ----- | ----- | ----- | 20 | 1.7 | ----- | ----- | ----- | ----- | ----- | 27 | 2.3 | ----- | 69 | 2.8 | ----- |
| 25 | 2.6 | ----- | ----- | ----- | 25 | 1.3 | ----- | ----- | ----- | ----- | ----- | 68 | 1.5 | 1.8 | 64 | 2.8 | 3.4 |

a=pressure exceeded; b=pressure not exceeded.

NOTE.—The lack of agreement between run numbers and highest pressures at adjacent points (particularly 1, 2, and 3) is likely due to lack of records at some points on various runs. (See Table I.) Units 14 and 17 never operated, 16 operated but once, and 11 four times.

ADDITIONAL COPIES
OF THIS PUBLICATION MAY BE PROCURED FROM
THE SUPERINTENDENT OF DOCUMENTS
U.S. GOVERNMENT PRINTING OFFICE
WASHINGTON, D. C.
AT
10 CENTS PER COPY
▽

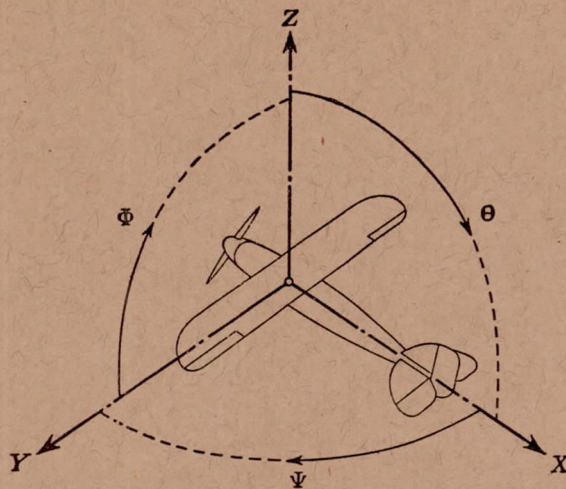

Positive directions of axes and angles (forces and moments) are shown by arrows

| Axis | | Force (parallel to axis) symbol | Moment about axis | | | Angle | | Velocities | |
|--------------|-------------|--|-------------------|-------------|-----------------------|------------------|-------------|--|---------|
| Designation | Sym- bol | | Designa- tion | Sym- bol | Positive direction | Designa- tion | Sym- bol | Linear (compo- nent along axis) | Angular |
| Longitudinal | X | X | rolling | L | Y → Z | roll | Φ | u | p |
| Lateral | Y | Y | pitching | M | Z → X | pitch | Θ | v | q |
| Normal | Z | Z | yawing | N | X → Y | yaw | Ψ | w | r |

Absolute coefficients of moment

$$C_L = \frac{L}{qbS} \quad C_M = \frac{M}{qcS} \quad C_N = \frac{N}{qfS}$$

Angle of set of control surface (relative to neu-
tral position), δ . (Indicate surface by proper
subscript.)

4. PROPELLER SYMBOLS

D , Diameter.
 p_e , Effective pitch
 p_g , Mean geometric pitch.
 p_s , Standard pitch.
 p_v , Zero thrust.
 p_a , Zero torque.
 p/D , Pitch ratio.
 V' , Inflow velocity.
 V_s , Slip stream velocity.

T , Thrust.
 Q , Torque.
 P , Power.

(If "coefficients" are introduced all
units used must be consistent.)

η , Efficiency = $T V/P$.
 n , Revolutions per sec., r. p. s.
 N , Revolutions per minute., R. P. M.
 Φ , Effective helix angle = $\tan^{-1} \left(\frac{V}{2\pi r n} \right)$

5. NUMERICAL RELATIONS

1 HP = 76.04 kg/m/sec. = 550 lb./ft./sec.
 1 kg/m/sec. = 0.01315 HP.
 1 mi./hr. = 0.44704 m/sec.
 1 m/sec. = 2.23693 mi./hr.

1 lb. = 0.4535924277 kg.
 1 kg = 2.2046224 lb.
 1 mi. = 1609.35 m = 5280 ft.
 1 m = 3.2808333 ft.