

*file as NACA-TR-452*

**NATIONAL ADVISORY COMMITTEE  
FOR AERONAUTICS**

**REPORT No. 452**

**GENERAL POTENTIAL THEORY OF ARBITRARY  
WING SECTIONS**

**By T. THEODORSEN and I. E. GARRICK**



**REPRINT OF REPORT No. 452, ORIGINALLY PUBLISHED APRIL**

**1940**

**REPRODUCED BY  
NATIONAL TECHNICAL  
INFORMATION SERVICE  
U. S. DEPARTMENT OF COMMERCE  
SPRINGFIELD, VA. 22161**

# AERONAUTIC SYMBOLS

## I. FUNDAMENTAL AND DERIVED UNITS

	Symbol	Metric		English	
		Unit	Abbreviation	Unit	Abbreviation
Length	$l$	meter	m	foot (or mile)	ft (or mi)
Time	$t$	second	s	second (or hour)	sec (or hr)
Force	$F$	weight of 1 kilogram	kg	weight of 1 pound	lb
Power	$P$	horsepower (metric)		horsepower	hp
Speed	$V$	kilometers per hour	kph	miles per hour	mph
		meters per second	mps	feet per second	fps

## 2. GENERAL SYMBOLS

<p><math>W</math> Weight = <math>mg</math></p> <p><math>g</math> Standard acceleration of gravity = <math>9.80665 \text{ m/s}^2</math> or <math>32.1740 \text{ ft/sec}^2</math></p> <p><math>m</math> Mass = <math>\frac{W}{g}</math></p> <p><math>I</math> Moment of inertia = <math>mk^2</math>. (Indicate axis of radius of gyration <math>k</math> by proper subscript.)</p> <p><math>\mu</math> Coefficient of viscosity</p>	<p><math>\nu</math> Kinematic viscosity</p> <p><math>\rho</math> Density (mass per unit volume)</p> <p>Standard density of dry air, <math>0.12497 \text{ kg-m}^{-3}\text{-s}^2</math> at <math>15^\circ \text{ C}</math> and <math>760 \text{ mm}</math>; or <math>0.002378 \text{ lb-ft}^{-3}\text{-sec}^2</math></p> <p>Specific weight of "standard" air, <math>1.2255 \text{ kg/m}^3</math> or <math>0.07651 \text{ lb/cu ft}</math></p>
---	--

## 3. AERODYNAMIC SYMBOLS

<p><math>S</math> Area</p> <p><math>S_w</math> Area of wing</p> <p><math>G</math> Gap</p> <p><math>b</math> Span</p> <p><math>c</math> Chord</p> <p><math>A</math> Aspect ratio, <math>\frac{b^2}{S}</math></p> <p><math>V</math> True air speed</p> <p><math>q</math> Dynamic pressure, <math>\frac{1}{2}\rho V^2</math></p> <p><math>L</math> Lift, absolute coefficient <math>C_L = \frac{L}{qS}</math></p> <p><math>D</math> Drag, absolute coefficient <math>C_D = \frac{D}{qS}</math></p> <p><math>D_0</math> Profile drag, absolute coefficient <math>C_{D_0} = \frac{D_0}{qS}</math></p> <p><math>D_i</math> Induced drag, absolute coefficient <math>C_{D_i} = \frac{D_i}{qS}</math></p> <p><math>D_p</math> Parasite drag, absolute coefficient <math>C_{D_p} = \frac{D_p}{qS}</math></p> <p><math>C</math> Cross-wind force, absolute coefficient <math>C_C = \frac{C}{qS}</math></p>	<p><math>i_w</math> Angle of setting of wings (relative to thrust line)</p> <p><math>i_s</math> Angle of stabilizer setting (relative to thrust line)</p> <p><math>Q</math> Resultant moment</p> <p><math>\Omega</math> Resultant angular velocity</p> <p><math>R</math> Reynolds number, <math>\rho \frac{Vl}{\mu}</math> where <math>l</math> is a linear dimension (e.g., for an airfoil of 1.0 ft chord, 100 mph, standard pressure at <math>15^\circ \text{ C}</math>, the corresponding Reynolds number is 935,400; or for an airfoil of 1.0 m chord, 100 mps, the corresponding Reynolds number is 6,865,000)</p> <p><math>\alpha</math> Angle of attack</p> <p><math>\epsilon</math> Angle of downwash</p> <p><math>\alpha_0</math> Angle of attack, infinite aspect ratio</p> <p><math>\alpha_i</math> Angle of attack, induced</p> <p><math>\alpha_w</math> Angle of attack, absolute (measured from zero-lift position)</p> <p><math>\gamma</math> Flight-path angle</p>
--	---

## NOTICE

THIS DOCUMENT HAS BEEN REPRODUCED FROM THE BEST COPY FURNISHED US BY THE SPONSORING AGENCY. ALTHOUGH IT IS RECOGNIZED THAT CERTAIN PORTIONS ARE ILLEGIBLE, IT IS BEING RELEASED IN THE INTEREST OF MAKING AVAILABLE AS MUCH INFORMATION AS POSSIBLE.

E R R A T A

NATIONAL ADVISORY COMMITTEE FOR AERONAUTICS

TECHNICAL REPORT NO. 452

GENERAL POTENTIAL THEORY OF ARBITRARY WING SECTIONS

Page 10, column 1, line 10:

$\bar{\epsilon} [\varphi (\theta')]$  should be  $\epsilon [\varphi (\theta')]$

$\frac{d \Psi (\theta)}{d \theta}$  should be  $\frac{d \bar{\Psi} (\theta)}{d \theta}$

Page 10, equation 19:

$\epsilon_k (\theta')$  should be  $\bar{\epsilon}_k (\theta')$

Page 11, column 2, line 10:

$z \frac{g(z)}{dz} \frac{d}{dz}$  should be  $z \frac{dg(z)}{dz}$

Page 17, equation 34:

The plus sign in this equation should be minus  
and the entire right-hand member should be  
multiplied by  $\frac{dz (\zeta)}{d \zeta}$

Page 18, equation 37)

$\frac{d \epsilon}{d \theta}$  should be  $\frac{d \bar{\epsilon}}{d \theta}$

Page 26, column 2, line 5:

The exponent  $n-i$  of  $(-1)$  should be  $n-1$ .

Page 26, Figure 25:

For the lower curve of this figure the ordinates  
should all be shifted downward by 0.05; i.e.,  
the present zero line is at +0.05.

Page 27, column 1, line 6:

$\epsilon (\theta)$  should be  $\bar{\epsilon} (\theta)$ .

Page 30, column 1, line 19:

equation (38) should be equation (39).

NACA REPORT  
452

---

---

**REPORT No. 452**

---

**GENERAL POTENTIAL THEORY OF ARBITRARY  
WING SECTIONS**

**By T. THEODORSEN and I. E. GARRICK**  
**Langley Memorial Aeronautical Laboratory**

## NATIONAL ADVISORY COMMITTEE FOR AERONAUTICS

HEADQUARTERS, NAVY BUILDING, WASHINGTON, D. C.

Created by act of Congress approved March 3, 1915, for the supervision and direction of the scientific study of the problems of flight (U. S. Code, Title 50, Sec. 151). Its membership was increased to 15 by act approved March 2, 1929. The members are appointed by the President, and serve as such without compensation.

VANNEYAR BUSH, Sc. D., *Chairman*,  
Washington, D. C.

GEORGE J. MEAD, Sc. D., *Vice Chairman*,  
Washington, D. C.

CHARLES G. ABBOT, Sc. D.,  
Secretary, Smithsonian Institution.

HENRY H. ARNOLD, Major General, United States Army,  
Deputy Chief of Staff, Chief of the Air Corps, War  
Department.

GEORGE H. BRETT, Major General, United States Army,  
Acting Chief of the Air Corps, War Department.

LYMAN J. BRIGGS, Ph. D.,  
Director, National Bureau of Standards.

DONALD H. CONNOLLY, B. S.,  
Administrator of Civil Aeronautics.

ROBERT E. DOHERTY, M. S.,  
Pittsburgh, Pa.

ROBERT H. HINCKLEY, A. B.,  
Assistant Secretary of Commerce.

JEROME C. HUNSAKER, Sc. D.,  
Cambridge, Mass.

SYDNEY M. KRAUS, Captain, United States Navy,  
Bureau of Aeronautics, Navy Department.

FRANCIS W. REICHELDERFER, Sc. D.,  
Chief, United States Weather Bureau.

JOHN H. TOWERS, Rear Admiral, United States Navy,  
Chief, Bureau of Aeronautics, Navy Department.

EDWARD WARNER, Sc. D.,  
Washington, D. C.

ORVILLE WRIGHT, Sc. D.,  
Dayton, Ohio.

---

GEORGE W. LEWIS, *Director of Aeronautical Research*

S. PAUL JOHNSTON, *Coordinator of Research*

JOHN F. VICTORY, *Secretary*

HENRY J. E. REID, *Engineer-in-Charge, Langley Memorial Aeronautical Laboratory, Langley Field, Va.*

SMITH J. DEFRANCE, *Engineer-in-Charge, Ames Aeronautical Laboratory, Moffett Field, Calif.*

### TECHNICAL COMMITTEES

AERODYNAMICS  
POWER PLANTS FOR AIRCRAFT  
AIRCRAFT MATERIALS

AIRCRAFT STRUCTURES  
AIRCRAFT ACCIDENTS  
INVENTIONS AND DESIGNS

*Coordination of Research Needs of Military and Civil Aviation*

*Preparation of Research Programs*

*Allocation of Problems*

*Prevention of Duplication*

*Consideration of Inventions*

LANGLEY MEMORIAL AERONAUTICAL LABORATORY

LANGLEY FIELD, VA.

AMES AERONAUTICAL LABORATORY

MOFFETT FIELD, CALIF.

Conduct, under unified control, for all agencies, of scientific research on the fundamental problems of flight.

### OFFICE OF AERONAUTICAL INTELLIGENCE

WASHINGTON, D. C.

Collection, classification, compilation, and dissemination of  
scientific and technical information on aeronautics

## REPORT No. 452

### GENERAL POTENTIAL THEORY OF ARBITRARY WING SECTIONS

By T. THEODORSEN and I. E. GARRICK

#### SUMMARY

*This report gives an exact treatment of the problem of determining the 2-dimensional potential flow around wing sections of any shape. The treatment is based directly on the solution of this problem as advanced by Theodorsen in N. A. C. A. Technical Report No. 411. The problem condenses into the compact form of an integral equation capable of yielding numerical solutions by a direct process.*

*An attempt has been made to analyze and coordinate the results of earlier studies relating to properties of wing sections. The existing approximate theory of thin wing sections and the Joukowsky theory with its numerous generalizations are reduced to special cases of the general theory of arbitrary sections, permitting a clearer perspective of the entire field. The method not only permits the determination of the velocity at any point of an arbitrary section and the associated lift and moments, but furnishes also a scheme for developing new shapes of preassigned aerodynamical properties. The theory applies also to bodies that are not airfoils, and is of importance in other branches of physics involving potential theory.*

#### INTRODUCTION

The solution of the problem of determining the 2-dimensional potential flow of a nonviscous incompressible fluid around bodies of arbitrary shape can be made to depend on a theorem in conformal representation stated by Riemann almost a century ago, known as the fundamental theorem of conformal representation. This theorem is equivalent to the statement that it is possible to transform the region bounded by a simple curve into the region bounded by a circle in such a way that all equipotential lines and stream lines of the first region transform respectively into those of the circle. The theorem will be stated more precisely in the body of this report and its significance for wing section theory shown—suffice it at present to state that if the analytic transformation by which the one region is transformed conformally into the region bounded by the circle is known, the potential field of this region is readily obtained in terms of the potential field of the circle.

A number of transformations have been found by means of which it is possible to transform a circle into

a contour resembling an airfoil shape. It is obviously true that such *theoretical* airfoils possess no particular qualities which make them superior to the types of more empirical origin. It was probably primarily because of the difficulty encountered in the inverse problem, viz, the problem of transforming an airfoil into a circle (which we shall denote as the direct process) that such artificial types came into existence. The 2-dimensional theoretical velocity distribution, or what is called the flow pattern, is known only for some special symmetrical bodies and for the particular class of Joukowsky airfoils and their extensions, the outstanding investigators<sup>1</sup> being Kutta, Joukowsky, and von Mises. Although useful in the development of airfoil theory these theoretical airfoils are based solely on special transformations employing only a small part of the freedom permitted in the general case. However, they still form the subject of numerous isolated investigations.

The direct process has been used in the theory of thin airfoils with some success. An approximate theory of thin wing sections applicable only to the mean camber line has been developed<sup>2</sup> by Munk and Birnbaum, and extended by others. However, attempts<sup>3</sup> which have been made to solve the general case of an arbitrary airfoil by direct processes have resulted in intricate and practically unmanageable solutions. Lamb, in his "Hydrodynamics" (reference 1, p. 77), referring to this problem as dependent upon the determination of the complex coefficients of a conformal transformation, states: "The difficulty, however, of determining these coefficients so as to satisfy given boundary conditions is now so great as to render this method of very limited application. Indeed, the determination of the irrotational motion of a liquid subject to given boundary conditions is a problem whose exact solution can be effected by direct processes in only a very few cases. Most of the cases for which we know the solution have been obtained by an inverse process; viz, instead of trying to find a value of  $\phi$  or  $\psi$  which satisfies [the Laplacian]  $\nabla^2\phi=0$  or  $\nabla^2\psi=0$  and given boundary conditions, we take some known solution of these differential equations

<sup>1</sup> See bibliography given in reference 9, pp. 24, 84, and 583.

<sup>2</sup> Cf. footnote 1.

<sup>3</sup> See Appendix II of this paper.

and inquire what boundary conditions it can be made to satisfy."

In a report (reference 2) recently published by the National Advisory Committee for Aeronautics a general solution employing a direct method was briefly given. It was shown that the problem could be stated in a condensed form as an integral equation and also that it was possible to effect the practical solution of this equation for the case of any given airfoil. A formula giving the velocity at any point of the surface of an arbitrary airfoil was developed. The first part of the present paper includes the essential developments of reference 2 and is devoted to a more complete and precise treatment of the method, in particular with respect to the evaluation of the integral equation.

In a later part of this paper, a geometric treatment of arbitrary airfoils, coordinating the results of earlier investigations, is given. Special airfoil types have also been studied on the basis of the general method and their relations to arbitrary airfoils have been analyzed. The solution of the inverse problem of creating airfoils of special types, in particular, types of specified aerodynamical properties, is indicated.

It is hoped that this paper will serve as a step toward the unification and ultimate simplification of the theory of the airfoil.

#### TRANSFORMATION OF AN ARBITRARY AIRFOIL INTO A CIRCLE

**Statement of the problem.**—The problem which this report proposes to treat may be formulated as follows. Given an arbitrary airfoil<sup>4</sup> inclined at a specified angle in a nonviscous incompressible fluid and translated with uniform velocity  $V$ . To determine the theoretical 2-dimensional velocity and pressure distribution at all points of the surface for all orientations, and to investigate the properties of the field of flow surrounding the airfoil. Also, to determine the important aerodynamical parameters of the airfoil. Of further interest, too, is the problem of finding shapes with given aerodynamical properties.

**Principles of the theory of fluid flow.**—We shall first briefly recall the known basic principles of the theory of the irrotational flow of a frictionless incompressible fluid in two dimensions. A flow is termed "2-dimensional" when the motion is the same in all planes parallel to a definite one, say  $xy$ . In this case the linear velocity components  $u$  and  $v$  of a fluid element are functions of  $x$ ,  $y$ , and  $t$  only.

The differential equation of the lines of flow in this case is

$$v \, dx - u \, dy = 0$$

<sup>4</sup> By an airfoil shape, or wing section, is roughly meant an elongated smooth shape rounded at the leading edge and ending in a sharp edge at the rear. All practical airfoils are characterized by a lack of abrupt change of curvature except for a rounded nose and a small radius of curvature at the tail.

and the equation of continuity is

$$\frac{\partial u}{\partial x} + \frac{\partial v}{\partial y} = 0 \text{ or } \frac{\partial u}{\partial x} = \frac{\partial(-v)}{\partial y}$$

which shows that the above first equation is an exact differential.

If  $Q=c$  is the integral, then

$$u = \frac{\partial Q}{\partial y} \text{ and } v = -\frac{\partial Q}{\partial x}$$

This function  $Q$  is called the stream function, and the lines of flow, or streamlines, are given by the equation  $Q=c$ , where  $c$  is in general an arbitrary function of time.

Furthermore, we note that the existence of the stream function does not depend on whether the motion is irrotational or rotational. When rotational its vorticity is

$$\zeta = \frac{\partial v}{\partial x} - \frac{\partial u}{\partial y} = \frac{\partial^2 Q}{\partial x^2} + \frac{\partial^2 Q}{\partial y^2}$$

which is twice the mean angular velocity or "rotation" of the fluid element. Hence, in irrotational flow the stream function has to satisfy

$$\frac{\partial^2 Q}{\partial x^2} + \frac{\partial^2 Q}{\partial y^2} = 0 \quad (2')$$

Then there exists a velocity potential  $P$  and we have

$$\left. \begin{aligned} \frac{\partial P}{\partial x} &= u = \frac{\partial Q}{\partial y} \\ \frac{\partial P}{\partial y} &= v = -\frac{\partial Q}{\partial x} \end{aligned} \right\} \quad (1)$$

The equation of continuity is now

$$\frac{\partial^2 P}{\partial x^2} + \frac{\partial^2 P}{\partial y^2} = 0 \quad (2)$$

Equations (1) show that

$$\frac{\partial P}{\partial x} \frac{\partial Q}{\partial x} + \frac{\partial P}{\partial y} \frac{\partial Q}{\partial y} = 0$$

so that the family of curves

$$P = \text{constant}, \quad Q = \text{constant}$$

cut orthogonally at all their points of intersection.

For steady flows, that is, flows that do not vary with time, the paths of the particles coincide with the streamlines so that no fluid passes normal to them. The Bernoulli formula then holds and the total pressure head  $H$  along a streamline is a constant, that is

$$\frac{1}{2} \rho v^2 + p' = H$$

where  $p'$  is the static pressure,  $v$  the velocity, and  $\rho$  the density. If we denote the undisturbed velocity at infinity by  $V$ , the quantities  $p' - p'_\infty$  by  $p$ , and  $\frac{1}{2} \rho V^2$  by  $q$ , the Bernoulli formula may be expressed as

$$\frac{p}{q} = 1 - \left( \frac{v}{V} \right)^2 \quad (3)$$



The solutions of equations (2) and (2'), infinite in number, represent all possible types of irrotational motion of a nonviscous incompressible fluid in two dimensions. For a given problem there are usually certain specified boundary conditions to be satisfied which may be sufficient to fix a unique solution or a family of solutions. The problem of an airfoil moving uniformly at a fixed angle of incidence in a fluid field is identical with that of an airfoil fixed in position and fluid streaming uniformly past it. Our problem is then to determine the functions  $P$  and  $Q$  so that the velocity at each point of the airfoil profile has a direction tangential to the surface (that is, the airfoil contour is itself a streamline) and so that at infinite distance from the airfoil the fluid has a constant velocity and direction.

The introduction of the complex variable,  $z = x + iy$ , simplifies the problem of determining  $P$  and  $Q$ . Any analytic function  $w(z)$  of a complex variable  $z$ , that is, a function of  $z$  possessing a unique derivative in a

each real functions of  $x$  and  $y$ . Suppose now in the  $xy$  complex plane there is traced a simple curve  $f(z)$ . (Fig. 1.) Each value of  $z$  along the curve defines a point  $w$  in the  $w$  plane and  $f(z)$  maps into a curve  $f(w)$  or  $F(z)$ . Because of the special properties of analytic functions of a complex variable, there exist certain special relations between  $f(z)$  and  $F(z)$ .

The outstanding property of functions of a complex variable analytic in a region is the existence of a unique derivative at every point of the region.

$$\frac{dw}{dz} = \lim_{z \rightarrow z'} \frac{w - w'}{z - z'} = \rho e^{i\gamma}$$

or

$$dw = \rho e^{i\gamma} dz$$

This relation expresses the fact that any small curve  $zz'$  through the point  $z$  is transformed into a small curve  $ww'$  through the point  $w$  by a magnification  $\rho$  and a rotation  $\gamma$ ; i. e., in Figure 1 the tangent  $t$  will coincide in direction with  $T$  by a rotation  $\gamma = \beta - \alpha$ .

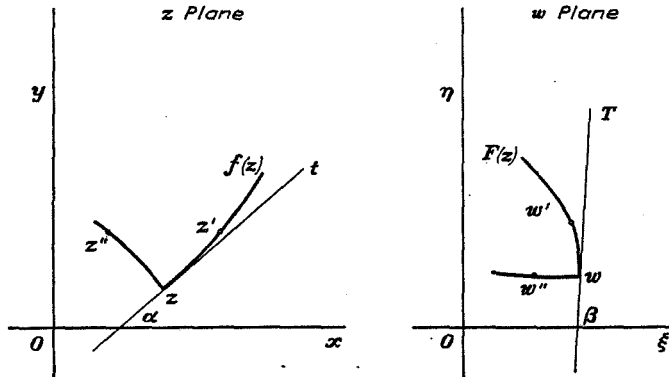

FIGURE 1.—Conformal property of analytic functions

region of the complex plane, may be separated into its real and imaginary parts as  $w(z) \equiv w(x + iy) = P(x, y) + iQ(x, y)$ , determining functions  $P$  and  $Q$  which may represent the velocity potential and stream function of a possible fluid motion. Thus, analytic functions of a complex variable possess the special property that the component functions  $P$  and  $Q$  satisfy the Cauchy-Riemann equations (eq. (1)), and each therefore also satisfies the equation of Laplace (eq. (2)). Conversely, any function  $P(x, y) + iQ(x, y)$  for which  $P$  and  $Q$  satisfy relations (1) and (2) may be written as  $w(x + iy) \equiv w(z)$ . The essential difficulty of the problem is to find the particular function  $w(z)$  which satisfies the special boundary-flow conditions mentioned above for a specified airfoil.

The method of conformal representation, a geometric application of the complex variable, is well adapted to this problem. The fundamental properties of transformations of this type may be stated as follows: Consider a function of a complex variable  $z = x + iy$ , say  $w(z)$  analytic in a given region, such that for each value of  $z$ ,  $w(z)$  is uniquely defined. The function  $w(z)$  may be expressed as  $w = \xi + i\eta$  where  $\xi$  and  $\eta$  are

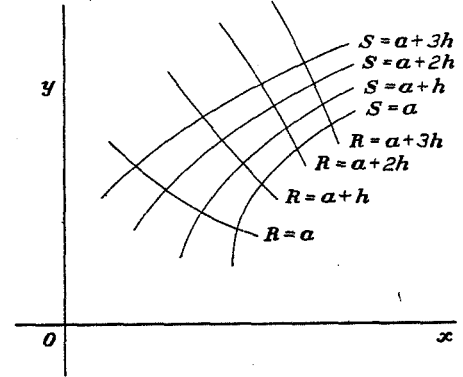

FIGURE 2.—Orthogonal network obtained by a conformal transformation

This is also true for any other pair of corresponding curves through  $z$  and  $w$ , so that in general, angles between corresponding curves are preserved. In particular, a curve  $zz''$  orthogonal to  $zz'$  transforms into a curve  $ww''$  orthogonal to  $ww'$ .

It has been seen that an analytic function  $f(z)$  may be written  $P(x, y) + iQ(x, y)$  where the curves  $P = \text{constant}$  and  $Q = \text{constant}$  form an orthogonal system. If then  $f(z)$  is transformed conformally into  $f(w) = P(\xi, \eta) + iQ(\xi, \eta)$  that is into  $f[w(z)] \equiv F(z) = R(x, y) + iS(x, y)$ , the curves  $P(x, y) = \text{constant}$ ,  $Q(x, y) = \text{constant}$  map into the orthogonal network of curves  $R(x, y) = \text{constant}$ ,  $S(x, y) = \text{constant}$ . (Fig. 2.) If the magnification  $|\frac{dw}{dz}| = \rho$  is zero at a point  $w$ , the transformation at that point is singular and ceases to be conformal.

We may use the method of conformal transformations to find the motion about a complicated boundary from that of a simpler boundary. Suppose  $w(z)$  is a function which corresponds to any definite fluid motion in the  $z$  plane, for instance, to that around a circle. Now if a new variable  $\zeta$  is introduced and  $z$  set equal

to any analytic function of  $\zeta$ , say  $z=f(\zeta)$ , then  $w(z)$  becomes  $w[f(\zeta)]$  or  $W(\zeta)$  representing a new motion in the  $\zeta$  plane. This new motion is, as has been seen, related to that in the  $z$  plane in such a way that the streamlines of the  $z$  plane are transformed by  $z=f(\zeta)$  into the streamlines of the  $\zeta$  plane. Thus, the contour into which the circle is transformed represents the profile around which the motion  $W(\zeta)$  exists. The problem of determining the flow around an airfoil is now reduced to finding the proper conformal transformation which maps a curve for which the flow is known into the airfoil. The existence of such a function was first shown by Riemann.

We shall first formulate the theorem for a simply connected region<sup>5</sup> bounded by a closed curve, and then show how it is readily applied to the region external to the closed curve. The guiding thought leading to the theorem is simple. We have seen that an analytic function may transform a given closed region into another closed region. But suppose we are given two separate regions bounded by closed curves—does there exist an analytic transformation which transforms one region conformally into the other? This question is answered by Riemann's theorem as follows:

**Riemann's theorem.**—The interior  $T$  of any simply connected region (whose boundary contains more than one point, but we shall be concerned only with regions having closed boundaries, the boundary curve being composed of piecewise differentiable curves [Jordan curve], corners at which two tangents exist being permitted) can be mapped in a one-to-one conformal manner on the interior of the unit circle, and the analytic<sup>6</sup> function  $\zeta=f(z)$  which consummates this transformation becomes *unique* when a given interior point  $z_0$  of  $T$  and a direction through  $z_0$  are chosen to correspond, respectively, to the center of the circle and a given direction through it. By this transformation the boundary of  $T$  is transformed uniquely and continuously into the circumference of the unit circle.

The unit circle in this theorem is, of course, only a convenient normalized region. For suppose the regions  $T_1$  in the  $\zeta$  plane and  $T_2$  in the  $w$  plane are transformed into the unit circle in the  $z$  plane by  $\zeta=f(z)$  and  $w=F(z)$ , respectively, then  $T_1$  is transformed into  $T_2$  by  $\zeta=\Phi(w)$ , obtained by eliminating  $z$  from the two transformation equations.

In airfoil theory it is in the region external to a closed curve that we are interested. Such a region can be readily transformed conformally into the region internal to a closed curve by an inversion. Thus, let us suppose a point  $z_0$  to be within a closed curve  $B$  whose

external region is  $\Gamma$ , and then choose a constant  $k$  such that for every point  $z$  on the boundary of  $\Gamma$ ,  $|z-z_0|>k$ . Then the inversion transformation  $w=\frac{k}{z-z_0}$  will transform every point in the external region  $\Gamma$  into a point internal to a closed region  $\Gamma'$  lying entirely within  $B$ , the boundary  $B$  mapping into the boundary of  $\Gamma'$ , the region at infinity into the region near  $z_0$ . We may now restate Riemann's theorem as follows:

One and only one analytic function  $\zeta=f(z)$  exists by means of which the region  $\Gamma$  external to a given curve  $B$  in the  $\zeta$  plane is transformed conformally into the region external to a circle  $C$  in the  $z$  plane (center at  $z=0$ ) such that the point  $z=\infty$  goes into the point  $\zeta=\infty$  and also  $\frac{df(z)}{dz}=1$  at infinity. This function can be developed in the external region of  $C$  in a uniformly convergent series with complex coefficients of the form

$$\zeta-m=f(z)-m=z+\frac{c_1}{z}+\frac{c_2}{z^2}+\frac{c_3}{z^3}+\dots \quad (4)$$

by means of which the radius  $R$  and also the constant  $m$  are completely determined. Also, the boundary  $B$  of  $\Gamma$  is transformed continuously and uniquely into the circumference of  $C$ .

It should be noticed that the transformation (4) is a normalized form of a more general series

$$\zeta-m=a_0+a_{-1}z+\frac{a_1}{z}+\frac{a_2}{z^2}+\dots$$

and is obtained from it by a finite translation by the vector  $a_0$  and a rotation and expansion of the entire field depending on the coefficient  $a_{-1}$ . The condition  $a_{-1}=1$  is necessary and sufficient for the fields at infinity to coincide in magnitude and direction.

The constants  $c_i$  of the transformation are functions of the shape of the boundary curve alone and our problem is, really, to determine the complex coefficients defining a given shape. With this in view, we proceed first to a convenient intermediate transformation.

The transformation  $\zeta=z'+\frac{a^2}{z'}$ —This initial trans-

formation, although not essential to a purely mathematical solution, is nevertheless very useful and important, as will be seen. It represents also the key transformation leading to Joukowski airfoils, and is the basis of nearly all approximate theories.

Let us define the points in the  $\zeta$  plane by  $\zeta=x+iy$  using rectangular coordinates  $(x, y)$ , and the points in the  $z'$  plane by  $z'=ae^{\psi+i\theta}$  using polar coordinates  $(ae^{\psi}, \theta)$ . The constant  $a$  may conveniently be considered unity and is added to preserve dimensions. We have

$$\zeta=z'+\frac{a^2}{z'} \quad (5)$$

<sup>5</sup> A region of the complex plane is simply connected when any closed contour lying entirely within the region may be shrunk to a point without passing out of the region. Cf. reference 3, p. 367, where a proof of the theorem based on Green's function is given.

<sup>6</sup> Attention is here directed to the fact that an analytic function is developable at a point in a power series convergent in any circle about the point and entirely within the region.

and substituting  $z' = ae^{\psi+i\theta}$

we obtain  $\zeta = 2a \cosh(\psi + i\theta)$

or  $\zeta = 2a \cosh \psi \cos \theta + 2ia \sinh \psi \sin \theta$

Since  $\zeta = x + iy$ , the coordinates  $(x, y)$  are given by

$$\begin{cases} x = 2a \cosh \psi \cos \theta \\ y = 2a \sinh \psi \sin \theta \end{cases} \quad (6)$$

If  $\psi = 0$ , then  $z' = ae^{i\theta}$  and  $\zeta = 2a \cos \theta$ . That is, if  $P$  and  $P'$  are corresponding points in the  $\zeta$  and  $z'$  planes, respectively, then as  $P$  traverses the  $x$  axis from  $2a$  to  $-2a$ ,  $P'$  traverses the circle  $ae^{i\theta}$  from  $\theta = 0$  to  $\theta = \pi$ , and as  $P$  retraces its path to  $\zeta = 2a$ ,  $P'$  completes the circle. The transformation (5) then may be seen to map the entire  $\zeta$  plane external to the line  $4a$  uniquely into the region external (or internal) to the circle of radius  $a$  about the origin in the  $z'$  plane.

Let us invert equations (6) and solve for the elliptic coordinates  $\psi$  and  $\theta$ . (Fig. 3.) We have

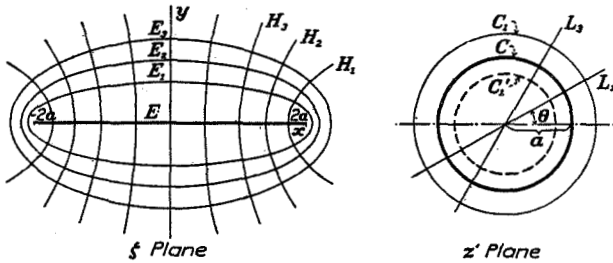

FIGURE 3.—Transformation by elliptic coordinates

$$\cosh \psi = \frac{x}{2a \cos \theta}$$

$$\sinh \psi = \frac{y}{2a \sin \theta}$$

and since  $\cosh^2 \psi - \sinh^2 \psi = 1$

$$\left(\frac{x}{2a \cos \theta}\right)^2 - \left(\frac{y}{2a \sin \theta}\right)^2 = 1$$

or solving for  $\sin^2 \theta$  (which can not become negative),

$$2 \sin^2 \theta = p + \sqrt{p^2 + \left(\frac{y}{a}\right)^2} \quad (7)$$

where

$$p = 1 - \left(\frac{x}{2a}\right)^2 - \left(\frac{y}{2a}\right)^2$$

Similarly we obtain

$$\left(\frac{x}{2a \cosh \psi}\right)^2 + \left(\frac{y}{2a \sinh \psi}\right)^2 = 1$$

or solving for  $\sinh^2 \psi$

$$2 \sinh^2 \psi = -p + \sqrt{p^2 + \left(\frac{y}{a}\right)^2} \quad (8)$$

We note that the system of radial lines  $\theta = \text{constant}$  become confocal hyperbolas in the  $\zeta$  plane. The circles  $\psi = \text{constant}$  become ellipses in the  $\zeta$  plane with major axis  $2a \cosh \psi$  and minor axis  $2a \sinh \psi$ . These orthogonal systems of curves represent the potential lines and streamlines in the two planes. The foci of these two confocal systems are located at  $(\pm 2a, 0)$ .

Equation (8) yields two values of  $\psi$  for a given point  $(x, y)$ , and one set of these values refers to the correspondence of  $(x, y)$  to the point  $(ae^\psi, \theta)$  external to a curve and the other set to the correspondence of  $(x, y)$  to the point  $(ae^{-\psi}, -\theta)$  internal to another curve. Thus, in Figure 3, for every point external to the ellipse  $E_1$  there is a corresponding point external to the circle  $C_1$ , and also one internal to  $C_1'$ .

The radius of curvature of the ellipse at the end of the major axis is  $\rho = 2a \frac{\sinh^2 \psi}{\cosh \psi}$  or for small values of  $\psi$ ,  $\rho \approx 2a\psi^2$ . The leading edge is at

$$2a \cosh \psi \approx 2a \left(1 + \frac{\psi^2}{2}\right) \approx 2a + \frac{\rho}{2}$$

Now if there is given an airfoil in the  $\zeta$  plane (fig. 4), and it is desired to transform the airfoil profile into a curve as nearly circular as possible in the  $z'$  plane by using only transformation (5), it is clear that the axes of coordinates should be chosen so that the airfoil appears as nearly elliptical as possible with respect to the chosen axes. It was seen that a focus of an elongated ellipse very nearly bisects the line joining the end of the major axis and the center of curvature of this point; thus, we arrive at a convenient choice of origin for the airfoil as the point bisecting the line of length  $4a$ , which extends from the point midway between the leading edge and the center of curvature of the leading edge to a point midway between the center of curvature of the trailing edge and the trailing edge. This latter point practically coincides with the trailing edge.

The curve  $B$ , defined by  $ae^{\psi+i\theta}$ , resulting in the  $z'$  plane, and the inverse and reflected curve  $B'$ , defined by  $ae^{-\psi-i\theta}$ , are shown superposed on the  $\zeta$  plane in Figure 4. The convenience and usefulness of trans-

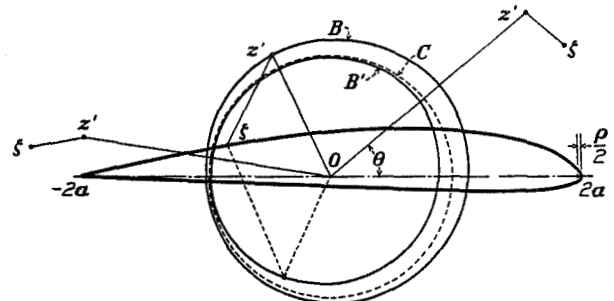

FIGURE 4.—Transformation of airfoil into a nearly circular contour

formation (5) and the choice of axes of coordinates will become evident after our next transformation.

The transformation  $z' = ze^{\sum_0^n \frac{c_n}{z^n}}$ .—Consider the transformation  $z' = ze^{f(z)}$  where  $f(z) = \sum_0^n \frac{c_n}{z^n}$ . Each exponential

term  $e^{\frac{c_n}{z^n}}$  represents the uniformly convergent series

$$1 + \frac{c_n}{z^n} + \frac{1}{2!} \left(\frac{c_n}{z^n}\right)^2 + \dots + \frac{1}{m!} \left(\frac{c_n}{z^n}\right)^m + \dots \quad (9)$$

where the coefficients  $c_n = A_n + iB_n$  are complex numbers. For  $f(z)$  convergent at all points in a region external to a certain circle,  $z'$  has a unique real absolute value  $|z|e^{|\psi_0|}$  in the region and its imaginary part is definitely defined except for integral multiples of  $2\pi i$ . When  $z = \infty$ ,  $z' = ze^{c_0}$ . The constant  $c_0 = A_0 + iB_0$  is then the determining factor at infinity, for the field at infinity is magnified by  $e^{A_0}$  and rotated by the angle  $B_0$ . It is thus clear that if it is desired that the regions at infinity be identical, that is,  $z' = z$  at infinity, the constant  $c_0$  must be zero. The constants  $c_1$  and  $c_2$  also play important rôles, as will be shown later.

We shall now transform the closed curved  $z' = ae^{\psi_0 + i\varphi}$  into the circle  $z = ae^{\psi_0 + i\varphi}$  (radius  $ae^{\psi_0}$ , origin at center) by means of the general transformation (reference 2)

$$z' = ze^{\sum_1^{\infty} \frac{c_n}{z^n}} \quad (10)$$

which leaves the fields at infinity unaltered, and we shall obtain expressions for the constants  $A_n$ ,  $B_n$ , and  $\psi_0$ . The justification of the solution will be assured by the actual convergence of  $\sum_1^{\infty} \frac{c_n}{z^n}$ , since if the solution exists it is unique.

By definition, for the correspondence of the boundary points, we have

$$z' = ze^{\psi_0 + i(\theta - \varphi)} \quad (10')$$

Also

$$z' = ze^{\sum_1^{\infty} (A_n + iB_n) \frac{1}{z^n}}$$

Consequently

$$\psi - \psi_0 + i(\theta - \varphi) = \sum_1^{\infty} (A_n + iB_n) \frac{1}{z^n}$$

where

$$z = ae^{\psi_0 + i\varphi}$$

On writing  $z = R(\cos \varphi + i \sin \varphi)$  where  $R = ae^{\psi_0}$ , we have

$$\psi - \psi_0 + i(\theta - \varphi) = \sum_1^{\infty} (A_n + iB_n) \frac{1}{R^n} (\cos n\varphi - i \sin n\varphi)$$

Equating the real and imaginary parts of this relation, we obtain the two conjugate Fourier expansions:

$$\psi - \psi_0 = \sum_1^{\infty} \left[ \frac{A_n}{R^n} \cos n\varphi + \frac{B_n}{R^n} \sin n\varphi \right] \quad (11)$$

$$\theta - \varphi = \sum_1^{\infty} \left[ \frac{B_n}{R^n} \cos n\varphi - \frac{A_n}{R^n} \sin n\varphi \right] \quad (12)$$

From equation (11), the values of the coefficients  $\frac{A_n}{R^n}$ ,  $\frac{B_n}{R^n}$ , and the constant  $\psi_0$  are obtained as follows:

$$\frac{A_n}{R^n} = \frac{1}{\pi} \int_0^{2\pi} \psi \cos n\varphi d\varphi \quad (a)$$

$$\frac{B_n}{R^n} = \frac{1}{\pi} \int_0^{2\pi} \psi \sin n\varphi d\varphi \quad (b)$$

<sup>7</sup> Unless otherwise stated,  $\psi$  and  $\theta$  will now be used in this restricted sense, i. e., as defining the boundary curve itself, and not all points in the  $z'$  plane.

$$\psi_0 = \frac{1}{2\pi} \int_0^{2\pi} \psi d\varphi \quad (c)$$

The evaluation of the infinite number of constants as represented by equations (a) and (b) can be made to depend upon an important single equation, which we shall obtain by eliminating these constants from equation (12).

Substitution of (a) and (b) for the coefficients of equation (12) gives

$$(\theta - \varphi)' = \frac{1}{\pi} \sum_1^{\infty} \left[ \cos n\varphi' \int_0^{2\pi} \psi(\varphi) \sin n\varphi d\varphi - \sin n\varphi' \int_0^{2\pi} \psi(\varphi) \cos n\varphi d\varphi \right]$$

where  $\psi(\varphi) = \psi$  and  $(\theta - \varphi)'$  represents  $\theta - \varphi$  as a function of  $\varphi'$ , and where  $\varphi'$  is used to distinguish the angle kept constant while the integrations are performed. The expression may be readily rewritten as

$$\begin{aligned} (\theta - \varphi)' &= \frac{1}{\pi} \sum_1^{\infty} \int_0^{2\pi} \psi(\varphi) (\sin n\varphi \cos n\varphi' - \cos n\varphi \sin n\varphi') d\varphi \\ &= \frac{1}{\pi} \sum_1^{\infty} \int_0^{2\pi} \psi(\varphi) \sin n(\varphi - \varphi') d\varphi \end{aligned}$$

But

$$\sum_1^{\infty} \sin n(\varphi - \varphi') = \frac{1}{2} \cot \frac{\varphi - \varphi'}{2} - \frac{\cos(2n+1) \frac{(\varphi - \varphi')}{2}}{2 \sin \frac{\varphi - \varphi'}{2}}$$

Then

$$\begin{aligned} (\theta - \varphi)' &= \lim_{n \rightarrow \infty} \left\{ \frac{1}{2\pi} \int_0^{2\pi} \psi(\varphi) \cot \frac{\varphi - \varphi'}{2} d\varphi \right. \\ &\quad \left. - \frac{1}{2\pi} \int_0^{2\pi} \psi(\varphi) \frac{\cos(2n+1) \frac{(\varphi - \varphi')}{2}}{\sin \frac{\varphi - \varphi'}{2}} d\varphi \right\} \end{aligned}$$

The first integral is independent of  $n$ , while the latter one becomes identically zero.

Then finally, representing  $\varphi - \theta$  by a single quantity  $\epsilon$ , viz  $\varphi - \theta = \epsilon = \epsilon(\varphi)$ , we have

$$\epsilon(\varphi') = -\frac{1}{2\pi} \int_0^{2\pi} \psi(\varphi) \cot \frac{\varphi - \varphi'}{2} d\varphi \quad (13)$$

By solving for the coefficients in equation (12) and substituting these in equation (11) it may be seen that a similar relation to equation (13) holds for the function  $\psi(\varphi)$ .

$$\psi(\varphi') = \frac{1}{2\pi} \int_0^{2\pi} \epsilon(\varphi) \cot \frac{\varphi - \varphi'}{2} d\varphi + \frac{1}{2\pi} \int_0^{2\pi} \psi(\varphi) d\varphi \quad (14)$$

The last term is merely the constant  $\psi_0$ , which is, as has been shown, determined by the condition of mag-

nification of the  $z$  and  $z'$  fields at infinity. The corresponding integral  $\frac{1}{2\pi} \int_0^{2\pi} \epsilon(\varphi) d\varphi$  does not appear in equation (13), being zero as a necessary consequence of the coincidence of directions at infinity and, in general, if the region at infinity is rotated, is a constant different from zero.

**Investigation of equation (13).**—This equation is of fundamental importance. A discussion of some of its properties is therefore of interest. It should be first noted that when the function  $\psi(\varphi)$  is considered known, the equation reduces to a definite integral. The function  $\epsilon(\varphi)$  obtained by this evaluation is the "conjugate" function to  $\psi(\varphi)$ , so called because of the relations existing between the coefficients of the Fourier expansions as given by equations (11) and (12). For the existence of the integral it is only necessary that  $\psi(\varphi)$  be piecewise continuous and differentiable, and may even have infinities which must be below first order. We shall, however, be interested only in continuous single-valued functions having a period  $2\pi$ , of a type which result from continuous closed curves with a proper choice of origin.

If equation (13) is regarded as a definite integral, it is seen to be related to the well-known Poisson integral which solves the following boundary-value problem of the circle. (Reference 3.) Given, say for the  $z$  plane a single-valued function  $u(R, \tau)$  for points on the circumference of a circle  $w = Re^{i\tau}$  (center at origin), then the single-valued continuous potential function  $u(r, \sigma)$  in the external region  $z = re^{i\sigma}$  of the circle which assumes the values  $u(R, \tau)$  on the circumference is given by

$$u(r, \sigma) = \frac{1}{2\pi} \int_0^{2\pi} u(R, \tau) \frac{r^2 - R^2}{R^2 + r^2 - 2Rr \cos(\sigma - \tau)} d\tau$$

and similarly for the conjugate function  $v(r, \sigma)$

$$v(r, \sigma) = \frac{1}{2\pi} \int_0^{2\pi} v(R, \tau) \frac{r^2 - R^2}{R^2 + r^2 - 2Rr \cos(\sigma - \tau)} d\tau$$

These may be written as a single equation

$$u(r, \sigma) + iv(r, \sigma) = f(z) = \frac{1}{2\pi} \int_C f(w) \frac{z+w}{z-w} dw$$

where the value  $f(z)$  at a point of the external region  $z = re^{i\sigma}$  is expressed in terms of the known values  $f(w)$  along the circumference  $w = Re^{i\tau}$ . In particular, we may note that at the boundary itself, since  $i \frac{e^{i\sigma} + e^{i\tau}}{e^{i\sigma} - e^{i\tau}} = \cot \frac{(\sigma - \tau)}{2}$ , we have

$$u(R, \sigma) + iv(R, \sigma) = -\frac{i}{2\pi} \int_0^{2\pi} [u(R, \tau) + iv(R, \tau)] \cot \frac{(\sigma - \tau)}{2} d\tau,$$

which is a special form of equations (13) and (14).

The quantity  $\psi$  is immediately given as a function of  $\theta$  when a particular closed curve is preassigned, and this is our starting point in the direct process of transforming from airfoil to circle. We desire, then, to find the quantity  $\psi$  as a function of  $\varphi$  from equation (13), and this equation is no longer a definite integral but an

\* This function will be called "conformal angular distortion" function, for reasons evident later.

integral equation whose process of solution becomes more intricate. It would be surprising, indeed, if anything less than a functional or integral equation were involved in the solution of the general problem stated. The evaluation of the solution of equation (13) is readily accomplished by a powerful method of successive approximations. It will be seen that the nearness of the curve  $ae^{i\psi}$  to a circle is very significant, and in practice, for airfoil shapes, one or at most two steps in the process is found to be sufficient for great accuracy.

The quantities  $\psi$  and  $\epsilon$  considered as functions of  $\varphi$  have been denoted by  $\psi(\varphi)$  and  $\epsilon(\varphi)$ , respectively. When these quantities are thought of as functions of  $\theta$  they shall be written as  $\bar{\psi}(\theta)$  and  $\bar{\epsilon}(\theta)$ , respectively.

Then, by definition

$$\text{and} \quad \begin{aligned} \bar{\psi}(\theta) &\equiv \psi[\varphi(\theta)] \\ \bar{\epsilon}(\theta) &\equiv \epsilon[\varphi(\theta)] \end{aligned} \quad (15)$$

Since  $\varphi - \theta = \epsilon$ , we have

$$\left. \begin{aligned} \theta(\varphi) &= \varphi - \epsilon(\varphi) \\ \varphi(\theta) &= \theta + \bar{\epsilon}(\theta) \end{aligned} \right\} \quad (16)$$

We are seeking then two functions,  $\psi(\varphi)$  and  $\epsilon(\varphi)$ , conjugate in the sense that their Fourier series expansions are given by (11) and (12), such that  $\psi[\varphi(\theta)] = \bar{\psi}(\theta)$  where  $\bar{\psi}(\theta)$  is a known single-valued function of period  $2\pi$ .

Integrating equation (13) by parts, we have

$$\epsilon(\varphi') = \frac{1}{\pi} \int_0^{2\pi} \log \sin \frac{\varphi - \varphi'}{2} \frac{d\psi(\varphi)}{d\varphi} d\varphi \quad (13')$$

The term  $\log \sin \frac{\varphi - \varphi'}{2}$  is real only in the range  $\varphi = \varphi'$  to  $\varphi = 2\pi + \varphi'$ , but we may use the interval 0 to  $2\pi$  for  $\varphi$  with the understanding that only the real part of the logarithm is retained.

Let us write down the following identity:

$$\begin{aligned} \log \sin \frac{\varphi - \varphi'}{2} &\equiv \log \sin \frac{\theta - \theta'}{2} \\ &+ \log \frac{\sin \frac{(\theta + \bar{\epsilon}_1) - (\theta + \bar{\epsilon}_1)'}{2}}{\sin \frac{\theta - \theta'}{2}} + \log \frac{\sin \frac{(\theta + \bar{\epsilon}_2) - (\theta + \bar{\epsilon}_2)'}{2}}{\sin \frac{(\theta + \bar{\epsilon}_1) - (\theta + \bar{\epsilon}_1)'}{2}} \\ &+ \dots + \log \frac{\sin \frac{(\theta + \bar{\epsilon}_k) - (\theta + \bar{\epsilon}_k)'}{2}}{\sin \frac{(\theta + \bar{\epsilon}_{k-1}) - (\theta + \bar{\epsilon}_{k-1})'}{2}} + \dots \\ &+ \log \frac{\sin \frac{(\theta + \bar{\epsilon}_n) - (\theta + \bar{\epsilon}_n)'}{2}}{\sin \frac{(\theta + \bar{\epsilon}_{n-1}) - (\theta + \bar{\epsilon}_{n-1})'}{2}} + \log \frac{\sin \frac{(\theta + \bar{\epsilon}) - (\theta + \bar{\epsilon})'}{2}}{\sin \frac{(\theta + \bar{\epsilon}_n) - (\theta + \bar{\epsilon}_n)'}{2}} \end{aligned} \quad (17)$$

where in the last term we recall that  $\theta + \bar{\epsilon}(\theta) = \varphi(\theta)$ ; and where it may be noted that each denominator is the

numerator of the preceding term. The symbols  $\bar{\epsilon}_k$  ( $k=1, 2, \dots, n$ ) represent functions of  $\theta$ , which thus far are arbitrary.<sup>9</sup>

Since by equation (15)  $\bar{\psi}(\theta) \equiv \psi[\varphi(\theta)]$  we have for corresponding elements  $d\theta$  and  $d\varphi$

$$\frac{d\psi(\varphi)}{d\varphi} d\varphi = \frac{d\bar{\psi}(\theta)}{d\theta} d\theta$$

Then multiplying the left side of equation (17) by  $\frac{1}{\pi} \frac{d\psi(\varphi)}{d\varphi} d\varphi$  and the right side by  $\frac{1}{\pi} \frac{d\bar{\psi}(\theta)}{d\theta} d\theta$  and integrating over the period 0 to  $2\pi$  we obtain

$$\begin{aligned} \bar{\epsilon}[\varphi(\theta')] &\equiv \bar{\epsilon}(\theta') = \frac{1}{\pi} \int_0^{2\pi} \log \sin \frac{\theta - \theta'}{2} \frac{d\bar{\psi}(\theta)}{d\theta} d\theta + \dots \\ &+ \frac{1}{\pi} \int_0^{2\pi} \log \frac{\sin \frac{(\theta + \bar{\epsilon}_k) - (\theta + \bar{\epsilon}_k)'}{2}}{\sin \frac{(\theta + \bar{\epsilon}_{k-1}) - (\theta + \bar{\epsilon}_{k-1})'}{2}} \frac{d\bar{\psi}(\theta)}{d\theta} d\theta + \dots \\ &+ \frac{1}{\pi} \int_0^{2\pi} \log \frac{\sin \frac{(\theta + \bar{\epsilon}(\theta)) - (\theta + \bar{\epsilon}(\theta))'}{2}}{\sin \frac{(\theta + \bar{\epsilon}_n) - (\theta + \bar{\epsilon}_n)'}{2}} \frac{d\bar{\psi}(\theta)}{d\theta} d\theta \quad (18) \end{aligned}$$

where  $k=1, 2, \dots, n$ .

We now choose the arbitrary functions  $\bar{\epsilon}_k(\theta')$  so that

$$\bar{\epsilon}_0(\theta') = 0$$

and

$$\epsilon_k(\theta') = \frac{1}{\pi} \int_0^{2\pi} \log \sin \frac{(\theta + \bar{\epsilon}_{k-1}) - (\theta + \bar{\epsilon}_{k-1})'}{2} \frac{d\bar{\psi}(\theta)}{d\theta} d\theta \quad (19)$$

where  $k=1, 2, \dots, n$ .

Equation (18) may then be written

$$\bar{\epsilon}(\theta') = \bar{\epsilon}_0 + \bar{\epsilon}_1 + (\bar{\epsilon}_2 - \bar{\epsilon}_1) \dots + (\bar{\epsilon}_n - \bar{\epsilon}_{n-1}) + (\bar{\epsilon} - \bar{\epsilon}_n) \quad (20)$$

or  $\bar{\epsilon}(\theta') = \lambda_1 + \lambda_2 + \dots + \lambda_n + \lambda$

where  $\lambda_k(\theta') = \bar{\epsilon}_k - \bar{\epsilon}_{k-1}$  and is in fact the  $k^{\text{th}}$  term of equation (18). The last term we denote by  $\lambda$ .

From equation (19) we see that the function  $\bar{\epsilon}_k(\theta')$  is obtained by a knowledge of the preceding function  $\bar{\epsilon}_{k-1}(\theta')$ . For convenience in the evaluation of these functions, say

$$\bar{\epsilon}_{k+1}(\theta') = \frac{1}{\pi} \int_0^{2\pi} \log \sin \frac{(\theta + \bar{\epsilon}_k) - (\theta + \bar{\epsilon}_k)'}{2} \frac{d\bar{\psi}(\theta)}{d\theta} d\theta$$

we introduce a new variable  $\varphi_k$  defined by

$$\varphi_k(\theta) = \theta + \bar{\epsilon}_k(\theta) \quad (k=1, 2, \dots, n)$$

Then

$$\begin{aligned} \bar{\epsilon}_{k+1}[\theta(\varphi'_{k+1})] &\equiv \epsilon^*_{k+1}(\varphi'_k) \\ &= \frac{1}{\pi} \int_0^{2\pi} \log \sin \frac{(\varphi_k - \varphi'_k)}{2} \frac{d\bar{\psi}[\theta(\varphi_k)]}{d\varphi_k} d\varphi_k \quad (21) \end{aligned}$$

From the definition of  $\varphi_k$  as

$$\varphi_k(\theta) = \theta + \bar{\epsilon}_k(\theta)$$

we may also define the symbol  $\epsilon_k(\varphi_k)$  by

$$\theta(\varphi_k) = \varphi_k - \epsilon_k(\varphi_k)$$

where

$$\bar{\epsilon}_k(\theta) \equiv \epsilon_k[\varphi_k(\theta)]$$

It is important to note that the symbols  $\bar{\epsilon}_k$ ,  $\epsilon_k$ ,  $\epsilon_k^*$  denote the same quantity considered, however, as a function of  $\theta$ ,  $\varphi_k$ ,  $\varphi_{k-1}$ , respectively.

The quantities  $(\bar{\epsilon}_k - \bar{\epsilon}_{k-1})$  in equation (20) rapidly approach zero for wide classes of initial curves  $\bar{\psi}(\theta)$ , i. e.,  $\bar{\psi}[\theta(\varphi_k)]$  very nearly equals  $\bar{\psi}[\theta(\varphi_{k+1})]$  for even small  $k$ 's. The process of solution of our problem is then one of obtaining successively the functions  $\bar{\psi}(\theta)$ ,  $\bar{\psi}[\theta(\varphi_1)]$ ,  $\bar{\psi}[\theta(\varphi_2)]$ ,  $\dots$ ,  $\bar{\psi}[\theta(\varphi_n)]$  where  $\bar{\psi}[\theta(\varphi_n)]$  and  $\bar{\epsilon}_n[\varphi_n]$  become more and more "conjugate." The process of obtaining the successive conjugates in practice is explained in a later paragraph. We first pause to state the conditions which the functions  $\varphi_k$  are subject to, necessary for a one-to-one correspondence of the boundary points, and for a one-to-one correspondence of points of the external regions, i. e., the conditions which are necessary in order that the transformations be conformal.

In order that the correspondence between boundary points of the circle in the  $z$  plane and boundary points of the contour in the  $z'$  plane be one-to-one, it is necessary that  $\theta(\varphi)$  be a monotonic increasing function of its argument. This statement requires a word of explanation. We consider only values of the angles between 0 and  $2\pi$ . For a point of the circle boundary, that is, for one value of  $\varphi$  there can be only one value of  $\theta$ , i. e.,  $\theta(\varphi)$  is always single valued. However,  $\varphi(\theta)$ , in general, does not need to be, as for example, by a poor choice of origin it may be many valued, a radius vector from the origin intersecting the boundary more than once; but since we have already postulated that  $\psi(\theta)$  is single valued this case can not occur, and  $\varphi(\theta)$  is also single valued. If we decide on a definite direction of rotation, then the inequality  $\frac{d\theta}{d\varphi} \geq 0$  expresses the statement that as the radius vector from the origin sweeps over the boundary of the circle  $C$ , the radius vector in the  $z'$  plane sweeps over the boundary of  $B$  and never retraces its path.

The inequality

$$\frac{d\theta}{d\varphi} = 1 - \frac{d\epsilon(\varphi)}{d\varphi} \geq 0$$

corresponds to

$$\frac{d\epsilon(\varphi)}{d\varphi} \leq 1$$

Also, the condition

$$\frac{d\varphi}{d\theta} = 1 + \frac{d\bar{\epsilon}(\theta)}{d\theta} \geq 0$$

corresponds to

$$\frac{d\bar{\epsilon}(\theta)}{d\theta} \geq -1$$

<sup>9</sup> The symbol  $(\theta + \bar{\epsilon}_k)'$  represents  $\theta' + \bar{\epsilon}_k(\theta')$  and is used to denote the same function of  $\theta'$  that  $\theta + \bar{\epsilon}_k(\theta)$  is of  $\theta$ . The variables  $\theta$  and  $\theta'$  are regarded as independent of each other.

Multiplying  $\frac{d\theta}{d\varphi}$  by  $\frac{d\varphi}{d\theta}$  we get

$$\left(1 - \frac{d\epsilon(\varphi)}{d\varphi}\right) \left(1 + \frac{d\bar{\epsilon}(\theta)}{d\theta}\right) = 1$$

This relation is shown in Figure 5 as a rectangular

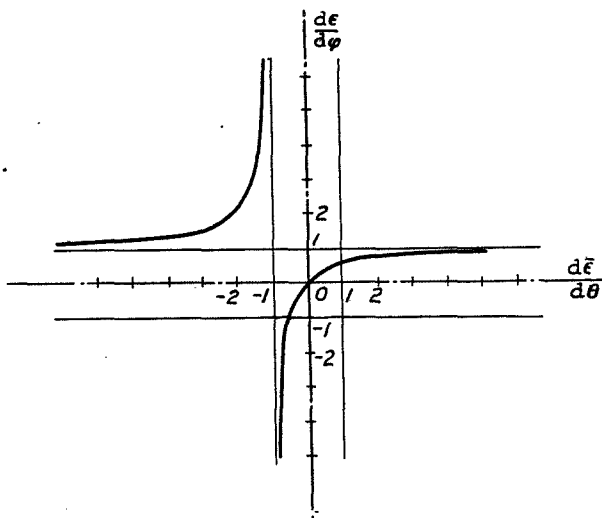

FIGURE 5.—The quantity  $\frac{d\epsilon}{d\psi}$  as a function of  $\frac{d\bar{\epsilon}}{d\theta}$

hyperbola. We may notice then that the monotonic behavior of  $\varphi(\theta)$  and  $\theta(\varphi)$  requires that  $\frac{d\epsilon}{d\varphi}$  remain on the lower branch<sup>10</sup> of the hyperbola, i. e.,

$$-\infty \leq \frac{d\epsilon}{d\varphi} \leq 1 \quad (22)$$

It will be seen later that the limiting values

$$\frac{d\epsilon(\varphi)}{d\varphi} = 1, \frac{d\epsilon(\varphi)}{d\varphi} = -\infty \quad (\text{i. e., } \frac{d\bar{\epsilon}}{d\theta} = \infty, \frac{d\bar{\epsilon}}{d\theta} = -1)$$

correspond to points of infinite velocity and of zero velocity, respectively, arising from sharp corners in the original curve.

The condition for a one-to-one conformal correspondence between points of the external region of the circle and of the external region of the contour in the  $z'$  plane may be given (reference 5, p. 98 and reference 6, Part II) as follows: There must be a one-to-one boundary point correspondence and the derivative of

the analytic function  $z' = ze^{\sum_{n=1}^{\infty} \frac{c_n}{z^n}}$  given by equation (10) must not vanish in the region. That is, writing  $g(z)$

for  $\sum_{n=1}^{\infty} \frac{c_n}{z^n}$  we have

$$\frac{dz'}{dz} = e^{g(z)} \left(1 + z \frac{dg(z)}{dz}\right) \neq 0 \text{ for } |z| > R \text{ or since}$$

the integral transcendental function  $e^{g(z)}$  does not vanish in the entire plane, the condition is equivalent to

$$z \frac{dg(z)}{dz} \neq -1 \text{ for } |z| > R$$

<sup>10</sup> The values of the upper branch of the hyperbola arise when the region internal to the curve  $ae^{\psi+i\theta}$  is transformed into the external region of a circle, but may also there be avoided by defining  $\epsilon = \varphi + \theta$  instead of  $\varphi - \theta$ .

By equation (10') we have on the boundary of the circle,  $g(Re^{i\varphi}) = \psi - \psi_0 - i\epsilon$ , and

$$\begin{aligned} z \frac{dg(z)}{dz} &= Re^{i\varphi} \frac{d[\psi(\varphi) - i\epsilon(\varphi)]}{iRe^{i\varphi} d\varphi} \\ &= -\frac{d\epsilon(\varphi)}{d\varphi} - i \frac{d\psi(\varphi)}{d\varphi} \end{aligned}$$

the first term on the right-hand side being real and the last term a pure imaginary. We have already postulated the condition

$$-\infty \leq \frac{d\epsilon}{d\varphi} \leq 1$$

as necessary for a one-to-one boundary point correspondence. Now by writing  $z = \xi + i\eta$  and  $z \frac{g(z)d}{dz} =$

$P(\xi, \eta) + iQ(\xi, \eta)$ , we note that  $\frac{d\epsilon(\varphi)}{d\varphi}$  gives the boundary values of a harmonic function  $P(\xi, \eta)$  and therefore this function assumes its maximum and minimum values on the boundary of the circle itself. (Reference 3, p.

223.) Hence  $z \frac{dg(z)}{dz}$  can never become  $-1$  in the external region, i. e.,  $\frac{dz'}{dz}$  can never vanish in this region.

At each step in the process of obtaining the successive conjugates we desire to maintain a one-to-one correspondence between  $\theta$  and  $\varphi_k$ , i. e., the functions  $\theta(\varphi_k)$  and  $\varphi_k(\theta)$  should be monotonic increasing and are hence subject to a restriction similar to equation (22), viz,

$$-\infty \leq \frac{d\epsilon_k}{d\varphi_k} \leq 1 \quad (22')$$

The process may be summed up as follows: We consider the function  $\bar{\psi}(\theta)$  as known, where  $\psi(\theta)$  is the functional relation between  $\psi$  and  $\theta$  defining a closed curve  $ae^{\psi+i\theta}$ . The conjugate of  $\bar{\psi}(\theta)$  with respect to  $\theta$  is  $\bar{\epsilon}_1(\theta)$ . We form the variable  $\varphi_1 = \theta + \bar{\epsilon}_1(\theta)$  and also the function  $\bar{\psi}[\theta(\varphi_1)]$ . The conjugate of  $\bar{\psi}[\theta(\varphi_1)]$  with respect to  $\varphi_1$  is  $\bar{\epsilon}_2^*(\varphi_1)$  which expressed as a function of  $\theta$  is  $\bar{\epsilon}_2(\theta)$ . We form the variable  $\varphi_2 = \theta + \bar{\epsilon}_2(\theta)$  and the function  $\bar{\psi}[\theta(\varphi_2)]$ . The conjugate of  $\bar{\psi}[\theta(\varphi_2)]$  is  $\bar{\epsilon}_3^*(\varphi_2)$ , which as a function of  $\theta$  is  $\bar{\epsilon}_3(\theta)$ , etc. The graphical criterion for convergence is, of course, reached when the function  $\bar{\psi}[\theta(\varphi_n)]$  is no longer altered by the process. The following figures illustrate the method and exhibit vividly the rapidity of convergence. The numerical calculations of the various conjugates are obtained from formula I of the appendix.

In Figure 6, the  $\bar{\psi}(\theta)$  curve represents a circle referred to an origin which bisects a radius (obtained from an extremely thick Joukowski airfoil) (see p. 26) and has numerical values approximately five times greater than occur for common airfoils. The  $\psi(\varphi)$  curve is known independently and is represented by the dashed curve. The process of going from  $\bar{\psi}(\theta)$  to  $\psi(\varphi)$  assuming  $\psi(\varphi)$  as unknown is as follows: The function  $\bar{\epsilon}_1(\theta)$ , the conjugate function of  $\bar{\psi}(\theta)$ , is found.

The quantity  $\psi$  is then plotted against the new variable  $\varphi_1 = \theta + \bar{\epsilon}_1(\theta)$  (i. e., each point of  $\bar{\psi}(\theta)$  is displaced horizontally a distance  $\bar{\epsilon}_1$ ) and yields the curve  $\bar{\psi}[\theta(\varphi_1)]$ . (Likewise,  $\bar{\epsilon}_1(\theta)$  is plotted against  $\varphi_1$  yielding  $\epsilon_1(\varphi_1)$ .)

is drawn at  $P'$ . This process yields the function  $\bar{\epsilon}_2(\theta)$ . The quantity  $\psi$  is now plotted against the new variable  $\varphi_2 = \theta + \bar{\epsilon}_2(\theta)$  (i. e., each point of  $\bar{\psi}(\theta)$  is displaced horizontally a distance  $\bar{\epsilon}_2$ ) giving the function  $\bar{\psi}[\theta(\varphi_2)]$ .

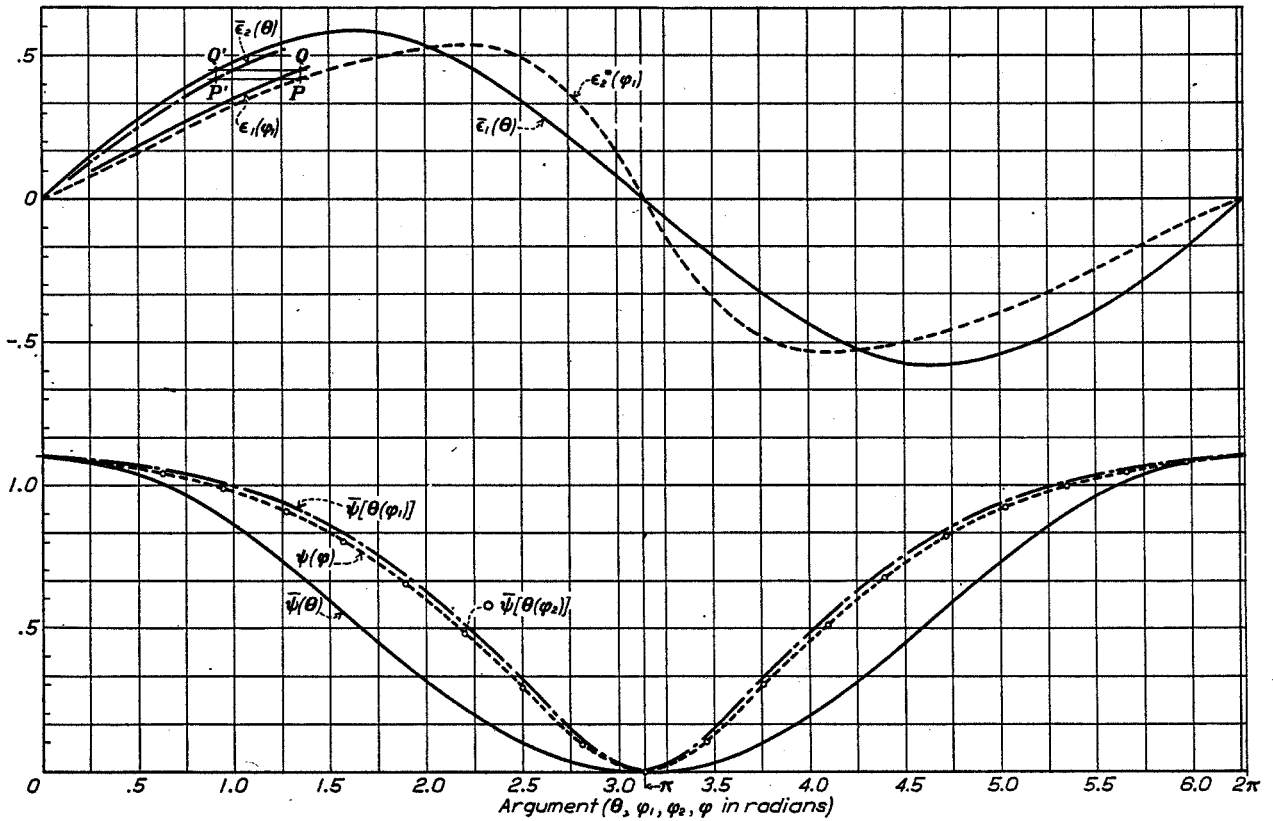

FIGURE 6.—The process of obtaining successive conjugates

The function  $\epsilon_2^*(\varphi_1)$  is now determined as the conjugate function of  $\bar{\psi}[\theta(\varphi_1)]$ . This function expressed as a function of  $\theta$  is  $\epsilon_2^*[\theta(\varphi_1)] \equiv \bar{\epsilon}_2(\theta)$ . It is plotted as follows:

This curve is shown with small circles and coincides with  $\psi(\varphi)$ . Further application of the process can yield no change in this curve. It may be remarked

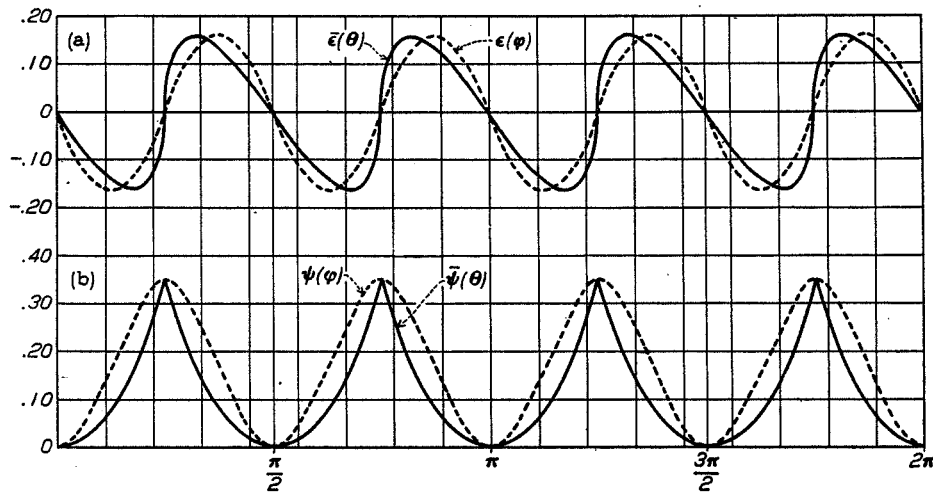

FIGURE 7.—Process applied to transforming a square into a circle

At a point  $P$  of  $\epsilon_2^*(\varphi_1)$  and  $Q$  of  $\epsilon_1(\varphi_1)$  corresponding to a definite value of  $\varphi_1$  one finds the value of  $\theta$  which corresponds to  $\varphi_1$  by a horizontal line through  $Q$  meeting  $\bar{\epsilon}_1(\theta)$  in  $Q'$ ; for this value of  $\theta$ , the quantity  $\epsilon_2$  at  $P$

here that for nearly all airfoils used in practice one step in the process is sufficient for very accurate results. As another example we shall show how a square (origin at center) is transformed into a circle by the



method. In Figure 7 the  $\bar{\psi}(\theta)$  curve is shown, and in Figure 8 it is reproduced for one octant.<sup>11</sup> The value is  $\bar{\psi}(\theta) = \log \sec \theta$ . The function  $\bar{\psi}[\theta(\varphi_1)]$  is shown dashed; the function  $\bar{\psi}[\theta(\varphi_2)]$  is shown with small crosses; and  $\bar{\psi}[\theta(\varphi_3)]$  is shown with small circles. The solution  $\psi(\varphi)$  is represented by the curve with small triangles and is obtained independently by the known transformation (reference 3, p. 375) which transforms the external region of a square into the external region of the unit circle, as follows:

$$w(z) = \int_{z_0}^z \frac{\sqrt{z^4 - 1}}{z^2} dz = z \left[ 1 + P\left(\frac{1}{z}\right) \right]$$

where  $P\left(\frac{1}{z}\right)$  denotes a power series. Comparing this with equation (10), we find that  $\psi(\varphi)$  except for the constant  $\psi_0$  is given as the real part of  $\log \left[ 1 + P\left(\frac{1}{z}\right) \right]$  evaluated for  $z = e^{i\varphi}$ , and that  $\epsilon(\varphi)$  is given as the negative of the imaginary part. It may be observed in Figure 8 that the function  $\bar{\psi}[\theta(\varphi_3)]$  very nearly

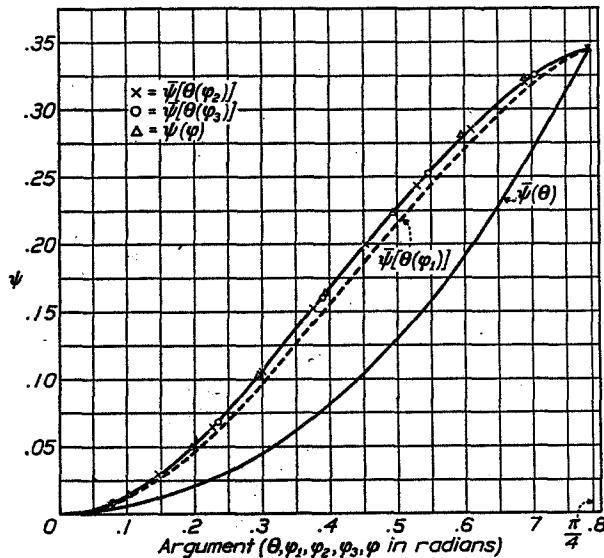

FIGURE 8.—Process applied to transforming a square into a circle

equals  $\psi(\varphi)$ . The functions  $\epsilon(\varphi)$  and  $\bar{\epsilon}(\theta)$  are shown in Figure 7 (a); we may note that at  $\varphi = \frac{\pi}{4}$ , which corresponds to a corner of the square,  $\frac{d\epsilon}{d\varphi} = 1$  or also,  $\frac{d\bar{\epsilon}}{d\theta} = \infty$ .

<sup>11</sup> Because of the symmetry involved only the interval 0 to  $\frac{\pi}{4}$  need be used. The integral in the appendix can be treated as

$$\begin{aligned} \epsilon(\varphi) &= -\frac{1}{2\pi} \int_0^{\frac{2\pi}{\varphi}} \psi(\varphi) \cot \frac{\varphi - \varphi'}{2} d\varphi \\ &= -\frac{2}{\pi} \int_0^{\frac{\pi}{\varphi}} \psi(\varphi) [\cot 2(\varphi - \varphi') - \cot 2(\varphi + \varphi')] d\varphi \end{aligned}$$

It may be remarked that the rapidity of convergence is influenced by certain factors. It is noticeably affected by the initial choice of  $\bar{\epsilon}_0(\theta)$ . The choice  $\bar{\epsilon}_0(\theta) = 0$  implies that  $\theta$  and  $\varphi$  are considered to be very nearly equal, i. e., that  $ae^{\psi+i\theta}$  represents a nearly circular curve. The initial transformation given by equation (5) and the choice of axes and origin were adapted for the purpose of obtaining a nearly circular

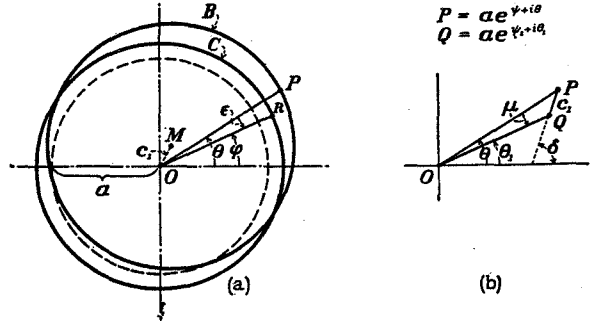

FIGURE 9.—Translation by the distance OM

curve for airfoil shapes. If we should be concerned with other classes of contours, more appropriate initial transformations can be developed. If, however, for a curve  $ae^{\psi+i\theta}$  the quantity  $\epsilon = \varphi - \theta$  has large values, either because of a poor initial transformation or because of an unfavorable choice of origin, it may occur that the choice  $\bar{\epsilon}_0(\theta) = 0$  will yield a function  $\epsilon_1(\varphi_1)$  for which  $\frac{d\epsilon_1}{d\varphi_1}$  may exceed unity at some points, thus violating condition (22'). Such slopes can be replaced by slopes less than unity, the resulting function chosen as  $\bar{\epsilon}_0(\theta)$  and the process continued as before.<sup>12</sup> Indeed, the closer the choice of the function  $\bar{\epsilon}_0(\theta)$  is to the final solution  $\bar{\epsilon}(\theta)$ , the more rapid is the convergence. The case of the square illustrates that even the relatively poor choice  $\bar{\epsilon}_0(\theta) = 0$  does not appreciably defer the convergence.

The translation  $z_1 = z + c_1$ .—Let us divert our attention momentarily to another transformation which will prove useful. We recall that the initial transformation (eq. (5)) applied to an airfoil in the  $\zeta$  plane gives a curve B in the  $z'$  plane shown schematically in Figure 9(a). Equation (10) transforms this curve into a circle C about the origin 0 as center and yields in fact small values of the quantity  $\varphi - \theta$ . We are, however, in a position to introduce a convenient transformation, namely, to translate the circle C into a most favorable position with respect to the curve B (or vice versa). These qualitative remarks admit of a mathematical formulation. It is clear that if the curve B itself happens to be a circle<sup>13</sup> the vector by which the circle C should be translated is exactly the distance between centers. It is readily shown that

<sup>12</sup> The first step in the process is now to define  $\varphi_0 = \theta + \epsilon_0(\theta)$  and form the function  $\bar{\psi}[\theta(\varphi_0)]$ . The conjugate function of  $\bar{\psi}[\theta(\varphi_0)]$  is  $\bar{\epsilon}_1(\varphi_0)$  which expressed as a function of  $\theta$  is  $\bar{\epsilon}_1(\theta)$ , etc..

<sup>13</sup> See p. 26.

then equation (10) should contain no constant term. We have

$$z' = ze^{\sum_1^{\infty} \frac{c_n}{z^n}} \tag{10}$$

$$= z \left( 1 + \frac{c_1}{z} + \frac{1}{2!} \left( \frac{c_1}{z} \right)^2 + \dots \right) \left( 1 + \frac{c_2}{z^2} + \dots \right) \times \left( 1 + \frac{c_3}{z^3} + \dots \right) \text{ etc.}$$

$$= z \left( 1 + \frac{k_1}{z} + \frac{k_2}{z^2} + \dots \right) \tag{10a}$$

where <sup>14</sup>

$$k_1 = c_1$$

$$k_2 = c_2 + \frac{c_1^2}{2}$$

$$k_3 = c_3 + c_2c_1 + \frac{c_1^3}{6}$$

.....

It is thus apparent that if equation (10) contains no first harmonic term, i. e., if

$$c_1 = A_1 + iB_1 = \frac{R^2}{\pi} \int_0^{2\pi} \psi e^{i\varphi} d\varphi = 0,$$

the transformation is obtained in the so-called normal form

$$z' = z_1 + \frac{d_1}{z_1} + \frac{d_2}{z_1^2} + \dots \tag{23}$$

This translation can be effected either by substituting a new variable  $z_1 = z + c_1$ , or a new variable  $z_1' = z' - c_1$ .

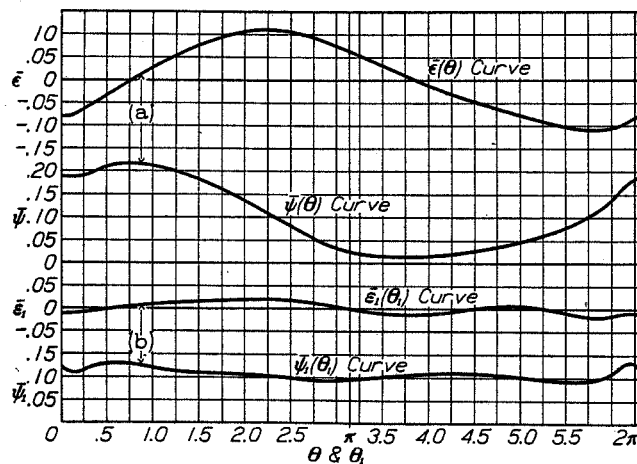

FIGURE 10.—The  $\bar{\psi}(\theta)$  and  $\bar{\psi}_1(\theta_1)$  curves (for Clark Y airfoil)

This latter substitution will be more convenient at this time. Writing

$$z_1' = ae^{\psi_1 + i\theta_1}, \quad c_1 = ae^{\gamma + i\delta}, \quad \text{and} \quad z' = ae^{\psi + i\theta}$$

we have

$$ae^{\psi_1 + i\theta_1} = ae^{\psi + i\theta} - ae^{\gamma + i\delta}$$

The variables  $\psi_1$ , and  $\theta_1$ , can be expressed in terms of  $\psi$ ,  $\theta$ ,  $\gamma$ , and  $\delta$ . In Figure 9(b),  $P$  is a point on the  $B$

<sup>14</sup> These constants can be obtained in a recursion form. See footnote 16,

curve, i. e.,  $OP = ae^{\psi}$ ,  $PQ$  represents the translation vector  $c_1 = ae^{\gamma + i\delta}$ ,  $OQ$  is  $ae^{\psi_1 + i\theta_1}$ , and angle  $POQ$  is denoted by  $\mu$ . Then by the law of cosines

$$e^{2\psi_1} = e^{2\psi} + e^{2\gamma} - 2e^{\psi}e^{\gamma} \cos(\theta - \delta) \tag{a}$$

and by the law of sines

$$\sin \mu = \frac{e^{\gamma} \sin(\theta - \delta)}{e^{\psi_1}}$$

$$\text{or} \quad \theta_1 = \theta + \mu = \theta + \tan^{-1} \frac{e^{\gamma - \psi} \sin(\theta - \delta)}{1 - e^{\gamma - \psi} \cos(\theta - \delta)} \tag{b}$$

In Figure 10 are shown the  $\bar{\psi}(\theta)$  and  $\bar{\epsilon}(\theta)$  curves for the Clark Y airfoil (shown in fig. 4) and the  $\bar{\psi}_1(\theta_1)$  and  $\bar{\epsilon}_1(\theta_1)$  curves which result when the origin is moved from 0 to  $M$ . It may be noted that  $\bar{\epsilon}_1(\theta_1)$  is indeed considerably smaller than  $\bar{\epsilon}(\theta)$ . It is obtained from

$$(\varphi - \theta_1)' = -\frac{1}{2\pi} \int_0^{2\pi} \psi_1(\varphi) \cot \frac{\varphi - \varphi'}{2} d\varphi$$

and the constant  $\psi_0$  is given <sup>15</sup> by

$$\psi_0 = \frac{1}{2\pi} \int_0^{2\pi} \psi_1(\varphi) d\varphi$$

**The combined transformations.**—It will be useful to combine the various transformations into one. We obtain from equations (5) and (10) an expression as follows:

$$\zeta = 2a \cosh \left( \log z + \sum_1^{\infty} \frac{c_n}{z^n} \right) \tag{24}$$

or we can also obtain a power series development in  $z$

$$\zeta = c_1 + z + \frac{a_1}{z} + \frac{a_2}{z^2} + \frac{a_3}{z^3} + \dots \tag{25}$$

where <sup>16</sup>

$$a_n = k_{n+1} + a^2 h_{n-1}$$

The constants  $k_n$  may be obtained in a convenient recursion form as

$$k_1 = c_1$$

$$2k_2 = k_1c_1 + 2c_2$$

$$3k_3 = k_2c_1 + 2k_1c_2 + 3c_3$$

$$4k_4 = k_3c_1 + 2k_2c_2 + 3k_1c_3 + 4c_4$$

.....

The constants  $h_n$  have the same form as  $k_n$  but with each  $c_i$  replaced by  $-c_i$  (and  $h_0 = 1$ ). It will be re-

<sup>15</sup> The constant  $\psi_0$  is invariant to change of origin. (See p. 26.) It should be remarked that the translation by the vector  $c_1$  is only a matter of convenience and is especially useful for very irregular shapes. For a study of the properties of airfoil shapes we shall use only the original  $\epsilon(\varphi)$  curve. (Fig. 10(a).)

<sup>16</sup> By equations (5) and (10) we have

$$\zeta = ze^{\sum_1^{\infty} \frac{c_n}{z^n}} + \frac{a^2}{z} e^{-\sum_1^{\infty} \frac{c_n}{z^n}}$$

The constant  $k_n$  is thus the coefficient of  $\frac{1}{z^n}$  in the expansion of  $e^{\sum_1^{\infty} \frac{c_n}{z^n}}$  and the constant

$h_n$  the coefficient of  $\frac{1}{z^n}$  in the expansion of  $e^{-\sum_1^{\infty} \frac{c_n}{z^n}}$ . For the recursion form for  $k_n$ , see Smithsonian Mathematical Formulæ and Tables of Elliptic Functions, p. 120.

called that the values of  $c_n$  are given by the coefficients of the Fourier expansion of  $\psi(\varphi)$  as

$$\frac{c_n}{R^n} = \frac{1}{\pi} \int_0^{2\pi} \psi(\varphi) e^{in\varphi} d\varphi \text{ where } R = ae^{i\varphi_0}$$

and

$$\psi_0 = \frac{1}{2\pi} \int_0^{2\pi} \psi(\varphi) d\varphi$$

The first few terms of equation (25) are then as follows:

$$\zeta = z + c_1 + \frac{c_2 + \frac{c_1^2}{2} + a^2}{z} + \frac{c_3 + c_2c_1 + \frac{c_1^3}{6} - c_1a^2}{z^2} + \dots \quad (25')$$

By writing  $z_1 = z + c_1$ , equation (25) is cast into the normal form

$$\zeta = z_1 + \frac{b_1}{z_1} + \frac{b_2}{z_1^2} + \dots \quad (26)$$

The constants  $b_n$  may be evaluated directly in terms of  $a_n$  or may be obtained merely by replacing  $\psi(\varphi)$  by  $\psi_1(\varphi)$  in the foregoing values for  $a_n$ .

The series given by equations (25) and (26) may be inverted and  $z$  or  $z_1$  developed as a power series in  $\zeta$ . Then

$$z(\zeta) = \zeta - c_1 - \frac{a_1}{\zeta} - \frac{a_2 + a_1c_1}{\zeta^2} - \frac{a_1c_1^2 + 2a_2c_1 + a_3 + a_1^2}{\zeta^3} \dots \quad (27)$$

and

$$z_1(\zeta) = \zeta - \frac{b_1}{\zeta} - \frac{b_2}{\zeta^2} - \frac{b_3 + b_1^2}{\zeta^3} \dots \quad (28)$$

The various transformations have been performed for the purpose of transforming the flow pattern of a

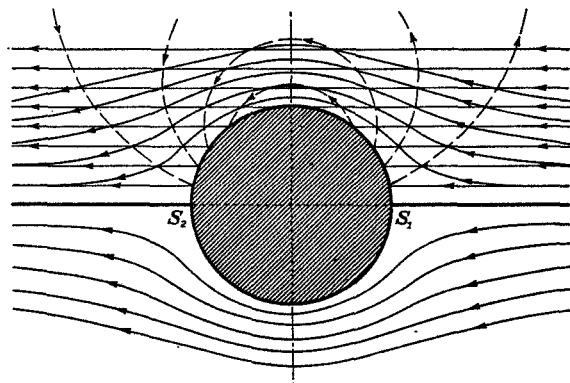

FIGURE 11.—Streamlines about circle with zero circulation (shown by the full lines)  $Q = -V \sinh \mu \sin \varphi = \text{constant}$

circle into the flow pattern of an airfoil. We are thus led immediately to the well-known problem of determining the most general type of irrotational flow around a circle satisfying certain specified boundary conditions.

**The flow about a circle.**—The boundary conditions to be satisfied are: The circle must be a streamline of flow and, at infinity, the velocity must have a given magnitude and direction. Let us choose the  $\xi$  axis as corresponding to the direction of the velocity at

infinity. Then the problem stated is equivalent to that of an infinite circular cylinder moving parallel to the  $\xi$  axis with velocity  $V$  in a fluid at rest at infinity.

The general complex flow potential<sup>17</sup> for a circle of radius  $R$ , and velocity at infinity  $V$  parallel to the  $x$  axis is

$$w(z) = -V \left( z + \frac{R^2}{z} \right) - \frac{i\Gamma}{2\pi} \log \frac{z}{R} \quad (29)$$

where  $\Gamma$  is a real constant parameter, known as the

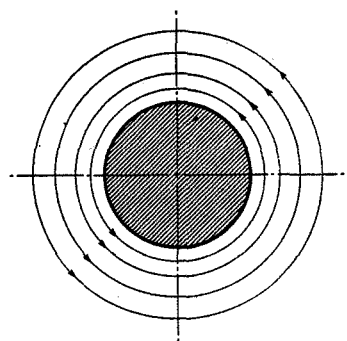

FIGURE 12.—Streamlines about circle for  $V=0$   $Q = -\frac{\Gamma}{2\pi}\mu = \text{constant}$

circulation. It is defined as  $\oint v_s ds$  along any closed curve inclosing the cylinder,  $v_s$  being the velocity along the tangent at each point.

Writing  $z = Re^{\mu+i\varphi}$  and  $w = P + iQ$ , equation (29) becomes

$$w = -V \cosh(\mu + i\varphi) - \frac{i\Gamma}{2\pi}(\mu + i\varphi) \quad (29')$$

$$\text{or } \left. \begin{aligned} P &= -V \cosh \mu \cos \varphi + \frac{\Gamma}{2\pi} \varphi \\ Q &= -V \sinh \mu \sin \varphi - \frac{\Gamma}{2\pi} \mu \end{aligned} \right\}$$

For the velocity components, we have

$$\frac{dw}{dz} = u - iv = -V \left( 1 - \frac{R^2}{z^2} \right) - \frac{i\Gamma}{2\pi z} \quad (30)$$

In Figures 11 and 12 are shown the streamlines for the cases  $\Gamma=0$ , and  $V=0$ , respectively. The cylinder experiences no resultant force in these cases since all streamlines are symmetrical with respect to it.

The stagnation points, that is, points for which  $u$  and  $v$  are both zero, are obtained as the roots of  $\frac{dw}{dz} = 0$ .

This equation has two roots.

$$z_0 = \frac{i\Gamma \pm \sqrt{16\pi^2 R^2 V^2 - \Gamma^2}}{4\pi V}$$

and we may distinguish different types of flow according as the discriminant  $16\pi^2 R^2 V^2 - \Gamma^2$  is positive, zero, or negative. We recall here that a conformal transformation  $w=f(z)$  ceases to be conformal at points where  $\frac{dw}{dz}$  vanishes, and at a stagnation point the flow divides and the streamline possesses a singularity.

<sup>17</sup> Reference 4, p. 56 or reference 5, p. 118. The log term must be added because the region outside the infinite cylinder (the point at infinity excluded) is doubly connected and therefore we must include the possibility of cyclic motion.

The different types of flow that result according as the parameter  $\Gamma^2 \geq 16\pi^2 R^2 V^2$  are represented in Figure 13. In the first case (fig. 13 (a)), which will not interest us later, the stagnation point occurs as a double point in the fluid on the  $\eta$  axis, and all fluid within this streamline circulates in closed orbits around the circle, while the rest of the fluid passes downstream. In the second case (fig. 13 (b)), the stagnation points are together at  $S$  on the circle  $Re^{i\varphi}$  and in the third case (fig. 13 (c)) they are symmetrically located on the circle. We have noted then that as  $\Gamma$  increases from 0 to  $4\pi RV$  the stagnation points move downward on

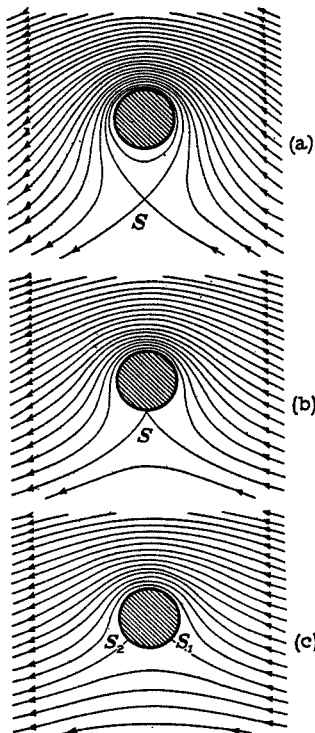

FIGURE 13.—Streamlines about circle [from Lagally—Handbuch der Physik Bd. VII]  $Q = V \sinh \mu \sin \varphi - \frac{\Gamma}{2\pi} \mu = \text{constant}$  (a)  $\Gamma^2 > 16\pi^2 R^2 V^2$  (b)  $\Gamma^2 = 16\pi^2 R^2 V^2$  (c)  $\Gamma^2 < 16\pi^2 R^2 V^2$

the circle  $Re^{i\varphi}$  from the  $\xi$  axis toward the  $\eta$  axis. Upon further increase in  $\Gamma$  they leave the circle and are located on the  $\eta$  axis in the fluid.

Conversely, it is clear that the position of the stagnation points can determine the circulation  $\Gamma$ . This fact will be shown to be significant for wing-section theory. At present, we note that when both  $\Gamma$  and  $V \neq 0$  a marked dissymmetry exists in the streamlines with respect to the circle. They are symmetrical about the  $\eta$  axis but are not symmetrical about the  $\xi$  axis. Since they are closer together on the upper side of the circle than on the lower side, a resultant force exists perpendicular to the motion.

We shall now combine the transformation (27) and the flow formula for

the circle equation (29) and obtain the general complex flow potential giving the 2-dimensional irrotational flow about an airfoil shape, and indeed, about any closed curve for which the Riemann theorem applies.

The flow around the airfoil.—In Figure 14 are given, in a convenient way, the different complex planes and transformations used thus far. The complex flow potential in the  $z$  plane for a circle of radius  $R$  origin at the center has been given as

$$w(z) = -V \left( z + \frac{R^2}{z} \right) - \frac{i\Gamma}{2\pi} \log z \quad (29)$$

where  $V$ , the velocity at infinity, is in the direction of the negative  $\xi$  axis. Let us introduce a parameter to

permit of a change in the direction of flow at infinity by the angle  $\alpha$  which will be designated *angle of attack* and defined by the direction of flow at infinity with respect to a fixed axis on the body, in this case the axis  $\varphi=0$ . This flow is obtained simply by writing  $ze^{i\alpha}$  for  $z$  in equation (29) and represents a rotation of

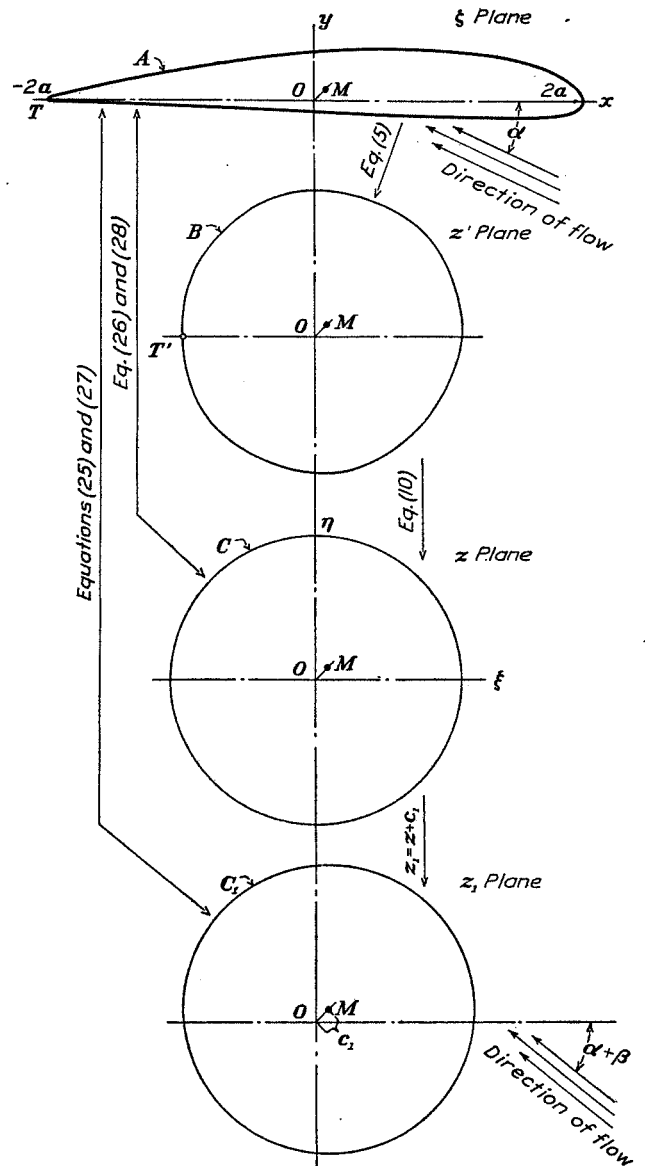

FIGURE 14.—The collected transformations

the entire flow field about the circle by angle  $\alpha$ . We have

$$w(z) = -V \left( ze^{i\alpha} + \frac{R^2}{z} e^{-i\alpha} \right) - \frac{i\Gamma}{2\pi} \log z \quad (31)$$

$$\begin{aligned} \frac{dw}{dz} &= u - iv \\ &= -Ve^{i\alpha} \left( 1 - \frac{R^2}{z^2} e^{-2i\alpha} \right) - \frac{i\Gamma}{2\pi z} \end{aligned} \quad (32)$$

Since a conformal transformation maps streamlines and potential lines into streamlines and potential lines,

we may obtain the complex flow potentials in the various planes by substitutions. For the flow about the circle in the  $z_1$  plane,  $z$  is replaced by  $z_1 - c_1$

$$w(z_1) = -V \left[ (z_1 - c_1)e^{i\alpha} + \frac{R^2 e^{-i\alpha}}{(z_1 - c_1)} \right] - \frac{i\Gamma}{2\pi} \log(z_1 - c_1) \quad (31')$$

$$\frac{dw}{dz_1} = -Ve^{i\alpha} \left[ 1 - \frac{R^2 e^{-2i\alpha}}{(z_1 - c_1)^2} \right] - \frac{i\Gamma}{2\pi(z_1 - c_1)} \quad (32')$$

For the flow about the  $B$ -curve in the  $z'$  plane,  $z$  is replaced by  $z(z')$  (the inverse of eq. (10a)) and for the flow about the airfoil in the  $\zeta$  plane  $z$  is replaced by  $z(\zeta)$  from equation (27)

$$W(\zeta) = -V \left[ z(\zeta)e^{i\alpha} + \frac{R^2}{z(\zeta)} e^{-i\alpha} \right] - \frac{i\Gamma}{2\pi} \log z(\zeta) \quad (33)$$

$$\frac{dW}{d\zeta} = -Ve^{i\alpha} \left( 1 + \frac{R^2 e^{-2i\alpha}}{[z(\zeta)]^2} \right) - \frac{i\Gamma}{2\pi[z(\zeta)]} \quad (34)$$

The flow fields at infinity for all these transformations have been made to coincide in magnitude and direction.

At this point attention is directed to two important facts. First, in the previous analysis the original closed curve may differ from an airfoil shape. The formulas, when convergent, are applicable to any closed curve satisfying the general requirements of the Riemann theorem. However, the peculiar ease of numerical evaluations for streamline shapes is noteworthy and significant. The second important fact is that the parameter  $\Gamma$  which as yet is completely undetermined is readily determined for airfoils and to a discussion of this statement the next section is devoted. It will be seen that airfoils may be regarded as fixing their own circulation.

**Kutta-Joukowski method for fixing the circulation.**—All contours used in practice as airfoil profiles possess the common property of terminating in either a cusp or sharp corner at the trailing edge (a point of two tangents). Upon transforming the circle into an airfoil by  $\zeta = f(z)$ , we shall find that  $\left| \frac{dz}{d\zeta} \right|$  is infinite at the trailing edge if the tail is perfectly sharp (or very large if the tail is almost sharp). This implies that the numerical value of the velocity  $\left| \frac{dw}{dz} \right| \left| \frac{dz}{d\zeta} \right| = |v|$  is infinite (or extremely large) provided the factor  $\left| \frac{dw}{dz} \right|$  is not zero at the tail. There is but one value of the circulation that avoids infinite velocities or gradients of pressure at the tail and this fact gives a practical basis for fixing the circulation.

The concept of the ideal fluid in irrotational potential flow implies no dissipation of energy, however large the velocity at any point. The circulation being a measure of the energy in a fluid is unaltered and independent of time. In particular, if the circulation is zero to begin with, it can never be different from zero.

However, since all real fluids have viscosity, a better physical concept of the ideal fluid is to endow the fluid with infinitesimal viscosity so that there is then no dissipation of energy for finite velocities and pressure gradients, but for infinite velocities, energy losses would result. Moreover, by Bernoulli's principle the pressure would become infinitely negative, whereas a real fluid can not sustain absolute negative pressures and the assumption of incompressibility becomes invalid long before this condition is reached. It should then be postulated that nowhere in the ideal fluid from the physical concept should the velocity become infinite. It is clear that the factor  $\left| \frac{dw}{dz} \right|$  must then be zero at the trailing edge in order to avoid infinite velocities. It is then precisely the sharpness of the trailing edge which furnishes us the following basis for fixing the circulation.

It will be recalled that the equation  $\frac{dw}{dz} = 0$  determines two stagnation points symmetrically located on the circle, the position of which varies with the value of the circulation and conversely the position of a stagnation point determines the circulation. In this paper the  $x$  axis of the airfoil has been chosen so that the negative end ( $\theta = \pi$ ) passes through the trailing edge. From the calculation of  $\epsilon = \varphi - \theta$  (by eq. (13)) the value of  $\varphi$  corresponding to any value of  $\theta$  is determined as  $\varphi = \theta + \epsilon$ , in particular at  $\theta = \pi$ ,  $\varphi = \pi + \beta$ , where  $\beta$  is the value of  $\epsilon$  at the tail and for a given airfoil is a geometric constant (although numerically it varies with the choice of axes). This angle  $\beta$  is of considerable significance and for good reasons is called the angle of zero lift. The substance of the foregoing discussion indicates that the point  $z = Re^{i(\pi+\beta)} = -Re^{i\beta}$  is a stagnation point on the circle. Then for this value of  $z$ , we have by equation (32)

$$\frac{dw}{dz} = -Ve^{i\alpha} \left( \frac{1 - R^2 e^{-2i\alpha}}{z^2} \right) - \frac{i\Gamma}{2\pi z} = 0$$

or

$$\begin{aligned} \Gamma &= -2\pi R V i e^{i(\alpha+\beta)} (1 - e^{-2i(\alpha+\beta)}) \\ &= 4\pi R V \left( \frac{e^{i(\alpha+\beta)} - e^{-i(\alpha+\beta)}}{2i} \right) \\ &= 4\pi R V \sin(\alpha + \beta) \end{aligned} \quad (35)$$

This value of the circulation is then sufficient to make the trailing edge a stagnation point for any value of  $\alpha$ . The airfoil may be considered to equip itself with that amount of circulation which enables the fluid to flow past the airfoil with a minimum energy loss, just as electricity flowing in a flat plate will distribute itself so that the heat loss is a minimum. The final justification for the Kutta assumption is not only its plausibility, but also the comparatively good agreement with experimental results. Figure 15 (b) shows the streamlines around an airfoil for a flow satisfying the Kutta condition, and Figures 15 (a) and 15 (c) illus-

trate cases for which the circulation is respectively too small and too large, the stagnation point being then on the upper and lower surfaces, respectively. For these latter cases, the complete flow is determinable only if, together with the angle of attack, the circulation or a stagnation point is specified.

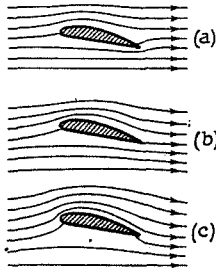

FIGURE 15.—(a) Flow with circulation smaller than for Kutta condition; (b) flow satisfying Kutta condition; (c) flow with circulation greater than for Kutta condition

**Velocity at the surface.**—The flow formulas for the entire field are now uniquely determined by substituting the value of  $\Gamma$  in equations (33) and (34). We are, however, in a position to obtain much simpler and more convenient relations for the boundary curves themselves. Indeed, we are chiefly interested in the velocity at the surface of the airfoil, which velocity is tangential to the surface, since the airfoil contour is a streamline of flow. The numerical value of the velocity at the surface of the airfoil is

$$v = \sqrt{v_x^2 + v_y^2} = |v_x - iv_y| = \left| \frac{dw}{d\zeta} \right| = \left| \frac{dw}{dz} \right| \cdot \left| \frac{dz}{dz'} \right| \cdot \left| \frac{dz'}{d\zeta} \right|$$

We shall evaluate each of these factors in turn. From equations (32 and (35)

$$\frac{dw}{dz} = -Ve^{i\alpha} \left( 1 - \frac{R^2}{z^2} e^{-2i\alpha} \right) - \frac{i4\pi RV \sin(\alpha + \beta)}{2\pi z}$$

At the boundary surface  $z = Re^{i\varphi}$ , and

$$\frac{dw}{dz} = -Ve^{i\alpha} (1 - e^{-2i(\alpha + \varphi)}) - 2iVe^{-i\varphi} \sin(\alpha + \beta)$$

or

$$\begin{aligned} \frac{dw}{dz} &= -Ve^{-i\varphi} [e^{i(\alpha + \varphi)} - e^{-i(\alpha + \varphi)}] + 2i \sin(\alpha + \beta) \\ &= -2iVe^{-i\varphi} [\sin(\alpha + \varphi) + \sin(\alpha + \beta)] \end{aligned}$$

and

$$\left| \frac{dw}{dz} \right| = 2V[\sin(\alpha + \varphi) + \sin(\alpha + \beta)] \quad (36)$$

In general, for arbitrary  $\Gamma$  we find that

$$\left| \frac{dw'}{dz} \right| = 2V \sin(\alpha + \varphi) + \frac{\Gamma}{2\pi R} \quad (36')$$

To evaluate  $\left| \frac{dz'}{dz} \right|$  we start with relation (10)

$$z' = ze \sum_{n=1}^{\infty} \frac{c_n}{z^n}$$

At the boundary surface

$$z' = ze^{\psi - \psi_0 - i\epsilon} \text{ where } \epsilon = \varphi - \theta \text{ and } z = ae^{\psi_0 + i\theta}$$

$$\frac{dz'}{dz} = \frac{z'}{z} \left( 1 + z \frac{d(\psi - i\epsilon)}{dz} \right)$$

$$= \frac{z'}{z} \left( 1 + \frac{d(\psi - i\epsilon)}{id\varphi} \right) \quad (37')$$

$$= \frac{z'}{z} \left( \frac{d\varphi}{d\theta} - \frac{d\bar{\epsilon}}{d\theta} - i \frac{d\bar{\psi}}{d\theta} \right) = \frac{z'}{z} \left( \frac{1 - i \frac{d\bar{\psi}}{d\theta}}{1 + \frac{d\bar{\epsilon}}{d\theta}} \right)$$

$$\text{Then } \left| \frac{dz'}{dz} \right| = e^{\psi - \psi_0} \sqrt{\frac{1 + \left( \frac{d\bar{\psi}}{d\theta} \right)^2}{1 + \frac{d\bar{\epsilon}}{d\theta}}} \quad (37)$$

By equation (5)

$$\zeta = z' + \frac{a^2}{z'} \text{ and at the boundary } z' = ae^{\psi + i\theta}, \text{ or}$$

$$\zeta = 2a \cosh(\psi + i\theta)$$

$$\begin{aligned} \frac{d\zeta}{dz'} &= 2a \sinh(\psi + i\theta) \frac{d(\psi + i\theta)}{dz'} \\ &= 2 \sinh(\psi + i\theta) e^{-(\psi + i\theta)}. \end{aligned}$$

$$\begin{aligned} \text{Then } \left| \frac{d\zeta}{dz'} \right|^2 &= 4e^{-2\psi} (\sinh^2\psi \cos^2\theta + \cosh^2\psi \sin^2\theta) \\ &= 4e^{-2\psi} (\sinh^2\psi + \sin^2\theta) \end{aligned}$$

$$\text{and } \left| \frac{d\zeta}{dz'} \right| = 2e^{-\psi} \sqrt{\sinh^2\psi + \sin^2\theta} \quad (38)$$

Then finally

$$\begin{aligned} v &= \left| \frac{dw}{d\zeta} \right| = \left| \frac{dw}{dz} \right| \cdot \left| \frac{dz}{dz'} \right| \cdot \left| \frac{dz'}{d\zeta} \right| \\ &= \frac{V[\sin(\alpha + \varphi) + \sin(\alpha + \beta)] \left( 1 + \frac{d\bar{\epsilon}}{d\theta} \right) e^{\psi_0}}{\sqrt{(\sinh^2\psi + \sin^2\theta) \left( 1 + \left( \frac{d\bar{\psi}}{d\theta} \right)^2 \right)}} \quad (39) \end{aligned}$$

In this formula the circulation is given by equation (35). In general, for an arbitrary value of  $\Gamma$  (see equation (36')), the equation retains its form and is given by

$$v = \frac{V \left[ \sin(\alpha + \varphi) + \frac{\Gamma}{4\pi R V} \right] \left( 1 + \frac{d\bar{\epsilon}}{d\theta} \right) e^{\psi_0}}{\sqrt{(\sinh^2\psi + \sin^2\theta) \left( 1 + \left( \frac{d\bar{\psi}}{d\theta} \right)^2 \right)}} \quad (40)$$

For the special case  $\Gamma = 0$ , we get

$$v = \frac{V \sin(\alpha + \varphi) \left( 1 + \frac{d\bar{\epsilon}}{d\theta} \right) e^{\psi_0}}{\sqrt{(\sinh^2\psi + \sin^2\theta) \left( 1 + \left( \frac{d\bar{\psi}}{d\theta} \right)^2 \right)}} \quad (41)$$

Equation (40) is a general result giving the velocity at any point of the surface of an arbitrary airfoil section, with arbitrary circulation for any angle of attack  $\alpha$ . Equation (39) represents the important special case in which the circulation is specified by the Kutta condition. The various symbols are functions only of the coordinates  $(x, y)$  of the airfoil boundary and expressions for them have already been given. In Tables

I and II are given numerical results for different airfoils, and explanation is there made of the methods of calculation and use of the formulas developed.

We have immediately by equation (3) the value of the pressure  $p$  at any point of the surface in terms of the pressure at infinity as

$$\frac{p}{q} = 1 - \left(\frac{v}{V}\right)^2$$

Some theoretical pressure distribution curves are given at the end of this report and comparison is there made with experimental results. These comparisons, it will be seen, within a large range of angles of attack, are strikingly good.<sup>18</sup>

**GENERAL WING-SECTION CHARACTERISTICS**

The remainder of this report will be devoted to a discussion of the parameters of the airfoil shape affecting aerodynamic properties with a view to determining airfoil shapes satisfying preassigned properties. This discussion will not only furnish an illuminating sequel

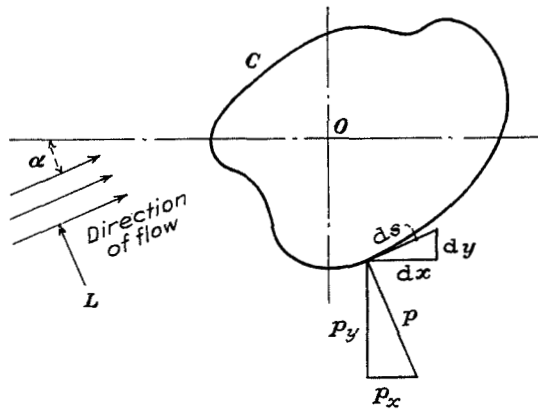

FIGURE 16.

to the foregoing analysis leading to a number of new results, but will also unify much of the existing theory of the airfoil. In the next section we shall obtain some expressions for the integrated characteristics of the airfoil. We start with the expressions for total lift and total moment, first developed by Blasius.

**Blasius' formulas.**—Let  $C$  in Figure 16 represent a closed streamline contour in an irrotational fluid field. Blasius' formulas give expressions for the total force and moment experienced by  $C$  in terms of the complex velocity potential. They may be obtained in the following simple manner. We have for the total forces in the  $x$  and  $y$  directions

$$P_x = - \int_C p_x ds = - \int_C p dy$$

$$P_y = \int_C p_y ds = \int_C p dx$$

$$P_x - iP_y = - \int_C p(dy + idx)$$

The pressure at any point is

$$p = p_o - \frac{1}{2}\rho v^2$$

Then,

$$P_x - iP_y = \frac{\rho}{2} \int_C v^2(dy + idx)$$

$$= \frac{i\rho}{2} \int_C \frac{dw}{dz} \frac{\bar{d}w}{\bar{d}z} \bar{d}z$$

where the bar denotes conjugate complex quantities. Since  $C$  is a streamline,  $v_x dy - v_y dx = 0$ . Adding the quantity

$$i\rho \int_C (v_y + iv_x)(v_x dy - v_y dx) = 0$$

to the last equation, we get<sup>19</sup>.

$$P_x - iP_y = \frac{i\rho}{2} \int_C (v_x - iv_y)^2(dx + idy)$$

$$= \frac{i\rho}{2} \int_C \left(\frac{dw}{dz}\right)^2 dz \tag{42}$$

The differential of the moment of the resultant force about the origin is,

$$\begin{aligned} dM_0 &= p(x dx + y dy) \\ &= R. P. \text{ of } p[x dx + y dy + i(y dx - x dy)] \\ &= R. P. \text{ of } p z \bar{d}z \end{aligned}$$

where "R. P. of" denotes the real part of the complex quantity. We have from the previous results

$$d(P_x - iP_y) = -i p \bar{d}z = \frac{i\rho}{2} \left(\frac{dw}{dz}\right)^2 dz$$

Then  $dM_0 = -R. P. \text{ of } \frac{\rho}{2} \left(\frac{dw}{dz}\right)^2 z dz$

and  $M_0 = -R. P. \text{ of } \frac{\rho}{2} \int_C \left(\frac{dw}{dz}\right)^2 z dz \tag{43}$

Let us now for completeness apply these formulas to the airfoil  $A$  in the  $\zeta$  plane (fig. 14) to derive the Kutta-Joukowski classical formula for the lift force. By equation (32) we have

$$\frac{dw}{dz} = -Ve^{i\alpha} - \frac{i\Gamma}{2\pi z} + \frac{R^2 V e^{-i\alpha}}{z^2}$$

and by equation (25)

$$\frac{d\zeta}{dz} = 1 - \frac{a_1}{z^2} - \frac{a_2}{z^3} - \dots$$

Then

$$\begin{aligned} \frac{dw}{d\zeta} &= \frac{dw}{dz} \cdot \frac{dz}{d\zeta} \\ &= -Ve^{i\alpha} - \frac{i\Gamma}{2\pi z} + (R^2 V e^{-i\alpha} - a_1 V e^{i\alpha}) \frac{1}{z^2} + \dots \end{aligned}$$

<sup>19</sup> Cf. Blasius, H: Zs. f. Math. u. Phys. Bd. 58 S. 93 and Bd. 59 S. 43, 1910. Similarly,

$$P_x + iP_y = -\frac{i\rho}{2} \int_C \left(\frac{dw}{dz}\right)^2 dz,$$

a less convenient relation to use than (42).

Note that when the region about  $C$  is regular the value of the integral (42) remains unchanged by integrating about any other curve enclosing  $C$ .

<sup>18</sup> A paper devoted to more extensive applications to present-day airfoils is in progress.

and

$$\left(\frac{dw}{d\zeta}\right)^2 = A_0 + \frac{A_1}{z} + \frac{A_2}{z^2} + \dots$$

where

$$A_0 = V^2 e^{2i\alpha}$$

$$A_1 = iVe^{i\alpha} \frac{\Gamma}{\pi}$$

$$A_2 = -2R^2 V^2 + 2a_1 V^2 e^{2i\alpha} - \frac{\Gamma^2}{4\pi^2}$$

Then

$$\begin{aligned} P_x - iP_y &= \frac{i\rho}{2} \int_A \left(\frac{dw}{d\zeta}\right)^2 d\zeta \\ &= \frac{i\rho}{2} \int_C \left(\frac{dw}{d\zeta}\right)^2 \frac{d\zeta}{dz} dz \\ &= \frac{i\rho}{2} (2\pi i A_1) \\ &= -ie^{i\alpha} \rho V \Gamma \end{aligned}$$

Therefore

$$\begin{cases} P_x = \rho V \Gamma \sin \alpha \\ P_y = \rho V \Gamma \cos \alpha \end{cases}$$

and are the components of a force  $\rho V \Gamma$  which is perpendicular to the direction of the stream at infinity. Thus the resultant lift force experienced by the airfoil is

$$L = \rho V \Gamma \quad (44)$$

and writing for the circulation  $\Gamma$  the value given by equation (35)

$$L = 4\pi R \rho V^2 \sin(\alpha + \beta) \quad (45)$$

The moment of the resultant lift force about the origin  $\zeta = 0$  is obtained as

$$\begin{aligned} M_0 &= R. P. \text{ of } -\frac{\rho}{2} \int_A \left(\frac{dw}{dz}\right)^2 \zeta d\zeta \\ &= R. P. \text{ of } -\frac{\rho}{2} \int_C \left(\frac{dw}{d\zeta}\right)^2 \zeta \frac{d\zeta}{dz} dz \\ &= R. P. \text{ of } -\frac{\rho}{2} \int_C \left(A_0 + \frac{A_1}{z} + \frac{A_2}{z^2} + \dots\right) \times \\ &\quad \left(c_1 + z + \frac{a_1}{z} + \frac{a_2}{z^2} + \dots\right) \left(1 - \frac{a_1}{z^2} + \dots\right) dz \\ &= R. P. \text{ of } -\frac{\rho}{2} 2\pi i \text{ (coefficient of } z^{-1}) \\ &= R. P. \text{ of } -\frac{\rho}{2} 2\pi i (A_2 + A_1 c_1) \end{aligned}$$

or,  $M_0$  is the imaginary part of  $\pi \rho (A_2 + A_1 c_1)$ . After putting  $c_1 = me^{i\delta}$  and  $a_1 = b^2 e^{2i\gamma}$  we get

$$M_0 = 2\pi \rho V^2 b^2 \sin 2(\alpha + \gamma) + \rho V \Gamma m \cos(\alpha + \delta) \quad (46)$$

The results given by equations (44) and (46) have physical significance and are invariant to a transforma-

tion of origin as may be readily verified by employing equations (26) and (32') and integrating around the  $C_1$  circle in the  $z_1$  plane. It is indeed a remarkable fact that the total integrated characteristics, lift and location of lift, of the airfoil depend on so few parameters of the transformation as to be almost independent of the shape of the contour. The parameters  $R$ ,  $\beta$ ,  $a_1$ , and  $c_1$  involved in these relations will be discussed in a later paragraph.

We shall obtain an interesting result<sup>21</sup> by taking moments about the point  $\zeta = c_1$  instead of the origin. ( $M$  in fig. 17.) By equation (25) we have,

$$\zeta - c_1 = z + \frac{a_1}{z} + \frac{a_2}{z^2} + \dots$$

and by equation (43)

$$\begin{aligned} M_M &= R. P. \text{ of } -\frac{\rho}{2} \int_A \left[\frac{dw}{d(\zeta - c_1)}\right]^2 (\zeta - c_1) d\zeta \\ &= R. P. \text{ of } -\frac{\rho}{2} \int_C \left(A_0 + \frac{A_1}{z} + \frac{A_2}{z^2} + \dots\right) \times \\ &\quad \left(z + \frac{a_1}{z} + \frac{a_2}{z^2} + \dots\right) \left(1 - \frac{a_1}{z^2} + \dots\right) dz \\ &= R. P. \text{ of } -i\pi \rho A_2 \end{aligned}$$

or

$$M_M = 2\pi b^2 \rho V^2 \sin 2(\alpha + \gamma) \quad (47)$$

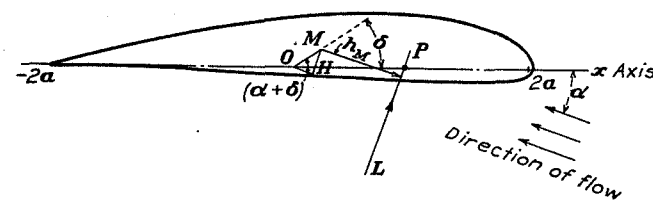

FIGURE 17.—Moment arm from  $M$  onto the lift vector

This result could have been obtained directly from equation (46) by noticing that  $\rho V \Gamma$  in the second term is the resultant lift force  $L$  and that  $L m \cos(\alpha + \delta)$  represents a moment which vanishes at  $M$  for all values of  $\alpha$ . (In fig. 17 the complex coordinate of  $M$  is  $\zeta = me^{i\delta}$ , the arm  $OH$  is  $m \cos(\alpha + \delta)$ .) The perpendicular  $h_M$  from  $M$  onto the resultant lift vector is simply obtained from  $M_M = L h_M$ , as

$$h_M = \frac{b^2 \sin 2(\alpha + \gamma)}{2R \sin(\alpha + \beta)} \quad (48)$$

The intersection of the resultant lift vector with the chord or axis of the airfoil locates a point which may be considered the center of pressure. The amount of travel of the center of pressure with change in angle of attack is an important characteristic of airfoils, especially for considerations of stability, and will be discussed in a later paragraph.

<sup>20</sup> It may be recalled that  $c_1 = \frac{R^2}{\pi} \int_0^{2\pi} \psi(\varphi) e^{i\varphi} d\varphi$  and  $a_1 = a^2 + \frac{c_1^2}{2} + c_2$ . (See eq. (25').)

<sup>21</sup> First obtained by R. von Mises. (Reference 6.) The work of von Mises forms an elegant geometrical study of the airfoil.



The lift force has been found to be proportional to  $\sin(\alpha + \beta)$  or writing  $\alpha + \beta = \alpha_1$

$$L = 4\pi\rho R V^2 \sin \alpha_1 \quad (49)$$

where  $\alpha_1$  may be termed the absolute angle of attack. Similarly writing  $\alpha + \gamma = \alpha_2$

$$M_M = 2\pi b^2 \rho V^2 \sin 2\alpha_2 \quad (50)$$

With von Mises (reference 6, Pt. II) we shall denote the axes determined by passing lines through  $M$  at angles  $\beta$  and  $\gamma$  to the  $x$  axis as the first and second axes of the airfoil, respectively. (Fig. 18.) The directions of these axes alone are important and these are fixed with respect to a given airfoil. Then the lift  $L$  is proportional to the sine of the angle of attack with respect to the first axis and the moment about  $M$  to

If this moment is to be independent of  $\alpha$ , the coefficients of  $\sin 2\alpha$  and  $\cos 2\alpha$  must vanish.

Then

$$b^2 \cos 2\gamma = Rr \cos(\beta + \sigma)$$

and

$$b^2 \sin 2\gamma = Rr \sin(\beta + \sigma)$$

Hence,

$$r = \frac{b^2}{R} \text{ and } \sigma = 2\gamma - \beta$$

Then if we move the reference point of the moment to a point  $F'$  whose radius vector from  $M$  is  $\frac{b^2}{R} e^{2\gamma - \beta}$ , the moment existing at  $F'$  is for all angles of attack constant, and given by

$$M_{F'} = 2\pi\rho b^2 V^2 \sin 2(\gamma - \beta) \quad (51)$$

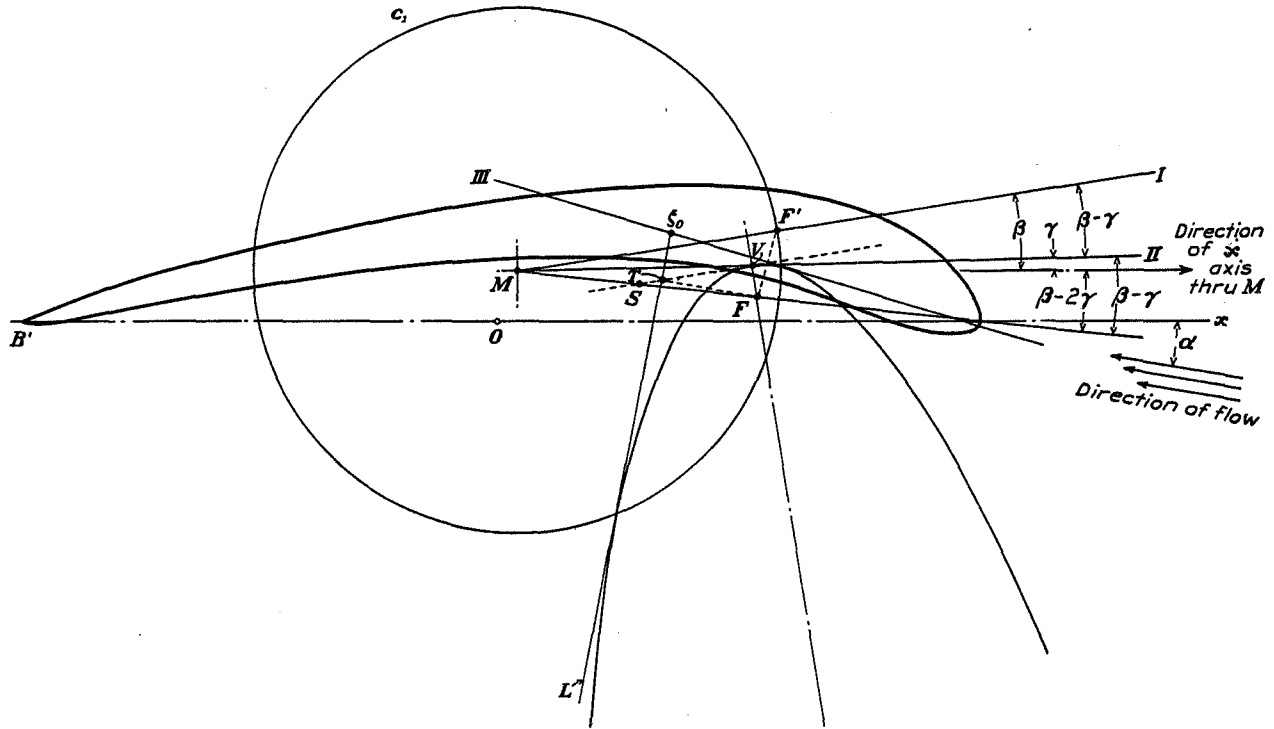

FIGURE 18.—Illustrating the geometrical properties of an airfoil (axes and lift parabola of the R. A. F. 19 airfoil)

the sine of twice the angle of attack with respect to the second axis.

From equation (47) we note that the moment at any point  $Q$  whose radius vector from  $M$  is  $re^{i\sigma}$ , is given by

$$M_Q = 2\pi\rho b^2 V^2 \sin 2(\alpha + \gamma) - Lr \cos(\alpha + \sigma)$$

Let us determine whether there exist particular values of  $r$  and  $\sigma$  for which  $M_Q$  is independent of the angle of attack  $\alpha$ . Writing for  $L$  its value given by equation (45),

$$M_Q = 2\pi\rho b^2 V^2 \sin 2(\alpha + \gamma) - 4\pi\rho Rr V^2 \sin(\alpha + \beta) \cos(\alpha + \sigma)$$

And separating this trigonometrically

$$M_Q = 2\pi\rho V^2 [(b^2 \cos 2\gamma - Rr \cos(\beta + \sigma)) \sin 2\alpha + (b^2 \sin 2\gamma - Rr \sin(\beta + \sigma)) \cos 2\alpha - Rr \sin(\beta - \sigma)]$$

It has thus been shown that with every airfoil profile there is associated a point  $F'$  for which the moment is independent of the angle of attack. A change in lift force resulting from a change in angle of attack distributes itself so that its moment about  $F'$  is zero.

From equation (47) it may be noted that at zero lift (i. e.,  $\alpha = -\beta$ ) the airfoil is subject to a moment couple which is, in fact, equal to  $M_{F'}$ . This moment is often termed "diving moment" or "moment for zero lift." If  $M_{F'}$  is zero, the resultant lift force must pass through  $F'$  for all angles of attack and we thus have the statement that the airfoil has a constant center of pressure, if and only if, the moment for zero lift is zero.

The point  $F'$ , denoted by von Mises as the focus of the airfoil, will be seen to have other interesting properties. We note here that its construction is very

simple. It lies at a distance  $\frac{b^2}{R}$  from  $M$  on a line making angle  $2\gamma - \beta$  with respect to the  $x$  axis. From Figure 18 we see that the angle between this line and the first axis is bisected by the second axis.

The arm  $h_F$  from  $F$  onto the resultant lift vector  $L$  ( $h_F$  is designated  $FT$  in Figure 18; note also that  $FT$ , being perpendicular to  $L$ , must be parallel to the direction of flow; the line  $TV$  is drawn parallel to the first axis and therefore angle  $VTF = \alpha + \beta$ ) is obtained as

$$h_F = \frac{M_F}{L} = \frac{-b^2 \sin 2(\beta - \gamma)}{2R \sin(\alpha + \beta)}$$

or setting  $h = \frac{b^2}{2R} \sin 2(\beta - \gamma)$

$$h_F = -\frac{h}{\sin(\alpha + \beta)} \quad (52)$$

But  $h_F$  is parallel to the direction of  $\alpha$ , and the relation  $h = -h_F \sin(\alpha + \beta)$  states then that the projection of  $h_F$  onto the line through  $F$  perpendicular to the first axis is equal to the constant  $h$  ( $h$  is designated  $FV$  in the figure) for all angles of attack. In other words, the pedal points  $T$  determined by the intersection of  $h_F$  and  $L$  for all positions of the lift vector  $L$  lie on a straight line. (The line is determined by  $T$  and  $V$  in fig. 18.) The parabola is the only curve having the property that pedal points of the perpendiculars dropped from its focus onto any tangent lie on a straight line, that line being the tangent at the vertex. This may be shown analytically by noting that the equation of  $L$  for a coordinate system having  $F$  as origin and  $FV$  as negative  $x$  axis is

$$x \sin \alpha_1 + y \cos \alpha_1 = h_F = -\frac{h}{\sin(\alpha + \beta)}$$

By differentiating with respect to  $\alpha_1 = \alpha + \beta$  and eliminating  $\alpha_1$  we get the equation of the curve which the lines  $L$  envelop as  $y^2 = 4h(x + h)$ . From triangle  $FVS$  in Figure 18, it may be seen that the distance  $MF = \frac{b^2}{R}$  is bisected at  $S$  by the line  $TV$ ; for, since  $FV = h = \frac{b^2}{2R} \sin 2(\gamma - \beta)$  and angle  $FSV = 2(\beta - \gamma)$ , then  $SF = \frac{b^2}{2R}$ . It has thus been shown that the resultant lift vectors envelop, in general, a parabola whose focus is at  $F$  and whose directrix is the first axis. The second axis and its perpendicular at  $M$ , it may be noted, are also tangents to the parabola being, by definition, the resultant lift vectors for  $\alpha = -\gamma$  and  $\alpha = \frac{\pi}{2} - \gamma$ , respectively.

If the constant  $h$  reduces to zero, the lift vectors reduce to a pencil of lines through  $F$ . Thus a constant center of pressure is given by  $h = 0$  or  $\sin 2(\beta - \gamma) = 0$  which is equivalent to stating that the first and second axes coincide. The lift parabola opens downward when the first axis is above the second axis ( $\beta > \gamma$ ); it reduces to a pencil of lines when the two axes are

coincident ( $\beta = \gamma$ ) and opens upward when the second axis is above the first ( $\beta < \gamma$ ).

W. Müller<sup>22</sup> introduced a third axis which has some interesting properties. Defining the complex coordinate  $\zeta_0$  as the centroid of the circulation by

$$\Gamma \zeta_0 = \int_A \zeta \left( \frac{dw}{d\zeta} \right) d\zeta$$

and using equations (25) and (32) one obtains

$$\zeta_0 - c_1 = x_0 + iy_0$$

where

$$\left. \begin{aligned} x_0 &= \frac{1}{2 \sin(\alpha + \beta)} [R \sin \alpha + \frac{b^2}{R} \sin(\alpha + 2\gamma)] \\ y_0 &= \frac{1}{2 \sin(\alpha + \beta)} [R \cos \alpha - \frac{b^2}{R} \cos(\alpha + 2\gamma)] \end{aligned} \right\} \quad (53)$$

The equation of the lift vector lines referred to the origin at  $M$  and  $x$  axis drawn through  $M$  is

$$x \cos \alpha - y \sin \alpha = \frac{b^2 \sin(\alpha + \gamma)}{2R \sin(\alpha + \beta)} \quad (54)$$

and it may be seen that the point  $(x_0, y_0)$  satisfies this equation. The centroid of the circulation then lies on the lift vectors. By elimination of  $\alpha$  from equation (53) one finds as the locus of  $(x_0, y_0)$

$$\begin{aligned} 2x_0 [R \cos \beta - \frac{b^2}{R} \cos(\beta - 2\gamma)] + 2y_0 [R \sin \beta \\ + \frac{b^2}{R} \sin(\beta - 2\gamma)] = R^2 - \frac{b^4}{R^2} \end{aligned} \quad (55)$$

which is the equation of a line, the third axis, and proves to be a tangent to the lift parabola. Geometrically, it is the perpendicular bisector of the line  $FF'$  joining the focus to the point of intersection of the first axis with the circle. (Fig. 18.)

**The conformal centroid of the contour.**—It has already been seen that the point  $M$  has special interesting properties. The transformation from the airfoil to the circle having  $M$  as center was expressed in the normal form and permitted of a very small  $\epsilon(\varphi)$  curve. (See p. 14.) It was also shown that the moment with respect to  $M$  is simply proportional to the sine of twice the angle of attack with respect to the second axis. We may note, too, that in the presentation of this report the coordinate of  $M$ ,  $\zeta = c_1$

$= \frac{R}{\pi} \int_0^{2\pi} \psi e^{i\varphi} d\varphi$ , is a function only of the first harmonic of the  $\psi(\varphi)$  curve.

We shall now obtain a significant property of  $M$  invariant with respect to the transformation from airfoil to circle. We start with the evaluation of the integral

$$\int_A \zeta \left| \frac{dz}{d\zeta} \right| ds$$

<sup>22</sup> Reference 7, p. 169. Also Zs. für Ang. Math. u. Mech. Bd. 3 S. 117, 1923. Airfoils having the same first, second, and third axes are alike theoretically in total lift properties and also in travel of the center of pressure, i. e., they have the same lift parabola.

where  $A$  is the airfoil contour,  $ds$  the differential of arc along  $A$ , and  $\left|\frac{dz}{d\zeta}\right|$ , as will be recalled, is the magnification factor of the transformation  $\zeta=f(z)$  mapping airfoil into circle; i. e., each element  $ds$  of  $A$  when magnified by  $\left|\frac{dz}{d\zeta}\right|$  gives  $dS$  the differential of arc in the plane of the circle, i. e.,  $|dz|$ . Then we have,

$$\begin{aligned} \int_A \zeta \left|\frac{dz}{d\zeta}\right| ds &= \int_C \zeta(z) |dz| \text{ and by equation (25),} \\ &= \int_C \left(c_1 + z + \frac{a_1}{z} + \frac{a_2}{z^2} + \dots\right) |dz| \\ &= \int_0^{2\pi} \left(c_1 + Re^{i\psi} + \frac{a_1}{R} e^{-i\psi} + \frac{a_2}{R^2} e^{-2i\psi} + \dots\right) R d\psi \\ &= 2\pi R c_1 \\ &= c_1 \int_C dS = c_1 \int_A \left|\frac{dz}{d\zeta}\right| ds \end{aligned}$$

Then

$$c_1 = \frac{\int_A \zeta \left|\frac{dz}{d\zeta}\right| ds}{\int_A \left|\frac{dz}{d\zeta}\right| ds} \tag{56}$$

The point  $M$  of the airfoil is thus the conformal-centroid obtained by giving each element of the contour a weight equal to the magnification of that element, which results when the airfoil is transformed into a circle, the region at infinity being unaltered. It lies within any convex region enclosing the airfoil contour.<sup>23</sup>

**ARBITRARY AIRFOILS AND THEIR RELATION TO SPECIAL TYPES**

The total lift and moment experienced by the airfoil have been seen to depend on but a few parameters of the airfoil shape. The resultant lift force is completely determined for a particular angle of attack by only the radius  $R$  and the angle of zero lift  $\beta$ . The moment about the origin depends, in addition, on the complex constants  $c_1$  and  $a_1$  or, what is the same, on the position of the conformal centroid  $M$  and the focus  $F$ . The constants  $c_1$  and  $a_1$  were also shown (see footnote 20) to depend only on the first and second harmonics of the  $\epsilon(\varphi)$  curve. Before studying these parameters for the case of the arbitrary airfoil, it will be instructive to begin with special airfoils and treat these from the point of view of the "conformal angular distortion" [ $\epsilon(\varphi)$ ] curve.

**Flow about the straight line or flat plate.**—As a first approximation to the theory of actual airfoils, there is the one which considers the airfoil section to be a straight line. It has been seen that the line of length  $4a$  is obtained by transforming a circle of radius  $a$ , center at the origin, by  $\zeta = z + \frac{a^2}{z}$ . The region ex-

ternal to the line  $4a$  in the  $\zeta$  plane maps uniquely into the region external to the circle  $|z|=a$ . A point  $Q$  of the line corresponding to a point  $P$  at  $ae^{i\theta}$  is obtained by simply adding the vectors  $a(e^{i\theta} + e^{-i\theta})$  or completing the parallelogram  $OPQP'$ .

For  $\psi=0$ , we have from equation (6).

$$\begin{aligned} x &= 2a \cosh \psi \cos \theta = 2a \cos \theta \\ y &= 2a \sinh \psi \sin \theta = 0 \end{aligned}$$

Then the parameters for this case are  $R=a$ ,  $\beta=0$ ,  $a_1=a^2$  (i. e.,  $b=a$ ,  $\gamma=0$ ), and  $M$  is at the origin  $O$ . Taking the Kutta assumption for determining the circulation we have,

$$\left. \begin{aligned} \text{the circulation,} & \quad \Gamma = 4\pi a V \sin \alpha \\ \text{the lift,} & \quad L = 4\pi a \rho V^2 \sin \alpha \\ \text{moment about } M, M_M &= 2\pi a^2 \rho V^2 \sin 2\alpha \\ \text{position of } F \text{ is at } z_F &= c_1 + \frac{b^2}{R} e^{i(2\gamma-\beta)} = a \end{aligned} \right\} \tag{57}$$

Since  $\beta=\gamma$ , we know that the travel of the center of pressure vanishes and that the center of pressure is at

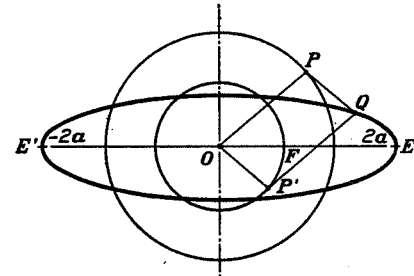

FIGURE 19.

$F$  or at one-fourth the length of the line from the leading edge. The complex flow potential for this case is

$$w(\zeta) = -V \left[ z(\zeta) e^{i\alpha} + \frac{a^2}{z(\zeta)} e^{-i\alpha} \right] + \frac{i\Gamma}{2\pi} \log z(\zeta) \tag{58}$$

where  $z(\zeta) = \frac{\zeta}{2} \pm \sqrt{\left(\frac{\zeta}{2}\right)^2 + a^2}$  is the inverse of equation (5). Since  $\psi(\varphi) = \epsilon(\varphi) = 0$  for this case, equation (39) giving the velocity at the surface reduces to

$$v = V \left[ \frac{\sin\left(\frac{\varphi}{2} + \alpha\right)}{\sin\frac{\varphi}{2}} \right] \text{ for } \Gamma = 4\pi a V \sin \alpha,$$

and by equation (41)  $v = V \left( \frac{\sin(\frac{\varphi + \alpha}{2})}{\sin\frac{\varphi}{2}} \right)$  for  $\Gamma=0$ .

**Flow about the elliptic cylinder.**—If equation (5) is applied to a circle with center at the origin and radius  $ae^\psi$ , the ellipse (fig. 19)

$$\frac{x^2}{(2a \cosh \psi)^2} + \frac{y^2}{(2a \sinh \psi)^2} = 1$$

is obtained in the  $\zeta$  plane and the region external to this ellipse is mapped uniquely into the region external to the circle. The same transformation also transforms this external region into the region internal to the inverse circle, radius  $ae^{-\psi}$ . We note that a point

<sup>23</sup> Cf. P. Frank and K. Lowner, Math. Zs. Bd. 3, S. 78, 1919. Also reference 5, p. 146.

$Q$  of the ellipse corresponding to  $P$  at  $ae^{\psi+i\theta}$  is obtained by simply completing the parallelogram  $OPQP'$  (fig. 19) where  $P'$  now terminates on the circle  $ae^{-\psi}$ . The parameters are obtained as  $R=ae^{\psi}$ ,  $\beta=0$ ,  $a_1=a_2$ ,  $M$  is at the origin  $O$ . Then, assuming the rear stagnation point at the end of the major axis,

$$\begin{aligned} \Gamma &= 4\pi a e^{\psi} V \sin \alpha \\ L &= 4\pi \rho a e^{\psi} V^2 \sin \alpha \\ M_M &= 2\pi a^2 \rho V^2 \sin 2\alpha \end{aligned}$$

Since  $\beta=\gamma$ , the point  $F$  is the center of pressure for all angles of attack and is located at  $z_F=ae^{-\psi}$  from  $O$  or a distance  $ae^{\psi}$  from the leading edge. The quantity

$$\frac{EF}{EE'} = \frac{ae^{\psi}}{2a(e^{\psi}+e^{-\psi})} = \frac{\cosh \psi + \sinh \psi}{4 \cosh \psi} = \frac{1}{4}(1 + \tanh \psi)$$

represents the ratio of the distance of  $F$  from the leading edge to the major diameter of the ellipse.

The complex flow potential is identical with that given by equation (58) for the flat plate, except that the quantity  $a^2$  in the numerator of the second term is replaced by the constant  $a^2 e^{2\psi}$ . Since  $\psi(\varphi) = \text{constant}$ ,  $\epsilon(\varphi) = 0$  and equation (39) giving the velocity at each point of the surface for a stagnation point at end of major axis becomes

$$v = V \frac{[\sin(\varphi + \alpha) + \sin \alpha] e^{\psi}}{\sqrt{\sinh^2 \psi + \sin^2 \varphi}} \quad (59)$$

and for zero circulation by equation (41)

$$v = V \frac{\sin(\varphi + \alpha) e^{\psi}}{\sqrt{\sinh^2 \psi + \sin^2 \varphi}} \quad (59')$$

**Circular arc sections.**—It has been shown that the transformation  $\zeta = z + \frac{a^2}{z}$  applied to a circle with center at  $z=0$  and radius  $a$  gives a straight line in the  $\zeta$  plane, and when applied to a circle with center  $z=0$  and radius different from  $a$  gives an ellipse in the  $\zeta$  plane. We now show that if it is used to transform a circle with center at  $z=is$  ( $s$  being a real number) and radius  $\sqrt{a^2+s^2}$ , a circular arc results. The coordinates of the transform of the circle  $C$  in the  $\zeta$  plane are given by equation (6) as

$$\begin{aligned} x &= 2a \cosh \psi \cos \theta \\ y &= 2a \cosh \psi \sin \theta \end{aligned}$$

A relation between  $\psi$  and  $\theta$  can be readily obtained. In right triangle  $OMD$  (fig. 20),  $OM=s$ , angle  $OMD=\theta$ , and recalling that the product of segments of any chord through  $O$  is equal to  $a^2$ ,  $OD = \frac{1}{2}(OP - OP_1) = \frac{a(e^{\psi} - e^{-\psi})}{2} = a \sinh \psi$ . Then  $s \sin \theta = a \sinh \psi$ , and from the equation for  $y$ ,  $y = 2s \sin^2 \theta$ . Eliminating both  $\theta$  and  $\psi$  in equation (6) we get

$$x^2 + \left( y + \left( \frac{a^2 - s^2}{s} \right) \right)^2 = \left( \frac{a^2 + s^2}{s} \right)^2 \quad (60)$$

the equation of a circle; but since  $y$  can have only positive values, we are limited to a circular arc. In fact, as the point  $P$  in Figure 20 moves from  $A'$  to  $A$  on the circle, the point  $Q$  traverses the arc  $A_1'A_1$  and as  $P$  completes the circuit  $AA'$  the arc is traversed in the opposite direction. As in the previous cases, we note that the point  $Q$  corresponding to either  $P$  or to the inverse and reflected point  $P'$  is obtained by completing the parallelogram  $OPQP'$ . We may also note

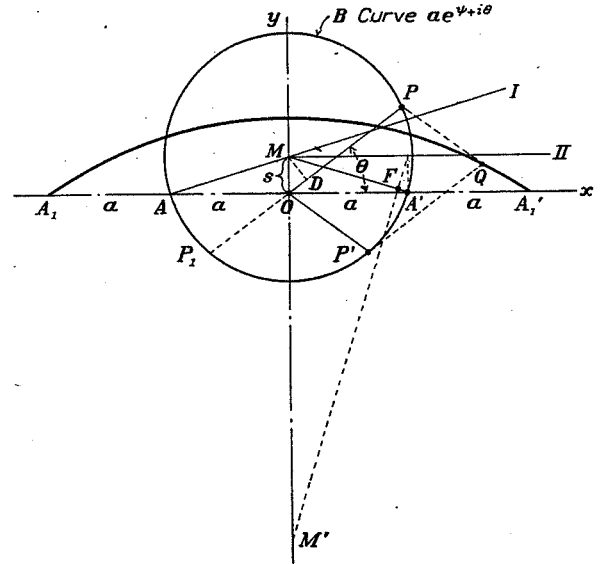

FIGURE 20.—The circular arc airfoil

that had the arc  $A_1A_1'$  been preassigned with the requirement of transforming it into the circle, the most convenient choice of origin of coordinates would be the midpoint of the line, length  $4a$ , joining the end points. The curve  $B$  then resulting from using transformation (5) would be a circle in the  $z'$  plane, center at  $z'=is$ , and the theory developed in the report could be directly applied to this continuous closed  $B$  curve.

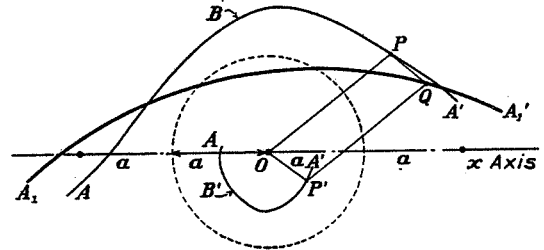

FIGURE 21.—Discontinuous  $B$  curve

Had another axis and origin been chosen, e. g., as in Figure 21, the  $B$  curve resulting would have finite discontinuities at  $A$  and  $A'$ , although the arc  $A_1A_1'$  is still obtained by completing the parallelogram  $OPQP'$ .

The parameters of the arc  $A_1A_1'$  of chord length  $4a$ , and maximum height  $2s$  are then,  $R = \sqrt{a^2 + s^2}$ ,  $\beta = \tan^{-1} \frac{s}{a}$ . The focus  $F$  may be constructed by erecting a perpendicular to the chord at  $A'$  of length  $s$

and projecting its extremity on  $MA'$ . The center  $M'$  of the arc also lies on this line.

The infinite sheet having the circular arc as cross section contains as a special case the flat plate, and thus permits of a better approximation to the mean camber line of actual airfoils. The complex flow potential and the formulas for the velocity at the surface for the circular arc are of the same form as those given in the next section for the Joukowski airfoil, where also a simple geometric interpretation of the parameters  $\epsilon$  and  $\psi$  are given.

**Joukowski airfoils.**—If equation (5) is applied to a circle with center at  $z=s$ ,  $s$  being a real number, and with radius  $R=a+s$ , a symmetrical Joukowski airfoil (or strut form) is obtained. The general Joukowski airfoil is obtained when the transformation  $\zeta = z + \frac{a^2}{z}$  is applied to a circle  $C$  passing through the point  $z = -a$  and containing  $z = a$  (near the circumference-usually), and whose center  $M$  is not limited to either the  $x$  or  $y$  axes, but may be on a line  $OM$  inclined to the axes. (Fig. 22.) The parametric equations of the shape are as before

$$\left. \begin{aligned} x &= 2a \cosh \psi \cos \theta \\ y &= 2a \sinh \psi \sin \theta \end{aligned} \right\} \quad (6)$$

Geometrically a point  $Q$  of the airfoil is obtained by adding the vectors  $ae^{\psi+i\theta}$  and  $ae^{-\psi-i\theta}$  or by completing the parallelogram  $OPQP'$  as before, but now  $P'$  lies on another circle  $B'$  defined as  $z = ae^{-\psi-i\theta}$ , the inverse and reflected circle of  $B$  with respect to the circle of radius  $a$  at the origin (obtained by the transformation of reciprocal radii and subsequent reflection in the  $x$  axis). Thus  $OP \cdot OP' = a^2$  for all positions of  $P$ , and  $OP'$  is readily constructed. The center  $M_1$  of the circle  $B'$  may be located on the line  $AM$  by drawing  $OM_1$  symmetrically to  $OM$  with respect to the  $y$  axis. Let the coordinate of  $M$  be  $z = is + de^{i\theta}$ , where  $d$ ,  $s$ , and  $\beta$  are real quantities. The circle of radius  $a$ , with center  $M_0$  at  $z = is$ , is transformed into a circular arc through  $A, A_1$  which may be considered the mean camber line of the airfoil. At the tail the Joukowski airfoil has a cusp and the upper and lower surfaces include a zero angle. The lift parameters are

$$R = \sqrt{a^2 + s^2} + d, \quad \beta = \tan^{-1} \frac{s}{a}, \quad a_1 = a^2 = b^2 e^{2i\gamma} \quad \text{or} \quad b = a \quad \text{and} \quad \gamma = 0.$$

Since  $\gamma = 0$ , the second axis has the direction of the  $x$  axis. The focus  $F$  is determined by laying off the segment  $MF = \frac{a^2}{R}$  on the line  $MA'$ . This quantity, it may be noted, is obtained easily by the following construction. In triangle  $MDC'$ ,  $MD = R$ ,  $MC'$  and  $MC$  are made equal to  $a$ , then  $CF$  drawn parallel to  $DC'$  determines  $MF = \frac{a^2}{R}$ . The lift parabola may be now determined uniquely since its directrix  $AM$  and focus  $F$  are known.

It may be observed that if it is desired to transform a preassigned Joukowski profile into a circle, there exists a choice of axis and origin for the airfoil such that the inverse of transformation (5) will map the airfoil directly into a circle. This axis is very approximately given by designating the tail as  $(-2a, 0)$  and the point midway between the leading edge and the center of curvature of the leading edge as  $(+2a, 0)$  the origin then bisecting the line joining these points.

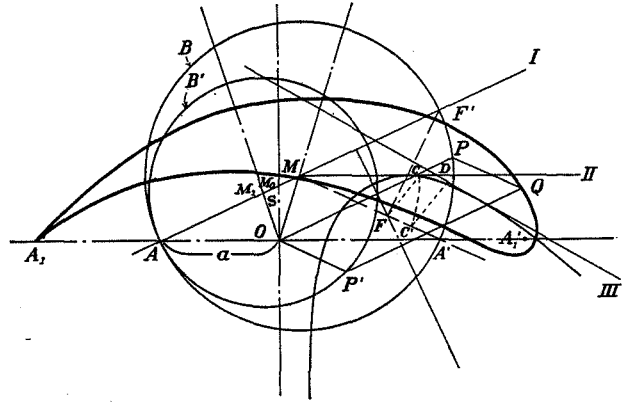

FIGURE 22.—The Joukowski airfoil

The complex potential flow function for the Joukowski airfoil is

$$w(\zeta) = -V \left[ g(\zeta) e^{i\alpha} + \frac{R^2 e^{-i\alpha}}{g(\zeta)} \right] + \frac{i\Gamma}{2\pi} \log g(\zeta) \quad (61)$$

where

$$g(\zeta) = \frac{\zeta}{2} \pm \sqrt{\left(\frac{\zeta}{2}\right)^2 + a^2 - m}$$

By equation (39) we have for the velocity at the surface

$$v = \frac{V [\sin(\alpha + \varphi) + \sin(\alpha + \beta)] \left(1 + \frac{d\epsilon}{d\theta}\right) e^{i\psi_0}}{\sqrt{(\sinh^2 \psi + \sin^2 \theta) \left(1 + \left(\frac{d\psi}{d\theta}\right)^2\right)}}$$

This formula was obtained by transforming the flow around  $C$  into that around  $B$  and then into that around  $A$ . Since we know that  $B$  is itself a circle for this case, we can simply use the latter two transformations alone.

We get

$$v = \frac{V [\sin(\alpha + \varphi) + \sin(\alpha + \beta)] e^{i\psi}}{\sqrt{\sinh^2 \psi + \sin^2 \theta}} \quad (62)$$

That these formulas are equivalent is immediately evident since the quantity

$$\frac{e^{i\psi_0 - \psi} \left(1 + \frac{d\epsilon}{d\theta}\right)}{\sqrt{1 + \left(\frac{d\psi}{d\theta}\right)^2}}$$

is unity being the ratio of the magnification of each arc element of  $C$  to that of  $B$ . (See eq. (37).)

A very simple geometrical picture of the parameters  $\epsilon$  and  $\psi$ , exists for the cases discussed. In Figure 23 the value of  $\epsilon$  or  $\varphi - \theta$  at the point  $P$  is simply

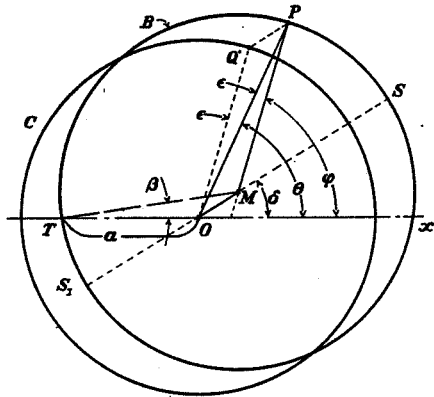

FIGURE 23.—Geometrical representation of  $\epsilon$  and  $\psi$  for Joukowski airfoils

angle  $OPM$ , i. e., the angle subtended at  $P$  by the origin  $O$  and the center  $M$ . The angle of zero lift is the value of  $\epsilon$  for  $\theta = \pi$ ; i. e.,  $\epsilon_{Tail} = \beta = OTM$ . In particular, we may note that  $\epsilon = 0$  at  $S$  and  $S_1$  which are on the straight line  $OM$ . Consider the triangle  $OMP$ , where  $OP = ae^{\psi}$ ,  $MP = R = ae^{\psi_0}$ ,  $\frac{OM}{MP} = \rho$ , angle  $OPM = \epsilon$ ; also,  $MOX = \delta$ ,  $MOP = \theta - \delta$ ,  $OMP = \pi - (\varphi - \delta)$ . Then by the law of cosines, we have

$$e^{2(\psi - \psi_0)} = 1 + 2\rho \cos(\varphi - \delta) + \rho^2$$

or

$$\psi - \psi_0 = \frac{1}{2} \log (1 + 2\rho \cos(\varphi - \delta) + \rho^2) \quad (63)$$

$$= \sum_1^{\infty} (-1)^{n-1} \frac{\cos n(\varphi - \delta)}{n} \rho^n$$

and by the law of sines

$$\sin \epsilon = \frac{\rho \sin(\varphi - \delta)}{(1 + 2\rho \cos(\varphi - \delta) + \rho^2)^{1/2}}$$

or

$$\begin{aligned} \epsilon(\varphi) &= \tan^{-1} \frac{\rho \sin(\varphi - \delta)}{1 + \rho \cos(\varphi - \delta)} \\ &= \sum_1^{\infty} (-1)^{n-1} \frac{\sin n(\varphi - \delta)}{n} \rho^n \end{aligned} \quad (64)$$

We see that, as required, the expressions for the "radial distortion"  $\psi(\varphi)$  and the "angular distortion"  $\epsilon(\varphi)$  are conjugate Fourier series and may be expressed as a single complex quantity

$$\begin{aligned} (\psi - \psi_0) - i\epsilon &= \sum_1^{\infty} \frac{(-1)^{n-1}}{n} \rho^n e^{-in(\varphi - \delta)} \\ &= -\log [1 + \rho e^{-i(\varphi - \delta)}] \end{aligned}$$

It is evident also that the coefficient for  $n=1$  or the "first harmonic term" is simply  $\rho e^{i\delta}$  and a translation by this quantity brings the circle  $C$  into coincidence with  $B$  as was pointed out on page 13.

The constant  $\psi_0 = \frac{1}{2\pi} \int_0^{2\pi} \psi d\varphi$  is readily shown to be

invariant to the choice of origin  $O$ , as long as  $O$  is within  $B$ . We have

$$\begin{aligned} \frac{1}{2\pi} \int_0^{2\pi} \psi d\varphi &= \frac{1}{2\pi} \int_0^{2\pi} \frac{1}{2} \log (1 + 2\rho \cos(\varphi - \delta) + \rho^2) e^{2\psi_0} d\varphi \\ &= \frac{1}{2\pi} \int_0^{2\pi} \left( \psi_0 + \sum_1^{\infty} \frac{(-1)^{n-1} \cos n(\varphi - \delta)}{n} \rho^n \right) d\varphi = \psi_0 \end{aligned}$$

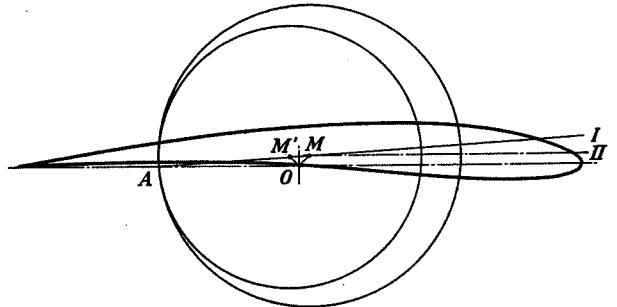

FIGURE 24.—The Joukowski airfoil  $\rho=0.10$ ,  $\delta=45^\circ$

Figure 24 shows the Joukowski airfoil defined by  $\rho=0.10$  and  $\delta=45^\circ$ , and Figure 25 shows the  $\psi(\theta)$ ,  $\psi(\varphi)$ ,  $\epsilon(\theta)$ , and  $\epsilon(\varphi)$  curves for this airfoil.

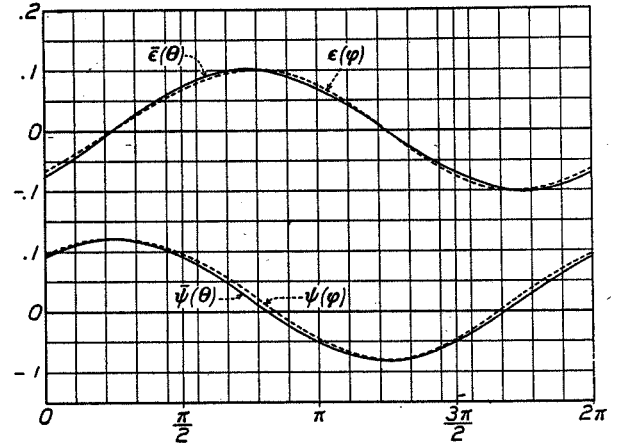

FIGURE 25.—The  $\epsilon(\theta)$  and  $\psi(\theta)$  curves for the airfoil in Figure 24

**Arbitrary sections.**—In order to obtain the lift parameters of an arbitrary airfoil, a convenient choice of coordinate axes is first made as indicated for the Joukowski airfoil and as stated previously. (Page 7.) The curve resulting from the use of transformation (5) will yield an arbitrary curve  $ae^{\psi+i\theta}$  which will, in general, differ very little from a circle. The inverse and reflected curve  $ae^{-\psi-i\theta}$  will also be almost circular. The transition from the curve  $ae^{\psi+i\theta}$  to a circle is reached by obtaining the solution  $\epsilon(\varphi)$  of equation (13). The method of obtaining this solution as already given converges with extreme rapidity for nearly circular curves.

The geometrical picture is analogous to that given for the special cases. In Figure 26 it may be seen that a point  $Q$  on the airfoil (N. A. C. A. -M6) corre-

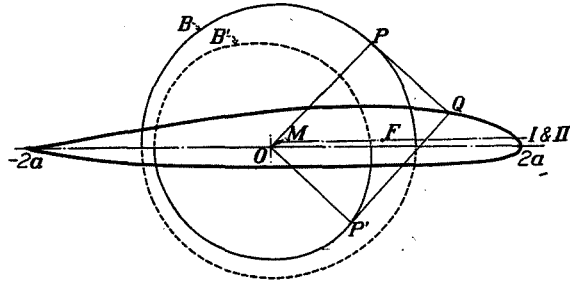

FIGURE 26.—The N. A. C. A. -M6 airfoil

sponding to  $P$  on the  $B$  curve (or  $P'$  on the  $B'$  curve) is obtained by constructing parallelogram  $OPQP'$ . The  $\bar{\psi}(\theta)$  and  $\epsilon(\theta)$  curves are shown in Figure 27 for this airfoil. The complex velocity potential and the expression for velocity at the surface are given respec-

The method used for arbitrary airfoils is readily applied to arbitrary thin arcs or to broken lines such as the sections of tail surfaces form approximately. In Figure 26 the part of the airfoil boundary above the  $x$  axis transforms by equation (5) into the two discontinuous arcs shown by full lines, while the lower boundary transforms into the arcs shown by dashed lines. If the upper boundary surface is alone given (thin airfoil) we may obtain a closed curve  $ae^{i\psi+i\theta}$  only by joining the end points by a chord of length  $4a$  and choosing the origin at its midpoint.<sup>25</sup> The resulting curve has two double points for which the first derivative is not uniquely defined and, in general, it may be seen that infinite velocities correspond to such points.

At a point of the  $\bar{\psi}(\theta)$  curve corresponding to a mathematically sharp corner, there exist two tangents, that is, the slope  $\frac{d\bar{\psi}(\theta)}{d\theta}$  is finitely discontinuous. The

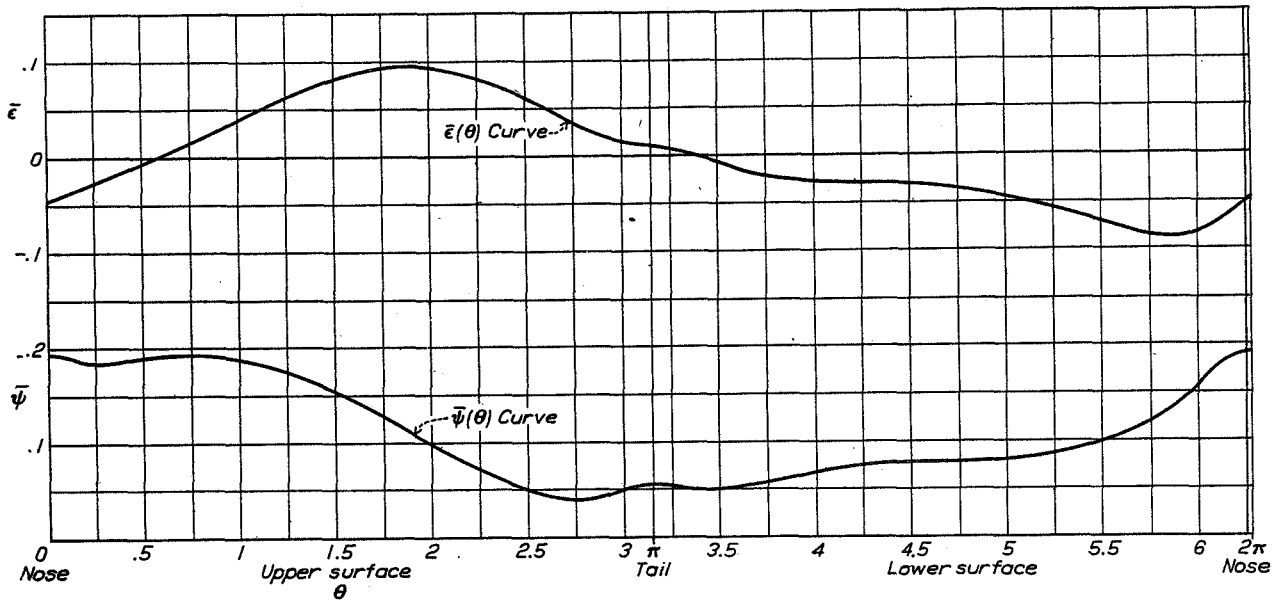

FIGURE 27.—The  $\epsilon(\theta)$  and  $\bar{\psi}(\theta)$  curves for the N. A. C. A. -M6 airfoil

tively by equations (33) and (39). The lift parameters are

$$R = ae^{\psi_0}, \beta = \epsilon_{tail} \text{ (at } \theta = \pi), M \text{ is at } z = c_1 = \frac{R}{\pi} \int_0^\pi \psi(\varphi) e^{i\varphi} d\varphi$$

and  $F$  is at  $z = c_1 + \frac{a_1}{R}$  where  $a_1$  is given in equation (25').

The first and second axes for the N. A. C. A. -M6 airfoil are found to coincide and this airfoil has then a constant center of pressure at  $F$ . Figures 28 (a) to 28 (l) give the pressure distribution (along the  $x$  axis) for a series of angles of attack as calculated by this theory and as obtained by experiment.<sup>24</sup> Table I contains the essential numerical data for this airfoil.

curve  $\bar{\epsilon}(\theta)$  must have an infinite slope at such a point for according to a theorem in the theory of Fourier series, at a point of discontinuity of a F. S., the conjugate F. S. is properly divergent. This manifests itself in the velocity-formula equation (39) in the factor  $(1 + \frac{d\bar{\epsilon}}{d\theta})$  which is infinite at these sharp corners. For practical purposes, however, a rounding of the sharp edge, however small, considerably alters the slope  $\frac{d\bar{\epsilon}(\theta)}{d\theta}$  at this point.

**Ideal angle of attack.**—A thin airfoil, represented by a line arc, has both a sharp leading edge and a sharp trailing edge. The Kutta assumption for fixing the circulation places a stagnation point at the tail for all angles of attack. At the leading edge, however,

<sup>24</sup> The experimental results are taken from test No. 323 of the N. A. C. A. variable-density wind tunnel. The angle of attack  $\alpha$  substituted in equation (39) has been modified arbitrarily to take account of the effects of finite span, tunnel-wall interference, and viscosity, by choosing it so that the theoretical lift is about 10 per cent more than the corresponding experimental value. The actual values of the lift coefficients are given in the figures.

<sup>25</sup> Note that  $\bar{\psi}(\theta + \pi) = -\bar{\psi}(\theta)$  for this case.

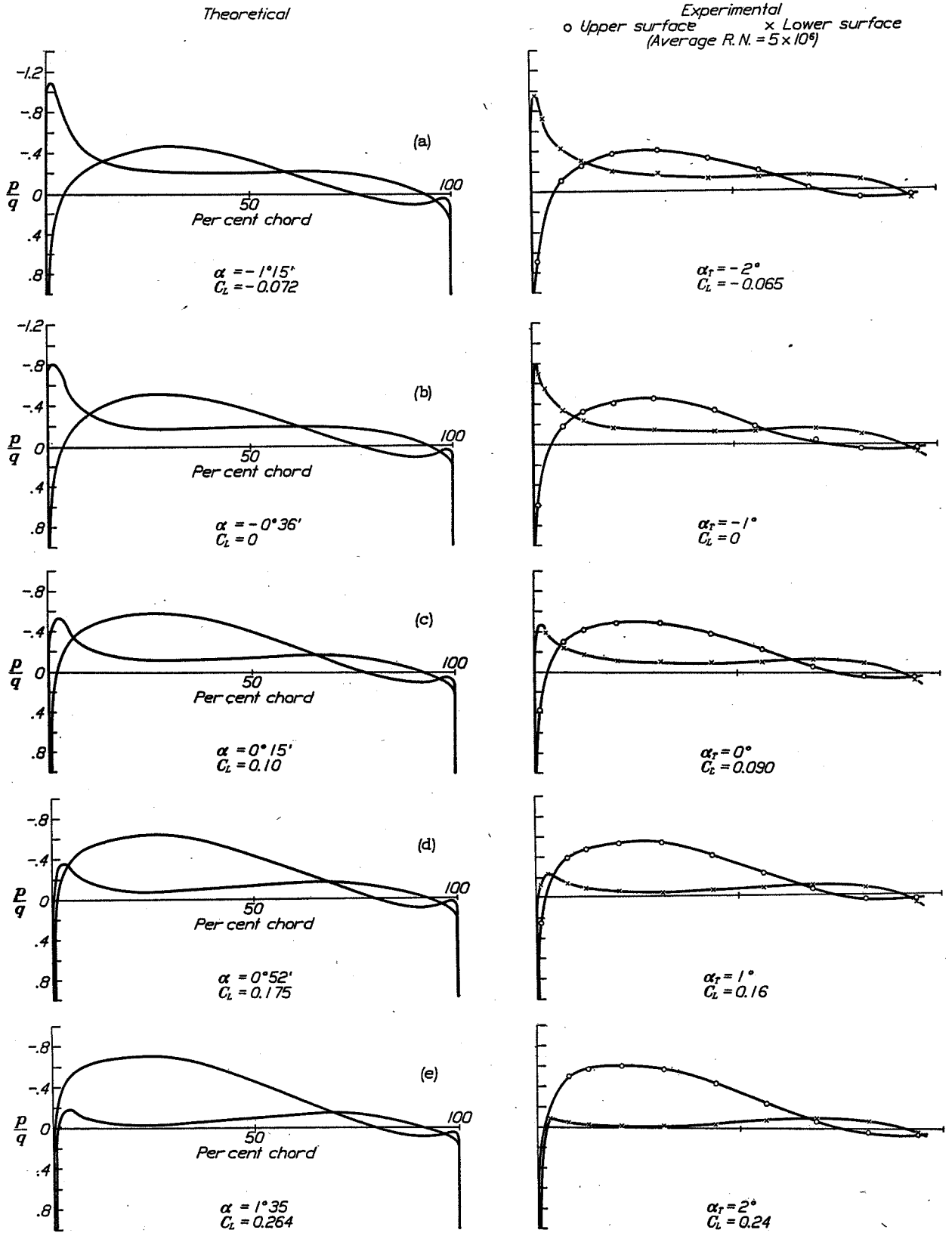

FIGURES 28 a to e.—Theoretical and experimental pressure distribution for the M6 airfoil at various angles of attack



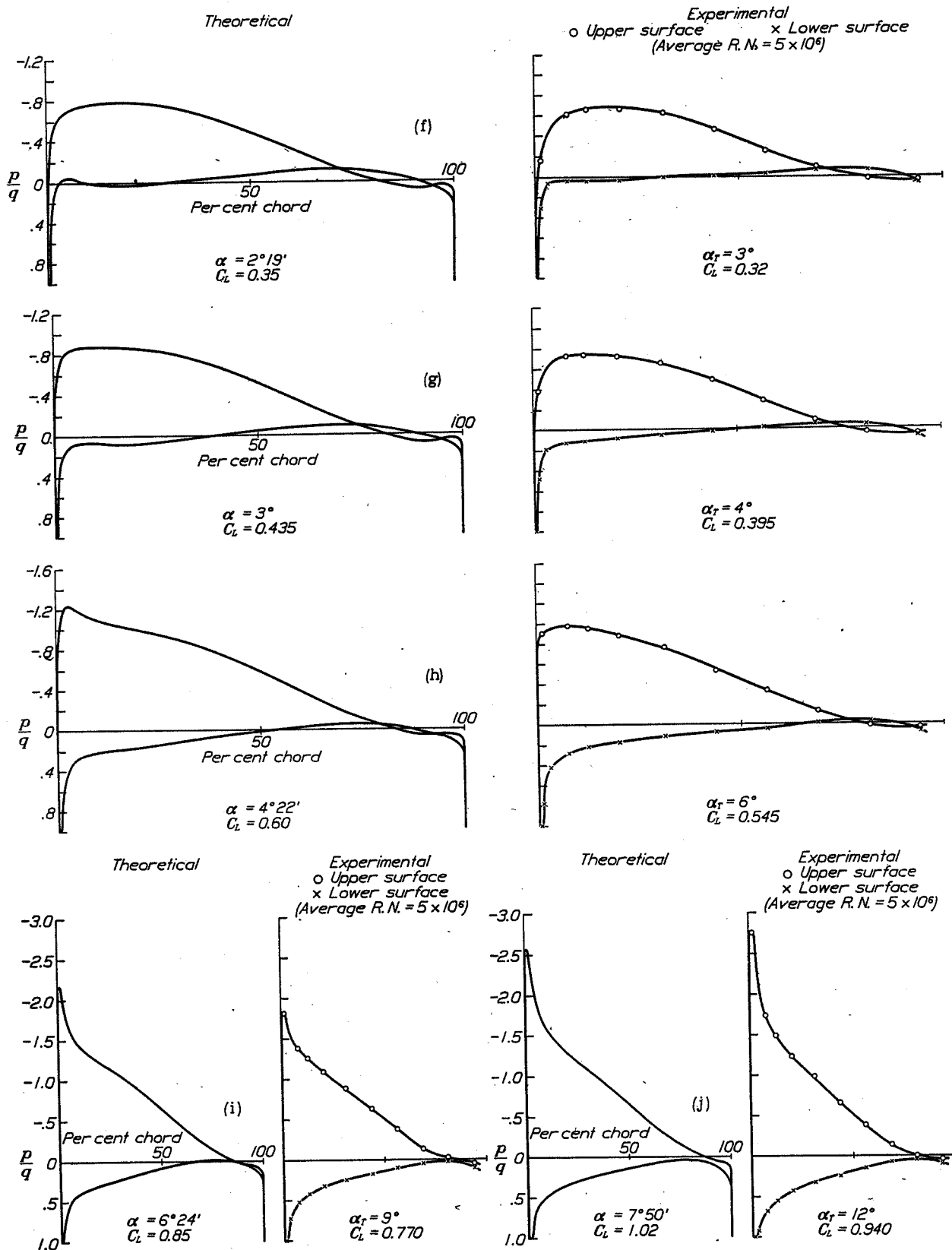

FIGURES 28 f to j.—Theoretical and experimental pressure distribution for the M6 airfoil at various angles of attack

the velocity is infinite at all angles of attack except one, namely, that angle for which the other stagnation point is at the leading edge. It is natural to expect that for this angle of attack in actual cases the frictional losses are at or near a minimum and thus arises the concept of "ideal" angle of attack introduced by Theodorsen (reference 8) and which has also been designated "angle of best streamlining." The definition for the ideal angle may be extended to thick airfoils, as that angle for which a stagnation point occurs directly at the foremost point of the mean camber line.

The lift at the leading edge vanishes and the change from velocity to pressure along the airfoil surface is usually more gradual than at any other angle of attack.

of this function, one can determine airfoil shapes of definite properties. The  $\epsilon(\varphi)$  function, which we have designated conformal angular distortion function, will be seen to determine not only the shape but also to give easily all the theoretical aerodynamic characteristics of the airfoil.

An arbitrary  $\epsilon(\varphi)$  curve is chosen, single valued, of period  $2\pi$ , of zero area, and such that  $-\infty \leq \frac{d\epsilon}{d\varphi} \leq 1$ .

These limiting values of  $\frac{d\epsilon}{d\varphi}$  are far beyond values yielding airfoil shapes.<sup>27</sup> The  $\psi(\varphi)$  function, except for the constant  $\psi_0$ , is given by the conjugate of the Fourier expansion of  $\epsilon(\varphi)$  or, what is the same, by evaluating equation (14) as a definite integral. The

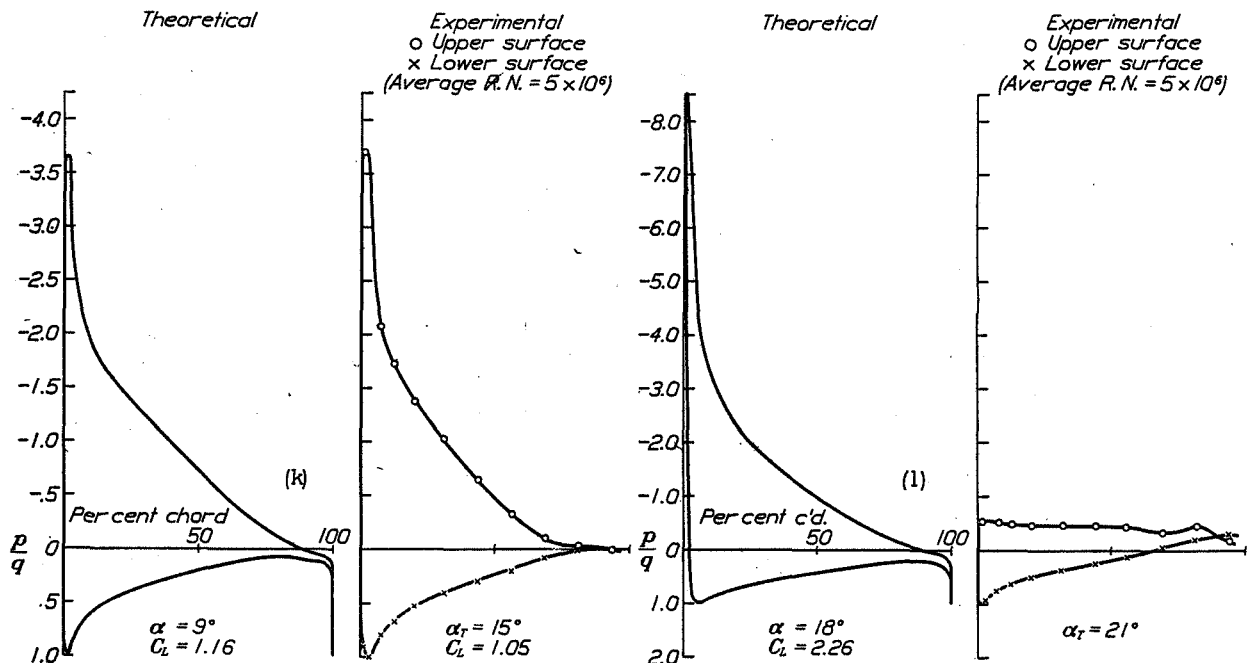

FIGURES 28 k to l.—Theoretical and experimental pressure distribution for the M6 airfoil at various angles of attack

The minimum profile drag of airfoils actually occurs very close to this angle. At the ideal angle, which we denote by  $\alpha_I$ , the factor  $[\sin(\alpha + \varphi) + \sin(\alpha + \beta)]$  in equation (38) is zero not only for  $\theta = \pi$  or  $\epsilon = \epsilon_T = \beta$  but also for  $\theta = 0$  or  $\epsilon = \epsilon_N$ . We get

$$\begin{aligned} \alpha_I + \epsilon_N &= -(\alpha_I + \epsilon_T) \text{ or} \\ \alpha_I &= -\frac{(\epsilon_N + \epsilon_T)}{2} \end{aligned} \quad (65)$$

#### CREATION OF FAMILIES OF WING SECTIONS

The process of transforming a circle into an airfoil is inherently less difficult than the inverse process of transforming an airfoil into a circle. By a direct application of previous results we can derive a powerful and flexible method for the creation of general families of airfoils. Instead of assuming that the  $\psi(\theta)$  curve is preassigned (that is, instead of a given airfoil), we assume an arbitrary  $\psi(\varphi)$  or  $\epsilon(\varphi)$  curve<sup>28</sup> as given. This is equivalent to assuming as known a boundary-value function along a circle and, by the proper choice

constant  $\psi_0$  is an important arbitrary<sup>28</sup> parameter which permits of changes in the shape and for a certain range of values may determine the sharpness of the trailing edge.

We first obtain the variable  $\theta$  as  $\theta(\varphi) = \varphi - \epsilon(\varphi)$ , so that the quantity  $\psi$  considered as a function of  $\theta$  is  $\psi(\theta) = \psi[\varphi(\theta)]$ . The coordinates of the airfoil surface are then

$$\begin{aligned} x &= 2a \cosh \psi \cos \theta \\ y &= 2a \sinh \psi \sin \theta. \end{aligned} \quad (6)$$

<sup>27</sup> For common airfoils, with a proper choice of origin,  $|\frac{d\epsilon}{d\varphi}| \ll 0.30$ .

<sup>28</sup> For common airfoils  $\psi_0$  is usually between 0.05 and 0.15. The constant  $\psi_0$  is not, however, completely arbitrary. We have seen that the condition given by equation (22) is sufficient to yield a contour free from double points in the  $z'$  plane. We may also state the criterion that the inverse of equation (5) applied to this contour shall yield a contour in the  $\zeta$  plane free from double points. Consider the function  $\psi(\theta)$  for  $\theta$  varying from 0 to  $\pi$  only. The negative of each value of  $\psi(\theta)$  in this range is considered associated with  $-\theta$ , i. e.,  $\pi \leq \theta \leq 2\pi$ . Designate the function thus formed from  $\theta = 0$  to  $2\pi$  by  $\psi(\theta)^*$ . Then  $\psi(\theta)^*$  represents a line arc in the  $\zeta$  plane, i. e., the upper surface of a contour. [See footnote 25.] Then for the entire contour to be free from double points it is necessary that the lower surface should not cross the upper, that is, the original  $\psi(\theta)$  curve for  $\theta$  varying from  $\pi$  to  $2\pi$  must not cross below  $\psi(\theta)^*$ .

<sup>28</sup> Subject to some general restrictions given in the next paragraph.

The velocity at the surface is

$$v = V \frac{[\sin(\alpha + \varphi) + \sin(\alpha + \beta)] e^{\psi_0}}{\sqrt{(\sinh^2 \psi + \sin^2 \theta) \left[ \left(1 - \frac{d\epsilon}{d\varphi}\right)^2 + \left(\frac{d\psi}{d\varphi}\right)^2 \right]}} \quad (39')$$

and is obtained by using equation (37') instead of (37) in deriving (39). The angle of zero lift  $\beta$  is given by  $\varphi(\theta) = \theta + \bar{\epsilon}(\theta)$  for  $\theta = \pi$ , i. e.,  $\varphi(\pi) = \pi + \beta$ .

The following figures and examples will make the process clear. We may first note that the most natural method of specifying the  $\epsilon(\varphi)$  function is by a Fourier series expansion. In this sense then the elementary types of  $\epsilon(\varphi)$  functions are the individual terms of this expansion.

29(h) to 29(t). In particular, the second harmonic term may yield S shapes, and by a proper combination of first and second harmonic terms, i. e., by a proper choice of the constants  $A_1, A_2, \delta_1$ , and  $\delta_2$  in the relation

$$\epsilon(\varphi) = A_1 \sin(\varphi - \delta_1) + A_2 \sin(2\varphi - \delta_2)$$

it is possible to fix the focus  $F$  of the lift parabola as the center of pressure for all angles of attack.<sup>29</sup> The equation

$$\epsilon(\varphi) = 0.1 \sin(\varphi - 60^\circ) + 0.05 \cos 2\varphi$$

represents such an airfoil and is shown in Figure 29(u).

The general process will yield infinite varieties of contours by superposition of sine functions; in fact, if

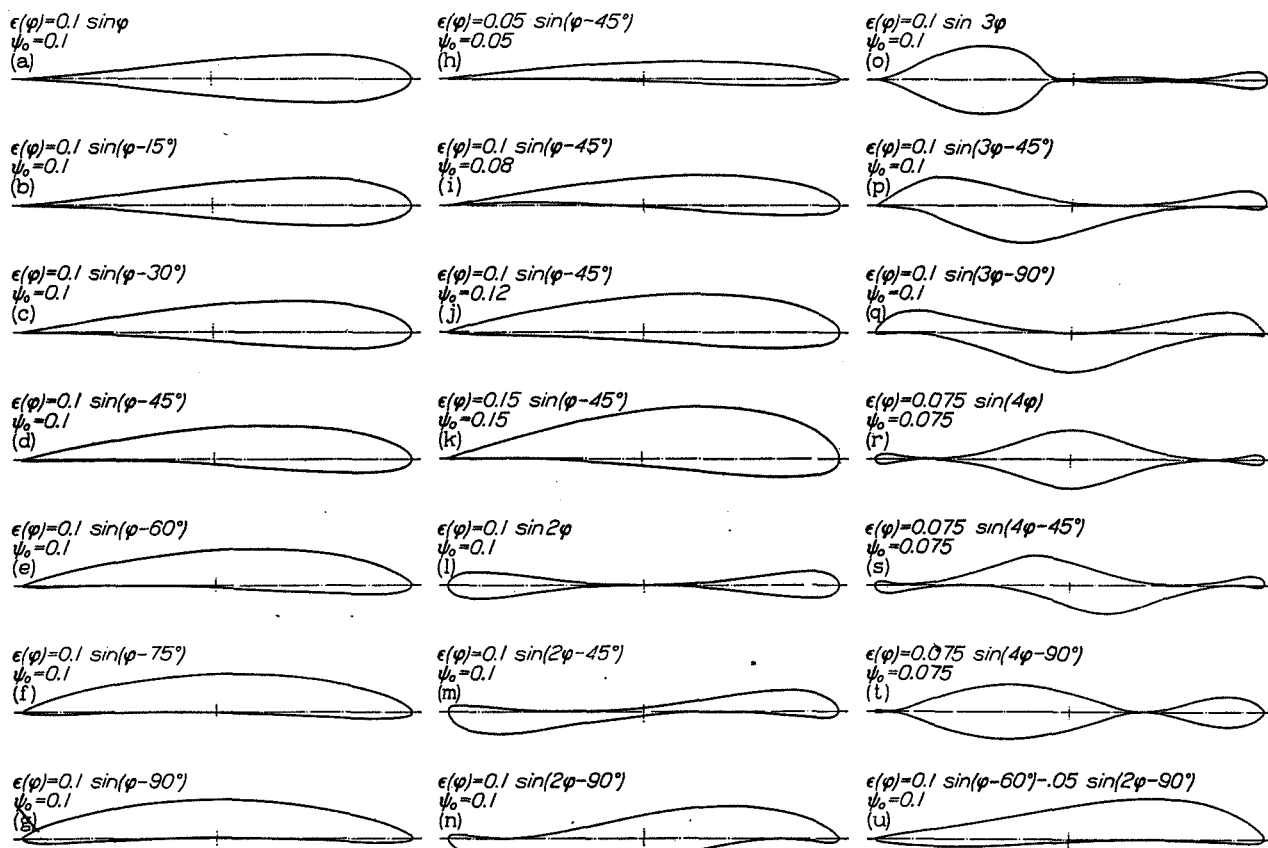

FIGURE 29.—Airfoils created by varying  $\epsilon(\varphi)$

Consider first the effect of the first harmonic term

$$\epsilon(\varphi) = A_1 \sin(\varphi - \delta_1), \psi_0 = c$$

In Figures 29(a) to 29(g) may be seen the shapes resulting by displacing  $\delta_1$  successively by intervals of  $15^\circ$  and keeping the constants  $A_1 = 0.10$  and  $\psi_0 = 0.10$ . The first harmonic term is of chief influence in determining the airfoil shape. The case  $\epsilon(\varphi) = 0.1 \sin(\varphi - 45^\circ)$  is given detailed in Table II. (This airfoil is remarkably close to the commonly used Clark Y airfoil.) The entire calculations are characterized by their simplicity and, as may be noted, are completely free from the necessity of any graphical evaluations or constructions.

The effect of the second and higher harmonics as well as the constant  $\psi_0$  may be observed in Figures

the process is thought of as a boundary-value problem of the circle, it is seen that it is sufficiently general to yield every closed curve for which Riemann's theorem applies.

LANGLEY MEMORIAL AERONAUTICAL LABORATORY,  
NATIONAL ADVISORY COMMITTEE FOR AERONAUTICS,  
LANGLEY FIELD, VA., November 4, 1932.

<sup>29</sup> This is accomplished as follows: We seek to determine the constants  $A_1, A_2, \delta_1$ , and  $\delta_2$  so that  $\beta = \gamma$ , where  $\gamma$  is obtained from equation (25') as  $a_1 = b^2 e^{2i\gamma} = a^2 + \frac{c_1^2}{2} + c_2$  and we may note that  $\frac{c_1}{a^2 e^{i\gamma}} = A_1 e^{i\delta_1}$  and  $\frac{c_2}{a^2 e^{i\gamma}} = A_2 e^{i\delta_2}$ . These relations are transcendental; however, with but a few practice trials, solutions can be obtained at will. Addition of higher harmonics will yield further shapes having the same center of pressure properties if  $\beta$  is kept unchanged.

## APPENDIX

### I. EVALUATION OF THE INTEGRAL.

$$\epsilon(\varphi') = -\frac{1}{2\pi} \int_0^{2\pi} \psi(\varphi) \cot \frac{\varphi - \varphi'}{2} d\varphi \quad (13)$$

$$= \frac{1}{\pi} \int_0^{2\pi} \frac{d\psi(\varphi)}{d\varphi} \log \left| \sin \frac{\varphi - \varphi'}{2} \right| d\varphi \quad (13')$$

The function  $\psi(\varphi)$  is of period  $2\pi$  and is considered known. (Note that the variables  $\varphi$  and  $\varphi'$  are replaced by  $\theta$  and  $\theta'$ ,  $\varphi_1$  and  $\varphi_1'$ ,  $\varphi_2$  and  $\varphi_2'$ , etc., in equation (21) and that the following formula is applicable for all these cases.)

A 20-point method for evaluating equation (13) as a definite integral gives

$$\epsilon(\varphi') \cong -\frac{1}{\pi} \left[ a_0 \frac{d\psi(\varphi)}{d\varphi} + a_1(\psi_1 - \psi_{-1}) + a_2(\psi_2 - \psi_{-2}) + \dots + a_9(\psi_9 - \psi_{-9}) \right]_{\varphi=\varphi'} \quad (I)$$

where

$$\psi_1 = \text{value of } \psi(\varphi) \text{ at } \varphi = \varphi' + \frac{\pi}{10}$$

.....

$$\psi_n = \text{value of } \psi(\varphi) \text{ at } \varphi = \varphi' + \frac{n\pi}{10}$$

$$(n=1, -1, 2, -2, \dots, 9, -9).$$

and the constants  $a_n$  are as follows:  $a_0 = \frac{\pi}{10} = 0.3142$ ;  $a_1 = 1.091$ ;  $a_2 = 0.494$ ;  $a_3 = 0.313$ ;  $a_4 = 0.217$ ;  $a_5 = 0.158$ ;  $a_6 = 0.115$ ;  $a_7 = 0.0884$ ;  $a_8 = 0.0511$ ; and  $a_9 = 0.0251$ .

This formula may be derived directly from the definition of the definite integral. The 20 intervals<sup>1</sup> chosen are  $\varphi - \frac{\pi}{20}$  to  $\varphi + \frac{\pi}{20}$ ,  $\varphi + \frac{\pi}{20}$  to  $\varphi + \frac{3\pi}{20}$ , etc.

It is only necessary to note that by expanding  $\psi(\varphi)$  in a Taylor series around  $\varphi = \varphi'$  we get

$$\frac{1}{2} \int_{\varphi'-s}^{\varphi'+s} \psi(\varphi) \cot \frac{\varphi - \varphi'}{2} d\varphi \cong -2s \left[ \frac{d\psi(\varphi)}{d\varphi} \right]_{\varphi=\varphi'}$$

where the interval  $\varphi' - s$  to  $\varphi' + s$  is small. And, in general,

$$\frac{1}{2} \int_{\varphi_1}^{\varphi_2} \psi(\varphi) \cot \frac{\varphi - \varphi'}{2} d\varphi$$

is very nearly

$$-\psi_A \log \left| \frac{\sin \frac{\varphi - \varphi_2}{2}}{\sin \frac{\varphi - \varphi_1}{2}} \right|$$

where the range  $\varphi_2 - \varphi_1$  is small and  $\psi_A$  is the average value of  $\psi(\varphi)$  in this range. The constants  $a_n$  for the 20 divisions chosen above are actually

$$a_n = \log \left| \frac{\sin \pi \frac{2n+1}{40}}{\sin \pi \frac{2n-1}{40}} \right| \quad (n = -9, \dots, +9)$$

As an example of the calculation of  $\bar{\epsilon}(\theta)$  we may refer to Table I and Figures 26 and 27 for the N. A. C. A. -M6 airfoil. From the  $\bar{\psi}(\theta)$  curve (fig. 27) we obtain the 20 values of  $\psi$  and  $\frac{d\bar{\psi}}{d\theta}$  for 20 equal intervals of  $\theta$ .

For the airfoil (fig. 26) we get the following values:

	(Upper $\theta$ surface)	$\psi$	$\frac{d\bar{\psi}}{d\theta}$	(Lower $\theta$ surface)	$\psi$	$\frac{d\bar{\psi}}{d\theta}$
0 (nose)	0.192	0.000	$\frac{11\pi}{10}$	0.049	-0.002	
$\frac{\pi}{10}$	.185	.027	$\frac{12\pi}{10}$	.057	.050	
$\frac{2\pi}{10}$	.192	.000	$\frac{13\pi}{10}$	.071	.030	
$\frac{3\pi}{10}$	.189	-.030	$\frac{14\pi}{10}$	.077	.011	
$\frac{4\pi}{10}$	.174	-.064	$\frac{15\pi}{10}$	.079	.000	
$\frac{5\pi}{10}$	.146	-.095	$\frac{16\pi}{10}$	.082	.016	
$\frac{6\pi}{10}$	.110	-.114	$\frac{17\pi}{10}$	.090	.039	
$\frac{7\pi}{10}$	.077	-.086	$\frac{18\pi}{10}$	.111	.091	
$\frac{8\pi}{10}$	.052	-.066	$\frac{19\pi}{10}$	.150	.154	
$\frac{9\pi}{10}$	.041	.025	$2\pi$ (nose)	.192	.000	
$\pi$ (tail)	.055	.000				

The value of  $\epsilon$  at the tail (i. e., the angle of zero lift) is, for example, using formula I

$$\begin{aligned} \epsilon = & -\frac{1}{\pi} \left[ \frac{\pi}{10} \times 0 \right. \\ & + 1.091(.049 - .041) \\ & + .494(.057 - .052) \\ & + .313(.071 - .077) \\ & + .217(.077 - .110) \\ & + .158(.079 - .146) \\ & + .115(.082 - .174) \\ & + .0884(.090 - .189) \\ & + .0511(.111 - .192) \\ & \left. + .0251(.150 - .185) \right] = .0105 \end{aligned}$$

<sup>1</sup> Reference 2, p. 11, gives a 10-point method result.

The value of  $\epsilon$  for  $\theta = \frac{3\pi}{10}$ , for example, is obtained by a cyclic rearrangement. Thus,

$$\begin{aligned} \epsilon = & -\frac{1}{\pi} \int_0^{\frac{\pi}{10}} (-.030) \\ & + 1.091(.174 - .192) \\ & + .494(.146 - .185) \\ & + .313(.110 - .192) \\ & + .217(.077 - .150) \\ & + .158(.052 - .111) \\ & + .115(.041 - .090) \\ & + .0884(.055 - .082) \\ & + .0511(.049 - .079) \\ & + .0251(.057 - .077)] = .0347 \end{aligned}$$

The 20 values obtained in this way form the  $\bar{\epsilon}_1(\theta)$  curve, which for all practical purposes for the airfoil considered, is actually identical with the final  $\bar{\epsilon}(\theta)$  curve.

II. NOTES ON THE TRANSFORMATION.

$$\zeta = f(z) = c_1 + z + \frac{a_1}{z} + \frac{a_2}{z^2} + \dots \quad (4')$$

There exist a number of theorems giving general limiting values for the coefficients of the transformation equation (4), which are interesting and to some extent useful. If  $\zeta = f(z)$  transforms the external region of the circle  $C$  of radius  $R$  in the  $z$  plane, into the external region of a contour  $A$  in the  $\zeta$  plane in a one-to-one conformal manner and the origin  $\zeta = 0$  lies within the contour  $A$  (and  $f'(\infty) = 1$ ) then the area  $S$  inclosed by  $A$  is given by the Faber-Bieberbach theorem as <sup>2</sup>

$$S = R^2\pi - \sum_{n=1}^{\infty} \frac{n|a_n|^2}{R^{2(n+1)}}$$

Since all members of the above series term are positive, it is observed that the area of  $C$  is greater than that inclosed by any contour  $A$  in the  $\zeta$  plane (or, at most, equal to the area inclosed by  $A$  if  $A$  is a circle).

This theorem leads to the following results

$$\begin{aligned} |a_1| & \leq R^2 & (a) \\ |c_1| & \leq 2R & (b) \end{aligned}$$

Let us designate the circle of radius  $R$  about the conformal centroid  $M$  as center as  $C_1$  (i. e., the center is at  $\zeta = c_1$ ; this circle has been called the "Grundkreis" or "basic" circle by von Mises). Then since  $\frac{|a_1|}{R}$  represents the distance of the focus  $F$  from  $M$ , the relation (a) states that the focus is always within  $C_1$ . In fact, a further extension shows that if  $r_0$  is the radius of the largest circle that can be inclosed within  $A$ , then  $F$  is removed from  $C_1$  by at least  $\frac{r_0^2}{R}$ .

<sup>2</sup> For details of this and following statements see reference 5, p. 100 and p. 147, and also reference 6, Part II.

From relation (b) may be derived the statement that if any circle within  $A$  is concentrically doubled in radius it is contained entirely within a circle about  $M$  as center of radius  $2R$ . Also, if we designate by  $c$  the largest diameter of  $A$  (this is usually the "chord" of the airfoil) then the following limits can be derived:

$$\begin{aligned} R & \geq \frac{1}{4}c \\ R & \leq \frac{1}{2}c \end{aligned}$$

These inequalities lead to interesting limits for the lift coefficient. Writing the lift coefficient as

$$C_L = \frac{L}{\frac{1}{2}\rho V^2 c}$$

where by equation (45) the lift force is given by

$$L = 4\pi R\rho V^2 \sin(\alpha + \beta)$$

we have

$$2\pi \sin(\alpha + \beta) \leq C_L \leq \frac{8\pi R}{c} \sin(\alpha + \beta) \leq 4\pi \sin(\alpha + \beta) \quad (II)$$

The flat plate is the only case where the lower limit is reached, while the upper limit is attained for the circular cylinder only. We may observe that a curved thin plate has a lift coefficient which exceeds  $2\pi \sin(\alpha + \beta)$  by a very small amount. In general, the thickness has a much greater effect on the value of the lift coefficient than the camber. For common airfoils the lift coefficient is but slightly greater than the lower limit and is approximately  $1.1 \times 2\pi \sin(\alpha + \beta)$ .

Another theorem, similar to the Faber-Bieberbach area theorem, states that if the equation  $\zeta = f(z)$  transforms the internal region of a circle in the  $z$  plane into the internal region of a contour  $B$  in the  $\zeta$  plane in a one-to-one conformal manner and  $f'(0) = 1$  (the origins are within the contours) then the area of the circle is less than that contained by any contour  $B$ . This theorem, extended by Bieberbach, has been used in an attempt to solve the arbitrary airfoil.<sup>3</sup> The process used is one in which the area theorem is a criterion as to the direction in which the convergence proceeds. Although theoretically sound, the process is, when applied, extremely laborious and very slowly convergent. It can not be said to have yielded as yet really satisfactory results.

III. LOCATION OF THE CENTER OF PRESSURE FOR AN ARBITRARY AIRFOIL

It is of some interest to know the exact location of the center of pressure on the  $x$  axis as a function of the angle of attack. In Figure 30,  $O$  is the origin,  $M$  the conformal centroid,  $L$  the line of action of the lift force for angle of attack  $\alpha$ . Let us designate the

<sup>3</sup> Müller, W., *Zs. f. angew. Math. u. Mech.* Bd. 5 S. 397, 1925.  
Höhndorf, F., *Zs. f. angew. Math. u. Mech.* Bd. 6 S. 265, 1926.  
Also reference 5, p. 185.

intersection of  $L$  with the  $x$  axis of the airfoil as the center of pressure  $P$ .

In the right  $\triangle ONM$  we have,

$$OM = c_1 = m e^{i\delta} = A_1 + iB_1$$

$$ON = m \cos \delta = A_1$$

$$MN = m \sin \delta = B_1$$

and in right  $\triangle JKM$ ,  $KM = \frac{MJ}{\sin \alpha} = \frac{h_M}{\sin \alpha}$

Then  $KN = \frac{h_M}{\sin \alpha} - B_1$

and  $NP = KN \tan \alpha = h_M \sec \alpha - B_1 \tan \alpha$

By equation (48)

$$h_M = \frac{M_M}{L} = \frac{b^2 \sin 2(\alpha + \gamma)}{2R \sin(\alpha + \beta)}$$

Then the distance from the origin to the center of pressure  $P$  is

$$OP = ON + NP = A_1 - B_1 \tan \alpha + \frac{b^2 \sin 2(\alpha + \gamma)}{2R \cos \alpha \sin(\alpha + \beta)} \quad (\text{III})$$

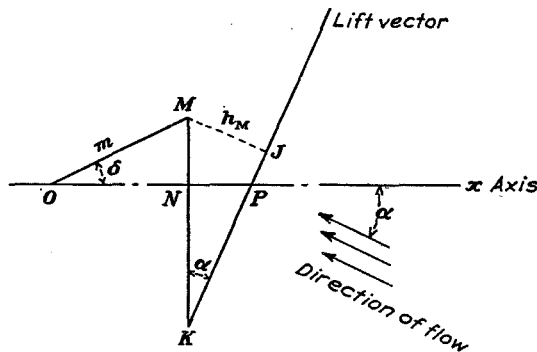

FIGURE 30.—Center of pressure location on the  $x$  axis

#### EXPLANATION OF THE TABLES

Table I gives the essential data for the transformation of the N. A. C. A. -M6 airfoil (shown in fig. 26) into a circle, and yields readily the complete theoretical aerodynamical characteristics. Columns (1) and (2) define the airfoil surface in per cent chord; (3) and (4) are the coordinates after choosing a convenient origin (p. 7); (5) and (6) are obtained from equations (7) and (8) of the report; (9) is the evaluation of equation (13) (see Appendix); (10) and (11) are the slopes, ob-

tained graphically, of the  $\psi$  against  $\theta$ , and  $\epsilon$  against  $\theta$  curves, respectively; (12) is given by

$$\frac{\left(1 + \frac{d\epsilon}{d\theta}\right) e^{\psi_0}}{\sqrt{(\sinh^2 \psi + \sin^2 \theta) \left(1 + \left(\frac{d\psi}{d\theta}\right)^2\right)}}$$

where  $\psi_0 = \frac{1}{2\pi} \int_0^{2\pi} \psi(\varphi) d\varphi$  and may be obtained graphically or numerically; column (13) gives  $\varphi = \theta + \epsilon$ . The velocity  $v$ , for any angle of attack, is by equation (39)

$$v = V k [\sin(\alpha + \varphi) + \sin(\alpha + \beta)]$$

and the pressure is given by equation (3). The angle of zero lift  $\beta$  is the value of  $\epsilon$  at the tail; i. e., the value of  $\epsilon$  for  $\theta = \pi$ .

Table II gives numerical data for the inverse process to that given in Table I; viz, the transformation of a circle into an airfoil. (See fig. 29.) The function  $\epsilon(\varphi) = 0.1 \sin(\varphi - 45^\circ)$  and constant  $\psi_0 = 0.10$  are chosen for this case. Then  $\psi(\varphi) = 0.1 \cos(\varphi - 45^\circ) + 0.10$ . It may be observed that columns (11) and (12) giving the coordinates of the airfoil surface are obtained from equations (6) of the report. Column (13) is given by

$$k = \frac{e^{\psi_0}}{\sqrt{(\sinh^2 \psi + \sin^2 \theta) \left[ \left(1 - \frac{d\epsilon}{d\varphi}\right)^2 + \left(\frac{d\psi}{d\varphi}\right)^2 \right]}}$$

and the velocity at the surface is by equation (39')

$$v = V k [\sin(\alpha + \varphi) + \sin(\alpha + \beta)]$$

#### REFERENCES

1. Lamb, H.: Hydrodynamics. Fifth Edition. Cambridge University Press, 1924.
2. Theodorsen, Theodore.: Theory of Wing Sections of Arbitrary Shape. T. R. No. 411, N. A. C. A., 1931.
3. Kellogg, O. D.: Foundations of Potential Theory. J. Springer, Berlin, 1929.
4. Glauert, H.: The Elements of Aerofoil and Airscrew Theory. Cambridge University Press, 1926.
5. Schmidt, H.: Aerodynamik des Fluges. W. de Gruyter, Berlin, 1929.
6. von Mises, R.: Zur Theorie des Tragflächenantriebs. Zeitschr. f. Flugtechn. u. Motorluftschiffahrt. First Part: (23-24) Bd. 8, 1917. Second Part: (5-6) Bd. 11, 1920.
7. Müller, W.: Mathematische Strömungslehre. J. Springer, Berlin, 1928.
8. Theodorsen, Theodore.: Theory of Wing Sections with Particular Reference to the Lift Distribution. T. R. No. 383, N. A. C. A., 1931.
9. Dryden, Murnaghan, and Bateman: Hydrodynamics. National Research Council, Washington, 1932.

TABLE I  
N. A. C. A.—M6  
UPPER SURFACE

Per cent c	y in per cent c	x	y	sin θ	sinh ψ	θ radians	ψ	e	$\frac{d\psi}{d\theta}$	$\frac{d\epsilon}{d\theta}$	k	$\phi = \theta + \epsilon$
0	0	2.037	0.000	0.000	0.0373	0.000	0.192	-0.0457	0.000	0.085	6.280	-2 37
1.25	1.97	1.986	-0.0796	0.0465	0.341	0.217	0.184	-0.0276	-0.010	0.080	4.249	10 52
2.50	2.81	1.936	-0.1135	0.0941	0.642	0.312	0.184	-0.0205	0.009	0.080	3.368	16 41
5.0	4.03	1.835	-0.163	0.187	1.187	0.447	0.187	-0.0098	0.022	0.080	2.557	25 4
7.5	4.94	1.734	-0.200	0.275	1.663	0.551	0.189	-0.0015	0.022	0.080	2.163	31 31
10	5.71	1.633	-0.231	0.357	2.113	0.640	0.192	0.0063	0.020	0.085	1.829	37 3
15	6.82	1.421	-0.276	0.507	2.875	0.782	0.193	0.0138	-0.009	0.085	1.360	46 27
20	7.55	1.229	-0.305	0.636	3.666	0.923	0.190	0.010	-0.031	1.00	1.498	54 38
30	8.22	0.825	-0.332	0.835	4.909	1.153	0.181	0.0549	-0.066	1.07	1.324	69 11
40	8.05	0.421	-0.325	0.957	6.276	1.361	0.165	0.0717	-0.085	0.98	1.220	82 7
50	7.26	0.017	-0.293	1.000	7.650	1.571	0.146	0.0856	-0.100	0.80	1.166	94 55
60	6.03	-0.387	-0.244	0.963	9.017	1.764	0.124	0.0932	-0.100	0.62	1.152	106 25
70	4.58	-0.791	-0.185	0.845	10.370	1.975	0.100	0.0920	-0.100	0.44	1.167	118 28
80	3.06	-1.195	-0.124	0.645	11.717	2.209	0.077	0.0828	-0.088	0.26	1.302	131 19
90	1.55	-1.599	-0.063	0.363	13.055	2.495	0.052	0.0617	-0.067	0.08	1.687	146 30
95	0.88	-1.801	-0.036	0.191	14.386	2.690	0.040	0.0410	-0.035	0.02	2.340	156 28
100	0.26	-2.003	0.000	0.000	15.713	3.142	0.055	0.0105	0.000	0.00	19.83	180 36

LOWER SURFACE

Per cent c	y in per cent c	x	y	sin θ	sinh ψ	θ radians	ψ	e	$\frac{d\psi}{d\theta}$	$\frac{d\epsilon}{d\theta}$	k	$\phi = \theta + \epsilon$
0	0	2.037	0.000	0.000	0.0373	0.283	0.192	-0.0457	0.000	0.085	6.280	-2 37
1.25	1.76	1.986	-0.071	0.0425	0.6297	0.675	0.172	-0.0781	0.133	0.120	4.615	-16 21
2.50	2.20	1.936	-0.089	0.0844	1.0234	0.989	0.152	-0.0850	0.160	0.050	3.525	-21 43
5.0	2.73	1.835	-0.110	0.173	1.6176	1.332	0.132	-0.0882	0.133	-0.100	2.510	-29 35
7.5	3.03	1.734	-0.122	0.259	2.1144	1.622	0.120	-0.0850	0.109	-0.045	2.025	-35 28
10	3.24	1.633	-0.131	0.342	2.6112	1.877	0.112	-0.0811	0.080	-0.057	1.764	-40 24
15	3.47	1.431	-0.140	0.494	3.6099	2.305	0.099	-0.0723	0.069	-0.067	1.466	-48 44
20	3.62	1.229	-0.146	0.626	4.5985	2.731	0.092	-0.0637	0.057	-0.067	1.307	-55 54
30	3.79	0.825	-0.153	0.831	6.0770	3.336	0.084	-0.0516	0.025	-0.052	1.156	-63 39
40	3.90	0.421	-0.158	0.956	7.6556	4.021	0.081	-0.0421	0.008	-0.036	1.098	-70 17
50	3.94	0.017	-0.159	1.000	9.0643	4.712	0.079	-0.0350	0.000	-0.029	1.081	-76 59
60	3.82	-0.387	-0.154	0.863	10.3830	5.403	0.075	-0.0310	0.010	-0.013	1.120	-82 53
70	3.48	-0.791	-0.141	0.645	11.7117	6.094	0.074	-0.0300	0.019	0.000	1.211	-88 55
80	2.83	-1.195	-0.114	0.445	13.0404	6.785	0.074	-0.0295	0.036	-0.011	1.370	-94 57
90	1.77	-1.599	-0.072	0.243	14.3691	7.476	0.069	-0.0235	0.044	-0.040	1.769	-100 59
95	1.08	-1.801	-0.044	0.191	15.6978	8.167	0.050	-0.0140	0.020	-0.067	2.368	-106 61
100	0.26	-2.003	0.000	0.000	17.0265	9.858	0.055	0.0105	0.000	-0.027	19.83	-180 24

TABLE II  
 $\epsilon(\phi) = 0.1 \sin(\phi - 45^\circ)$   $\psi_0 = 0.10$   $\beta = \bar{\alpha}(\alpha) = 0.0657 = 3^\circ 47'$

UPPER SURFACE

Degrees	Radians	e	θ		ψ	$\frac{d\epsilon}{d\phi}$	$\frac{d\psi}{d\phi}$	cosh ψ	sinh ψ	cos θ	sin θ	$\frac{x}{2}$	$\frac{y}{2}$	k
			Radians	Degrees										
0	0.0000	-0.0707	0.0707	4 3	0.1707	0.0707	0.0707	1.0146	0.1715	0.9975	0.0706	1.0121	0.0121	6.3941
5	0.0873	-0.0643	0.1516	8 41	0.1766	0.0766	0.0643	1.0156	0.1775	0.9885	0.1510	1.0039	0.0268	5.1215
10	0.1745	-0.0574	0.2319	13 17	0.1819	0.0819	0.0574	1.0166	0.1826	0.9733	0.2298	0.9895	0.0420	4.0960
15	0.2618	-0.0500	0.3118	17 52	0.1866	0.0866	0.0500	1.0175	0.1877	0.9618	0.3068	0.9685	0.0576	3.3602
20	0.3491	-0.0423	0.3914	22 26	0.1906	0.0906	0.0423	1.0182	0.1918	0.9433	0.3816	0.9411	0.0732	2.8421
25	0.4363	-0.0342	0.4705	26 57	0.1940	0.0940	0.0342	1.0189	0.1952	0.9194	0.4532	0.9082	0.0885	2.4704
30	0.5236	-0.0259	0.5495	31 29	0.1966	0.0966	0.0259	1.0194	0.1979	0.8828	0.5223	0.8693	0.1034	2.1892
35	0.6109	-0.0174	0.6283	36 0	0.1985	0.0985	0.0174	1.0198	0.1998	0.8390	0.5878	0.8090	0.1174	1.9746
45	0.7854	0.0000	0.7854	45 0	0.2000	0.1000	0.0000	1.0201	0.2013	0.7071	0.7071	0.7213	0.1423	1.6689
55	0.9599	0.0174	0.9425	54 0	0.1985	0.0985	-0.0174	1.0198	0.1998	0.5878	0.8090	0.5994	0.1616	1.4709
60	1.2217	0.0423	1.1794	67 35	0.1906	0.0906	-0.0423	1.0182	0.1918	0.3813	0.9244	0.3882	0.1773	1.2859
70	1.5963	0.0574	1.3389	76 43	0.1819	0.0819	-0.0574	1.0166	0.1826	0.2298	0.9733	0.2596	0.1777	1.2133
80	1.9708	0.0707	1.5001	85 57	0.1707	0.0707	-0.0707	1.0146	0.1715	0.0706	0.9975	0.0716	0.1711	1.1717
100	1.7453	0.0819	1.6684	95 18	0.1574	0.0574	-0.0819	1.0124	0.1581	-0.0824	0.9897	-0.0925	0.1574	1.1586
110	1.9199	0.0906	1.8283	104 49	0.1423	0.0423	-0.0906	1.0101	0.1428	-0.2557	0.9668	-0.2583	0.1351	1.1756
125	2.1817	0.0985	2.0852	119 22	0.1174	0.0174	-0.0985	1.0080	0.1177	-0.4904	0.8715	-0.4938	0.1096	1.2727
135	2.3562	0.1000	2.2522	129 16	0.1000	0.0000	-0.1000	1.0050	0.1002	-0.6329	0.7742	-0.6361	0.0776	1.4088
150	2.6180	0.0966	2.5214	144 28	0.0741	-0.0259	-0.0966	1.0028	0.0742	-0.8138	0.5812	-0.8161	0.0431	1.8306
160	2.7925	0.0906	2.7019	154 48	0.0577	-0.0423	-0.0906	1.0017	0.0577	-0.9048	0.4258	-0.9063	0.0246	2.4584
170	2.9671	0.0819	2.8852	165 19	0.0426	-0.0574	-0.0819	1.0009	0.0426	-0.9673	0.2538	-0.9682	0.0108	4.0496
180	3.1416	0.0707	3.0709	175 57	0.0293	-0.0707	-0.0707	1.0004	0.0293	-0.9975	0.0706	-0.9979	0.0021	13.4411

LOWER SURFACE

Degrees	Radians	e	θ		ψ	$\frac{d\epsilon}{d\phi}$	$\frac{d\psi}{d\phi}$	cosh ψ	sinh ψ	cos θ	sin θ	$\frac{x}{2}$	$\frac{y}{2}$	k
			Radians	Degrees										
0	0.0000	-0.0707	0.0707	4 3	0.1707	0.0707	0.0707	1.0146	0.1715	0.9975	0.0706	1.0121	0.0121	6.3941
-5	-0.0873	-0.0766	-0.107	-0 37	0.1643	0.0643	0.0766	1.0135	0.1650	0.9999	-0.0706	1.0134	-0.0018	7.1236
-10	-0.1745	-0.0819	-0.0926	-5 18	0.1574	0.0574	0.0819	1.0124	0.1581	0.9957	-0.0924	1.0080	-0.0146	6.3827
-15	-0.2618	-0.0866	-0.1752	-10 2	0.1500	0.0500	0.0866	1.0113	0.1506	0.9847	-0.1742	0.9958	-0.0262	5.0338
-20	-0.3491	-0.0906	-0.2585	-14 49	0.1423	0.0423	0.0906	1.0101	0.1428	0.9668	-0.2557	0.9766	-0.0365	3.9225
-25	-0.4363	-0.0940	-0.3423	-19 37	0.1342	0.0342	0.0940	1.0090	0.1346	0.9420	-0.3357	0.9505	-0.0452	3.1489
-30	-0.5236	-0.0966	-0.4270	-24 28	0.1259	0.0259	0.0966	1.0079	0.1262	0.9102	-0.4142	0.9174	-0.0523	2.6077
-35	-0.6109	-0.0985	-0.5124	-29 21	0.1174	0.0174	0.0985	1.0069	0.1177	0.8716	-0.4901	0.8776	-0.0577	2.2203
-45	-0.7854	-0.1000	-0.6854	-39 16	0.1000	0.0000	0.1000	1.0050	0.1002	0.7742	-0.6329	0.7781	-0.0634	1.7161
-55	-0.9599	-0.0985	-0.8614	-49 21	0.0826	-0.0174	0.0985	1.0034	0.0827	0.6514	-0.7587	0.6536	-0.0627	1.4168
-60	-1.2217	-0.0906	-1.1311	-64 48	0.0577	-0.0423	0.0906	1.0017	0.0577	0.4258	-0.9048	0.4265	-0.0522	1.1650
-70	-1.5963	-0.0819	-1.3144	-75 19	0.0426	-0.0574	0.0819	1.0009	0.0426	0.2538	-0.9673	0.2537	-0.0412	1.0763
-80	-1.9708	-0.0707	-1.5001	-85 57	0.0293	-0.0707	0.0707	1.0004	0.0293	0.0706	-0.9975	0.0706	-0.0292	1.0322
-100	-1.7453	-0.0574	-1.6879	-96 43	0.0181	-0.0819	0.0574	1.0002	0.0181	-0.1170	-0.9931	-0.1170	-0.0180	1.0270
-110	-1.9199	-0.0423	-1.8776	-107 3	0.0094	-0.0906	0.0423	1.0000	0.0094	-0.3021	-0.9533	-0.3021	-0.0090	1.0616
-125	-2.1817	-0.0174	-2.1643	-124 1	0.0015	-0.0985	0.0174	1.0000	0.0015	-0.5594	-0.8289	-0.5594	-0.0012	1.2136
-135	-2.3562	0.0000	-2.3562	-135 0	0.0000	0.0000	0.0000	1.0000	0.0000	-0.7071	-0.7071	-0.7071	0.0000	1.4209
-150	-2.6180	0.0259	-2.6439	-151 29	0.0394	-0.0966	-0.0259	1.0000	0.0394	-0.8737	-0.4774	-0.8737	-0.0394	2.1106
-160	-2.7925	0.0423	-2.5348	-162 25	0.0694	-0.0906	-0.0423	1.0000	0.0694	-0.8021	-0.3533	-0		

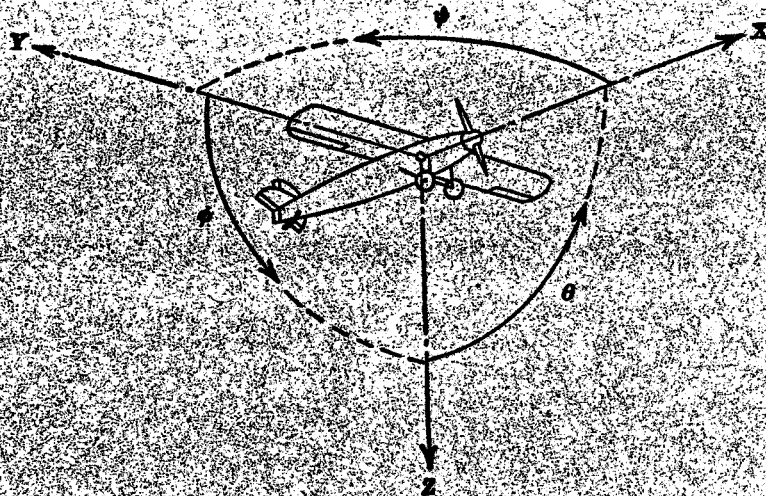

Positive directions of axes and angles (forces and moments) are shown by arrows

Axis		Force (parallel to axis) symbol	Moment about axis			Angle		Velocities	
Designation	Symbol		Designation	Symbol	Positive direction	Designation	Symbol	Linear (component along axis)	Angular
Longitudinal	X	X	Rolling	L	Y → Z	Roll	$\phi$	u	p
Lateral	Y	Y	Pitching	M	Z → X	Pitch	$\theta$	v	q
Normal	Z	Z	Yawing	N	X → Y	Yaw	$\psi$	w	r

Absolute coefficients of moment

$$C_l = \frac{L}{qbS}$$

(rolling)

$$C_m = \frac{M}{qcS}$$

(pitching)

$$C_n = \frac{N}{qbS}$$

(yawing)

Angle of set of control surface (relative to neutral position),  $\delta$ . (Indicate surface by proper subscript.)

#### 4. PROPELLER SYMBOLS

$D$  Diameter

$p$  Geometric pitch

$p/D$  Pitch ratio

$V'$  Inflow velocity

$V_s$  Slipstream velocity

$T$  Thrust, absolute coefficient  $C_T = \frac{T}{\rho n^2 D^4}$

$Q$  Torque, absolute coefficient  $C_Q = \frac{Q}{\rho n^2 D^5}$

$P$  Power, absolute coefficient  $C_P = \frac{P}{\rho n^3 D^5}$

$C_s$  Speed-power coefficient  $= \sqrt{\frac{\rho V_s^3}{P n^2}}$

$\eta$  Efficiency

$n$  Revolutions per second, rps

$\alpha$  Effective helix angle  $= \tan^{-1} \left( \frac{V}{2\pi r n} \right)$

#### 5. NUMERICAL RELATIONS

1 hp = 76.04 kg-m/s = 550 ft-lb/sec

metric horsepower = 0.9863 hp

1 mph = 0.4470 mps

1 mps = 2.2369 mph

1 lb = 0.4536 kg

1 kg = 2.2046 lb

1 mi = 1,609.35 m = 5,280 ft

1 m = 3.2808 ft