

FILE COPY
NO. 5

NATIONAL ADVISORY COMMITTEE FOR AERONAUTICS

REPORT No. 513

EXPERIMENTAL INVESTIGATION OF THE ROBINSON- TYPE CUP ANEMOMETER

By M. J. BREVOORT and U. T. JOYNER



NACA FILE COPY

Loan expires on last
date stamped on back cover.

PLEASE RETURN TO

REPORT DISTRIBUTION AND STORAGE SECTION
LANGLEY AERONAUTICAL LABORATORY
NATIONAL ADVISORY COMMITTEE
FOR AERONAUTICS
Langley Field, Virginia

1935

AERONAUTIC SYMBOLS

1. FUNDAMENTAL AND DERIVED UNITS

	Symbol	Metric		English	
		Unit	Abbrevia- tion	Unit	Abbrevia- tion
Length-----	<i>l</i>	meter-----	m	foot (or mile)-----	ft. (or mi.)
Time-----	<i>t</i>	second-----	s	second (or hour)-----	sec. (or hr.)
Force-----	<i>F</i>	weight of 1 kilogram-----	kg	weight of 1 pound-----	lb.
Power-----	<i>P</i>	horsepower (metric)-----		horsepower-----	hp.
Speed-----	<i>V</i>	{kilometers per hour-----	k.p.h.	miles per hour-----	m.p.h.
		{meters per second-----	m.p.s.	feet per second-----	f.p.s.

2. GENERAL SYMBOLS

<p><i>W</i>, Weight = mg</p> <p><i>g</i>, Standard acceleration of gravity = 9.80665 m/s² or 32.1740 ft./sec.²</p> <p><i>m</i>, Mass = $\frac{W}{g}$</p> <p><i>I</i>, Moment of inertia = mk^2. (Indicate axis of radius of gyration <i>k</i> by proper subscript.)</p> <p><i>μ</i>, Coefficient of viscosity</p>	<p><i>ν</i>, Kinematic viscosity</p> <p><i>ρ</i>, Density (mass per unit volume)</p> <p>Standard density of dry air, 0.12497 kg-m⁻⁴-s² at 15° C. and 760 mm; or 0.002378 lb.-ft.⁻⁴ sec.²</p> <p>Specific weight of "standard" air, 1.2255 kg/m³ or 0.07651 lb./cu.ft.</p>
--	--

3. AERODYNAMIC SYMBOLS

<p><i>S</i>, Area</p> <p><i>S_w</i>, Area of wing</p> <p><i>G</i>, Gap</p> <p><i>b</i>, Span</p> <p><i>c</i>, Chord</p> <p>$\frac{b^2}{S}$, Aspect ratio</p> <p><i>V</i>, True air speed</p> <p><i>q</i>, Dynamic pressure = $\frac{1}{2}\rho V^2$</p> <p><i>L</i>, Lift, absolute coefficient $C_L = \frac{L}{qS}$</p> <p><i>D</i>, Drag, absolute coefficient $C_D = \frac{D}{qS}$</p> <p><i>D_o</i>, Profile drag, absolute coefficient $C_{D_o} = \frac{D_o}{qS}$</p> <p><i>D_i</i>, Induced drag, absolute coefficient $C_{D_i} = \frac{D_i}{qS}$</p> <p><i>D_v</i>, Parasite drag, absolute coefficient $C_{D_v} = \frac{D_v}{qS}$</p> <p><i>C</i>, Cross-wind force, absolute coefficient $C_C = \frac{C}{qS}$</p> <p><i>R</i>, Resultant force</p>	<p><i>i_w</i>, Angle of setting of wings (relative to thrust line)</p> <p><i>i_t</i>, Angle of stabilizer setting (relative to thrust line)</p> <p><i>Q</i>, Resultant moment</p> <p><i>Ω</i>, Resultant angular velocity</p> <p>$\frac{Vl}{\mu}$, Reynolds Number, where <i>l</i> is a linear dimension (e.g., for a model airfoil 3 in. chord, 100 m.p.h. normal pressure at 15° C., the corresponding number is 234,000; or for a model of 10 cm chord, 40 m.p.s. the corresponding number is 274,000)</p> <p><i>C_p</i>, Center-of-pressure coefficient (ratio of distance of <i>c.p.</i> from leading edge to chord length)</p> <p><i>α</i>, Angle of attack</p> <p><i>ε</i>, Angle of downwash</p> <p><i>α_o</i>, Angle of attack, infinite aspect ratio</p> <p><i>α_i</i>, Angle of attack, induced</p> <p><i>α_a</i>, Angle of attack, absolute (measured from zero-lift position)</p> <p><i>γ</i>, Flight-path angle</p>
--	--

REPORT No. 513

**EXPERIMENTAL INVESTIGATION OF THE ROBINSON-
TYPE CUP ANEMOMETER**

By M. J. BREVOORT and U. T. JOYNER
Langley Memorial Aeronautical Laboratory

NATIONAL ADVISORY COMMITTEE FOR AERONAUTICS

HEADQUARTERS, NAVY BUILDING, WASHINGTON, D.C.

LABORATORIES, LANGLEY FIELD, VA.

Created by act of Congress approved March 3, 1915, for the supervision and direction of the scientific study of the problems of flight. Its membership was increased to 15 by act approved March 2, 1929. The members are appointed by the President, and serve as such without compensation.

JOSEPH S. AMES, Ph.D., <i>Chairman</i> , President, Johns Hopkins University, Baltimore, Md.	WILLIAM P. MACCRACKEN, Jr., Ph.B., Washington, D.C.
DAVID W. TAYLOR, D.Eng., <i>Vice Chairman</i> , Washington, D.C.	CHARLES F. MARVIN, Sc.D., United States Weather Bureau.
CHARLES G. ABBOT, Sc.D., Secretary, Smithsonian Institution.	HENRY C. PRATT, Brigadier General, United States Army, Chief, Matériel Division, Air Corps, Wright Field, Dayton, Ohio.
LYMAN J. BRIGGS, Ph.D., Director, National Bureau of Standards.	EUGENE L. VIDAL, C.E., Director of Aeronautics, Department of Commerce.
BENJAMIN D. FOULOIS, Major General, United States Army, Chief of Air Corps, War Department.	EDWARD P. WARNER, M.S., Editor of Aviation, New York City.
HARRY F. GUGGENHEIM, M.A., Port Washington, Long Island, N.Y.	R. D. WEYERBACHER, Commander, United States Navy, Bureau of Aeronautics, Navy Department.
ERNEST J. KING, Rear Admiral, United States Navy, Chief, Bureau of Aeronautics, Navy Department.	ORVILLE WRIGHT, Sc.D., Dayton, Ohio.
CHARLES A. LINDBERGH, LL.D., New York City.	

GEORGE W. LEWIS, *Director of Aeronautical Research*

JOHN F. VICTORY, *Secretary*

HENRY J. E. REID, *Engineer in Charge, Langley Memorial Aeronautical Laboratory, Langley Field, Va.*

JOHN J. IDE, *Technical Assistant in Europe, Paris, France*

TECHNICAL COMMITTEES

AERODYNAMICS
POWER PLANTS FOR AIRCRAFT
MATERIALS FOR AIRCRAFT

PROBLEMS OF AIR NAVIGATION
AIRCRAFT ACCIDENTS
INVENTIONS AND DESIGNS

Coordination of Research Needs of Military and Civil Aviation

Preparation of Research Programs

Allocation of Problems

Prevention of Duplication

Consideration of Inventions

LANGLEY MEMORIAL AERONAUTICAL LABORATORY

OFFICE OF AERONAUTICAL INTELLIGENCE

LANGLEY FIELD, VA.

WASHINGTON, D.C.

Unified conduct for all agencies of scientific research on the fundamental problems of flight.

Collection, classification, compilation, and dissemination of scientific and technical information on aeronautics.

REPORT No. 513

EXPERIMENTAL INVESTIGATION OF THE ROBINSON-TYPE CUP ANEMOMETER

By M. J. BREVOORT and U. T. JOYNER

SUMMARY

An investigation on the Robinson-type cup anemometer has been completed by the National Advisory Committee for Aeronautics. This investigation covered force measurements on individual cups, as well as static and dynamic torque measurements and calibrations on complete cup wheels. In the tests on individual cups 5 cup forms were used and in the measurements on complete cup wheels 4 cup wheels with 3 arm lengths for each cup wheel were tested. All the results are presented in graphical form.

INTRODUCTION

The National Advisory Committee for Aeronautics, in cooperation with the United States Weather Bureau, has conducted an investigation on the Robinson-type cup anemometer.

This investigation comprised: (1) a study of the forces on individual cups through a wide range of Reynolds Number; (2) static-torque measurements on several cup wheels, using three different arm lengths for each cup wheel tested; (3) dynamic-torque tests of the same cup wheels with the same arm lengths as used in the static-torque measurements; (4) calibration tests of the same cup wheels on a regular service spindle as used by the Weather Bureau; (5) torque measurements on a single cup through a complete revolution under operating conditions, i. e., mounted in a cup wheel in such a manner that the torque produced by the individual cup could be measured, a comparison of the plotted results thus obtained with results calculated from static-torque measurements on individual cups; and (6) drag tests on complete cup wheels.

Patterson (reference 1) made an extensive investigation covering part of the same field and presented a very complete history of the problem. The agreement between the results from the two investigations is, in general, close.

STATIC FORCE TESTS ON INDIVIDUAL CUPS

All the measurements presented in this report were made in the model of the full-scale tunnel described in reference 2.

The forces on hemispherical cups have already been measured over a small range of Reynolds Number. The work of Eiffel (reference 3) was of a preliminary nature performed in connection with measurements on spheres. Bradfield's tests (reference 4) were part of an investigation on complete cup wheels; no attempt was made to determine the effect of Reynolds Number. Hansen's tests (reference 5) were made on both open and closed hemispherical cups at Reynolds Numbers ranging from 130,000 to 430,000. Cup diameter is the dimension used in determining Reynolds Number.

In view of the fact that in service the cups on a cup wheel are subject to a very great range of velocities and in consideration of the lack of satisfactory agreement among available data, it was considered desirable to extend and repeat this work to determine the effect of Reynolds Number more completely. The influence of various supports in several orientations with respect to the cup was also determined.

A preliminary report of the static tests of individual cups has already been published as reference 6.

APPARATUS AND METHODS

A special balance was constructed for measuring the lift and drag on individual cups (fig. 1). Forces of the order of 1 gram could be accurately measured. The maximum load on each arm was limited to about 1 kilogram. Since the forces on the 15.25 centimeter (6-inch) cup considerably exceeded this limit at high speeds, a balance arrangement (fig. 2), assembled for subsequent tests, was utilized for the high-velocity part of the range.

The dimensions of the five cups used in this investigation are given in the following table; the conical forms are shown in figure 3.

Cup number	Shape	Outside diameter
I.....	Hemispherical (without bead).....	10.25 cm (4.03 in.)
II.....	Conical (without bead).....	11.60 cm (4.56 in.)
III.....	Hemispherical (with bead).....	5.10 cm (2.03 in.)
IV.....	Conical (with bead).....	11.95 cm (4.70 in.)
V.....	Hemispherical (without bead).....	15.25 cm (6.00 in.)

A velocity survey was made with and without the cup in the tunnel. A point was found above and in

front of the cup at which the air speed could be measured without interference from the cup and at which the true reading was maintained throughout the speed

was used in this range. For comparison, the two ranges were always made to overlap.

RESULTS AND DISCUSSION

The results for cup I at 0° and 10° angle of attack are presented in table I. Similar tables for the complete range of angle of attack for all five cups are available upon request from the National Advisory Committee for Aeronautics.

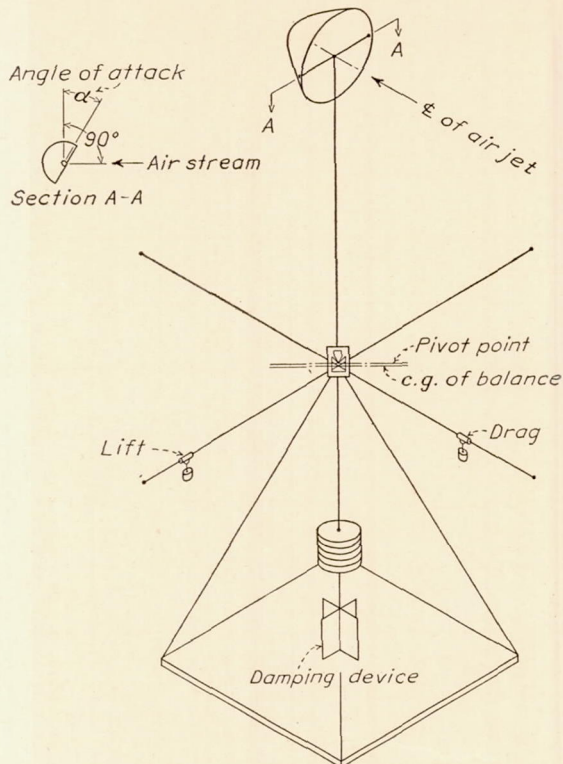
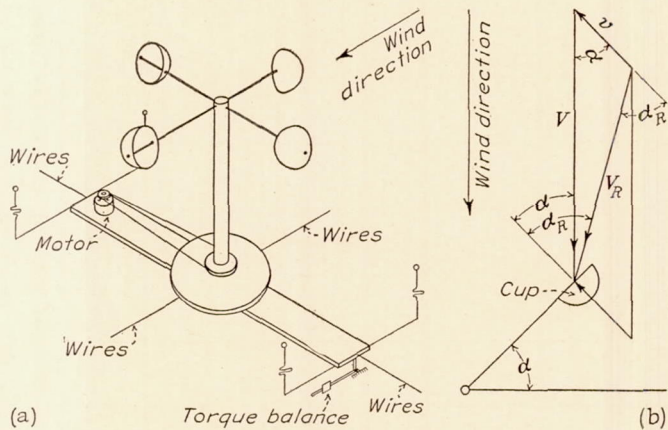

FIGURE 1.—The pivot balance.



(a) The balance.
(b) The relation of the angles and velocities.
FIGURE 2.—The pendulum balance.

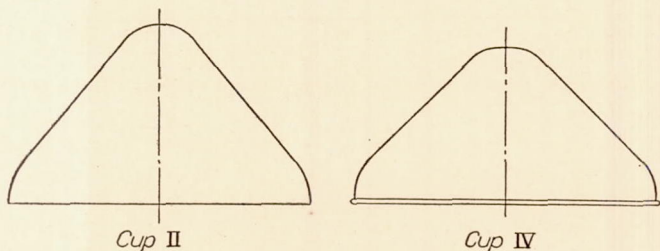

FIGURE 3.—Conical cups.

range. A calibrated pitot tube was used for measuring air speed. Owing to the lack of sensitivity of a pitot-static tube for low velocity, a hot-wire anemometer

TABLE I
FORCE MEASUREMENTS ON CUP I

$\alpha=0^\circ$					
q	V	$R \times 10^{-4}$	C_D	C_L	C_N
<i>cm water</i>	<i>meters/sec.</i>				
1.41	14.9	10.5	1.479	0	1.48
1.85	17.1	12.0	1.385	0	1.38
3.91	24.8	17.6	1.360	0	1.36
4.57	27.0	19.0	1.386	0	1.39
4.77	27.6	19.4	1.370	0	1.37
5.50	29.6	20.9	1.409	0	1.41
6.38	31.8	22.4	1.390	0	1.39
6.32	31.7	22.4	1.388	0	1.39
7.18	33.8	23.9	1.393	0	1.39
8.05	36.0	25.3	1.396	0	1.40
1.44	15.3	10.6	1.409	0	1.41
1.15	13.5	9.50	1.405	0	1.40
.84	11.5	8.10	1.408	0	1.41
.59	9.7	6.80	1.417	0	1.42
1.23	14.0	9.80	1.381	0	1.38
.53	9.2	6.44	1.368	0	1.37
.23	6.0	4.25	1.311	0	1.31
.375	7.7	5.41	1.303	0	1.30
.129	4.5	3.20	1.574	0	1.57
.025	2.0	1.40	1.400	0	1.40
.039	2.5	1.75	1.310	0	1.31
$\alpha=10^\circ$					
0.81	11.4	7.95	1.380	0.264	1.41
.61	9.8	6.90	1.380	.267	1.41
1.30	14.3	10.1	1.380	.266	1.41
1.87	17.3	12.1	1.381	.267	1.41
2.81	21.1	14.9	1.398	.268	1.42
3.66	24.0	17.0	1.390	.268	1.42
4.57	27.0	19.0	1.400	.272	1.42
5.46	29.5	20.8	1.397	.272	1.42
6.46	32.3	22.6	1.387	.270	1.42
7.31	34.2	24.1	1.400	.272	1.42
8.24	36.5	25.6	1.385	.275	1.43
.72	10.7	7.50	1.599	.320	1.63
.60	9.8	6.85	1.335	.254	1.36
.37	7.65	5.40	1.474	.285	1.50
.165	5.10	3.61	1.334	.232	1.35
.077	3.50	2.47	1.224	.260	1.25
.115	4.30	3.00	1.242	.194	1.26
.033	2.30	1.61	1.290	.276	1.32
.057	3.03	2.11	1.181	.181	1.20

The coefficients are defined as follows:

$$C_D = \frac{\text{force downstream}}{q A}$$

$$C_L = \frac{\text{force cross-stream}}{q A}$$

$$C_N = C_D \cos \alpha + C_L \sin \alpha$$

$$R = \frac{VD}{\nu}$$

where A , the cross-sectional area of the open face of the cup using outside dimensions.

V , the air speed.

ν , kinematic viscosity.

D , the outside diameter of the open face of the cup.

α , the angle of attack measured as indicated in figure 1.

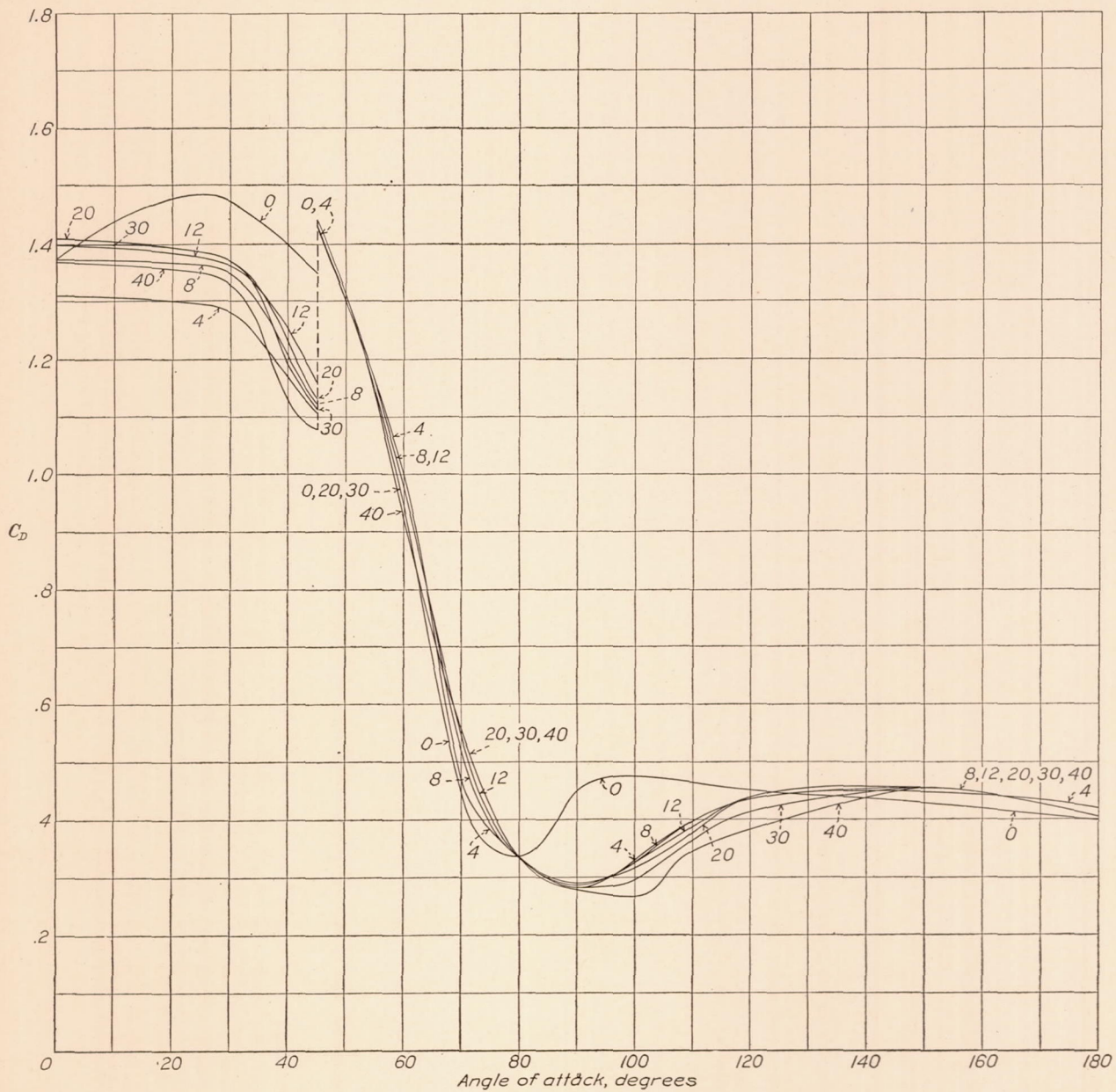

FIGURE 4.—The variation of drag coefficient with angle of attack for hemispherical anemometer cups. Cups I, III, and V. Values indicate Reynolds Number $\times 10^{-4}$.

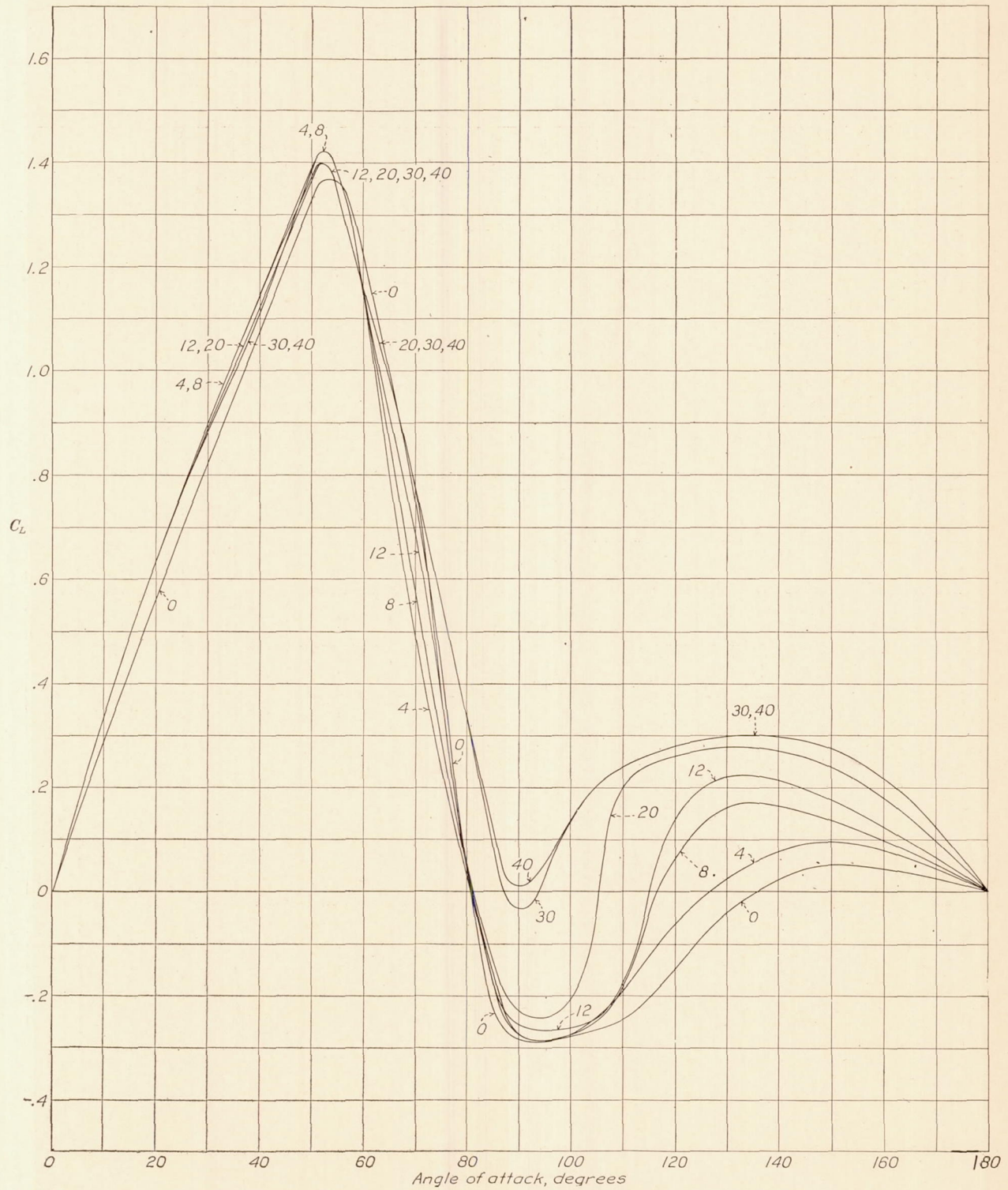

FIGURE 5.—The variation of lift coefficient with angle of attack for hemispherical anemometer cups. Cups I, III, and V. Values indicate Reynolds Number $\times 10^{-4}$.

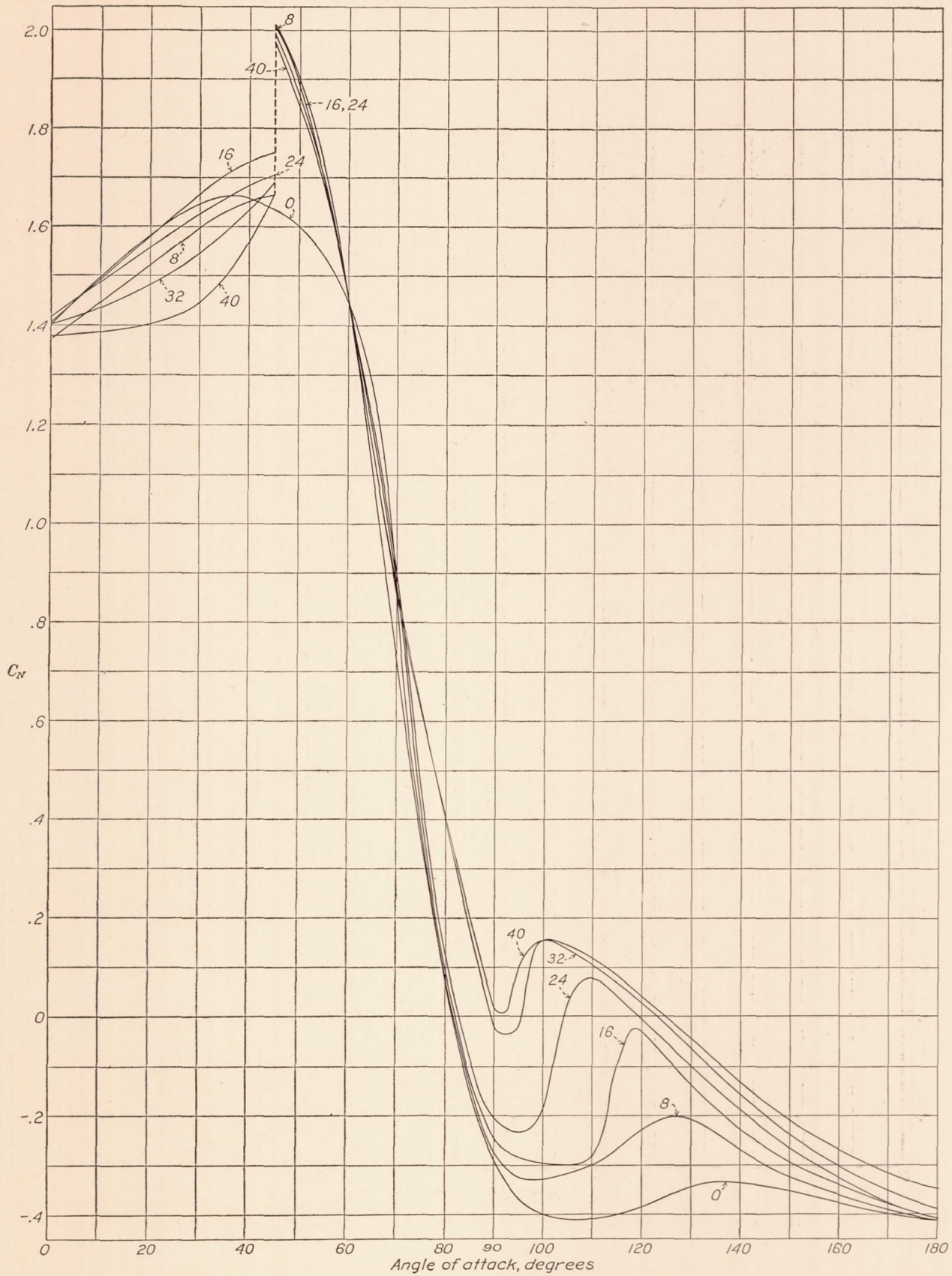

FIGURE 6.—The variation of normal-force coefficient with angle of attack for hemispherical anemometer cups. Cups I, III, and V. Values indicate Reynolds Number $\times 10^{-4}$.

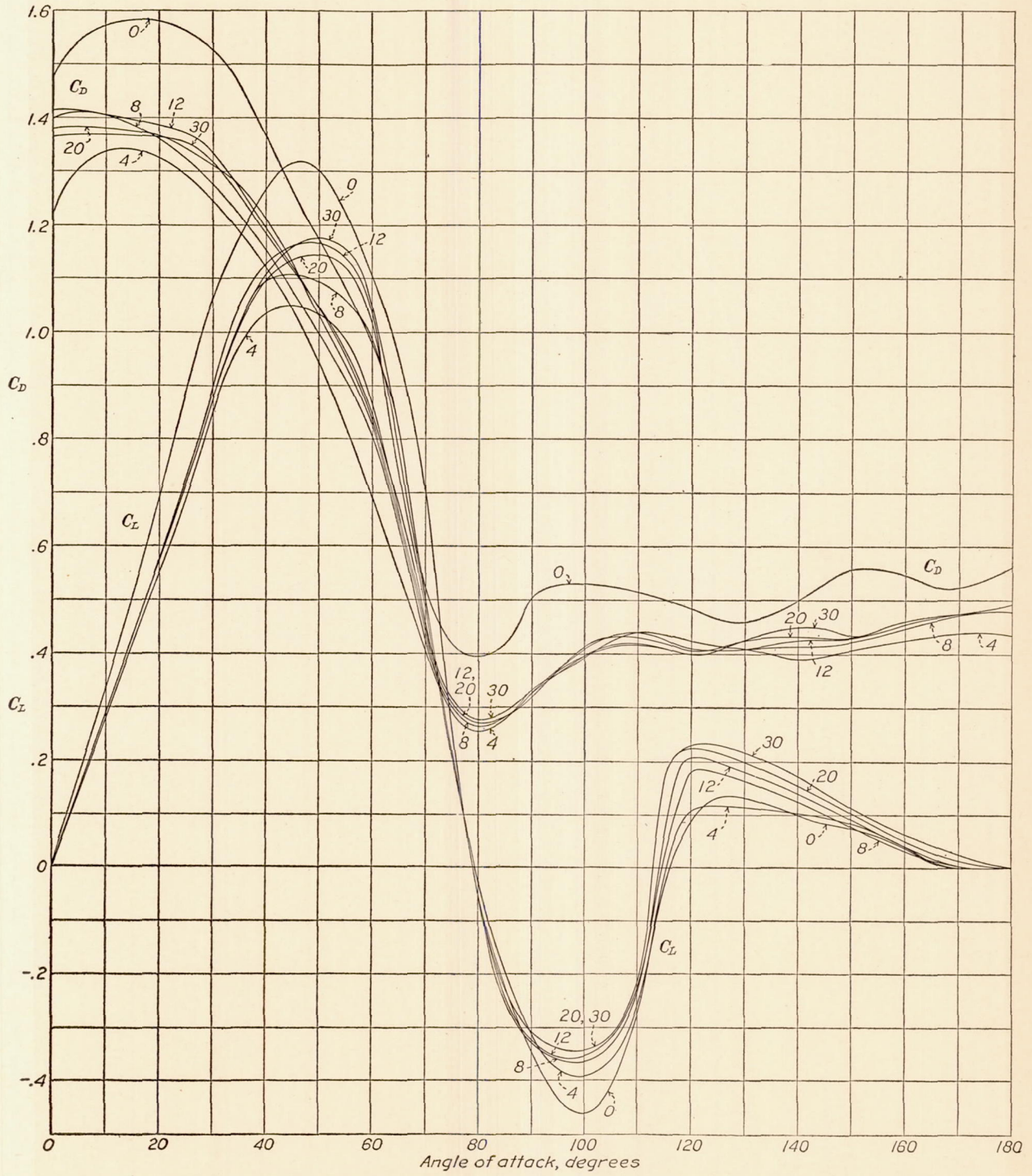

FIGURE 7.—The variation of lift and drag coefficients with angle of attack for conical anemometer cup II. Values indicate Reynolds Number $\times 10^{-4}$.

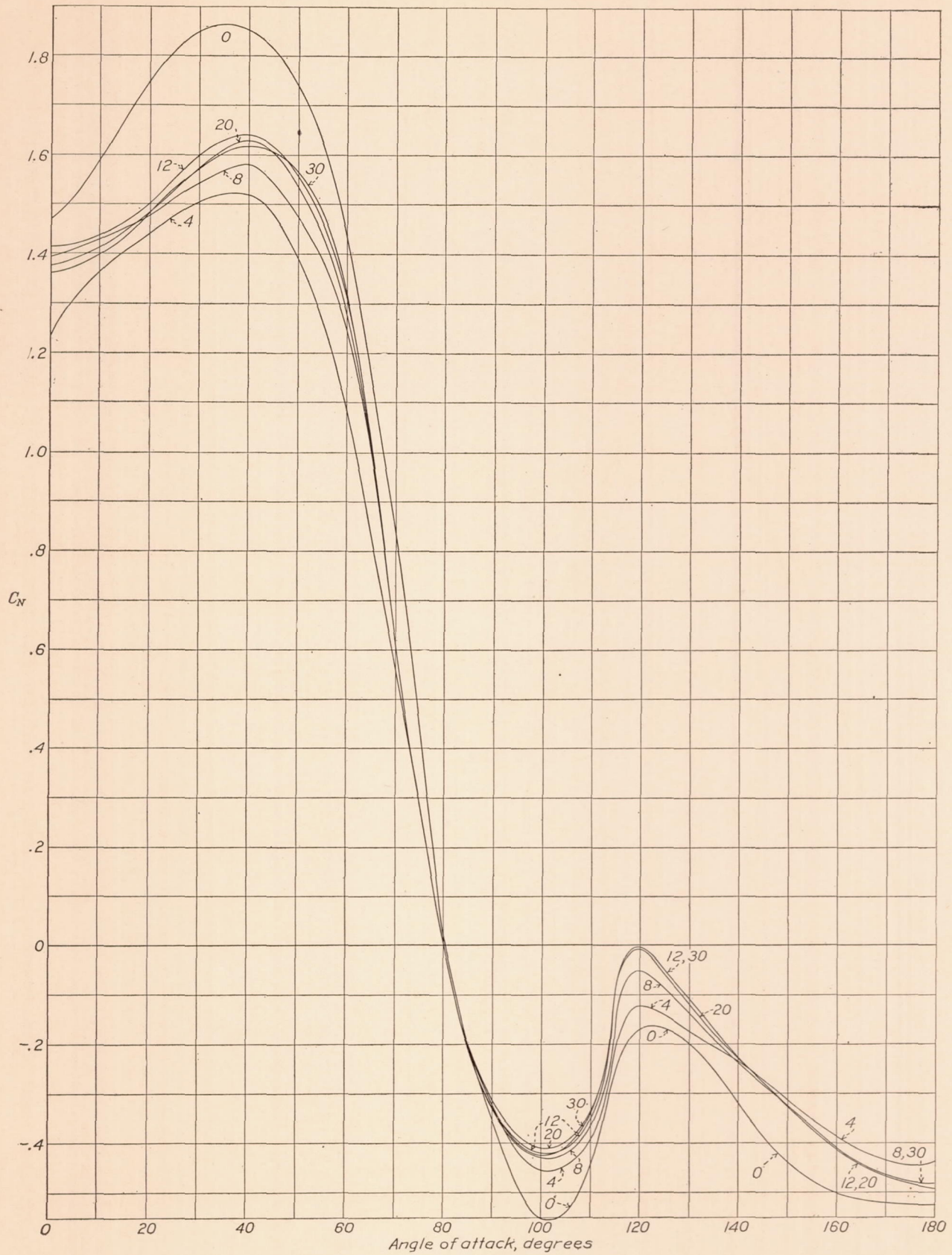

FIGURE 8.—The variation of normal-force coefficient with angle of attack for conical anemometer cup II. Values indicate Reynolds Number $\times 10^{-4}$.

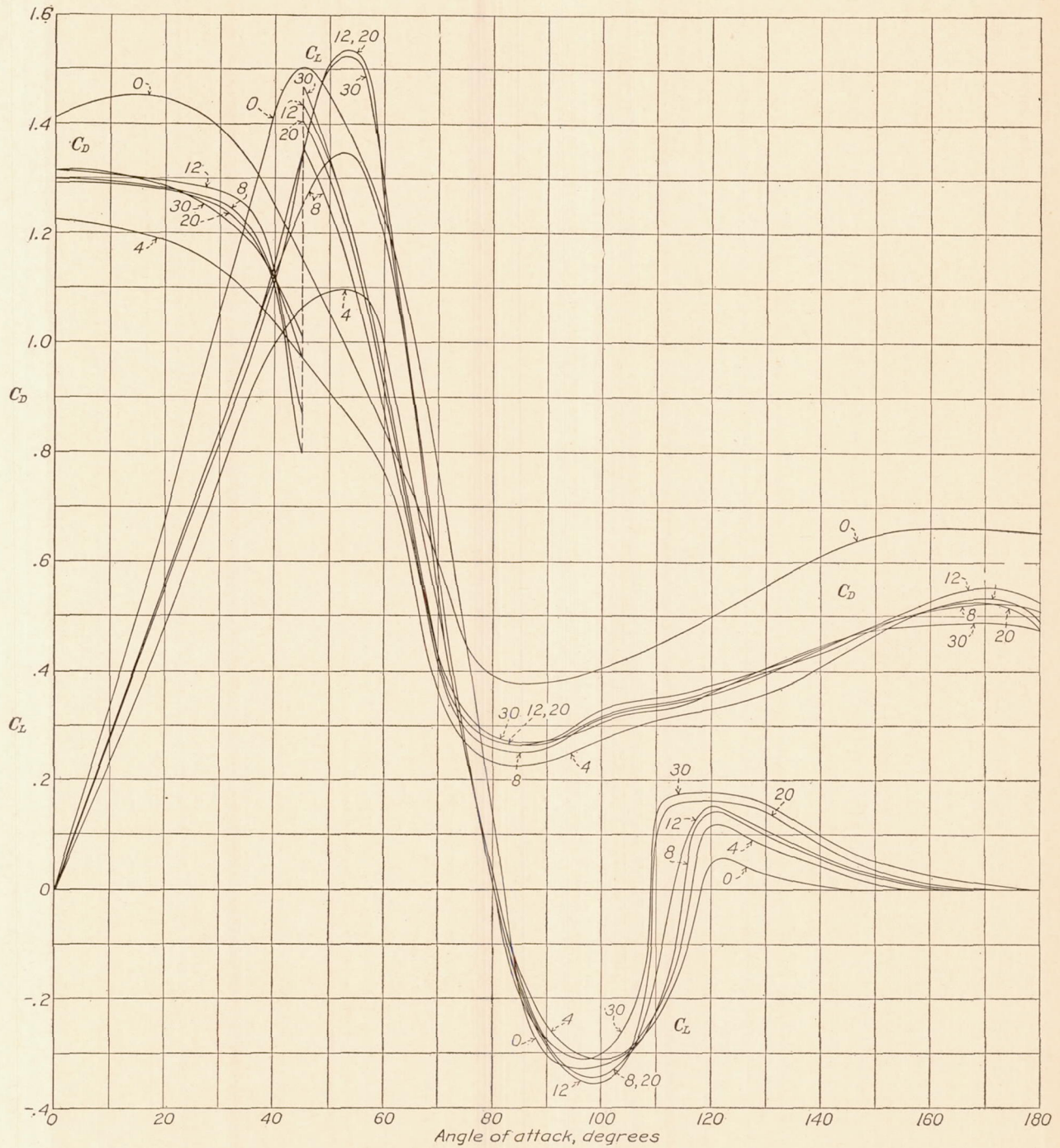

FIGURE 9.—The variation of lift and drag coefficients with angle of attack for conical anemometer cup IV. Values indicate Reynolds Number $\times 10^{-4}$.

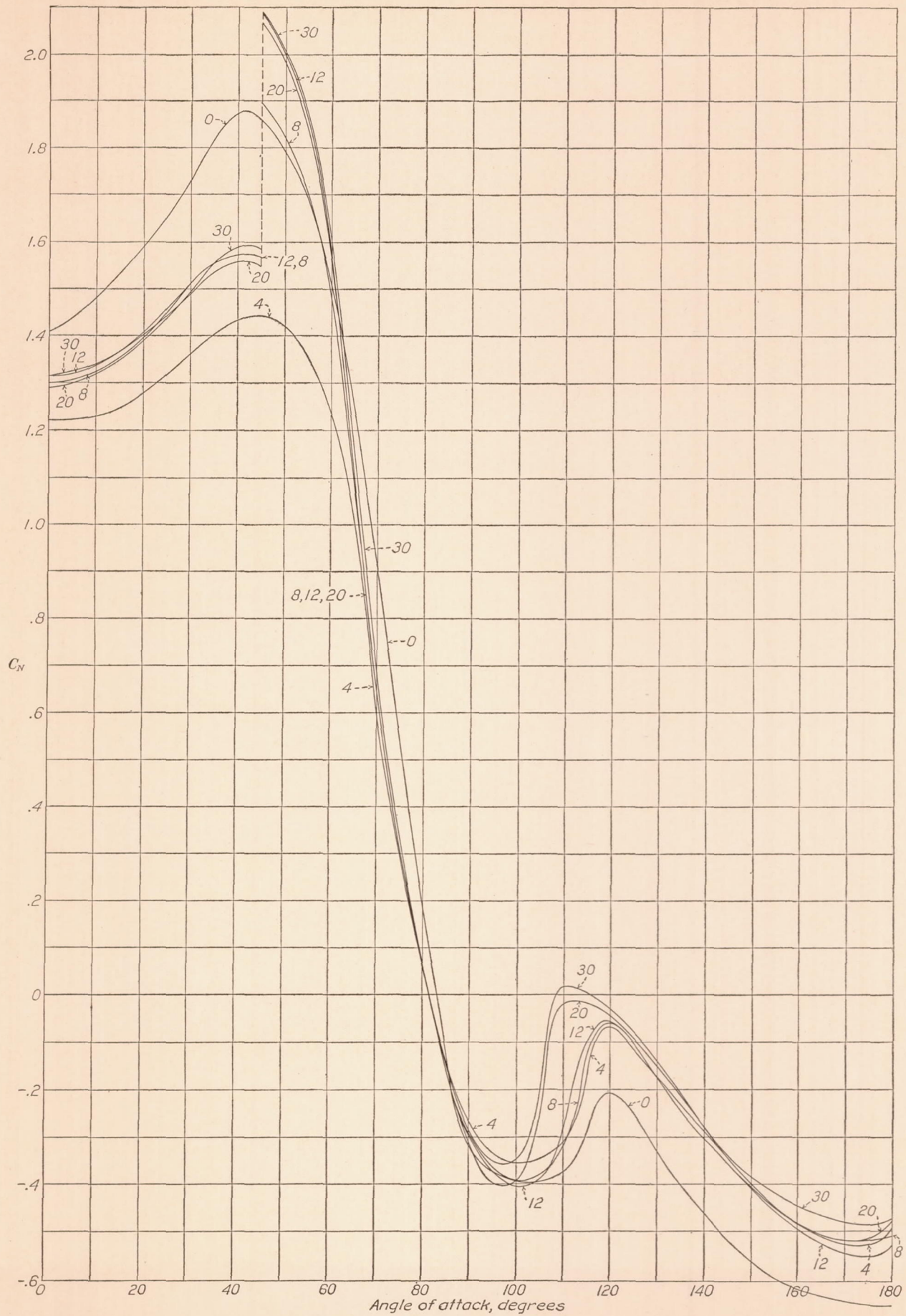

FIGURE 10.—The variation of normal-force coefficient with angle of attack for conical anemometer cup IV. Values indicate Reynolds Number $\times 10^{-4}$.

The normal-force coefficient C_N is positive when the normal force is in the direction of rotation of a cup mounted on a cup wheel.

The results obtained for the five cups are shown in figures 4 to 10. These curves are a result of cross-plotting faired curves of the coefficients against Reynolds Number. Each of the original curves of a coefficient against Reynolds Number at a particular angle of attack was determined by passing a smooth curve through the greatest number of about 20 points.

Figures 4, 5, and 6 are cross plots of the faired curves of cups I, III, and V. They check the results of Bradfield and Hansen (references 4 and 5). A more direct comparison at the same Reynolds Number is given in figure 11. Bradfield has discussed the discontinuity occurring at 45° angle of attack on the C_D curves. He found, on gradually varying the angle, that around 45° angle of attack the balance vibrated between two extremes. The points before and after

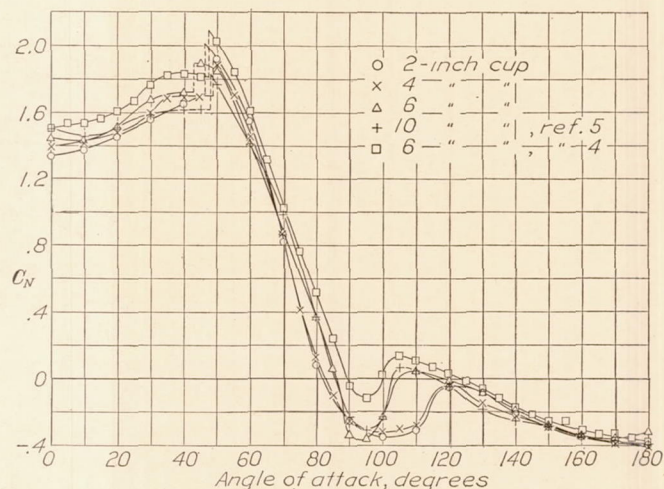

FIGURE 11.—The variation of normal-force coefficient with angle of attack for hemispherical cups at Reynolds Number of 16×10^4 .

this angle definitely fall on two different curves. The results presented here confirm Bradfield's observations and also exhibit singular points on the C_L curves in the range of angles of attack from 90° to 120° . The exact location of these singularities apparently depends largely upon the Reynolds Number.

The conical cups (figs. 7, 8, 9, and 10) exhibit much the same tendencies as do the hemispherical cups, with the exception of cup II at 45° angle of attack for which the usual discontinuity does not occur. This property makes no material difference in the performance of a cup wheel employing this cup form.

A series of tests was performed to determine the effect of the mounting on the forces on the anemometer cups. The results show that the rod extending from the trailing edge has little effect as compared with a rod extending from the leading edge. The tests indicated that there should be some discrepancy between the results using our mounting and those of Bradfield and Hansen.

In figure 11, which gives a comparison of the results of this investigation with those of Bradfield and Hansen, there is fair agreement except in the range of 40° to 120° angle of attack where the method of mounting is important, and in the range of 110° to 120° where the size of cup has an effect not accounted for by Reynolds Number.

In order to determine the effect of turbulence, a series of tests was made in which the normal turbulence of 0.4 percent, measured by the method outlined in reference 7, was varied up to 2.0 percent. When the average dynamic pressure at the position of the cup was used for q , no dependence of the coefficients on turbulence could be detected.

STATIC-TORQUE TESTS ON COMPLETE CUP WHEELS

Static torque is the moment in gram-centimeters about the axis of rotation of the forces acting on the cup wheel when stationary.

The static torque was measured for each of 12 different cup wheels. Four different combinations of size, shape, and number of cups were used, with three arm lengths for each combination. These arm lengths were chosen so that ratios of cup diameter to arm length (D/L) of 0.30, 0.43, and 0.80 were obtained for each combination.

The four different kinds of cup wheels used were:

- A. 10.16-centimeter (4-inch) hemispherical cups in 4-cup wheel.
- B. 10.16-centimeter (4-inch) hemispherical cups in 3-cup wheel.
- C. 5.08-centimeter (2-inch) hemispherical cups in 4-cup wheel.
- D. 11.60-centimeters (4.56-inch) conical cups in 4-cup wheel.

Arms were all 0.65 centimeter ($\frac{1}{4}$ inch) in diameter. Cups A, B, and D were braced by a small wire stretched between the outer ends of the cup arms.

These tests were made using the balance shown in figure 2 (a). The balance frame is supported in pendulum style with 4 wires, 1 at each corner. The balance frame is restrained from fore-and-aft and lateral motions by a ball bearing that fits on the pendulum by having its axis directly in line with the spindle axis. This bearing is held rigidly in place by wires and allows the frame to move only in torsion. The balance that measures torque is attached to the frame about 70 centimeters from the spindle axis. The movement of the balance frame is small, being of the order of 0.0254 centimeter (0.010 inch) at the 70-centimeter radius; hence any restoring force due to displacement may be neglected.

The cup wheel is held rigidly to the spindle by means of dowel pins, thus insuring against any change of angle of attack from slipping. The spindle is equipped with a sector and can be turned and clamped at any angle.

Test on cup wheels A, C, and D were made through a 90° range of angle of attack at intervals of 10° , and cup wheel B was tested through a 120° range at intervals of 15° .

When running these tests the cup wheel was set at a given angle of attack and readings were taken at a series of tunnel air speeds ranging from 5 meters per second to 35 meters per second. These results were plotted as curves of torque against air speed, each curve being for a constant angle of attack. Cross plots of these curves were made in order to obtain curves of torque against angle of attack, each curve being for constant air speed. The final cross plots are given in figures 12 to 15. The results presented in these figures may be interpolated with confidence within the range covered as the torque-air speed curves were generally smooth and were usually straight lines.

When comparing these results with those of Patterson, it should be borne in mind that his angle $\theta = 90^\circ - \alpha$. In figure 16 is given a comparison between Patterson's results and the results of the present tests. The comparison is made for cup wheel A at an air speed of 9.41 meters per second. In order to make a direct comparison at the same value of D/L , it was necessary to multiply Patterson's results by a correction factor obtained by dividing the arm length necessary for the D/L ratio given by the nearest arm length used by him. The correction applied to Patterson's results was less than 10 percent in all cases. This correction makes the results check well except for a small difference in angle of attack, of the order of 1° or 2° .

Cup wheel D, with a D/L of 0.30, was the largest wheel used. In order to determine the tunnel-wall effect on the tests presented, this large cup wheel was checked for static torque in the N. A. C. A. 7- by 10-foot wind tunnel. As no measurable difference could be detected, it was concluded that the tunnel-wall effect is smaller than the experimental error. The interference between cups in static-torque tests has been measured for one cup wheel at one arm length at four velocities by Hubbard and Brescoll (reference 8). The interference in the static-torque case is, however, of only academic interest.¹

CALIBRATION TESTS

Each of the 12 different combinations of cup and arm length was calibrated on a regular service spindle supplied by the Weather Bureau. This spindle is a shaft

¹ Although the results presented herein were not obtained with the object of calculating the interference between cups for the static-torque case, it is possible to calculate this interference by using the data for individual cups and for complete cup wheels. The static torque for a complete cup wheel may be computed by assuming the proper arm length and using the values of C_s obtained in tests on individual cups. This value should be correct if there were no interference between the cups. The arms of the cup wheel are 0.63-centimeter ($\frac{1}{4}$ inch) rods and the integrated effect on the static torque may be computed on the basis of force tests on cylinders. The difference between the computed value of static torque for the complete cup wheel and the value of static torque determined in tests on a complete cup wheel is a measure of the interference between cups.

mounted in ball bearings so as to be as nearly frictionless as possible. The cup wheel is mounted on one end of the shaft. A gear arrangement on the other end closes an electrical contact each 50 revolutions of the cup wheel. The revolution speed is secured by timing the flashes of a neon light in series with these contacts.

The spindle was mounted in the wind tunnel so that it supported the cup wheel in the center of the air stream. The cup wheel was allowed to turn freely in the air stream and a curve of revolution speed against air speed was obtained for each cup wheel (figs. 17 to 20). As these curves give straight lines when plotted on logarithm paper, it is possible to obtain a calibration throughout the usual working range of an anemometer by determining two points on the calibration curve, although three points are desirable.

DYNAMIC TORQUE

When a cup wheel is turning freely in an air stream, it reaches a steady value of rotation speed where there is no torque tending either to accelerate or decelerate the cup wheel except the small amount of torque necessary to overcome the friction in the bearings. When the cup wheel rotation speed is maintained at a higher value than that in the steady state, accelerating torque must be supplied to the cup wheel; when the cup wheel is maintained at a lower rotation speed than that in the steady state, decelerating torque must be supplied to the cup wheel. This supplied torque is the dynamic torque defined as the moment in gram-centimeters, about the axis of rotation, of the air forces acting on the cup wheel when rotating. The decelerating torque is considered positive dynamic torque and the accelerating torque negative dynamic torque.

In order to have a clear understanding of the effect of the ratio of cup diameter to arm length D/L and of the ratio of cup speed to speed of the air stream v/V on the performance of an anemometer cup wheel, the relationships between V , D/L , v , and torque were determined. The effect of Reynolds Number $\frac{VD}{\nu}$ may be obtained from this information. The torque was arbitrarily taken as a measure of performance while D/L , V , and v were varied.

MEASUREMENT OF DYNAMIC TORQUE

All the dynamic-torque tests made by the point-by-point method were obtained with the balance described in detail in the previous section. For the dynamic-torque measurements, a flywheel and motor were added (see fig. 2(a)). The motor was mounted on the balance frame, thus making it unnecessary to correct the torque for the torque supplied by the motor and requiring only one balance reading for torque. A set of contacts was so arranged that a neon lamp was lighted momentarily once in every 50 revolutions.

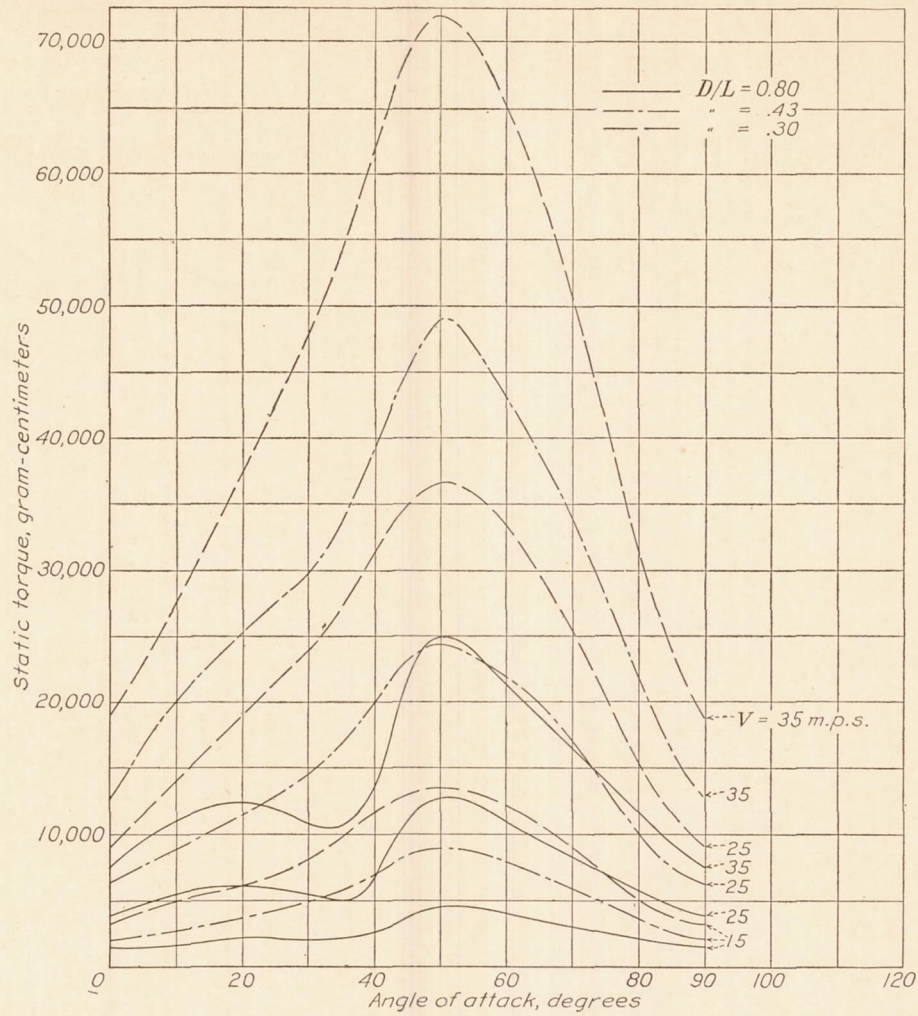

FIGURE 12.—Variation of static torque with angle of attack for cup wheel A, for different air speeds and different arm lengths.

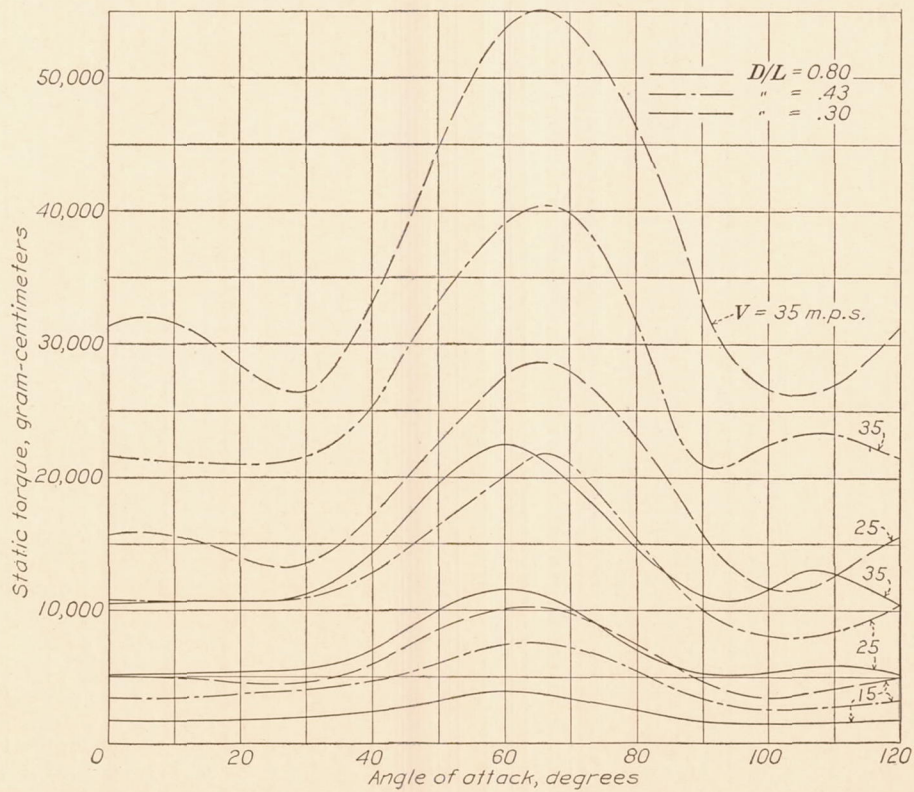

FIGURE 13.—Variation of static torque with angle of attack for cup wheel B, for different air speeds and different arm lengths.

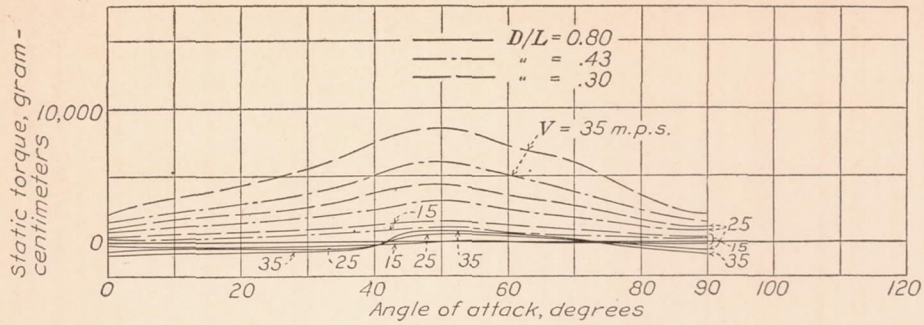

FIGURE 14.—Variation of static torque with angle of attack for cup wheel C, for different air speeds and different arm lengths

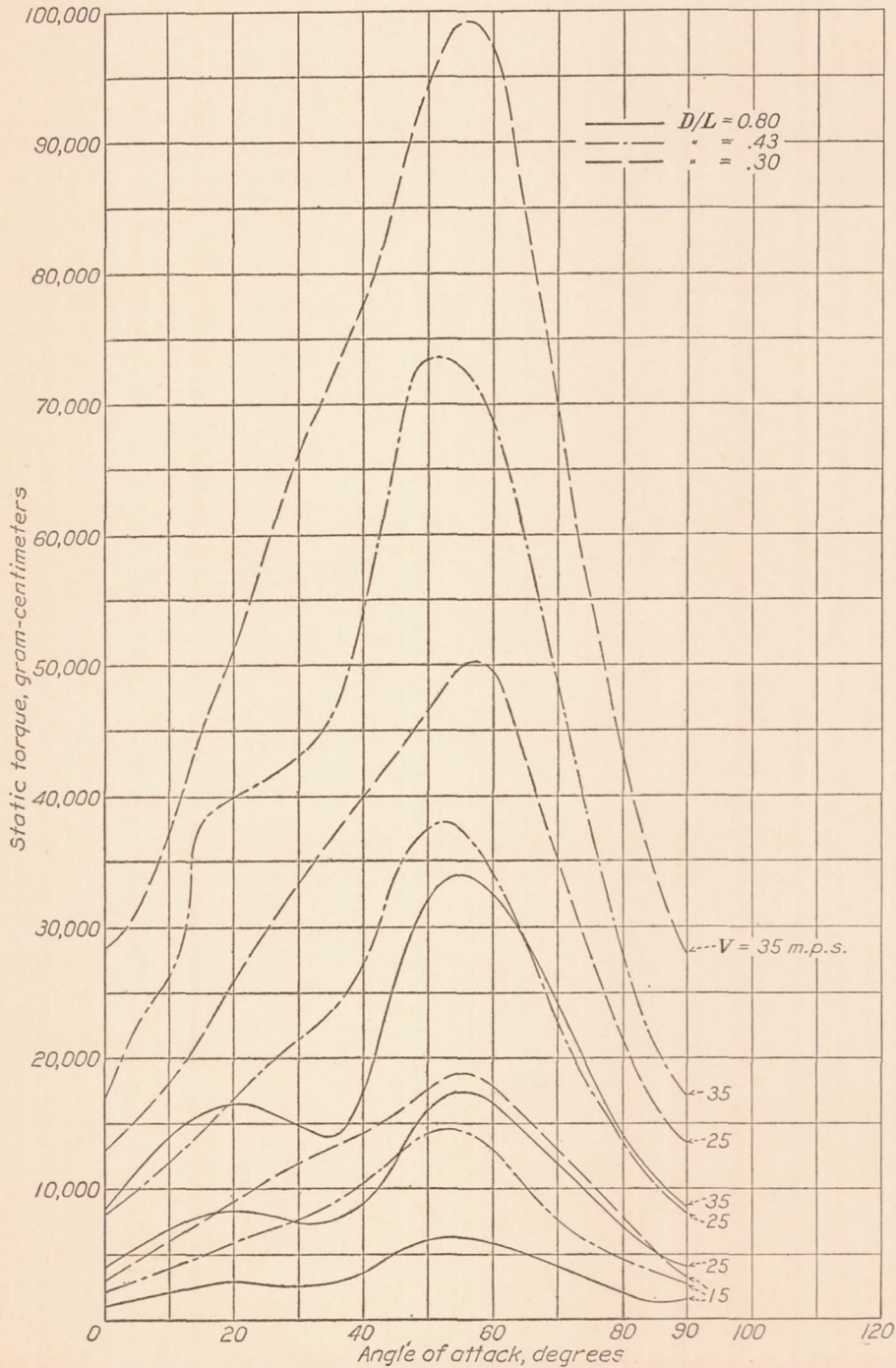

FIGURE 15.—Variation of static torque with angle of attack for cup wheel D, for different air speeds and different arm lengths

Mass was added to the pendulum and damping was installed on the balance so that variation in torque of the cup wheel throughout a revolution caused no appreciable trouble in reading. The motor was used as a brake, being hooked to the spindle with a belt. It was equipped with a reversing switch and rheostat, so that it was possible to change the speed of the cup wheels. This type of brake is more satisfactory than a friction brake because it gives more uniform braking effect and can be adjusted very finely by controlling the voltage applied to the motor. Revolution speed was obtained by timing the flashes of the neoa lamp with a stop watch.

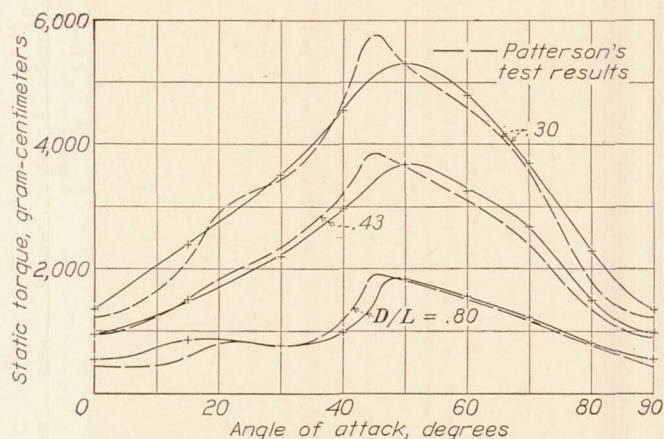

FIGURE 16.—Comparison between static-torque results obtained by Patterson and the results of subject tests for cup wheel A. Air speed is 9.41 meters per second.

This series of tests was made on the same cup wheels that were used in making the static-torque tests. Four cup wheels, with three arm lengths for each cup wheel, were used.

When running these tests, the air speed V was held constant and the torque was read for a number of different cup speeds v within the range permitted by the braking motor, v being the linear speed of the cup in its path. Curves of torque against v/V were plotted from the data thus obtained, each curve being for constant air speed. A sample set of these curves for $D/L=0.43$ for cup wheel A is given in fig. 21. A similar set of curves was obtained for each cup wheel tested. From these curves, cross plots of air speed against v/V were made for each combination tested, each curve being for constant torque. These curves are shown in figures 22 to 25. Each figure contains the three sets of curves for one cup wheel, one set of curves for each arm length used. On each set of curves is plotted the zero-torque curve as obtained from the calibration tests.

Since the Weather Bureau spindle is so nearly frictionless, the calibration curve obtained using it should

check the zero torque as obtained from the dynamic-torque tests. These curves may be checked on figs. 22 to 25. The results have been corrected to N. A. C. A. standard conditions of temperature and pressure. The agreement between the zero-torque curve as obtained from the dynamic-torque tests and the zero-torque curve as obtained from the calibration tests is best, in all cases, for the long arms.

Patterson (reference 1), gives a table of anemometer factors that are the reciprocals of v/V . The results of his investigation as well as the results of the present investigation show that for a value of D/L between 0.40 and 0.50, the performance, i. e., v/V , is a maximum. This fact was not commented upon by Patterson, and nothing in our results makes it possible to offer a completely convincing explanation. A possible explanation of these high values may be that there is an opportune choice of arm length which causes the air stream to pass by the cup wheel as though it were a cylinder. At longer arm lengths part of the air would go through the cup wheel and with shorter arm lengths the speeding up of the air around the imaginary cylinder would be less.

CALCULATION OF DYNAMIC TORQUE

The theoretical torque calculations made by Patterson not being entirely satisfactory and comprehensive data on individual cups being available, the torque distribution for a single hemispherical cup through a complete revolution was calculated. These calculations were made for several values of v/V and for several values of V . The following equations were used in making these calculations:

$$\frac{V_R}{V} = \sqrt{1 + \left(\frac{v}{V}\right)^2 + \frac{2v}{V} \cos \alpha} \quad (1)$$

$$\cos \alpha_R = \frac{\cos \alpha - \frac{v}{V}}{\frac{V_R}{V}} \quad (2)$$

$$T = C_N A L (1/2 \rho V_R^2) \quad (3)$$

where

V_R , resultant air speed.

V , air speed.

v , linear speed of cup center.

α , angle of attack of cup.

α_R , relative angle of attack of cup.

T , instantaneous torque.

C_N , normal-force coefficient of cup.

A , area of open face of cup.

L , arm length from axis to center of cup.

(See fig. 2.)

ρ , density of the air.

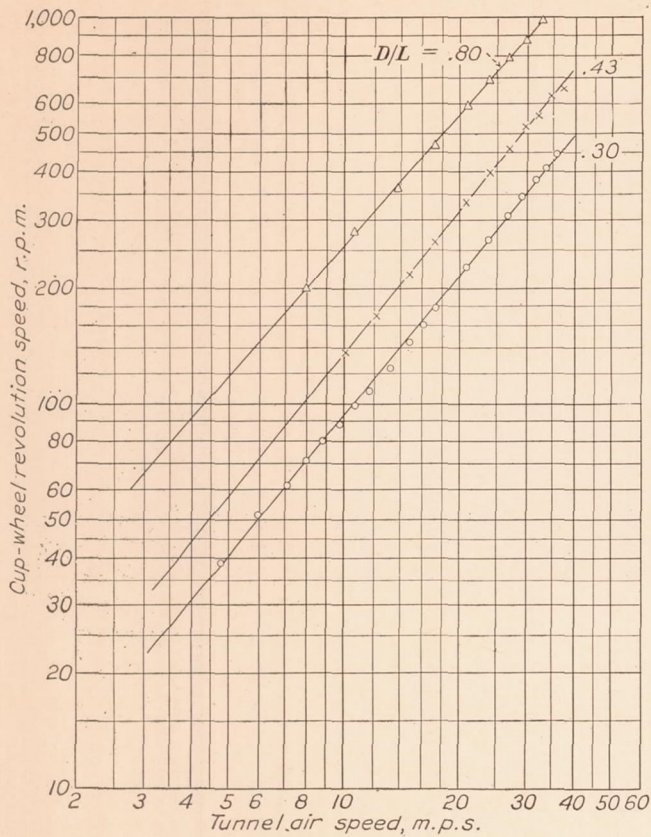

FIGURE 17.—Calibration curves for cup wheel A. The variation of revolution speed with air speed.

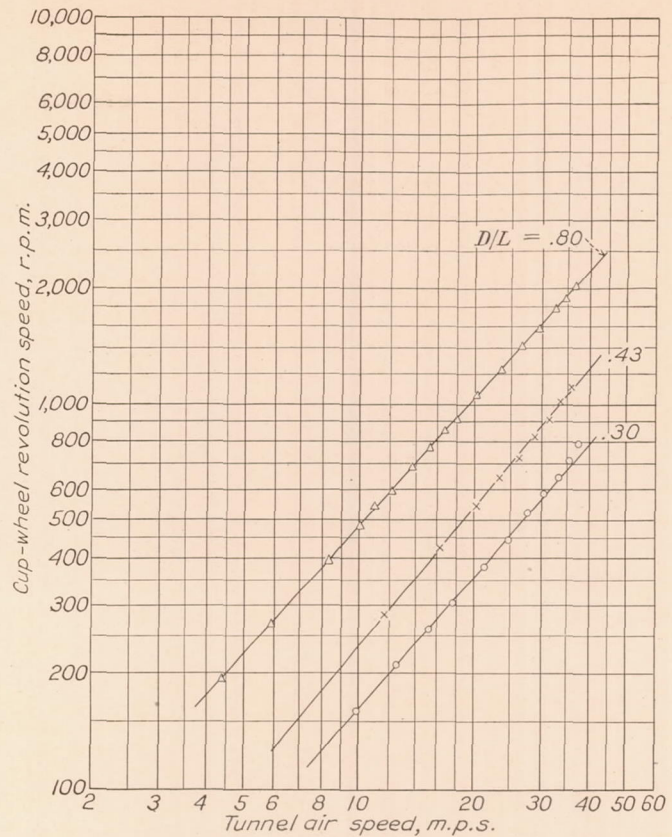

FIGURE 19.—Calibration curves for cup wheel C. The variation of revolution speed with air speed.

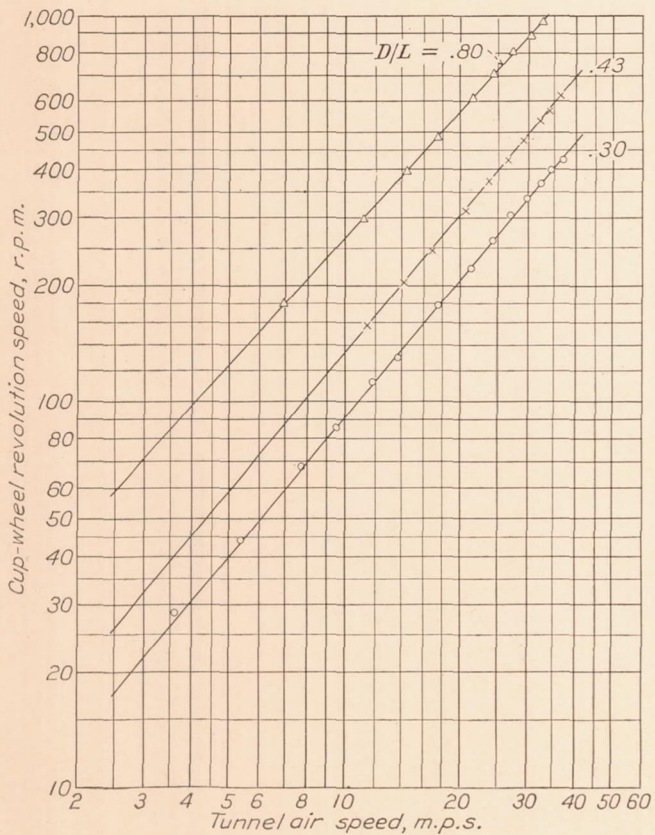

FIGURE 18.—Calibration curves for cup wheel B. The variation of revolution speed with air speed.

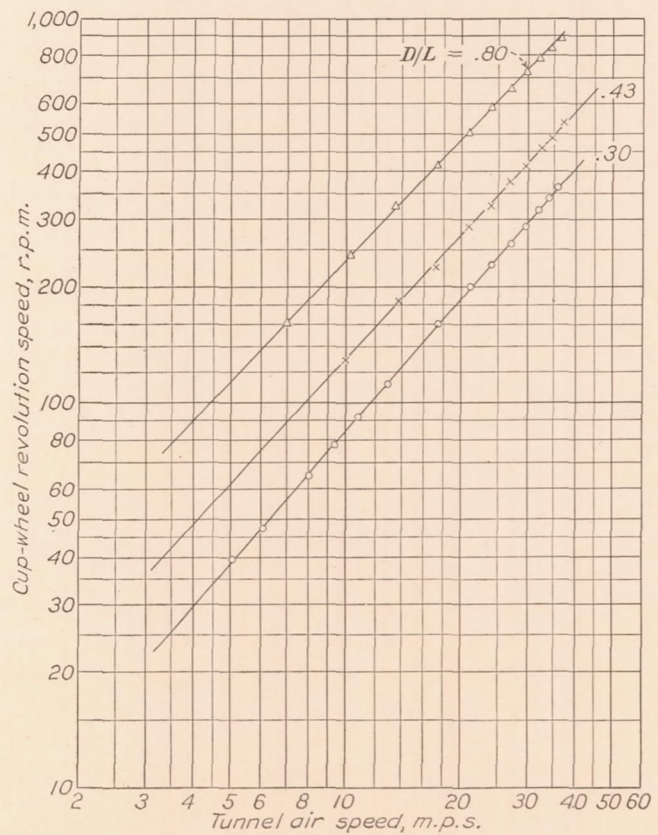

FIGURE 20.—Calibration curves for cup wheel D. The variation of revolution speed with air speed.

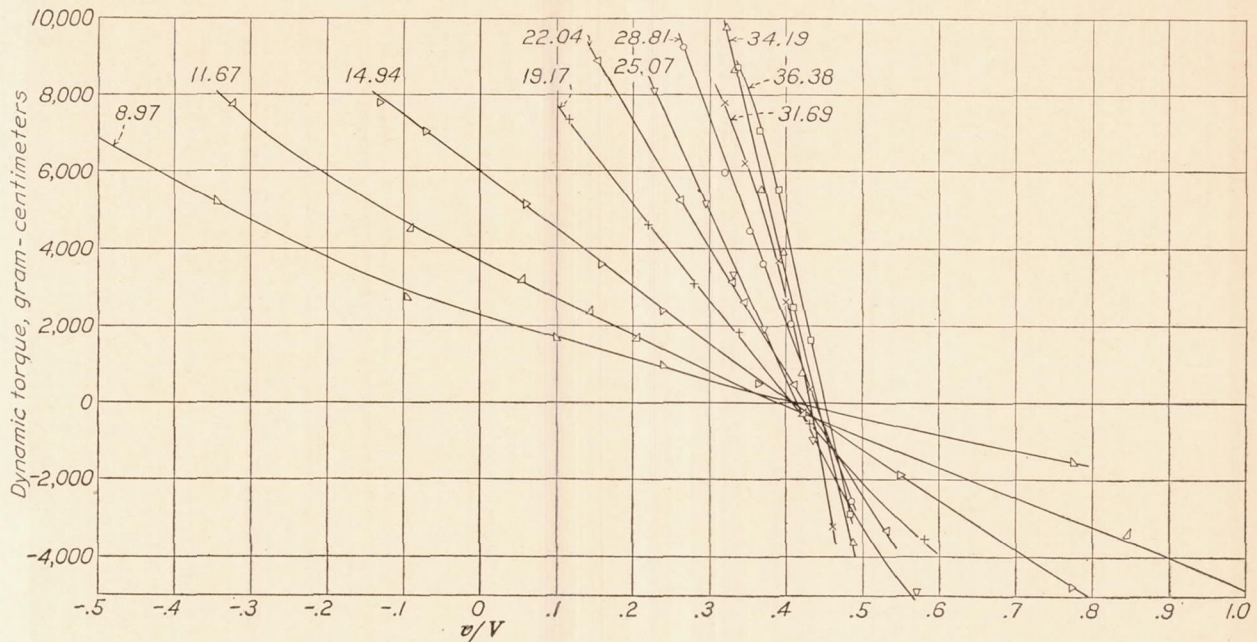

FIGURE 21.—Variation of dynamic torque with v/V for different air speeds for cup wheel A. Values indicate tunnel air speed in meters per second.

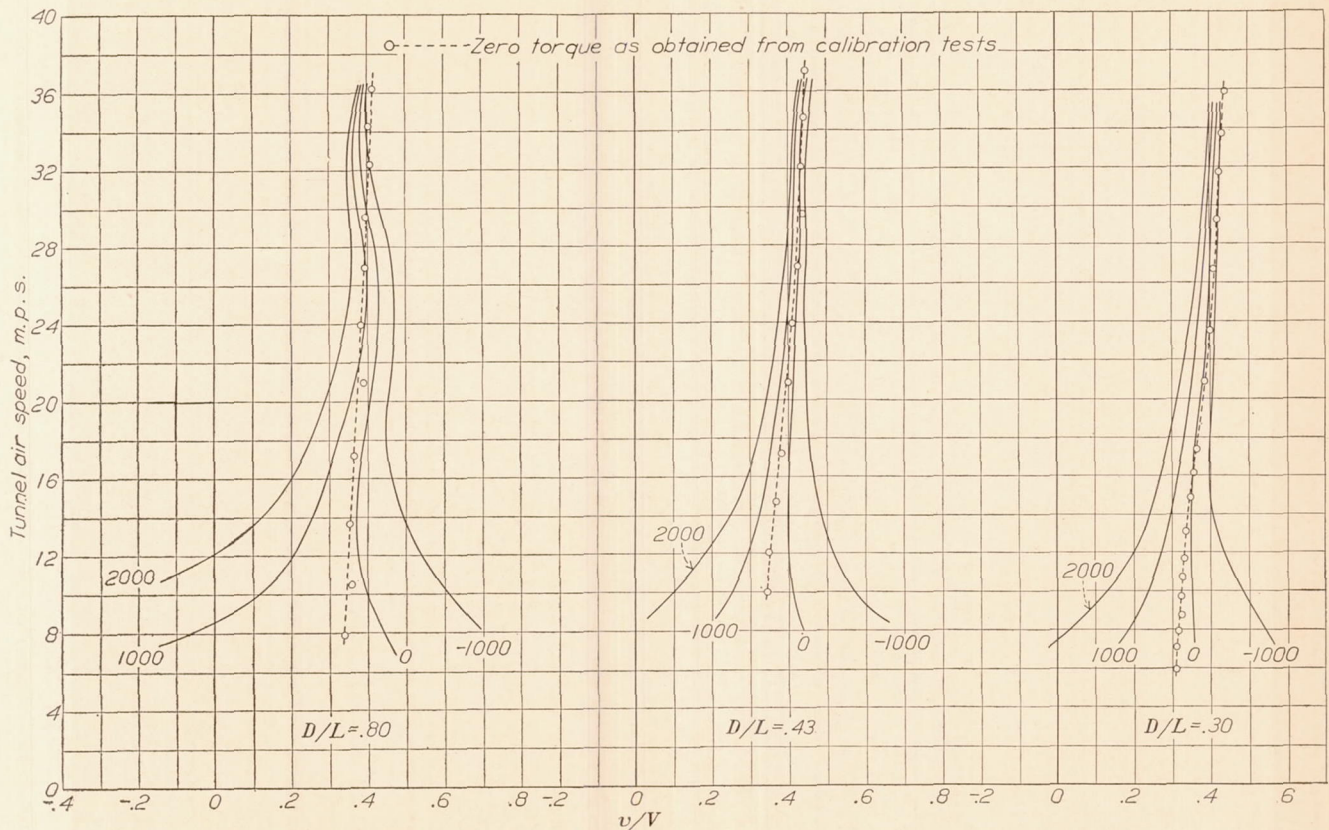

FIGURE 22.—Variation of v/V with tunnel air speed for cup wheel A for different arm lengths. Values indicate torque in gram-centimeters.

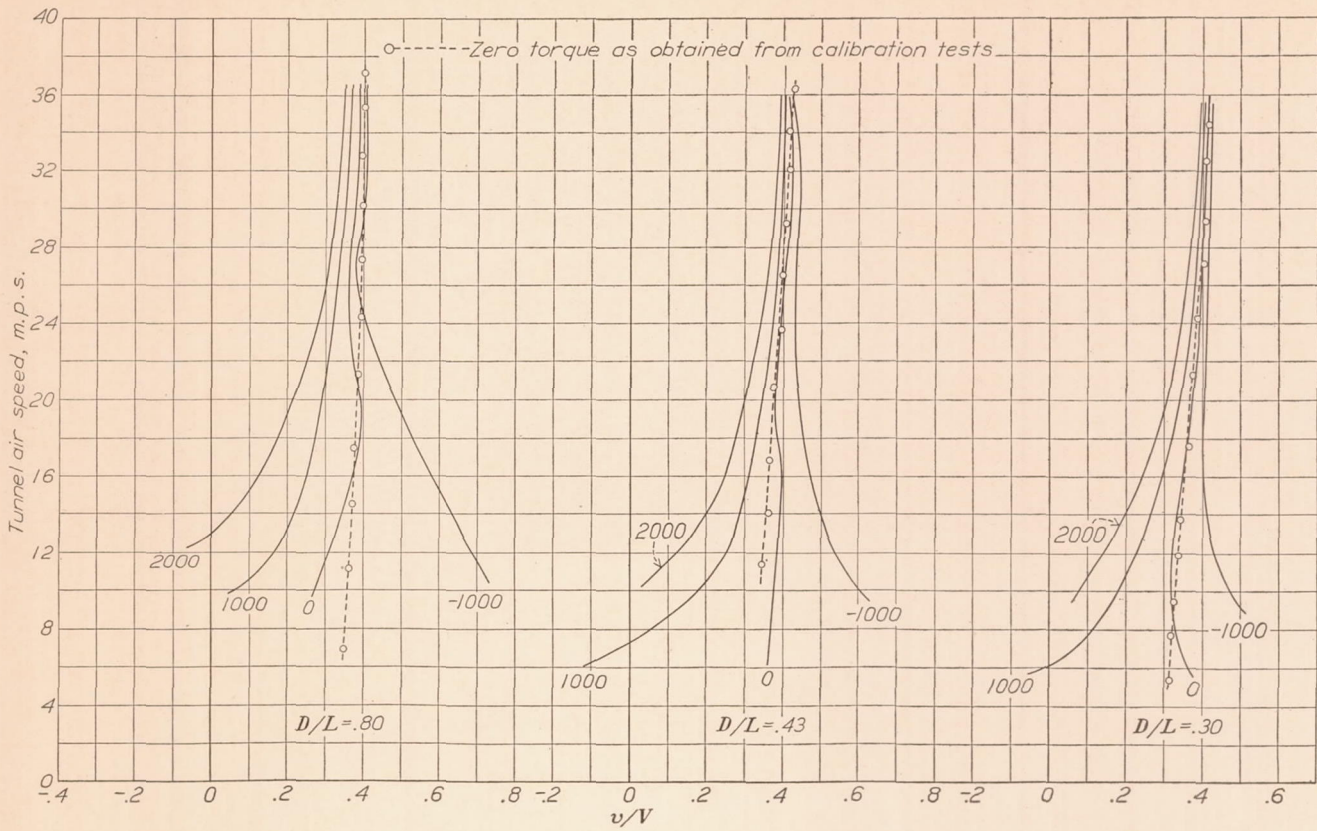

FIGURE 23.—Variation of v/V with tunnel air speed for cup wheel B for different arm lengths. Values indicate torque in gram-centimeters.

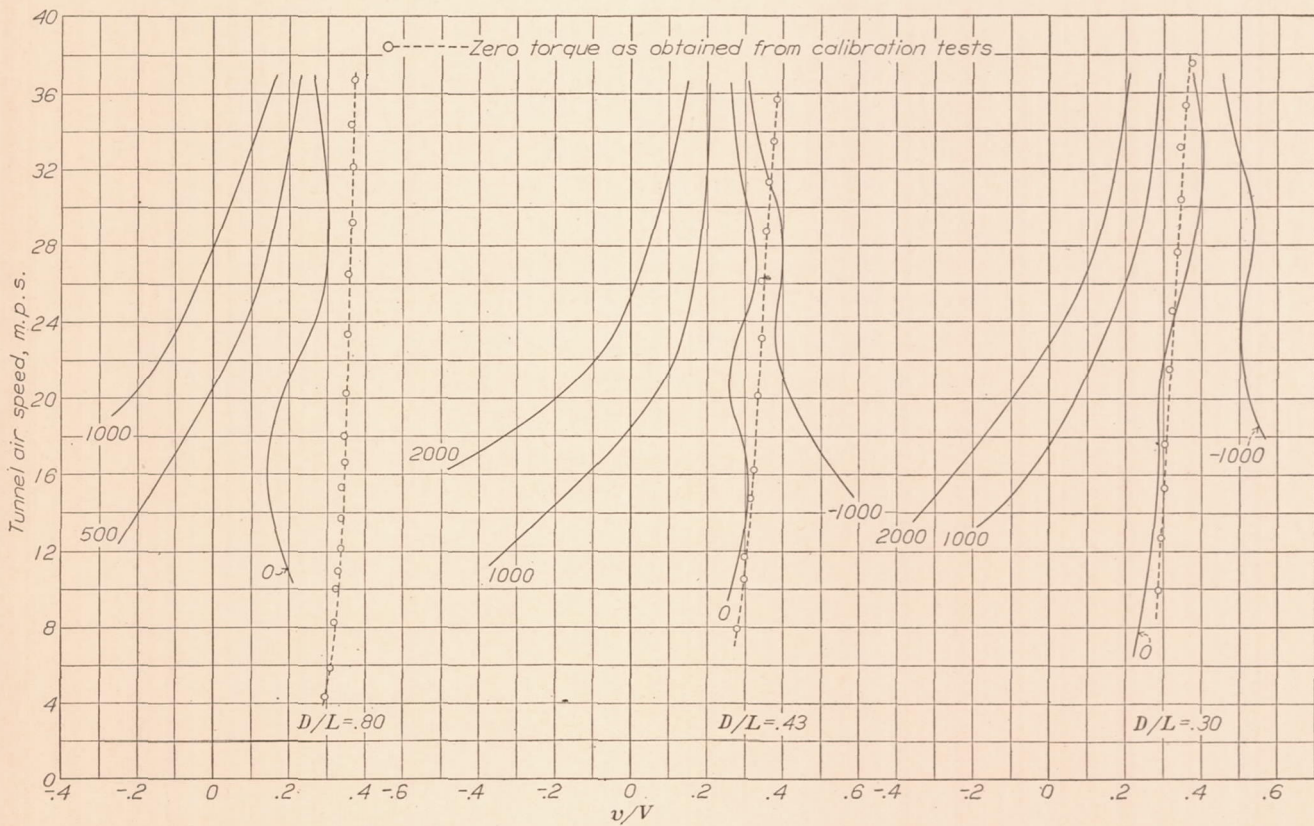

FIGURE 24.—Variation of v/V with tunnel air speed for cup wheel C for different arm lengths. Values indicate torque in gram-centimeters.

For each calculation a curve of torque against angle of attack was plotted. These curves were integrated and the average torque thus obtained was multiplied by the number of cups in order to get the mean torque for the complete wheel. A cross plot of all these calculations was made, each test furnishing one point. Mean torque was plotted against v/V and from this curve the value of v/V for zero torque was obtained. The value thus obtained represents a theoretical value employing experimental values for C_N and taking no account of the interference between cups. The value of v/V for zero torque was lower than the experimental values already found. It was assumed that the higher

The arm lengths used were the same as those used in the dynamic-torque tests. Records were taken at several values of v/V for each combination tested. Six of the curves obtained are given in figures 27 to 32. The value of V was so chosen that the natural frequency of the recording mechanism would be high enough to show truthfully the variations in torque.

An exact agreement between calculated and observed torque throughout a complete revolution was not expected but rather a reduced torque in the downstream position that would indicate shielding. This shielding would account for the fact that the experimental curves show higher performance values

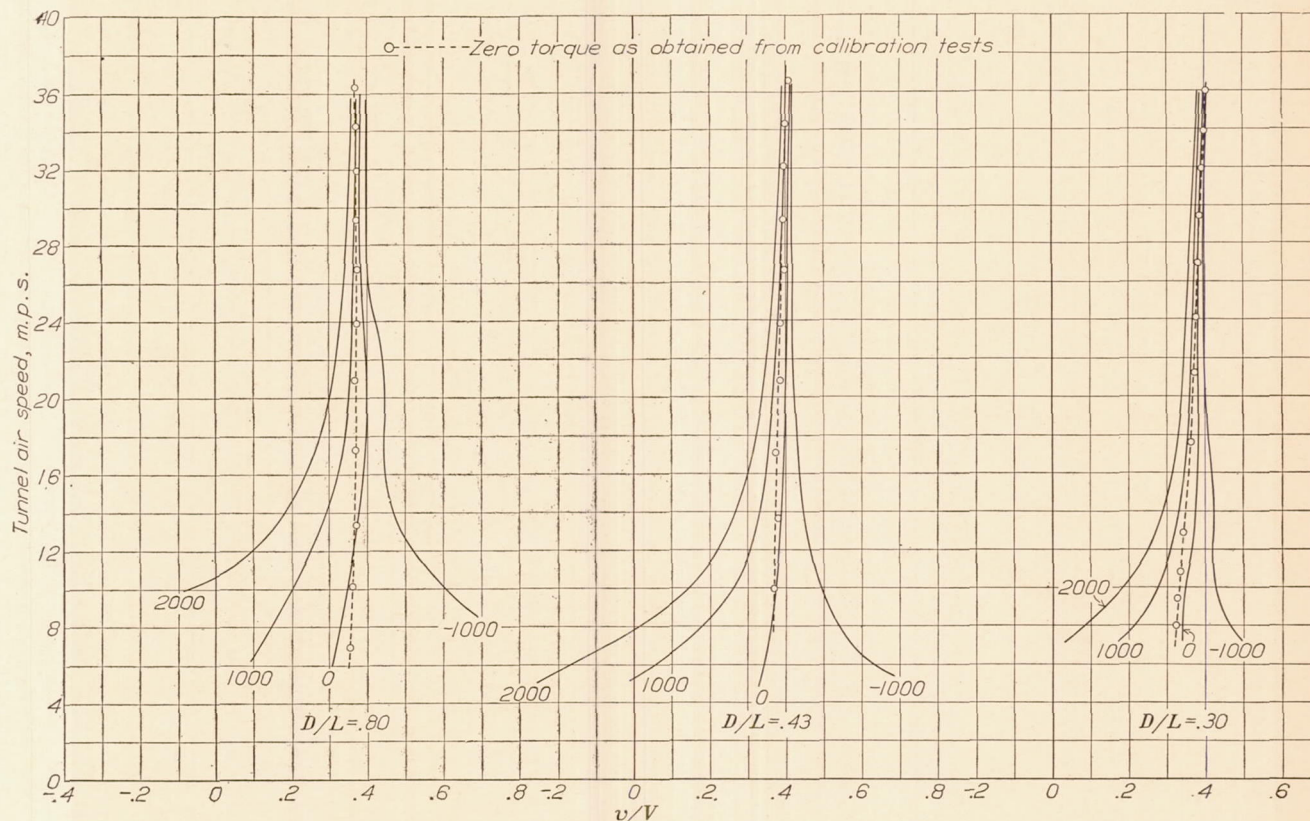

FIGURE 25.—Variation of v/V with tunnel air speed for cup wheel D for different arm lengths. Values indicate torque in gram-centimeters.

performance indicated by the experimental results was due to the interference between cups.

DYNAMIC-TORQUE RECORDER

It was thought that if the curve of torque against angle of attack of a single cup and a cup wheel could be obtained, a comparison of this curve with the calculated curve for identical conditions might yield information that would make it possible to determine definitely the nature of this interference. In order to make these measurements, a dynamic-torque recorder was built; its construction may be seen from figure 26. Photographic recording is used in this instrument, and the torque on a single cup through 360° is recorded on a single film. A series of tests was made using a 3-cup wheel and a 4-cup wheel, with 4-inch hemispherical cups.

than the calculated curves. The chief difference between the experimental results and the calculated results (fig. 33) is that the experimental results show a larger range of angle of attack in which the torque is positive than do the calculated results. Apparently this case is one in which the air stream is deflected on passing through the cup wheel.

This change in direction was recognized and taken into account by Patterson, who assumed that the whole air stream was deflected and that the angle of attack was changed by the amount of this deflection. That the amount of deflection is variable through one revolution and cannot be dealt with so simply is shown by the smoke-flow pictures in figure 34. These pictures were taken in the N. A. C. A. smoke-flow tunnel with the anemometer turning freely on its

spindle in an air stream having a velocity of 1.83 meters per second. Besides this change of direction of the air stream, our records show another phenomenon, a certain lag in change of flow. This lag has been clearly shown by high-speed pictures of smoke flow over airfoils. When the airfoil is quickly shifted

It may therefore be concluded that cup interference is due not so much to the effect of the turbulent wake of one cup on another as to the effect of the change of direction of the air stream and to the effect of the lag of the aerodynamic forces in attaining the values they should attain corresponding to the angle of attack.

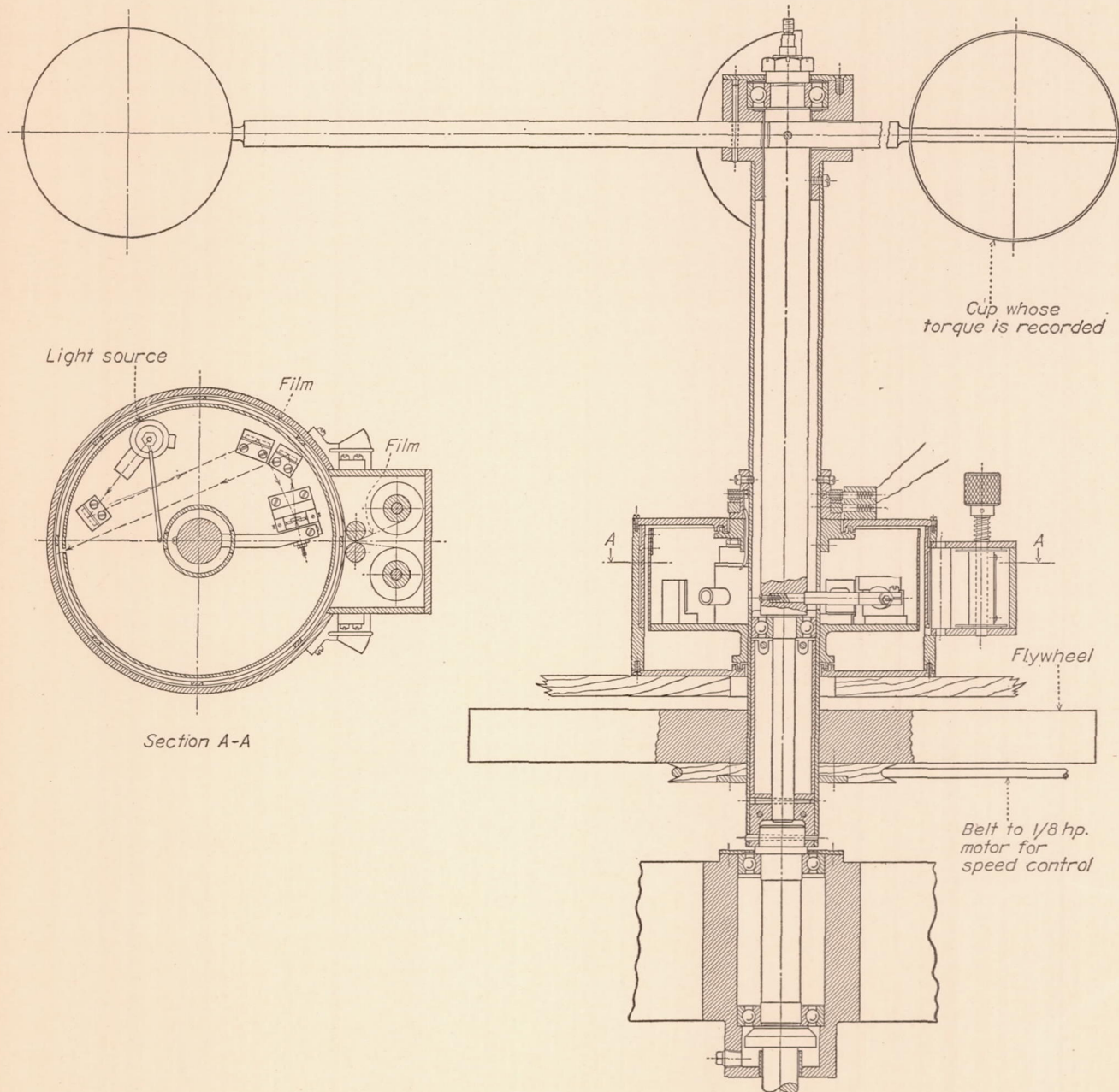

FIGURE 26.—Drawing of dynamic-torque recorder.

from one angle of attack to another there is an appreciable time before the air flow over the airfoil assumes a final steady state. It is easy to imagine that there may be an appreciable lag in change of flow over a cup which is changing its angle of attack continuously at a high rate of speed.

Wind direction and lag vary with wind speed, arm length, and cup diameter. Although the present results and those of Patterson bear out the validity of the conclusion, they do not aid in an easy solution of the problem but only emphasize its complexity. To map out both the lag and effective change of direction

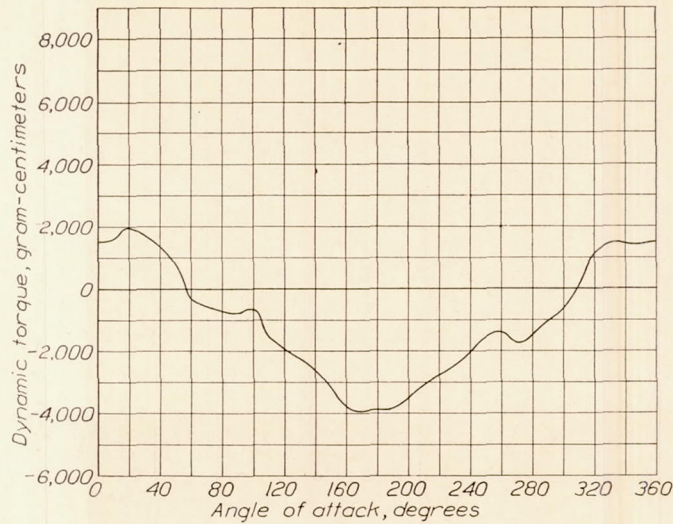

FIGURE 27.—Variation of dynamic torque with angle of attack for a single cup in cup wheel A with $D/L=0.30$. Performance factor $v/V=0.351$. Tunnel air speed, 12.0 meters per second.

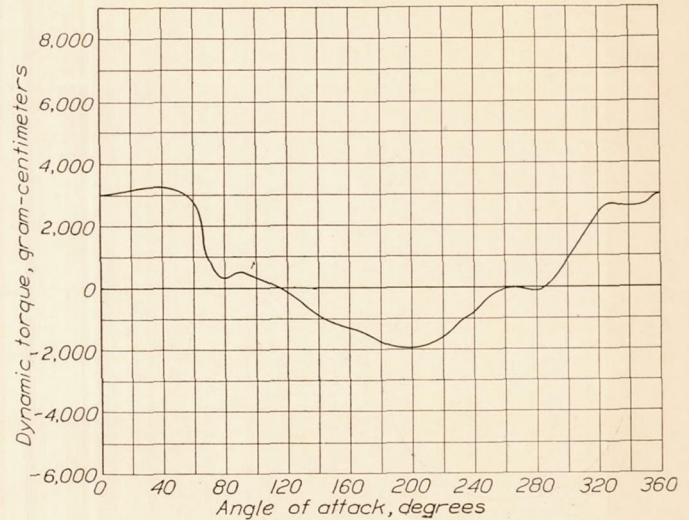

FIGURE 30.—Variation of dynamic torque with angle of attack for a single cup in cup wheel B with $D/L=0.30$. Performance factor $v/V=0.272$. Tunnel air speed, 12.03 meters per second.

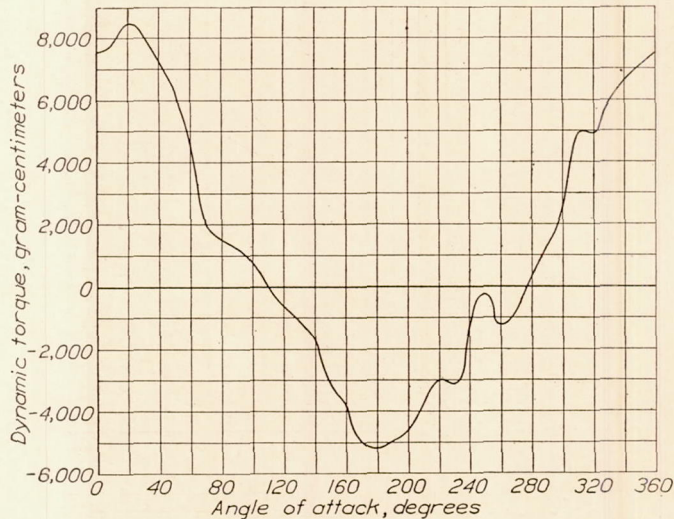

FIGURE 28.—Variation of dynamic torque with angle of attack for a single cup in cup wheel A with $D/L=0.43$. Performance factor $v/V=0.429$. Tunnel air speed, 21.8 meters per second.

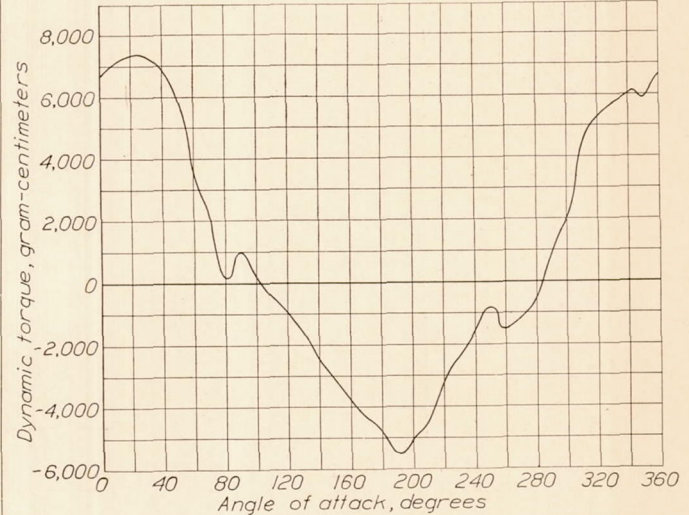

FIGURE 31.—Variation of dynamic torque with angle of attack for a single cup in cup wheel B with $D/L=0.43$. Performance factor $v/V=0.238$. Tunnel air speed, 21.8 meters per second.

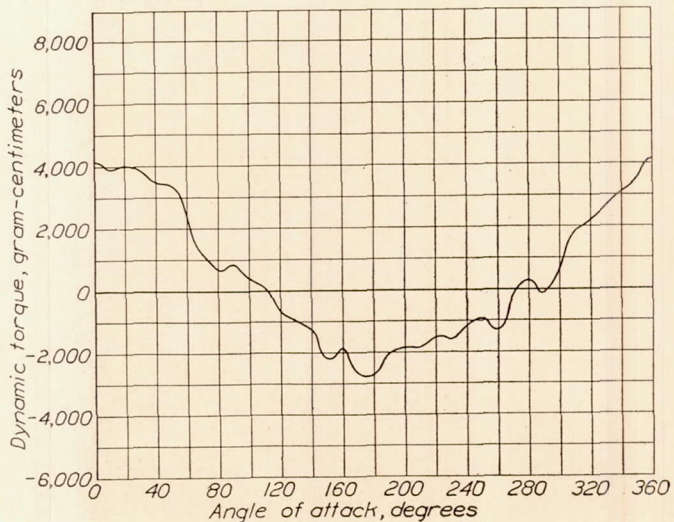

FIGURE 29.—Variation of dynamic torque with angle of attack for a single cup in cup wheel A with $D/L=0.80$. Performance factor $v/V=0.212$. Tunnel air speed, 21.8 meters per second.

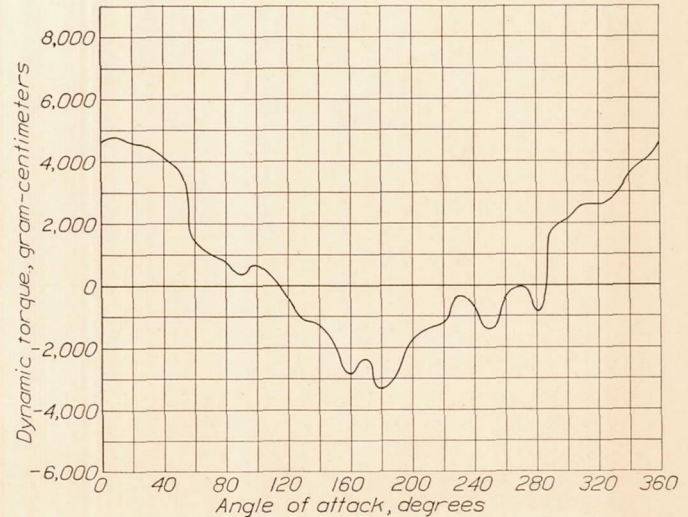

FIGURE 32.—Variation of dynamic torque with angle of attack for a single cup in cup wheel B with $D/L=0.80$. Performance factor $v/V=0.226$. Tunnel air speed, 21.8 meters per second.

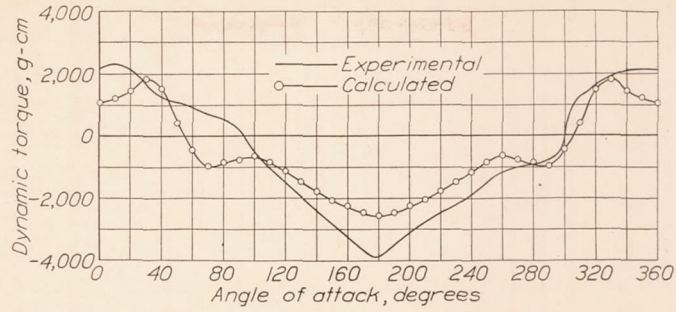

FIGURE 33.—Comparison of experimental and calculated curves of dynamic torque against angle of attack for one cup of cup wheel A with $D/L=0.30$. Ratio $v/V=0.459$. Tunnel air speed, 12.03 meters per second.

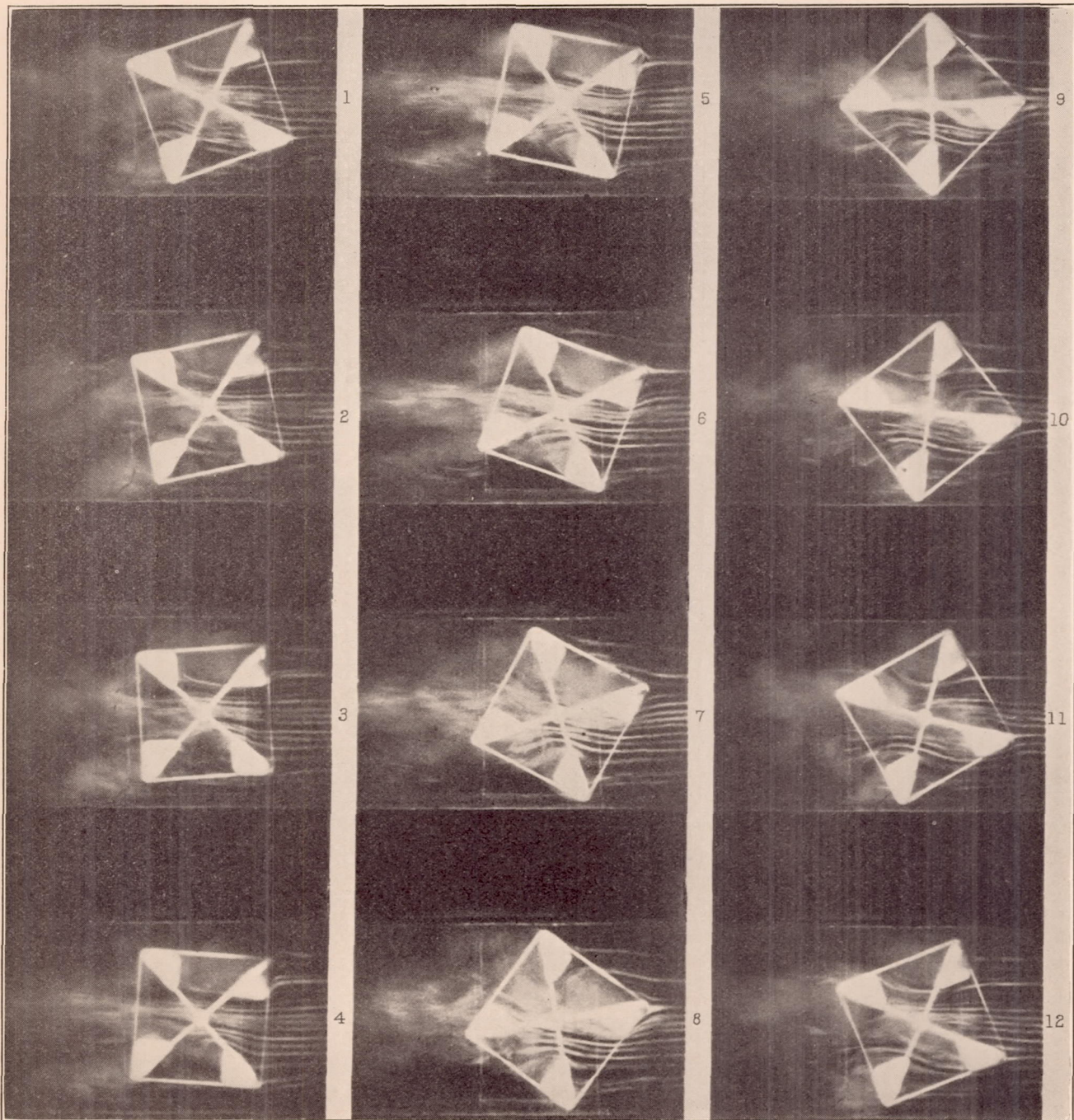

FIGURE 34.—Smoke flow through anemometer cup wheel turning freely in air stream. Air speed, 1.83 meters per second.

for each angle of attack for a range of arm lengths, cup sizes, and wind speeds would involve considerable time and effort. If further work is to be undertaken to clear up the general problem of cup interference, the work will necessarily have to be limited to fewer cup sizes and cup arrangements than were used in this

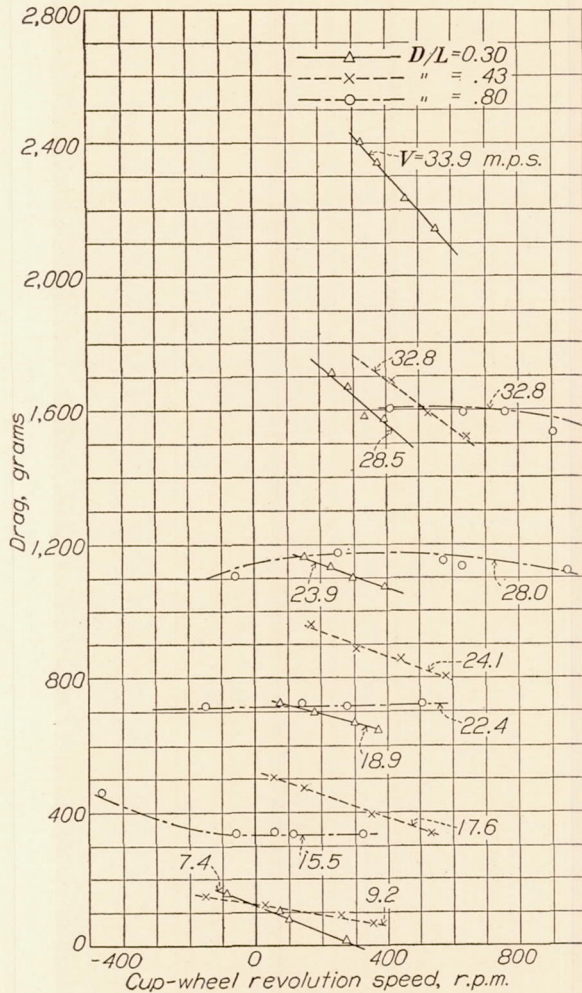

FIGURE 35.—Variation of drag with revolution speed for cup wheel A for different arm lengths and different air speeds.

investigation. Obviously, such a restriction would seriously limit the value of the work.

From the collective results of the dynamic-torque and calibration tests, it appears that a value of $D/L = 0.40$ will give nearest to a straight line for the performance factor v/V , at least for the 4-inch cups.

A comparison of the v/V for zero torque as obtained by the four methods used is given in table II.

TABLE II

VALUES OF v/V FOR ZERO TORQUE OBTAINED BY FOUR DIFFERENT METHODS

[Diameter of hemispherical cups=10.16 centimeters]

D/L	Calculated	Dynamic-torque tests	Dynamic-torque recorder	Calibration tests
3-cup wheel				
0.30	0.315	0.332	0.348	0.336
.43	.315	.385	.327	.345
.80	.315	.375	.360	.362
4-cup wheel				
0.30	0.315	0.350	0.322	0.336
.43	.315	.405	.370	.350
.80	.315	.377	.400	.354

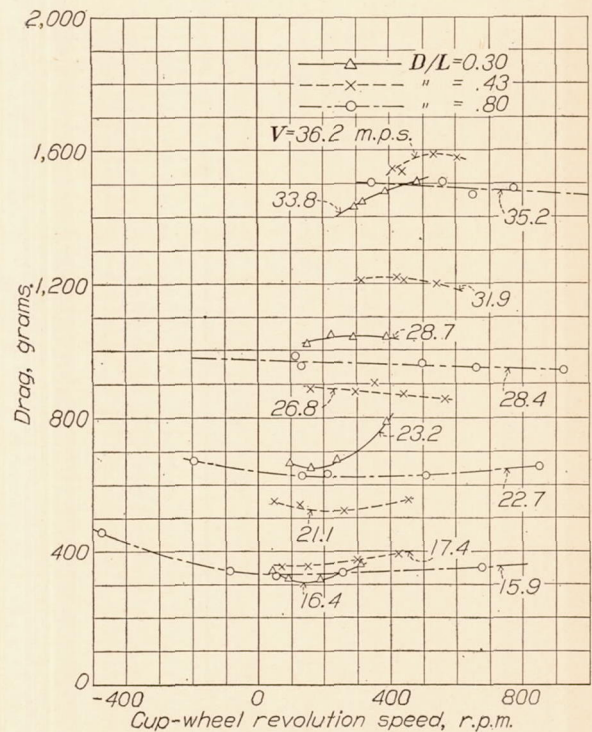

FIGURE 36.—Variation of drag with revolution speed for cup wheel B for different arm lengths and different air speeds.

DRAG MEASUREMENTS

In order to obtain information regarding the forces experienced by anemometer mountings and bearings under operating conditions, the drag on several cup wheels was measured. The drag of the spindle has been subtracted from these results.

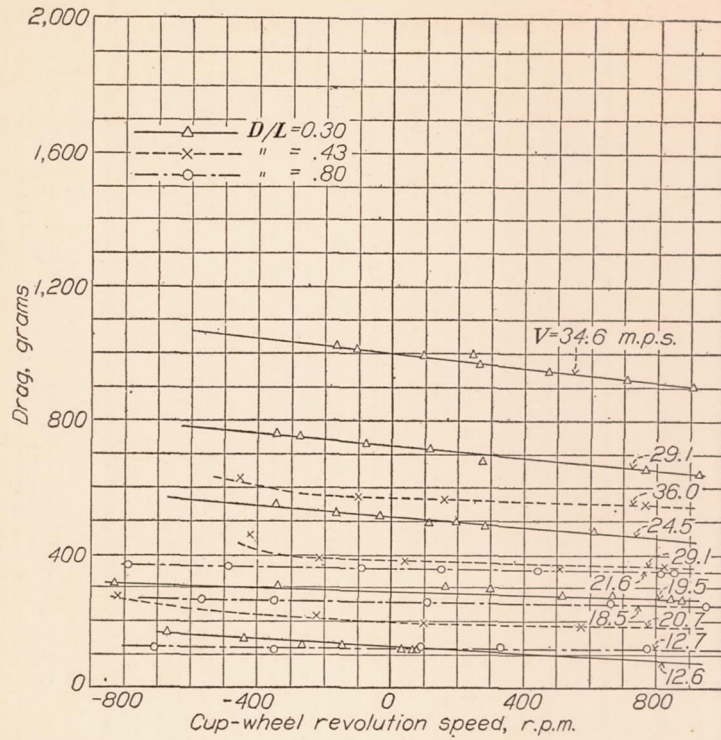

FIGURE 37.—Variation of drag with revolution speed for cup wheel C for different arm lengths and different air speeds.

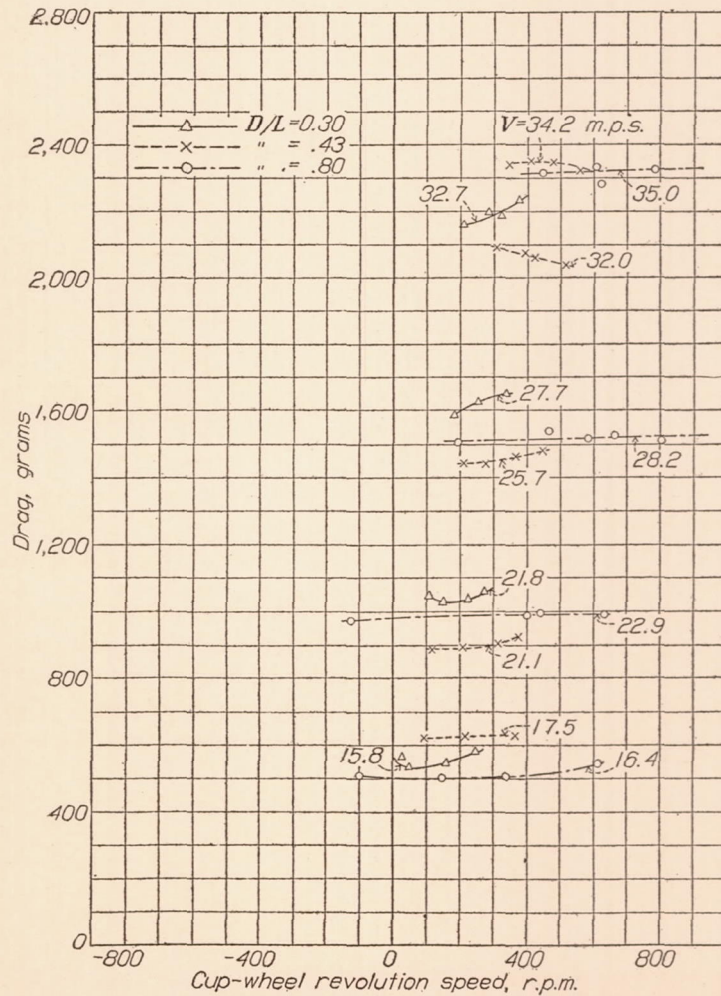

FIGURE 38.—Variation of drag with revolution speed for cup wheel D for different arm lengths and different air speeds.

Curves of cup-wheel revolution speed against drag, each curve being for constant air speed, are given in figures 35 to 38.

ACCURACY OF MEASUREMENTS

Static and dynamic torque could be measured with a precision of ± 35 gram-centimeters except in a few cases where the balance was vibrating. This vibration was occasionally set up by a resonant response of the whole pendulum at certain combinations of air speed and cup-wheel revolution speed to such an extent that it could not be completely damped. These resonance conditions were avoided insofar as possible. Air speed was measured with an accuracy of ± 2 percent and cup-wheel revolution speed could be determined within ± 1 percent. The error in measurement of cup diameters and arm lengths was negligible. The precision of measurement of lift and drag forces on individual cups varied from ± 0.5 gram at low air speeds to ± 5 grams at high air speeds. The drag measurements on complete cup wheels are correct to within ± 10 grams.

Certain irregularities occur in the plotted curves, that is, the curves from various cup sizes and arm lengths do not always show similar shapes when they apparently should. When small cups or short arm lengths are used, thus making the torques to be measured small, it is reasonable to assume that these irregularities are due to errors in measurement. With the larger cups and longer arm lengths, however, the same assumption cannot be made. The results have been checked in many cases and found to repeat

themselves. It is therefore concluded that these irregularities must be due to certain abnormalities in the aerodynamic forces.

LANGLEY MEMORIAL AERONAUTICAL LABORATORY,
NATIONAL ADVISORY COMMITTEE FOR AERONAUTICS,
LANGLEY FIELD, VA., *October 10, 1934.*

REFERENCES

1. Patterson, J.: The Cup Anemometer. Roy. Soc. Canada Trans., Third Series, vol. XX, sec. III, 1926.
2. Theodorsen, Theodore, and Silverstein, Abe: Experimental Verification of the Theory of Wind-Tunnel Boundary Interference. T. R. No. 478, N. A. C. A., 1934.
3. Eiffel, G.: Nouvelles Recherches sur la Résistance de l'Air et l'Aviation Faites au Laboratoire d'Auteuil. H. Dunod et E. Pinat (Paris), 1914, Texte, p. 3.
4. Bradfield, F. B.: Aerodynamic Properties of a Hemispherical Cup. With Application to the Hemispherical Cup Windmill and Anemometer. R. & M. No. 712, British A. R. C., 1919.
5. Hansen, M.: Untersuchung einer offenen und geschlossenen Halbkugel. Ergb. Aero. Vers. zu Göttingen. IV Lieferung 1932, pp. 108-112.
6. Brevoort, M. J., and Joyner, U. T.: Aerodynamic Characteristics of Anemometer Cups. T. N. No. 489, N. A. C. A., 1934.
7. Dryden, H. L., and Kuethe, A. M.: Effect of Turbulence in Wind Tunnel Measurements. T. R. No. 342, N. A. C. A., 1930.
8. Hubbard, John D., and Brescoll, George P.: Aerodynamic Investigation of a Cup Anemometer. T. N. No. 502, N. A. C. A., 1934.

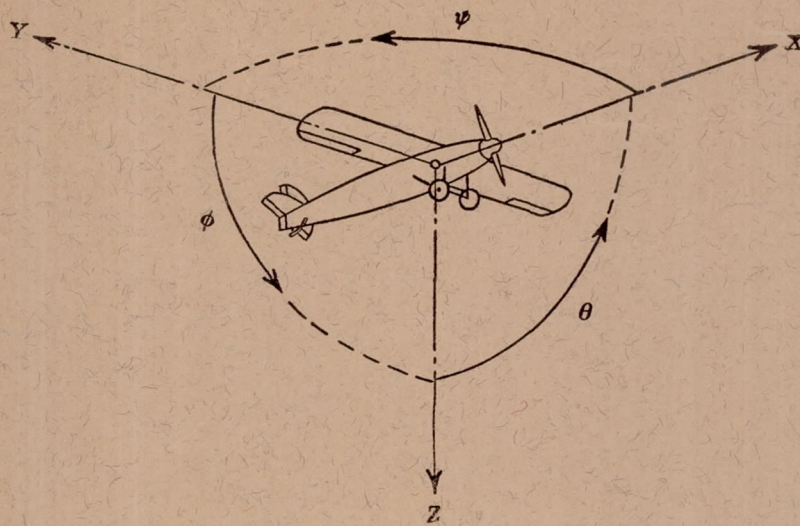

Positive directions of axes and angles (forces and moments) are shown by arrows

Axis		Force (parallel to axis) symbol	Moment about axis			Angle		Velocities	
Designation	Sym- bol		Designation	Sym- bol	Positive direction	Designa- tion	Sym- bol	Linear (compo- nent along axis)	Angular
Longitudinal	X	X	Rolling	L	Y → Z	Roll	φ	u	p
Lateral	Y	Y	Pitching	M	Z → X	Pitch	θ	v	q
Normal	Z	Z	Yawing	N	X → Y	Yaw	ψ	w	r

Absolute coefficients of moment

$$C_l = \frac{L}{q b S}$$

(rolling)

$$C_m = \frac{M}{q c S}$$

(pitching)

$$C_n = \frac{N}{q b S}$$

(yawing)

Angle of set of control surface (relative to neutral position), δ . (Indicate surface by proper subscript.)

4. PROPELLER SYMBOLS

D , Diameter

p , Geometric pitch

p/D , Pitch ratio

V , Inflow velocity

V_s , Slipstream velocity

T , Thrust, absolute coefficient $C_T = \frac{T}{\rho n^2 D^4}$

Q , Torque, absolute coefficient $C_Q = \frac{Q}{\rho n^2 D^5}$

P , Power, absolute coefficient $C_P = \frac{P}{\rho n^3 D^5}$

C_s , Speed-power coefficient = $\sqrt[5]{\frac{\rho V^5}{P n^2}}$

η , Efficiency

n , Revolutions per second, r.p.s.

Φ , Effective helix angle = $\tan^{-1} \left(\frac{V}{2\pi r n} \right)$

5. NUMERICAL RELATIONS

1 hp. = 76.04 kg-m/s = 550 ft-lb./sec.

1 metric horsepower = 1.0132 hp.

1 m.p.h. = 0.4470 m.p.s.

1 m.p.s. = 2.2369 m.p.h

1 lb. = 0.4536 kg.

1 kg = 2.2046 lb.

1 mi. = 1,609.35 m = 5,280 ft.

1 m = 3.2808 ft.