

TECH LIBRARY KAFB, NM
0143061

7811
6192

NATIONAL ADVISORY COMMITTEE FOR AERONAUTICS

REPORT 1182

COMPARISON OF EFFECTIVENESS OF CONVECTION-, TRANSPARATION-, AND FILM-COOLING METHODS WITH AIR AS COOLANT

By E. R. G. ECKERT and JOHN N. B. LIVINGOOD



1954



REPORT 1182

COMPARISON OF EFFECTIVENESS OF CONVECTION-, TRANSPIRATION-, AND FILM-COOLING METHODS WITH AIR AS COOLANT

By E. R. G. ECKERT and JOHN N. B. LIVINGOOD

Lewis Flight Propulsion Laboratory
Cleveland, Ohio

National Advisory Committee for Aeronautics

Headquarters, 1512 H Street NW., Washington 25, D. C.

Created by act of Congress approved March 3, 1915, for the supervision and direction of the scientific study of the problems of flight (U. S. Code, title 50, sec. 151). Its membership was increased from 12 to 15 by act approved March 2, 1929, and to 17 by act approved May 25, 1948. The members are appointed by the President, and serve as such without compensation.

JEROME C. HUNSAKER, Sc. D., Massachusetts Institute of Technology, *Chairman*

DETLEV W. BRONK, Ph. D., President, Rockefeller Institute for Medical Research, *Vice Chairman*

JOSEPH P. ADAMS, LL. D., member, Civil Aeronautics Board.
ALLEN V. ASTIN, Ph. D., Director, National Bureau of Standards.
PRESTON R. BASSETT, M. A., President, Sperry Gyroscope Co., Inc.
LEONARD CARMICHAEL, Ph. D., Secretary, Smithsonian Institution.
RALPH S. DAMON, D. Eng., President, Trans World Airlines, Inc.
JAMES H. DOOLITTLE, Sc. D., Vice President, Shell Oil Co.
LLOYD HARRISON, Rear Admiral, United States Navy, Deputy and Assistant Chief of the Bureau of Aeronautics.
RONALD M. HAZEN, B. S., Director of Engineering, Allison Division, General Motors Corp.

RALPH A. OFSTIE, Vice Admiral, United States Navy, Deputy Chief of Naval Operations (Air).
DONALD L. PUTT, Lieutenant General, United States Air Force, Deputy Chief of Staff (Development).
DONALD A. QUARLES, D. Eng., Assistant Secretary of Defense (Research and Development).
ARTHUR E. RAYMOND, Sc. D., Vice President—Engineering, Douglas Aircraft Co., Inc.
FRANCIS W. REICHELDERFER, Sc. D., Chief, United States Weather Bureau.
OSWALD RYAN, LL. D., member, Civil Aeronautics Board.
NATHAN F. TWINING, General, United States Air Force, Chief of Staff.

HUGH L. DRYDEN, Ph. D., *Director*

JOHN F. VICTORY, LL. D., *Executive Secretary*

JOHN W. CROWLEY, JR., B. S., *Associate Director for Research*

EDWARD H. CHAMBERLIN, *Executive Officer*

HENRY J. E. REID, D. Eng., Director, Langley Aeronautical Laboratory, Langley Field, Va.

SMITH J. DEFRANCE, D. Eng., Director, Ames Aeronautical Laboratory, Moffett Field, Calif.

EDWARD R. SHARP, Sc. D., Director, Lewis Flight Propulsion Laboratory, Cleveland Airport, Cleveland, Ohio

LANGLEY AERONAUTICAL LABORATORY
Langley Field, Va.

AMES AERONAUTICAL LABORATORY
Moffett Field, Calif.

LEWIS FLIGHT PROPULSION LABORATORY
Cleveland Airport, Cleveland, Ohio

Conduct, under unified control, for all agencies, of scientific research on the fundamental problems of flight

REPORT 1182

COMPARISON OF EFFECTIVENESS OF CONVECTION-, TRANSPIRATION-, AND FILM-COOLING METHODS WITH AIR AS COOLANT¹

By E. R. G. ECKERT and JOHN N. B. LIVINGOOD

SUMMARY

Various parts of aircraft propulsion engines that are in contact with hot gases often require cooling. Transpiration and film cooling, new methods that supposedly utilize cooling air more effectively than conventional convection cooling, have already been proposed. This report presents material necessary for a comparison of the cooling requirements of these three methods. Correlations that are regarded by the authors as the most reliable today are employed in evaluating each of the cooling processes.

Calculations for the special case in which the gas velocity is constant along the cooled wall (flat plate) are presented. These results should give a good indication of the relative effectiveness of the cooling methods under other flow conditions as well. Air is stipulated as the coolant and as the outside flow medium (a good approximation for combustion gases). Both laminar and turbulent flow, with and without radiation, are considered for Reynolds numbers between 10^3 and 10^9 and coolant-flow ratios from 0 to 0.012; for convection cooling, thermal-effectiveness parameters of 0.6, 0.8, and 1.0 are included.

The calculations reveal that a comparison of the three cooling processes can be made on quite a general basis. The superiority of transpiration cooling is clearly shown for both laminar and turbulent flow. This superiority is reduced when the effects of radiation are included; for gas-turbine blades, however, there is evidence indicating that radiation may be neglected.

INTRODUCTION

In aircraft propulsion engines such as turbojets, ram jets, and rockets, it is necessary to cool various parts of the engines exposed to hot-gas flows to temperatures the materials can safely withstand. At the supersonic speeds reached today, the skin of the aircraft is also heated to quite high temperatures by the aerodynamic heating effect, and future development of airplanes and missiles will probably require cooling of at least some portions of the aircraft skin. The use of both air and liquids for cooling these critical parts of aircraft is currently under consideration; the present discussion, however, is restricted to the use of air.

Air is advantageous as the cooling medium for the processes previously mentioned, because it can be scooped up continuously during flight at all altitudes where air-burning engines are used. At high flight velocities the temperature of the air increases unavoidably by the scooping process, so

that it is often useless as a coolant unless its temperature is decreased by some cooling cycle. The scooping as well as the cooling process consumes power and weight and necessitates reducing to a minimum the amount of cooling air required. New cooling methods, transpiration and film cooling, which are supposed to use less cooling air than conventional convection cooling, have been proposed.

The present report compares transpiration- and film-cooling methods with standard convection cooling. The calculations are carried out for the specific case in which the gas velocity is constant over the surface to be cooled (flat plate). The results, however, should also give a good indication of the relative effectiveness of the cooling methods considered under different flow conditions. The comparison is based on correlations that are regarded by the authors as the most reliable today, and by which convection-, transpiration-, and film-cooling processes can be calculated. The calculations reveal that a comparison of the three cooling methods can be made on quite a general basis. Numerical evaluations of such comparisons are carried out for both laminar and turbulent flow for Reynolds numbers between 10^3 and 10^9 and for coolant-flow ratios from 0 to 0.012.

This investigation was conducted at the NACA Lewis laboratory in the spring of 1953.

SYMBOLS

The following symbols with a system of consistent units are used:

A	surface area
A'	surface area separating element under consideration (see fig. 3)
a_1, a_2, a_n	distance from leading edge of wall to successive heat sinks, film cooling
c_p	specific heat at constant pressure
f_w	coolant-flow parameter
$g(\xi, x)$	integrating kernel, film cooling (eq. (37))
h	local heat-transfer coefficient
\bar{h}	average heat-transfer coefficient
k	thermal conductivity
L	length of wall
l_a	ratio of augmented surface area on coolant side to surface area on gas side of wall, convection cooling
$\frac{Nu_g}{Nu_g}$	local Nusselt number, $h_g x/k$
	average Nusselt number, $\bar{h}_g L/k$

¹Supersedes NACA TN 3010, "Comparison of Effectiveness of Convection-, Transpiration-, and Film-Cooling Methods with Air as Coolant," by E. R. G. Eckert and John N. B. Livingood.

n	number of slots, film cooling
Pr_g	Prandtl number, $c_p\mu/k$
q	heat flow
$q(\xi)$	heat flux, film cooling
$Re_{a,s}$	slot Reynolds number for film cooling, $\rho_{a,s}V_{a,s}s/\mu_{a,s}$
Re_g	Reynolds number based on L , $\rho_g V_g L/\mu$
$Re_{g,x}$	local Reynolds number based on x , $\rho_g V_g x/\mu$
r	$2.11/Re_g^{0.1}$
St_g	local Stanton number, $Nu_g/Re_{g,x}Pr_g$
\overline{St}_g	average Stanton number, \overline{Nu}_g/Re_gPr_g
s	slot width
T	temperature
V	velocity
v	fictitious velocity based on unit surface area
w	coolant flow
x	distance from leading edge of wall
y	distance normal to wall
η_r	fin effectiveness factor, $\frac{T_{w,a} - T_{a,x}}{T_w - T_{a,x}}$
η_t	thermal effectiveness factor, $\frac{T_{a,e} - T_a}{T_w - T_a}$
θ	$\frac{T_{a,x} - T_a}{T_g - T_w}$
λ	x/L
μ	absolute viscosity
ξ	dummy variable
ρ	density
$\rho_a v_a$	average mass velocity of cooling air
$\rho_g V_g$	average mass velocity of main flow
φ	$c_p \rho_a v_a / h_{g,cw}$
Subscripts:	
a	coolant (air)
cd	conduction
cv	convection
e	designates value at downstream end of wall
g	combustion gas or gas side ²
r	radiation
s	slot
t	transpiration
w	wall
x	designates value at specific location

COMPARISON OF COOLING CONFIGURATIONS

The following process is investigated in this report: A wall is subjected to a hot-gas stream of temperature T_g . In practically all applications, the length of the wall in flow direction and the depth of the gas stream are such that the cooling effect penetrates only a small distance from the wall into the gas flow (the temperature boundary layer); whereas, in the bulk of the fluid, the temperature T_g does not change in flow direction. The velocity V_g in the gas flow outside the boundary layer is also assumed constant along the wall. Under normal conditions, the thickness of the boundary layer is so small that the curvature of the wall does not influence heat transfer. Consequently, for the present investigation, a plane wall subjected on one side to a gas flow with uniform temperature T_g and uniform velocity V_g is considered. The temperature drop through the wall is assumed

to be negligible compared with that on the gas side and on the coolant side. Schematic sketches of the convection-, transpiration-, and film-cooling arrangements for such a wall are shown in figure 1.

In the convection-cooling arrangement, the cooling-air flow is directed along the coolant side of the wall (fig. 1 (a)). This cooling-air flow has to be limited for the reasons mentioned in the **INTRODUCTION**; and, hence, the cooling air heats up considerably on its passage along the surface. Optimum conditions for convection cooling, obtained by increasing the surface area on the coolant side of the wall by fins, are assumed. The strength characteristics of the wall material prescribe a certain wall temperature T_w that can be tolerated. The optimum conditions are attained when the entire surface is kept at that temperature. Overcooling of certain parts to lower temperatures would consume cooling air unnecessarily. This constant wall temperature T_w can be obtained either by varying the fin surface along the cooling-air path in order to compensate for smaller temperature differences between the wall and the cooling air in the downstream direction, or by increasing the cooling-air velocity toward the downstream end of the surface, or by a combination of both.

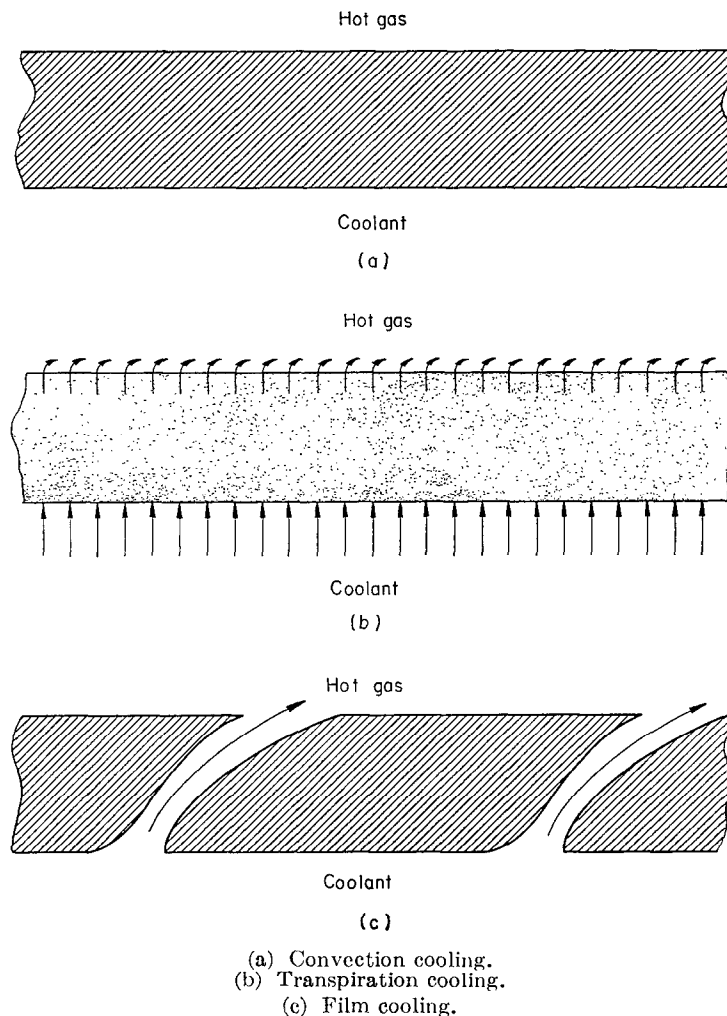

FIGURE 1.—Different methods of cooling.

² The subscripts w, g and a, g refer to local conditions based on wall temperature and cooling-air temperature, respectively, at the surface next to the gas stream

The arrangement for transpiration cooling is shown in figure 1 (b). For this cooling method, the wall is fabricated from a porous material, and the cooling air passes through the wall into the gas flow. A protective film builds up on the gas side of the wall and insulates it from the hot-gas stream. The cooling air is directed away from the surface as it leaves the wall. In this way, a counterflow condition is created between the heat carried away from the surface with the coolant stream and the heat transferred from the hot gas toward the wall. This counterflow reduces the overall heat transfer between the gas and the wall surface. Another advantage of this cooling method is based on the fact that the area of contact between the air on its way through the wall and the wall material is very large. As a consequence, the cooling air will be heated almost to the wall temperature. As a matter of fact, it is easy to understand that, for the case in which heat transfer by radiation to the gas-side surface of the wall can be neglected, the wall temperature on the gas-side surface is equal to the temperature with which the coolant leaves the wall. This fact may be explained with the help of figure 2. In the upper part of this figure a cross section of a porous wall is shown in which the coolant passages are simplified as straight ducts. The lower part of the figure indicates the wall temperature T_w and the cooling-air temperature T_a as it changes on its path into the wall, through the wall, and into the hot gas stream. The temperature curves are drawn with the wall temperature on the gas-side surface assumed higher than the coolant exit temperature. The question arises as to which heat-transfer mechanism can cause the wall temperature to be higher than the temperature in the layers just outside the surface when the heat flow is directed as indicated by the arrow. Since any convective or conductive heat transport always occurs in a direction of decreasing temperature, the only mechanism that can cause the condition shown in figure 2 is radiation.

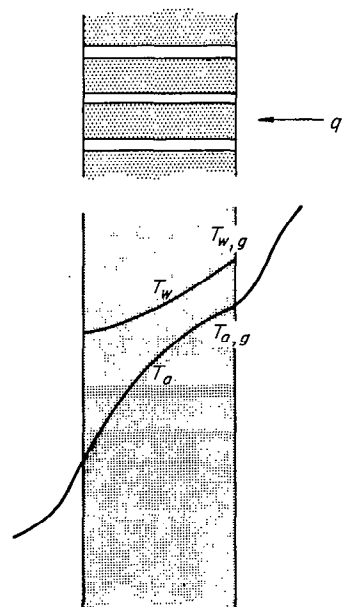

FIGURE 2.—Temperature variation through porous wall.

Therefore, it is concluded that, in the absence of radiation, the wall surface temperature must be equal to the temperature at which the coolant leaves the wall. A constant wall temperature can be obtained over the entire surface by proper adjustment of the local coolant flow through the porous wall.

Film cooling is illustrated in figure 1 (c). Cooling air is ejected through slots in a direction parallel to the surface. A cool film is built up, but the film is gradually destroyed by turbulent mixing and heat conduction from the hot gas flow. The cooling film can be renewed by use of additional slots arranged at certain distances downstream. No uniform wall temperature is possible for film cooling. The wall is coolest near a slot and increases in temperature in the downstream direction to the next slot. The temperature of the wall, which would eventually approach the gas temperature at sufficient distance from the slot, can be decreased by increasing the number of slots. Therefore, the influence of the number of slots on the effectiveness of this cooling method is included in this investigation. The comparison of film cooling with the other cooling methods will be made on the basis of the highest wall temperature that is found just upstream of the slots. This basis somewhat underestimates film cooling, since the average wall temperature for this method is lower than that for the previously described transpiration- and convection-cooling methods when the maximum temperatures are adjusted equal for all three methods. Therefore, parts of the film-cooled wall will have lower temperatures and better strengths, and, to a certain degree, these parts can support the hot portions of the wall. Consequently, under the same strength limitations, the maximum temperature of the film-cooled wall could be somewhat higher than the temperatures for comparable transpiration- and convection-cooled walls.

CONVECTION COOLING

CALCULATION PROCEDURE

Heat balance.—With the aid of figure 3, a heat balance can easily be set up for an element of the wall with an infinitely small dimension in flow direction. On the gas side of the wall, heat transferred by conduction through the fluid layers immediately adjacent to the wall surface is designated $-k_w(\partial T/\partial y)_w dA$, where dA is the surface area of the element on the gas side of the wall. Heat transferred to the outside wall of the element by radiation is designated $q_r dA$; and heat conducted into the wall element within the solid wall is denoted by $q_{ca} dA'$, where dA' is the surface area separating the element under consideration from the rest of the wall. The heat that leaves the element is given by $h_{a,cv} dA_a(T_w - T_{a,x})$, where dA_a is the augmented surface of the element on the coolant side of the wall, equal to $l_a dA$ (fig. 3), and $h_{a,cv}$ is the convective heat-transfer coefficient on the coolant side of the wall. The heat balance may then be written

$$k_w \left(\frac{\partial T}{\partial y} \right)_w dA + q_r dA + q_{ca} dA' = h_{a,cv} l_a dA (T_w - T_{a,x}) \quad (1)$$

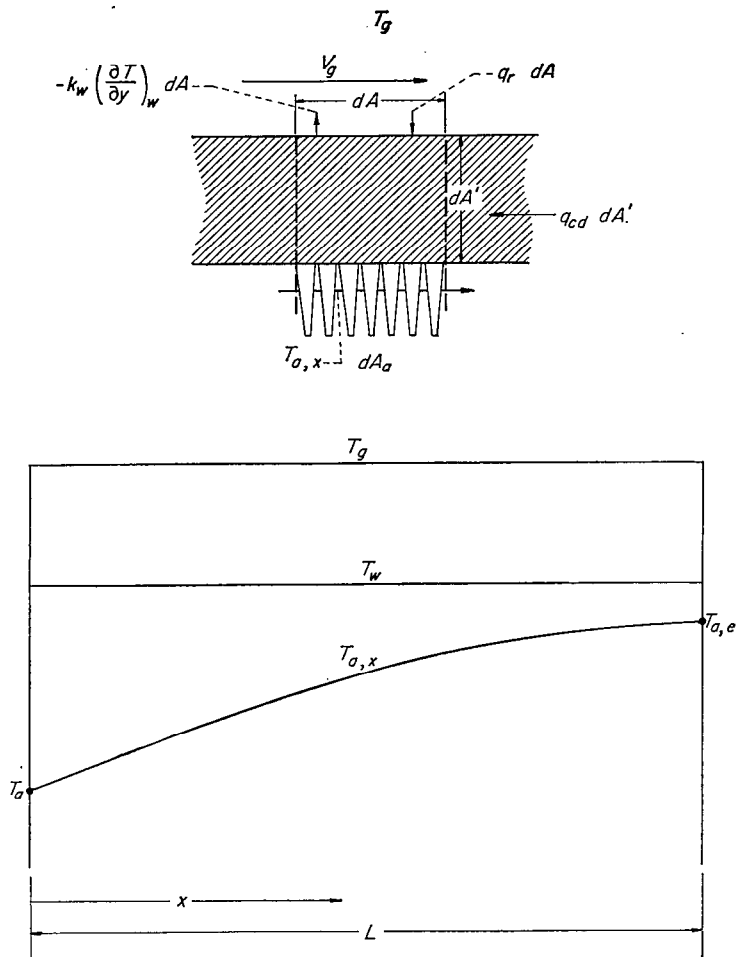

FIGURE 3.—Sketch of element of wall used in setting up heat balance for convection cooling.

The first term in this equation is conventionally expressed by a heat-transfer coefficient defined by the relation

$$k_w \left(\frac{\partial T}{\partial y} \right)_w dA = h_{g,cv} (T_g - T_w) dA$$

The heat radiation q_r can be expressed similarly by a radiative heat-transfer coefficient as

$$q_r = h_r (T_g - T_w)$$

The heat conduction within the wall is zero in the case considered herein, since the wall temperature is assumed constant. In integrating equation (1) over the total wall area A , the first and second terms on the left side can be expressed by average heat-transfer coefficients, because the temperature difference in these terms is constant. This expression results in

$$\bar{h}_{g,cv} A (T_g - T_w) + \bar{h}_r A (T_g - T_w) = \int h_{a,cv} l_a (T_w - T_{a,x}) dA \quad (2)$$

The heat that leaves the wall, represented by the right member of equation (2), must be picked up by the coolant. Hence,

$$\int h_{a,cv} l_a (T_w - T_{a,x}) dA = w c_p (T_{a,e} - T_a) \quad (3)$$

where T_a is the coolant inlet temperature and $T_{a,e}$ is the coolant temperature at the end of the heating surface. It is convenient, for the following considerations, to refer the coolant flow w to unit surface area A and express in this way a fictitious mass velocity (coolant flow) $w/A = \rho_a v_a$. When, in addition, the thermal effectiveness

$$\eta_x = \frac{T_{a,e} - T_a}{T_w - T_a}$$

is introduced, equation (2) changes to

$$\bar{h}_{g,cv} A (T_g - T_w) + \bar{h}_r A (T_g - T_w) = c_p \rho_a v_a \eta_x A (T_w - T_a) \quad (4)$$

From this equation, the following expression describing the wall temperature is obtained:

$$\frac{T_w - T_a}{T_g - T_a} = \frac{1}{1 + \frac{c_p \rho_a v_a \eta_x}{\bar{h}_{g,cv}} \left(\frac{1}{1 + \frac{\bar{h}_r}{\bar{h}_{g,cv}}} \right)} \quad (5)$$

Heat-transfer coefficients.—For chosen values of $\rho_a v_a$ and η_x , the temperature-difference ratio $(T_w - T_a)/(T_g - T_a)$ is dependent only upon the convective and the radiative heat-transfer coefficients on the gas side of the wall. The convective coefficient, in turn, may be expressed in the following way:

$$\bar{h}_{g,cv} = c_p \rho_g V_g \bar{S} t_{g,cv} = \frac{c_p \rho_g V_g \bar{N} u_{g,cv}}{Re_g Pr_g} \quad (6)$$

when $\bar{N} u_{g,cv}$ and Re_g are based on the plate length L . The value of $\bar{N} u_{g,cv}$, however, depends upon whether the boundary layer is laminar or turbulent. These cases will be discussed separately.

(1) Laminar flow: The Nusselt number for laminar flow over a flat plate has been calculated by E. Pohlhausen. The local Nusselt number resulting from this calculation is given in reference 1 (eq. (140a), p. 92). The average Nusselt number is twice as large (ref. 1, eq. (141), p. 93). Therefore, the following expression is obtained:

$$\bar{N} u_{g,cv} = 0.664 \sqrt{Re_g} Pr_g^{1/3} \quad (7)$$

This equation has been verified by experiments.

(2) Turbulent flow: For the turbulent-flow region, the value of the Nusselt number is well established; it is given in reference 1 (p. 118) as

$$\bar{N} u_{g,cv} = 0.037 Re_g^{0.8} Pr_g^{1/3} \quad (8)$$

For large temperature differences between the gas and the wall, the question arises concerning the temperature at which the property values should be introduced into the parameters $\bar{S} t_{g,cv}$, $\bar{N} u_{g,cv}$, Re_g , and Pr_g to assure that equations (7) and (8) properly describe heat transfer under such conditions. The following rule applying to gases is supported by most experiments and calculations: The reference temperature for the property values should be chosen as the arithmetic mean between the wall temperature and the gas temperature. This temperature is often referred to as film temperature.

Final relations for temperature ratio.—(1) Laminar flow without radiation: In this case, $\bar{h}_r=0$. Substitution of equations (6) and (7) into equation (5) then yields the following relation, valid for the laminar-flow region:

$$\frac{T_w - T_a}{T_g - T_a} = \frac{1}{1 + \frac{\rho_a v_a}{\rho_g V_g} \eta_T \frac{\sqrt{Re_g} Pr_g^{2/3}}{0.664}} \quad (9)$$

(2) Laminar flow with radiation: For this case, the equation is

$$\frac{T_w - T_a}{T_g - T_a} = \frac{1}{1 + \frac{\rho_a v_a}{\rho_g V_g} \eta_T \frac{\sqrt{Re_g} Pr_g^{2/3}}{0.664} \left(\frac{1}{1 + \frac{\bar{h}_r}{\bar{h}_{g,cv}}} \right)} \quad (10)$$

(3) Turbulent flow without radiation: When radiation can be neglected, substitution of equations (8) and (6) into equation (5) gives the equation

$$\frac{T_w - T_a}{T_g - T_a} = \frac{1}{1 + \frac{\rho_a v_a}{\rho_g V_g} \eta_T \frac{Re_g^{0.2} Pr_g^{2/3}}{0.037}} \quad (11)$$

(4) Turbulent flow with radiation: For this case, the equation becomes

$$\frac{T_w - T_a}{T_g - T_a} = \frac{1}{1 + \frac{\rho_a v_a}{\rho_g V_g} \eta_T \frac{Re_g^{0.2} Pr_g^{2/3}}{0.037} \left(\frac{1}{1 + \frac{\bar{h}_r}{\bar{h}_{g,cv}}} \right)} \quad (12)$$

Determination of fin area necessary to maintain a constant wall temperature.—In this section the local augmentation to the coolant-side surface of the wall by fins is determined. The variation in number or height of the fins along the surface that is necessary to keep the wall temperature constant can be found from this calculation. Only turbulent flow without radiation is investigated, since this type of flow is usually encountered in practical applications. For laminar flow, a completely analogous procedure can be used. For the calculation, it is necessary to determine the coolant temperature at any local point. In order to do so, a heat balance for an infinitesimal surface area (with unit width of the gas-side surface) at any local position along the wall is written (see fig. 3). This heat balance is

$$h_{g,cv} dx (T_g - T_w) = c_p w dT_{a,x}$$

or

$$\frac{dT_{a,x}}{dx} = \frac{h_{g,cv}}{c_p w} (T_g - T_w) \quad (13)$$

where $dT_{a,x}/dx$ is the coolant temperature gradient. It must be remembered that $h_{g,cv}$ varies with x . Introduction of dimensionless quantities

$$\left. \begin{aligned} \theta &= \frac{T_{a,x} - T_a}{T_g - T_w} \\ \lambda &= \frac{x}{L} \end{aligned} \right\} \quad (14)$$

and

into equation (13) and consideration of equation (6) result in

$$\frac{d\theta}{d\lambda} = \frac{h_{g,cv}}{c_p \rho_a v_a} = \frac{\rho_g V_g St_{g,cv}}{\rho_a v_a} \quad (15)$$

For turbulent flow, the average value of the heat-transfer coefficient over the length x is $5/4$ the local coefficient at position x . Therefore, the local Stanton number is obtained from equation (8) by multiplying by $4/5$ and dividing by $Re_{g,x} Pr_g$:

$$St_{g,cv} = 0.0296 Re_{g,x}^{-1/5} Pr_g^{-2/3}$$

where $Re_{g,x}$ is based on the local distance x . When the Reynolds number is based on the entire length L of the plate, this relation becomes

$$St_{g,cv} = 0.0296 Re_g^{-1/5} Pr_g^{-2/3} \lambda^{-1/5} \quad (16)$$

Inserting equation (16) into equation (15) and integrating lead to

$$\theta = \theta_e \lambda^{4/5} \quad (17)$$

where θ_e is the value of θ for $\lambda=1$ ($x=L$).

A second form of the heat balance for the element of the wall may be written as

$$h_{g,cv} (T_g - T_w) = h_{a,cv} l_a (T_{w,a} - T_{a,x})$$

in which $T_{w,a}$ is the average surface temperature on the coolant side. The temperature $T_{w,a}$ is different from the temperature T_w of the plane wall surface, since the temperature decreases within the fins with increasing distance from the plane wall. The temperature $T_{w,a}$ is usually expressed by a dimensionless term

$$\eta_F = \frac{T_{w,a} - T_{a,x}}{T_w - T_{a,x}}$$

called the fin effectiveness. Values of the fin effectiveness for different fin shapes are found in reference 2 (pp. 235–237). Introduction of the fin effectiveness transforms the heat-balance equation to

$$\eta_F h_{a,cv} l_a = h_{g,cv} \frac{T_g - T_w}{T_w - T_{a,x}} \quad (18)$$

The local convective heat-transfer coefficient may be replaced by an average value upon integration of equation (16); that is,

$$h_{g,cv} = \frac{4}{5} \bar{h}_{g,cv} \lambda^{-1/5}$$

Equation (18) may then be altered to yield the following relation:

$$\frac{\eta_F h_{a,cv} l_a}{\bar{h}_{g,cv}} = \frac{4}{5} \frac{\lambda^{-1/5}}{\frac{T_w - T_a}{T_g - T_w} - \theta_e \lambda^{4/5}}$$

Finally, by replacing θ_e by $\frac{T_w - T_a}{T_g - T_w} \eta_T$, there is obtained

$$\frac{\eta_F h_{a,cv} l_a}{\bar{h}_{g,cv}} = \frac{4}{5} \frac{T_g - T_w}{T_w - T_a} \frac{\lambda^{-1/5}}{1 - \eta_T \lambda^{4/5}} \quad (19)$$

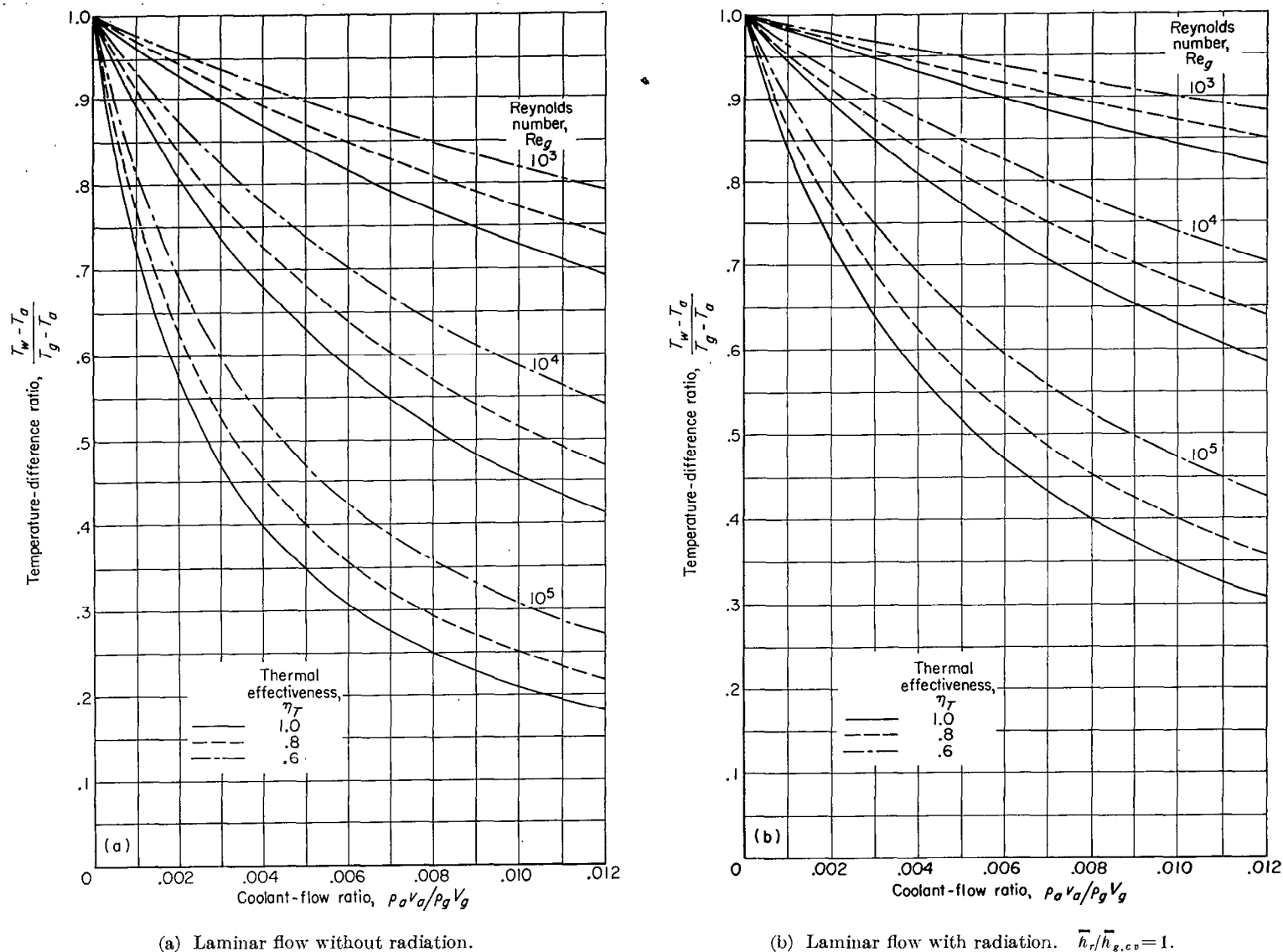

FIGURE 4.—Convection cooling. Prandtl number, 0.7.

The dimensionless term on the left side of the equation determines the fin area (as expressed by l_a) as soon as the heat-transfer coefficients on the gas and coolant surfaces and the fin effectiveness are known.

RESULTS OF NUMERICAL CALCULATIONS

Calculations for the determination of the temperature-difference ratio $(T_w - T_a)/(T_g - T_a)$ as given by equations (9) to (12) were made for the convection-cooling method for values of the thermal effectiveness η_T of 0.6, 0.8, and 1, and for a range of coolant-flow ratio $\rho_a v_a / \rho_g V_g$ from 0 to 0.012. Reynolds numbers of 10^3 , 10^4 , and 10^5 were used in the laminar-flow region, and 10^5 , 10^7 , and 10^9 in the turbulent-flow region. A Prandtl number of 0.7 was used in all the calculations.

Results for laminar flow without radiation, obtained by use of equation (9), are shown in figure 4 (a); those for laminar flow with radiation, obtained by use of equation (10), and for the case in which $\bar{h}_r / \bar{h}_{g,cv} = 1$ are shown in figure 4 (b). (The ratio of radiative to convective heat-transfer coefficients is of this order of magnitude in some components of jet engines such as combustors operating at high temperatures.) The cooling effectiveness is seen to increase with increasing coolant-flow ratio, increasing Reynolds number, and increasing thermal effectiveness. The limiting thermal-effectiveness parameter is 1.0. Actually, this condition can be approached but not reached with a finite wall area. A comparison of figures 4 (a) and (b) shows the effect of radiation. For $\rho_a v_a / \rho_g V_g = 0.010$, $Re_g = 10^5$, and $\eta_T = 1$, the value of $(T_w - T_a)/(T_g - T_a)$ when radiation (with $\bar{h}_r / \bar{h}_{g,cv} = 1$) is included is 0.347 as against 0.210 when radiation is neglected.

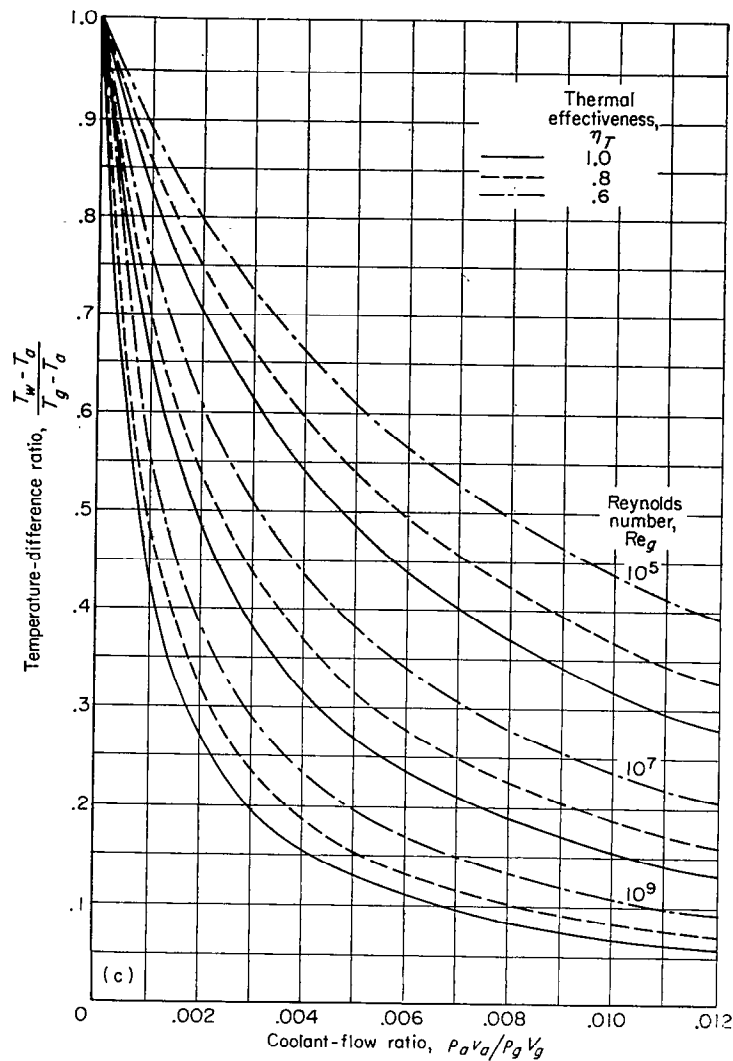

(c) Turbulent flow without radiation.



 (d) Turbulent flow with radiation. $\bar{h}_r/\bar{h}_{g,cv}=1$.

FIGURE 4.—Concluded. Convection cooling. Prandtl number, 0.7.

The results of the calculations for turbulent flow without radiation, obtained by use of equation (11), are shown in figure 4 (c); and those including radiation, obtained by use of equation (12) and $\bar{h}_r/\bar{h}_{g,cv}=1$, in figure 4 (d). These curves show the same general trend as those for laminar flow. For $\rho_a v_a / \rho_g V_g = 0.010$, $Re_g = 10^9$, and $\eta_T = 1$, the value of $(T_w - T_a) / (T_g - T_a)$ is 0.129 with radiation and 0.069 without radiation. Figure 4 (particularly 4 (c)) shows that the slope of the curves decreases as the coolant-flow ratio increases, and only slight increases in cooling effectiveness can be achieved by an increase in coolant flow after a certain limit is exceeded. A comparison of the corresponding curves for $Re_g = 10^9$ in figures 4 (a) and (c) or 4 (b) and (d) indicates that at the same Reynolds number the cooling effectiveness of laminar flow is better than that of turbulent flow.

With values of $(T_w - T_a) / (T_g - T_a)$ now available, it is a simple matter to calculate the parameter $\eta_T h_{a,cv} l_a / \bar{h}_{g,cv}$ from equation (19). The results for turbulent flow without radiation are presented in figure 5. Equation (19) shows that, for all cases, the ordinate $\eta_T h_{a,cv} l_a / \bar{h}_{g,cv}$ is infinite at the leading edge of the plate; the same is true at the downstream end of the plate for the optimum case $\eta_T = 1$. All other values are finite; a minimum point occurs on each curve, for every value of $\rho_a v_a / \rho_g V_g$ considered, at about 0.2 of the plate length from the plate leading edge.

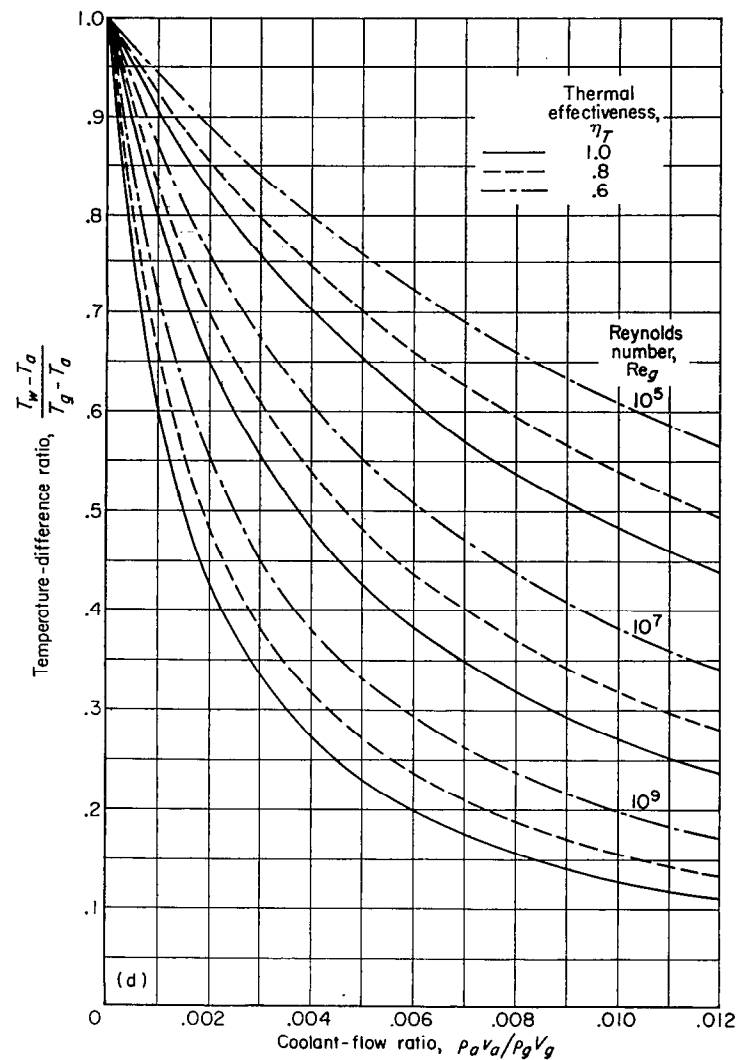
The required parameter $\eta_T h_{a,cv} l_a / \bar{h}_{g,cv}$ can be obtained for fixed conditions on the gas side either by adjusting the $h_{a,cv}$ (influenced by the local coolant velocity) or by properly choosing the fin area (influencing $\eta_T l_a$). That the

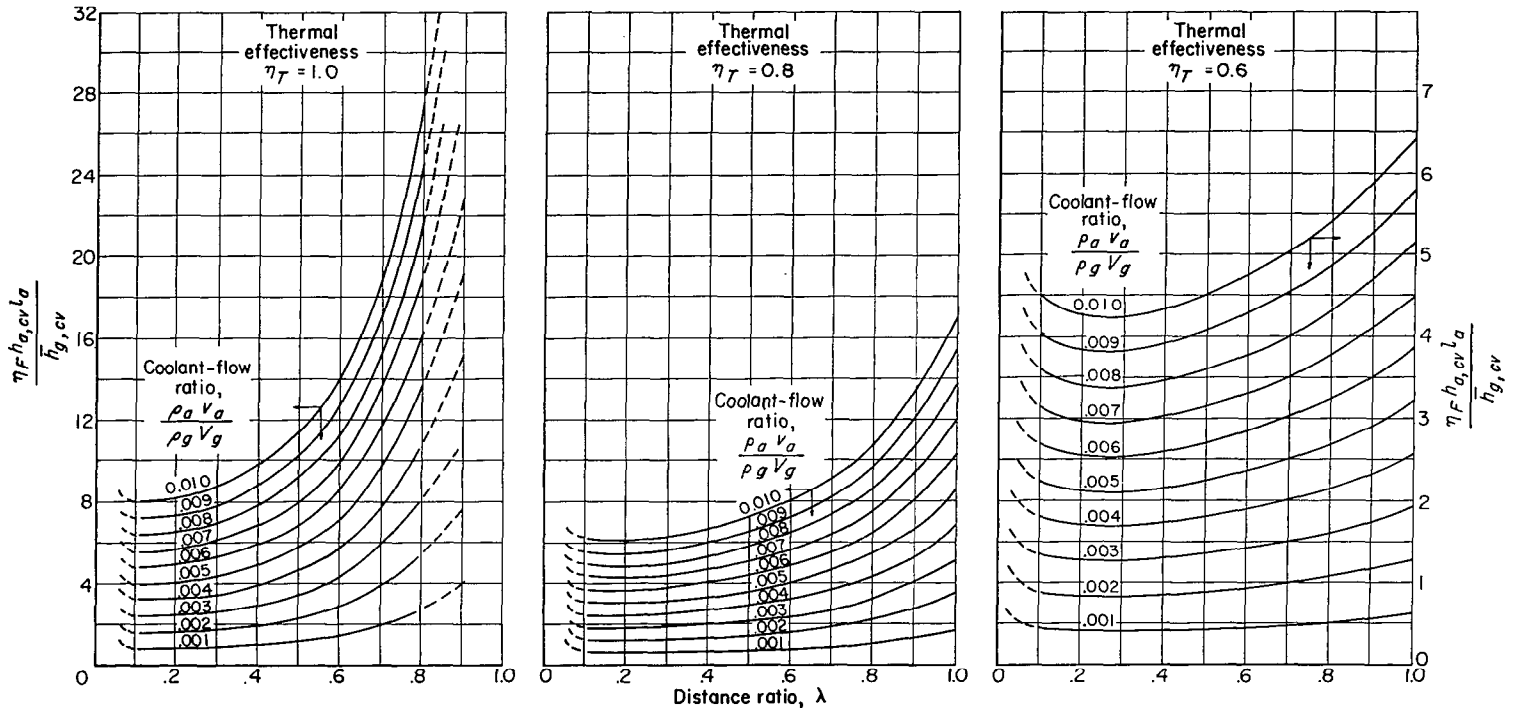

FIGURE 5.—Parameter indicating distribution of fin area necessary to maintain constant wall temperature for convection cooling. Turbulent flow without radiation. Prandtl number, 0.7; Reynolds number, $Re_s, 10^7$.

curves in figure 5 tend towards infinity for $\lambda=0$ is of little practical importance. This tendency is caused by the fact that theoretically the heat-transfer coefficient on the gas side is infinite at the leading edge of the surface. The trend of all curves with $\eta_T=1$ towards infinity expresses the well-known fact that actually a thermal effectiveness $\eta_T=1$ can be obtained only with an infinitely large cooling surface; $\eta_T=1$ can, therefore, only be considered as a limiting case approached in convection cooling under optimum conditions.

The most advantageous feature of figure 5 is that it allows a rapid determination of the fin area necessary to obtain a certain thermal effectiveness. Consider, for instance, a coolant-flow ratio $\rho_a v_a / \rho_g V_g$ of 0.005. Figure 5 indicates that a value of $\eta_F h_{a,cv} l_a / \bar{h}_{g,cv}$ between 3 and 8.5, depending upon the location along the cooling surface, is necessary to obtain a thermal effectiveness η_T of 0.8, and a value of $\eta_F h_{a,cv} l_a / \bar{h}_{g,cv}$ between 2.1 and 3.2 to obtain a thermal effectiveness η_T of 0.6. The average values of $\eta_F h_{a,cv} l_a / \bar{h}_{g,cv}$ over the length L of the wall can be determined from figure 5 as 4.5 for $\eta_T=0.8$ and as 2.4 for $\eta_T=0.6$. The heat-transfer coefficient on the coolant side $h_{a,cv}$ seldom can be made larger than the one on the gas side $\bar{h}_{g,cv}$. When the ratio $h_{a,cv} / \bar{h}_{g,cv}$ is accepted as 1 and the fin effectiveness η_F as 1 (a limiting value that can never actually be obtained), it is concluded that the ratio of the fin surface area to the area of the plane wall must be made larger than 2.4 to obtain a thermal effectiveness $\eta_T=0.6$, and larger than 4.5 to reach the value $\eta_T=0.8$. The latter value will mean a serious increase in weight for this cooling arrangement.

TRANSPIRATION COOLING

CALCULATION PRECEDURE

Heat balance.—A heat balance for a section with the surface area dA of a transpiration-cooled wall can be set

up with the aid of figure 6. The element considered has a plane surface (1) coinciding with the outside wall surface, and a plane surface (2) apart from the inside surface of the wall by such a distance that it is situated outside the boundary layer present on this side. (The inside surface must be considered as a surface to which suction is applied and on which a boundary layer builds up.) Heat is carried by convection with the cooling air through surfaces (1) and (2). The amount per unit time is indicated in figure 6. It is assumed that the coolant has attained the wall surface temperature T_w when it leaves the wall; the validity of this assumption has been discussed previously. Heat will also be transferred by conduction through the fluid layers immediately adjacent to the outside wall surface in the amount

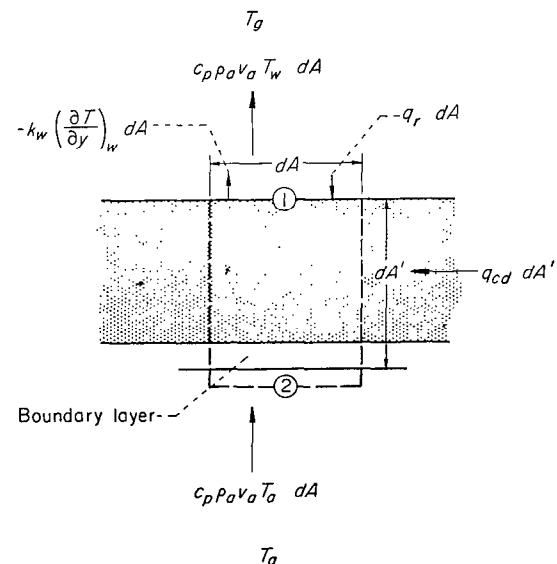

FIGURE 6.—Sketch of element of wall used in setting up heat balance for transpiration cooling.

$-k_w(\partial T/\partial y)_w dA$. Furthermore, heat may be transferred to the outside wall by radiation $q_r dA$. In addition, heat may also flow into the element by conduction in the porous material or by transverse flow of the cooling air within the boundary layer on the suction side; the sum of these flows is designated $q_{cd} dA'$. The heat balance may then be written

$$k_w \left(\frac{\partial T}{\partial y} \right)_w dA + q_r dA + q_{cd} dA' = c_p \rho_a v_a (T_w - T_a) dA \quad (20)$$

For a constant wall temperature and negligible heat flow along the boundary layer, $q_{cd} = 0$.

If the heat transferred to the outer surface by both conduction through the fluid layers and radiation is written in terms of gas-to-surface heat-transfer coefficients, equation (20) reduces after some transformation to

$$\frac{T_w - T_a}{T_g - T_a} = \frac{1}{1 + \frac{c_p \rho_a v_a}{\bar{h}_{g,cv}} \left(\frac{1}{\frac{\bar{h}_{g,t}}{\bar{h}_{g,cv}} + \frac{\bar{h}_r}{\bar{h}_{g,cv}}} \right)} \quad (21)$$

Heat-transfer coefficients.—As in CONVECTION COOLING, the values of the heat-transfer coefficients to be used in equation (21) depend upon whether the boundary layer on the gas side of the wall is laminar or turbulent. The average heat-transfer coefficient on the gas side of the wall, for transpiration cooling, may be written in a manner similar to equation (6), that is,

$$\bar{h}_{g,t} = c_p \rho_g V_g \bar{St}_{g,t} \quad (22)$$

Division of this equation by equation (6) leads to the following relation between the average heat-transfer coefficient for a transpiration-cooled surface and for a solid surface for identical values of c_p , ρ_g , and V_g :

$$\frac{\bar{h}_{g,t}}{\bar{h}_{g,cv}} = \frac{\bar{St}_{g,t}}{\bar{St}_{g,cv}} \quad (23)$$

(1) Laminar flow: Values of $\bar{h}_{g,t}/\bar{h}_{g,cv}$ may be obtained from reference 3 for a Prandtl number of 0.7 and from reference 4 for a Prandtl number of 1. The local heat-transfer coefficients on the gas side are, for transpiration cooling as for convection cooling, proportional to the reciprocal of the square root of the distance from the leading edge. Therefore, the ratio of the average values $\bar{St}_{g,t}/\bar{St}_{g,cv}$ is equal to the ratio of the local values $St_{g,t}/St_{g,cv}$ and also equal to $Nu_{g,t}/Nu_{g,cv}$ when both values are introduced at the same Reynolds and Prandtl numbers. The values Nu_g are included in the previously mentioned references.

From the results presented in reference 3, the ratio $Nu_{g,t}/Nu_{g,cv}$ can be obtained as a function of the ratio of gas temperature to wall temperature and of a coolant-flow parameter f_w (see ref. 5), which for flow over a flat plate assumes the form

$$f_w = -2 \frac{\rho_a v_a}{\rho_g V_g} \sqrt{Re_g}$$

The values for the temperature ratio of 1 are used in this report.

(2) Turbulent flow: Compared with knowledge of convective heat transfer on a solid surface, little is known at present about heat transfer on a transpiration-cooled surface under turbulent-flow conditions. The experiments made under well-defined conditions are limited and were performed for configurations different from the one considered herein. As a result, data found in the literature differ considerably, from statements that no reduction in the heat-transfer coefficient is obtained by transpiration cooling in turbulent flow to statements that considerable changes in the heat-transfer coefficient result for transpiration cooling.

Theories offered for the calculation of heat-transfer coefficients for transpiration cooling are of a semiempirical nature and employ very serious simplifications. Two theories are discussed briefly herein, one presented by Rannie (ref. 6) and independently by Friedman (ref. 7) and the other proposed recently by H. S. Mickley and his associates of the Massachusetts Institute of Technology. Rannie simplifies the actual conditions by assuming that the flow consists of a turbulent region and a laminar sublayer that separates the turbulent flow from the wall surface. He also assumes that the temperatures and velocities in the turbulent region have the same values on a transpiration-cooled wall as in an ordinary boundary layer on a solid surface under otherwise identical conditions. Friedman restricts the Prandtl number to values near 1 and obtains in this way simpler relations. Mickley proposes to obtain the ratio of the heat-transfer coefficient in transpiration cooling to that in convection cooling from a "film theory" concept that radically simplifies real conditions. This concept replaces the heat-transfer process within the boundary layer with the transfer through a laminar film with no heat convection in a direction parallel to the wall. The thickness of this film is again assumed equal on transpiration-cooled and on convection-cooled surfaces for otherwise identical conditions in the gas flow.

According to reference 7, the ratio of average heat-transfer coefficients for a transpiration-cooled wall to those for a solid wall may be expressed by the relation

$$\frac{\bar{h}_{g,t}}{\bar{h}_{g,cv}} = \frac{r\varphi}{e^{r\varphi} - 1} \quad (24)$$

where r , the ratio of the velocity parallel to the surface at the border between the laminar sublayer and the turbulent part of the boundary layer to the stream velocity outside the boundary layer, may be expressed as (ref. 1)

$$r = \frac{2.11}{Re_g^{0.1}} \quad (25)$$

and

$$\varphi = \frac{c_p \rho_a v_a}{\bar{h}_{g,cv}} \quad (26)$$

where $\bar{h}_{g,cv}$ is the coefficient that would apply to a solid surface under identical outside flow conditions.

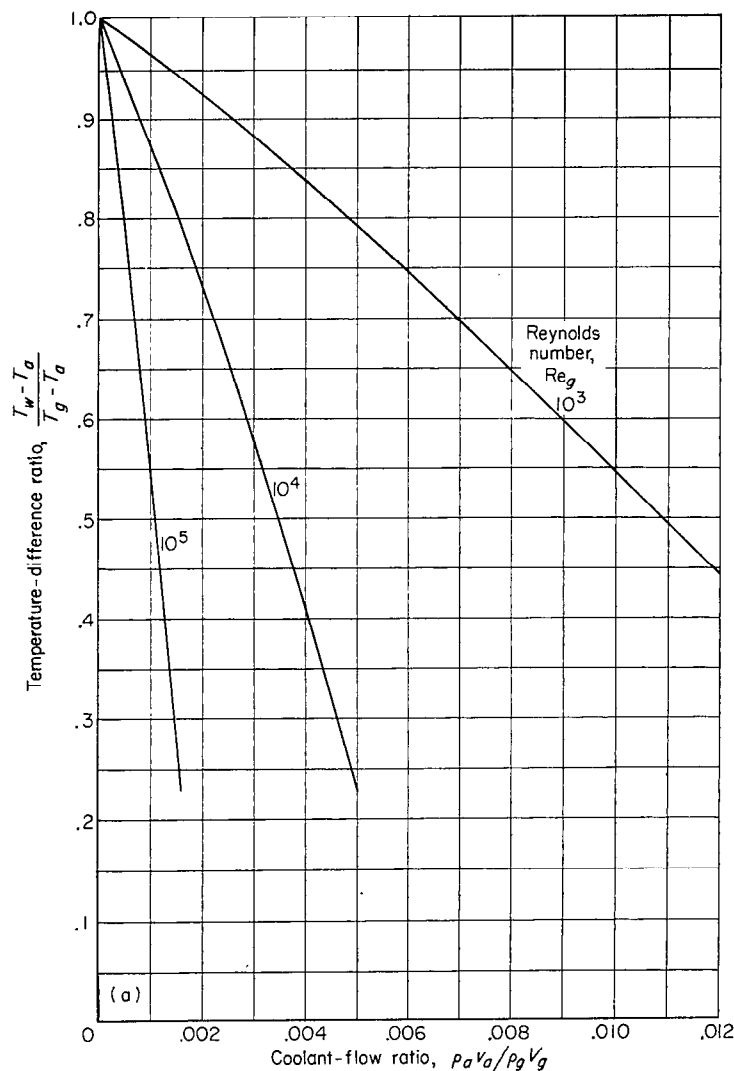

(a) Laminar flow without radiation.

(b) Laminar flow with radiation. $\bar{h}_r/\bar{h}_{g,cv}=1$.

FIGURE 7.—Transpiration cooling. Prandtl number, 0.7.

“Film theory” yields the relation

$$\frac{\bar{h}_{g,t}}{\bar{h}_{g,cv}} = \frac{\varphi}{e^\varphi - 1} \quad (27)$$

(which can be obtained from eq. (24) by letting $r=1$). Heat-transfer coefficients obtained by use of equation (24) appear to be approximately in the center of the range of experimental data reported. They also agree with a limited amount of data obtained by the NACA (ref. 8). Equation (24) will therefore be used herein. Mickley's own experiments agree better with equation (27). When the preceding relations are to be applied to conditions where the temperature difference between gas and wall is large, the problem arises again as in convection cooling at what temperature the properties should be introduced into the equations. Information on transpiration cooling available today is insufficient to answer this question.

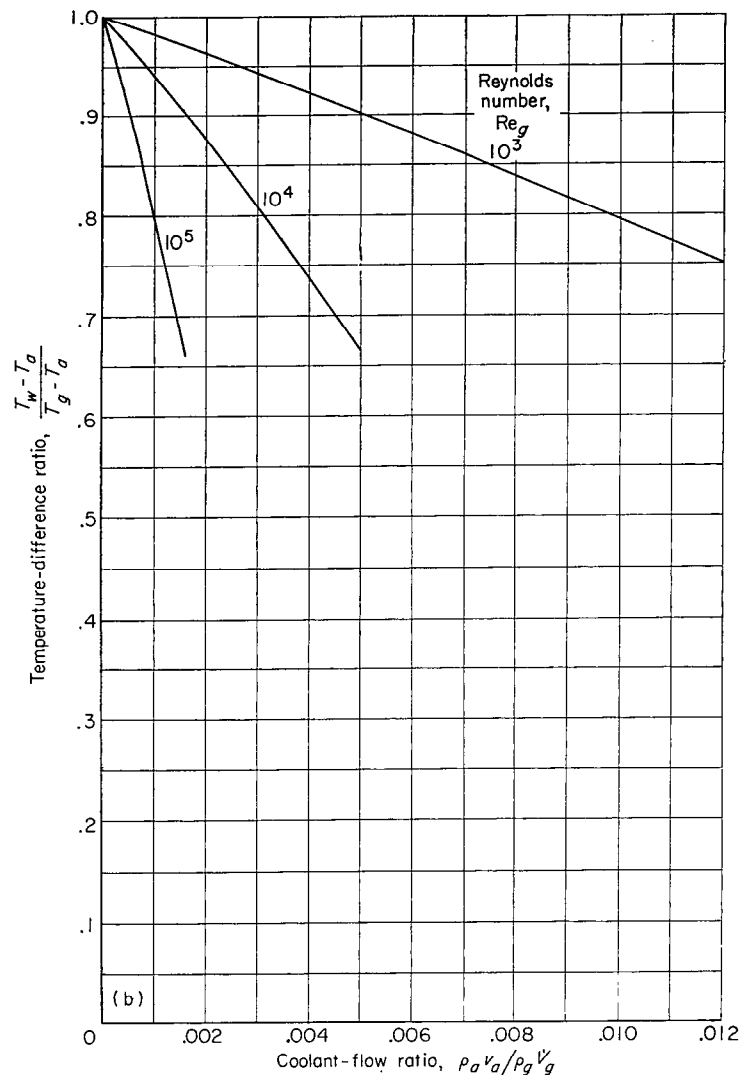
Final relations for temperature ratio.—The final relations

for the temperature ratio are obtained by substituting equations (6) and (7) in equation (21) for laminar flow and equations (6) and (8) as well as (24), (25), and (26) in equation (21) for turbulent flow. The results follow.

(1) Laminar flow without radiation: In this case $\bar{h}_r=0$, and the final equation becomes

$$\frac{T_w - T_a}{T_g - T_a} = \frac{1}{1 + \frac{\rho_a v_a \bar{h}_{g,cv} \sqrt{Re_g Pr_g^{2/3}}}{\rho_g V_g \bar{h}_{g,t}} \cdot 0.664} \quad (28)$$

(2) Laminar flow with radiation: With radiation included, the final equation is

$$\frac{T_w - T_a}{T_g - T_a} = \frac{1}{1 + \frac{\rho_a v_a \sqrt{Re_g Pr_g^{2/3}}}{\rho_g V_g} \cdot 0.664 \left(\frac{1}{\frac{\bar{h}_{g,t}}{\bar{h}_{g,cv}} + \bar{h}_r} \right)} \quad (29)$$

(3) Turbulent flow without radiation: For this case there is obtained

$$\frac{T_w - T_a}{T_g - T_a} = \frac{1}{1 + \frac{Re_g^{0.1}}{2.11} (e^{r\varphi} - 1)} \quad (30)$$

where

$$r\varphi = \frac{2.11}{0.037} Re_g^{0.1} Pr_g^{2/3} \frac{\rho_a v_a}{\rho_g V_g}$$

(4) Turbulent flow with radiation: The final equation becomes, for this case,

$$\frac{T_w - T_a}{T_g - T_a} = \frac{1}{1 + \frac{\rho_a v_a}{\rho_g V_g} \frac{Re_g^{0.2} Pr_g^{2/3}}{0.037} \left(\frac{1}{\frac{\bar{h}_r}{\bar{h}_{g,cv}} + \frac{r\varphi}{e^{r\varphi} - 1}} \right)} \quad (31)$$

Replacement of r by 1 in equations (30) and (31) and replacement of $Re_g^{0.1}/2.11$ by 1 in equation (30) give the results for the "film theory."

RESULTS OF NUMERICAL CALCULATIONS

Calculations for $(T_w - T_a)/(T_g - T_a)$ were made for the transpiration-cooling method for a Prandtl number of 0.7, coolant-flow ratios from 0 to 0.012, and Reynolds numbers of 10^3 , 10^4 , and 10^5 for laminar flow and 10^5 , 10^7 , and 10^9 for turbulent flow.

Figure 7 (a) shows the results for laminar flow without radiation as obtained by use of equation (28); and figure 7 (b), those for laminar flow with radiation as obtained by use of equation (29). Again a ratio $\bar{h}_r/\bar{h}_{g,cv}=1$ was assumed for these calculations. Values of $\bar{h}_{g,cv}/\bar{h}_{g,t}$ were obtained from reference 3. A peculiar feature is the shape of the curves in figures 7 (a) and (b); the direction of bending of these curves is opposite to that for all other curves presented. For larger values of $\rho_a v_a/\rho_g V_g$, the curvature of the lines must go in the opposite direction, since the cooling effectiveness $(T_w - T_a)/(T_g - T_a)$ must approach the value zero asymptotically with increasing coolant-flow ratio $\rho_a v_a/\rho_g V_g$.³ Figures 7 (a) and (b) show that the required coolant-flow ratio decreases considerably with increasing Reynolds number. Approximately the same cooling effectiveness is obtainable at a Reynolds number of 10^5 with only about one-third of the coolant flow required at a Reynolds number of 10^4 . A comparison of figures 7 (a) and (b) illustrates the large influence of radiation on the cooling effectiveness. Inspection of equations (6), (7), and (21), together with the relation for f_w , reveals that for laminar transpiration cooling the temperature-difference ratio $(T_w - T_a)/(T_g - T_a)$ depends on the coolant-flow ratio $\rho_a v_a/\rho_g V_g$ and Reynolds number Re_g only in the combination $(\rho_a v_a/\rho_g V_g)\sqrt{Re_g}$. This fact leads to the more general presentation of figure 7 (c).

Figures 7 (d) and (e) show the results for turbulent flow without and with radiation, respectively. The solid curves in figure 7 (d) were obtained by use of equation (30). For larger Reynolds numbers, increases in coolant flow beyond a

certain point (say 0.005) have only small effects on cooling. Curves were also calculated by use of "film theory" in order to compare the wall temperatures determined in this way with those calculated previously. It can be observed that the "film theory" (dashed) curves lie below the Rannie-Friedman theory (solid) curves. In the following comparisons of the different cooling methods, the values obtained by the Rannie-Friedman theory will be used, since they result in a more conservative evaluation of the transpiration-cooling method. Results obtained by use of equation (31) are shown in figure 7 (e). The influence of radiation for the turbulent-flow case is also apparent from a review of figures 7 (d) and (e).

A comparison of the curves for $Re_g=10^5$ in figures 7 (a) and (d) or 7 (b) and (e) indicates that laminar transpiration cooling is considerably more effective than turbulent transpiration cooling at the same Reynolds number. An analogous situation was found for convection cooling.

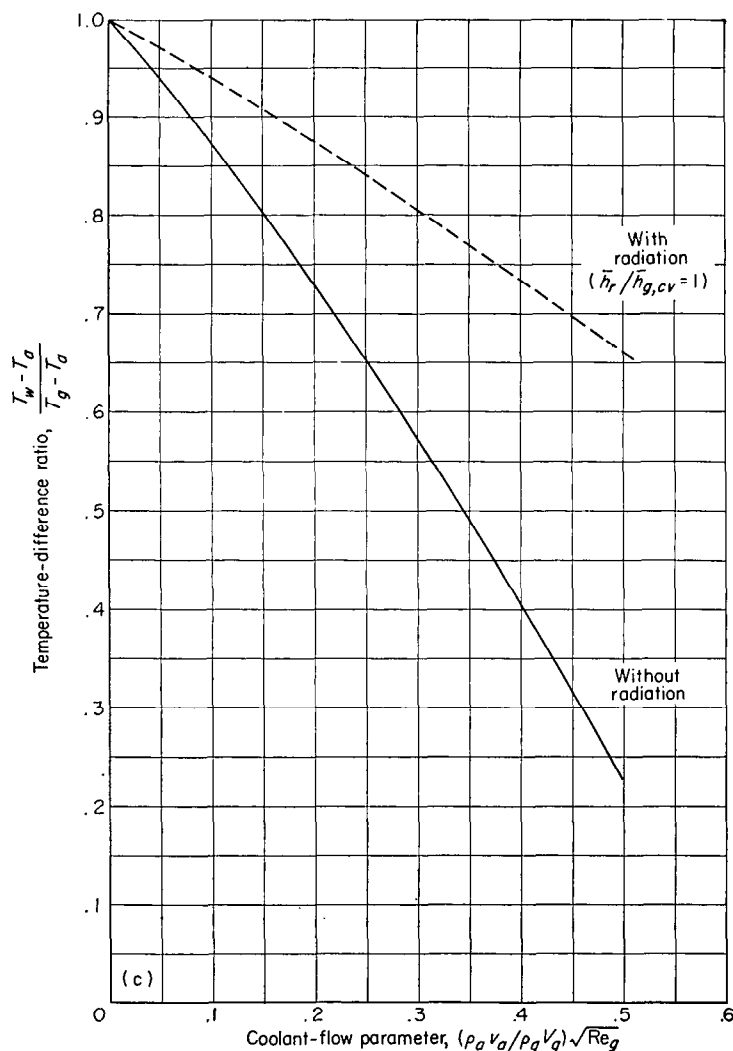

(c) Laminar flow with and without radiation.
FIGURE 7.—Continued. Transpiration cooling.
Prandtl number, 0.7.

³ See footnote, page 609.

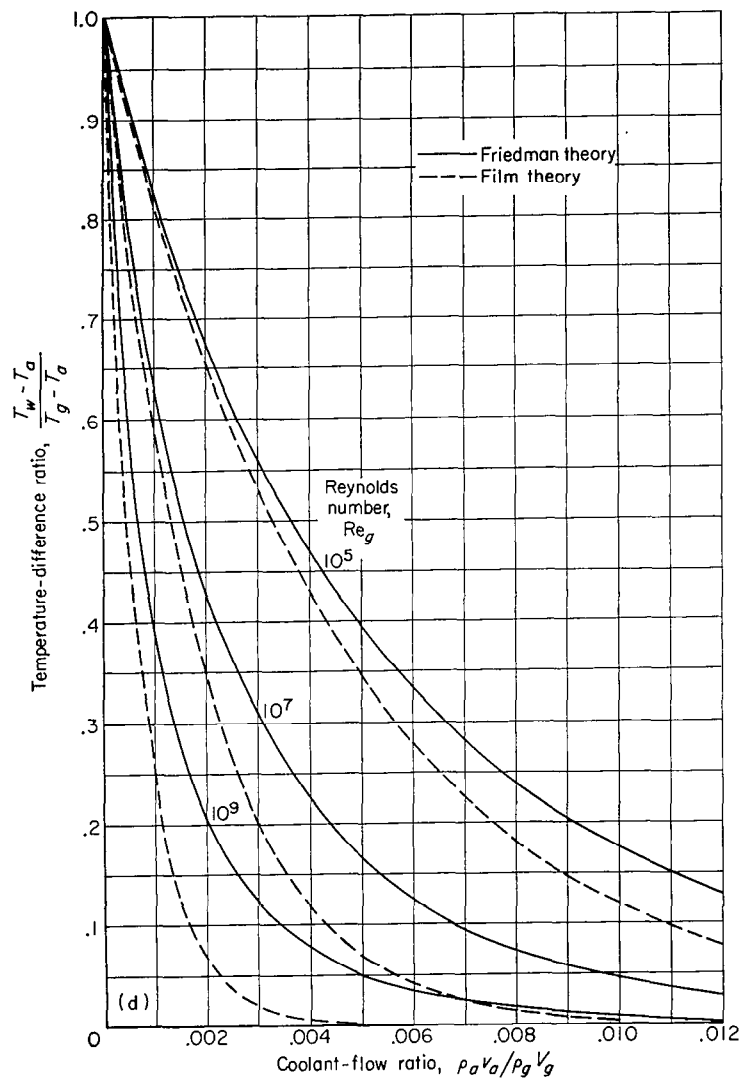

(d) Turbulent flow without radiation.

(e) Turbulent flow with radiation. $\bar{h}_r / \bar{h}_{g,av} = 1$.

FIGURE 7.—Concluded. Transpiration cooling. Prandtl number, 0.7.

FILM COOLING

The film-cooling method will be considered only under turbulent-flow conditions, since it is expected that laminar flow can be maintained only for very low Reynolds numbers.

CALCULATION PROCEDURE

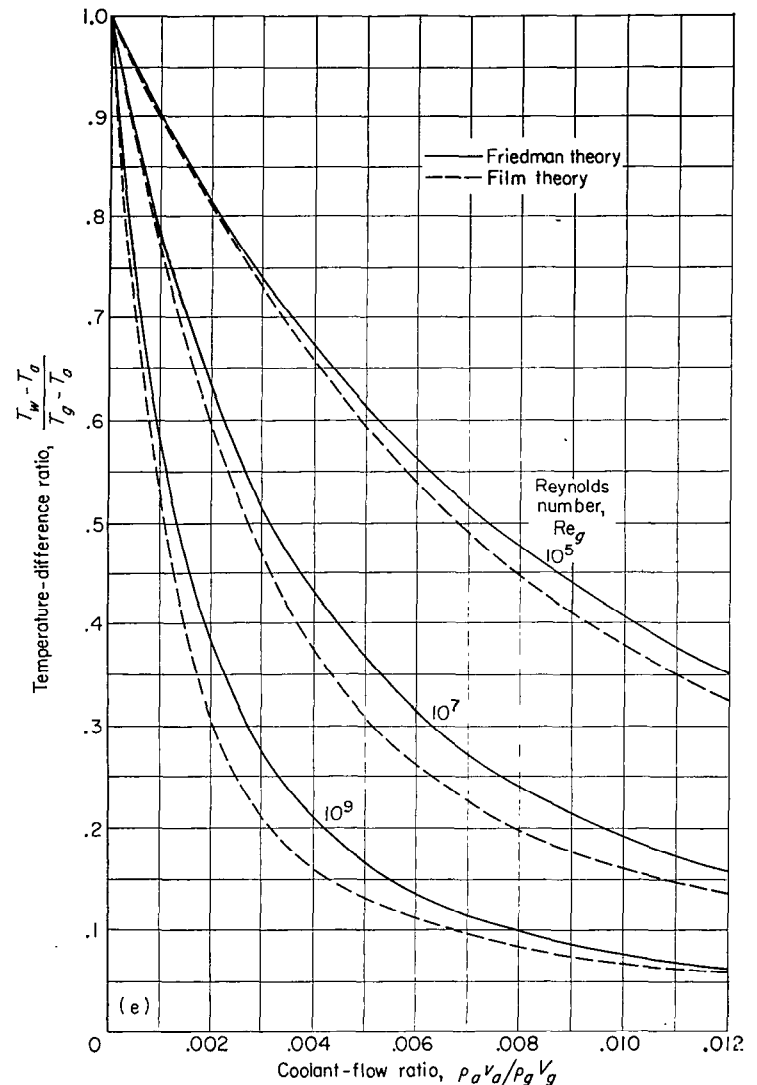
Temperature ratio for single jet.—The cooling-air film is diffused by turbulent mixing with the hot gas and is thus gradually destroyed on its downstream path after leaving the slot. Consequently, as the downstream distance from the slot increases, the wall temperature rises and approaches the gas temperature asymptotically. The most extensive experimental investigation on the temperature conditions in a film-cooled boundary layer is reported in reference 9.

In connection with de-icing studies, Wieghardt (ref. 9) investigated a hot-air jet blown into a cold-air stream through a slot in a flat plate. The temperature conditions within the boundary layer were opposite to the conditions found in film cooling. However, the results obtained in reference 9 can be used for the film-cooling process as long as the tem-

perature differences are small enough to permit the property values to be considered constant. The investigation indicates that the temperature ratio $(T_w - T_{a,s}) / (T_g - T_{a,s})$, with $T_{a,s}$ indicating the temperature with which the cooling air leaves the slot, depends on the parameter $s \rho_{a,s} V_{a,s} / x \rho_g V_g$, where s is the slot width and x is the distance downstream from the slot. This relation is valid for values of $\rho_{a,s} V_{a,s} / \rho_g V_g \leq 1$. It gives a wall temperature that decreases with increasing coolant-flow ratio at a given distance x . Use of the results of reference 9 for film cooling shows that, for values of $\rho_{a,s} V_{a,s} / \rho_g V_g > 1$, the wall temperature increases again with increasing coolant-flow ratio. Therefore, a value of 1 for $\rho_{a,s} V_{a,s} / \rho_g V_g$ gives the maximum cooling effectiveness in the range in which the results of Wieghardt may be applied to film cooling. The Reynolds number for the outside flow varied between 10^6 and 10^7 . For a length ratio $x/s > 100$, the experimentally determined temperature ratio could be well represented by the equation

$$\frac{T_w - T_{a,s}}{T_g - T_{a,s}} = 1 - 21.8 \left(\frac{s \rho_{a,s} V_{a,s}}{x \rho_g V_g} \right)^{0.8} \quad (32)$$

A comparison of the film-cooling method with the two other methods previously discussed is facilitated when again a mass velocity $\rho_a v_a$ is introduced which the coolant would have if it passed the surface area of the cooled plate. The coolant ejected from the slot per unit time is $s\rho_{a,s}V_{a,s}$. The mass velocity $\rho_a v_a$ of a surface with length x is, therefore, $\rho_a v_a = s\rho_{a,s}V_{a,s}/x$. Introducing this mass velocity into equation (32) and remembering that the temperature $T_{a,s}$ with which the coolant leaves the slots is equal to the coolant inlet temperature in the previous methods result in

$$\frac{T_w - T_a}{T_g - T_a} = 1 - 21.8 \left(\frac{\rho_a v_a}{\rho_g V_g} \right)^{0.8} \quad (33)$$

for $\rho_a v_a / \rho_g V_g < 1/100$ and $\rho_{a,s} V_{a,s} / \rho_g V_g \leq 1$. In this form the equation contains the same parameters as used in the preceding discussions of the other cooling methods. Wieghardt's experiments were made with small temperature differences between gas and cooling air. Therefore, no information is available on the influence of a large temperature variation throughout the cooling film on the cooling effectiveness.

In order to compare the film-cooling method with the other cooling methods, it is of considerable interest to determine the improvement in film-cooling effectiveness by the use of a number of slots along the walls instead of a single slot. Experimental information available is insufficient to answer this question. Therefore, a calculation procedure proposed in reference 10 will be used. This procedure is applied to the condition investigated by Wieghardt and compared with his test results in reference 11 (pp. 229-231). The procedure will be reviewed briefly herein; a detailed explanation may be found in reference 11.

Calculated temperature relation for one jet.—Changes in the shape of velocity profiles within boundary layers have only a secondary effect on heat transfer. Therefore, it may be expected that a calculation which neglects the distortion of the flow boundary layer caused by the coolant ejected through the slot will give results that agree with the real conditions to a first approximation. The air ejected through the slot decreases the temperatures within the boundary layer in the downstream direction. The same situation is obtained by a heat sink of the strength $c_{p,s}\rho_{a,s}V_{a,s}(T_{a,s} - T_g)$ that replaces the slot. Such a calculation is made in reference 11 for a single sink placed at the leading edge of a flat plate. The result obtained is

$$\frac{T_w - T_g}{T_{a,s} - T_g} = \frac{28 Pr_g^{2/3} Re_{a,s}^{0.2} \left(\frac{\mu_{a,s}}{\mu} \right)^{0.2} \frac{c_{p,a,s}}{c_p} \left(\frac{x\rho_g V_g}{s\rho_{a,s} V_{a,s}} \right)^{-0.8}}{195 \left(\frac{32}{39} \right)! \left(\frac{7}{39} \right)! (0.0288)} \quad (34)$$

The following comparison of equation (34) with Wieghardt's experiments is made in reference 11. For the range of temperatures used by Wieghardt, $Pr_g = Pr_{a,s} = 0.72$, $(\mu/\mu_{a,s})^{0.2} = 1$, and $c_{p,a,s}/c_p = 1$. Moreover, since Wieghardt did not include the air temperature in his data, a value of 68° F is assumed. Slot Reynolds numbers considered by Wieghardt are then found by calculation to be between 3760 and 12,630. Equation (34) then reads

$$\frac{T_w - T_{a,s}}{T_g - T_{a,s}} = 1 - \left\{ \begin{array}{l} 24 \\ \text{to} \\ 30 \end{array} \right\} \left(\frac{s\rho_{a,s} V_{a,s}}{x\rho_g V_g} \right)^{0.8} \quad (35)$$

which compares favorably with equation (32). Part of the discrepancy between equations (32) and (35) may be ascribed to the fact that in Wieghardt's experiments a flow boundary layer of finite thickness already exists at the location of the slot, whereas in the calculations in reference 11 the flow boundary layer is assumed to start at the location of the heat sink. The rest of the discrepancy is probably due to increased turbulence created by the cooling-air jet.

Calculated temperature relation for succession of slots.—The agreement between equations (32) and (35) makes possible the use of the calculation procedure that resulted in equation (35) to predict the cooling effectiveness of film cooling with a succession of slots. For a plate with a continuous distribution of heat sinks of strength $q(\xi)$ per unit length, the wall temperature T_w is obtainable from the following equation (ref. 11):

$$T_w - T_g = \int_{\xi=0}^x q(\xi) g(\xi, x) d\xi \quad (36)$$

where $g(\xi, x)$ is an integrating kernel contained in table II of reference 11 for different flow configurations. In the developments that follow, the kernel given in line 7 of this table for turbulent flow over a flat plate will be used; it is rewritten here as

$$g(\xi, x) = \frac{28 Pr_g^{-1/3} Re_{g,x}^{-0.8}}{\left(\frac{32}{39} \right)! \left(\frac{7}{39} \right)! (0.0288k)} \left[1 - \left(\frac{\xi}{x} \right)^{39/40} \right]^{-32/39} \quad (37)$$

The arrangement that idealizes the film-cooled surface has only discrete sinks which are assumed to be of equal strength. The spacing of the sinks is determined in such a way that the wall temperature has the same value ahead of each sink, as illustrated in figure 8. The first sink is located at the leading edge of the plate, the second at a distance a_1 from the leading edge, the third at a distance a_2 , and so forth.

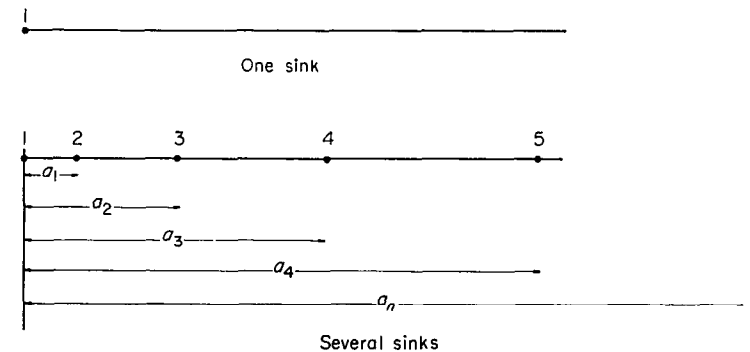

FIGURE 8.—Schematic sketch showing heat sinks as replacements for cooling air emerging from slots.

Equation (34) gives a relation that describes the wall temperature $T_{w,1}$ ahead of the second sink when $x = a_1$:

$$\frac{T_{w,1} - T_a}{T_g - T_a} = 1 - K \left(\frac{\rho_g V_g a_1}{\rho_{a,s} V_{a,s} s} \right)^{-0.8} \quad (38)$$

The constant K comprises the group of parameters for which Wieghardt's experiments give the numerical value 21.8. This value is used herein and restricts the analysis to air as coolant and the Reynolds number range to that covered experimentally ($Re_g=10^6$ to 10^7). From equations (36) and (37), the wall temperature $T_{w,2}$ ahead of the third sink is

$$\frac{T_{w,2}-T_a}{T_g-T_a}=1-K\left(\frac{\rho_g V_g a_2}{\rho_{a,s} V_{a,s} s}\right)^{-0.8}\left\{1+\left[1-\left(\frac{a_1}{a_2}\right)^{39/40}\right]^{-32/39}\right\} \quad (39)$$

In the same way, the temperatures ahead of the successive sinks are

$$\frac{T_{w,3}-T_a}{T_g-T_a}=1-K\left(\frac{\rho_g V_g a_3}{\rho_{a,s} V_{a,s} s}\right)^{-0.8}\left\{1+\left[1-\left(\frac{a_1}{a_2}\right)^{39/40}\right]^{-32/39}+\left[1-\left(\frac{a_2}{a_3}\right)^{39/40}\right]^{-32/39}\right\} \quad (40)$$

$$\frac{T_{w,n}-T_a}{T_g-T_a}=1-K\left(\frac{\rho_g V_g a_n}{\rho_{a,s} V_{a,s} s}\right)^{-0.8}\left\{1+\left[1-\left(\frac{a_1}{a_2}\right)^{39/40}\right]^{-32/39}+\dots+\left[1-\left(\frac{a_{n-1}}{a_n}\right)^{39/40}\right]^{-32/39}\right\} \quad (41)$$

The condition is employed that gives the best basis for a comparison with the other cooling methods, that is, that the wall temperature ahead of each sink be the same ($T_{w,1}=T_{w,2}=T_{w,3}=\dots=T_{w,n}$). When this condition is imposed on equations (38) to (41), a system of equations results that determines the positions at which the sinks must be located. These equations are:

$$\left(\frac{a_1}{a_2}\right)^{-0.8}=1+\left[1-\left(\frac{a_1}{a_2}\right)^{39/40}\right]^{-32/39} \quad (42)$$

$$\left(\frac{a_2}{a_3}\right)^{-0.8}=\left(\frac{a_1}{a_2}\right)^{0.8}\left\{1+\left[1-\left(\frac{a_1}{a_2}\right)^{39/40}\right]^{-32/39}+\left[1-\left(\frac{a_2}{a_3}\right)^{39/40}\right]^{-32/39}\right\} \quad (43)$$

$$\left(\frac{a_{n-1}}{a_n}\right)^{-0.8}=\left(\frac{a_1}{a_{n-1}}\right)^{0.8}\left\{1+\left[1-\left(\frac{a_1}{a_2}\right)^{39/40}\right]^{-32/39}+\dots+\left[1-\left(\frac{a_{n-1}}{a_n}\right)^{39/40}\right]^{-32/39}\right\} \quad (44)$$

Under the condition $T_{w,1}=T_{w,2}=\dots=T_{w,n}$, the temperature ratio describing the wall temperature for any number of sinks may be expressed as

$$\frac{T_w-T_a}{T_g-T_a}=1-K\left(\frac{\rho_g V_g a_1}{\rho_{a,s} V_{a,s} s}\right)^{-0.8} \quad (45)$$

A fictitious velocity is again introduced in order to facilitate the comparison of film cooling with the other cooling methods; this velocity v_a is that which the total cooling air would have in passing through the wall surface area. The coolant flow per slot is $\rho_{a,s} V_{a,s} s$. For n slots it is $n\rho_{a,s} V_{a,s} s$. The same amount expressed by the fictitious air velocity v_a is $a_n \rho_a v_a$. Therefore,

$$\rho_{a,s} V_{a,s} s = \frac{a_n \rho_a v_a}{n} \quad (46)$$

Introducing this relation into equation (45) gives ($K=21.8$)

$$\frac{T_w-T_a}{T_g-T_a}=1-21.8\left(\frac{na_1}{a_n}\right)^{-0.8}\left(\frac{\rho_a v_a}{\rho_g V_g}\right)^{0.8} \quad (47)$$

From equation (47) the temperature ratio can be calculated for any number of slots after the ratio a_1/a_n has been determined from equations (42) to (44). Equation (47) is of course subject to the same restrictions as equation (32), namely $a_n/s > 100$ and $\rho_{a,s} V_{a,s} s / \rho_g V_g \leq 1$.

RESULTS OF NUMERICAL CALCULATIONS

Values of $(T_w-T_a)/(T_g-T_a)$ were determined for one to six slots by use of equation (47), and the results are presented in figure 9. For a fixed wall temperature T_w , a decrease in required coolant flow accompanies an increase in the number of slots. For a fixed value of $\rho_a v_a / \rho_g V_g$, figure 9 shows a decrease in maximum wall temperature T_w with an increase in the number of slots, the decrease becoming smaller with a larger number of slots. The curves in figure 9 were all ended at a value of $(T_w-T_a)/(T_g-T_a)$ of about 0.5, because the line for a single slot is in agreement with experimental data only to this value.

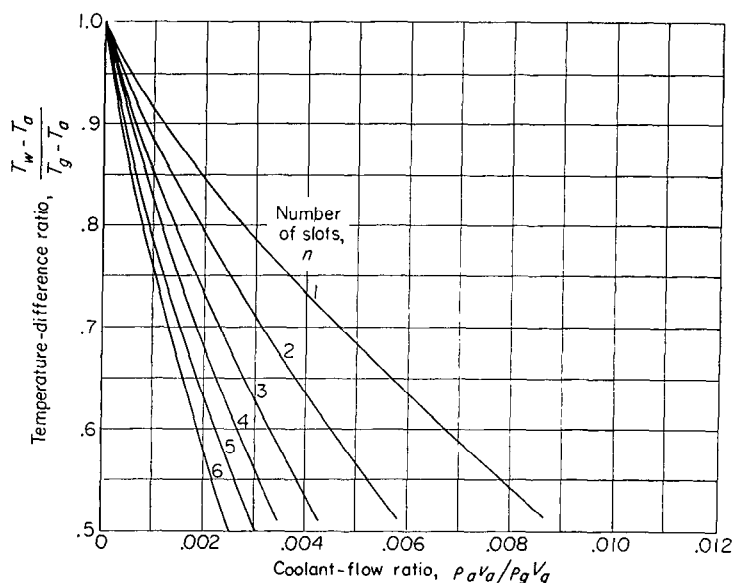
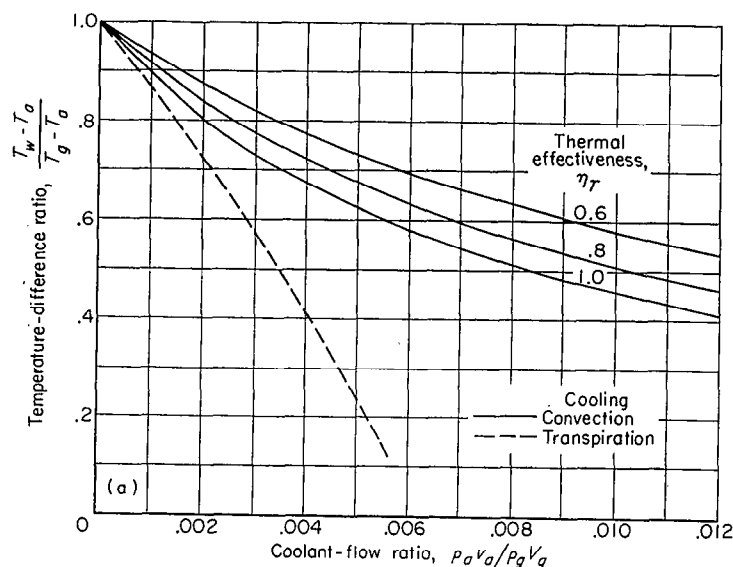
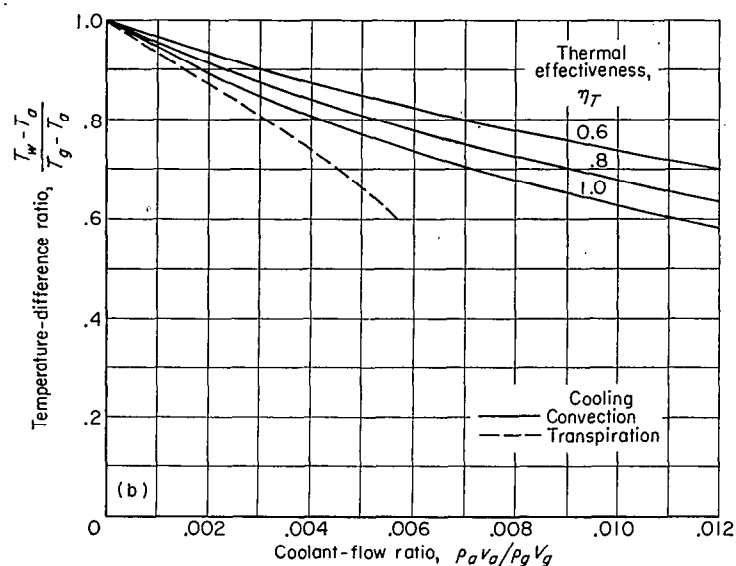

FIGURE 9.—Film cooling. Prandtl number, 0.7; Reynolds numbers, Re_g , 10^6 to 10^7 .

COMPARISON OF COOLING METHODS

In order to show the relative effectiveness of the various cooling methods for identical conditions, several additional figures are presented. Figure 10 (a) compares transpiration cooling with convection cooling (for thermal effectiveness parameters η_r of 0.6, 0.8, and 1) for laminar flow without radiation and for a Prandtl number of 0.7 and a Reynolds number of 10^4 . For a value of $(T_w-T_a)/(T_g-T_a)$ equal to about 0.4, which corresponds to relatively good cooling, about three times as much coolant flow is required, even for the optimum convection cooling ($\eta_r=1$), as for transpiration cooling. For smaller coolant flows, the difference in the cooling-air requirement becomes smaller and smaller.

(a) Laminar flow without radiation. Reynolds number, $Re_g, 10^4$.(b) Laminar flow with radiation. Reynolds number, $Re_g, 10^4$.

$$\bar{h}_r / \bar{h}_{g,cv} = 1.$$

FIGURE 10.—Comparison of cooling methods. Prandtl number, 0.7.

This smaller difference should be expected, since the gas-side heat-transfer coefficient in transpiration cooling decreases as compared with that of convection cooling, because part of the heat that flows in the gas boundary layer by conduction and turbulent exchange towards the cooled surface is picked up and again carried away from the surface by the cooling air leaving the surface. This effect will be larger as the coolant velocity v_a becomes larger. This situation indicates that transpiration cooling is more advantageous in applications in which considerable cooling is required. For convection cooling other than optimum, considerably greater amounts of coolant flow are required to obtain the value 0.4 for $(T_w - T_a)/(T_g - T_a)$. A typical value of η_T for good air-cooled turbines is about 0.7. Figure 10 (a) also shows that, for a coolant-flow ratio of 0.004, transpiration cooling yields a value of $(T_w - T_a)/(T_g - T_a)$ of approximately 0.4; whereas, the optimum convection cooling yields a value of about 0.68.

Figure 10 (b) shows similar results for the same conditions as those employed in the calculations of figure 10 (a), but for laminar flow with radiation ($\bar{h}_r / \bar{h}_{g,cv} = 1$). For a value of $(T_w - T_a)/(T_g - T_a)$ of 0.6, the optimum convection cooling requires about twice the coolant flow required for transpiration cooling. In this case, however, for a given flow rate, the superiority of transpiration cooling is considerably less than it was in the case where radiation was not present. On gas-turbine blades the heat transfer by radiation can practically always be neglected (refs. 8 and 12). In other parts of a gas turbine, such as combustion-chamber walls, the contribution of radiation to the total heat transfer is considerable.

For other Reynolds numbers, the relative position of the curves in the $(T_w - T_a)/(T_g - T_a)$ against $\rho_a v_a / \rho_g V_g$ diagrams in figures 4 (a) and (b) and 7 (a) and (b) is approximately the same as for $Re_g = 10^4$. As the Reynolds number increases, the difference between transpiration and optimum convection cooling becomes smaller.

For a Prandtl number of 0.7 and a Reynolds number of 10^5 , a comparison of convection and transpiration cooling is shown in figure 10 (c) for turbulent flow without radiation. The different curves for convection cooling hold for different values of the thermal effectiveness obtained in this method. Transpiration cooling is again shown to be the better of the two cooling methods compared.

The superiority of transpiration cooling is based on two factors. First, a decrease in the heat-transfer coefficients is the cause for the improvement of the transpiration-cooling curve over the limiting convection-cooling curve ($\eta_T = 1$). Secondly, convection cooling results in a temperature effectiveness less than 1, and the difference between the convection-cooling curve for the actual η_T value (for instance, $\eta_T = 0.6$) and the limiting curve $\eta_T = 1$ indicates the improvement obtained in transpiration cooling by the fact

(c) Turbulent flow without radiation. Reynolds number, $Re_g, 10^5$

FIGURE 10.—Continued. Comparison of cooling methods. Prandtl number, 0.7.

(d) Turbulent flow without radiation. Reynolds number, Re_g , 10^7 .(e) Turbulent flow with radiation. Reynolds number, Re_g , 10^7 .
 $\bar{h}_r/\bar{h}_{g,co}=1$.

FIGURE 10.—Concluded. Comparison of cooling methods. Prandtl number, 0.7.

that the temperature at which the cooling air leaves the wall is practically always equal to the wall temperature.

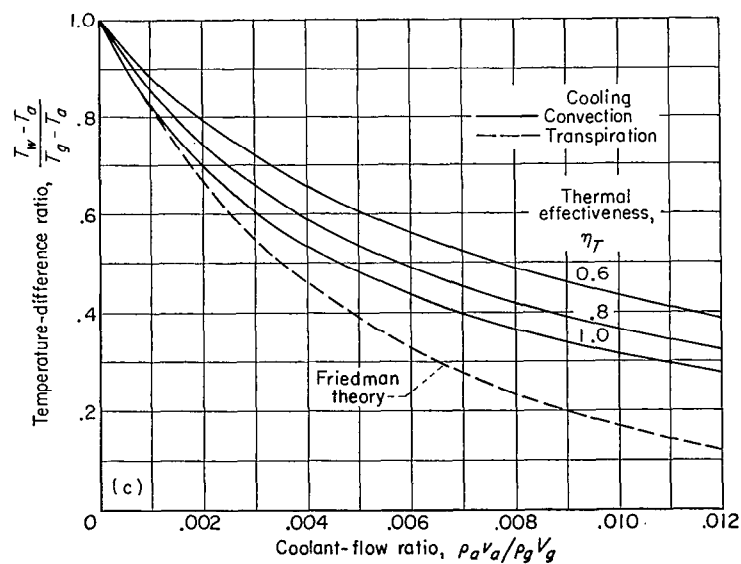
The difference in coolant-flow ratio required for transpiration cooling becomes larger for larger coolant flows. The same trend has been observed for laminar flow. The magnitude of the difference, however, is smaller for turbulent flow. To obtain a temperature ratio $(T_w - T_a)/(T_g - T_a)$ equal to about 0.4, a coolant-flow ratio between 0.004 and 0.005 is required in transpiration cooling, and a coolant-flow ratio of 0.007 for the optimum ($\eta_T=1$) convection cooling. The latter value increases considerably when the thermal efficiency η_T is less than 1, a value of about 0.012 being obtained for $\eta_T=0.6$ (fig. 10 (c)).

In figure 10 (d), convection, transpiration, and film cooling are compared for a Reynolds number of 10^7 for turbulent flow without radiation. The relative position of the convection- and transpiration-cooling curves is approximately the same as in figure 10 (c). The differences between transpiration cooling and optimum convection cooling have slightly decreased. For film cooling, the curves calculated for various numbers of slots are plotted.

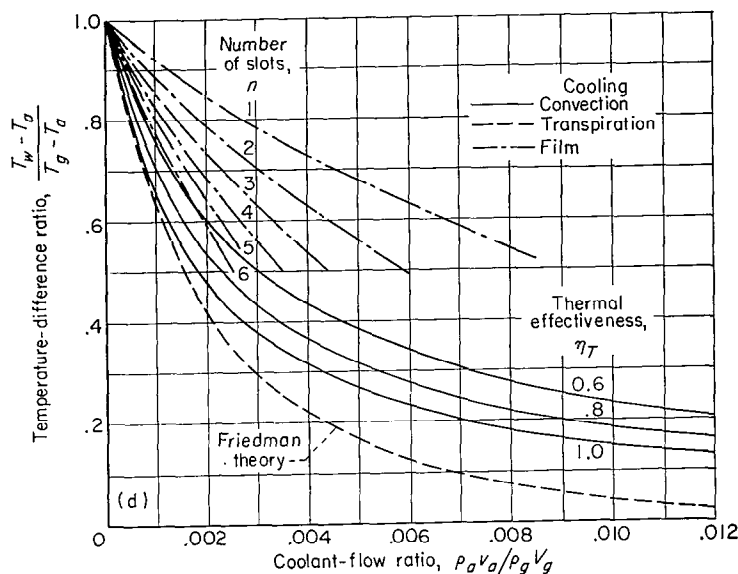
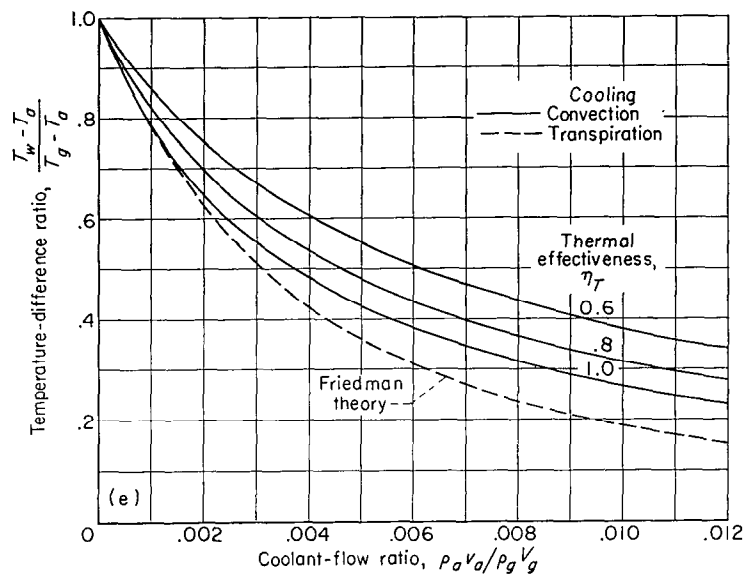
Film cooling with a single slot at the leading edge of the plate is not as effective as the poorest convection cooling considered (fig. 10 (d)). However, it must be remembered that for this method the wall temperature T_w contained in the parameter $(T_w - T_a)/(T_g - T_a)$ is the highest temperature occurring within the wall. At smaller downstream distances, this temperature decreases toward the value T_a obtained immediately behind the slot (when heat conduction within the wall is neglected). Film cooling appears, from this consideration, to be a good method for thoroughly cooling a specific location. It must be expected that film cooling eventually transforms into transpiration cooling when the number of slots (or sinks in the calculation procedure) becomes very large. The calculation procedure offered herein holds only for sinks at finite distances and therefore will not show the above feature. An advantage of film

cooling for practical applications is that it can be very easily incorporated in most designs.

In figure 10 (e) convection and transpiration cooling are compared for turbulent flow with radiation ($\bar{h}_r/\bar{h}_{g,co}=1$) for a Prandtl number of 0.7 and a Reynolds number of 10^7 . As in the laminar case, the temperature ratio for a specific set of conditions is greater when radiation is present, and the differences between the various cooling arrangements are smaller than in the case without radiation.

In a specific application, the choice of the cooling method used will be influenced by design considerations as well as by the coolant requirements. One advantage of convection cooling that is important in some applications is that the coolant may have any pressure level; whereas, for transpiration and film cooling, the supply pressure has to be higher than that in the hot-gas stream. The present report presents the material necessary for a comparison only with respect to cooling requirements. Although the calculations were made for a specific condition in the hot-gas stream (constant velocity and constant temperature), the results should be applicable, at least qualitatively, for other conditions as well.

SUMMARY OF RESULTS

A comparison of two new cooling methods (transpiration and film cooling) with standard convection cooling is presented. The comparison is based on correlations that permit simple evaluation of each of these three cooling processes. Although presented for a flat plate with constant gas velocity and temperature, the calculations give qualitative indications of the relative effectiveness of the various cooling methods under different flow conditions as well and reveal that the three cooling methods can be compared on quite a general basis. Numerical evaluations of the cooling processes are made for a flat plate, for both laminar and turbulent flow, with and without radiation, for Reynolds numbers between 10^3 and 10^9 , and for coolant-flow ratios from 0 to 0.012. Air

s considered as the coolant as well as the outside flow medium (a good approximation to combustion gases), and a Prandtl number of 0.7 is therefore used. Thermal effectiveness parameters of 0.6, 0.8, and 1.0 are considered for convection cooling. For laminar flow without radiation, a comparison of the results for a Reynolds number of 10^4 indicated that about three times as much coolant flow was required for optimum convection cooling as for transpiration cooling in order to maintain a temperature-difference ratio of 0.4. Considerably larger coolant flows are required to maintain this temperature-difference ratio for convection cooling other than optimum. Moreover, the difference in cooling-air requirement increases for increasing coolant flow, and hence the advantages of transpiration cooling are larger in applications where strong cooling is required. Including the effects of radiation reduces the superiority of transpiration cooling considerably; however, heat transfer to gas-turbine blades by radiation can usually be neglected.

Similar results were obtained for turbulent flow. For a Reynolds number of 10^5 , without radiation, and at the same temperature-difference ratio of 0.4, about $1\frac{1}{2}$ times the coolant flow is required for optimum convection cooling as for transpiration cooling, and correspondingly larger flows are required for convection cooling other than optimum.

Analogous results were also obtained for turbulent flow with a Reynolds number of 10^7 , with slight decreases in the differences between transpiration and optimum convection cooling. Including the effects of radiation again reduces the superiority of transpiration cooling. Film cooling can be employed to cool a specific location effectively and can be made to approach the other cooling methods in effectiveness by increasing the number of slots.

LEWIS FLIGHT PROPULSION LABORATORY
NATIONAL ADVISORY COMMITTEE FOR AERONAUTICS
CLEVELAND, OHIO, July 9, 1953

REFERENCES

1. Eckert, E. R. G.: Introduction to the Transfer of Heat and Mass. McGraw-Hill Book Co., Inc., 1950.
2. Jakob, Max: Heat Transfer. Vol. I. John Wiley & Sons, Inc., 1949.
3. Brown, W. Byron, and Donoughe, Patrick L.: Tables of Exact Laminar-Boundary-Layer Solutions When the Wall Is Porous and Fluid Properties Are Variable. NACA TN 2479, 1951.
4. Eckert, E. R. G.: Heat Transfer and Temperature Profiles in Laminar Boundary Layers on a Sweat-Cooled Wall. Tech. Rep. No. 5646, Air Materiel Command, Nov. 3, 1947.
5. Brown, W. Byron: Exact Solution of the Laminar Boundary Layer Equations for a Porous Plate with Variable Fluid Properties and a Pressure Gradient in the Main Stream. A. S. M. E. Proc. First U. S. Nat. Cong. Appl. Mech., pub. by A. S. M. E., 1952, pp. 843-852.
6. Rannie, W. D.: A Simplified Theory of Porous Wall Cooling. Prog. Rep. 4-50, Power Plant Lab. Proj. No. MX801, Jet Prop. Lab., C. I. T., Nov. 24, 1947. (AMC Contract No. W-535-ac-20260, Ord. Dept. Contract No. W-04-200-ORD-455.)
7. Friedman, Joseph: A Theoretical and Experimental Investigation of Rocket-Motor Sweat Cooling. Jour. Am. Rocket Soc., No. 79, Dec. 1949, pp. 147-154.
8. Ellerbrock, Herman H., Jr.: Some NACA Investigations on Heat Transfer Characteristics of Cooled Gas-Turbine Blades. Paper presented at Gen. Discussion on Heat Transfer. Inst. Mech. Eng. (London) and A. S. M. E. (New York) Conf. (London), Sept. 11-13, 1951.
9. Wieghardt, K.: Hot-Air Discharge for De-Icing. AAF Trans. No. F-TS-919-RE, Air Materiel Command, Dec. 1946.
10. Eckert, E. R. G.: Transpiration and Film Cooling. Presented at Symposium on Heat Transfer, Univ. Mich., 1952. Pub. by Eng. Res. Inst., Univ. Mich., 1953.
11. Tribus, Myron, and Klein, John: Forced Convection from Non-isothermal Surfaces. Presented at Symposium on Heat Transfer, Univ. Mich., 1952. Pub. by Eng. Res. Inst., Univ. Mich., 1953.
12. Brown, T. W. F.: The Effect of the Radiation Correction on Cooling Loss in High-Temperature Cooled Gas Turbines. Paper Presented at Gen. Discussion on Heat Transfer. Inst. Mech. Eng. (London) and A. S. M. E. (New York) Conf. (London), Sept. 11-13, 1951.

³ Emmons and Leigh show in a paper published after this report was written that the velocity gradient at the surface of a flat plate as obtained by solution of the boundary-layer equations with constant properties decreases to zero for a finite value of the coolant-flow parameter $\rho_c v_c / \rho_s V_s \sqrt{Re_s} = 0.6924$. Inspection of the boundary-layer energy equation for constant properties shows that, at the same coolant-flow parameter, the heat-transfer coefficient becomes zero for all Prandtl numbers. Both boundary-layer profiles move simultaneously away from the wall to infinity. Physically this situation is probably caused by a breakdown of the boundary-layer simplifications. H. W. Emmons and D. Leigh, "Tabulation of the Blasius Function with Blowing and Suction," Interim Tech. Rep. No. 9, Combustion Aero. Lab., Div. Appl. Sci., Harvard Univ., Nov. 1953. (Army Ord. Dept. Contract No. DA-19-020-ORD-1029.)