

REPORT 1303

WIND-TUNNEL INVESTIGATION OF A NUMBER OF TOTAL-PRESSURE TUBES AT HIGH ANGLES OF ATTACK

SUBSONIC, TRANSONIC, AND SUPERSONIC SPEEDS¹

By WILLIAM GRACEY

SUMMARY

The effect of inclination of the airstream on the measured pressures of 54 total-pressure tubes has been determined for angles of attack up to 60° and over a Mach number range from 0.26 to 1.62. The investigation was conducted in five wind tunnels at the Langley Aeronautical Laboratory.

For simple, nonshielded tubes, the usable angular range was found to depend on the external shape of the nose section, the size of the impact opening (relative to the tube diameter), and the shape of the internal chamber behind the impact opening. The best combination of these design features (that is, a tube having a cylindrical nose shape, an impact opening equal to the tube diameter, and a 30° conical chamber) produced the highest usable range (about 28° at a Mach number of 0.26) of any of the nonshielded tubes.

In cases where a usable angular range larger than ±28° is required, a much higher range may be obtained with shielded tubes. The usable range of a tube with a shield having a conical entry, for example, is about ±41° at a Mach number of 0.26. Changing the shape of the entry of the shield to a highly curved section increases the usable range to about ±63°, the highest of any of the tubes tested. The throats of these tubes were vented through the walls of the shield, a design feature permitting end-mounting of the tube on a horizontal boom.

For airspeed applications where it is not essential that the tube have a large negative angle-of-attack range, the usable range may be extended to higher positive angles of attack by means of a leading-edge slant profile. For slant profiles up to 20°, the usable range at positive angles of attack can be extended by about 1° for each degree of slant.

The effect of Mach number on both unshielded and shielded tubes was found to be considerable. For most of the unshielded tubes the usable range increased with Mach number, whereas that of the shielded tubes decreased with Mach number.

INTRODUCTION

The National Advisory Committee for Aeronautics has conducted a series of wind-tunnel investigations to determine the effect of inclination of the airstream on the measured pressures of a number of total-pressure tubes through a wide range of angle of attack at subsonic, transonic, and supersonic speeds. The results of these investigations have

been reported in references 1 to 6. This report summarizes these results and presents the data in a form permitting a more detailed comparison of the effects of the pertinent design variables.

These investigations were conducted for the purpose of obtaining information which would lead to the design of rigid-type tubes capable of measuring total pressures correctly at high angles of attack and at high speeds. The need for this information has arisen in recent years because of the development of airplanes having the capability of maneuvering to high angles of attack at supersonic speeds and because conventional tubes, both rigid and swiveling, are unsatisfactory under these conditions. Conventional rigid tubes, that is, those with hemispherical or ogival nose shapes, are unsatisfactory because the measured pressure begins to deviate from the free-stream value at moderate angles of attack. Swiveling tubes, on the other hand, are considered undesirable because of the possibility of structural failure at high speeds.

Information needed for designing a tube which would be satisfactory at high angles of attack at subsonic speeds has been available for some time. In 1935, for example, Merriam and Spaulding (ref. 7) showed that a tube could be made insensitive over a wide range of angle of attack by making the impact opening a large percent of the tube diameter. During the same year, Kiel (ref. 8) reported a design of a shielded tube which read correctly to an angle of attack of about 35°. Unpublished tests by the National Advisory Committee for Aeronautics of this tube, however, showed that the flow about the circular spindle on which the tube was mounted caused the tube to vibrate so severely at a Mach number of about 0.6 that the tube could not be used above this speed.

With this information as a starting point, the program for the present investigation was formulated to investigate (1) various configurations of simple, unshielded tubes having large impact openings and (2) a design of a shielded tube in which the throat would be vented through the wall of the shield and thereby eliminate the spindle mount and permit the tube to be mounted on the end of a horizontal boom. In addition, various conical-shaped tubes were included in the tests because of their possible use as instruments to

¹ Supersedes NACA Technical Note 3641 by William Gracey, 1956.

measure angles of attack and yaw (ref. 9). Also, because of its widespread use in service operations, an ogival-shaped tube was investigated. Although this particular tube had already been tested at supersonic speeds (ref. 10), these tests were limited to angles of attack of 10°. Hemispherical-shaped tubes, as exemplified by the Prandtl tube, were not included in the present investigation because they were known to be very sensitive to angle of attack (ref. 11).

SYMBOLS

- A_0 frontal area of shield (shielded tubes)
- A_v vent area of shield (shielded tubes)
- a distance from leading edge of total-pressure probe to face of shield (shielded tubes)
- d diameter of impact opening of tube
- D body diameter of tube
- D_1 diameter of tube at face of conical tube
- D_2 diameter of throat of shielded tube
- p_t total pressure of free stream
- p_t' total pressure measured by tube at $\alpha=0^\circ$
- p_t'' total pressure measured by tube at $\alpha \neq 0^\circ$
- Δp_t total-pressure error ($p_t - p_t''$ at subsonic speeds; $p_t' - p_t''$ at supersonic speeds)
- p static pressure of free stream
- q_e' indicated impact pressure ($p_t - p$ at subsonic speeds; $p_t' - p$ at supersonic speeds)
- M free-stream Mach number
- α angle of attack of tube, deg
- ψ angle of yaw of tube, deg
- β internal cone angle, deg
- γ slant profile angle, deg

APPARATUS AND TESTS

Diagrams of the 54 total-pressure tubes which were tested during the investigation are shown in figure 1. For purposes of comparison, the tubes were divided into five groups on the basis of the external shape of the nose section: cylindrical (series A), 15° conical (series B), 30° conical (series C), 45° conical (series D), and ogival (series E). For convenience, the cylindrical tubes in series A have been divided into two subgroups: A (nonshielded) and A_s (shielded). Tubes A_s -1, A_s -2, A_s -3, and A_s -4 had body diameters of 3/4 inch so that they could be tested in the test section of the Langley 9-inch supersonic tunnel during the initial part of the investigation. All other tubes had body diameters of 1 inch. The design of the various tubes in each of the five series was varied as regards both internal shape and configuration of the total-pressure entry.

The investigation was conducted in five wind tunnels: the 6- by 6-foot test section of the Langley stability tunnel, the Langley high-speed 7- by 10-foot tunnel, the Langley 8-foot transonic tunnel, the Langley 9-inch supersonic tunnel, and the Langley 4- by 4-foot supersonic tunnel. For the tests in the Langley stability, 9-inch supersonic, and 4- by 4-foot supersonic tunnels, the total-pressure tube to be tested was mounted on a special U-shaped swivel mechanism which was

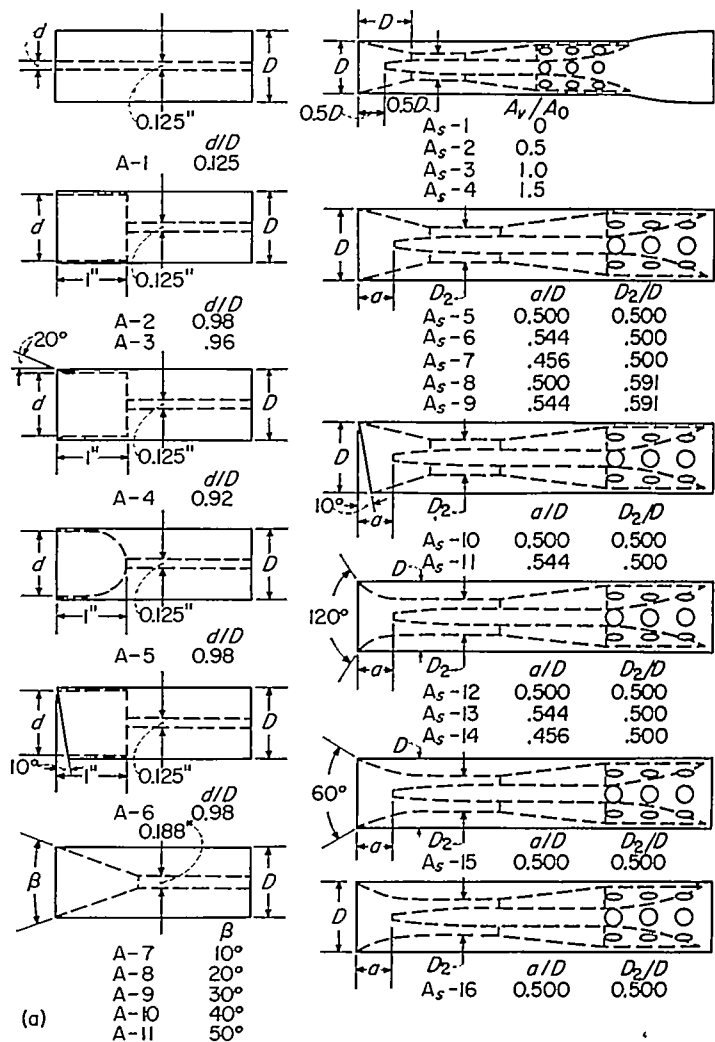

(a) Series A (cylindrical) and A_s (shielded). (Vent area A_v/A_0 of tubes A_s -4 to A_s -16 is 1.5.)

FIGURE 1.—Diagrams of total-pressure tubes.

mounted on the side wall of the tunnel. A typical installation is that of the stability tunnel shown in figure 2. These U-supports were designed with the axis of rotation in line with the leading edge of the total-pressure tube in order that the total-pressure entry would remain at the same point in the airstream for all angles of attack. The inclination of the tube to the air flow was set by means of a control arm attached to the U-support and located outside the tunnel wall. The angle of attack of the tube was measured either on a circular scale attached to the control arm or with a cathetometer located outside the tunnel. For those tests in which angle of attack was measured by a scale, deflection of the U-support under air load was investigated and in each case was found to be negligible.

For the tests in the Langley high-speed 7- by 10-foot tunnel and 8-foot transonic tunnel, the tubes were mounted on a bent sting adapter attached to a sting support. The angular setting of the sting-coupling combination was such

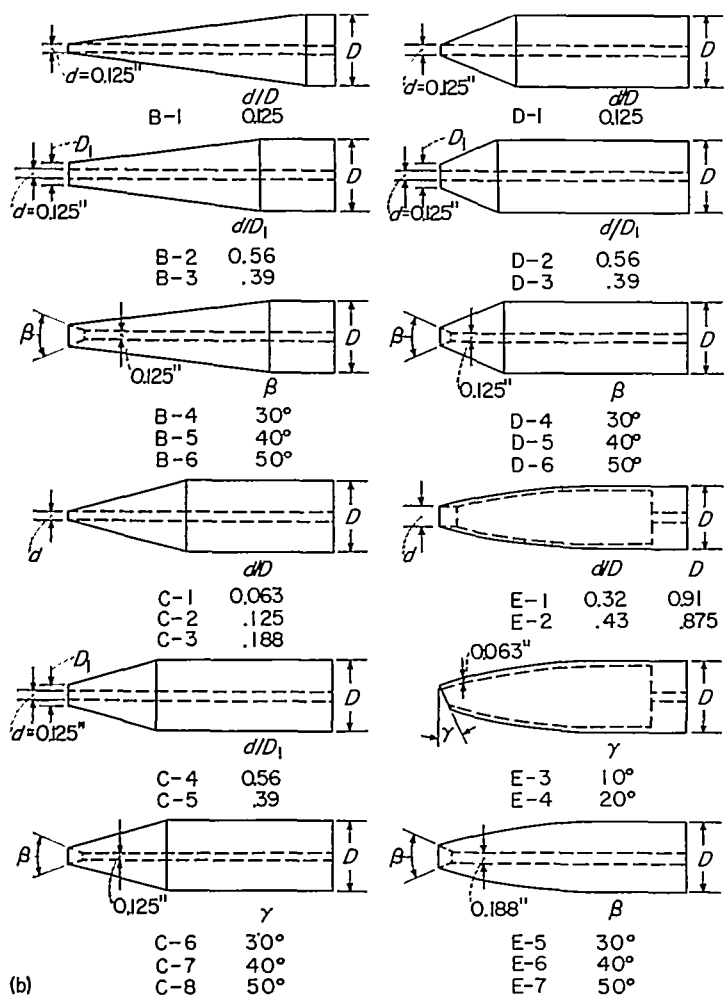

(b) Series B (15° conical); series C (30° conical); series D (45° conical); and series E (ogival).

FIGURE 1.—Concluded.

that the leading edge of the tube remained in approximately the same point in the tunnel for all settings of the tube. The inclination of the tubes with this apparatus was set by means of a remote-control mechanism and the angles of attack of the tubes were measured by means of a cathetometer. The measurements of angle of attack were made with the tunnel operating in order that the effects of sting deflection due to airloads might be eliminated.

The various tubes were tested at one or more values of Mach number between 0.26 and 1.62. For each test speed, the tubes were moved through the angle-of-attack range ($\pm 45^\circ$ for most tests but as high as 60° in some cases) in increments of about 5° . For each setting of the tube, the total-pressure error was determined by measuring the difference between the total pressure registered by the test tube and a suitable reference pressure. In most of the subsonic tests, a total-pressure tube fixed at zero angle of attack and located in another part of the tunnel provided the reference pressure. In the supersonic tests, the pressure in the tunnel settling chamber was used as the reference pressure. For the

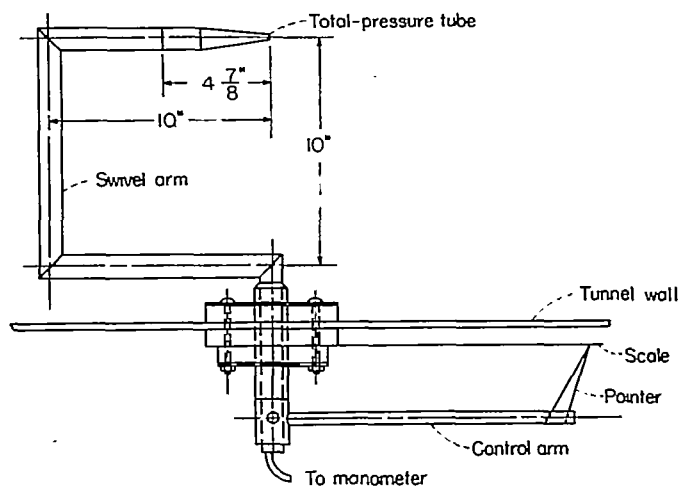

FIGURE 2.—Diagram of swivel mechanism used for changing angle of attack of total-pressure tubes in stability tunnel.

subsonic tests, the total-pressure error was determined directly as the difference between the pressure of the test tube and the pressure of the reference tube ($p_i'' - p_i'$). For the supersonic tests, where shock formed ahead of the test tube, the total-pressure error was determined as the difference between the pressure measured by the tube at a given angle of attack and the pressure measured by the tube at zero angle of attack ($p_i'' - p_i'$). As this test procedure corrected, in effect, for the total-pressure loss through the shock ahead of the tube, the total-pressure errors presented in this report for supersonic speeds are a function only of changes in angle of attack and are therefore directly comparable with the subsonic data. Estimated accuracies are as follows:

Tunnel	Angle of attack, α , deg	$\Delta p_i' / q_c'$
Langley stability	0.25	± 0.002 at $M=0.26$
Langley high-speed 7- by 10-foot	.25	$\pm .005$ at $M=0.5$ $\pm .002$ at $M=0.9$
Langley 8-foot transonic	.1	$\pm .003$ at $M=0.6$ $\pm .001$ at $M=1.11$
Langley 9-inch supersonic	.1	$\pm .002$ at $M=1.62$ $\pm .003$ at $M=1.61$ (15 lb/sq in.)
Langley 4- by 4-foot super-sonic	.2	$\pm .007$ at $M=1.61$ (16 lb/sq in.)

RESULTS AND DISCUSSION

The results of the tests of the 54 total-pressure tubes are summarized in table I, which presents the range of insensitivity of each of the tubes at Mach numbers ranging from 0.26 to 1.62.

The range of insensitivity as used in this report is a criterion which has been chosen as a basis for comparing the performance of the various tubes. It is defined as the range of angle of attack over which a tube remains insensitive to inclination to within 1 percent of q_c' . For convenience, another term, the

sensitivity angle, is also used. This is defined as the angle of attack at which the total-pressure error reaches a value of 1 percent of q_c' . For symmetrical tubes the sensitivity angle is half the range of insensitivity.

An example of the basic data from which the sensitivity angle of each of the tubes was determined is given in figure 3 for tube A-2. This figure shows the variation of the total-pressure error $\Delta p_i/q_c'$ with angle of attack for Mach numbers of 0.26 and 1.62. As defined by these curves, the sensitivity angle is 23° at $M=0.26$ and is 29° at $M=1.62$.

It will be seen from figure 3 that the total-pressure error remains zero up to a certain angle and then begins to deviate in a negative direction. In this case the sensitivity angle is determined by the angle of attack at which the total-pressure error becomes -1 percent of q_c' . This variation of total-pressure error with angle of attack is typical for the non-shielded tubes at all Mach numbers and for the shielded tubes at subsonic and transonic speeds. In the calibration of one shielded tube at supersonic speeds, however, the error deviated first to positive values and then, at a higher angle of attack, began the normal deviation in a negative direction as shown in figure 4. In this case the sensitivity angle is determined by the angle of attack at which the error reaches a value of $+1$ percent of q_c' .

EFFECT OF IMPACT-OPENING SIZE

The effect of varying the size of the impact opening (or more specifically, the ratio of the impact-opening diameter d to the tube diameter D) of three cylindrical tubes at $M=0.26$

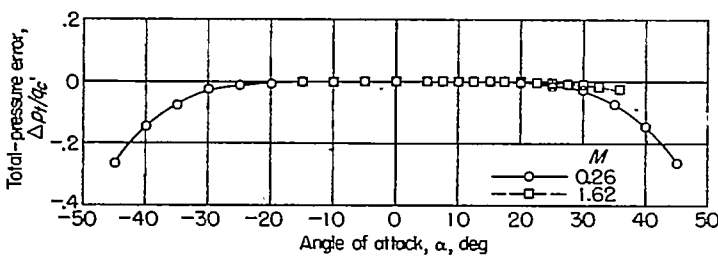

FIGURE 3.—Variation of total-pressure error with angle of attack of tube A-2 at subsonic and supersonic speeds.

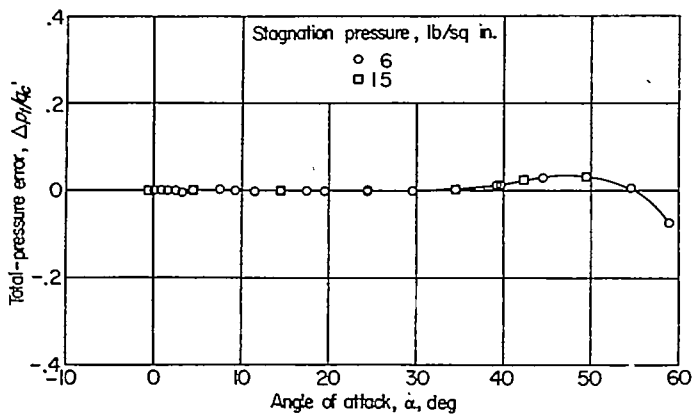

FIGURE 4.—Variation of total-pressure error with angle of attack of shielded tube A-12 at $M=1.61$.

may be seen from figure 5 (a). This figure shows that the sensitivity angle increases with increasing size of impact opening and reaches a value of 23° for the tubes having impact openings of 0.96 and 0.98. Although the calibrations of these two tubes (ref. 1) showed that the tube having the larger opening was actually less sensitive to inclination at angles of attack above the sensitivity angle, the differences were insufficient to produce a noticeable effect on the values of the sensitivity angle.

The variation of sensitivity angle with impact-opening size for tubes having a 30° conical nose section is presented in figure 5 (b). As in the case of the cylindrical tubes, the sensitivity angle is shown to increase with increasing size of the impact opening.

The effect of varying the size of the impact opening for tubes having 15° , 30° , and 45° conical nose sections is shown in figure 5 (c). In contrast to the data shown in figure 5 (b), the size of the impact opening in this case is defined as the ratio of the impact diameter d to the diameter of the face of the tube D_1 . The curves in figure 5 (c) show that for each of the three conical tubes the sensitivity angle increases with increasing values of d/D_1 , the rate of increase being greatest for the 15° conical tube and least for the 45° conical tube.

EFFECT OF VARYING THE SHAPE OF THE INTERNAL CHAMBER

The effect of the shape of the internal chamber on the characteristics of cylindrical tubes having blunt leading edges can be shown from a comparison of the sensitivity angles of tubes A-2 and A-5 at $M=0.26$. (See table I.) The design of these tubes was similar in leading-edge shape, size of impact opening ($0.98D$), and depth of chamber ($1.0D$); the tubes differed, however, in that the chamber of tube A-2 was cylindrical whereas that of tube A-5 was hemispherical. Comparison of the sensitivity angles of the two tubes shows that the performance is improved by changing the chamber from cylindrical to hemispherical and that the magnitude of the improvement is about $2\frac{1}{2}^\circ$.

The effect of internal shape on cylindrical tubes having sharp leading edges may be seen from a comparison of the

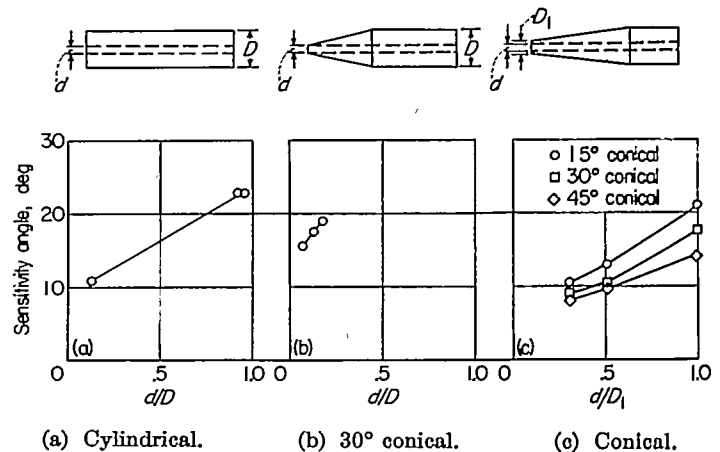

FIGURE 5.—Variation of sensitivity angle with size of impact opening of cylindrical and conical tubes. $M=0.26$.

sensitivity angle of tube A-4 with that of tubes A-10 and A-11 (table I). These tubes are alike in that each has an internally beveled leading edge but differ in that tube A-4 has a cylindrical chamber ($1.0D$ in depth); whereas tubes A-10 and A-11 have conical chambers extending $1.15D$ and $0.90D$, respectively, behind the leading edge. Since the average depth of the chambers of tubes A-10 and A-11 approximates that of tube A-4, an average value of the sensitivity angles of tubes A-10 and A-11 should provide a valid comparison of the relative merits of the two chambers. On this basis, the sensitivity angle for the conical chamber would be 24.5° , a value which compares with 23° for the cylindrical chamber. The conical chamber is therefore shown to be slightly superior to the cylindrical chamber for $M=0.26$.

The effect of varying the angle of the conical chambers in tubes having cylindrical, conical, and ogival external shapes is shown in figure 6. For each of the five series of tubes the sensitivity angle increased with decreasing angle for cone angles between 30° and 50° . Tests of cylindrical tubes with cone angles less than 30° , however, showed that the sensitivity angle remains essentially constant for cone angles below this value.

EFFECT OF EXTERNAL SHAPE

The effect of external shape on the angle-of-attack characteristics of total-pressure tubes may be determined by comparing tubes having the same type of pressure entry in each of the five series. Such a comparison may be made from figure 6, where data are presented for five external shapes, each having conical chambers of 30° , 40° , and 50° . It will be seen from figure 6 that the sensitivity angles of the cylindrical tubes are greater than those of any of the conical or ogival tubes. Of the conical tubes, the sensitivity angle of the 15° tube is the greatest and that of the 45° tube, the least.

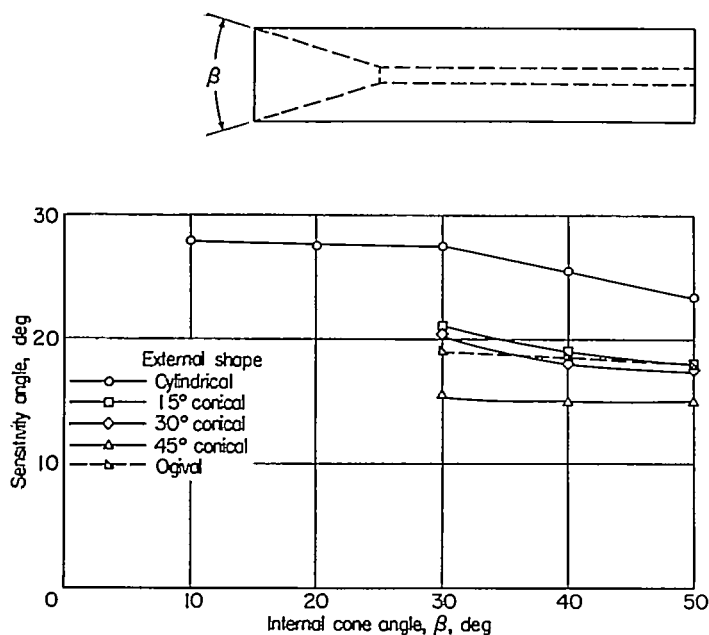

FIGURE 6.—Variation of sensitivity angle with internal cone angle for cylindrical, conical, and ogival tubes. $M=0.26$.

The sensitivity angles of the ogival tubes approximate those of the 15° and 30° conical tubes.

From the foregoing discussion it will be seen that the usable angular range of simple nonshielded tubes depends on the external shape of the nose section, the size of the impact opening (relative to the tube diameter), and the shape of the internal chamber behind the impact opening. The best combination of these three design features (a cylindrical tube having an impact opening equal to the tube diameter and a 15° conical chamber) produced the highest range of insensitivity ($\pm 27.5^\circ$ at $M=0.26$) of any of the nonshielded tubes.

EFFECT OF SLANT PROFILE

The effect of varying the slant of the leading-edge profile of a cylindrical tube may be seen by comparing the calibrations of tubes A-2 and A-6 (fig. 7 (a)). The range of insensitivity of tube A-2 is $\pm 23^\circ$ whereas that of tube A-6 is -13 to 32 . Changing the profile from square to a slant of 10° is shown to have the beneficial effect in shifting the calibration of a square-ended tube along the angle-of-attack scale by 9.5° so that the tube remains insensitive to higher positive angles of attack. The range of insensitivity of tube A-6 at angles of yaw was shown in reference 1 to be $\pm 23^\circ$ or the same as that of tube A-2 at angles of attack and yaw. From tests of tube A-6 at angles of attack combined with angles of yaw (ref. 1), it is possible to define the complete boundaries within which the tube will remain insensitive to within 1 percent of the impact pressure (fig. 7 (b)). This figure shows that, for angles of yaw up to 15° , the sensitivity angle of the tube is still as high (23°) as that of tube A-2. It may be concluded, therefore, that a slant profile has the effect of extending the range of insensitivity to higher positive angles of attack (with $\psi=0^\circ$) without loss in performance at either angles of yaw (with $\alpha=0^\circ$) or at angles of attack combined with angles of yaw up to 15° .

The effect of changing the slant of the leading-edge profile of an ogival tube from 10° to 20° may be determined by comparing the ranges of insensitivity of tubes E-2 and E-3. (See table I.) It will be seen from these values (-1.5° to 11.5° for tube E-2 and 8.5° to 21.5° for tube E-3) that the effect of increasing the slant angle from 10° to 20° is a shift of the curve along the angle-of-attack scale by 10° . It would appear, therefore, from the results of the tests of cylindrical and ogival tubes having slant profiles that, for slant angles up to 20° , the sensitivity angle may be extended to higher positive angles of attack by about 1° for each degree of slant angle.

EFFECT OF VENTING OF SHIELDED TUBES

The effect of venting Kiel-type shielded tubes is shown in figure 8 (a). This figure shows that at $M=0.26$ the effect of venting is considerable, for the addition of a vent area equal to one-half the frontal area of the shield increases the sensitivity angle from 24° (for the no-flow condition) to 38.5° . A further increase in the vent area to 1.0 times the frontal area is not nearly as effective because the sensitivity

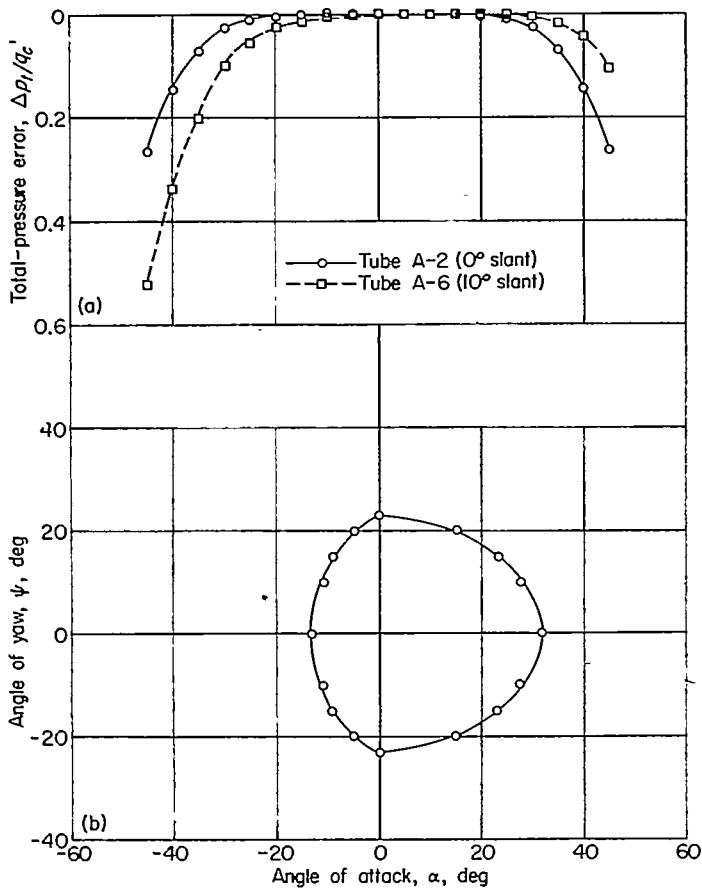

(a) Variation of total-pressure error of cylindrical tubes having slant profiles of 0° and 10°.

(b) Limits of angle of attack and yaw to which total-pressure error is within 1 percent q_0' .

FIGURE 7.—Total-pressure errors and sensitivity angles of cylindrical tube having slant profile. $M=0.26$.

angle in this case was extended to only 41°. Increasing the vent area to 1.5 times the frontal area produced a negligible further increase in the sensitivity angle ($\frac{1}{2}^\circ$).

The curve in figure 8 (a) indicates that at $M=0.26$ the throat becomes choked when the vent area A_v/A_0 is somewhat less than 1.0. Since the size of the vent area corresponding to the choked condition decreases with increasing Mach number, a vent area of about 1.0 would be satisfactory for Mach numbers above 0.26. In order that the vent area be large enough for Mach numbers below 0.26, a vent area A_v/A_0 of 1.5 was adopted as a standard for the shielded tubes of this investigation. A point of interest in this connection is the fact that, at least for $M=0.26$, the wall-type venting of these tubes was shown to be as effective as the type of venting of the Kiel tube (ref. 8).

EFFECT OF VARYING THE PROBE POSITION AND THE THROAT DIAMETER OF SHIELDED TUBES

The effects of varying (1) the location of the leading edge of the probe with respect to the leading edge of the shield (a/D) and (2) the diameter of the throat of the shield (D_2/D) were investigated by tests of tubes A_s-5 , A_s-6 , A_s-7 , A_s-8 ,

and A_s-9 . Tubes A_s-8 and A_s-9 were the same as A_s-5 , A_s-6 , and A_s-7 except for the throat diameter which was increased from the Kiel standard of 0.5 to 0.591 (an increase of 50 percent in the area of the throat). (Note that the increase in throat diameter of tubes A_s-8 and A_s-9 was accompanied by a small decrease in the angle of the entrance cone.)

The variation of sensitivity angle with varying probe position and throat diameter is shown in figure 8(b). This figure shows that, for this particular configuration and at $M=0.26$, moving the probe forward of the 0.5 position has a negligible effect on the value of the sensitivity angle, whereas moving the probe to the rear decreases the sensitivity angle by 1.2°. The effect of increasing the area of the throat 50 percent is shown to increase the sensitivity angle by about 2.5°.

EFFECT OF SLANT PROFILE ON SHIELDED TUBES

The effect of varying the leading-edge profile of a shielded tube by 10° may be seen by comparing the sensitivity angles of tubes A_s-5 and A_s-10 for $M=0.26$ (table I). The probe position for each of these tubes was 0.500. The effect of the profile in this case was to increase the sensitivity angle by 9.7°, which corresponds almost exactly with the increase obtained with the nonvented cylindrical and ogival tubes.

It had been thought that, in order for the tube with the slant profile to be comparable with that of the standard Kiel design, the position of the probe for the slanted shield should be moved rearward to a point where the leading edge of the probe would be midway between the rear of the cone and the point where the slant intersects the axis of the tube. It was for this reason that tube A_s-11 was tested with the probe located at $a/D=0.544$. The results of the tests of this probe position, however, showed the sensitivity angle to decrease by 3.3° from the value of the sensitivity angle with the probe at the 0.5 station.

In the tests of the shielded tubes with the slant profile the angular range in the negative direction was insufficient to define the negative sensitivity angle. From the tests of the nonvented cylindrical tube $A-6$, however, it was shown

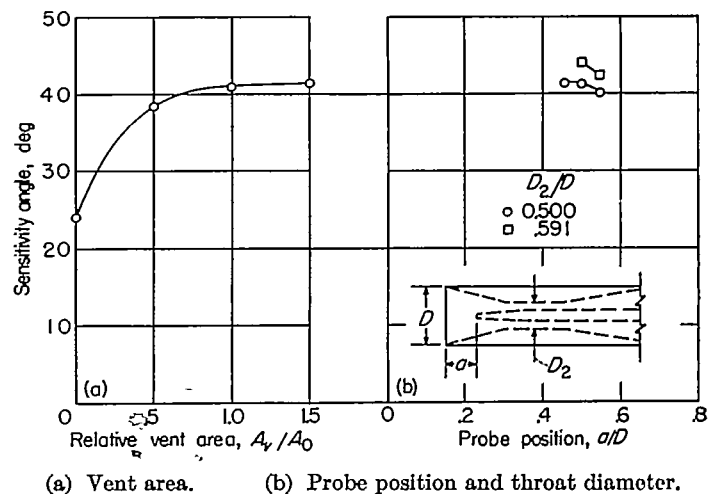

FIGURE 8.—Variation of sensitivity angle with vent area, probe position, and throat diameter of shielded tubes. $M=0.26$.

that the range of insensitivity remains essentially constant when the profile is changed from square to a 10° slant. On the assumption that the range of insensitivity of shielded tubes also remains constant, the negative sensitivity angles of these tubes were estimated on the basis of the range of insensitivity of tube A_s-5. These estimated values are included in table I.

From the calibration of tube A_s-10 at angles of yaw (with $\alpha=0^\circ$) at $M=0.9$ (ref. 3), the sensitivity angle was found to be 38° . This is essentially the same as that of tube A_s-5 at $M=0.9$. A 10° slant profile on a shielded tube, therefore, exhibits the same characteristics as those of a nonshielded cylindrical tube; that is, the sensitivity angle is extended to higher positive angles of attack without loss in performance at angles of yaw ($\alpha=0^\circ$).

EFFECT OF THE SHAPE OF THE ENTRY OF SHIELDED TUBES

The effect of varying the shape of the entry of shielded tubes will be seen by comparing the results of the tests of tubes A_s-5, A_s-12, A_s-15, and A_s-16 at a Mach number of 0.26. For each of these tubes, the dimensions a/D and D_2/D were the same (0.500). The entry of tube A_s-5 was conical with a 14° angle whereas that of the remaining tubes was curved. The slope of the entry of A_s-12 was 60° at the leading edge and 0° at a distance $0.5D$ behind the leading edge. The slope of the entry of tube A_s-15 was 30° at the leading edge and 0° at a distance $1.0D$ behind the leading edge. The entry of tube A_s-16 is an adaptation of an NACA nose inlet, and the leading edge of this tube was round whereas that of the remaining tubes was sharp. The design of the tubes having curved entries was suggested by a report by Moffat (ref. 12) of tests with small-scale shielded tubes designed for engine and duct survey work.

The sensitivity angles of tubes A_s-5, A_s-12, and A_s-15 at $M=0.26$ are shown in figure 9 as a function of the internal cone angle of the shield. (The sensitivity angle of tube A_s-16 was not included in figure 9 since its leading edge is round, whereas those of the other tubes were sharp.) This figure shows the sensitivity angle to increase with an increase in the cone angle and that the magnitude of the increase between the 28° cone of the Kiel tube and the 120° angle of tube A_s-12 is 21.9° . Thus, the sensitivity angle of a shielded tube may be increased by about 50 percent by changing the conical entry of the Kiel design to a curved entry having a high degree of curvature.

The effect of varying the position of the probe in a tube having a curved entry was investigated for positions a/D of 0.456 and 0.544 (tubes A_s-13 and A_s-14). The results of these tests (see table I) showed the sensitivity angle to be affected to only a negligible extent for this variation in probe position.

When the results of the tests of the total-pressure tubes at subsonic speeds are summarized, it will be remembered that the best of the nonshielded tubes (aside from those having slant profiles) produced a range of insensitivity of about $\pm 28^\circ$. For those cases where a usable angular range larger than $\pm 28^\circ$ is required, a much higher range of insensitivity may be obtained with a shielded tube. The range of insen-

sitivity of a tube with a shield having a conical entry, for example, is $\pm 41^\circ$ at $M=0.26$. Changing the shape of the entry of the shield to a highly curved section increases the range of insensitivity to about $\pm 63^\circ$, the highest of any of the tubes tested.

EFFECT OF MACH NUMBER ON NONSHIELDED TUBES

The effect of Mach number on the sensitivity of nonshielded tubes, as based on the data at $M=0.26$ and 1.62, is shown in figure 10. It will be seen from this figure that, for those tubes in each of the five series having conical chambers (for which d/D and $d/D_1=1.0$), the sensitivity angles at supersonic speeds are appreciably greater than those at subsonic speeds. The increase in the sensitivity angle for cylindrical tubes is $4\frac{1}{2}^\circ$ to 6° , whereas the increase for conical and ogival tubes is 8° to 10° . Tubes having relatively small impact openings, on the other hand, were affected by Mach number to a lesser extent. The sensitivity angle of cylindrical tube A-1, for example, showed no increase with Mach number, whereas the sensitivity angles for the 15° conical tubes, B-2 and B-3, increased by about only 4° .

The calibration of ogival tube E-2 at transonic speeds (ref. 5) is presented in figure 11 to show the effect of Mach number on nonshielded tubes throughout the Mach number range. In order to extend this calibration to lower subsonic speeds, use has been made of the data of tube E-1 at $M=0.26$. The design of these two tubes was the same with the exception that the impact opening d/D of tube E-2 was 0.43 whereas that of tube E-1 was 0.32. The sensitivity angle of

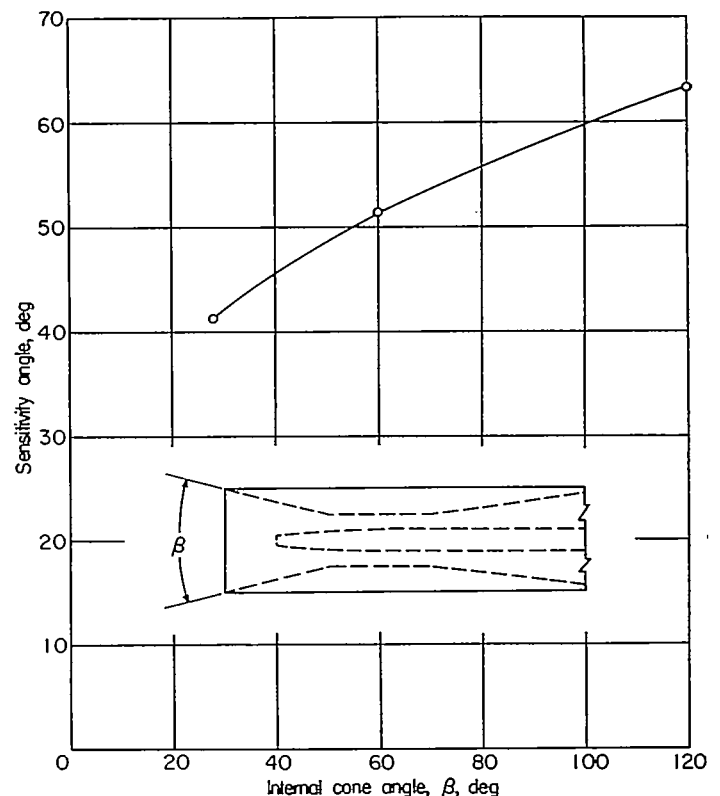

FIGURE 9.—Variation of sensitivity angle with angles of entry of shield of three shielded tubes at $M=0.26$. Tubes A_s-5, A_s-12, and A_s-15.

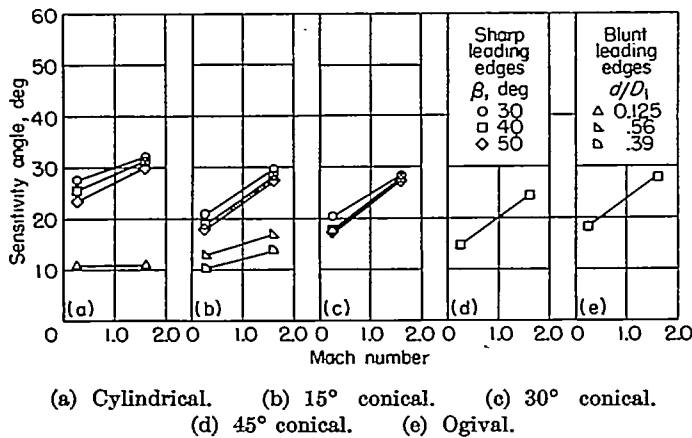

FIGURE 10.—Variation of sensitivity angle with Mach number of tubes having cylindrical, conical, and ogival external shapes with sharp and blunt leading edges.

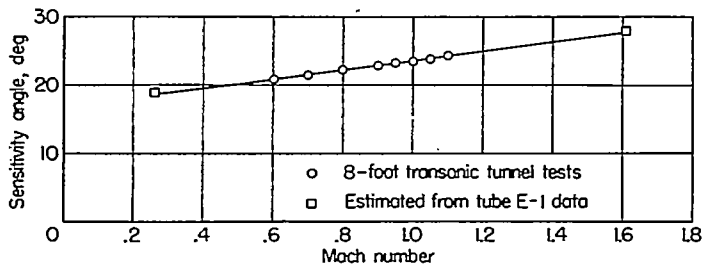

FIGURE 11.—Variation of sensitivity angle with Mach number of ogival tube E-2.

tube E-2 at $M=0.26$ has been estimated from that of tube E-1 by assuming the impact opening of tube E-1 to be increased to 0.43. The rate of increase of the sensitivity angle with impact-opening size of tube E-1 was assumed to be the same as that of the conical tubes shown in figure 5 (b). On the basis of these assumptions, the sensitivity angle of tube E-1 was found to increase from 16° to about 19° . In order to estimate the sensitivity angle of tube E-2 at $M=1.62$, the assumption was made that the increase in sensitivity angle of tube E-2 between $M=0.26$ and $M=1.62$ would be the same as that of tube E-6 (9.5°). On this basis, the estimated value for tube E-2 at $M=1.62$ would be 28.5° . It will be seen from figure 11 that the estimated sensitivity angles at subsonic and supersonic speeds are in good agreement with the linear calibration of tube E-2 through the transonic speed range. From these data it would appear that the sensitivity angle of non-shielded tubes varies in a linear manner with Mach number throughout the Mach number range from $M=0.26$ to 1.62.

EFFECT OF MACH NUMBER ON SHIELDED TUBES

The effect of Mach number on the sensitivity of four shielded tubes over a Mach number range from 0.26 to 0.9 is shown in figure 12. It will be seen from figure 12 that the sensitivity angle of all the tubes decreased with increasing Mach number, the magnitude of the decrease varying from 3° for tube A_s-5 to 6° for tube A_s-12. The variation in sensitivity angle with Mach number of the tube with a shield having a conical entry (A_s-5) was linear, whereas the

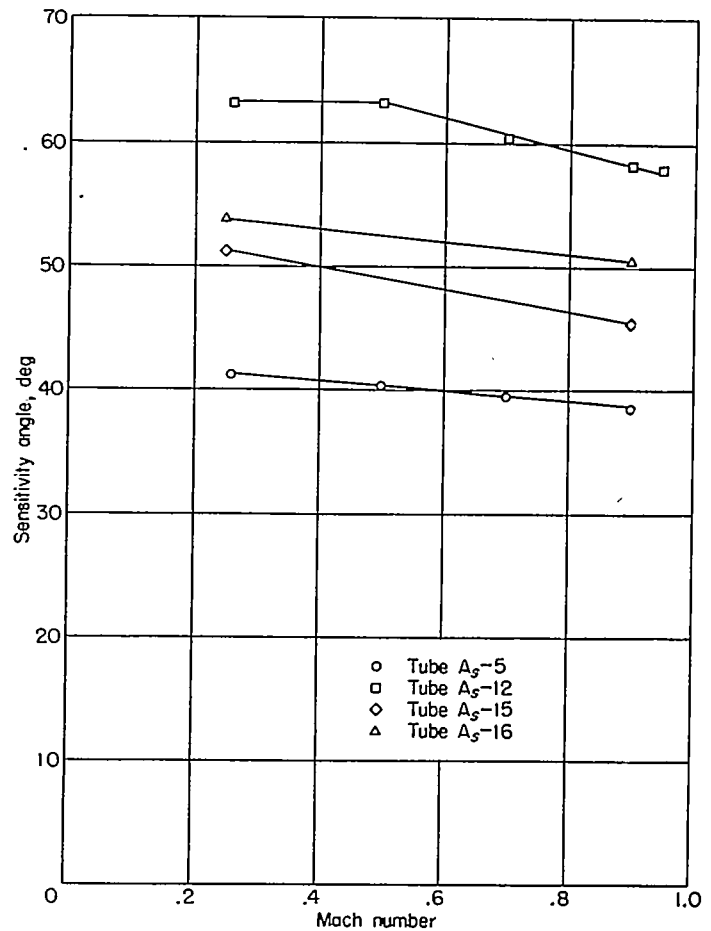

FIGURE 12.—Variation of sensitivity angle with Mach number of four tubes with shields having conical and curved entries.

calibration of the tube with a curved entry (A_s-12) shows a break in the curve at $M=0.5$.

The effect of Mach number on a shielded tube throughout the subsonic, transonic, and supersonic speed ranges (up to $M=1.61$) is given in figure 13. As indicated by figure 13, the sensitivity angle remains at a constant value of 63° from $M=0.26$ to $M=0.5$, decreases linearly to 56° at $M=1.10$, and then decreases further to 40° at $M=1.61$.

The calibration of tube A_s-12 at Mach number 1.61 is presented in figure 4 because it differs from the calibrations of this tube at subsonic and transonic speeds in one important respect. At the lower speeds, the total-pressure error remained zero up to an angle of attack just below the critical angle. Beyond this point, the errors became increasingly negative. The calibration at $M=1.61$, however, shows the error to become positive at angles of attack below the range where the error becomes negative. It is believed that the positive errors at angles of attack between 34° and 55° results from the fact that, at angles of attack above 34° , the tube no longer measures the total pressure behind a normal shock but measures instead the pressure behind an oblique shock with higher total pressure.

From the preceding discussion it will be seen that the effect of Mach number on the range of insensitivity of both

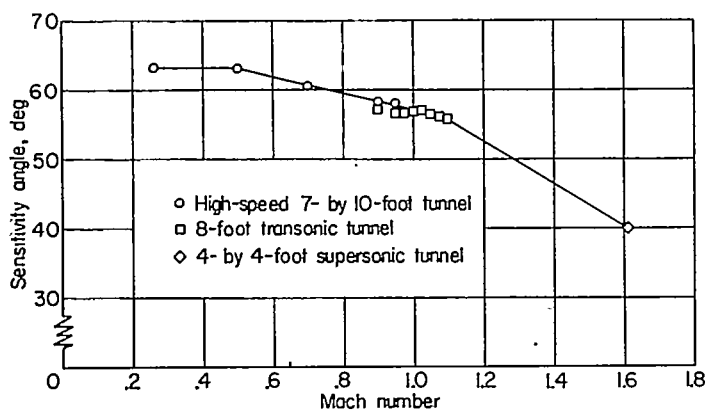

FIGURE 13.—Variation of sensitivity angle with Mach number of shielded tube A_r-16.

nonshielded and shielded tubes is considerable. For most nonshielded tubes, the range of insensitivity increased linearly with Mach number, the increase amounting to as much as 10° over a Mach number range of 0.26 to 1.62. The range of insensitivity of shielded tubes, on the other hand, was found to decrease with Mach number, and, in this case, the variation was nonlinear.

CONCLUSIONS

The more significant conclusions which may be drawn from the results of the tests of 54 total-pressure tubes at angles of attack up to 60° and over a Mach number range of from 0.26 to 1.62 are summarized as follows:

For simple, nonshielded tubes the usable angular range (or the range of insensitivity, arbitrarily defined as the angle-of-attack range over which the total-pressure error remains within 1 percent of the impact pressure) was found to depend on the external shape of the nose section, the size of the impact opening (relative to the tube diameter), and the shape of the internal chamber behind the impact opening. The best combination of these design features, a cylindrical tube having an impact opening equal to the tube diameter and a 30° conical chamber, produced the highest range of insensitivity (about 28° at a Mach number of 0.26) of any of the nonshielded tubes.

For airspeed applications where it is not essential that the tube have a large negative angle-of-attack range, the usable range may be extended to higher positive angles of attack by means of a leading-edge slant profile. For slant profiles up to 20°, the usable range at positive angles of attack can be extended by about 1° for each degree of slant. The range of insensitivity of a thin-walled cylindrical tube, for example, was extended from 23° to 32° by a slant profile of 10°. The sensitivity of this tube at angles of yaw and at angles of attack combined with angles of yaw up to 15° was found to be no greater than that of a similar tube without leading-edge slant.

In cases where a usable angular range larger than ±28° is required, a much higher range of insensitivity may be obtained with a shielded tube. The range of insensitivity of

a tube with a shield having a conical entry, for example, is about ±41° at a Mach number of 0.26. Changing the shape of the entry of the shield to a highly curved section increases the range of insensitivity to about ±63°, the highest of any of the tubes tested. The throats of these tubes were vented through the walls of the shield, a design feature permitting end-mounting of the tube on a horizontal boom.

The effect of Mach number on both unshielded and shielded tubes was found to be considerable. For most of the unshielded tubes the range of insensitivity increased linearly with Mach number, the increase amounting to as much as 10° over a Mach number range of 0.26 to 1.62. The range of insensitivity of shielded tubes, on the other hand, was found to decrease with Mach number. For the tube with the shield having the highly curved entry, the range of insensitivity remains at a constant value of ±63° from Mach numbers of 0.26 to 0.5, decreases linearly to ±56° at a Mach number of 1.10, and then decreases further to ±40° at a Mach number of 1.61.

LANGLEY AERONAUTICAL LABORATORY,
NATIONAL ADVISORY COMMITTEE FOR AERONAUTICS,
LANGLEY FIELD, VA., *January 17, 1956.*

REFERENCES

1. Gracey, William, Letko, William, and Russell, Walter R.: Wind-Tunnel Investigation of a Number of Total-Pressure Tubes at High Angles of Attack—Subsonic Speeds. NACA TN 2331, 1951. (Supersedes NACA RM L50G19.)
2. Gracey, William, Coletti, Donald E., and Russell, Walter R.: Wind-Tunnel Investigation of a Number of Total-Pressure Tubes at High Angles of Attack—Supersonic Speeds. NACA TN 2261, 1951.
3. Russell, Walter R., Gracey, William, Letko, William, and Fournier, Paul G.: Wind-Tunnel Investigation of Six Shielded Total-Pressure Tubes at High Angles of Attack—Subsonic Speeds. NACA TN 2530, 1951.
4. Gracey, William, Pearson, Albin O., and Russell, Walter R.: Wind-Tunnel Investigation of a Shielded Total-Pressure Tube at Transonic Speeds. NACA RM L51K19, 1952.
5. Pearson, Albin O., and Brown, Harold A.: Calibration of a Combined Pitot-Static Tube and Vane-Type Flow Angularity Indicator at Transonic Speeds and at Large Angles of Attack or Yaw. NACA RM L52F24, 1952.
6. Russell, Walter R., and Gracey, William: Wind-Tunnel Investigation of a Shielded Total-Pressure Tube at a Mach Number of 1.61. NACA RM L53L23a, 1954.
7. Merriam, Kenneth G., and Spaulding, Ellis R.: Comparative Tests of Pitot-Static Tubes. NACA TN 546, 1935.
8. Kiel, G.: Total-Head Meter With Small Sensitivity to Yaw. NACA TM 775, 1935.
9. McClanahan, Herbert C., Jr.: Wing-Flow Investigation of a 45° Cone as an Angle-of-Attack Measuring Device at Transonic Speeds. NACA RM L51E16, 1951.
10. Hasel, Lowell E., and Coletti, Donald E.: Investigation of Two Pitot-Static Tubes at Supersonic Speeds. NACA RM L8102, 1948.
11. Eckert, B.: Experiences With Flow-Direction Instruments. NACA TM 969, 1941.
12. Moffat, Marston: Report on Kiel Probes. Rep. No. PWA-576, Pratt & Whitney Aircraft, Oct. 17, 1945.

TABLE I
RANGE OF ANGLE OF ATTACK OVER WHICH TOTAL-PRESSURE TUBES REMAIN INSENSITIVE TO INCLINATION TO WITHIN 1 PERCENT q_c'

Tube	Range of angle of attack for Mach numbers of—											
	0.26	0.5	0.6	0.7	0.8	0.9	0.95	1.00	1.05	1.10	1.61	1.62
Cylindrical tubes												
A-1	±11	-----	-----	-----	-----	-----	-----	-----	-----	-----	-----	±11
A-2	±23	-----	-----	-----	-----	-----	-----	-----	-----	-----	-----	±20
A-3	±23	-----	-----	-----	-----	-----	-----	-----	-----	-----	-----	±29
A-4	±23	-----	-----	-----	-----	-----	-----	-----	-----	-----	-----	±27.5
A-5	±25.5	-----	-----	-----	-----	-----	-----	-----	-----	-----	-----	-----
A-6	-13, 32	-----	-----	-----	-----	-----	-----	-----	-----	-----	-----	±20, 38
A-7	±28.0	-----	-----	-----	-----	-----	-----	-----	-----	-----	-----	-----
A-8	±27.5	-----	-----	-----	-----	-----	-----	-----	-----	-----	-----	-----
A-9	±27.5	-----	-----	-----	-----	-----	-----	-----	-----	-----	-----	±32
A-10	±25.5	-----	-----	-----	-----	-----	-----	-----	-----	-----	-----	±31.5
A-11	±23.5	-----	-----	-----	-----	-----	-----	-----	-----	-----	-----	±30
Shielded tubes												
A _s -1	±24	-----	-----	-----	-----	-----	-----	-----	-----	-----	-----	-----
A _s -2	±38.5	-----	-----	-----	-----	-----	-----	-----	-----	-----	-----	-----
A _s -3	±41	-----	-----	-----	-----	-----	-----	-----	-----	-----	-----	-----
A _s -4	±41.5	-----	-----	-----	-----	-----	-----	-----	-----	-----	-----	-----
A _s -5	±41.3	±40.4	-----	±39.5	-----	±38.6	-----	-----	-----	-----	-----	-----
A _s -6	±40.1	-----	-----	-----	-----	-----	-----	-----	-----	-----	-----	-----
A _s -7	±41.5	-----	-----	-----	-----	-----	-----	-----	-----	-----	-----	-----
A _s -8	±44.0	-----	-----	-----	-----	-----	-----	-----	-----	-----	-----	-----
A _s -9	±42.5	-----	-----	-----	-----	-----	-----	-----	-----	-----	-----	-----
A _s -10	*-31.6, 51	-----	-----	-----	-----	*-30.7, 46.5	-----	-----	-----	-----	-----	-----
A _s -11	*-32.5, 47.7	-----	-----	-----	-----	-----	-----	-----	-----	-----	-----	-----
A _s -12	±63.2	±63.3	-----	±60.6	-----	±57.1	±56.6	±57.0	±56.3	±55.7	±40.0	-----
A _s -13	±63.8	-----	-----	-----	-----	-----	-----	-----	-----	-----	-----	-----
A _s -14	±63.8	-----	-----	-----	-----	-----	-----	-----	-----	-----	-----	-----
A _s -15	±51.4	-----	-----	-----	-----	±45.5	-----	-----	-----	-----	-----	-----
A _s -16	±53.9	-----	-----	-----	-----	±50.6	-----	-----	-----	-----	-----	-----
15° conical tubes												
B-1	±21	-----	-----	-----	-----	-----	-----	-----	-----	-----	-----	±20
B-2	±13	-----	-----	-----	-----	-----	-----	-----	-----	-----	-----	±17
B-3	±10.5	-----	-----	-----	-----	-----	-----	-----	-----	-----	-----	±14
B-4	±21	-----	-----	-----	-----	-----	-----	-----	-----	-----	-----	±20.5
B-5	±19	-----	-----	-----	-----	-----	-----	-----	-----	-----	-----	±28.5
B-6	±18	-----	-----	-----	-----	-----	-----	-----	-----	-----	-----	±27.5
30° conical tubes												
C-1	±15.5	-----	-----	-----	-----	-----	-----	-----	-----	-----	-----	-----
C-2	±17.5	-----	-----	-----	-----	-----	-----	-----	-----	-----	-----	-----
C-3	±19	-----	-----	-----	-----	-----	-----	-----	-----	-----	-----	-----
C-4	±10.5	-----	-----	-----	-----	-----	-----	-----	-----	-----	-----	-----
C-5	±9	-----	-----	-----	-----	-----	-----	-----	-----	-----	-----	-----
C-6	±20.5	-----	-----	-----	-----	-----	-----	-----	-----	-----	-----	±28.5
C-7	±18	-----	-----	-----	-----	-----	-----	-----	-----	-----	-----	±28
C-8	±17.5	-----	-----	-----	-----	-----	-----	-----	-----	-----	-----	±27.5
45° conical tubes												
D-1	±14	-----	-----	-----	-----	-----	-----	-----	-----	-----	-----	-----
D-2	±9.5	-----	-----	-----	-----	-----	-----	-----	-----	-----	-----	-----
D-3	±8	-----	-----	-----	-----	-----	-----	-----	-----	-----	-----	-----
D-4	±15.5	-----	-----	-----	-----	-----	-----	-----	-----	-----	-----	-----
D-5	±15	-----	-----	-----	-----	-----	-----	-----	-----	-----	-----	±24.5
D-6	±13.5	-----	-----	-----	-----	-----	-----	-----	-----	-----	-----	-----
Ogival tubes												
E-1	±16	-----	±21	±21.5	±22.2	±22.8	±23.1	±23.5	±23.8	±24.2	-----	-----
E-2	-----	-----	-----	-----	-----	-----	-----	-----	-----	-----	-----	-----
E-3	-1.5, 11.5	-----	-----	-----	-----	-----	-----	-----	-----	-----	-----	-----
E-4	8.5, 21.5	-----	-----	-----	-----	-----	-----	-----	-----	-----	-----	-----
E-5	±19	-----	-----	-----	-----	-----	-----	-----	-----	-----	-----	±28
E-6	±18.5	-----	-----	-----	-----	-----	-----	-----	-----	-----	-----	-----
E-7	±18	-----	-----	-----	-----	-----	-----	-----	-----	-----	-----	-----

* Estimated.