

NATIONAL ADVISORY COMMITTEE FOR AERONAUTICS

WARTIME REPORT

ORIGINALLY ISSUED

August 1943 as
Advance Restricted Report 3H16

IMPROVED BAFFLE DESIGNS FOR AIR-COOLED

ENGINE CYLINDERS

By Abe Silverstein and George F. Kinghorn

Langley Memorial Aeronautical Laboratory
Langley Field, Va.

JPL LIBRARY
CALIFORNIA INSTITUTE OF TECHNOLOGY

CAS
FOR
REF



WASHINGTON

NACA WARTIME REPORTS are reprints of papers originally issued to provide rapid distribution of advance research results to an authorized group requiring them for the war effort. They were previously held under a security status but are now unclassified. Some of these reports were not technically edited. All have been reproduced without change in order to expedite general distribution.

L-767

APR 9 - 1948

ADVANCE RESTRICTED REPORT

IMPROVED BAFFLE DESIGNS FOR AIR-COOLED
ENGINE CYLINDERS

By Abe Silverstein and George F. Kinghorn

SUMMARY

An investigation has been made to determine methods for improving the cooling of air-cooled engine cylinders by means of baffle modifications. The tests were conducted on a Pratt & Whitney R-1830-43 engine mounted on a ground test stand.

The effects upon the cylinder temperature of various modifications to the original baffles were determined. In addition, new baffles for the engine were designed and tested. The cylinder temperatures as measured at the rear spark-plug gasket were reduced as much as 50° F with the new baffles. The improved cooling extended over a considerable portion of the top and rear of the cylinders where the temperatures are high. The noncritical temperatures at the front of the cylinder were slightly increased.

INTRODUCTION

At the request of the Army Air Forces, methods have been investigated for improving the cooling of air-cooled engine cylinders by means of baffle modifications. This approach to the problem of reducing cylinder temperatures is attractive because changes to the engine baffles can be effected without delaying engine production.

The purpose of the baffles on an air-cooled engine cylinder is to direct an adequate quantity of cool air to the fins on the rear half of the cylinder. Without the baffles, the air flow separates from the cylinder, and the fins around the exhaust outlet and the rear spark plug are not cooled. Studies of the baffles on several modern engines showed that the cooling air was not properly directed on the rear fins and that the cooling-air passages

leading the air to the rear of the cylinder were unduly restricted.

Tests were made, therefore, with baffles that were modified to correct these faults. The baffles were tested first on a single cylinder of the Pratt & Whitney R-1830-43 engine and then on all the cylinders of the engine. The investigation was made on a ground-test installation at the NACA full-scale tunnel.

CONSIDERATIONS LEADING TO BAFFLE MODIFICATIONS

The hottest cylinder-head temperatures normally occur around the exhaust-gas port and the rear spark plug. A large area of fin surface is usually provided over this region of the head; however, on many baffle installations an adequate supply of cooling air is not directed through these rear fins and their effectiveness is reduced. This loss in fin effectiveness occurs on some engines because the baffles are too short (fig. 1) and the cooling air is discharged along the side rather than at the rear of the cylinder. In other cases, a bottleneck is formed between the baffles and the top or the side of the cylinder head and the air for cooling the rear fins is required to pass through a restricted passage (fig. 2). Behind the restriction, the air flow separates and the quantity of cooling air that will flow through the engine at a given pressure drop is decreased. The effectiveness of the rear fins is further reduced because the cooling air has been heated in passing over the front and the sides of the cylinder. The temperature differential available for removing heat is, in some cases, almost halved.

The cooling on the front of the cylinders is greatly improved by large-scale turbulence in the air stream ahead of the engine. On most engine installations, the clearance between the baffle and the tips of the fins is small (fig. 3(a)) and the possibilities of continuing the beneficial effects of the turbulence for cooling the fins on the sides of the head are reduced. It might be anticipated, therefore, that increasing the area of the baffle inlet would improve the heat transfer from the fins on the sides of the head and reduce the cylinder temperatures,

The foregoing considerations and the results of previous baffle investigations (references 1 and 2) indicated

L-767

that the following modifications offered possibilities for improving the cooling:

- (1) Extension of the baffles farther around to the rear of the cylinder
- (2) Elimination of the bottlenecks in the fin passages by providing more space between the tip of the fins and the baffles over the restricted areas
- (3) Enlargement of the inlets to the baffle passages in order that the turbulence ahead of the engine may be utilized to cool the sides of the cylinder
- (4) Provision of a diffuser with a well-rounded inlet on the baffle outlet in order that a part of the kinetic energy of the cooling flow may be recovered and the pressure drop across the baffle reduced
- (5) Provision of separate ducts to carry unheated air to the hottest parts of the cylinder head

METHODS AND TESTS

The tests were conducted on a Pratt & Whitney R-1830-43 engine installed in a Consolidated B-24D wing nacelle. The engine has a normal rating of 1100 horsepower and a military rating of 1200 horsepower. A propeller-speed blower fan and large-chord cowl flaps were used to supply cooling air for the engine. The nacelle, as mounted on the ground stand for tests, is shown in figure 4.

The temperatures of the rear spark-plug gaskets and the cylinder flanges were measured on all the cylinders. On the rear top cylinder 1, the temperatures at 16 points over the head and barrel were also measured. Total-pressure tubes at the baffle inlets and static tubes at the baffle outlets were used to measure the cooling-air pressure drop.

A preliminary part of the investigation consisted of tests of various baffle changes on a single cylinder to determine separately the improvement in cooling possible with different types of modification. The modifications

that effected improvement in the cooling were then combined into revised baffles which were applied and tested, first on a single cylinder and then on all the engine cylinders. The baffles for the front- and rear-row cylinders were revised differently in an attempt to obtain a more uniform temperature pattern around the engine.

The modifications that were tested separately on a single cylinder are shown in figures 3, 5, and 6. The baffle design shown in figure 5 includes an enlarged inlet and an extension of the baffle farther to the rear of the cylinder with the result that the outlet width is decreased from 5 inches to $2\frac{1}{4}$ inches. The baffle outlet was rounded with a radius of $1\frac{1}{2}$ inch. A comparison with the standard baffle for the cylinder is shown in figure 5.

The effect of continuing the standard baffle farther to the rear of the cylinder and of adding a short diffuser outlet was investigated by means of the baffle configuration shown in figure 6. The outlet area was the same as that for the baffle design shown in figure 5.

In order to provide unheated air to the rear of the cylinder, a new head baffle was designed that included a separate duct for carrying air from the front of the engine to the rear top fins. The inlet to this separate cooling passage is shown in figure 3(b). A comb was provided in the head baffle that projected down into the fin passages about at the top of the head and diverted out of the rear fin passages the heated air which flowed over the front fins. The teeth of the comb may be seen between the fins in figure 3(b).

After a review of the preliminary test results, the separate modifications were integrated into a completely revised baffle design. Comparisons of the original and the revised baffles are shown in figures 3, 7, and 8. Further detail views of the revised baffle are shown in figure 9. The completely revised baffle was tested first on top rear cylinder 1 and then on all the rear cylinders.

The completely revised baffle was not applied to the front cylinders; a baffle with fewer revisions, as shown in figure 10, was used instead. With the original baffle installation, the head temperatures on the front-row cylinders averaged 25° to 30° lower than those for the rear-row cylinders, and it was planned to make fewer revisions to the front-cylinder baffles to obtain more nearly the same temperatures on the two rows.

The tests were made at engine powers varying from low cruising power to normal power. Tests for direct comparisons of the various baffle arrangements were made at the same cooling pressure drop, engine power, and fuel-air ratio.

RESULTS AND DISCUSSION

The temperature data have been corrected for variations in atmospheric conditions and small variations in engine-operating conditions in order that the results obtained for the modified baffles may be compared directly with the results obtained for the original baffles. The results have been correlated by the method of reference 3.

The most important results obtained from the tests of various baffle modifications are summarized in the following table:

Baffle modification	Average temperature reduction (°F)	Figure
Baffle extended farther to rear of cylinder; inlet gap enlarged to 5/8 inch; 1/2-inch radius at baffle outlet (fig. 5)	31	11
Short diffuser at baffle outlet; 1 1/4-inch radius at diffuser inlet (fig. 6)	17	12
Separate duct in head baffle (fig. 3(b))	10	13
Revised baffles tested on cylinder 1 (fig. 8); original baffles on other cylinders	50	14
Original baffles replaced on cylinder 1; revised baffles on other cylinders	-56	20,21
Outlet diffuser tested on front cylinders (fig. 10)	18	15,19

The results in the table show that a reduction in cylinder-head temperature of 31° was effected by the extension of the baffle farther to the rear on the cylinder and the enlargement of the baffle inlet. A temperature reduction of 17° was obtained by extending the original baffle farther to the rear on the cylinder and by adding a short diffuser, whereas a 10° reduction was effected by means of a separate duct in the head baffle. When these different modifications were combined into the final revised baffle, the cylinder-head temperature was reduced about 50° , which is approximately the temperature reduction that would be expected from the simple addition of the gains effected by the separate modifications.

The changes in cylinder temperatures that result from applying the revised baffles to the entire engine are shown for various power conditions in figures 15 to 19. The improved cooling indicated from tests of cylinder 1 was obtained on all the rear cylinders of the engine, and the average front-cylinder temperatures were reduced 18° by the partial baffle modification. The uniformity of the temperature pattern around the engine was considerably improved as a result of the dissimilar baffle changes applied to the front and rear rows.

As a check on the effectiveness of the revised baffles, the original baffles were reinstalled on cylinder 1 with the revised baffles on the rest of the cylinders of the engine. The spark-plug temperature on cylinder 1 was increased 56° above the value with the revised baffle (figs. 20 and 21).

Temperatures at 16 points on cylinder 1, as measured with the original and revised baffles, are shown in figures 22 and 23. As will be noted by reference to the figures, the hottest temperatures in general were reduced; whereas, the cooler temperatures were not particularly affected by the baffle change. The single exception is the exhaust-valve-guide temperature, which was increased due to the baffle revision. This temperature increase was found to be due to an inadvertent restriction of the cooling-air outlet on the exhaust side of the cylinder below the rocker box (fig. 7(b)).

In order to reduce the temperature of the exhaust valve guide, the baffle was cut back at this point and a small radius of curvature of the baffle was provided at the new outlet. The cylinder temperatures as measured

with the revised baffles with this modification are compared with the temperatures measured with the original baffles in figures 24 and 25. The temperature at nearly every point measured over the combustion chamber has been reduced with the new baffles; the only exception is that of a comparatively cool point located toward the front of the cylinder.

The cylinder flange and the rear center barrel temperatures showed reductions of about 10° to 15° ; whereas the front temperature of the barrel increased approximately 15° .

Several other modifications of the revised baffles were tested in an attempt to reduce further the temperature of the exhaust valve guide. It was found that, by cutting a small hole in the baffle to provide an outlet for air passing between the fins at the front of the rocker box and by increasing the gap between the baffle and the ends of the fins on the side of the cylinder as shown in figure 26, the temperature of the exhaust valve guide could be reduced about 5° .

The effect of the baffle modifications on the conductivity of the engine was not measured. It is expected that the conductivity of the engine will be slightly increased; however, for the condition with the cowling flaps open, it was found that the baffle changes did not affect the pressure drop across the engine. Because the present limit on engine cooling occurs as a result of insufficient available pressure drop and the limit is not fixed by the availability of a sufficient mass of cooling air flow, small changes to the conductivity of the engine are not believed to be important.

Based on the correlation of the engine temperatures and pressure drops by the methods of reference 3, it has been calculated that reducing the cylinder-head temperatures 50° will enable the pressure drop required for cooling to be reduced from 40 to 50 percent. Further, for the same pressure drop that is required with the original baffles, 15 to 20 percent more engine power may be cooled with the modified baffles.

CONCLUSIONS

1. The critical head temperatures of an air-cooled engine cylinder, as measured at the rear spark-plug gasket, were reduced as much as 50° F by baffle modifications that included:

- (a) Extending the baffles farther around the rear of the cylinder
- (b) Removing bottlenecks in the baffle passages
- (c) Enlarging the baffle inlet
- (d) Adding a diffuser with a well-rounded inlet to the rear of the baffles
- (e) Providing separate ducts to the rear of the cylinder

2. The temperatures measured with the modified baffles were reduced not only at the spark-plug bushing but over a considerable portion of the top and the rear of the cylinder head. The noncritical temperatures at the front of the head were slightly increased.

3. The barrel temperatures, as measured at the rear center of the barrel, were reduced slightly by the baffle modifications.

Langley Memorial Aeronautical Laboratory,
National Advisory Committee for Aeronautics,
Langley Field, Va.

REFERENCES

1. Schey, Oscar W., and Rollin, Vern G.: The Effect of Baffles on the Temperature Distribution and Heat-Transfer Coefficients of Finned Cylinders. Rep. No. 511, NACA, 1934.
2. Brevoort, M. J., and Joyner, U. T.: The Problem of Cooling an Air-Cooled Cylinder on an Aircraft Engine. Rep. No. 719, NACA, 1941.
3. Pinkel, Benjamin: Heat-Transfer Processes in Air-Cooled Engine Cylinders. Rep. No. 612, NACA, 1938.

L-767

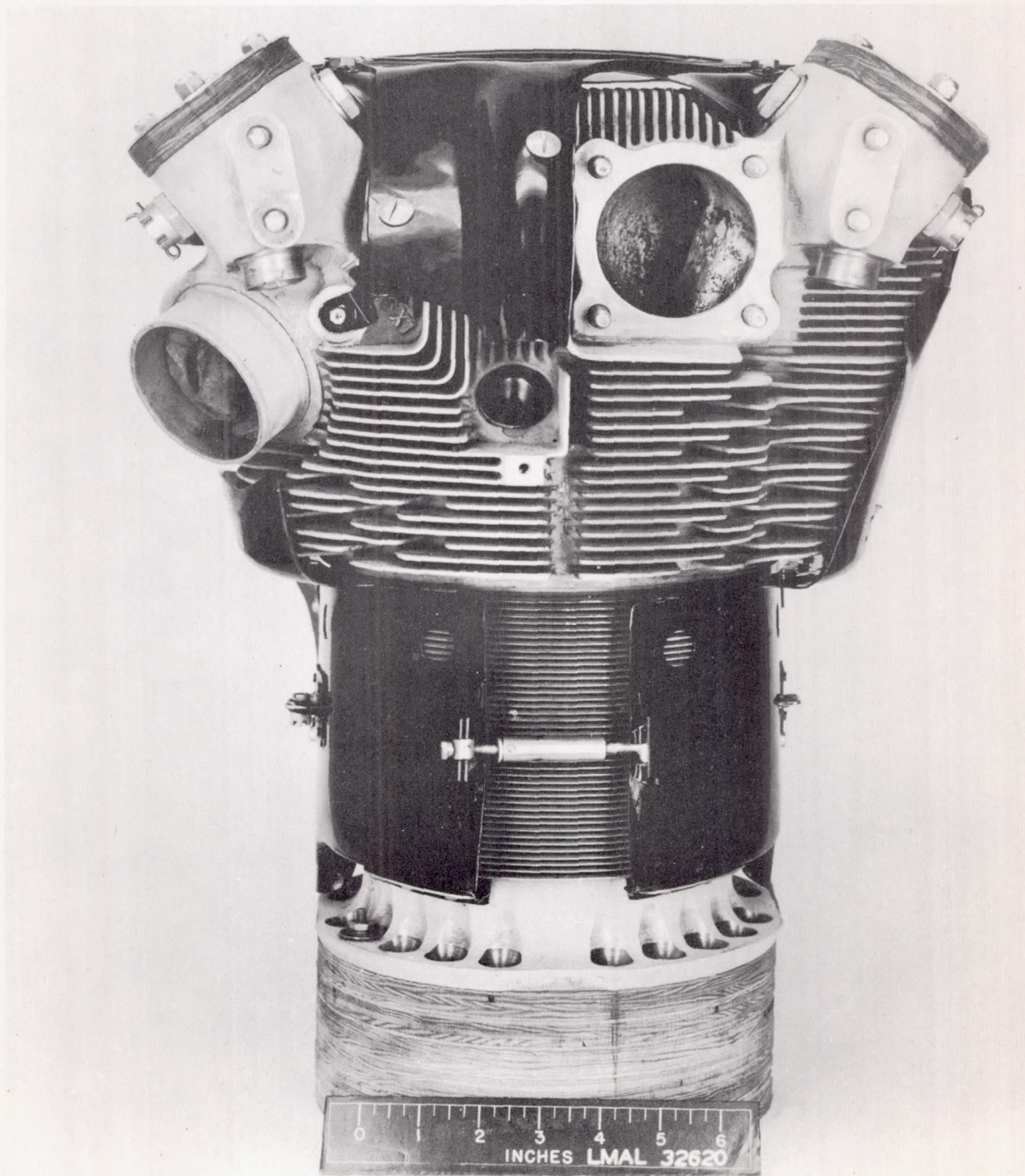

Figure 1.- Rear view of an air-cooled cylinder showing lack of baffling over rear of cylinder.

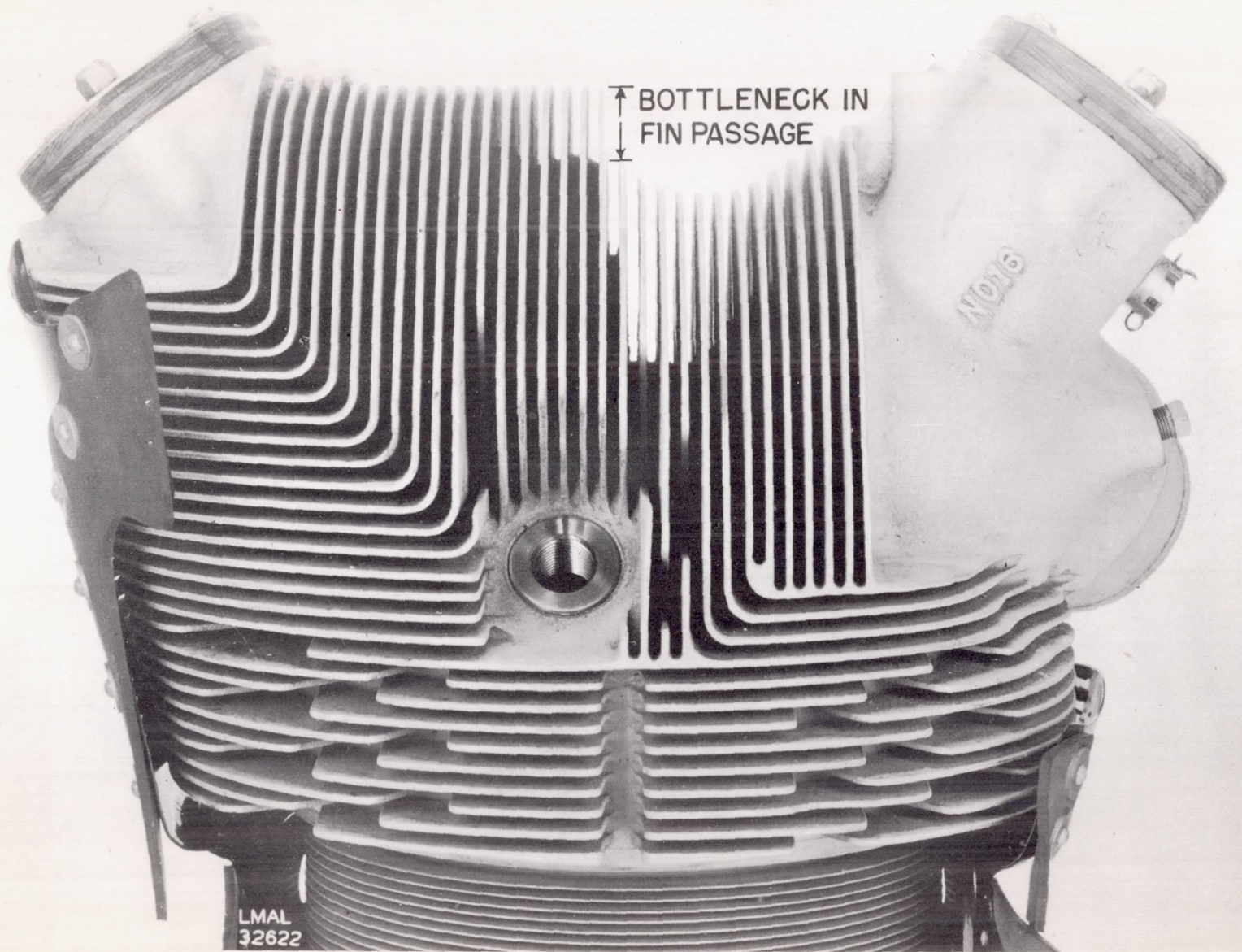
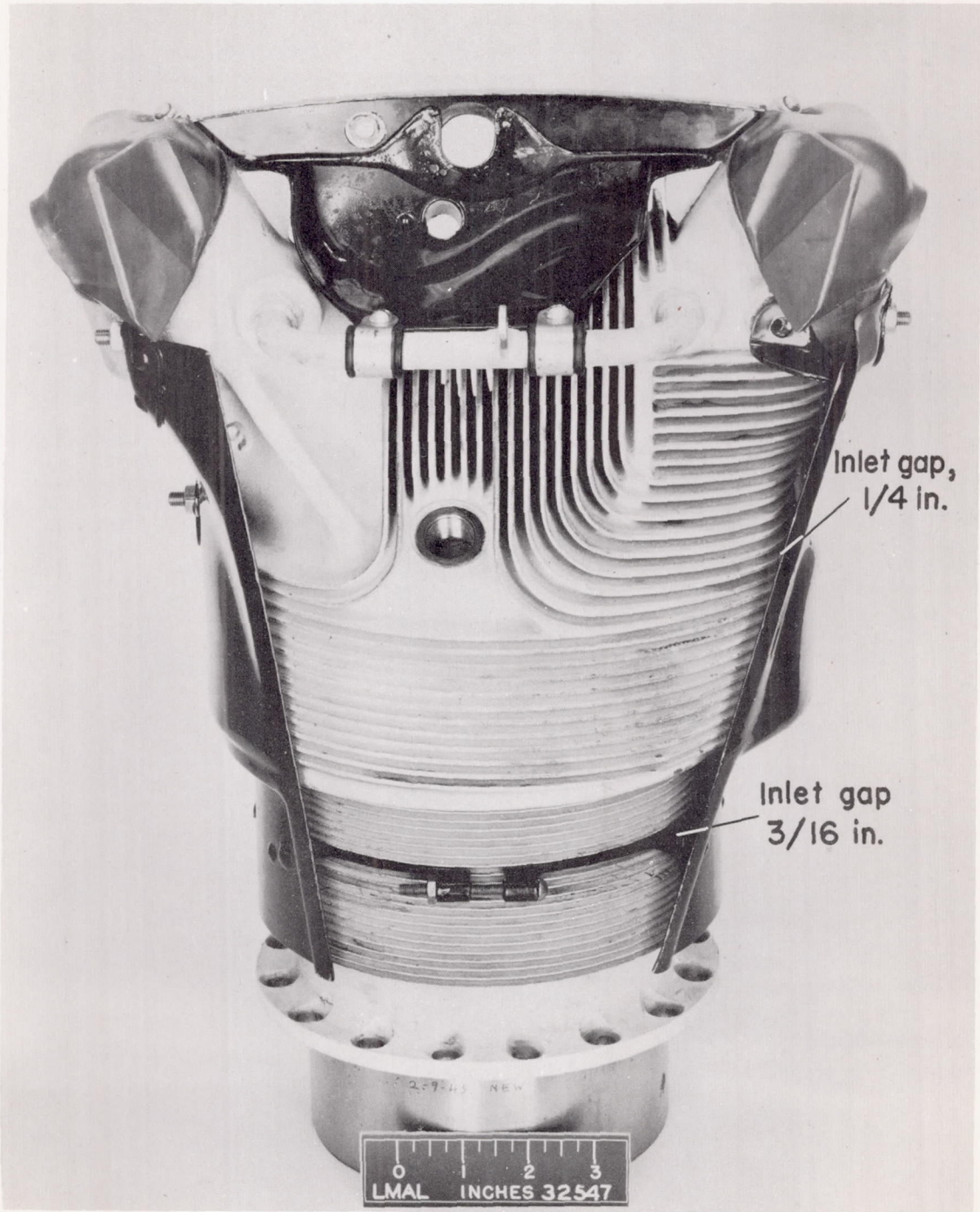
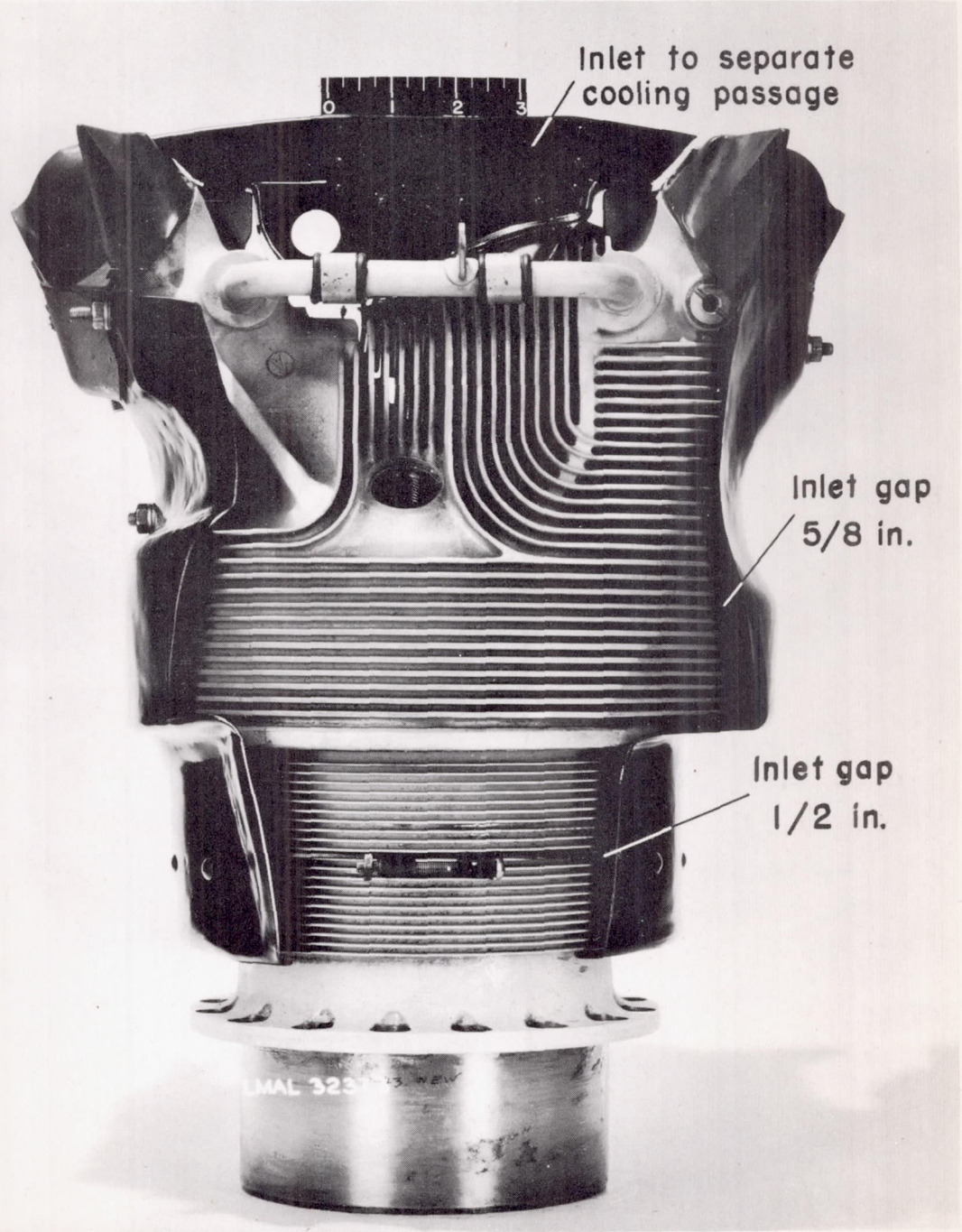

Figure 2.- Front view of an air-cooled cylinder head showing bottleneck in fin passage.



(a) Original baffle.

Figure 3.- Comparison of original and revised baffles. Front view.



(b) Revised baffle.

Figure 3.- Concluded.



Figure 4.- Ground test setup of Pratt & Whitney R-1830-43 engine in the Consolidated B-24D engine nacelle.

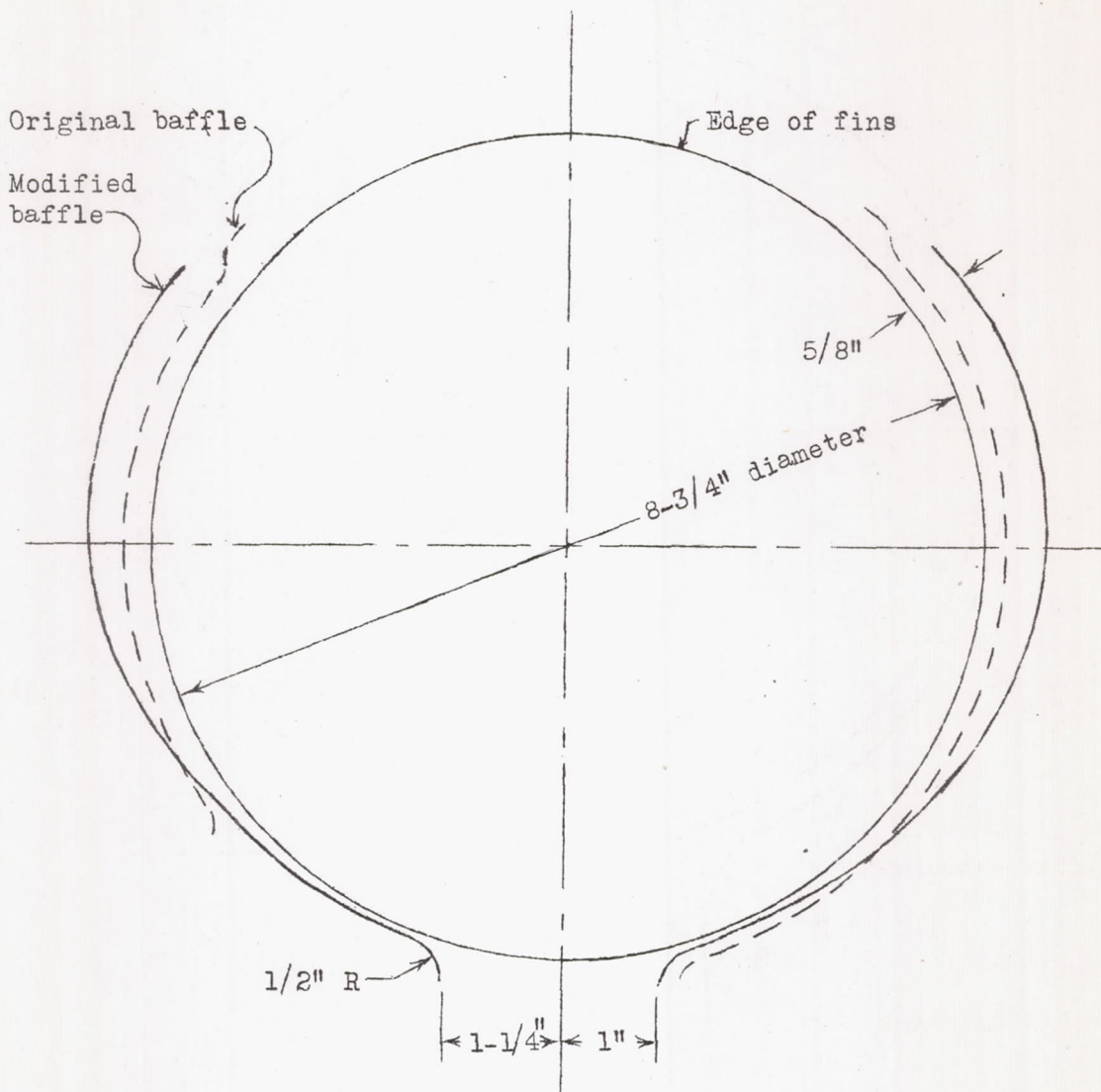

Figure 5.- Partially modified baffle tested on cylinder 3. Baffle inlet enlarged and baffle continued farther to rear of cylinder.

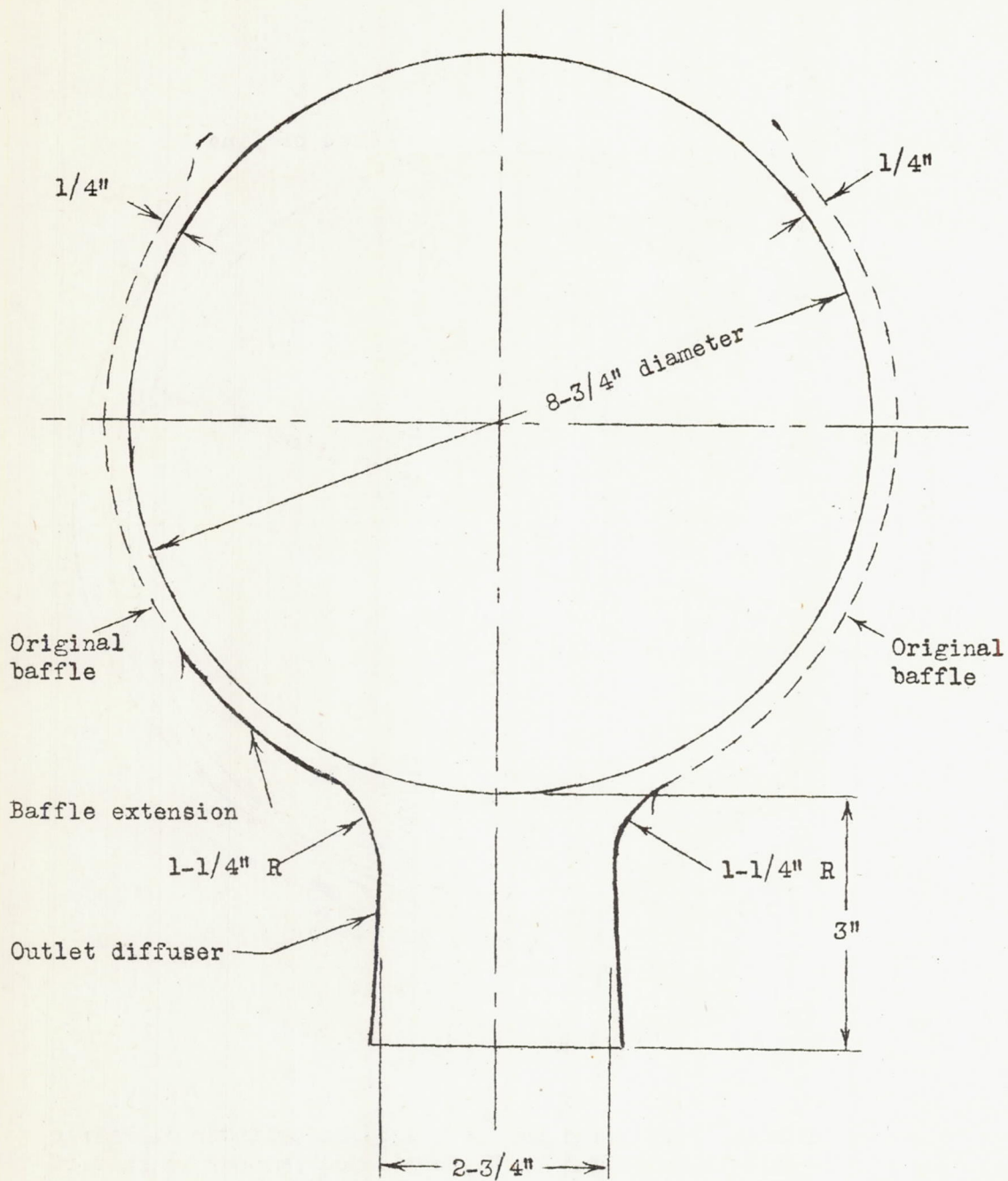
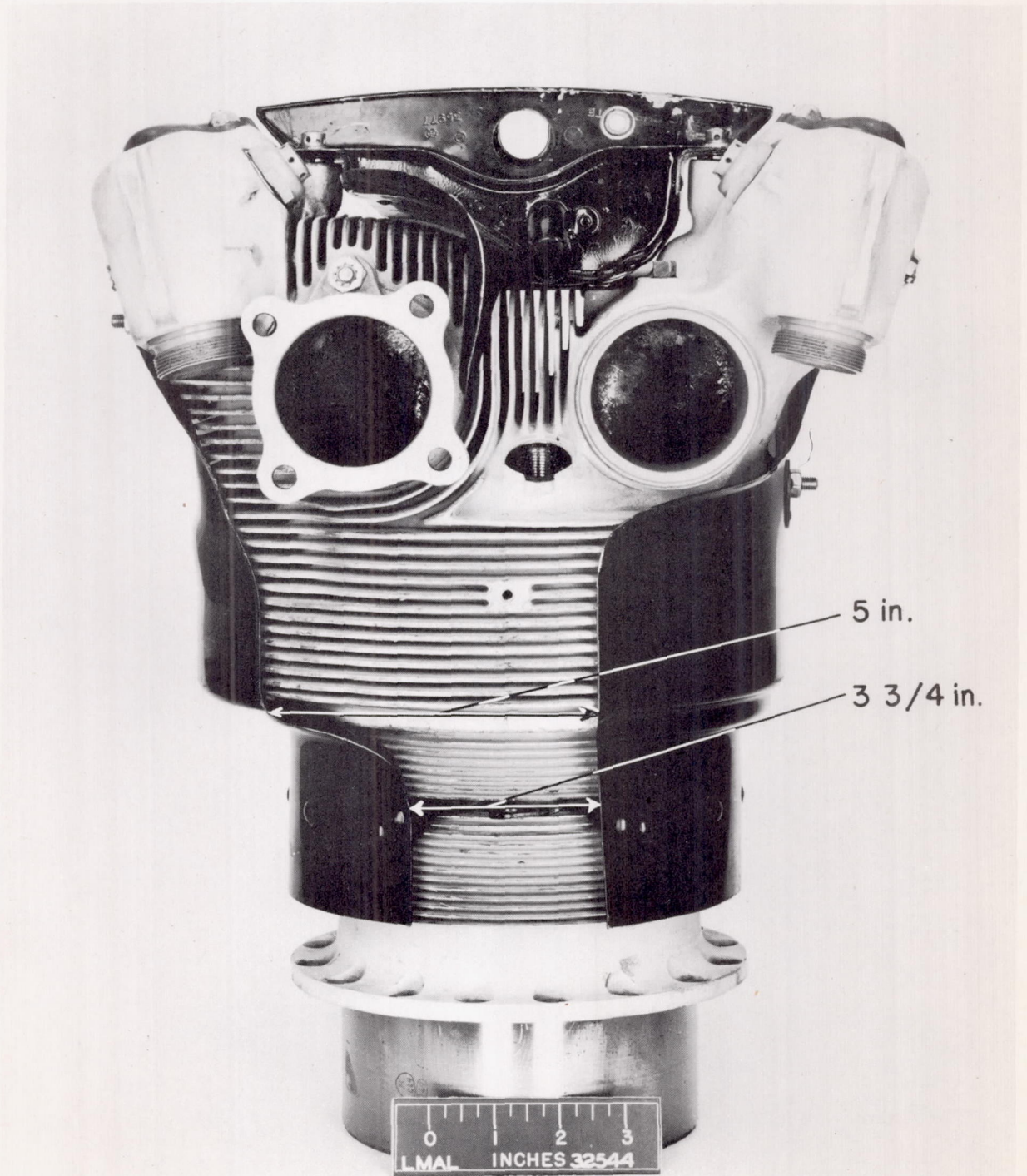

Figure 6.- Baffle extension and outlet diffuser tested on cylinder 1.

U-107



(a) Original baffle.

Figure 7.- Comparison of original and revised baffles. Rear view.

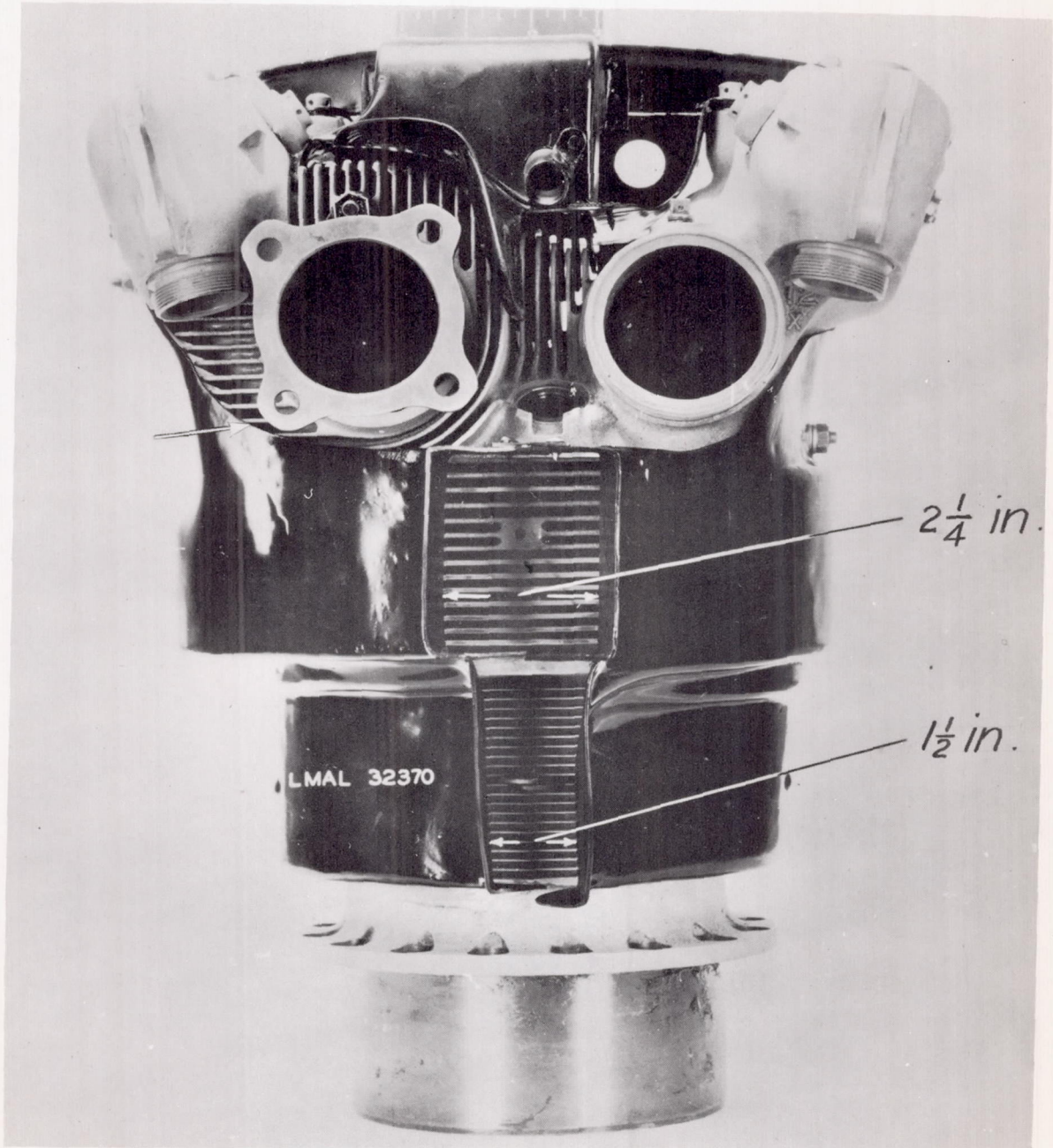

(b) Revised baffle. Arrow points to restriction at baffle outlet.

Figure 7.- Concluded.

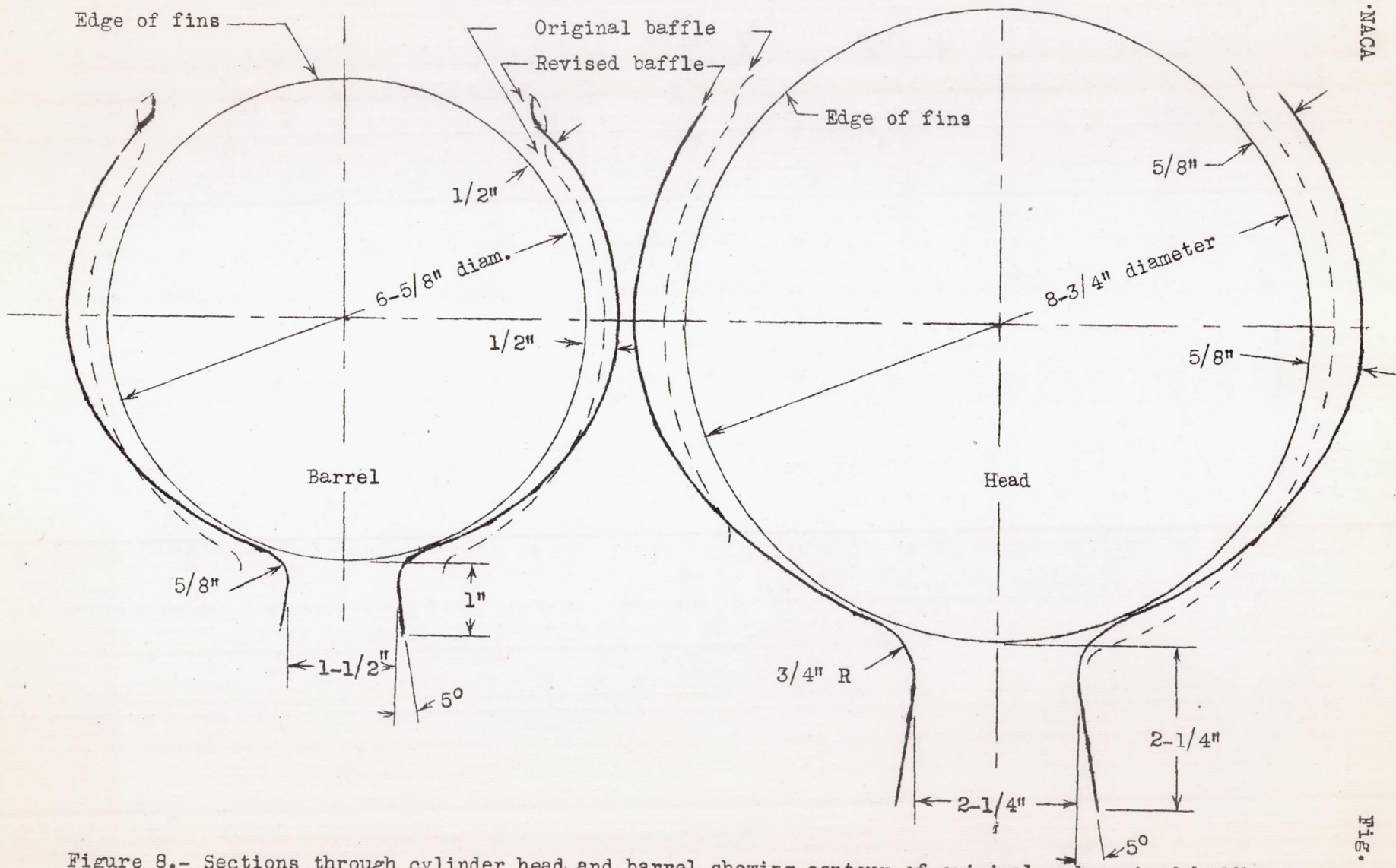
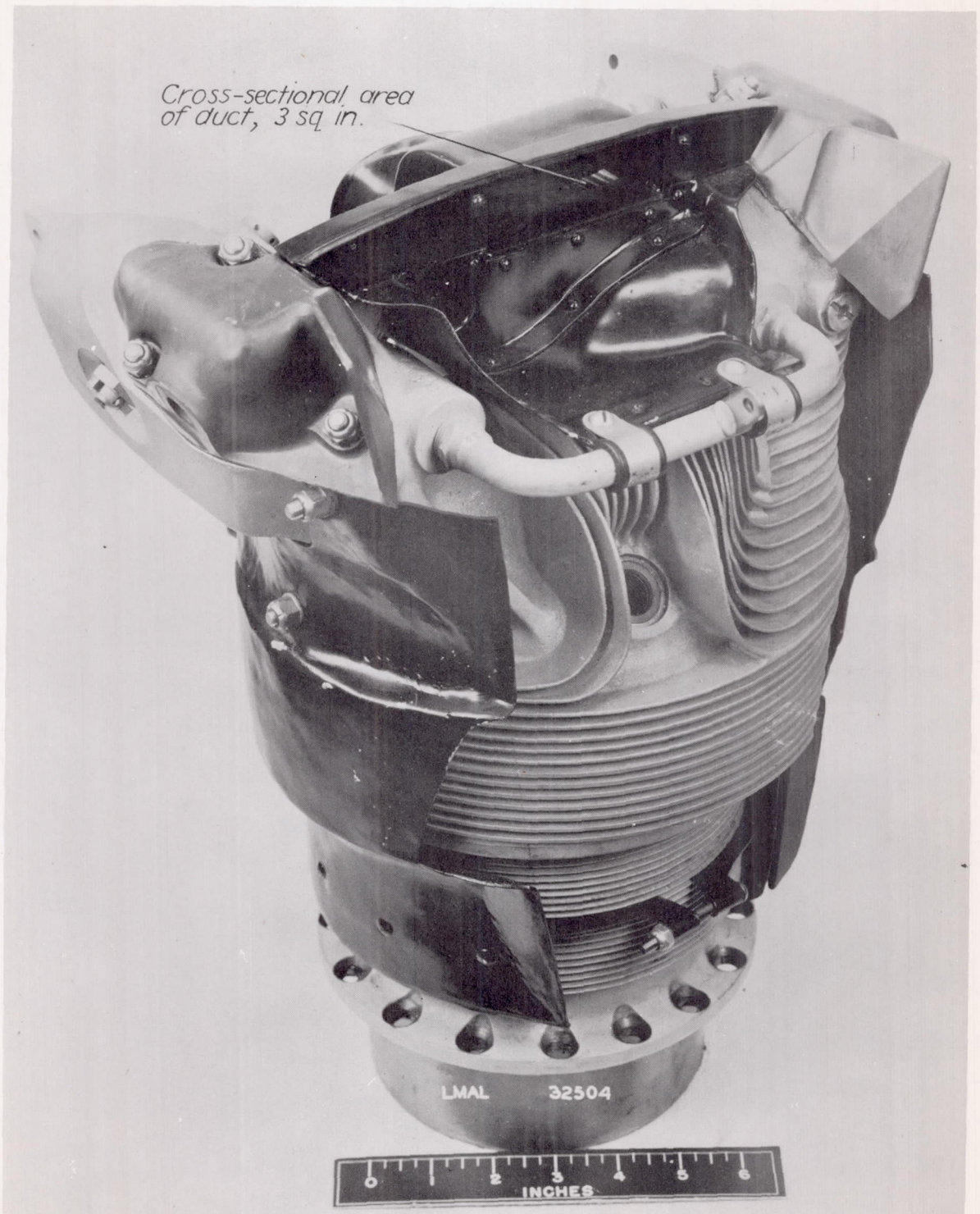

Figure 8.- Sections through cylinder head and barrel showing contour of original and revised baffles tested on rear cylinders.

L-767



*Cross-sectional area
of duct, 3 sq in.*

LMAL 32504



(a) Three-quarter front view.

Figure 9.- Revised baffles as installed on rear cylinder of Pratt & Whitney R-1830-43 engine.

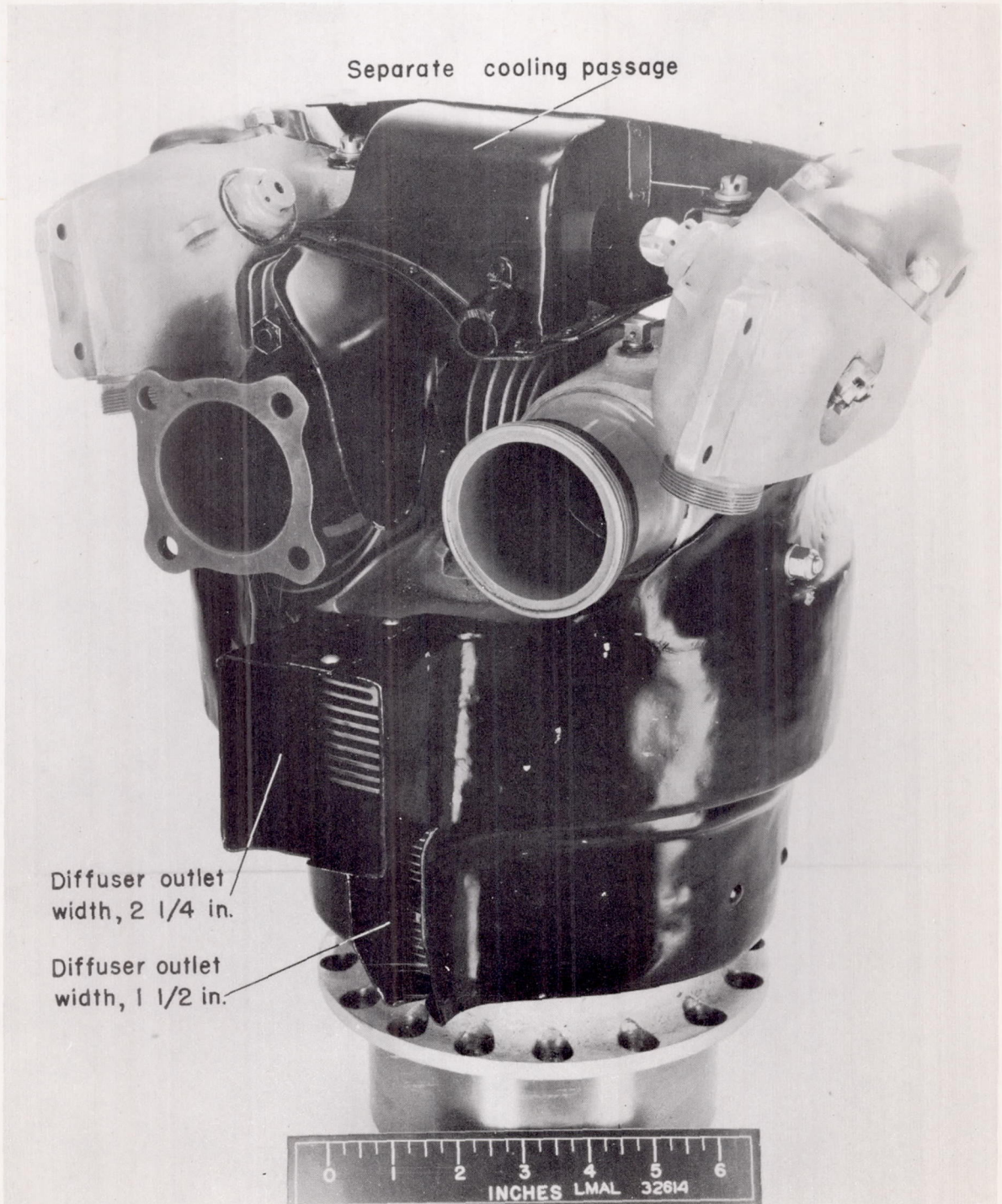

(b) Three-quarter rear view.

Figure 9.- Concluded.

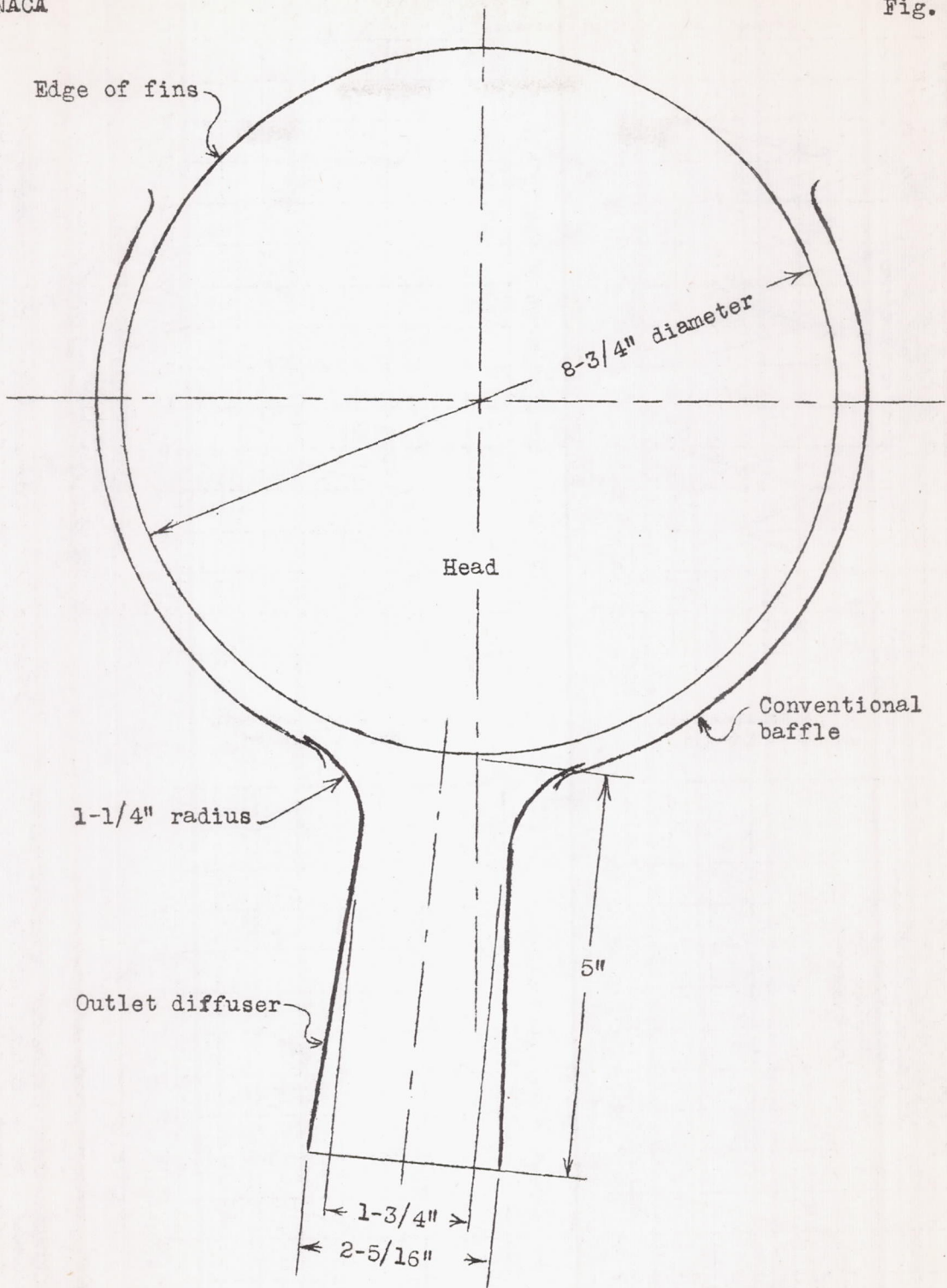
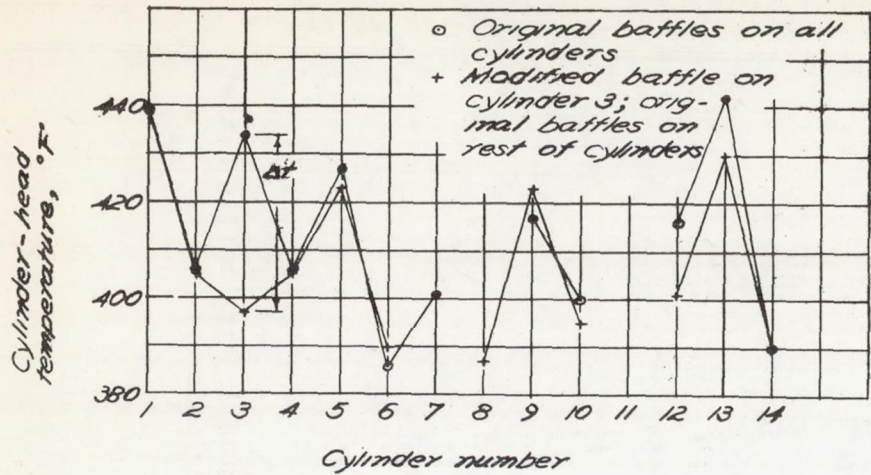
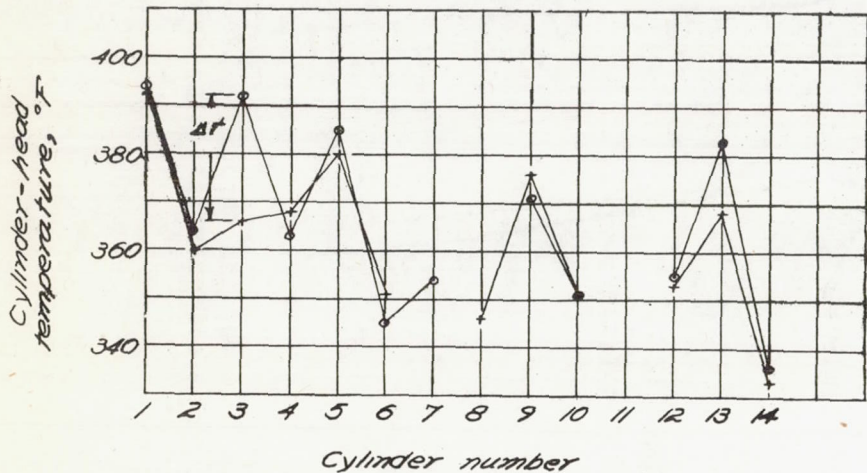

Figure 10.- Section through cylinder head showing baffle outlet diffuser tested on front cylinders.

L-767



(a) 60 percent normal power.



(b) 89 percent normal power.

Figure 11.- Comparison of head temperatures with original and modified baffle on cylinder 3. Modified baffle having enlarged inlet and extending farther to rear of cylinder.

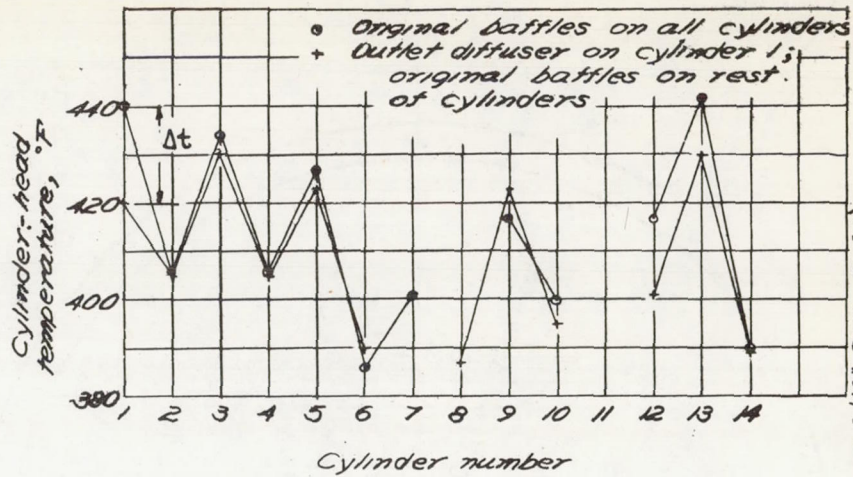

(a) 60 percent normal power.

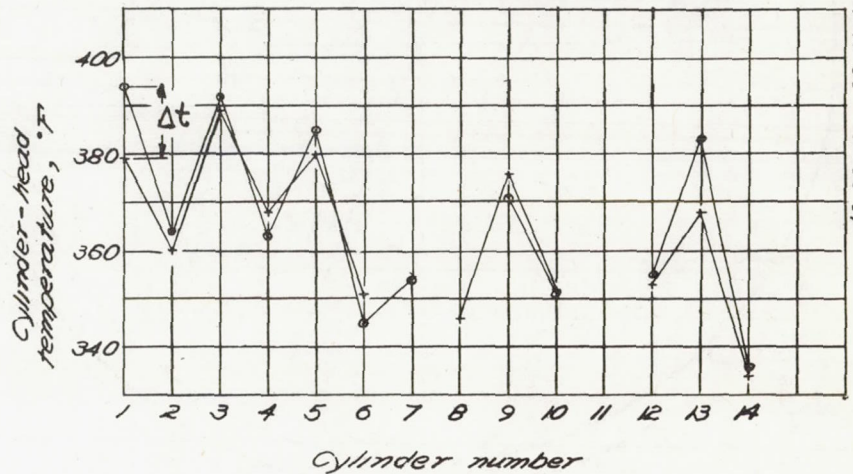

(b) 89 percent normal power.

Figure 12.- Comparison of cylinder-head temperatures with and without outlet diffuser on cylinder 1.

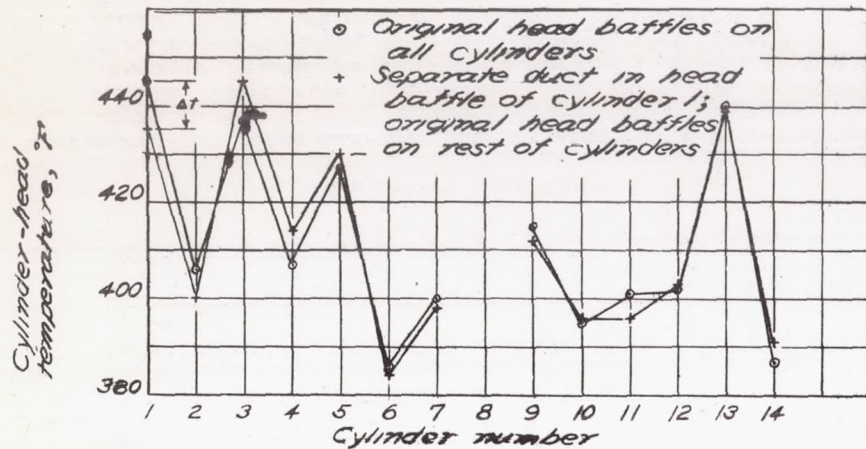

(a) 59 percent normal power.

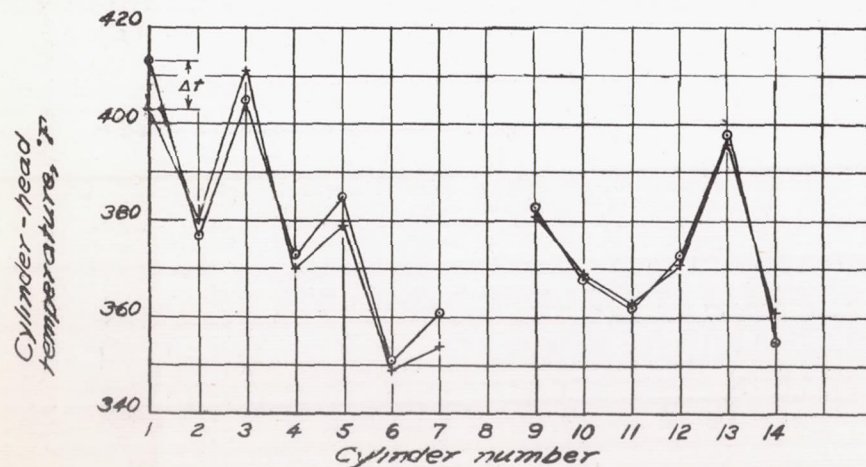

(b) 100 percent normal power.

Figure 13.- Comparison of cylinder-head temperatures with original head baffles on all cylinders and with separate duct in head baffle of cylinder 1.

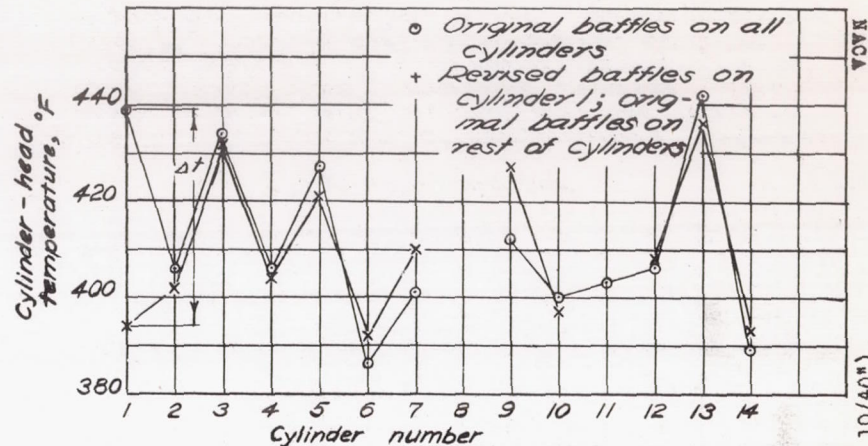

(a) 59 percent normal power.

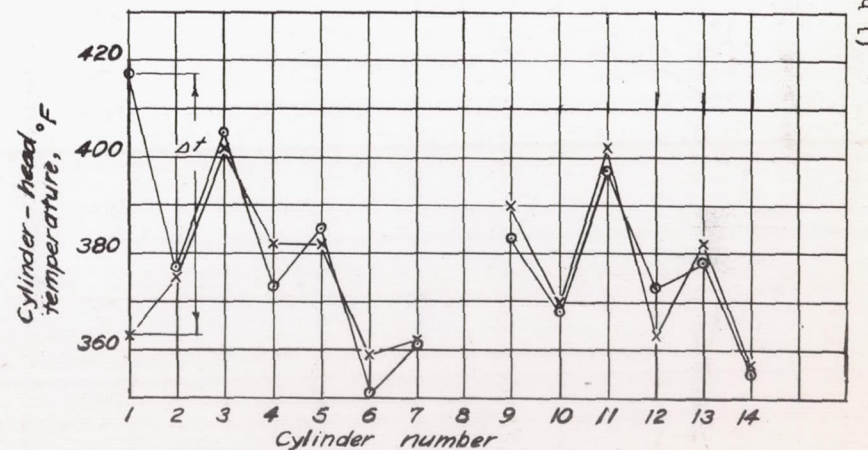

(b) 99 percent normal power.

Figure 14.- Comparison of head temperatures with original and revised baffles on cylinder 1; rest of cylinders with original baffles.

NOV

(1 block = 10/40")

FIGS. 13, 14

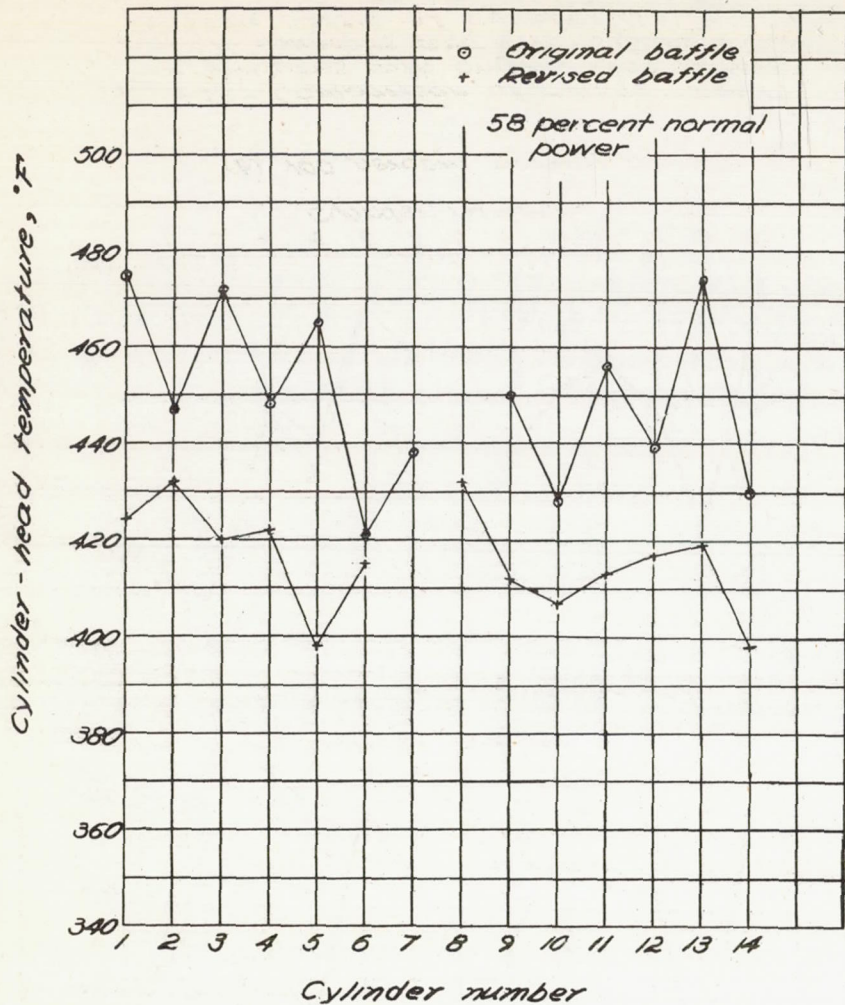

Figure 15.- Comparison of temperature patterns with original and revised baffles. Engine speed, 2150 rpm; manifold pressure, 29.5 inches mercury; carburetor temperature, 78°F; cooling-air temperature, 64°F; engine fuel-air ratio, 0.071; average cooling pressure drop σ_{Ap} , 3.41 inches water.

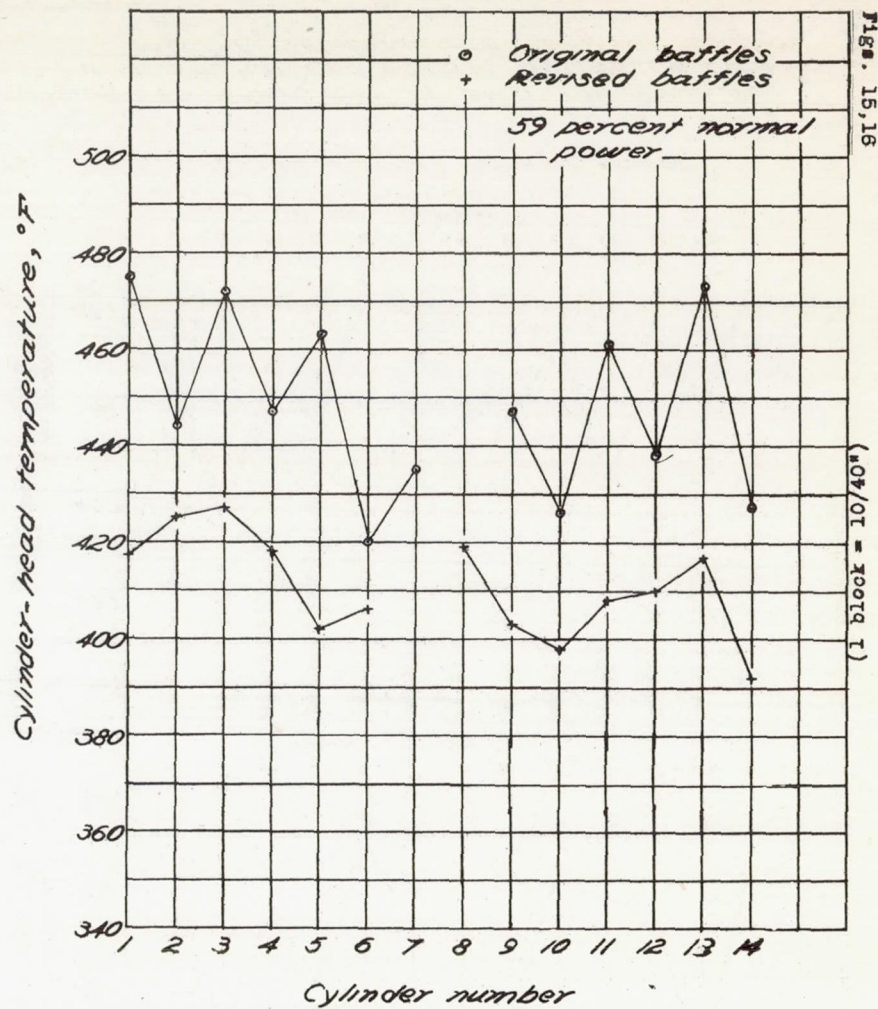

Figure 16.- Comparison of temperature patterns with original and revised baffles. Engine speed, 2250 rpm; manifold pressure, 28.0 inches mercury; carburetor temperature, 80.0°F; cooling-air temperature, 65.0°F; engine fuel-air ratio, 0.072; average cooling pressure drop σ_{Ap} , 3.41 inches water.

Fig. 15, 16

(1 block = 10/40°)

NOVA

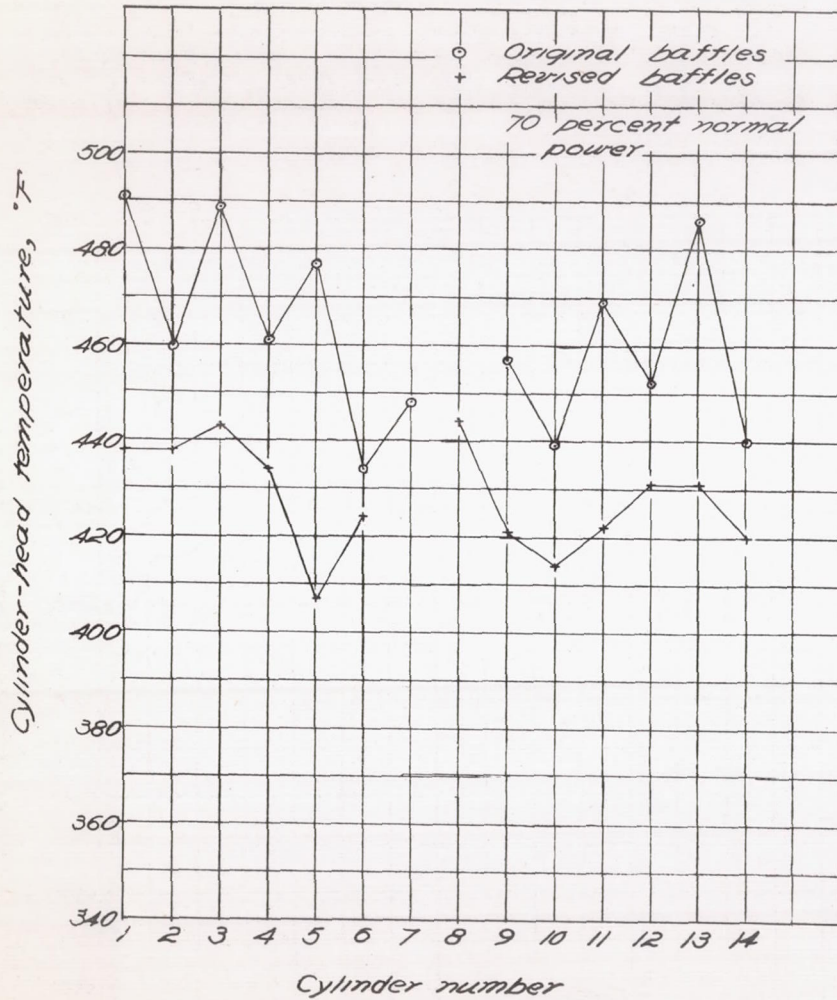

Figure 17.- Comparison of temperature patterns with original and revised baffles. Engine speed, 2250 rpm; manifold pressure, 32.0 inches mercury; carburetor temperature, 79.0 °F; cooling-air temperature, 64.0 °F; engine fuel-air ratio, 0.075; average cooling pressure drop σ_{dp} , 3.57 inches water.

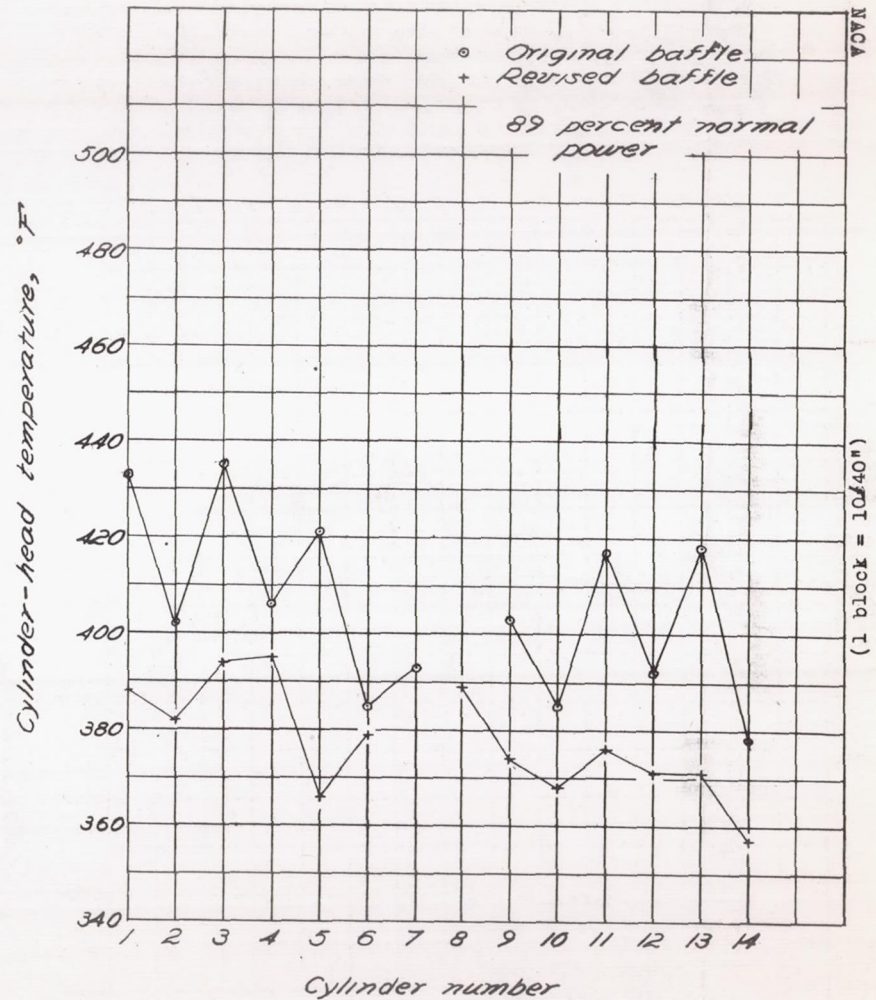

Figure 18.- Comparison of temperature patterns with original and revised baffles. Engine speed, 2550 rpm; manifold pressure, 36.0 inches mercury; carburetor temperature, 80.0 °F; cooling-air temperature, 64.0 °F; engine fuel-air ratio, 0.108; average cooling pressure drop σ_{dp} , 3.57 inches water.

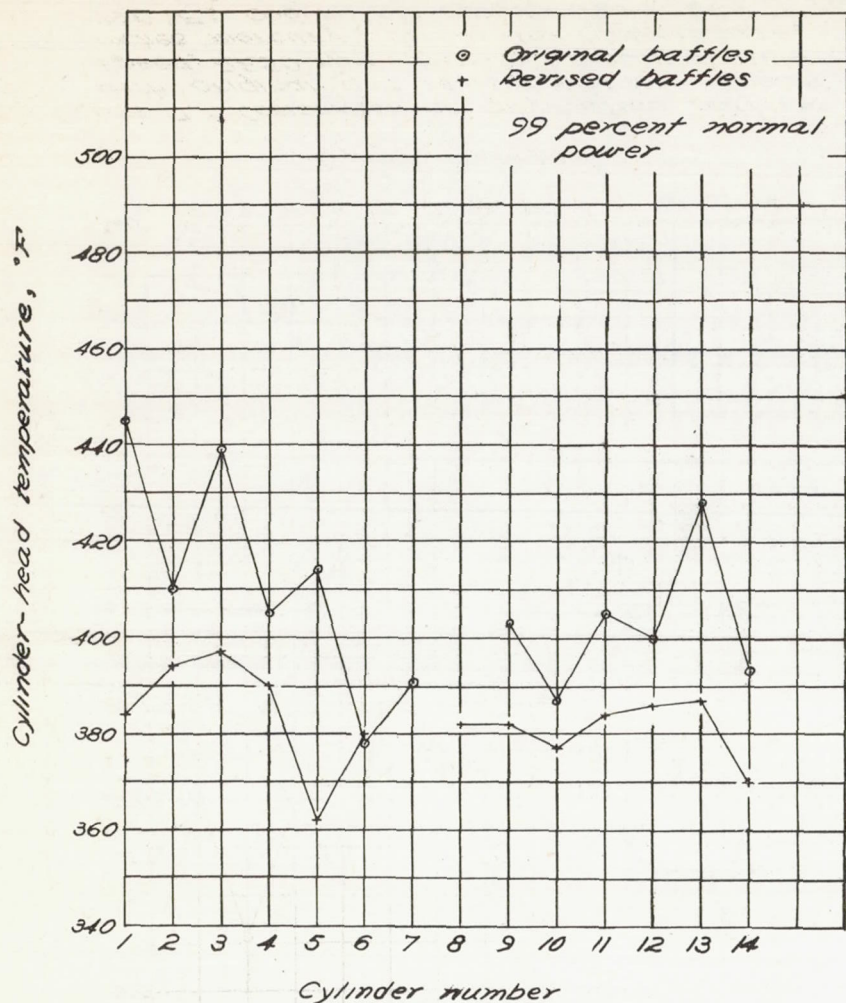

Figure 19.- Comparison of temperature patterns with original and revised baffles. Engine speed, 2550 rpm; manifold pressure, 39.5 inches mercury; carburetor temperature, 90.0 °F; cooling-air temperature, 76.0 °F; engine fuel-air ratio, 0.105; average cooling pressure drop Δp , 4.51 inches water.

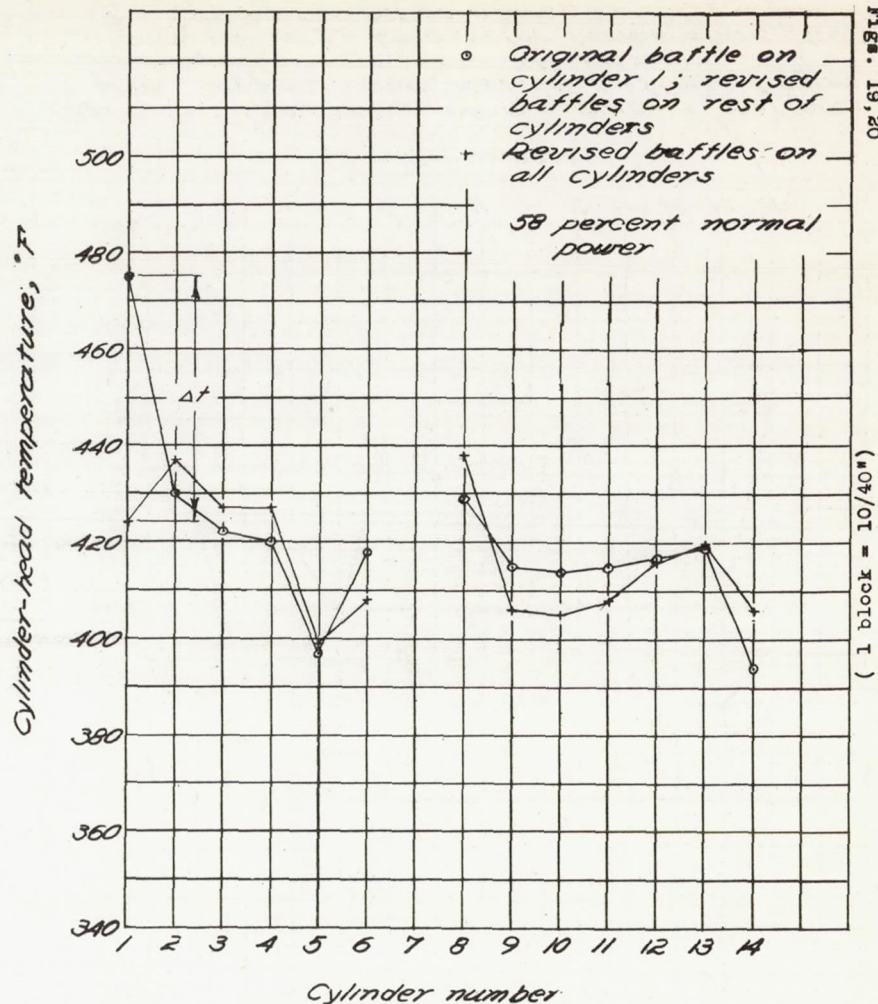

Figure 20.- Comparison of head temperatures with original and revised baffle on cylinder 1; rest of cylinders with revised baffles. Engine speed, 2150 rpm; manifold pressure, 29.5 inches mercury; carburetor temperature, 78 °F; cooling-air temperature, 64 °F; engine fuel-air ratio, 0.071; average cooling pressure drop Δp , 3.41 inches water.

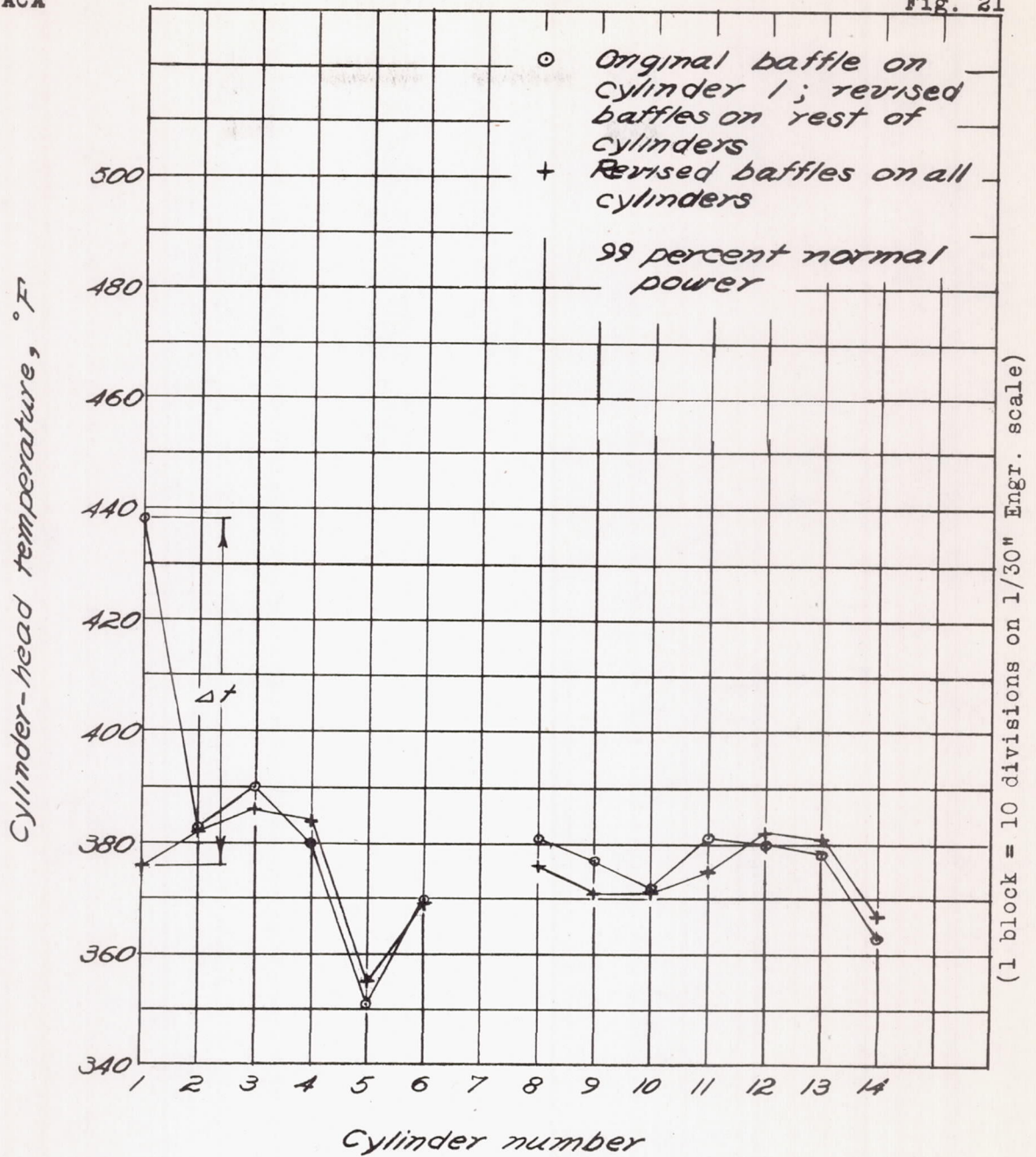
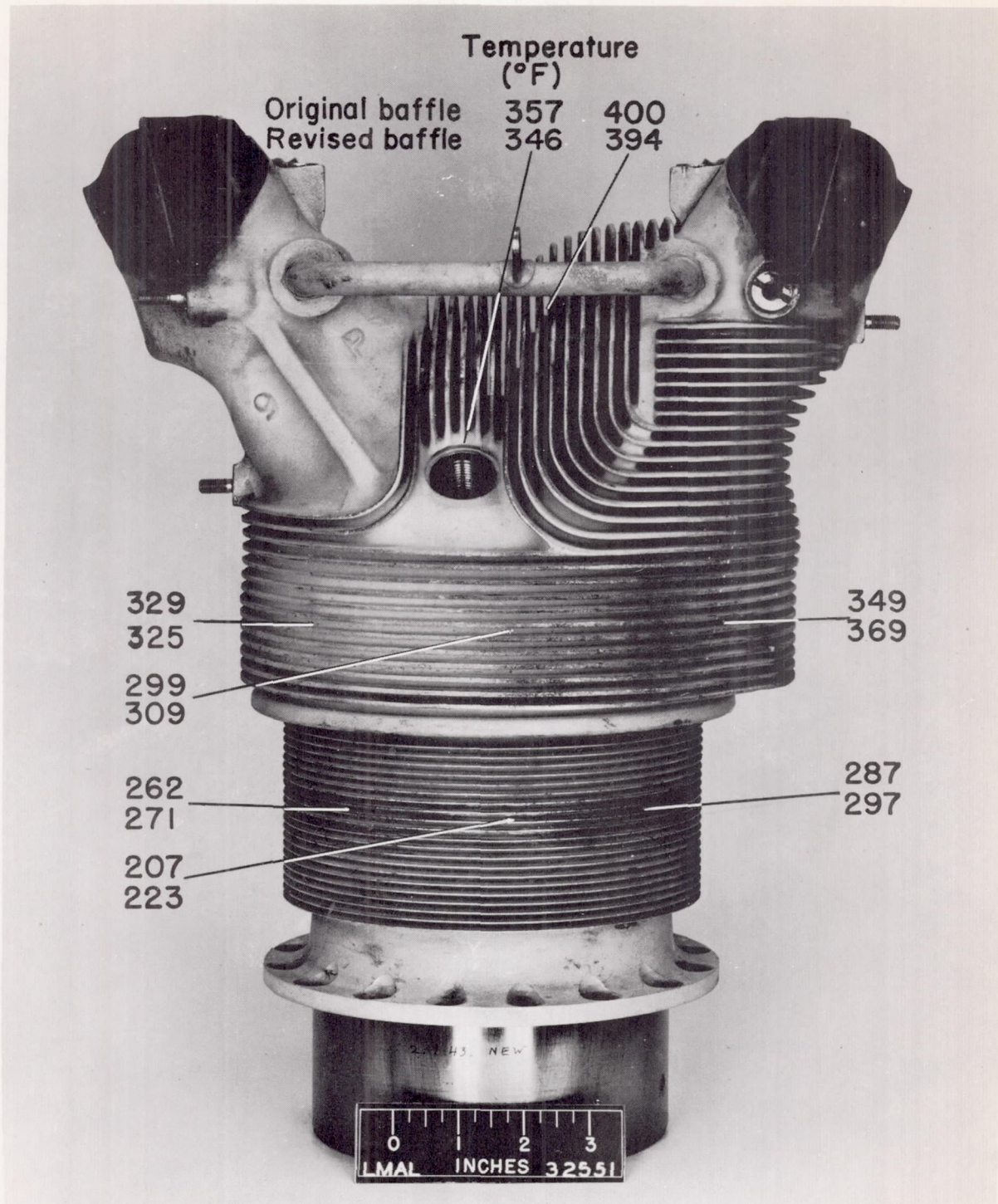

Figure 21.- Comparison of head temperatures with original and revised baffle on cylinder 1; rest of cylinders with revised baffles. Engine speed, 2550 rpm; manifold pressure, 39.5 inches mercury; carburetor temperature, 90.0 °F; cooling-air temperature, 76.0 °F; engine fuel-air ratio, 0.105; average cooling pressure drop $\sigma\Delta p$, 4.51 inches water.



(a) Front view.

Figure 22.- Temperature on cylinder 1 with original and revised baffles (with small restriction on exhaust side of cylinder as shown in fig. 7(b)). Engine speed, 2250 rpm; manifold pressure, 28.0 inches mercury; carburetor temperature, 80.0° F; cooling-air temperature, 65.0° F; engine fuel-air ratio, 0.072; average cooling pressure drop $\sigma\Delta p$, 3.41 inches water.

L-767

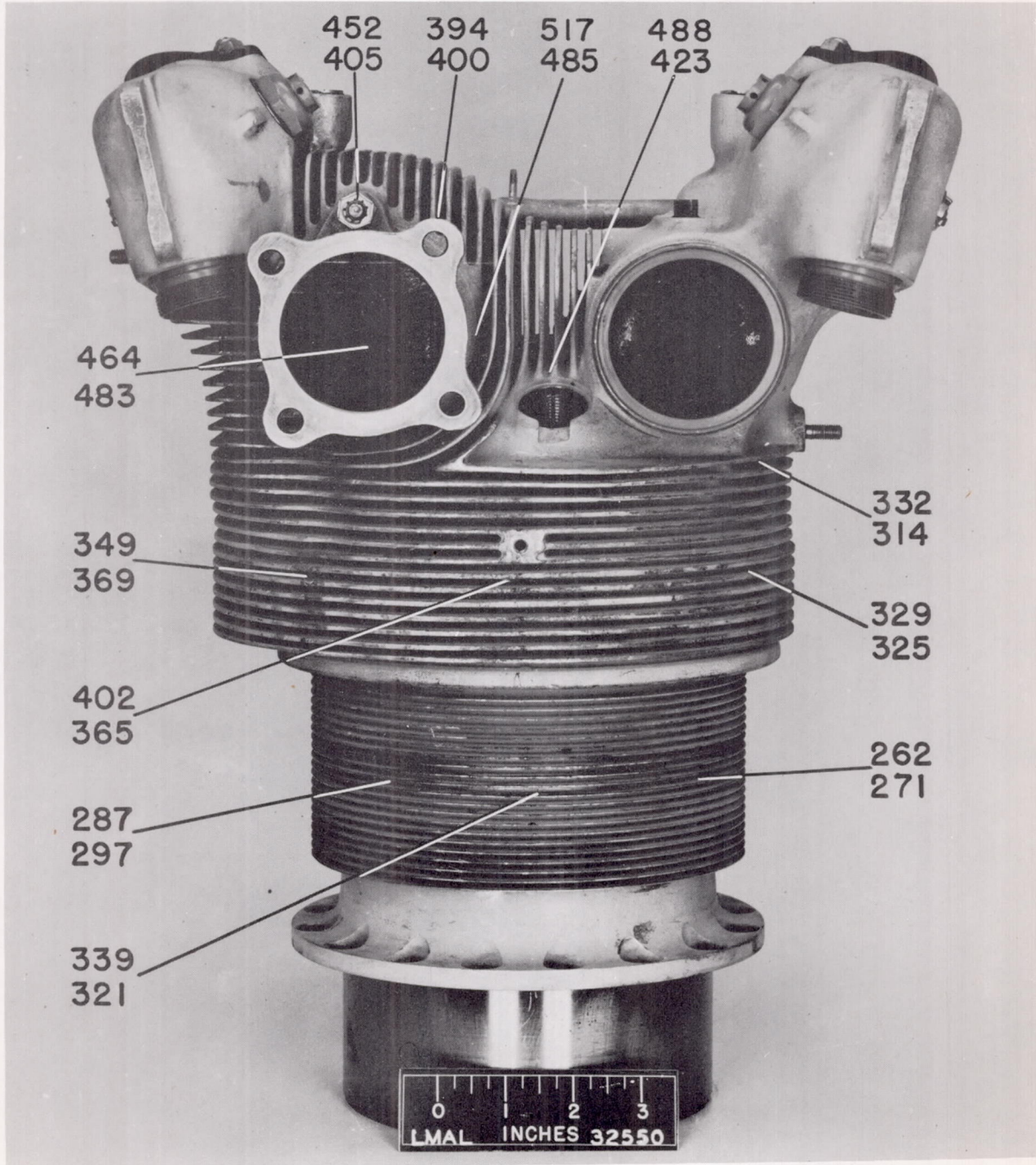

(b) Rear view.

Figure 22.- Concluded.

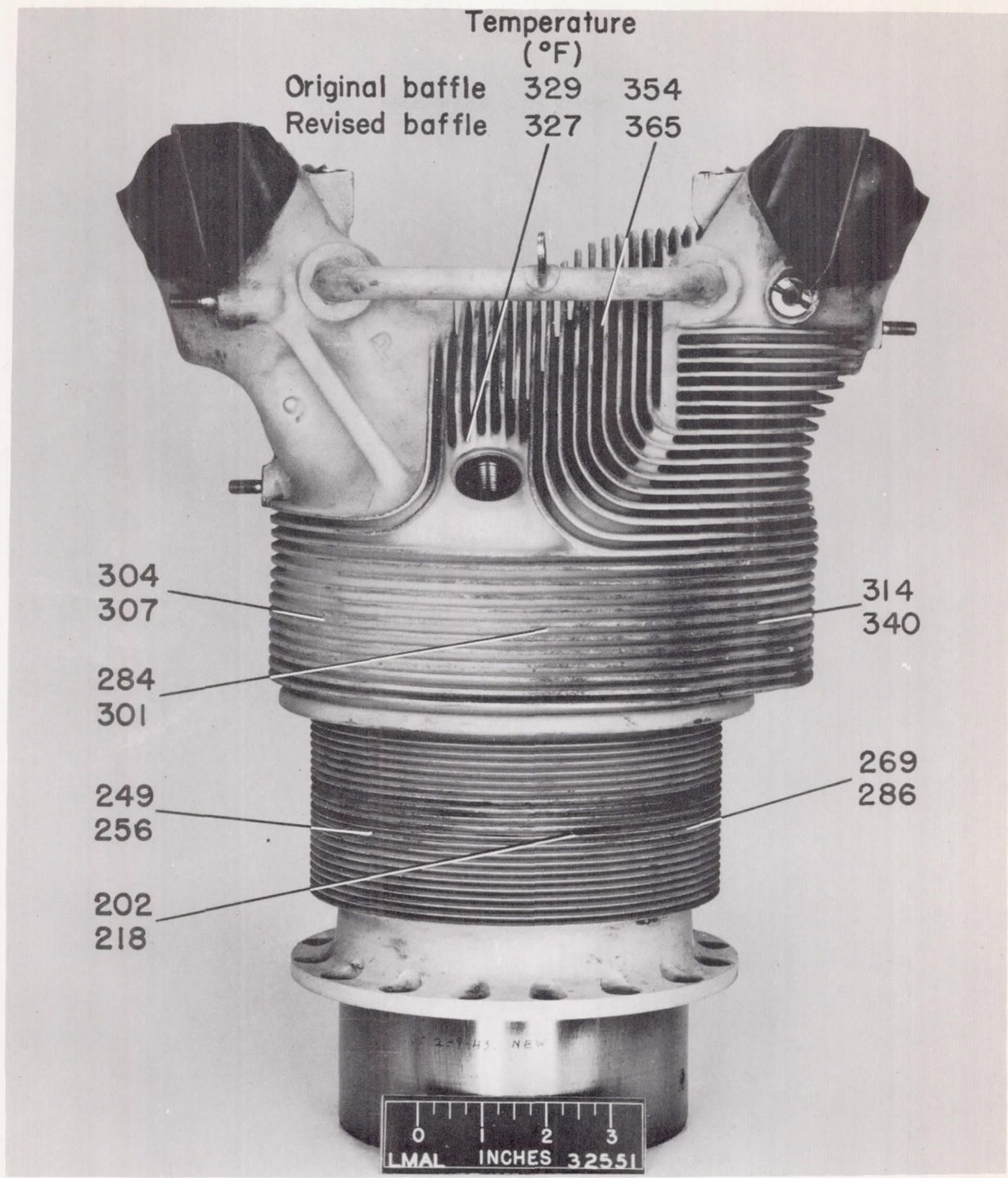

(a) Front view.

Figure 23.- Temperature on cylinder 1 with original and revised baffles (with small restriction on exhaust side of cylinder as shown in fig. 7(b)). Engine speed, 2550 rpm; manifold pressure, 39.5 inches mercury; carburetor temperature, 90.0° F; cooling-air temperature, 76.0° F; engine fuel-air ratio, 0.105; average cooling pressure drop $\sigma\Delta p$, 4.51 inches water.

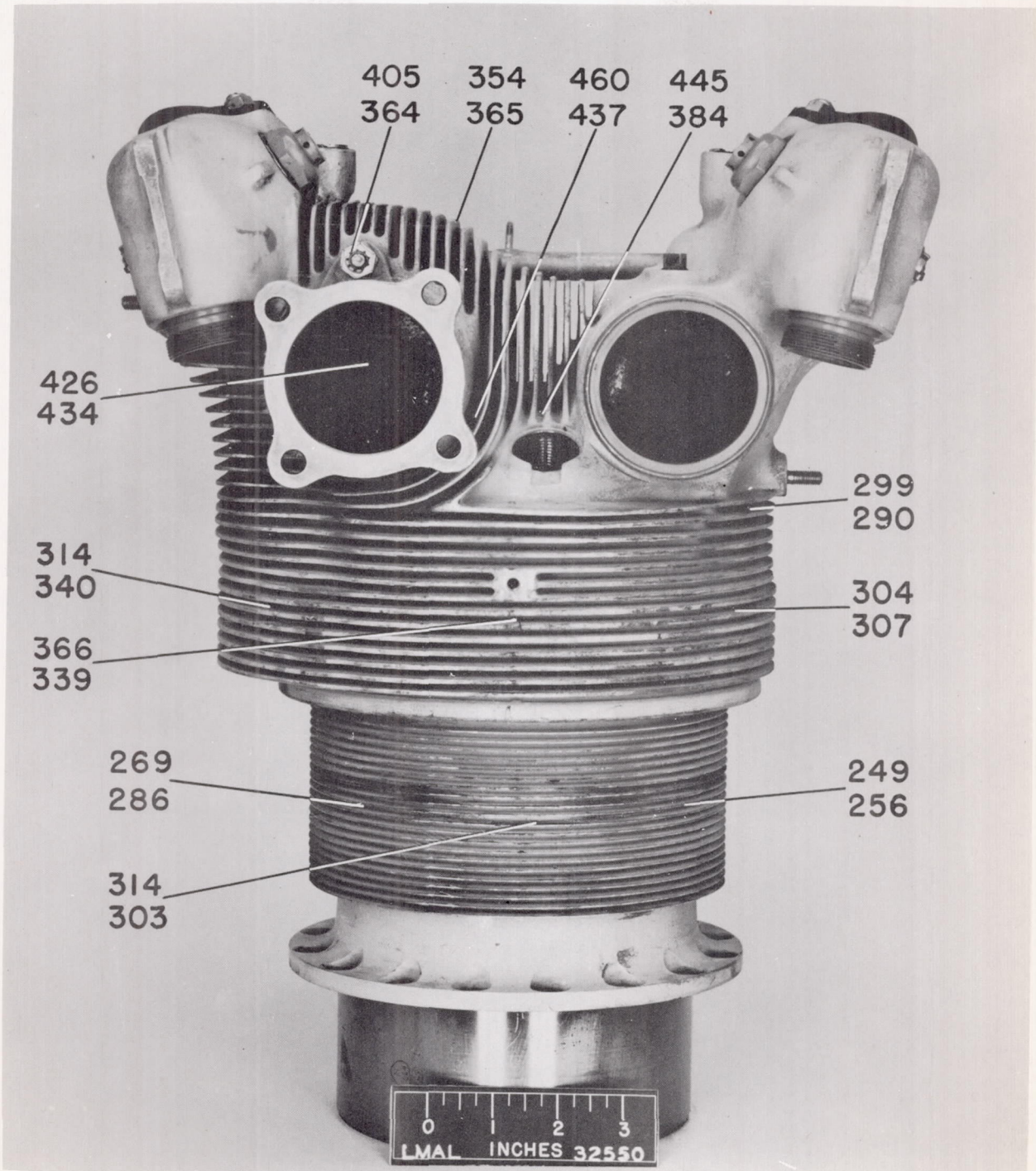

(b) Rear view.

Figure 23.- Concluded.

L-767

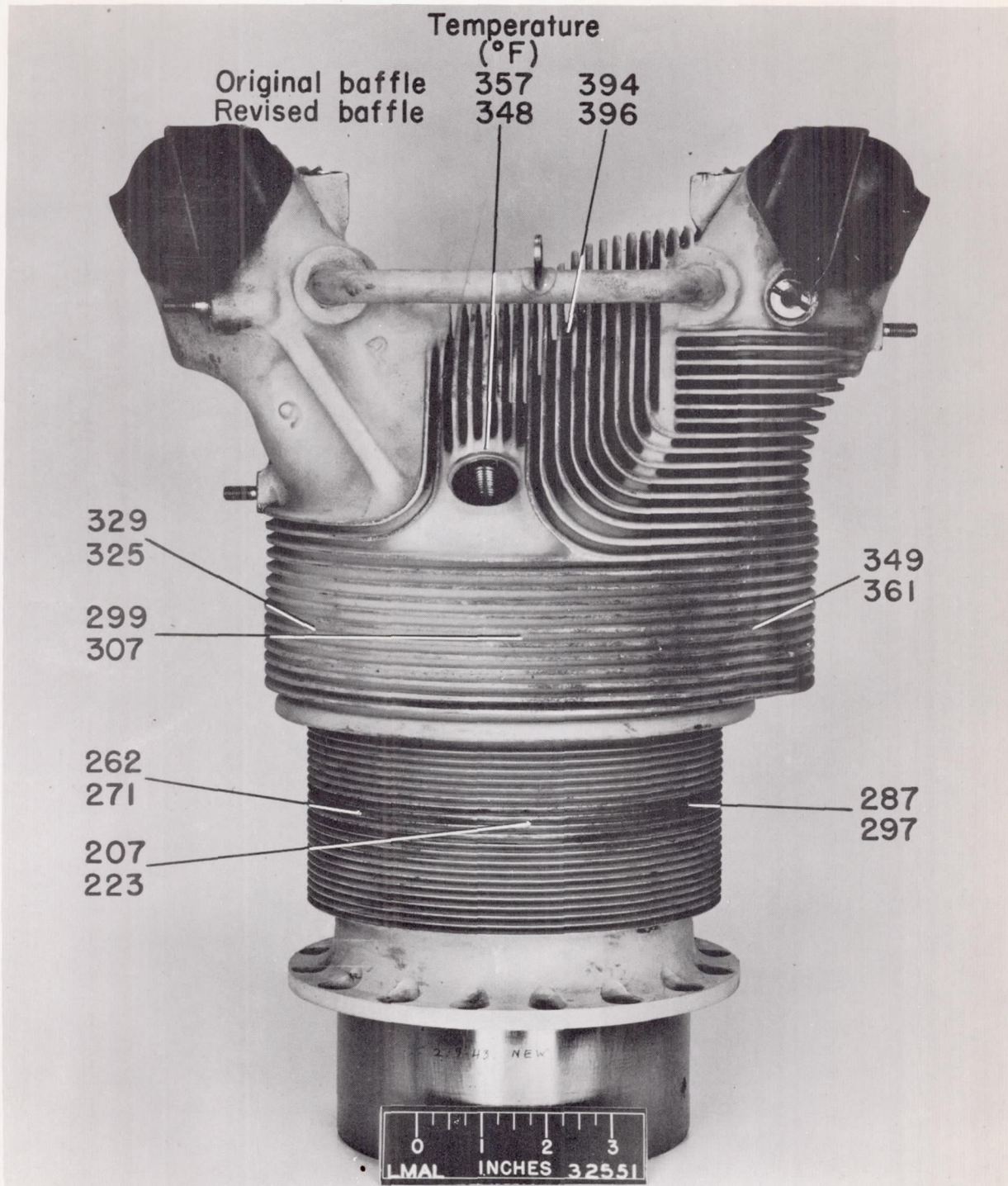

(a) Front view.

Figure 24.- Temperature on cylinder 1 with original and revised baffles. Engine speed, 2250 rpm; manifold pressure, 28.0 inches mercury; carburetor temperature, 80.0° F; cooling-air temperature, 65.0° F; engine fuel-air ratio, 0.072; average cooling pressure drop $\sigma\Delta p$, 3.41 inches water.

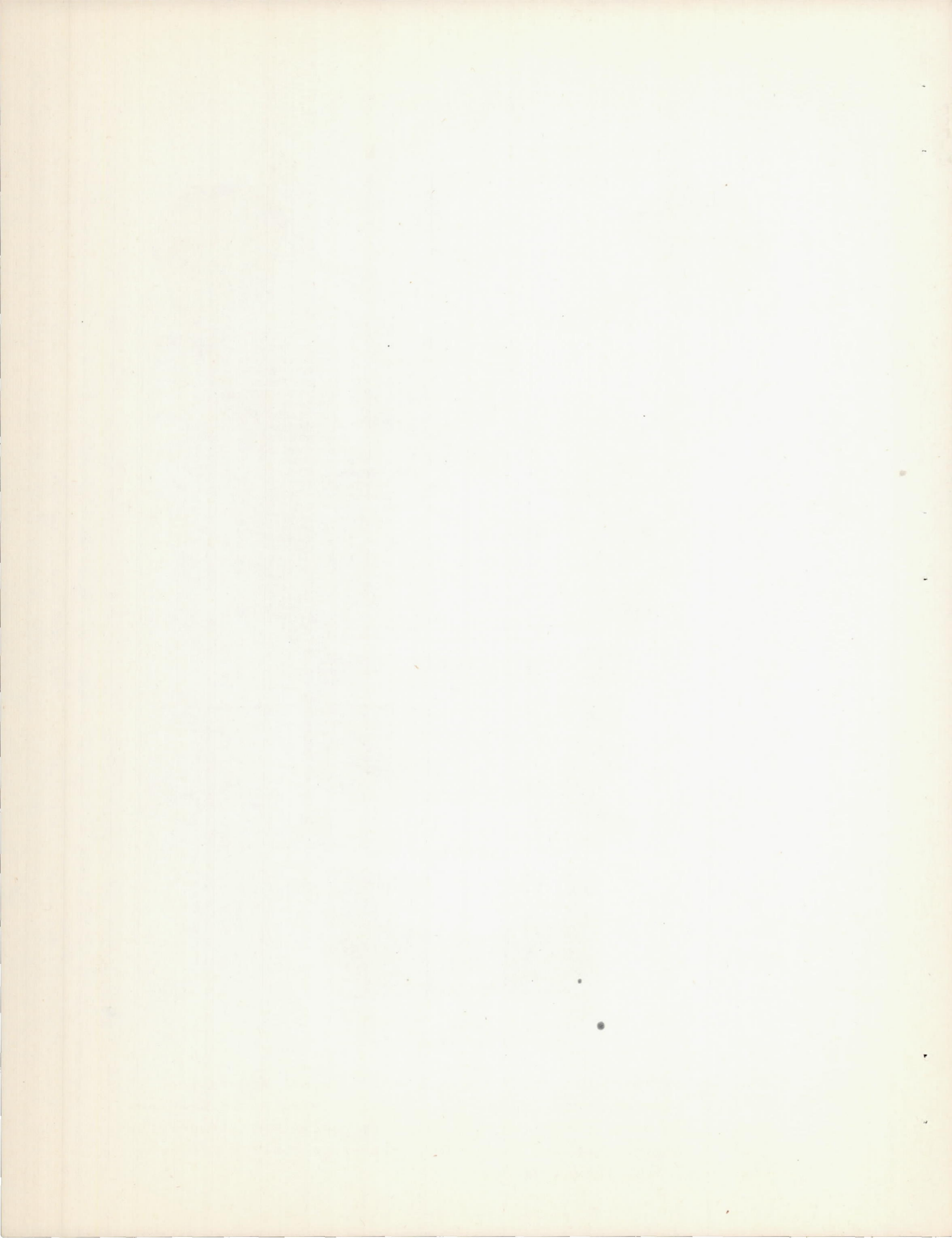

L-767

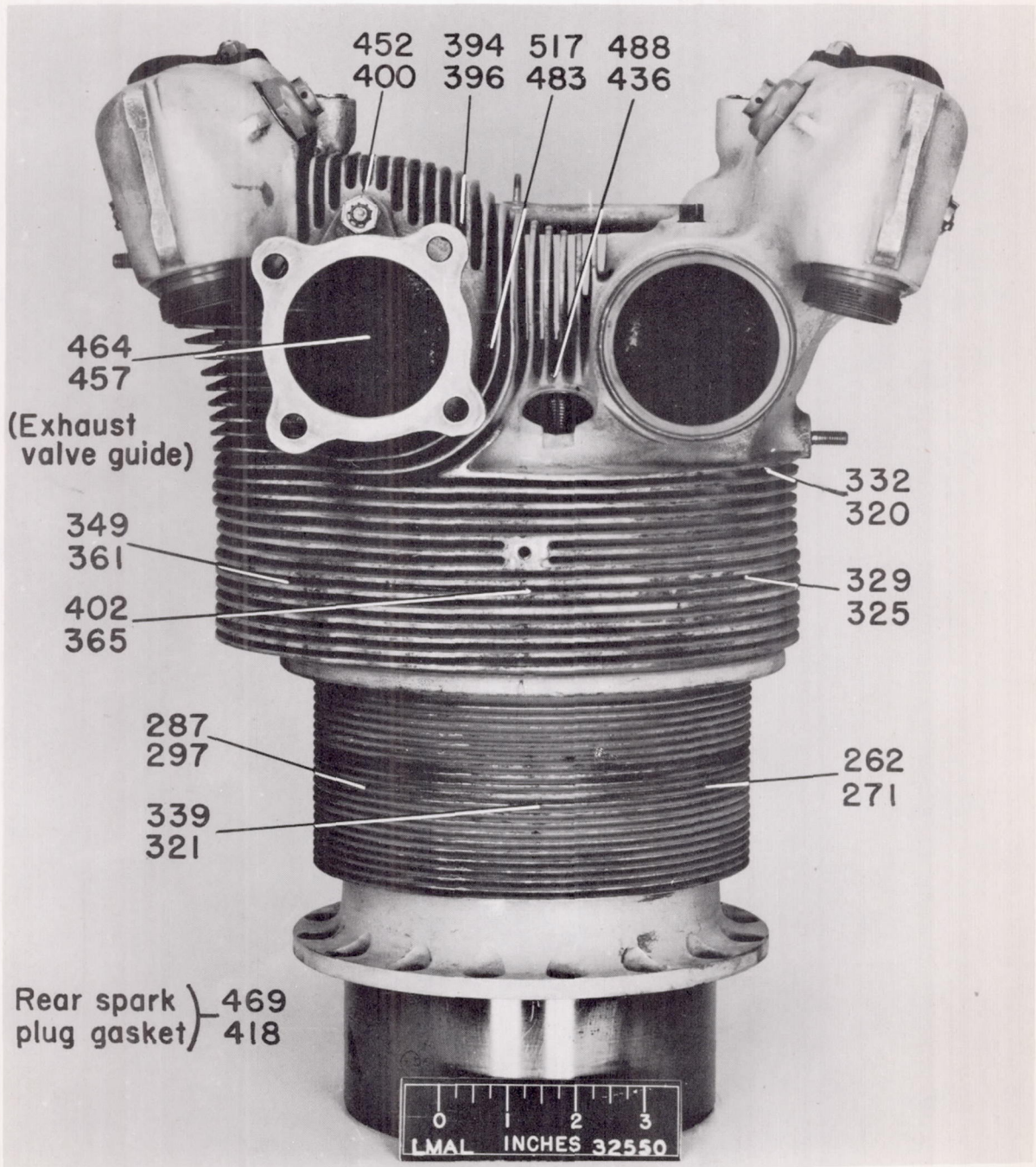

(b) Rear view.

Figure 24.- Concluded.

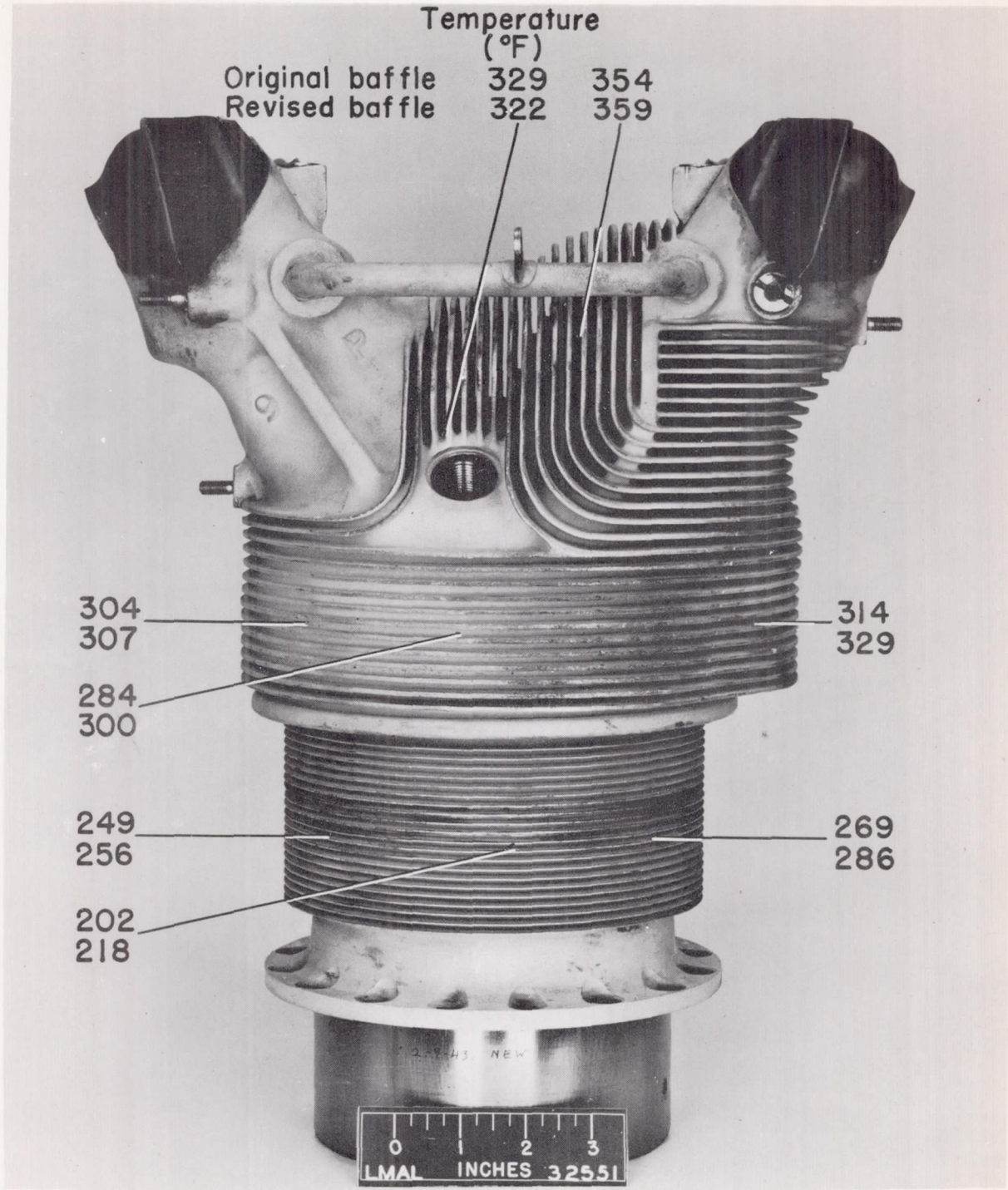

(a) Front view.

Figure 25.- Temperature on cylinder 1 with original and revised baffles. Engine speed, 2550 rpm; manifold pressure, 39.5 inches mercury; carburetor temperature, 90.0° F; cooling-air temperature, 76° F; engine fuel-air ratio, 0.105; average cooling pressure drop $\sigma\Delta p$, 4.51 inches water.

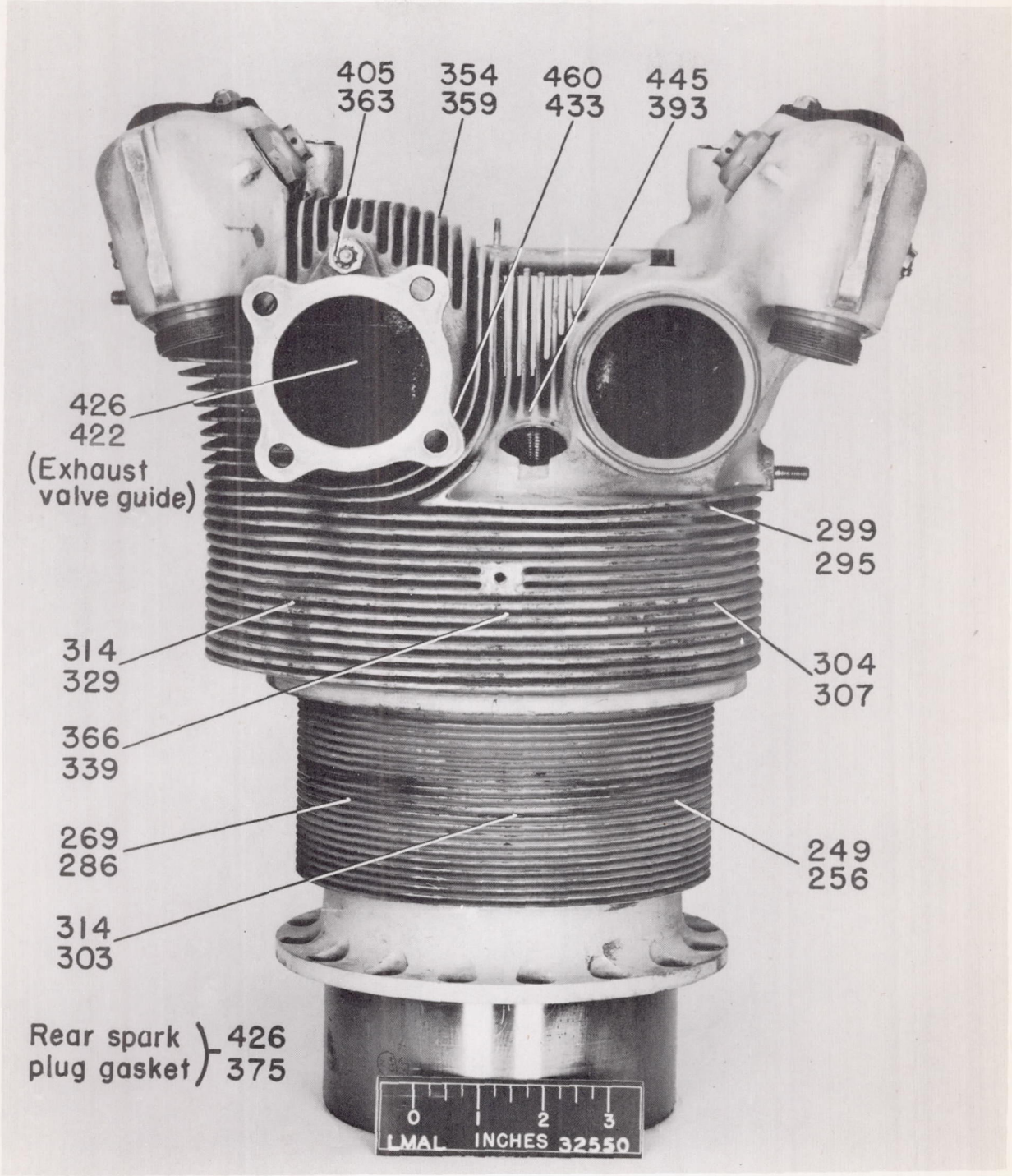

(b) Rear view.

Figure 25.- Concluded.

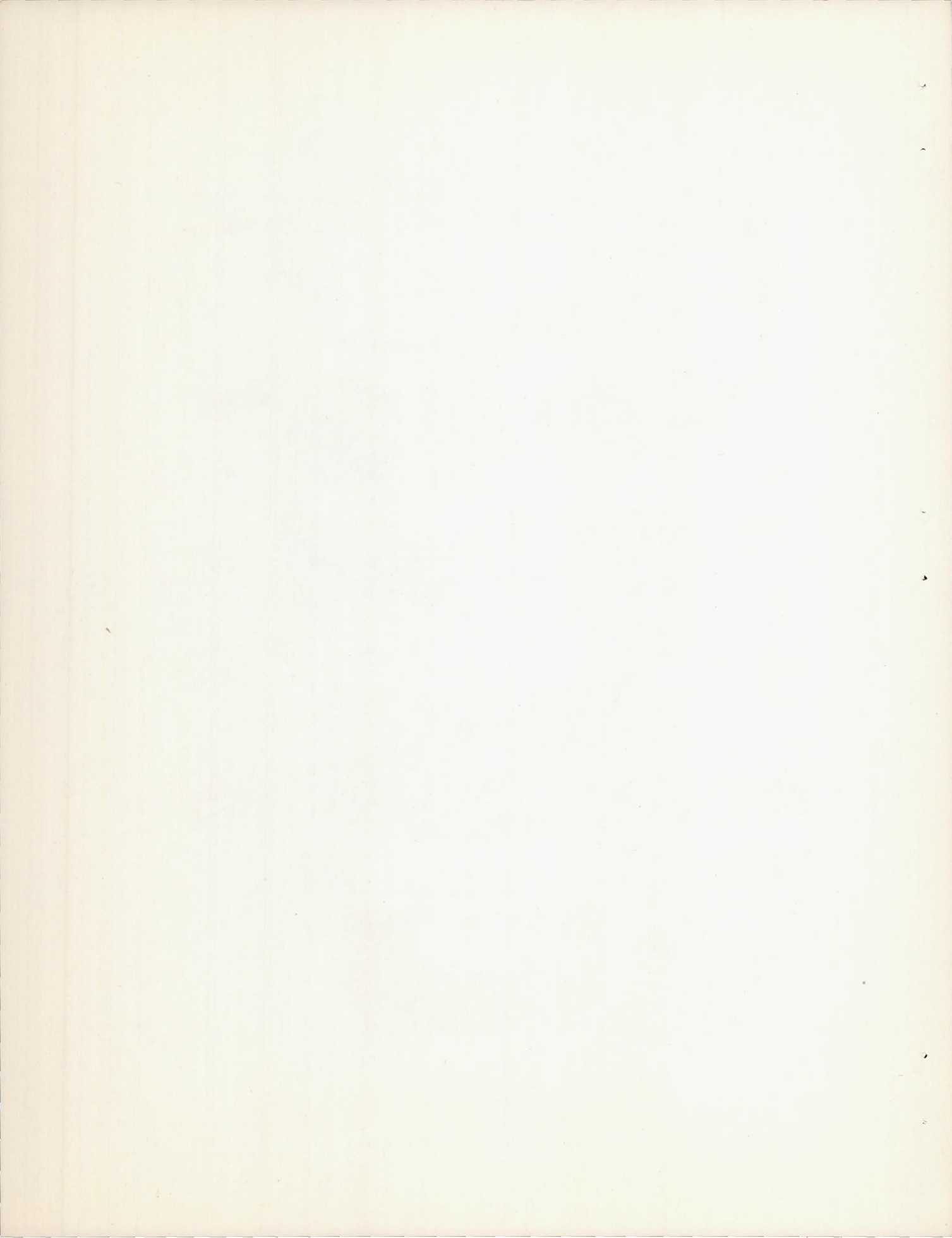

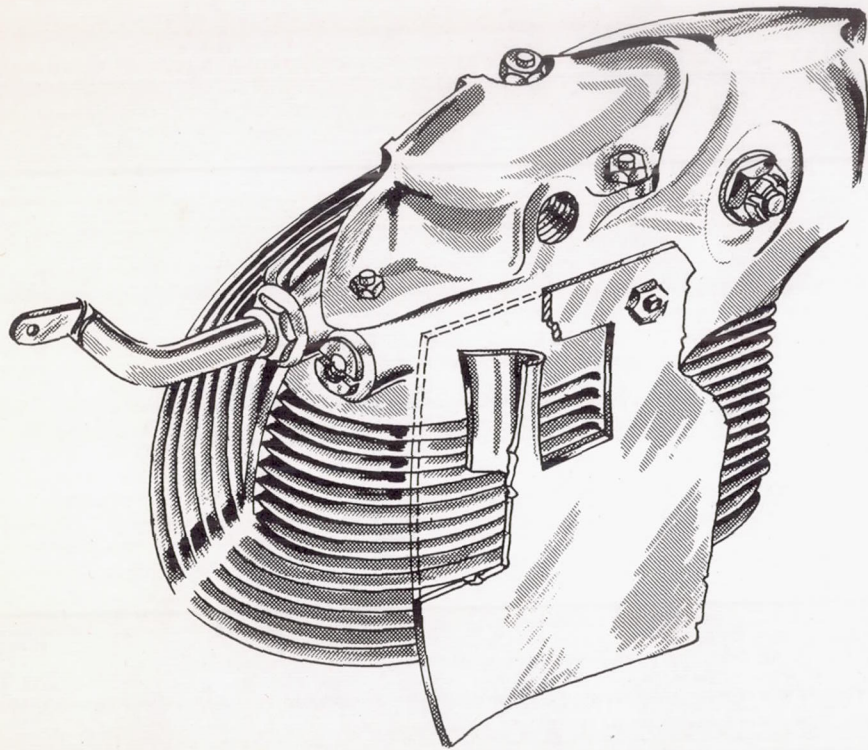

(a) Small outlet cut in revised baffles to allow cooling air to pass between the topmost fins on front of rocker box.

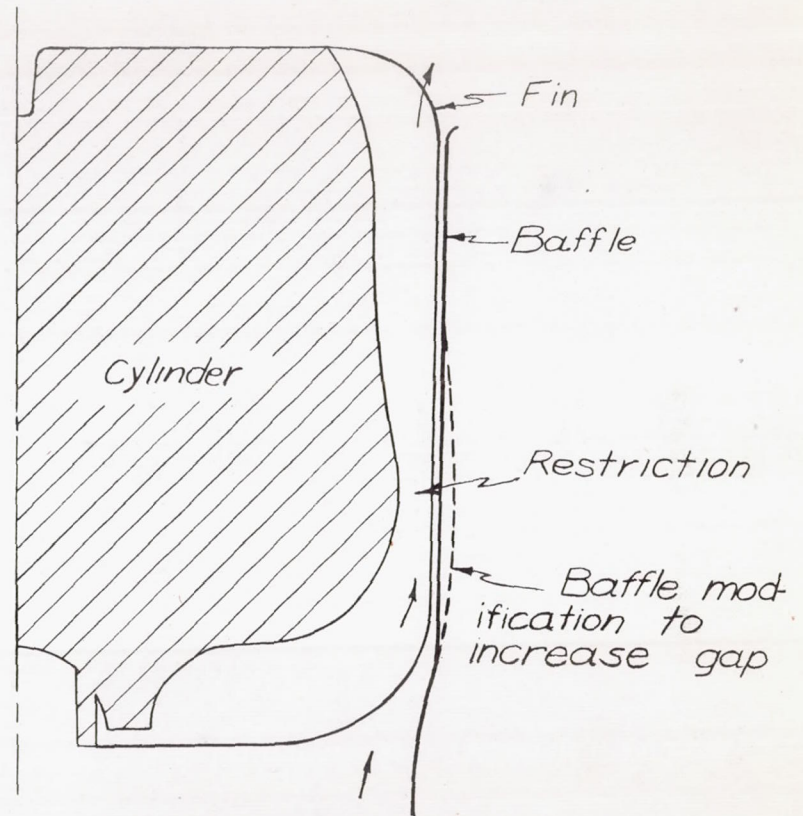

(b) Modification of revised baffles to increase cooling-air flow around side of rocker box by increasing gap between the fins and baffle where fins are short.

Figure 26. - Modifications of revised baffles to reduce the temperature of the exhaust valve guide.

