

NATIONAL ADVISORY COMMITTEE FOR AERONAUTICS

**WARTIME REPORT**

ORIGINALLY ISSUED

January 1946 as  
Memorandum Report E5K30a

AN INVESTIGATION OF COWL-FLAP AND COWL-OUTLET DESIGNS

FOR THE B-29 POWER-PLANT INSTALLATION

By DeMarquis D. Wyatt and E. William Conrad

Aircraft Engine Research Laboratory  
Cleveland, Ohio

JPL LIBRARY  
CALIFORNIA INSTITUTE OF TECHNOLOGY



WASHINGTON

NACA WARTIME REPORTS are reprints of papers originally issued to provide rapid distribution of advance research results to an authorized group requiring them for the war effort. They were previously held under a security status but are now unclassified. Some of these reports were not technically edited. All have been reproduced without change in order to expedite general distribution.

E-206

Faint, illegible text, possibly bleed-through from the reverse side of the page.

NATIONAL ADVISORY COMMITTEE FOR AERONAUTICS

MEMORANDUM REPORT

for the

Air Technical Service Command, Army Air Forces

AN INVESTIGATION OF COWL-FLAP AND COWL-OUTLET DESIGNS

FOR THE B-29 POWER-PLANT INSTALLATION

By DeMarquis D. Wyatt and E. William Conrad

SUMMARY

An investigation of cowl-flap and cowl-outlet designs for the B-29 power-plant installation was conducted in the NACA Cleveland altitude wind tunnel to determine the effects of cowling performance of changes in hinged-flap design details, the use of sliding flaps, and the use of fixed top flaps in combination with hinged flaps.

The distribution of pressure drop around the engine with a given deflection of the fixed top flaps was the same for all flaps tested. Deflection of the fixed top flaps greatly influenced the distribution of pressure drop at low cooling-air flows but only slightly at large cooling-air flows. The maximum average pressure drop obtained with the hinged flaps was not greatly affected by the flap chord length, the internal contour, or the hinge position within the range of cooling-air flows investigated. A sharp break at the metering section on the inner contour of a hinged 16-inch-chord flap produced large pressure losses at small flap deflections. The maximum air flow obtained with sliding flaps was only 83 percent of that obtained with the hinged flaps. At cooling-air flows greater than those obtainable with the sliding flaps, the drag of the installation was a minimum with a modified 16-inch-chord flap. This flap had a smooth internal contour and a hinge point that was so moved radially outward that when the flap was undeflected its outer surface was offset about  $1\frac{1}{2}$  inches from the nacelle afterbody.

## INTRODUCTION

The most important variables in cowl-outlet design are the longitudinal location of the outlet on the nacelle, the degree of peripheral opening, and the design of the flap details. A discussion of cowl outlets and the comparative characteristics of hinged flaps, sliding flaps, and bottom opening doors is given in references 1 and 2.

As part of an extensive investigation to improve the cooling and reduce the cooling drag of the B-29 power-plant installation requested by the Air Technical Service Command, Army Air Forces, tests were conducted in the NACA Cleveland altitude wind tunnel. The results of an investigation of cowl inlets for the B-29 airplane are given in reference 3.

This paper presents the effects of flap chord length, flap internal contour, and offset of the flaps relative to the nacelle afterbody. Results of tests conducted to determine the effects of variations in the deflection of the fixed top flaps, the effects of the addition of a fairing to the rear exhaust-collector ring, and the comparative characteristics of sliding and hinged flaps are also presented.

Tests with the propeller operating and the propeller removed were conducted with each cowl-flap configuration for a range of cowl-outlet areas to determine the available engine cooling-air pressure drop, the distribution of cooling-air pressure drop around the engine, and the drag of the installation. A total-pressure survey was taken to determine the losses occurring between the engine and the cowl outlet.

## DESCRIPTION OF APPARATUS

The tests were conducted on a B-29 right inboard nacelle mounted in the wind tunnel on the adjacent wing section, as shown in figure 1. The installation was equipped with an 18-cylinder, double-row radial engine and a four-bladed propeller 16 feet 7 inches in diameter, which rotated at 0.35 engine speed. A cutaway drawing of the nacelle showing the location of the engine and accessories is presented in figure 2.

### Nacelle

The investigation of the cowl flaps was made simultaneously with an investigation of cowl-inlet designs (reference 3) and

consequently all of the cowl-flap tests were not conducted on the same nacelle configuration. Two cowl inlets were used for the tests: A  $38\frac{1}{2}$ - by 35-inch oval cowl inlet was installed for tests of the original 16-inch-chord hinged flaps and the simulated sliding flaps and a 43-inch-diameter cowl inlet was used during tests of the modified 16-inch-chord flaps, 13-inch-chord flaps, and for additional tests of the original 16-inch-chord flaps.

The installation included 10 hinged and 2 fixed flaps, located as shown in figures 1 and 3, which extended almost completely around the nacelle; no flaps were located at the bottom of the nacelle because of the installation of an air duct for charge air, inter-cooler air, and oil-cooler air. (See fig. 1.) The deflection of the 10 hinged flaps was controlled by remotely operated actuators. A rear view of the flap section of the nacelle showing the fixed and the hinged original 16-inch-chord flaps is presented in figure 3.

#### Cowl Flaps

Three types of hinged flap and a simulated sliding flap were investigated during the tests. The principal design features of the flaps are listed in the following table:

Flap designation	Shown in figure	Flap length (in.)	Flap position with respect to nacelle afterbody	Contour of inner-flap surface
Original 16-inch chord	4	16	Flush	Sharp break at metering section
13-inch chord	5	13	Flush	Smooth
Modified 16-inch chord	6, 7	16	Offset	Smooth
Simulated sliding	8, 9	Variable	Flush	Smooth

The original 16-inch-chord flap, which was the production flap on the B-29 airplane at the time of the investigation, is shown in figure 4. The minimum area of the exit passage was at section A (fig. 4) because of the sharp break in the contour of the inner surface of the flap at that point. Except for a small air leakage, the flaps sealed the outlet when undeflected.

The 13-inch-chord flap (fig. 5) was hinged at the same point as the original 16-inch-chord flap. As a result of the shortened

length, the 13-inch-chord flap provided a gap of approximately 0.75 inch at the cowl outlet when in the undeflected position and thus produced an equal outlet area with less deflection than the longer flaps. The sharp break in the contour of the inner surface on the original 16-inch-chord flap was eliminated in the design of the 13-inch-chord flap with the result that metering of the cooling-air flow occurred at the trailing edge of the shorter flap.

A sketch of the modified 16-inch-chord flap is presented in figure 6. The structure of the flap was similar to that of the 13-inch-chord flap, except for the lengthened trailing skirt. The hinge point for this flap was moved radially outward in order to bring the outer surface of the undeflected flap about  $1\frac{1}{2}$  inches outside of the original nacelle afterbody. (See fig. 6.) This offset location of the flap necessitated enlarging the cowl afterbody. (See fig. 7.)

Sliding flaps were simulated by the removable peripheral strips shown in figures 8 and 9. The several strips were bolted together at the overlaps and successive removal of the strips simulated retraction of sliding flaps.

The rear exhaust-collector ring was located near the cowl outlets, as shown in figure 10. In an attempt to reduce the blocking effect of the collector ring, a fairing (fig. 10) was installed around the collector.

#### Instrumentation

The cooling-air pressures at several stations throughout the nacelle were measured by shielded total-pressure tubes installed in front of all cylinder heads, static tubes along the rear barrel-baffle skirt of the rear-row cylinders, and shielded total-pressure tubes in rakes at the outlets of No. 1 outboard, No. 3 inboard and outboard, and No. 5 inboard and outboard flaps. (See fig. 1 for flap locations and figs. 3, 11, and 12 for tube locations.) Additional shielded total-pressure tubes were installed for one test in a traverse from the rear of cylinder 5 to the cowl outlet behind it in order to obtain specific data relating to the pressure gradient behind the engine. (See fig. 13.)

All pressures were measured on a multiple-tube manometer board and were recorded photographically. The drag of the installation was measured on the wind-tunnel recording scales. Brake horsepower was determined by means of a torquemeter furnished with the engine.

## TESTS AND METHODS

Comparative tests with the different flaps were made at an indicated airspeed forward of the model of 190 miles per hour and at a pressure altitude of 15,000 feet. The tests to determine the losses between the engine and the cowl outlet were made at a pressure altitude of 28,500 feet and at an indicated airspeed of 180 miles per hour. All tests were conducted with an inclination of the thrust axis of  $-2^\circ$  and were made by varying the cowl-outlet areas while tunnel and operating conditions were held constant.

Exhaust-shroud covers were installed for all of the tests except those with the modified 16-inch-chord flaps and the simulated sliding flaps. Propeller-operating tests were made at normal cruising power of 1350 brake horsepower at an engine speed of 2100 rpm and normal rated power of 2000 brake horsepower at 2400 rpm.

Tests were made with the configurations shown in the following table:

Cowl flap	Propeller	Cowl inlet	Cowl afterbody
Original 16-inch chord	Operating and removed	$38\frac{1}{2}$ - by 35-inch oval	Original
Original 16-inch chord	Operating and removed	43-inch diameter	Original
13-inch chord	Removed	43-inch diameter	Original
Modified 16-inch chord	Operating and removed	43-inch diameter	Enlarged
Simulated sliding	Operating and removed	$38\frac{1}{2}$ - by 35-inch oval	Original

Tests with and without the rear exhaust-collector fairing were conducted with the propeller removed and with a configuration consisting of the  $38\frac{1}{2}$ - by 35-inch oval cowl inlet, the original cowl afterbody, and the original 16-inch-chord flaps.

## RESULTS AND DISCUSSION

## Presentation of Data

Static pressures are presented in the form  $(p - p_0)/q_c$  and total pressures in the form  $(H - p_0)/q_c$ , where  $p$  and  $H$  are

the measured static and total pressures, respectively,  $q_c$  is the impact pressure, and  $p_o$  the reference static pressure measured just ahead of the installation. The cooling-air pressure drop across the engine  $\Delta p/q_c$  was obtained from the difference between the average of the total pressures in front of the engine and the average of the static pressures at the rear of the engine. (See fig. 14.)

Drag data from the propeller-removed tests are presented in the form  $D/q_o$  where  $D$  is the total drag in pounds of the entire installation as measured on the wind-tunnel scales and  $q_o$  is the dynamic pressure just ahead of the installation. All drag data were corrected to correspond to operation of the installation with the exhaust-shroud covers installed.

The data presented were not corrected for the jet-boundary effects of the wind tunnel, which have not yet been definitely established. Cowl-flap effectiveness, as indicated by the cooling-air pressure drop obtained for a given flap position, is known to be greater in the wind tunnel than in flight owing to the reduced static pressure at the cowl outlets caused by constriction of the flow through the test section. Data on the average static pressures measured at the rear of the top six cylinders (1, 2, 3, 16, 17, and 18) obtained from flight tests of the B-29 airplane conducted by the Boeing Aircraft Company and comparable data from the wind-tunnel tests are presented in figure 14 to show the wind-tunnel effect. Although the absolute values of the static pressure obtained in the wind tunnel are not the same as those obtained in flight for comparable flap deflections, the validity of direct comparisons of wind-tunnel data is not affected inasmuch as all comparative tests were made at the same tunnel operating conditions.

Most of the data presenting cowl-flap position as an independent variable indicate the flap position in terms of the total area at the cowl outlets, rather than in terms of the angular deflection of the hinged flaps or the gap of the sliding flaps. In this manner the effect of the fixed top cowl flaps may be accounted for and a basis for comparison of the hinged and sliding flaps provided. A calibration showing the total outlet area obtained at different positions of the various flaps is presented in figure 15.

#### Available Pressure Drop

On the basis of performance, a good cowl installation may be defined as one that provides adequate, properly distributed



cooling-air flow for all operating conditions with a minimum amount of drag. The effects of several variables in flap and outlet design of these performance characteristics are presented in the following paragraphs.

For a given engine installation operating at conditions of constant free-stream air density, the mass of cooling air flowing through the cowl, if compressibility and Reynolds number effects are neglected, is proportional to the square root of the cooling-air pressure drop across the engine. Comparisons of the cooling-air mass flow obtainable with the various flaps may therefore be approximated in terms of the mass-flow parameter  $\sqrt{\Delta p/q_c}$ .

Effect of flap and outlet design. - The cooling-air flow through the different hinged flaps for a range of outlet areas is shown in figure 16 for the propeller-removed and the propeller-operating tests with the 43-inch-diameter and the  $38\frac{1}{2}$ - by 35-inch oval cowl inlets. The maximum value of  $\sqrt{\Delta p/q_c}$  obtained was not greatly affected by changes of the flap chord length, and the internal contour, or the hinge position in the range investigated. Approximately 5 percent larger values of  $\sqrt{\Delta p/q_c}$  were obtained with the original 16-inch-chord flaps for a given outlet area than with either the 13-inch-chord or modified 16-inch-chord flaps. (See fig. 16(a).) A detailed discussion of the various factors that affect the mass air flow through a cowl outlet is given in references 4 and 5.

The data presented in figure 16(b) show the comparative cooling-air flows obtained with hinged and sliding flaps and the  $38\frac{1}{2}$ - by 35-inch oval cowl inlet. At the maximum outlet areas investigated during tests with the propeller removed, only 83 percent of the air obtained with the 16-inch-chord hinged flaps was obtained with the sliding flaps. The greater air flows through the hinged flaps were provided by the lower static pressure at the outlets of the hinged flaps (fig. 17), which occurred as a result of the deflection.

The data presented in figure 16 show that for the same outlet areas the cooling-air flows obtained with the propeller operating were slightly less than those obtained with the propeller removed. The smaller air flows obtained with the propeller operating are attributed primarily to the decreased total pressures at the face of the engine (fig. 17) owing to blocking of the inlet by the unbladed shanks of the propeller. The increased momentum of the cooling air leaving the engine as a result of the heat added

results in a further decrease in the pressure drop available for inducing cooling-air flow across the engine and further accounts for the smaller air flow obtained with the propeller operating.

Effect of fixed top-flap gap. - The influence of the fixed top cowl-flap gap on the mass-flow parameter through the nacelle is shown in figure 18 for propeller-operating tests with the original 16-inch-chord flaps. Increasing the gap of the fixed flaps from 1.5 inches to 3.5 inches increased the mass-flow parameter 19 percent at  $2^\circ$  deflection of the movable flaps but only 2.2 percent at  $16^\circ$  deflection of the movable flaps.

#### Cooling-Air Pressure-Drop Distribution

Effect of flap and outlet design. - Providing a uniform cooling-air flow to a radial-engine installation does not necessarily result in satisfactory operation because, in general, satisfactory cooling requires adequate cooling of the hottest cylinders, the temperatures of which may vary considerably from the average cylinder temperature due to the fuel-air-distribution and other characteristics of the engine. The effect of flap design on the cooling-air pressure-drop distribution was therefore evaluated by comparing the average pressure drop across all cylinders with the average pressure drop across the six top cylinders (1, 2, 3, 16, 17, and 18), which were the most critical for this engine for most operating conditions.

Data obtained from propeller-removed tests of the various flaps shown that the cooling-air flow distribution around the engine was negligibly affected by changes in design of the flaps. The data show (fig. 19) that for a given average cooling-air pressure drop across all cylinders, the maximum difference in the average pressure drop across the six top cylinders for the different flap configurations was only about  $0.03 q_c$ .

Effect of fixed top-flap deflection. - As shown in reference 2 for a cowl equipped with bottom opening doors, more air flowed across the cylinders close to the door than across the more remote cylinders. A similar effect was observed in the present installation, as shown in figure 20. Increasing the gap of the fixed top flaps from 1.5 to 3.5 inches at a  $2^\circ$  deflection of the movable flaps increased the average pressure drop across the six top cylinders  $0.15 q_c$  as compared with an increase of average pressure drop across all cylinders of only  $0.12 q_c$ . At a  $16^\circ$  deflection of the movable flaps, the distribution of pressure drop was relatively unaffected by a change of fixed flap deflection.

The reduced influence on the air flow through the engine of the fixed top-flap deflection with large movable flap deflections is shown in figure 21. As the movable-flap deflection is increased, thus increasing the cowl outlet area from 1 to 4 square feet, the portion of the total air flow through the fixed top flaps decreased from about 35 percent to 12 percent in the range tested.

#### Installation Drag

The drag of the installation obtained with the different flap configurations at an indicated airspeed of 190 miles per hour is shown in figure 22. The differences in drag as compared with the drag of the installation with the original 16-inch-chord flaps are appreciable when the data are translated into terms of engine horsepower savings, as shown in figure 23 for an indicated airspeed of 190 miles per hour at a density altitude of 15,000 feet and a propeller efficiency of 85 percent. For the range of average cooling-air pressure drops obtainable with the simulated sliding flaps, the horsepower required by the installation with sliding flaps was from 62 to 80 horsepower less than that required with the installation of the original 16-inch-chord flap. At cooling-air pressure drops greater than those obtainable with the sliding flaps, the installation of the modified 16-inch-chord flap produced the greatest saving in drag, which is attributed primarily to the offset of the flap.

The horsepower savings with the 13-inch-chord flaps were greater at small cooling-air pressure drops than at large pressure drops (fig. 23), which is attributed in part to the differences in flap internal contour. The total-pressure losses from the rear of the engine through the cowl outlet with the different flaps are shown in figure 24 for a range of cooling-air pressure drops. The pressure losses at a value of  $\Delta p/q_c$  of about 0.3 with the 13-inch-chord and the modified 16-inch-chord flaps were small, whereas the losses with the original 16-inch-chord flap were about  $0.20 q_c$ . These high losses occurred largely through the metering section (fig. 4), as shown by the data in figure 25. At a  $2^\circ$  flap deflection, the losses through this portion of the flap, as indicated by the difference in total pressures between tube 9 (fig. 25) and the cowl-outlet rake, constituted two-thirds of the total losses behind the engine. At a  $16^\circ$  flap deflection, only about 10 percent of the losses occurred through this section.

Installation of the fairing around the rear exhaust collector did not appreciably affect the drag of the installation. (See fig. 26.)

## SUMMARY OF RESULTS

The following results were obtained from an altitude-wind-tunnel investigation of cowl-flap and cowl-outlet designs for the B-29 power-plant installation:

1. The maximum pressure drop obtained with the different hinged flaps was not greatly affected by the flap chord length, the internal contour, or the hinge position in the range of conditions investigated.

2. The maximum cooling-air flow obtained with simulated sliding flaps was 83 percent of that obtained with the hinged flaps.

3. The distribution of the cooling-air pressure drop was not affected by changes in cowl-flap design.

4. The deflection of the fixed top flaps had a large influence on the distribution of the cooling-air pressure drop at small deflections of the movable flaps but had little influence at large deflections.

5. Within the range of cooling-air pressure drops obtained with sliding flaps, the installation drag with the sliding flaps was much less than with the original 16-inch-chord flaps. A saving of 62 to 80 horsepower was effected at a density altitude of 15,000 feet and an indicated airspeed of 190 miles per hour.

6. At cooling-air pressure drops greater than those obtained with the sliding flaps, the lowest drag was obtained with a modified 16-inch-chord flap with a smooth internal contour and having the outer surface offset  $1\frac{1}{2}$  inches from the nacelle afterbody when the flap is undeflected.

7. A sharp break at the metering section on the inner contour of the hinged 16-inch-chord flap produced large pressure losses at small flap deflections.

8. The addition of a fairing around the rear exhaust collector did not appreciably affect the drag of the installation.

Aircraft Engine Research Laboratory,  
National Advisory Committee for Aeronautics,  
Cleveland, Ohio.

## REFERENCES

1. Malloy, Richard C., and Brewster, James H., III.: New Research on the Cowling and Cooling of Radial Engines. NACA ARR, May 1942.
2. McHugh, James G.: Comparison of Three Exit-Area Control Devices on an NACA Cowling. NACA ACR, May 1940.
3. Monroe, Louis L., and Saari, Martin J.: An Investigation of Cowl Inlets for the B-29 Power-Plant Installation. NACA MR No. E5K30, 1946.
4. Katzoff, Samuel: High-Altitude Cooling. V - Cowling and Ducting. NACA ARR No. L4I11d, 1944.
5. Czarnecki, K. R., and Nelson, W. J.: Wind-Tunnel Investigation of Rear Underslung Fuselage Ducts. NACA ARR No. 3I21, 1943.

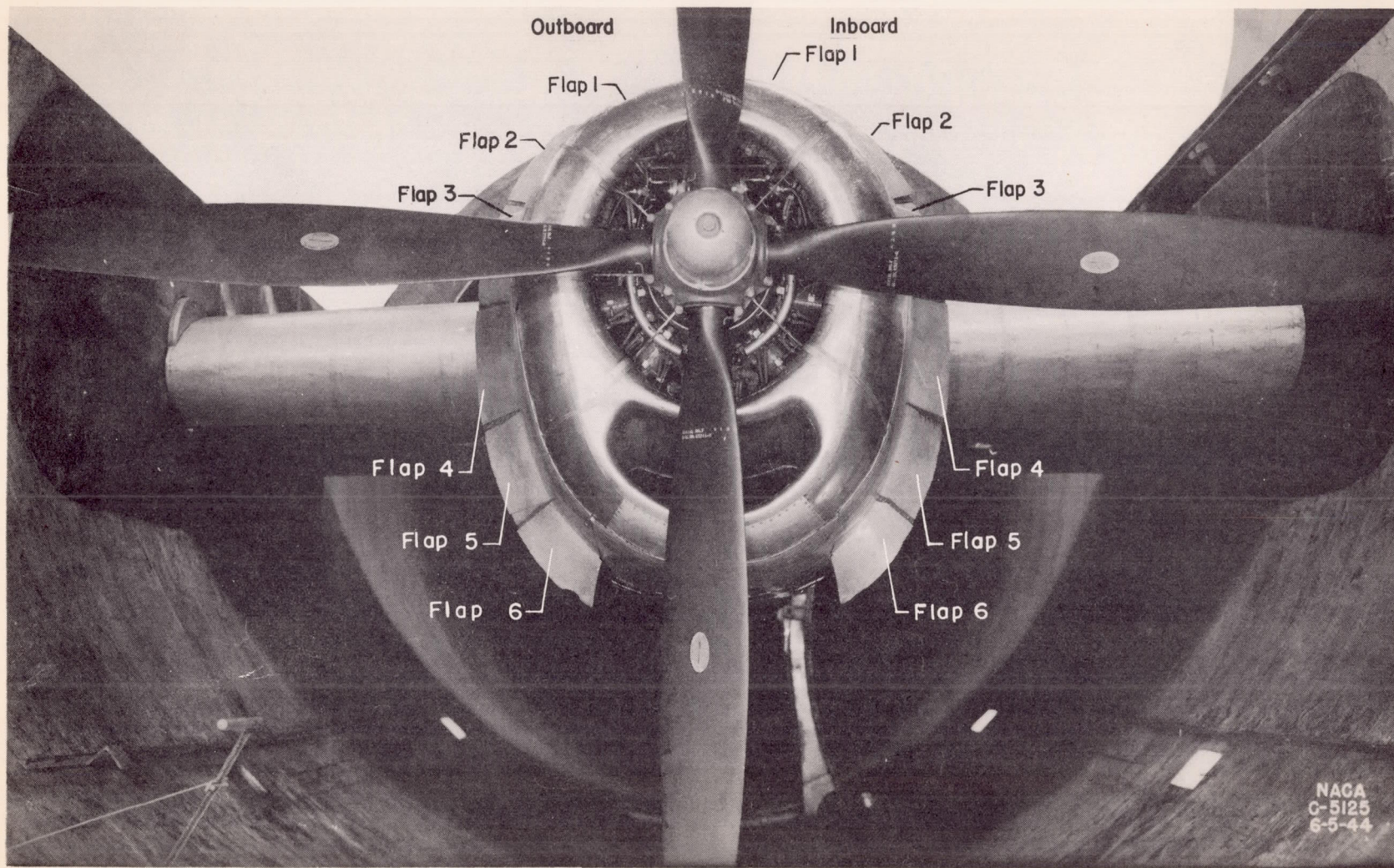

Figure 1. - Front view of power-plant installation in altitude wind tunnel.  
Production configuration.

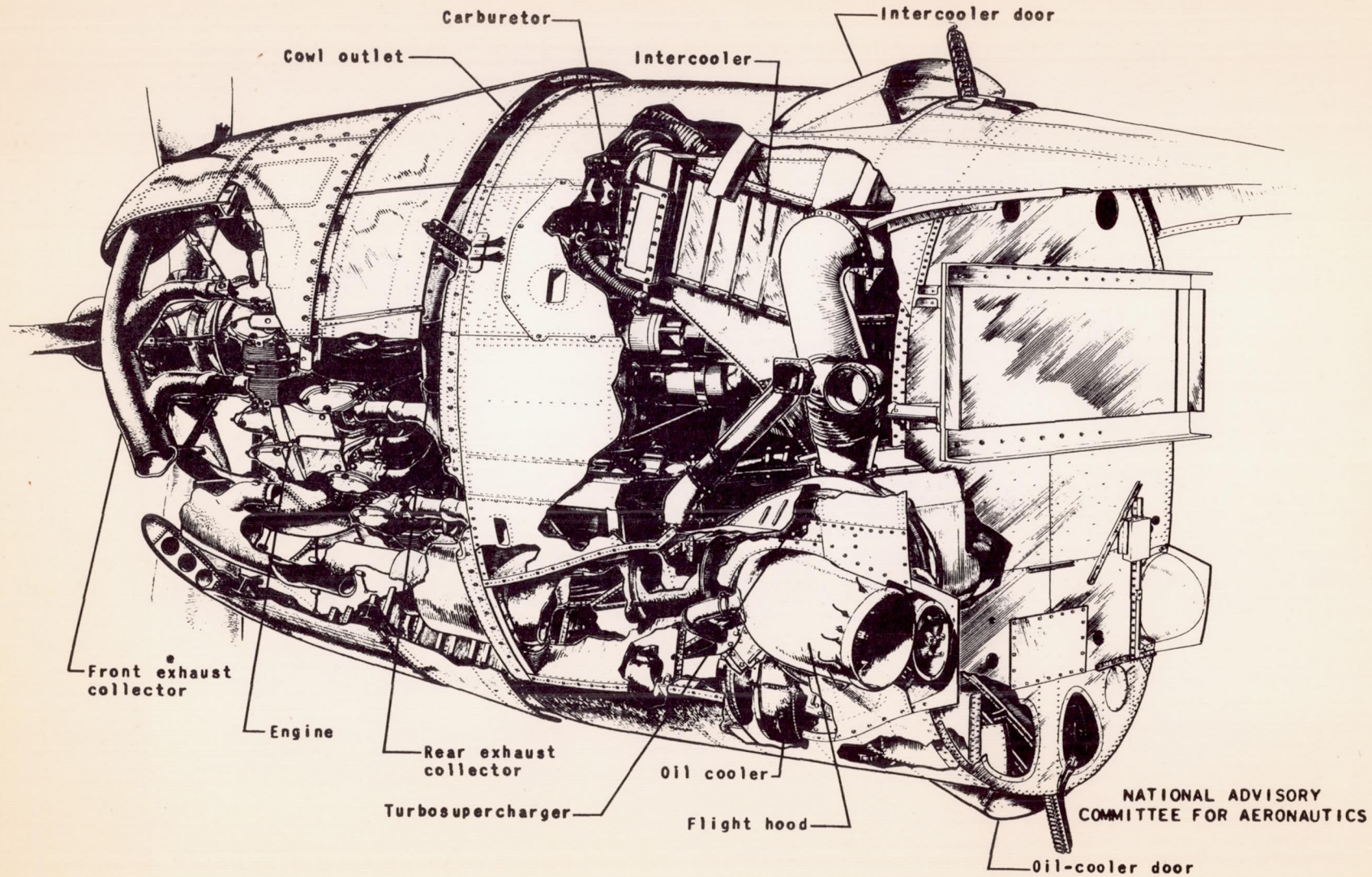

Figure 2. - Cutaway drawing of right inboard nacelle.

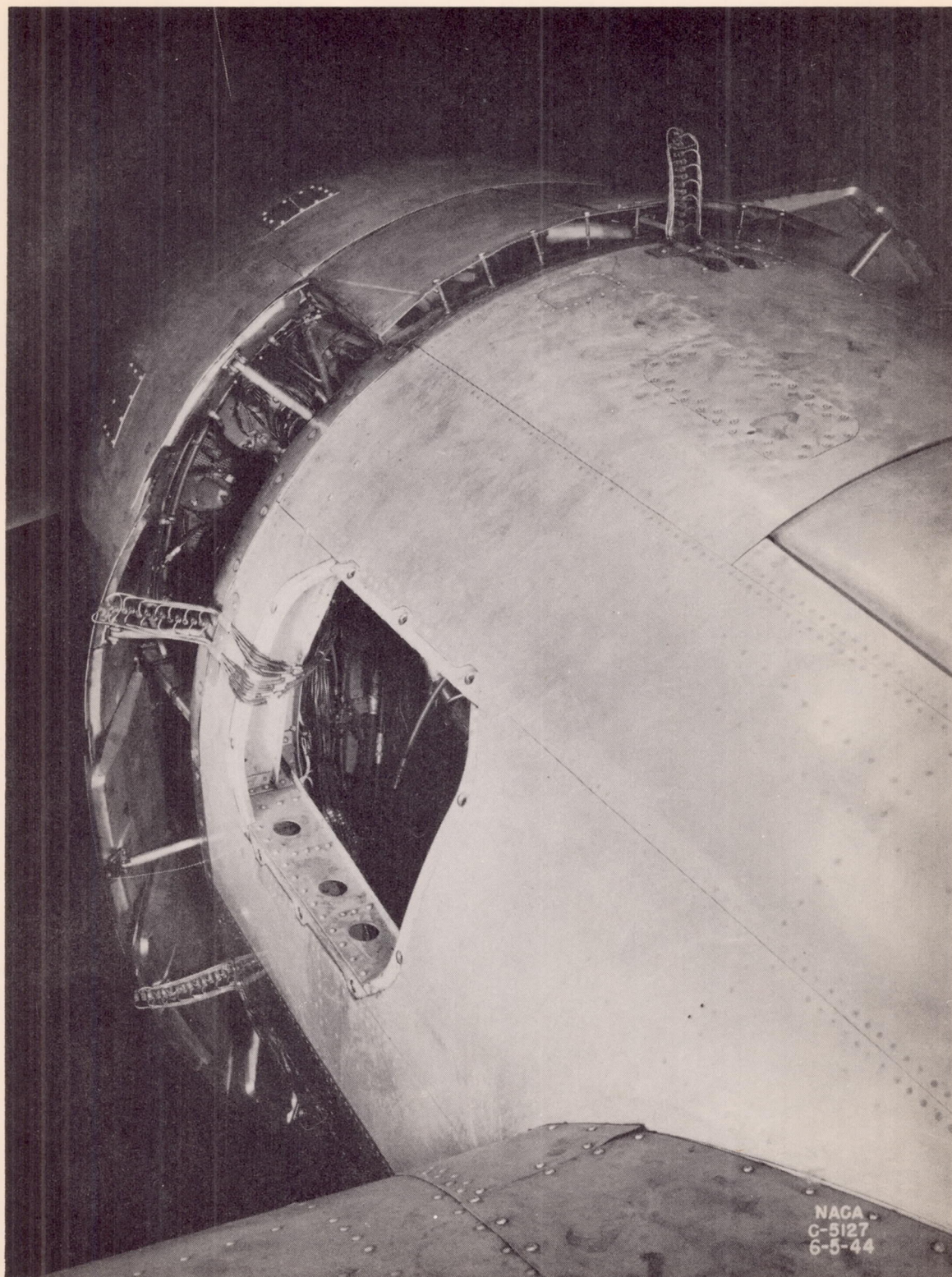

Figure 3. - Rear view of power-plant installation showing fixed and hinged original 16-inch-chord flaps.



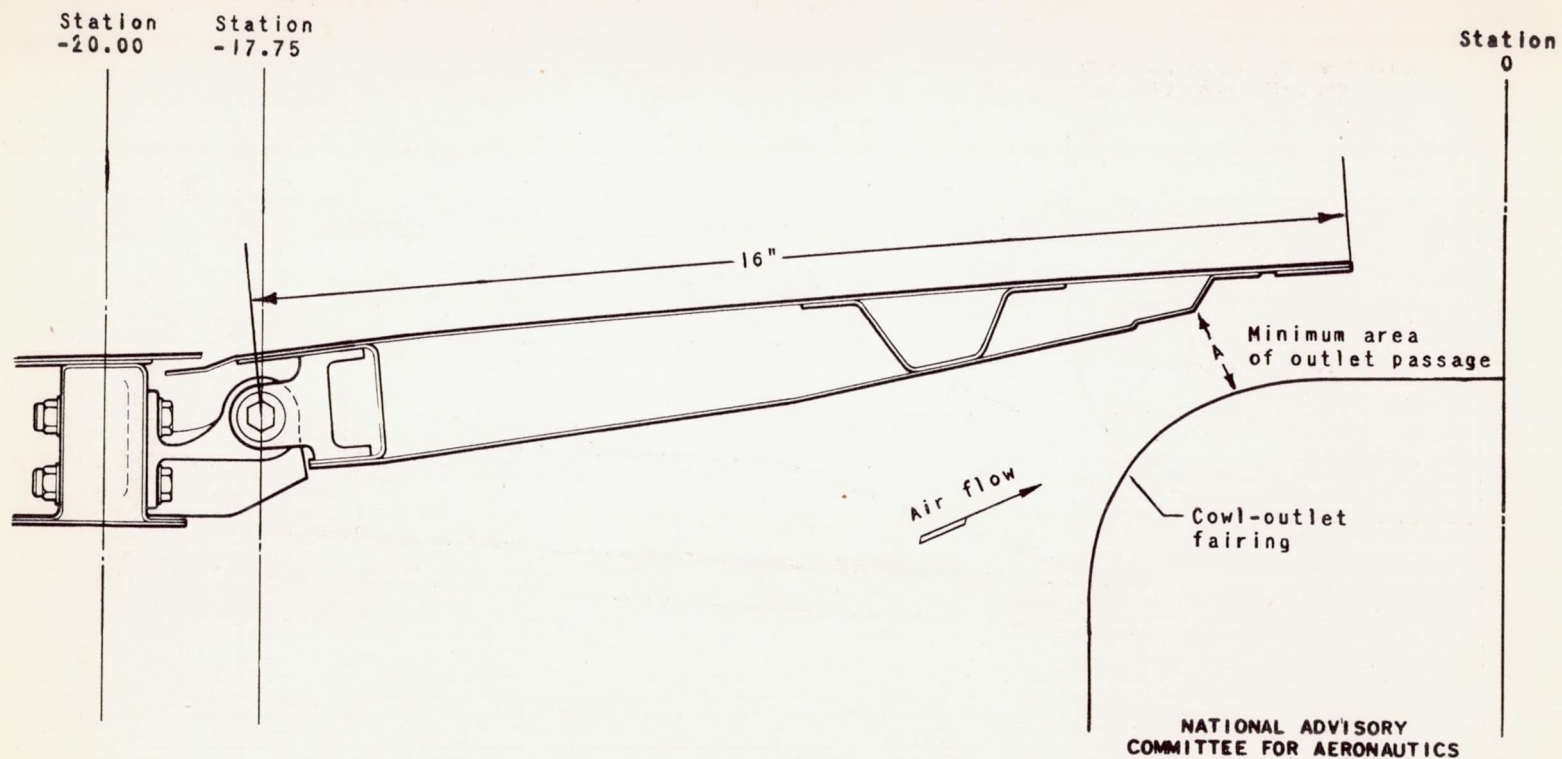

Figure 4. - Installation of original 16-inch-chord flap.

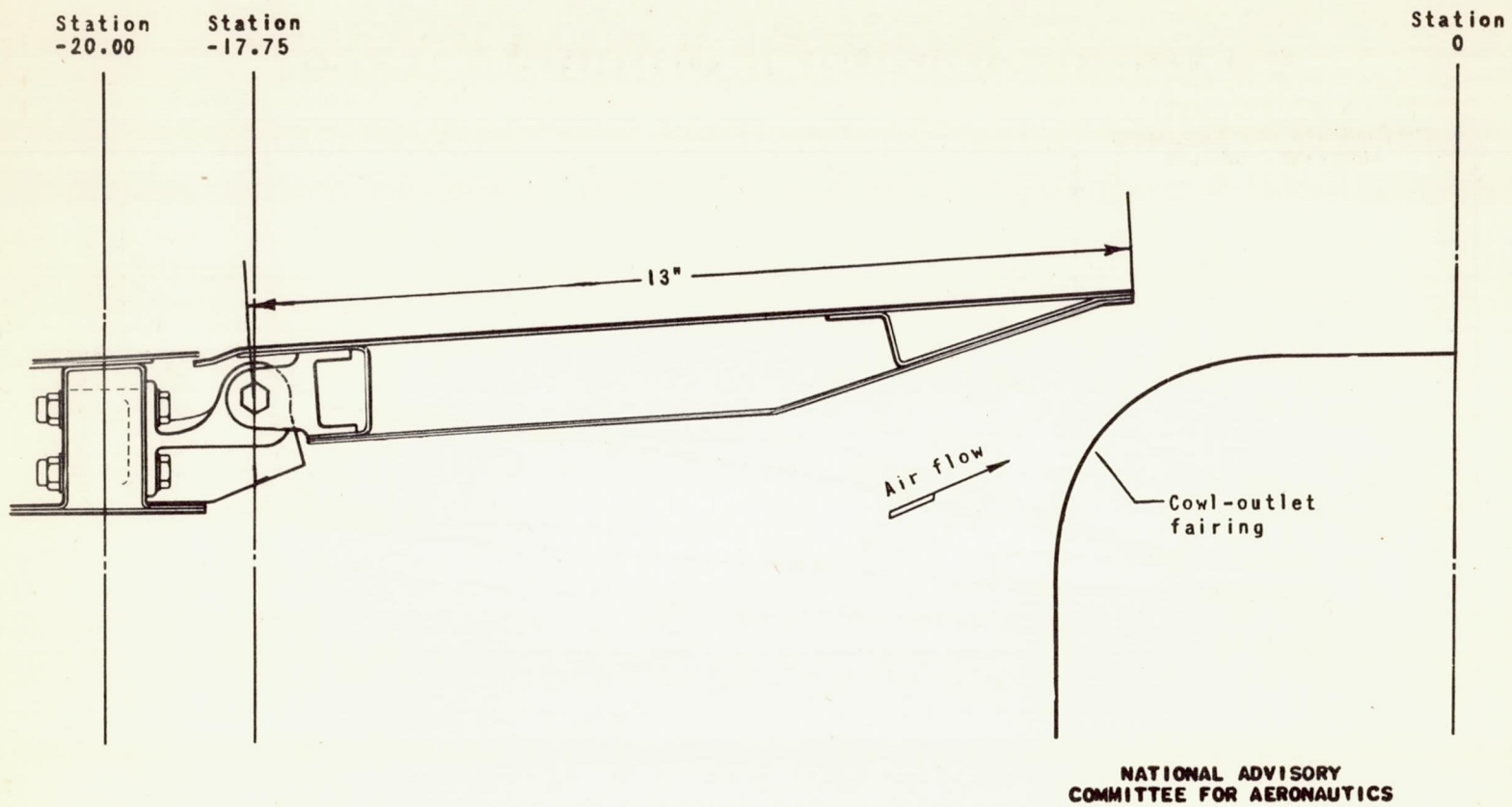

Figure 5. - Installation of 13-inch-chord flap.

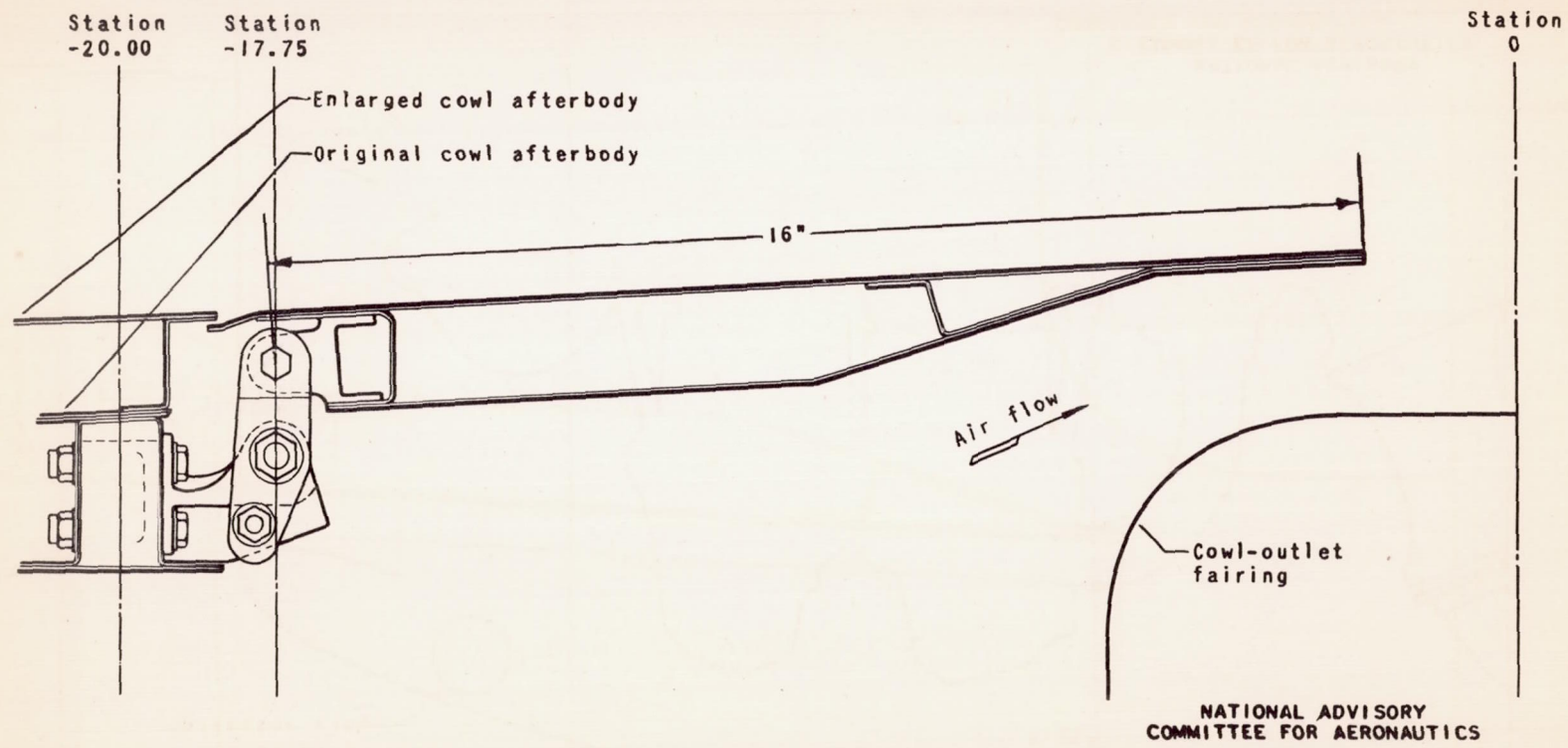

Figure 6. - Installation of modified 16-inch-chord flap.

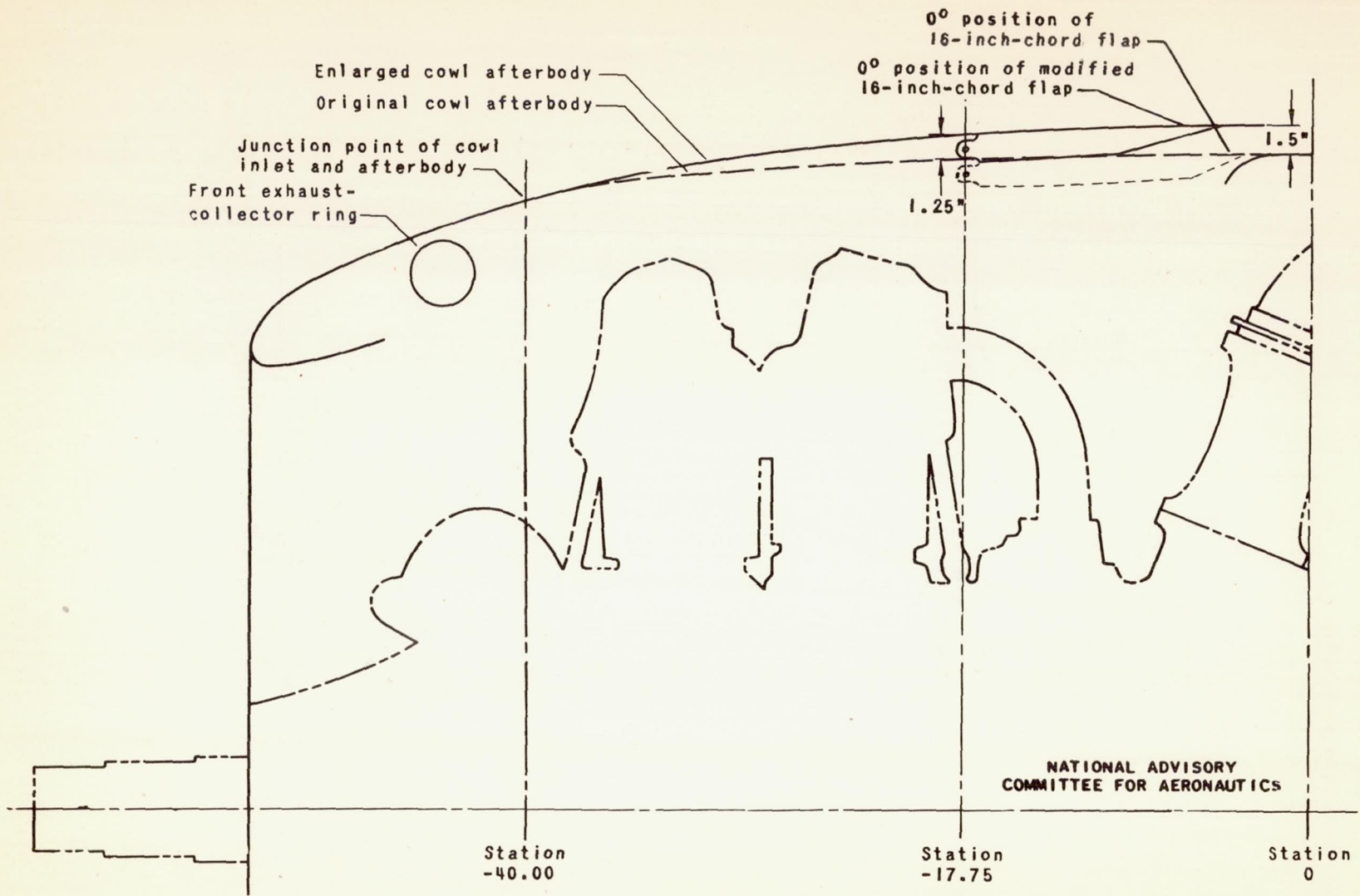
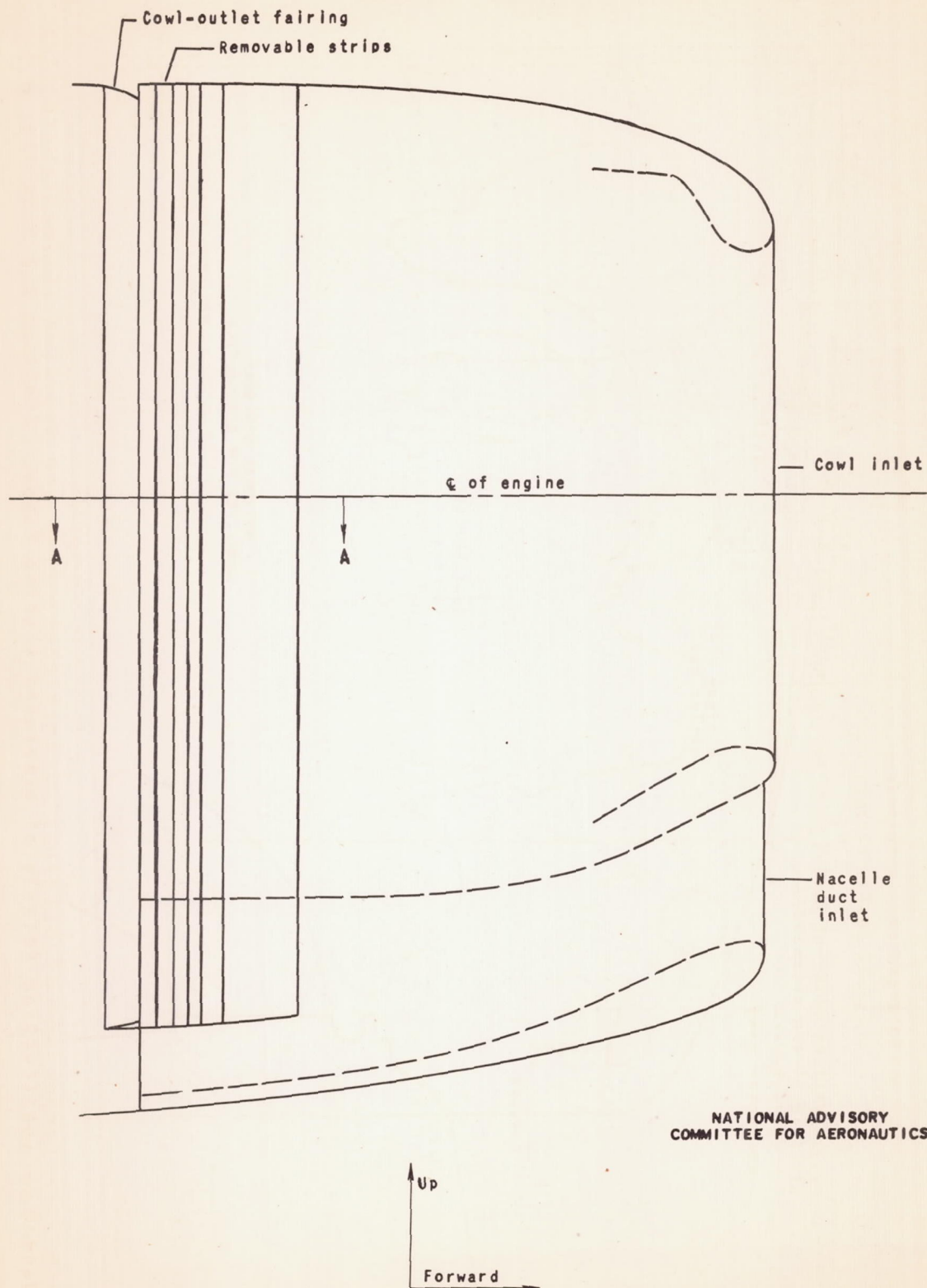

Figure 7. - Comparison of original 16-inch-chord flap and modified 16-inch-chord flap installations.



NATIONAL ADVISORY  
COMMITTEE FOR AERONAUTICS

Figure 8. - Location and assembly of simulated sliding flaps.  
(See fig. 9 for details of Section A-A.)

L-206

39-331 D

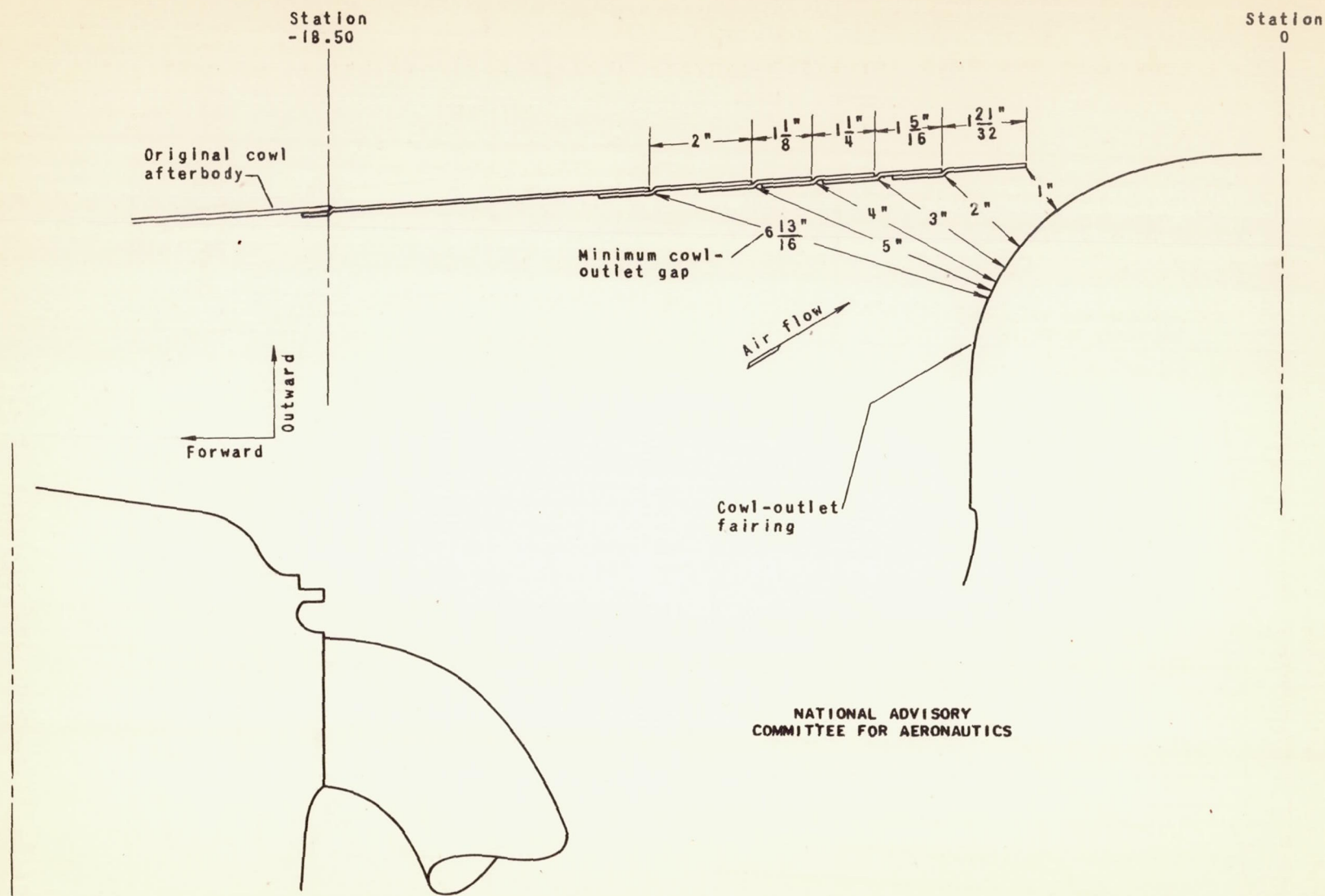
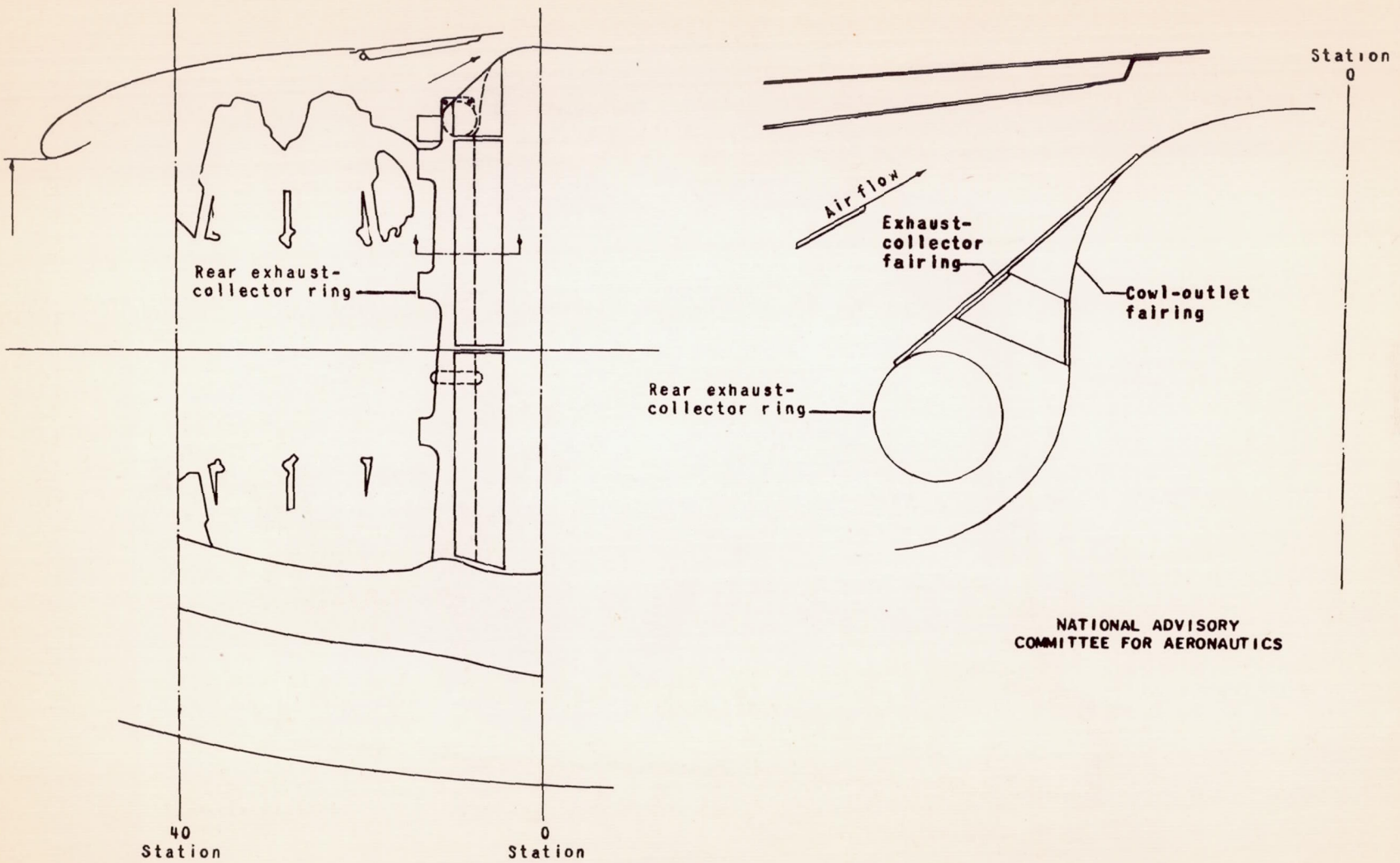

Figure 9. - Construction details of simulated sliding flaps. (Section A-A from fig. 8.)



NATIONAL ADVISORY  
COMMITTEE FOR AERONAUTICS

Figure 10. - Installation of rear exhaust-collector ring and fairing.

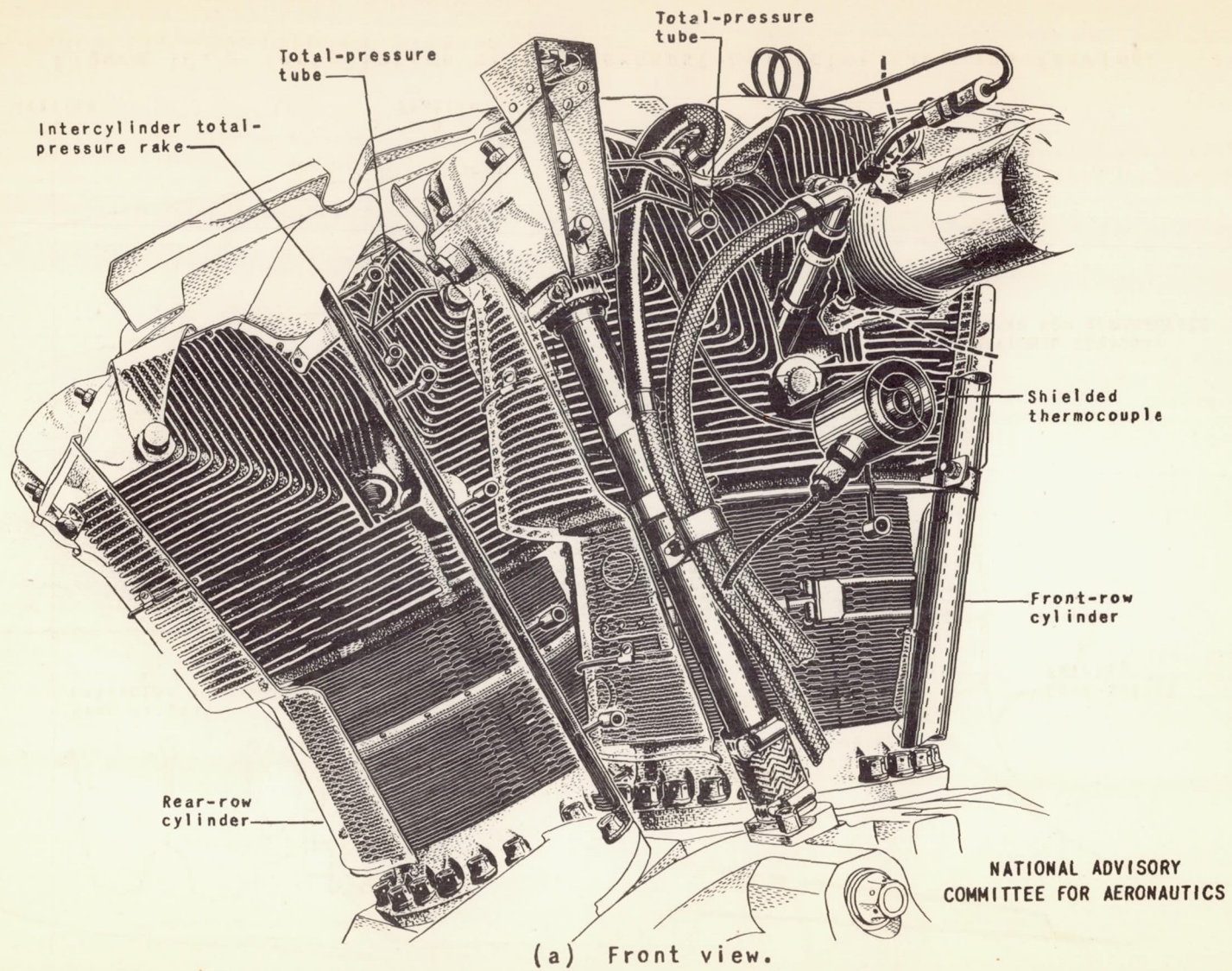
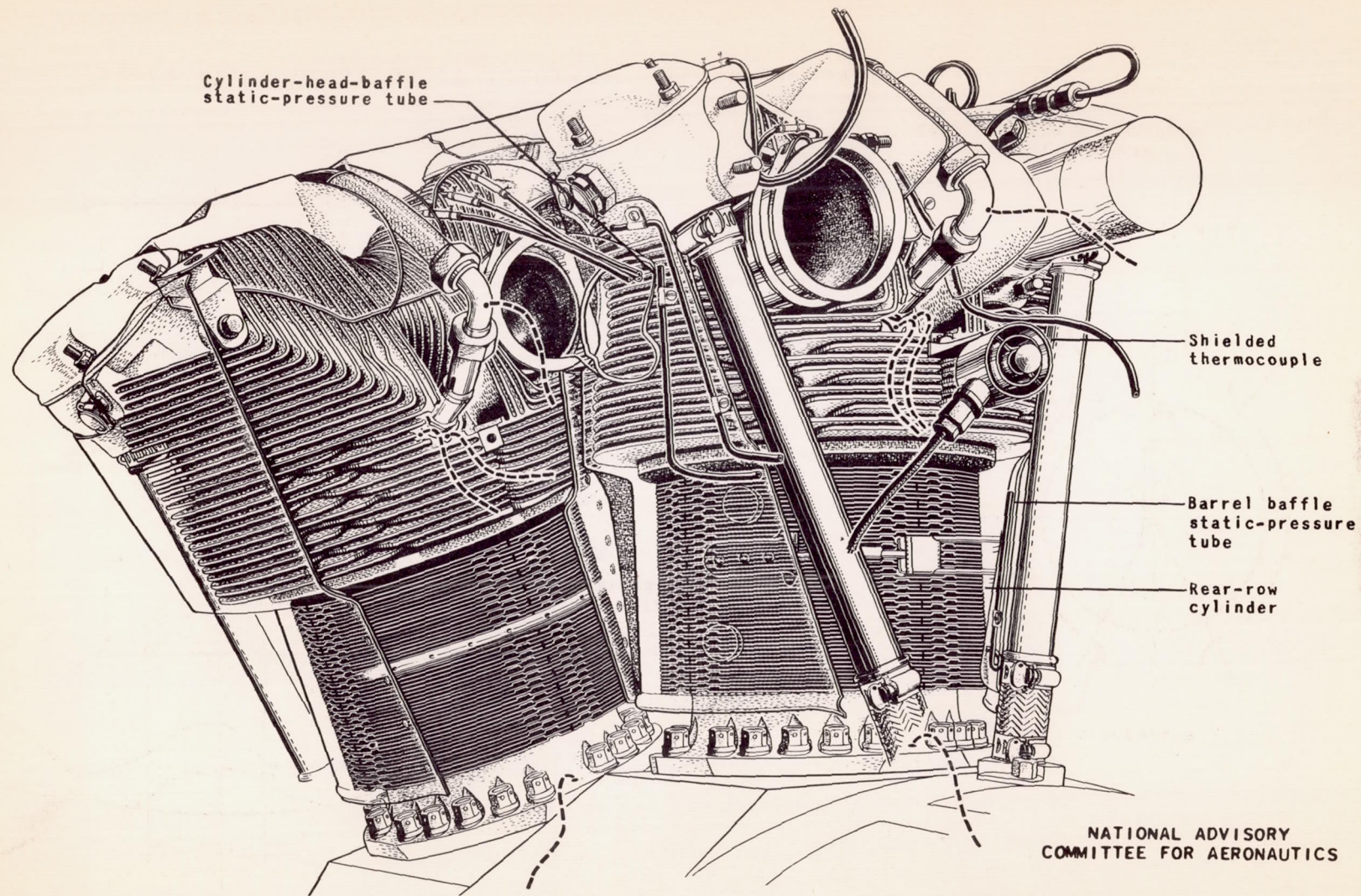

Figure 11. - General location of instrumentation on cylinders.





NATIONAL ADVISORY  
COMMITTEE FOR AERONAUTICS

(b) Rear view.

Figure 11. - Concluded. General location of instrumentation on cylinders.

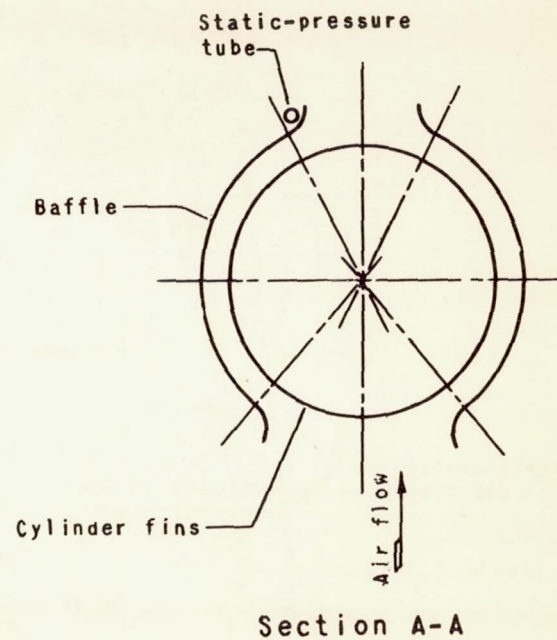
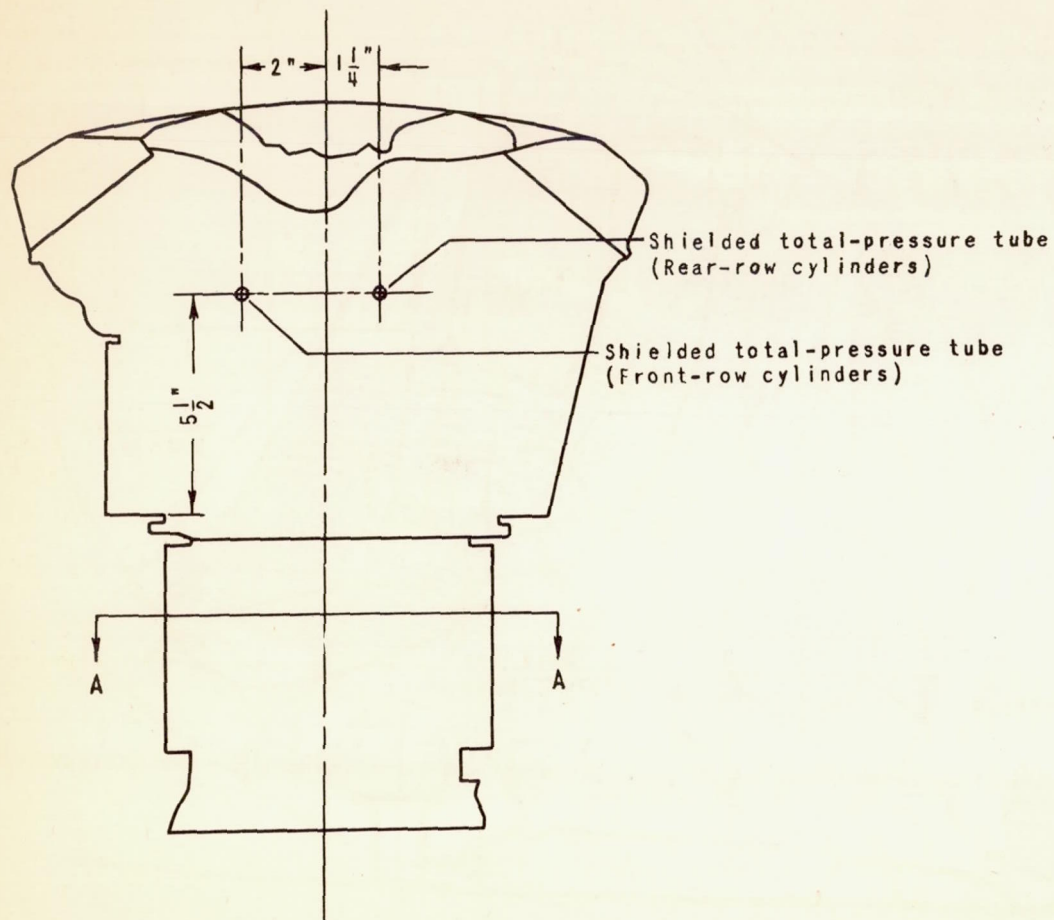

NATIONAL ADVISORY  
COMMITTEE FOR AERONAUTICS

Figure 12. - Location of total- and static-pressure tubes on cylinder.

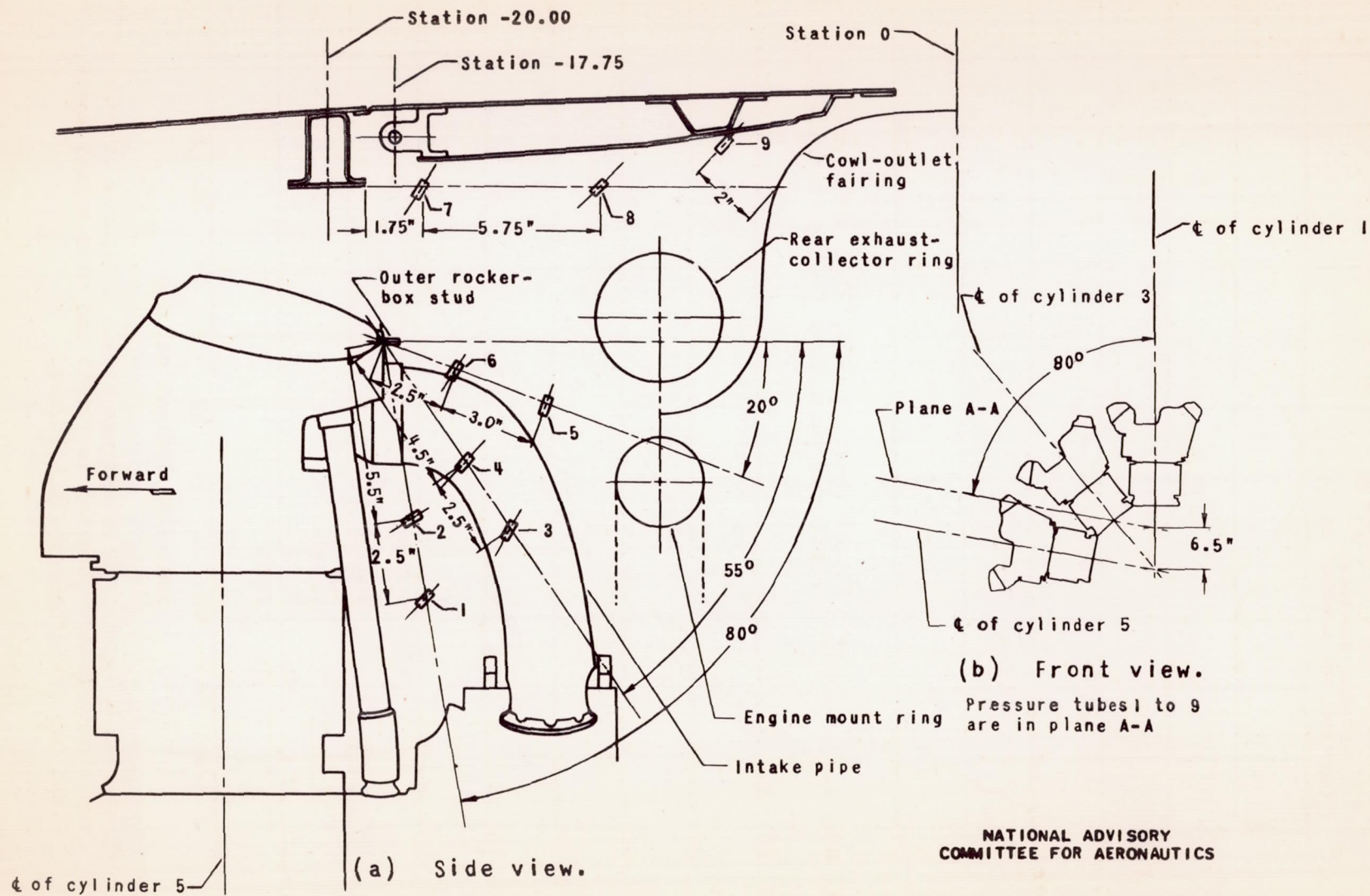

Figure 13. - Location of total-pressure tubes on traverse behind engine.

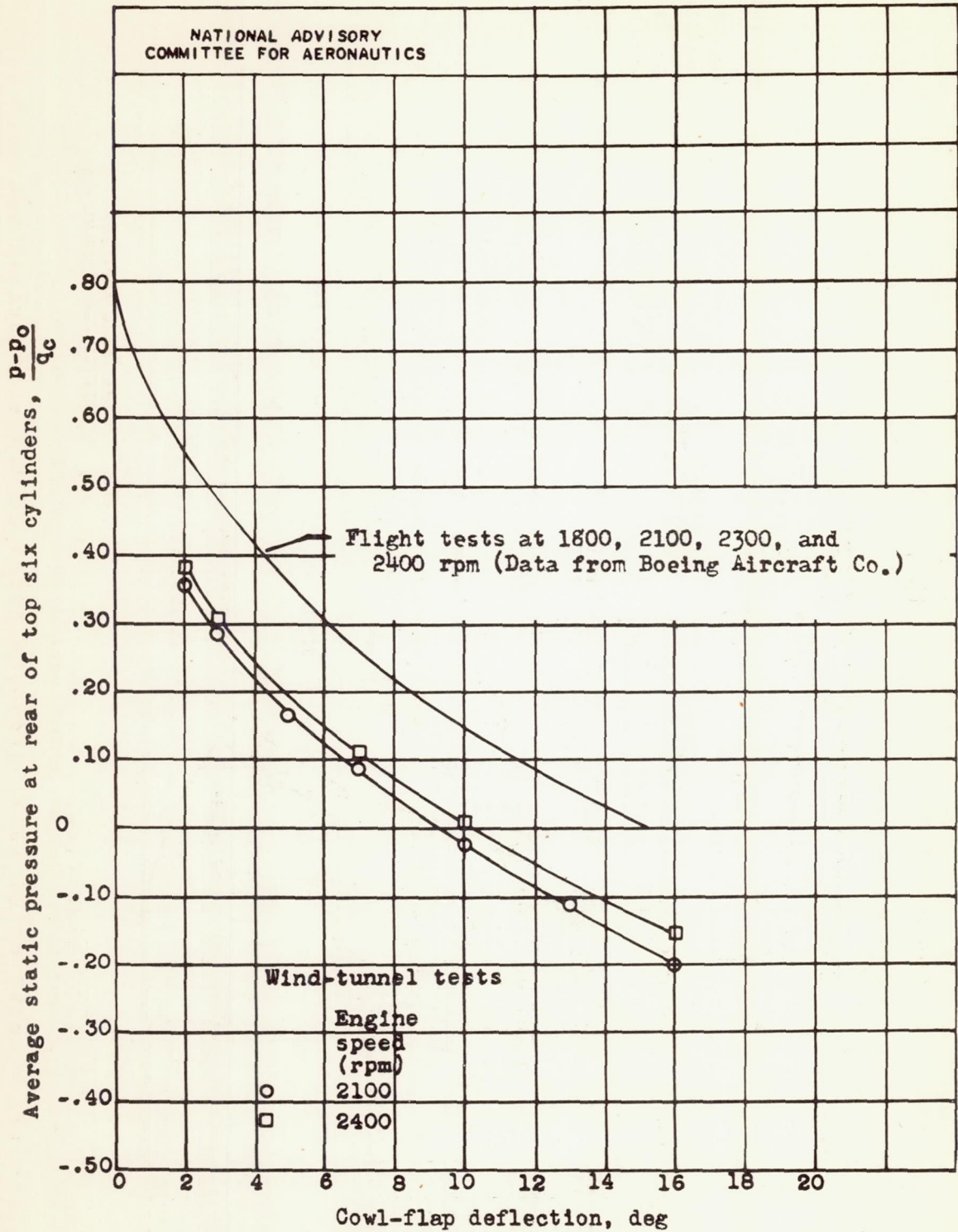

Figure 14. - Comparison of average static pressures at rear of top six cylinders obtained in flight and wind-tunnel tests. Fixed top cowl-flap gap, 2.5 inches.

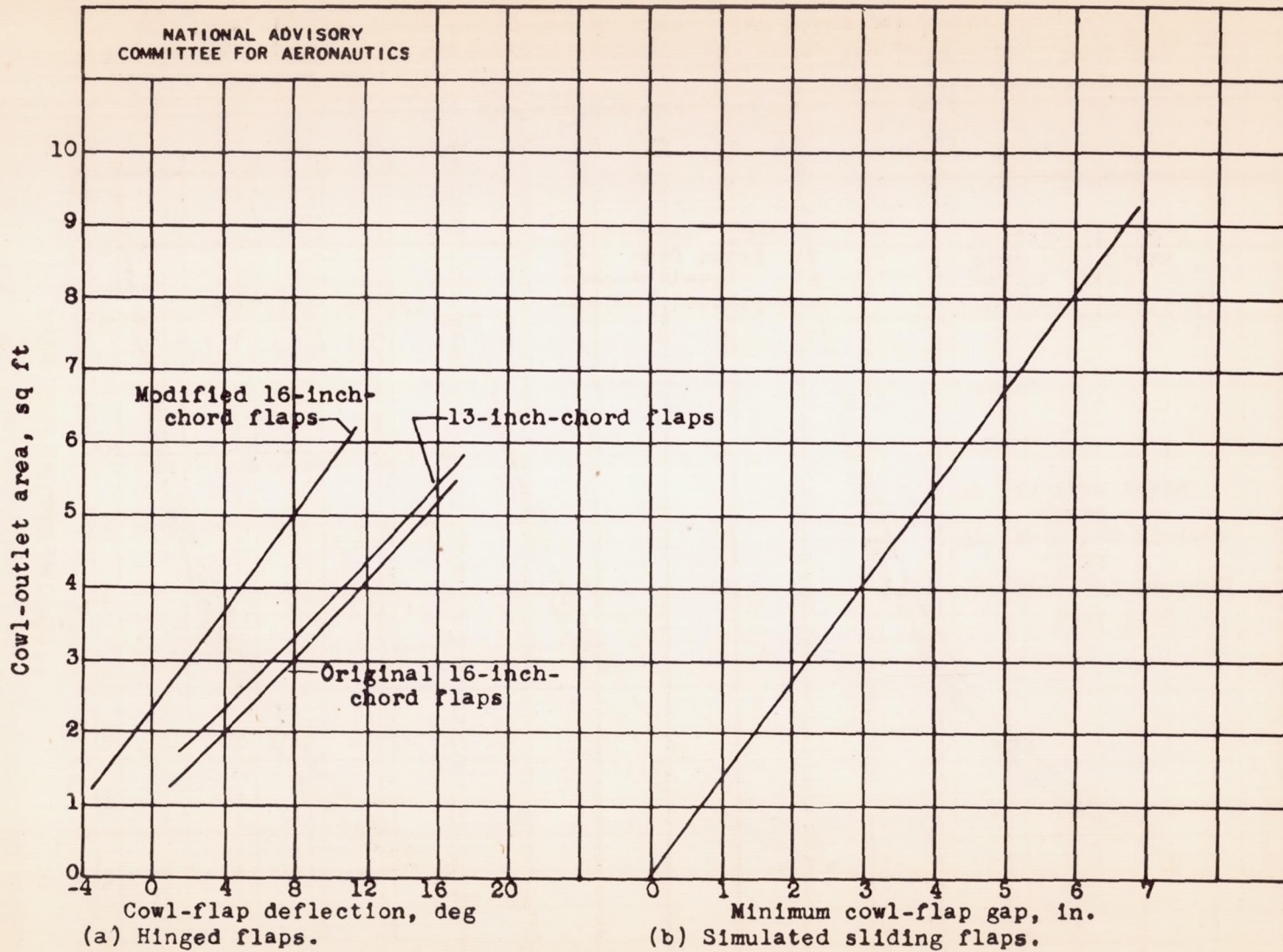
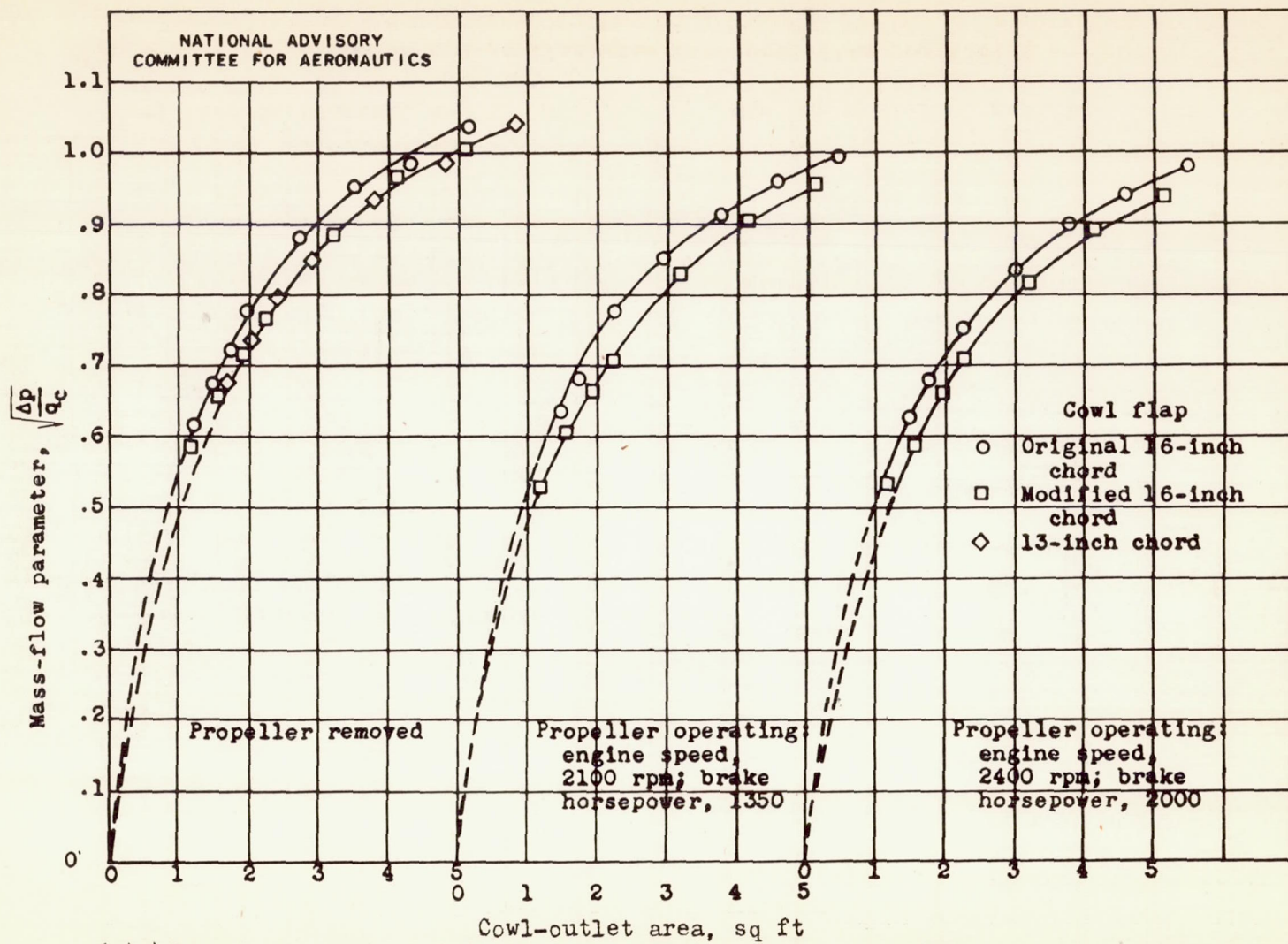
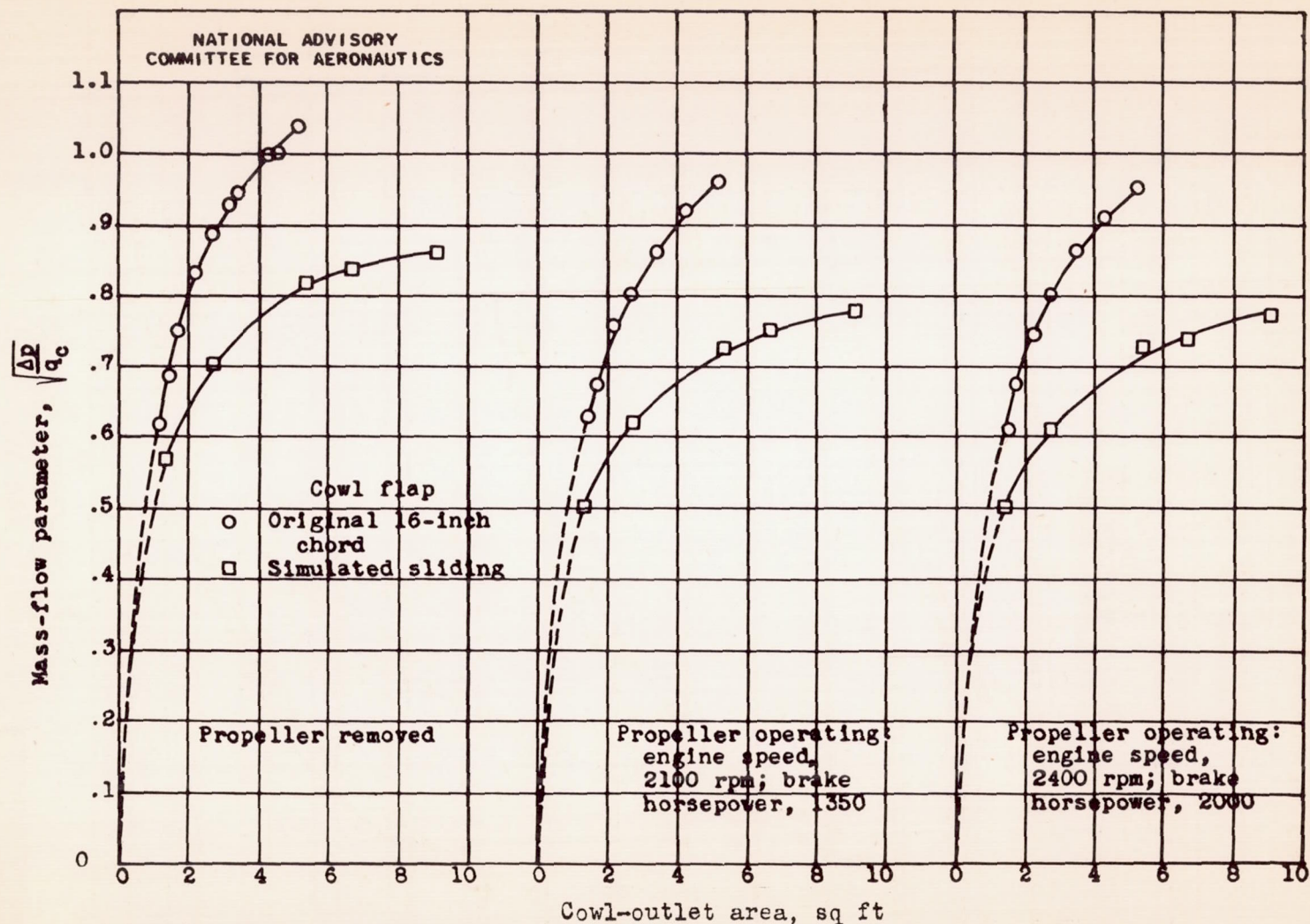

Figure 15.- Variation of cowl-outlet area with cowl-flap position.



(a) 43-inch-diameter cowl inlet.

Figure 16. - Effect of cowl-outlet area on the mass-flow parameter. Pressure altitude, 15,000 feet; indicated airspeed, 190 miles per hour.



(b)  $38\frac{1}{2}$ - by 35-inch oval cowl inlet.

Figure 16. - Concluded. Effect of cowl-outlet area on the mass-flow parameter.

Pressure altitude, 15,000 feet; indicated airspeed, 190 miles per hour.

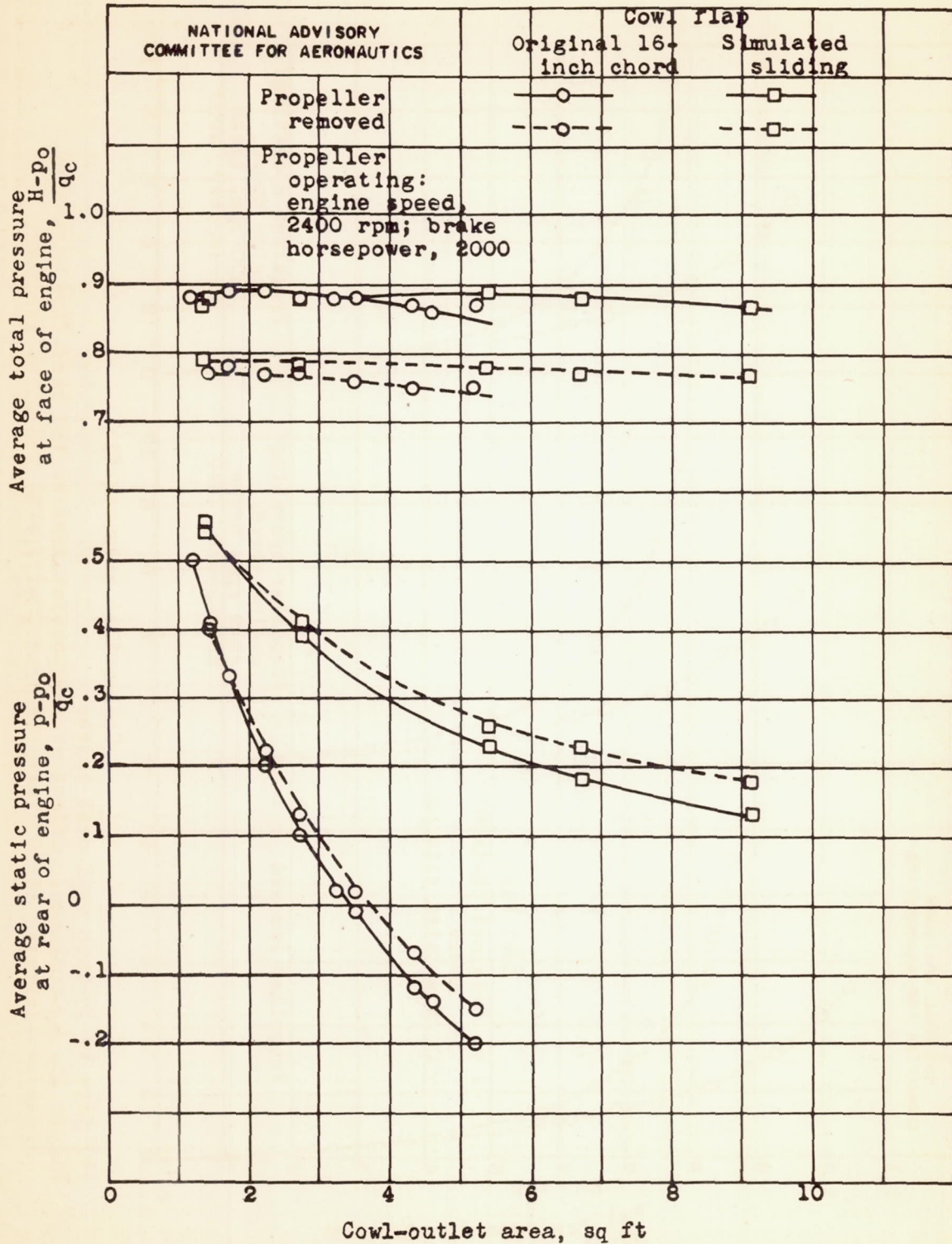

Figure 17. - Effect of cowl flaps and propeller operation on average cooling-air total pressure at face of engine and average static pressure at rear of engine. Pressure altitude, 15,000 feet; indicated airspeed, 190 miles per hour.



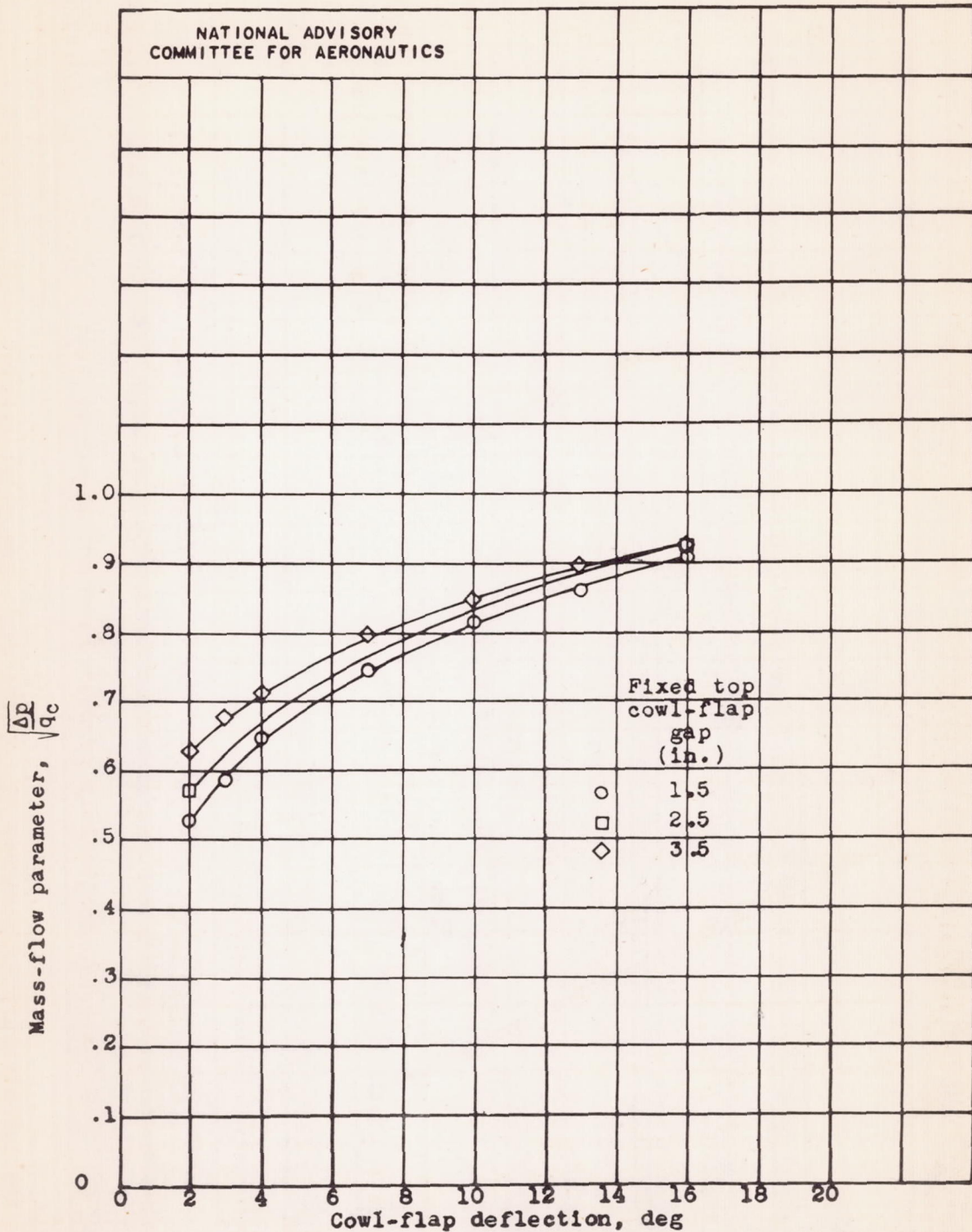

Figure 18. - Effect of fixed top cowl-flap gap on mass-flow parameter for tests with original 16-inch-chord flaps. Engine speed, 2400 rpm; brake horsepower, 2000; pressure altitude, 15,000 feet; indicated airspeed, 190 miles per hour.

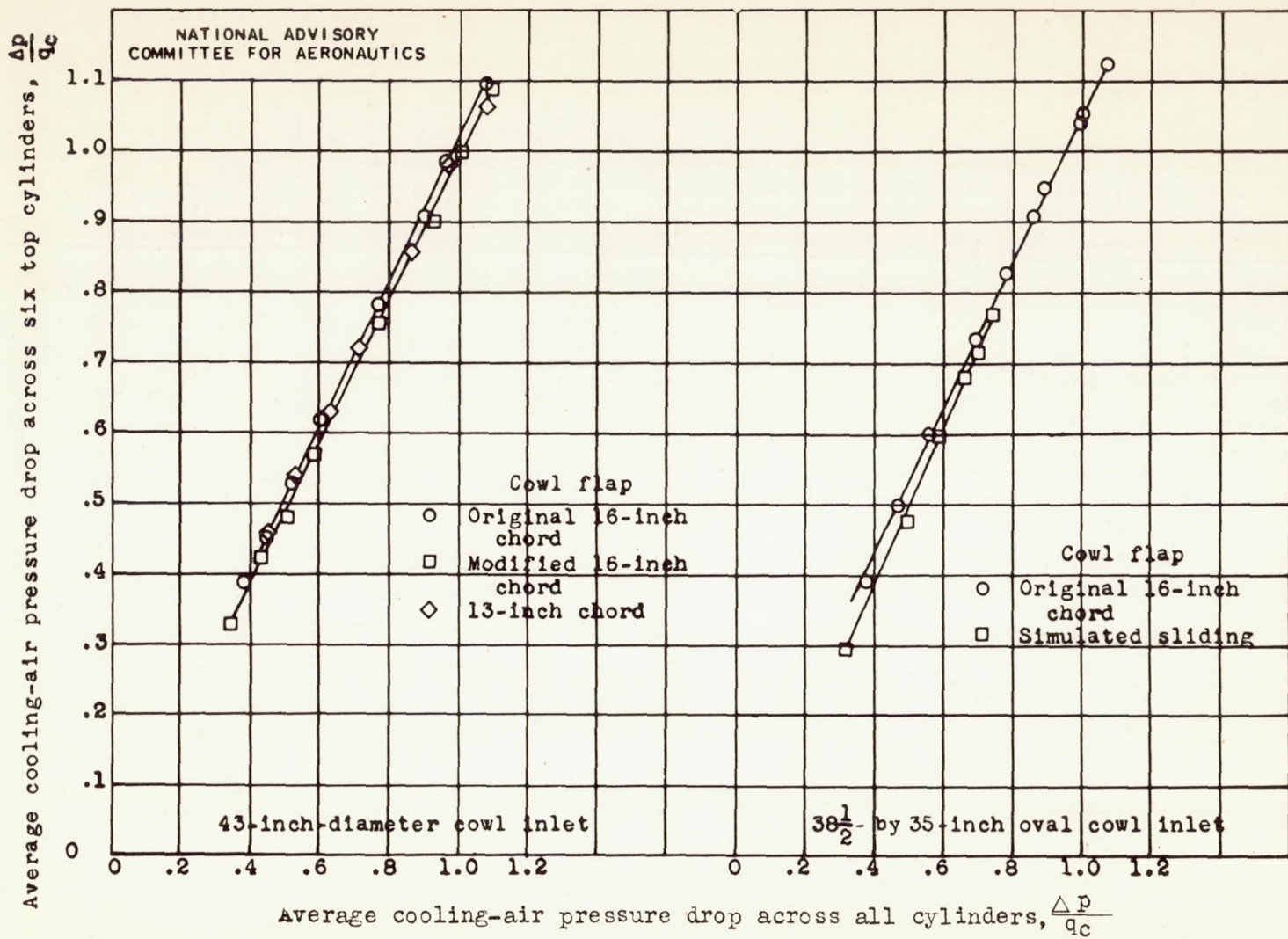

Figure 19. - Variation of average cooling-air pressure drop across six top cylinders with average pressure drop across all cylinders in propeller-removed tests. Pressure altitude, 15,000 feet; indicated airspeed, 190 miles per hour.

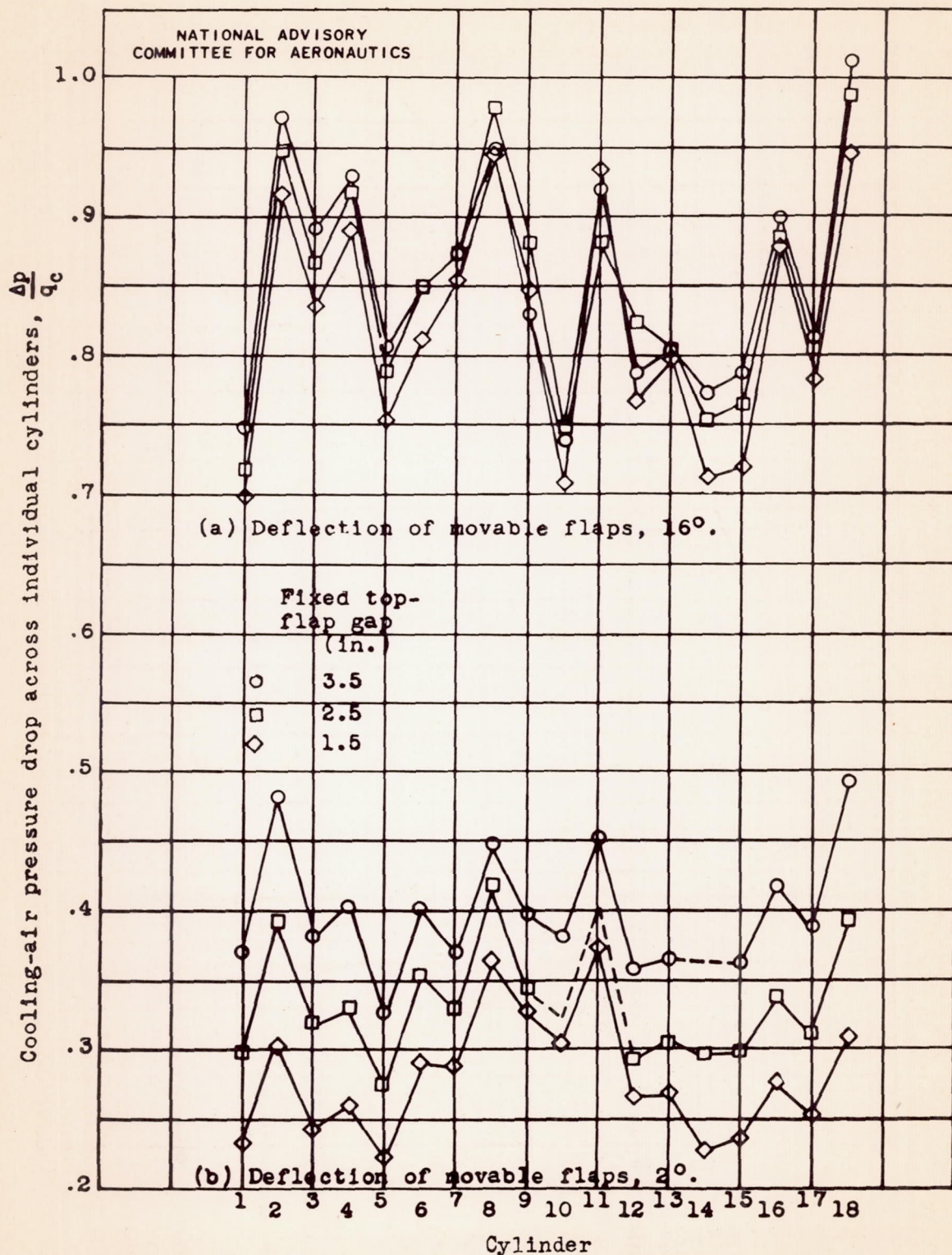

Figure 20. - Effect of fixed top-flap gap on cooling-air pressure drop across individual cylinders. Engine speed, 2400 rpm; brake horsepower, 2000; pressure altitude, 15,000 feet; indicated airspeed, 190 miles per hour.

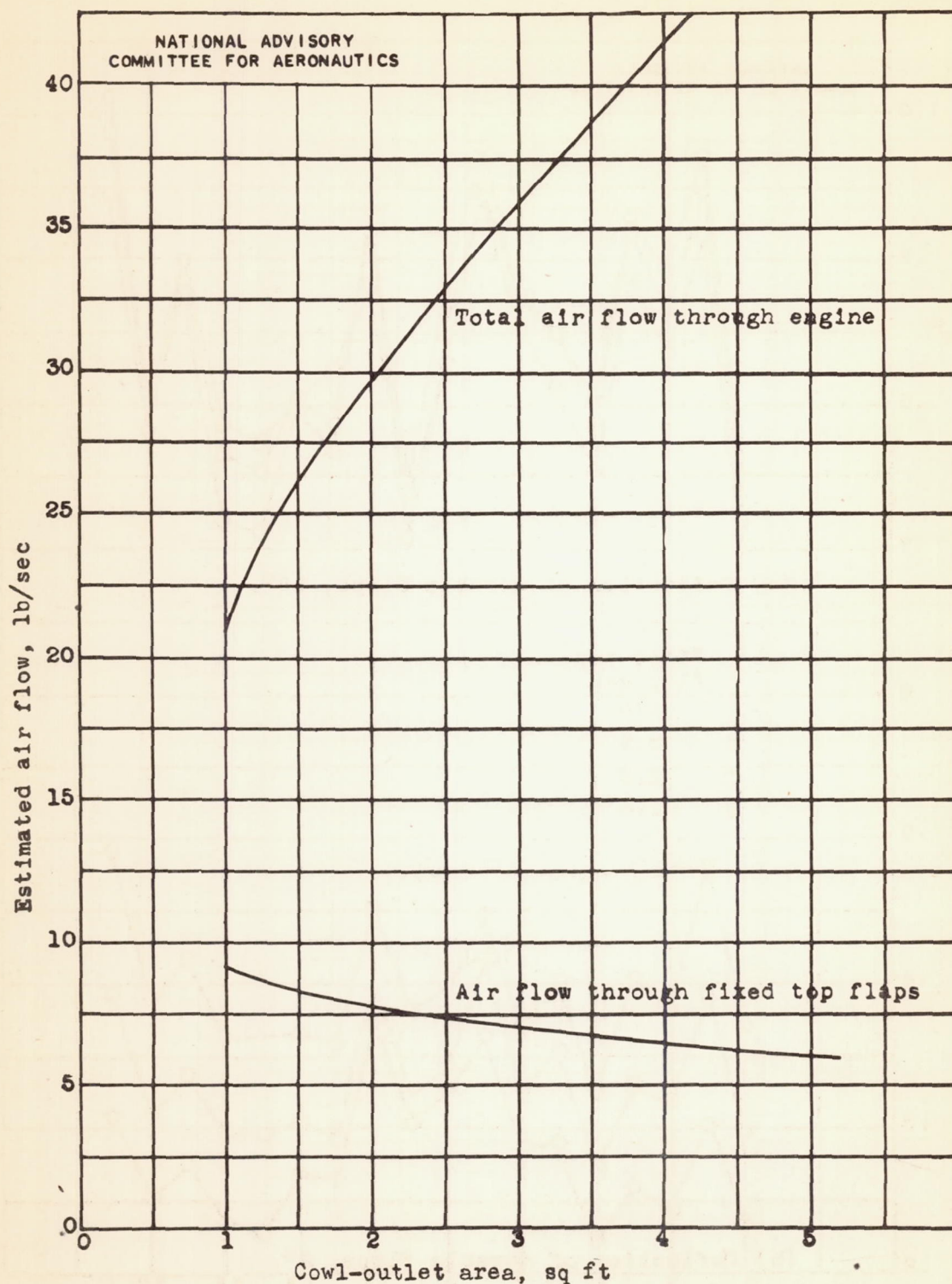
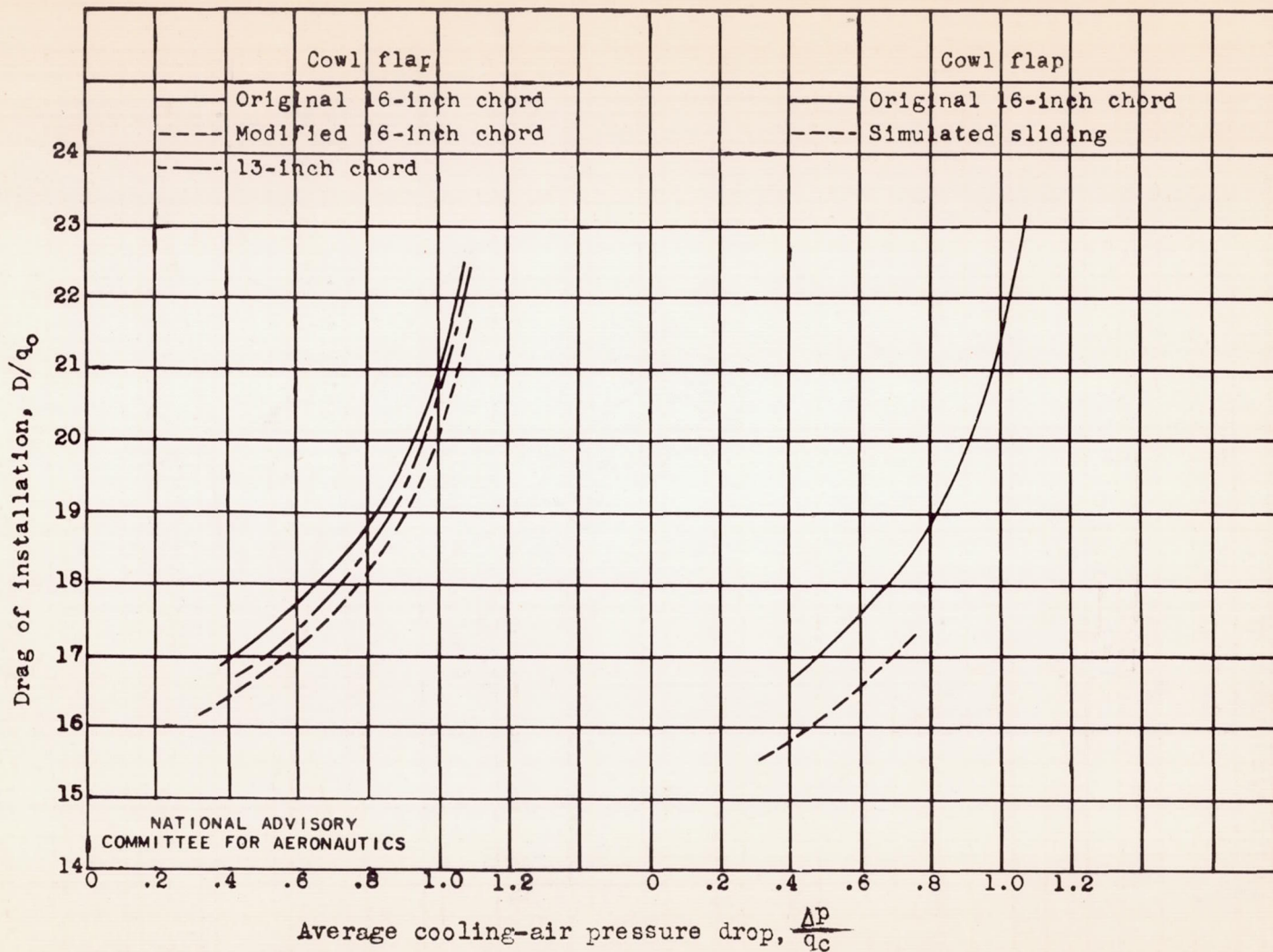

Figure 21. - Effect of cowl-outlet area on estimated total air flow through engine and through fixed top flaps. Engine speed, 2400 rpm; brake horsepower, 2000; pressure altitude, 15,000 feet; indicated airspeed, 190 miles per hour; original 16-inch-chord flaps; fixed top-flap gap, 2.5 inches.



(a) 43-inch-diameter cowl inlet.

(b) 38½ by 35-inch oval cowl inlet.

Figure 22. - Variation in drag of installation with average cooling-air pressure drop. Propeller removed; pressure altitude, 15,000 feet; indicated airspeed, 190 miles per hour.

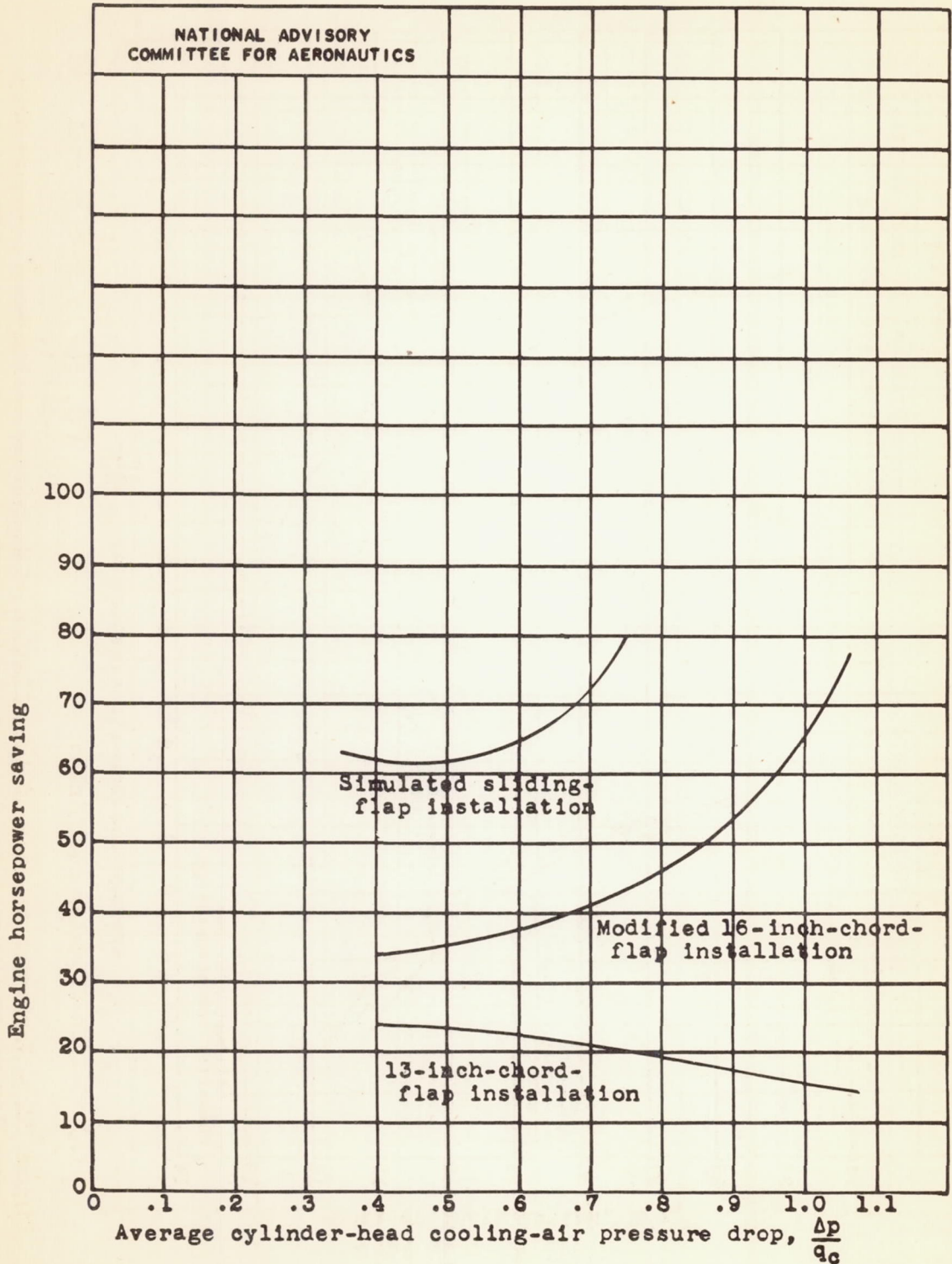

Figure 23. - Engine horsepower savings with various cowl-flap installations, based on power requirements of original 16-inch-chord-flap configuration. Density altitude, 15,000 feet; indicated air-speed, 190 miles per hour; assumed propeller efficiency, 85 percent.

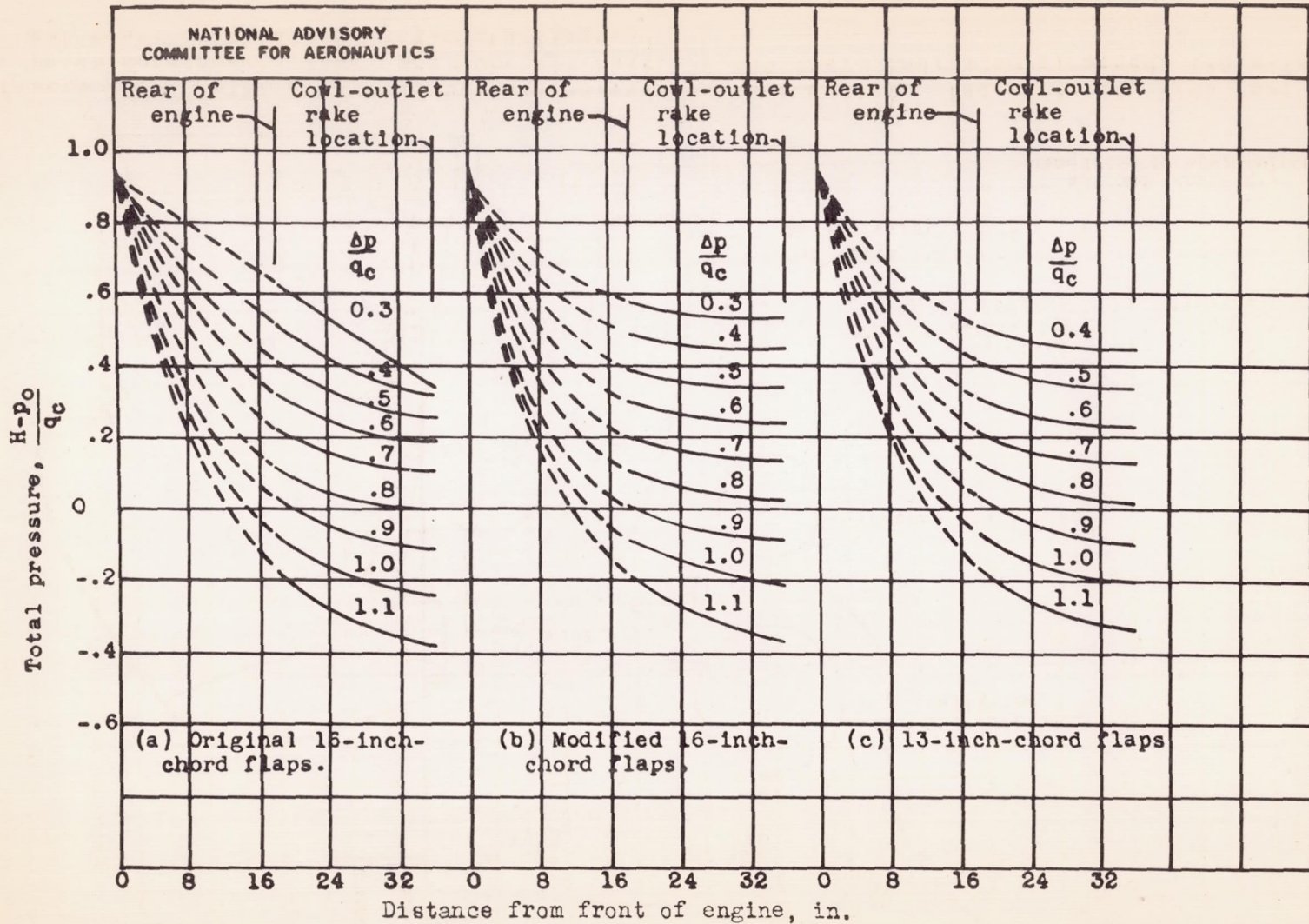

Figure 24. - Total-pressure gradients from front of engine to cowl outlets. Propeller removed; pressure altitude, 15,000 feet; indicated airspeed, 190 miles per hour.

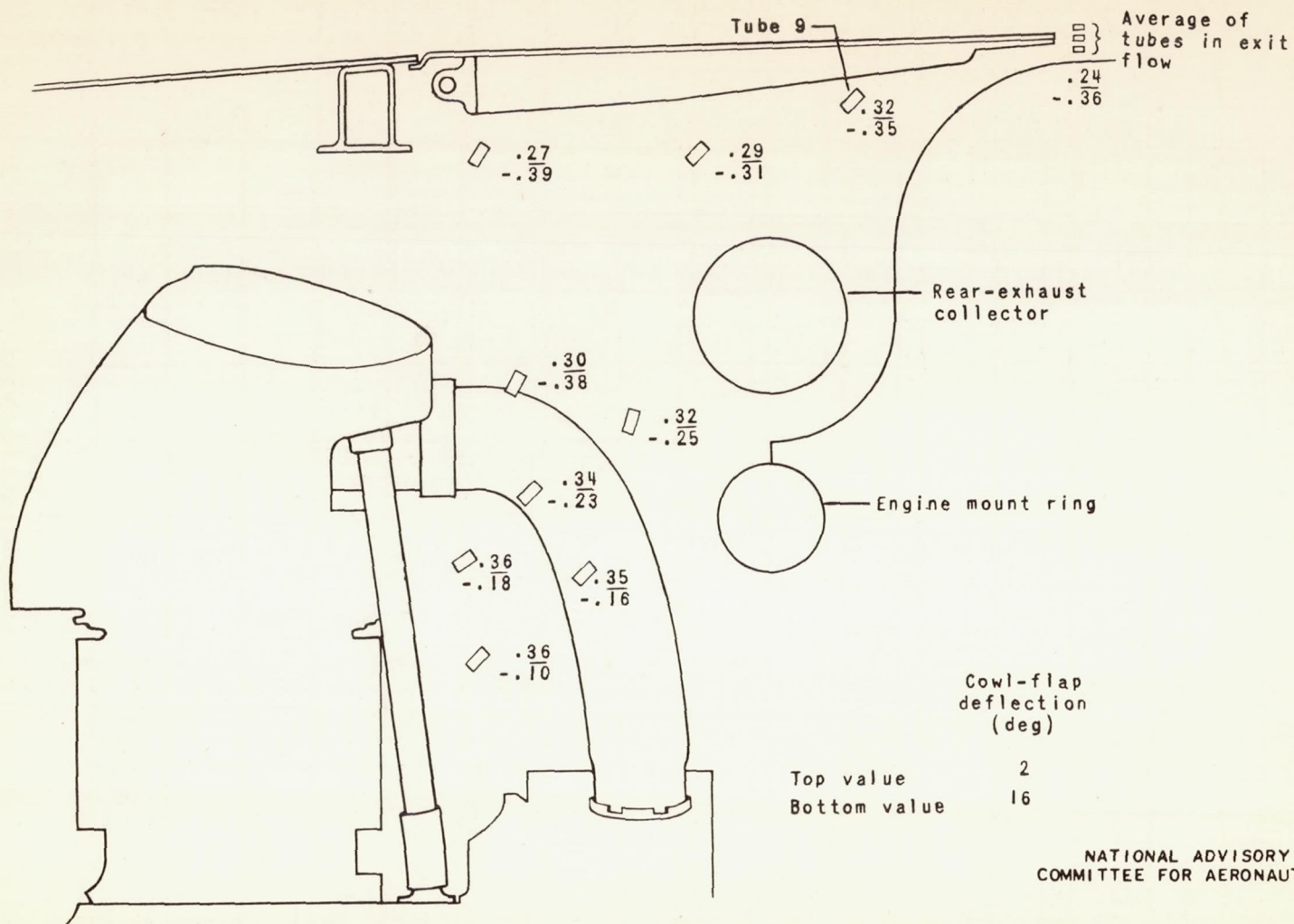

Figure 25. - Total pressures between engine and cowl outlet. Engine speed, 2100 rpm; brake horsepower, 1350; pressure altitude, 28,500 feet; indicated airspeed, 180 miles per hour; original 16-inch-chord flaps.



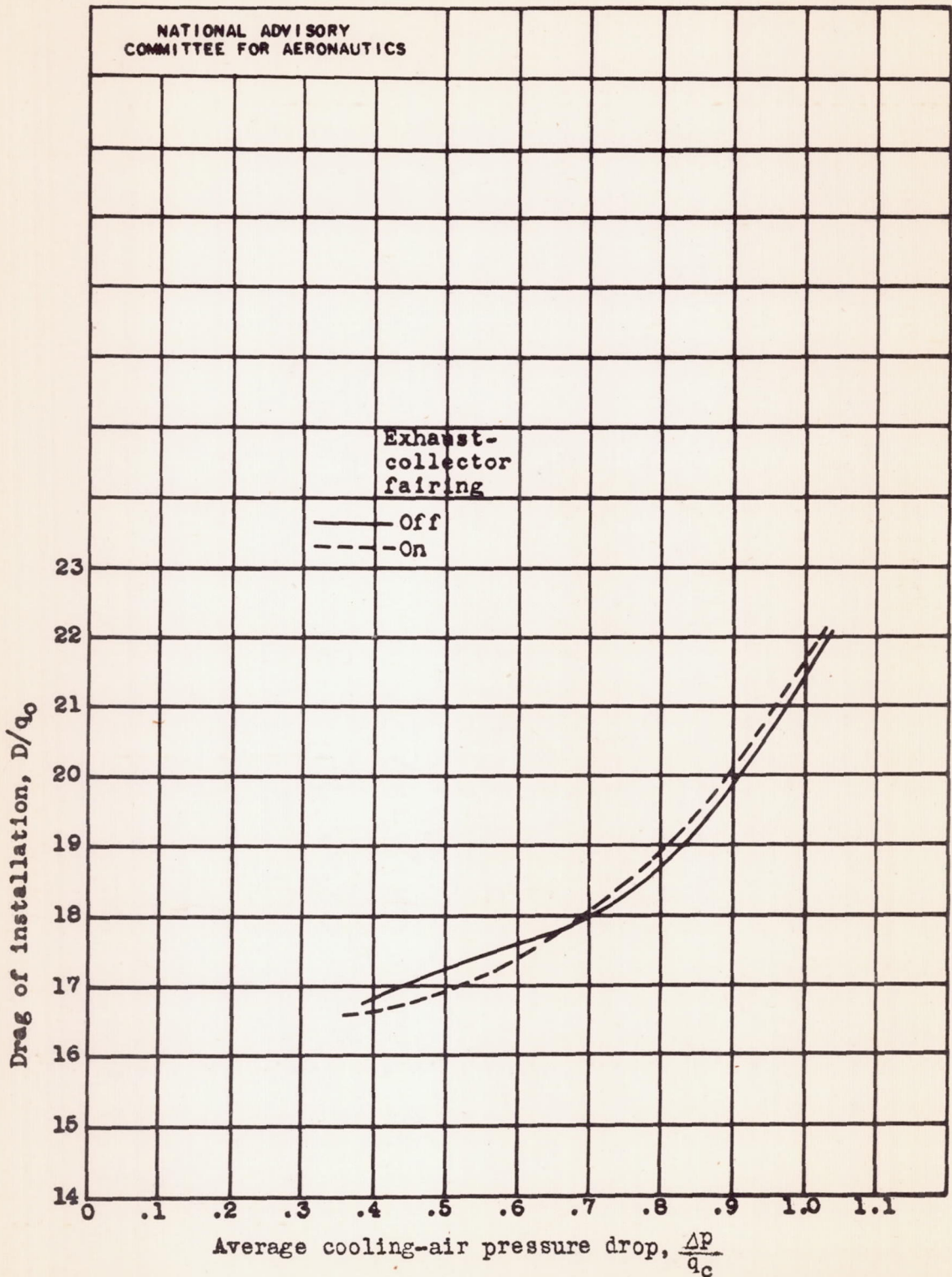

Figure 26. - Effect of rear exhaust-collector fairing on drag of installation. Propeller removed; pressure altitude, 15,000 feet; indicated airspeed, 190 miles per hour.

