

TECHNICAL MEMORANDUMS
NATIONAL ADVISORY COMMITTEE FOR AERONAUTICS

No. 794

CHIEF CHARACTERISTICS AND ADVANTAGES
OF TAILLESS AIRPLANES

By A. Dufaure De Lajarte

Association Technique Maritime et Aéronautique
June 1935

Washington
May 1936

1Q

NATIONAL ADVISORY COMMITTEE FOR AERONAUTICS

TECHNICAL MEMORANDUM NO. 794

CHIEF CHARACTERISTICS AND ADVANTAGES OF TAILLESS AIRPLANES*

By A. Dufaure De Lajarte

The discovery of profiles commonly known as "autostable" but for which a better term would be "self-balanced" profiles, which were unknown in the first days of aviation, was bound sooner or later to bring up the question of the all-wing or tailless airplane. This new idea in airplane design, whose practicability may have been questioned but which is nevertheless based on sound theoretical principles, has now entered a phase of practical construction and in England, Germany, the United States, and France there may now be seen several types of airplanes and motorless gliders deprived of any system of tail surfaces.

Although pilots who have handled this type of apparatus have declared themselves fully satisfied with their flight characteristics - which should be the same as those of ordinary airplanes - it may be proper to ask whether the tailless airplane does possess real advantages and whether it does not, on the contrary, present certain disadvantages from the point of view of engineering or safety in flight.

It is the investigation and study of these advantages and disadvantages that is the object of this paper. As will be seen, these advantages are principally of a practical or tactical order (civil and military airplanes). As such they will not probably find immediate application. They present rather some interesting possibilities for the future. As for the disadvantages, the most important is whether flight itself is possible. Some of these are due to engineering difficulties not met with in the ordinary airplane. Other disadvantages appear to be in connection with safety, but only experience and practice can tell just how large these disadvantages are.

* "Caractères Principaux et Intérêt de L'Avion sans Queue."
Reprint from Association Technique Maritime et Aéronautique, June 1935, pp. 1-37.

This study will be concerned with the critical examination of the two main questions that are of interest. They are: first, the question concerned with "susceptibility of centering"* and more generally the conditions of static stability and longitudinal equilibrium; second, the question of dynamic stability, or at least the damping of longitudinal vibrations about a position of equilibrium that may result from a small variation in the angle of attack. Since these two problems lead to relatively long and laborious computations their complete treatment will be given separately in a supplement to this paper. In the present paper we shall treat in order:

(1) Some general observations on the tailless-type airplane, a brief history and explanation of the principle involved.

(2) A résumé of the problem of centering and the possibilities of flight, and a comparison with the ordinary tail airplane.

(3) Conclusions from the study of dynamic stability (damping of the vibrations about the lateral axis).

(4) An enumeration of the principal advantages of the tailless airplane.

(5) A statement of the disadvantages.

(6) Some significant figures on two French constructions.

(7) Some idea of its possible development in the future.

(8) General conclusions.

In the supplement will be found a general treatment of the conditions of stability and equilibrium at large angles of attack for the conventional and tailless airplanes.

*Translator's note: This term is defined later on.

I. GENERAL OBSERVATIONS

Historical

The first tailless airplane that flew perfectly seems to have been the one designed and built by the Englishman Dunne in 1912. It was a biplane having a very large positive sweepback, the propeller-engine system being placed aft inside the vee. The planes were warped negatively toward the tips and therefore, due to the sweepback toward the rear. This arrangement might be regarded as an airplane having two horizontal tail surfaces connected in a continuous manner to the lift or principal surface. Although this airplane of Dunne may be considered as the first practical tailless airplane, it is no less true that the apparatus with which the great Ader experimented 15 years earlier at Satory was entirely without horizontal tail surfaces. There should also be mentioned the experiments of Arnoux in 1911 with the first all-wing apparatus possessing a double curvature or camber. In 1918 this same Arnoux obtained at Villacoublay some definite results using a cellule with doubly cambered profiles. Among these earlier airplanes should also be mentioned the monoplane Simplex constructed in 1923 and which was studied by Cormer and experimented with by Captain Madon. Unfortunately the airplane crashed during the tests.

Since that time in spite of the efforts made at the Eiffel Laboratory by G. Landwerlin and Berreur to develop the general principles, the tailless airplane retired to the background in France, while in Germany Lippisch began to study the problem thoroughly and experimented with his ideas first on small-scale models, next on gliders, and finally on powered airplanes (1928). Almost at the same time, still in Germany, there appears the work of Kupper, Budig, Soldenhof, Langguth, and others.

It may be said that the general principles of construction of the tailless airplanes were already known at that time and that the characteristic properties of doubly cambered profiles, or more exactly, those having a negative zero lift moment coefficient c_{m_0} , were now at the disposition of inventors or engineers after the theoretical work of Von Mises and the experimental investigation of Abrial. Based on these more accurate data a number of serious studies were undertaken in 1929-30 giving rise to a

large number of patents, the most important being those of G. Abrial and Ch. Fauvel; the former has furnished a concrete basis for further study by constructing a sufficient number of excellent profiles with negative c_{m_0} and utilizing these profiles for the construction of a small touring airplane having all the advantages that could be derived from the tailless-type principle. The latter, Ch. Fauvel, was the first man in France to build tailless airplanes of excellent flight characteristics, first a glider and then more recently a touring airplane powered with a Pobjoy 85 horsepower engine which was put on the recent aeronautical exposition. Following the names of these two inventors should be mentioned that of the engineer Jean Charpentier who likewise recently constructed a multiengine-tailless airplane, the tests on which were unfortunately interrupted by a slight accident. We must still mention Janin who uses the same aerodynamic principles in his construction, although the absence of tail surfaces is not considered an essential condition in his investigations.

About the same time, in 1930, in England, appears the invention of Captain Hill, the "Pterodactyl," which already has been the object of much careful and detailed experimentation both in full-scale flight and in the laboratory using models, and especially in the vertical-spinning tunnel. This design is similar to the sesquiplane which offers an extensive shooting range for the military-type airplane.

Together with this brief history of tailless airplanes, we shall say a few words on the history of double-curvature or "autostable" profiles. These profiles were used, although rarely, long before the detailed characteristics were known and for reasons which do not seem today to be very evident. There was, for example, the "Canard" of Voisin before the War. About 1925 after much progress and experimental study at the laboratory, especially in the measurement of longitudinal moments, there appear profile outlines with constant negative c_{m_0} (Royer, Abrial, Peyret), while the theoretical developments of Von Mises, based on the general theory of Joukowski and the work of Girault, emphasizes the engineering interest of small or negative value for the coefficient c_{m_0} by indicating the importance of geometric parameters for obtaining this result. Since then profiles of low mean curvature or low value of c_{m_0} (less than 0.05, whereas the profiles with

strong camber first used easily reached a value of about 0.15 for c_{m0}) were used to a large extent, all the more, since laboratory tests had shown that these profiles could stand a relatively large increase in thickness without a notable increase in the drag coefficient. Most of this enthusiasm shown for the prototypes that "came out" toward 1927-28 was principally due to the removal of the serious mechanical disadvantages presented by the profiles with large c_{m0} values. Some airplane builders, although they still remained faithful to the traditional rules of airplane technic, saw in these new profiles the possibility of new improvements in flight characteristics, especially in the field of stability (longitudinal); this was a mistake since from the stability point of view, as we shall see more clearly later on, all profiles are equivalent, or nearly so. The stability (or the degree of stability) of a lift surface, a wing or a set of wings, is essentially a matter of centering and in this respect only the form of the profile, together with the way it is arranged, is of importance for obtaining equilibrium of the airplane. However it may be, aeronautical science became aware of the importance of the parameter c_{m0} in the choice of profiles and from the mechanical viewpoint of the airplane this is the essential parameter which will probably play an even more important part in the perfecting and developing of the airplane.

At the present time there are known a certain number of profiles having a small negative value for c_{m0} (between 0 and 0.05) whose polar is comparable with those of the good profiles with positive c_{m0} that have been used for the past 10 years, if the principal characteristics of a profile are considered to be the lift-drag ratio (which is a misleading factor for the case of the simple profile) and the maximum lift coefficient. It is now known that the polar of a profile or a complete wing is of significance in connection with the value of the ratio of the maximum lift coefficient c_z to the minimum drag coefficient c_x . With this as a criterion, the profiles with negative c_{m0} whose minimum c_x may go down to less than 0.01 and whose maximum c_z may reach or even exceed 1.3 do not appear to be generally inferior to the others, especially to those of single camber. In each case of low value of c_{m0} there is confirmed the advantage of doubly cambered profiles (inferiority of biconvex symmetrical profiles

compared with asymmetrical profiles of fixed center of pressure).

These doubly curved profiles with negative c_{m_0} , improperly called "autostable," were indispensable for the conception and development of "tailless" airplanes. Nevertheless, at the present stage of development those characteristics, which we have just pointed out as most important for these profiles, are less applied in practice than in theory, chiefly on account of the following fact. The profile of the wing, at least over part of its span, must have a break in the rear necessitated by attachment of a control surface whose function is to obtain longitudinal control of the apparatus as well as stability at all flight angles. This control surface, which is really a cambered flap, is only in exceptional cases placed along the prolongation of the fixed portion of the surface, and for this reason there is an increase in the drag.

Principle of the all-wing or tailless design.— For every section of a wing considered in the range of angles of attack for which there is no separation of flow the moment coefficient c_{m_G} about any point G in the plane of the profile is given by the following equation which follows from a rigorous formula in which the negligible terms have been omitted.*

$$c_{m_G} = c_{m_0} + \mu c_x - \lambda \left(1 - \frac{c_z}{2k^2} \right) c_z - \frac{\mu}{k} c_z^2 \quad (1)$$

where c_{m_0} is the constant focal moment of the profile, or more precisely, the value of c_m at zero lift; k is the coefficient of the proportionality of c_z with respect to the effective angle of attack i ($c_z = ki$, or more exactly, $k \sin i$), whose value generally lies between 5 and 6, i being given in radians; λ and μ are the "relative" coordinates x_G/l , z_G/l of the point G with respect to the axis F_{x_0} and F_{z_0} defined as follows (fig. 1): F is the focus or aerodynamic center of the profile; F_{x_0} is parallel to the axis of zero lift and directed in the same sense of the relative velocity, F_{z_0} is perpendicular to F_{x_0} and along the direction of positive lift; finally, c_x represents the coefficient of the drag of the profile, that is, corresponding to the effective angle i ; equation (1) is independent of any induc-

*The establishment of this formula will be found in the supplement to this paper.

tion to the right of the section.

Formula (1) is not valid unless the equation $c_z = ki$ holds true. In the supplement to this paper will be found the generalized form of the coefficient c_{mG} (formula (2) applicable to the regions of separation).

Assuming a moderate value for c_z and the sum $c_{m0} + \mu c_x$ being regarded as a constant c_{m1} , equation (1) may be simplified to give the following approximate expression:

$$c_{mG} = c_{m1} - \lambda c_z - \frac{\mu}{k} c_z^2 \quad (2)$$

The static stability of the profile about the axis through G perpendicular to the profile plane depends on the sign of the derivative

$$\frac{dc_{mG}}{di} = \frac{dc_{mG}}{dc_z} \frac{dc_z}{di}$$

From (1), neglecting the variations in c_x , we have

$$\frac{dc_{mG}}{dc_z} = -\lambda + \frac{2}{k} c_z \left(\frac{3}{4k} \lambda c_z - \mu \right) \quad (3)$$

There is a maximum or minimum for this derivative defined by

$$c_z = \frac{2k}{3} \frac{\mu}{\lambda}$$

This value of c_z does not correspond to a usual incidence angle unless μ/λ has a value very much less than unity. According to the signs of λ and μ the variations of dc_{mG}/dc_z are of four different types corresponding to the four cases of figure 2. These figures, although their validity is confined to moderate angles of incidence, clearly show that only a negative value for λ is suitable for an airplane without horizontal tail surfaces (with the usual sign convention assumed for the moments, the condition for stability is $dc_{mG}/di > 0$).

For a complete wing the expression for c_{mG} or its

derivative has an analogous form except in some cases which are unimportant in practice. In order that the formula might retain an absolute significance, it will be regarded as referred to the mean profile of the wing (the section passing through the center of gravity of the projected surface of the half wing), that is, the reference chord l is the chord of this mean profile and the centering of the airplane is found with respect to the focus F of this profile and the corresponding axes F_{x_0} , F_{z_0} (this is not rigorously true for any case whatever but is sufficient for our purposes). The axis F_{x_0} is parallel to the direction of the zero lift of the surface. It is understood that G now denotes the center of gravity of the airplane.

In what follows we shall assume that equations (1), (2), and (3) refer to the wing, c_z being the lift coefficient of this wing, c_x its "profile" drag, i the effective angle of attack in the usual sense which is connected with the total angle of attack by the relation $i = m\alpha$,

where $m = \frac{1}{1 + \frac{K}{\pi A}}$, A being the effective aspect ratio

of the wing. The degree of stability $\Sigma = \frac{dc_{mG}}{d\alpha}$ has the same sign, whatever the value of α , as the derivative $\frac{dc_{mG}}{di}$ and may be studied as regards sign from the variations of the latter.

For simplification we shall regard the fuselage as being an integral part of the wing. In straight flight and at moderate angles of attack the stability of the airplane is expressed according to equation (2) by the condition

$$c_{m_1} = \lambda c_z - \frac{\mu}{k} c_z^2 = 0 \quad (4)$$

Assuming a condition of stability ($\Sigma > 0$), c_{m_1} or c_{m_0} appears as a decreasing function of c_z ; c_{m_1} will be positive for $c_z < 0$, 0 for $c_z = 0$ and negative for $c_z > 0$. Since the term μc_x in practice should always be very small, it may be seen that a tailless airplane, and in particular one without any auxiliary surface separated from

2Q

the lifting element, requires the use of profiles having negative values of c_{m_0} .* The upward deflection of the controls should increase at the same time the angle of attack increases (the same action as raising the elevator surface on the usual type of airplane). If there had been static instability within a certain range of angles of attack, this law of deflection would be reversed and the apparatus would become impossible to maneuver (general characteristic of static instability). In brief, it is possible for an airplane to dispense with all auxiliary stabilizing surfaces if the two following general conditions are fulfilled:

(1) Centering is forward of the wing focus or aerodynamic center (at least 25 percent approximately from the chord of the mean profile).

(2) The wing profile or at least the mean profile must have c_{m_0} negative (airfoil with pronounced double camber).**

It should be recalled that the first of these conditions is the condition of static stability; the second is required for equilibrium.

* It is clear that this result is characteristic chiefly of the normal state of the wing profile, that is, with flap neutral. This normal state, having the minimum aerodynamic resistance, should correspond to the normal flight of the apparatus, full speed, or cruising speed. As will be seen later, the value of c_{m_0} of this normal profile will always be very small in absolute value (at the most equal to 0.02). Equation (4) indicates moreover that this coefficient varies algebraically in a sense opposite to that of μ ; it may become positive for a sufficiently large negative value of μ (parasol wing). The requirement for a normally negative value of c_m for a tailless airplane is therefore not absolute, but a consequence of fact.

** Of course a normal profile is here being considered. As will be seen later, its c_{m_0} will always have in practice a very small value of the order of -0.01 or -0.02. It will also be seen what limiting value below 0 c_{m_0} could assume when the flap is deflected upward so as to obtain equilibrium at the larger flight angles.

II. THE CENTERING SUSCEPTIBILITY AND THE LIMITING VALUES
OF THE FLIGHT ANGLES: COMPARISON WITH THE
ORDINARY AIRPLANE WITH TAIL SURFACES

We call the "centering susceptibility" of a given apparatus the characteristic this apparatus possesses for permitting more or less large displacements of the center of gravity without compromising the necessary conditions of flight at all angles of attack within a certain range (stability and equilibrium). A study of this characteristic consists in the determination of the limits within which the center of gravity must remain in the plane of symmetry of the airplane. In this problem the position of G will be given by the coordinates λ and μ as we have defined them above. For an apparatus of the tailless type the limits of the center of gravity travel, that is, the limiting values of λ and μ are determined by two conditions:

(1) Absolute requirement of static stability at all possible angles of incidence.

(2) The necessity for being able to attain in flight and in landing a limiting angle that should not be too small, the coefficient c_{m_0} of the wing (flaps deflected upward) being fixed at a given value $-C$, regarded as a practical limit.

The expression for these conditions, in which all the parameters upon which the flight of the airplane depends would be explicitly given, would lead to very complicated results. For this reason we have limited ourselves to the treatment of a single concrete case corresponding on the average to what would occur in practice. Moreover, we have assumed the body of the apparatus to be designed and attached to the wings in such a manner that the whole has a homogeneous and well-defined aerodynamic character (all-wing or "habitable" airplane). With these conditions it is found that the region of centering is an area limited by: (See the supplement.)

(1) Two straight lines δ_1 and δ_2 passing through the origin and having angular coefficients of 5 and -3, respectively.

(2) The two straight lines CA_1 and CA_2 whose equations are:

$$\lambda + 12.5 \mu + 55 \frac{\epsilon_1}{k} = 0$$

$$\lambda - 8.5 \mu + 25 \frac{\epsilon_2}{k} = 0$$

where ϵ_1 and ϵ_2 are numerical coefficients whose value is of the order of 0.5 or 0.7 according to the flow conditions at large angles of incidence.

(3) The straight line whose equation is:

$$(1 + 0.45 i_l^2) \lambda + i_l (0.83 - 0.9 i_l^2) \mu = (-C + c_{m2}) \left(i_l + \frac{0.17}{i} \right) + \epsilon_2 (i_l^2 - 0.02) \quad (5)$$

where c_{m2} denotes the moment coefficient assumed constant which is due to secondary elements of the plane (landing gear in particular); C is the limiting value for $-c_{m0}$; i_l the maximum (effective) angle of incidence that will be used in flight.

The point C is, in fact, very far removed toward the left of the diagram so that within the region of centering (cross-hatched region in fig. 3), the segments $A_1 D_1$ and $A_2 D_2$ may be considered as horizontal. We shall then have in general:

$$\lambda_{A_1} \approx -0.07 \text{ to } -0.12$$

$$\lambda_{A_2} \approx -0.08 \text{ to } -0.13$$

$$\mu_{A_1}, \mu_{D_1} \approx -0.35 \text{ to } -0.6$$

$$\mu_{A_2}, \mu_{D_2} \approx 0.25 \text{ to } 0.4$$

The slope t of the straight line Δ decreases (in absolute value) as i_l increases but varies rather slowly. On the other hand, the abscissa λ_B of the point B where

Δ meets the axis of λ , and is given very nearly by

$$\lambda_B = (1.7 - 3.3 i) (-C + c_{m_2}) + \epsilon_2 (i^2 - 0.2)$$

varies considerably with the value given for i_l . The factor ϵ_2 being of the order of 0.5 to 0.7, if i_l is made equal to 0.2 or 11.5° , which may correspond to a total incidence angle α of 16° , the term $\epsilon_2 i_l^2$ is of the order 0.02 to 0.03. Assuming $c_{m_2} = 0$ (which is practically true in many cases) and taking $C = 0.06$, we then have $\lambda_B = -0.05$ or -0.02 and as may be seen λ_B depends very much on the coefficient ϵ_2 . The point D_1 will be found on the straight line δ_1 and for D_2 we shall have

$$\lambda_{D_2} = \lambda_B + \frac{1}{t} \mu_{A_2} = \lambda_B - (0.04 \text{ or } 0.06)$$

$$\lambda_{D_2} = -0.09 \text{ or } 0.08$$

Practically there will always be obtained a diagram resembling that shown in figure 4 and 4 bis, according to the value of ϵ_2 ; OD_1 has a slope of +5, OA_2 of -3;

$A_2 D_2$ is horizontal, the ordinate being $2.9 \frac{\epsilon_2}{k}$; $D_1' D_2$ has a slope included between -4.5 (relatively large value for i_l) and -6.5 (small value for i_l of the order of 11°); $-\lambda_B$ is at the most equal to 0.06.

Let us assume i_l is given as the limit of positive angles of incidence. The coordinate μ will have a certain fixed value, λ is constrained to well-defined limits whose interval is a maximum for $\mu = 0$. Therefore each time that the vertical variations in the centering becomes small, it will be necessary to arrange the wing in such a way that the mean section is at the height of the center of gravity (low wing with a definite dihedral or intermediary wing without much dihedral). Since the range of λ decreases rapidly as μ becomes negative, it may be seen that the high wing with dihedral and even more so the parasol wing would be at a disadvantage; that is, the horizontal travel of the center of gravity will be very small or there will be the danger from instability at negative lift.

With λ fixed, there similarly results a definite range for μ ; above the focus ($\mu > 0$) (aerodynamic center) this range is well-defined and independent of i ; below the focus ($\mu < 0$) the range varies considerably both with the value of λ and the value of i_l . As a matter of fact, the negative value of μ can only be very small in absolute value.

The essential parameter on which the "centering susceptibility" of a tailless airplane depends is the limit i_l of the positive angles of incidence. In order to increase λ_B and therefore the dimensions of the centering area, it is necessary to reduce i_l , that is, to employ lower angles of incidence for the plane. For $i_l = 11.5^\circ$ ($\alpha \approx 16^\circ$), $c_{m2} = 0$ and $C = 0.06$, the horizontal range at $\mu = 0$ will be below 3 percent, which is very small. Now, $i = 11.5^\circ$ is already a relatively small incidence angle, in most cases clearly below the incidence for maximum lift. In order to have a larger range, that is, to be able to center the apparatus more forward it would be necessary to assume an even smaller incidence limit (for example, $\alpha < 15^\circ$), that is, a very moderate value of the order of 1 for the maximum absolute value of c_z which may be considerably lower than the maximum c_z of the polar. As far as landing is concerned this results in first, a decrease in the landing speed with respect to the minimum theoretical speed indicated by the polar and second, in the requirement of giving the airplane a relatively small ground angle which in turn necessitates suitable arrangement for the landing gear. If such a special arrangement is omitted, that is, if the airplane while resting on the ground on its three points presents too large an angle (greater than 15° , for example) then it will be either impossible in landing to have the airplane come down normally or it will be necessary to land all the time on the wheels, which practically necessitates a certain increase in speed.

In citing the figures above we have assumed the coefficient c_{m2} to be zero or negligible. In the majority of cases occurring in practice c_{m2} if not zero is positive; this coefficient is, in fact, due mostly to the landing gear (diving moment). Where we have a group or groups of raised propellers (placed at a certain height above the wing) that part of c_{m2} which is due to the

drag of the nacelle, of the engines as well as the propellers, at low speeds, is negative (stalling moment). This circumstance is therefore favorable to landing (increase of i_l at a given limit of centering) or permits an advancement of the centering for a given i_l , but it is unfavorable (c_{m_2} positive) for starting (i_l may become less than the angle of incidence at which it is desired to take off).

Since the drag of the landing gear introduces a negative element in the coefficient c_{m_2} , it results that well streamlined landing gear has an advantage over retractable landing gear (from the point of view of centering).

In short, for a tailless airplane "centering susceptibility" is always small but depends very much on the upper limit of the angles of incidence that are desired in flight; the higher the incidence limit desired, the smaller it is. In any case, this maximum incidence angle is itself limited above a certain low value which is in general considerably below the maximum lift angle of the polar. From this results a considerable limitation in the lift coefficient c_z which normally cannot exceed the value of 1. This advantage might be overcome by the use of wings of relatively small aspect ratio. This would permit an increase in the range of centering or an increase in the maximum amount of lift that may be obtained.

Remark.- If the airplane includes a fuselage clearly distinct from the lifting surface and streamlined, it is necessary in the computations to consider separately the aerodynamic action on this fuselage, as in the case of an ordinary airplane. The centering being given with respect to the focus of the lifting surface, the centering limits are advanced with respect to their corresponding positions in the case of a pure wing, but the range will not be appreciably affected and everything that was said above still applies approximately.

Comparison with an Ordinary Airplane

For an airplane provided with rear tail surfaces having a fixed part and a movable part, the centering is limited on the one hand by the condition of static stability at all angles and on the other by the condition that it be possible to maintain equilibrium at the largest angles of inci-

dence of which the apparatus is capable. This second condition applies especially to landing, in which maneuver the angle of attack being practically determined by the attitude of the plane, it is indispensable, in order that a correct landing be made that longitudinal equilibrium be possible at this angle. This condition would not affect the centering if the tail surfaces were entirely movable; in fact the centering is limited by conditions which depend on the trimming of the tail surfaces and especially on the magnitude of the movable surfaces with respect to the fixed surface. In practice, however, these two parameters vary but slightly, thus permitting a simple law for the forward centering limit which in every case is sufficient for actual study.

The centering being defined as above by the relative coordinates λ and μ (origin taken at the focus of the wing with axis of the abscissas along the direction of the zero lift of the wing), the region of centering is determined by the four following inequalities (See the supplement):

$$\lambda + 0.2 \mu - 0.9 \left(c_{m_0} + c_{m_2} + 0.15 \epsilon_z + c_{f_a} \frac{FL}{Sl} \right) - 0.04 k' m' \frac{sD}{Sl} \geq 0 \quad (6)$$

$$\lambda - \left(1 - p \frac{s}{S} \right) \left[p \frac{sD}{Sl} - \frac{\kappa (1 - \delta')}{km} \frac{FL}{Sl} \right] \leq 0 \quad (7)$$

$$\left(1 + p \frac{s}{S} \right) \lambda + \frac{1}{3} \mu - 1.04 \left[p \frac{sD}{Sl} - \frac{\kappa (1 - \delta')}{km} \frac{FL}{Sl} \right] \leq 0 \quad (8)$$

$$\left(1 + p \frac{s}{S} \right) \lambda - \frac{1}{4} \mu - 1.015 \left[p \frac{sD}{Sl} - \frac{\kappa (1 - \delta')}{km} \frac{FL}{Sl} \right] \leq 0 \quad (9)$$

where the letters have the following meaning:

k , the coefficient of proportionality of c_z to the effective angle of incidence (region of moderate angles of incidence).

k' , the same for the tail surfaces.

S , the effective wing surface.

s , the effective tail surface.

D , distance from the focus (aerodynamic center) of the tail surface to the focus of the wing.

m , ratio of the effective angle of incidence i of the wing to the total incidence angle α within the range of small incidence angles.

m' , the corresponding ratio for the tail surface.

δ , the ratio of the angle of deflection at the right of the wing surface to the angle of attack α of the main wing.

$p = \frac{k'm'(1-\delta)}{km}$, coefficient of effectiveness of the tail surface.

c_{m_0} , constant aerodynamic moment of the wing for the mean chord l .

c_{m_2} , the constant moment coefficient of the elements of the airplane outside those of the wing, tail surface, and the fuselage (that is, the parasitic resistance of the strutting and landing gear whether the usual or retractable type).

F , maximum cross section of the fuselage.

L , total length of the fuselage.

c_f , the moment coefficient of the fuselage with respect to the center of gravity (or a neighboring point since this coefficient varies slightly; in fact, when the point remains in a somewhat extended region).

The coefficient c_f occurs in the defining formula:

$$M_f = \frac{\rho}{2} c_f FLV^2$$

At moderate angles of incidence we may write approximately:

$$c_f = c_{f_0} - \kappa [\alpha (1 - \delta') - \gamma]$$

α still being the angle of attack, $\delta'\alpha$ the mean deflection at the fuselage and γ the inclination of the axis of zero lift of the wing to the zero lift axis of the fuselage; κ is a positive coefficient which may be considered constant for all moderate values of $\alpha - \gamma$ (angle of attack of fuselage); c_{f_0} is a constant of the fuselage

and may be positive or negative. In the condition (6) c_{f_a} denotes the value of c_f at the landing angle of attack. This value is always clearly negative (stalling moment).

Figure 5 shows the limiting region of the centering; the ratio s/S varies in general between the limits 0.12 and 0.15, $sD/S\bar{l}$ between 0.28 and 0.35, p between 0.3 and 0.55. The factor $c_{f_a} \frac{FL}{S\bar{l}}$ appears most often to be included between the values -0.05 and -0.15; the quantity $\frac{\kappa(1-\delta')}{\text{km } S\bar{l}} \frac{FL}{S\bar{l}}$ lies between 0.02 and 0.05. For most present-day airplanes c_{m_0} varies between 0.03 and 0.07, and c_{m_2} between -0.005 and +0.02.

From these data it is found that λ_B may vary approximately between 0.07 and 0.16, $\lambda_{B'}$ between -0.03 and +0.20. This last figure shows that the equilibrium condition may be impossible for certain airplanes at large incidence angles and that in any case it reduces considerably the range of centering. From this point of view the parasol-type airplanes similarly to the tailless airplanes are distinctly unfavorable. On the contrary, those types of airplanes for which the center of gravity is almost at the height of mean focus (low or intermediate wing) having a more favorable range of centering. It is for $\mu = 0$ that the horizontal centering range is the largest (as for a tailless airplane). In a certain number of practical cases $\lambda_{B'}$ is of the order 0.07, but the average present-day value, however, of λ_B is about 0.10 or 0.12 (centering limited to 35 or 36 percent of the chord of the mean profile). Under these conditions the maximum horizontal range (at $\mu = 0$) is of the order of 3 to 5 percent but for other cases it may be much higher (15 percent, for example). This range is the larger, the greater the "action" coefficient of the tail surface $p \frac{sD}{S\bar{l}}$, the smaller the c_{m_0} coefficient of the wing, the better the streamlining of the fuselage and especially the better the wing profiles behave at the large incidence angles (stable flow without much displacement of the center of pressure toward the rear).

On the average $p \frac{sD}{S\bar{l}}$ is of the order of 0.15 and

$\frac{k(1 - \delta')}{km} \frac{FL}{Sl}$ of the order of 0.03. It may therefore be seen that about $1/5$ of the stabilizing action of the wing is effective against the counterstabilizing action of the fuselage.

If these results are compared with those of tailless airplanes, it may be seen immediately that the range of centering with respect to the average chord of the wing, although in these two cases it may be very small or negative, has a wide range of variation for the ordinary airplane whereas it is narrowly restricted in the case of the tailless airplane. Moreover this wide range permits the usual type of airplane to land at the desired incidence angle fixed in our computations at a value that is clearly above the maximum angle of lift. On the other hand, the tailless airplane, such as we have assumed, having a very small region of centering, is unable to exceed even in flight or in landing a very moderate incidence angle, much less than the angle for maximum lift.

It should be further remarked that it is always possible if necessary to extend the lower centering limit of an airplane with tail surfaces by increasing the amount of the surface (especially the span). This is not possible for the tailless airplane. At most it is only possible to decrease the aspect ratio of the wing; besides, all the tailless airplanes that have been built up to now in France, as well as outside of France, show a tendency toward small aspect ratio. At any rate this is not a very effective method and presents several objections as we shall point out later.

III. DYNAMIC STABILITY

(Damping of Vibrations about Lateral Axis)

Since we are still concerned only with the order of magnitudes, we may simplify the question of dynamic stability (which is, in fact, rather complicated) by considering only those vibrations about an axis perpendicular to the plane of symmetry of the airplane and passing through the center of gravity and assumed fixed in space. These vibrations may arise from a small displacement from the position of equilibrium at any given incidence angle. The vibrations are governed by the following differential equation:

$$a\theta'' + b\theta' + c\theta = 0 \quad (10)$$

where θ is the displacement which is the function of the time t , θ' and θ'' are the first and second derivatives, and a , b , c are positive constants. The displacement θ in the case of the airplane motion corresponds to the angular displacement about the position of equilibrium, a to the moment of inertia of the airplane about the lateral axis, b to the damping coefficient, and c to the coefficient of static stability. The motion determined by equation (10) and by initial conditions $\theta = \theta_0$ and $\theta' = 0$ is well known. If the determinant $b^2 - 4ac$ is negative, the motion is oscillatory; if $b^2 - 4ac$ is positive or zero, it is aperiodic. In fact, except where the static stability is zero or almost zero, the first condition is usually the one satisfied by an airplane whether with tail surfaces or without. The oscillation period is given by

$$T = \frac{2\pi}{\sqrt{\frac{c}{a} - \left(\frac{b}{2a}\right)^2}}$$

and the amplitude of the successive oscillations decreases

according to the exponential law $e^{-\frac{b}{2a}t}$. The degree of damping or decrement depends therefore only on the ratio b/a , that is, the ratio of the damping constant to the longitudinal moment of inertia of the airplane. With equal ratio b/a and equal coefficient of stability, the period T varies in the same sense as the moment of inertia.

It is known, a priori, that a and b have smaller values for tailless airplanes than for tail surface airplanes and that c is of the same order of magnitude in each case. If b/a has the same values, the amount of damping of the oscillations will be identical and the tailless airplane will have a smaller period. If b/a is smaller for the tailless airplane, as would appear possible, the damping will be less and the period even still shorter (tendency toward fluttering). To see this clearly, it is sufficient to evaluate the constants a , b , c in each case.*

*In the supplement will be found the details of the calculations as well as all necessary explanations.

a and c may be written down immediately. In each case

$$a = l = \frac{P}{g} r^2$$

calling P the total weight and r the lateral radius of gyration, and

$$c = \frac{\rho}{2} S l V^2 \frac{dc_{mG}}{d\theta} = \frac{Pl}{c_z}$$

Σ being the degree of static stability at the angle of incidence considered (position of equilibrium). The damping coefficient b is difficult to evaluate exactly, especially with regard to the wing and the fuselage. For an airplane with tail surface we may write approximately:

$$b = \frac{Pl}{c_z} \frac{l}{V} \left[(0.25 - \lambda) \Sigma + 0.93 k'm' \frac{sD^2}{Sl^2} \right]$$

where the effect of the fuselage is taken care of by the coefficient 0.93 in the second term. For a tailless airplane the expression differs according to whether a pure wing or a wing with fuselage is considered. For the former case we have:

$$b = \frac{Pl}{c_z} \frac{l}{V} (0.25 - \lambda) \Sigma$$

For the latter, calling Σ_a the part of the static stability $\frac{dc_{mG}}{d\alpha}$ which refers to the wing ($\Sigma_a > \Sigma$) and ψ , a numerical coefficient which should ordinarily be positive and less than 0.15 or 0.2 and which depends especially on the position of the fuselage with respect to the wing, we have:

$$b = \frac{Pl}{c_z} \frac{l}{V} [(0.25 - \lambda - \psi) \Sigma_a + \psi \Sigma]$$

Let us denote the factor which multiplies $\frac{Pl}{c_z} \frac{l}{V}$ in the expression for b by the letter β and see what the order of magnitude is in the two cases. For the wing with tail surface the term in Σ is in general very small compared to the term in sD/Sl ; β is approximately given by

the latter, its value varying between 2.5 and 3.5 is therefore almost constant and roughly equal to 3.

In the case of the tailless airplane, on the contrary, β is essentially a variable factor. In the usual cases (with small and positive value of μ) Σ is less than 0.2 or 0.25 at the usual flight angles, and β is less than 0.1 or 0.15 at the most and becomes even still smaller at the largest flight angles for which the stability is the minimum. The factor β in the tailless airplanes is therefore at the most of the order of 1/20 of the value that it has for an ordinary airplane.

Values of $x = \frac{b}{2a}$ and $y = \frac{c}{a}$. From what precedes, we obtain for these two factors the expressions:

$$x = \frac{a}{4} \left(\frac{l}{r} \right)^2 \frac{\beta V}{\frac{P}{S}}$$

$$y = \frac{a}{2} \frac{1}{l} \left(\frac{l}{r} \right)^2 \frac{\Sigma V^2}{\frac{P}{S}}$$

where a now denotes according to the usual notation the specific weight of the air.

For an ordinary airplane as built nowadays $\left(\frac{P}{S} \sim 80, \frac{l}{r} \sim 1.5 \right)$, x is of the order of magnitude 2 or 3 for a speed of 300 k.p.h. (186.4 m.p.h.). For a tailless airplane under what may be considered as corresponding conditions $\left(\frac{P}{S} \sim 80, \frac{l}{r} \sim 2.5 \right)$, x is of the order of 0.10 or 0.2 at the most for the same velocity. Thus the logarithmic decrement of the oscillations is 10, 20, or 30 or more times smaller for the tailless airplane than for the ordinary airplane. As for the coefficient y , it may be doubled in value in the case of the tailless airplane at corresponding conditions (especially at the same value of static stability). This number y is inversely proportional to the linear dimensions of the airplane. For an airplane of small dimensions (whose weight is of the order of 1,500 kg (3,307 lb.) with the data given above and $\Sigma = 0.2$, y is equal to 15 for the ordinary airplane and 30 for the tailless airplane.

The discriminant $b^2 - 4ac$ having the same sign as the difference $x^2 - y$ or of the quantity

$$\frac{a}{8} l \left(\frac{l}{r}\right)^2 \frac{\beta^2}{\frac{P}{S}} - \Sigma$$

it may be seen that it is always negative and moreover under normal conditions. It is zero for value of Σ of the order of $l/15$ in the case of an ordinary airplane and of the order $l/1000$ in the case of a tailless airplane (l , the mean chord of the wing being given in meters). It may be seen then, that, except in the neighborhood of zero static stability the motion is always oscillatory even for the largest airplanes.

Period of the oscillations.- This is given rigorously by the formula

$$T = \frac{2\pi}{\sqrt{y - x^2}}$$

and approximately by

$$T = \frac{2\pi}{\sqrt{y}} = 8 \frac{r}{l} \sqrt{\frac{P}{S}} \sqrt{l} \frac{1}{V} \frac{1}{\sqrt{\Sigma}}$$

With the given values above ($V = 300$ k.p.h.) there is obtained a value of $T = 1.6$ seconds for the airplane with tail surface and $T = 1.15$ for the tailless airplane. The order of magnitude is the same; the oscillations are somewhat more rapid in the case of the tailless airplane (concentration of mass along the length with the smaller aspect ratio).

Conclusion.- From the point of view of dynamic stability the tailless airplane differs from the ordinary airplane by a slight decrease in the oscillation period and by a considerable decrease in the decrement of the amplitudes. The period and the damping being opposite in sense as functions of the parameters on which they depend (in particular P/S , r/l , Σ) any desirable increase in the one or the other case meets with incompatibility. The smallness of the damping is not, however, as dangerous a disadvantage as the extremely small value of the period. Moreover, any increase in x would be misleading since the value must always remain very small on account of the

smallness of β . It is sufficient therefore, when necessary, to avoid the danger of rapid oscillations (especially to be feared at small angles of incidence) by not centering the apparatus too far forward, which amounts practically to remaining at least within the centering limits we have indicated in section II.

There is yet to be noted that the period is decreased by concentrating the mass longitudinally and by decreasing the aspect ratio. In seeking to slow up the vibration by increasing the aspect ratio, however, there is the disadvantage of decreasing the range of travel of the center of gravity or the range of flight angles. Some compromise is probably possible, and its nature only experience can determine. In any case, the disadvantage becomes of less importance when the dimensions of the airplane are increased.

IV. PRINCIPAL ADVANTAGES OF THE TAILLESS AIRPLANE

1. Possible decrease in the aerodynamic resistance of the plane by the suppression of the horizontal wing surfaces and shortening of the fuselage.- The chief interest in the tailless airplane lies in the conception of a pure or habitable wing in which the difficult and still unsolved problem of the attachment of the wing to the fuselage is eliminated.

It should be remarked that the advantage gained by the removal of the horizontal tail surfaces and the reduction of the fuselage is partially compensated by the much larger resistance of profiles with negative c_{m0} (at least when these profiles are "broken" for the attachment of the control surface) and also by the increase in the vertical fin and rudder surface, an increase which corresponds with the decrease in the lever arm. At small incidence angles the gain on the total drag resulting from the suppression of the horizontal tail surfaces may be estimated at 10 or 20 percent and about 5 percent gain from the decrease in the length of the fuselage, whereas on the other hand, there is about 3 or 4 percent loss corresponding to the increase in the vertical surfaces. As for the increase in the drag due to the employment of profiles that are raised in the rear, it is not appreciable when these profiles are compared with those of positive curvature which are used on present-day airplanes, at least when the flap consti-

tuting the rear part of the profile takes up the neutral position (normal profile). This would correspond in practice to a value of c_{m_0} of the order of -0.01 and would be obtained at the smallest angles of level flight. On the other hand, at large angles when the flap is deflected upward so as to give a value of c_{m_0} of the order of -0.05 , there will be introduced a certain increase in resistance which depends moreover on the way the discontinuity of the connection behaves from the aerodynamic viewpoint. It should be noted, however, that this fault is always relatively unimportant because of the variation of the induced drag and also of passive resistance which increases considerably above a certain incidence angle.

In spite of the fact that the induced resistance tends to be larger for the tailless airplane due to the smaller aspect ratio, it is nevertheless true that the tailless airplane has the advantage of an appreciably smaller resistance over the ordinary airplane (between 5 and 25 percent) at small incidence angles in flight, whereas at average and large incidence angles the advantage tends to decrease and may even go to the ordinary airplane if the difference in aspect ratio is large. If, for example, the tailless airplane having an aspect ratio 4 is compared with an ordinary airplane having an aspect ratio 7, the advantage in this case will not be on the side of the tailless airplane, except at low values of lift at $c_z = 0.4$ or 0.3 . From the point of view of the aerodynamic drag-lift ratio the tailless plane has a real advantage only if the aspect ratio of the wing does not become too small.

2. Removal of difficulties due to the horizontal wing surfaces in the case of low-wing airplanes and of the limitations brought about by the torsional flexibility of the fuselage.— On airplanes where wings are attached to the fuselage no effective method has been found up to the present time for preventing the formation of turbulence at the top of the wing near the fuselage. This is an important problem that is occupying the attention of all airplane builders in view of the frequent accidents which are attributed to it. It is found, in fact, particularly on the low-wing airplanes, that this turbulence, which moreover under the effect of the propeller wash may bring about a flow of air about the fuselage, is in danger of enveloping the tail surfaces or at least affecting its action very unfavorably. There may thus result the danger of longitudinal instability, a more or less important loss

of elevator control, and the danger of tail vibration, if the torsional rigidity of the fuselage is insufficient. All these disadvantages are obviated by the removal of the rear surfaces.

3. The possibility of an appreciable decrease in the radii of gyration of pitch and yaw (increase in maneuverability).- From the dynamic viewpoint the tailless airplane is of interest in pursuit airplane design.*

4. Facilities for arranging good visibility conditions, with engine and propeller placed aft, pilot's cockpit forward, and the field of fire entirely clear (pursuit airplane armed with machine guns or a cannon).- In pursuit airplanes they permit the mounting of the cannon without any difficulty.

5. Reduction or elimination of the danger of nose-overs by having a landing gear of high stability.- The principal wheels of the landing gear would be aft and the small wheel forward. The vertical from the center of gravity would fall very far behind, inside the lift triangle near the base. Landing would normally be affected on three points and the contact of the small front wheel with the ground would never be in danger of passing behind the center of gravity.**

6. Possibility of lighter construction.- Due to:

- (a) The suppression of the tail surfaces and of the fuselage structure and also due to the necessary reduction of the aspect ratio of the wing (decrease in the load per square meter).
- (b) The fact that the twisting moment on the framework of the wing is almost independent of the flight angle in ordinary flight.

*An example may be found in the case of an English "Pterodactyl". It should be noted, however, that the tailless airplane such as we have studied, is incapable of acrobatics, such as spinning and barrel rolls, due to the limitation of angle of incidence. This characteristic may make it unsuitable for a single-seat pursuit airplane.

**This principle has been applied in the design Abrial A.83, concerning which we shall say a few words in section VI.

7. Various other advantages.- Several possibilities in propeller-engine mounting as with single engine with propeller in the rear of the airplane (removal of the effect of propeller slipstream on the wing); visibility and field of fire toward the rear, etc.

V. DISADVANTAGES AND POSSIBLE DANGERS

1. The disadvantages due to small range of longitudinal centering.

2. Relative lack of dynamic stability due to insufficient damping.

3. Lack of suitability for high degrees of lift and certain acrobatics.- This unfitness for large lifts, as we have already mentioned, results essentially from the limitation of the incidence angle imposed by the general condition of stability. It does not matter much that the profile with a large negative value for c_{m_0} is by itself capable of a small maximum lift coefficient, more or less lower than that of the profiles with positive c_{m_0} that are utilized in the conventional airplanes of today. The maximum value of c_z that can be realized in normal flight or in landing is almost independent of the characteristics of the profile or of the wing in the region of very large incidence angles.

If the aspect ratio is large (greater than 6) this limiting value for c_z will be of the order of unity. It may be slightly increased by adopting a smaller aspect ratio (less than 5, for example) which will permit the compensating of a relatively smaller range of centering (range with respect to the mean chord of the wing).

Under these conditions the use of high-lift devices appears ineffective as far as the increase of the maximum lift coefficient c_z is concerned. Nevertheless, certain arrangements, such as the front slot, capable of putting off the appearance of separation and therefore the receding of the center of gravity might be used to advantage. This question merits careful study on the basis of reliable test data.

More generally, it would be advantageous to investigate and study the geometric profile parameters on which the laws of flow and of separation depend, and especially the law for c_m . This, moreover, is a problem with which, less precisely stated, present-day aerodynamics practically concerns itself.

In any case, it appears that the tailless airplane in its present form, all other conditions remaining equal, must land at an appreciably higher speed than the conventional-type airplane. It is seen, moreover, since the incidence cannot reach a value where c_z decreases when the angle of attack increases, that this type of apparatus is incapable of acrobatics which utilize the phenomenon of autorotation, that is, spinning, barrel rolls, and all other acrobatics of this type; but the dangers of stalling are at the same time removed.

The inability to exceed a certain moderate incidence angle considerably less than the angle of maximum lift is certainly one of the chief disadvantages of the tailless airplanes as they are conceived at the present time. It is the inevitable price paid for the absence of all auxiliary horizontal surfaces. It is possible, however, at least in our opinion, that this solution may not be the best, as we shall indicate in section VII.

4. Limitation as regards directional stability and maneuvering.—As we have already mentioned, we are led to increase considerably the vertical surfaces (fin and rudder). This increase has several disadvantages; for example, it increases the drag coefficient, the weight of the construction, etc., and especially the control surface moment, that is, the stiffness of the control. If it is true that these effects may be lessened by appropriate means (compensation of the controls, large aspect ratio for the surfaces), it still remains necessary to have a large increase in the vertical surfaces (from 1 to 2 or 3 times as much as for an ordinary airplane). Two tentative solutions have been currently adopted by the several tailless-airplane builders:

- (a) Allow the fuselage a certain length (or if a pure wing is considered, give it a sufficient chord in the plane of symmetry). In other words, allow a certain increase in the length along the longitudinal axis of the apparatus. It is evident that this solution practically

or entirely removes a part of the possibilities of the tailless-airplane principle. (Advantages 4. and 7. enumerated above.)

- (b) Place two vertical fins at the ends of the wings and give them a large positive sweepback. To attain the desired effect by this means without having the disadvantage of an exaggerated sweepback, it is necessary to adopt a triangular plan form for the wing (a rapid decrease in the depth of the wing from the fuselage outward). This latter method leads to a relatively large span for a given lift surface and aspect ratio which in itself is not a big disadvantage owing to the relative smallness of the aspect ratio.

It appears useful in this connection to point out that from the aerodynamic point of view the advantage which may be realized by the addition of vertical surfaces at the end of the wings does not apply only to tailless airplanes.* We are here concerned with the general question of the termination of the wings at the tips which may have a considerable importance for the lift-drag ratios at moderate and large angles of attack. It should be remarked, however, that the principle of placing vertical fins at the wing tips is particularly advantageous for the tailless airplane. The figures given in the following section on the Aerial design emphasizes this fact.

5. Possible dangers of various kinds.- Finally, among other defects of the tailless airplane, some that deal with safety may be revealed by experimentation in the lab-

*A series of systematic tests carried out at Göttingen under the direction of Professor Prandtl, and other tests at the laboratory of Saint-Cyr on tailless airplanes (report 608-A), have shown that the presence of a large vertical surface at each tip of a rectangular wing improves the polar in the same way as an increase in the aspect ratio, and the improvement is greater, the smaller the aspect ratio of the wing. The importance of this effect is considerable in some cases. It is probable that it would be less for a wing of the elliptic type. This fact nevertheless brings out the importance of a thorough experimental study of the wing-tip phenomena which have not yet been studied sufficiently and whose effect on the drag are not yet known.

oratory and in flight, especially as regards lateral stability at high incidence angle, the tendency toward autorotation and the spinning characteristics. It may be asked how the tailless airplane compares with the conventional airplane. The several tests carried out in England for this purpose in the vertical wind tunnel on a model of the "Pterodactyl" appeared to justify the interest in vertical tunnels of large diameter for the study of spinning but these tests, however, do not tell us how the tailless airplane would behave in a stall and in a spin. Nevertheless, it should be noted that according to the way it is now built, the tailless airplane does not run into the danger of stalling since in regular flight it could not exceed a certain incidence angle less than that of the maximum c_z . Stalling could only occur as a result of some exceptional circumstance (gusty air) which in any case would be incapable of putting the airplane into a complete spin.

VI. CHIEF CHARACTERISTICS OF SOME FRENCH CONSTRUCTIONS

When we recalled at the beginning of this paper the efforts that have been made since the recent progress of aerodynamics in the field of tailless airplanes, we mentioned besides the German Lippisch, the French inventors, G. Abrial and Ch. Fauvel. In order to estimate these efforts and give a concrete idea of the possibilities to which these results might lead, we should like to add here some critical considerations together with exact data and figures on the projects that have been planned and carried out by our two countrymen.

After his investigations on profiles with negative c_{m_0} and on wings with fins at the tips, Abrial conceived a design of a touring airplane that was studied by the Caudron Company in 1932. The airplane was not actually built but its design was prepared with sufficient care for us to be able to mention the elements it contained.

Fauvel, who in his studies employed the data of Abrial on profiles with negative c_{m_0} , has built three airplanes since 1930, one of which was motorless. The first one flew in the preliminary flight tests but its construction was held up (for financial reasons) when its design was almost completed. The other two airplanes, the glider and the small touring plane, which were placed on exhibition

in 1934, successfully completed their first flights and supplied the pilot Fauvel with some interesting results. We shall give some details on these three designs.

Abrial A.83 (80 Horsepower Two-Seater)

The principal considerations were those of safety (in flight and on the ground) and convenience in piloting:

(1) The engine with propeller mounted aft (considerable decrease in the danger and consequences of the engine's catching fire).

(2) Pilot seat in front of the fuselage as in the case of a glider (excellent visibility conditions against the dangers of collision in flight and on the ground).

(3) Landing gear consisting of two principal wheels situated somewhat behind the center of gravity and an auxiliary wheel in front (with large stability, possibility of energetic braking without danger of nose-over).

Figure 6 shows a photograph of the model. It has a single cantilever low wing of a trapezoidal form having an aspect ratio 4 and a large positive sweepback. The fin surfaces and the rudder surfaces are arranged at the tip of the wing and are capable of acting as aerodynamic brakes. Official report 735-A gives the results of tunnel tests on the complete model. Following are the chief characteristics:

$$c_{x_{\min}} = 0.025$$

$$c_{x_{\max}} = 1.32$$

$$\text{maximum lift-drag ratio} = 13$$

$$c_{m_0} \text{ for the isolated wing} = -0.02$$

At the average incidence angles, the polar of the complete airplane turns out to be better than that of the theoretical simple wing (effect of the vertical surfaces at the tips). The aerodynamic characteristics which the above

figures indicate are remarkable for an airplane of such small aspect ratio and which had not been specially designed for high performance. Moreover, this design dates from 1930, that is, when aerodynamic finesse was not yet sufficiently appreciated (manner of attachment of the wing to the fuselage, retractable landing gear, etc.). From this point of view it does not differ from the contemporary models, the minimum drag $c_{x_{min}}$ of which does not get below 0.035 and which have no better lift-drag ratio for an aspect ratio of 6 or 7.

The airplane was to have a lift surface of 18 square meters and a total weight of 600 kilograms ($P/S = 33$), its performance with an 80-horsepower engine would be approximately as follows:

Maximum horizontal speed	190.0 km/h (118.1 mi./hr.)
Landing speed	70.0 km/h (43.5 mi./hr.)
Theoretical ceiling	6,000 m (19,685 ft.)
Time required for climbing 1,000 m (3,280 ft.)	5 min.

Flying Wings of Fauvel

a) Test airplane A.V.2.— This was presented before the Examining Commission as an apparatus for the study and investigation of a certain design for a "habitable wing without tail." The engine-propeller group separated from the wing was arranged above the wing so that it might be removable and allow the apparatus to be used as a glider. In spite of the small amount of surface (20 m² (215.3 sq. ft.)) and its large aspect ratio (8), this little airplane had room enough for seating the pilot entirely within the wing and therefore could be studied in flight as a reduced model for a large airplane of high loading capacity. Its study was begun after preliminary tests on a first model were carried out in the wind tunnel (report 515-A, Saint-Cyr, 1929), tests which had revealed excellent conditions of longitudinal stability, the existence of a directional stability without use of fin, and a very much reduced value of c_{x_0} , in short, a real advantage in directional control (braking flaps at the extremities of the wing).

Two other models were tested before that of the A.V.2 which was the subject of report 694-A.

In spite of large parasitic resistance, which was introduced by the nonretractable landing gear and especially by the raised engine-propeller group, the lift and drag were approximately the same as those obtained in previous designs:

$$c_{x_{\min}} = 0.0185$$

$$c_{z_{\max}} = 1.24$$

$$\text{maximum lift-} \\ \text{drag ratio} = 15.35$$

The tests on stability indicated longitudinal stability similar to that of the usual type airplane, with equilibrium being obtained at convenient angles of incidence and with different deflections of the altitude flaps. Positive directional stability was obtained without any fin surface. This stability was later increased by mounting two small triangular fins (supplement to report 515-A). These fin surfaces were doubled in the amount of surface and aspect ratio which practically doubled their effectiveness (according to the flight tests). The tests on the directional flaps proved them to be as effective as it was assumed they would be.

In its present state the airplane carries a special flap designed to compensate for the moment due to the propeller thrust. There still remain to correct several errors that were made during the construction (the elevator-flap travel and the propeller bearing) and to increase the compensated flap surface.

The airplane, equipped with an engine developing 22 horsepower, would have a total weight of about 310 kg (683.4 lb.) (15.5 kg/m² (34.2 lb./sq.ft.) and 14 kg (30.9 lb.) per horsepower), and its principal performance data using an ordinary propeller are approximately:

Horizontal maximum speed	130 km/h (80.8 mi./hr.)
Landing speed	50 km/h (31.1 mi./hr.)
Climbing take-off speed	2 m/s (6.56 ft./sec.)

The level flight near the ground with full power on is at a lift $c_z = 0.185$, which gives an idea of the reserve power of the airplane.

The inventor is of the opinion that this same airplane provided with a retractable landing gear and a raised propeller in the same position but isolated and driven by transmission from an engine placed within the body of the airplane would present even better characteristics with a minimum c_z in the neighborhood of 0.014. Such a result does not appear to be at all impossible with an airplane that is reduced to a simple wing provided with vertical surfaces and which is not subject to any slip-stream effect or other interference.

b) A.V.3*.— This airplane, whose study began in 1930 and whose construction was completed in 1933, flew to the Banne d'Ordanche in the same year and over the dunes of Pilat in 1935. The inventor considers it a reduced model of an airplane of larger dimensions and particularly of a twin-engine, three-seat pursuit airplane with complete defense in the rear. It is of the same design as that of A.V.2 but simplified and more refined. The aspect ratio is 8.3. The flight tests confirm a theoretical lift-drag ratio of 21 together with a $c_{x_{min}}$ of 0.014 and a $c_{x_{max}}$ of 0.135 (flaps not deflected) and likewise show excellent stability and maneuverability.

As regards the ease of piloting, the inventor says: "A pilot is not aware during take-off, flight, or landing that the airplane is not of the conventional type." With regard to dynamic stability, the inventor points out the perfect behavior of this airplane, stating that during the flights conducted at Pilat, he felt only very slight vibrations at certain times and "found the air to be very slightly disturbed whereas other pilots using conventional airplanes, complained at the same time of being strongly buffeted." Similar observations were also made by Abrial on a tailless airplane of his invention, the "Bagoas".

c) Flying wing A.V.10.— The apparatus, constructed under the direction of the Service Aéronautique, is a touring airplane for which the lift-drag ratio has partly been sacrificed to the simplicity of the construction and the small cost of production. The general design remains the same although the wing no longer seats the pilot and there is a large separation between the center body (which is

*Described in L'Aérophile of January 1934.

constructed like a lift surface of very small aspect ratio) and the wing itself. The aspect ratio has been reduced to 5.5.

Some very complete model tests (report 750-A, Saint-Cyr) have shown: a very good lift-drag ratio for the whole assembly in spite of the existence of numerous causes for drag; an amply sufficient static longitudinal stability with the incidence angle for equilibrium in the neighborhood of incidence angle for normal flight, for zero deflection of the control surfaces and for the centering utilized (17 percent with respect to the main wing); a satisfactory performance of the altitude control until about the maximum value of c_z with a useful travel of 15° on either side of the neutral position;* an entirely normal directional stability obtained with a single fin whose surface is only 5 percent of the lift surface (which proportion is no larger than the usual one with conventional airplanes); a suitable effectiveness of the rudder (the movable part of the surface just considered) which for a deflection of 20° permits a lateral incidence of about 10° (the surface of this rudder has been slightly increased on the actual airplane).

These tests were carried out on two forms, the "torpedo" and the "interior conduit," the maximum cross section of the central body being appreciably increased in the latter (fig. 7). The polars in the two cases are slightly different, the advantage lying with the "torpedo." The difference is much more appreciable as regards the longitudinal moments. The increase in the height of the "interior conduit" adds a diving moment but is compensated by a slight increase in the degree of stability.

Figure 7 gives three views of the 1/10-model size which was used in the tests. The change from the torpedo form to the interior conduit is shown by dotted lines. The principal characteristics of the torpedo form are:

*The upward travel of 15° makes the equilibrium angle increase from 6.2° ($c_z = 0.43$) to 19.5° (maximum lift angle 18.5°). It appears difficult to obtain a higher incidence angle by increasing the travel, a fact which may be expected since after a certain position the flap falls into a dead region. This disadvantage disappears when the separated stabilizer is used, concerning which we shall speak in the next section.

$$c_{x_{\min}} = 0.023$$

$$c_{z_{\min}} = 1.17$$

$$\begin{array}{l} \text{maximum lift-} \\ \text{drag ratio} \end{array} = 13.1$$

The pure theoretical wing has the following characteristic values, the reference surface being the same as the preceding:

$$c_{x_{\min}} = 0.014$$

$$c_{z_{\max}} = 1.23$$

$$c_{m_0} = -0.02$$

$$\left(\frac{c_z}{c_x} \right)_{\max} = 17.3$$

The completed airplane, which had already performed initial flights at the beginning of this year, has 18 m² (193.8 sq.ft.) of surface and weighs about 480 kg (1,058.2 lb.) (P/S = 26). It is powered by a Pobjoy engine of 85 horsepower (4.7 hp/m² (0.44 hp./sq.ft.), weight per horsepower 5.65 kg (12.5 lb./hp.)). The maximum velocity approaches 200 km/h (124.3 mi./hr.), the minimum theoretical speed being 70 km/h (43.5 mi./hr.); (the landing speed would be about 60 km/h (37.3 mi./hr.)).

Remark.— The several types of preceding airplanes, which are mainly test or demonstration airplanes, have been designed for a very small wing loading, which fact allows them a very moderate landing speed. Under these conditions it is very evident that the question of maximum c_z loses every real significance; when it is possible to land in still air at 60 km/h, one is not concerned over a difference of 5 or 10 km/h (3.1 or 6.2 mi./hr.). The question, as we have presented it, has practical significance only in the limit; that is, when, with the object of improving the horizontal performance of the airplane, the lift surface is reduced to a minimum compatible with a practical landing speed.

This observation calls up another remark as to the value of the figures we have given above. To judge by

these figures, the aerodynamic superiority of the tailless airplane would be considerable, exceeding what we have said about it in section IV,(1). The remarkably low values which were obtained for the minima of c_x are due partly to the relatively large importance of the lift surface with respect to the airplane elements of irreducible volume which are essentially, from the aerodynamic viewpoint, passive resistances (fuselage or airplane body, engines, radiators, vertical surfaces, nonretractable landing gear, etc.); the dimensions of these elements being almost independent of the lifting surface they cannot be decreased without changing the characteristics of the whole airplane. In assuming therefore that the wing dimensions of the different types here examined may, for a given total weight, be reduced so that the wing loading may have a normal value for each type of airplane (for example, 40 kg/m² (8.2 lb./sq.ft.) for a touring airplane), it would be possible for these airplanes to realize a still greater performance in level flight than the one we have indicated, but their aerodynamic characteristics would be appreciably lowered and would show itself in a strong increase in the landing speed, a reduction in the speed range, and a lowered climbing performance. Without taking away any credit from the first builders of tailless airplanes whose merit is shown by the results obtained, it must be admitted that from the strict point of view of performance, the tailless airplane idea in itself can only be rather limited in its application.

VII. POSSIBLE PROGRESS WITH TAILLESS AIRPLANES, DESIRABLE OBJECTS TO BE ATTAINED, VARIANTS IN THE CONSTRUCTION

Most of the recent tailless airplane designs, including those we have just considered, are all based on the same principle of the single wing surface with separate flaps for climbing and banking.* These two control systems are arranged along almost the whole length of the trailing edge of the wing. Aerodynamically, as we have already said, this solution is not the best possible. If one holds to the all-wing principle, it would be desirable to study

*The "Pterodactyl" is an exception, having a single pair of ailerons at the tips of the wings which are used at the same time for longitudinal and lateral control.

the application of a single-control system which performs simultaneously the functions of longitudinal and lateral control as well as a simple procedure capable of removing the harmful effect due to the discontinuity of the profile at the place where the flaps are joined. This same principle requires the investigation of a new high-lift device which is more effective than the front slot, acting without a stalling moment and even introducing if possible a restoring moment. This study would be incomplete if we did not point out the possibility of two variants to the preceding solution based rigorously on the same principle but using a separate auxiliary surface. Both of these correspond to the principle of tailless airplane with fixed lift surface and separate balancing organ. The idea for this design naturally comes to mind after a critical study of the problem under its most general aspects. Its chief object is to overcome without any special devices the limitation of the incidence angles. The principle is as follows: A centering is obtained ahead of the aerodynamic center of the wing under the same identical conditions as before; this assures static longitudinal stability. Equilibrium is obtained by the addition of an auxiliary surface s of suitable size, more or less removed horizontally from the center of gravity G of the airplane and capable of being maneuvered. This auxiliary surface does not in principle play the part of a stabilizer. It fulfills in a way the same purpose as raising the rear of the profiles for the single surface with negative c_{m_0} ; its object is to make the aerodynamic resultant go through G and create a stalling moment opposite to the diving moment due to the principal surface S , which in theory has a positive c_{m_0} as that of ordinary airplanes. It is possible to place s behind S (system A) or ahead of it (system B), figure 8; the aerodynamic force f or s is directed downward in the first case and upward in the second. System A functions exactly in normal flight as a single wing with negative c_{m_0} ; but at large attack angles the surface s which can maintain its complete effectiveness permits the production of a stalling moment as large as desired, compensating for the effect of the receding of the center of pressure on surface S . It is true that this compensation is obtained at the price of an additional negative lift but in any case it appears to be a definite advantage over a wing not employing an auxiliary surface.

System B at first view presents advantages only, with no disadvantages, the auxiliary surface aiding the lift.

This is the principle of the "Canard" and the same principle that is applied to the "Pou-de-ciel" of Mignet. However, this system presents a serious difficulty which if not solved may render it inferior to all the others. This difficulty is due to the element of instability, which is introduced by the balancing surface. It is found that if no suitable measure is taken for eliminating or reducing this destabilizing action, then either the apparatus would be unsuitable within a certain region of angles of attack or the incidence angles will be limited (under conditions independent of the behavior of the profiles).* The solution could be realized for a biplane or sesquiplane having strongly staggered wings, the stabilizer being placed near the top or bottom of the forward wing.**

In the two systems, the auxiliary surfaces would have slightly negative value of c_{m_0} (their normal lift being taken positive) and entirely movable about an axis situated forward of their focus. In this way the question of the compensation of the control surfaces, which is particularly important, will be solved and in the most satisfactory way possible since there will be absolute freedom, by adjusting the position of the hinge axis, in controlling the average size of the moment about the axis, without any aerodynamic disadvantage.

CONCLUSION

The tailless airplane principle which is founded on an irreproachably sound basis has several interesting aspects and appears to be capable of competing with the conventional airplane of today, thanks to several advantages which it possesses and of which the chief ones may be summed up under three headings:

*This property is in agreement with the fact that the balancing object of the auxiliary surface and its destabilizing action impose on the coefficient of action sD/S^2 of this surface two conditions (inequalities) which are incompatible under ordinary conditions. The lower limit imposed by one is higher than the upper limit required by the other.

**In this way the counterstabilizing action of the balancing surface will be strongly decreased since this surface will have an attack angle which will vary slightly with the general incidence angle.

(1) Improvement in the horizontal performance at given conditions of load and power and at equal unit loading.

(2) Greater freedom in the arrangement of the different elements of the airplane from the point of view of its use as a civil or military airplane.

(3) Greater maneuverability.

Nevertheless, in addition to several dangers that may be expected, and which experience alone would indicate, these advantages have a counterpart, chiefly in the difficulty of maintaining the maximum effective lift coefficient at a normal value (landing speed). The relatively low range of the "centering susceptibility" is a consequence of this requirement. To a certain extent it may be considered, in this respect, that the future of the tailless airplane is tied up with the practical problem of aerodynamics concerning the characteristics of the profile with respect to separation. It nevertheless remains true that within a certain range of application, especially from the point of view of safety, the tailless airplane principle has certain desirable qualities which are sufficient to justify the opinions of its partisans.

Translation by S. Reiss,
National Advisory Committee
for Aeronautics.

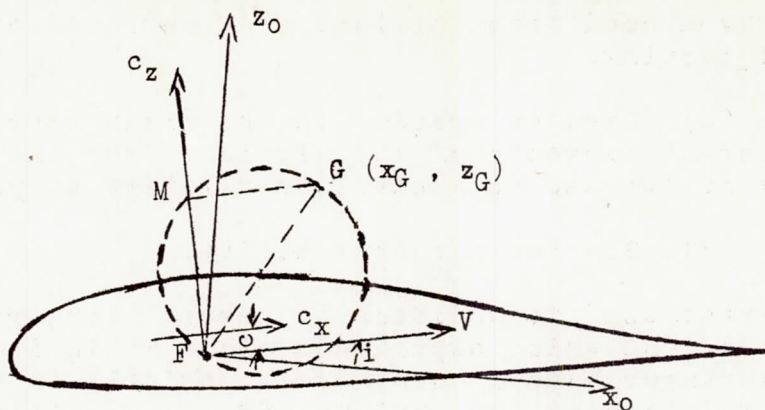

Figure 1

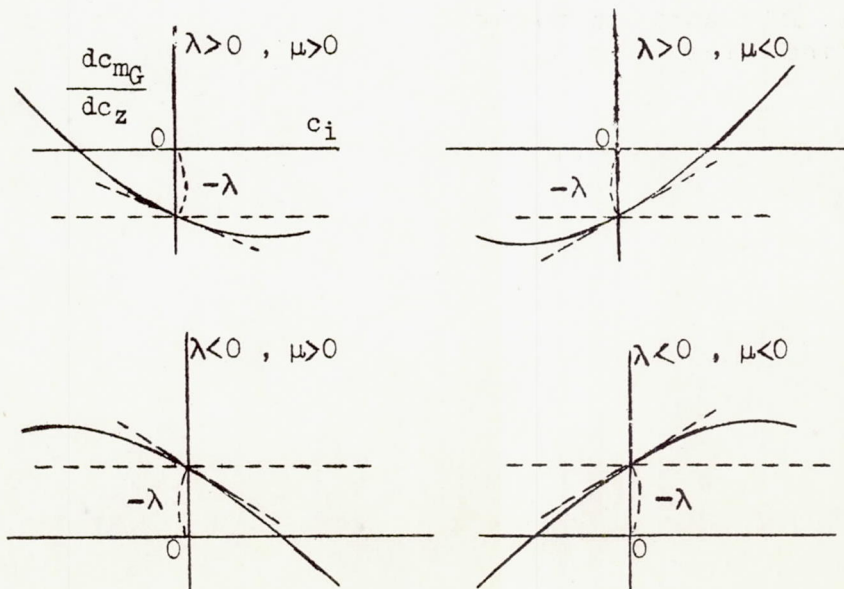

Figure 2

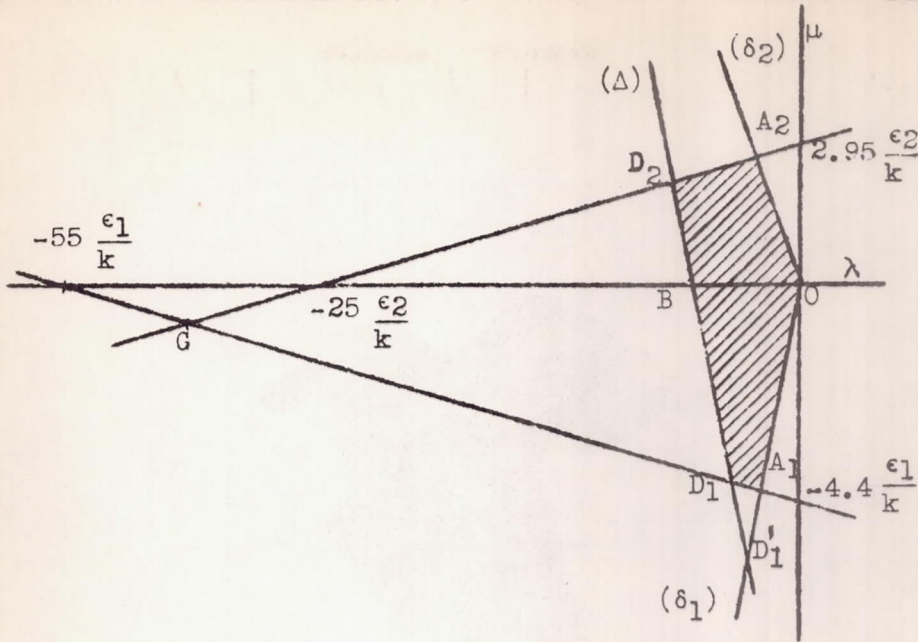

Figure 3

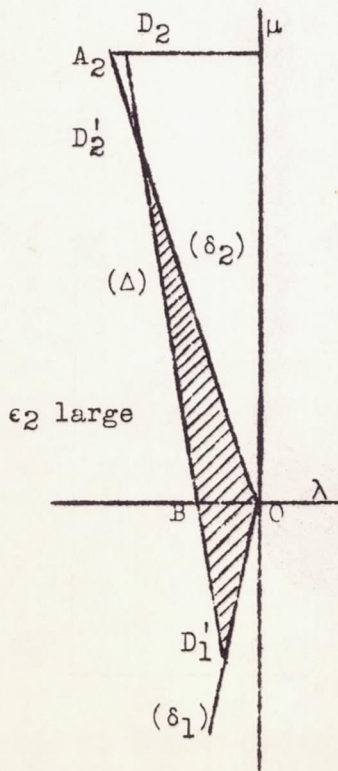

Figure 4

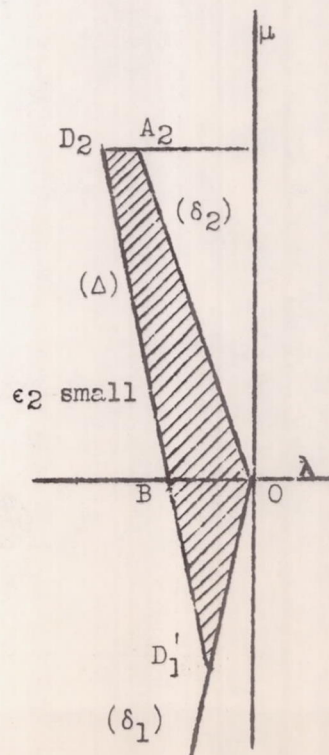

Figure 4 bis.

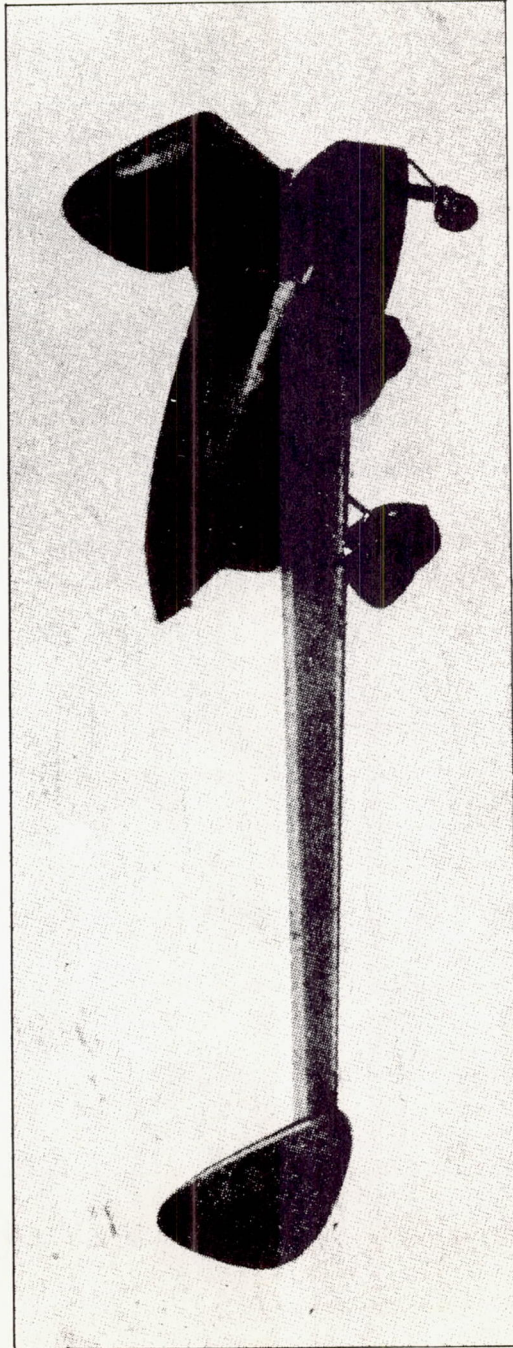

Figure 6.

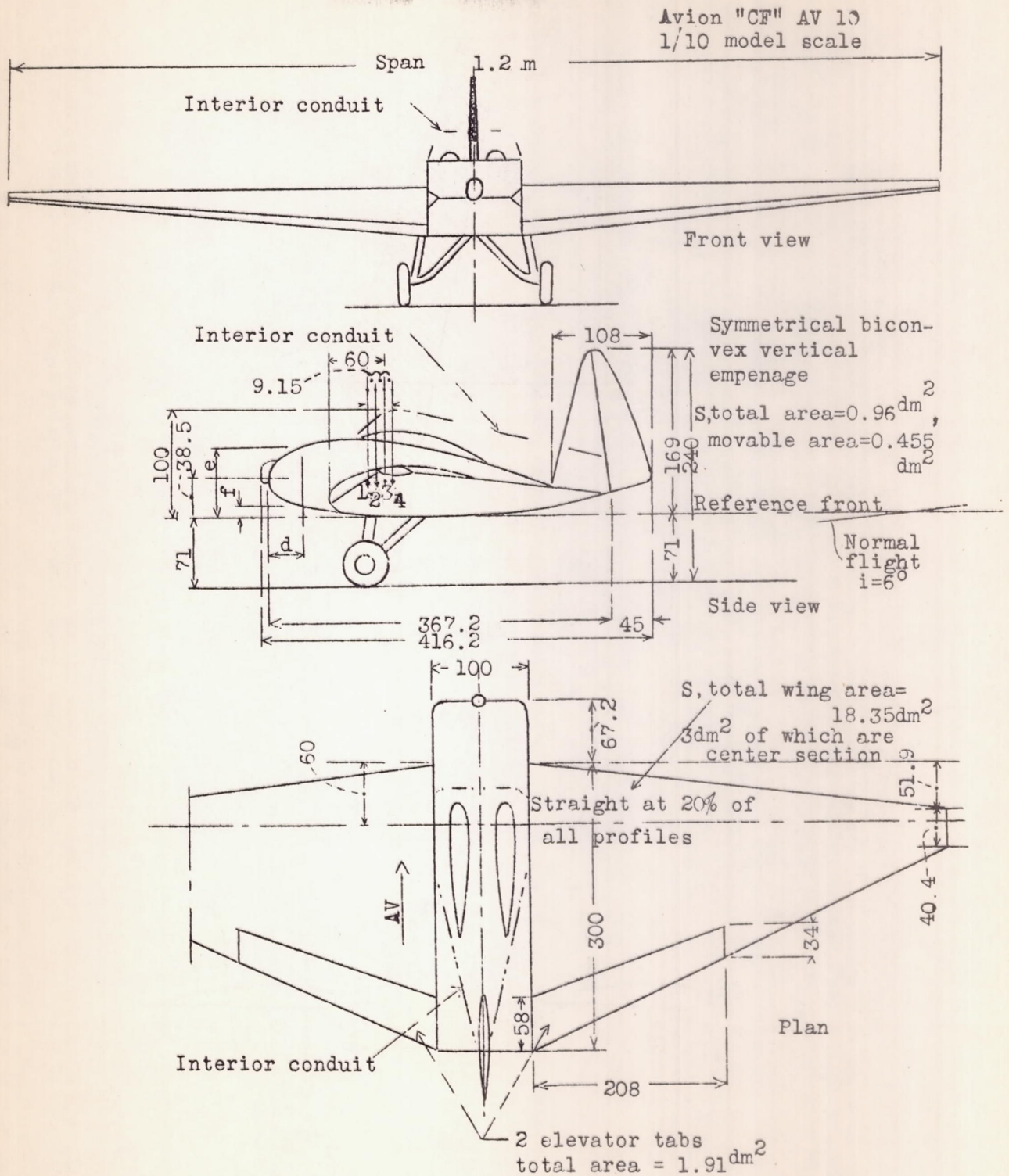

Figure 7

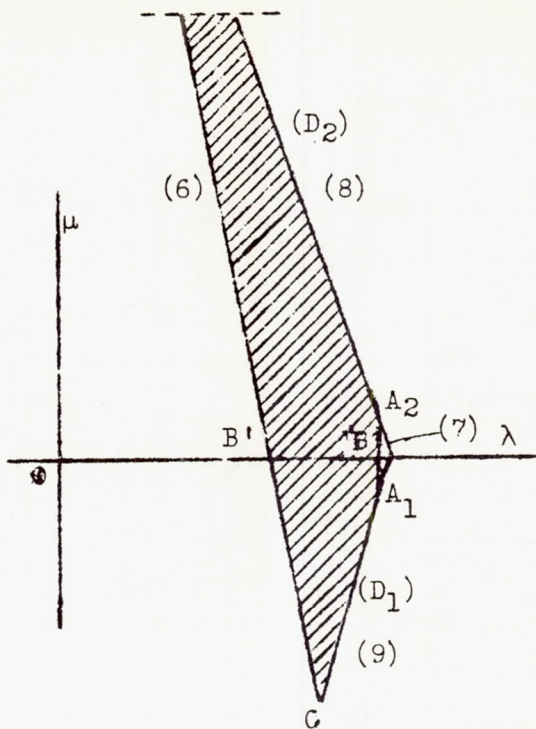

Figure 5

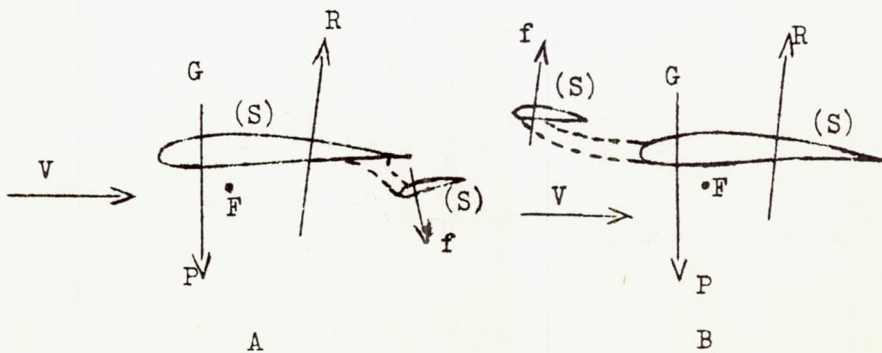

Figure 8