

**CASE FILE
COPY**

TECHNICAL MEMORANDUMS

NATIONAL ADVISORY COMMITTEE FOR AERONAUTICS

No. 712

THE SCHNEIDER TROPHY CONTEST

By Alfred Richard Weyl

Zeitschrift für Flugtechnik und Motorluftschiffahrt
Vol. 23, Nos. 15 & 16, August 12, and 27, 1932
Verlag von R. Oldenbourg, München und Berlin

Washington
June 1933

NATIONAL ADVISORY COMMITTEE FOR AERONAUTICS

TECHNICAL MEMORANDUM NO. 712

THE SCHNEIDER TROPHY CONTEST*

By Alfred Richard Weyl

On September 13, 1931, the English flight lieutenant Boothman received from his squadron commander Orlebar the order to take the S.6B No. 7 and go out and win the Schneider Trophy for England. Scarcely an hour later, Lieutenant Boothman returned to report that the order had been successfully carried out with an average speed of 548.5 km/h (340.8 mi./hr.).

This is not a paragraph from some fantastic novel of the future, but of an actual accomplishment. Thus one of the most bitterly fought contests in the history of aviation had been brought to what might almost be called an unpretentious end. But for all that, the end marks a glowing chapter of achievement for English aviation.

Some nineteen years ago - December 5, 1912 - the youthful French sportsman Jacques Schneider, a relative of the founder of the well-known Schneider-Creuzot concern, endowed a prize to go to the country that in three successive international seaplane races remained victorious. The rules and regulations called for yearly races, nationality of pilot as entry of the respective country, and seaworthiness.

The will of the donor, entry restricted to high seaworthiness, was - let it be remarked at the outset - not complied with. Admittedly, a so-called seaworthiness test was stipulated in every race. But being confined to riding, taking off, and alighting on calm, protected water, it can therefore hardly be called a proof of seaworthiness. Thus the entries in the various races were anything but seaworthy.

Technically this limitation has certainly done no harm, for it made the problem of the designer unambiguous and the solution clear. Such limitations speed up and promote any development.

*"Der Wettbewerb um den Schneider-Pokal." Z.F.M., August 12, 1932, pp. 442-454; and August 27, 1932, pp. 477-483.

SURVEY OF RACES

Table I is a survey of the time, place, and winner of the various races. With the exception of the war period, the races were held every year until 1926. Then it was decided to hold them every second year because of the almost prohibitive amount of technical work and money involved.

Altogether there were twelve races. No decision was declared in 1919, because the sole entrant was not seen on a turn, due to foggy weather. The 1924 race was by agreement with the U.S.A. postponed because of the inability of the other nations to have their entries ready in time.

Participants of the races were:

France - 1913 (winner), 1914, 1919 (not started), 1923.

England - 1914 (winner), 1919, 1922 (winner), 1923, 1925, 1927 (winner), 1929 (winner), 1931 (winner).

Italy - 1919, 1920 (winner), 1921 (winner), 1922, 1925, 1926 (winner), 1927, 1929.

U.S.A. - 1913 and 1914 (French airplanes), 1923 (winner), 1925 (winner), 1926.

Switzerland - 1914 (French airplanes).

Germany - 1914 (Aviatik biplane; washed out before race).

Germany never was much interested in these races, nor in the development of racing airplanes; with the exception of Claude Dornier.

France never had much success, after 1914, in spite of all its efforts. In fact, there never had been any really serious attempt until 1926, when the French Government commenced to grasp the real significance behind these technical competitions. Nevertheless, they were unable to participate before 1931. In that year Nieuport, Bernard, and Dewoitine were each to build a racing seaplane with two

different types of engines, but the first practice flights revealed their utter hopelessness compared with the speeds of the English and Italian entries.

Both England and Italy have evinced keen interest in high-speed seaplanes since the war. England had already gained a very signal victory in 1914, which exerted a lasting influence on the war-time design. (Compare the Sopwith pursuit airplanes.)

America showed only a passing interest (1923-1926). Following the defeat of 1926, the U.S. Government declined all further cooperation. This change was based upon the completion of a well-defined building program. Even Lieutenant Williams' strenuous efforts failed to effect any postponement.

All in all, the Schneider Trophy Races registered no marked technical progress until the respective governments took an active interest in the races. Up to 1923 the race remained a field of activity for the sportsman and the airplane manufacturer. Technical development was slow, systematic preparation a minimum. The victorious Sopwith of 1914 (fig. 5), although specially built for racing, was, after all, designed according to the specifications for light scouting seaplanes, used at that time by the British Navy. The entries from 1919 to 1922 were single-seat pursuit seaplanes (figs. 6-9). The engine power was raised by higher compression and r.p.m.

Real racing seaplanes did not appear until 1923, although the attention of the Air Services of the U.S.A. had been directed toward the development of racing seaplanes as a basis for the design of high-speed military airplanes as far back as 1919. The chief sponsors of this movement were the Curtiss airplane company. And so Curtiss seaplanes were shipped to Europe as entries of the 1923 contest (fig. 10). They had been built at government expense and were flown by U.S. Navy officers. The race revealed a 42 km/h (26 mi./hr.) higher speed of the U.S. entries over the highest European entry. Marked technical superiority was the reason for this.

This acted as a stimulus for England as well as for Italy. Pursuant to a definite policy of development, the English Air Ministry placed an order with the Gloster Aircraft Co., Ltd. which, on its own account, had already built the Bamel racing landplanes, and with the Supermarine Avi-

ation Company which, since 1920, had successfully represented England in the races with its speedy "Sea Lion" flying boats.

The Italian Air Ministry also took over the development of seaplane racers. Several firms, among them the Italian branch of the Dornier, were called upon to submit competitive designs. Thus, January 1924 saw the design of a Dornier monoplane racer which had all the characteristics of the very promising Supermarine monoplane S.4, of October 1925 (figs. 13, 14, and 15). Unfortunately, this design of German technique never reached the building stage. It already incorporated the refinements of the modern racing seaplane; its superior qualities were revealed in the wind tunnel and furnished without a doubt, many valuable hints for the Italian racing seaplane design.

In 1925 the United States still had the start over all other countries. The English Supermarine S.4 developed serious wing flutter, and had to be withdrawn after a forced landing. The Gloster III biplanes (fig. 16) were obviously inferior to the American entries. The same applied to the Italian Macchi M.33 (fig. 17) which, in addition, were mounted with a less powerful Curtiss D.12 engine. Even the English metal propellers were considered inferior by the Americans.

The 1926 race ended with a very close victory of the Italian Macchi M.39 (figs 18 and 19), and was in no small measure due to the excellent skill of Di Bernardi. It became more and more evident that skill and especially, abundant training played a decisive role in the piloting of such racers. With Italy's victory, the technical advantages of the United States were wiped out. England could not participate in 1926, because the preparations could not be completed in time.

England also realized that the flight training for such races was just as important as the technical preparations. Heretofore, factory pilots had flown the English racing airplanes but the highly technical ability and the flight practice of these test pilots could never offer a substitute for an intensive course in training for such races. The result was the formation of a special High Speed Flight. Its sole function consisted in the training of pilots and the testing of airplanes for the purposes of the Schneider race. This organization proved to be up to the mark. It had military training; The personnel was

supplied by the Air Ministry. Apart from the success in the Schneider races, other extremely valuable information - technical as well as medical - was obtained and put to practical use. In agreement with American experience, it was found that flying a racing seaplane is more difficult for a seaplane flyer than for a landplane flyer. As a matter of record, all Schneider races, since 1923, were won by landplane flyers.

Whereas the Americans had already shown careful preparation, the English in the coming races demonstrated an exactness that is hard to beat in the selection and training of its pilots, which in no small measure was due to the zeal and application of Wing Commander - then squadron leader of the High Speed Flight - A. H. Orlebar.

The races of 1927, 1929, and 1931 revealed England as superior winner with its Supermarine low-wing monoplanes, all designed along the same lines (figs. 4, 20, 30-35). The careful preparations bore abundant fruit. The races were devoid of the spectacular. It was the calmly thought-out plan that let England win, that gave England the victory uncontested.

When evaluating the performances, let it be noted that a comparison, limited exclusively to the winning airplanes, yields no true picture of the status of the technique. Many times it was not the speediest nor the most technically advanced type that carried away the prize. Quite often promising entries had to be withdrawn from the race because of some unfortunate circumstances as, for instance, the fastest entry of the first race, flown by the German-American Weymann, in a Nieuport monoplane (substantially the design of our countryman Franz Schneider), was forced by a break in a fuel line to quit after covering 240 kilometers. The very promising Gloster VI (fig 30) was unable to enter in 1920 because of engine trouble. At other times airplanes crashed prior to the races (e.g., Curtiss and Wright biplanes, 1925-26, Short "Crusader," 1927 (fig. 21). France and Italy both had several such mishaps. In many cases the real cause could be traced to lack of preparation.

After 1926 the race had narrowed down to a duel between England and Italy. Their methods of technical development followed two basically different lines. Great Britain concentrated on one type of seaplane and one en-

gine, namely, the braced low-wing type of monoplane with water-cooled engine. The biplane type later on was more a matter of comparison. The design was under the jurisdiction of the Air Ministry, which also controlled the technical development without, however, placing undue restrictions on the designer. The contracts stipulated design and construction only in agreement with the Air Ministry. This explains the uniformity in design of the English racers.

Italy evidently did not cooperate that closely. The responsible officials shifted the brunt of the development to the industry. Hence the different methods of attack and a greater multiplicity of types. Among them they developed promising theories for obtaining higher speed. The dispersal of the efforts, on the other hand, was followed by a less perfect product of the individual types.

Thus, when England finally won the Schneider Trophy, uncontested, it had well earned the victory by systematic effort concentrated to direct results. Italy's aims, on the other hand, were ostensibly more with an eye to future developments to insure a permanent technical superiority. For, after all, the persistent endeavors for higher speed did not terminate with the Schneider Trophy Race. Future development will tell whether Italy's activity in this respect was successful or not.

In contrast to the British, which disbanded their High Speed Flight, Italy still carries on its experiments with racing airplanes. The next aim of the Italian Experimental Branch for high-speed flight at Lake Garda is the world's speed record. This branch is experimenting with several novel racers. In one, a Macchi twin-engine seaplane, Lieutenant Meri is alleged to have reached a speed of 745 km/h (462.9 mi./hr.) over a 3 km (1.86 mile) course in May 1932, according to newspaper reports. The particular seaplane has two Fiat engines in tandem, developing 2,750 hp. each at 3,300 r.p.m., with only 50 liters (3,051 cu.in.) displacement and 980 kg (2,160 lb.) weight (0.357 kg/hp = 0.776 lb./hp.).

France also continues its experimentation with seaplane racers, although no special performances have become known.

For general flight technique the Schneider race is of much more significance than we are wont to believe here in

Germany. This assertion is fully borne out by some statements from various foreign experts.

As concerns the engine development of racing airplanes, the Director General of the Rolls Royce, Ltd., has this to say: "The development of racing engines has led to improved design of every vital engine part. It will result in longer life of the standard service engine types of the air services.

Economically, high-speed engine development is a saving, because much time is saved to attain to technical perfection. In fact, it is safe to say that the research for the Schneider race, carried on during the past two years, is equivalent to a normal development activity of our Engine Section of from six to ten years.

Besides, the publicity for the superiority of British products is not to be underestimated."

Wing Commander A. H. Orlebar, of the High Speed Flight, in a speech before the Royal United Service Institution, in March 1932, stated: "Without the stimulus of a Schneider Contest, it would have been an impossibility to get the cooperation of all the experts. The knowledge was bought cheaply notwithstanding all the cost. All progress levies a toll in human life as well as in money, a fact which is usually overlooked.

One brief Antarctic expedition costs more than $2\frac{1}{2}$ times as much as all the money expended here in England for the Schneider race. The results of high speed are surely just as useful to humanity as Polar research. The Schneider Cup racing seaplanes point the way to higher speeds in commercial flying."

William Wait, Jr., one of the leading designers of the Curtiss racers (1920-1926) writes undisputedly, as follows: "We hear so much about the efficiency of our Air Services. This is not quite the case from the point of view of the materials. According to reliable information the English service airplanes have a speed of well over 360 km/h (223.7 mi./hr.). Our service airplanes had high speed so long as we kept on developing racing airplanes; but no longer. This is not to be construed as inability of our designers, but rather as the result of lack of means to carry on the research work on racing seaplanes."

The most powerful pursuit airplane of the U.S.A. was, as is known, developed from the Curtiss racer. The world-known Curtiss "Conqueror" engine is also a direct result of the racing engine development. Metal propellers, internally sprung wheels, wheel brakes, wing radiators, and many other technical refinements are the fruits of the American racing airplane development.

In the face of the technical gain, the objection of almost prohibitive development costs does not "hold water." The 1927 race cost England, between 1925 and 1927, approximately 5,500,000 Marks. Italy is said to have spent even more since 1923. For the 1931 race, Lady Houston donated 2,000,000 Marks. This sum defrayed all expenses incidental to airplane and engine development. Two airplanes were remodeled, at least three airplanes were built completely new, and about six engines manufactured.

THE PILOT'S SIDE

Piloting a racing airplane presents special difficulties. On top of that the races must, in most cases, be flown by pilots who are not at all, or little used to very high-speed flying. The short life of the engines permits no extensive training. Most racing airplanes are therefore patently not completely developed from the point of view of flight qualities. That explains many difficulties and accidents.

The pilots in the Schneider race always emphasized two objectionable features, namely, insufficient visibility and annoyance from exhaust gases. In this respect the biplanes (as the Gloster IV and the Supermarine S.4, for instance) showed especially poor visibility, which was the main reason the British changed over to the low-wing type. The danger of poisoning by exhaust gas, which may have been responsible for many otherwise unexplained accidents, has now been removed by a fresh air feed in the pilot's cockpit.

With the high take-off and landing speeds it is mandatory that the pilot be used to them. Hence, piloting a racer stipulates a corresponding training, as first recognized by the U.S.A., and along which lines the English High Speed Flight was organized in 1926. Italy followed along similar lines. These training sections also took

over the flight testing of new racing types as well as all other experimental flights. One important feature of the training was the teamwork of the selected pilots.

For the 1931 race the English pilots were schooled in the following order: Fairey III F biplane with floats, Fairey Firefly (one place) biplane, Gloster IV biplane, Supermarine S.5 low-wing monoplane, Gloster IV low-wing monoplane, Supermarine S.6 low-wing monoplane, Supermarine S.6A, Supermarine S.6B. Each pilot received about 12 hours' flight training on racing airplanes.

The land flyers claimed that the most difficult stage in the training occurred when changing from the service seaplane to the Gloster IV biplane. The instability about the normal axis was especially disturbing in the Gloster IV A and IV B as result of the raised upper wing for better visibility. The high accelerations to which one becomes only gradually accustomed, were likewise very disquieting. But the take-off was the real difficulty, because of the propeller torque at times making starting altogether impossible, except by well-defined wind and wave conditions. Waghorn's report on take-off difficulties in the Supermarine S.6 is very pertinent (reference 1). The torque made the left wing dig into the water, bringing the tip dangerously close to the water and swinging viciously to the left. The drag of the floats was high. Take-off was not exactly into the wind but at 20° to the left and with rudder hard to the left in order to get her on the step. In the air the S.6 was said to be easier to fly and to be more stable when stalled than the S.5.

A. H. Orlebar expressed himself similarly (reference 2). When taking off the seaplane would veer to the left until it gained sufficient speed to make the rudder effective. In the early stage the pilot is almost blinded by the spray. There is absolutely nothing to do except keep the head down and start off to the right of the wind, holding the stick to the right and back and be ready to take control as soon as the airplane gains way. In the latter stages of the run the floats are subjected to enormous stresses, and the V shape and strength of the floats in the absence of shock absorbers are therefore very vital factors. It takes almost 1.6 km (1 mile) to get off the water (with the S.6) and another kilometer (.62 mile) before the seaplane climbs comfortably. Once when the engine cut out suddenly after just taking off, the seaplane covered about 4.5 km (2.8 miles) before it could be landed. From

full throttle at 60 m (200 ft.) it takes about 5 km (3 miles) to pull up. At 530 km/h (330 mi./hr.) the S.6 flies itself with hands and feet off.

When landing the S.6 the pilot has to approach at 240 km/h (149 mi./hr.). The speed drops slowly. The seaplane touches the water very gently at about 165 km/h (102.5 mi./hr.), but the deceleration is very rapid. The pilot needs to brace his shoulders well back to prevent being thrown forward and breaking his goggles on the board. "Oily" sea makes landing difficult. When the waves show whitecaps (say a wind of 6.5 m/s = 21 ft./sec.), it is too rough to take off.

One of the first problems in the races was, the most efficient method of cornering. A tight steep turn at the pylons produces in high-speed airplanes, high centrifugal forces, which stipulate very high structural strength and impair the efficiency of the pilot. According to Waghorn, trained pilots suffer between 5 and 7 g the loss of sight, starting with blurred vision. He is of the opinion that the pilot does not lose consciousness but rather loses his quickness of thought and that if done repeatedly, has a weakening effect, although H. E. Wimperis (reference 3) disputes it. A. H. Orlebar (loc. cit.) states that in a sustained steep turn the first effect is a feeling of tightness around the neck, then a blurring of sight, and finally, blacking out. As soon as the airplane is straightened out, these sensations vanish. There are no after effects. Most pilots see black at 5 g in a sustained turn, although different pilots can withstand different amounts of g. In the High Speed Flight it was a point of honor to confess if one felt unfit. Six of the twelve flyers were nonsmokers and teetotalers. It was advisable to wear a loose collar. Elastic belts had been tried but had proved useless.

Loose turns at the pylons mean greater distance flown and lower average speed.

The Italians preferred in 1927 and 1929 a climbing turn (half loop followed by rolling out on top), utilizing the height gain of about 200 m (650 ft.) to increase the speed on the straightaway. This method of cornering although very spectacular, was not as efficient as that of the British.

Elaborate theoretical studies led the British to conclude in 1926 (reference 4) that a sustained, not unduly steep turn with no loss or gain of height, would be most efficient. Radius of turn and bank were so chosen that the acceleration did not exceed 5 g. This yielded turns with about 50° bank. The best possible average speed was defined at about 97 percent of the top speed in level flight. The investigations also revealed that the gain of mean speed becomes less with increasing acceleration. Consequently, circling the pylons in steep and tight turns presents no appreciable advantage.

Conversely to these theoretical studies, flight measurements on high-speed single-seat pursuit and racing airplanes have shown that not the turn without change of height but the curve with minimum gain of height, yields the best average speed. Airplanes with very low power loading have a tendency to climb at the commencement of the turn. If this height change is counteracted by the rudder, there is quite an appreciable loss of speed in racing airplanes. The best compromise is afforded from free flight measurements, as practiced by the British for the 1929 race for defining the best radius of turn, acceleration at each point of the path of turn, and best dynamic pressure. The radius of turn of the S.6B in the 1931 race was estimated at around 700 to 750 m (2,300 to 2,450 ft.), the flying height on the straightaway at about 120 m (394 ft.). The best turns with the S.6B were flown at around 730 m (2,395 ft.) radius, and at 560 km/h (348 mi./hr.) speed indication, according to Orlebar; then there are no unpleasant effects.

High speed with its attendant accelerations, and the unusual landing speeds, together with the difficulty of taking off from water, always involve greater hazards. Added to that were the very limited practicing facilities in most cases. But in spite of all that the Schneider races remained without fatal accidents, although there was no lack of serious mishaps. Airplanes caught fire in the air, others developed propeller trouble, wings and tail surfaces showed signs of flutter; there were forced landings due to exhaust-gas poisoning, or blinding caused by leaking fuel or lack of fuel. Most races had some accidents. In most cases they were trifling. The preparatory stages of the races, on the other hand, took a number of valuable human lives, particularly during the practice trials. But these accidents were not in vain: technique and science were able to gather much useful information. In this respect also the Schneider Trophy Race can in no way be classed among the ordinary airplane races.

SURVEY OF ENTRIES

The development of the Schneider Race entries is similar to that of the racing landplanes; from braced monoplane to braced biplane, then to cantilever monoplane and back to braced monoplane.

Admittedly, the 1913 monoplane (fig. 3) is in no way like the modern racing monoplane. The bracing system shows in place of the numerous cables a few but very carefully streamlined wires. In spite of more than twice the total weight, the wing area is only a portion of the original size. The contour of the wing corresponds to the advances made in the science of flow research.

The first law for the racing airplane is the elimination of all avoidable drag. All dimensions are kept to a minimum.

There has been a radical change in the flotation gear. The plump, three-float gear with two small, mostly unstepped main floats and a tail float, is now replaced by two long, single-step floats of most carefully designed form. Aerodynamically and hydrodynamically the floats have been very much improved. Instead of nine struts, the flotation gear now has four.

Even if the 1913 designer had had a modern racing engine, he would never have been able to reach the speeds which to-day are looked upon as ordinary.

As compared to 1913-14, the wing loading is five times as high and the horsepower per square foot of wing area 30 times as high, whereas the power loading is now about one seventh of the original figure. The engines of 140 and 70 horsepower then, have risen to 2,300-2,600 horsepower.

In spite of more than twice the total weight, the airplane dimensions have become smaller. One remarkable feature is that all racing monoplanes since 1913 have practically the same aspect ratio, namely, around 6.

The largest factor in the speed increase between 1913 and 1931 is, unquestionably, the rise in engine power. The speed diagram (fig. 2) manifests a relationship of the 3d power of engine horsepower. It follows from this that

the development of racing airplanes hitherto followed the same high-handed and uneconomical method as in the other motor vehicles (automobiles, motor boats, etc.). But this fact is neither a reproach nor a reason for pessimistic interpretation of the growth in speed. The technique of flight still offers the engineer many new avenues of attack.

Even though the winners since 1926 have been with braced low-wing monoplanes, this is no sign of their superiority. Experienced designers still maintain that superior biplanes could be built.

Since, as already mentioned, the induced drag of a racing airplane is without significance, a comparison of the wing structure forms need not go beyond the static side of it. In this respect the multiplane appears, ordinarily, to have the advantage.

The cantilever monoplane never was looked upon with favor, and this design was soon abandoned. The transition to the wire-braced type was evidently brought about by the wing flutter rather than for any static-aerodynamic reasons (wing weight, profile drag). This change led to the low-wing, with drag wires attached directly to the fuselage, the lift wires at the flotation gear, lower landing speed (ground effect), and improved visibility.

The wing of the modern racer is a semi-thick (about 8 percent of the chord) section (fig. 37) cambered on top and bottom. Fully symmetrical sections are very seldom resorted to. Thin sections never did find favor, in spite of their lower profile drag.

The flying boat as racer has almost disappeared since 1923. Apart from the power plant, it should be possible to design one with just as low frontal drag and just as satisfactory aerodynamic qualities as the float type seaplane. But a direct propeller drive demands an engine outside of the hull, which means greater drag. The British made an attempt in this direction with their Supermarine in 1924, but gave it up as hopeless because of seemingly insurmountable difficulties involved in the gears. A more recent design of a twin-engine flying boat with direct-driven propeller is that of Dornier (fig. 36).

Another original, but unsuccessful, design was that of the Italians in 1929, in the Piaggio P.7 (figs. 31 and 32), which had no floats, (the fuselage acting as main float).

There were no multi-engine entries in the Schneider races. France, and more recently Italy, have developed some twin-engine racers. The fastest Italian competitor in 1931 was, allegedly, the twin-engine Savoia, but it did not fly in the race. Dornier published in 1928 designs for a twin-float racer with engines in tandem (fig. 25), similar to the Italian Savoia S.65 of 1929 (figs. 26 and 27).

The latest and most promising design of Macchi is a monoplane with two engines joined together end-to-end, the propeller shaft from the rear engine lying in the Vee between the front unit cylinders. The propellers rotate in opposite directions.

The very same method had been used back in 1912 by Hellmuth Hirth in the Rumpler "Taube" fitted with two 100 hp. Argus engines. It is quite remarkable that a long-forgotten, apparently unfit, design again becomes the latest after 20 years.

Since 1923, the flotation gear of the modern racer (table III) consists of two long, stepped floats. In fact, the influence of the Schneider Trophy Contest has been particularly noticeable in the advanced float design, which otherwise it would have taken years to achieve. Take-off and landing speeds of the modern racing seaplanes are in the neighborhood of 200 km/h (125 mi./hr.), which is far beyond any other form of water craft.

Single-float landing gears were never tried on racing seaplanes. The necessary support floats evidently induce such high frontal resistance as to make this type useless.

One particularly disturbing feature in racing seaplanes is the effect of the high torque reaction of the propeller. The propeller torque renders taxiing and taking off difficult and must also be taken into account in flight. The performance loading of modern racers is slightly more than 1 kg/hp (2.2 lb./hp.). Span and float spacing are small compared to propeller diameter and propeller disk loading, while the propeller r.p.m. has decreased rather than increased.

At take-off the torque reaction becomes an added load on one float. The consequence is an inclination of the wing and an abrupt turning of the seaplane at a time when

the controls are still ineffective. The 1923 Curtiss racers therefore used a weight balance in the float. The float, lightened by the torque reaction, was fitted with an additional weight in the form of a fuel tank.

Subsequent developments revealed the inadequacy of this weight balance for larger engines and the same dimensions. As a result, the more modern racer has a flotation gear in which the float loaded additionally at the take-off is farther away from the plane of symmetry and, in addition, larger than the unloaded float (resistance balance). But even these measures did not always prove sufficient on all racing seaplanes. Thus the propellers of the Supermarine S.6 B had to have a diameter greater than the optimum figure, because at take-off with smaller propellers, it was impossible to keep the seaplane on the course, thus making the take-off altogether impossible.* The greatest obstacle of the modern racing seaplane evidently seems to be smooth lift-off without unduly long run. The take-off requires, in fact, a technique all by itself, entirely different from that used for service airplanes. This difference may not be quite so great in landplanes - at least, there never has been any special mention of take-off difficulties with racing landplanes.

It was left to the Supermarine S.6 B, with its markedly symmetrical flotation gear, to prove the possibility of smooth landing with perfect weight balance. The rules of the 1931 contest stipulated a seaworthiness test immediately before the start of the race, comprising take-off, landing, and taxiing in a circle on the water. That meant a landing with full load of fuel for the 350-kilometer course.

The torque of the geared-down engine** in the S.6 B attained to 940 m kg (6,800 ft.-lb.) at take-off. The left float had an additional load of 450 kg (992.08 lb.); it is 170 mm (6.69 in.) longer than the right float and its eccentricity is about 250 mm (9.84 in.) (for a float spacing of about 2,300 mm = 90.55 in.). Besides, the left float contained from two to three times as much fuel as the right float.

*Various promising entries were frustrated by take-off difficulties. So the Curtiss R 3 C-3 with a Packard engine (1926) is said to have been practically uncontrollable (reference 5).

**For 2,300 hp. engine power.

LIFT AND DRAG

There are two typical signs of progress in modern racing airplanes, namely, lower air resistance and increased horsepower per square foot of wing area. The first denotes a more perfect airplane design from the static as well as the aerodynamic point of view. A low-drag coefficient is indicative of great economy.

A high horsepower-area ratio is obtained at the expense of low power loading and high wing loading. So that the power-area ratio is primarily a problem of engine development, and secondarily, a question of admissible take-off and landing speed when standard airplanes are used.

A third factor is the propeller efficiency. For, strictly speaking, the thrust output power of the propeller should be referred to the wing area rather than to the engine power. So long as propellers with fixed pitch are used, the propeller efficiency of the racing airplane has a comparatively low limit. Propellers with optimum efficiency and high speed cannot be used, because the correspondingly high pitch would make the take-off almost impossible. To be sure, the difference between serviceable and optimum pitch in metal propellers has heretofore never been so great as to make variable pitch propellers absolutely necessary. But future developments will have to resort to this expedient. It is significant, at any rate, that most trial flights with the newer racing seaplanes included propeller tests.

There must have been discrepancies in propeller efficiency when - contrary to the model tests in the wind tunnel - the high-speed figures of the Supermarine low-wing types between 1927 and 1931 showed a persistent decline (from $\eta/c_w = 20.2$ to $\eta/c_w = 17.8$). Here the high-speed figures offer a good basis of comparison, because the seaplanes are very much alike and engine power and speeds represent reliable figures.

Unfortunately, no detailed test data are available other than those of the British, and they only cover the year 1927 (reference 6). The British program followed a very systematic schedule, but they have been rather reticent about publishing their latest data. For example, take the test data published on the Supermarine S.5 low-wing

monoplane (No. 19 in table II, fig. 20). On the basis of very carefully made investigations a propeller efficiency of $\eta = 0.7$ may be assumed. The optimum efficiency was estimated by the British at $\eta = 0.835$,* although never reached with the employed propeller for stated reasons.

PARTIAL RESISTANCES

The "high-speed figure" with our assumedly practical propeller efficiency yields a drag coefficient for the seaplane in the neighborhood of c_{wmin} of

$$c_w = 0.035$$

This figure is in close agreement with the wind-tunnel data of

$$c_w = 0.0346$$

However, this accord may be accidental. For the much higher characteristics of the seaplane in flight the coefficients are perhaps lower, but the resistance in the slipstream is therefore greater.**

It is of interest to estimate how this total drag is distributed. The induced drag of the wing is of very little influence, because the seaplane flies with very low lift coefficients. For the case in point

$$c_a = 0.137 \quad (\alpha = 1.8^\circ)$$

or

$$c_{wi} = 0.00095$$

induced drag coefficient, i.e., an induced drag of 2.7 percent of the total drag. Wings with greater aspect ratio are therefore without significance as far as speed increase is concerned.

*The optimum propeller efficiency of the Supermarine S.6 at top speed is $\eta = 0.78$, according to a diagram by F. Holroyd. (reference 7).

**Careful U.S. flight tests revealed $c_w = 0.04$ for the Verville CPR-1 and $c_w = 0.544$ for the Fokker D VII.

But for the entries of the first Trophy Contest the conditions were different. For the 1913 winner (No. 1, table II), the lift coefficient in the contest was

$$c_a = 0.96$$

the induced drag

$$c_{wi} = 0.044,$$

or an induced drag of about 20 percent of the total drag. These seaplanes can no longer be classed as racing seaplanes. Their range of maximum speed was far removed from the angle of attack corresponding to the minimum drag coefficient; the obtained "high-speed figures" therefore offer no basis of comparison.

According to a new Göttingen interpolation formula (Ergebnisse der Aerodynamischen Versuchsanstalt zu Göttingen IV, p. 27)

$$c_f^T = \frac{0.455}{\left(\log \frac{v l}{\nu}\right)^{2.58}} - \frac{1700}{\frac{v l}{\nu}}$$

the surface friction for a

$$\frac{v l}{\nu} = 11.7 \times 10^6$$

Reynolds Number may be assumed with a coefficient of friction (referred to wing area) of

$$c_{wF\text{friction}} = 0.00552^*$$

The frictional drag of the S.5 wings at $V = 453$ km/h (281.5 mi./hr.) then amounts to 58.5 kg (129 lb.) or 16 percent of the total drag. Hence the effect of skin friction must not be underestimated in racing seaplanes. This leaves for the form drag of the S.5 wings a coefficient of

$$c_{wF\text{form}} = 0.00313$$

*A wind-tunnel test on the model S.5 wing revealed for a Reynolds Number 4.5×10^5 , a friction coefficient of 0.00984 (R. & M. No. 1299, table 127). But extrapolation is not admissible because this Reynolds Number is still within the transition zone between laminar and turbulent flow, according to L. Prandtl.

Compared with Schrenk's (reference 8) profile drag studies, the above drag coefficients are acceptable. According to him (loc. cit. table III) coefficients of the order of magnitude of

$$c_{w_{\text{profile}}} = 0.006$$

were to be expected. The profile drag coefficient

$$c_{w_{\text{profile}}} = 0.00865$$

obtained for the S.5, is ostensibly about 44 percent higher* which may, perhaps, be explained by the influence of the air flow on the wing as a result of the bracing wires. The influence of the slipstream may also have some significance, particularly since Schrenk's investigations had, as known, been made on a cantilever wing without slipstream effect.

But closely agreeing with Schrenk, the skin friction of the S.5 is substantially higher than the pure form drag of the wing. The R.A.F. 30 airfoil (fig. 31) is very symmetrical. The skeleton line of the profile is a straight line. The form drag of the wing is only 25.6 percent of the profile drag, whereas the skin friction is no less than 74.4 percent.

RESIDUAL DRAG

For the parasite resistance of fuselage, flotation gear, control surfaces, and bracing system the residual drag coefficient of the S.5 is

$$c_{ws} = 0.025$$

or no less than 72.5 percent of the total drag. About 17.5 percent of it is attributable to increased drag due to mutual interference. English measurements reveal that the greater part is due to the system of bracing. Consequently, the sum of the individual drag quotas is 17.5 percent lower than the actual drag.

*For comparison the profile drag coefficient for the S.5 was computed with R. E. Upson's empirical formula (for $\frac{vL}{\nu} = 3.5 \times 10^6$ Reynolds Number). The result was $c_{w_{\text{profile}}} = 0.0095$. (See reference 9.)

On the Supermarine S.6, the drag quota due to mutual interference is 16.4 percent, while measurements on the Sperry Messenger sport biplane disclose at 160 km/h, according to R. H. Upson (loc. cit.), an additional drag due to mutual interference, which amounts to 23.5 percent of the total drag.

The drag quotas, according to British wind-tunnel tests are:

	Supermarine S.5		Supermarine S.6	
	c_{ws}	Quota to total drag percent		Mutual interference percent
Bracing system	0.00221	6.4	5.6	+14.0
4 struts	0.00246	7.1	5.4	+ 4.6
2 floats	0.00675	19.5	21.4	+ 1.6
Fuselage			17.8	-
Vertical tail surface	0.00580	16.7	2.3	- 0.6
Horizontal tail surface	0.00268	7.75	3.4	- 1.9

According to this the mutual interference sets up a drag of the order of the body drag. The wing drag of the S.5 and of the S.6 was approximately the same (27.5 percent against 27.7 percent).

The separate drag quotas of the S.5 are of particular interest. The fuselage length is 6.36 m (20.87 ft.), with a maximum width of 505 mm (19.9 in.), and maximum height of 940 mm (37 in.) (the faired cylinder cowlings included; see figs. 38 and 39) and is of oval section. The maximum bulkhead area is 0.48 m² (5.17 sq.ft.), the total fuselage area 12.6 m² (135.6 sq.ft.), and the total volume 1.57 m³ (55.44 cu.ft.), inclusive of the fin.

The drag of the complete fuselage, relative to maximum cross section is

$$c' = 0.128$$

About 67 percent of this is perhaps due to surface friction, thus leaving

$$c_f' = 0.043$$

for body drag.

According to measurements the drag for the bare fuselage minus vertical tail surfaces was only

$$c = 0.107,$$

which certainly attests to the aerodynamic qualities of modern racing airplanes.*

The notable feature of the 1925 Supermarine S.4 was its still lower drag coefficient

$$c = 0.082,$$

despite its 85 percent greater maximum bulkhead and its 47 percent higher drag than of the S.5 fuselage (fig. 38).

According to McKinnon Wood and Glauert, the fuselage of the Curtiss CR 3 (fig. 10) has a drag coefficient of

$$c = 0.21 \text{ to } 0.25$$

for a maximum bulkhead of 0.65 m^2 (7 sq.ft.).

*E. Ower (Jour. Roy. Aero. Soc., July 1932, p. 535) states that a streamline body equivalent to the fuselage has a turbulent frictional drag of

$$c_r = 0.00144$$

or

$$c_r = 0.037 \left(\frac{v}{v_L} \right)^{0.2}$$

According to that, about 5 percent of the total seaplane drag would be surface friction on a bare, perfectly smooth fuselage such as the S.5. In reality, the skin friction of the complete S.5 fuselage, inclusive of fin, should be estimated at around 11 percent of the total drag. A further 6 percent of the total drag is therefore caused by the body drag of the complete S.5 fuselage.

The following tabulation shows the maximum fuselage sections of various racers:

FUSELAGE SECTIONS AT MAXIMUM BULKHEAD

Seaplane type	Cross-sectional area (m ²)
Supermarine "Sea Lion" flying boat	1.17
Gloster II biplane	0.95
Gloster III "	0.95
Curtiss CR.3 "	0.65
Supermarine S.4 monoplane	0.91
Curtiss R3C.2 biplane	0.61
Gloster IV "	0.50
Supermarine S.5 low-wing monoplane	0.48
Short "Crusader" low-wing monoplane	0.59

(m² × 10.7639 = sq.ft.)

The reduced drag between the S.4 and the S.5 is primarily due to the reduced cross sections.

The float drag of the S.4, relative to the maximum bulkhead area, was

$$c = 0.115$$

by 0.342 m² (3.68 sq.ft.) maximum bulkhead and an excess lift of 55 percent of the total weight as compared to

$$c = 0.118$$

for the S.5 (table III) with a maximum bulkhead area of only 0.295 m² (3.18 sq.ft.). The result was a 11 percent lower float drag. The float area of the S.5 was 8.95 m² (96.34 sq.ft.) - the excess lift about 47 percent of the total weight.

The four float support struts of the S.5 of R.A.F. 30

form gave a fineness ratio of 4:1. The drag of a single strut relative to strut diameter was

$$c = 0.0796$$

at a Reynolds Number of 5.26×10^5 .

Originally of pisciform section, the streamline brace wires on the S.5 were replaced by such of lenticular form after wind-tunnel tests had shown the latter to be more propitious, with a drag coefficient of

$$c = 0.80 \text{ to } 0.40,$$

at very low Reynolds Numbers.

Beginning in 1928, the S.6, S.6B, and Gloster VI were again fitted with streamline section wires because of their superiority with a 22 percent lower drag than those of lenticular section. Admittedly, these wires must be finished by hand to insure satisfaction.

The cinematographic records taken of the landings of the S.6 revealed 143 km/h (89 mi./hr.) as best landing speed with an angle of attack of 11.6° . The accuracy of these measurements was within ± 2 percent. This gives a maximum lift coefficient of the seaplane of

$$c_{aL} = 1.37 \text{ to } c_L = 11.6^\circ \text{ (reference 10)}$$

Wind-tunnel tests on the S.5 wing having R.A.F. 30 wing section (reference 11) showed

$$c_a = 0.83 \text{ at } \alpha = 11.6^\circ$$

$$c_{a_{\max}} = 0.96 \text{ at } \alpha = 15^\circ$$

or $c_a = 0.92$ at $\alpha = 11.6^\circ$ after allowance for ground interference. For the whole seaplane the lift was $c_a = 1.09$ (inclusive of allowance for ground effect and Reynolds Number from comparative measurements on R.A.F. 30 wing section).

The maximum lift, according to the measurement on the complete seaplane model was reached at around $\alpha = 19^\circ$.

The not inappreciable discrepancy of $\Delta c_a = 0.28$ in lift coefficient between flight measurement and carefully corrected model test is perhaps attributable to slipstream effect.*

On the basis of the measurements, the choice of wing section for the S.6 fell to one giving the maximum lift coefficient at $\alpha = 14^\circ$. The fact that racing airplanes land at comparatively low α (up to 12.6° , according to measurements), proves that the angle of attack range which is available for purposes of landing, has not been fully utilized hitherto. The English wind-tunnel tests on racing seaplane models revealed a delayed separation of the flow at high angles of attack as compared to wing models. Apart from that, it was precisely at high angles of attack that the lift of the nonlifting parts was perceptibly felt. To illustrate: the model of the Gloster IV biplane showed a critical $\alpha = 25^\circ$ in contrast to $\alpha = 13^\circ$ for the model wing. The behavior of the Short "Crusader" was very peculiar. At $\alpha = 18^\circ$ and $c_a = 0.85$, a separation of flow, i.e., a lift decrease, was noted; but as α increased the lift did not disappear in the same measure as common for airplane wings, but gradually increased again to $c_{a_{max}} = 1.2$ at $\alpha = 35^\circ$ to 40° (uncorrected model figure). The floats and the cylinder helmets are large contributory factors to these lift conditions, as also is the comparatively small aspect ratio of the wings.

The lift of the seaplane in flight most likely reveals a similar behavior, from which it may be concluded that with racing airplanes especially, a much lower landing speed is obtainable when effected at greater angle of attack. The remarkably extended speed range of high-speed airplanes may be assumed as attestation to this surmise.

When interpreting the measurements it should be borne in mind that the S.5 is said to develop very disagreeable stability conditions (tendency to suddenly go into a spin) when approaching the critical angle of attack (stalling).

*English measurements on the Fokker F VII commercial non-oplane show a discrepancy of only $\Delta c_a = 0.1$ (reference 12) between nonrunning and running engine.

As concerns the drag conditions, the graph (fig. 2) and table II manifest that there is no longer any difference between landplanes and seaplanes, although there was considerable in 1923, on account of the high float drag. For example, the identical Curtiss army racer CR 2 with the same engine but fitted with landing gear, reached a speed of 331 km/h (195 mi./hr.) over a 250 km (155.3 mi.) course in the 1922 Pulitzer Race which, in the 1923 Schneider Contest, fitted with two floats and with 55 kg (121 lb.) more fuel load, reached a speed of 285 km/h (177 mi./hr.). The 13.5 percent speed loss in favor of the landplane proved therefrom has, however, disappeared to-day, thanks to systematic measurements.

Figure 2 likewise shows some speed records. It is seen that these, however, can make no claim as suitable basis for checking. For one thing, the accuracy of even the very latest photogrammetric methods with an accuracy of within 1/20 second over a 3 km (1.86 mi.) course, is far from being as great as the timing over a 350 km (217.5 mi.) closed circuit. Moreover, the distance is not flown at steady speed. Prior to entering the course the pilot attains altitude so as to insure a maximum acceleration. The result is a much higher top speed than the actual top speed in unaccelerated horizontal flight. Contrariwise, the measured figures of the Schneider races are much more reliable. The measured speeds - owing to the losses in cornering - are approximately from 3 to 6 percent lower than the true maximum speed in unaccelerated level flight. This speed loss is about the same for all seaplanes. But there is yet another, more substantial error which equally results in an unduly low estimation of the true top speed, and that is that several of the newer racing seaplanes could not be flown at full throttle during the whole race because of insufficient cooling. In fact, the English pilots of 1929 and 1931 stated that they literally flew the race according to the cooling water thermometer, i.e., throttled the engine so as not to exceed the maximum permissible cooling water temperature.

In any case the average speed of the Schneider races was therefore somewhat less than the true top speed.

A fair average for modern racing seaplanes of standard type, according to figure 2, is found from the empirical formula

$$V_{\max} = 102 \sqrt[3]{N/F}$$

wherein V_{\max} is expressed in kilometers per hour, N = engine output in horsepower and F = wing area in m^2 .^{*} This approximation bases modern racing seaplanes on a "high-speed figure" of

$$\eta/c_w = 19.5 \text{ approximately,}$$

which, as the graph reveals, is fairly accurate for land-planes and seaplanes in high-speed flights over greater distances. On the other hand, the world's speed records over a 3-kilometer course do not lend themselves to such averaging.

The racers of the Schneider Contests were designed solely for high-speed work at low altitude. In spite of that these seaplanes with their low power loading have at times revealed climbing speeds which are far beyond anything developed by service airplanes. Thus the Gloster VI (see table II) had a speed of climb of 26.8 m/s (87.9 ft./sec.) near ground level. The American entries also showed remarkable climbing power.

Under otherwise identical conditions, the take-off and landing speeds of the different seaplanes were widely at variance. The take-off difficulties due to torque reaction have already been pointed out. Then there is the propeller thrust during taxiing,^{**} the hydrodynamic qualities of the flotation gear, and above all the training of the pilot. Careful float design conformable to towing tests has lowered the water resistance considerably and the tendency to porpoising when approaching the hump speed.

*L. Hirschauer, in his report (reference 13), attempts to set up a similar approximation for the speed performance by means of his "quality" factor, which corresponds to the German "distance figure" (η/c). With an assumed average of $\eta/c = 3.0$, his approximation is $V = \sim 810 \text{ M/G}$. But the agreement with experience is not as satisfactory as by our approximation method, as seen when comparing the "distance figures" in table II. The comparison with equal high-speed figures is less objectionable. Besides, the horsepower in Hirschauer's Deperdussin airplane, which he used as illustration, should read 140 hp. effective performance instead of 160 hp. rated output, that is, $\eta/c = 3.2$ instead of $\eta/c = 3.0$.

**The propeller efficiency at maximum hump speed (on take-off) is about $\eta = 0.08$.

In this respect the floats on the S.6 B are claimed to be much superior to those of the S.6.

Static thrust tests on the Gloster III B biplane with direct-drive Napier-Lion VIII engine developed 601 hp. at 2,600 r.p.m., a thrust of 375 kg (827 lb.) for a propeller of 2,050 mm (6.73 ft.) diameter, and 38° pitch at 0.7 radius. Another propeller of the same type but with approximately 37° pitch, was unsatisfactory for starting (reference 15).

In contrast to this the S.6 A (modified S.6) and the S.6 B (subsequent development of S.6) showed a much cleaner float design and a much quicker take-off despite the much higher take-off speeds. The longest take-off of the S.6 B was 43 seconds at the time the world's record was established with a propeller of higher pitch. The quickest take-off of the 1931 Schneider Race was 17 seconds. The landings are as a whole more uniform, ranging from 18 to 20 seconds for the S.6 B. The longest take-off was that of the S.6, with an average of 60 seconds.

The Short "Crusader" had a quick take-off, i.e., 8 seconds, with full load. The take-off for the S.5 and the Gloster IV B ranged from 15 to 32 seconds in a slight breeze; that of the Macchi M.52 was 18 seconds, in a slight head wind, and 25 seconds in flat calm.

Translation by J. Vanier,
National Advisory Committee
for Aeronautics.

REFERENCES

1. Waghorn, H. R. D.: The Schneider Trophy, 1929. Jour. Roy. Aero. Soc., vol. 34, no. 233, May 1930, p. 400 ff.
2. Orlebar, A. H.: High Speed Flying. Flight, April 1, 1932, p. 290.
3. Wimperis, H. E.: High Speed Flying. Jour. Roy. Aero. Soc., vol. 35, no. 251, Nov. 1931, p. 1040 ff.

4. Jennings, W. A.: "Cornering" at High Speeds. R. & M. No. 1281, British A.R.C., 1930.
5. Cowley, W. L., and Warden, R.: Tests on Quarter Scale Models of High Speed Seaplanes for the Schneider Trophy Contest of 1927. Section IV. Comparison with Full-Scale and Conclusions - Appendix III. R. & M. No. 1299, British A.R.C., 1930.
6. Kean, John S.: Racing Seaplanes ... Present and Future. Aviation, June 28, 1930, p. 1269.
7. Collected Reports on British High Speed Aircraft for the 1927 Schneider Trophy Contest. (With an introduction by W. L. Cowley.) R. & M. No. 1300, British A.R.C., 1931.
8. Holroyd, F.: Racing Seaplanes. Jour. Roy. Aero. Soc., May 1930, p. 434.
9. Schrenk, M.: "Über Profilwiderstandsmessung im Fluge nach dem Impulsverfahren." D.V.L. Yearbook, 1929, p. 9.
10. Upson, Ralph H.: Wings - A Coordinated System of Basic Design. S.A.E. Jour., January 1930, p. 16.
11. Jones, E. T.: Measurements of Incidence and Speed of the S.5 Seaplane on Alighting. R. & M. No. 1300 (E.1), British A.R.C., 1931.
12. Cowley, W. L., and Warden, R.: Tests of Models of High Speed Seaplanes for the Schneider Trophy Contest of 1927. Section I. R. & M. No. 1296, British A.R.C., 1930.
13. Hardy, J. K.: Full Scale Measurements of Lift and Drag of the Fokker F.VII-3M Monoplane. R. & M. No. 1096, British A.R.C., 1927.
14. Weyl, A. R.: Discussion of Topfer's paper, "Auftriebsverteilung und Längsstabilität." Z.F.M., Nov. 28, 1931, p. 662.
15. Hirschauer, L.: La "qualite" des avions de grande vitesse. L'Aeronautique, January 1932, pp. 3-4.

14. Buchanan, J. S.: The Schneider Cup Race, 1925. Jour. Roy. Aero. Soc., vol. 30, no. 187, July 1926, p. 442.
15. Static Thrust Tests of Two Airscrews on Gloster III B No. N.195. R. & M. No. 1300 (B.19), British A.R.C., 1931; and Tests of Two Airscrews on Gloster III A No. N.194. R. & M. No. 1300 (B.20, Fourth Interim Report), British A.R.C., 1931.

TABLE I. SURVEY OF RACES

No.	Year	Date	Place	Course		Country of winner	Pilot	Air-plane type	Engine	hp.	Speed km/h	Remarks
				laps km	total km							
1	1913	April 6	Monaco	28x10	280	France	Prévost	Deperdussin float MD	Gnome	160	96.5	Evaluated speed only 72.6 km/h
2	1914	April 20	Monaco	28x10	280	England	H. Pixton	Sopwith float DD	Gnome	100	139.7	
No race because of war, 1915-1918												
3	1919	Sept. 9	Bournemouth	10x36	360							Remaining entry (Janello) not recognized because of fog
4	1920	Sept. 21	Venice	10x36	360	Italy	L. Bologna	Savoia S.19 flying boat DD	Ansaldo	500	172.5	
5	1921	Aug. 11	Venice	10x36	360	Italy	G. di Briganti	Macchi VII flying boat DD	Isotta-Fraschini	200	178.5	Actual speed about 4 km/h higher
6	1922	Aug. 12	Naples	13x28	365	England	H. Biard	Supermarine Sea Lion II flying boat DD	Napier Lion	450	234.5	
7	1923	Sept. 28	Cowes	5x68	340	U.S.A.	D. Rittenhouse	Curtiss CR-3 float DD	Curtiss D-12A	465	285.4	
8	1924	Oct. 25	Baltimore	5x68	340							Only U.S. entries ready
Postponed for lack of entries												

TABLE I. SURVEY OF RACES (Cont'd)

No.	Year	Date	Place	Course		Country of winner	Pilot	Air-plane type	Engine	Speed		Remarks
				laps	total					hp.	km/h	
9	1925	Oct. 26	Baltimore	7x50	350	U.S.A.	J. Doolittle	Curtiss R3-C2 float DD	Curtiss V-1400	619	377	
10	1926	Nov. 13	Hampton Roads	7x50	350	Italy	Di Bernardi	Macchi M.39 float TD	Fiat AS II	880	396	
11	1927	Sept. 26	Venice	7x50	350	England	S. N. Webster	Supermarine S.5 float TD	Napier Lion VII B	875	453	
12	1929	Sept. 7	Ryde	7x50	350	England	Waghorn	Supermarine S.6 float TD	Rolls-Royce R	1950	529	
13	1931	Sept. 13	Lee-On-Solent	7x50	350	England	Boothman	Supermarine S.6B float TD	Rolls-Royce R	2300	547.3	

DD, biplane
 TD, low-wing monoplane
 MD, mid-wing monoplane

Table II. Entries in Schneider Trophy Race, 1913-1931

Airplane	Year	Type	Flotation gear	Power plant		Dimensions				Weights			Speeds		Computed flight performance				Remarks							
				Engine	Propeller	Dia. m	Pitch, m	Span, m	Wing area, m ²	Aspect ratio, b/c	Power per hp/m ² N/f	Weight empty, kg	Load, kg	Gross wt. w/ fuel, kg	Wing loading, kg/m ²	Design factor, kg/m ² /hp ²	Maximum speed (km/h)	Landing speed		Unit speed, km/h (Ve)	High speed factor, (V _h /V _e)	Range factor, (V _h /V _e)	Vertical ascent, m/s	Max. speed	Land. speed	
Deperdussin-ED	1913	Braced MD	3 Floats	Gnome-Rotary	2 Wood blades	2.50	13.90	27.5	6.8	5.1	950	250	1200	43	8.6	3160	96.5	94.5	3.0	3.06	5.84	1	1913 winner			
Nieuport-ED	1913	"	"	"	2 Wood blades	2.60	12.0	24	6.0	5.85	600	250	850	35.5	6.1	1320	111	86	4.22	2.5	8.2	2	Fuel line failure, withdrawn			
Sopwith-DD	1914	Braced 1 strut	"	Gnome-Mono-Rotary	2 Wood blades	2.40	7.50	23	2.44	3.4	400	200	650	28.3	8.1	1830	139	77	14.3	4.16	6.2	3	1914 winner			
F. B. A. Flying boat-DD	1914	2 Struts Flying boat	"	"	Chauviere	2.12	7.30	19	4.2	4.2	600	250	850	45	10.6	5060	100	97	4.25	4.0	4.74	4	Lack of fuel, withdrawn			
Savoia-S. 13a Flying boat-DD	1919	1 strut	"	Isotta Fraschini V.6	4 blades, wood (Pusher)	2.12	2.27	8.10	19.6	2.35	15.8	730	210	940	48	3.04	442	201	100	9.2	2.25	16.5	5	Fastest in 1919 race		
Savoia-S. 19a Flying boat-DD	1920	"	"	Ansaldo-E. 28a	"	"	"	11/11	34.5	3.5	14.5	"	"	2170	62.8	4.24	1120	172.5	114	6.3	2.7	11.8	6	1920 winner		
Macchi-VIIa Flying boat-DD	1921	"	"	Isotta Fraschini Fiat	2 blades, wood (Pusher)	"	"	9.05/9.15	26	3.8	9.65	780	250	1030	39.8	4.12	675	182.5	95	95.6	10.5	2.78	12.2	1.92	7	1921 "
Macchi-III-19a Flying boat-DD	1921	M. Bacing	"	"	4 blades, wood (Tractor)	"	"	15.75/11.30	45	5.5	16.0	2490	300	2790	62.0	3.87	930	216	113	11.3	3.1	12.9	8	Forced landing due to fire		
Supermarine-Sea Lion III Flying boat-DD	1922	1 Strut	"	Napier-Lions	4 blades, wood (Pusher)	2.64	3.2	0.77	26.5	3.55	17.0	1080	400	1480	55.8	3.3	605	234.5	102	108	13.5	2.86	15.2	2.29	9	1922 winner
Savoia-S. 51a Flying boat-DD	1922	V strut	"	Hispano-Suiza	2 blades, wood (Pusher)	"	"	10.4	23.0	4.35	13.0	780	300	1080	47.0	3.6	610	229	99	16.4	2.85	13.9	10	2nd. in 1922		
Curtiss-CR-3-DD	1923	1 strut	2 Floats	Curtiss-D 12 Av	2 blades, metal (Pusher)	2.59	2.84	6.4/6.1	13.7	2.98	34.0	960	280	1240	90.4	2.66	640	285.4	119	137	12.1	2.8	18.9	2.41	11	1923 winner
Supermarine-Sea Lion III Flying boat-DD	1923	1 strut	floating bit	Napier-Lions	2 blades, metal (Pusher)	"	"	9.7	26.5	3.55	21.6	1000	380	1470	55.5	2.56	364	254	90	107	13.5	2.4	19.5	2.82	12	3rd. in 1923
Curtiss-R3-C2-DD	1924	Half strut	2 Floats	Curtiss-V-1400	2 blades, metal (Pusher)	2.34	3.1	6.4/6.1	14.1	2.64	50.0	920	300	1220	86.5	1.75	265	377	127	130	20.4	2.76	25.3	2.98	13	1925 winner, 396 km/h, 3 km course
Gloster-III-DD	1925	"	"	Napier-Lion VII-D	"	2.36	2.72	6.1/6.1	14.1	2.64	50.0	940	315	1255	83.5	2.5	520	321	120	134	11.8	2.1	28.7	2.47	14	2nd. in 1925
Macchi-M. 33c TD Flying boat	1925	Can'tiler MD	2 Floats	Curtiss-D. 12	(Tractor)	"	"	9.73	15.0	6.3	26.8	1100	350	1450	115	2.14	525	381	145	154	(18.4)	(3.04)	23.3	(2.68)	16	Wing flutter, crashed
Supermarine-S. 4c ED	1925	"	"	Napier-Lion VII-D	2 bl. metal (Tractor)	"	"	9.25	12.6	6.7	53.8	1100	350	1450	115	2.14	525	381	145	154	(18.4)	(3.04)	23.3	(2.68)	16	Wing flutter, crashed
Macchi-M. 39c TD	1926	Braced TD	"	Fiat-A.S. IIe	"	"	"	9.26	14.3	5.9	56.0	1300	315	1615	111	2.02	455	396	153	19.8	2.96	24.8	"	17	1926 winner	
Navy-Curtiss-R3-C4c DD	1926	Half strut	"	Curtiss-V-1550	"	"	"	6.4/6.1	13.7	3.1	51.0	"	"	"	"	"	390	135	"	"	"	"	"	18	2nd in 1926	
Supermarine-S. 5c TD	1927	Braced TD	"	Napier-Lion VII-Gs	2 bl. Metal	2.20	3.50	8.15	10.6	6.25	82.5	1150	300	1450	136	1.66	375	453	145	168	20.2	2.78	30.2	3.13	19	1927 winner, 514 km/h, 3 km course
Supermarine-S. 5c TD	1927	"	"	Fairley-Reed	"	2.13	2.80	8.15	10.6	6.25	81.0	1080	300	1380	130	1.60	334	440	145	164	18.7	2.60	31.2	3.04	20	2nd in 1927
Short-Crossader TD	1927	"	"	Not geared down Bristol-Mercury	"	2.30	8.40	13.5	5.22	64.4	1000	270	1270	94	1.46	200	345	136	140	(11.4)	(1.87)	34.3	(2.54)	21	Crashed during trial, (420 km/h model test)	
Gloster-IVc DD	1927	Braced Half strut	"	Napier-Lion VII-Gs	"	2.34	3.44	6.85/5.55	12.6	3.88	72.2	1090	270	1360	112	1.56	273	~445	143	153	(21.8)	(2.68)	32.2	(~3.08)	22	Forced landing, damaged spinner
Macchi-M. 52c TD	1927	Braced TD	"	Fiat-A.S. IIIe	2bl. Metal	"	"	8.98	13.3	6.12	77.5	"	"	1560	127	1.52	293	479	162	(25.2)	(2.7)	35.6	"	23	World speed record, Venice, 1927	
Packard-Williams-Kirkham-DD	1927	Braced Half strut	"	Packard-X-24	2bl. Metal	1.97	9.10/7.40	20.0	4.12	62.5	1810	274	2084	104	1.66	286	444	147	(25.0)	(2.72)	30.2	"	24	Not ready		
Supermarine-S. 6c TD	1929	Braced TD	"	Rolls-Royce-R	2bl. Metal	2.90	5.90	9.10	13.5	6.12	145	1830	550	2380	177	1.22	204	529	176	191	18.0	2.4	41.0	3.01	25	1929 winner, 575 km/h, 3 km course
Gloster-VIIc TD	1929	"	"	Napier-Lion VII-D	2bl. Metal	2.24	3.05	8.0	10.6	6.05	113	1400	400	1800	170	1.50	880	541	177	188	(25.0)	(2.65)	33.4	(3.07)	26	World speed record, 1929, 565 km/h
Macchi-M. 62c R	1929	"	"	Fiat-A.S. IIIe	2bl. Metal	"	"	7.85	10.2	6.04	101	"	"	1480	145	1.41	286	456	173	(8.6)	(2.38)	35.5	"	27	" " " 1928, 512.8 km/h	
Savoia-S. 65c TD	1929	"	"	2x Isotta Fraschini	"	"	"	9.5	18.8	4.8	103	"	"	3305	177	1.71	518	420	191	(12.8)	(2.65)	29.4	"	28	Not entered	
Fiat-C. 29c TD	1929	"	"	Fiat-A.S. Vc	Tandem 1 Pusher (Tractor)	"	"	6.3	7.25	5.5	137	"	"	1080	149	1.08	174	477	176	(21.2)	(1.92)	46.3	"	29	" " "	
Macchi-M. 67c TD	1929	"	"	Isotta Fraschini	2bl. Metal	"	"	8.96	13.3	6.0	106	"	"	2145	161	1.53	378	665	183	(29.3)	(3.0)	32.8	"	30	" " "	
Piaggio-P7c TD (floatless)	1929	Can'tiler TD	2 Floats	Isotta Fraschini V.6/500	2bl. Metal	"	"	6.76	9.8	5.36	99	"	"	1738	177	1.8	575	[580]	192	(35.2)	(3.87)	27.8	"	31	Not flown in final form, Computed V _{max}	
Supermarine-S. 6c TD	1931	Braced TD	"	Rolls-Royce-R	Fairley-Reed	2.78	(7.3)	9.15	13.5	6.2	171	2070	650	2720	202	1.18	272	547	205	17.1	2.39	42.4	"	32	1931 winner	
Supermarine-S. 6c TD	1931	"	"	"	"	"	"	9.15	13.5	6.2	193	2070	~330	~2400	"	"	658	~200	(26.3)	"	(~3.29)	"	33	World speed record over 3 km course, 1931		
Deperdussin-G.B. 1913c ED	1913	Braced MD	Landing gear	Gnome-Umlauf-lambda-lambda	2 bl. wood Chauviere	2.20	8.6	9.0	8.18	15.5	450	100	640	50	3.2	510	204	102	9.8	3.20	15.7	"	34	V _{max} over 200 km course with 20 laps 1913, Reims (Gordon Bennett)		
Bernard-S. J. M. B. ED	1924	Can'tiler MD	"	Hispano-Suiza-AV-50	2bl. Metal	"	"	9.90	11.0	8.9	54.8	"	"	1175	107	1.96	410	448	149	29.3	3.25	25.6	"	35	World speed record, 1924 over 1 km course at Istres	
Ferrous V. 2c ED Laird-Super-Solutions DD	1931	Braced 1st DD	"	Pratt-Whitney-Wasp-Juniors	2bl. Metal	2.50	2.78	6.40/5.48	3.95	10.4	49	720	300	1100	106	2.16	405	360	148	17.0	2.9	23.2	"	36	Average speed for 3400 km cross country course	
Granville-V. Gee-Bee Supersportsters-TD	1931	1st DD	"	Pratt-Whitney-Wasp-Juniors	2bl. Metal	2.48	2.82	7.15	7.0	7.3	76.0	640	370	1010	142	1.80	510	435	130	17.2	19.4	3.05	26.4	3.35	37	World speed record over 200 km course, 10 laps

m x 3.28083 = ft. m² x 10.7639 = sq. ft. Kg x 2.20462 = lb. Kg/m² x .204818 = lb./sq. ft. km/h x .62137 = mi/hr. Kg³ x 10.7152 = lb³ Kg/hp x 2.20462 = lb./hp.

TABLE III. FLOTATION GEARS

Type	Nieuport ED 1913	Sopwith DD 1914	Gloster IV DD 1927	Short "Crusader" TD 1927	Super- marine S.5 TD 1927	Superma- rine S.6 TD(S.6B) 1929	Kirkham- Packard DD 1927
Type offloat	2 main floats 1 stern float	2 main floats 1 stern float	2 floats	2 floats	2 floats	2 floats	2 floats
Step of float	main float partially stepped	unstepped	1 step	1 step	1 step	1 step	1 step
Material of float	wood	wood	duralumin	duralumin	duralumin	duralumin	wood, sheet metal bottom
Float length (mm)	3150	2500	5820	5530	BB 5620 StB 5800	BB 5860 (~7200) StB 6180	6180
Float width at maximum section (mm)	800 (240 mm at edge of step)	500	658	635	674		1020
Float height at maximum section (mm)	400	450	583	600	682	800	
Float spacing (mm)	2800	2500	1970	1980	2290	2290	2440
Maximum cross sec- tion (m ²)	0.32	0.23	0.28	0.29	0.295		
Float displace- ment (l)	~680	380	1060	980	BB 990 StB 1190	(aver- age 2230)	1400

TABLE III. FLOTATION GEARS (Cont'd)

Type	Nieuport ED 1913	Sopwith DD 1914	Gloster IV DD 1927	Short "Crusader" TD 1927	Super- marine S.5 TD 1927	Superma- rine S.6 TD(S.6B) 1929	Kirkham- Packard DD 1927
Float surface (m ²)	~7.2 (includ- ing de- flecting vanes)	~4.7	9.1	8.2	~9		
Float weight (kg)			108		av. ~115		127
Maximum water resistance (kg)					336 kg at 39 km/h	594 kg at 34 km/h	
Location of step aft of nose (mm)	1st step: 1050 2d step: 2050	-	2860	2880	BB 2810	BB 3170	3240
Total weight (kg)	850	650	1360	1270	1450	2380	2084
Excess lift (%)	60	17	55	52.5	47	87	35

mm x .03937 = in. l x .035314 = cu.ft.

ED, monoplane
BB, port (larboard)
StB, starboard

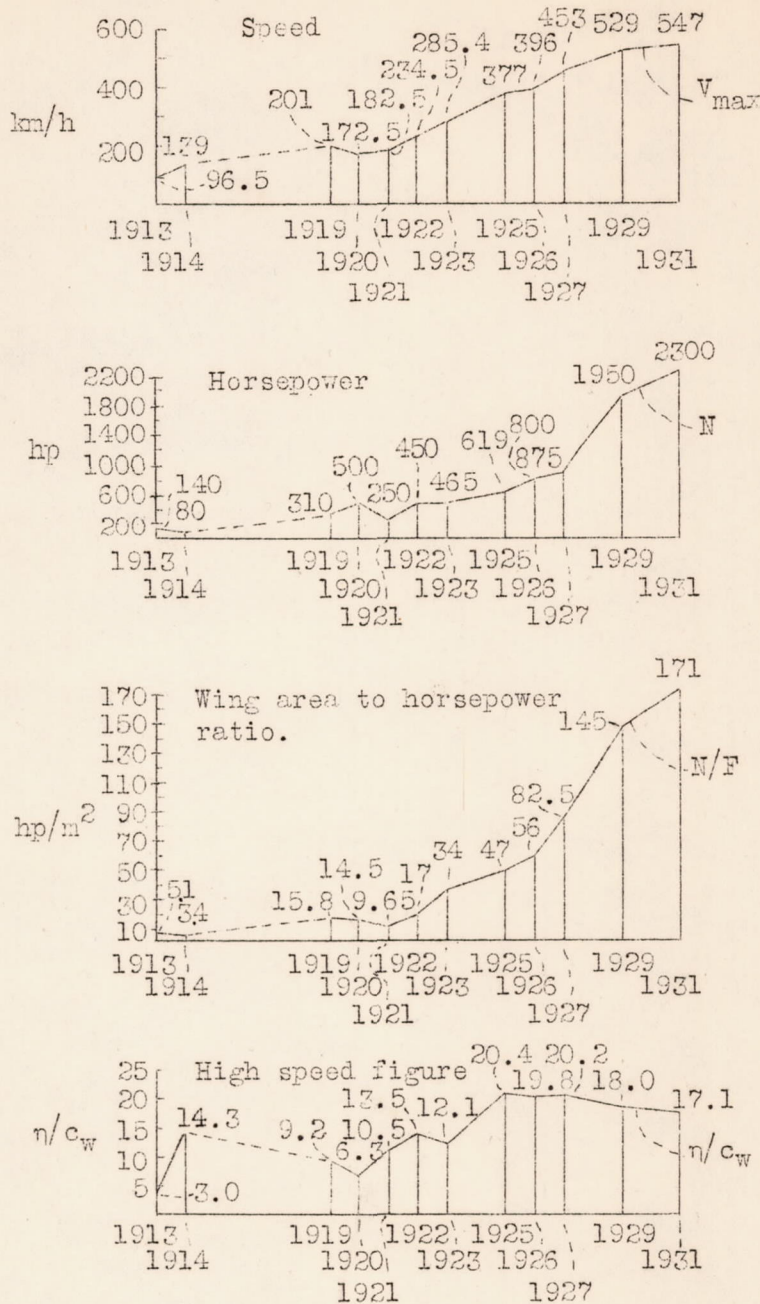

Figure 1a. - Speed, hp, wing-area to horsepower ratio, and high speed figure of the Schneider Trophy winners, 1913-1931.

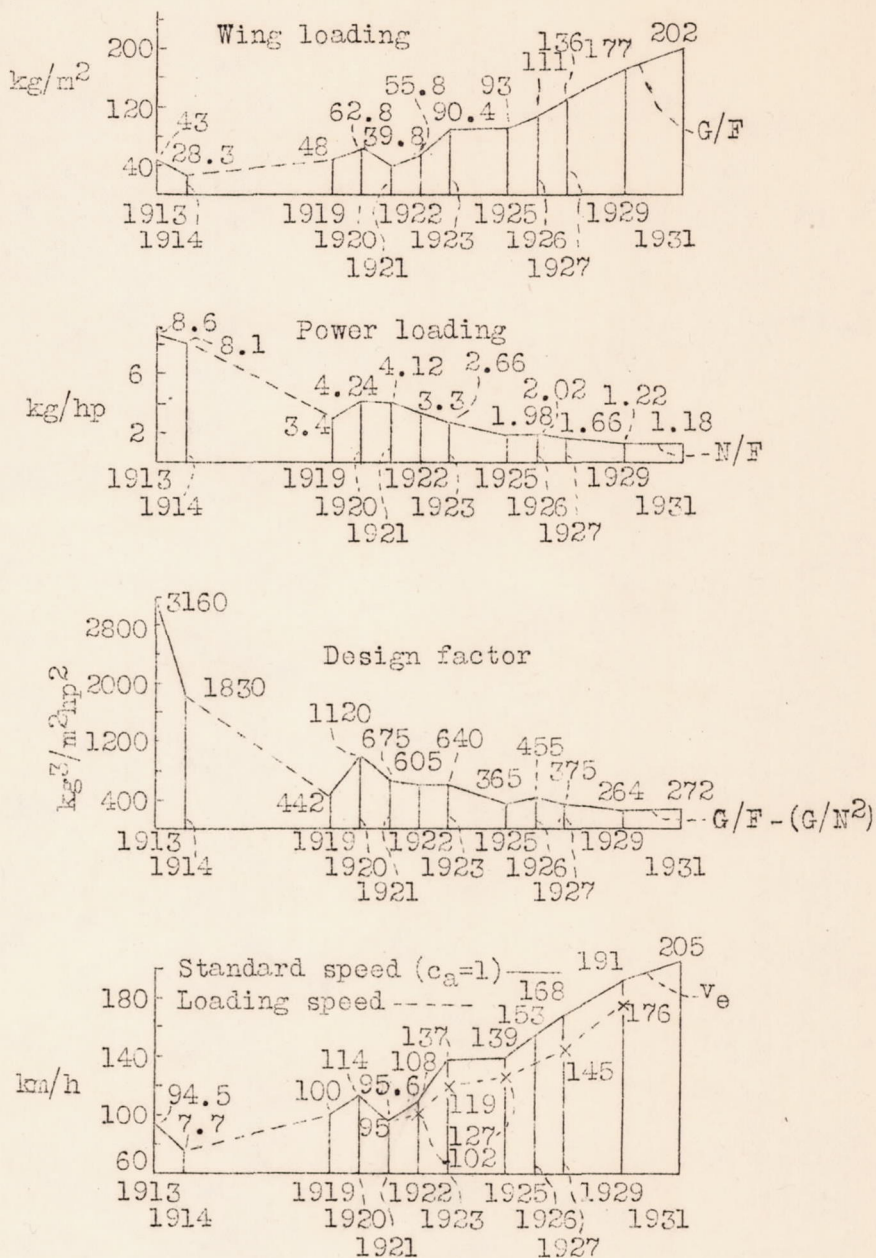

Figure 1b. - Wing loading, power loading, design factor and standard speed of the winning airplanes, 1913-1931.

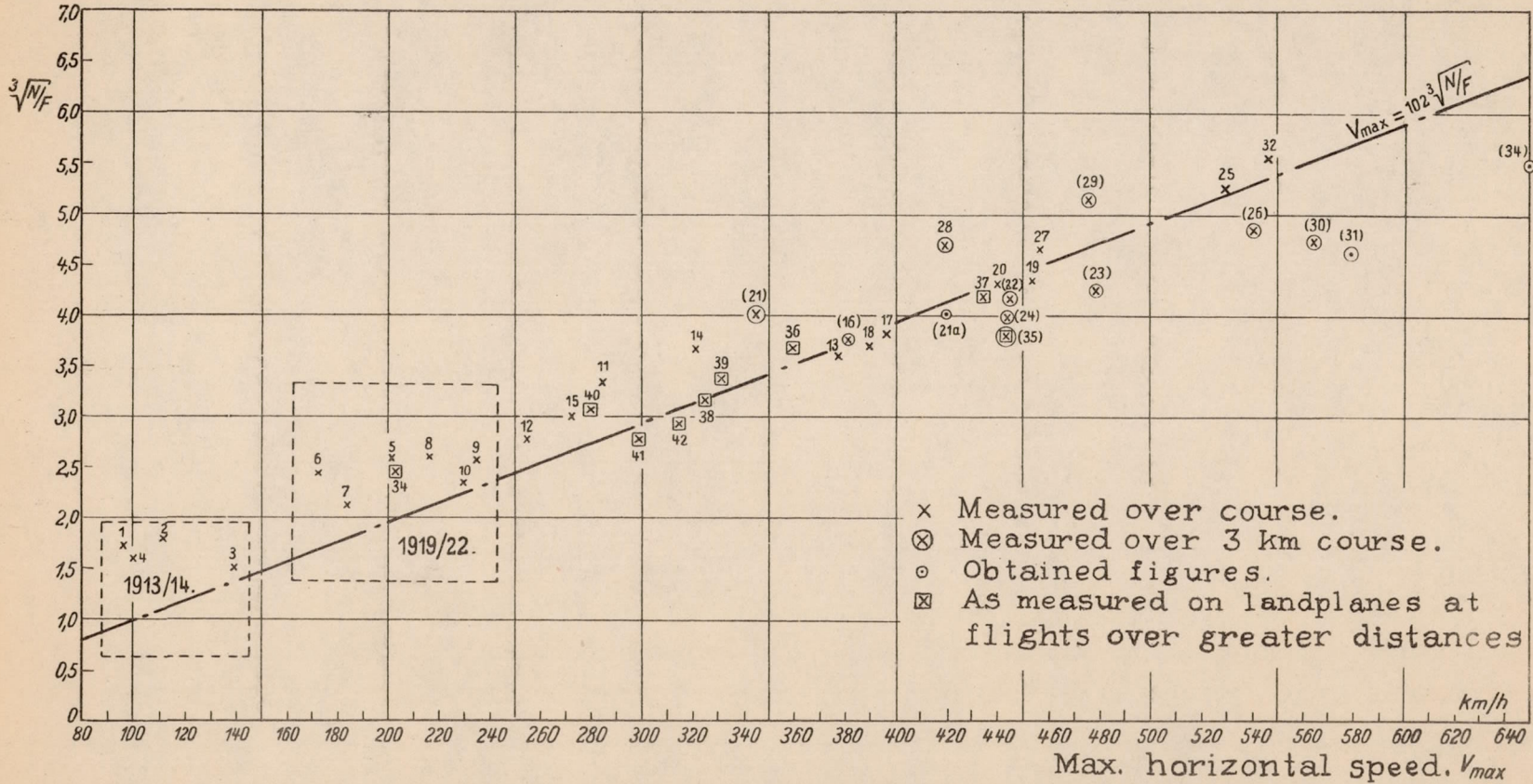

Figure 2.- Speed of racing planes, 1913-1931. (The figures from 1 to 37 refer to the running numbers in table II.)

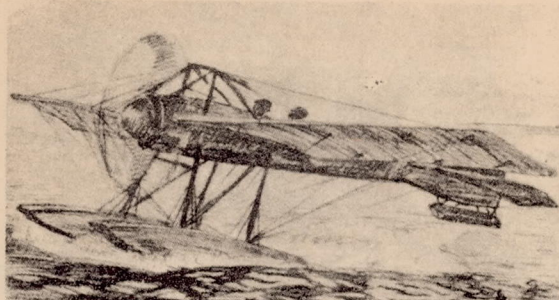

Figure 3.- Deperdussin seaplane 1913, (160 hp Gnome rotary), designer Bêchevau, no step.

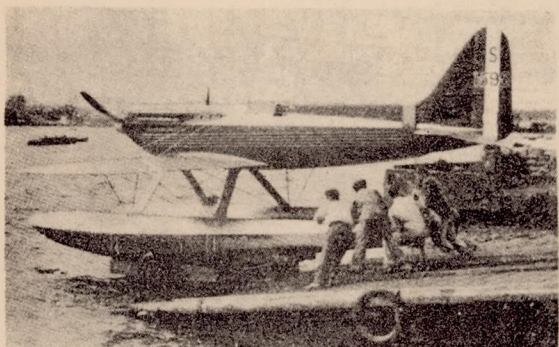

Figure 4.- Supermarine S 6, 1931, (2300-2600 hp R.R. water cooled) designer R.J. Mitchell (see also Figures 33-36)

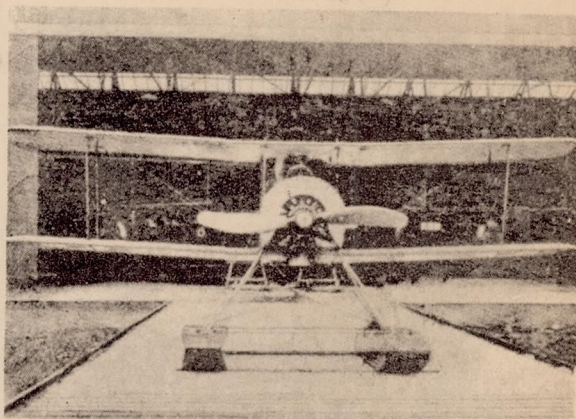

Figure 5. Sopwith "Baby", 1914 (80 hp single cylinder Gnome, rotary), designer F. Sigrist. This type was used during 1914-1916 as scout and bomber against ships when fitted with two bombs of 30 kg each.



Figure 7.- Savoia S 19, 1920, 500 hp Ansaldo, designer R. Conflenti.

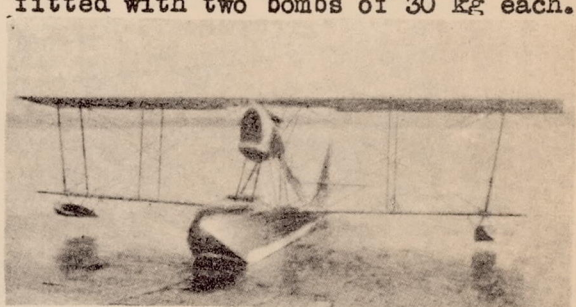

Figure 6.- Savoia S 13, flying boat 1919, 300 hp I.F. 6 cylinder water cooled engine. Converted navy pursuit, designer R. Conflenti.

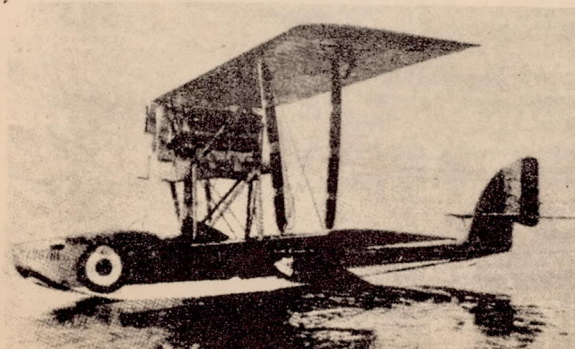

Figure 8.- Macchi M VII, 1921, 250 hp I.F. designer Tonini.

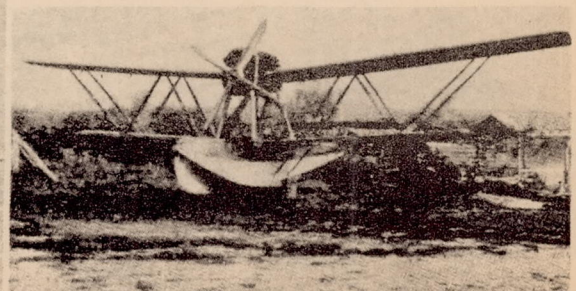

Figure 9.- Macchi M 19, 1921, 720 hp Fiat, designer Tonini.



Figure 10.- Curtiss CR 3, 1923, 465 hp Curtiss, designer T.P. Wright.



Figure 11.- Curtiss R 3 C-2, 1925, 625 hp Curtiss engine, designer T.P. Wright.

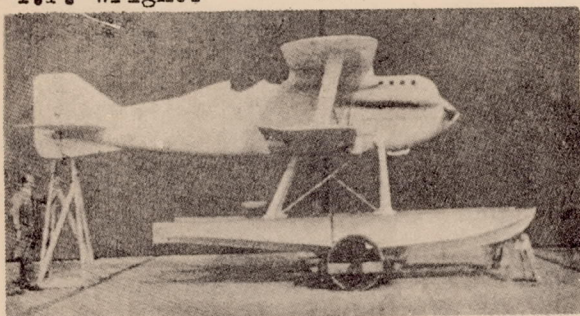

Figure 16.- Gloster III, 1925, 700 hp Napier engine, designer H.P. Folland, (wing radiators)

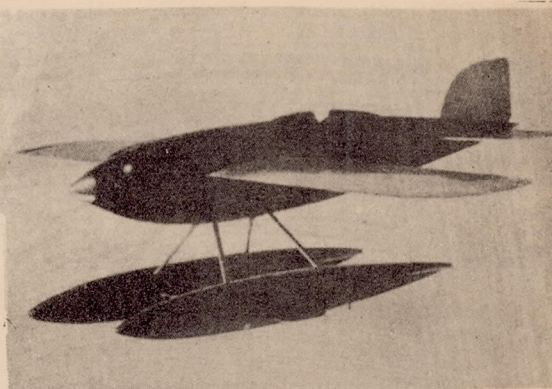

Figure 14.- Dornier racing design 1924, wind tunnel model.

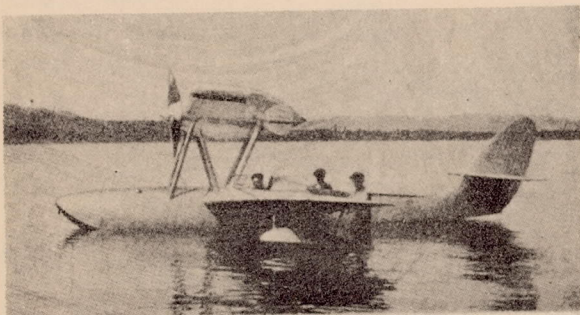

Figure 17.- Macchi M 33, 1925, 400 hp Curtiss engine, designer Castoldi.

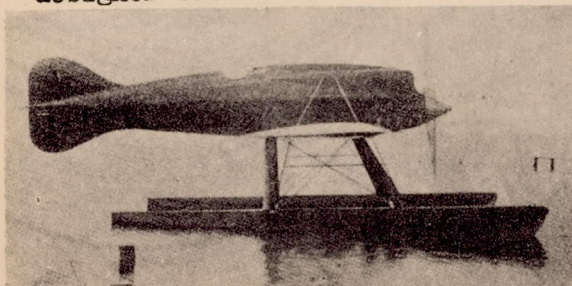

Figure 18.- Macchi M 39, 1926, 800 hp Fiat engine, designer Castoldi.

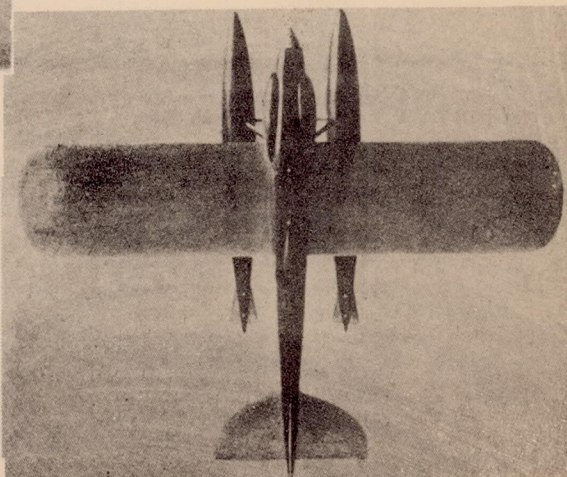

Figure 15.- Dornier racing design 1924, wind tunnel model.

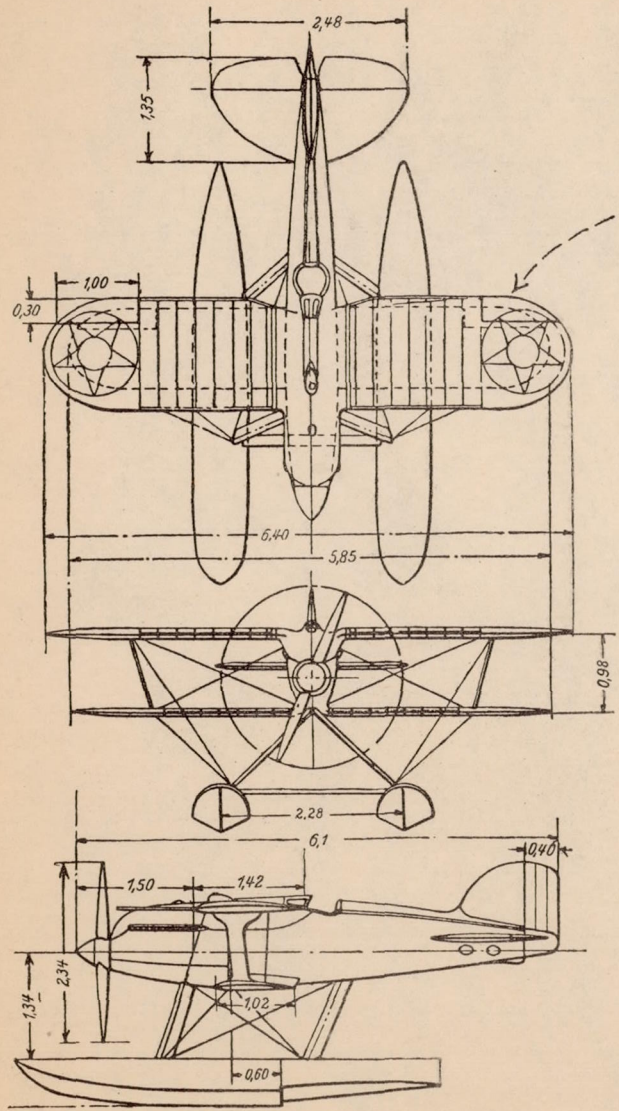

Figure 12.- Curtiss R3 C2, 1925, three view drawing.

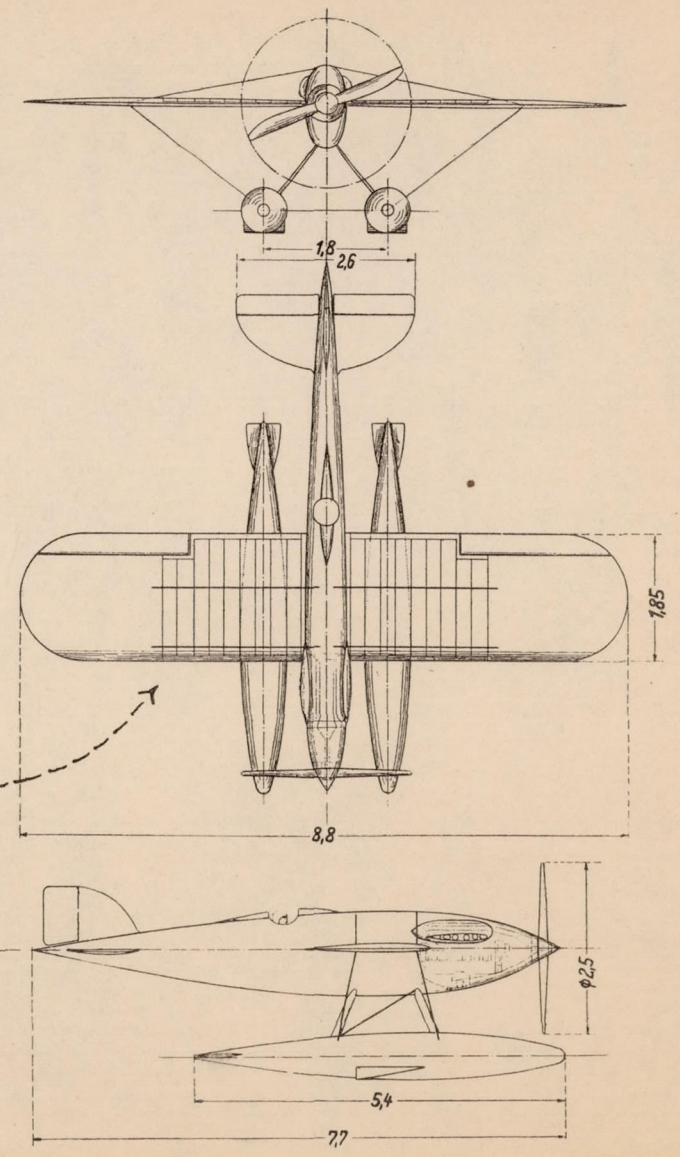

Figure 13.- Dornier design of January 4 1924 with 450 hp Curtiss engine, design speed 330 km/h (205 m.p.h.) Note the float design.

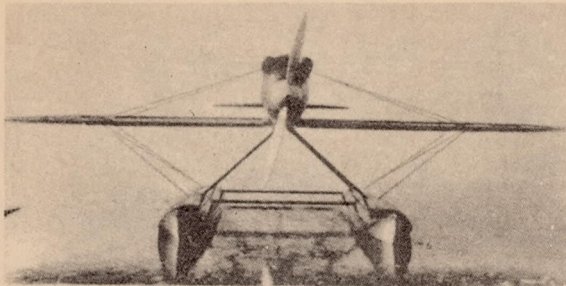

Figure 19.- Macchi M 39, 1926, 800 hp Fiat engine, designer Castoldi.



Figure 20.- Supermarine S 5, 1927 875 hp Napier engine, designer R.J. Mitchell

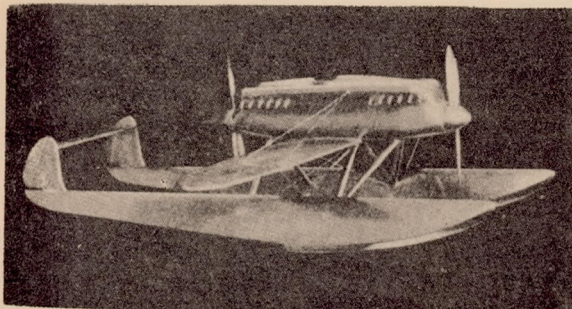

Figure 25.- Dornier design with two 1000 hp engines, exhibited at the I.L.A. 1928.

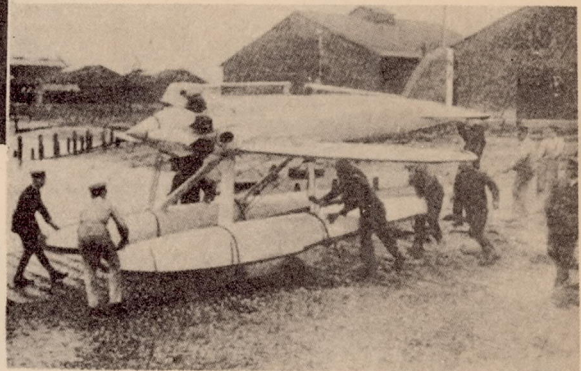

Figure 21.- Short "Crusader", 1927, air cooled 870 hp Bristol Mercury radial engine, only modern high speed racer with air cooled engine, design speed according to model tests, 425 km/h (264 m.p.h.) designer W.A. Bristow.



Figure 26.- Savoia S 65, 1929, two 970 hp I.F. engines, designer Marchetti.

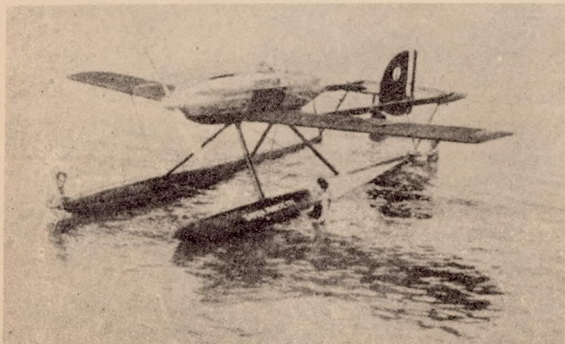

Figure 27.- Savoia S 65, 1929, two 970 hp I.F. engines, designer Marchetti.

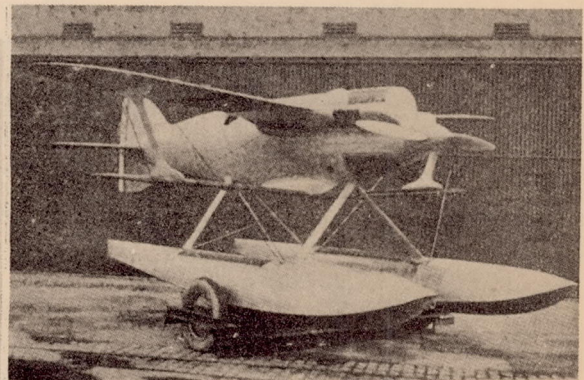

Figure 22.- Gloster IV, 1927, 875 hp Napier, designer H.P. Folland.

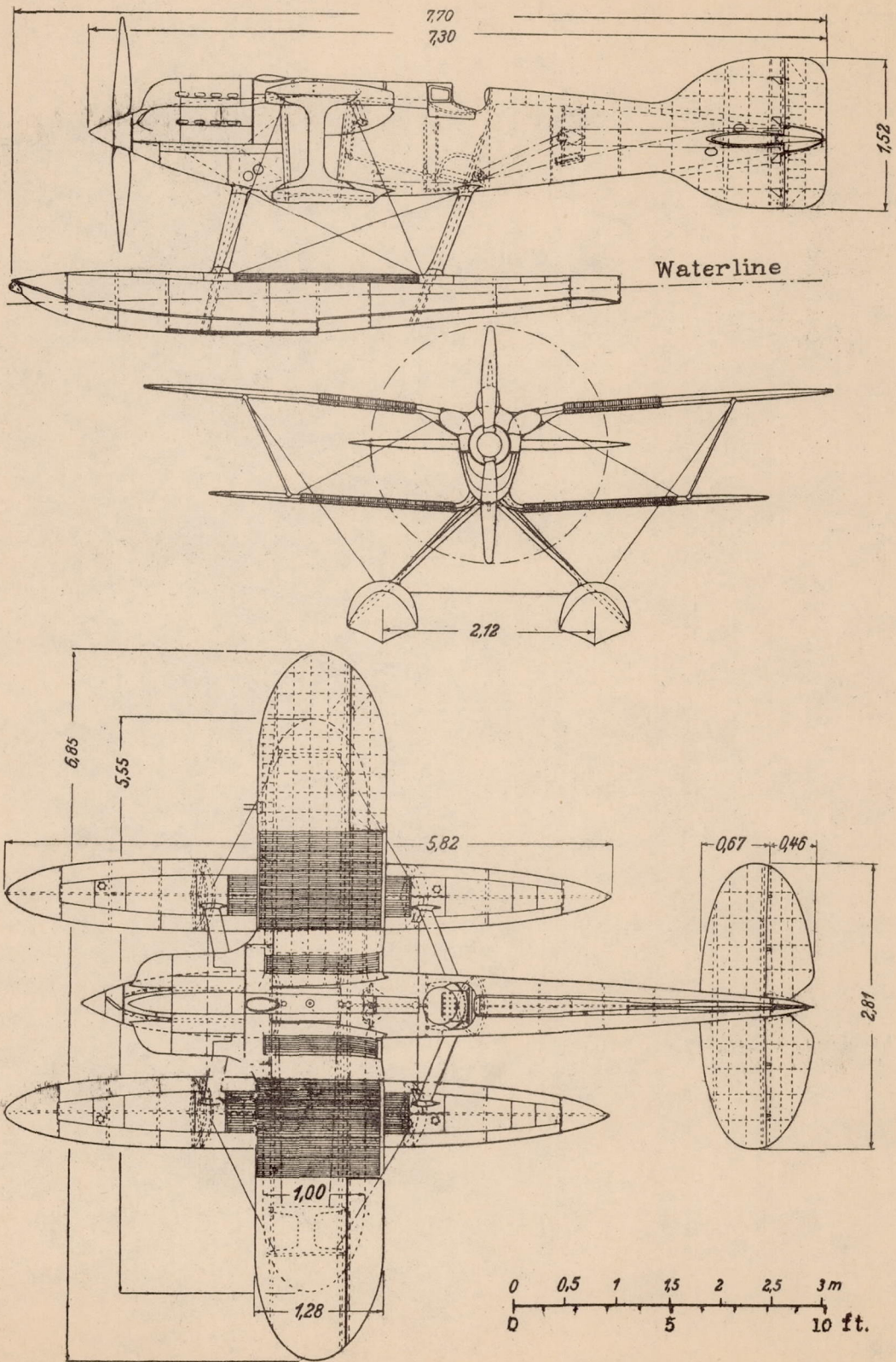

Figure 23. Gloster IV B, 1927/1928

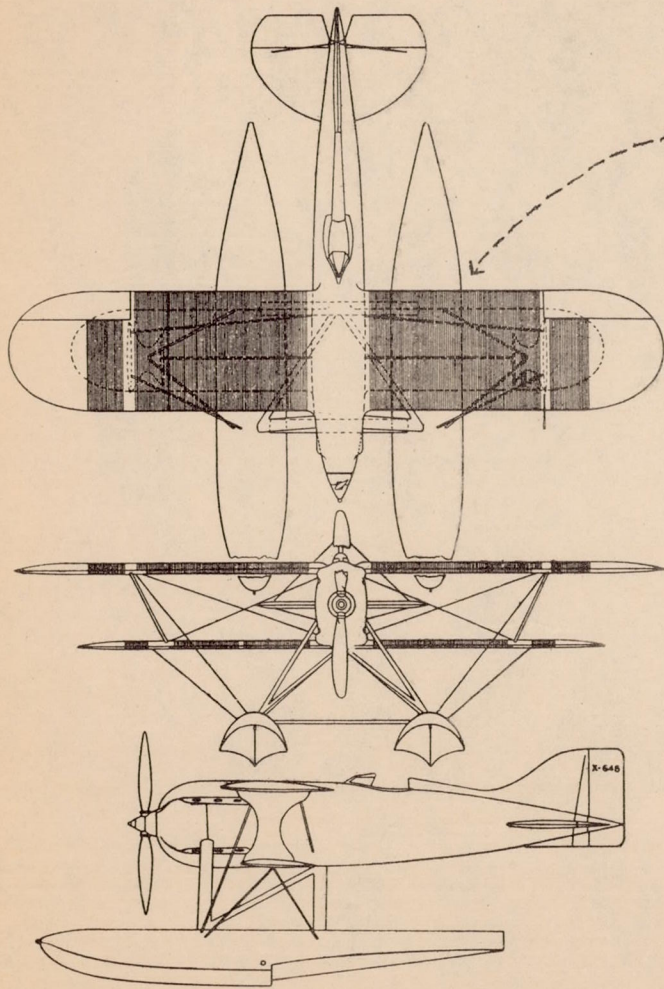

Figure 24.- Kirkham -
Packard -
Williams - X, 1927,
1250 hp Packard,
designer, Kirkham -
Williams

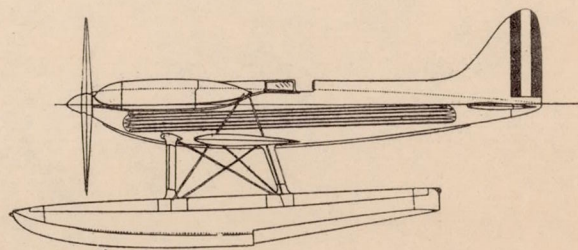
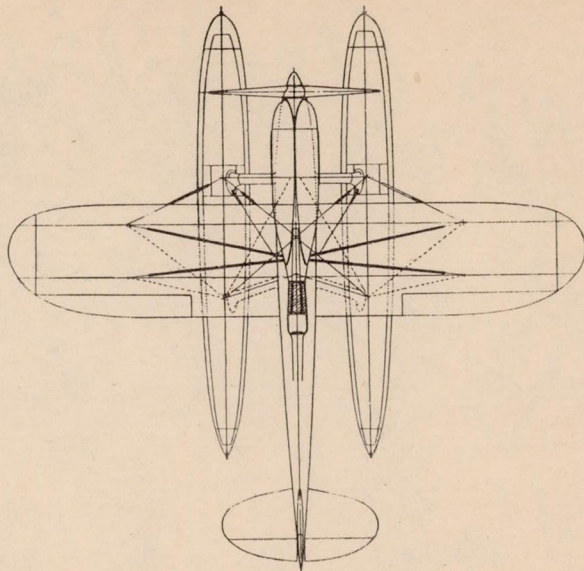
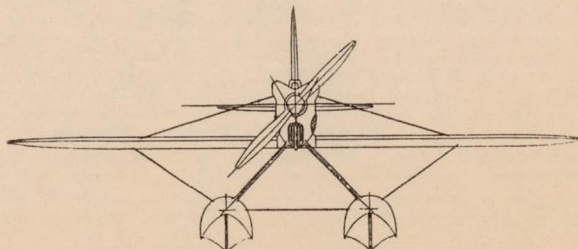

Figure 35.- Super -
marine
S 6 B, 1931, 2300 -
2600 hp R.R. engine,
designer
R.J. Mitchell



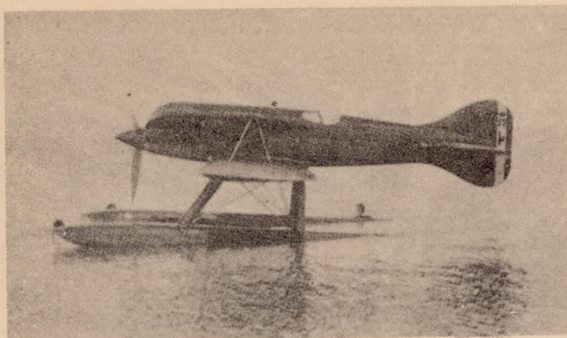

Figure 28.- Macchi M 67, 1929, 1400 hp I.F. engine, designer Castoldi.

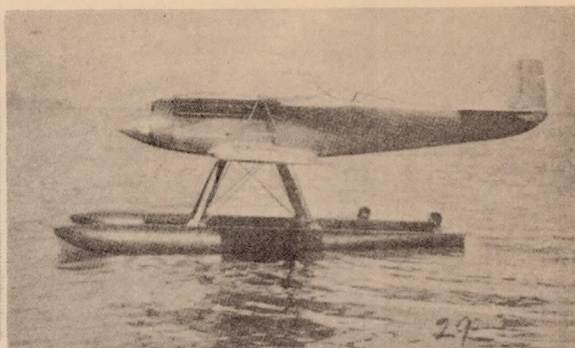

Figure 29.- Fiat C 29, 1929, 1000 hp Fiat engine, span 6.3 m (20.7 ft.), wing area 7.25 m² (78.04 sq.ft.) design factor, =174

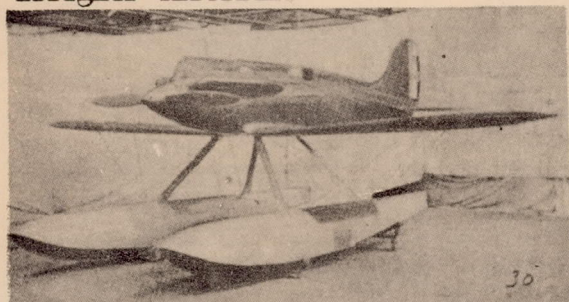

Figure 30.- Gloster VI, 1929, 1200 hp Napier engine, designer H.P. Folland.



Figure 31.- Floatless Piaggio P 7, 1929, 970 hp I.F. engine



Figure 32.- Floatless Piaggio P 7, 1929, 970 hp I.F. engine

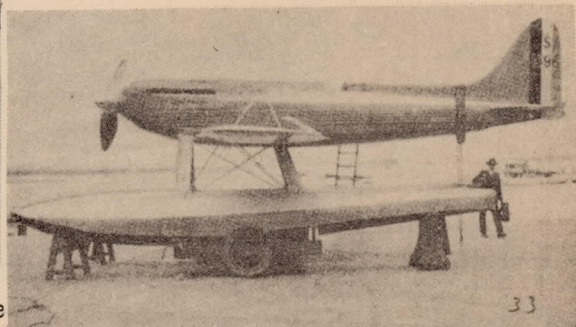

Figure 33.- Supermarine S 6 B, 1931 2300 - 2600 hp R.R. engine, designer R.J. Mitchell.

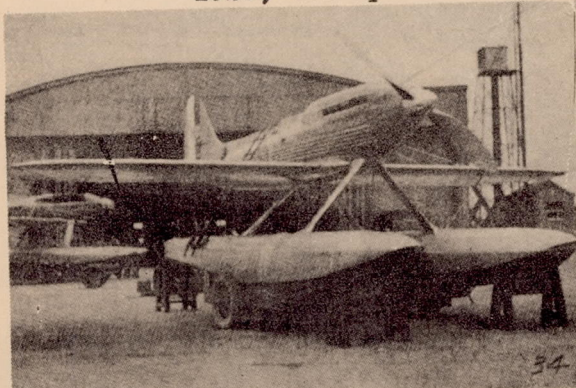

Figure 34.- Supermarine S 6 B, 1931, 2300-2600 hp R.R. engine direct propeller drive, design speed 650 km/h (403.9 m.p.h.) designer R.J. Mitchell

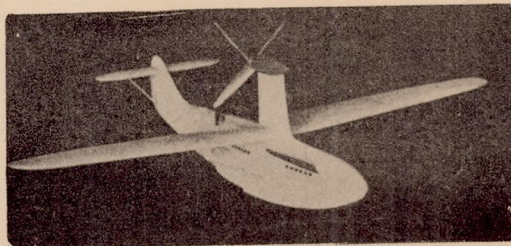

Figure 36.- Dornier design 1931, two 2000 hp engines with direct propeller drive, design speed 650 km/h (403.9 m.p.h.)

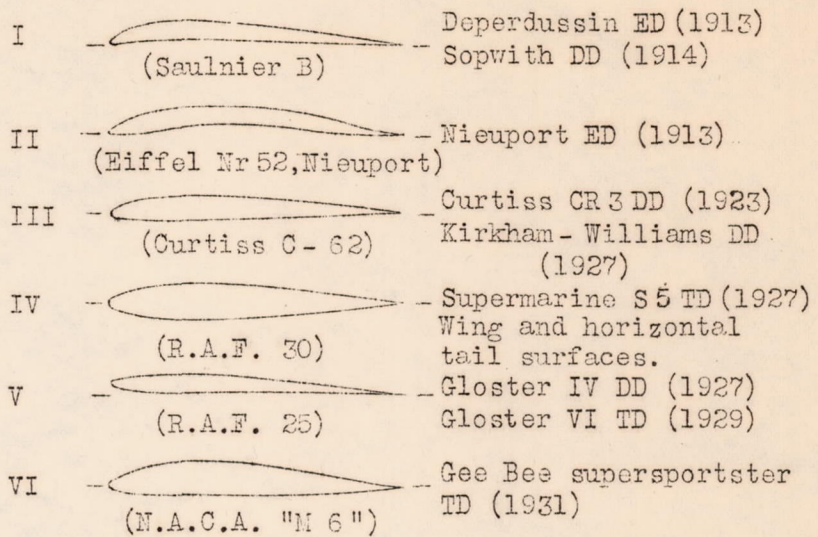

Figure 37.- Wing sections of racing planes.

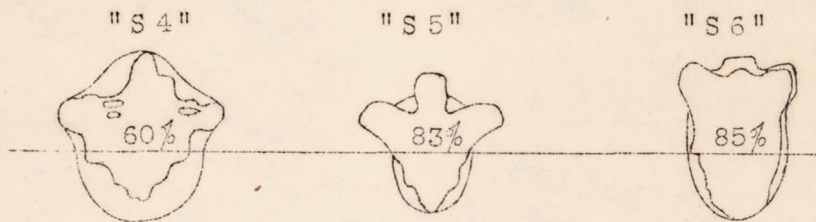

Figure 38.- Frontal area of engines superimposed on maximum cross section of fuselage 1924-1929.

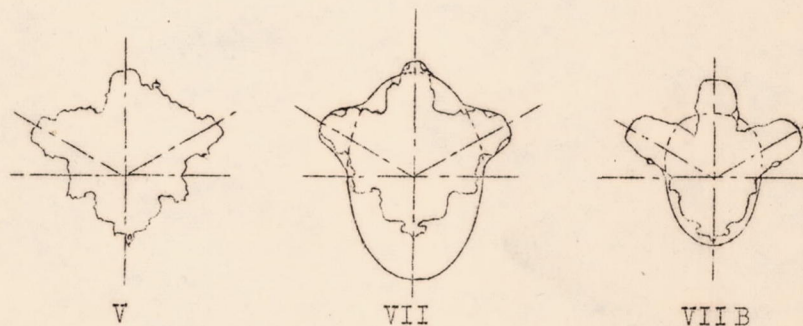

Figure 39.- Left, standard Lion V, center Lion VII in Gloster III 1925, right Lion VII B in Supermarine S 5 1927.