

NASA

# UNIVERSITY OF COLORADO AT BOULDER

## CENTER FOR SPACE CONSTRUCTION

(NASA-CR-193009) FIRST ANNUAL  
SYMPOSIUM. VOLUME 1: PLENARY  
SESSION (Colorado Univ.) 411 p

N94-70944  
--THRU--  
N94-70971  
Unclas

Z9/66 0160671

ORIGINAL PAGE IS  
OF POOR QUALITY

## ANNUAL SYMPOSIUM

### VOLUME 1: PLENARY SESSION



S<sub>1</sub>-14  
165672  
p. 19

## Overview of the Center for Space Construction

by Donald P. Hearth

The purpose of this overview is to outline the position of the Center for Space Construction within the context of space-related programs at the University of Colorado. The University's historically strong research and graduate programs in space science and its strong undergraduate aerospace engineering program were the starting point in 1984 for a major expansion of space-related education and research programs at the Boulder campus. This initiative has resulted in a tripling of space-related research as well as a large increase in the enrollment of high quality engineering students, particularly at the graduate level. The Center for Space Construction is a major element of this initiative, since it represents a mechanism for interdisciplinary and system level research and education within the Engineering College, thus filling a major need. Seventeen faculty members and 37 students from 7 academic units are associated with the Center and are interacting with each other and with the CSC Associates (a group of industrial organizations and government laboratories). The first PhD has been awarded to a student working in the Center; the second PhD is expected later this year. Several new courses have been introduced in the College. Finally, excellent research is being conducted and Center participants are publishing in the open literature.

**UNIVERSITY OF COLORADO  
CENTER FOR SPACE CONSTRUCTION**

**A NASA SPACE ENGINEERING  
RESEARCH CENTER**

**OVERVIEW**

- Donald P. Hearth (CSC Director)

**UNIVERSITY OF COLORADO  
AT BOULDER**

**CENTER FOR SPACE CONSTRUCTION**

**ANNUAL SYMPOSIUM**

**October 11-13, 1989**

**Stanley Hotel  
Estes Park, Colorado**

# Overview

---

- **Space Program at the University**
  - Background**
  - Changes in Recent Years**
- **Center for Space Construction**
  - Purpose**
  - Programs**
  - Structure**

# CU Space Initiative

---

- Goal: "To Achieve National Preeminence as a Leading University in Space Education and Research"
  
- Invest \$2 M over 3 years (starting in 1984)
  - Strengthen Existing Programs & Start New Programs
  - New Faculty — Seed Funding — Startup Funding
  
- Select Areas Where Match Between
  - Capability— Faculty Interest — Funding Opportunity
  
- Specific Objectives
  1. Continue Space Science Strength at UCB
  2. Increase Space Technology Research & Graduate Education at UCB
  3. Broaden UCB Program to Law, Business, Political Science, etc.
  4. Initiate Space Medicine at HSC
  5. Identify Niche at UCD
  6. Establish Solid Space Program at UCCS
  7. Increase National Visibility of CU Program
  8. Diversify External Funding Sources

## Space at CU 1984

---

- Strong Space Science at UCB
  - Astrophysics — Solar — Planetary
  - Unique Student Activity ( Hdw & Ops)
- Space Engineering at UCB
  - Aerospace Education: 425 Undergraduate Students  
49 Graduate Students
  - Other Eng. Disciplines: 1,700 Undergraduate Students  
325 Graduate Students
  - Very Little Space-Related Research (About \$200K out of \$4 M/yr. Total)
- Very Little Space-Related Education & Research at Other Campuses
- Space-Related Research
  - About \$7 M per year
  - In Top 10 of NASA Funding

# Space Related Research Univ. of Colorado

---

## Campus Total

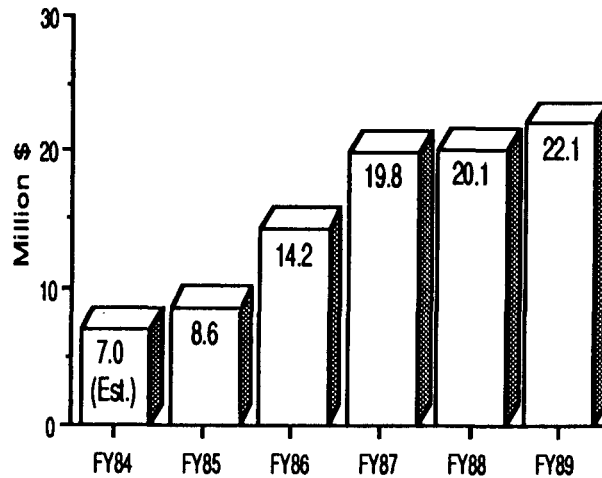

## Engineering College

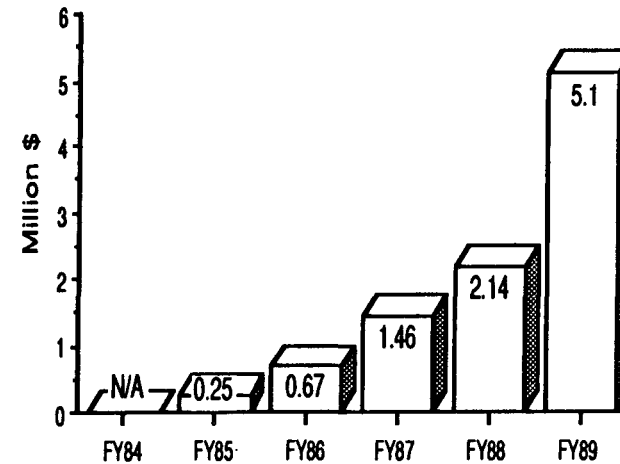

**CSC  
89-15**



# Aerospace Engineering

## Student Enrollment

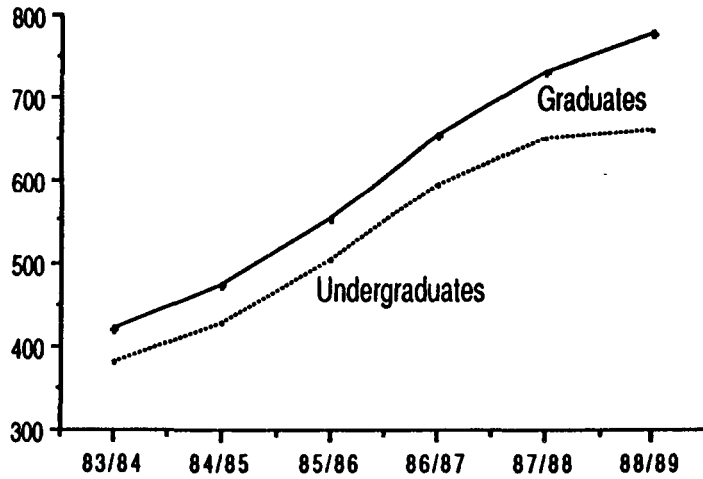

## Faculty

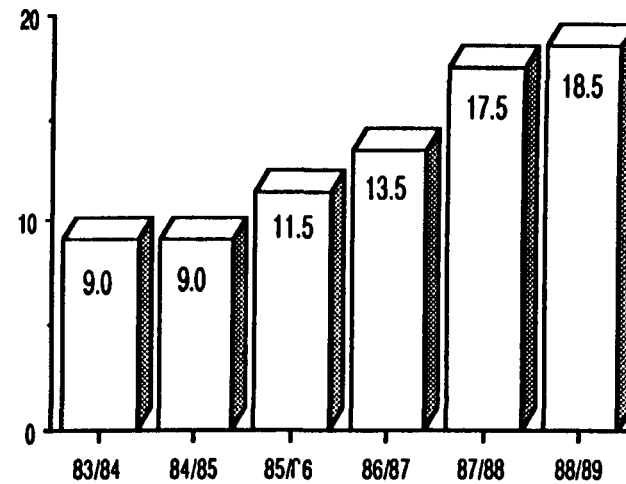

# ***Colorado Space Grant College***

## **NASA's National Space Grant College & Fellowship Program goals:**

- ✓ to increase the understanding, assessment, development & utilization of space resources
- ✓ to encourage cooperative programs among universities, aerospace industry, and federal, state, and local governments
- ✓ to encourage interdisciplinary training, research, and public-service programs related to aerospace
- ✓ to recruit and train professional, especially women and underrepresented minorities, for careers in aerospace science, technology, and allied fields
- ✓ to promote a strong science, math, and technology educational base from elementary through university levels

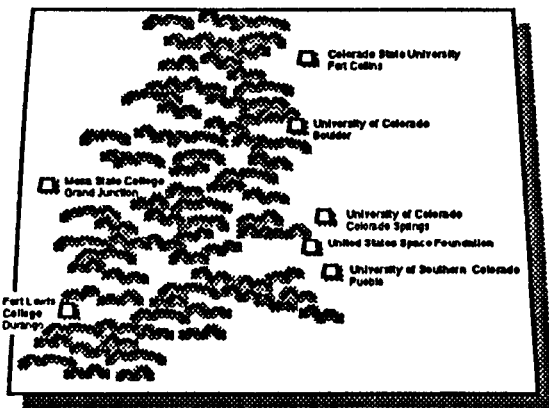

## OUTREACH

To current and future students and teachers throughout Colorado

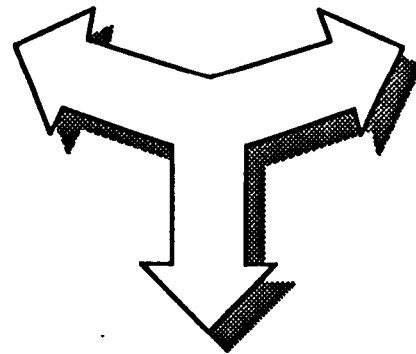

## TEACHING

To train the next generation of space scientists and engineers

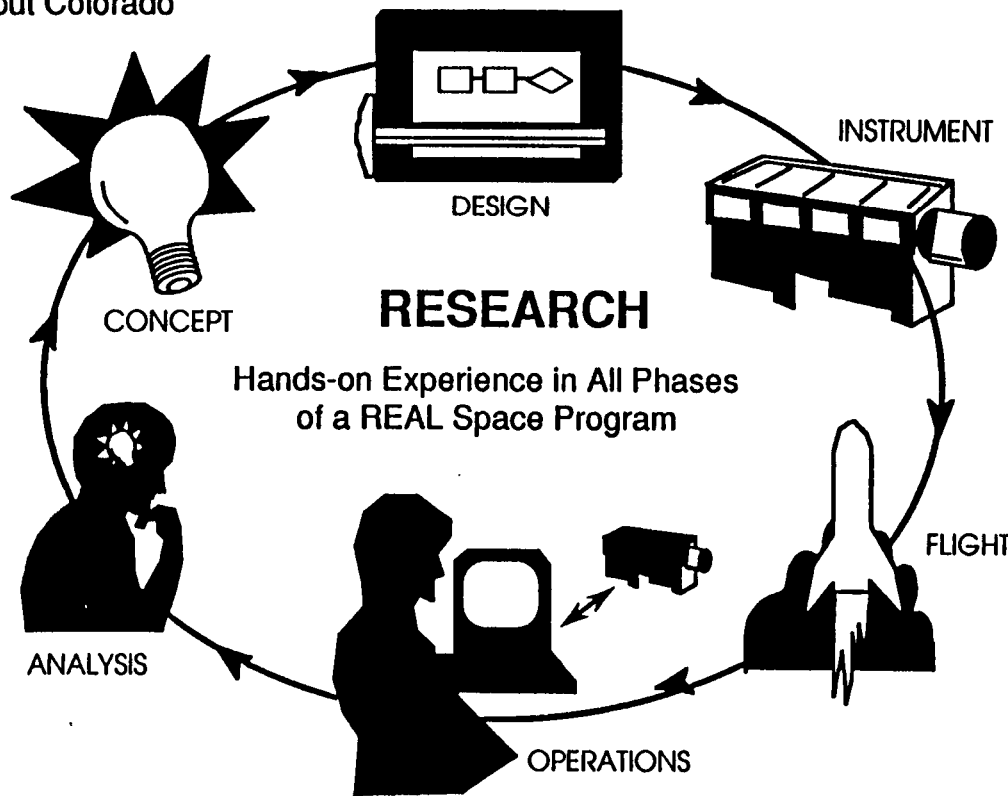

Elaine Hansen  
August 21, 1989

# Center Purpose

---

## NASA

- To establish, expand, and modernize space eng. educational programs using the strong foundation provided by aerospace engineering departments
- To execute innovative, creative, and clearly needed space eng. research

## CU

- To strengthen disciplinary space eng. programs
- To enhance inter-disciplinary & system engineering within CU's space eng. programs
- - - To create "T People"

CSC  
89-17

# **Center for Space Construction**

---

- **Conduct space engineering research/education programs by "clusters" of faculty & students in several departments**
  - **Strong disciplinary/multi-disciplinary focus in each cluster**
    - Systems cluster included**
  - **Promote natural & mutually beneficial interdisciplinary/intercluster activities.**
- **Augment in-house program through cooperative efforts with the "real world" of industry & gov. labs.**

**CSC  
89-18**

# **CSC Program**

---

- 1. Concentrate on Tasks Associated with**
  - a. In-Space Construction Process Itself**
  - b. Space System Design/Operation As Influenced by Construction Process**
- 2. Formulate and Execute CSC Program within Context of Non-CSC Program**
- 3. Actively Seek Non-CSC Support for**
  - a. In-Space Experiments**
  - b. Large Scale Ground Based Experiments & Analytical Programs**
- 4. Actively Seek Non-NASA Grant Support for CSC**

# **Case Studies - Design Ref. Missions**

---

**Space Station**

**Large Unmanned  
Space Platforms**

**Lunar  
Base**

**Martian  
Outpost**

**CSC  
89-9**

# CSC Clusters

---

## Structures

- Structures
- Materials
- Controls
- Fluids

## Operations

- Robotics
- AI
- Human Perf.
- Comm. & Control

## Extraterrestrial

- Soil Mechanics
- Structure - Soil Interaction
- Construction Process
- In-Situ Materials

## Systems

- Construction Integration
- Computer Models for Process
- Optimization



# Example of Interaction Between Clusters Operations & Systems

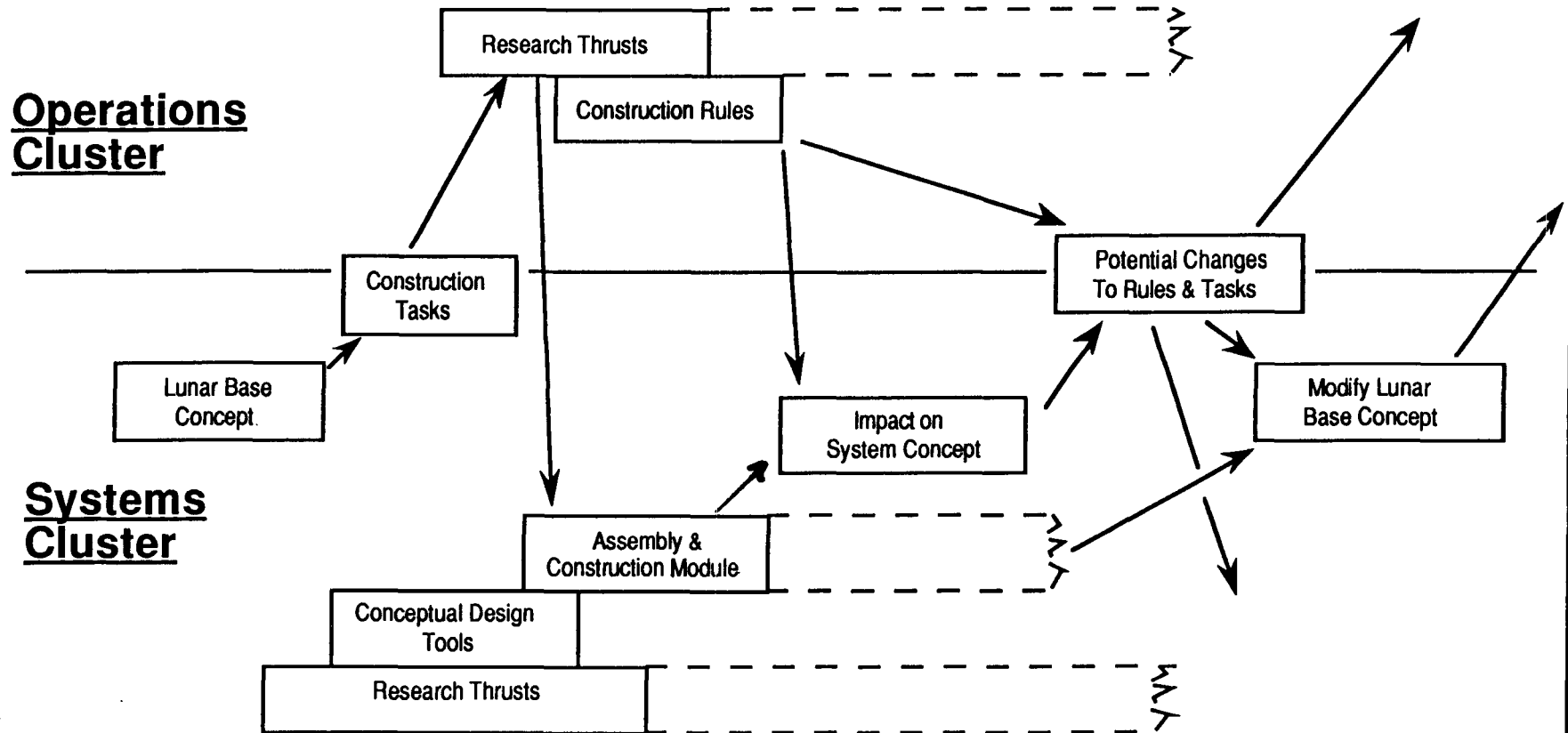

# CSC Team

## Director' Office

D. Hearth, Dir.  
C. Osborne, AO

### Structures

S. Datta  
M. Balas  
C. Farhat  
L. Pinson  
H. Snyder  
12 Students

### Operations

E. Hansen  
J. Avery  
F. Barnes  
R. Davis  
J. Faber  
C. Lewis  
R. Su  
10 Students

### Extra. - -

S. Sture  
H. Ko

2 Students

### Systems

G. Morgenthaler  
F. Glover  
U. Racheli

11 Students

## Associates

- Ball Aerospace
- BDM
- Bechtel
- Computer Technology
- EG&G
- Exploive Fabricators
- External Tanks Corp.
- Fluor-Daniel
- Johnson Eng.
- Lockheed
- Martin Marietta
- Robotool
- Space Studies Institue
- Stearns - Roger

## Other CU Groups

- Center for Applied Parallel Processelng
- Center for Astroynamics Research
- Institute for Cognitive Sciences
- Center for Geo-Technical Eng.
- Center for Space Structures & Control
- Lab. for Space & Atmos. Physics
- Individual Faculty Pls

CSC  
89-10

# **CSC Associate Program**

---

- 1. To promote collaborative activities with Industry, Gov. Labs, and other Universities**
- 2. May include joint research projects and**
  - Use of CSC/Associate facilities, etc. without compensation**
  - Personnel exchanges**
  - Joint proposals**
- 3. No membership fee for Associate**
- 4. CSC & Associates pay own costs**
- 5. Associates have pre-publication review rights to prevent publication of proprietary information**
- 6. Intellectual property rights shared by University and Associates depending upon the intellectual property**

# **Student Participation on CSC as of October 1, 1989**

---

- **37 Students affiliated with center**  
**11 - PhD          16 - MS          10 - BS**
- **Students in 6 departments**
- **First PhD awarded in August 1989, second PhD in Fall 1989**
- **They are very high quality**

# **CSC Publication Policy**

---

- 1. Faculty and students encouraged to publish results of CSC programs in open literature.**
- 2. Associate personnel may co-author publications with faculty and/or students.**
- 3. Associates have pre-publication review rights to prevent publication of proprietary information.**
- 4. CSC will implement report system & library of**
  - Publications in open literature**
  - Other papers and reports deemed worthy of internal & external distribution**

# **CSC Publications as of October 1, 1989**

---

- **2 Theses**
- **15 Journal Articles**
- **29 Proceedings of Technical Conferences**

**CSC  
89-23**

UNIVERSITY OF COLORADO  
CENTER FOR SPACE CONSTRUCTION

*omit*

OPERATIONS CLUSTER

SPEAKERS

- Elaine Hansen (Cluster Leader)
- Brent Helleckson/John Blanco/Chris Echohawk
- Randy Davis/Chris Grasso
- Renjeng Su/Noureddine Kermiche
- Nick Wilde/Clayton Lewis

Abstract

Construction Operation Research  
by Elaine Hansen

S2-66

160673

P. 25

"Construction Operations Research" will be an introductory paper summarizing the research issues addressed by the CSC Operations Cluster and the research thrusts of its faculty and students. The paper will provide the framework for the papers, posters and demonstrations to be given by the operations group throughout the symposium.



# CENTER FOR SPACE CONSTRUCTION

## Construction Operations

Elaine Hansen

CSC Operations Cluster

October 12, 1989

CSC-Ops

12-Oct-89; erh

# Construction Operations

## Outline

- ❖ **Issues**
- ❖ Research Thrusts
- ❖ Introduction of Paper, Posters and Demonstrations

# Construction Operations



CSC-Ops

12-Oct-89; erh

# CONSTRUCTION OPERATIONS

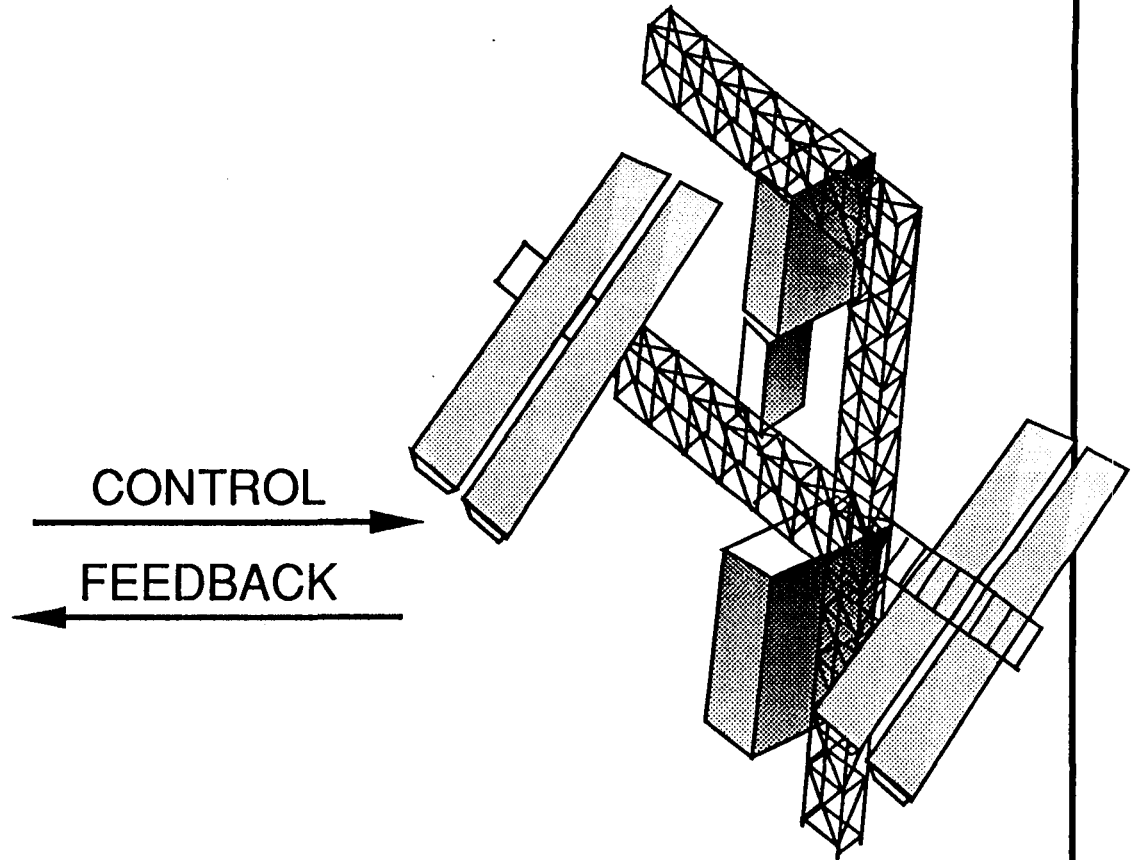

- Space Station
- Lunar Base
- Mars Station
- Large Antenna Arrays
- Large Space Craft

CSC-Ops

12-Oct-89; erh

# CONSTRUCTION OPERATIONS METHODS

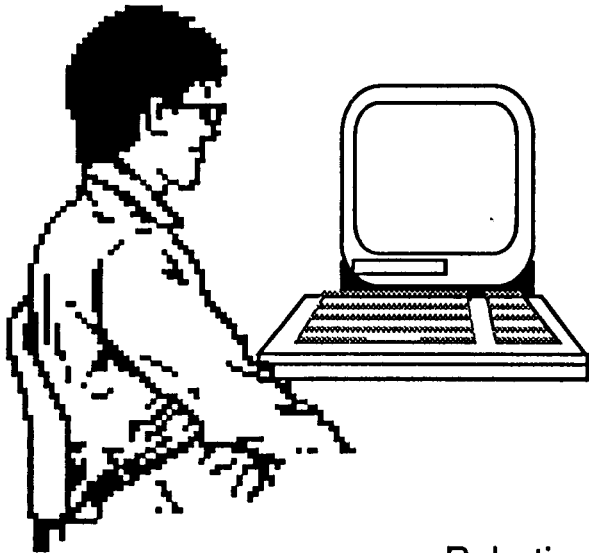

Manual



Distributed Operations  
("Telescience")



Automation

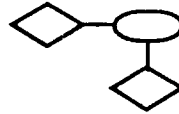

Robotics



Bionics



Integrated

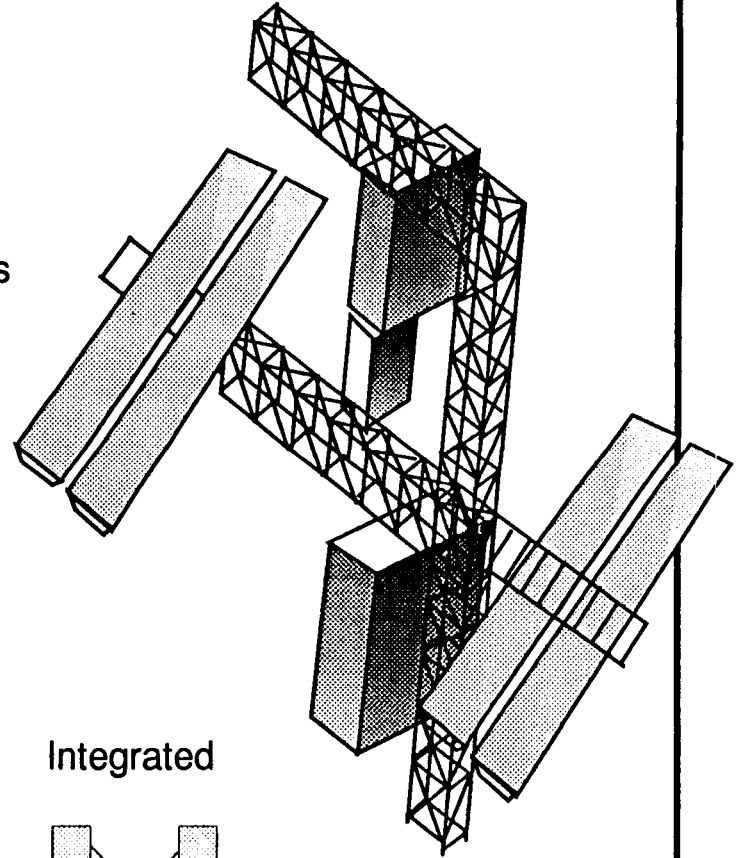
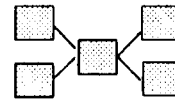

CSC-Ops

12-Oct-89; erh

# Construction Operations

## Methods & Issues

### ❖ Manual



- Number of crew members? Availability?
- Appropriate role of crew? Capabilities? Cost?
- What construction operations are even possible?
- Effects of space environment on human performance? on health?

### ❖ Distributed Operations (telescience)



- How can a user interact with construction tools and system?
- What control delays (or losses) are acceptable for various tasks?
- What operations can be distributed? What activities must be locally operated? (space-ground, space-space)
- How do intelligent, loosely connected ground crew and flight crew/subsystems/modules/robots/tools communicate?
- How do they cooperate? share resources? handoff tasks? trade roles? operate reliably? operate adaptively? operate safely?

### ❖ Automation and Robotics



- What levels of automation, learning & self-maintenance are achievable?
- What automation levels are appropriate within subsystems? within modules? within robots? within tools? within vehicles? within the structures themselves?
- What are the advantages of specialized or generalized robots?
- What robotic sensors and autonomously performed tasks are needed in typical construction environment?

# Construction Operations

## Methods & Issues

### ❖ Bionics



- What crew-assist devices are feasible?
- How will they affect crew performance?

### ❖ Integrated

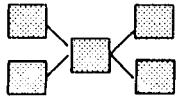

- Can these construction methods be integrated?
- Can humans and machines work together to perform construction tasks?
- How should these worker roles be synthesized? Partitioned?
- How can we communicate among the elements of the construction ensemble?

# CONSTRUCTION OPERATIONS INTEGRATED CONSTRUCTION ENSEMBLE

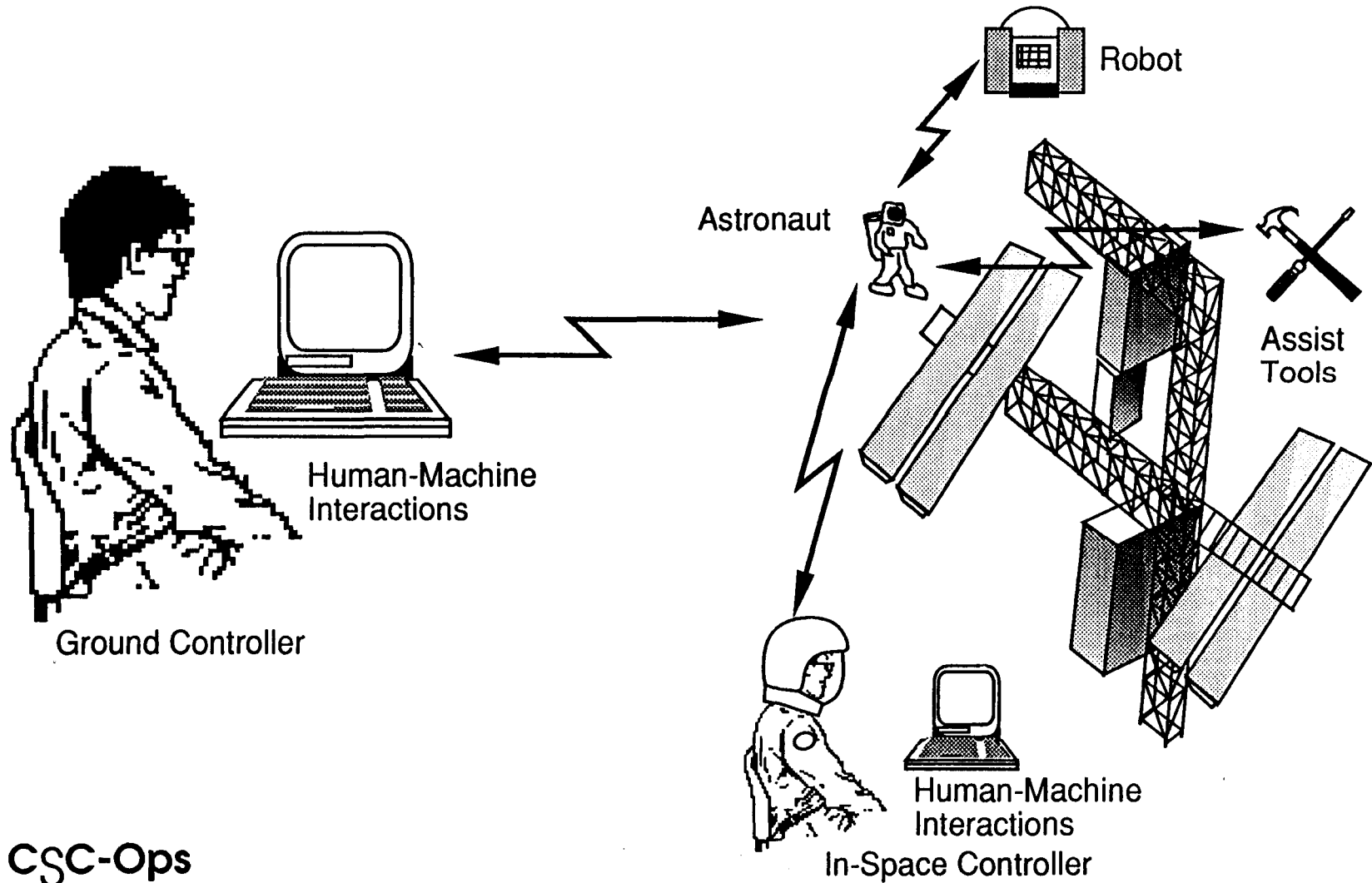

CSC-Ops

12-Oct-89; erh



# Construction Operations

## Some Cost Considerations

- Can a common set of subsystems/robots/tools/techniques be used for multiple tasks? throughout the life cycle? for multiple projects?
- Can operations tools & techniques be designed to promote evolution? Maintainability?
- How can operations tools & techniques be verified?
- What resource margins are needed?

# Construction Operations

## Outline

- ❖ Issues
- ❖ **Research Thrusts**
- ❖ Introduction of Paper, Posters and Demonstrations

# Construction Operations

## Research Thrusts

THRUST	RESEARCH FACULTY	RESEARCH STUDENTS	ASSOCS.
1. Human-Machine Operations in the Distributed Construction Environment	E. Hansen R. Davis F. Glover T. Sparn	J. Blanco B. Helleckson S. Peppin C. Grasso	GSFC JSC Martin JPL
1.1 Architectures and Tradeoffs	C. Lewis	D. Hunter	LaRC
1.2 Operations Management	J. Faber	J. Paulich	EG&G
1.3 Command and Control	J. Avery F. Barnes R. Su	C. Echohawk A. Meiman N. Wilde K. Stockton	CTA
1.4 Communications			
2. Automation and Robotics	R. Su	D. Hunter	LaRC
2.1 Machine Learning in Motion Control	J. Avery	J. Blanco	JPL
2.2 Machine Sensors-Motion Estimation and Prediction	C. Lewis T. Sparn	S. Peppin	Martin McDAC
2.3 Symbolic Dynamics and Control	J. Faber C. Lewis		
3. Human Interfaces and Work Environment	C. Lewis	N. Wilde	JSC
3.1 Human-Computer Interaction	F. Barnes	R. Johnson T. Hibbs	Johnson Eng.
3.2 In-Space Work Environment			

# Construction Operations

## Research Areas

### 1. Human-Machine Operations in the Distributed Construction Environment

#### 1.1 Architectures and Tradeoffs

- Define problem
- Develop conceptual models of space construction process
  - Design, predictive scheduling, adaptive scheduling, assembly, management
- Provide an architectural framework for further research
- Develop principles for tradeoffs between:
  - Human vs. machine vs. a mix of constructors
  - In-space vs. ground controlled operations
  - Specialized vs. generalized tasks and tools
  - Centralized vs. distributed
- Develop tradeoff selection tools

# Construction Operations

## Research Areas

### 1. Human-Machine Operations in the Distributed Construction Environment

#### 1.2 Operations Management

- Will address:
  - How can construction activities be effectively preplanned, prescheduled, and prevalidated?
  - How can we provide for human and equipment safety?
  - Can we design our human-machine-robotic systems to be adaptive to environmental changes and unscheduled events? to be reactive to problems?
  - How can conflicts be resolved and/or avoided?
  - How can intelligent systems, capable of learning, be managed?
  - How can we translate a design in its assembly process?
- Will develop technologies for the safe and harmonious operation of complex, loosely connected construction ensembles made up of humans and machines
- Will prototype tools and techniques in an in-space environment

# Construction Operations

## Research Areas

### 1. Human-Machine Operations in the Distributed Construction Environment

#### 1.3 Command and Control

- Will address implications arising from the need to work in a widely distributed environment
  - What remotely controlled tasks are possible?
  - How do distributed players cooperate?
  - How can distributed humans and machines work together to perform complex tasks?
  - Goal-oriented instructions vs. step-by-step commands
  - What tasks can be predictively controlled?
  - What sensing and status information should be available to the distributed controllers?
- Will demonstrate tools and techniques in local and distributed testbeds (LaRC)
- Will develop principles and models for the distribution and dynamics of construction roles, functions and knowledge

# Construction Operations

## Research Areas

### 1. Human-Machine Operations in the Distributed Construction Environment

#### 1.4 Communications

- Will address:
  - Languages for specifying construction sequences and actions
  - Symbolic control of discrete systems
  - Goal-oriented control sequences
  - Hierarchical, coordinated, and hybrid architectures for the distribution of knowledge and control among "supervisors," "managers" and "workers"
  - Adaption of current communications concepts (eg. MAP) for communicating between & coordinating the elements of space construction projects
  - Distribution and migration of functions between humans and machines—and between construction elements
  - Shared control of assembly tasks between machines and humans
  - Investigate role of CAD Systems for planning and generating construction assembly instructions

# Construction Operations

## Research Areas

### 2. Automation and Robotics

#### 2.1 Machine Learning in Motion Control

- Will investigate the issues of machine learning in motion control systems
- Explore the use of memory to make machines learn from their repetitive motions
- To develop and demonstrate a machine with learning capabilities applicable to the in-space construction problem

#### 2.2 Machine Sensors-Motion Estimation and Prediction

- To investigate the problem of using cameras to estimate and predict the motion of moving objects
  - Development of computational algorithms
  - Exploration of the limitations imposed by the optical sensor technologies
- To fuse vision sensing with tactile sensing
  - Eventual inclusion of ranging and laser sensors
- Demonstrate with an in-space construction problem

#### 2.3 Symbolic Dynamics and Control of Discrete Systems

- Develop languages for describing dynamic processes in a symbolic manner
- Provide supervisory control for interactive, multiple processes



# Construction Operations

## Research Areas

### 3. Human Interfaces and Work Environment

#### 3.1 Human-Computer Interactions

##### Research Summary

- Provide straightforward, cost efficient, easy to use, human-computer interfaces
- Take advantage of substantial body of computer science research results to provide advanced user work environment
- Use spreadsheet concepts to produce "No-Pump G" interface
- Refine and adapt for robot control of in-space construction operations

#### 3.2 In-Space Work Environment

- Develop models of human capabilities in the space environment
- Determine effects of space environment on astronaut's work performance and health
- Investigate countermeasures to detrimental effects
- Investigate power assisted tools (bionics) to extend capabilities of astronauts

# Construction Operations

## Outline

- ❖ Issues
- ❖ Research Thrusts
- ❖ **Introduction of Papers, Posters and Demonstrations**

# Construction Operations

## Research Presentations

### THRUST

### PRESENTATIONS (Thursday)

- 
- |   |   |
|---|---|
| 1. Human-Machine Operations in the Distributed Construction Environment | "Constructor Selection Research"<br><i>Hellackson, Hansen, Blanco, Echohawk</i> |
| 1.1 Architectures and Tradeoffs   |   |
| 1.2 Operations Management   | "Communications Among Elements of the Space Construction Ensemble"              |
| 1.3 Command and Control   | <i>Davis, Grasso, CTA</i>   |
| 1.4 Communications  |   |
| 2. Automation and Robotics  | "Machine Learning in Motion Control"  |
| 2.1 Machine Learning in Motion Control                                  | <i>Su, Kermiche</i>   |
| 2.2 Machine Sensors-Motion Estimation and Prediction                    |   |
| 2.3 Symbolic Dynamics and Control                                       |   |
| 3. Human Interfaces and Work Environment                                | "User Interface Support"  |
| 3.1 Human-Computer Interaction  | <i>Wilde, Lewis</i>   |
| 3.2 In-Space Work Environment   |   |

# Construction Operations

## Research Posters and Demonstrations

### THRUST

### POSTERS AND DEMONSTRATIONS (Friday)

- 
- |   |  |
|---|--|
| 1. Human-Machine Operations in the Distributed Construction Environment | "Construction Planning in a Distributed Environment," <i>Sparrn, Hansen</i><br>"Allocation of Construction Resources," <i>Glover, Stockton</i><br>"Construction Operations Management," <i>Hansen, Sparrn</i><br>"Remote Control of a Multi-Arm Testbed," <i>Paulich, Harrison</i><br>"OASIS as a Tool for Space Construction Ops," <i>Grasso, SIRR, Klemp</i><br>"A Telerobotic Testbed," <i>Meiman, Monk</i><br>"Command and Control in a Distributed Environment," <i>Faber</i><br>"Construction Control Languages," <i>Davis</i><br>"Goal-Oriented Control Sequences," <i>Peppin</i><br>"New Perspectives in Construction Ensemble Management,"<br><i>Blanco, Helleckson</i> |
| 1.1 Architectures and Tradeoffs   |  |
| 1.2 Operations Management   |  |
| 1.3 Command and Control   |  |
| 1.4 Communications  |  |
| 2. Automation and Robotics  |  |
| 2.1 Machine Learning in Motion Control                                  | "Sensor Fusion," <i>Blanco, Su</i><br>"Automation and Robotic Studies for Space Construction," <i>Avery</i>  |
| 2.2 Machine Sensors-Motion Estimation and Prediction                    | "Symbolic Control of Discrete Systems," <i>Hunter, Wilde, Su, Lewis</i>  |
| 2.3 Symbolic Dynamics and Control                                       |  |
| 3. Human Interfaces and Work Environment                                |  |
| 3.1 Human-Computer Interaction  | "No Pump G," <i>Wilde, Lewis</i><br>"In-Space Work Environment," <i>Barnes</i>   |
| 3.2 In-Space Work Environment   | "Rating Humans & Machines for Space Construction Tasks,"<br><i>Echohawk, Helleckson, Polson</i>  |

# Construction Operations

## An Integrated Approach

Faculty and Student Researchers, Industrial Partners, NASA contacts

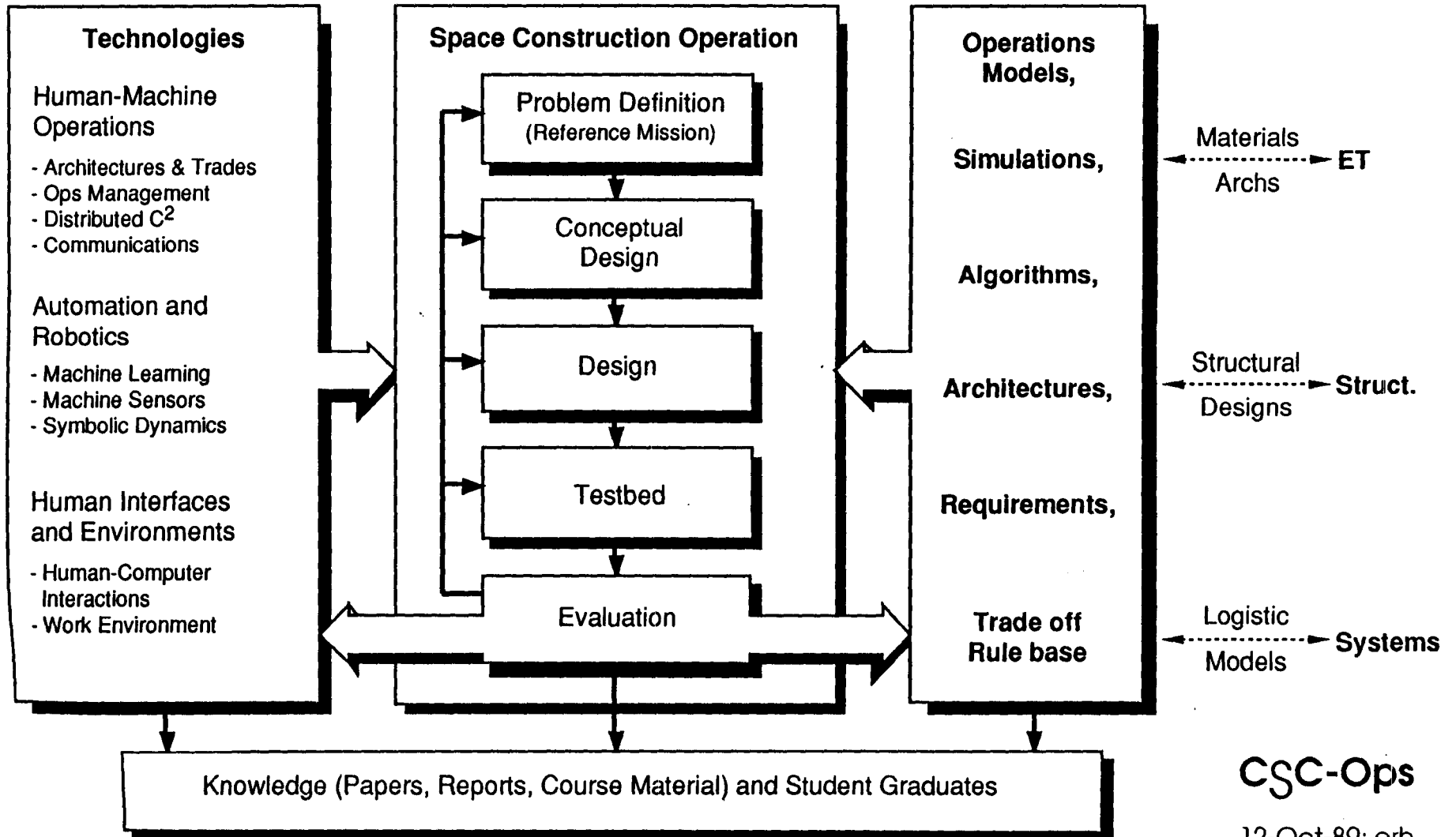

CSC-Ops

12-Oct-89; erh

# Construction Operations

## Integrated Research Approach

### ❖ Features

- A systems-level perspective
- An educational environment that fosters systems-level research
- Integrates construction operations research tasks
- Links to the other CSC clusters
- Ties to NASA and industrial associates

# Construction Operations

## Integrated Research Approach

- ❖ Problem Definition
  - An analysis of the construction problem
  - Produces objectives, scope, task set, users, user needs, concerns, constraints, special issues
  - Driven by actual reference missions
- ❖ Conceptual Design
  - A study to determine the elements, roles, and relationships that work together to support all the requirements
  - To maximize the total advantages of the integrated concept
- ❖ Design
  - Elements, functions performed, and services needed by each element and data/objects exchanged between elements
  - Physical representation of above elements, functions and interfaces
- ❖ Testbed
  - End-to-end environment for evaluation of design concepts, architectures, tools, techniques and interfaces
  - Increasing in fidelity
- ❖ Evaluation with respect to problems
- ❖ Iteration

# Construction Operations

## Integrated Research Approach

### ❖ Design Reference Missions

#### #1: Space Station payload servicing bay

- Internally defined
- To address broad range of space construction issues
- To drive basic conceptual design and testbed

#### #2: Space Station Freedom assembly assisted by Flight Telerobotics Servicer

- With support from JSC Astronaut group, and FTS groups at GSFC and Martin Marietta Aerospace
- To augment requirements, conceptual design, and testbed
- To clarify safety concerns and role sensitivities
- To drive technology research
- Demonstration opportunity?

#### #3: NASA's Office of Exploration, Code Z, Lunar and Martian Outposts

- Addressed with support from Code Z group at JSC
- To refine requirements, conceptual design, testbed, and technology research
- Opportunity to influence concept, assembly sequence and techniques

#### #4: Large Space Systems

- Supporting the mission to planet Earth





## Constructor Selection Research

Brent Helleckson, John Blanco,  
Chris Echohawk, Elaine Hansen

S3-66

160674

P- 16

The process of space construction is defined by the construction goal and by the construction system selected to accomplish that goal. The former provides the tasks that must be executed, while the latter provides the capabilities to execute them. This presentation outlines a high-level model of space construction and illustrates the relationship between constructor and task. The construction model is then utilized to develop a preliminary theory of constructor selection. The need for broad models of construction, constructor selection, and constructor management is identified. From this preliminary work it can be concluded that task decomposition is dependent upon both task and constructor; The selection process is separable from the optimization process; and that logical, defensible selection is possible.

# **Center For Space Construction Operations Cluster**

## **Constructor Selection Research**

**Brent Helleckson, John Blanco,  
Chris Echohawk, Elaine Hansen**

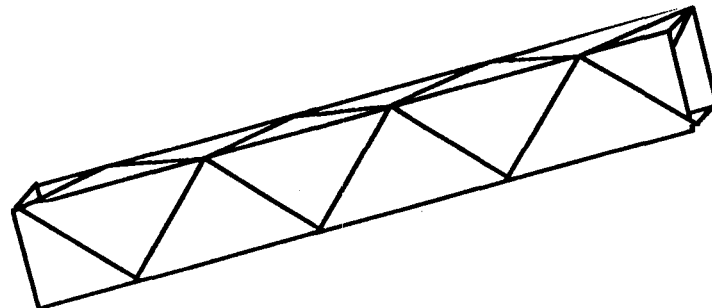

**CSC Operations Cluster  
Constructor Selection  
10/12/89      BAH**

# Space Construction System

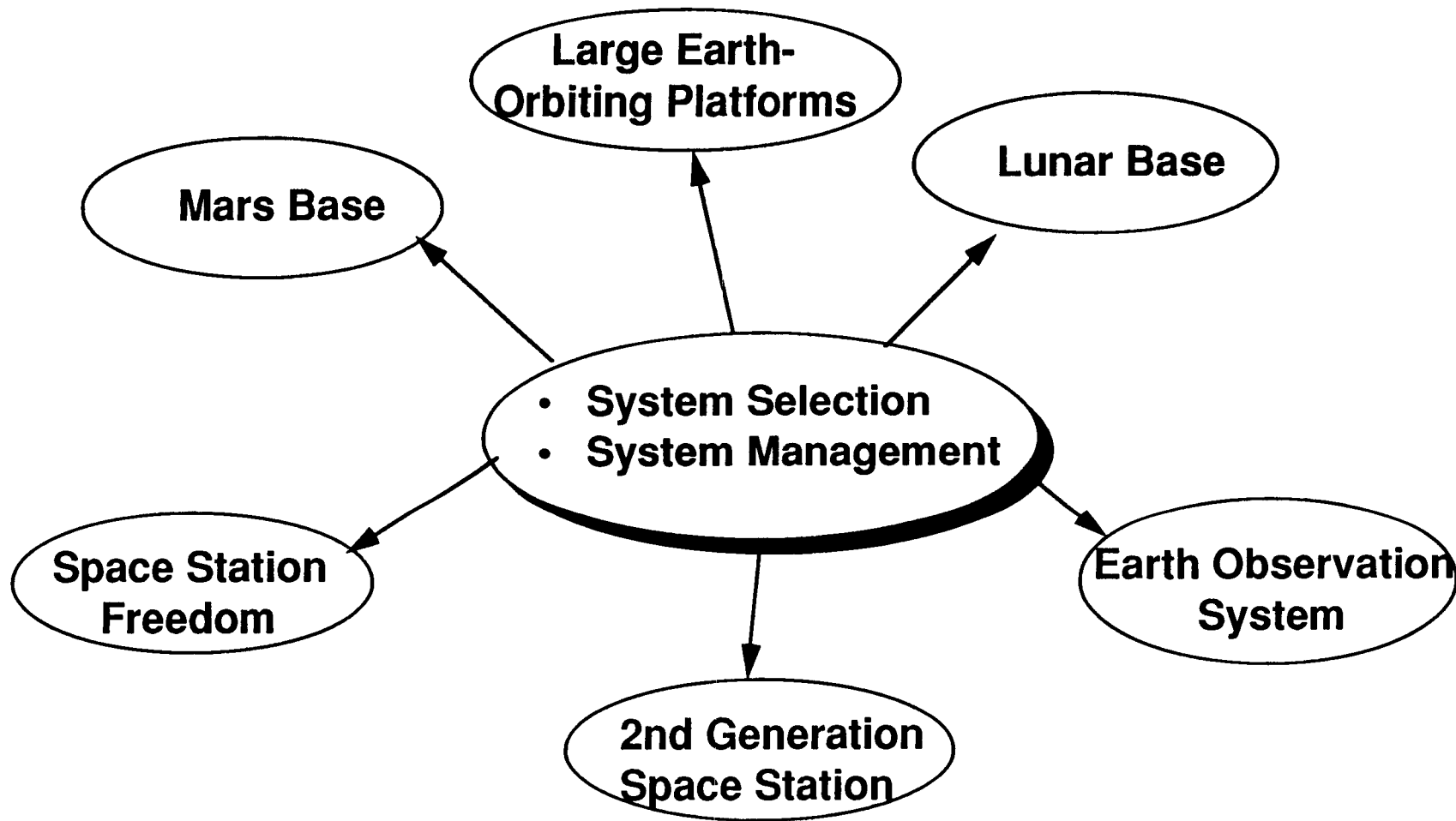

**CSC Operations Cluster  
Constructor Selection  
10/12/89      BAH**

# Constructor Selection

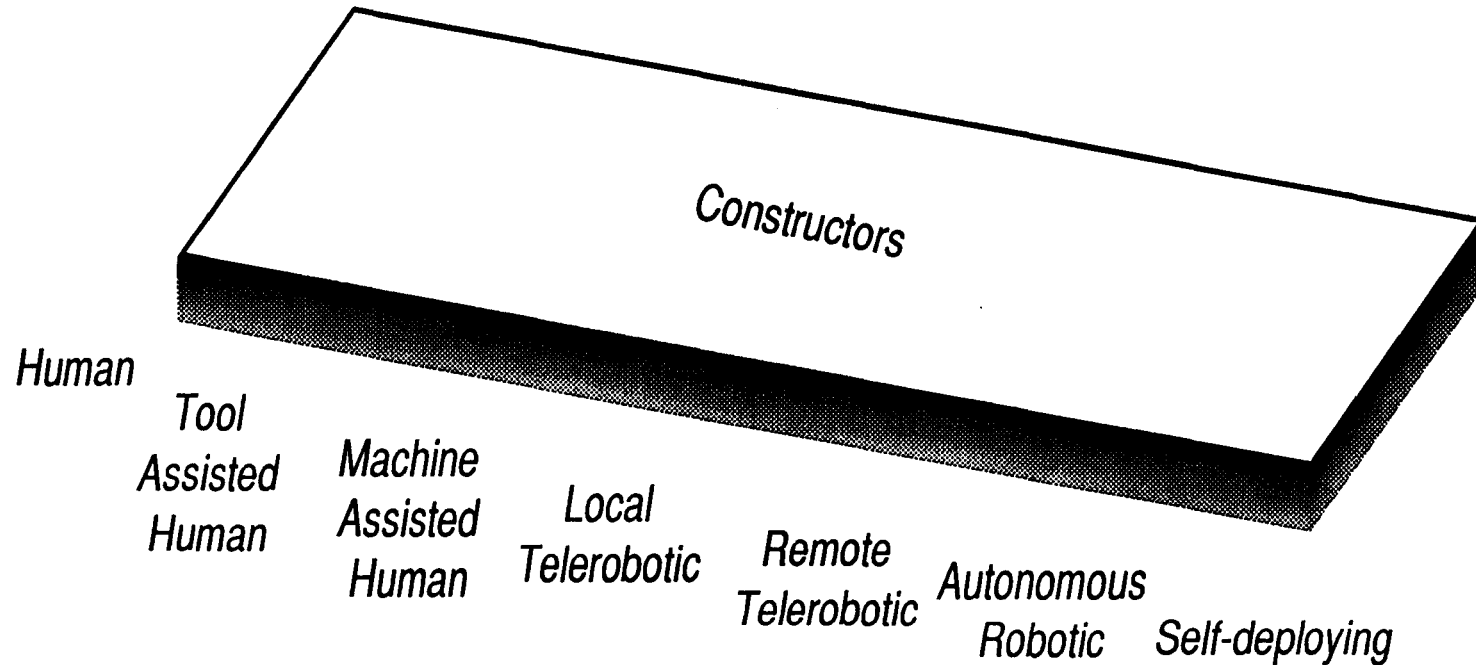

- **How are choices between constructors made ?**
- **What is the appropriate mix of constructors ?**
- **This preliminary research addresses choices between individual constructors**

# Prerequisites

- **Understand the requirements of the construction process in terms of tasks**
- **Understand the capabilities of constructors**
- **Understand the construction process in order to express task requirements in terms of constructor capabilities**
- **Understand the selection rationale and selection criteria**

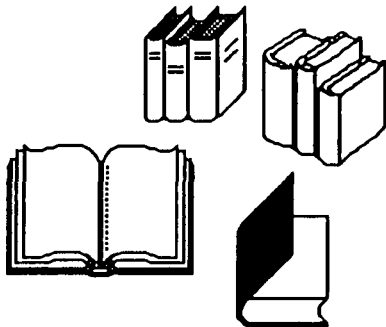

# Generalized Construction Process Model

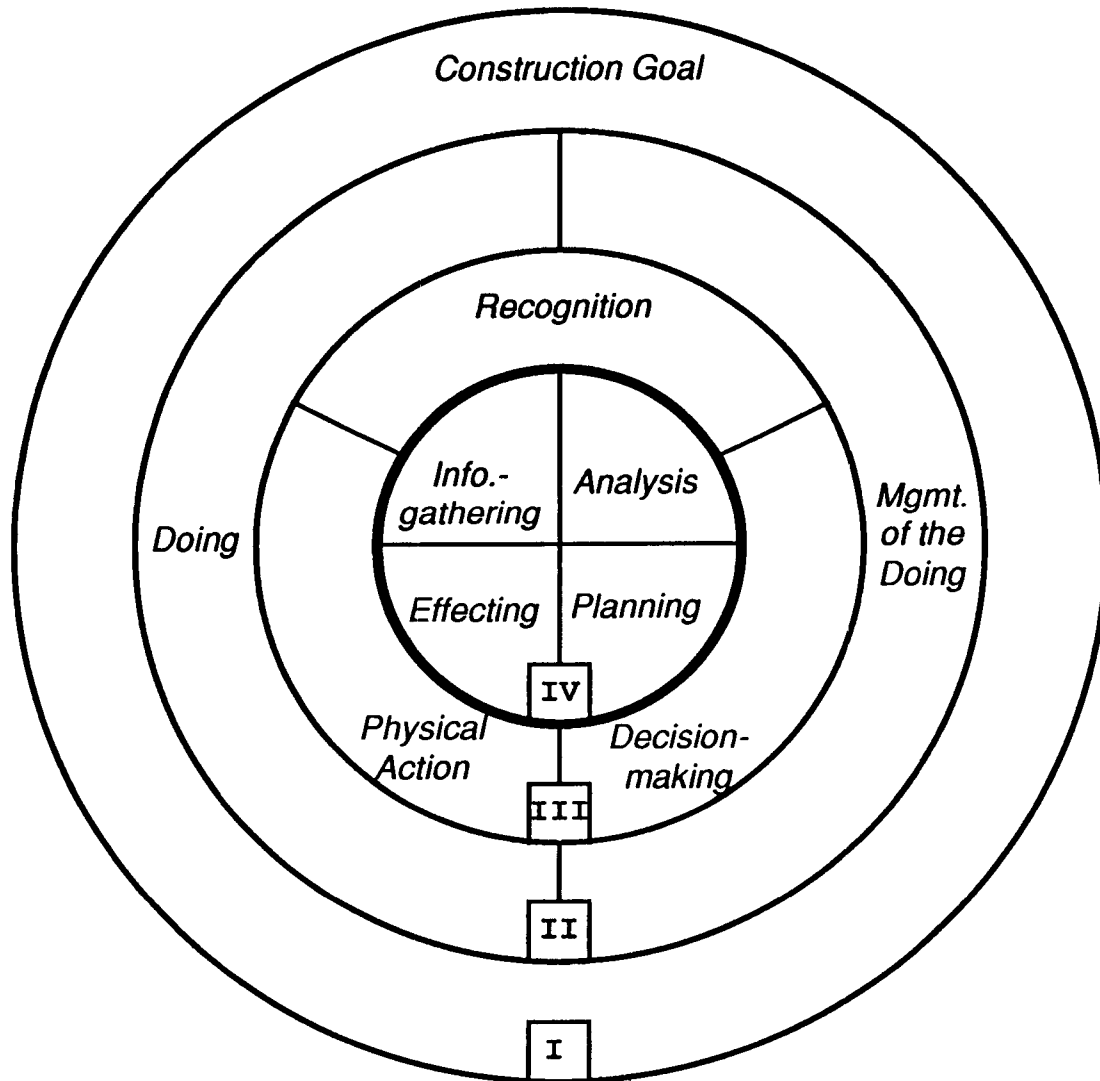

- **Four levels**
- **Each level is increasingly more task-dependent**

**Consider the problem of installing an Orbital Replacement Unit (ORU)**

# Construction Model: Level I

## Construction Goal

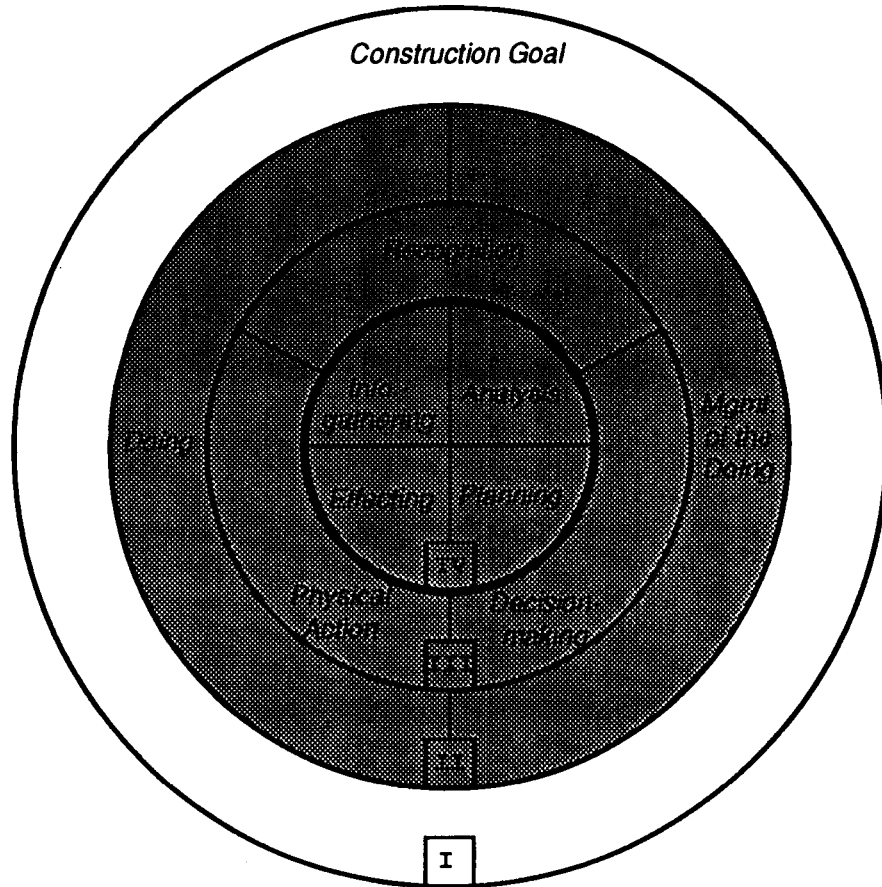

"Install ORU"

- What you are trying to build
- Needed to generate the construction product
- Totally task-dependent

CSC Operations Cluster  
Constructor Selection  
10/12/89 BAH

# Construction Model: Level II

## Doing/Management of the Doing

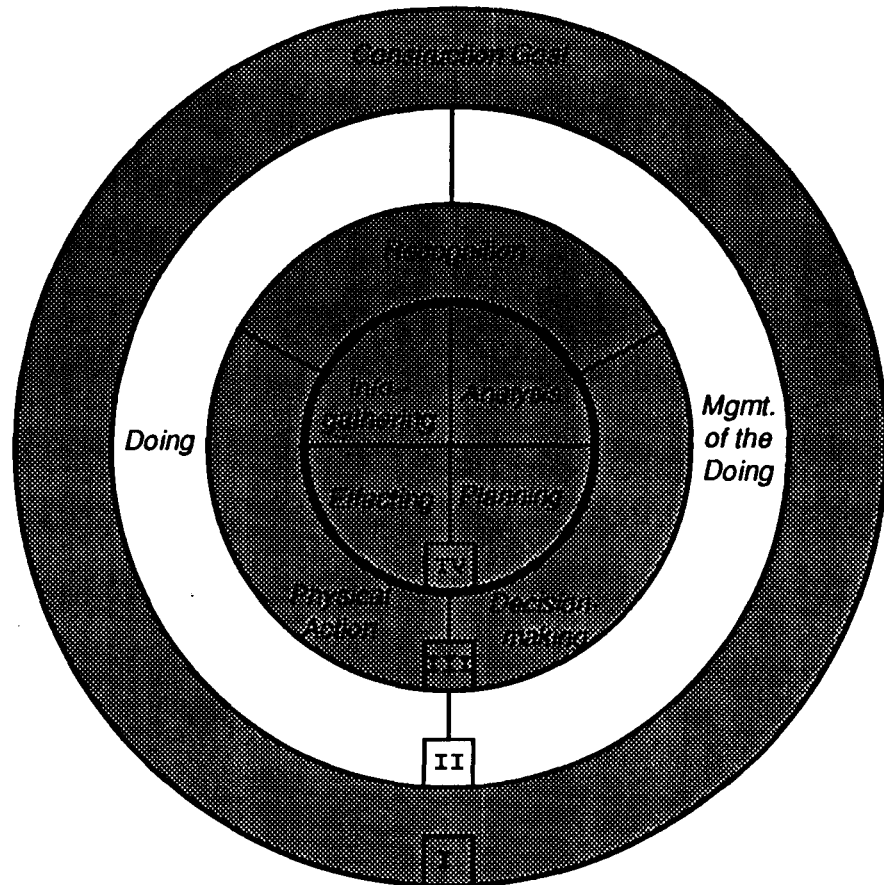

- Physical actions required to complete construction
- Managerial functions required to allow physical actions to be completed within the overall constraints
- Highly task-dependent

**"Attach ORU housing within time, safety, and power limitations"**

CSC Operations Cluster  
Constructor Selection  
10/12/89      BAH



# Construction Model: Level III

## Physical Action/Recognition/ Decision-making

---

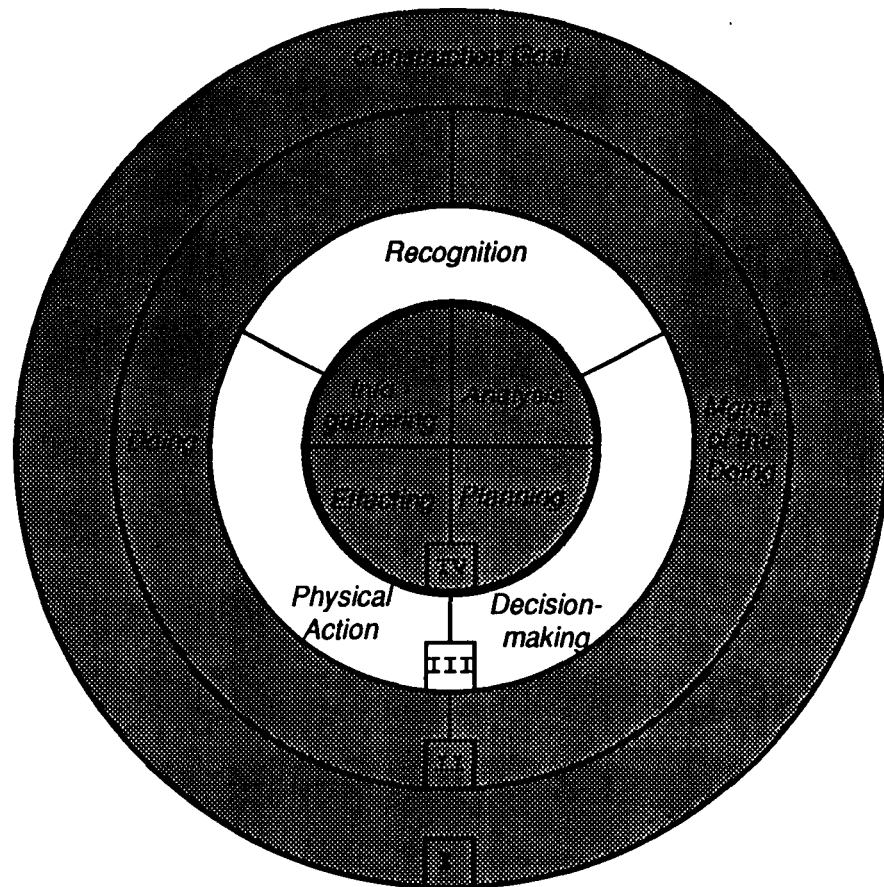

- The actual motion needed to accomplish construction
- The abilities needed to recognize conditions
- The abilities needed to arrive at required decisions
- Highly task-dependent, somewhat constructor-dependent

**"Locate housing bolt and tighten to specified torque. Release when complete"**

CSC Operations Cluster  
Constructor Selection  
10/12/89      BAH

# Construction Model: Level IV

## Information-gathering/ Analysis/Planning/Effecting

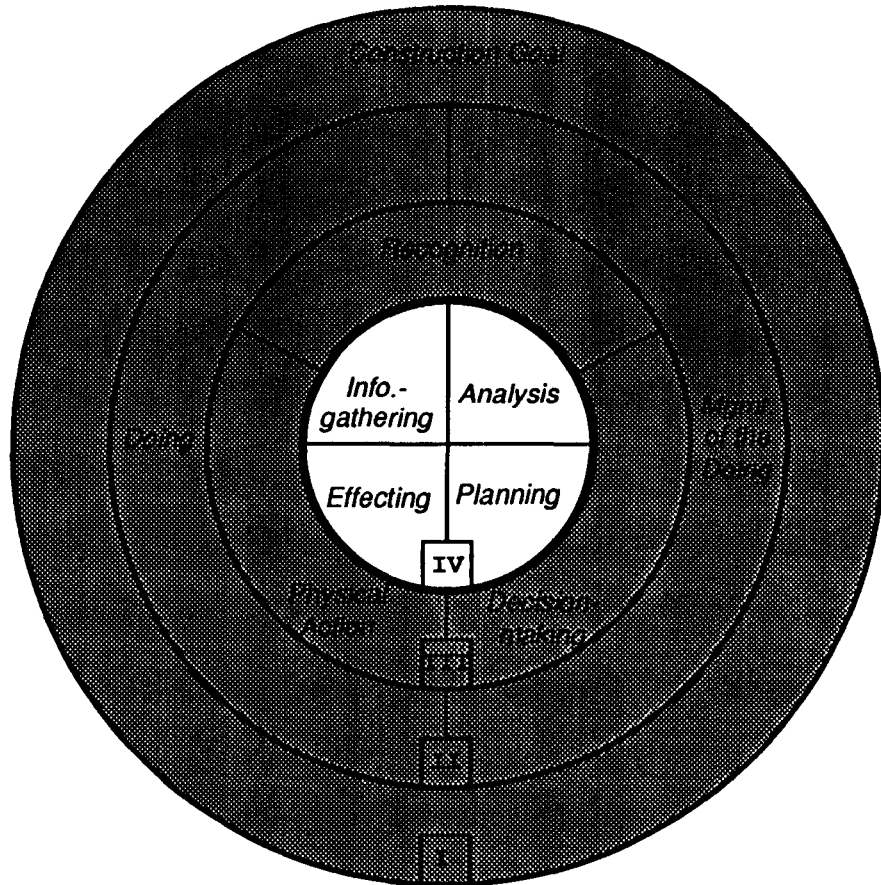

- Both constructor and task dependent
- Made up of elementary functions (i.e. grasp, move, sense, compare to expected, etc.)

"Sense bolt, compare to database,  
plan acquisition path, execute move"

# Constructor Selection Theory

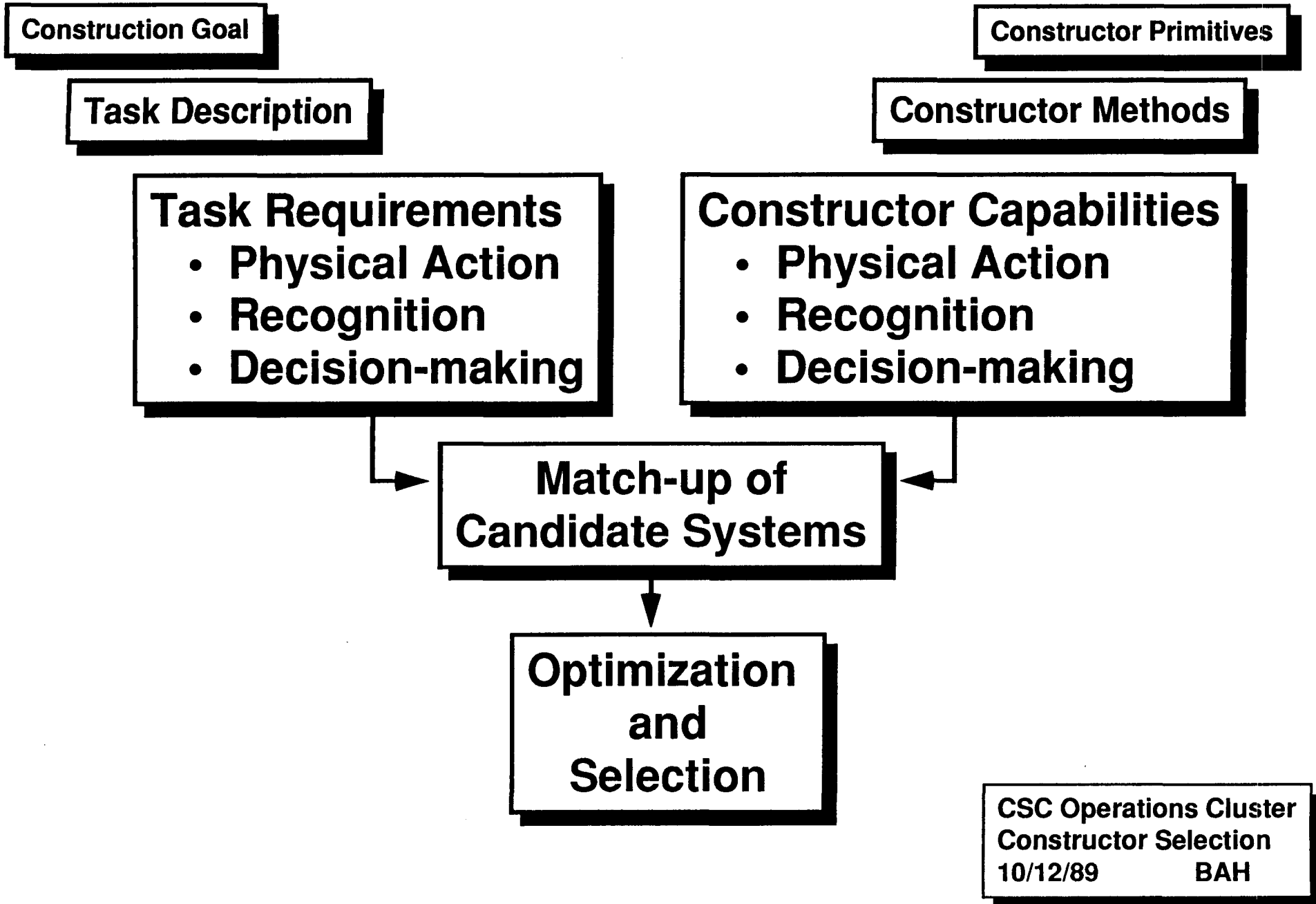

# Constructor Capabilities and Task Descriptions

Stated in terms of:

- Physical Actions
- Recognition
- Decision-making

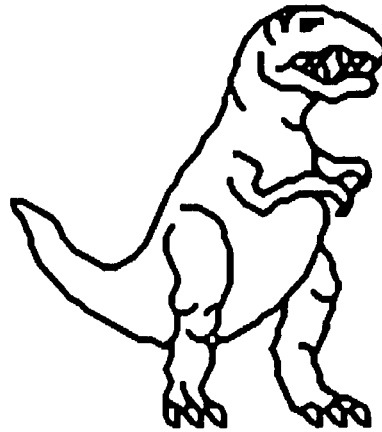

Constructor  
Capabilities

?

Task  
Requirements

$mc^2 = ?$

Requirements of "install ORU" vs Capabilities of FTS

CSC Operations Cluster  
Constructor Selection  
10/12/89      BAH

# Match-up of Candidate Systems

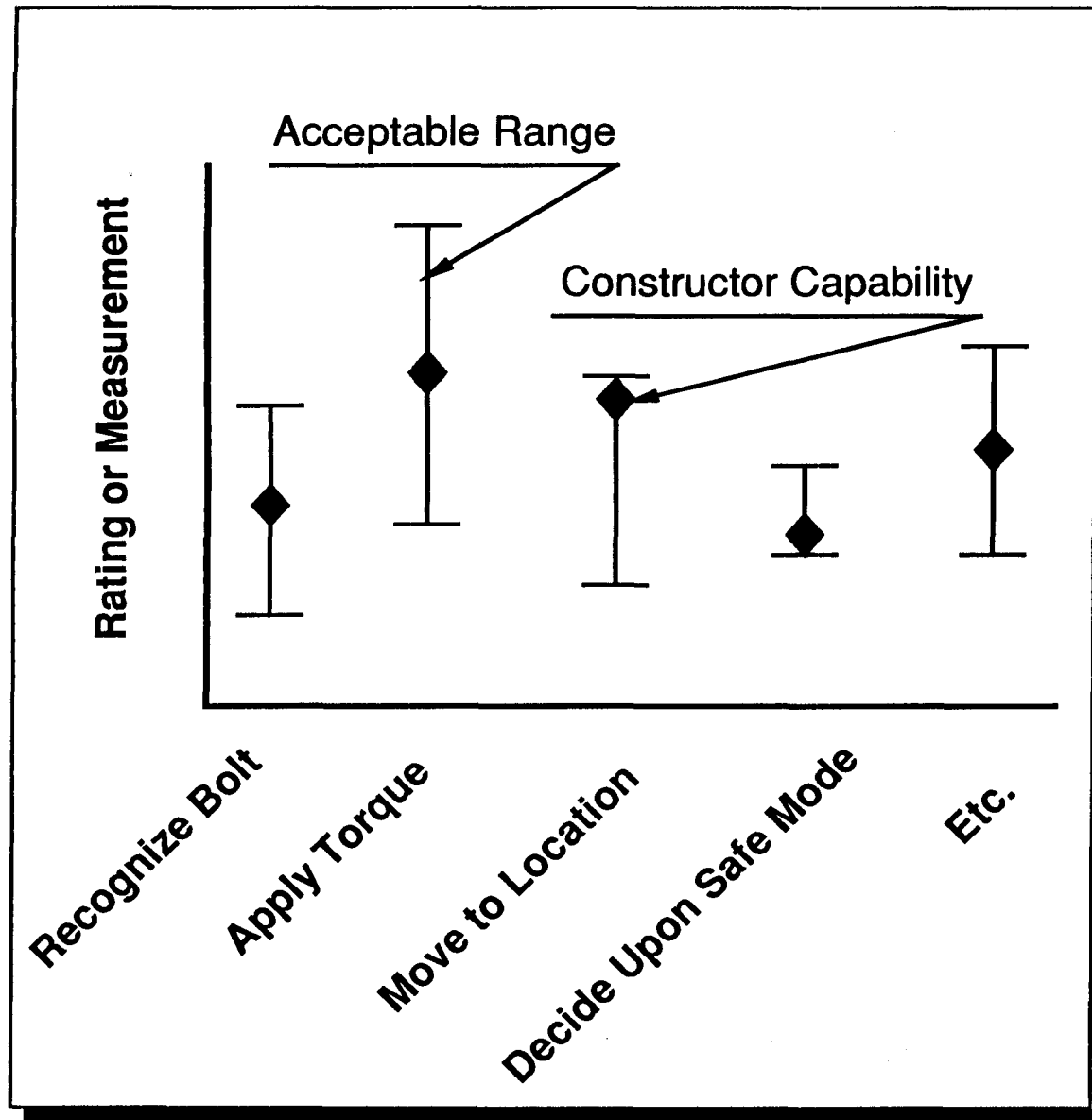

- **Constructor capabilities must be within the acceptable range of task requirements**
- **No attempt at optimization**

# Optimization and Selection

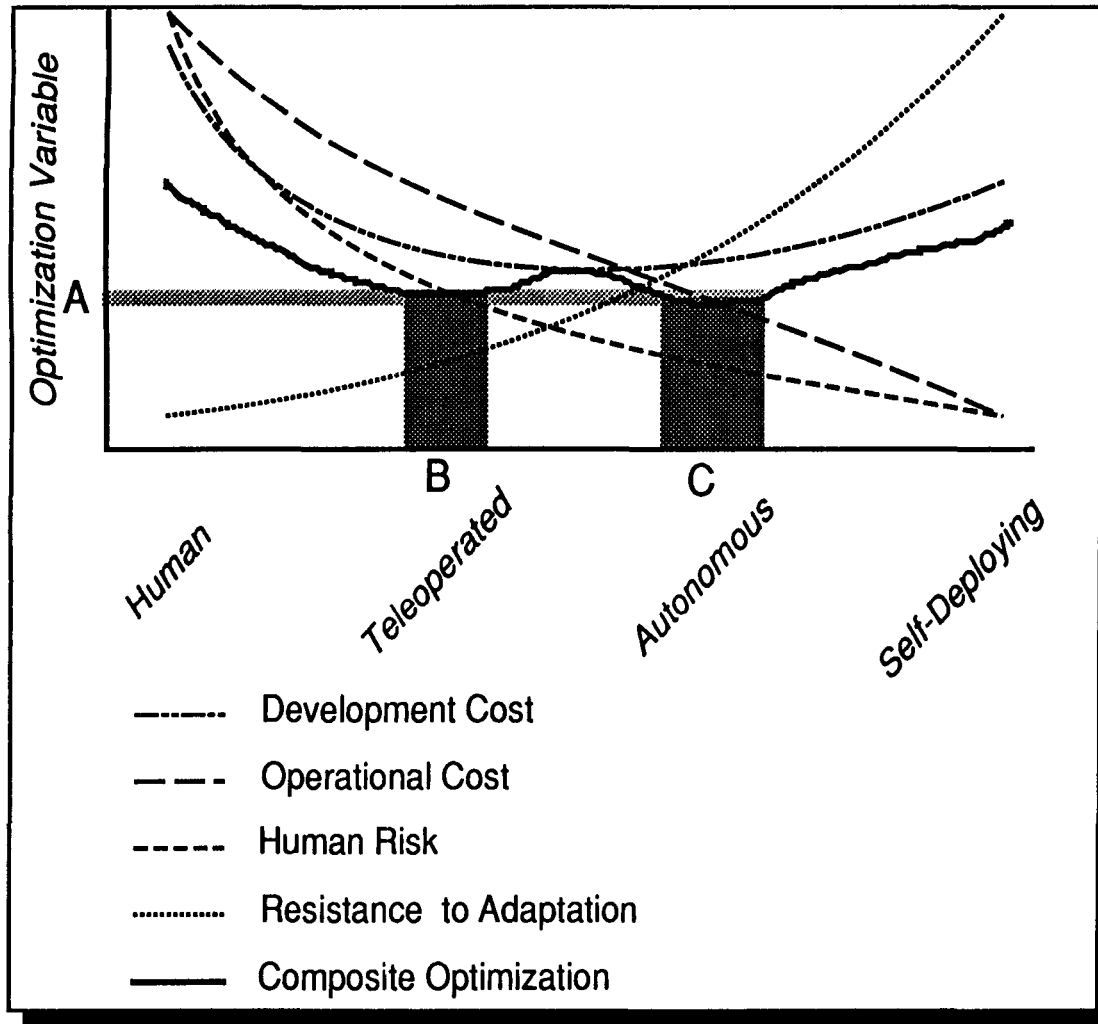

**A = Acceptable Range of Optimization**

**B,C = Constructors Capable of Attaining the Acceptable Range**

## Example Variables

- **Development Cost**
- **Operational Cost**
- **Human Risk**
- **Mass**
- **Resistance to Adaptation**
- **Etc.**

CSC Operations Cluster  
Constructor Selection  
10/12/89      BAH

# Supporting Research

- **Human cognition and information processing experiment**
- **Models of constructor management**
- **Space Station Freedom / Flight Telerobotic Servicer Usage**
- **Design reference missions**
  - **Lunar base**
  - **Mars base**
- **Technology demonstrations**

# Conclusions

- **Task decomposition is both task and constructor dependent**
- **The selection process can be distinct from the optimization process**
- **Logical, defensible selection is possible**
- **At least three broad models are required for an adequate understanding:**
  - **Construction (GCP)**
  - **Selection**
  - **Management**



**\*\* Abstract for Talk \*\***

**Communications Among Elements of a  
Space Construction Ensemble**

Randal L. Davis and Christopher A. Grasso

54-66  
160675  
12 9

Space construction projects will require careful coordination between managers, designers, manufacturers, operators, astronauts and robots, with large volumes of information of varying resolution, timeliness and accuracy flowing between the distributed participants over computer communications networks. Within the CSC Operations Branch, we are researching the requirements and options for such communications. Based on our work to date, we feel that communications standards being developed by the International Standards Organization, the CCITT and other groups can be applied to space construction. We are currently studying in depth how such standards can be used to communicate with robots and automated construction equipment used in a space project. Specifically, we are looking at how the Manufacturing Automation Protocol (MAP) and the Manufacturing Message Specification (MMS), which tie together computers and machines in automated factories, might be applied to space construction projects. Together with our CSC industrial partner Computer Technology Associates, we are developing a MAP/MMS companion standard for space construction and we will produce software to allow the MAP/MMS protocol to be used in our CSC operations testbed.

# **Communications Among Elements of the Space Construction Ensemble**

**Randal L. Davis and Christopher A. Grasso  
Center for Space Construction  
Operations Branch**

**Presented at CSC Workshop  
Estes Park, Colorado  
12 October 1989**

# **The Goals of Our CSC Communications Research**

- **Determine requirements for communications between the humans and computerized equipment involved in space construction projects**
- **Examine the communications options available**
  - **Emphasis is on adapting existing communications technologies and protocols**
- **Incorporate promising technologies and protocols into our CSC testbed**

**This research is performed with our CSC industrial partner  
Computer Technology Associates**

# The Space Construction Ensemble

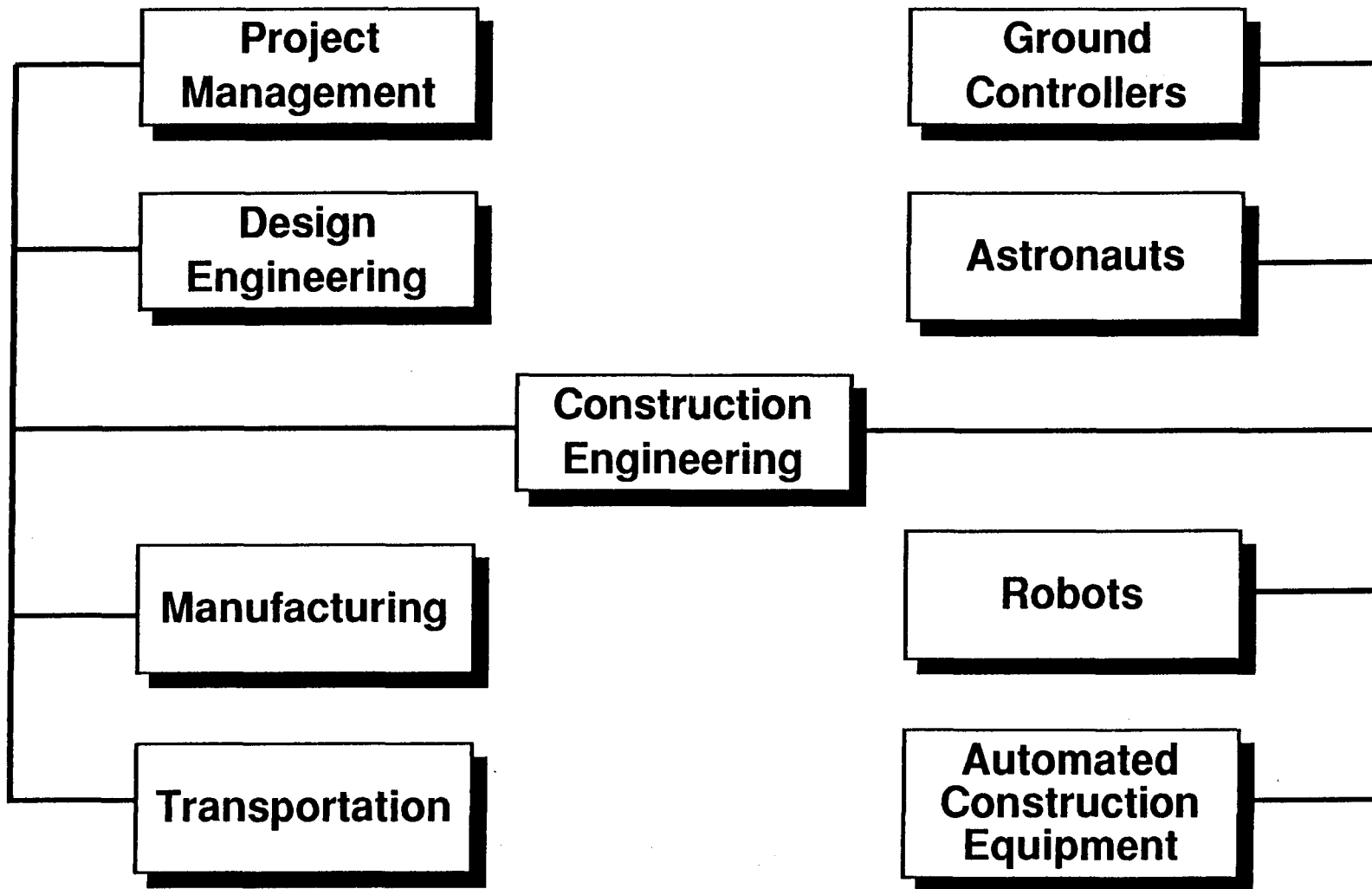

# Three Types of Data Flowing During Space Construction

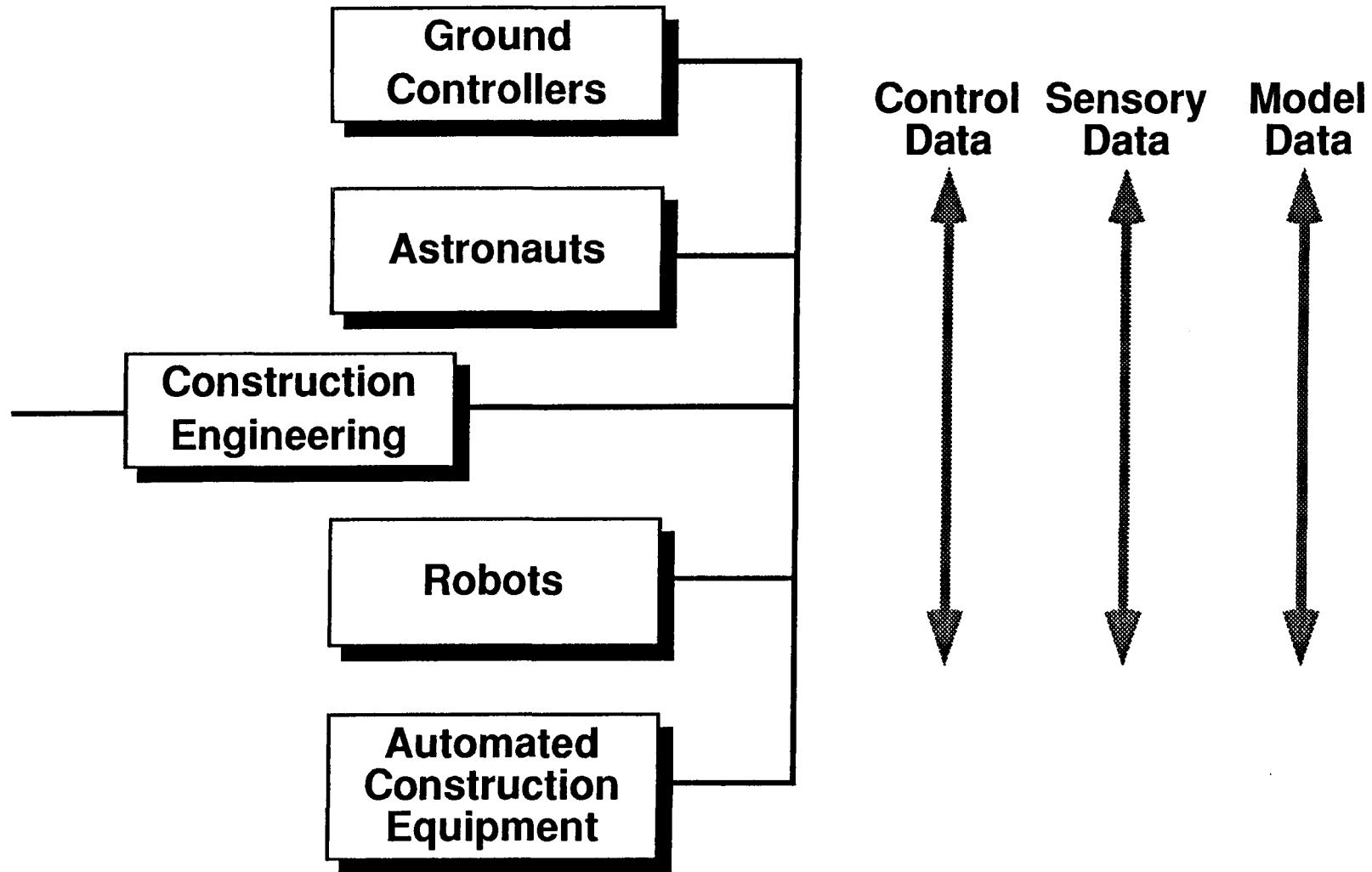

# To Control a Construction Activity We Specify Tasks and Operations

- **High-Level Tasks**
  - **INSTALL LOGISTICS MODULE**
- **Low-Level Tasks**
  - **TIGHTEN ACCESS COVER BOLTS TO 25 FT LBS**
- **Elementary Moves**
  - **MOVE MANIPULATOR TO HATCH RELEASE**
- **Simple Commands**
  - **START ACTUATOR MOTOR**

- **Humans can often work with high-order tasks**
- **Robots need low-level tasks or elementary moves**
- **Automated equipment needs elementary moves or simple commands**

**? Question: Do We Need Different Communications Protocols for Different Levels of Control or for Different Kinds of Devices?**

# Existing Protocols May Allow Us To Communicate with and Control All Construction Devices In the Same Way

- In terrestrial manufacturing, the Manufacturing Messaging Specification (MMS) has been developed to allow uniform control of different types of equipment on the factory floor
  - MMS is a key part of the Manufacturing Automation Protocol (MAP) suite of communications protocols
  - MMS maps the characteristics of a real device onto a *Virtual Manufacturing Device (VMD)*

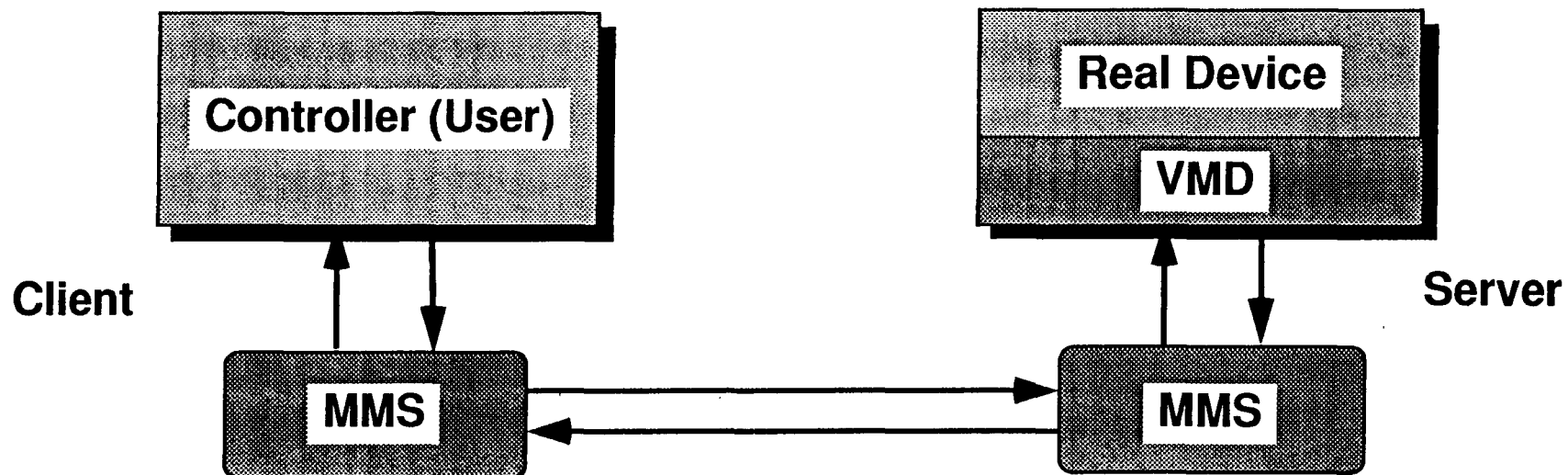

# Development of an MMS Standard for Space Construction

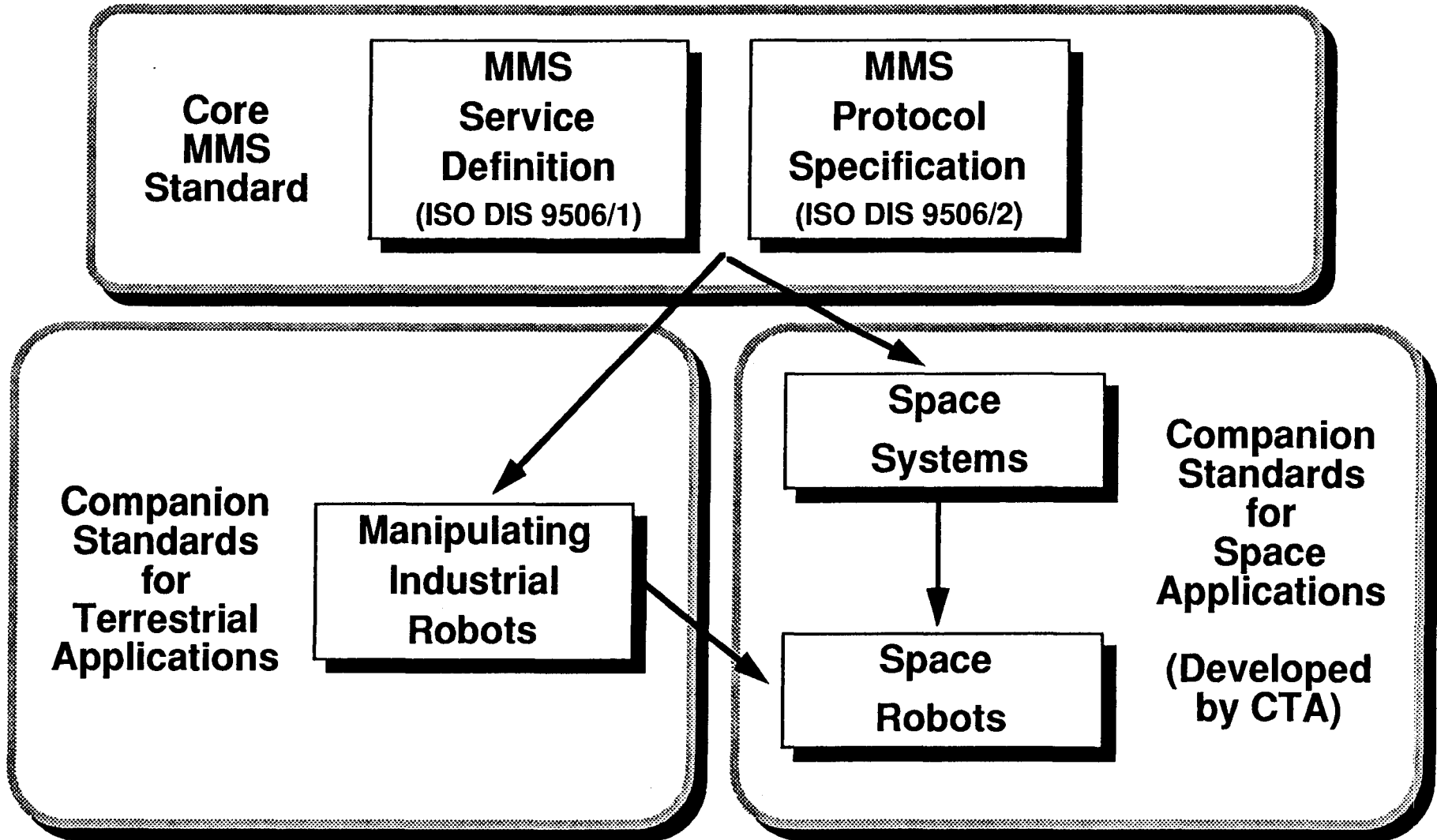



# Applying MMS in Our CSC Testbed

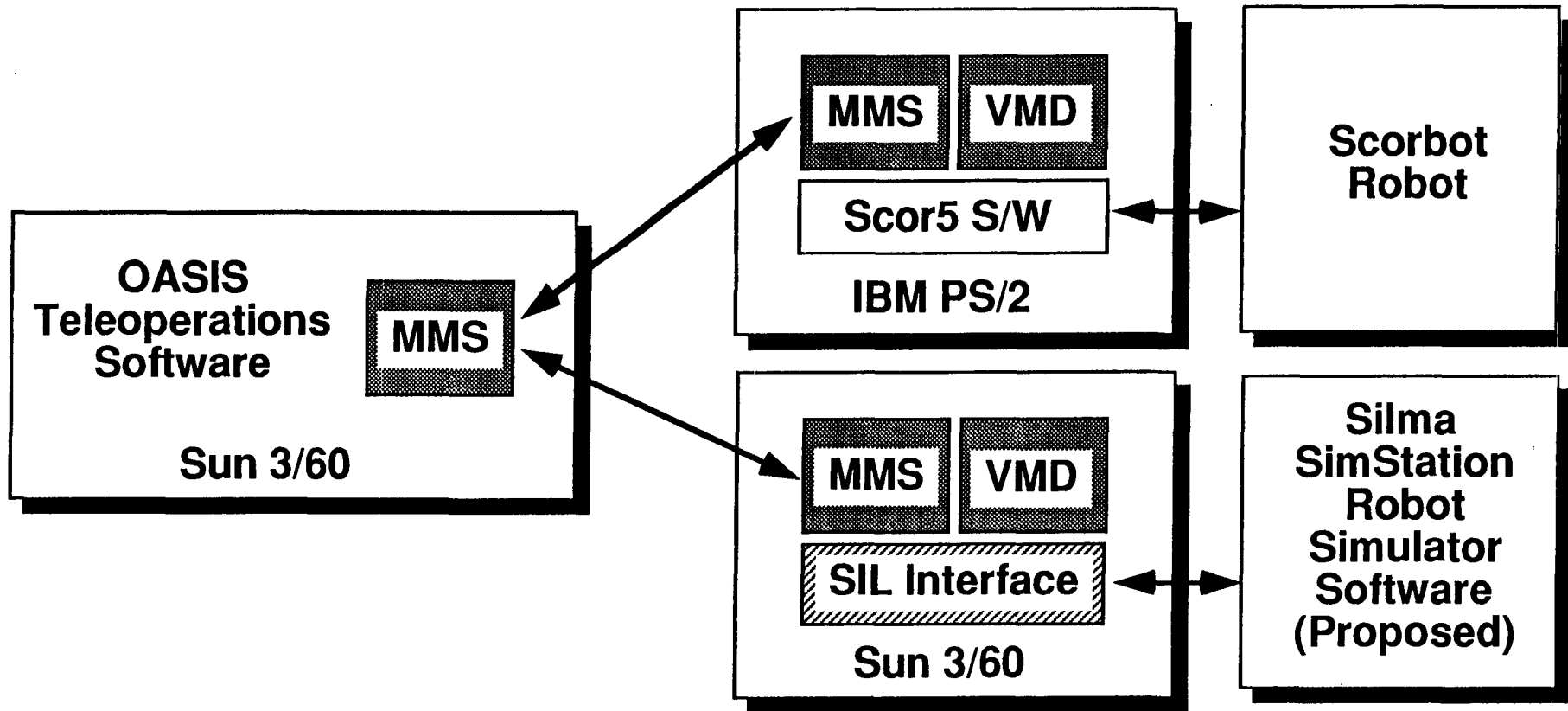



# MACHINE LEARNING IN MOTION CONTROL

Renjeng Su and Nouredine Kermiche  
Center for Space Construction

55-66

160676

p. 15

## ABSTRACT

The existing methodologies for robot programming originate primarily from robotic applications to manufacturing, where uncertainties of the robots and their task environment may be minimized by repeated off-line modeling and identification. In space application of robots, however, higher degree of automation is required for robot programming because the desire of minimizing the human intervention. We discuss a new paradigm of robotic programming which is based on the concept of machine learning. The goal is to let robots practice tasks by themselves and the operational data are used to automatically improve their motion performance. The underlying mathematical problem is to solve the problem of dynamical inverse by iterative methods. One of the key question is how to ensure the convergence of the iterative process. There have been a few small steps taken into this important approach to robot programming. We give a representative result on the convergence problem.

**Machine Learning In Motion Control**

**Renjeng Su and Nouredine Kermiche**  
**Center for Space Construction**  
**University of Colorado**  
**Boulder, Colorado**

**The problem of robot programming is to find input signals which will drive a robot to perform desirable tasks.**

A robot is a motion control system.

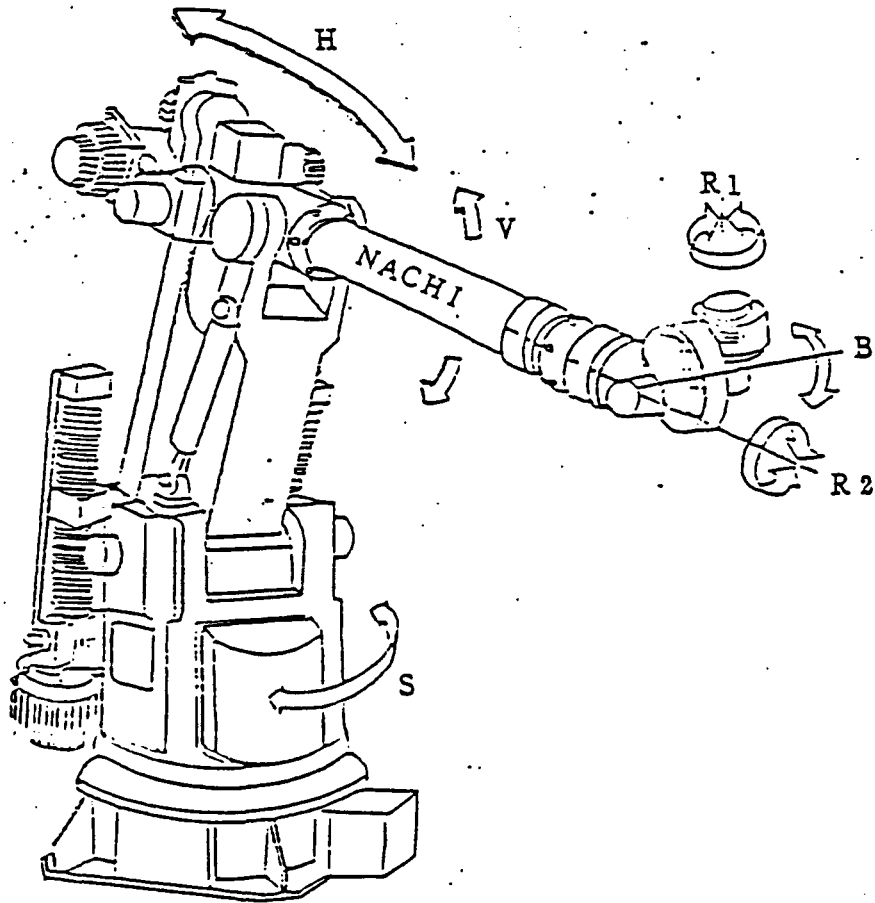

## **Existing Methods For Robot Programming**

1. Lead through programming
2. Teach pendant programming
3. Off-line programming

The robot programming problem may be formulated as a mathematical problem.

Robot Dynamics:

$$F : \{v(t)\} \longrightarrow \{q(t)\}$$

$v(t)$  the input voltages

$q(t)$  the location and orientation of the end effector

The robot programming is to solve the dynamic inverse problem: given a desired trajectory of the location and orientation of the end effector to find a time function of the input voltage which will produce a satisfactory motion trajectory.

## Lead Through Method

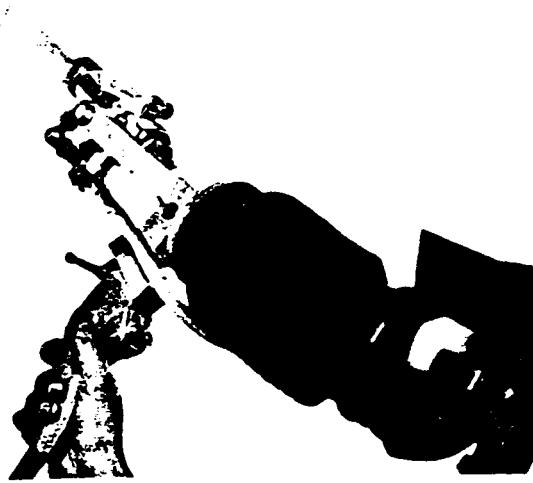



# Teach Pendant Programming

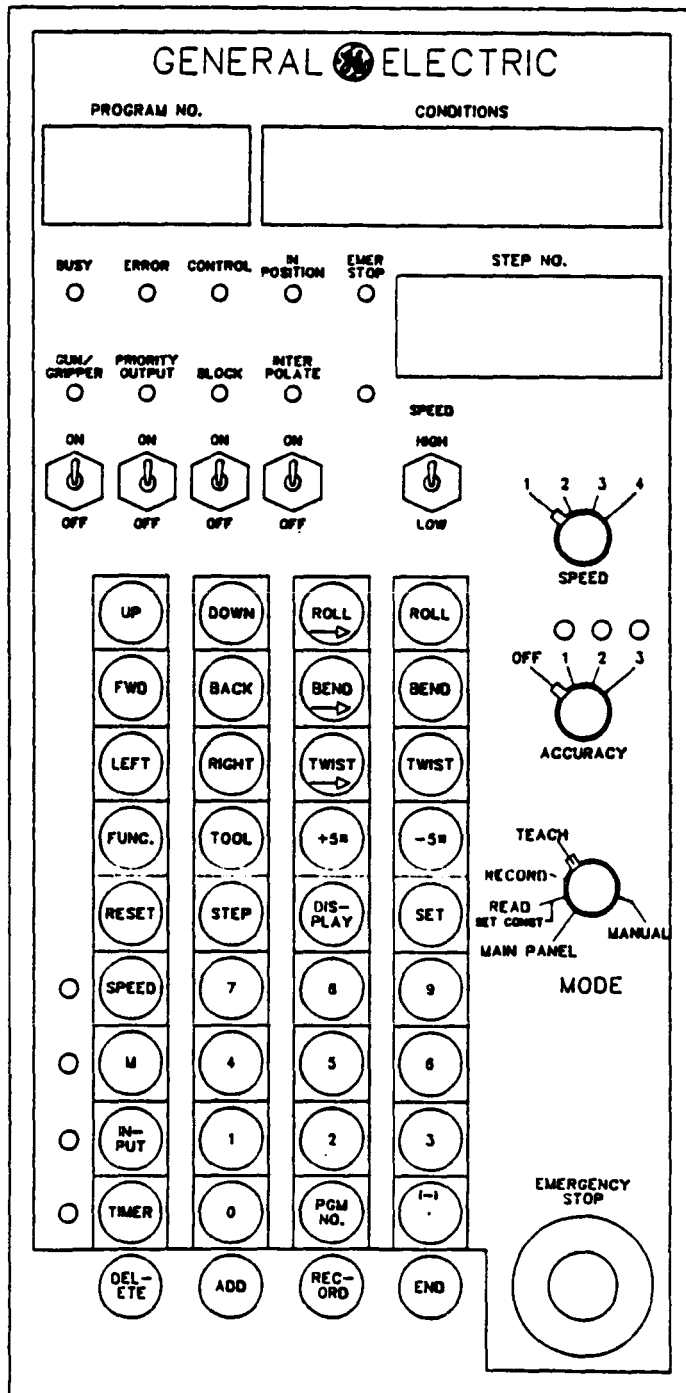

# Control Systems For Teach Pendant Programming

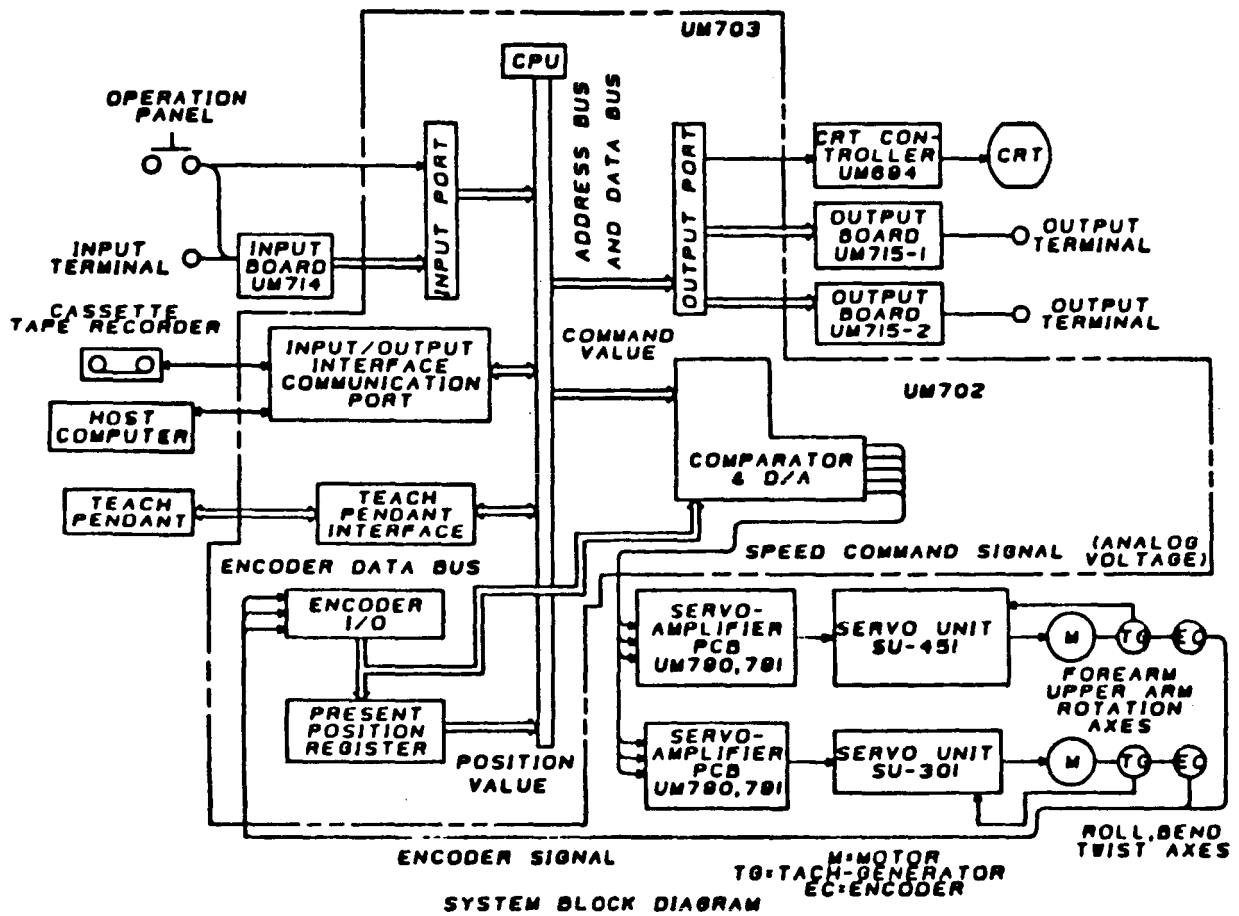

## Off-Line Programming

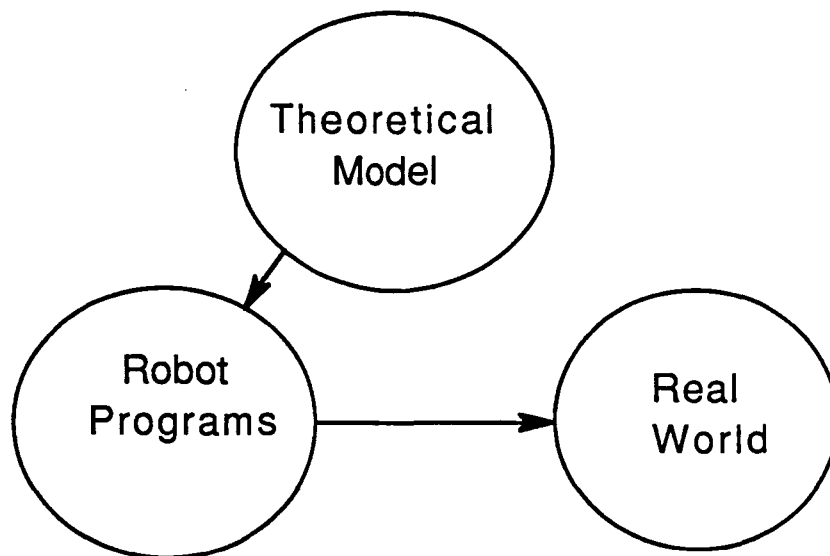

## Machine Learning Approach to Robot Programming

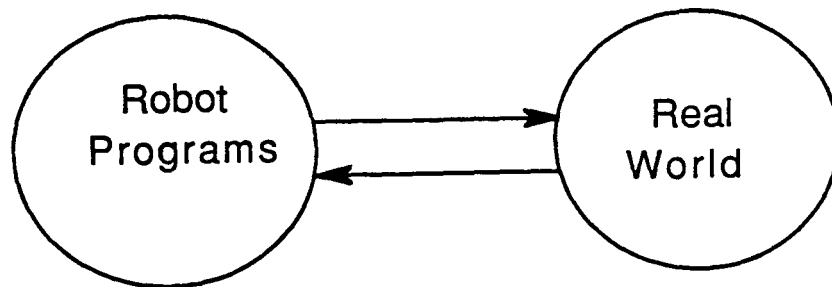

The robot tracks a desired trajectory repeatedly and improves its tracking performance using tracking results from the previous iterations.

## Learning Control For Linear Systems

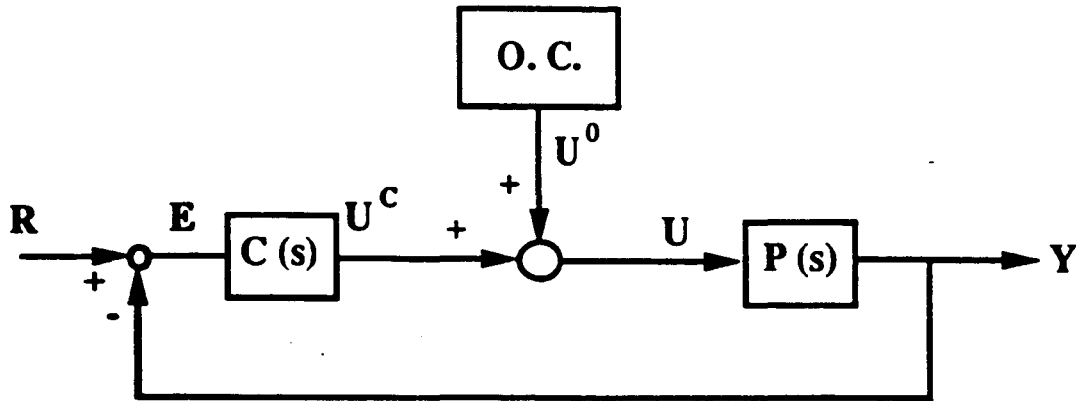

$$U_{k+1}^0 = U_k^C + U_k^0 + L(s) E_k$$

$$k \geq 1, U_0^0 = E_0^0 = 0$$

**Error Equation:**

$$E_{k+1} = \frac{1 - PL}{1 + PC} E_k$$

# Circle Condition for Convergent Learning

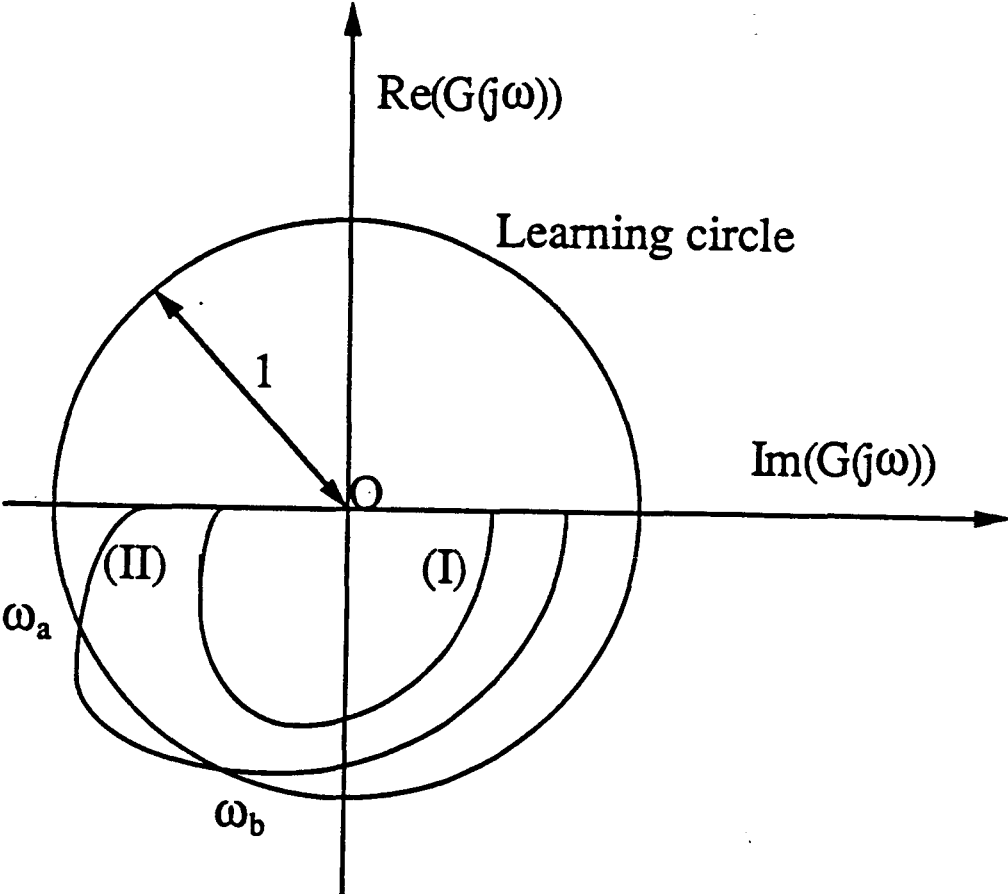

## Application to A Flexible Beam Control

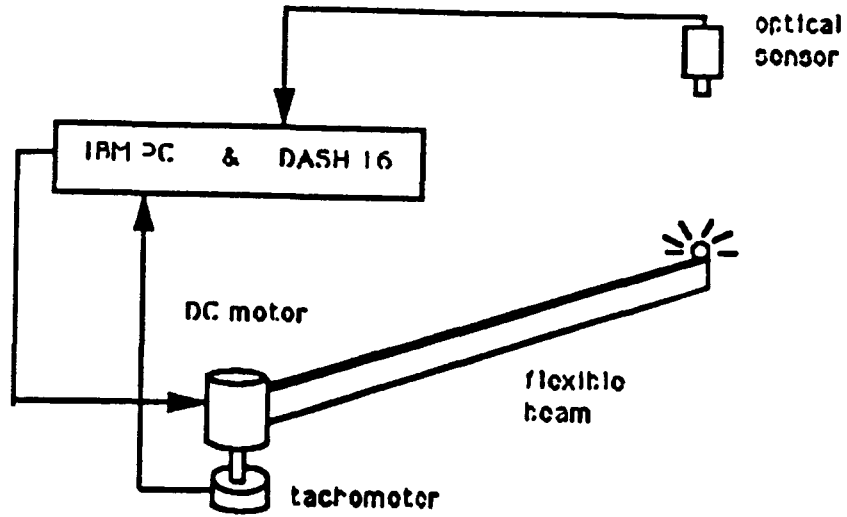

$$k_c=20, k_l=0.1, k=20, c_1=1, c_2=2, l_1=-1, l_2=1, dT=0.1$$

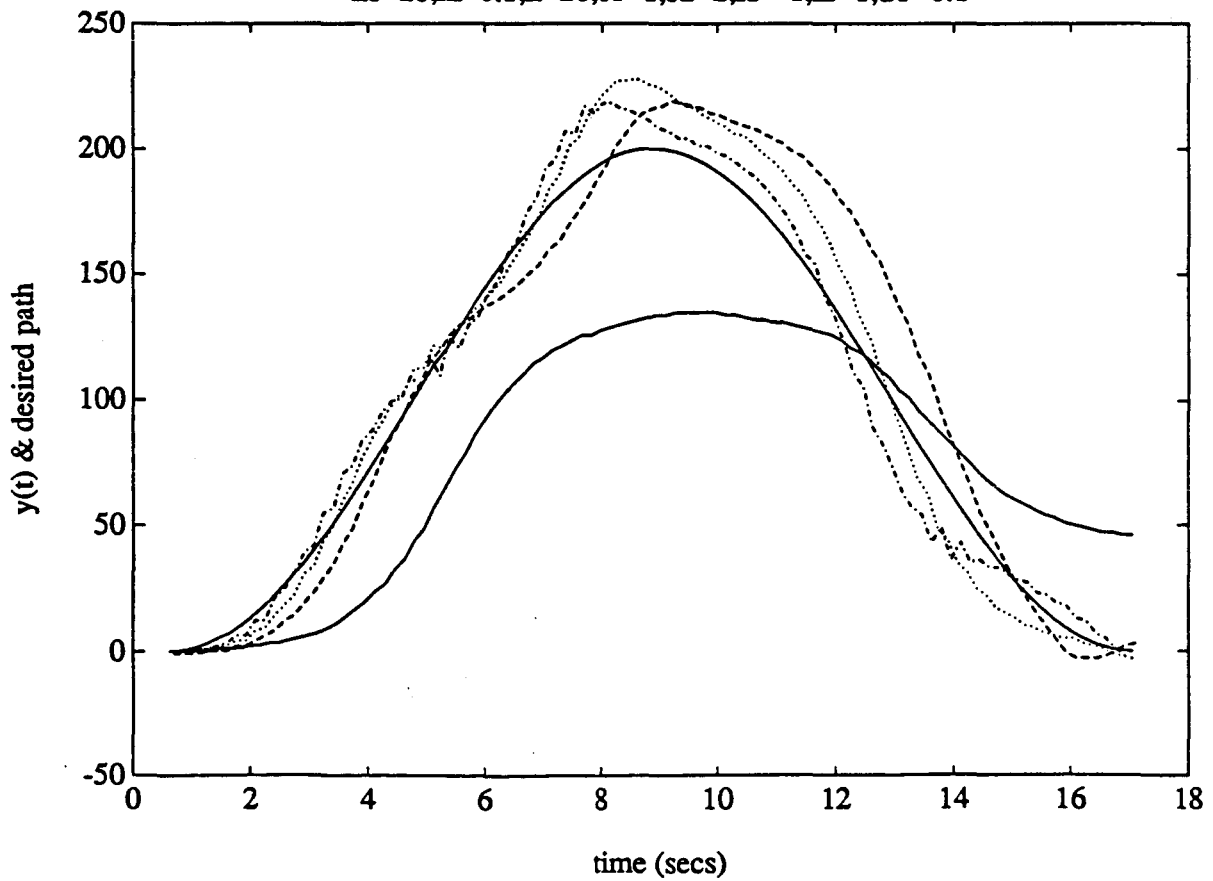

## **Future Problems**

1. Learning for multi-axis nonlinear dynamics
2. Task-level learning



CSC Workshop presentation

User Interface Support

Clayton Lewis and Nick Wilde  
Department of Computer Science  
University of Colorado, Boulder

*Abstract:* Space construction will require heavy investment in the development of a wide variety of user interfaces for the computer-based tools that will be involved at every stage of construction operations. Using today's technology user interface development is very expensive, for two reasons. First, specialized and scarce programming skills are required to implement the necessary graphical representations and complex control regimes for high-quality interfaces. Second, iteration on prototypes is required to meet user and task requirements, since these are difficult to anticipate with current (and foreseeable) design knowledge. We are attacking this problem by building a user interface development tool based on extensions to the spreadsheet model of computation. The tool provides high-level support for graphical user interfaces and permits dynamic modification of interfaces, without requiring conventional programming concepts and skills.

5000  
160677  
1-15

# User Interface Support

Clayton Lewis and Nick Wilde  
Department of Computer Science  
University of Colorado, Boulder

Space construction will require heavy investment in user interfaces.

Examples:

telemanipulation

remote monitoring of autonomous robots

reprogramming of remote systems

...

## User interfaces are expensive

- They are strange programs

graphics

mixed-initiative control

- They require iterative design and development...

because user needs are hard to predict

The NoPumpG project aims to cut costs dramatically by

- reducing the programming skill required to build an interface
- permitting changes to be made on the fly to running interface prototypes

The key idea:

build on the *spreadsheet* model of computing

A spreadsheet manages a collection of interdefined quantities.

When data or formulae change dependent quantities are automatically updated.

The notions of procedural programming are not needed.

Data and program can be freely viewed and modified.

## Pumping:

In conventional programming data and program cannot be seen or changed unless specific i/o code is written to pump information across a barrier that separates user from program.

## No pumping:

The spreadsheet is shared between underlying program and user. Either can update it. User can modify data (or program) without writing i/o code.

## Dealing with graphics and user interactions in spreadsheet model

Graphical objects have spreadsheet cells attached to them.

When cell's value changes, position of associated object is updated.

- this provides graphical output from computation

When object is moved by user, associated cells are updated.

- this provides graphical input to computation



# Examples

slide controller

modelling automated system

robot control (poster)

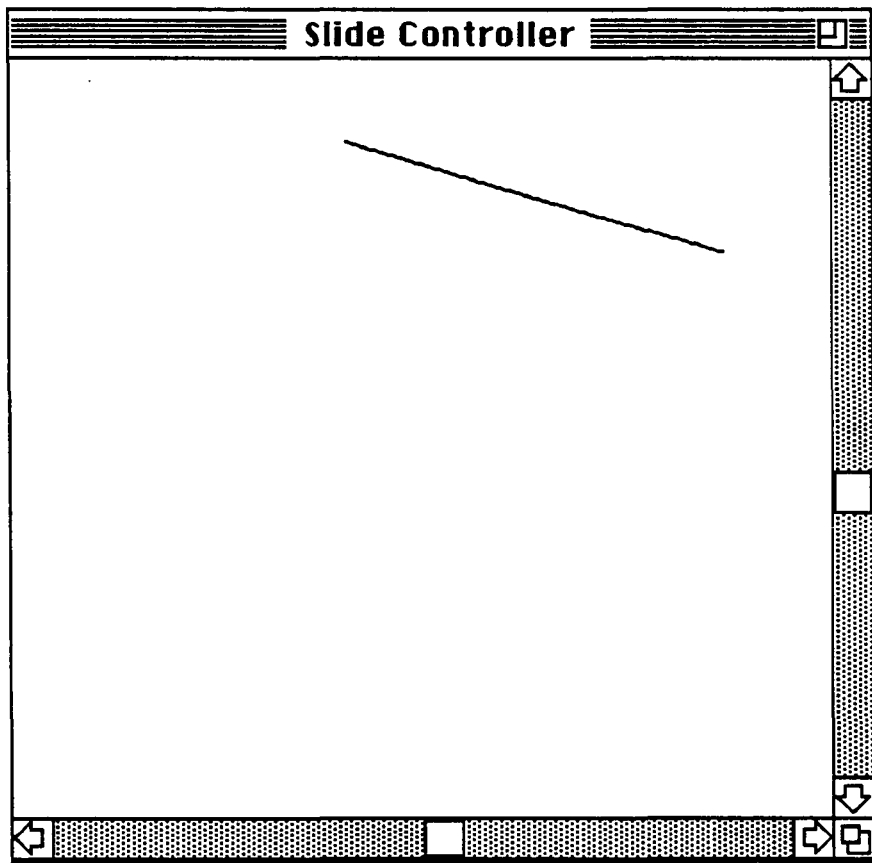

Creating a slide controller

Figure a.

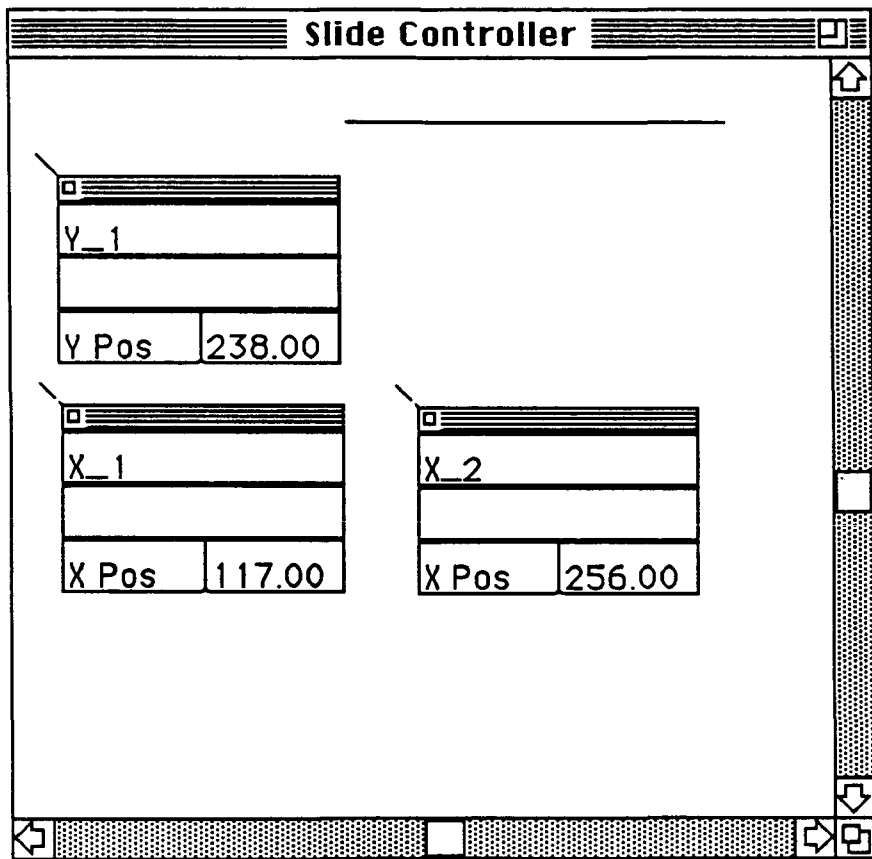

Figure . b.

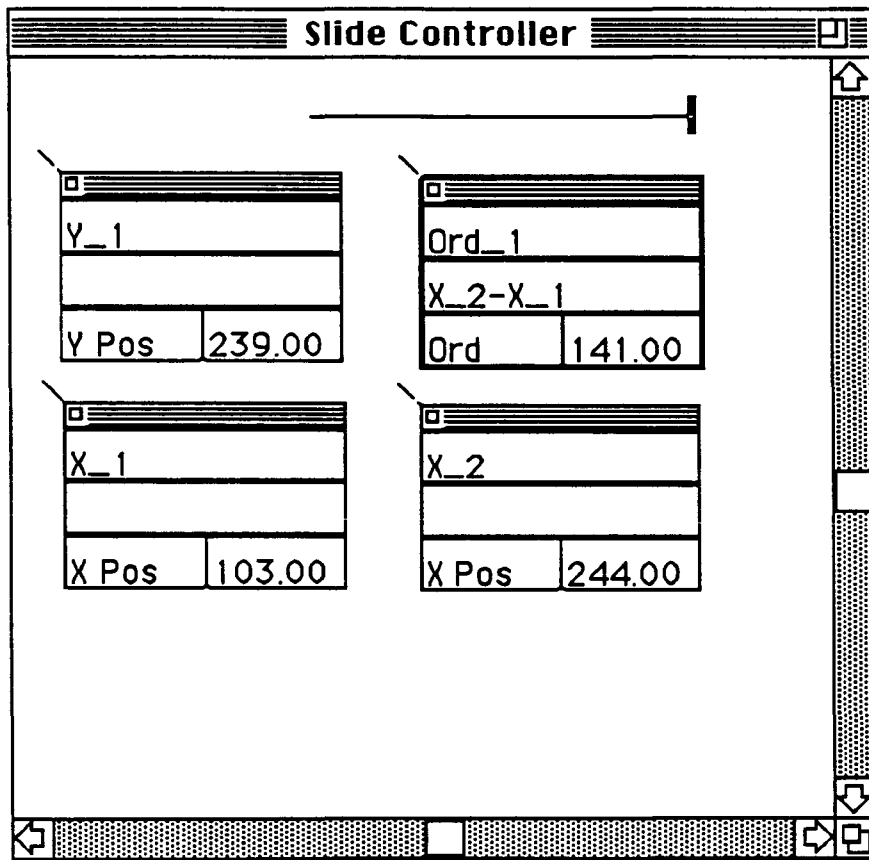

Figure c.

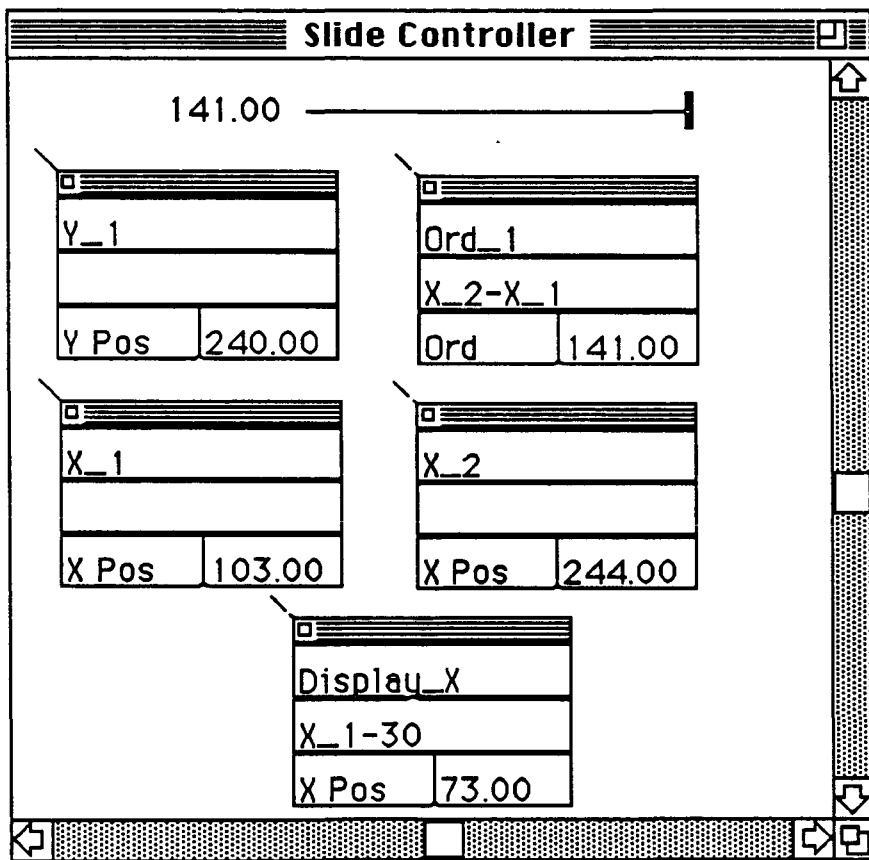
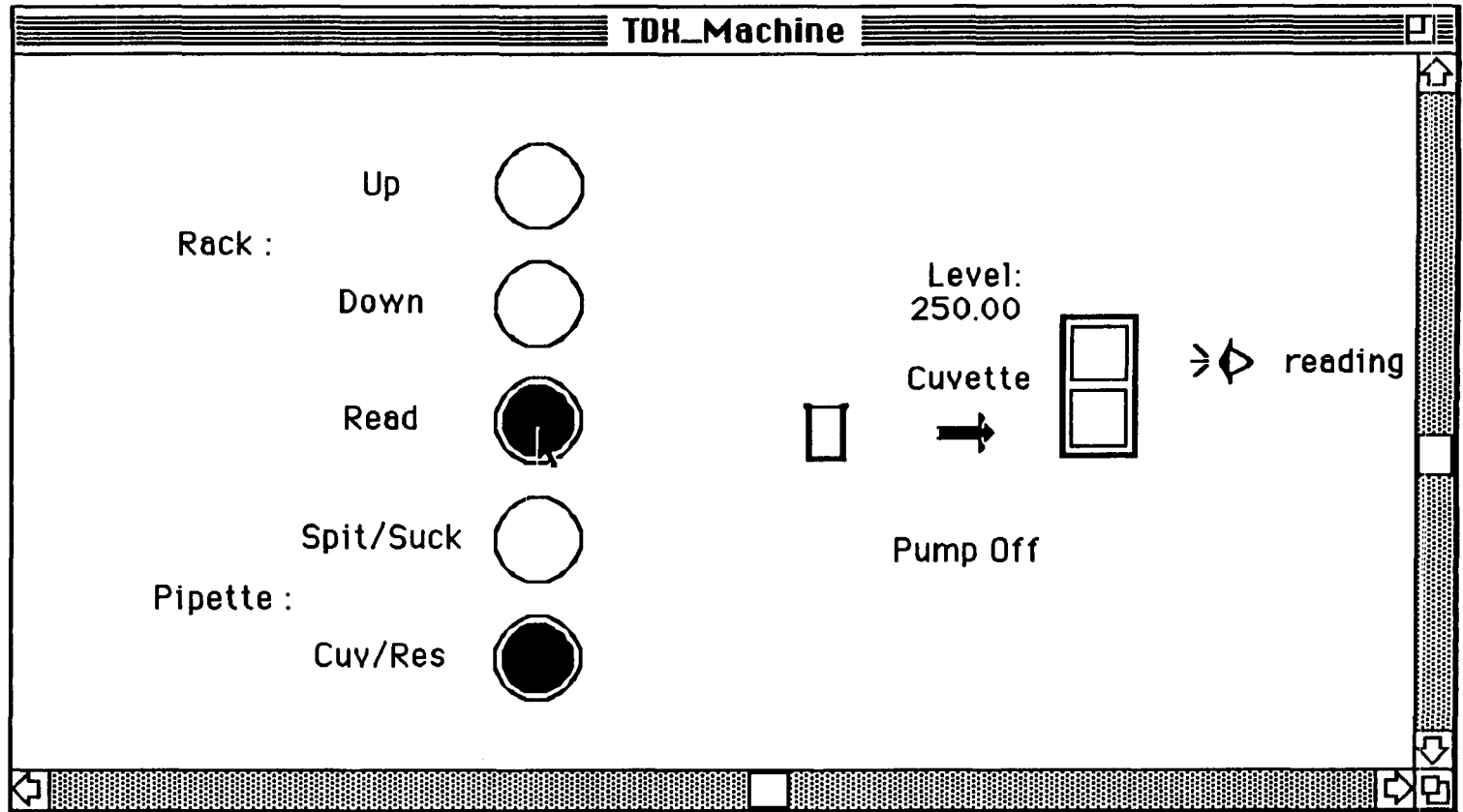

Figure d.



## Comparison with other approaches

We are gambling for greater payoff than mainline efforts like MacApp, X, NeWS, or NeXTStep.

- while these efforts are valuable they still require sophisticated programmers
- they aim to make sophisticated programmers more productive

Hypercard is closer to our approach.

- Hypercard relies on ordinary programming underneath

UNIVERSITY OF COLORADO  
CENTER FOR SPACE CONSTRUCTION

STRUCTURES CLUSTER

*omit*

SPEAKERS

- Subhendu K. Datta (Cluster Leader)
- Robert L. Bratton
- Thomas Kohl
- Charbel Farhat
- Mark J. Balas
- Howard Snyder



**Center for Space Construction**

**Structures Cluster**

**Subhendu K. Datta**

**Department of Mechanical Engineering and CIRES**

**Center for Space Construction**

**University of Colorado, Boulder, CO 80309-0427**

162678  
8/13



# **Center for Space Construction**

## **Structures Cluster**

### **Organization of the Session**

- Overview
- Composite structures: dynamics and space applicability
- Presentations by other structures cluster P.I.'s  
(Charbel Farhat, Mark Balas, Howard Snyder)
- Conclusion

## Center for Space Construction

### Structures Cluster

**Objective:** To develop technology needed for structural evaluation of alternative space construction concepts including:

- Interactive effects on dynamic performance of various environment and self-generated disturbances.
- New materials concepts, failure mechanisms, and non-destructive evaluation/failure detection.
- Develop stable control algorithms and design effective combination of hierarchical and adaptive controls.
- Assess control-structure integrated performance and stability.

**Center for Space Construction**

**Structures Cluster**

**Control/Structures/Materials Research**  
**(bold items are revisions as of August 1989)**

- O Space Structures Design Concepts
- O **Methods for Large-Scale Dynamics and Control Simulations**
- O **Computational/Experimental approach to CSI**
- O **Hierarchical/Adaptive Control**
- O **Structural Composites for Space Applications**
- O **Low-g Fluid/Structure Interaction**

## **Center for Space Construction**

### **Structures Cluster**

#### **Control/Structures/Materials Research**

#### **Faculty**

C. Farhat	(AES)	Parallel processing, coupled field problems, computational methods. (Presidential Young Investigator)
M. Balas	(AES)	Control of flexible structures, mathematical modeling, distributed parameter controls
S. Datta	(ME)	Mechanics of materials, wave propagation, advanced composites, NDE
H. Snyder	(AES)	Cryogenic fluid flow, low-g fluid flow
L. Pinson	(AES)	(Visiting Professor, LaRC) Structural Dynamics of Large Space Systems
W. Rogers	(ME)	Experimental mechanics, mechanics of materials

## Center for Space Construction

### Structures Cluster

#### Accomplishments

- O Discipline Interactions: Computational Methods for High Performance Architectures and Coupled Field Interaction Problems**
  - Development and demonstration of massively parallel general purpose transient finite element explicit code, 560 Mflops (7500 times faster than a SUN workstation with FPA)
  - Development of unconditionally stable second order accurate algorithm for transient solution of thermomechanical problems.
  
- O Composite Structures: Dynamics and Space Applicability**
  - Development of solution techniques and investigation of dispersion and scattering of guided waves in laminated and clad composite plates.
  - Investigation of axially symmetric waves in laminated composite cylinders

# Center for Space Construction

## Structures Cluster

### Accomplishments

#### **O Control of Space Structures**

- Large-scale simulation of actively controlled structures
- Techniques to handle effects of unmodeled dynamics in controller design and close-loop operation
- Decentralized hierarchical control algorithms for partitioned space structures
- Adaptive control of partially assembled space structures
- Control experiments in space structures

#### **O Zero-G Fluid Dynamics**

- Implemented and demonstrated superfluid helium (SFHe) transfer model in Ames shuttle-space station proof-of-principle experiment (600 lbs/hr)
- Analytically and experimentally demonstrated new sloshing mechanism of bubbles in low-g tankage, called cooperative oscillations
- Development and confirmation of theory of use of pressure gauge in low-g

# **Center for Space Construction Structures Cluster**

## **Courses Created by CSC Faculty**

( (S), (M), (D), = senior, master, doctoral level, resp.)

Computational Engineering Software (M)

Variational Methods in Mechanics (M)

Control of Large Aerospace Structures I (M)

Introduction to Finite Element Methods (S)

Adaptive Control of Flexible Structures (D)

Advanced Finite Element Seminar (D)

Control of Large Aerospace Structures II (D)

Special Topics in Vibration Testing and Identification (M)



## **Center for Space Construction**

### **Structures Cluster**

#### **Near-Term Goals (~1 yr.):**

1. Simple demonstration of large angle slewing code as analytical testbed. Examine design reference missions for likely construction process. Initial inputs to Operations Cluster 3/90
2. Develop equations for thermal effects on dynamics and implement in an appropriate software package.
3. Approximate effects of fluids in low-g on dynamic performance and evaluate criticality.
4. Design hierarchical/adaptive control for simple articulated structure and illustrate in analytical testbed.
5. Parametric investigation of dynamics of metal matrix and clad composite tubes and exploration of ultrasonic non-destructive evaluation(NDE) methods.

## **Center for Space Construction**

### **Structures Cluster**

#### **Intermediate Goals ( 2~yrs.):**

6. Investigate controlled deployment varying parameters and assess deployment loads and reliability.  
Initial performance inputs to Systems Cluster 1/91
7. Initiate numerical efficiency improvements in analytical testbed (algorithmic and hardware).
8. Guidelines for criticality of interdisciplinary interactions such as thermal/dynamics and low-g fluid/structural dynamics.
9. Quantify benefits of hierarchical/adaptive control approach over conventional approaches for large angle robotic excursions.
10. Modes of failure for metal matrix and clad composite tubes and possible NDE failure detection approaches.
11. Initiate concept definition studies for lightweight joints for large space trusses with emphasis on advanced materials.

# CENTER FOR SPACE CONSTRUCTION

## STRUCTURES CLUSTER PROGRAM

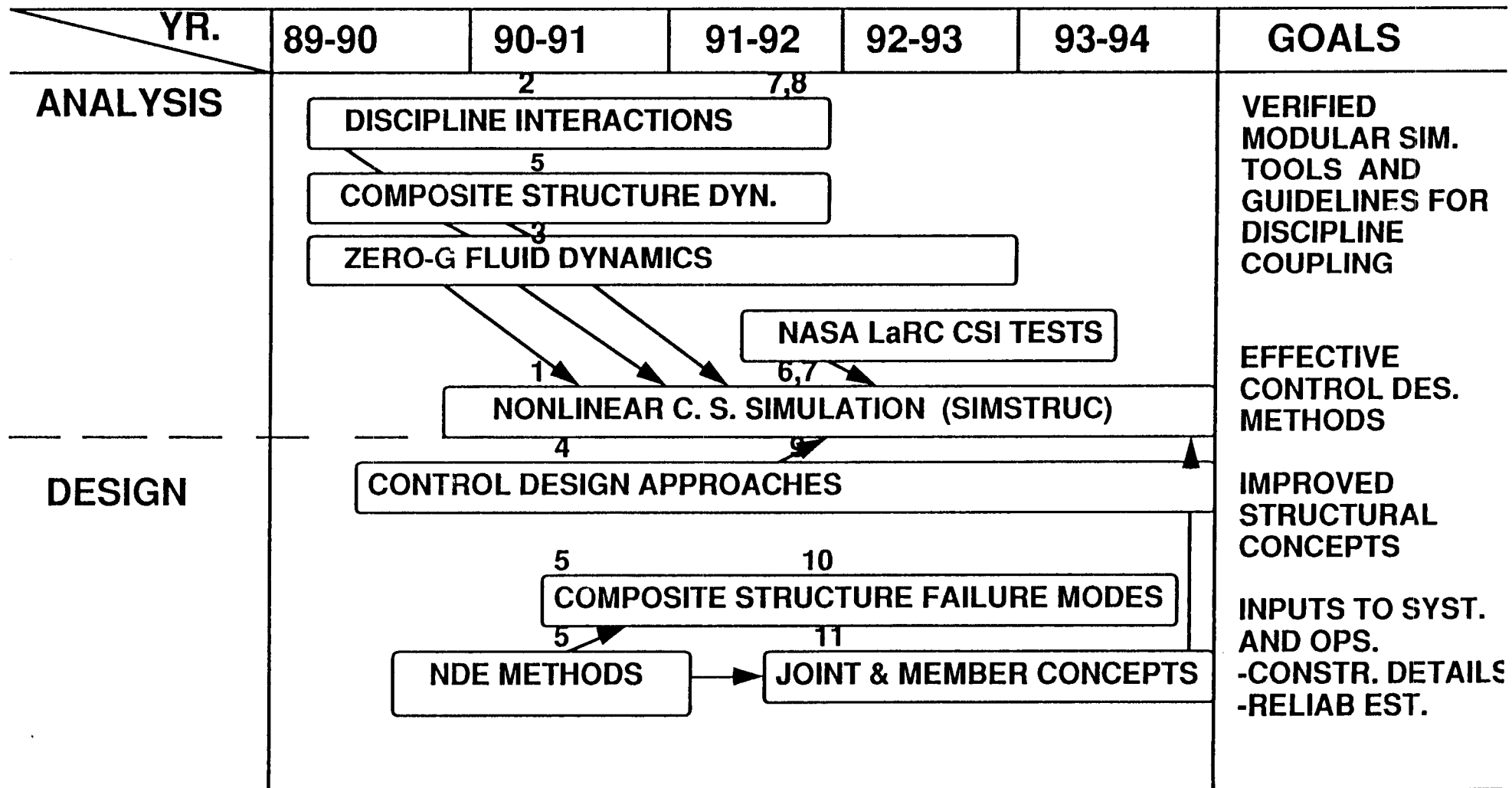

# Center for Space Construction

## Structures Cluster

### CSC-CSI Relationship

#### Portion of CSI activities:

- Investigate experimentally various control approaches using sophisticated computational capabilities on large test structures
- Implement promising control approaches on large test structures using reduced order models and new SCI flight computer to illustrate viability for space use

#### Portion of CSC activities:

- Educate students in control and large angle simulation aspects of space construction
- Understand the controls and stability requirements for structures during the construction process (deployable or erectable structures)
- Provide system-level estimates of the construction process, including deployment times and reliability to the Systems Cluster

#### Propose:

- Send graduate students to LaRC to aid in the experimental implementation, gain access to experimental data, and to learn first hand about CSI implementation
- Install LaRC LATDYN program at CU as an instructional aid and research tool to aid understanding of the construction process

## Center for Space Construction

### Structures Cluster

#### Interactions

**Objective:** To develop technology needed for structural evaluation of alternative space construction concepts including:

- Interactive effects on dynamic performance of various environment and self-generated disturbances.

NASA Space Station, MIT MODE Fluid Flight Experiment, Ball Aerospace Systems

- New materials concepts, failure mechanisms, and non-destructive evaluation/failure detection.

Martin Marietta, NASA: Str. Concepts Br., Mat'ls Div, NDE Lab, LMSC

- Develop stable control algorithms and design effective combination of hierarchical and adaptive controls.

TRW, Martin Marietta, USAF Academy

- Assess control-structure integrated performance and stability.

NASA Space Station, NASA CSI, NASA Pathfinder, TRW, Texas A&M

Center for Space Construction  
Structures Cluster

160079  
11

## COMPOSITE STRUCTURE DYNAMICS AND SPACE APPLICABILITY

*Subhendu K. Datta*  
*Department of Mechanical Engineering*  
*Center for Space Construction*  
*University of Colorado, Boulder, CO 80309*

October 12, 1989

Guided wave modes in cladded or uncladded fiber-reinforced composite plates and tubes have been analyzed using a stiffness method in which the displacement variation through the thickness is approximated by polynomial interpolation functions. This allows for arbitrary number of laminations and fiber orientations different from lamina to lamina. It is shown that dispersive behavior of guided modes depends significantly on the cladding, number of laminae, and interfaces between the adjacent laminae.

A hybrid modeling technique is described in which an inner region containing cracks (or other defects) is discretized by finite elements and the field in the exterior region is represented in terms of modes that are found using the stiffness method described above. It is found that the reflected and transmitted amplitudes of modes vary significantly with the size of a transverse or longitudinal (delamination) crack and frequency.

We have also studied the impact response of a unidirectional fiber-reinforced plate. Received signals at the epicentral and other locations are shown. Strong longitudinal anisotropy of the gr/epoxy plate causes the signal to be considerably different from that in an isotropic plate.

### **Associates**

#### **Supported by CSC:**

- Mr. Robert L. Bratton, Ph.D Student (Expected graduation, December 1989)
- Mr. Thomas Kohl, M.S. Student (Expected graduation, May 1990)
- Mr. Jonathan Fox, Undergraduate Assistant (Expected graduation, December 1989)

#### **Supported by other grants:**

- Dr. P. C. Xu, Research Associate and Lecturer
- Mr. Mounir Bouden, Ph.D. Student (Expected graduation, December 1989)
- Mr. T. H. Ju, Ph.D. Student

# **Center for Space Construction**

## **Structures Cluster**

### **Composite Structures: Dynamics and Space Applicability**

- Guided waves in laminated plates
- Guided waves in a cladded tube
- Interface/interphase effects
- Impact response
- Ultrasonic Scattering
- Conclusion

# Wave Dispersion in Unidirectional and Cross-ply Laminates

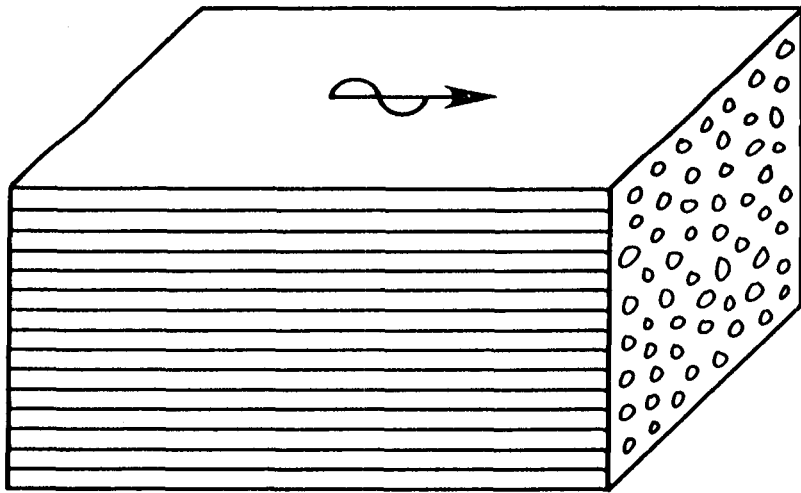

Unidirectional

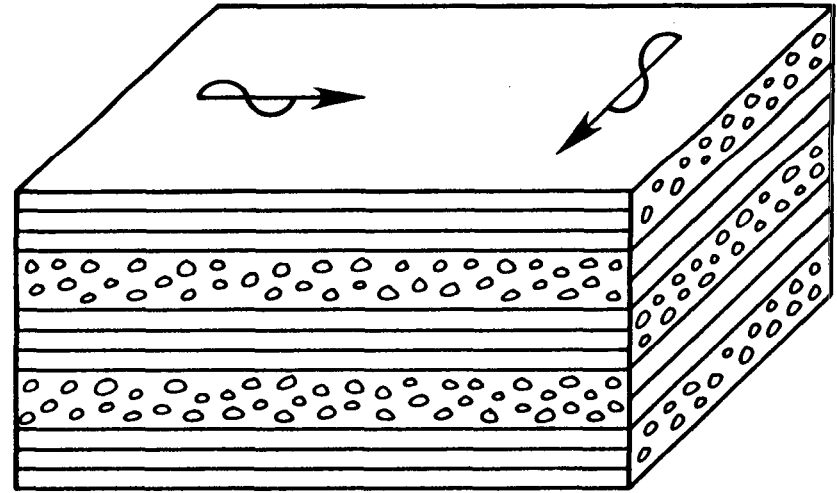

Cross-ply



# With No Interface

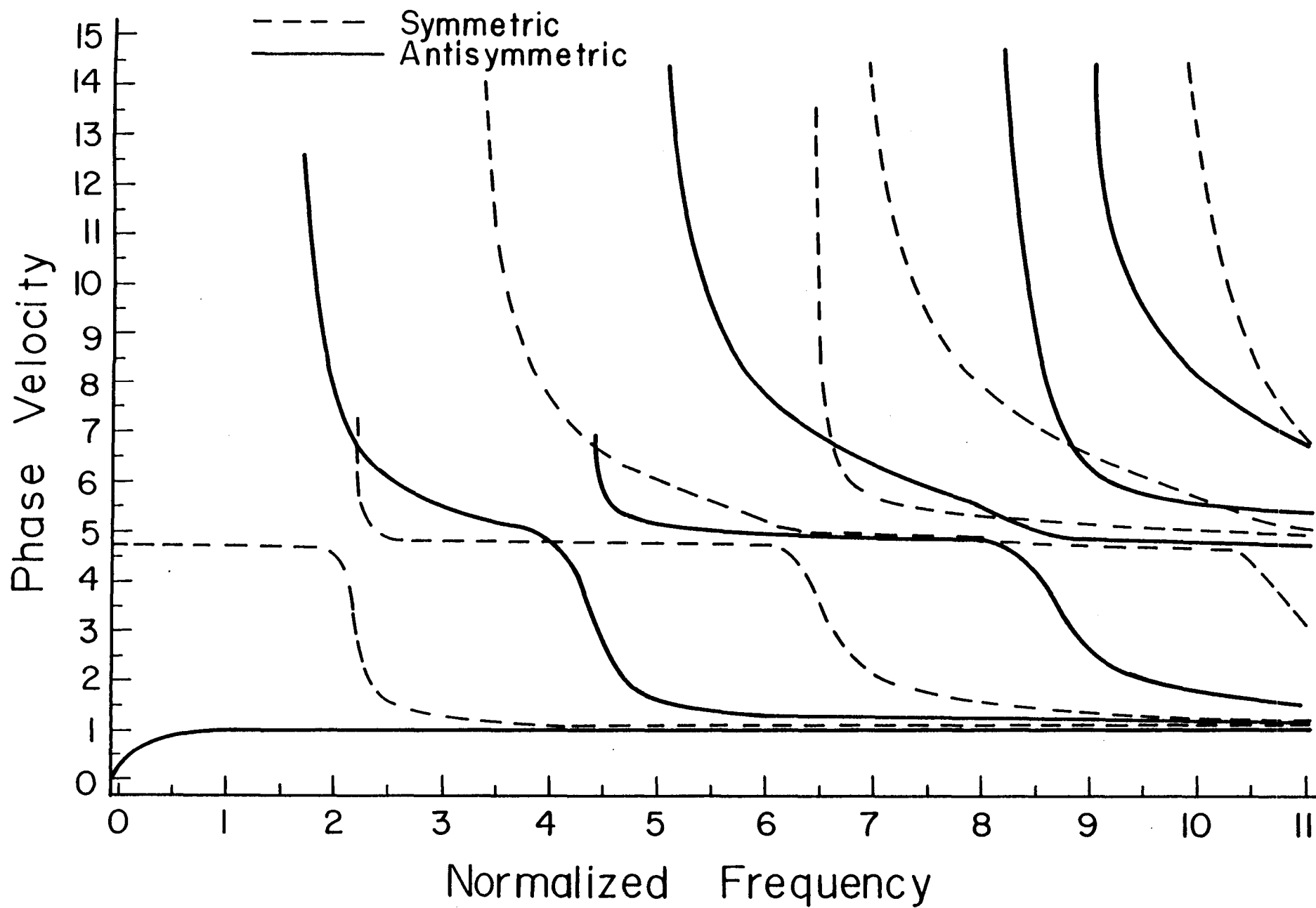

# With No Interface

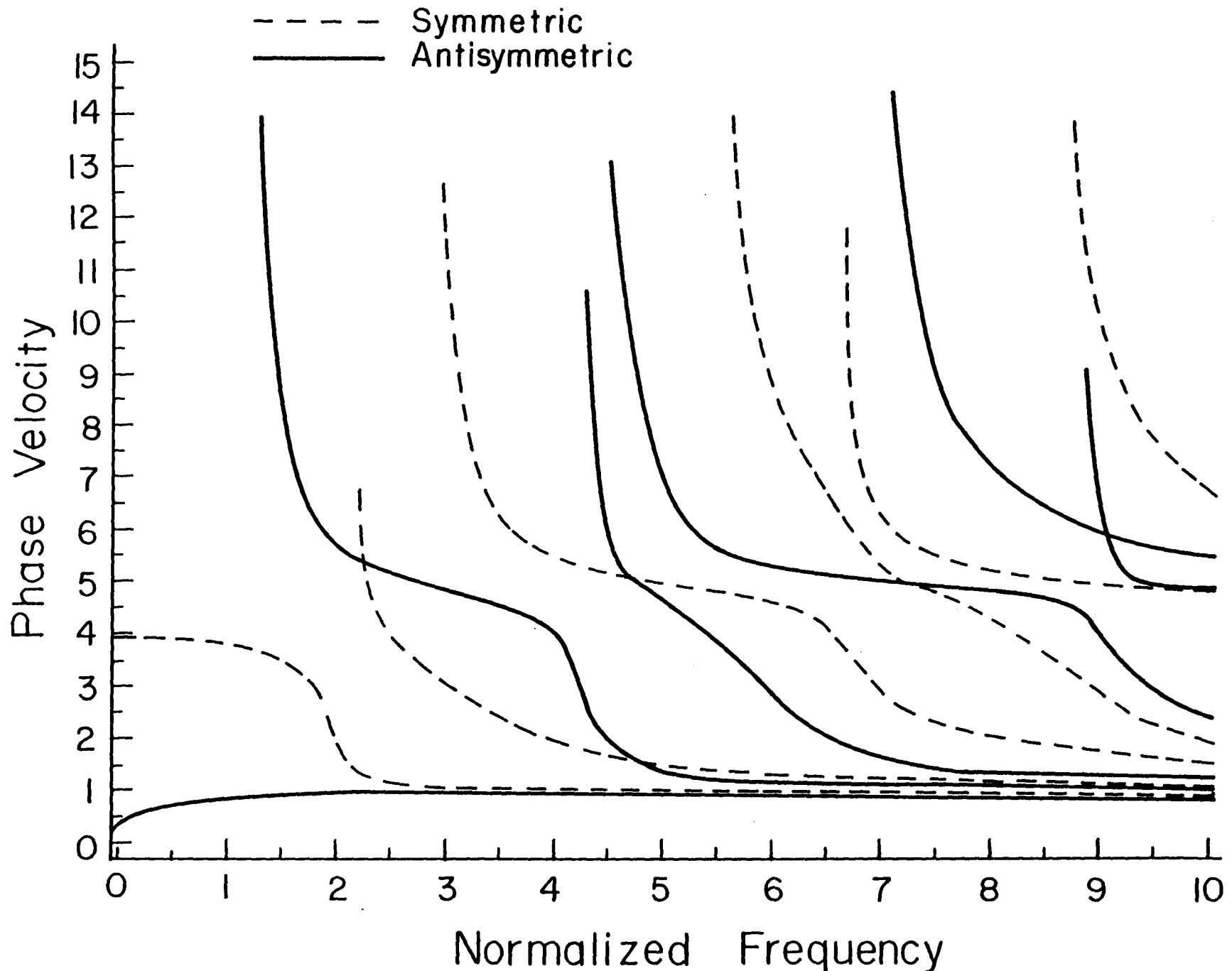

# Laminated Plate With Interlaminar Bond Layers

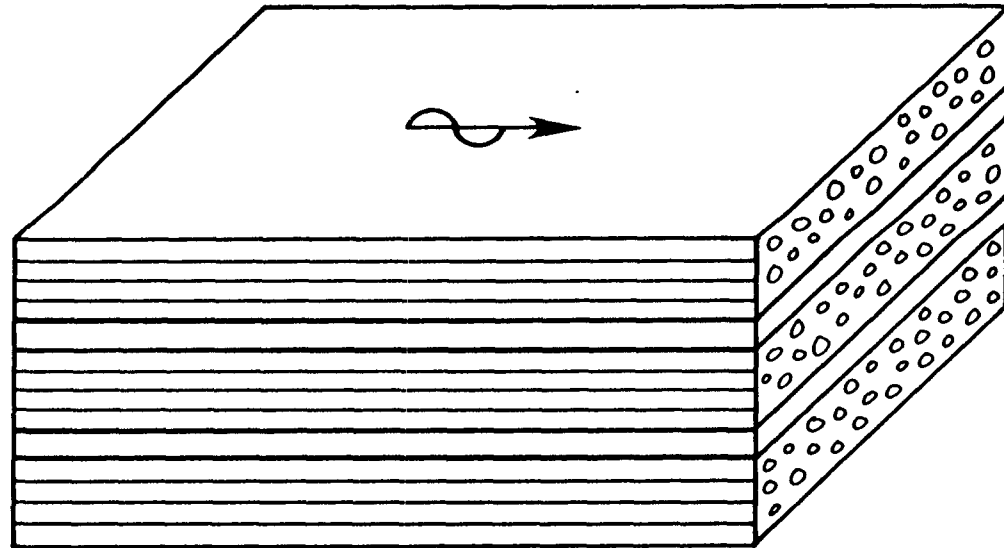

Interface Thickness = 0.1

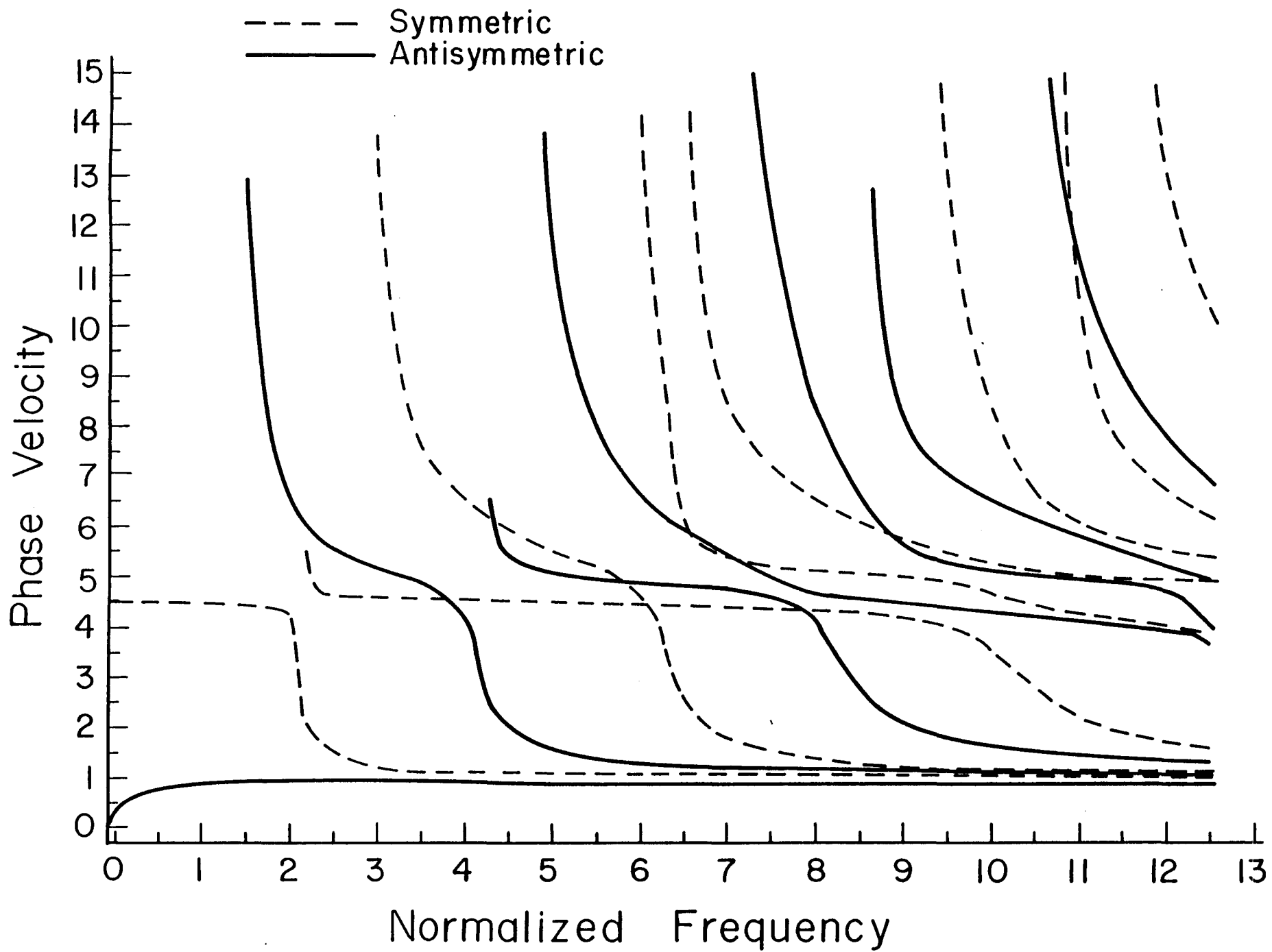

Interface Thickness = 0.2

--- Symmetric  
— Antisymmetric

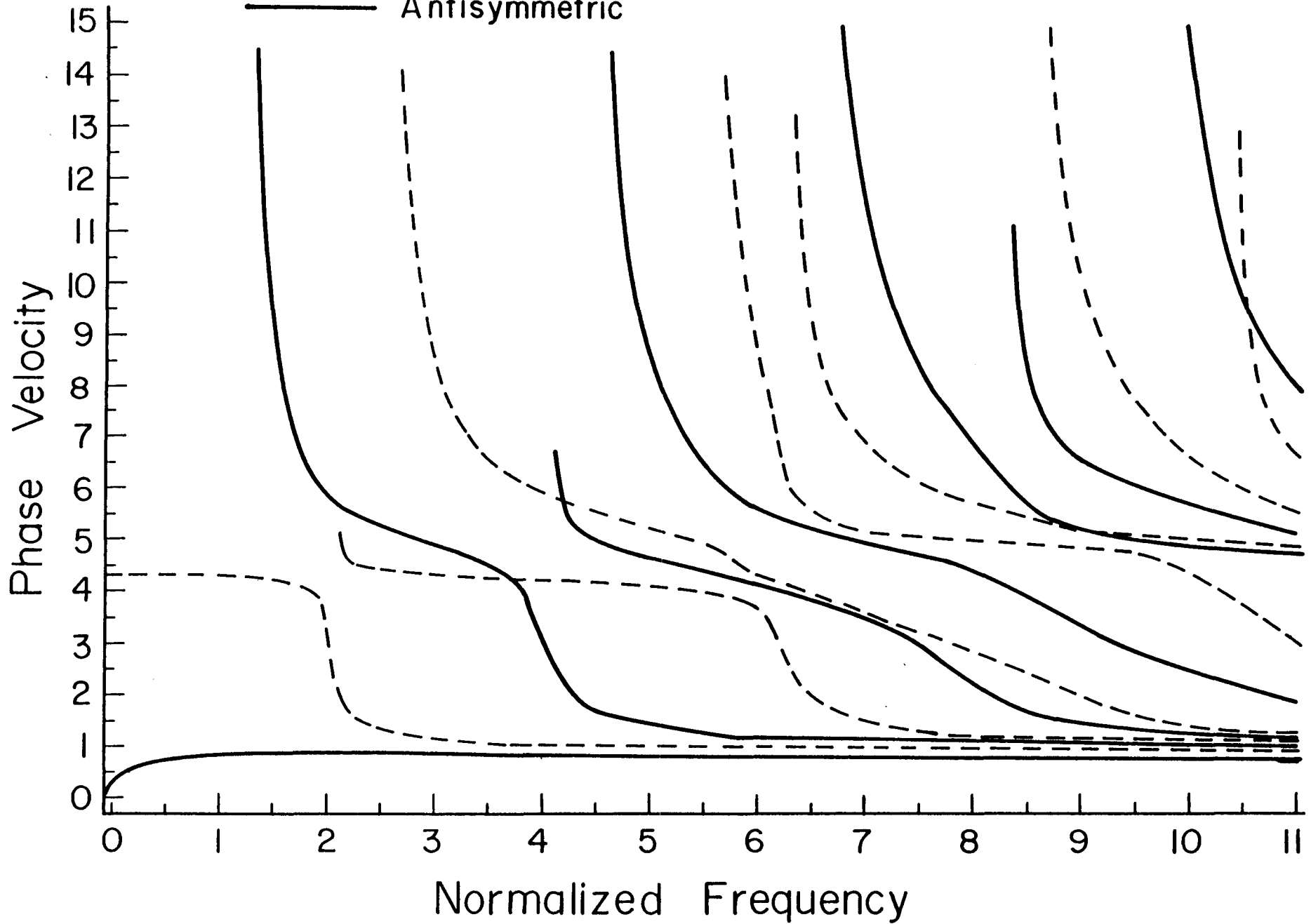

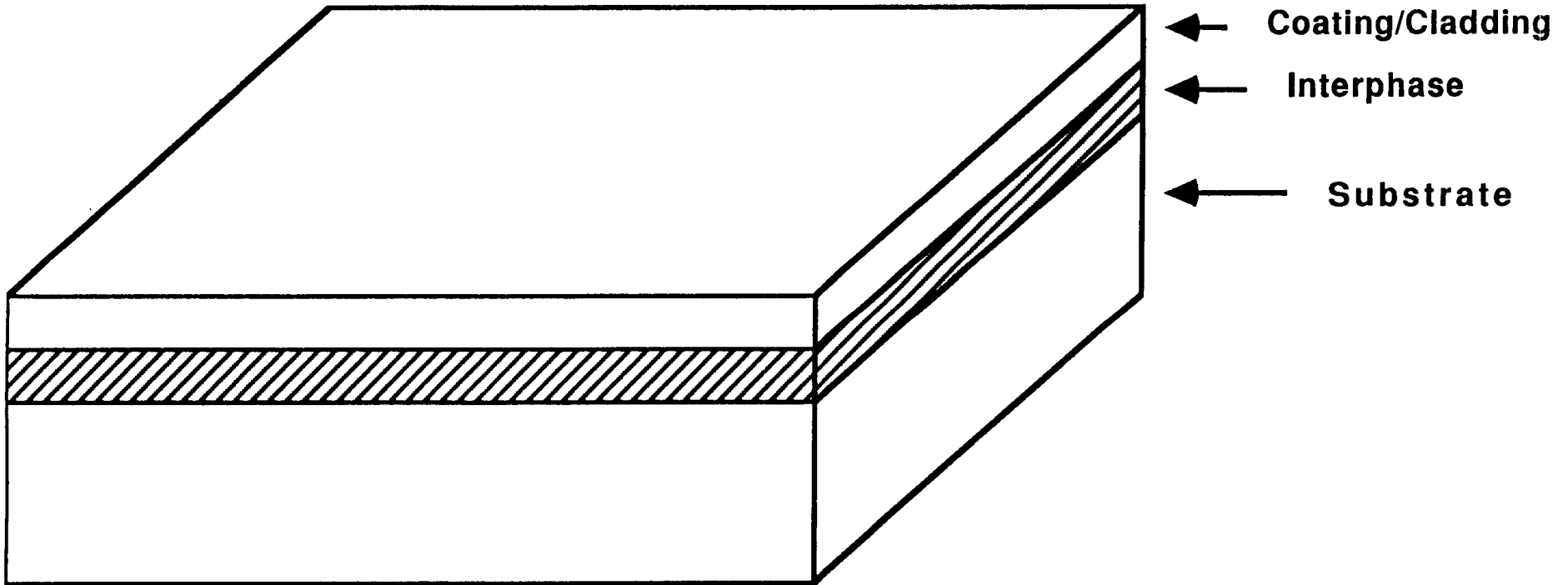

DISPERSION: Au/Bond/Fe-42%Ni (0.45mm / .05mm, M=10, D=10 / 10.mm)

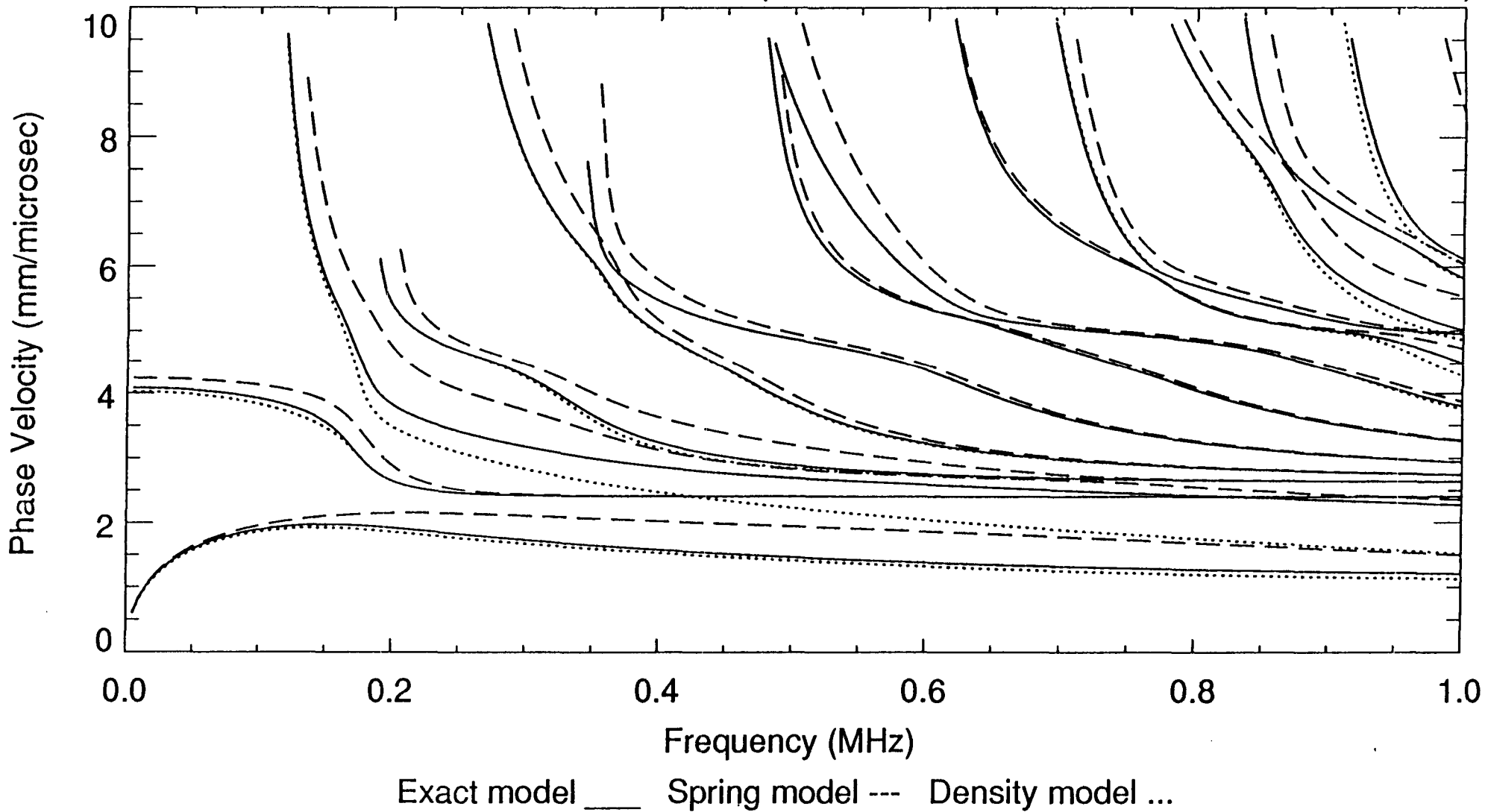

DISPERSION: Au/Bond/Fe-42%Ni (0.45mm / .05mm, M=.1, D=.1 / 10.mm)

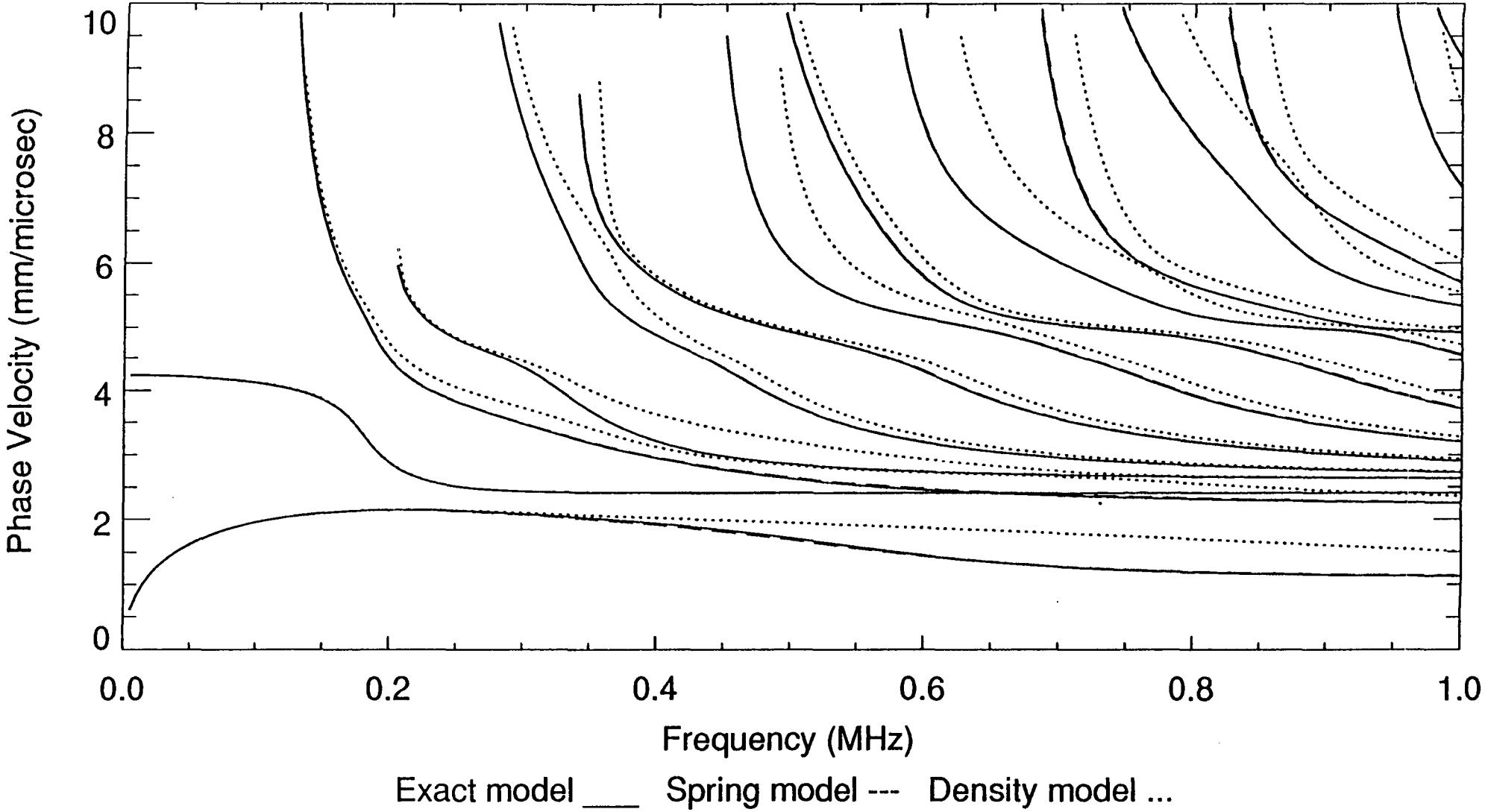



# PROPAGATION AND SCATTERING OF ELASTIC WAVES IN FIBER-REINFORCED PLATES

ROBERT L. BRATTON  
Department of Mechanical Engineering  
Center for Space Construction  
University of Colorado, Boulder, CO 80309-0427

## OBJECTIVES

- Modelling of guided waves in fiber-reinforced plates in terms of different modes
- Analysis of scattering by transverse cracks using modal representation

## NUMERICAL METHODS

- A hybrid method combining finite element representation of a region around the crack with the modal representation in the exterior region
- Modes are obtained using through - the - thickness discretization of the displacement field

160630  
P 15



## **RESULTS AND DISCUSSION**

- Reflected and transmitted amplitudes of modes vary significantly with crack length and frequency
- Advantages of the method are: arbitrary crack orientations, large number of laminates, unidirectional and angle-ply laminates, and delamination defects.

## **FUTURE RESEARCH**

- Representation of transmitted field from transducers in terms of modes
- Modal representation of acoustic emission signals
- Impact response
- Scattering by three dimensional planar defects
- Effect of material degradation on guided waves
- End effect

## **ACKNOWLEDGMENT**

The work was performed under the auspices of the Center for Space Construction and was supported by a NASA grant (# NAGW-1388).

# Scattering Zone (Finite Element Mesh)

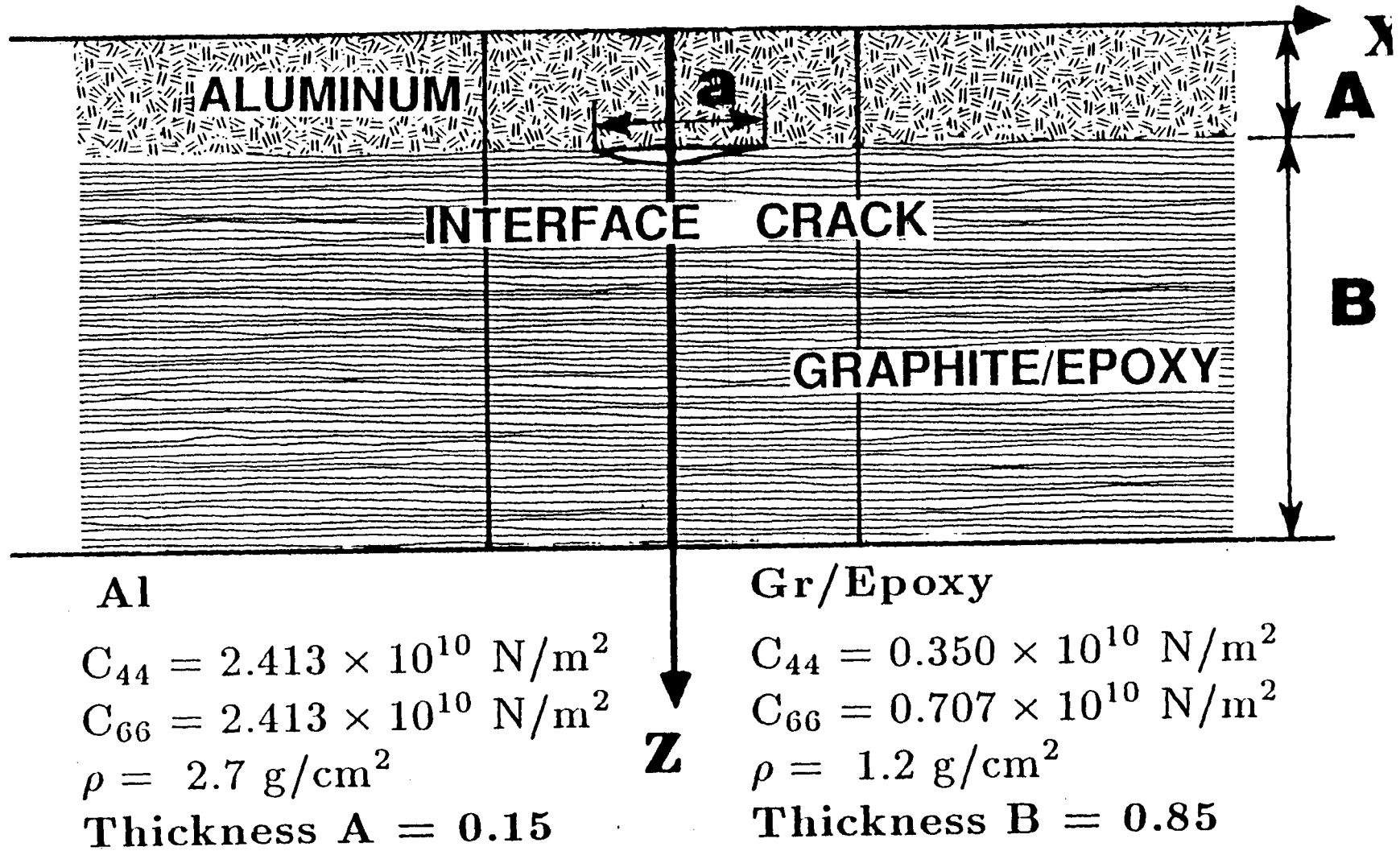

**Crack Length a = 0.2**

Figure 7 Geometry of Plate and Scatters

# REFLECTION COEFFICIENT VS FREQUENCY

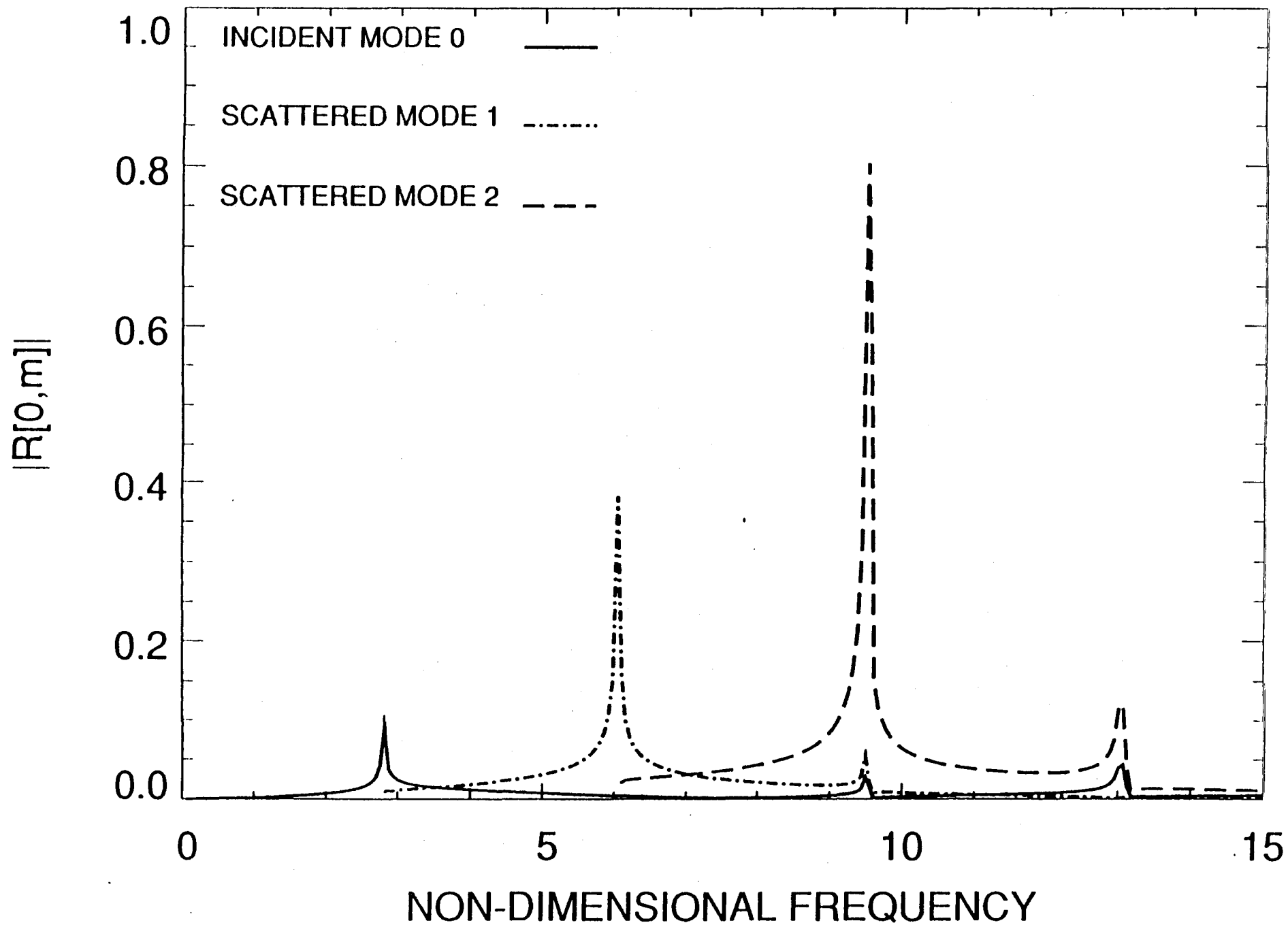

Figure 10 Reflection Coefficients vs Frequency for the zeroth incident

# REFLECTION COEFFICIENT VS FREQUENCY

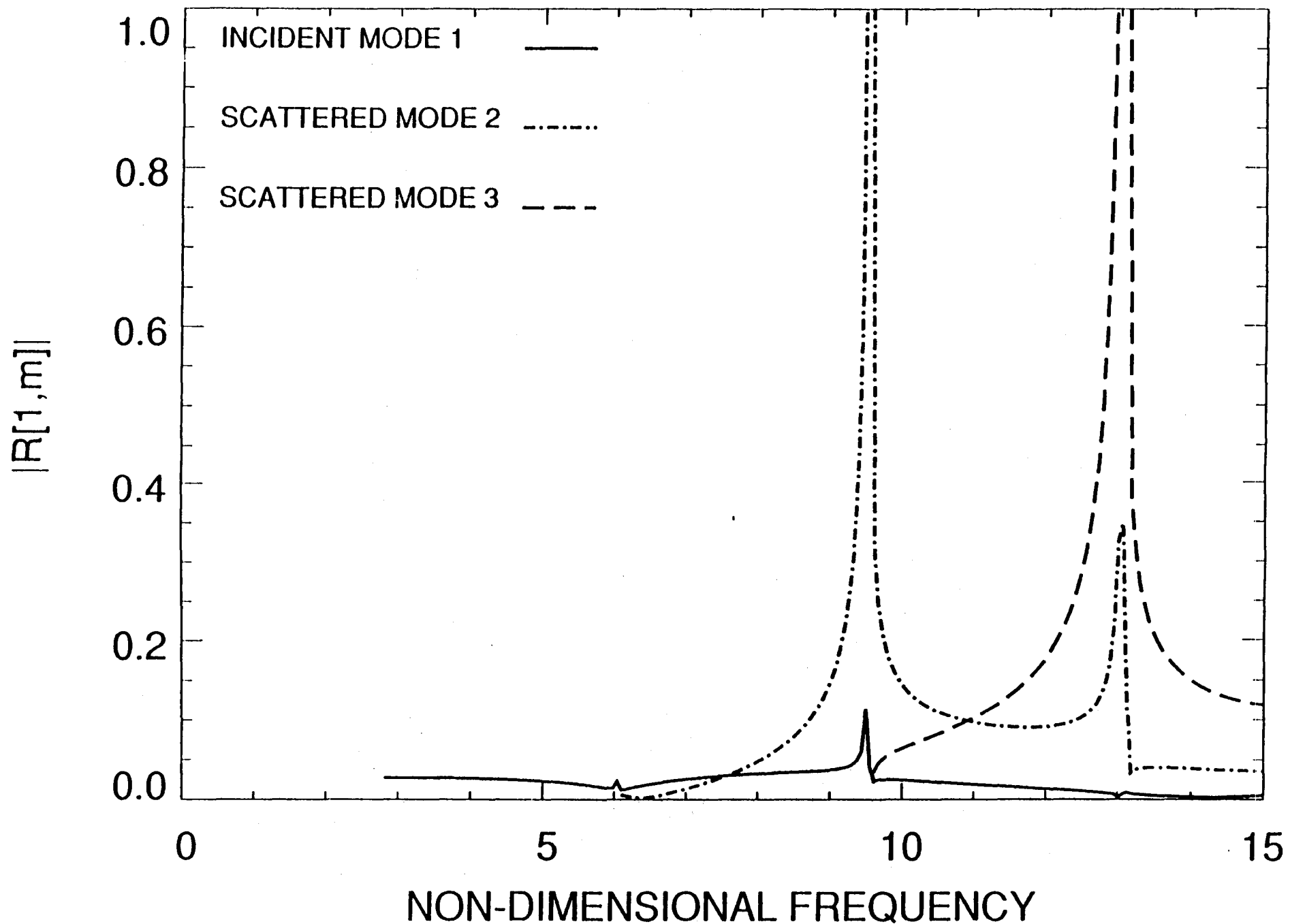

Figure // Reflection Coefficients vs Frequency for the first incident

# REFLECTION COEFFICIENT VS FREQUENCY

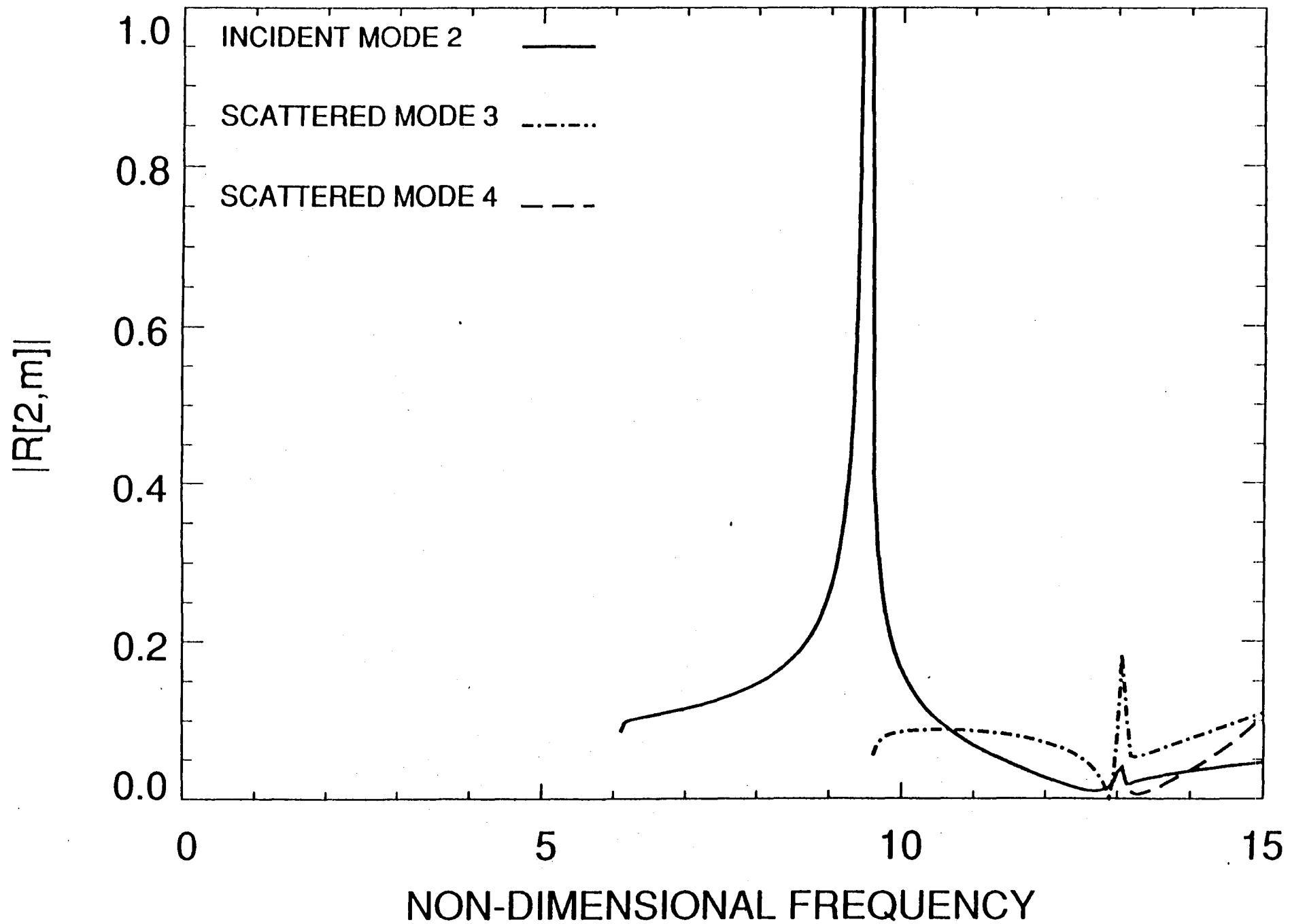
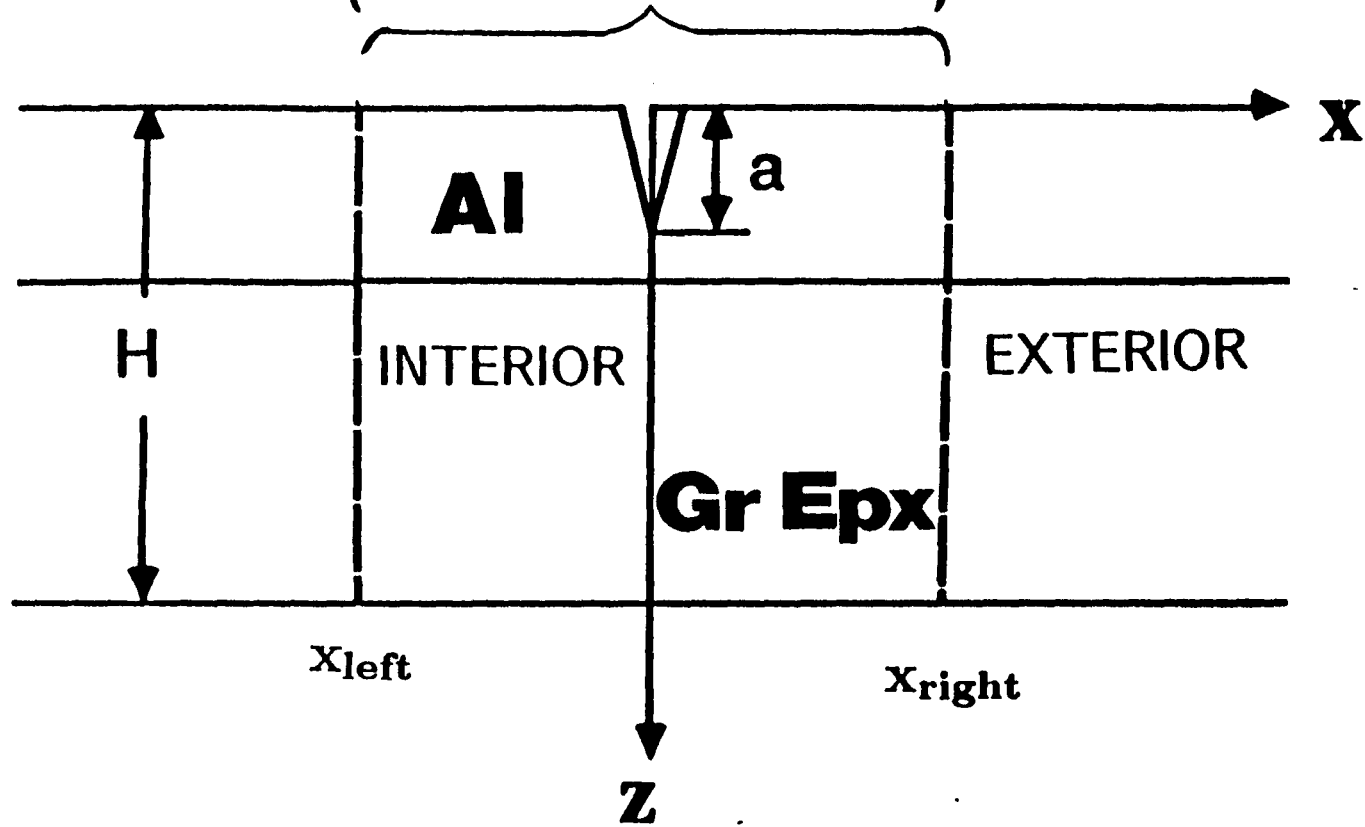
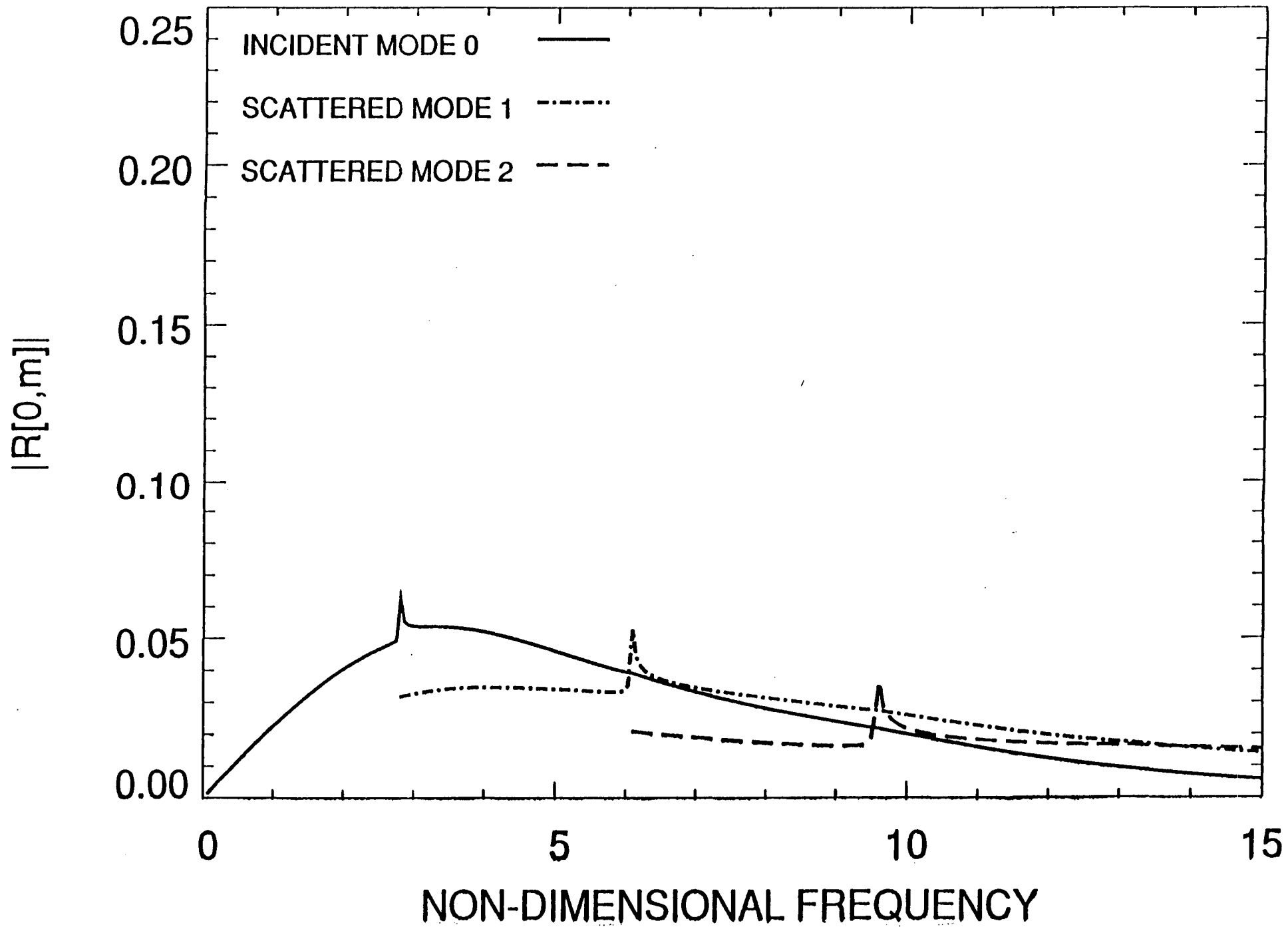

Figure #2 Reflection Coefficients vs Frequency for the second incident

Scattering Zone  
(Finite Element Mesh)







REFLECTION COEFFICIENT VS FREQUENCY

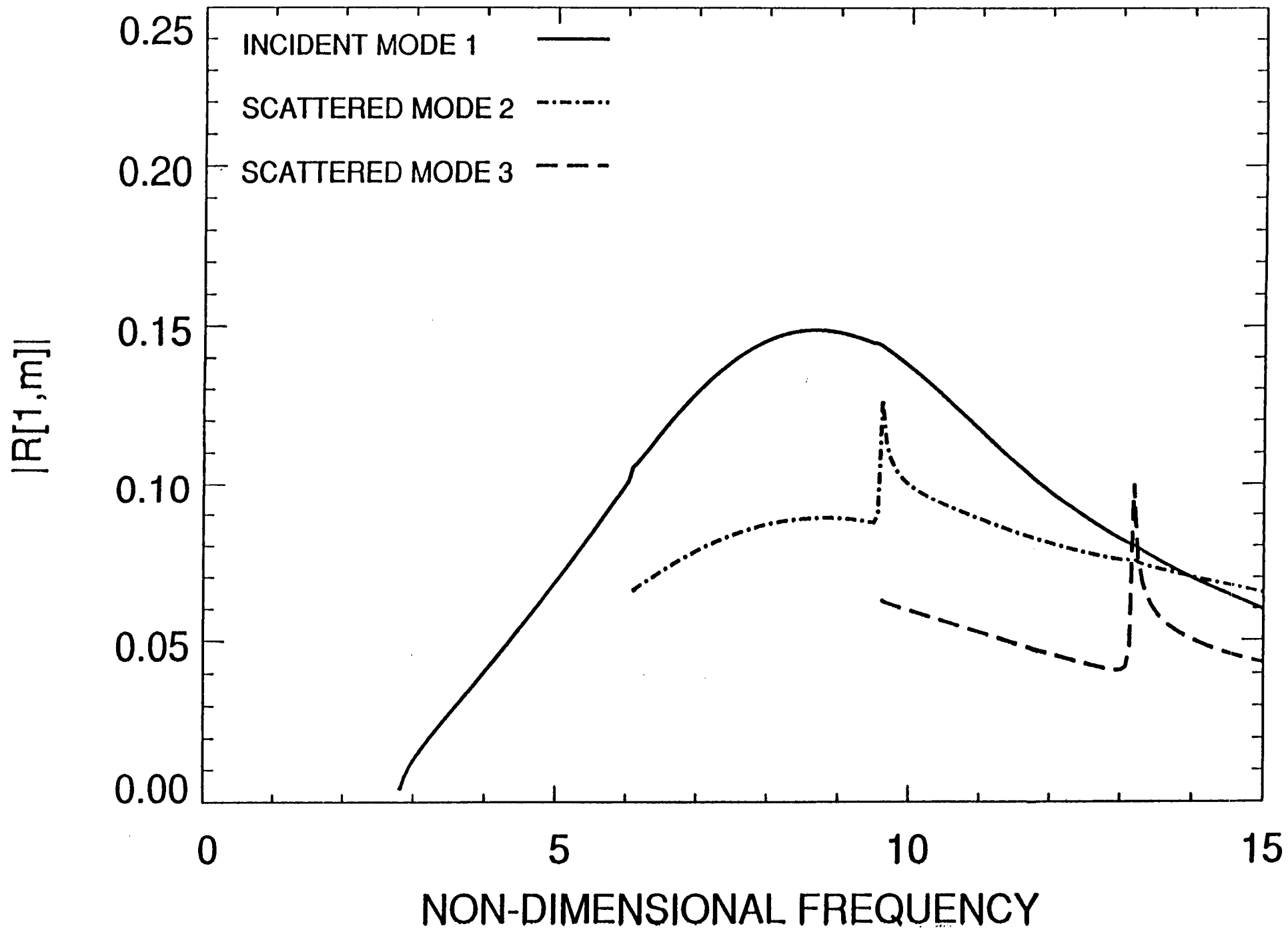

REFLECTION COEFFICIENT VS FREQUENCY

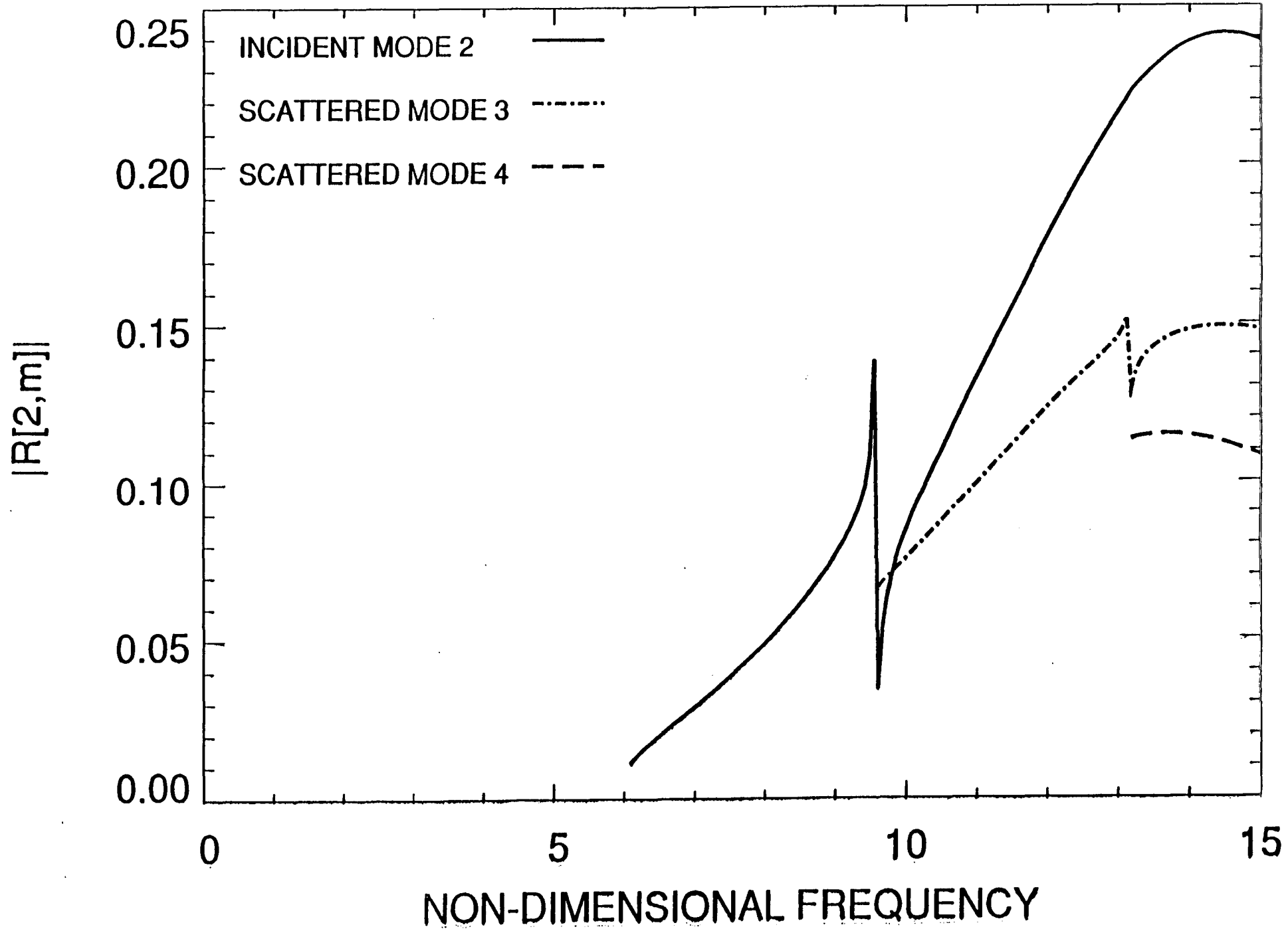

# Ultrasonic Scattering by a Crack in a Unidirectional Composite Plate

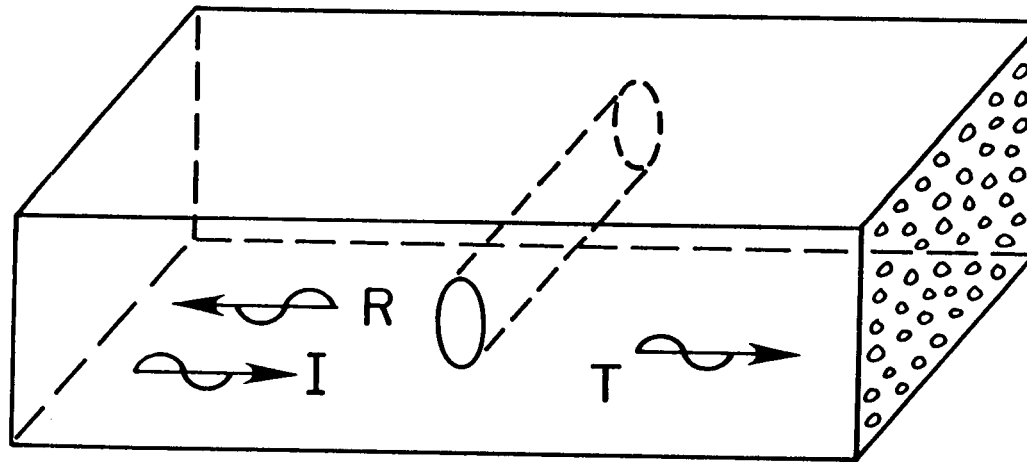

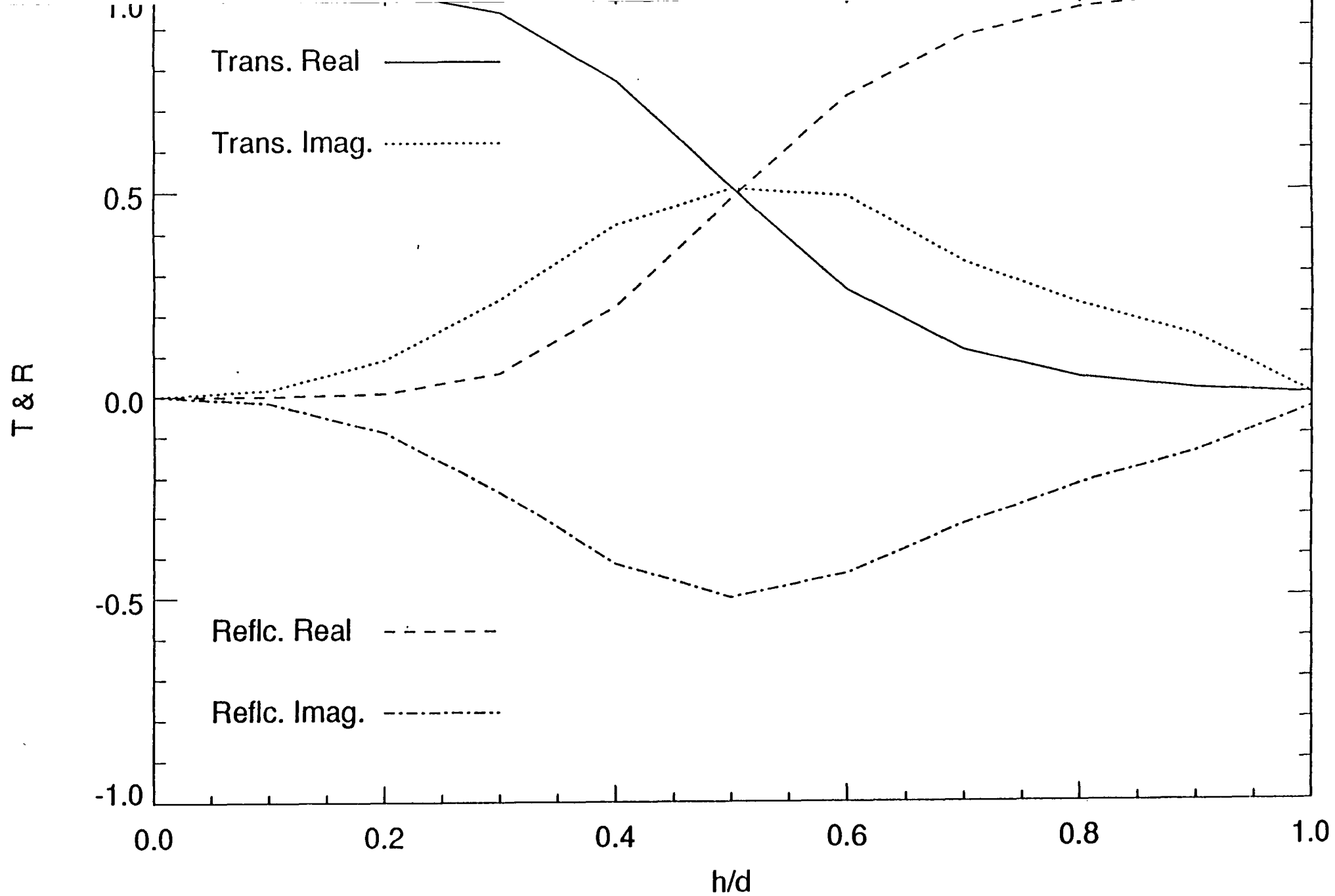

Dimensionless Frequency of .600000

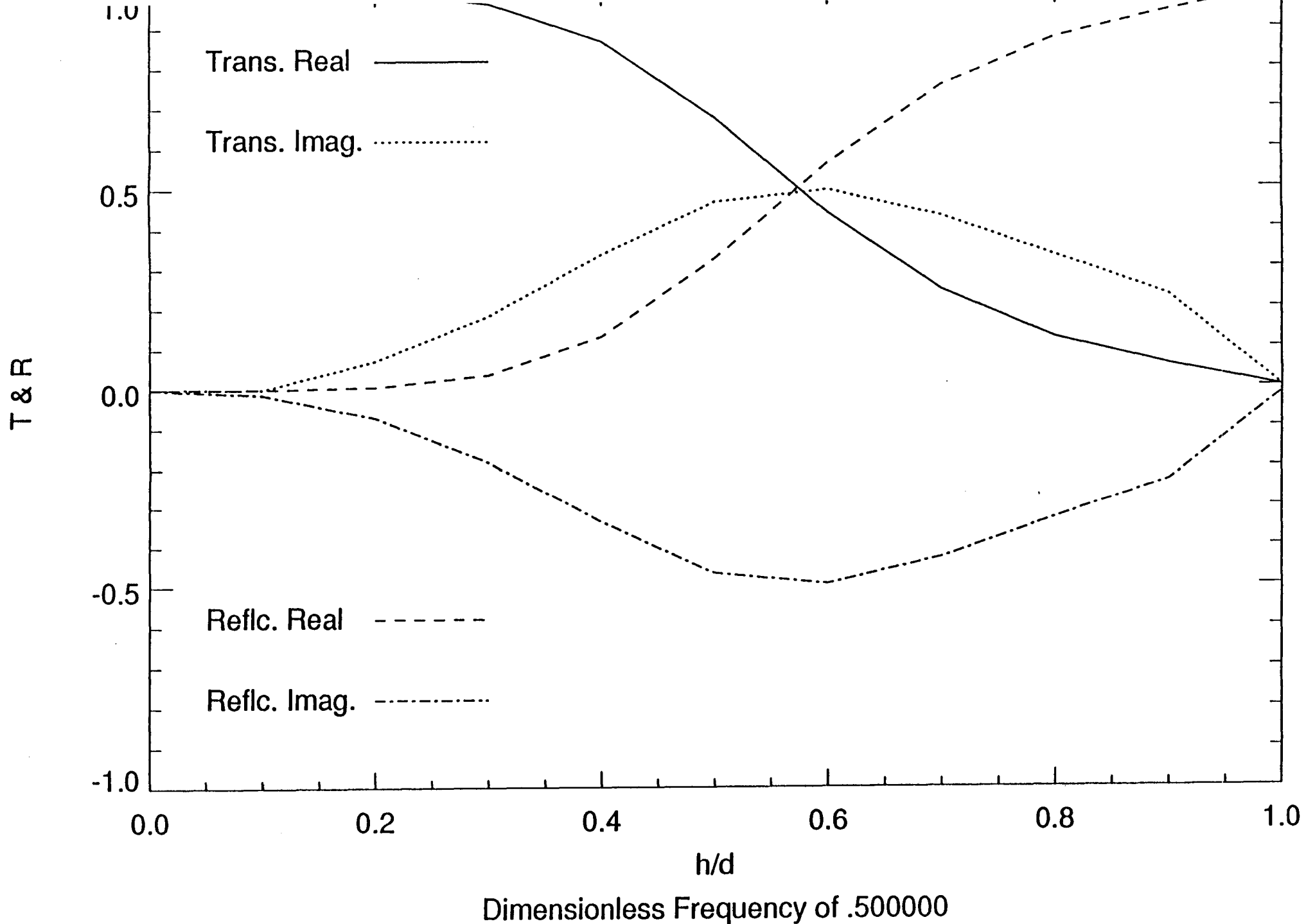

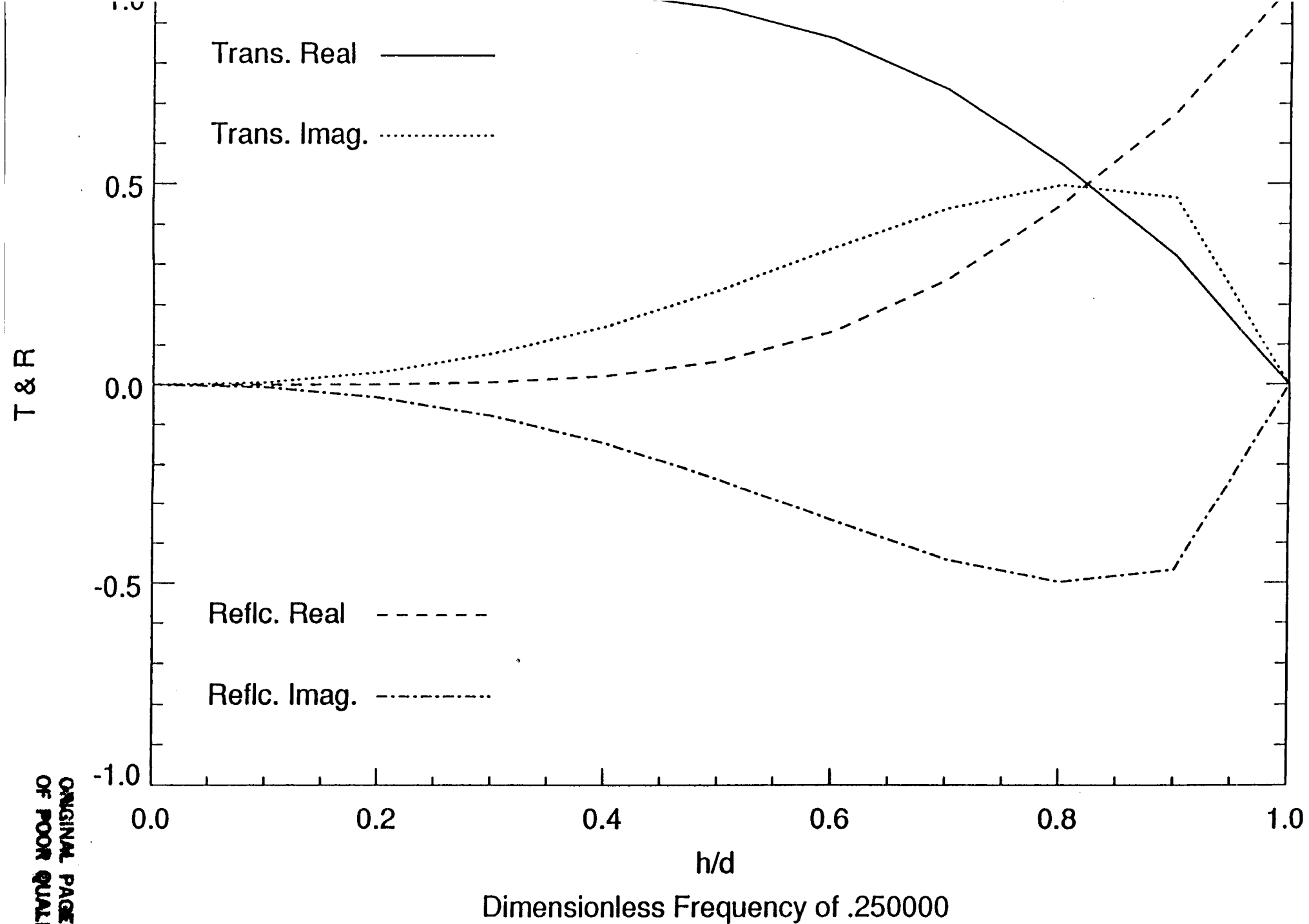

ORIGINAL PAGE IS  
OF POOR QUALITY

# GUIDED WAVES IN CLADDED COMPOSITE TUBES

Thomas Kohl  
Department of Mechanical Engineering  
Center for Space Construction  
University of Colorado, Boulder, CO 80309-0427

## OBJECTIVES

- Modelling of dynamics of composite tubular space structure truss members
- Ultrasonic waves as probes for material and defect characterization

160681  
11 19





## NUMERICAL METHODS

○ Assumed displacement field:

○ Tube is discretized into concentric cylindrical shells

○  $U(r)$  is approximated by quadratic interpolation polynomials within each shell region

○ Equations of motion involving nodal generalized coordinates are obtained using a variational principle

○ Resulting eigenvalue problem is solved to obtain the dispersion characteristics:

## **RESULTS AND DISCUSSION**

- Dispersion behavior shows significant dependence on cladding and fiber orientation
- Guided wave modes show complicated coupling due to off-axis fiber orientation

## **FUTURE RESEARCH**

- Effect of material degradation and interfaces on dispersion
- Use of first few modes to model dynamics of finite tubes
- Impact Response
- Analysis of scattering by longitudinal and transverse cracks using modal representation
- Modelling of joints

## **ACKNOWLEDGMENT**

The work was performed under the auspices of the Center for Space Construction and was supported by a NASA grant (# NAGW-1388).

CSC SPACE STRUCTURAL MATERIALS PROGRAM  
UNIVERSITY OF COLORADO

- INTER-DISCIPLINARY AND FUNDAMENTAL RESEARCH AND EDUCATION IN MATERIALS AND MECHANICS
- OPTIMAL DESIGN FOR STABILITY, SERVICEABILITY, AND REMOTE INSPECTABILITY

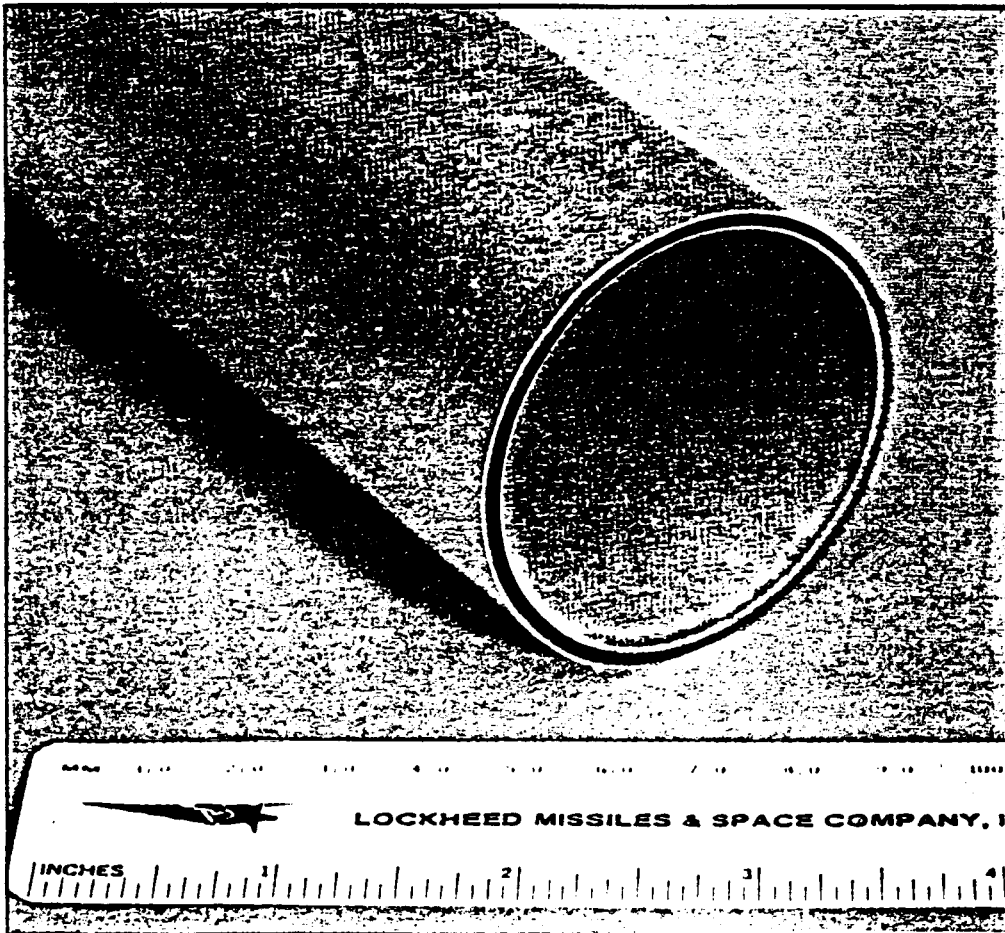

# Guided Waves in a Cladded Composite Tube

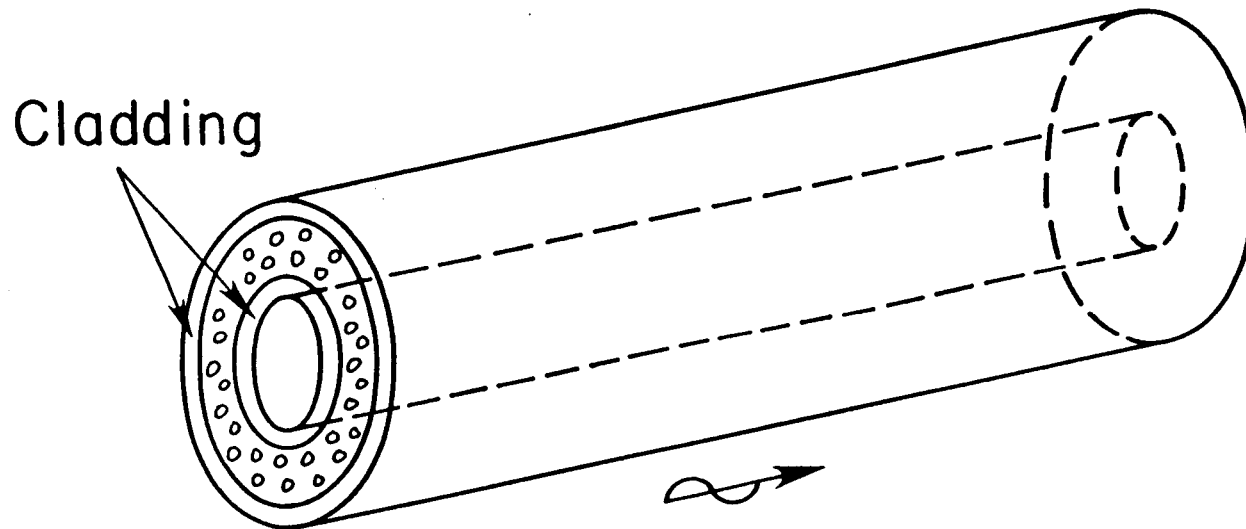

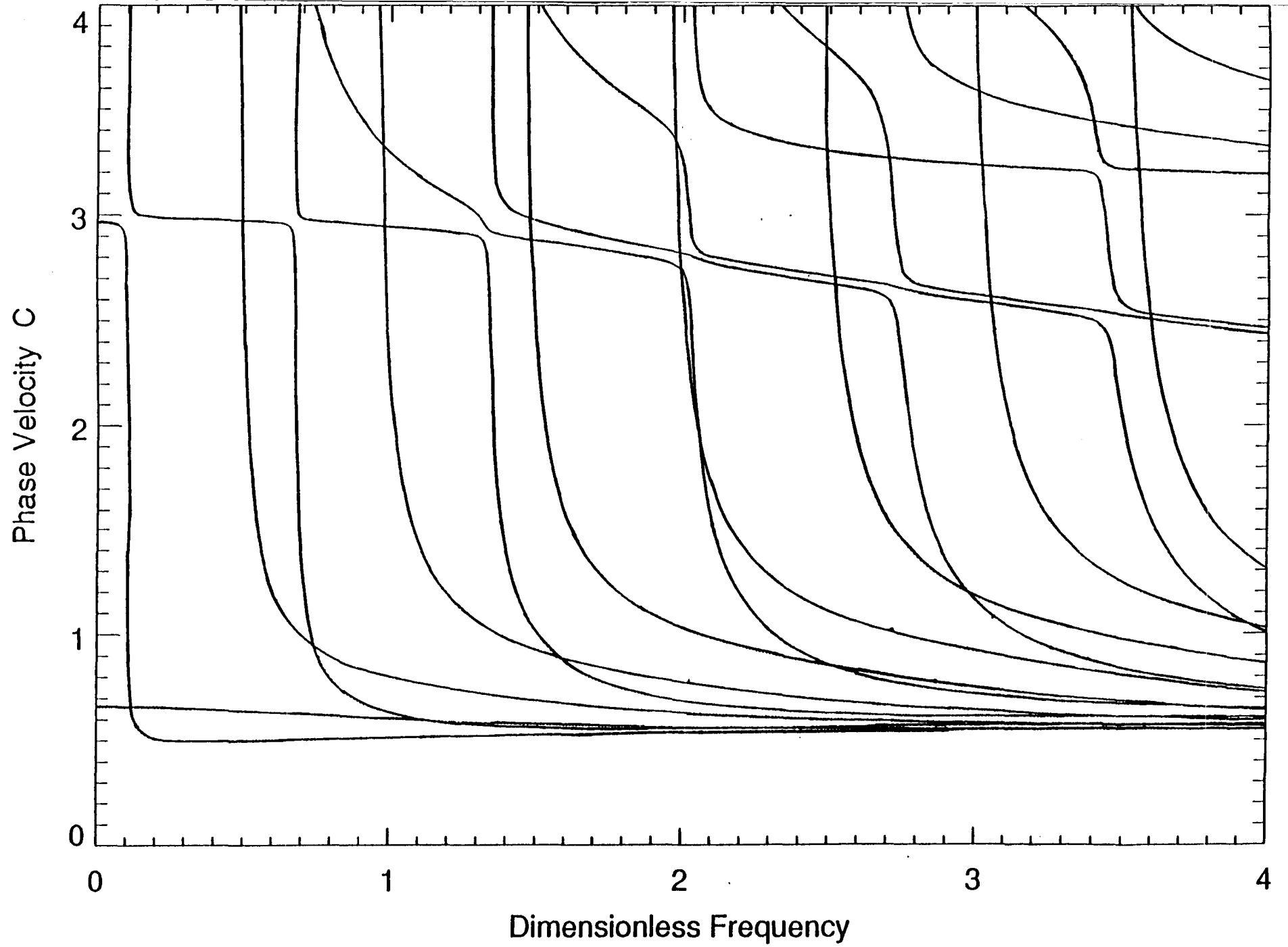

Aluminum Cladded Graphite/Epoxy 0 Deg. Fiber Angle

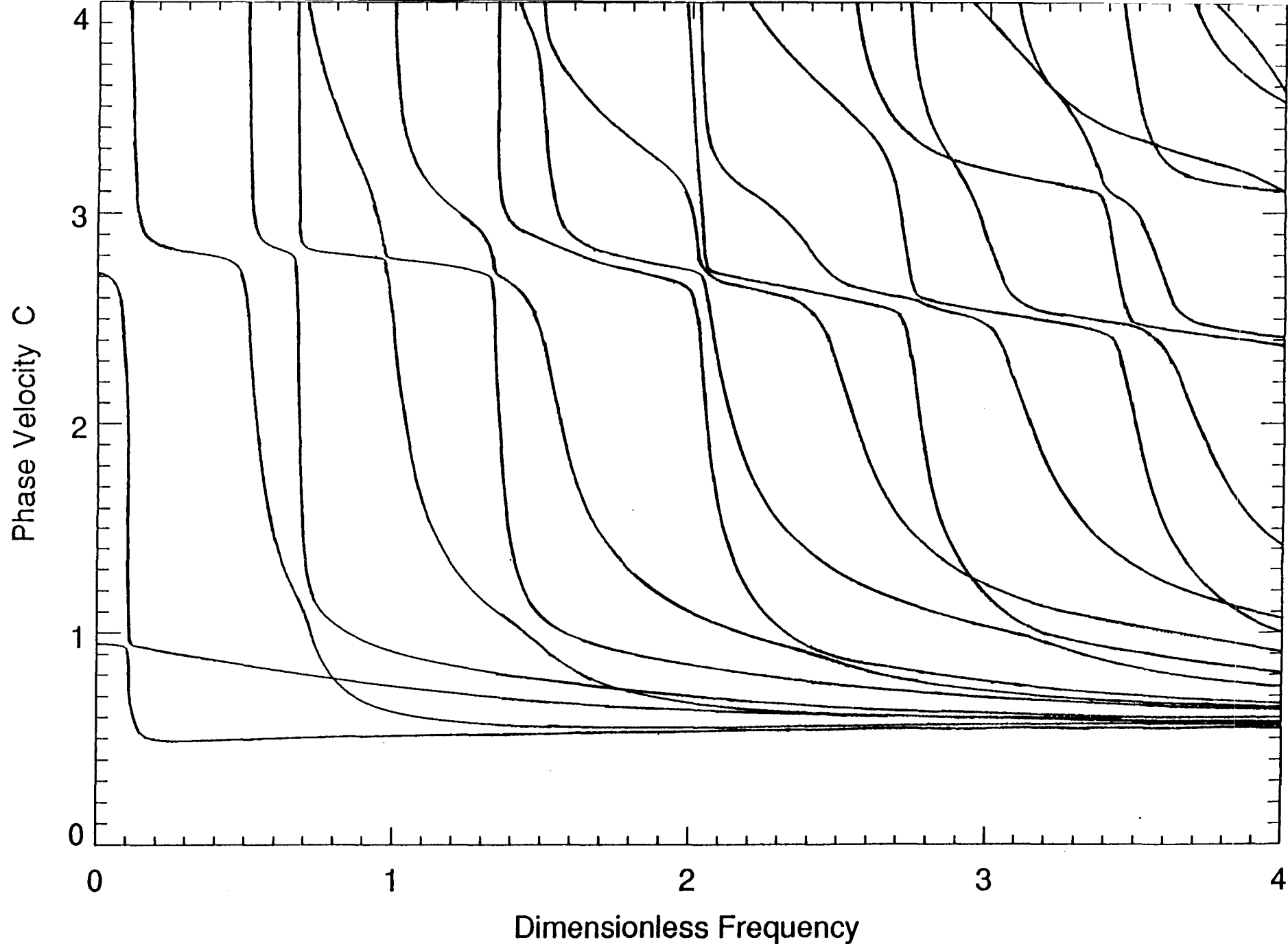

Aluminum Cladded Graphite/Epoxy [15/-15/15/-15] Deg. Fiber Angle

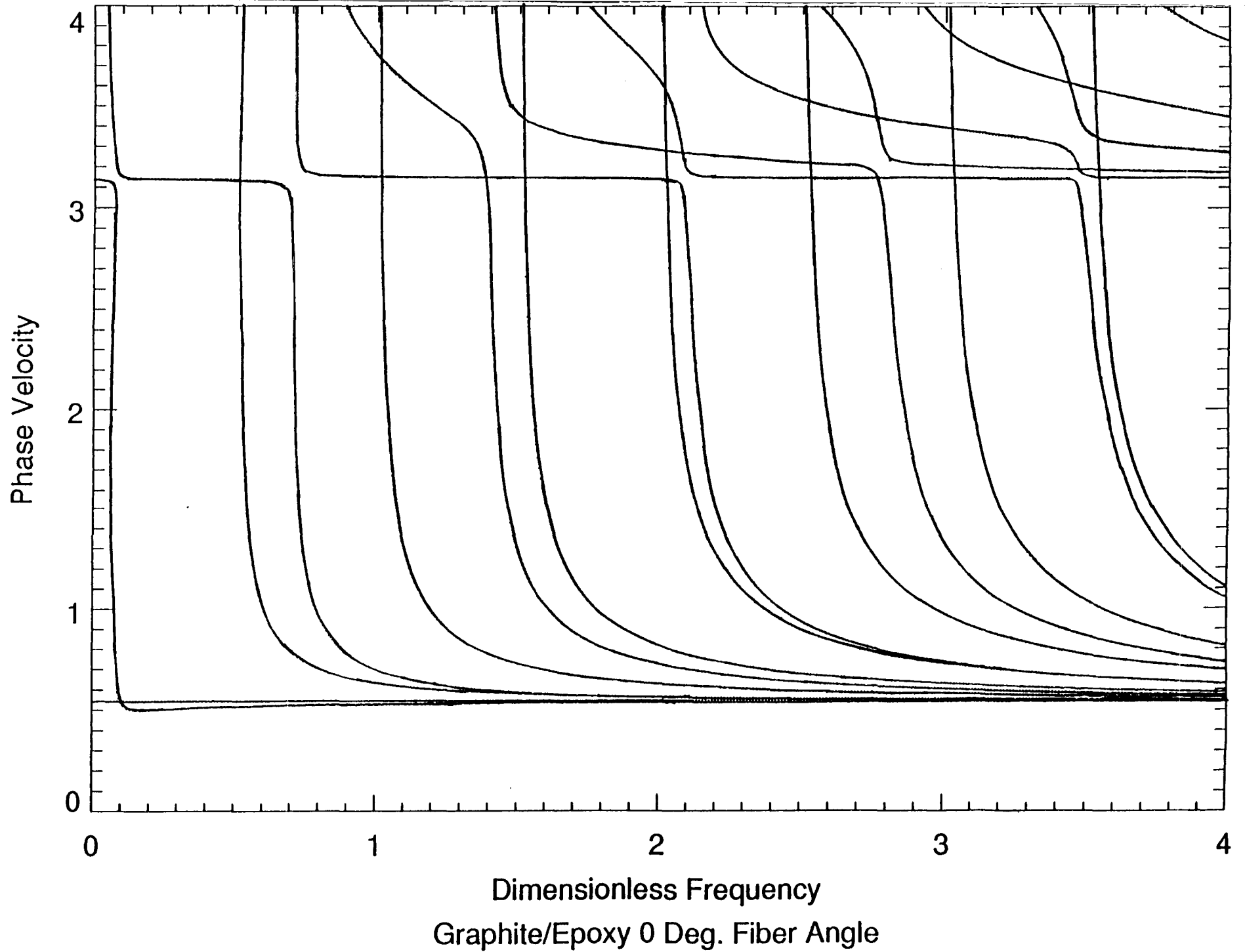

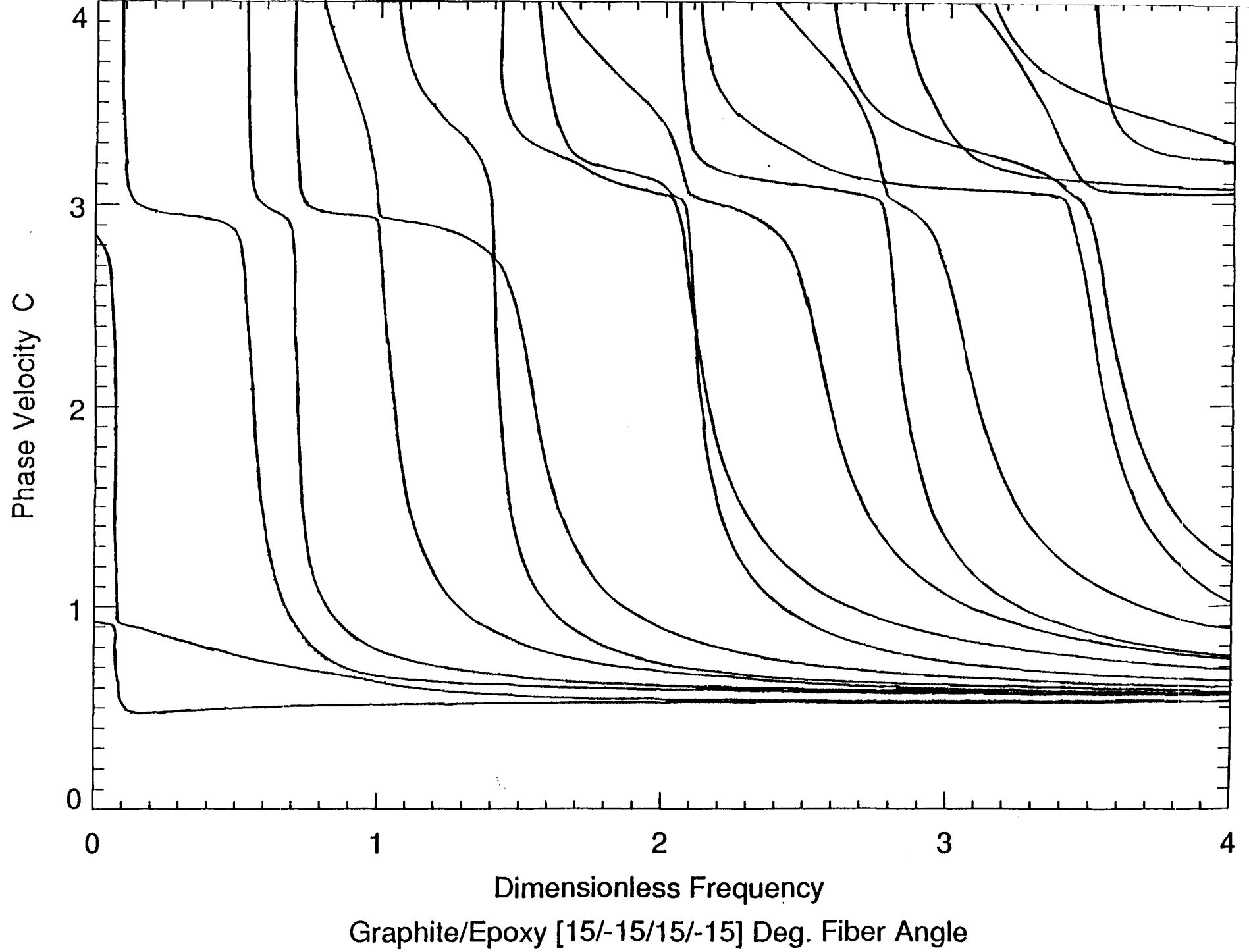



# Impact Response of a Composite Plate

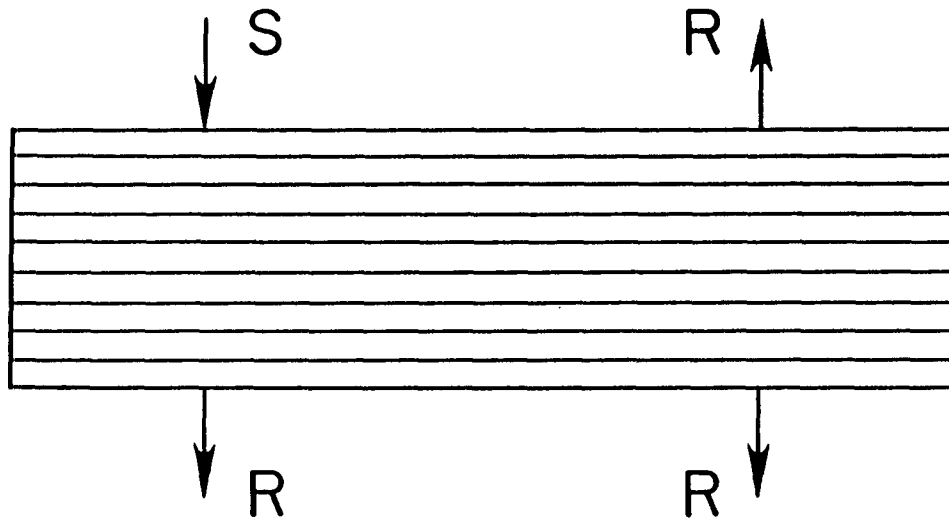

# RESPONSE in TIME DOMAIN HANNIN PULSE

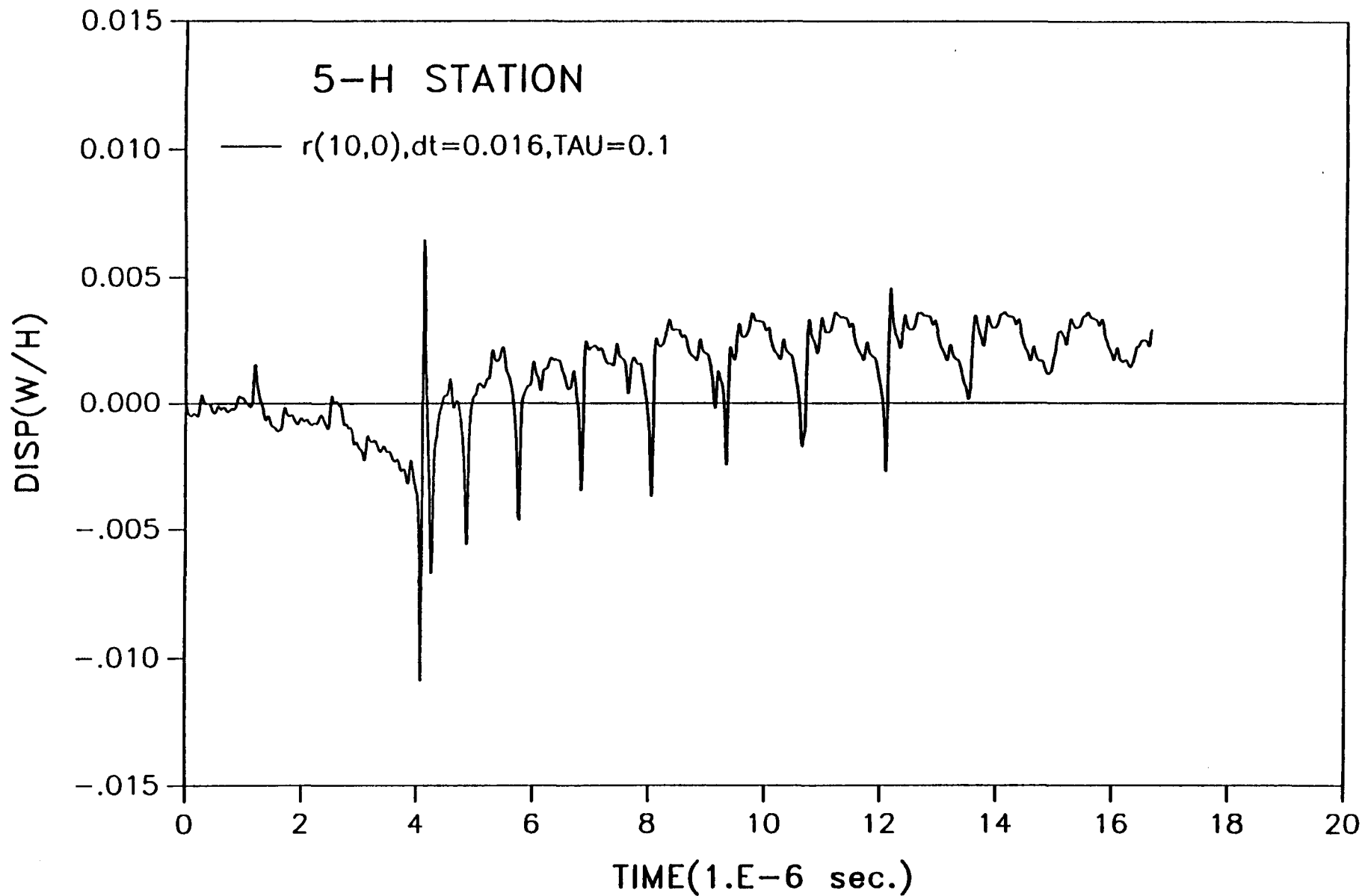

# RESPONSE in TIME DOMAIN HANNIN PULSE

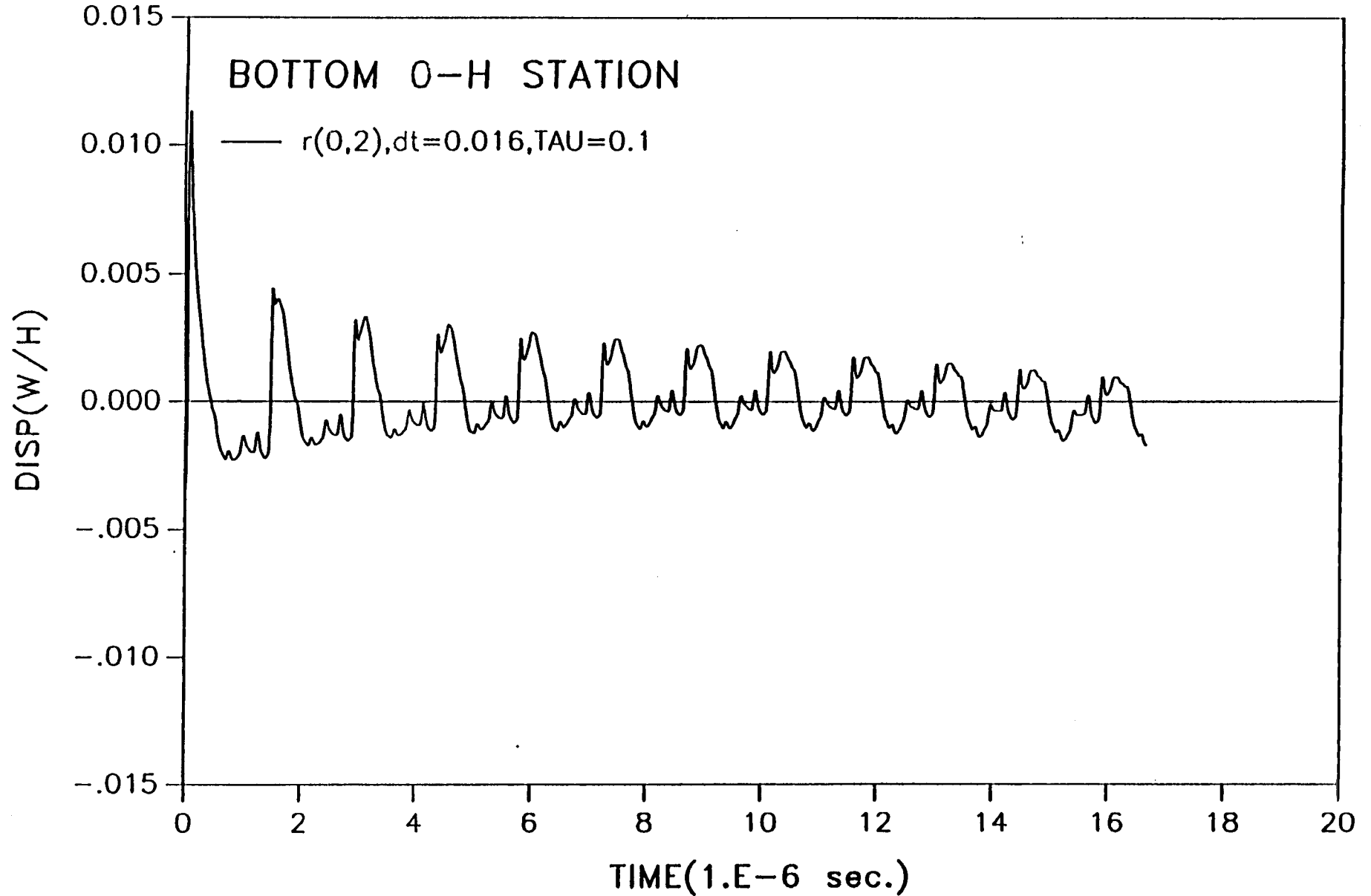

# RESPONSE in TIME DOMAIN HANNIN PULSE

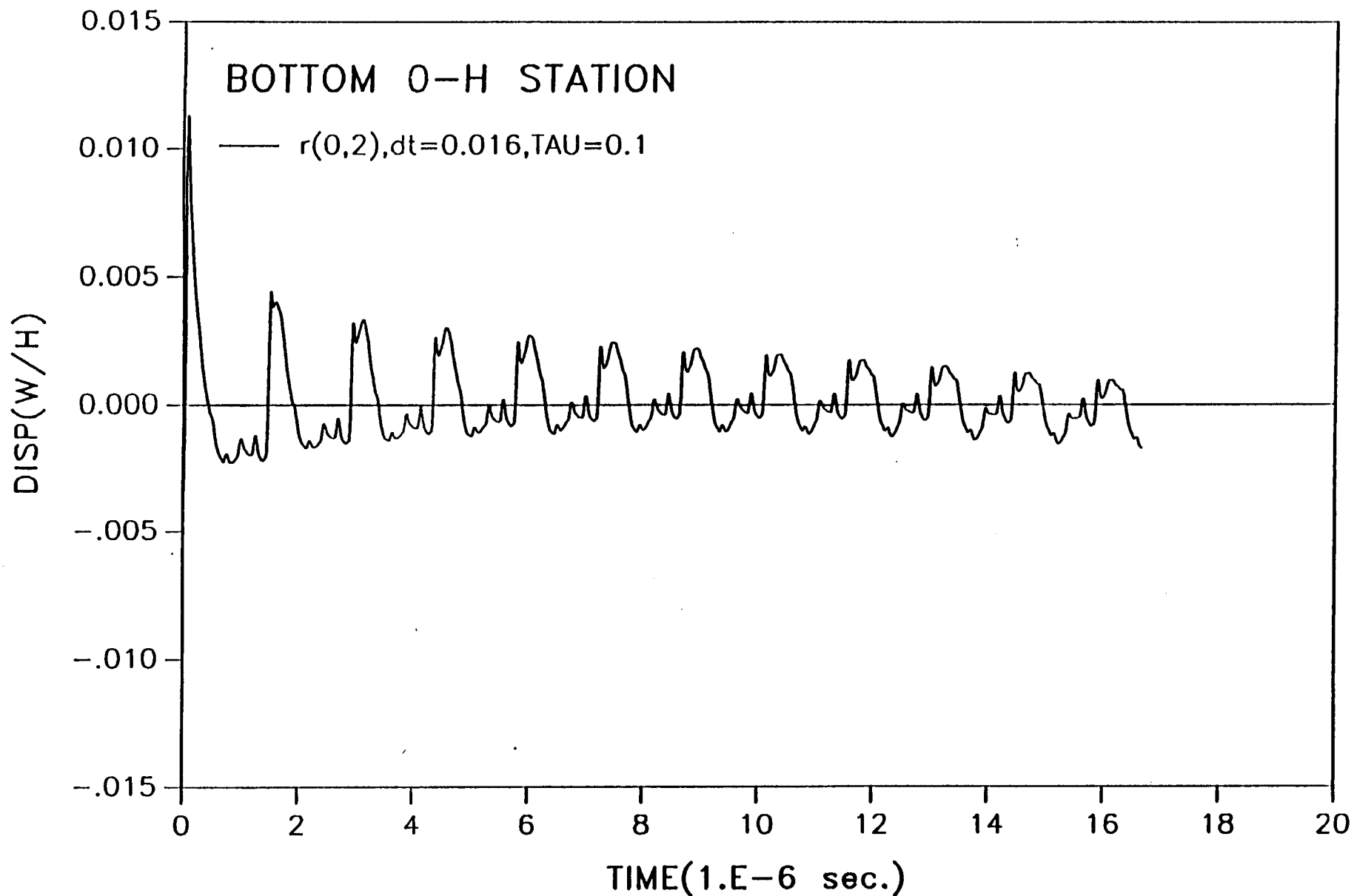

# RESPONSE in TIME DOMAIN HANNIN PULSE

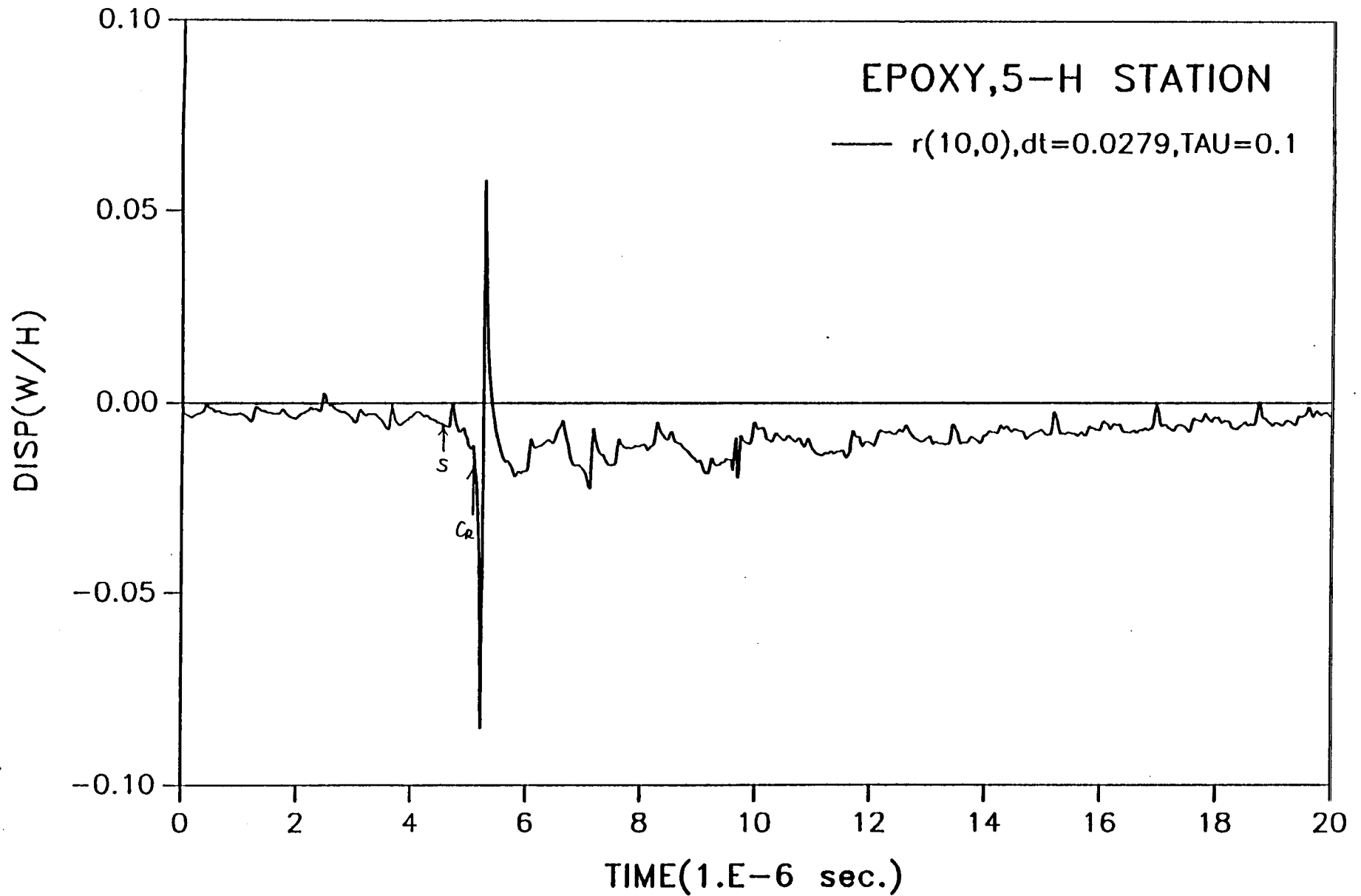

# RESPONSE in TIME DOMAIN HANNIN PULSE

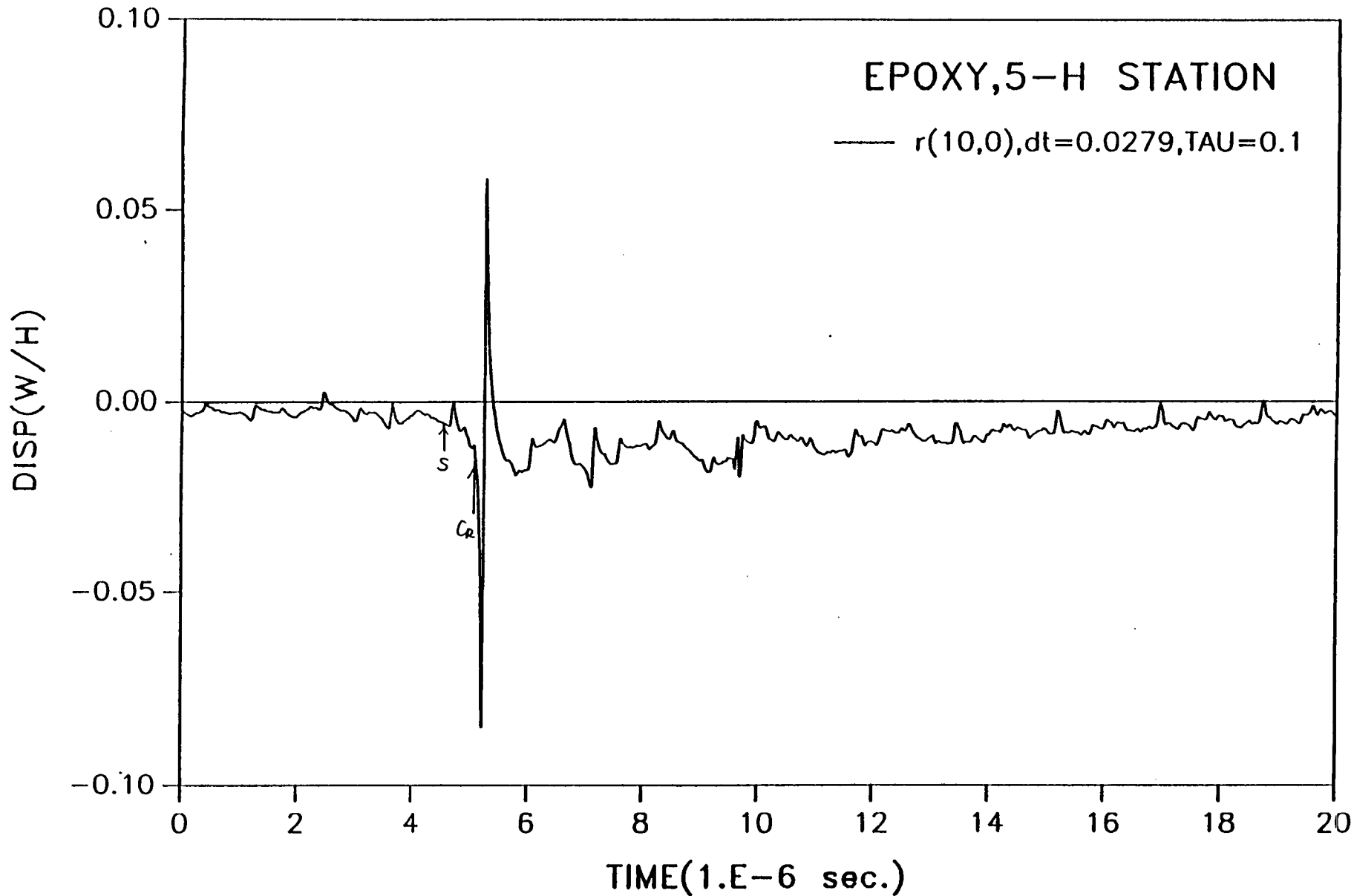

# Interface Effects in Particle Reinforced Composites

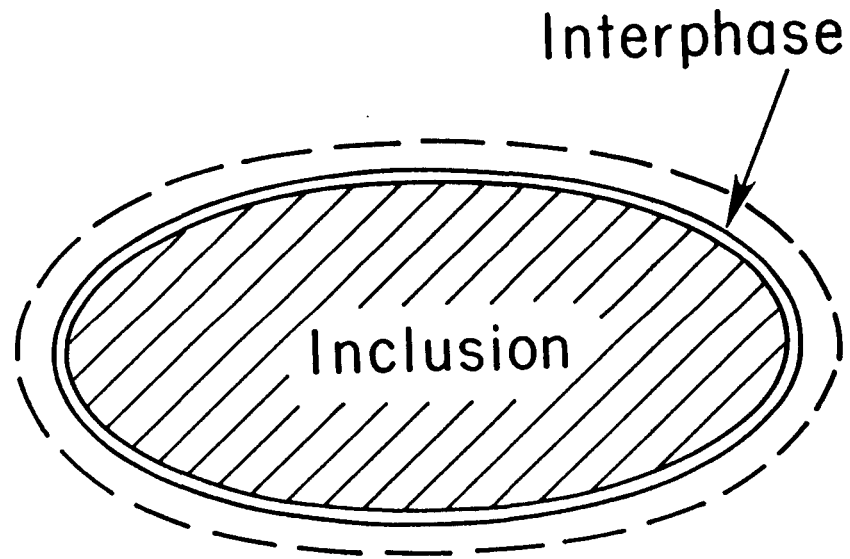

# Center for Space Construction

## Structures Cluster

### Composite Structures: Dynamics and Space Applicability

#### ○ Future research

- Dynamics of finite tubes
- Ultrasonic scattering by finite planar defects
- 3-D response due to impact
- Effect of material and interface degradation
- Experimental investigation of guided waves in tubes
- Modelling of joints
- Advanced materials



Center for Space Construction  
Structures Cluster

160682  
P 17

**TOWARDS REAL-TIME SIMULATION OF LARGE SPACE STRUCTURES:  
Stabilization of Fluid/Thermal/Structure Interactions  
and Implementation on High Performance Supercomputers**

*C. Farhat*  
*Department of Aerospace Engineering*  
*Center for Space Construction*  
*University of Colorado, Boulder, CO 80309*

October 12, 1989

Within the Center for Space Construction, the SIMSTRUC project's objectives center around the development of simulation tools for the realistic analysis of large space structures. Here, the word "tools" is in the broad sense: it designates mathematical models, finite element/finite difference formulations, computational algorithms, implementations on advanced computer architectures, and visualization capabilities.

In this talk, we report on the results of our activities during the first year within the SIMSTRUC project. On the modeling side, we describe an alternative approach to fluid/thermal/structure interaction analysis that is a departure from the "loosely coupled" and "unified" approaches that are being currently practiced. We demonstrate the advantages of our approach both in terms of accuracy and computational efficiency. On the computational side, we present a software architecture for parallel/vector and massively parallel supercomputers that speeds up finite element and finite difference computations by several orders of magnitude. As an example, the simulation of the deployment of a space structure that used to require over six hours on a workstation using a conventional finite element software, now runs on a multiprocessor using a parallel computation strategy in less than three seconds. In order to promote the physical understanding of the simulation behavior, we have also developed a real-time visualization capability on the Connection Machine, which allows the analyst to watch the graphical animation of the results at the same time these are generated.

We believe that by combining efficient analytical formulations with the state-of-the-art high performance computer implementations and superfast visualization capabilities, SIMSTRUC is moving fast towards the real-time simulation of large space structures. The designers as well as the researchers will certainly benefit from this technology.

## **Associates**

### **Supported by CSC:**

Mr. Paul Stern, Ph.D Student

Dr. Nahil Sobh, Research Associate, Sept. '88–Aug. '89

### **Supported by other grants:**

Mr. Francois Hemez, Ph.D. Student

Ms. Sophie Zurquiyah, Ph.D. Student

Mr. Jack Lin, Ph.D. Student (Expected graduation, Dec. 1989)

TOWARDS REAL-TIME SIMULATION  
OF LARGE SPACE STRUCTURES

C. Farhat, N. Sobh and P. Stern

*Department of Aerospace Engineering Sciences  
University of Colorado at Boulder*

**STRUCTURES CLUSTER**  
*TOWARDS REAL-TIME SIMULATION  
OF LARGE SPACE STRUCTURES*

---

**THE SIMSTRUC PROJECT**

- Build based on existing activities:
  - Structure/Control and Dynamics/Robotics Interaction Problems.
  - Large-Scale Dynamics Simulation/Computer Science.
  - Coupled Thermal/Electromagnetic/Fluid/Structural Analyses.

## STRUCTURES CLUSTER

### *TOWARDS REAL-TIME SIMULATION OF LARGE SPACE STRUCTURES*

---

#### THE SIMSTRUC PROJECT

*(continue)*

- Allow initially single disciplines pursue their own depth and then gradually let them widen their horizons.
- Integrate one-by-one those interdisciplinary research results carried out into a new entity through experimental and/or computer simulation activities.

STRUCTURES CLUSTER  
TOWARDS REAL-TIME SIMULATION  
OF LARGE SPACE STRUCTURES

---

MOTIVATION  
(extracted from Site Visit presentation)

*Current Capability*

Limited to No. Eqn.  $\leq 100$

Flexibility is Not Adequately Modeled.

Virtually No Capability for Interface with Controls

Real-Time Simulation Is Beyond Capacity

*Future Needs*

May Require No. Eqn.  $\geq 1000$

Correct Modeling of Flexibility Becomes Essential.

Interface with Controls Is A Must for Space Robotics

Real-Time Simulation Is An Absolute Necessity

# STRUCTURES CLUSTER

## *TOWARDS REAL-TIME SIMULATION OF LARGE SPACE STRUCTURES*

---

### FIRST YEAR PROGRESS REPORT

- Mathematical/Numerical modeling of thermal/structure interaction problems. Stabilization of a staggered time integration procedure.
  
- Mathematical/Numerical modeling of fluid/structure interaction problems. Incorporation of flexibility and moving boundary conditions. Application to transport problems.

# STRUCTURES CLUSTER

## TOWARDS REAL-TIME SIMULATION OF LARGE SPACE STRUCTURES

---

### FIRST YEAR PROGRESS REPORT

*(continue)*

- Development of the foundations for Real-Time Simulation:
  - stabilization of implicit staggered procedures for coupled field problems.
  - finite element/finite difference software architecture for parallel/vector supercomputers (CRAY Y-MP (8 processors), Connection Machine CM2 (65536 processors)).
  - fast parallel/vector numerical algorithms for computational methods in dynamics of large space structures.
  
- Development of a Real-Time visualization capability of structural dynamics that is now operational.
  
- Application to the deployment of a space structure model (in collaboration with the University of Liege, Belgium).

**NOTE:** Some of this work originated before the SIMSTRUC project and benefited from the interaction with other on-going research projects. CSC support was used to pursue the invested effort.



STRUCTURES CLUSTER  
TOWARDS REAL-TIME SIMULATION  
OF LARGE SPACE STRUCTURES

---

THERMAL/STRUCTURE INTERACTION PROBLEMS

$$\rho \ddot{\mathbf{u}} = \operatorname{div} \boldsymbol{\sigma} + \mathbf{b} \quad \text{in } B$$

$$c \dot{\theta} = -\operatorname{div}(-k \nabla \theta) - \alpha(3\lambda + 2\mu)\theta_0 \operatorname{tr}(\dot{\boldsymbol{\epsilon}}) + \mathbf{r} \quad \text{in } B$$

$$\boldsymbol{\sigma} = 2\mu \boldsymbol{\epsilon} + \lambda(\operatorname{tr} \boldsymbol{\epsilon})\mathbf{I} - \alpha(3\lambda + 2\mu)(\theta - \theta_0)\mathbf{I}$$

$$\boldsymbol{\epsilon} = \frac{1}{2}(\nabla \mathbf{u} + \nabla \mathbf{u}^T)$$

- Finite Element modeling for space discretization.
- Stabilized staggered procedure for time integration: computational efficiency and software modularity.
- "Tool" for verifying the effect of the *two-way* thermocoupling.

# STRUCTURES CLUSTER

## TOWARDS REAL-TIME SIMULATION OF LARGE SPACE STRUCTURES

### THERMAL/STRUCTURE INTERACTION PROBLEMS (continue)

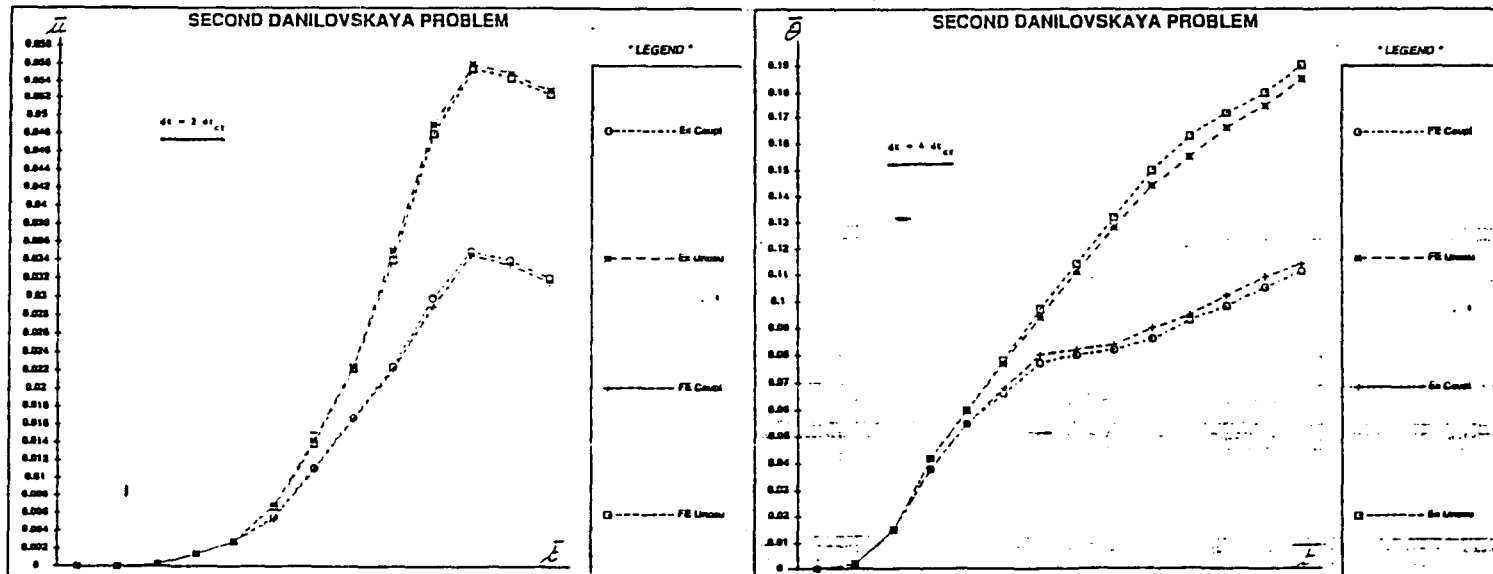

STRUCTURES CLUSTER  
TOWARDS REAL-TIME SIMULATION  
OF LARGE SPACE STRUCTURES

---

THERMAL/STRUCTURE INTERACTION PROBLEMS  
*(continue)*

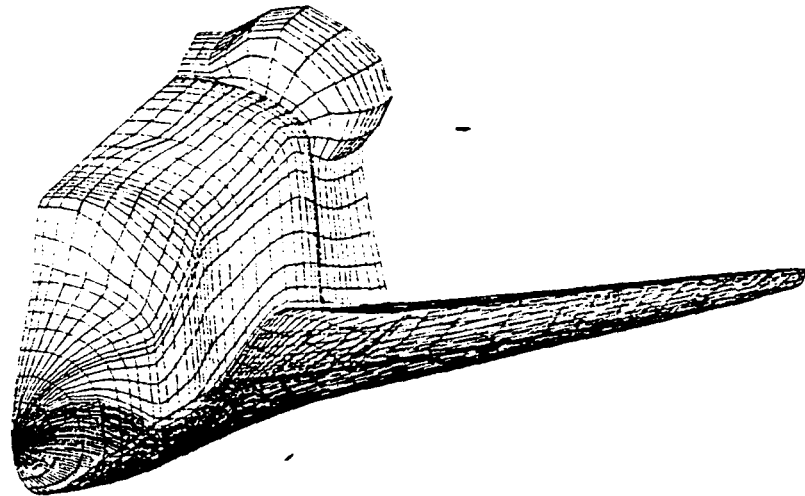

## STRUCTURES CLUSTER

### *TOWARDS REAL-TIME SIMULATION OF LARGE SPACE STRUCTURES*

---

#### SOFTWARE ARCHITECTURE FOR HIGH PERFORMANCE PARALLEL/VECTOR SUPERCOMPUTERS

- Domain decomposition: explicit/implicit.
- Mapping problem.
- Suitable finite element formulation.
- Parallelizable/Vectorizable numerical algorithms.
- Real-Time visualization capability.

STRUCTURES CLUSTER  
TOWARDS REAL-TIME SIMULATION  
OF LARGE SPACE STRUCTURES

SOFTWARE ARCHITECTURE  
FOR HIGH PERFORMANCE  
PARALLEL/VECTOR SUPERCOMPUTERS (CRAY Series)

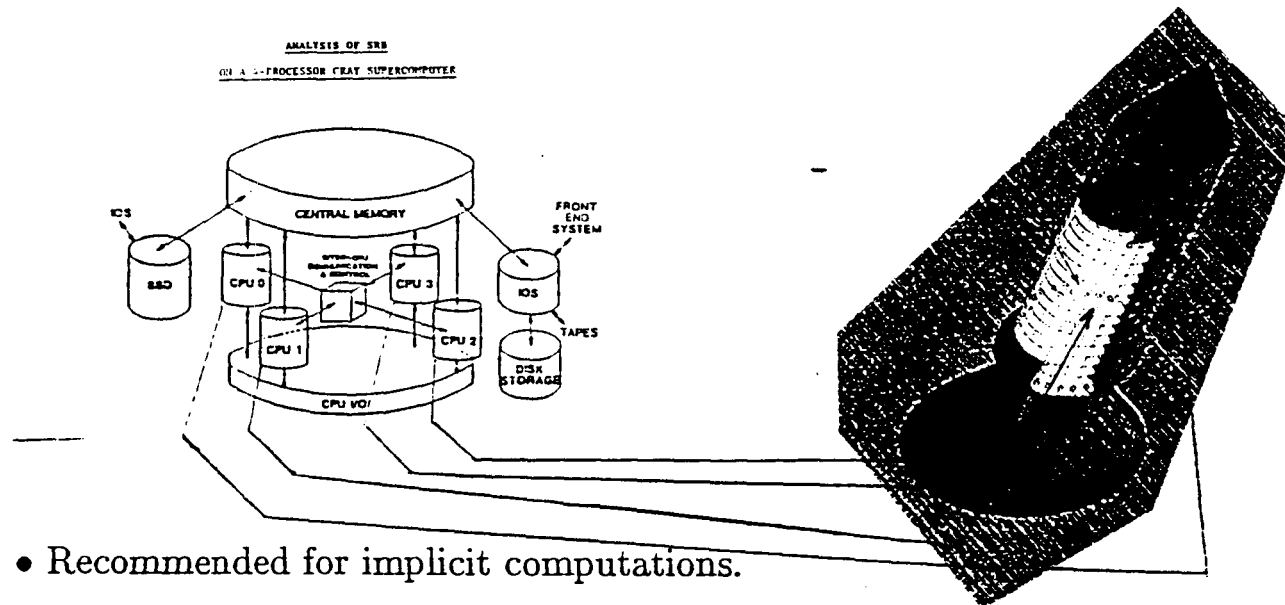

# STRUCTURES CLUSTER

## TOWARDS REAL-TIME SIMULATION OF LARGE SPACE STRUCTURES

### SOFTWARE ARCHITECTURE FOR MASSIVELY PARALLEL SUPERCOMPUTERS (Connection Machine CM2)

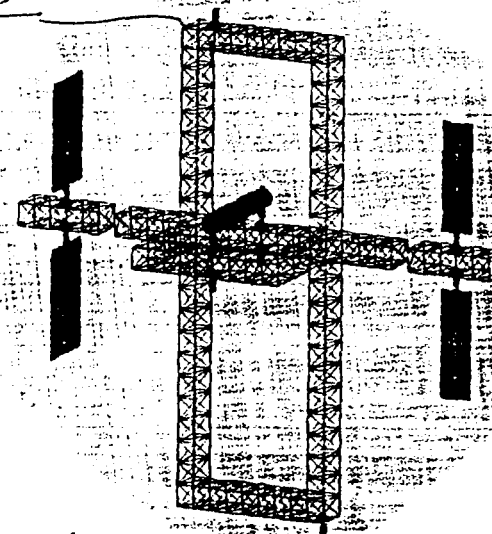
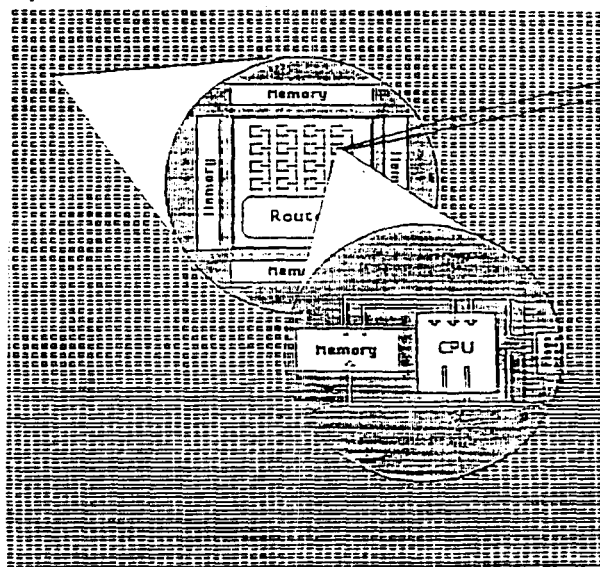

- Recommended for very large-scale explicit computations.



**STRUCTURES CLUSTER**  
*TOWARDS REAL-TIME SIMULATION  
OF LARGE SPACE STRUCTURES*

---

**REAL-TIME VISUALIZATION CAPABILITY**  
*(continue)*  
**(Connection Machine CM2)**

- Animation of a space structure model will be shown on a video tape.



# STRUCTURES CLUSTER

## TOWARDS REAL-TIME SIMULATION OF LARGE SPACE STRUCTURES

---

### DEPLOYMENT EXAMPLE (CRAY Y-MP, IBM 3090-VF)

- Software platform: MECANO, a module for the simulation of the deployment of 3D flexible multibody systems with sophisticated kinematics, University of Liege, Belgium.

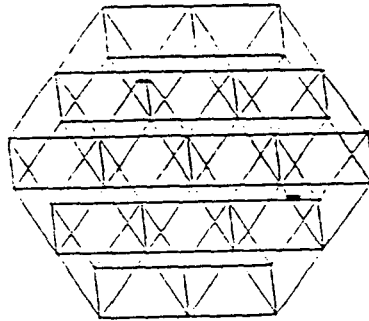

*ERA structure*

- 24 modules.
- motorisation of the deployment is provided by the elastic energy stored at rotation springs located at the hinges in the middle of the battens.
  - nonlinear torque/angle law.
  - locking device.
  - simplified finite element model: 612 DOF.
  - 2 hours 20 minutes CPU time on a workstation for 1.2 physical seconds.
  - 8.2 secs on a CRAY Y-MP (4 processors) using our software architecture for parallel/vector finite element computations.
  - final model will incorporate 8000 DOF.

## STRUCTURES CLUSTER

### TOWARDS REAL-TIME SIMULATION OF LARGE SPACE STRUCTURES

---

#### SOME IMPLICATIONS OF LARGE-SCALE COMPUTING CAPABILITIES

- Detailed modeling.
- Analytically simpler modeling. Example: SPACE CRANE.

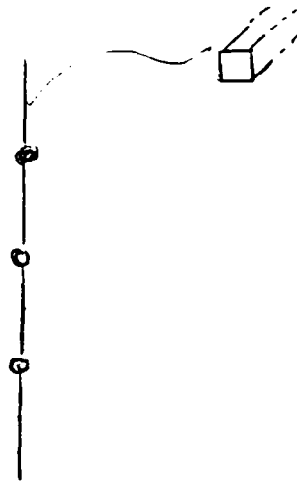
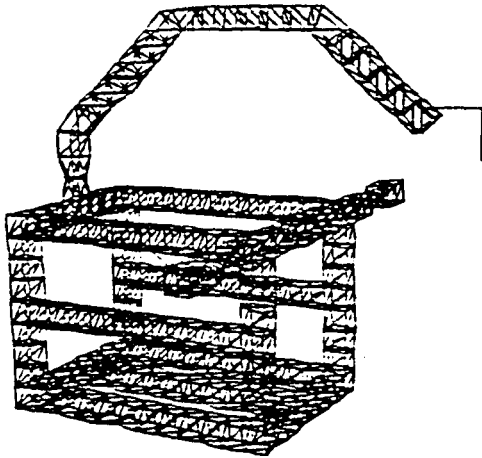

- homogenized model is numerically simpler, but requires the treatment of torsion/bending coupling (warping effect).
- full-scale model is numerically more complicated and computationally intensive. However, since all members have a circular cross-section, there is no warping effect to be included. Control is done at the substructure level.

[REDACTED]

# LOW-ORDER DESIGN AND HIGH-ORDER SIMULATION OF ACTIVE CLOSED-LOOP CONTROL FOR AEROSPACE STRUCTURES UNDER CONSTRUCTION

Mark J. Balas  
*Department of Aerospace Engineering Sciences  
and Center for Space Structures and Controls  
University of Colorado at Boulder  
Boulder, CO 80309-0429*

Sp-18  
100 883  
24

## ABSTRACT

Partially constructed/assembled structures in space are complicated enough but their dynamics will also be operating in closed-loop with feedback controllers. The dynamics of such structures are modeled by large-scale finite element models of the form:

$$\begin{cases} M_0 \ddot{q} + D_0 \dot{q} + K_0 q = B_0 u + F_0 \\ y = C_0 q + E_0 \dot{q} + H_0 u \end{cases}$$

where  $q$  is the L-dimensional vector of nodal displacements,  $u$  is the M-dimensional vector of actuator inputs and  $y$  is the P-dimensional vector of sensor outputs. The model dimension L is extremely large ( $\sim 10,000$ ) while the numbers of actuators (M) and sensors (P) are small. The model parameters  $M_0$  mass matrix,  $D_0$  damping matrix, and  $K_0$  stiffness matrix, are all symmetric and sparse (banded). Thus simulation of open-loop structure models of very large dimension can be accomplished by special integration techniques for sparse matrices.

The problem of simulation of closed-loop control of such structures is complicated by the addition of controllers of the form:

$$\begin{cases} u = L_{11} y + L_{12} z \\ \dot{z} = L_{21} y + L_{22} z \end{cases}$$

where the sensor outputs  $y$  are processed by the above control algorithm to produce actuator inputs  $u$  for control of the structure. Although the controller dimension ( $s = \dim z$ ) may be small, the closed-loop combination of structure plus controller must be integrated rapidly in any good simulation and the symmetry and sparsity of such a combination is no longer the same as that of the original structure. Simulation of closed-loop controlled structures is an essential part of the controller design and evaluation process.

We will present our current research in the following areas:

- (1) High-order simulation of actively controlled aerospace structures
- (2) Low-order controller design and CSI compensation for unmodeled dynamics
- (3) Prediction of closed-loop stability using asymptotic eigenvalue series
- (4) Flexible robot manipulator control experiments.

We hope you enjoy them.

## Current Research

- ⊙ Distributed Parameter System Theory for Model Reduction and Low-Order Controller Design
- ⊙ CSI Compensation By Residual Mode Filters
- ⊙ Numerically Well-Conditioned Methods for Structure/Controller Redesign to Reduce Detrimental CSI

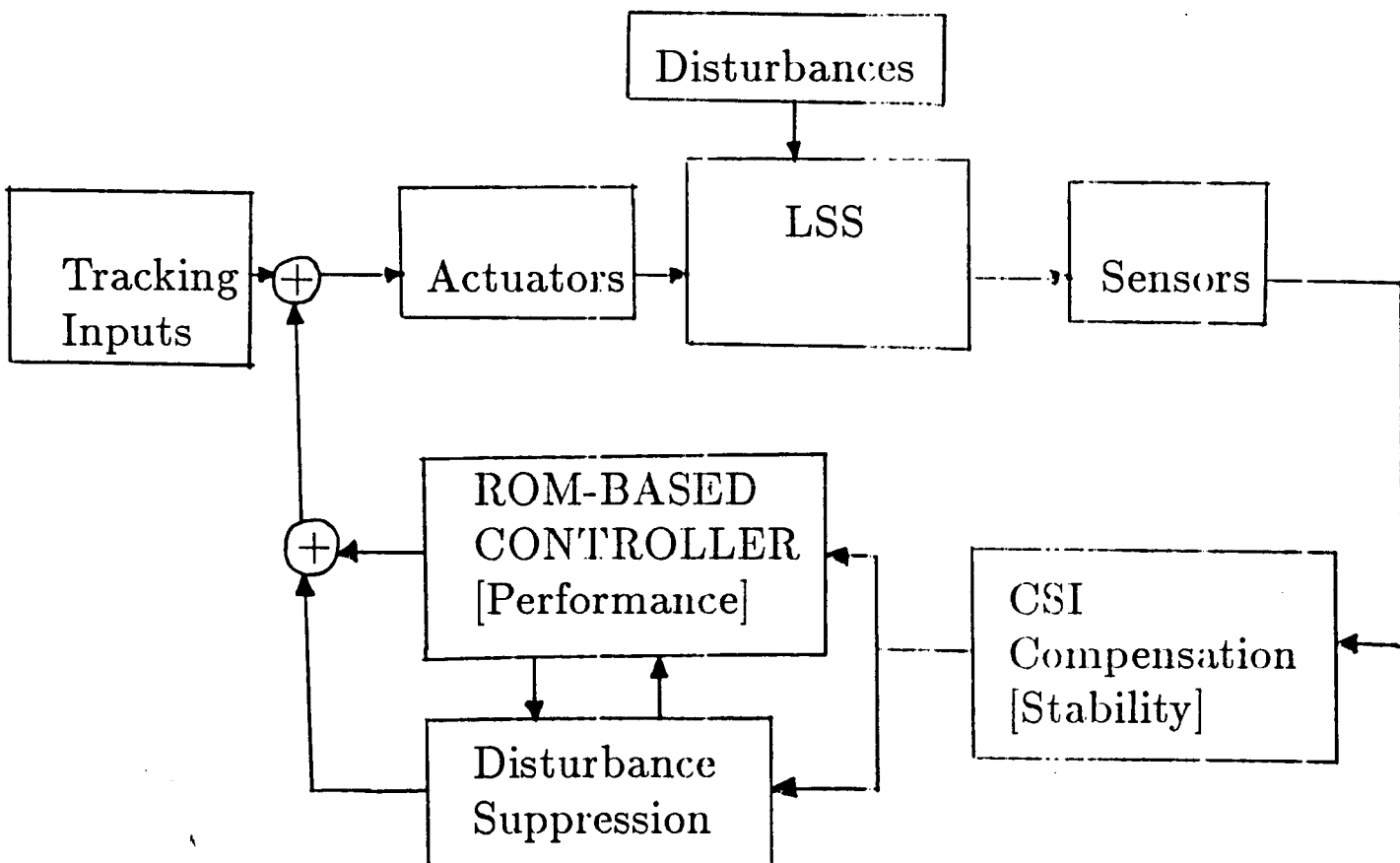

# Ph D Students

Advisor : M. Balas

B. Das  
R. Davidson\*  
S-C Liang  
R. Quan\*  
B. Reisenauer\* } AES

J. Galvez ■  
A. Gooyabadi ■ } ECE

\* partially supported by  
NASA - CSC

■ advised through ECE Joint Appt.

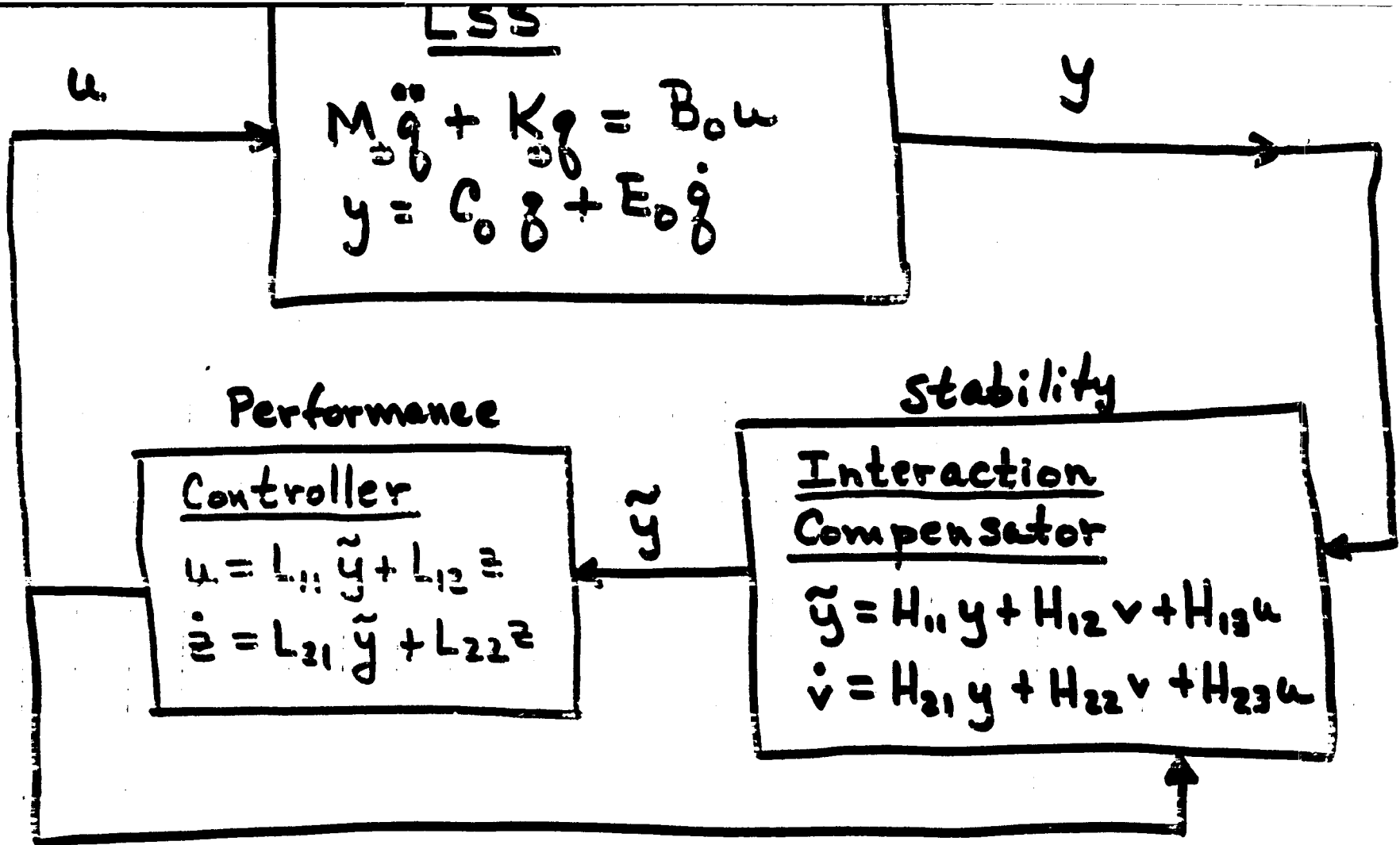

# Proposed Research Program: Interdisciplinary Structures/Controls

Where We Are Now In Control

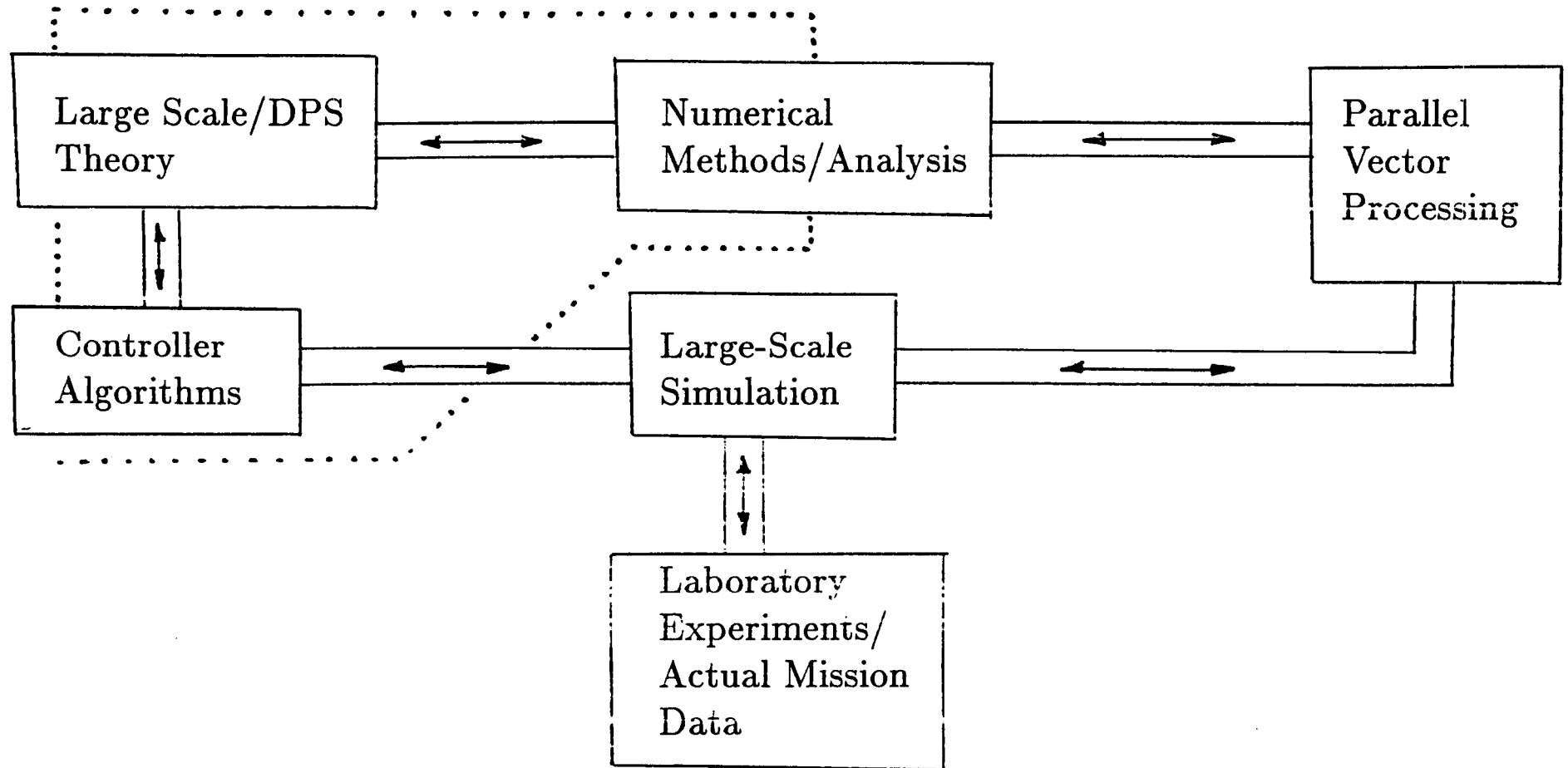

# The Simulation Problem

$$\text{SS} \begin{cases} M_0 \ddot{q} + D_0 \dot{q} + K_0 q = B_0 u \\ y = C_0 q + E_0 \dot{q} \end{cases} \quad \dim q = L \quad \underline{\underline{\text{big!}}}$$

$M_0, D_0, K_0$  sym & sparse !!

Controller :

$$\begin{cases} \dot{u} = L_{11} y + L_{12} z \\ \dot{z} = L_{21} y + L_{22} z \end{cases}$$

$\dim z = \alpha$  small !!

Closed-Loop :

$$M_0 \ddot{q} + D_0 \dot{q} + K_0 q = B_0 (L_{11} y + L_{12} z)$$

$$\dot{z} = L_{21} y + L_{22} z$$

$$y = C_0 q + E_0 \dot{q}$$

Integrate this system quickly.



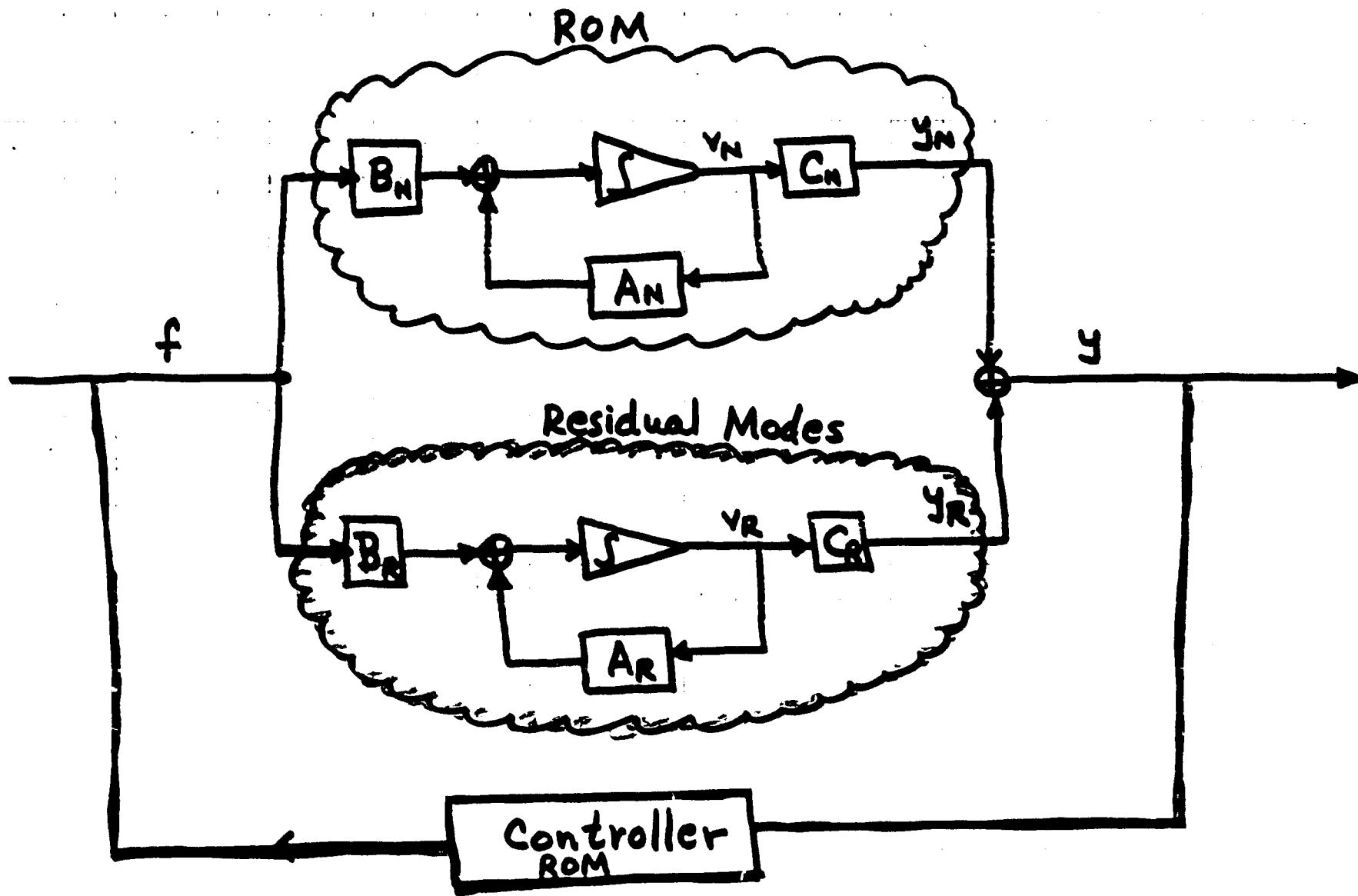

New Result: Balas-Ouyang (1988)

Only need Residual Mode Filters  
for Closed-Loop Unstable Modes

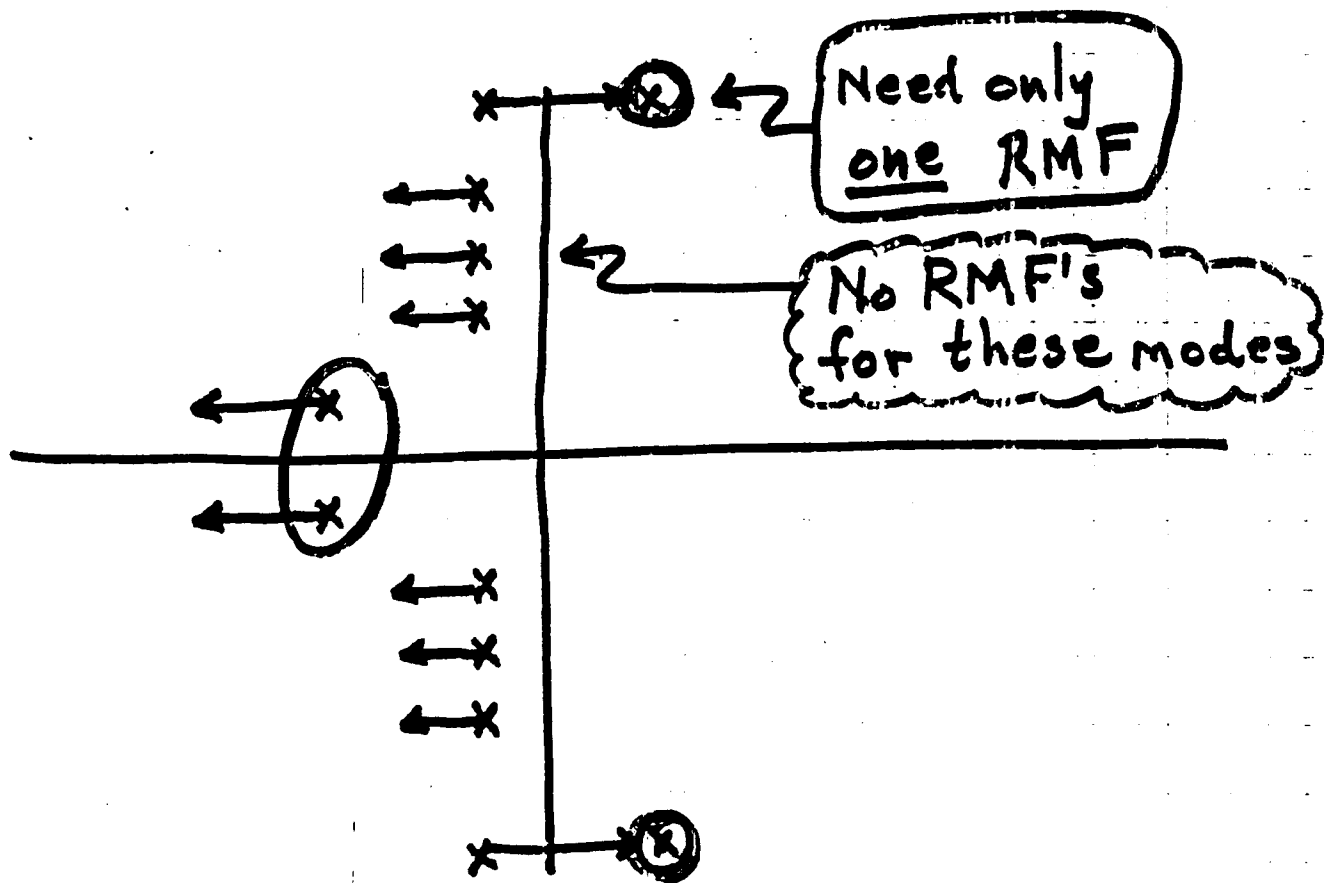

## Good Stuff

- ① RMF designed indep. of original ROM-Based Controller (an Add-on)
- ② RMF simple to implement
- ③ Very little sacrifice of original designed performance

## Bad Stuff

- ① How to guess closed-loop unstable modes? Perturbation Methods
- ② RMF very sensitive to mode frequency knowledge  
Adaptive Filter

# Perturbation Analysis

$$A_c(\epsilon) = \overset{\text{well known}}{A_0} + \epsilon \Delta A \quad \text{Small Perturbation}$$

Asymptotic Eigenvalue Series:

$$\hat{\lambda}_c(\epsilon) = \lambda_0 + \epsilon \lambda_1 + \epsilon^2 \lambda_2 + \dots$$

Closed-Loop (LSS + ROM Controller):

$$A_c(\epsilon) = \begin{bmatrix} A_M & B_M G_M & 0 \\ K_M C_M & L_M & \epsilon K_M C_R \\ 0 & \epsilon B_R G_M & A_R \end{bmatrix}$$

$$\therefore \hat{\lambda}_c(\epsilon) = \lambda_0 + \epsilon^2 \lambda_2$$

# Self Tuning Adaptive Controller using on line Frequency Locked Loops

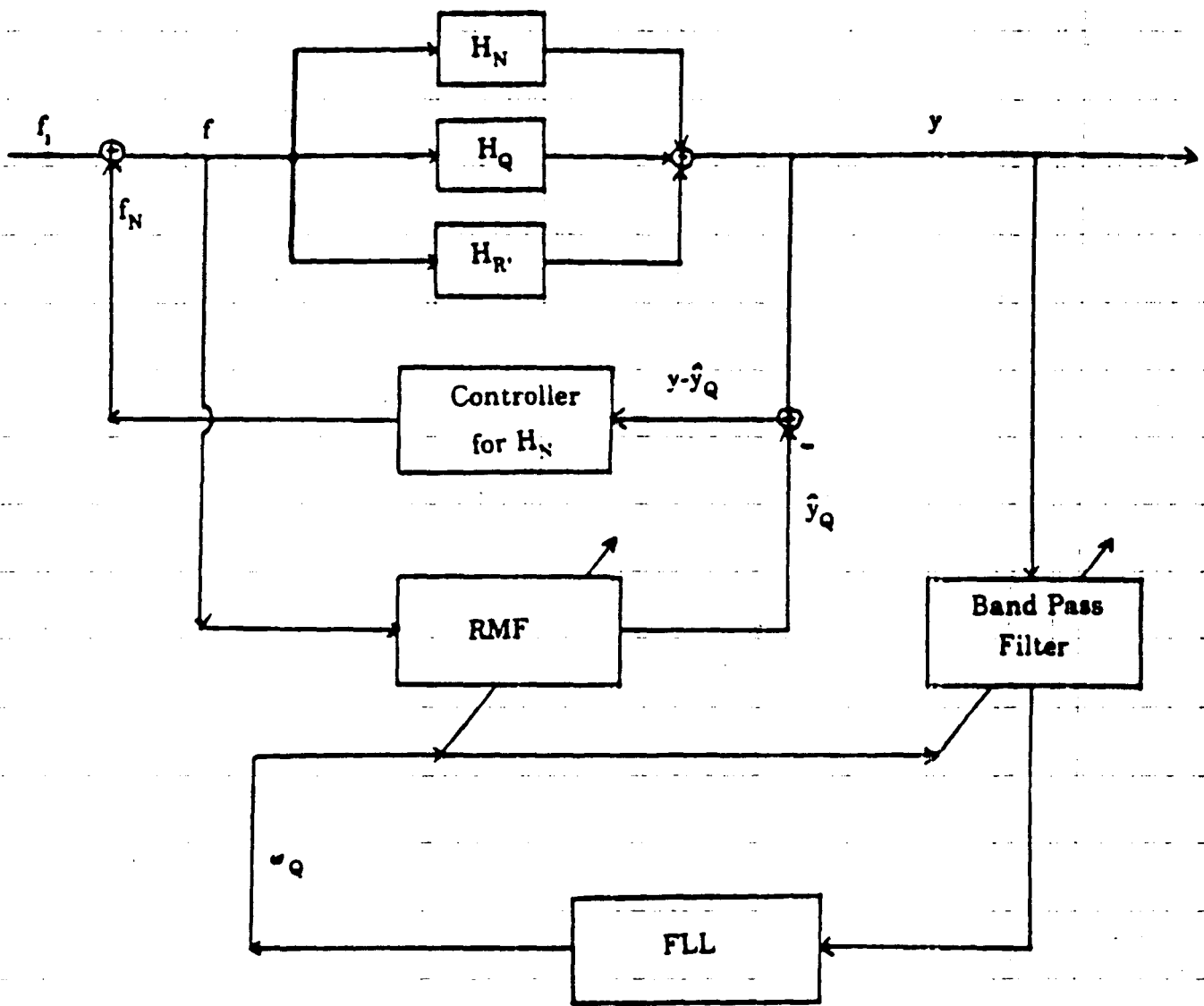
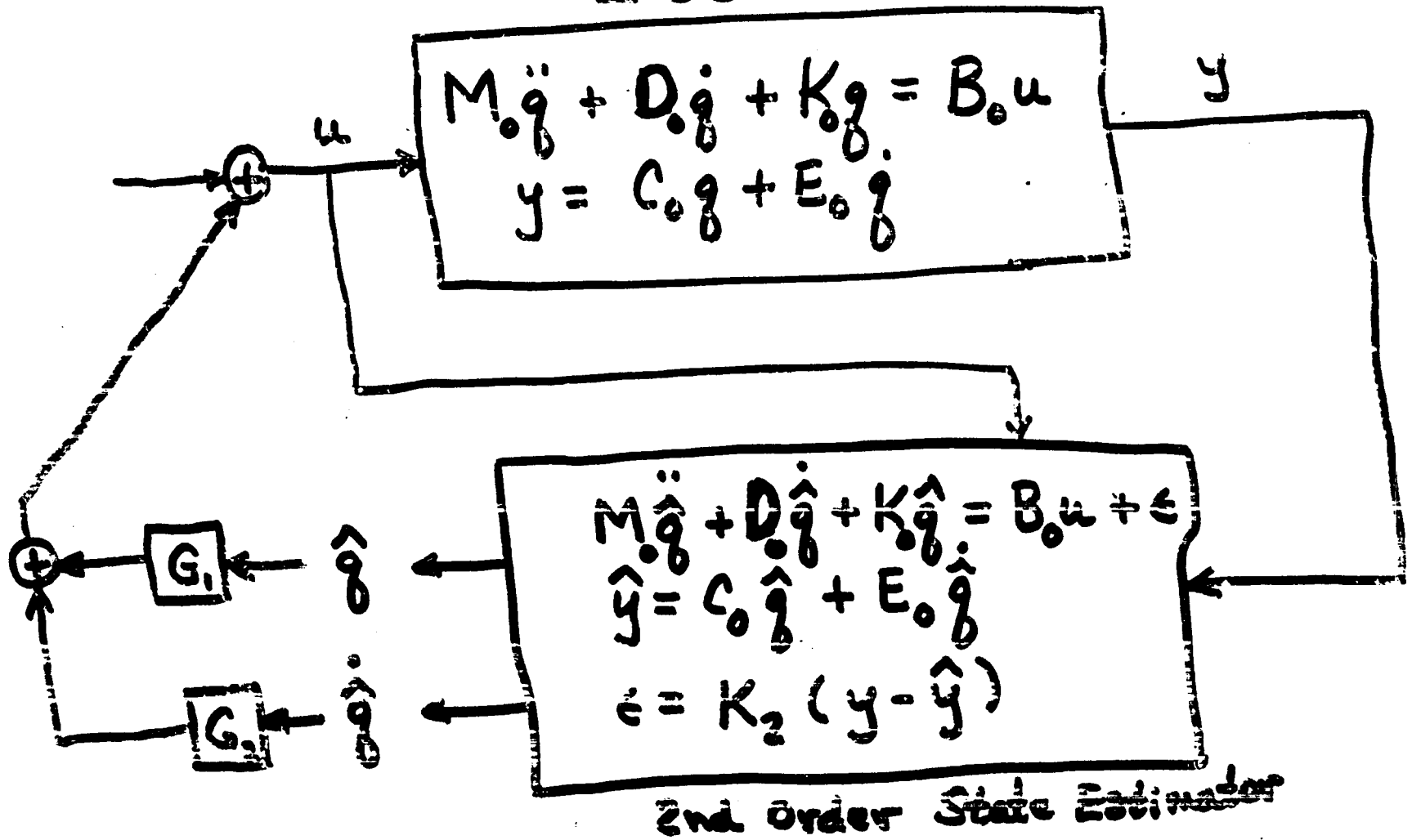
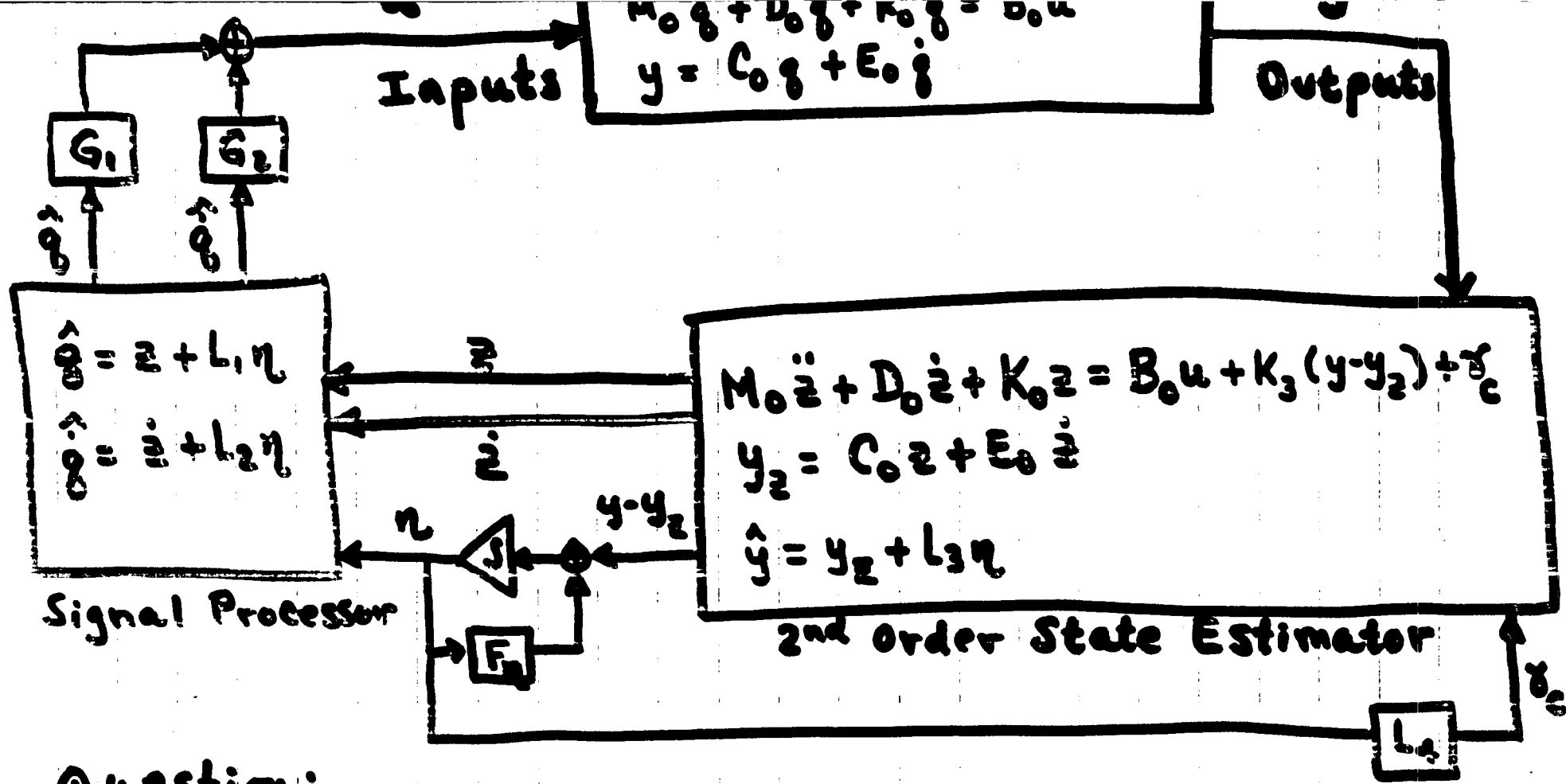

Figure 1. Block Diagram of Adaptive RMF controller

LSS





Question:

"Do LSS Have Convergent (Arb. Fast) 2<sup>nd</sup> order Controllers?"

Ans: Yes, but they are not "natural".

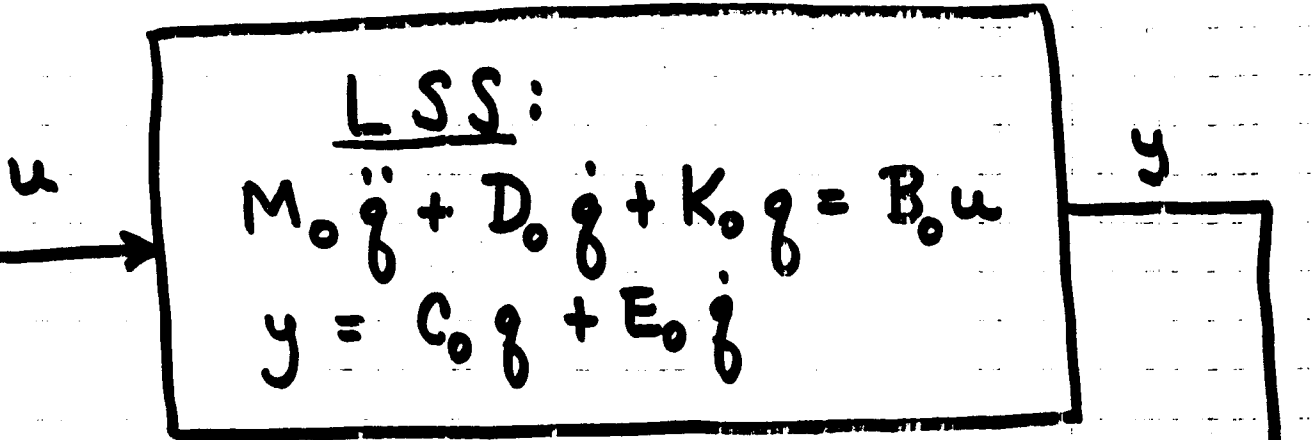

Real ↑

Computer ↓

2nd order Architecture

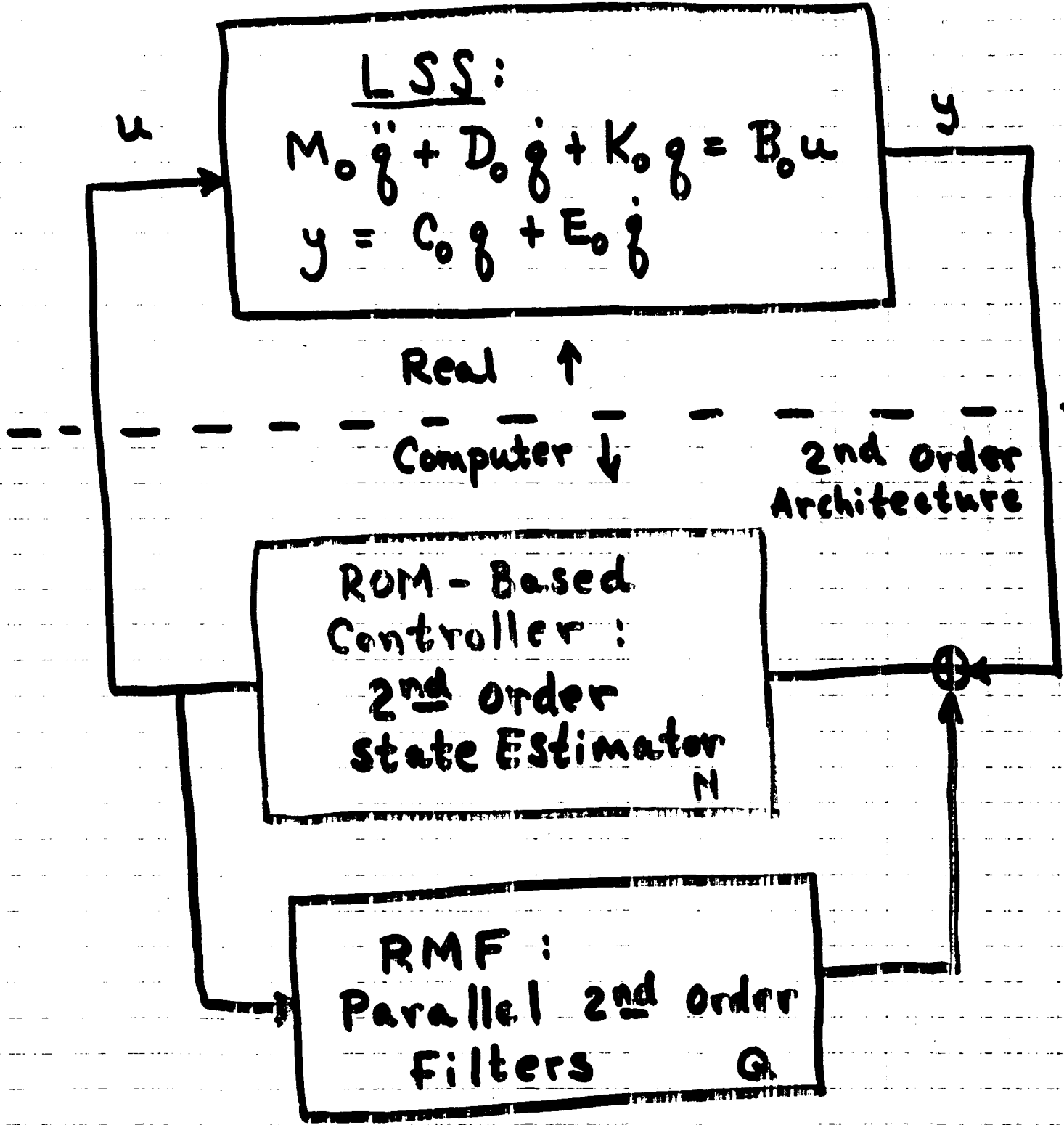
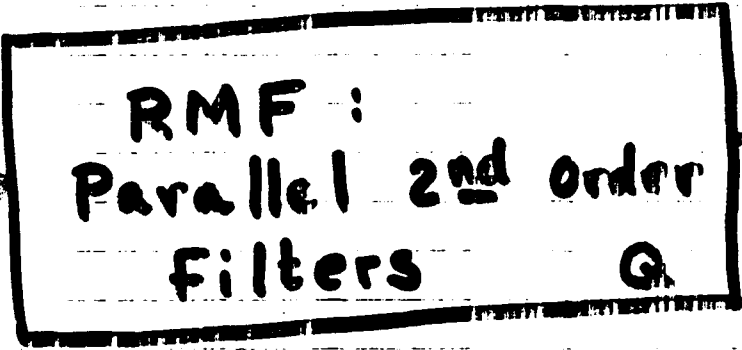
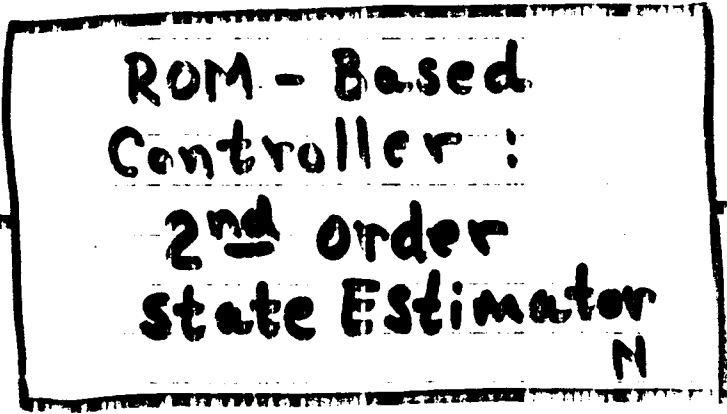



# Using Structural Partitioning

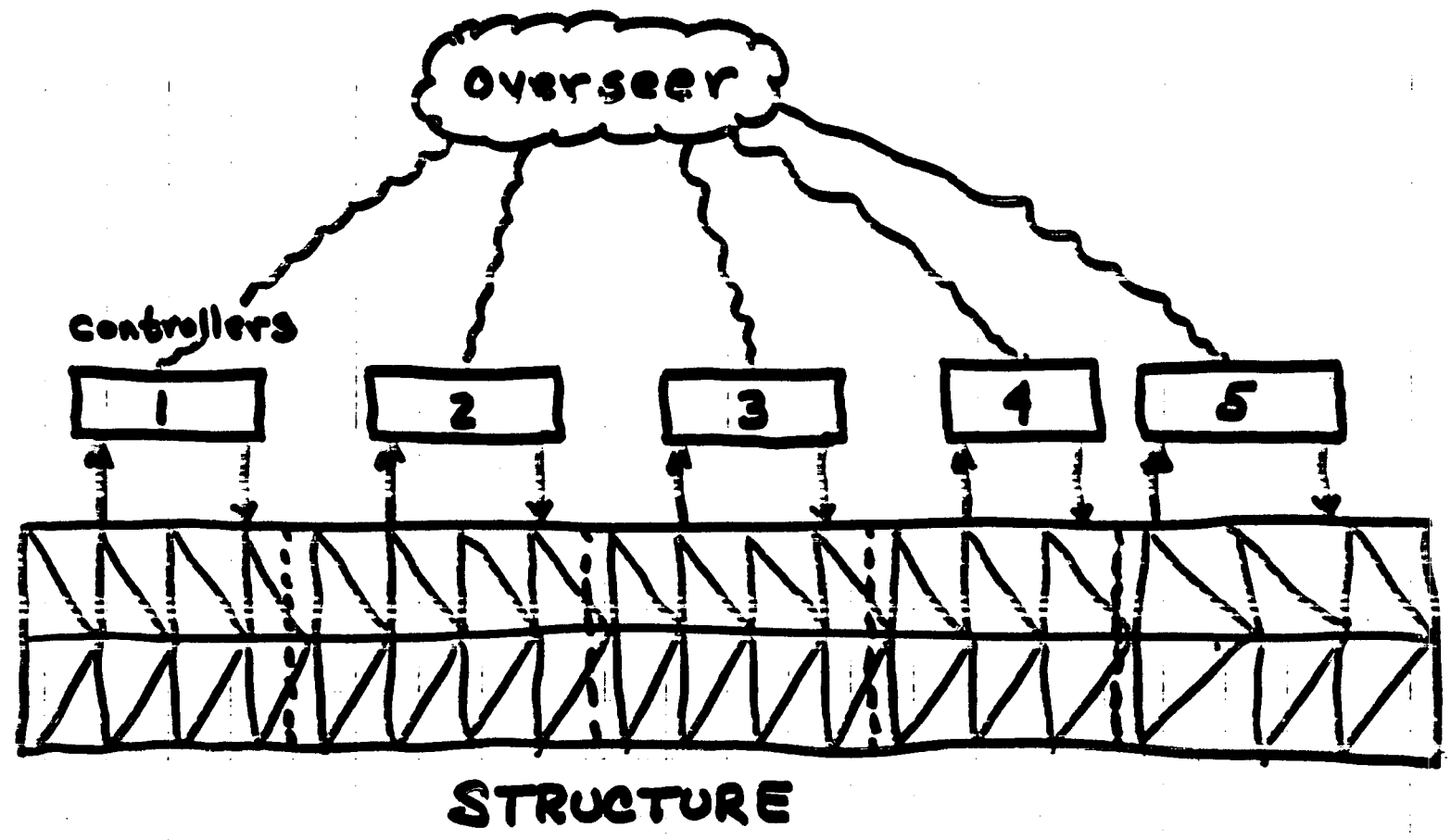

Controller 1

$$\begin{aligned} \dot{x}_1 &= K_1^0 u_1 + K_1^1 y_1 \\ \dot{w}_1 &= L_1^0 u_1 + L_1^1 y_1 \end{aligned}$$

$u_1$

$y_1$

Controller 2

$$\begin{aligned} \dot{x}_2 &= K_2^0 u_2 + K_2^1 y_2 \\ \dot{w}_2 &= L_2^0 u_2 + L_2^1 y_2 \end{aligned}$$

$y_2$

$u_2$

LSS

ROM :

$$\begin{cases} \dot{x}_N = A_N x_N + B_{1N} u_1 + B_{2N} u_2 \\ y_1 = C_{1N} x_N + \text{residuals} \\ y_2 = C_{2N} x_N + \text{residuals} \end{cases}$$

Decentralized Controller Design  
→ performance ←

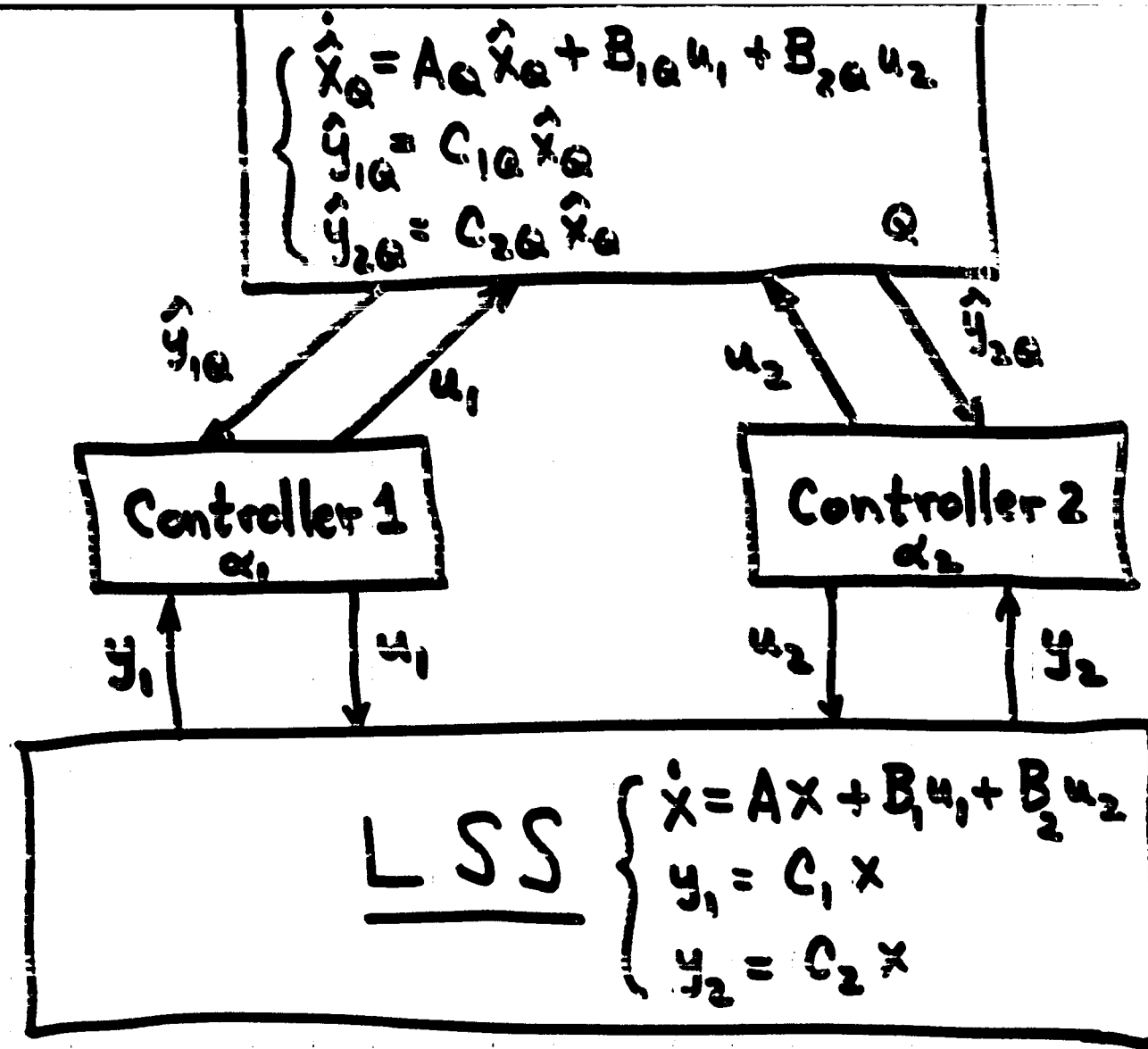

RMF Compensation for Stable Control

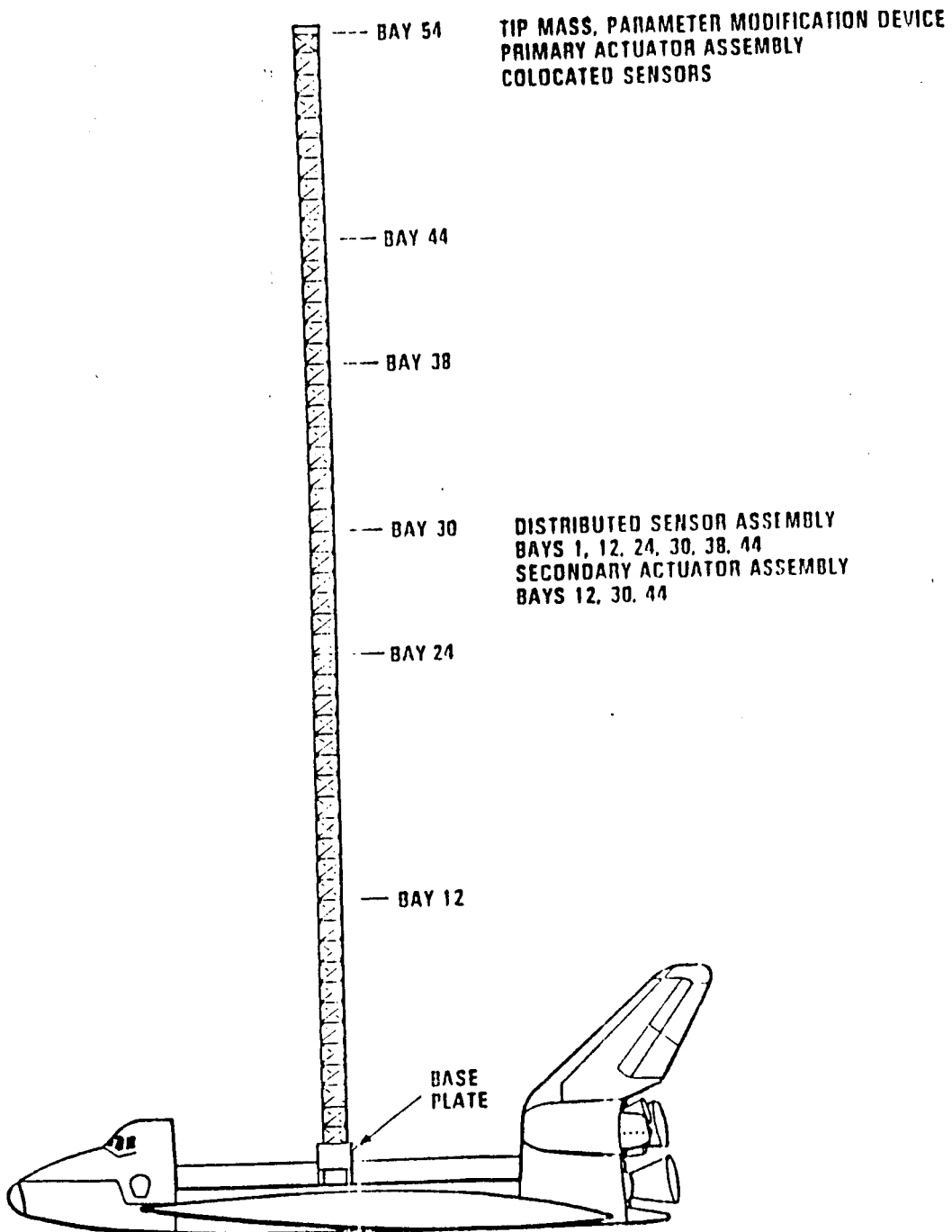

OPEN LOOP POLES

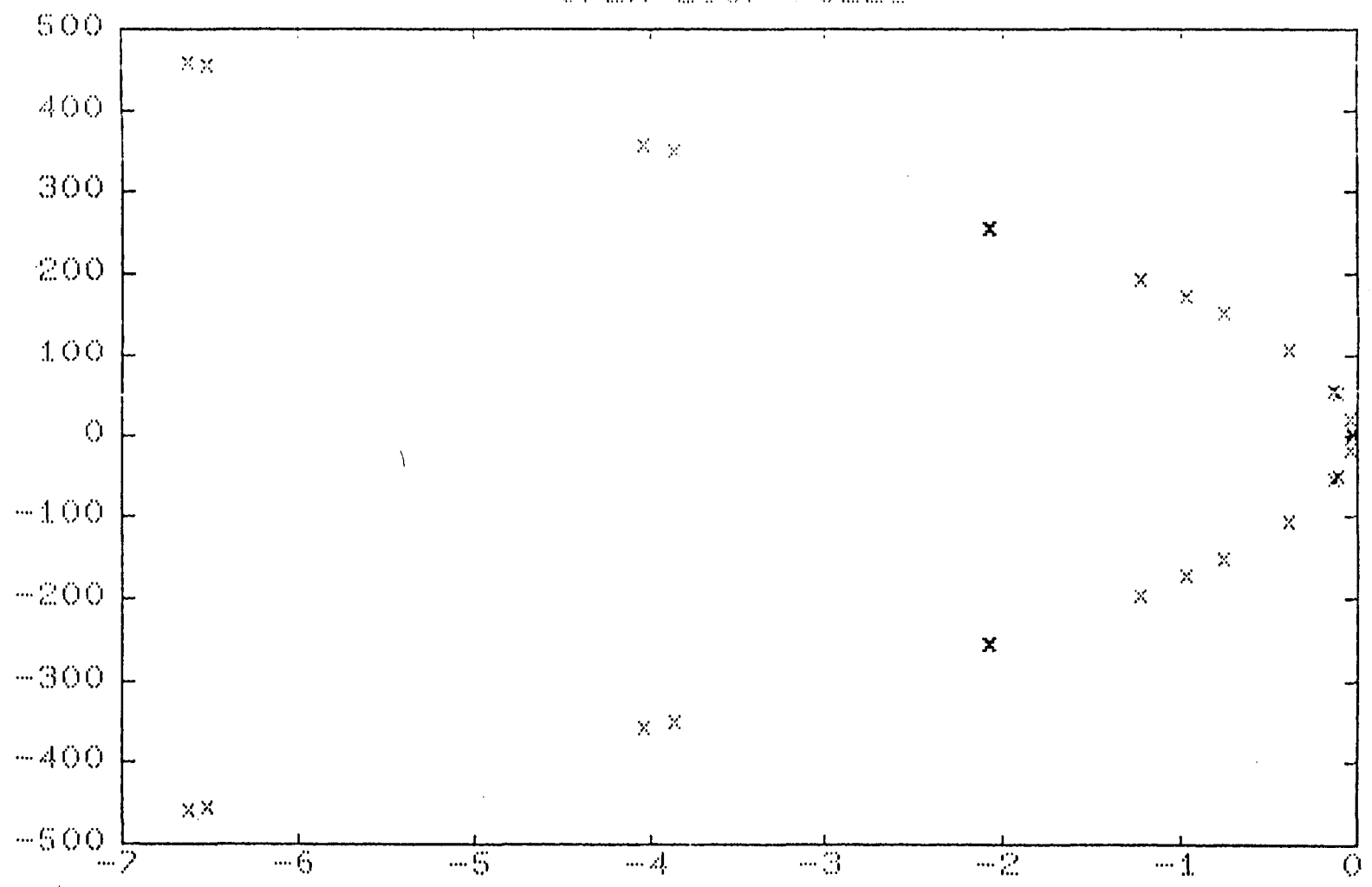

ORIGINAL PAGE IS  
OF POOR QUALITY



OPEN LOOP

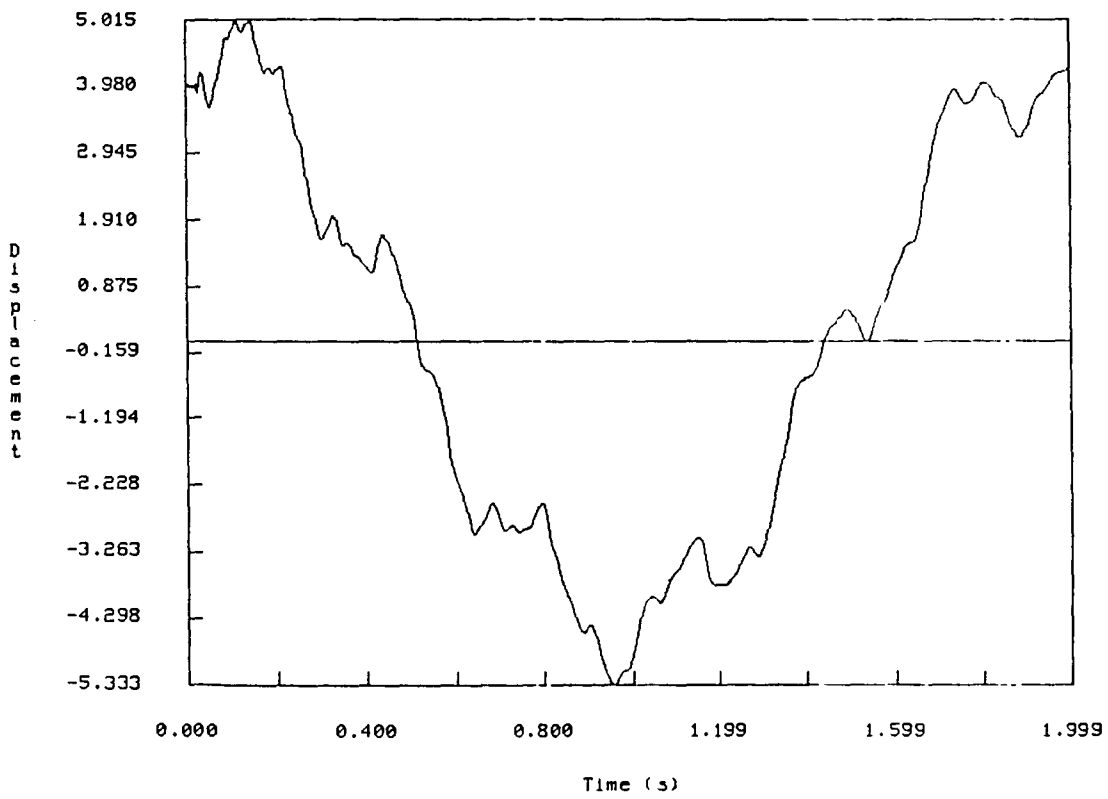

iter23x ■

### OPEN LOOP versus RMF CLOSED LOOP

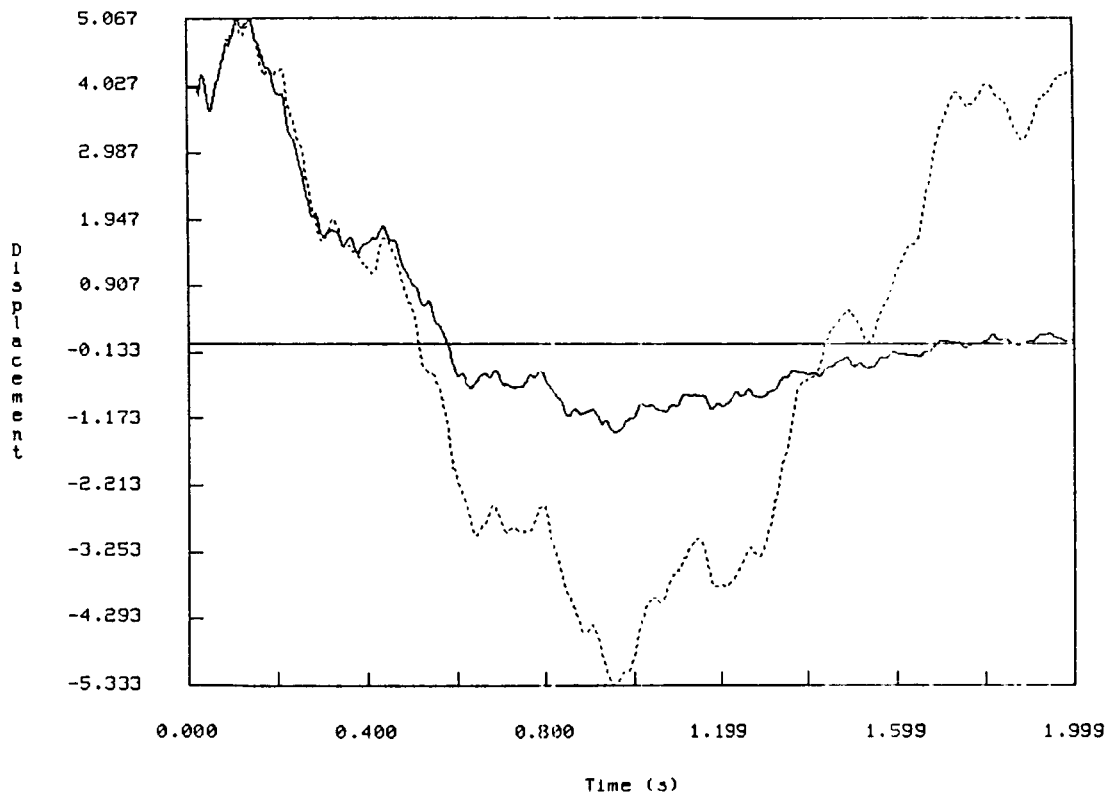

----- Open Loop  
————— RMF Closed Loop



# Flexible Link Robot Arm

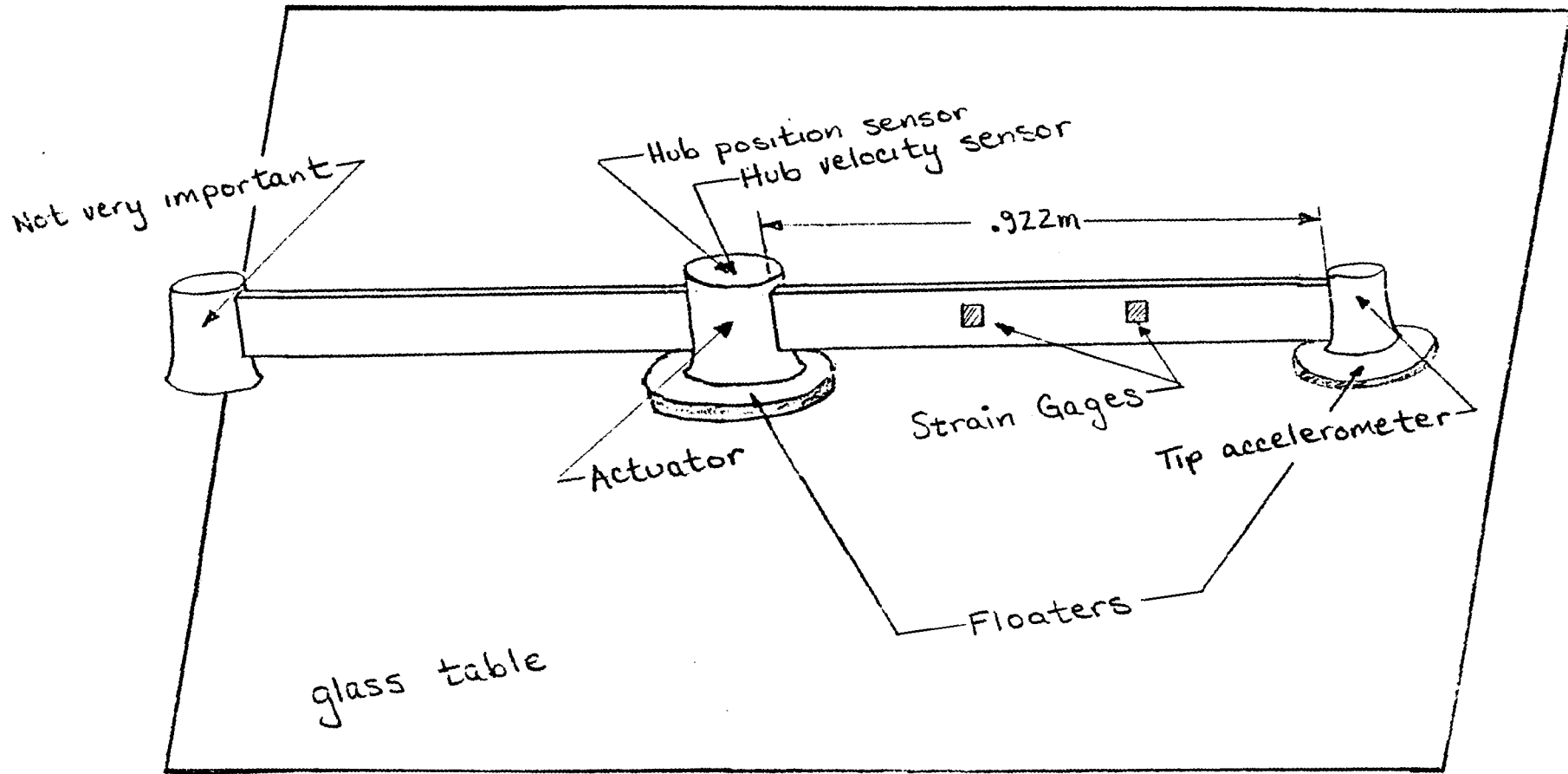

# Tip Position

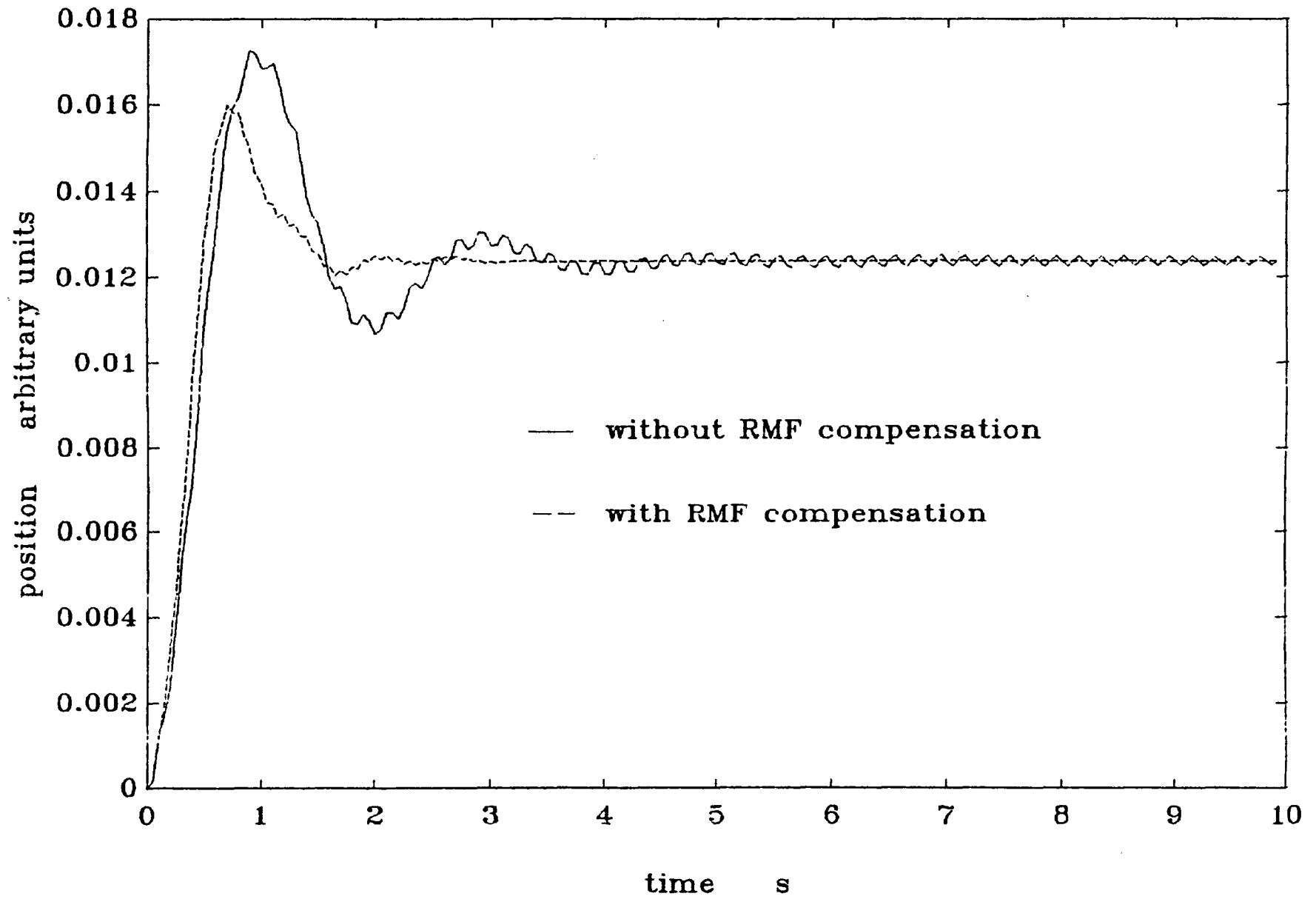

# CSI Compensation for Reduced-Order Model Based Control of a Flexible Robot Manipulator

Brian T. Reisenauer and Mark J. Balas  
*Center for Space Construction*  
*University of Colorado at Boulder*

In controller design for flexible structures, certain system modes are extremely important for the overall performance of the structure. A reduced-order model (ROM) based control focuses on these modes, providing a viable, active control algorithm for large systems. Unfortunately, unmodeled structure dynamics can interact with the ROM controller (CSI), and cause crippling deterioration of system performance, possibly to the point that system stability is lost. A residual mode filter (RMF) eliminates one channel of CSI, while adding only a simple, second-order filter to the control loop. Thus, the ROM controller can be designed independently, based strictly on performance criteria, and residual mode filters can then be selected to compensate for CSI.

A flexible robot manipulator is used for preliminary experimentation with the ROM/RMF design methodology. Since the controller was to be implemented both with, and without compensation for CSI, the ROM control gains are carefully chosen such that closed loop stability is never compromised. In this way, RMF effectiveness is easily evaluated in terms of the improvement in system performance resulting from CSI compensation.

17-1  
165684  
p. 10



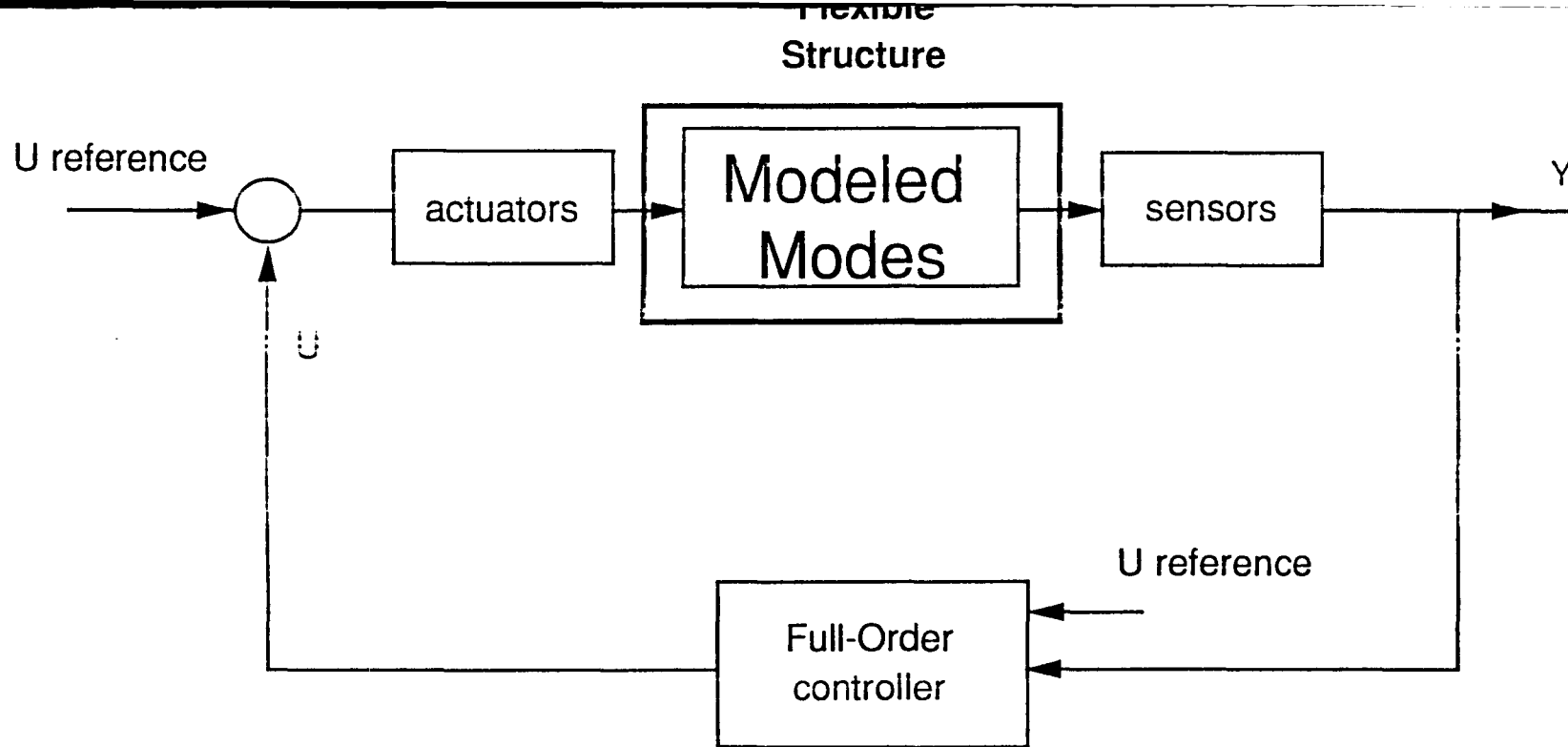

- **Develop a full-order controller, designed for stability and performance.**
  - **No Residual Mode Interaction (R.M.I.) since controller is full order.**
- BUT**
- **Design becomes impossible to implement as the size of the flexible structure increases.**

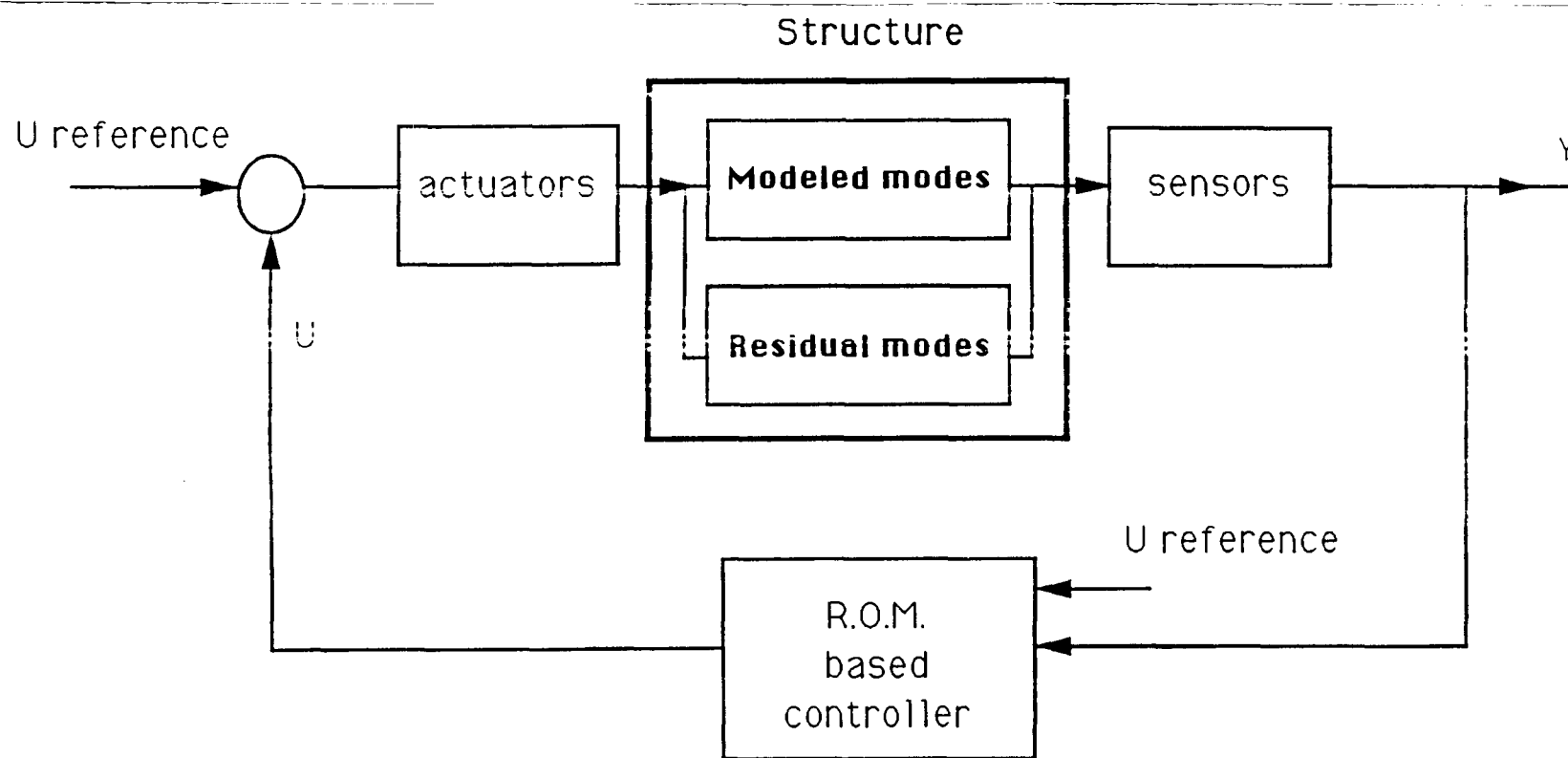

- **Develop a R.O.M. controller, designed for performance.**
- **Dimension of the controller  $\ll$  dimension of the structure.**

BUT

- **Energy is pumped into all modes by the R.O.M. controller.**
- **Some residual modes may be driven unstable; this is known as Controller / Structure Interaction (C.S.I.)**

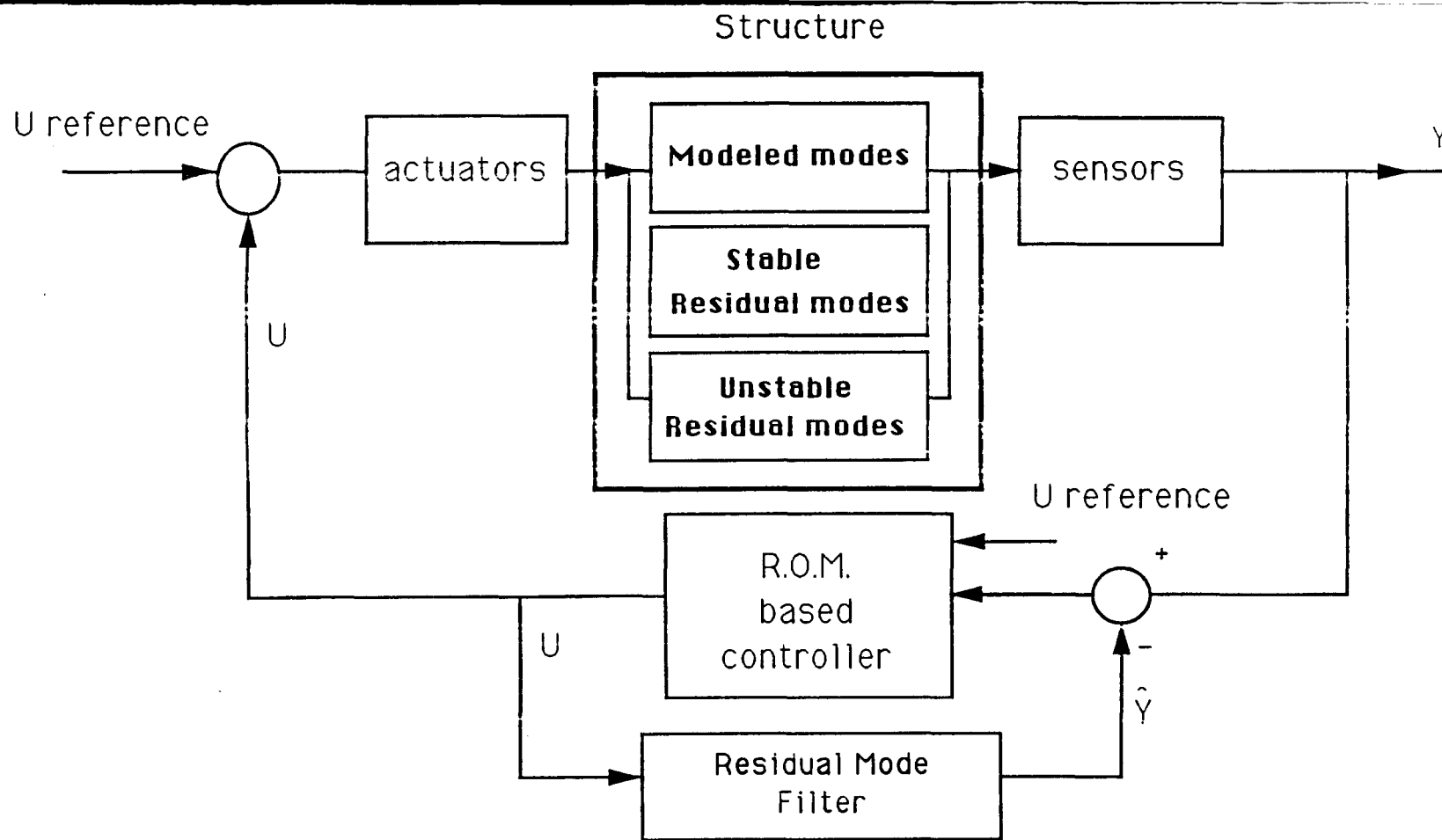

- **Develop R.M.F. as a bank of parallel second-order filters; one filter for each unstable residual mode.**
- **R.M.F. interrupts the control loop around all unstable residual modes; R.O.M control input is screened.**
- **R.M.F. compensates for C.S.I. , insuring system stability.**

ROM / RMF  
Implementation  
on  
the

A.L.S. Flexible Robot  
Manipulator Experiment

at

Martin  
Marietta

# Flexible Link Robot Arm

M. Stoughton  
M. Ramey

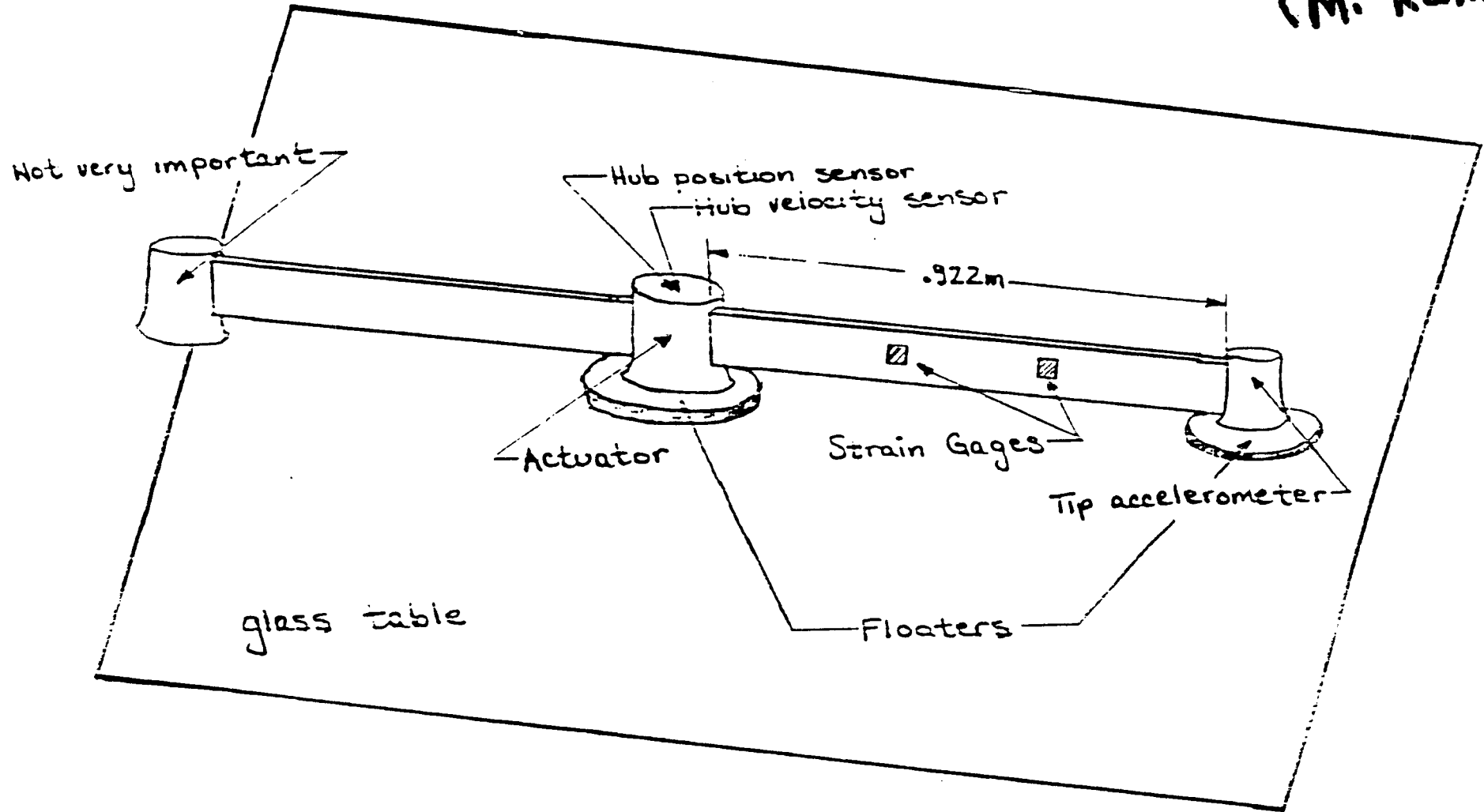

NOTE: Drawing is not to scale nor to perspective nor does it even resemble the actual arm in the slightest



# Closed Loop Poles S-plane

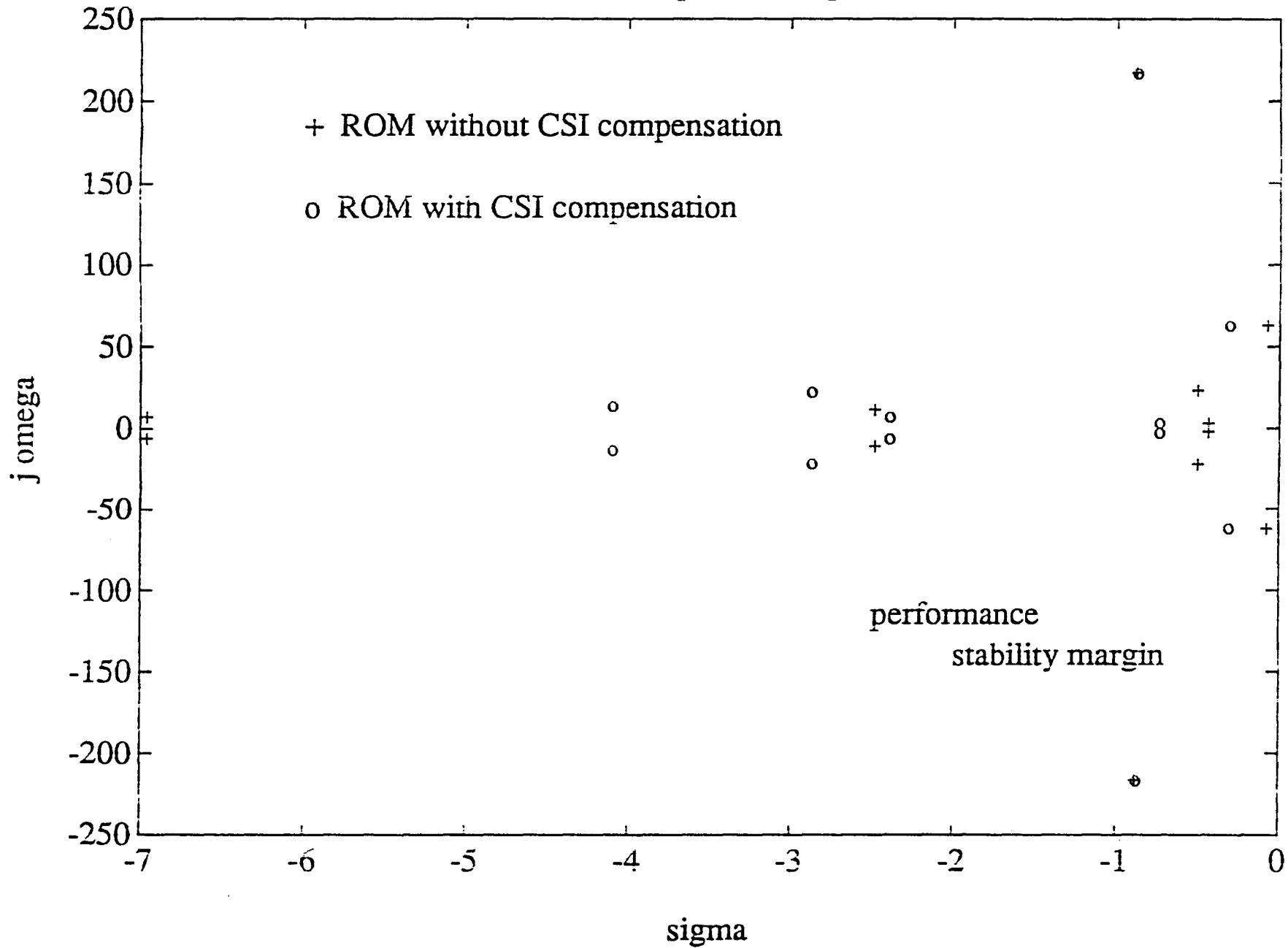

# Tip Position

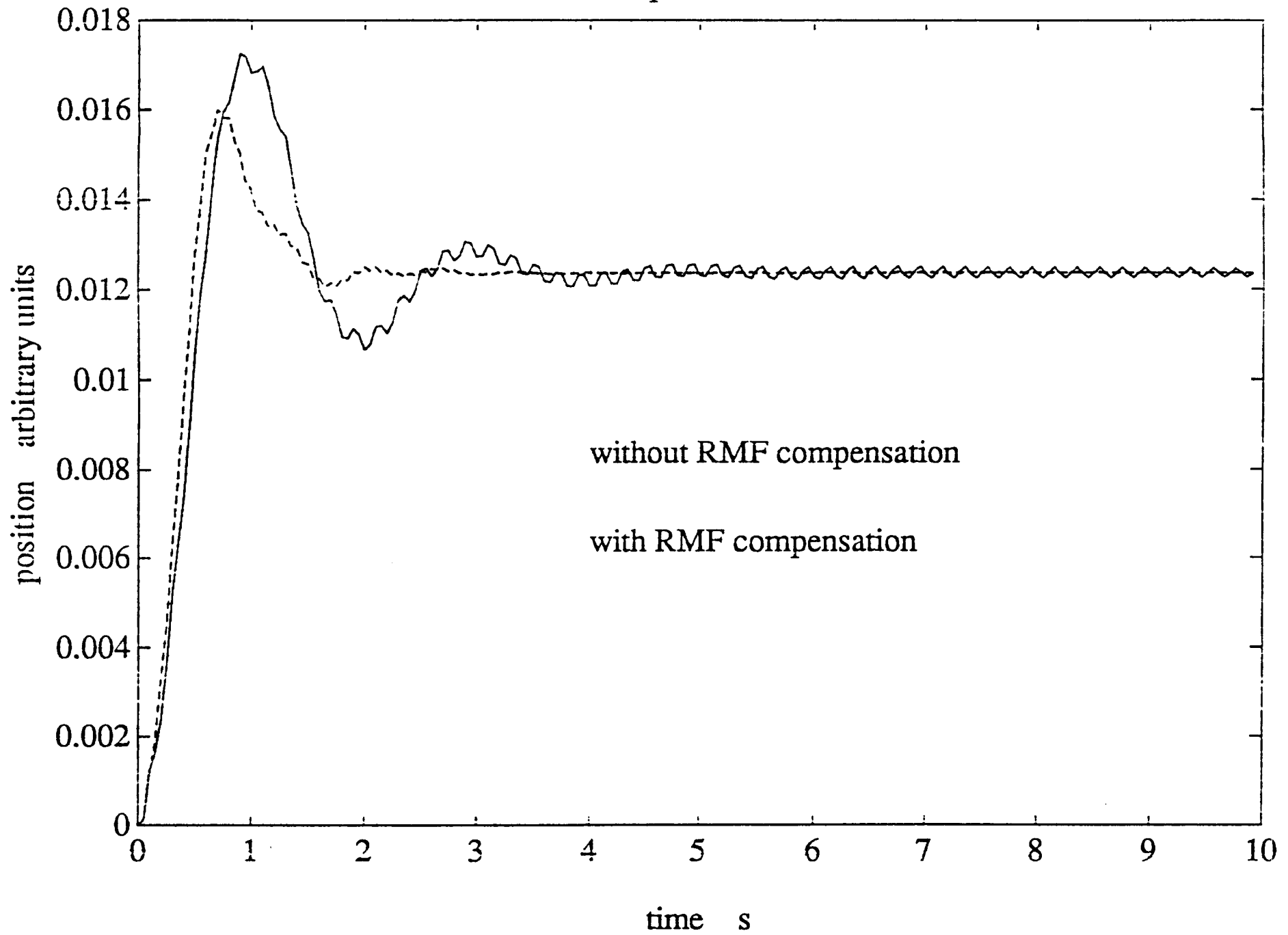

# Tip Velocity

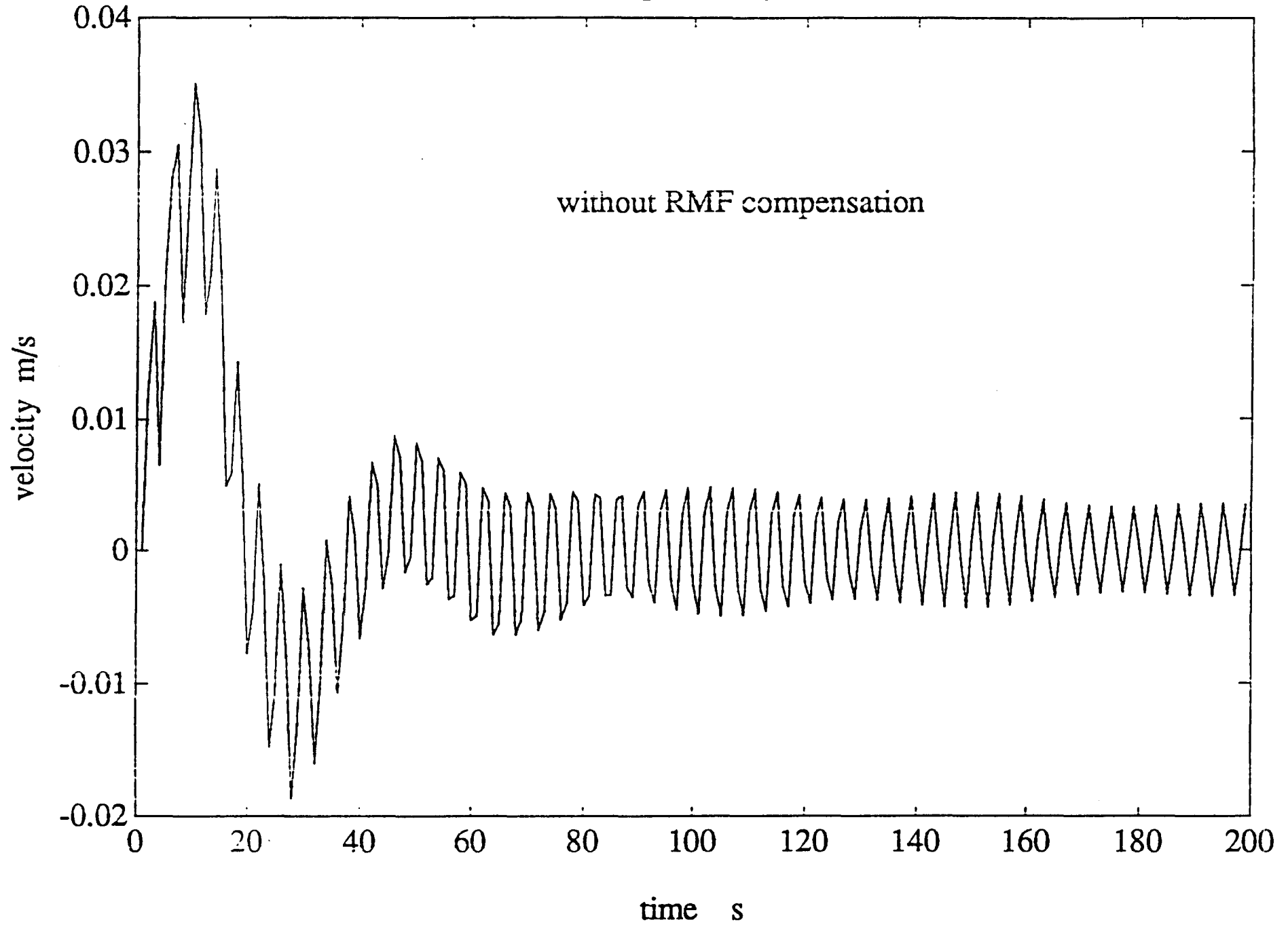

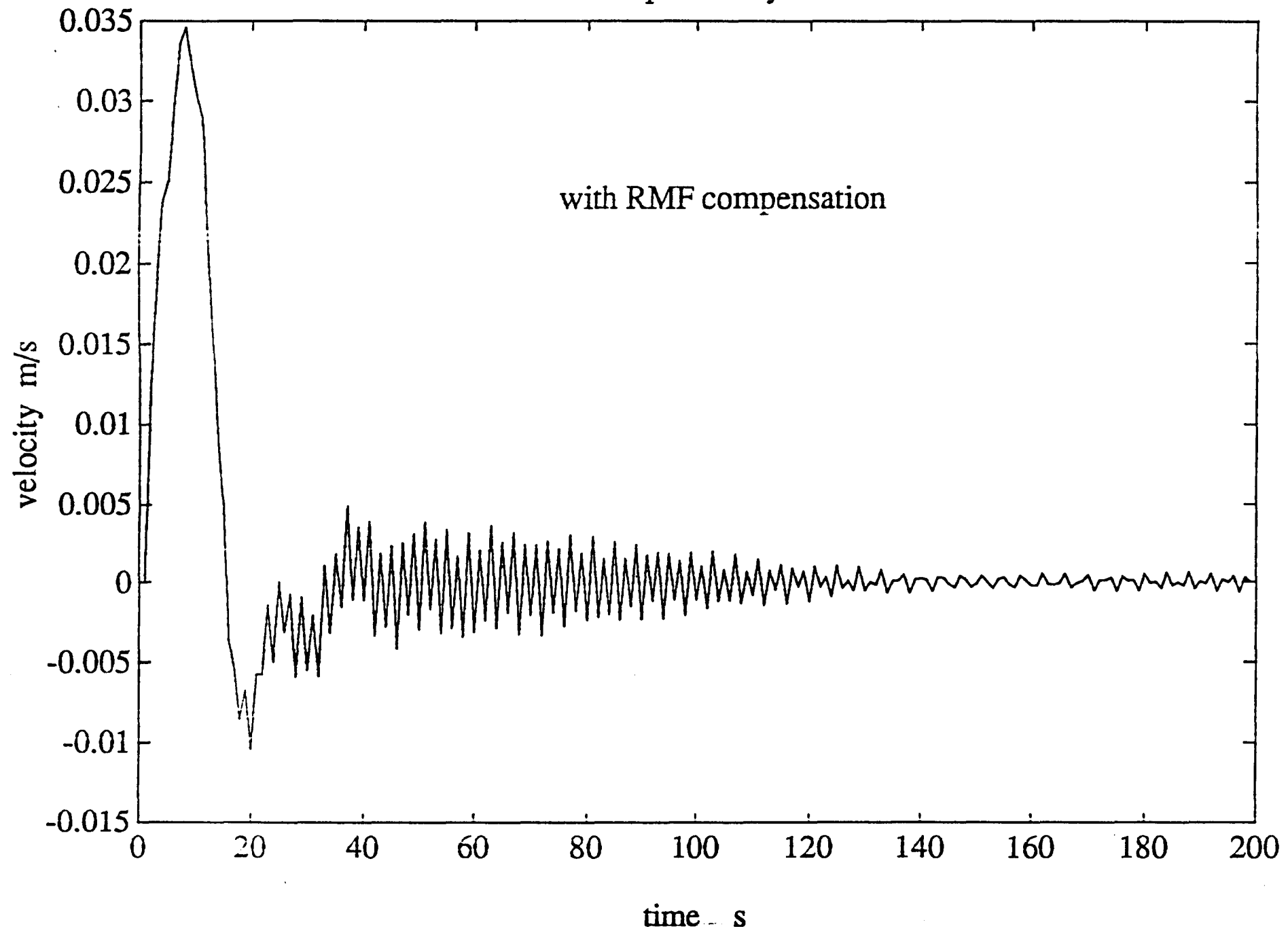

with RMF compensation

# Residual Mode Filters and Adaptive Control in Large Space Structures

Roger A. Davidson and Mark J. Balas

Center for Space Construction  
University of Colorado at Boulder

One of the most difficult problems in controlling large systems and structures is compensating for the destructive interaction which can occur between the reduced-order model (ROM) of the plant, which is used by the controller, and the unmodeled dynamics of the plant, often called the residual modes. The problem is more significant in the case of large space structures because their naturally light damping and high performance requirements lead to more frequent, destructive residual mode interaction (RMI). Using the design/compensation technique of residual mode filters (RMF's), effective compensation of RMI can be accomplished in a straightforward manner when using linear controllers. The use of RMF's has been shown to be effective for a variety of large structures, including a space-based laser and infinite dimensional systems.

However, the dynamics of space structures is often uncertain and may even change over time due to on-orbit erosion from space debris and corrosive chemicals in the upper atmosphere. In this case, adaptive control can be extremely beneficial in meeting the performance requirements of the structure. Adaptive control for large structures is also based on ROM's, and so destructive RMI may occur. Unfortunately, adaptive control is inherently nonlinear, and therefore the known results of RMF's cannot be applied here. The purpose of this paper is to present the results of new research showing the effects of RMI when using adaptive control and the work which will hopefully lead to RMF compensation of this problem.

1102685  
P. 9

## What is R.M.I.?

- A) Really Maddening Institution
- B) Roving Mediocre Individuals
- C) Residual Mode Interaction
- D) All of the above
- E) It depends on your audience.

The correct answer is ~~A~~.

C

RMI is the interaction between the residual modes (unmodeled dynamics) of a large flexible structure and its controller.

RMI may lead to performance degradation and even instability.

# Large Space Structure

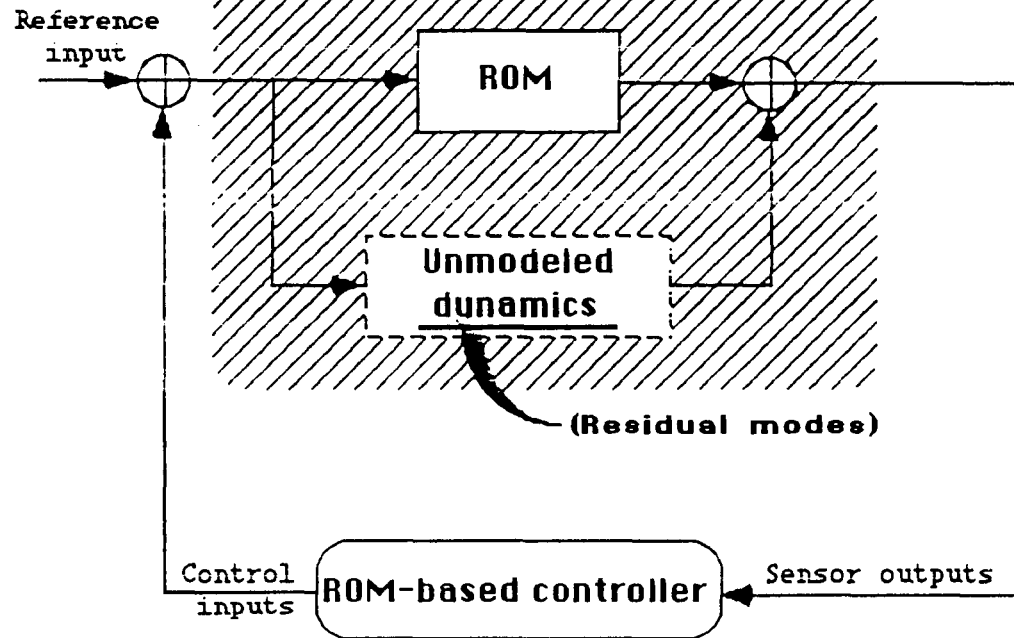

Controller-structure Interaction  
or  
Residual mode Interaction

IS THERE A CURE FOR RMI?

***YES!!!***

Until relatively recently RMI was incurable, but due to the work of Dr. Mark Balas (and his students), Residual Mode Filters were discovered.

The technique for using RMF's is a proven step-by-step method of RMI compensation which prevents costly, unguided redesign of linear controllers.

RMF's are simple to construct, are designed separately from the original controller, and are guaranteed to restore stability to your structure!



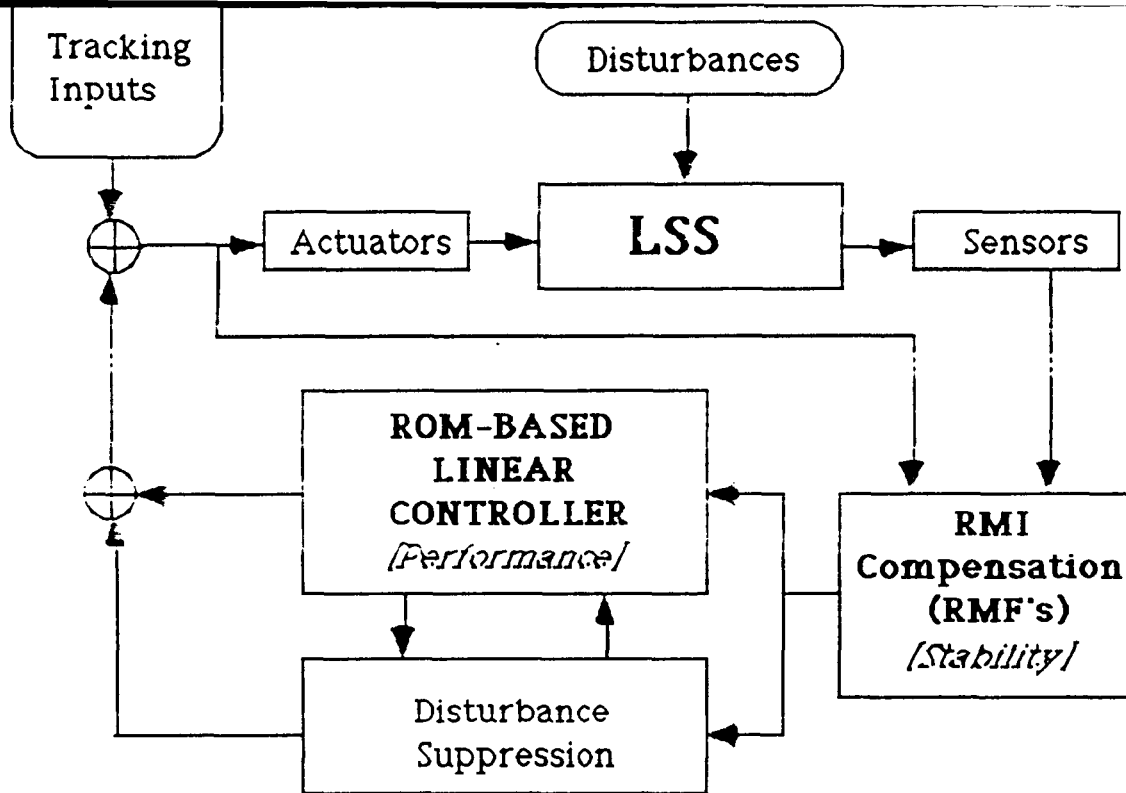

Regaining stability using Residual Mode Filters (RMF's) to compensate for Residual Mode Interaction (RMI) between a Large Space Structure (LSS) and its Reduced-Order-Model-Based Linear Controller.

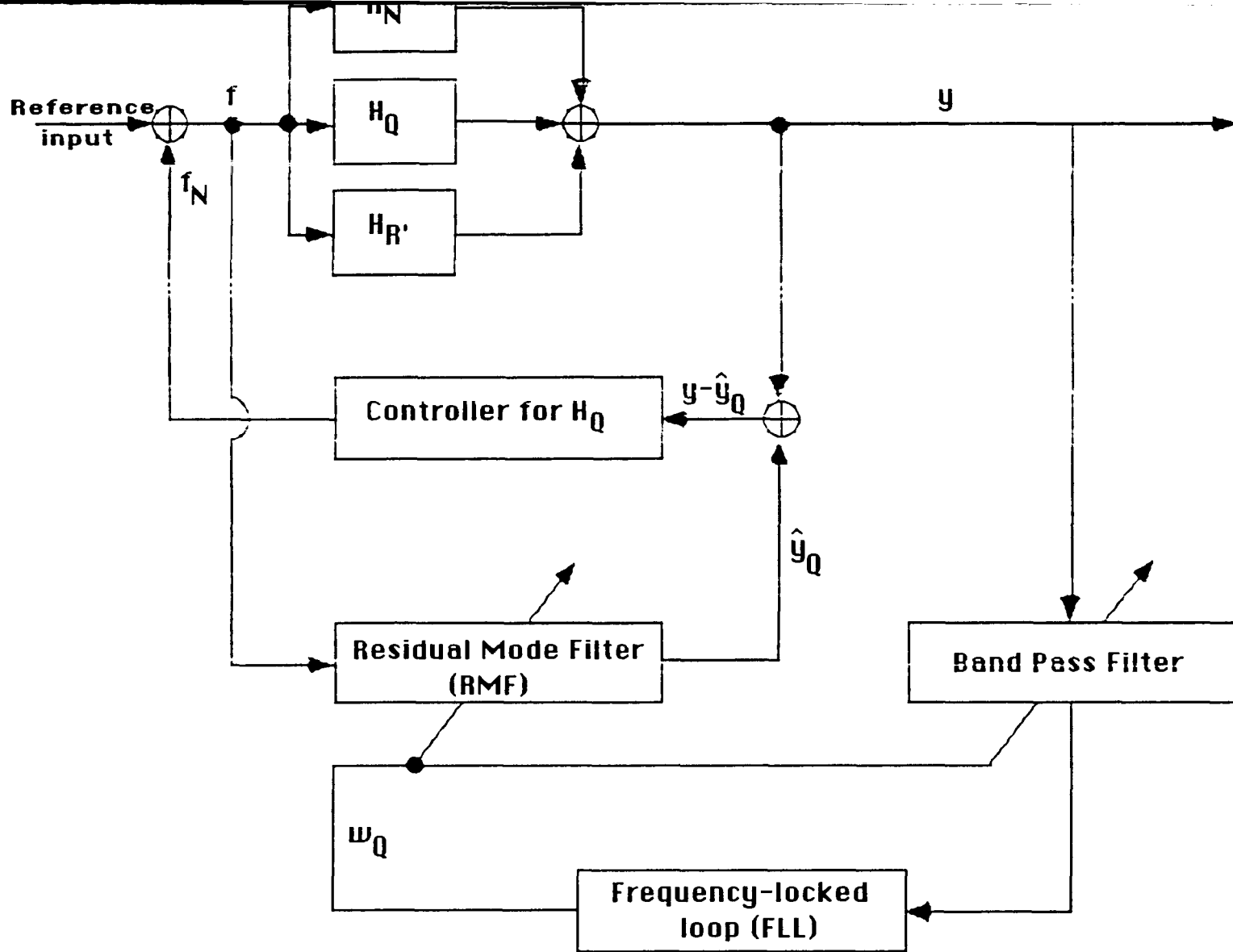

Block diagram of adaptive RMF controller

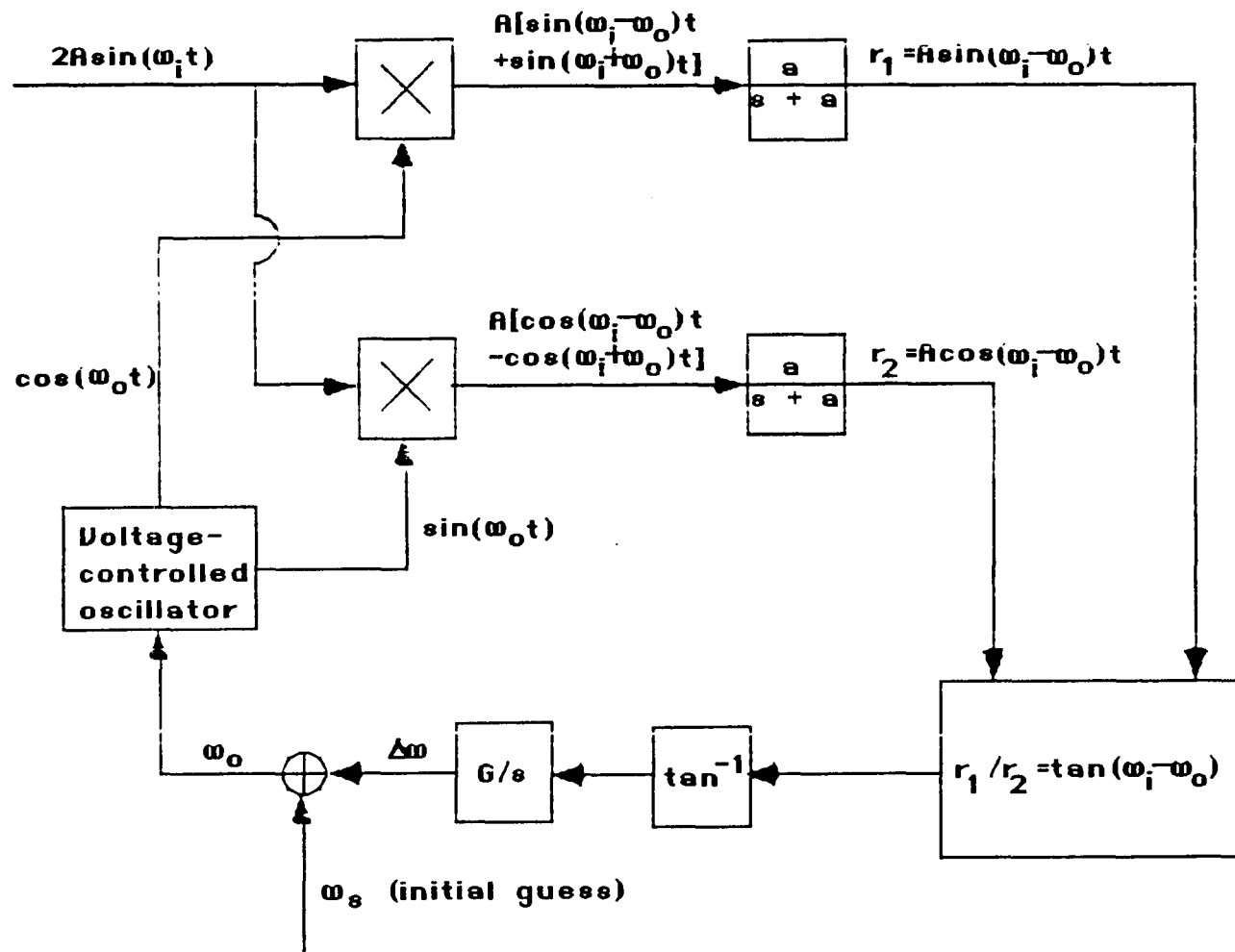

Block diagram of the FLL implementation

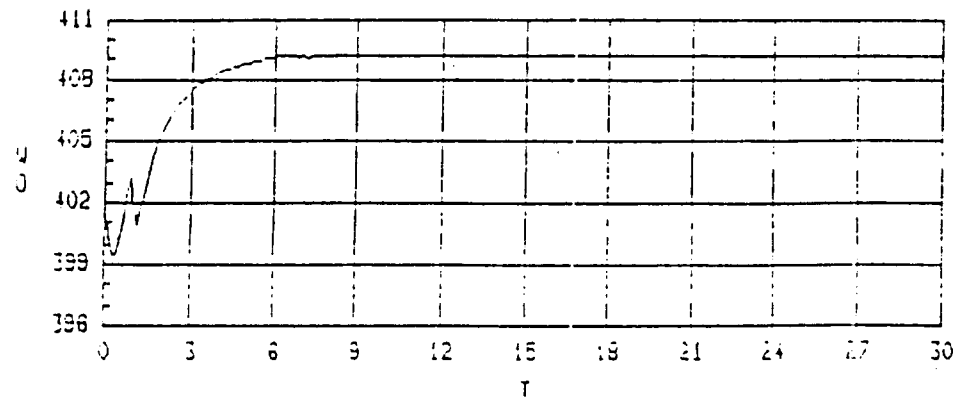

**FLL output for RMF in Space Based Laser (SBL) control simulation**  
 $\omega_s = 400.62, a = 2, G = 10$

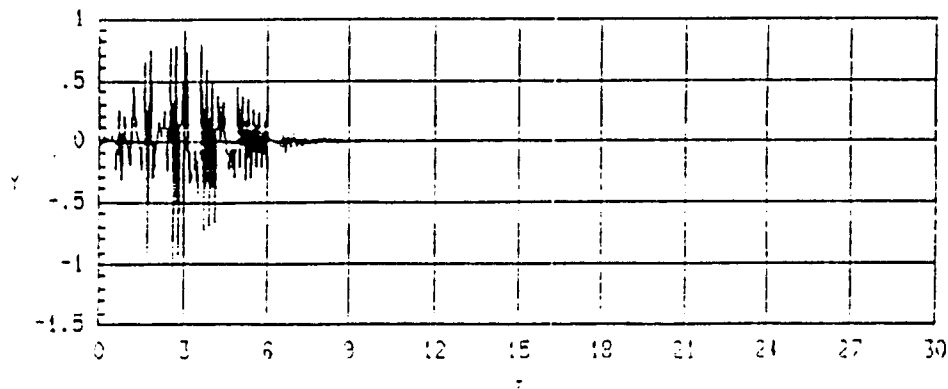

**SBL output using adaptive RMF's with on-line FLL's**

that sounds great, but what happens if the original controller is nonlinear, such as an adaptive control scheme?

In this case, RMF compensation has no theoretical basis, and the alternatives are neither kinder nor gentler.

However, there is a glimmer of hope because much research is being done now into the area of RMI with adaptive control and how to compensate for it.

Please feel free to ask this young man any questions on this research (his Ph.D. topic) or related concerns.

Center for Space Construction  
Structures Cluster

160-186

P. 30

## FLUID MANAGEMENT IN SPACE CONSTRUCTION

*H. Snyder*  
*Department of Space Construction*  
*Center for Space Construction*  
*University of Colorado, Boulder, CO 80309*

October 12, 1989

The low-g fluids management group within the Center for Space Construction is engaged in active research on the following topics: gauging; venting; controlling contamination; sloshing; transfer; acquisition; and two-phase flow. Our basic understanding of each of these topics at present is inadequate to design space structures optimally. A brief report will be made on each topic showing the present status, recent accomplishments by our group and our plans for future research.

### **Associates**

#### **Supported by CSC:**

Mr. G. Mills, Ph.D. Student  
Mr. D. Newell, Undergraduate Assistant

**Fluid Management**

in

**Space Construction**

Prof. Howard Snyder

## **Construction requires:**

### **Fuel:**

hydrazine  
liquid oxygen  
liquid hydrogen

### **Life support:**

water  
liquid nitrogen  
liquid oxygen

**Save weight by storing at saturation.**



## Functions of Fluid Management System

- 1 Transportation from Earth to Station
- 2 Transportation from Station to other satellites
- 3 Storage
- 4 Distribution and control on Station
- 5 Habitability by astronauts
- 6 Disposal and contamination control

## Complications of Space Operation

- 1 Low gravity – physical processes change
- 2 Weight limiatations
- 3 Low power usage
- 4 Interaction with Station
- 5 Reliability
- 6 Safety

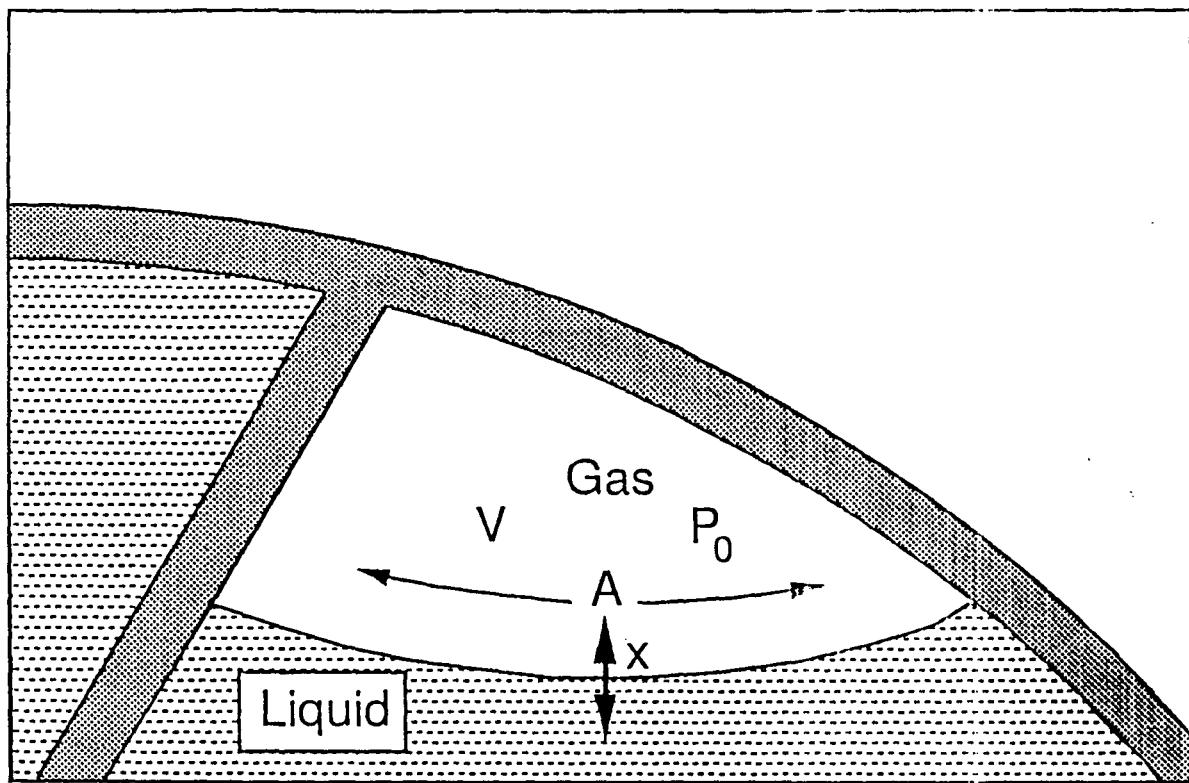

A trapped bubble

## Functional Units

- 1 Storage container
- 2 Thermal control – stratification
- 3 Venting – for saturated storage
- 4 Gauging
- 5 Sloshing and dynamic coupling
- 6 Acquisition of liquid
- 7 Pumping
- 8 Transfer
- 9 Couplings – heat and leak control
- 10 Dispersing
- 11 Separation
- 12 Waste fluid treatment

## Gauging

JSC + BALL AEROSPACE

HOWARD SNYDER (CSC)

ALLAN MORD (BALL)

Trade-off study leads to:

Sinusoidal adiabatic compression,  
Radio frequency probing.

Developed experimental apparatus  
to meet JSC specifications.

Developed theory of compression gauging –  
a data reduction algorithm.

Publication: Analysis of acoustic  
boundary layers in  
compression gauging.  
APS fall meeting 1988.

# COMPRESSION GAGING CONCEPT

URE 2-1  
/ISED 10/26/88

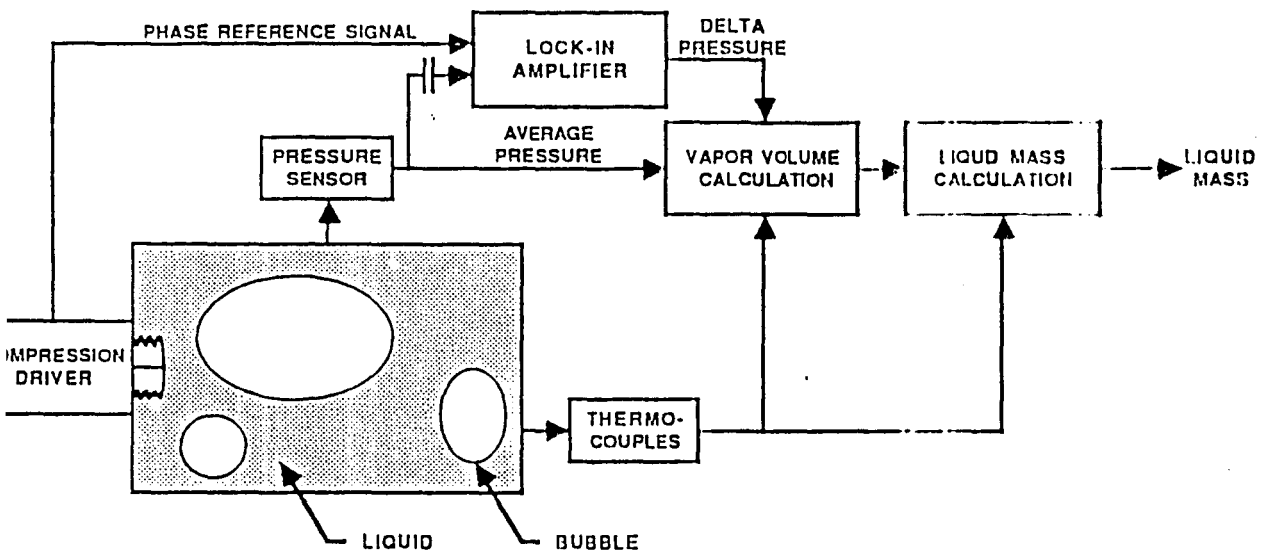

# Acoustic Boundary Layer

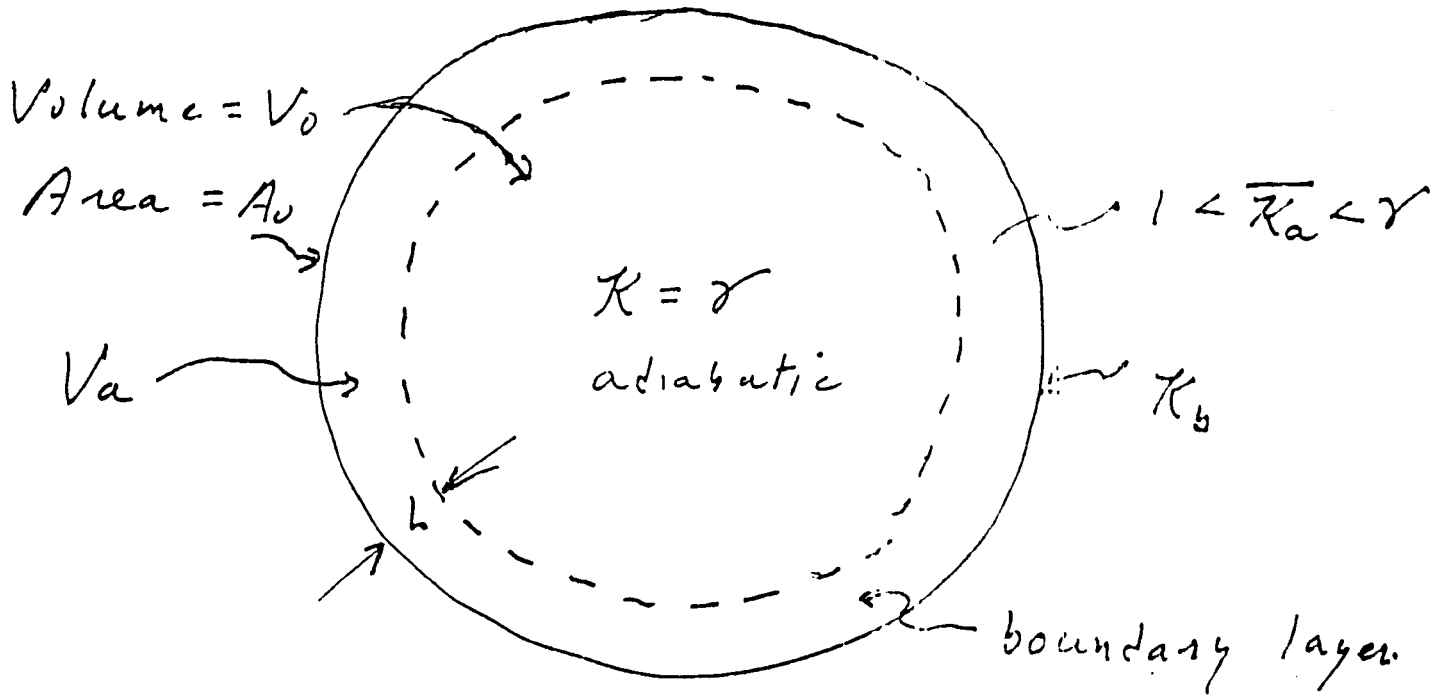

Average Compressibility - a volume average

$$\frac{1}{K} = \frac{1}{K_{\text{average}}} = \frac{1}{\gamma} \frac{[V_0 - V_a]}{V_0} + \frac{1}{K_a} \frac{V_a}{V_0}$$

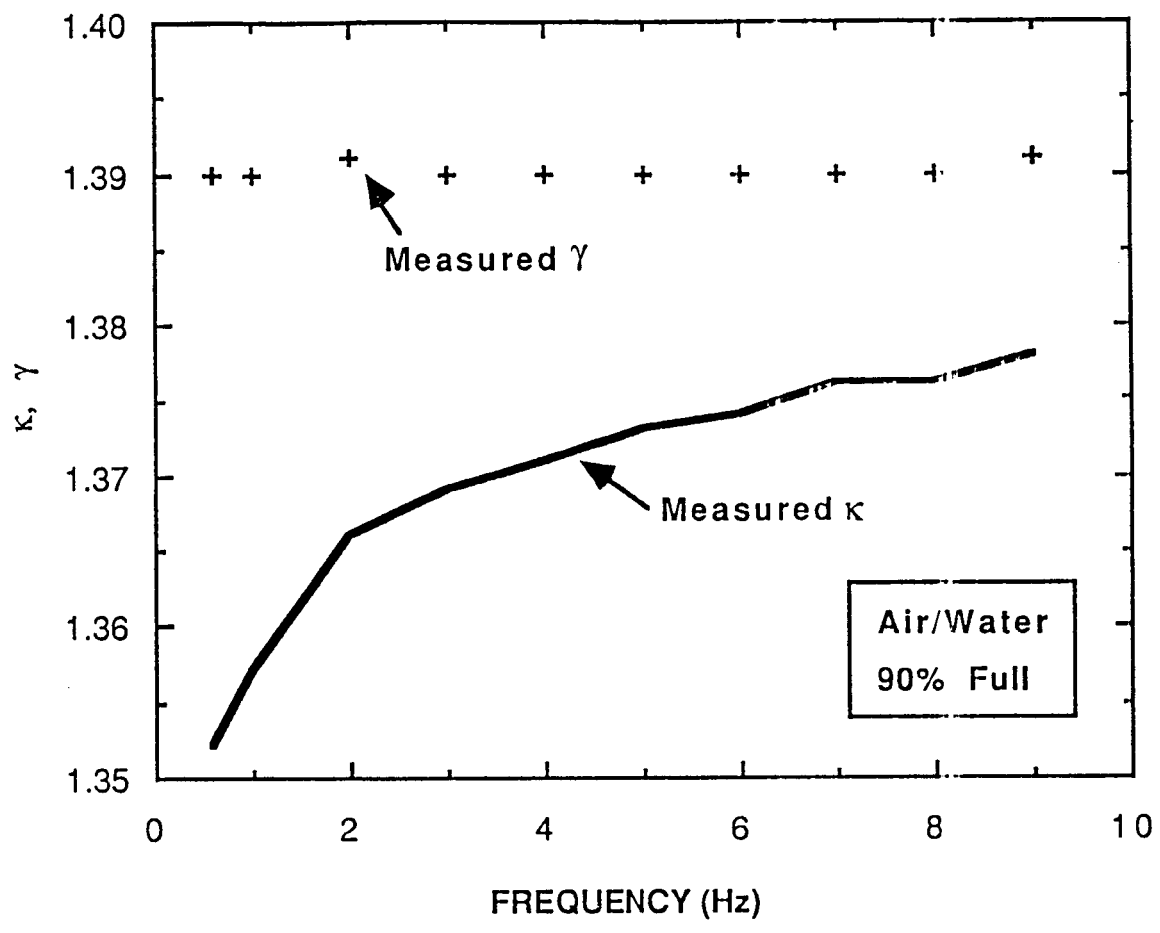

Figure C-2



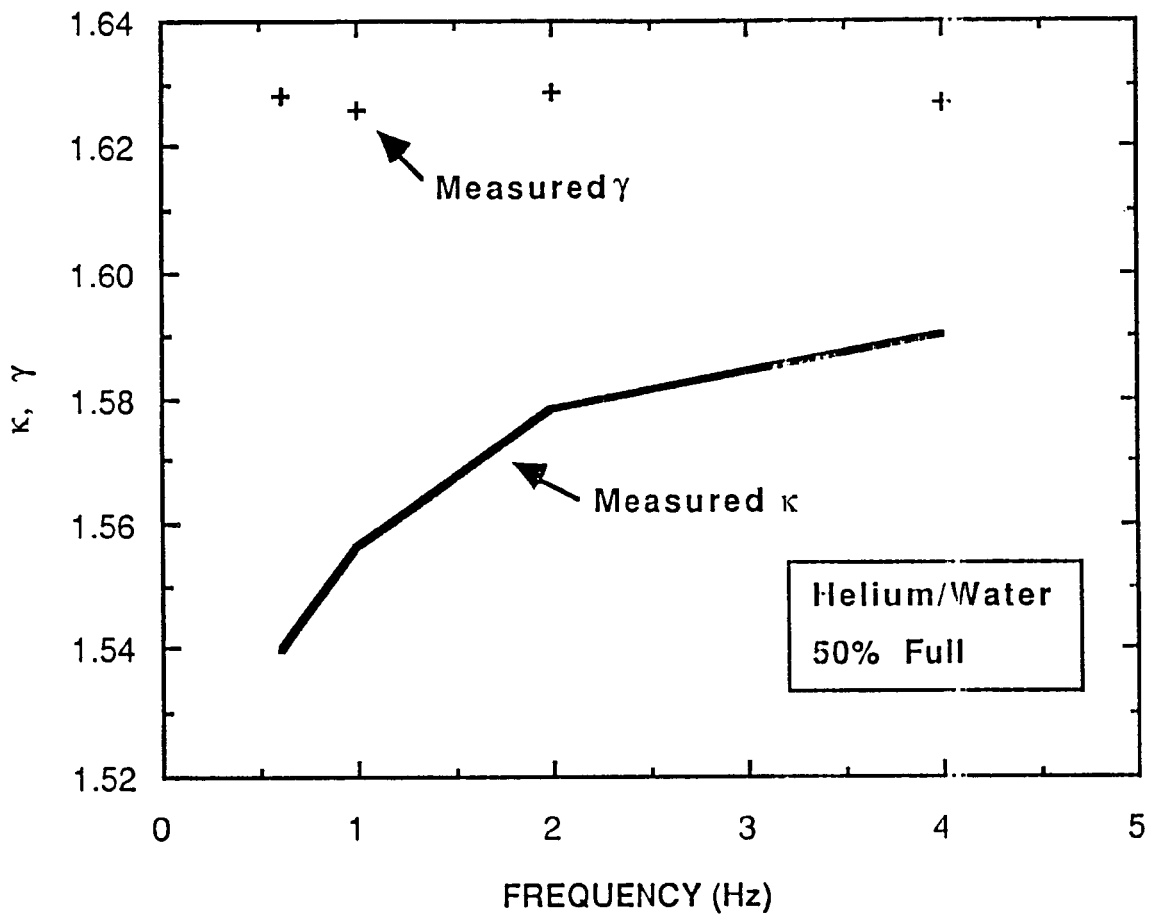

Figure C-3

**Use of Pressure Gauge  
in Low-g**

**JSC + BALL AEROSPACE**

**HOWARD SNYDER (CSC)  
ALLAN MORD (BALL)**

Developed theory for use  
immersed in liquid or gas.

Correct reading at very low frequencies.

Background acceleration  
in random directions  
at random frequencies

How to design diaphragm gauges  
to reduce effect.

How to correct readings  
to reduce effect.

# MASS-SPRING MODEL WITH BUBBLE

FIGURE H-4  
REVISED 10/27/88

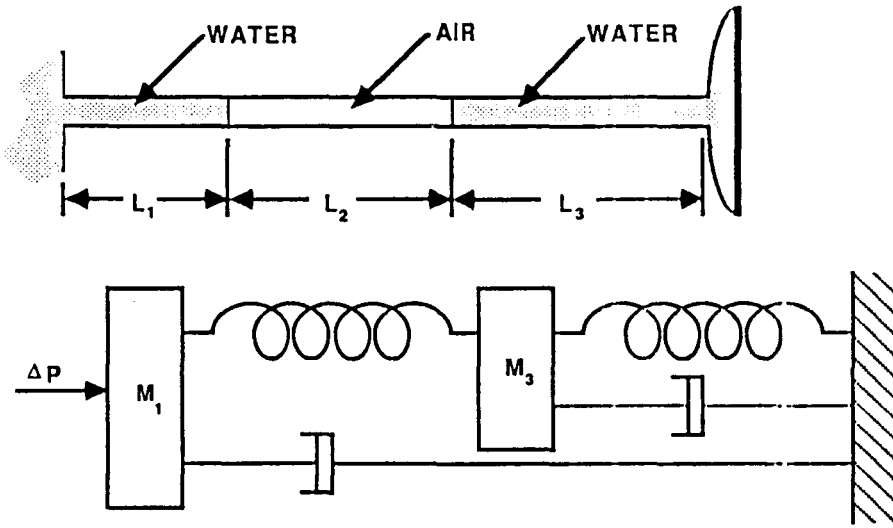

# TRANSDUCER TUBE AND DIAPHRAGM GEOMETRY

FIGURE H-1  
REVISED 10/27/88

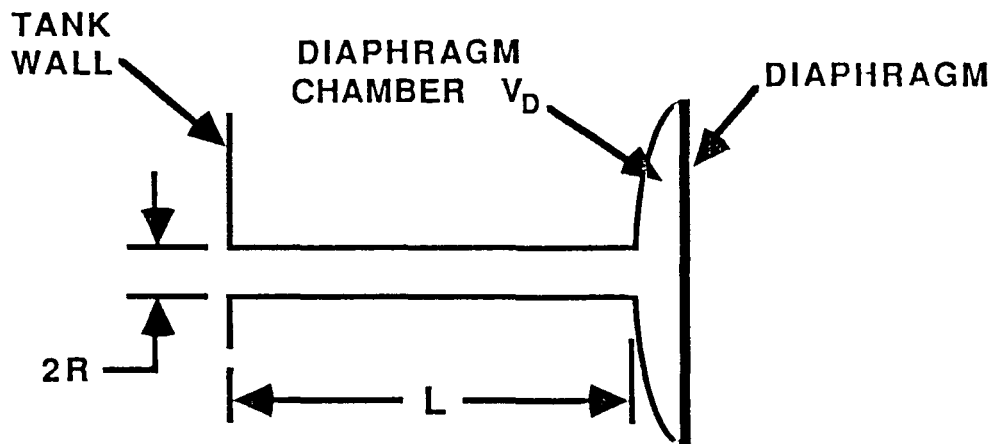

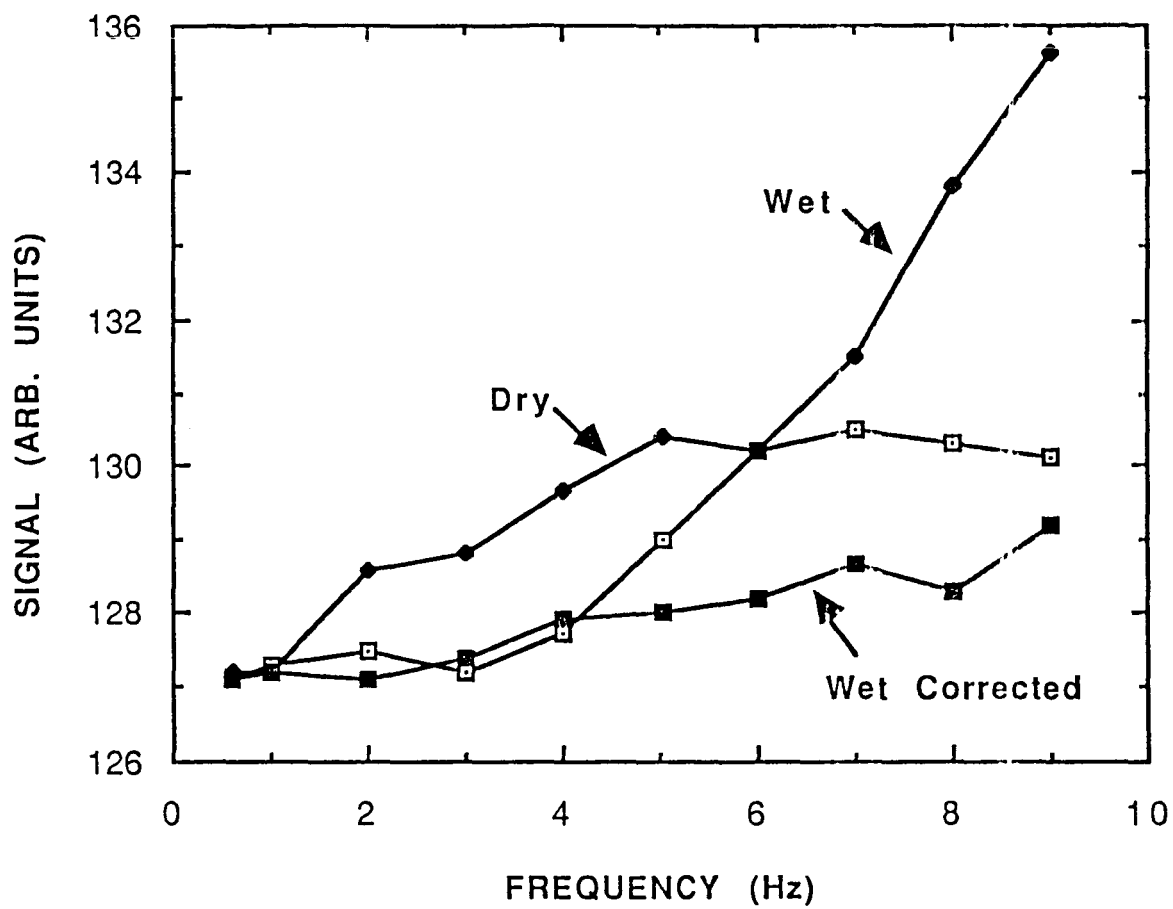

Figure 4-11

Venting  
by Porous Plug

BALL AEROSPACE IR&D  
HOWARD SNYDER (CSC)

Computer model:

Includes:

- Flow of liquid
- Thermal flow in liquid
- Thermal flow in matrix
- Evaporation
- Downstream line impedance
- Regression of evaporation  
front into matrix.

Plan lab test of theory as part of XFIS.

## Transfer

**BALL AEROSPACE FUNDS  
HOWARD SNYDER (CSC)  
ALLAN MORD (BALL)**

Computer model of transfer  
of a cryogen.

Includes superfluid helium

Models:

- heat flux in liquid
- heat flux through  
walls of transfer tube
- pumps
- heat exchangers
- constrictions due to valves,  
change of diameter,  
bends, corregation, etc.

Calculates:

- heat flux
- mass transfer rates
- pressure and  
temperature profiles
- point of boiling

Used to optimize transfer system.

TEMPERATURE  
System

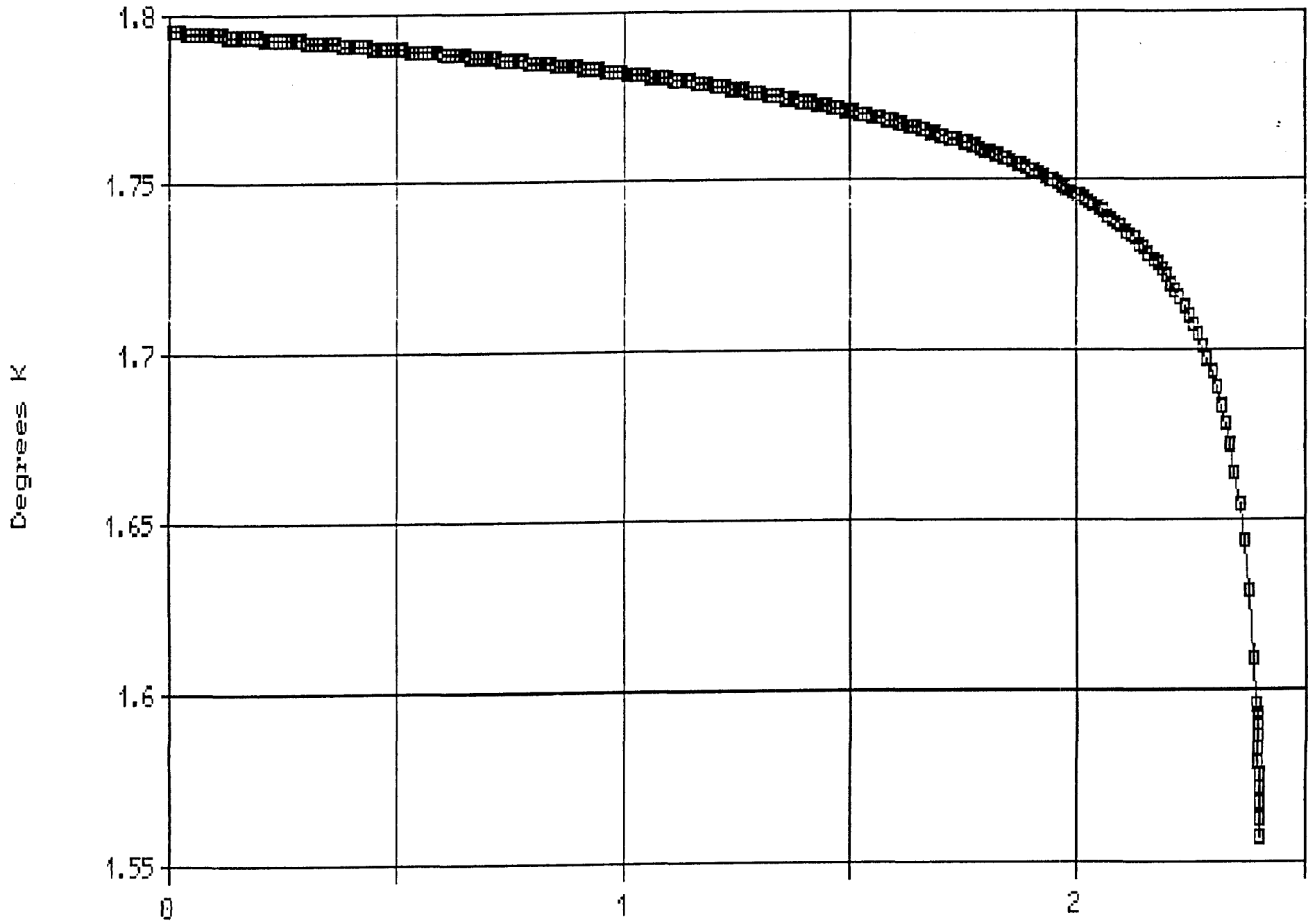



Transfer  
and  
Pumping

AMES + BALL + CSC

GARY MILLS (BALL & CSC)

DAVID NEWELL (CSC)

Proof of principal experiments:

- transfer of superfluid helium
- transfer at high rate
- realistic large heat leak
- porous plug pump
  - with no moving parts
- realistic lengths and impedances
- comparison of results with computer model.

**Acquisition**  
**and**  
**Fluid Management**

**CSC & BALL IR&D (?)**  
**GARY MILLS (CSC & BALL)**  
**DAVID NEWELL (CSC)**  
**HOWARD SNYDER (CSC)**

Swirl – used for:

acquisition  
venting  
gauging  
thermal management

Thermal gradient management

used for:

acquisition  
venting

Acoustic coalescence

used for:

gauging  
venting

Planned for next two years.

# SWIRL CONCEPT

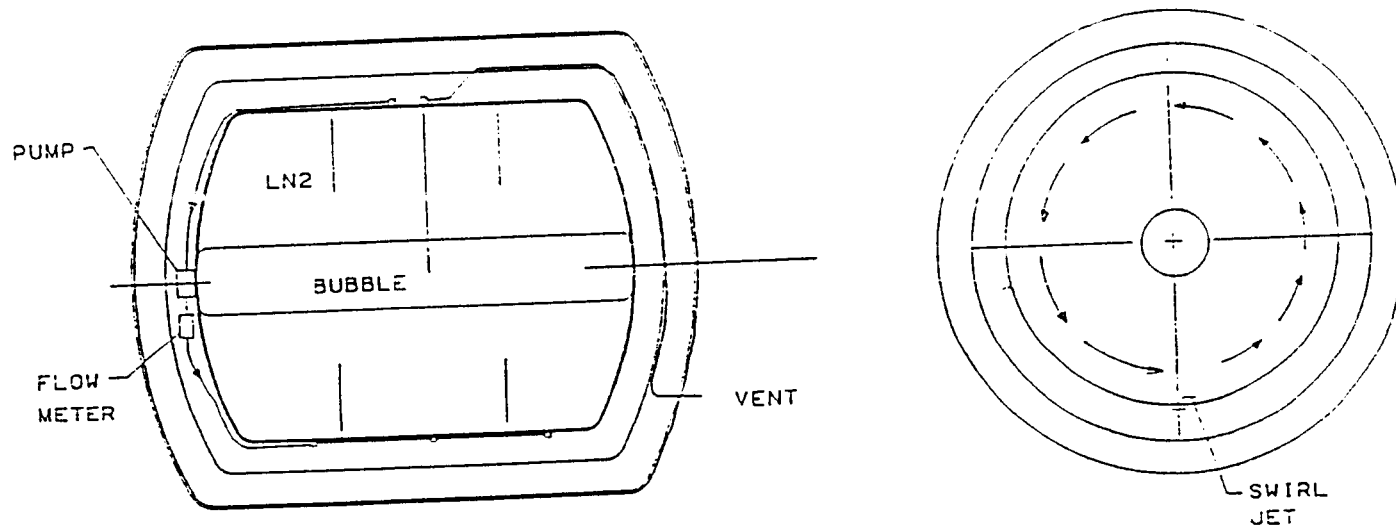

FIGURE 1

## Sloshing

CSC + BALL IR&D

HOWARD SNYDER (CSC)

ALLAN MORD (BALL)

DAVID NEWELL (CSC)

Discovered cooperative oscillations  
of bubbles.

A serious problem:

    motion of center of gravity  
    same frequency range as  
    structural vibrations of Station

Did experiments and developed theory  
Theory and experiment agree

Can predict:

    frequency  
    amplitude  
    Q of resonance

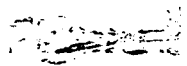
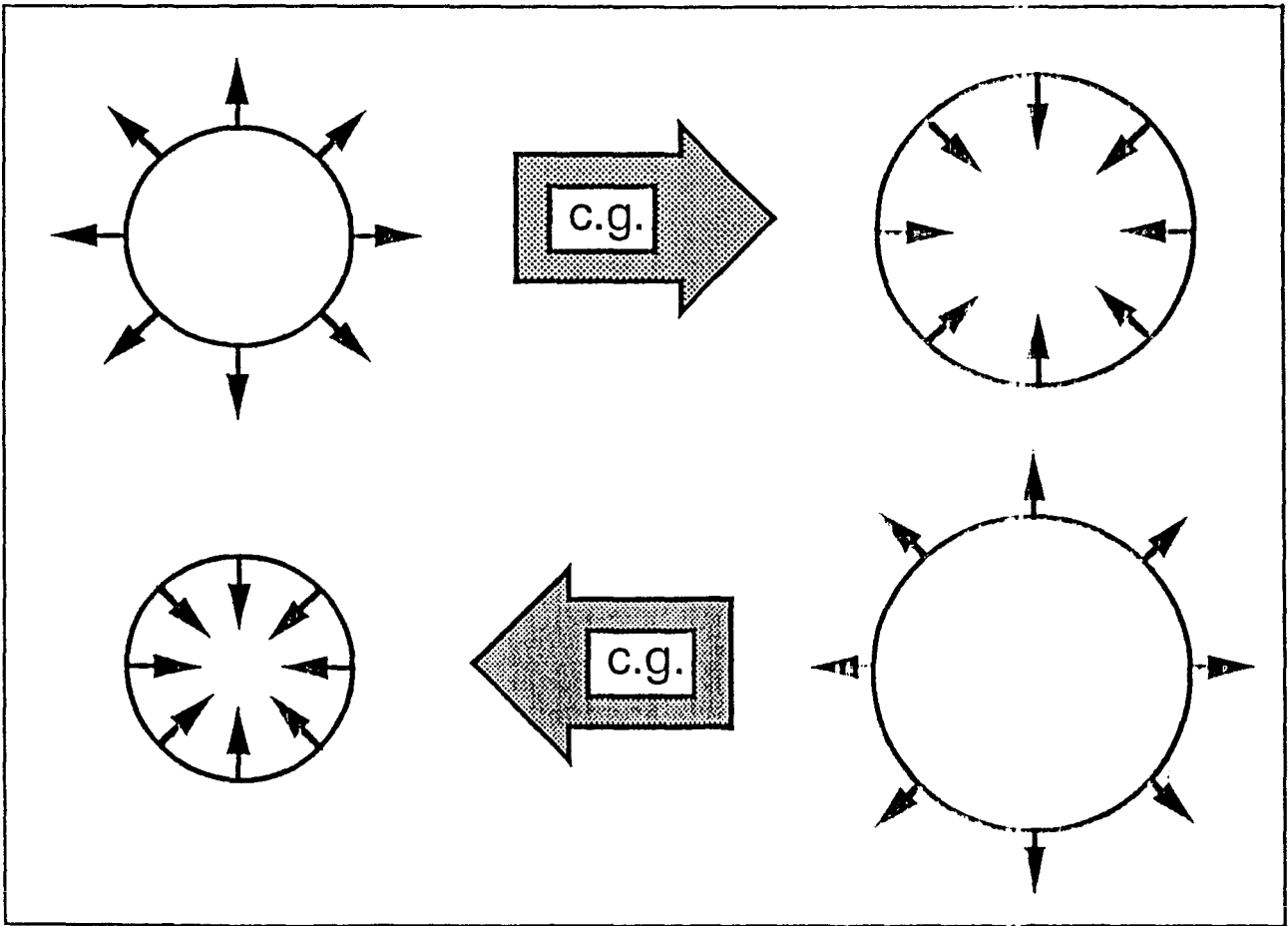

Motion of the center of gravity due to cooperative oscillations

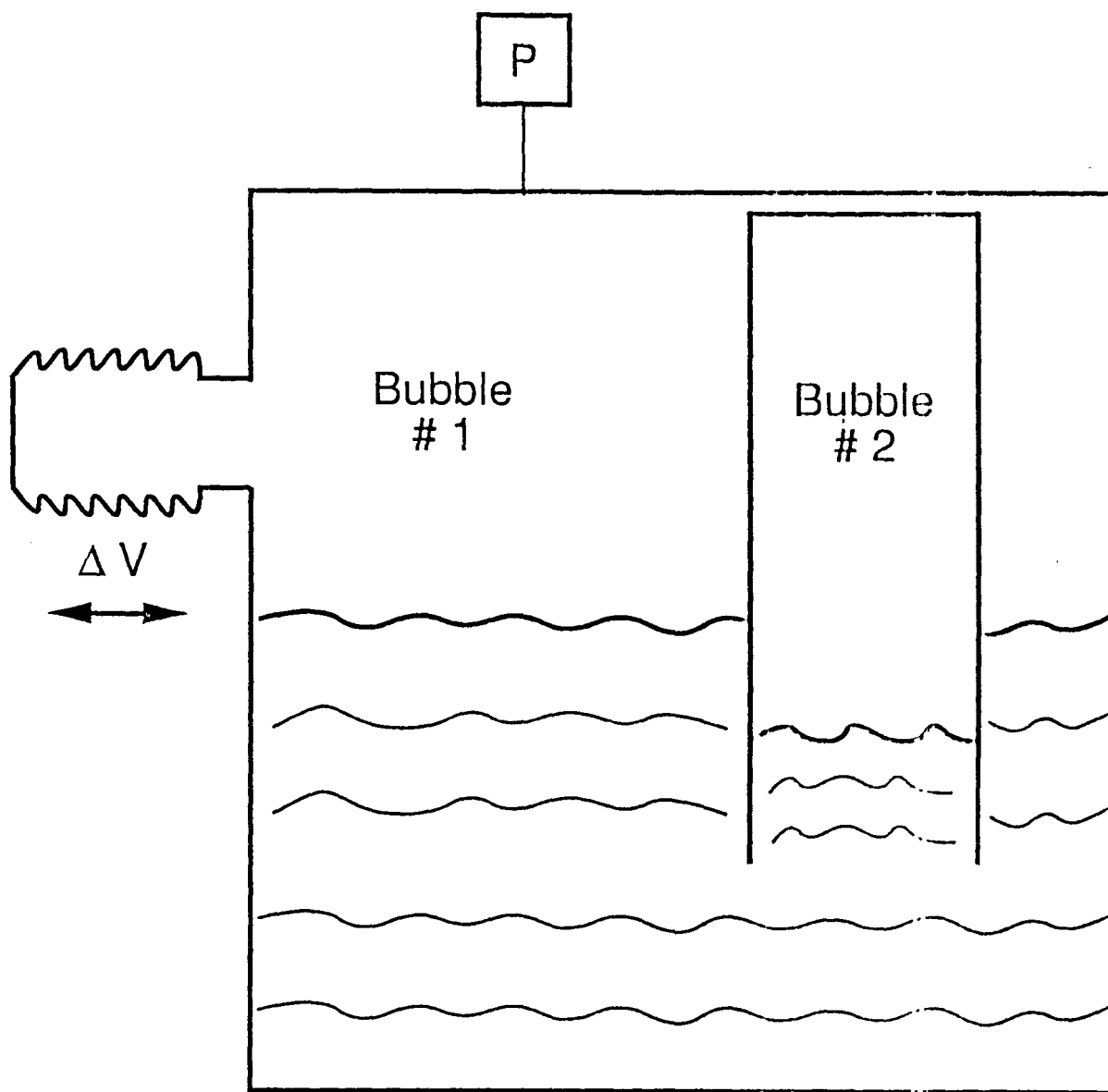

Figure 4 Schematic of Apparatus

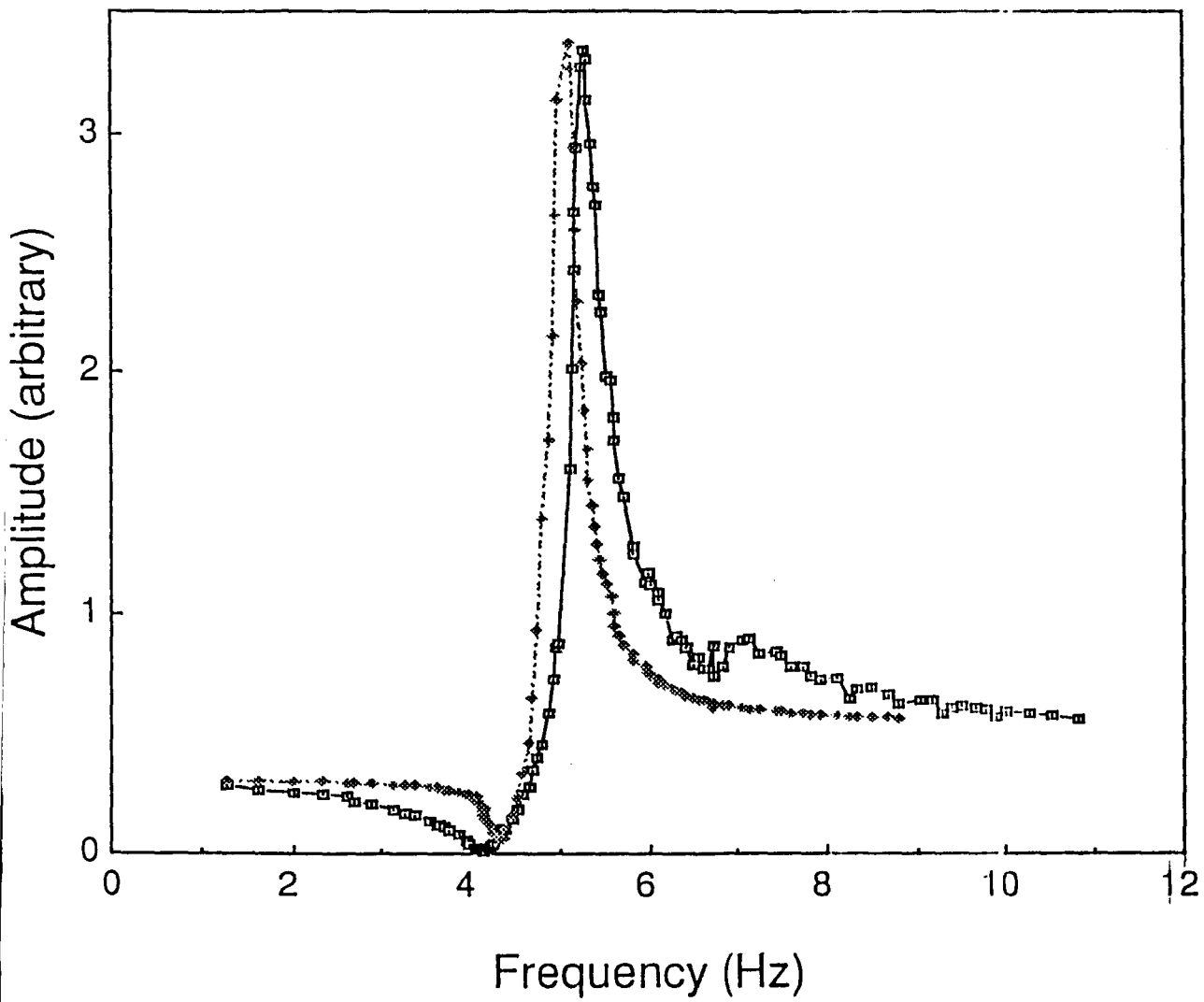

Figure 5 Frequency response curve, theory and experiment

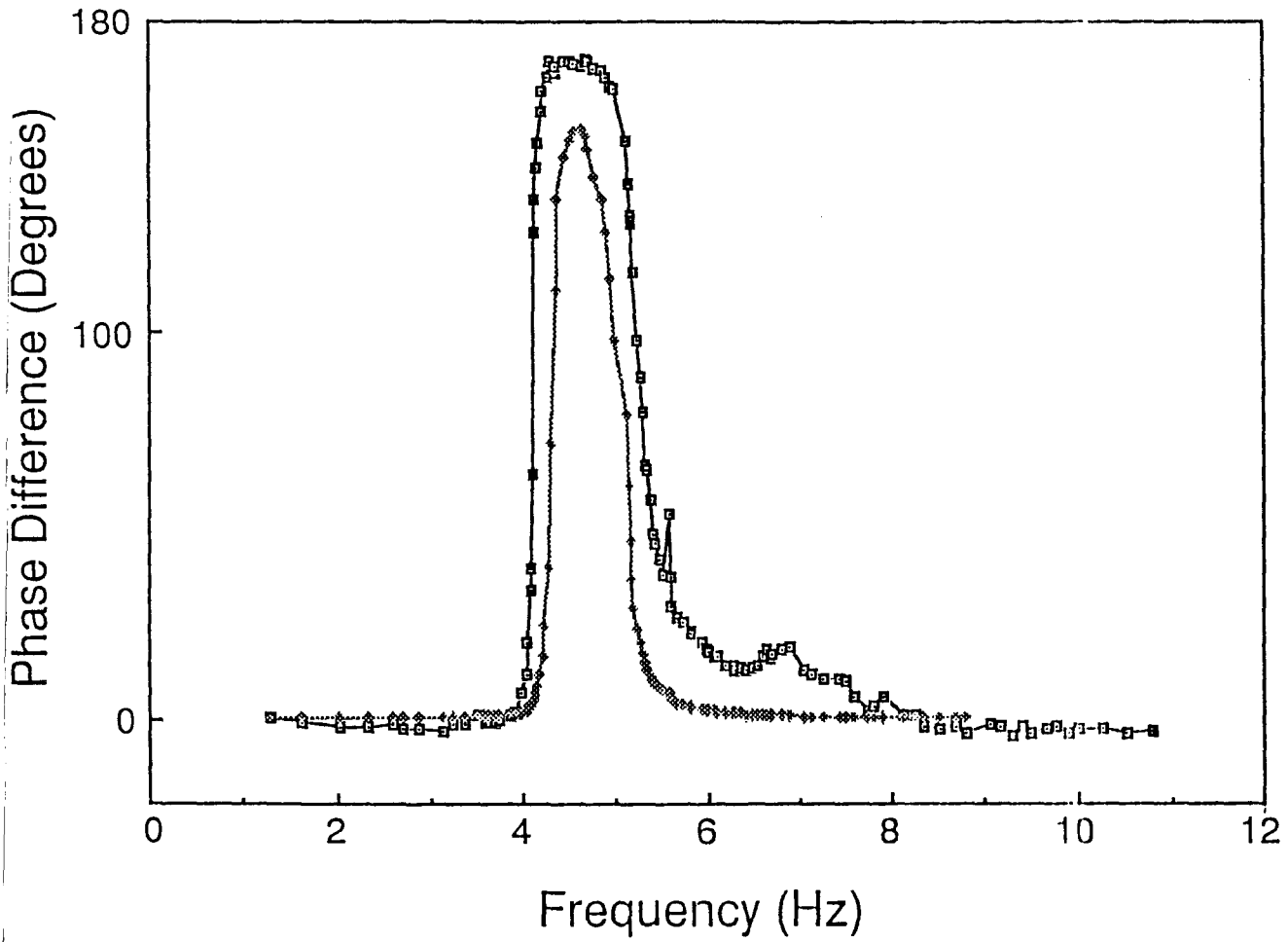

Figure 6 Frequency response curve, theory and experiment



# Transfer of Helium II with a Thermomechanical Pump

G. L. Mills, H. A. Snyder

## Experiment Apparatus:

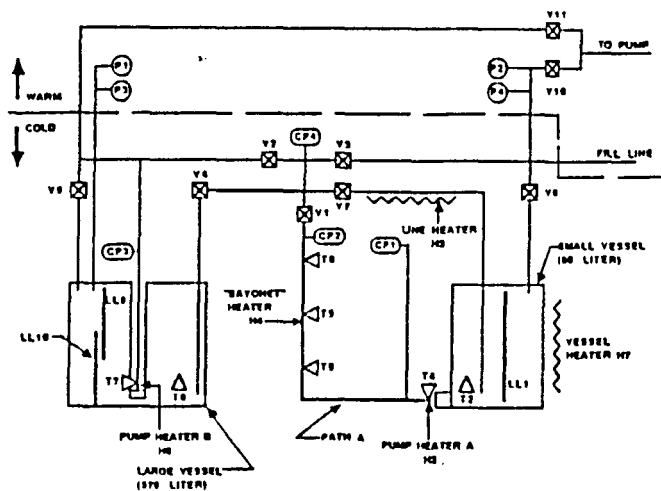

## Experiment Results:

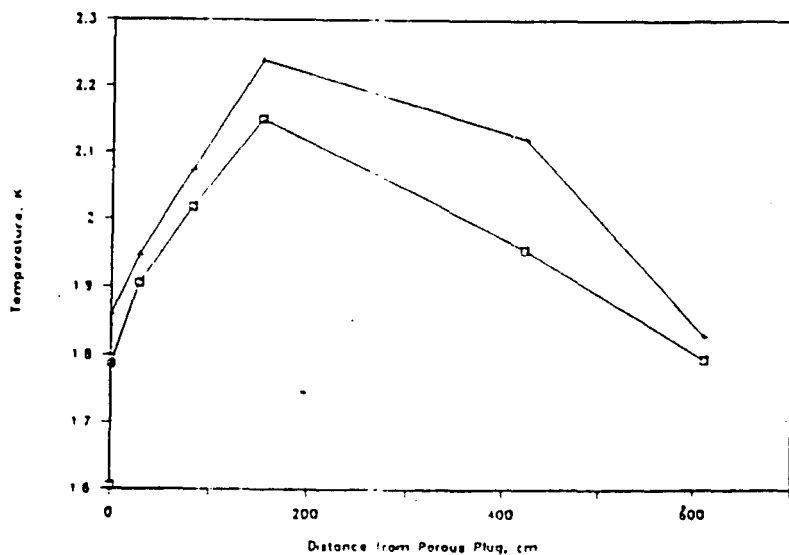
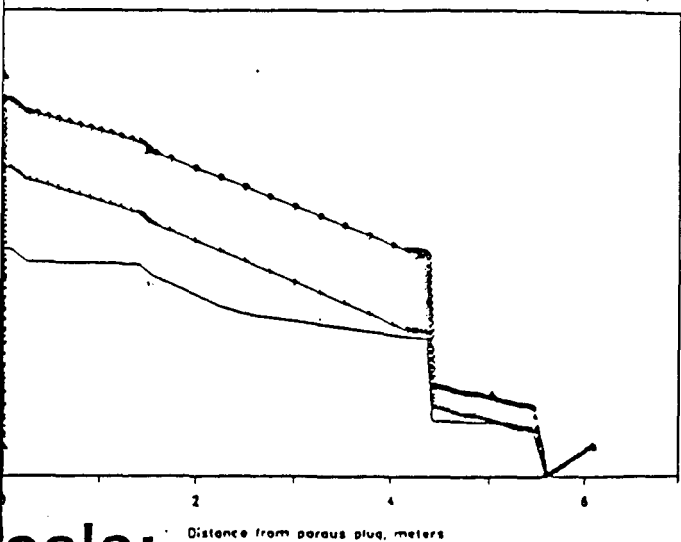

## Goals:

to verify a computer model of helium II flow driven by a thermomechanical pump

## Motivation:

Large quantities of helium II may be used at space stations to supply instruments. Thermomechanical pumps appear to be an efficient and reliable method of transferring helium II.

# Phase Separation by Vortex Flow

G. L. Mills, H. A. Snyder

## Concept :

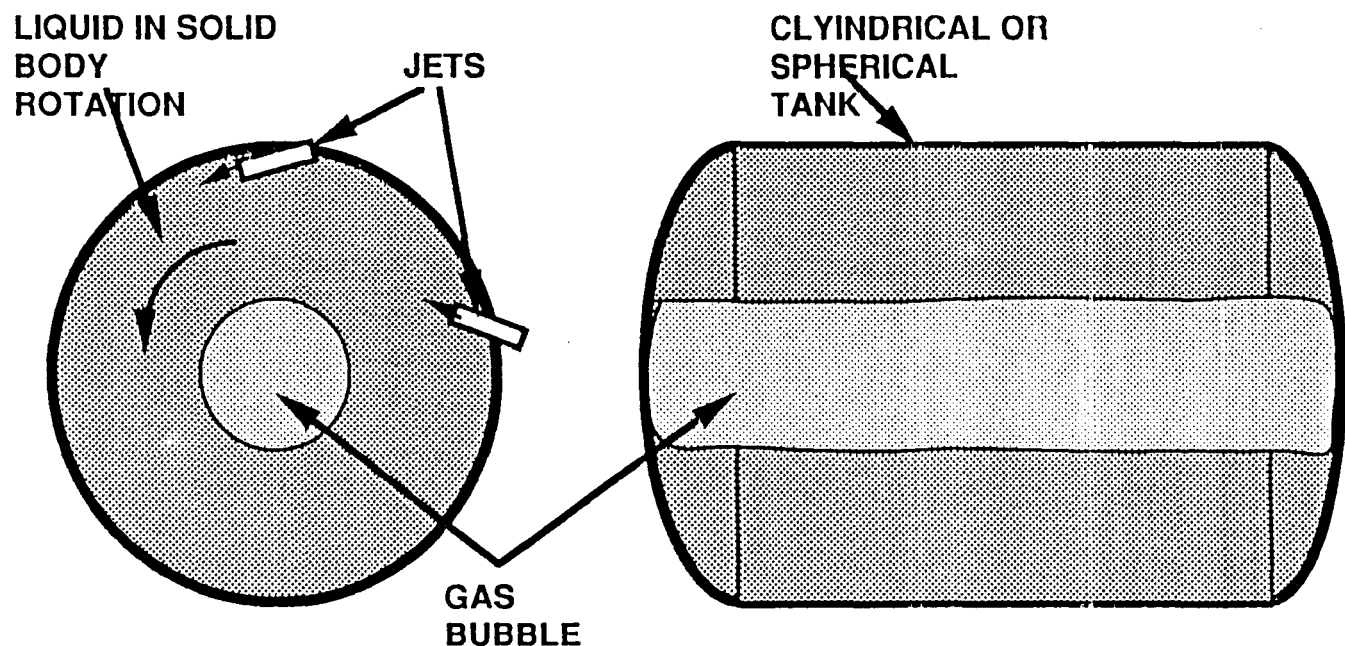

## Goals:

To formulate a complete and reliable mathematical model of vortex flow in a cylindrical tank in low gravity tank and to investigate the effect of different parameters such as jet placement and liquid/gas ratios.

## Motivation:

Large quantities of two phase fluids such as water, liquid hydrogen and liquid oxygen will be part of space construction projects. Current methods of orientating phases are not entirely satisfactory. Vortex flows appear to provide a simple, reliable method for phase orientation, but will have an effect on dynamics of the rest of the structure.

TITLE  
PAGE

Picture  
of  
TANK

Schematic  
of  
TEST

Theory  
Description

Theory  
Figure

Theory  
Figure

Comparison  
of  
Theory  
to  
DATA  
Amplitude

Comparison  
of  
Theory  
to  
DATA  
Phase

Comparison  
of  
Theory  
to  
DATA

CONCLUSIONS

APPLICATION  
to  
Space  
Structures

**UNIVERSITY OF COLORADO  
CENTER FOR SPACE CONSTRUCTION**

**EXTRATERRESTRIAL CLUSTER**

**SPEAKERS**

- Stein Sture (Cluster Leader)
- Steven W. Perkins
- Jose Emir Macari-Pasqualino

# EXTRATERRESTRIAL ENGINEERING

## CENTER FOR SPACE CONSTRUCTION

University of Colorado at Boulder

(Department of Civil, Environmental, and  
Architectural Engineering)

### Faculty and Student(s)

- Prof. Stein Sture
- Prof. Hon-Yim Ko
- Dr. José Emir Macari-Pasqualino
- Mr. Steven W. Perkins

5/7-31  
1600-37  
F. 4



# **Extraterrestrial Cluster** **Objectives**

**Objective:** To develop technology needed for constructing and maintaining the outposts and bases on the Moon and Mars including:

- 1. To characterize the mechanical properties of Lunar and Martian soils.**
- 2. To develop analytical models of Lunar and Martian soils.**
- 3. To analyze space system structure - soil interactions**
- 4. To design foundation and support systems for constructed facilities.**
- 5. To simulate and test foundation / support designs in geo-technical centrifuge.**
- 6. To modify in-situ materials for construction purposes.**

# **Extraterrestrial Cluster**

## **Near-Term Goals ( $\approx$ 1 yr.)**

- **Enhancement of existing and development of new experimental techniques for evaluating the constitutive properties including load (stress) - displacement (strain) and strength behavior of Lunar Soil Simulant subjected to various forms of pure tension, combined tension-shear, pure shear, and combined compression-shear loading at very low to high effective stress levels.**
- **Conduct experiments on Lunar Soil Simulant at various initial densities, fabric arrangement, and composition.**
- **Formulation of constitutive equations and implementation in nonlinear finite element code.**
- **Perform parametric numerical analyses of specified boundary value problems pertinent to Lunar outpost and base construction.**
- **Design of centrifuge model experiment program based on parametric numerical studies.**

# **Extraterrestrial Cluster**

## **Intermediate Goals ( $\approx$ 2 yrs.)**

- **Perform analytical studies of Lunar soil-structure interactions with different structural parameters and loading conditions and compare results to those obtained in centrifuge model investigations.**
- **Perform centrifuge model studies including modeling-of-model experiments to assess scaling relations and structure-soil performance and validation of nonlinear finite element analyses.**
- **Perform additional laboratory material property experiments in which appropriate amounts of agglutinates (Lunar glass spheroids) are included to assess their influence on response.**
- **Initiate studies on the performance of sintered and cemented Lunar soils comprising of composite regolith as well as purified or segregated minerals such as agglutinates. Assessment of cementitious binders, cementing techniques, and sintering processes is also included.**





70-91  
160685  
P-14

# MECHANICAL PROPERTIES OF LUNAR REGOLITH AND LUNAR SOIL SIMULANT

Steven W. Perkins

- STATE OF KNOWLEDGE OF THE PROPERTIES OF LUNAR REGOLITH
- CHARACTERIZATION OF STRENGTH AND DEFORMATION PROPERTIES OF LUNAR REGOLITH AND SIMULANT
- MODELING OF SOIL-STRUCTURE INTERACTION

## ABSTRACT

Through the Surveyor 3 and 7, and Apollo 11-17 missions a knowledge of the mechanical properties of Lunar regolith were gained. These properties, including material cohesion, friction, in-situ density, grain-size distribution and shape, and porosity, were determined by indirect means of trenching, penetration, and vane shear testing. Several of these properties were shown to be significantly different from those of terrestrial soils, such as an interlocking cohesion and tensile strength formed in the absence of moisture and particle cementation.

To characterize the strength and deformation properties of Lunar regolith experiments have been conducted on a lunar soil simulant at various initial densities, fabric arrangements, and composition. These experiments included conventional triaxial compression and extension, direct tension, and combined tension-shear. Experiments have been conducted at low levels of effective confining stress. External conditions such as membrane induced confining stresses, end platten friction and material self weight have been shown to have a dramatic effect on the strength properties at low levels of confining stress. The solution has been to treat these external conditions and the specimen as a full-fledged boundary value problem rather than the idealized elemental cube of mechanics.

Centrifuge modeling allows for the study of Lunar soil-structure interaction problems. In recent years centrifuge modeling has become an important tool for modeling processes that are dominated by gravity and for verifying analysis procedures and studying deformation and failure modes. Centrifuge modeling is well established for terrestrial engineering and applies equally as well to Lunar engineering.

## MECHANICAL PROPERTIES OF LUNAR REGOLITH

- PRIOR TO LUNAR MISSIONS THE MECHANICAL PROPERTIES OF THE REGOLITH WERE MODELED WITH A LUNAR SOIL SIMULANT.
- THE MECHANICAL PROPERTIES OF THE LUNAR REGOLITH WERE STUDIED IN-SITU BY MEANS OF TRENCHING, PENETRATION, AND VANE SHEAR TESTING (SURVEYOR 3 AND 7, APOLLO 11-17, LUNOKHOD).
- LUNAR REGOLITH EXHIBITS AN INTERLOCKING COHESION AND TENSILE STRENGTH IN THE ABSENCE OF MOISTURE AND ANY PARTICLE CEMENTATION.
- A LIMITED EVALUATION OF THE MECHANICAL PROPERTIES WAS CONDUCTED IN THE LUNAR RECEIVING LABORATORY (JSC) AFTER EACH MISSION.
- THE REGOLITH AT ALL APOLLO LANDING SITES HAS NEARLY THE SAME MECHANICAL PROPERTIES.
- THE NEAR SURFACE (< 20 cm) REGOLITH IS HIGHLY COMPACTIVE IN ITS NATURAL IN-SITU STATE.
- AFTER COMPACTION IT IS HIGHLY DILATIVE WHEN SUBJECTED TO DISTORTIONS (SHEAR).
- IN REGIONS NEAR CRATER RIMS THE REGOLITH IS VERY SOFT AND HIGHLY POROUS.

# MECHANICAL PROPERTIES OF LUNAR REGOLITH

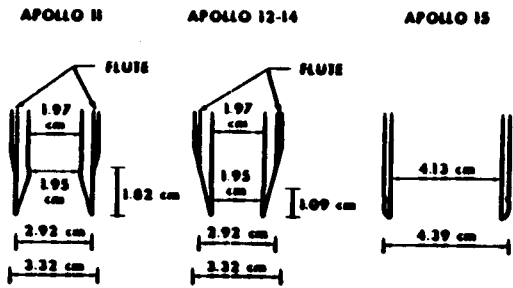

COMPARISON OF CORE TUBE BITS

(COSTES, ET AL.,  
NASA TR R-401, 1972)

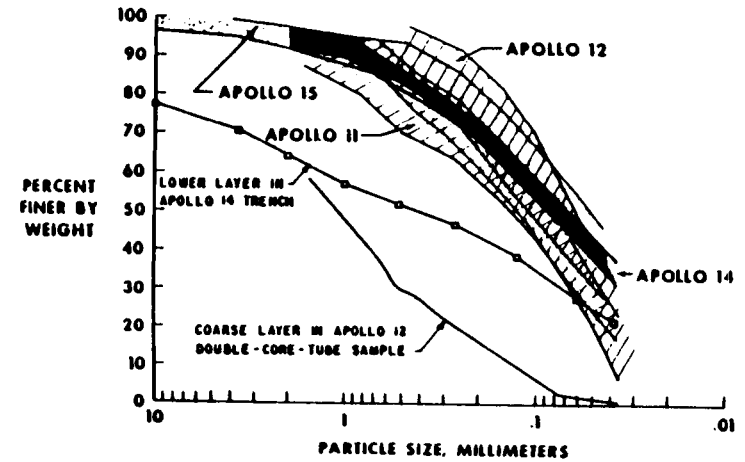

GRAIN SIZE DISTRIBUTION OF APOLLO LUNAR SOIL SAMPLES AND LUNAR SOIL SIMULANTS

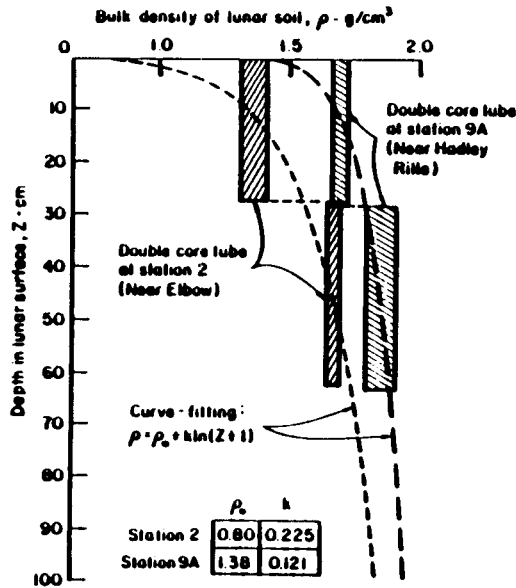

DENSITY OF LUNAR REGOLITH AT APOLLO 15  
CORE TUBE SITES

(MITCHELL, ET AL.; PROC 3<sup>RD</sup> LUNAR SCI. CONF., 1972)

- SPECIFIC GRAVITY OF SOLIDS;  $G_s = 3.1$
- POROSITY OF REGOLITH;  $38\% \leq n \leq 56\%$ 
  - POROSITY IS THE MOST IMPORTANT SINGLE VARIABLE CONTROLLING COHESION AND FRICTION PROPERTIES OF THE REGOLITH
- COHESION (ADHESION);  $0.1 \leq c \leq 1.0 \text{ kN/m}^2$
- FRICTION (ANGLE OF INTERNAL FRICTION)  $32^\circ \leq \phi \leq 55^\circ$ 
  - THE FRICTION ANGLE IS ALSO DEPENDENT ON MEAN STRESS LEVEL. IT DECREASES WITH INCREASING MEAN STRESS STATE

PROPERTY SUMMARY

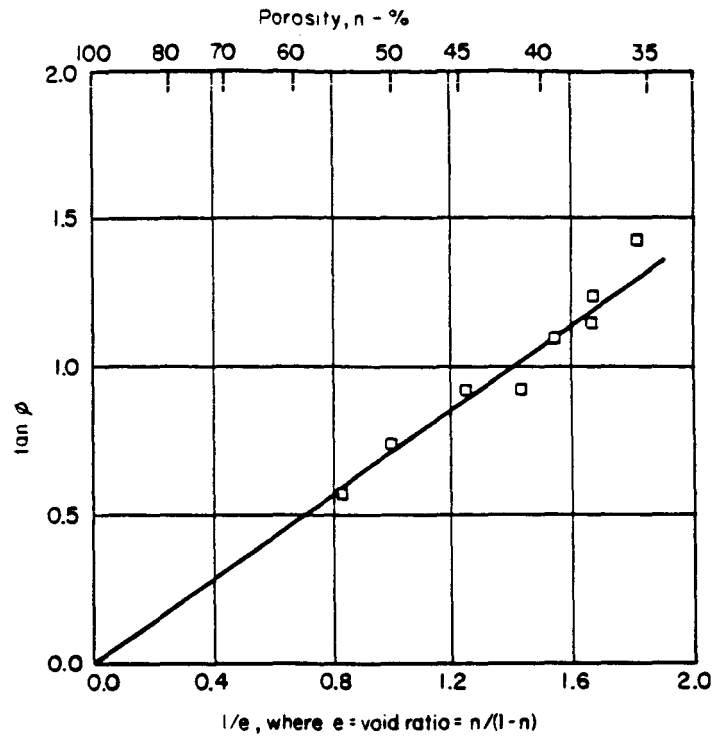

Fig. 2. Friction angle as a function of porosity for a lunar soil simulant (ground basalt).

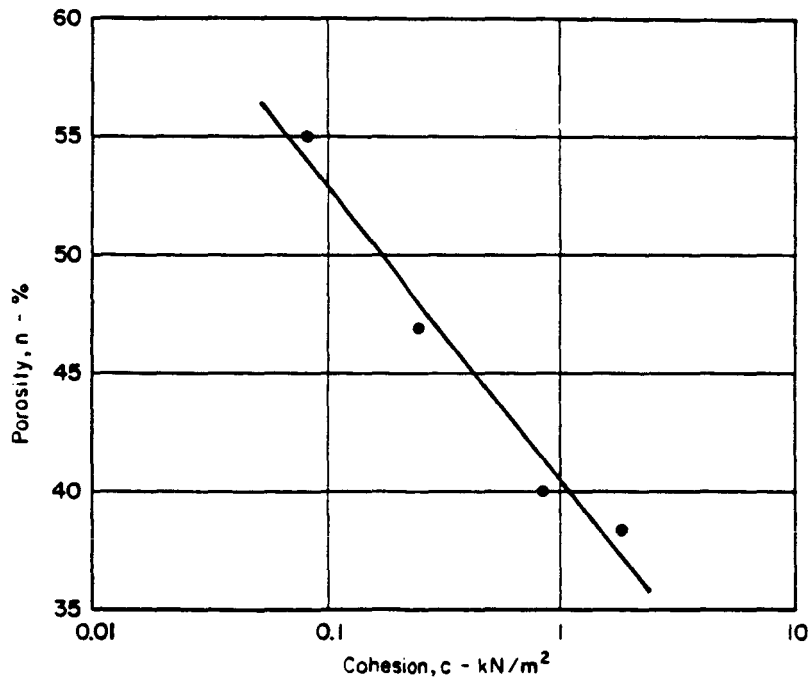

Fig. 3. Cohesion as a function of porosity for a lunar soil simulant (ground basalt).

(MITCHELL, ET AL.; PROC 3<sup>RD</sup> LUNAR SCI. CONF., 1972)

# MECHANICAL PROPERTIES OF A SIMULATED LUNAR SOIL

## CURRENT ACTIVITIES

- CONDUCT EXPERIMENTS ON A LUNAR SOIL SIMULANT AT VARIOUS INITIAL DENSITIES, FABRIC ARRANGEMENT, AND COMPOSITION.
- CONVENTIONAL TRIAXIAL COMPRESSION AND EXTENSION EXPERIMENTS ON CYLINDRICAL AND CUBICAL SPECIMENS.
- DIRECT TENSION AND COMBINED TENSION-SHEAR EXPERIMENTS ON CUBICAL SPECIMENS.

# THE TRIAXIAL APPARATUS

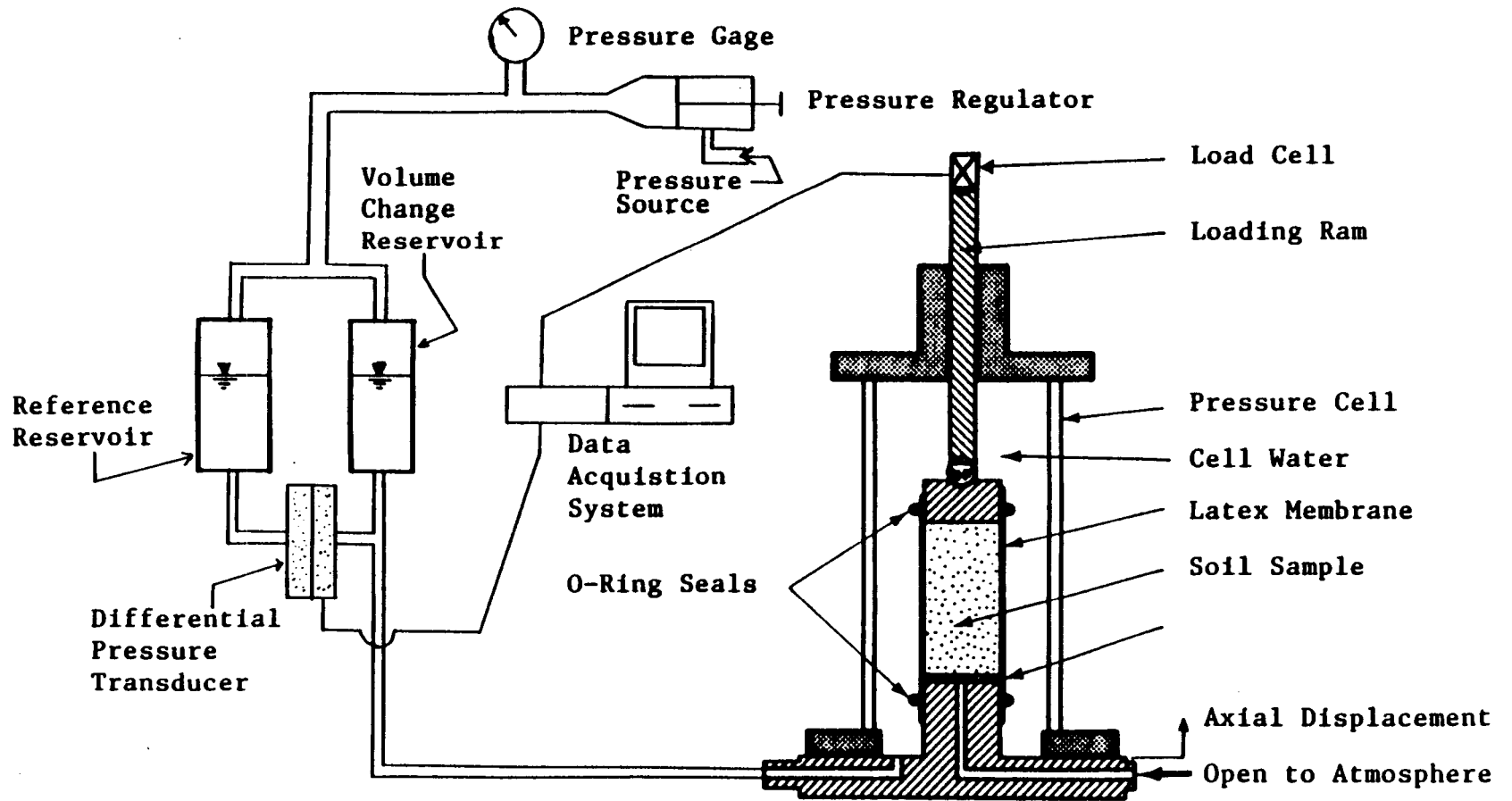

D-4.

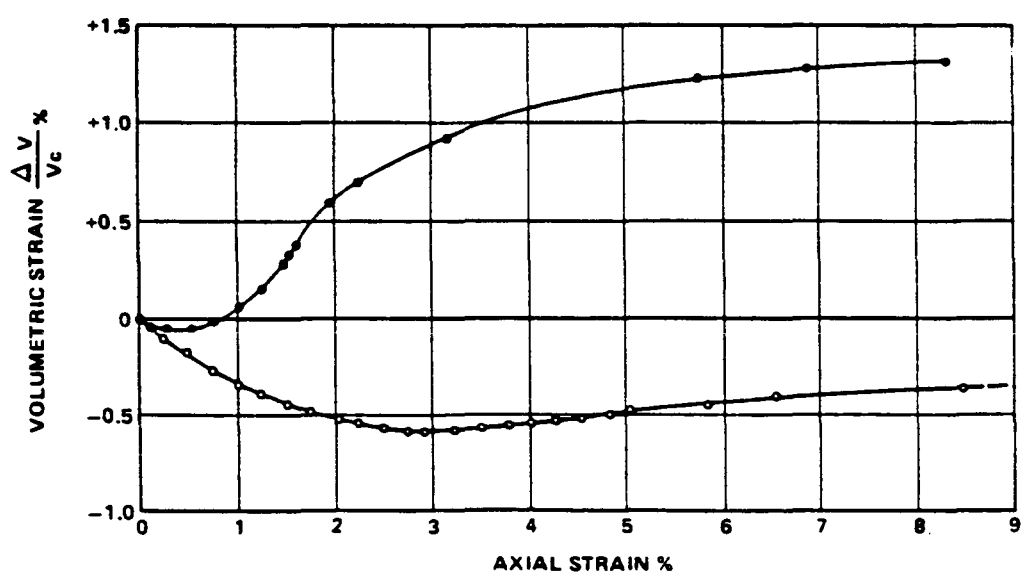
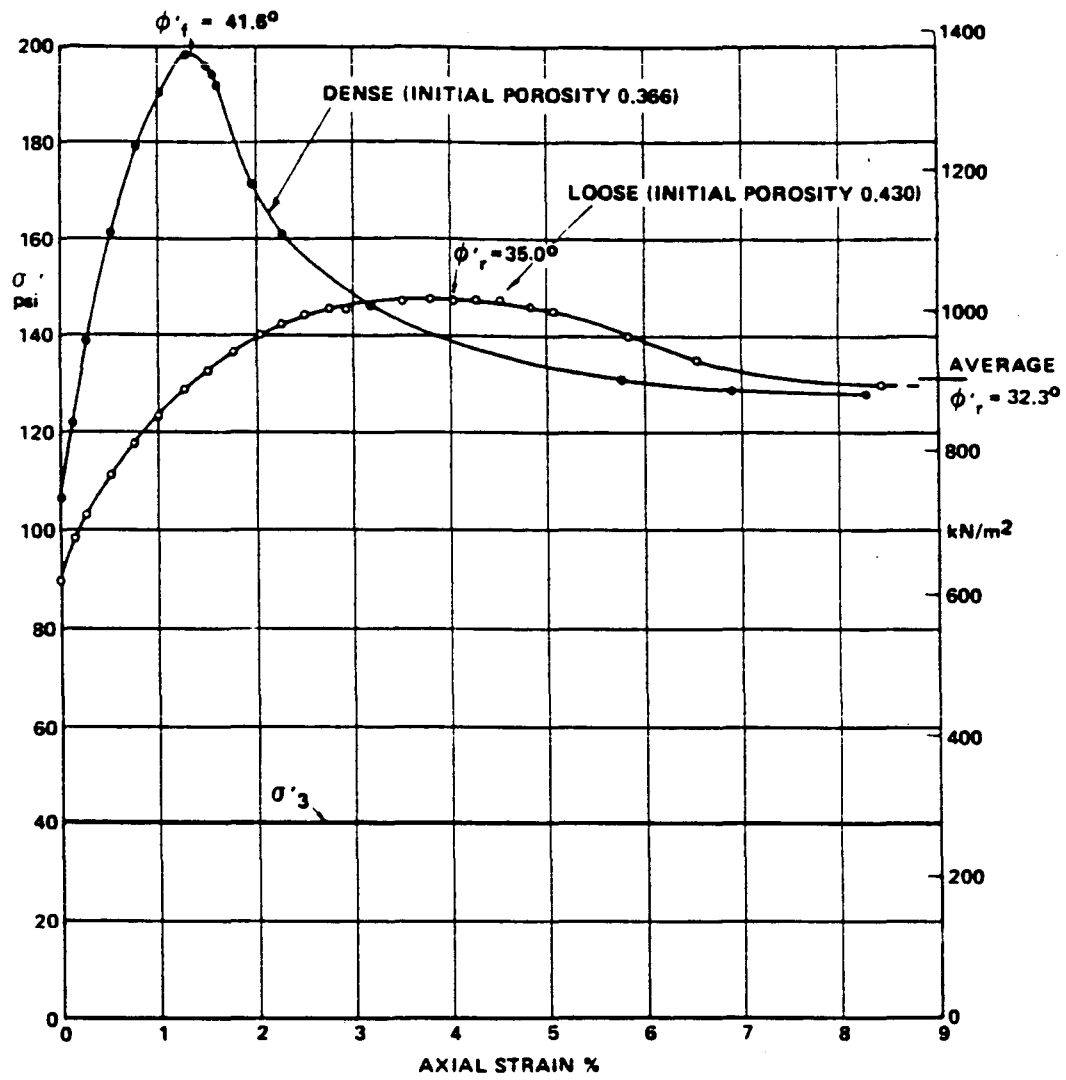

STRESS-STRAIN AND VOLUME CHANGE RELATIONSHIPS FOR DRAINED PLANE STRAIN TESTS ON SATURATED BRASTED SAND. (DATA FROM CORNFORTH, 1961.)



# TRIAXIAL COMPRESSION EXPERIMENTS (MLS)

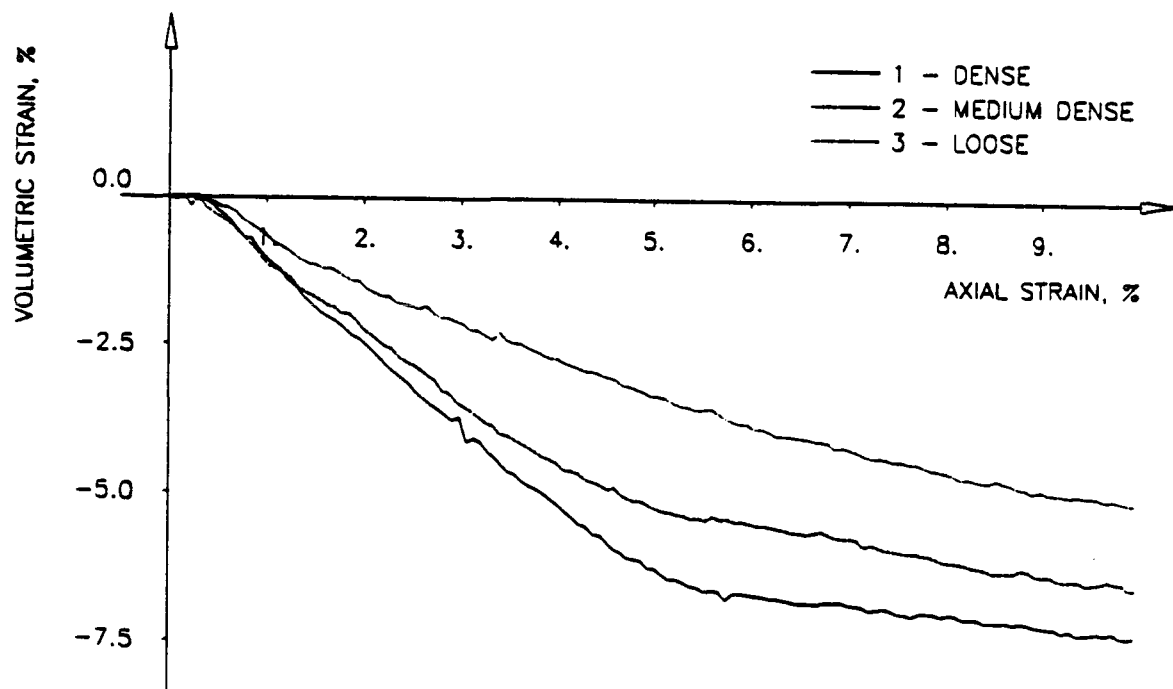
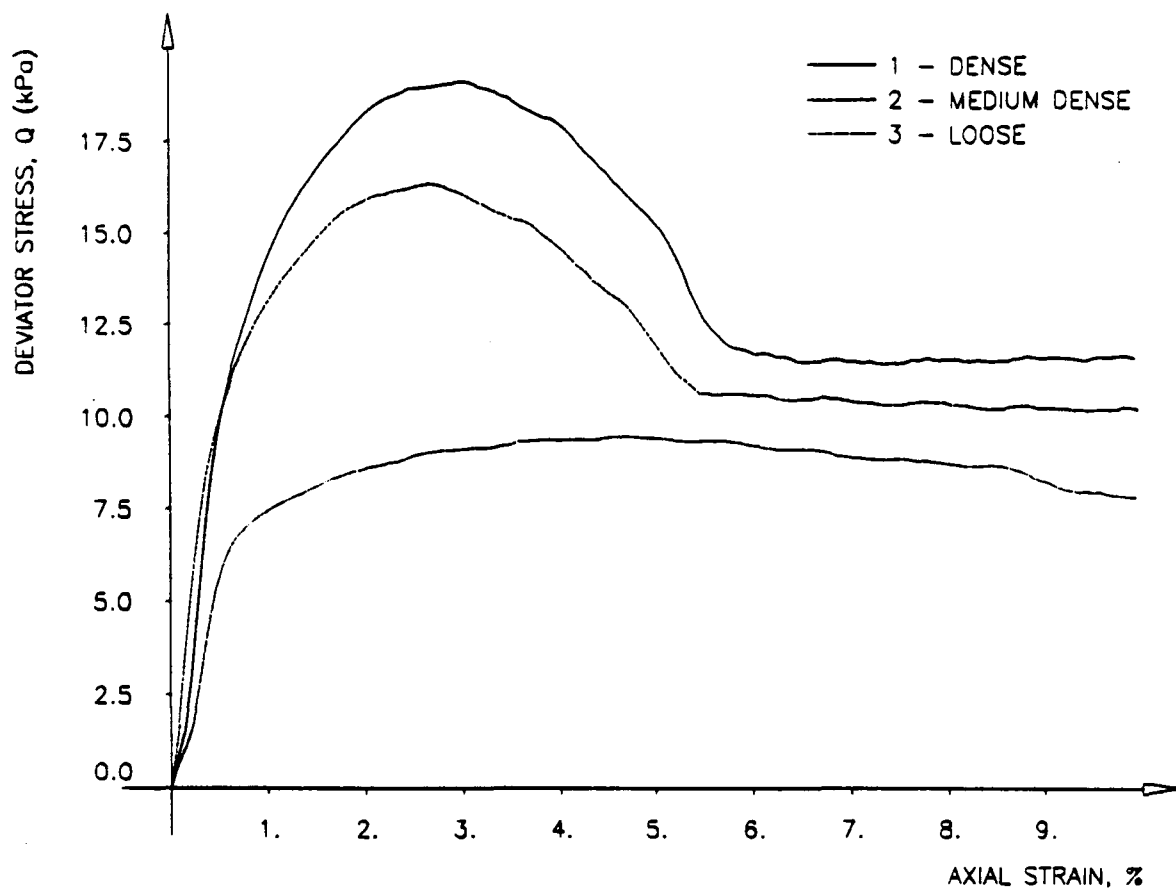

## EXTERNAL CONDITIONS IN TRIAxIAL EXPERIMENTS

- MEMBRANE INDUCED CONFINING STRESSES.
- END PLATTEN FRICTION.
- SPECIMEN SELF WEIGHT.
- SOLUTION: TREAT THE SPECIMEN AND EXTERNAL CONDITIONS AS A FULL-FLEDGED B.V.P. RATHER THAN THE IDEALIZED ELEMENTAL CUBE OF MECHANICS.

# COMBINED TENSION-SHEAR APPARATUS

(SCHEMATIC ILLUSTRATION)

The apparatus receives a 17.8 cm specimen.

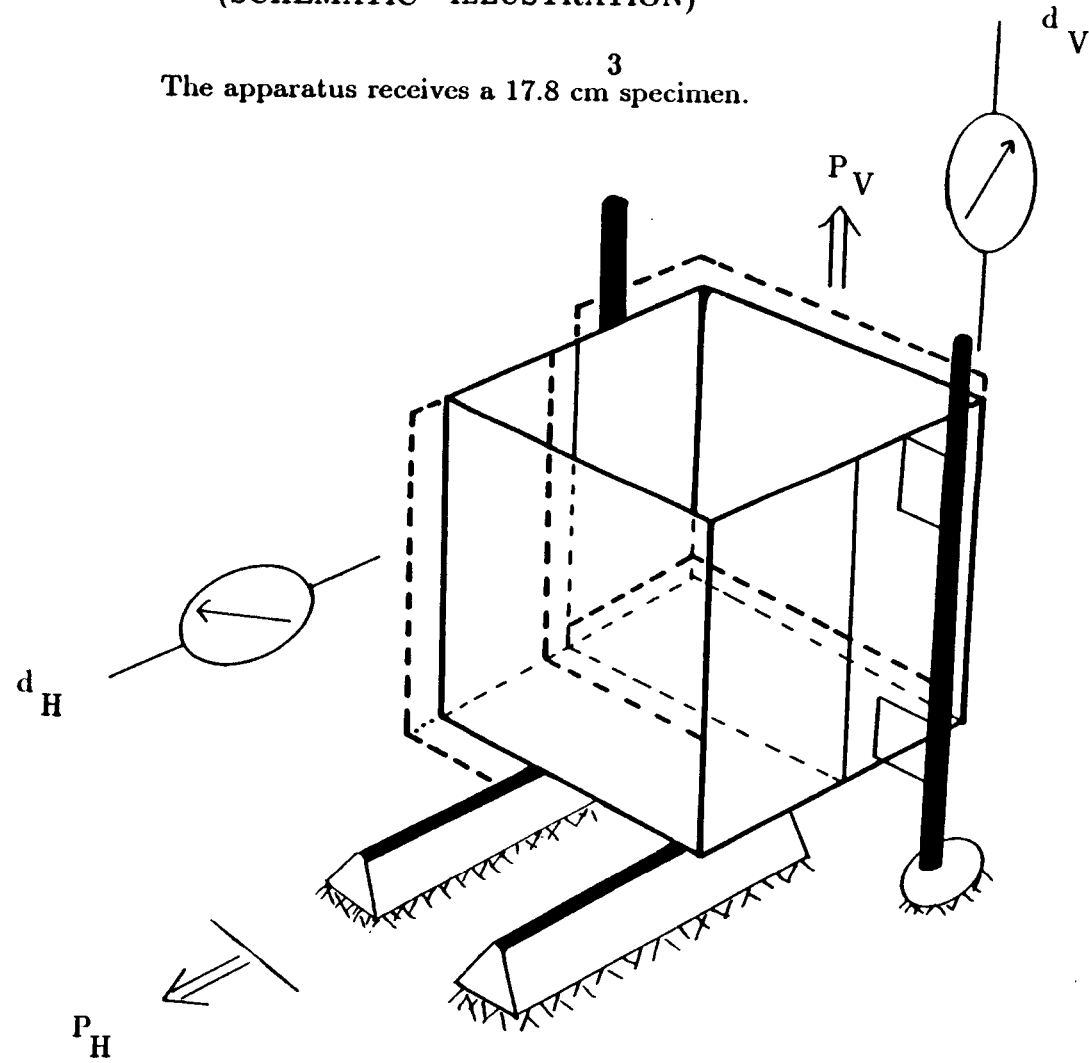

EXAMPLE OF CENTRIFUGE MODELING USING AN EMBANKMENT COVERING BURIED STRUCTURES

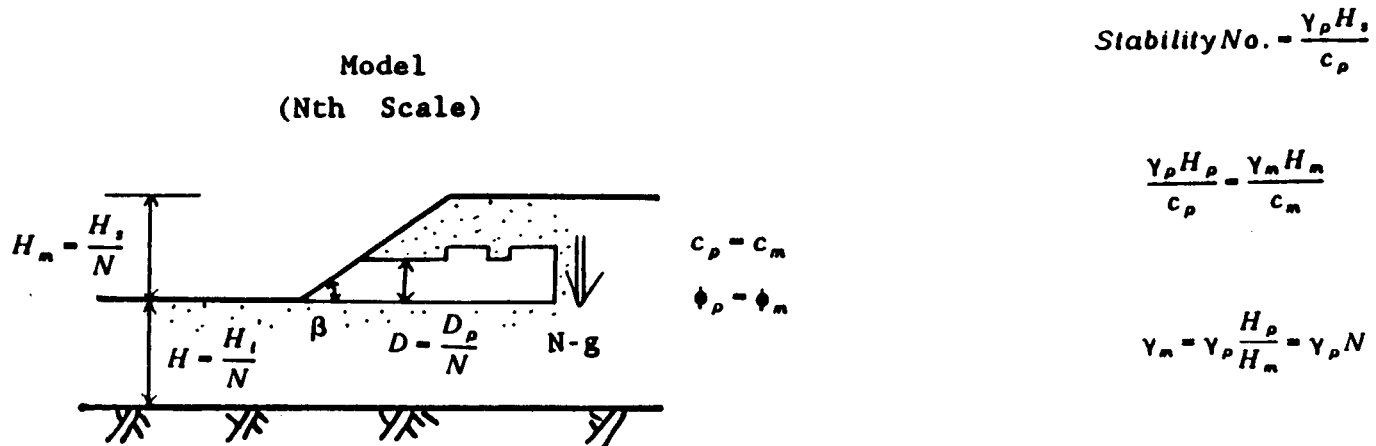
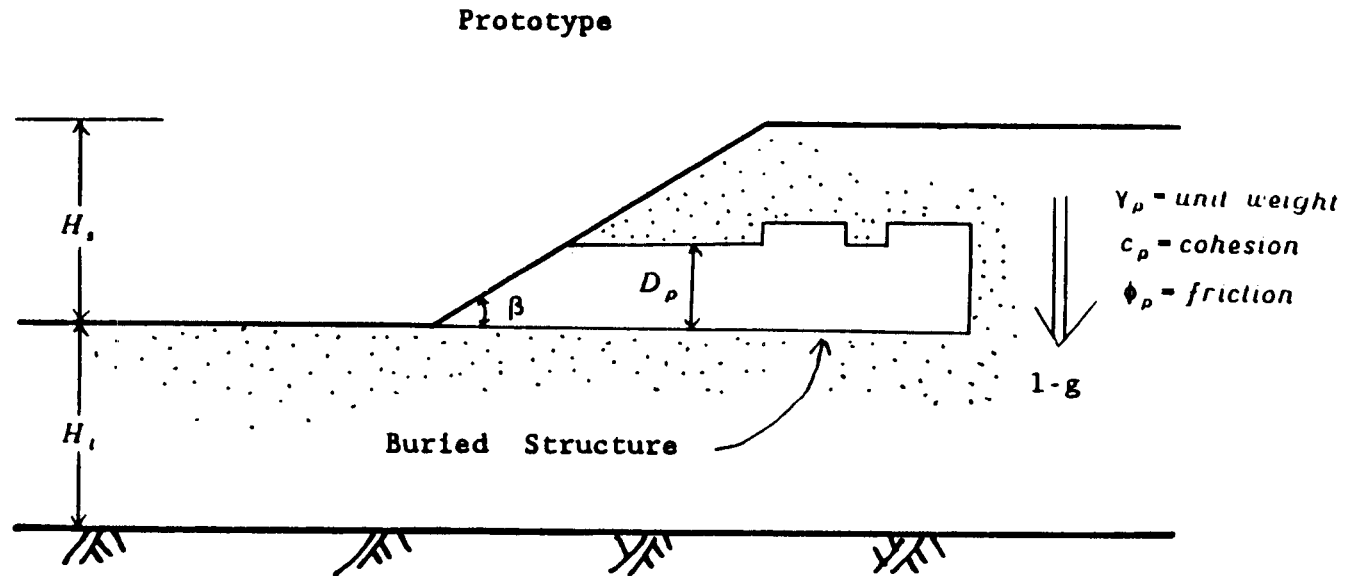

# ILLUSTRATION OF THE CONCEPT OF MODELING-OF-MODELS

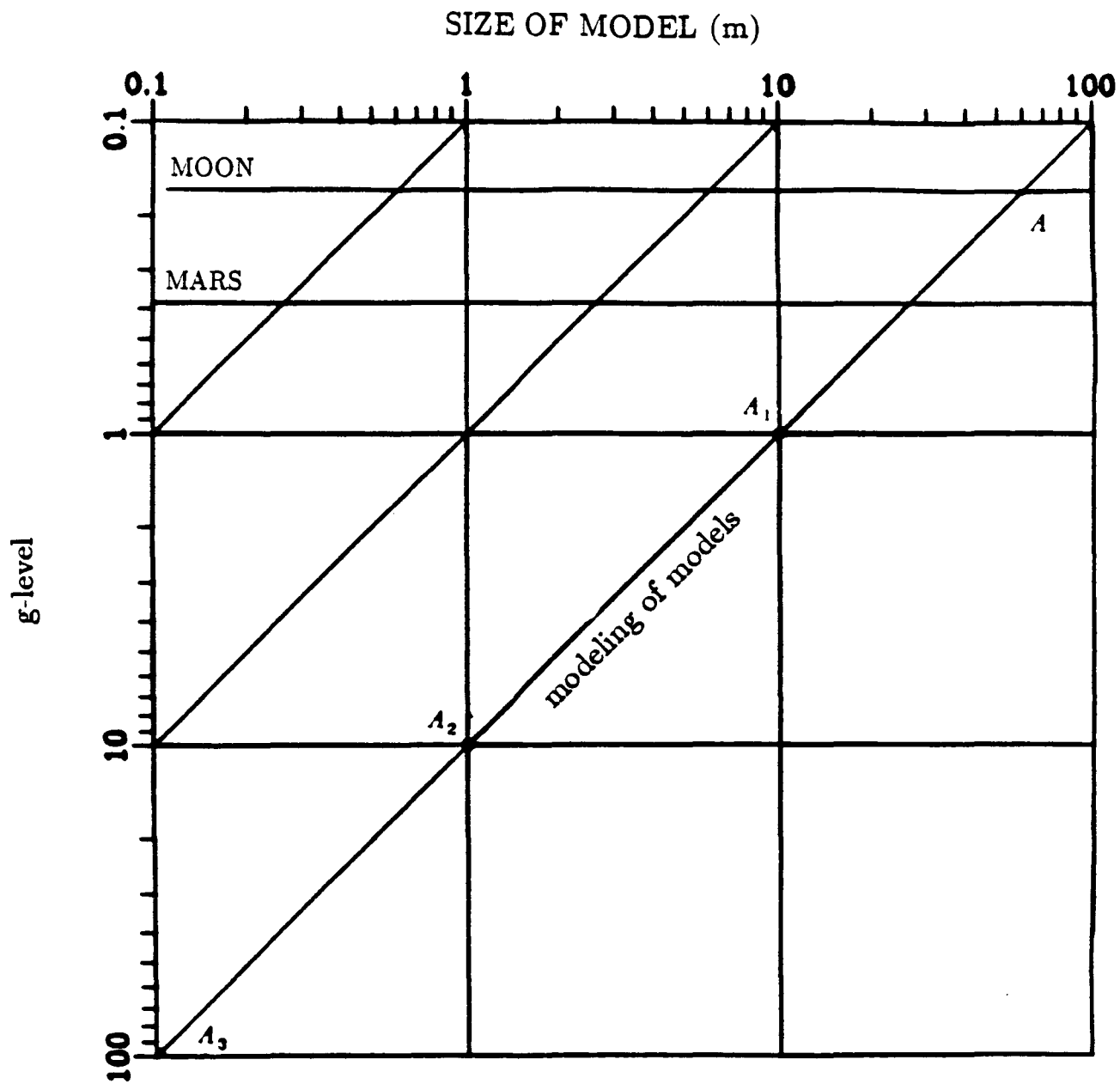

**ANALYTICAL MODELING OF  
STRUCTURE-SOIL SYSTEMS  
FOR LUNAR BASES**

**University of Colorado  
Center for Space Construction  
(CSC/NASA)**

**José Emir Macari-Pasqualino**

# ANALYTICAL MODELING OF STRUCTURE-SOIL SYSTEMS FOR LUNAR BASES

Jose Emir Macari-Pasqualino

## ABSTRACT

The study of the behavior of granular materials in a reduced gravity environment and under low effective stresses became a subject of great interest in the mid 1960's when NASA's Surveyor missions to the Moon began the first extraterrestrial investigation and it was found that Lunar soils exhibited properties quite unlike those on Earth. This subject gained interest during the years of the Apollo missions and more recently due to NASA's plans for future exploration and colonization of Moon and Mars. It has since been clear that a good understanding of the mechanical properties of granular materials under reduced gravity and at low effective stress levels is of paramount importance for the design and construction of surface and buried structures on these bodies. In order to achieve such an understanding it is desirable to develop a set of constitutive equations that describes the response of such materials as they are subjected to tractions and displacements.

This presentation examines issues associated with conducting experiments on highly nonlinear granular materials under high and low effective stresses. The friction and dilatancy properties which affect the behavior of granular soils with low cohesion values are assessed. In order to simulate the highly nonlinear strength and stress-strain behavior of soils at low as well as high effective stresses, a versatile isotropic, pressure sensitive, third stress invariant dependent, cone-cap elasto-plastic constitutive model was proposed. The integration of the constitutive relations is performed via a fully implicit Backward Euler technique known as the Closest Point Projection Method. The model was implemented into a finite element code in order to study nonlinear boundary value problems associated with homogeneous as well as nonhomogeneous deformations at low as well as high effective stresses. The effect of gravity (self-weight) on the stress-strain-strength response of these materials is evaluated. The calibration of the model is performed via three techniques: 1) Physical identification, 2) Optimized calibration at the constitutive level, and 3) Optimized calibration at the finite element level (Inverse Identification).

Laboratory experiments have shown that the effects of gravity have significant influence on the stress-strain-strength response of granular soils with low cohesion especially when the confining levels are below a certain threshold stress (approximately 1 psi; 7 kN/m<sup>2</sup>). The proposed model is used to predict the response of boundary value problems (such as bearing capacity) of granular materials in reduced gravity environments and under low effective stresses.

579-31  
100689  
P-28

# **CONTENTS**

- **Behavior of Granular Materials.**
- **Formulation of the Proposed Analytical Model for the Prediction of the Behavior of Granular Materials.**
- **Calibration of the Analytical Model.**
- **Analysis of Soil-Structure Systems Under Reduced Gravity.**
- **Concluding Remarks.**



# TYPICAL TRIAXIAL STRESS-STRAIN RESULTS ON DENSE TO LOOSE SAND

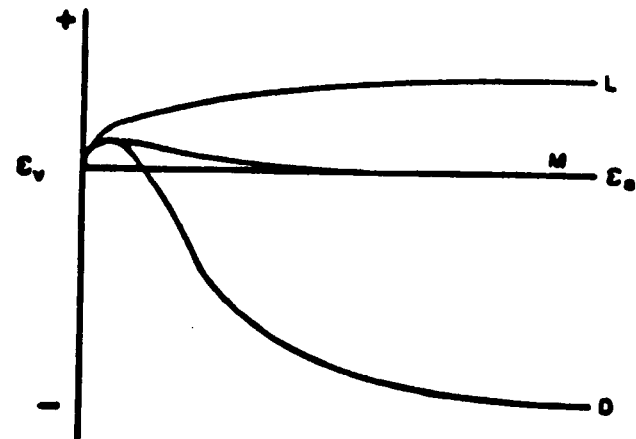
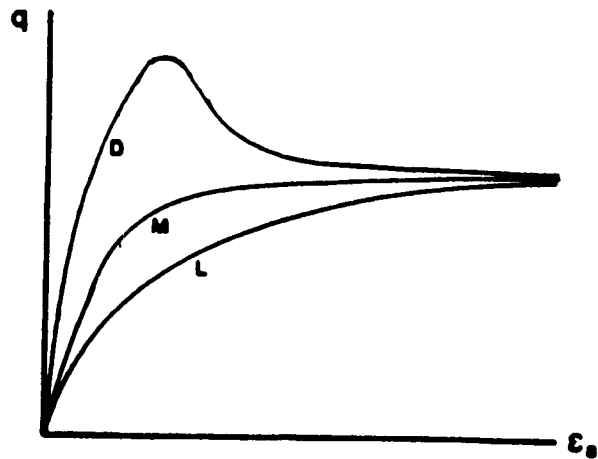

## SHAPE OF FAILURE ENVELOPE

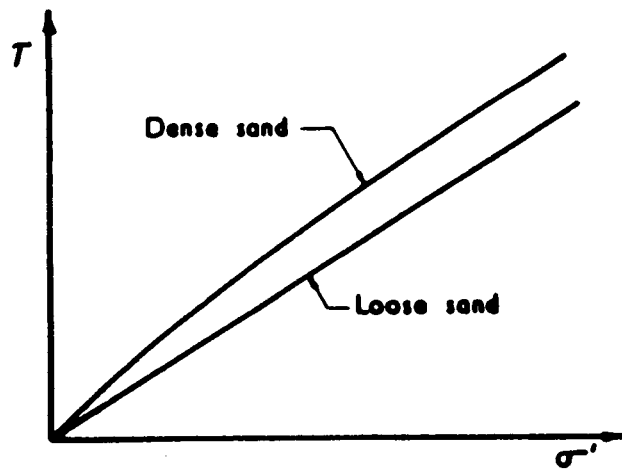

Mohr-Coulomb envelope of shear strength of loose and dense sands

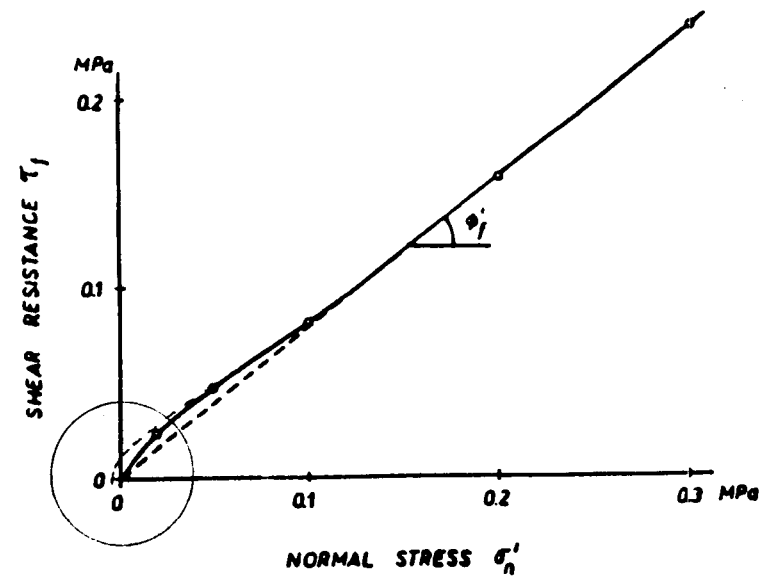

Mohr-Coulomb envelope of shear strength of a dense dry sand

# PROPOSED THREE INVARIANT MODEL

## • CONE FUNCTION

$$F_{\text{cone}}(p, q, \theta, \kappa_{\text{cone}}) = f(q, \theta) - \eta_{\text{cone}}(\kappa_{\text{cone}})(p - p_c) = 0$$

$$f = q\left(1 + \frac{q}{q_a}\right)^m g(\theta)$$

## • CAP FUNCTION

$$F_{\text{cap}}(p, q, \theta, \kappa_{\text{cap}}) = \left(\frac{p - p_m}{p_r}\right)^2 + \left(\frac{f}{f_r}\right)^2 - 1 = 0$$

SHAPE IN THE RENDULIC PLANE

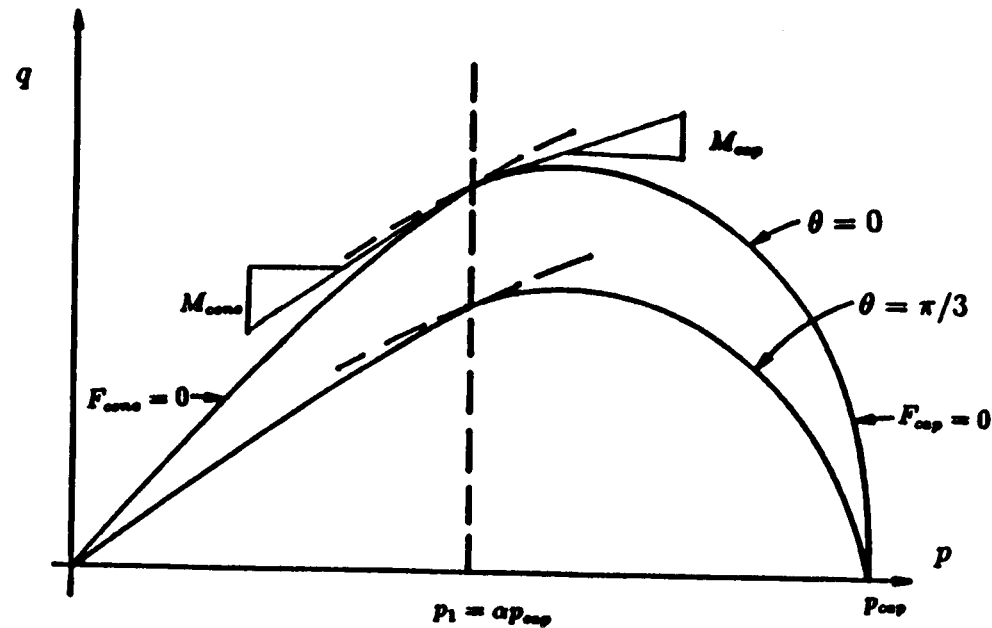

# SHAPE OF THE YIELD - FUNCTION

## SHAPE IN THE DEVIATORIC PLANE

$$g = \frac{4(1 - e^2) \cos^2(\frac{\pi}{3} - \theta) + (2e - 1)^2}{2(1 - e^2) \cos(\frac{\pi}{3} - \theta) + (2e - 1)[4(1 - e^2) \cos^2(\frac{\pi}{3} - \theta) + 5e^2 - 4e]^{1/2}}$$

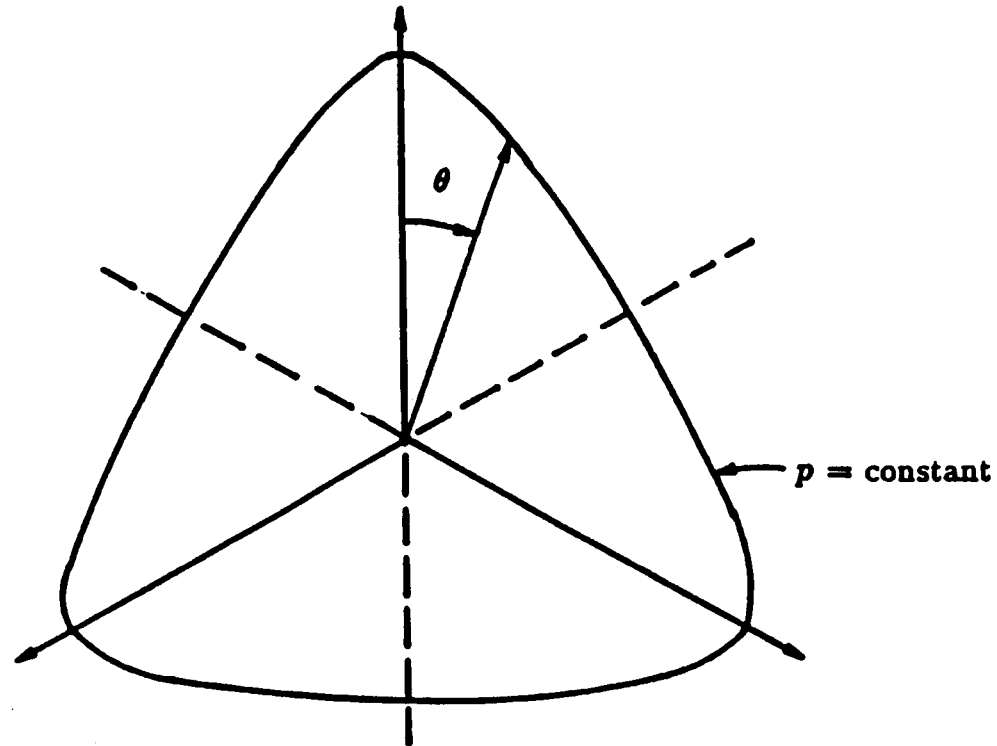

# MODEL CALIBRATION

- **VIA SIMPLE PARAMETER IDENTIFICATION**  
Solving Model Equations for Experimental Failure Conditions.
- **VIA OPTIMIZATION AT THE CONSTITUIVE LEVEL**  
Assuming Idealized Conditions - Elemental Cube  
(i.e. Homogeneous Deformations).
- **VIA OPTIMIZATION AT THE FINITE ELEMENT LEVEL INCLUDING:**
  - Self-Weight (Gravity) Effects.
  - End Platen Frictional Effects.
  - Membrane Confinement Effects.

# EXPERIMENTAL AND PREDICTED RESPONSE BASED ON CALIBRATION VIA SIMPLE PHYSICAL PARAMETERS IDENTIFICATION

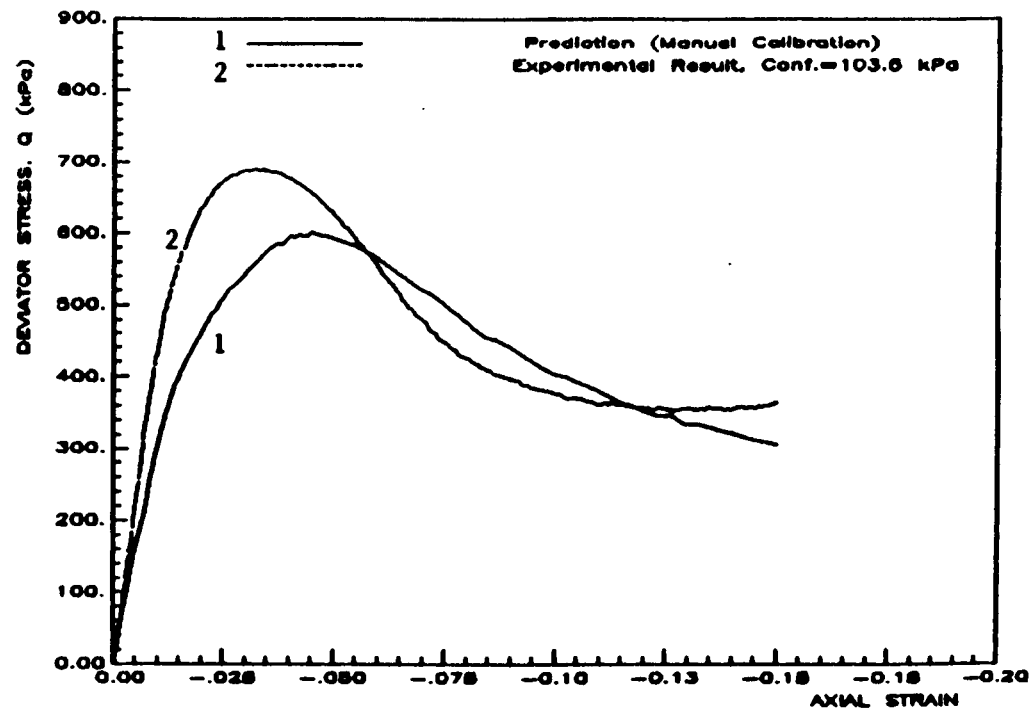

# EXPERIMENTAL AND PREDICTED RESPONSE BASED ON CALIBRATION VIA OPTIMIZED PARAMETERS AT CONSTITUTIVE LEVEL

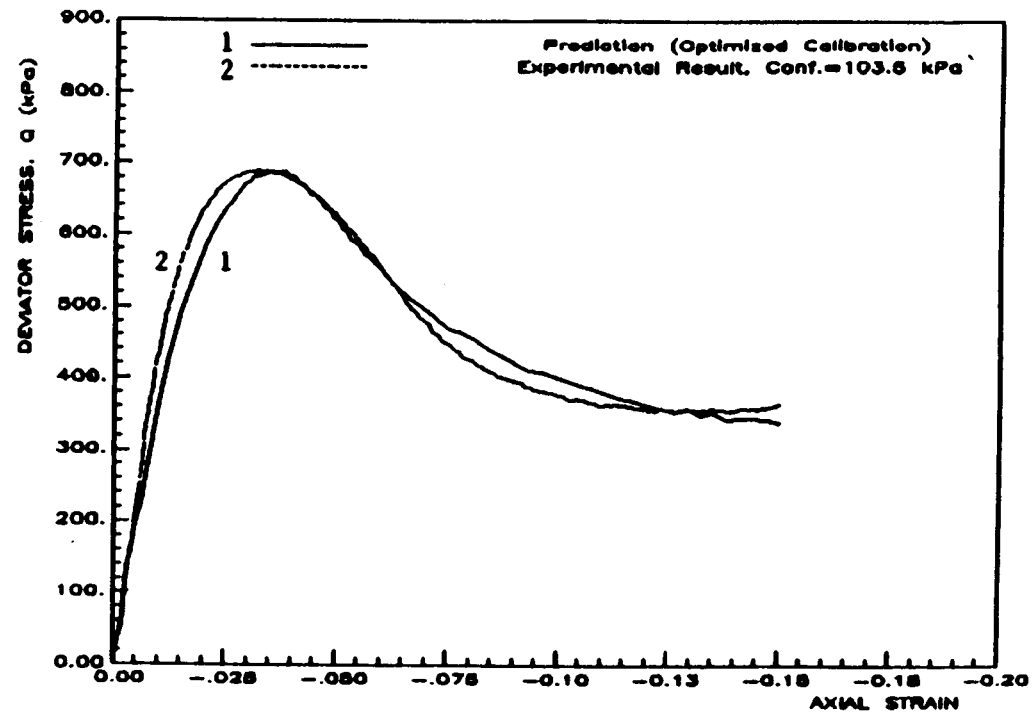

# EXPERIMENTAL AND PREDICTED RESPONSE BASED ON CALIBRATION VIA OPTIMIZED PARAMETERS AT F.E. LEVEL

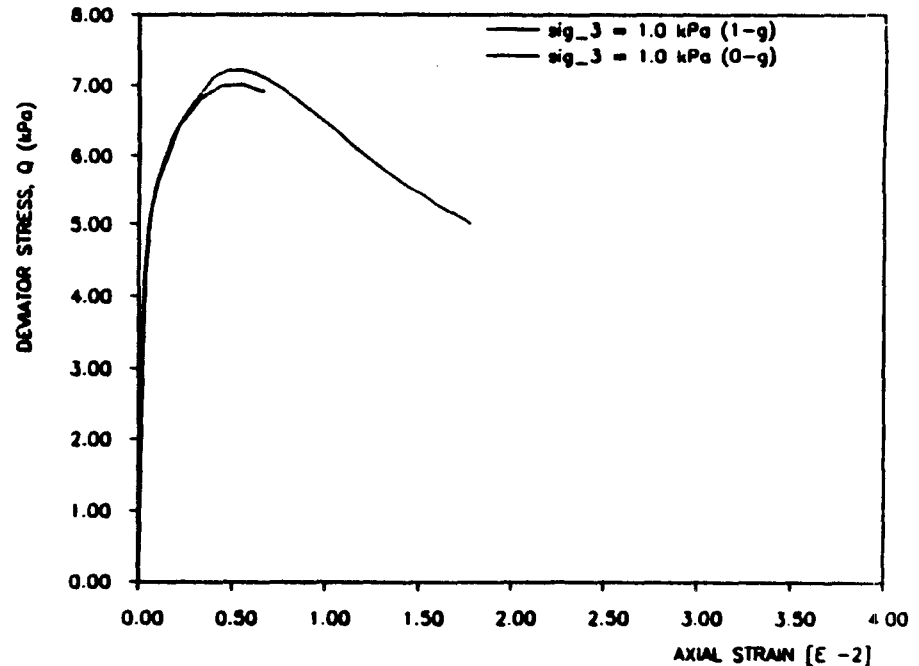
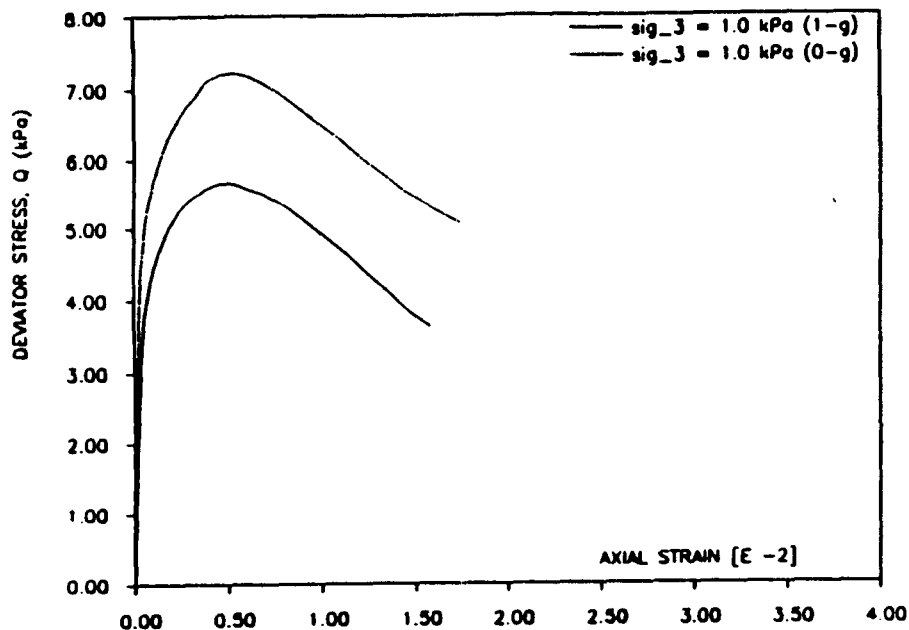

COMPARISON BETWEEN PREDICTED AND EXPERIMENTAL STRESS-DEFORMATION RESPONSE CURVES BEFORE (a) AND AFTER (b) OPTIMIZATION OF MATERIAL PARAMETERS FROM NONLINEAR INVERSE SOLUTION SCHEME ( $\sigma_3 = 1.0$  kPa), (MACARI-PASQUALINO, 1989).



TESTING SEQUENCE OF GRANULAR MATERIAL IN 1-G

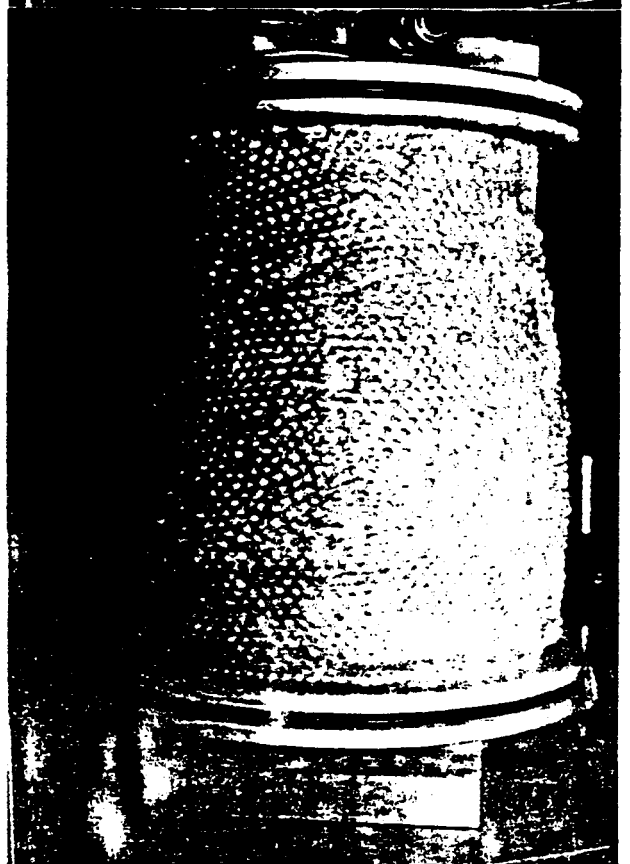
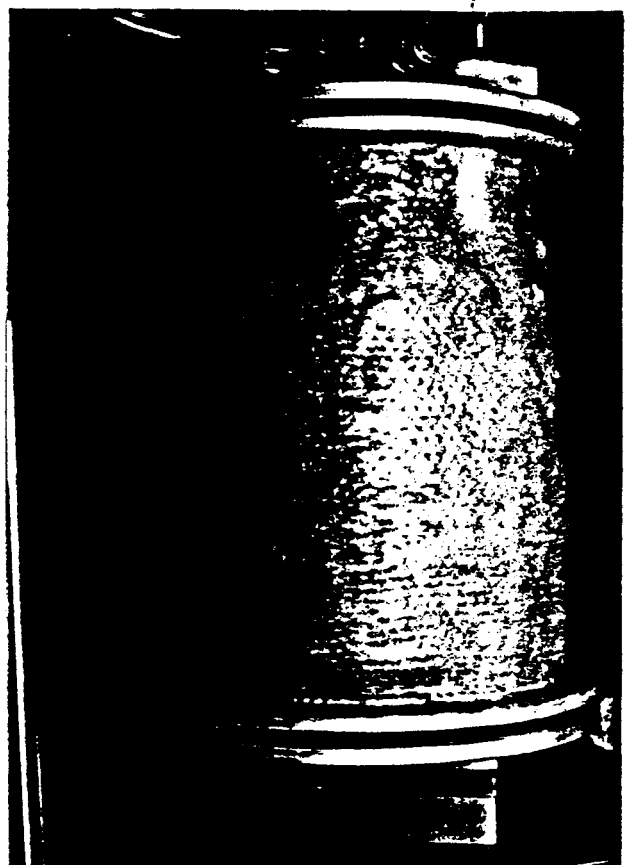

$\sigma_c = 0.25$  psi

# MECHANICS OF GRANULAR MEDIA (MGM)

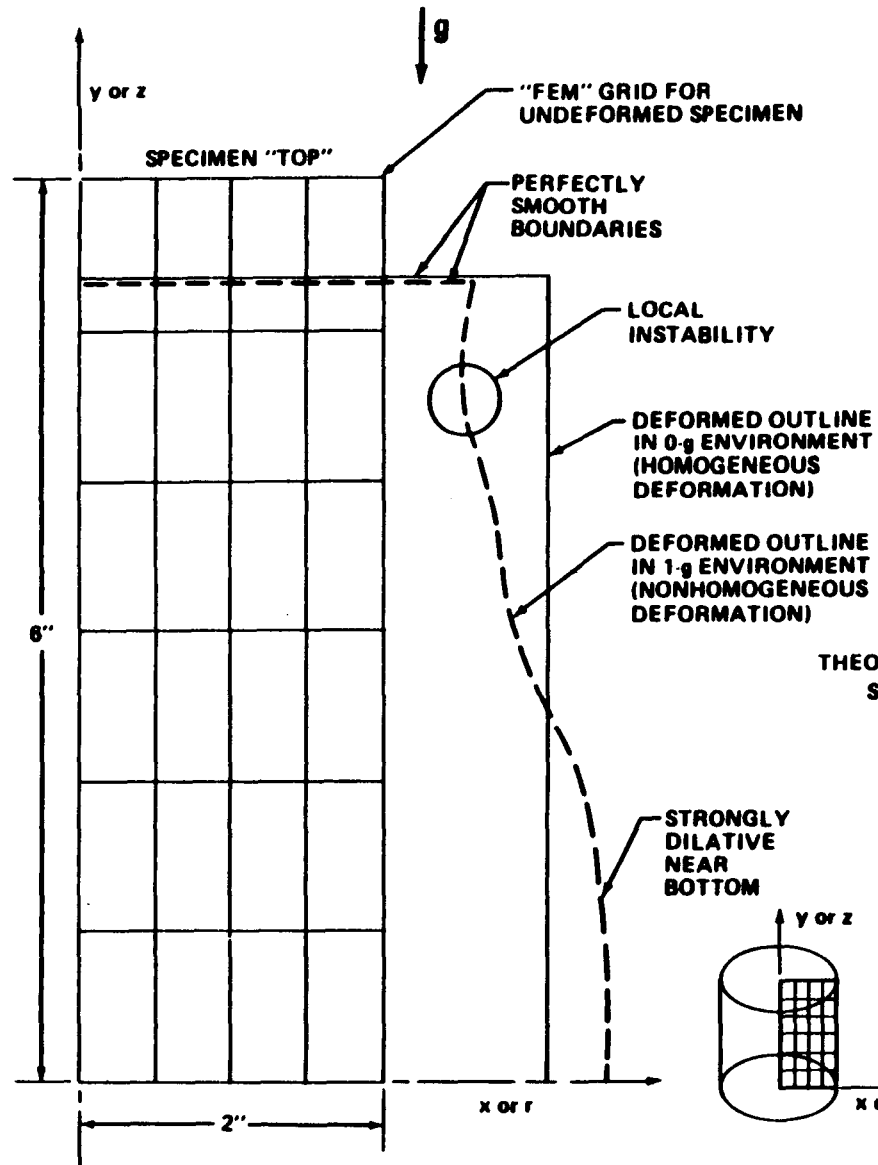

THEORETICAL PREDICTIONS OF SPECIMEN DEFORMATION UNDER STRAIN-CONTROLLED TRIAXIAL COMPRESSION LOADING USING FINITE ELEMENT METHOD (FEM). EFFECTIVE CONFINING PRESSURE,  $\sigma_c' = 0.25$  psi

**DEFORMED MESHES OF TRIAXIAL TEST  
SIMULATION AT LOW STRESSES  
WITH/WITHOUT INFLUENCE OF GRAVITY**

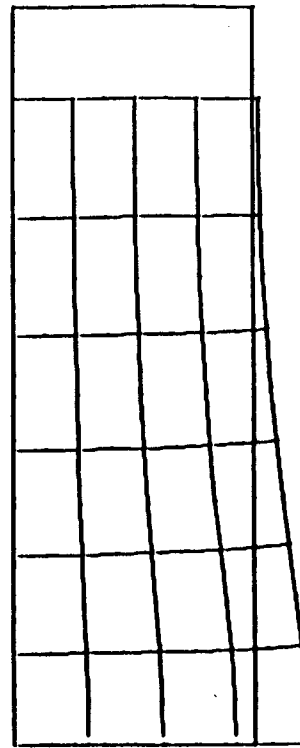
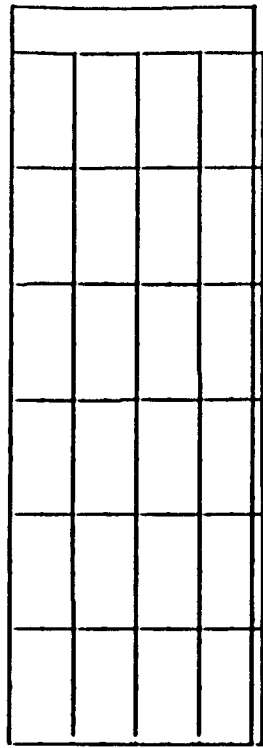

# TRIAxIAL TEST SIMULATION

## WITH/WITHOUT INFLUENCE OF GRAVITY

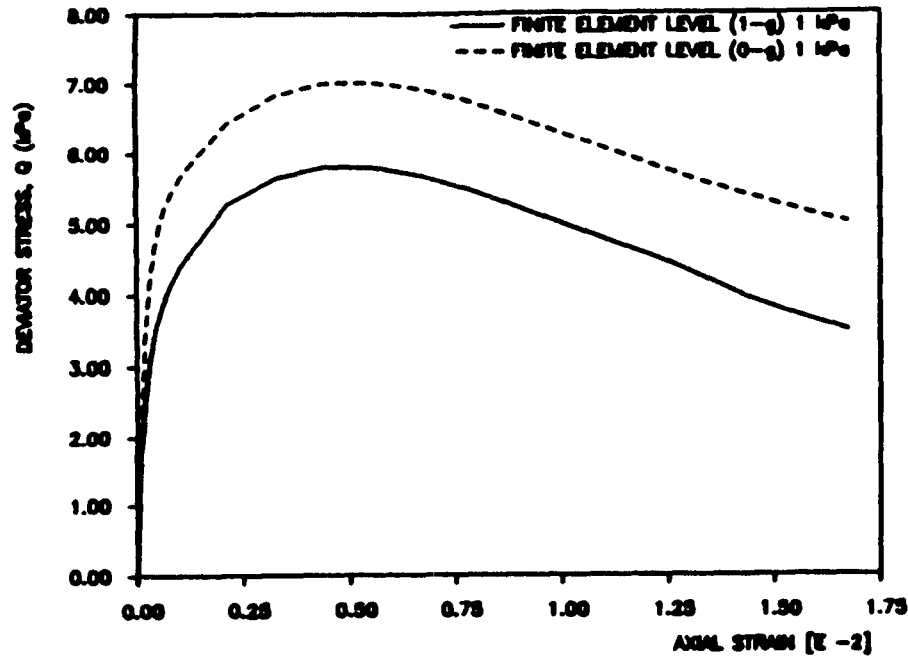

STRESS-DEFORMATION RESPONSE FOR CONVENTIONAL TRIAXIAL SPECIMENS SUBJECTED TO 1.0 kPa CONFINING STRESS UNDER  $\mu$ -G AND 1-G CONDITIONS

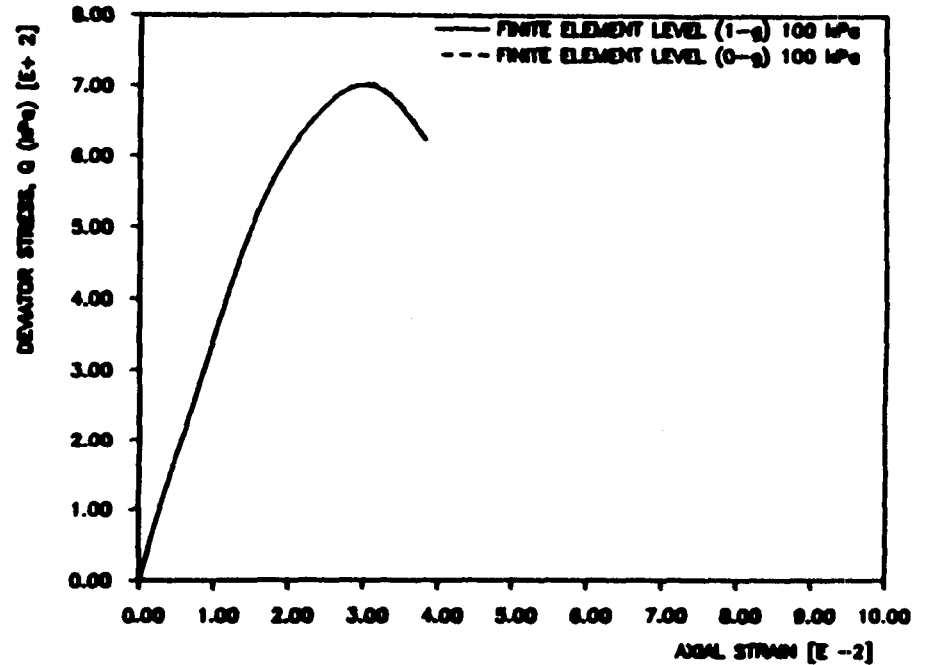

(a) STRESS-DEFORMATION RESPONSES FOR CONVENTIONAL TRIAXIAL SPECIMENS AT 100.0 kPa CONFINING STRESS UNDER  $\mu$ -G AND 1-G CONDITIONS

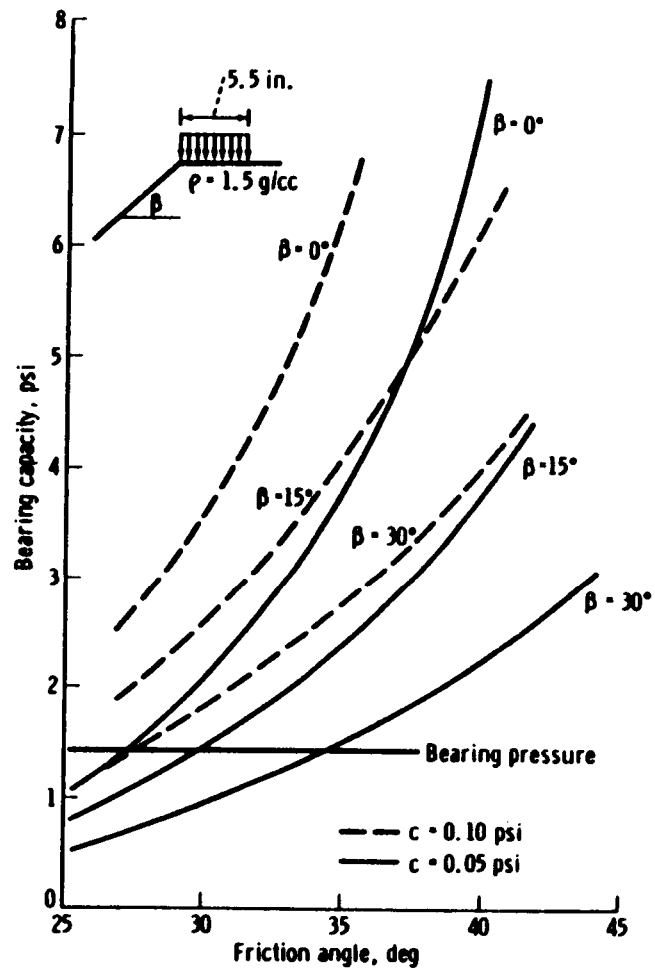

**BEARING CAPACITIES UNDER ASTRONAUT BOOT ADJACENT TO SLOPES FOR VARIOUS SOIL CONDITIONS (PRELIMINARY SCIENCE REPORT, APOLLO 11, NASA SP-214, 1969).**

UNDEFORMED F.E.M. MESH FOR A STRIP FOOTING (PAD)  
ON SLOPE CREST, (MACARI-PASQUALINO, 1989).

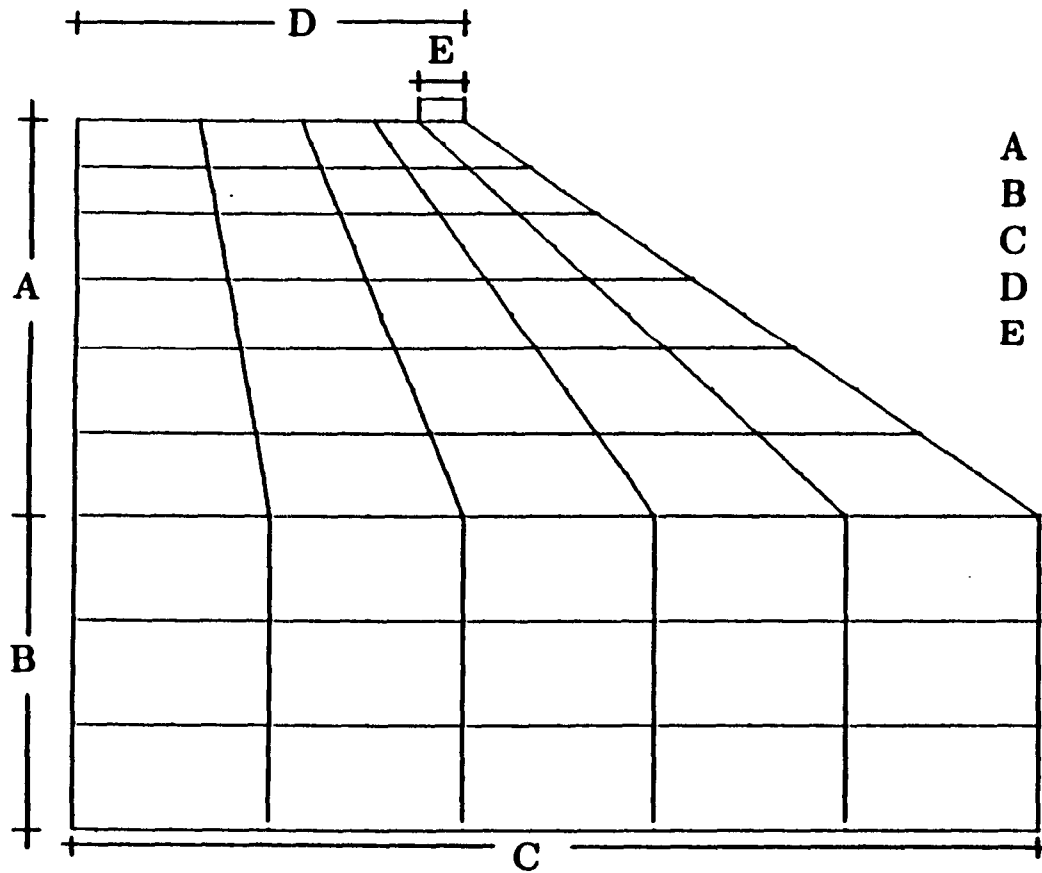

**DIMENSIONS (meters)**  
**MODEL - PROTOTYPE**

A	0.163	10.3
B	0.129	8.2
C	0.406	25.6
D	0.162	10.2
E	0.019	1.2

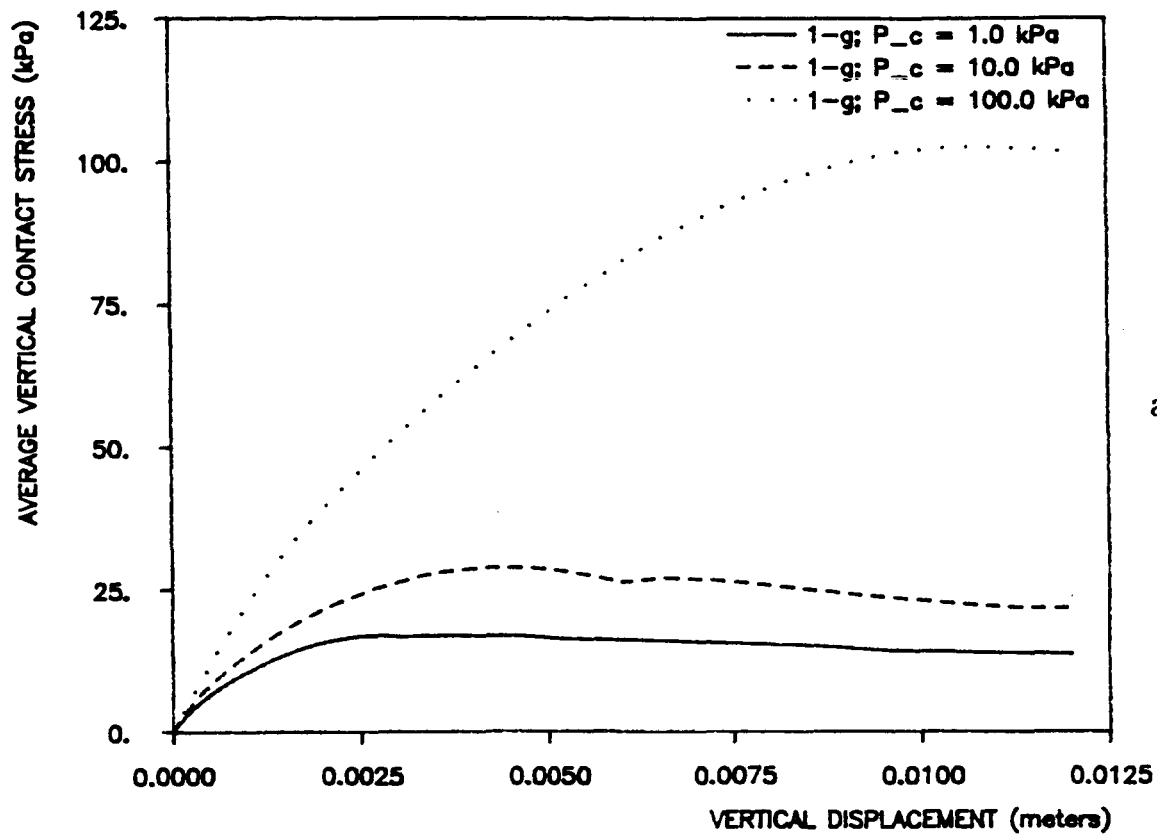

a)

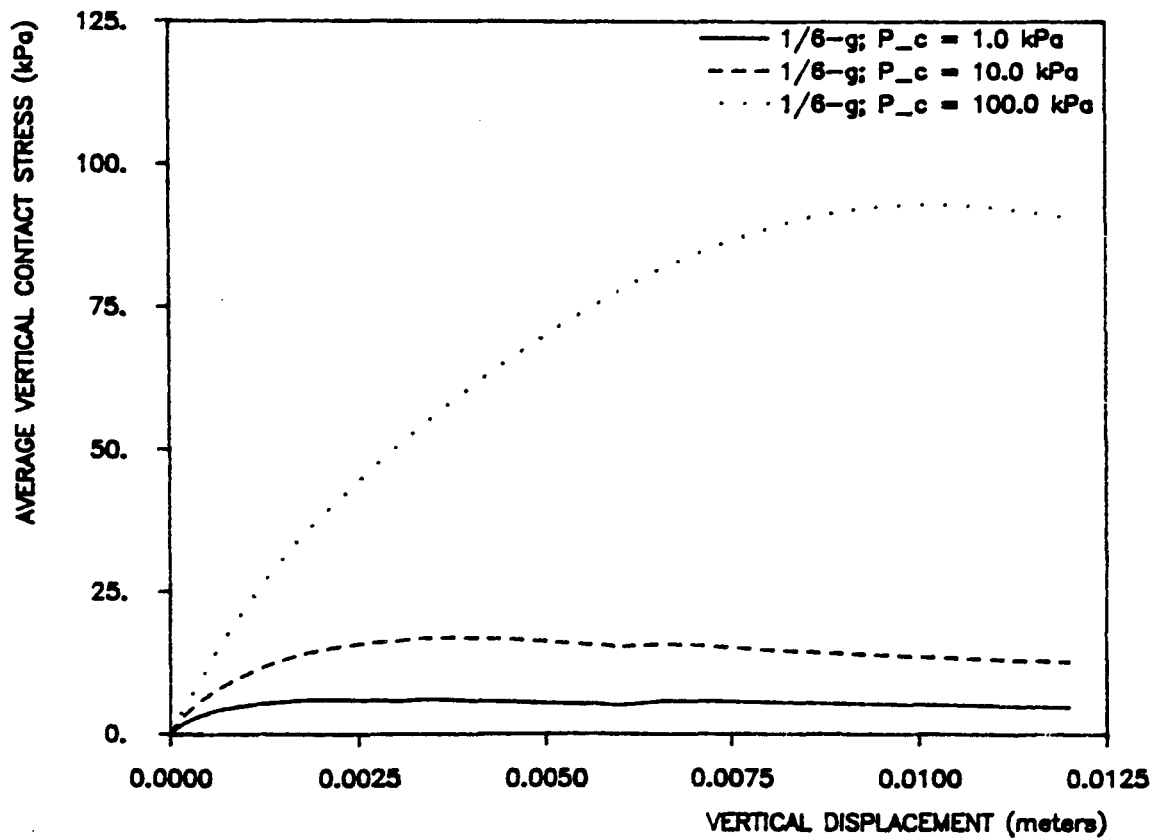

b)

LOAD-SETTLEMENT RESPONSES OF A STRIP FOOTING (PAD) ON A SLOPE CREST FOR VARIOUS VALUES OF ISOTROPIC TENSILE STRENGTH ( $p_c$ ) AND UNDER a) 1-G and b) 1/6-G CONDITIONS.

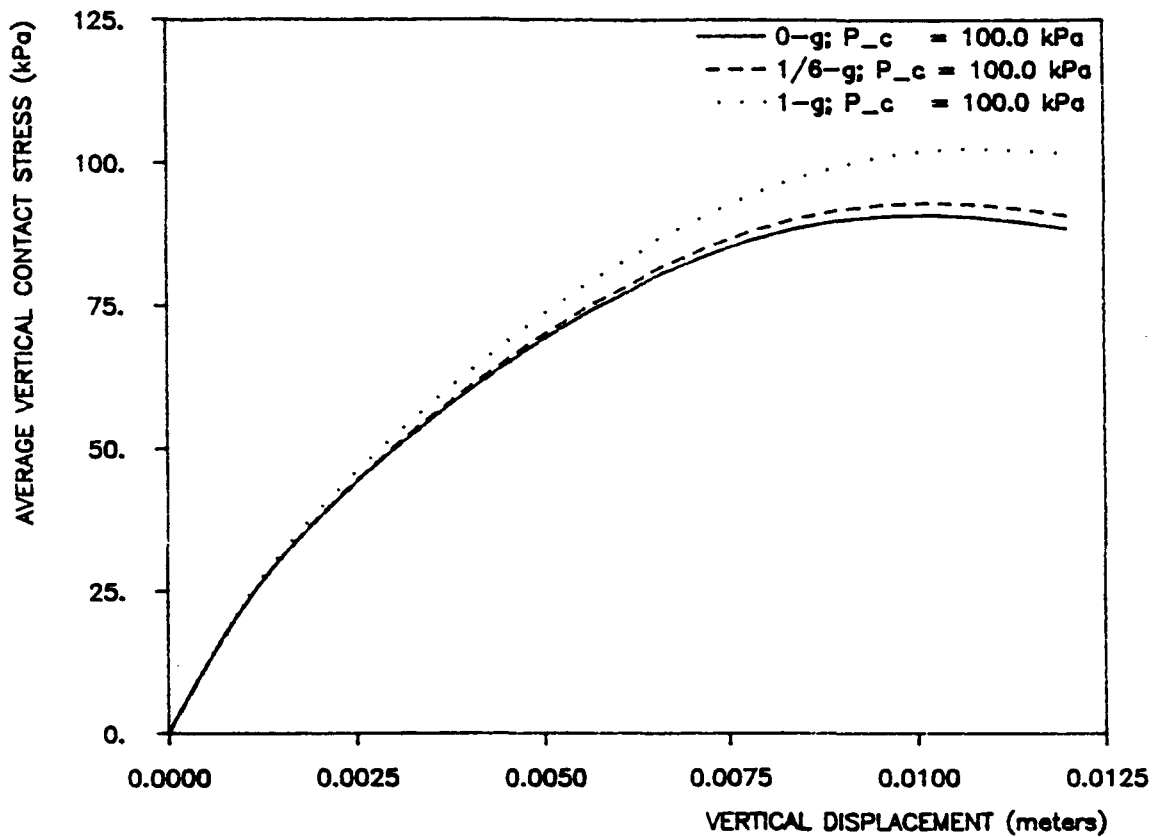

a.)

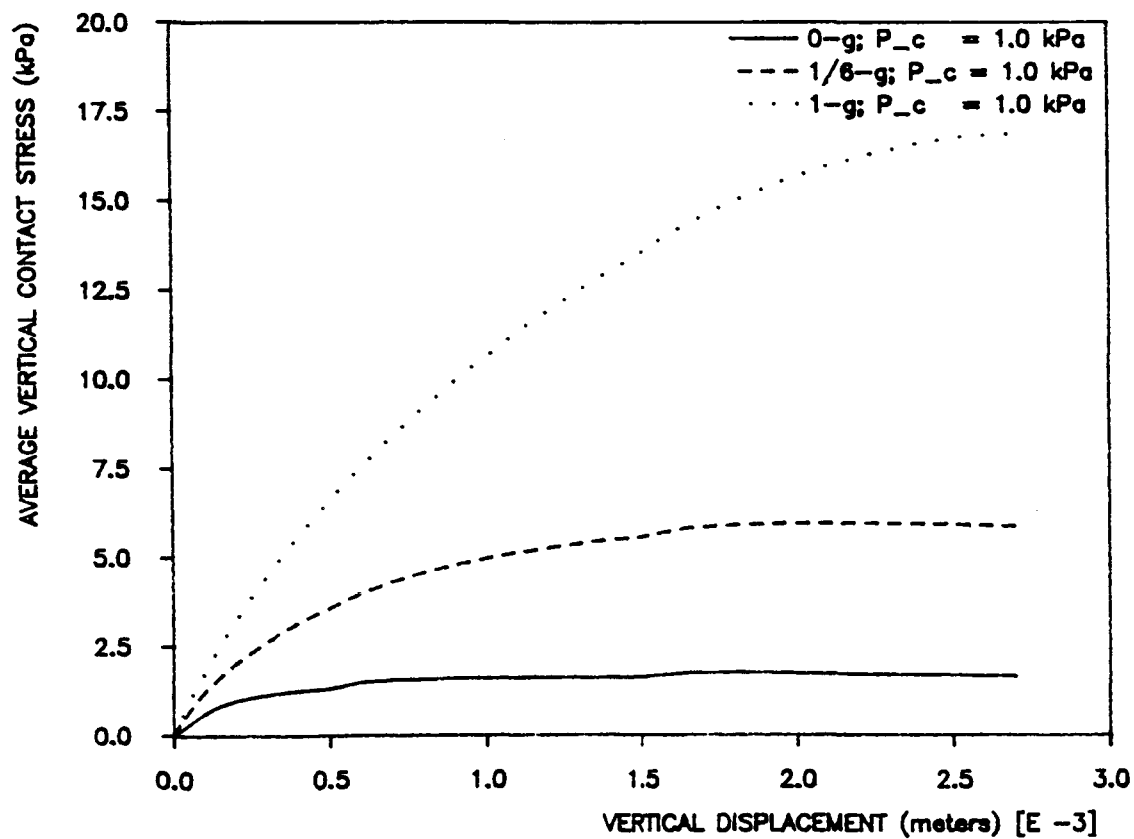

b.)

LOAD-SETTLEMENT RESPONSES OF A STRIP FOOTING (PAD) ON A SLOPE CREST FOR VARIOUS GRAVITY CONDITIONS AND FOR VALUES OF THE ISOTROPIC TENSILE STRENGTH ( $p_c$ ) a) 100 kPa and b) 1 kPa.



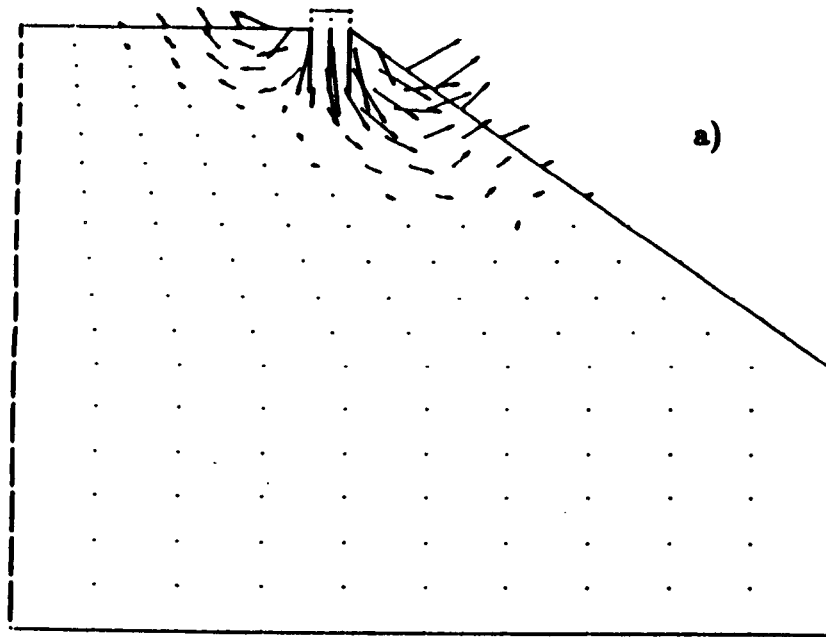

a)

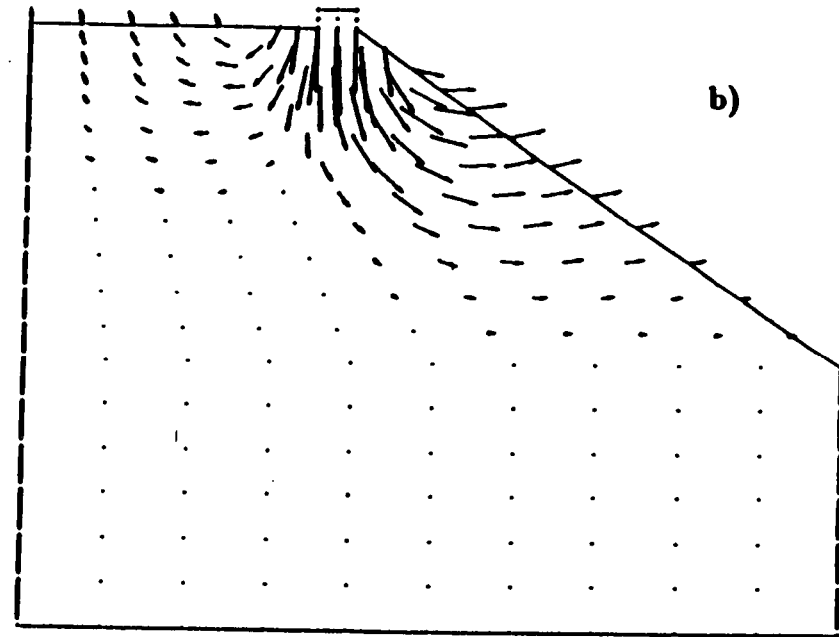

b)

F.E.M. MESH OUTLINES AND INCREMENTAL DISPLACEMENT VECTORS FOR 1/6-G WHERE THE TENSILE STRENGTH ( $p_c$ ) IS (a) 100.0 kPa AND (b) 1.0 kPa.

## CONVENTIONAL LIMIT EQUILIBRIUM ANALYSIS

(PRANDTL, 1921; BUISMAN, 1940; TERZAGHI, 1943)

$$q_f = \rho g B s_\gamma N_\gamma + c N_c + \rho g z N_q$$

$$q_{ALLOWABLE} = \frac{q_f}{F.S.}$$

- **F.S. = FACTOR OF SAFETY**
- **$q_f$  = BEARING CAPACITY ( $\frac{F}{A}$ )**
- **$\rho$  = MASS DENSITY**
- **$g$  = ACCELERATION OF GRAVITY**
- **$B$  = FOOTING (PAD) WIDTH, LENGTH, OR DIAMETER**
- **$s_\gamma$  = SHAPE FACTOR**
- **$\phi$  = ANGLE OF INTERNAL FRICTION**
- **$c$  = COHESION**
- **$z$  = DEPTH OF OVERBURDEN SOIL (REGOLITH)**
- **$N_\gamma$ ,  $N_c$  and  $N_q$  = DIMENSIONLESS BEARING CAPACITY FACTORS,  $N = N(\phi)$** 
  - $N_q = e^{\pi \tan \phi} \tan^2\left(\frac{\pi}{4} + \frac{\phi}{2}\right)$
  - $N_c = (N_q - 1) \cot \phi$
  - $N_\gamma \approx 2(N_q + 1) \tan \phi$

# CLASSICAL BEARING CAPACITY

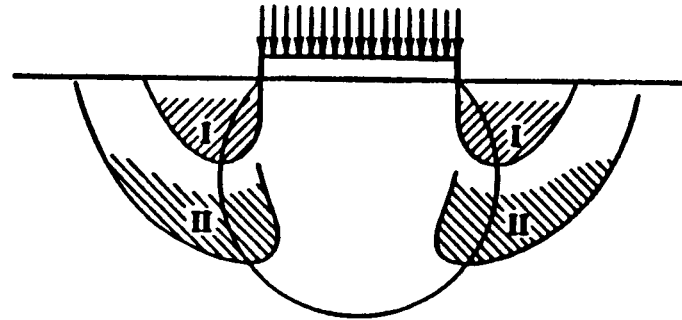

Plastic zones below the edges of a long loaded footing on sand.

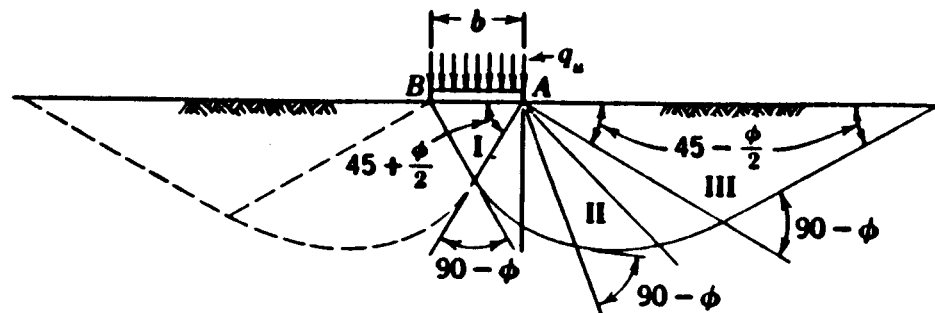

Cross section illustrating Prandtl's plastic equilibrium theory.

(TAYLOR, 1948)

# BEARING CAPACITY OF A SHALLOW FOUNDATION

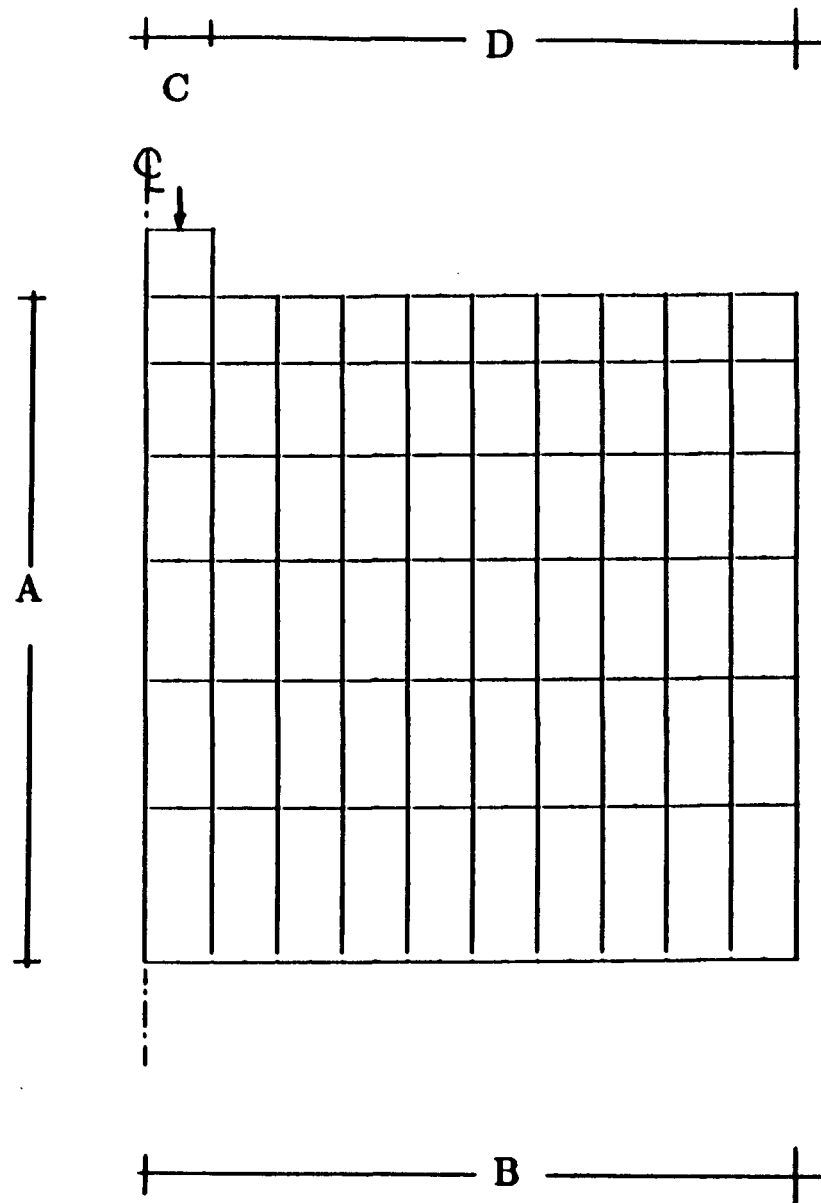

## DIMENSIONS (meters)

A	1.00
B	1.00
C	0.10
D	0.90

**BEARING CAPACITY OF A SHALLOW FOUNDATION  
(Strip Footing - Pad)  
ON UNIFORM SOIL (Regolith)**

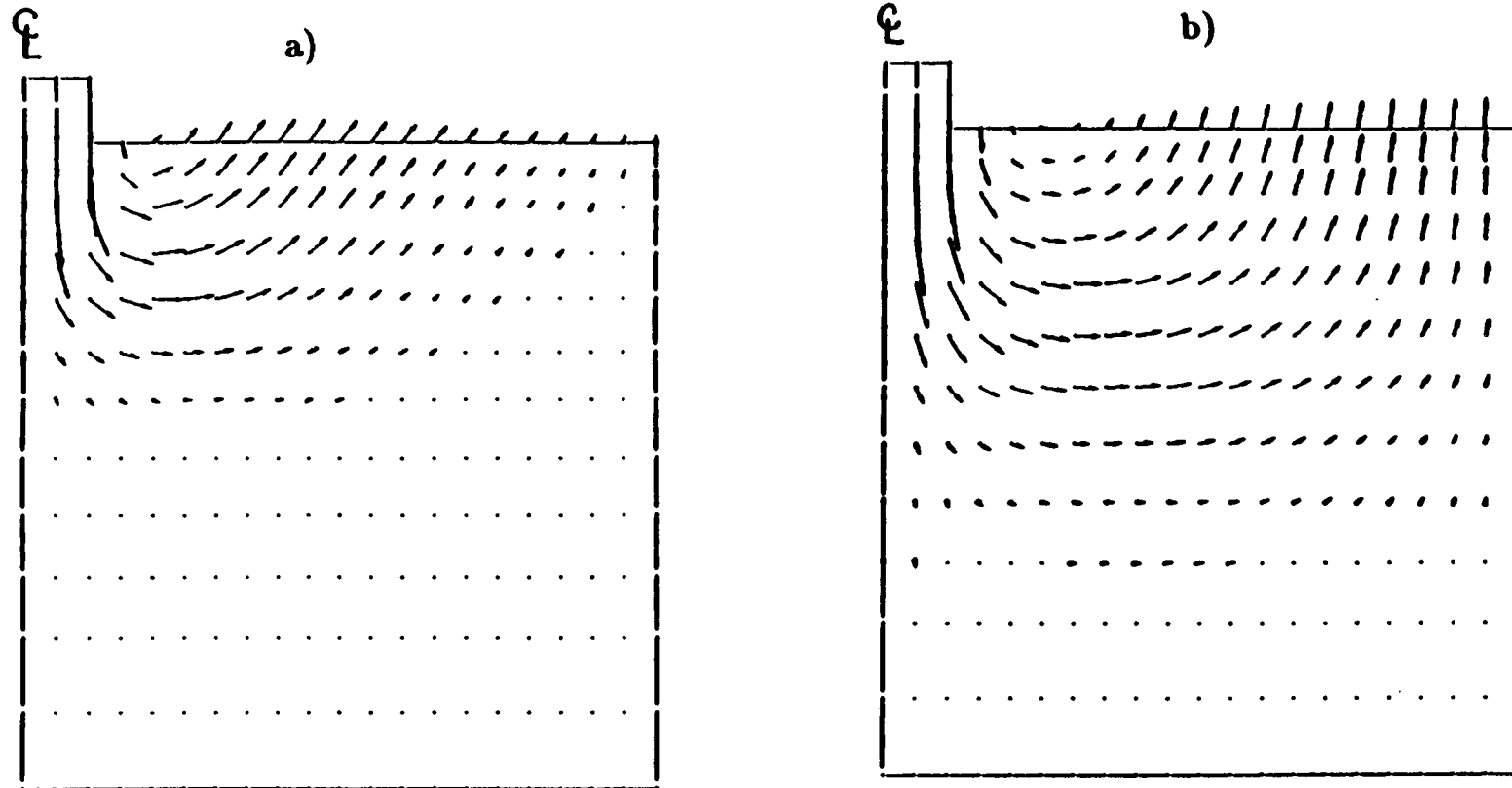

F.E.M. MESH OUTLINE AND INCREMENTAL DISPLACEMENT VECTORS FOR (a) 1-G, AND (b)  $\mu$ -G CONDITIONS WHERE THE TENSILE STRENGTH ( $p_c$ ) IS 1.0 kPa.

# BEARING CAPACITY ANALYSIS

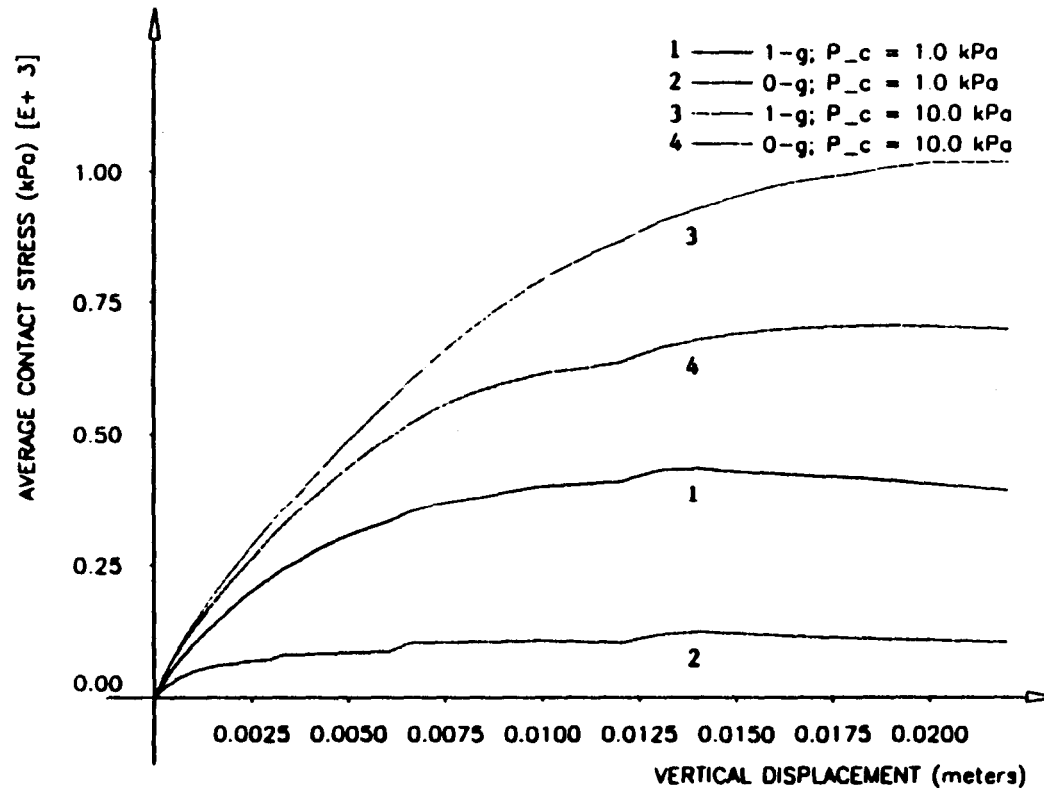

LOAD-SETTLEMENT RESPONSES OF STRIP FOOTINGS UNDER  $\mu$ -G AND 1-G CONDITIONS WHERE THE TENSILE STRENGTH ( $p_c$ ) IS 1.0 AND 10.0 kPa, (MACARI-PASQUALINO, 1989).

## CONCLUSIONS AND FUTURE RESEARCH

- THE MECHANICAL PROPERTIES OF THE LUNAR REGOLITH ESTABLISHED DURING THE APOLLO MISSION BY MEANS OF SIMULATIONS, IN SITU TESTING, AND EXPERIMENTS CONDUCTED AFTER MISSIONS, SHOW THAT THE REGOLITH BEHAVES LIKE A FINE GRAINED SOIL WITH LOW COHESION.
- THE COHESION, ALTHOUGH LOW, HAS A SIGNIFICANT INFLUENCE ON THE STRENGTH AND STIFFNESS (DEFORMATION) PROPERTIES OF THE REGOLITH.
- THE EFFECT OF REDUCED GRAVITY IS VERY PRONOUNCED FOR SOILS WITH LOW COHESION VALUES.
- OPTIMIZATION AT F.E.M. LEVEL WILL BE USED TO PREDICT EXPERIMENTAL (CENTRIFUGE) OR FULL SCALE PROBLEMS.
- BIFURCATION ANALYSES AT THE CONSTITUTIVE LEVEL AND F.E.M. LEVEL WILL BE USED TO PREDICT THE FORMATION OF SHEAR BANDS OF BOUNDARY VALUE PROBLEMS.
- REMESHING TECHNIQUES WILL BE USED TO REFINE MESHES ALONG THE DIRECTION OF POTENTIAL FAILURE SURFACES (SHEAR BANDS).

# BIFURCATION ANALYSIS

MESH ALIGNED ALONG POTENTIAL FAILURE SURFACE

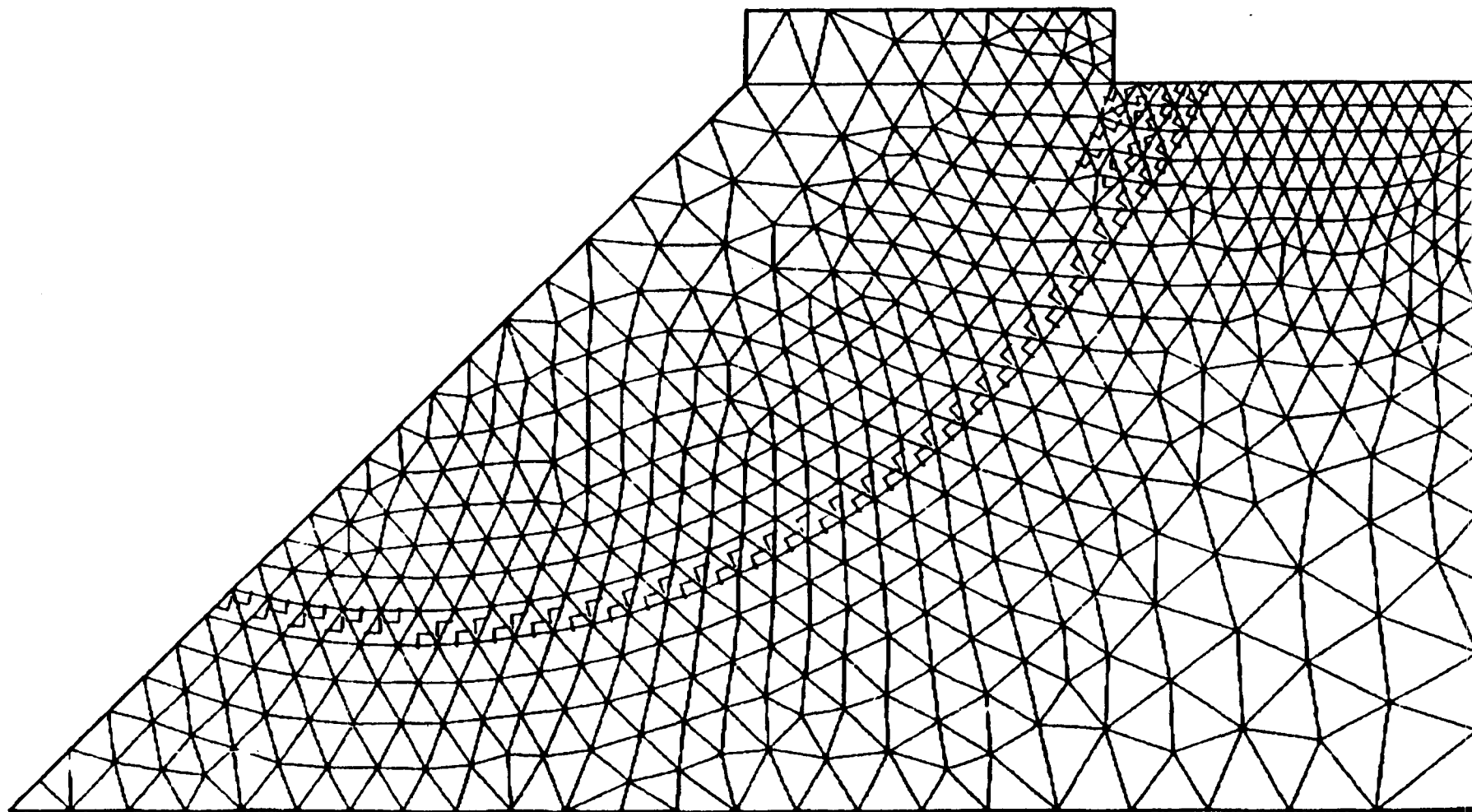



# WELL DEFINED CIRCULAR SLIP FAILURE

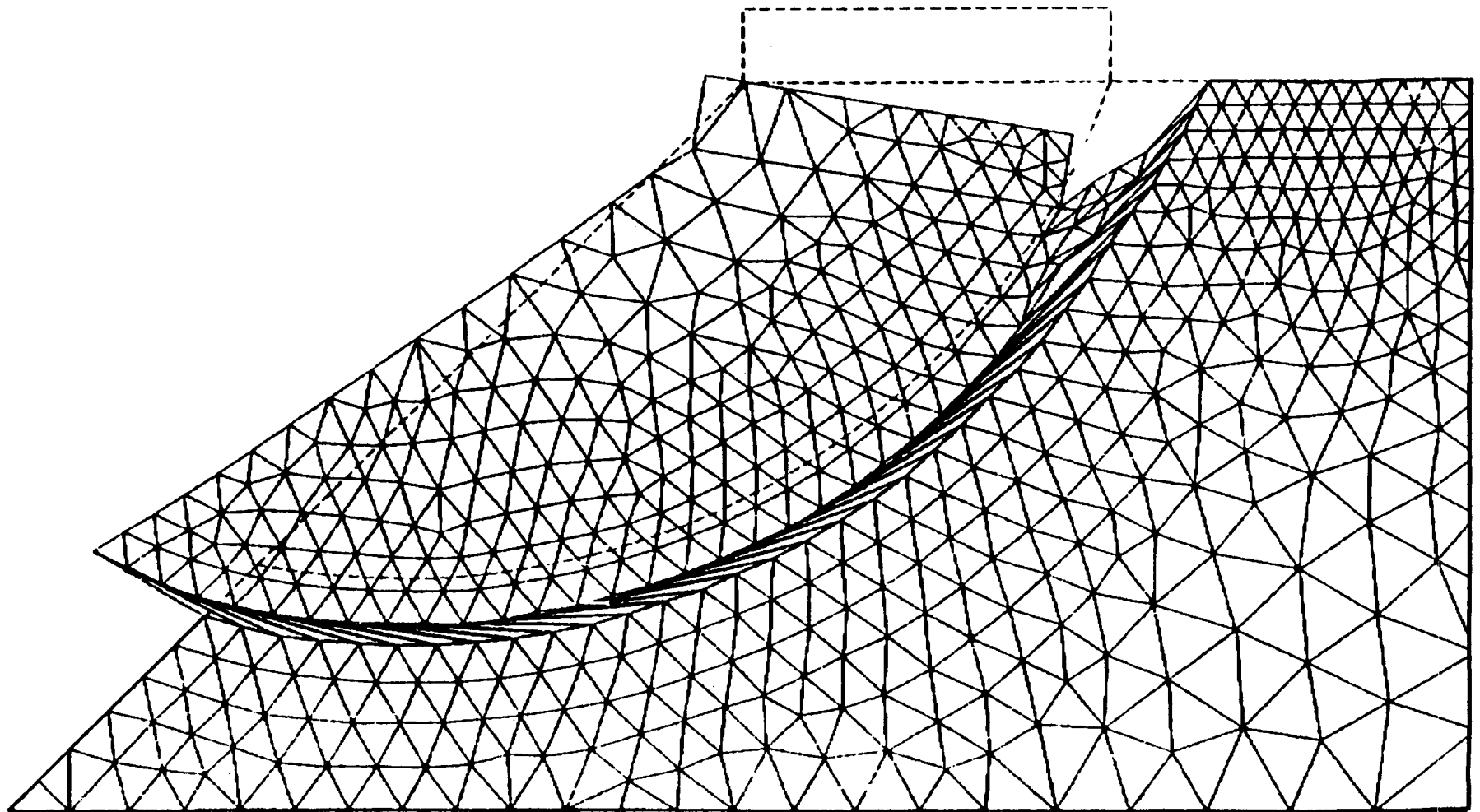

# INDENTATION FAILURE

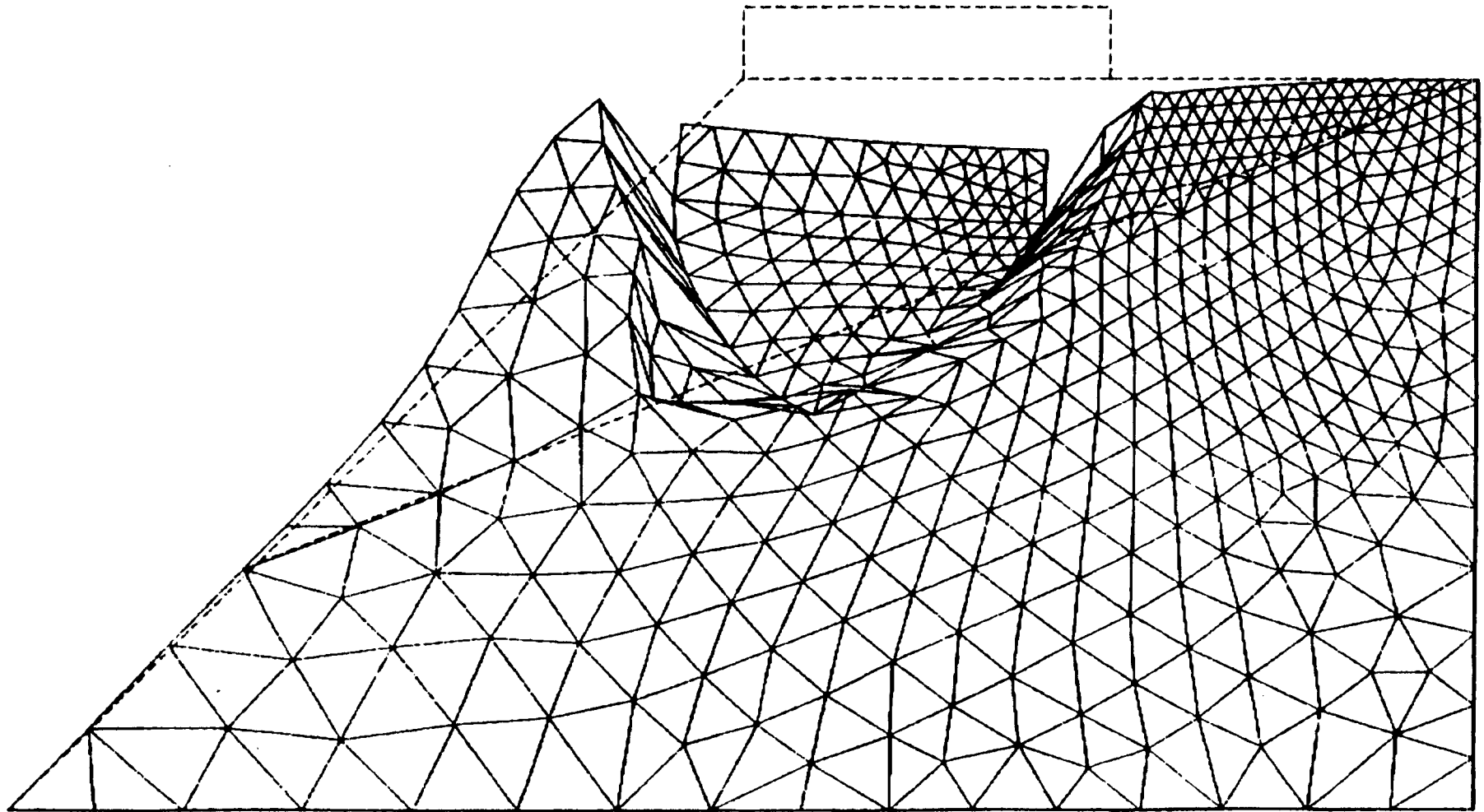

UNIVERSITY OF COLORADO  
CENTER FOR SPACE CONSTRUCTION

SYSTEMS CLUSTER

*MIT*

SPEAKERS

- George W. Morgenthaler (Cluster Leader)
- Kadett Chan/Kendall Nii
- Alex Montoya
- Ugo Racheli
- Chauncey Uphoff
- Randy Coffey
- Richard Johnson
- Roger Davidson

**CENTER FOR SPACE CONSTRUCTION**  
**ANNUAL SYMPOSIUM**  
**PRESENTATION ON SYSTEMS CLUSTER**  
**RESEARCH**

**GEORGE W. MORGENTHALER**

**UNIVERSITY OF COLORADO**

**BOULDER, COLORADO**

**OCTOBER 12 AND 13, 1989**

*p. 14*  
*160690*  
*28-66*  

# CSC - Systems Cluster - Goals

## I) Develop Concepts, Insights, and Models for Space Construction.

- **Where** do we want to go? **When?** **In What Order?**
- **How** best to get there?
- **What** to construct there?
- **Sub-optimizations** (Trade-offs)
- **"Global" Optimization**
- **Everything is Interrelated:**
  - Vehicle choices affect later missions.
  - Orbital choices are important.
  - Structural choices and "worker" choices are important.
  - Mission activities (exploration, mining, etc.) affect choices.
  - Impacts on budgets and national goals are important.

## II) Develop Systems Engineering/Analysis curricula critical for training future aerospace engineers and develop innovative research results.

# Original Proposal of SIMCON Model

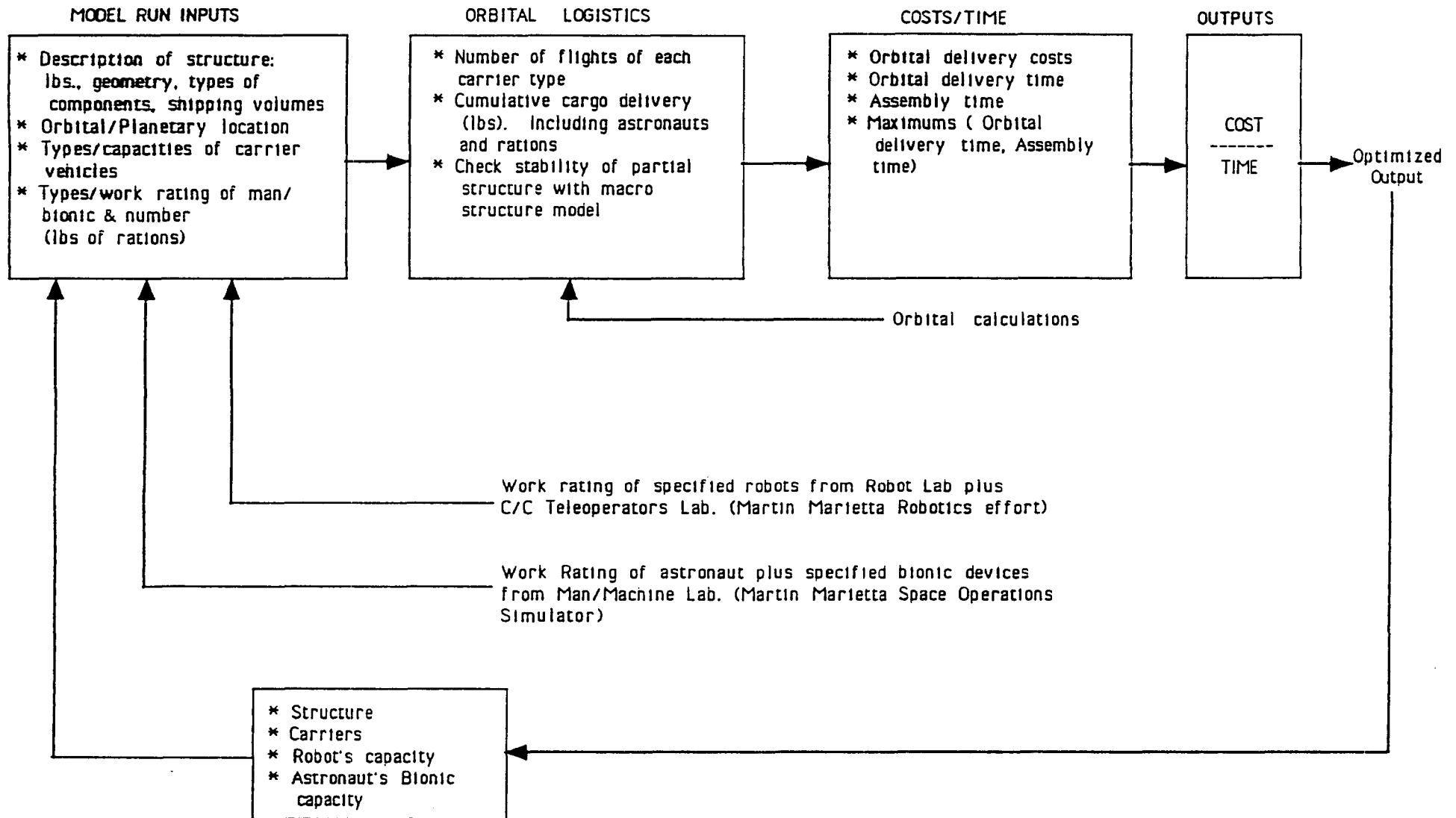



# CSC Systems Cluster Schedule

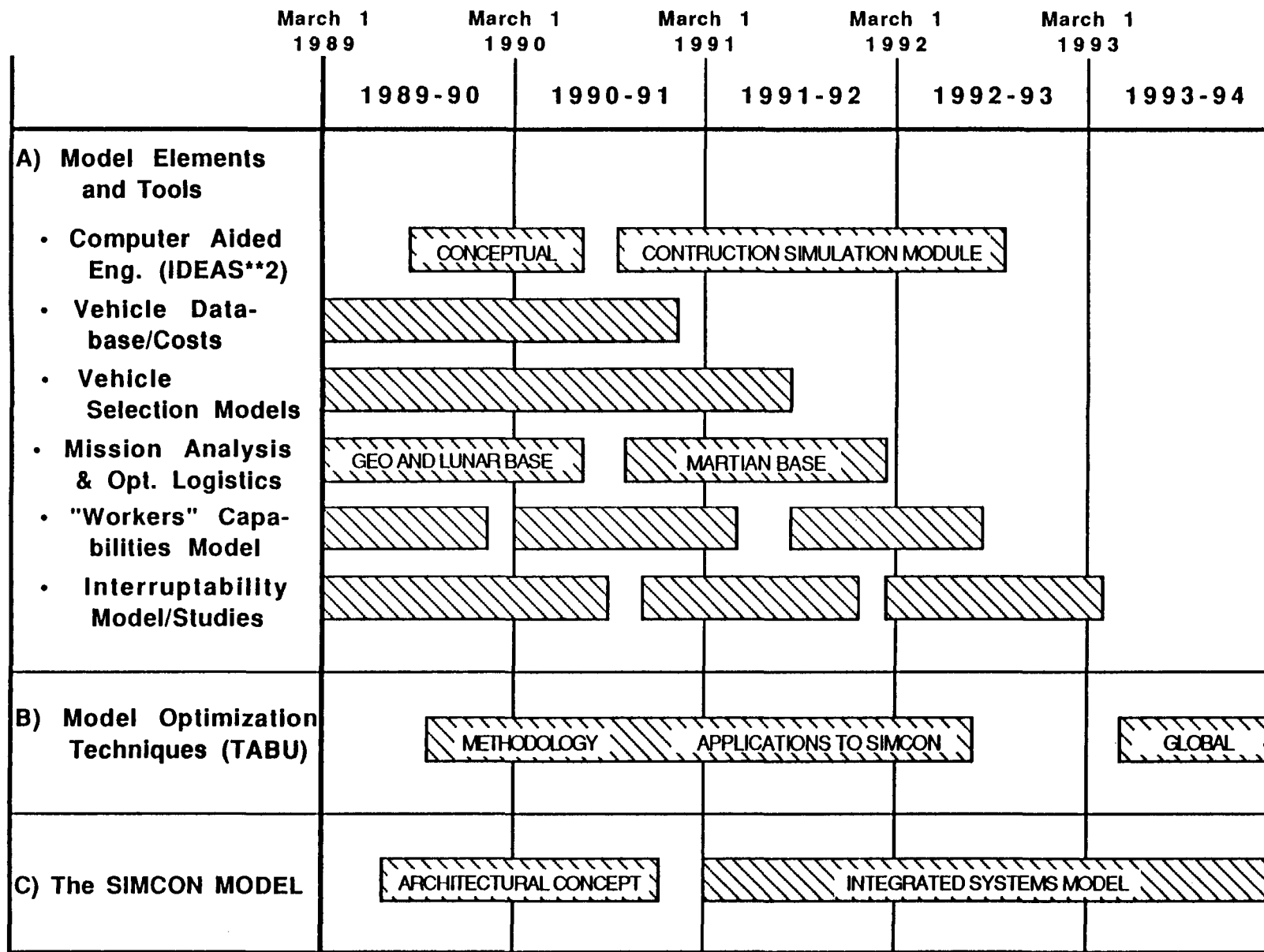



**CENTER FOR SPACE CONSTRUCTION  
SYSTEM ENGINEERING/ANALYSIS CLUSTER**

**SYSTEM LIFECYCLE**

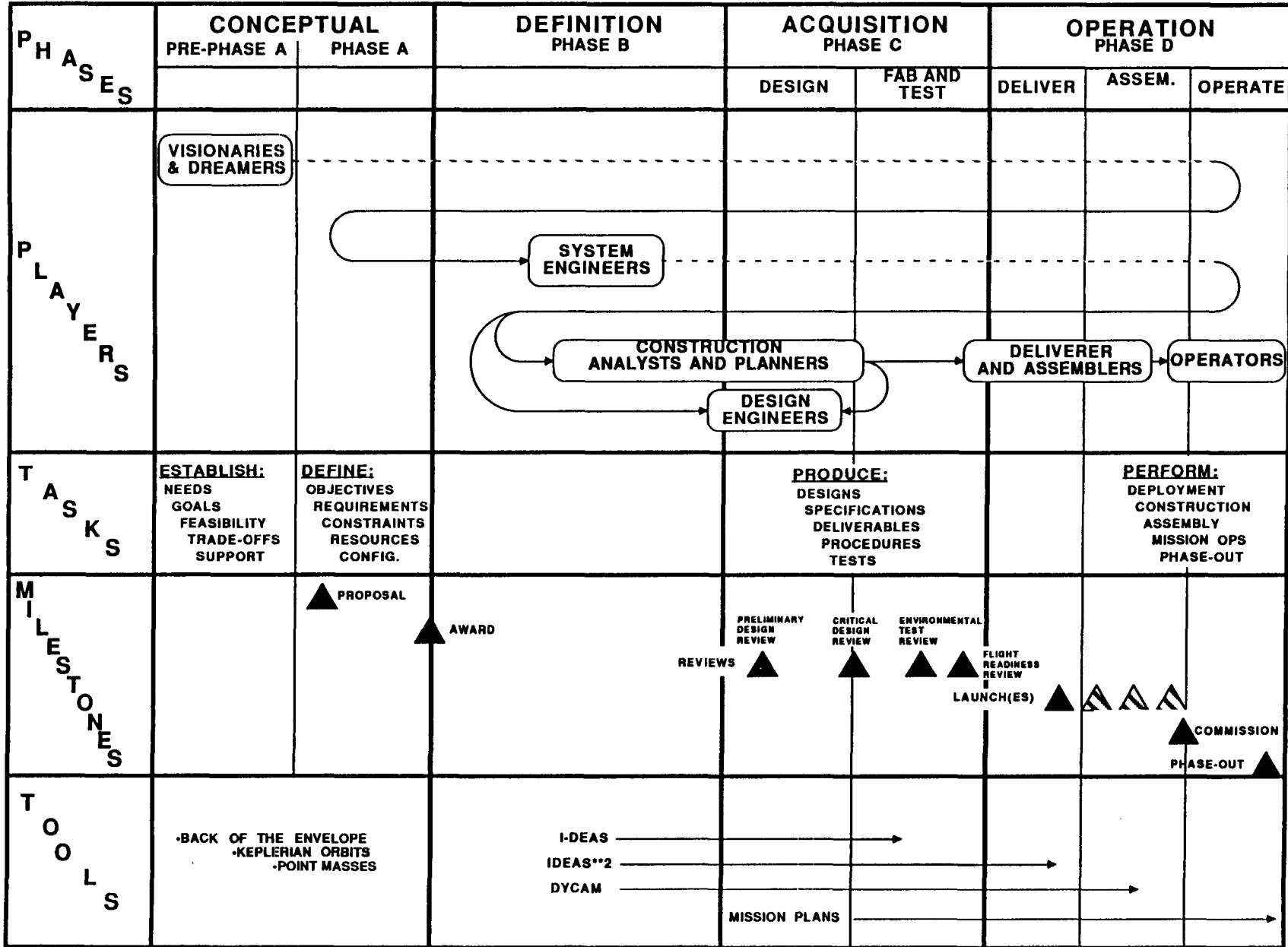

# Systems Cluster

## The SIMCON model

**Objective:** Develop an integrated Space Construction Optimization Model that reflects the variability of construction design, orbital energetics, space "worker" combinations, and mission terminal activities and that can assist in selection of "preferred" solutions, given cost and other constraints.

1. Develop insights and one-at-a-time, sequentially used system engineering tools for vehicle design, orbital selection, and "worker" trade-offs for selection of efficient space construction methods.
2. Include the above system engineering tools as modules in the IDEAS\*\*2 CAE shell and in SIMCON model.
3. Establish architecture and input/output formats for SIMCON.
4. Investigate and apply optimal search techniques with SIMCON to select preferred space construction techniques and plans.

## Model Optimization Techniques

**Objective:** Investigate methods for optimization of large-scale network models and simulation models including those where solutions are integer quantities

1. Review formulation of CAE IDEAS\*\*2 and SIMCON model and sub-models to determine nature of required optimization techniques.
2. Investigate TABU and other search techniques and compare with mathematical linear and nonlinear programming techniques and other optimal "search" methods.
3. Assist in the development of operations sequencing computer planning and AI models to improve space construction operations efficiency.
4. Apply optimization methods to representative space construction simulation models.

## CSC System Group Technical Notes

No.	Title	Author	Date
1	PIRET-Program Interruptability and Risk Evaluation Techniques	Roger A. Davidson	February, 1989
2	Program Interruptability and Risk Evaluation Technique (PIRET)	George W. Morgenthaler	February 27, 1989
3	Optimal Selection of Space Transportation Fleet to Meet Multi-Mission Space Program Needs	George W. Morgenthaler	March 8, 1989
4	Statistics of PIRET Network Junctions	Roger A. Davidson	March 16, 1989
5	Orbital Energetics Plan of Study	Mark A. Crouch	March 22, 1989
6	Launch Vehicle Design Group	Mike Loucks	April 4, 1989
7	N-Event PIRET Juncture Statistical Problem	Roger A. Davidson	April 10, 1989
8	Space Construction: Micro-gravity and the Human Element	Richard Johnson	April 12, 1989
9	Construction Activities Network CAE Model	Ugo Racheli	September 1, 1989
10	Preliminary Trajectory Design for Mission Planning	Mark A. Crouch	(August 28, 1989)*
11	Preliminary Vehicle Design Methodology	Mike Loucks	(September 1, 1989)

\*( ) Parentheses indicate a target completion date.

## CSC System Group Technical Notes

### CONTINUED

No.	Title	Author	Date
12	Cementitious Materials and Their Use in Lunar Base Construction	Alex J. Montoya	April 26, 1989
13	Ideas **2 Computer Aided Engineering Plan	Ugo Racheli	August 2, 1989
14	Time and Cost Analysis of Space Station Assembly Sequence 22/15 Using Statistical Methods	Kadett Chan	August 8, 1989
15	Construction Assembly Analysis of Space Station 22/15 for Input into PIRET Model	Ronald Moncada	August 8, 1989
16	Compound Distribution Theory Applied to Space Construction Problems	George W. Morgenthaler (Catherine Gonet)	August 23, 1989
17	Interruptability Analysis of Space Station 22/15 Construction	Todd K. Eastman Janet Gleave	(August 20, 1989)
18	Modeling Methodology for Human/Automation Tradeoff	Richard Johnson	August 28, 1989
19	Lunar Cycler Logistical Supply Concepts	C. Uphoff, M. Crouch, M. Loucks	(August 28, 1989)
20	TABU Search	Fred Glover	July, 1989
21	Candidate List Strategies and TABU Search	Fred Glover	July, 1989

- Morgenthauer, George W., Space Exploration and Utilization: The Next Frontier, invited lecture, Chubu Industrial Advancement Center's 1st Anniversary Commemorative Symposium -- New Frontier-Space, Oceans, Subterranean -- Future Dream, Human and Technology, November 29, 30, 1988, Nagoya, Japan. (Proceedings to appear.)
- Coffey E., Randall, "Launch Mass Reduction via Constrained Keplerian Depot Orbit Selection for Cyclic High Orbit Missions." Proceedings of the Third Pacific Basin International Symposium on Advances in Space Science Technology and Its Applications (PISSTA), Sponsors: American Astronautical Society, Chinese Astronautical Society, and Japanese Rocket Society, Los Angeles, California, November 6-8, 1989 (to appear).
- Morgenthauer, George W. and Randolph H. Ware, "Scientific, Commercial, and Space Construction Uses of Shuttle External Fuel Tanks," Proceedings of the Third Pacific Basin International Symposium on Advances in Space Science Technology and Its Applications (PISSTA), Sponsors: American Astronautical Society, Chinese Astronautical Society, and Japanese Rocket Society, Los Angeles, California, November 6-8, 1989 (to appear).
- Davidson, Roger A. and George W. Morgenthauer, "Addressing the Problem of Interruptability in the Construction of Large Space Structures," Proceedings of the Third Pacific Basin International Symposium on Advances in Space Science Technology and Its Applications (PISSTA), Sponsors: American Astronautical Society, Chinese Astronautical Society, and Japanese Rocket Society, Los Angeles, California, November 6-8, 1989 (to appear).

## REPORTS AND PAPERS

- Johnson, Richard, "A Prototype Model for Human/Automation Trade-Offs," Proceedings of the Space '90 Engineering, Construction and Operations in Space Conference, American Society of Civil Engineers, Albuquerque, New Mexico, April 23-26, 1990 (to appear).
- Racheli, Ugo, "Computer Aided Engineering for Space Systems Construction," Proceedings of the Space '90 Engineering, Construction and Operations in Space Conference, American Society of Civil Engineers, Albuquerque, New Mexico, April 23-26, 1990 (to appear).
- Uphoff, C., Mark Crouch, and Mike Loucks, "Lunar Cyclor Orbital Logistics Optimization," Proceedings of the Space '90 Engineering, Construction and Operations in Space Conference, American Society of Civil Engineers, Albuquerque, New Mexico, April 23-26, 1990 (to appear).
- Morgenthaler, George W. and Alex Montoya, "Optimal Selection of Space Transportation Fleet to Meet Multi-Mission Space Program Needs," Proceedings of the Space '90 Engineering, Construction and Operations in Space Conference, American Society of Civil Engineers, Albuquerque, New Mexico, April 23-26, 1990 (to appear).
- Glover, Fred, "Tabu Search Optimization Tool" Operations Research Society of America, New York, New York, September 11-14, 1989.
- Morgenthaler, George W., "Application of Statistical Distribution Theory to Launch-On-Time for Space Construction Logistic Support," Proceedings of the Space '90 Engineering, Construction and Operations in Space Conference, American Society of Civil Engineers, Albuquerque, New Mexico, April 23-26, 1990 (to appear).

# SYSTEMS CLUSTER COOPERATIVE EFFORTS

1. Ball Aerospace
  - Chauncey Uphoff orbital dynamics expert - Seminars
  - Internship for two graduate students (Summer of '89)
  - One Graduate Fellowship
2. Apollo Computer, Inc.
  - Hardware and networking support (workstation) for implementation of IDEAS\*\*2
3. Apple Computer, Inc.
  - PC hardware and software donations for program development
4. Martin Marietta Companies
  - Data compilation and report on the Advanced Launch System (ALS)
5. Explosive Fabricators, Inc.
6. NASA/JSC
  - Joint effort on Space Station Freedom "interruptability" problem
7. McDonnell Douglas
  - Launch Vehicle Data
8. General Dynamics
  - Launch Vehicle and Spacecraft data



# Systems Cluster

## Sponsored Research

1. **Aerospace Century XXI Fellowships (Dept. of Education)**
  - Five fellowships for graduate students
  
2. **SMART**
  - (Summer Minority Access to Research Training)  
Two students
  
3. **Summer Internships**
  - E.P.F. (Ecole Polytechnique Feminine - Sceaux, France)  
One student
  
4. **Undergraduate Research Opportunity Awards (UROPs)**
  - K. Chan (Interruptability) and K. Nii (Compound Distributions)

[REDACTED]

**APPLICATION OF STATISTICAL DISTRIBUTION  
THEORY TO LAUNCH-ON-TIME FOR SPACE CONSTRUCTION  
LOGISTIC SUPPORT**

George W. Morgenthaler<sup>1,2</sup>

521-66  
160691  
F-10

Abstract

The ability to launch-on-time and to send payloads into space has progressed dramatically since the days of the earliest missile and space programs. Causes for delay during launch, i.e., unplanned "holds", are attributable to several sources: weather, range activities, vehicle conditions, human performance, etc. Recent developments in the Space Program, particularly the need for highly reliable logistic support of space construction and the subsequent planned operation of: space stations, large unmanned space structures, Lunar and Mars bases, and the necessity of providing "guaranteed" commercial launches have placed increased emphasis on understanding and mastering every aspect of launch vehicle operations.

The Center for Space Construction has acquired historical launch vehicle data and is applying these data to the analysis of space launch vehicle logistic support of space construction. This analysis will include development of a better understanding of launch-on-time capability, and simulation of required support systems for vehicle assembly and launch which are necessary to support national Space Program construction schedules.

In this paper, we present actual launch data on unscheduled "hold" distributions of various launch vehicles. The data have been supplied by Industrial Associate companies of the Center for Space Construction. We seek to determine suitable probability models which describe these historical data and that can be used for several purposes such as: a) inputs to broader simulations of launch vehicle logistic space construction support processes, and b) to determine which launch operations sources cause the majority of the unscheduled "holds", and hence to suggest changes which might improve launch-on-time. In particular, the paper investigates the ability of a compound distribution probability model to fit actual data, versus alternative models, and recommends the most productive avenues for future statistical work.

---

<sup>1</sup>Professor, Aerospace Engineering Sciences Dept. and Center for Space Construction, and Associate Dean, College of Engineering and Applied Sciences, University of Colorado at Boulder, 80309-0429.

<sup>2</sup>The author gratefully acknowledges the assistance of the following Center for Space Construction undergraduate students: Catherine Gonet, Ecole Polytechnique Feminine, Paris, France; and Kadett Chan and Kendall Nii, Department of Aerospace Engineering Sciences, University of Colorado.

# COMPOUND DISTRIBUTIONS APPLIED TO CONTROLLING

## LAUNCH-ON-TIME:

- Space Construction Interruptability Problem - failure to keep logistic supply schedule could cause loss of space construction structure.
- Commercial Competitiveness - vendors will offer "guaranteed" launch-on-time, not only launch reliability, smooth ride, and low cost.
- Make Critical "Launch Windows" - e.g., meet Halley's Comet, do Voyager II - type multi-planet encounters, deep-space rendezvous, etc.
- Space Rescue, Space Police Action, Military Space Peace-Keeping - require controllable "launch-on-time" systems.

# SIMULATIONS OF SPACE CONSTRUCTION LOGISTICS SUPPLY REQUIRES UNDERSTANDING OF LAUNCH STATISTICS

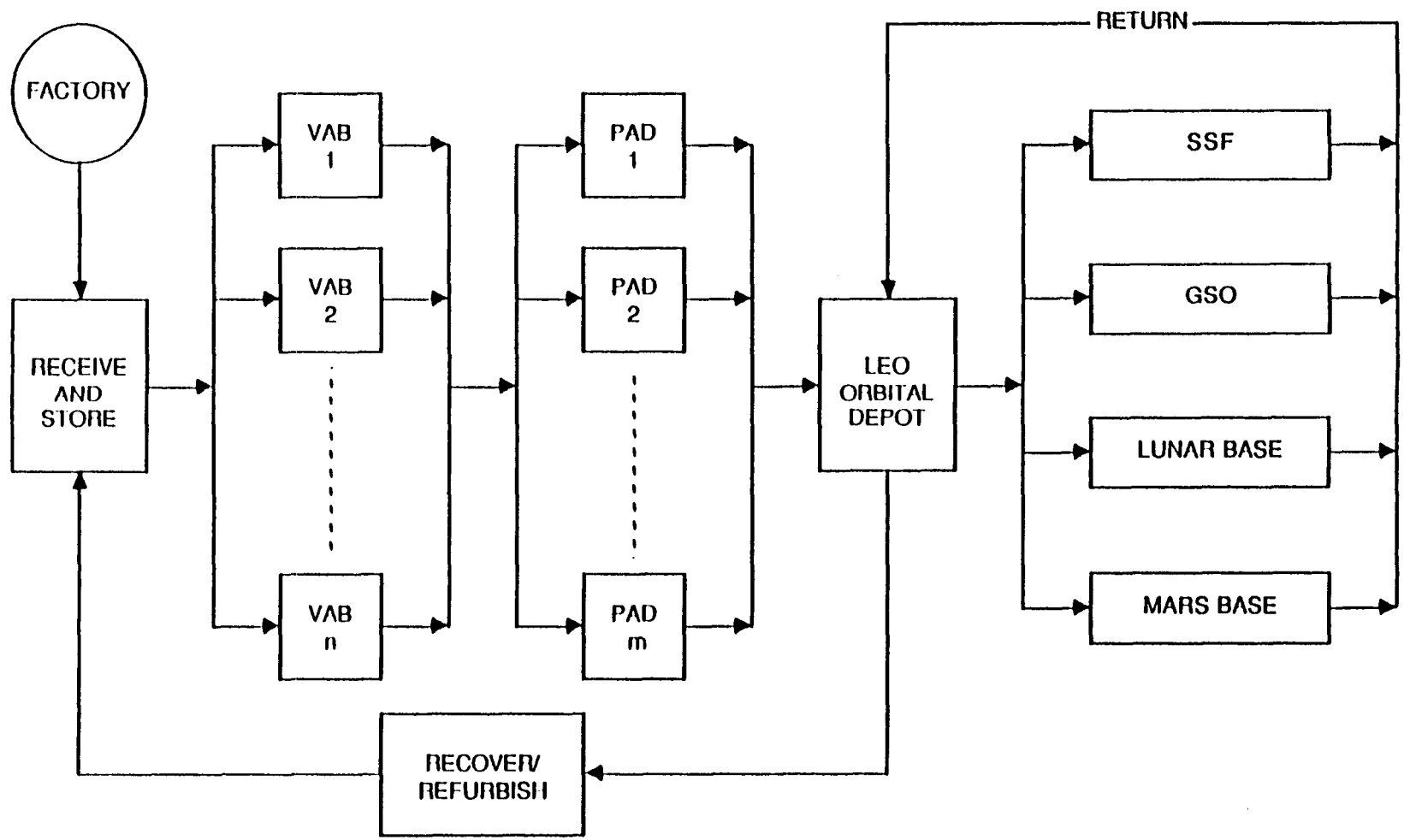

- Launch operations have scheduled "holds" to control launch times.
- $N$  = number of unscheduled "holds" (random integer)
- $t_i$  = duration of ith unscheduled "hold"
- $S_N = \sum_{i=1}^N t_i$  is total of unscheduled "hold" time,  
sum of a random number of random variables

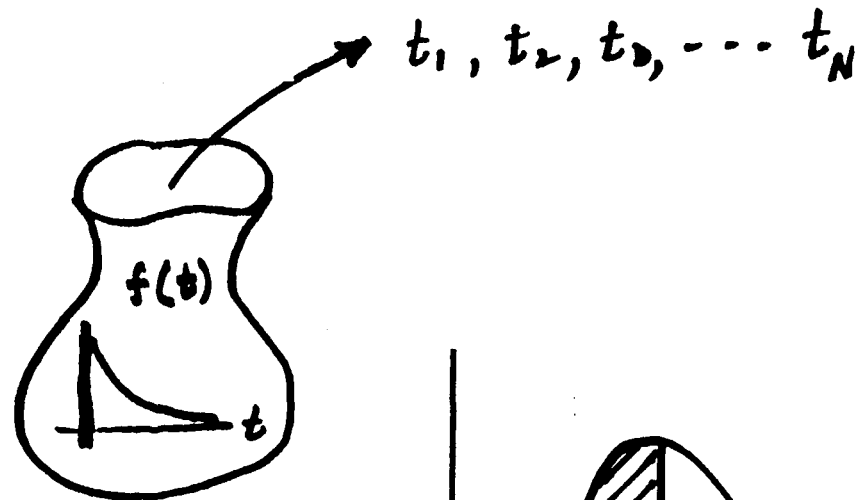
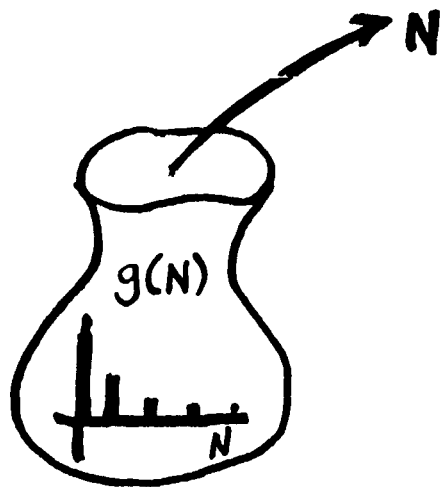

- Find

$$H(t_0) = P [S_N \leq t_0]$$

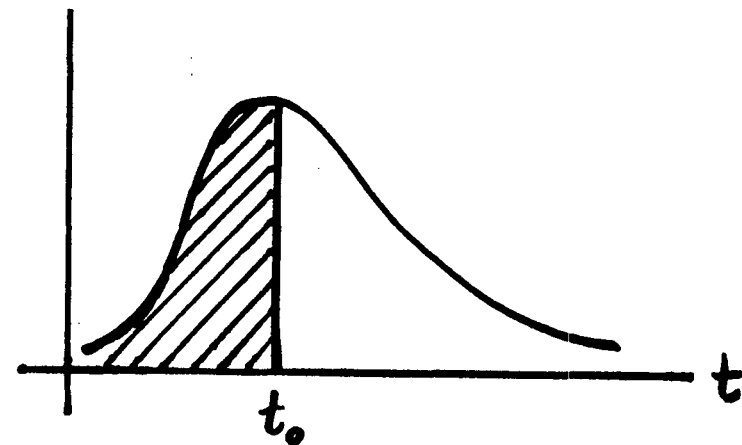

# LAUNCH VEHICLE SYSTEMS

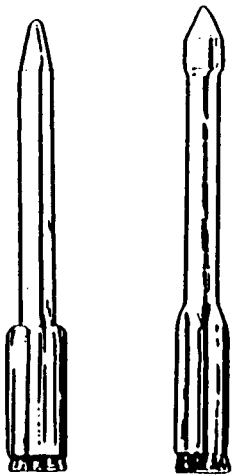

89 Delta Launches

---

Delta

Delta 2



38 Atlas/Centaur Launches

---

Atlas 1

Atlas 2

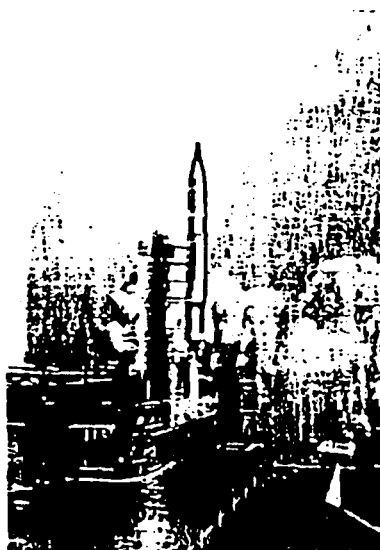

12 Titan/Gemini Launches

---

Titan/Gemini

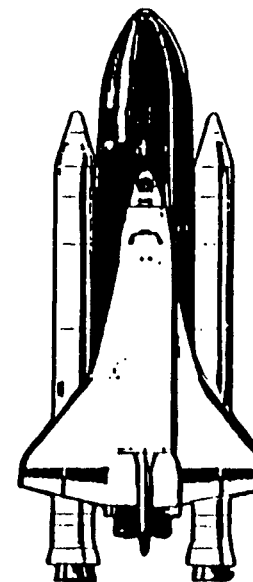

30 Shuttle Launches

---

Shuttle

N distributed Geometric

N	P[N "holds"] = g(N)
0	p
1	qp
2	q <sup>2</sup> p
3	q <sup>3</sup> p
⋮	⋮
⋮	⋮
⋮	⋮
N	q <sup>N</sup> p = g(N)

$$\sum_{N=0}^{\infty} q^N p = p \frac{1}{1-q} = 1$$

$$E[N] = \frac{q}{p}$$

$$V[N] = \frac{q}{p^2}$$

Alternatives

$$g(N) = \text{Poisson} = \frac{e^{-\lambda} \lambda^N}{N!}$$

$$g(N) = \text{Binomial} = \binom{n}{N} p^N q^{n-N}$$

Delta Number of Holds (89 Launches)

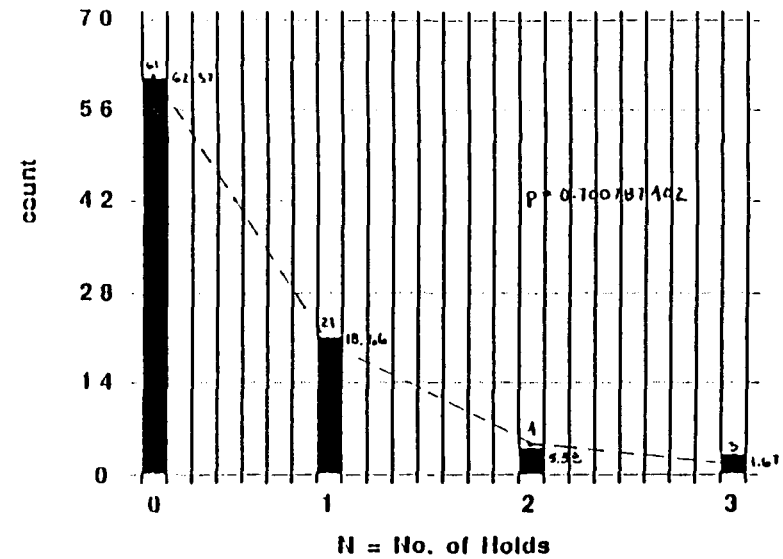

Shuttle Number of Holds (30)

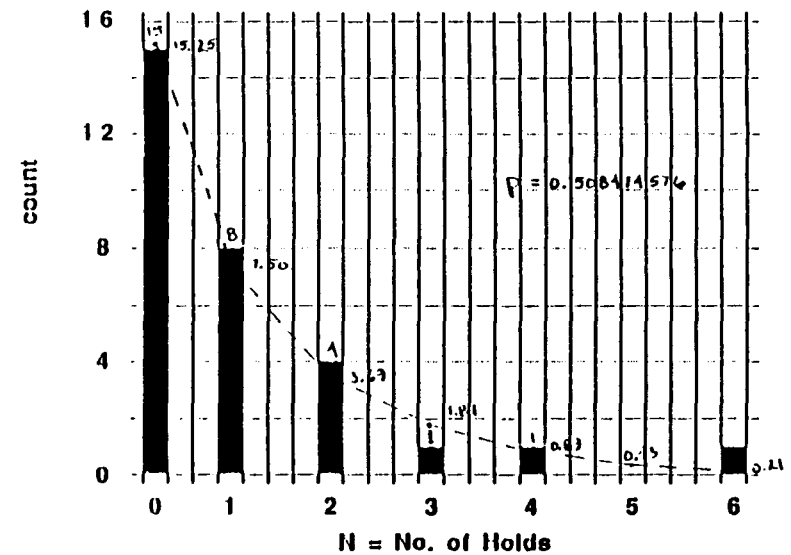

# t = "hold" time per hold has exponential distribution

$$y = f(t)$$

- Probability of fixing "hold" problem is proportional to dt
- Probability of "hold" continuing, dy, is negatively proportional to dt

$$\cdot dy = -\lambda y dt$$

$$\frac{dy}{y} = -\lambda dt$$

$$y = Ae^{-\lambda t}$$

$$\cdot \int_0^{\infty} y dt = 1, \therefore A = \lambda$$

$$\cdot E[t] = \frac{1}{\lambda}, \text{Var}[t] = \frac{1}{\lambda^2}$$

Hold Time per Hold for 89 Delta Launches

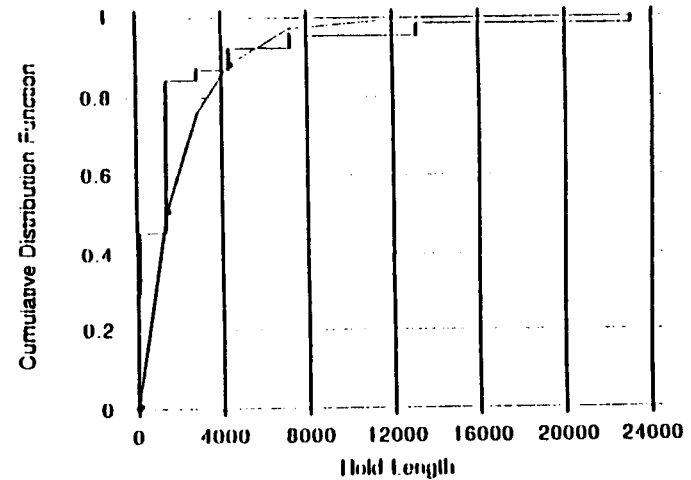

Hold Time per Hold for 30 Shuttle Launches

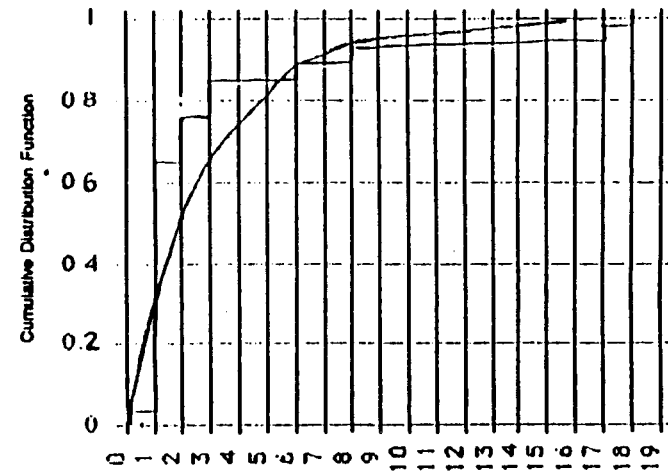



Theorem If  $N$  is Distributed geometrically with parameter  $p$  and  $(t_i)$  are distributed exponentially with parameter  $\lambda$ , independently of  $N$  and each other, then

$S_N = \sum_{i=1}^N t_i$  is distributed exponentially with parameter

$$\lambda p \text{ and } P[S_N \leq t_0] = 1 - e^{-\lambda p t_0}, \quad E[S_N] = \frac{1}{\lambda p}, \quad \text{Var}[S_N] = \frac{1}{\lambda^2 p^2}.$$

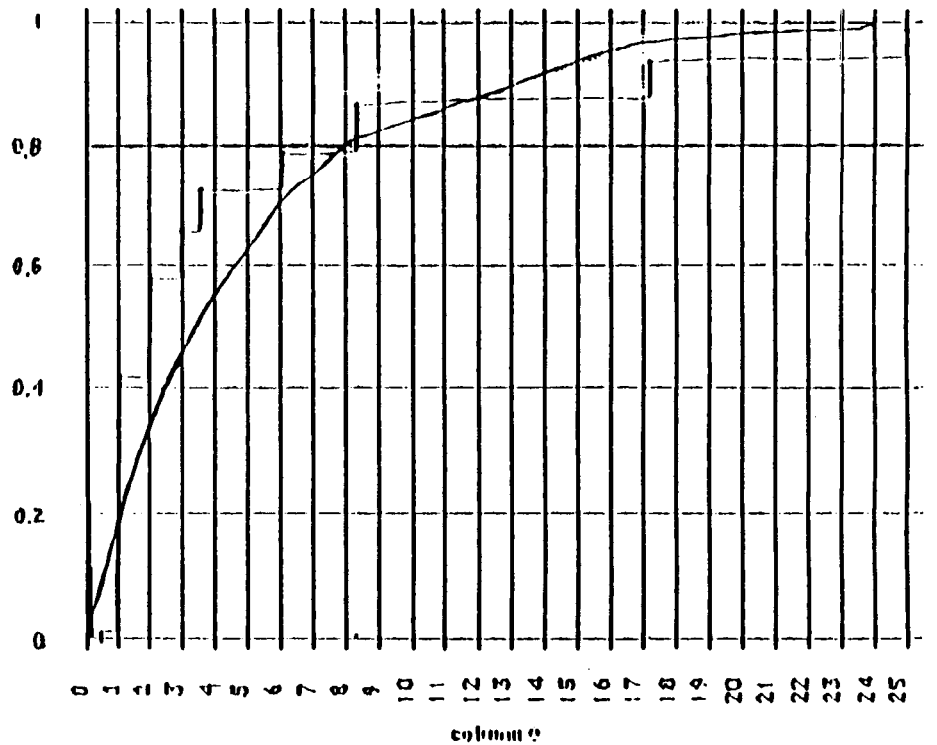
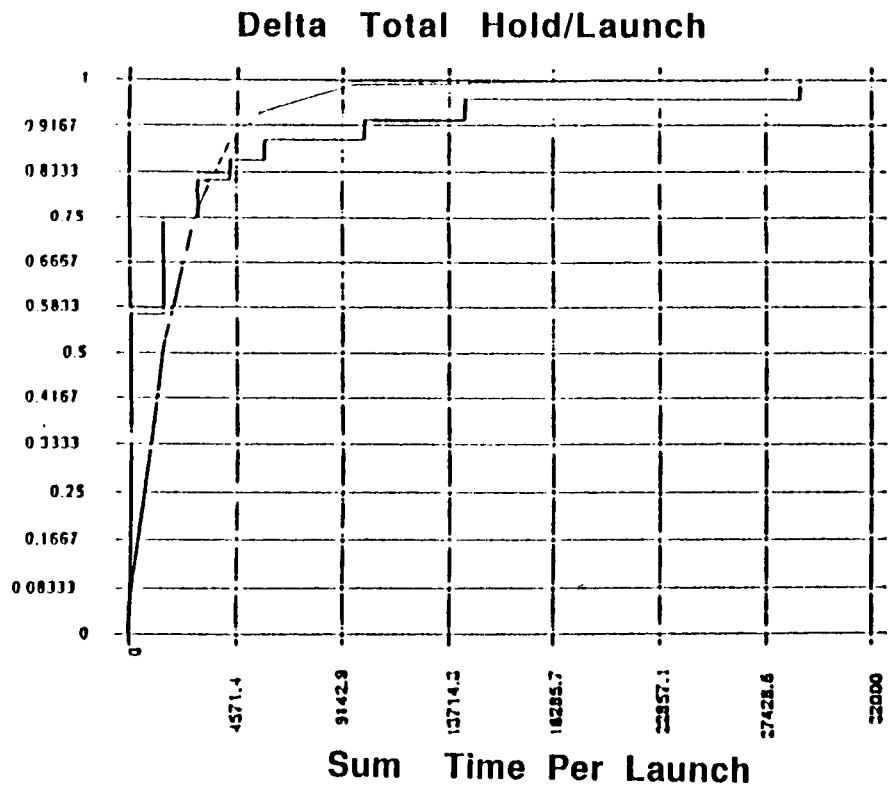

# Frequency of Holds by Cause

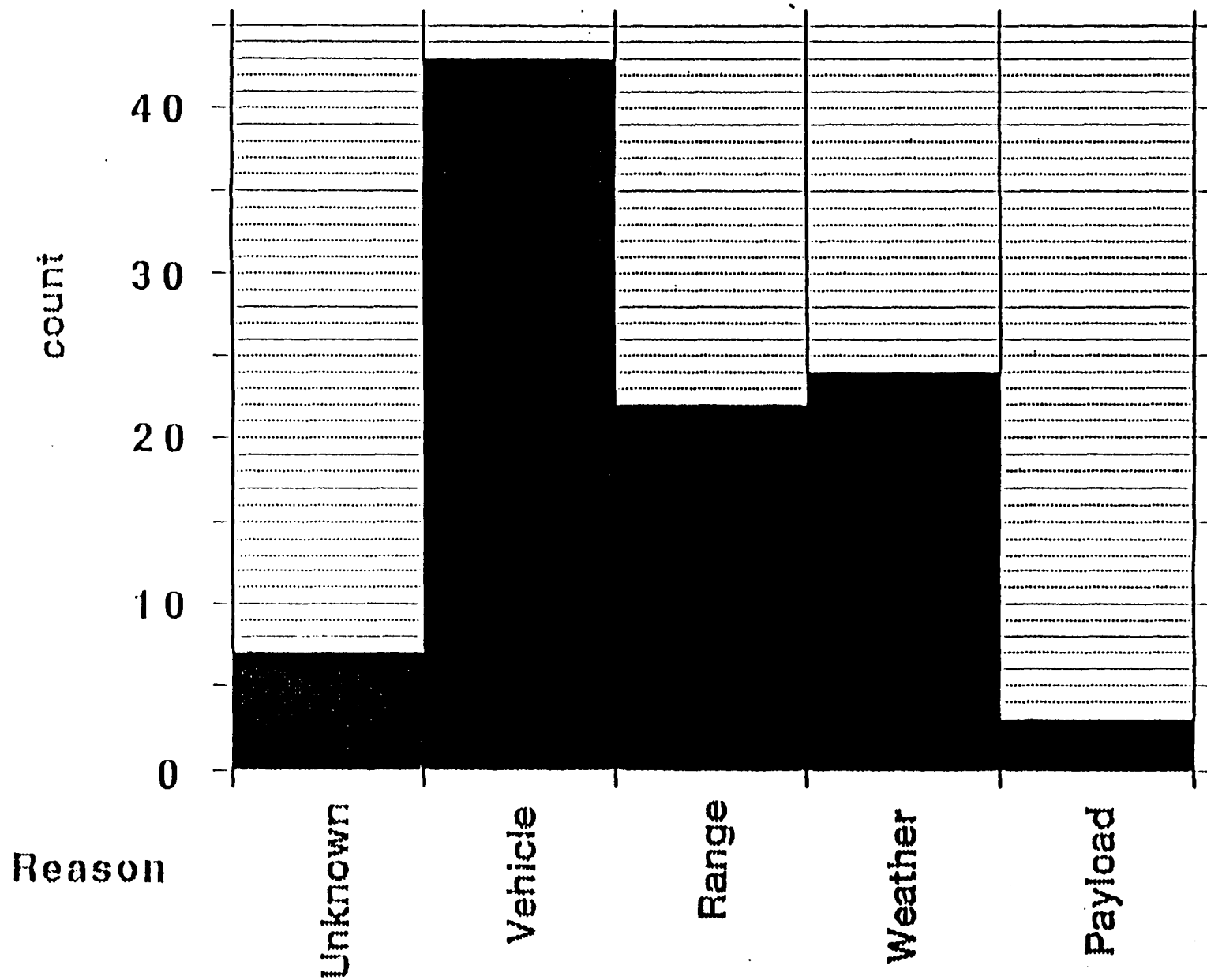

(89 Delta, 38 Atlas/Centaur, 12 Titan/Gemini, 30 Shuttle)

What is the Relative Effect of increasing  $\rho$  or increasing  $\lambda$  as regards  $E[S_N]$  ?

From  $f = E[S_N] = \frac{1}{\rho\lambda}$  we have:

$$df = \frac{\partial f}{\partial \rho} d\rho + \frac{\partial f}{\partial \lambda} d\lambda$$

$$d\{E[S_N]\} = -\frac{d\rho}{\rho^2\lambda} - \frac{d\lambda}{\rho\lambda^2}$$

$d\rho =$  {better weather model, range equipment, vehicle design

$$= -\frac{1}{\rho\lambda} \left[ \frac{d\rho}{\rho} + \frac{d\lambda}{\lambda} \right]$$

$$= -E[S_N] \left[ \frac{d\rho}{\rho} + \frac{d\lambda}{\lambda} \right]$$

Hence,

$$\frac{dE[S_N]}{E[S_N]} = - \left[ \frac{d\rho}{\rho} + \frac{d\lambda}{\lambda} \right]$$

$d\lambda =$  {AI diagnostics, spares on hand, modular design

and thus a 5% increase in  $\rho$  alone, or a 5% increase in  $\lambda$  alone will each give a 5% decrease in  $E[S_N]$ .

Optimal Selection of Space Transportation Fleet  
To Meet Multi-Mission Space Program Needs

George W. Morgenthaler<sup>1</sup> and Alex J. Montoya<sup>2</sup>  
Center for Space Construction, University of Colorado, Boulder

22-16  
1606??  
P-9

Abstract

A Space Program that spans several decades will be comprised of a collection of missions such as Low Earth Orbital Space Station, a Polar Platform, Geosynchronous Space Station, Lunar Base, Mars Astronaut Mission, and Mars Base. The optimal selection of a fleet of several recoverable and expendable launch vehicles, upper stages, and interplanetary spacecraft necessary to logistically establish and support these space missions can be examined by means of a linear integer programming optimization model. Such a selection must be made because the economies of scale which comes from producing large quantities of a few standard vehicle types, rather than many, will be needed to provide learning curve effects to reduce the overall cost of space transportation if these future missions are to be affordable.

Optimization model inputs come from data and from vehicle designs. Each launch vehicle currently in existence has a launch history, giving rise to statistical estimates of launch reliability. For future, not-yet-developed launch vehicles, theoretical reliabilities corresponding to the maturity of the launch vehicles's technology and the degree of design redundancy must be estimated (Ref. 1). Also, each such launch vehicle has a certain historical or estimated development cost, tooling cost, and a variable cost. The cost of a launch used in this paper includes the variable cost plus an amortized portion of the fixed and development costs.

The integer linear programming model will have several constraint equations based on our assumptions of mission mass requirements, volume requirements, and number of astronauts needed. The model will minimize launch vehicle logistic support cost and will select the most desirable launch vehicle fleet.

<sup>1</sup>Professor Aerospace Engineering Sciences Dept. and Associate Dean, College of Engineering and Applied Sciences, University of Colorado at Boulder, 80309-0429

<sup>2</sup>Senior, Department of Mathematics, and member, Center for Space Construction, University of Colorado at Boulder 80309-0429

# **Systems Cluster**

## **Vehicle Selection Model**

**Objective: Develop quantitative model to select optimum set of launch vehicles, upper stages, spacecraft, and orbital assembly vehicles (OMVs) for emplacing and re-supplying space construction projects.**

- 1. Develop Linear Programming (LP) Optimal Vehicle Selection Model.**
- 2. Integrate LP selection model into CAE module of IDEAS\*\*2 and SIMCON global optimization model.**
- 3. Integrate selection model with orbital logistics supply techniques and Cost Estimating Relationships (CERs).**
- 4. Investigate efficient solutions of LP optimization models using TABU or other methods.**

# Systems Cluster

## Vehicle Database/Costs

**Objective:** Collect space and launch vehicle database including cost, reliability, cargo volume, payload delivery capability, etc. for quantitative trade-offs.

1. Obtain database for existing vehicles from NASA Centers and from CSC Industrial Associates. Obtain established "Cost Estimating Relationships" (CERs) for use in scoping new vehicles and space constructions. Extend database to robotic's and "workers" costs, weights, etc.
2. Develop vehicle/"workers" database into CAE module for IDEAS\*\*2.
3. Utilize vehicle/"workers" database in trade-offs and sub-optimizations in studying space construction projects.
4. Include in SIMCON model.

# LAUNCH VEHICLE LOGISTIC SUPPORT COSTS FOR MULTI-MISSION SPACE PROGRAM MUST BE REDUCED

- Large Cost - 10% - 50% of NASA 1989 Budget

1000 MTPY x \$3000/lb. = \$6B/year

1000 MTPY x \$500/lb. = \$1B/year

- Additional large, low-cost Cargo Vehicles needed - Shuttle C, ALS, Shuttle Z
  - Vehicles remain in use 20-30 years
  - Multi-mission effectiveness
  - Bring launch costs down to \$300/lb. to LEO
- Mix of ELV's/recoverable; human-rated versus cargo
- Logistic Support Launch System:
  - Multiple Vertical Assembly Buildings
  - Multiple launch pads
  - Multiple recovery areas

## U.S. Launch Vehicles

---

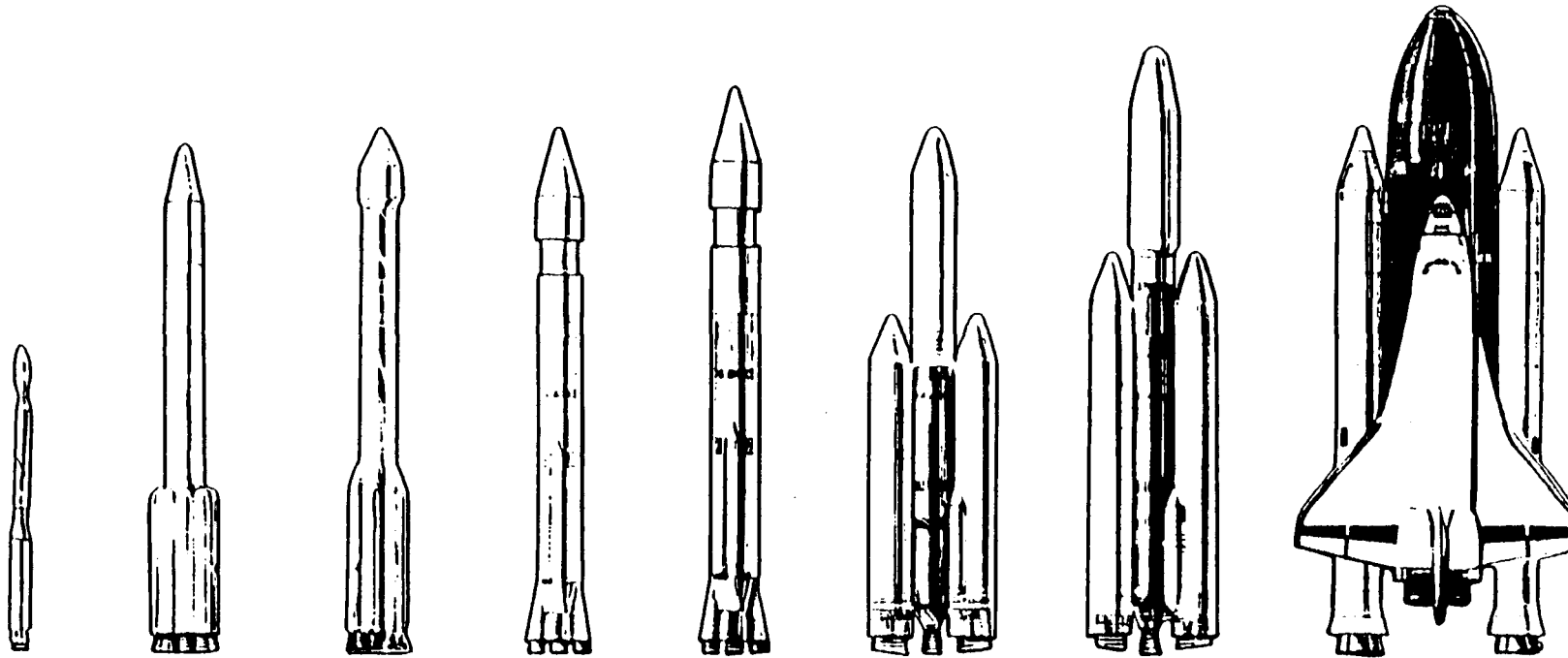

---

Scout  
475 lbs.

Delta  
7,800 lbs.

Delta 2  
11,100 lbs.

Atlas 1  
12,300 lbs.

Atlas 2  
14,400 lbs.

Titan 3  
33,000 lbs.

Titan 4  
40,000 lbs.

Shuttle  
55,000 lbs.

**Pounds to Low Earth Orbit**



# ALS Operations Flow

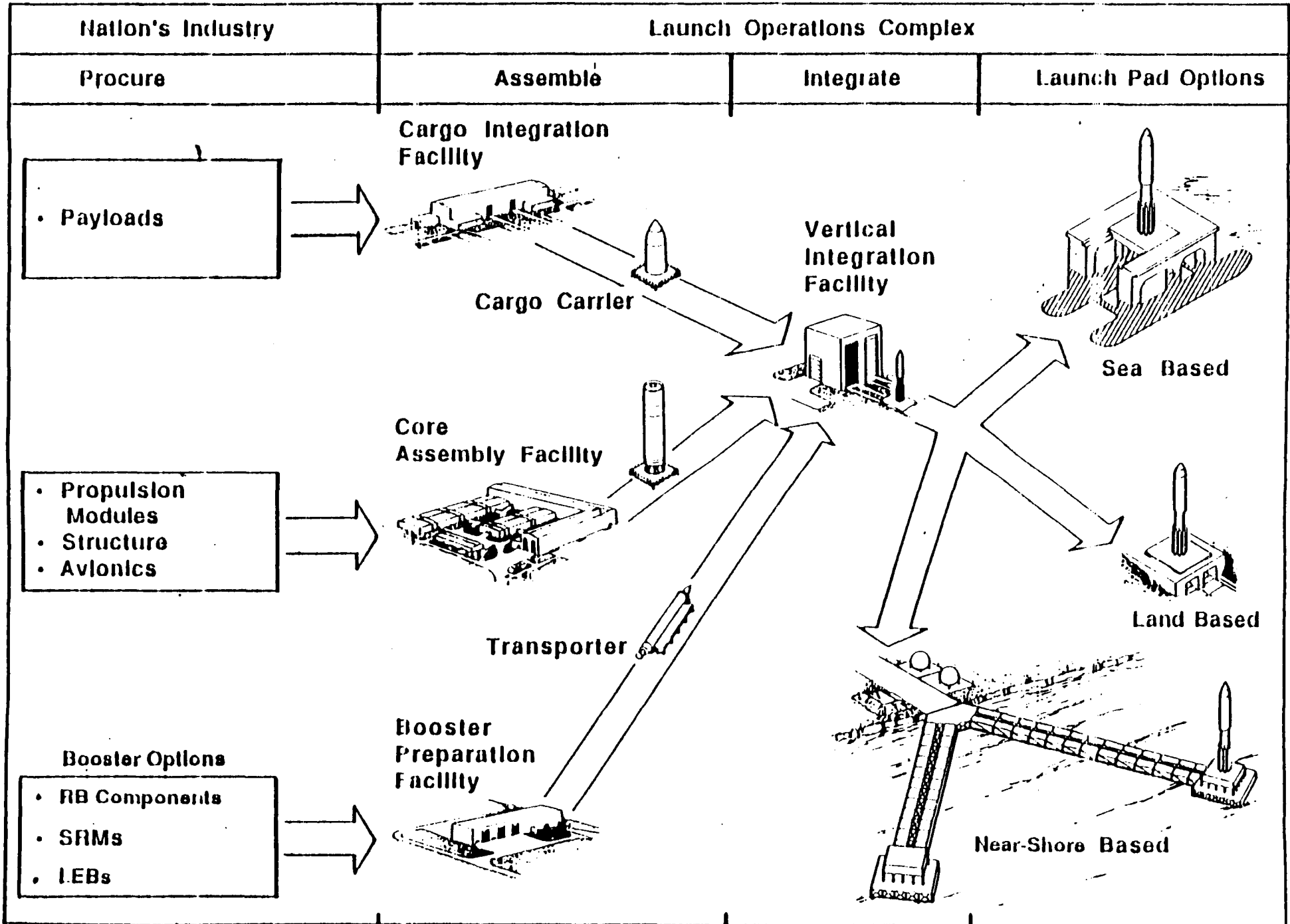

# LINEAR INTEGER PROGRAMMING LAUNCH VEHICLE SELECTION MODEL

$C_{ijk}$  = Cost (including amortized development cost) of launching vehicle  $k$  for mission  $i$  in year  $j$ .

$X_{ijk}$  = Integer number of launches of Vehicle  $k$  for mission  $i$  in year  $j$ .

$P_{ijk}$  = Probability of successful launch of Vehicle  $k$  for mission  $i$  in year  $j$ .

$W_{ijk}$  = Payload mass deliverable by Vehicle  $k$  for destination  $i$  in year  $j$ .

$V_{ijk}$  = Payload volume deliverable by Vehicle  $k$  for destination  $i$  in year  $j$ .

$H_{ijk}$  = Number of astronauts deliverable by Vehicle  $k$  for destination  $i$  in year  $j$ .

$$\text{Minimize } C = \sum_i \sum_j \sum_k \frac{C_{ijk}}{P_{ijk}} X_{ijk}$$

$$\sum_k X_{ijk} W_{ijk} \geq W_{ij} \geq 0$$

$$\sum_k X_{ijk} H_{ijk} \geq H_{ij} \geq 0$$

$$\sum_k X_{ijk} V_{ijk} \geq V_{ij} \geq 0$$

$$\sum_i \sum_j \sum_k X_{ijk} H_{ijk} (1 - P_{ijk}) \leq H^*$$

$$\sum_k W_{ijk} X_{ijk} \leq \beta_{ij}$$

$$0 \leq n_{jk} \leq \sum_i X_{ijk} \leq N_{jk}$$

## Example: Office of Exploration Space Program-SSB, Lunar Base, Mars Base.

### A. Mission Model:

Year	SSF-Supply			Lunar Missions			Mars Missions		
	Vol (ft <sup>3</sup> )	People	Tonnes	Vol (ft <sup>3</sup> )	People	Tonnes	Vol (ft <sup>3</sup> )	People	Tonnes
2005	11663	5	40	29158	0	100	139960	0	480
2006	11663	5	40	40821	3	140	0	0	0
2007	11663	5	40	75812	6	260	524851	0	1800
2008	11663	5	40	104970	14	360	0	0	0
2009	11663	5	40	173492	14	595	58317	6	200
2010	11663	5	40	167660	18	575	0	0	0
2011	11663	5	40	51027	18	175	233267	12	800
2012	11663	5	40	51027	18	175	524851	14	1800
2013	11663	5	40	90391	18	310	349901	6	1200
2014	11663	5	40	90391	18	310	437376	0	1500
2015	11663	5	40	43737	18	250	204109	6	700
2016	11663	5	40	61232	18	210	349901	14	1200
2017	11663	5	40	51027	18	175	0	0	0
2018	11663	5	40	61232	18	210	0	0	0
2019	11663	5	40	61232	18	210	0	0	0
2020	11663	5	40	93307	18	320	0	0	0
2021	11663	5	40	72896	18	250	0	0	0
2022	11663	5	40	23326	11	80	0	0	0
2023	11663	5	40	847	11	30	0	0	0
2024	11663	5	40	0	0	0	0	0	0
	233260	100	800	1343585	227	4788	2822533	144	8680

### B. Launch Vehicle Fleet Capabilities:

Launch Vehicle	Payload		Man-Rated	Volume (in cubic feet)	Cost/Launch (1989 Dollars)
	Tons	Tonnes			
Atlas II	8.1	7.36	NO	1570	\$70,000,000
Titan IV	16	14.54	NO	8500	\$170,000,000
Shuttle	20	18.18	YES	5301	\$110,000,000
Shuttle C	75	68.18	NO	9500	\$199,625,000
Shuttle Z	150	136.36	NO	11500	\$243,861,924

**Optimal Launch Assignment/Total Annual Launch Costs**

Year\Launch Vehicle	Annual Launch					Cost(in millions)
	Atlas II	Titan IV	Shuttle	Shuttle C	Shuttle Z	
2005	14.45	0	17	1	1	3325.514
2006	0	0	2	0	1.05	476.881
2007	20	13.95	24.99	7	6	9383.087
2008	0	0	3	0	2.53	947.809
2009	0	0	4	3.17	3.99	2050.559
2010	0	0	4	0	3.97	1409.796
2011	0	0	7.07	5	3.99	2752.394
2012	20	8.1	24.99	7	6	8389.276
2013	19.99	5.82	20	6	3.99	6763.687
2014	20	3.01	20	7	5.99	6972.907
2015	0	0	13.2	5	2.99	3182.327
2016	0	0	8.5	7	5.99	3796.339
2017	0	0	3	0	1.04	694.449
2018	0	0	4	0	1.3	757.041
2019	0	0	4	0	1.3	757.041
2020	0	0	4	0	2.1	953.762
2021	0	0	4	0	1.59	828.576
2022	0	0	3	0	0.48	447.066
2023	0	0	3	0	0.16	369.022
2024	0	0	1	0	0.16	149.022
<b>Total:</b>	<b>94.45</b>	<b>30.89</b>	<b>173.78</b>	<b>48.18</b>	<b>55.71</b>	<b>54407.314</b>

**Note: Future work will employ integer programming**

**Future Work:**

- Include combination recoverable/expendable vehicles (recovery cost and reliability)
- Include upper stage transfer vehicle/spacecraft
- Include new trajectory and logistic supply concepts such as fuel caches
- Include additional realistic constraints, e.g. quality of ride.
- Improve solution techniques and software



523-61  
160693  
P. 13

# Computer Aided System Engineering for Space Construction

by  
Ugo Racheli, Ph.D., P.E.<sup>1</sup>

## Abstract

Construction activities envisioned for the assembly of large platforms in space (as well as interplanetary spacecraft and bases on extraterrestrial surfaces) require computational tools that exceed the capability of conventional construction management programs. The Center for Space Construction is investigating the requirements for new computational tools and, at the same time, suggesting the expansion of graduate and undergraduate curricula to include proficiency in Computer Aided Engineering (CAE) through design courses and individual or team projects in advanced space systems design. In the Center's research, special emphasis is placed on problems of constructability and of the interruptability of planned activity sequences to be carried out by crews operating under hostile environmental conditions.

The departure point for the planned work is the acquisition of the MCAE I-DEAS software, developed by the Structural Dynamics Research Corporation (SDRC), and its expansion to the level of capability denoted by the acronym IDEAS\*\*2 currently used for configuration maintenance on Space Station Freedom.

In addition to improving proficiency in the use of I-DEAS and IDEAS\*\*2, it is contemplated that new software modules will be developed to expand the architecture of IDEAS\*\*2. Such modules will deal with those analyses that require the integration of a space platform's configuration with a breakdown of planned construction activities and with a failure modes analysis to support Computer Aided System Engineering (CASE) applied to space construction.

---

<sup>1</sup>Research Associate with the Center for Space Construction at the University of Colorado, Boulder

CENTER FOR SPACE CONSTRUCTION  
SYSTEM ENGINEERING/ANALYSIS CLUSTER

---

IDEAS

I-DEAS

IDEAS\*\*2

DYCAM

COMPUTER AIDED SYSTEM ENGINEERING  
FOR SPACE CONSTRUCTION  
OPERATIONS MANAGEMENT ANALYSIS

**CENTER FOR SPACE CONSTRUCTION  
SYSTEM ENGINEERING/ANALYSIS CLUSTER**

---

2

**SPECIFIC OBJECTIVES**

- **CSC PRIMARY OBJECTIVES**
  - DEVELOPMENT OF DYCAM
  - MEMBERSHIP IN SDRC UNIV. CONSORTIUM
  - EXPANSION OF I-DEAS INTO IDEAS\*\*2
  
- **NON-CSC INSTRUCTIONAL OBJECTIVES**
  - USE OF IDEAS\*\*2 FOR SPACECRAFT DESIGN
  - CREATION OF AN I-DEAS SENIOR LAB

CENTER FOR SPACE CONSTRUCTION  
SYSTEM ENGINEERING/ANALYSIS CLUSTER

SYSTEM LIFECYCLE

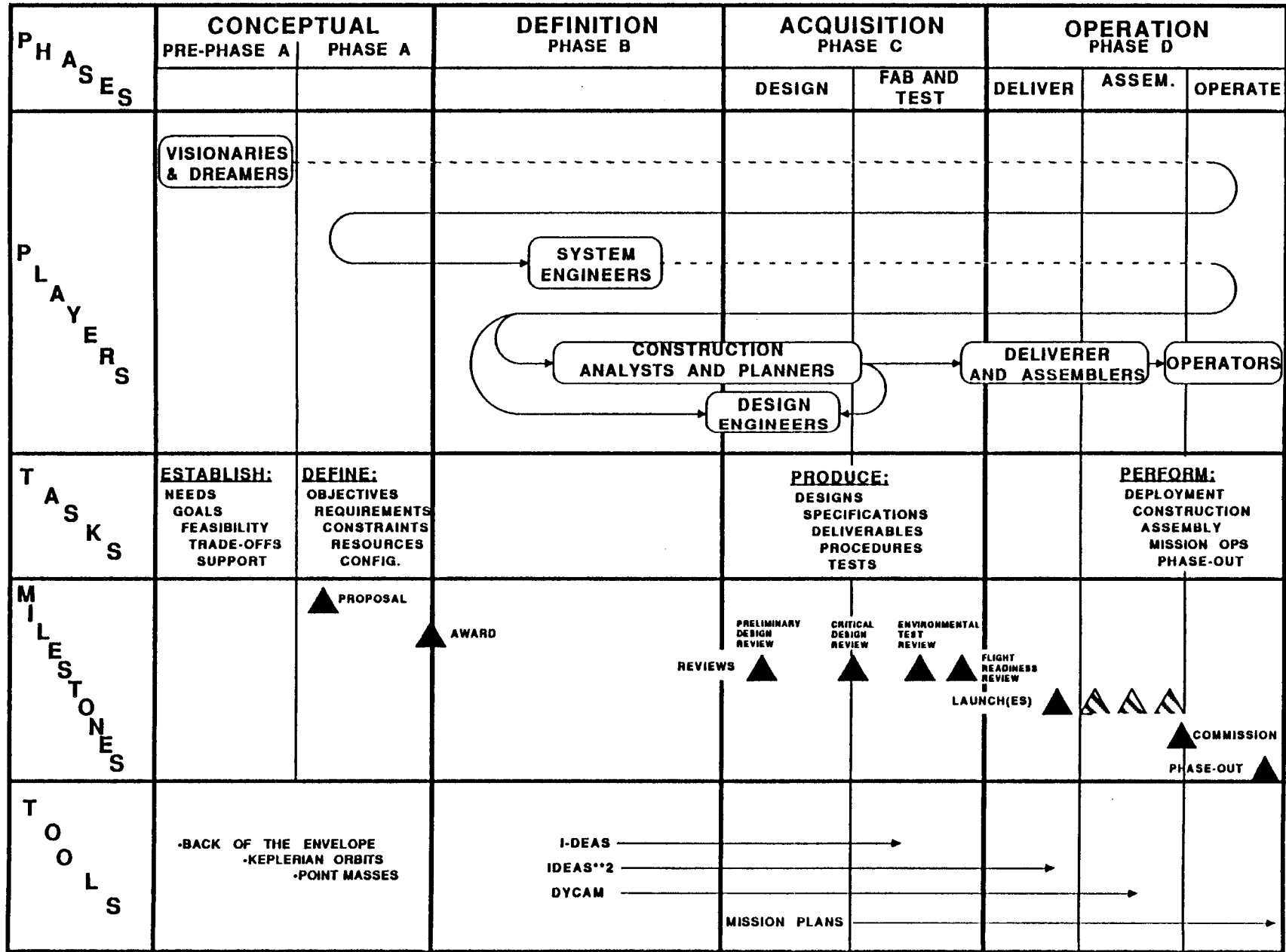



**CENTER FOR SPACE CONSTRUCTION  
SYSTEM ENGINEERING/ANALYSIS CLUSTER**

---

4

**NEED FOR NEW TOOLS IN  
SPACE CONSTRUCTION  
OPERATIONS MANAGEMENT  
ANALYSIS**

- **UNIQUE FACTORS IN SPACE CONSTRUCTION**
  - NOVELTY
  - COMPLEXITY
  - CRITICALITY
  - COST
  - POLITICAL REALITIES
  
- **TYPES OF EXISTING TOOLS**
  
- **INADEQUACY OF EXISTING TOOLS**

# CENTER FOR SPACE CONSTRUCTION SYSTEM ENGINEERING/ANALYSIS CLUSTER

## CONFIGURATIONS vs. ACTIVITIES

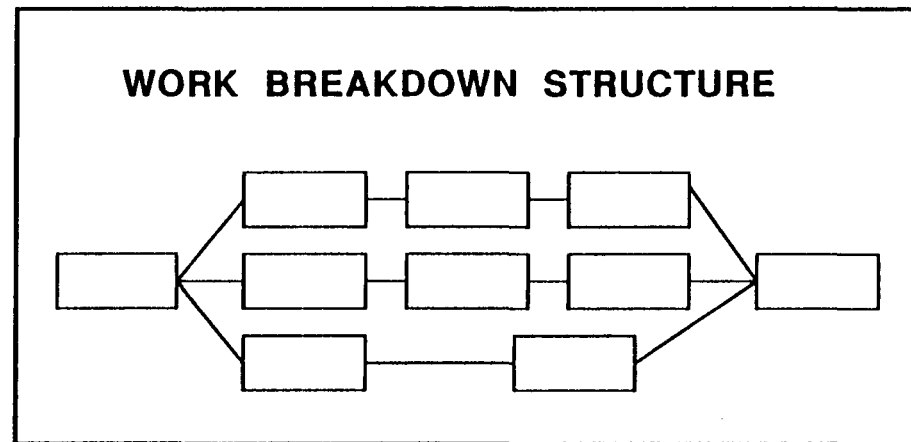
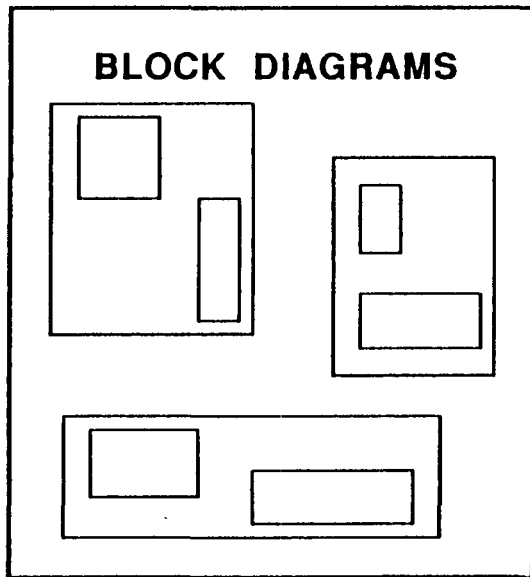
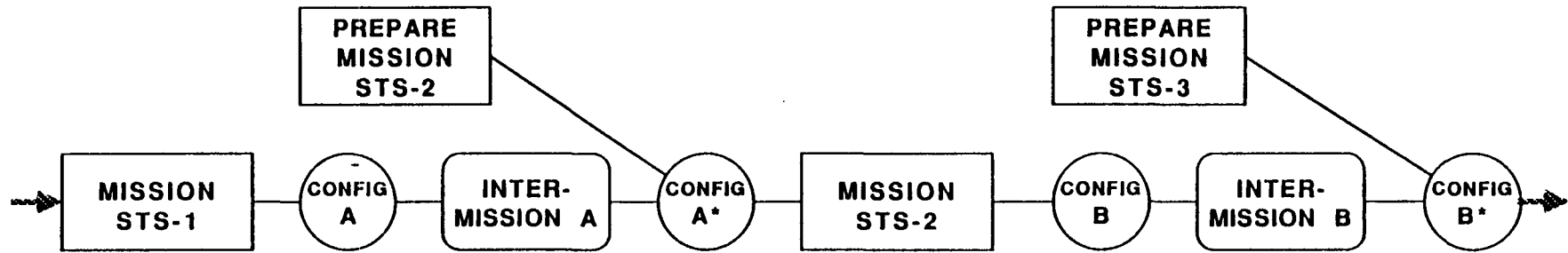

# TYPICAL MISSION ACTIVITIES DIAGRAM

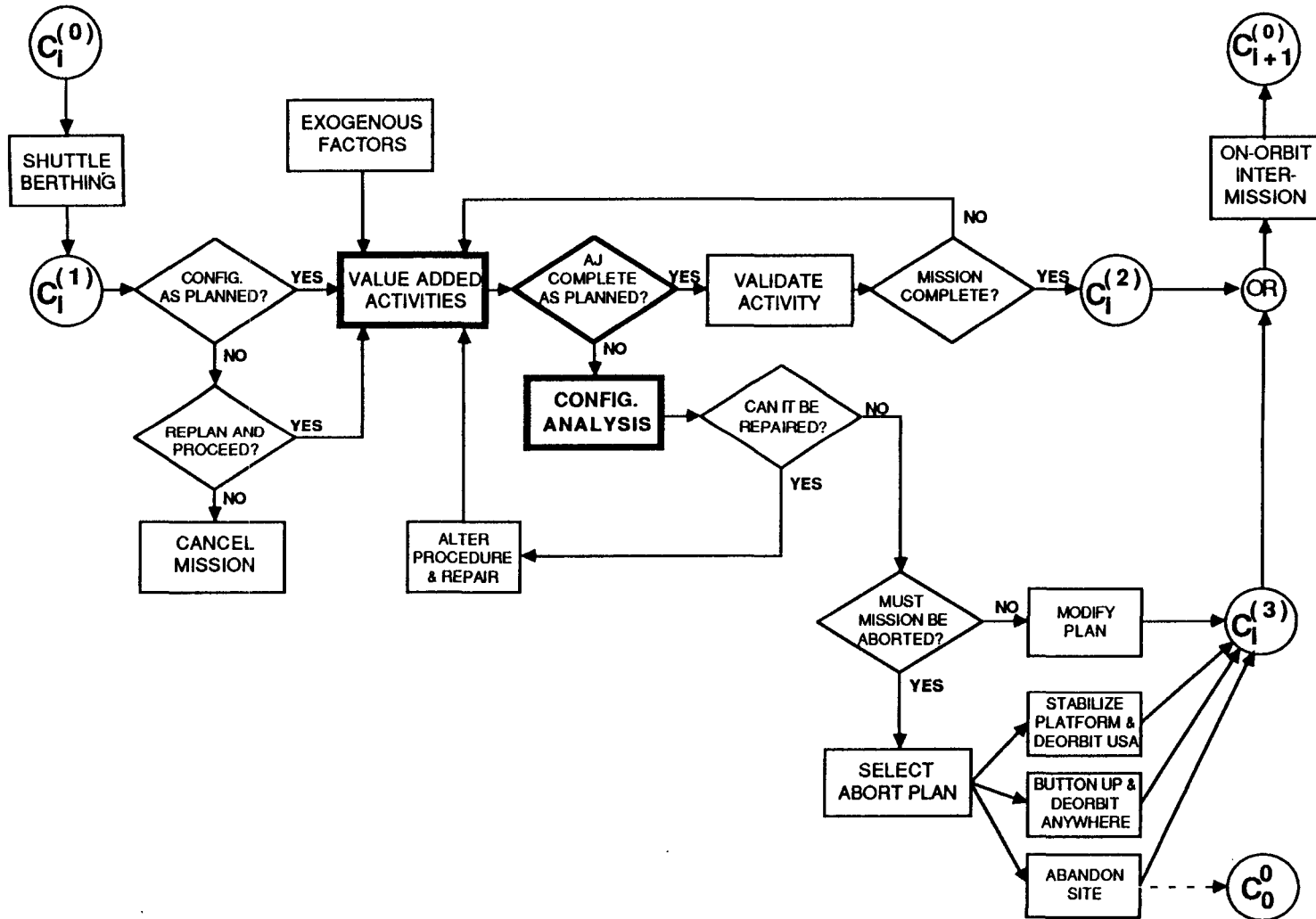

# COMPUTER AIDED SYSTEM ENGINEERING DATA FLOW

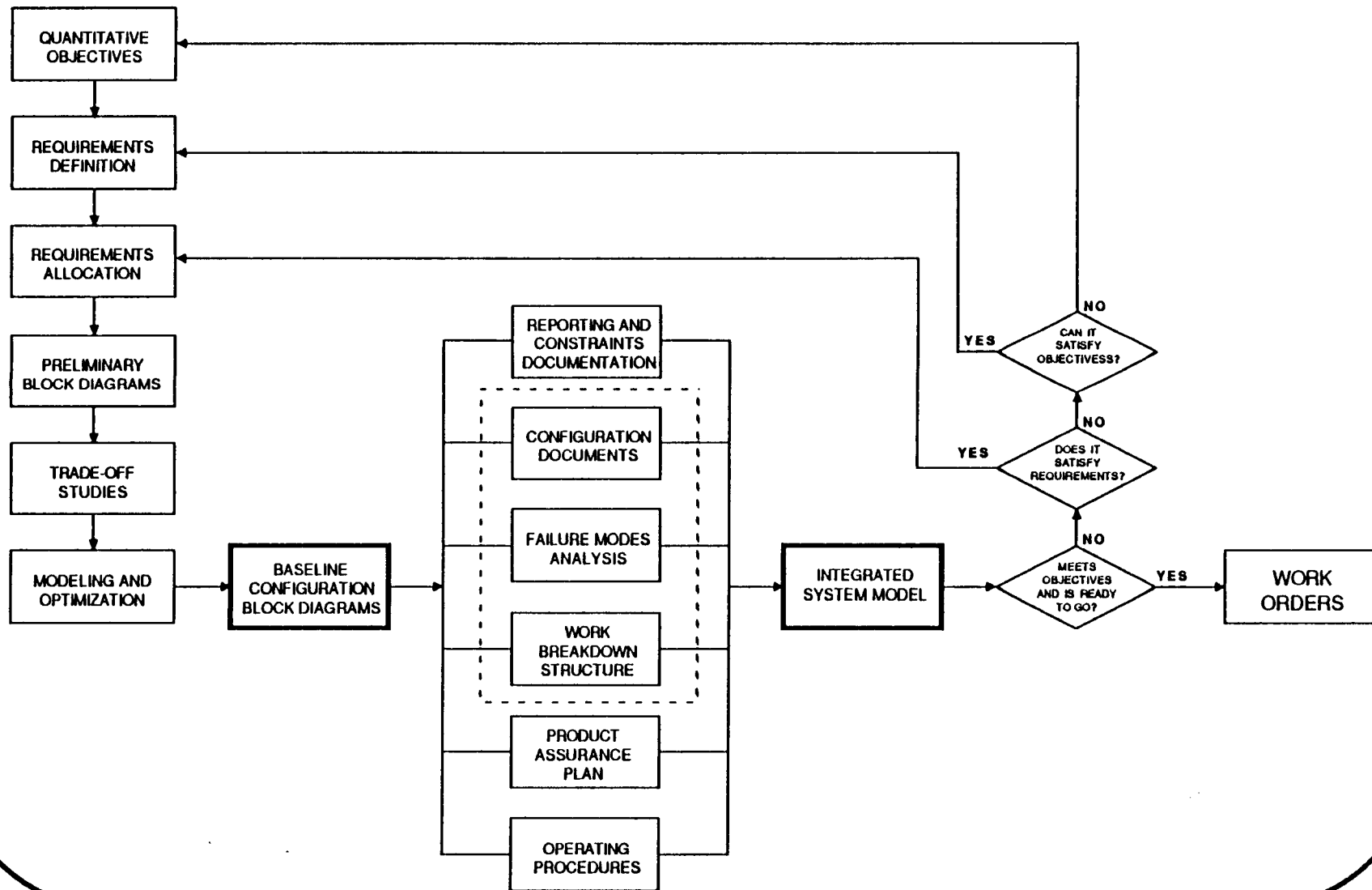

CENTER FOR SPACE CONSTRUCTION  
SYSTEM ENGINEERING/ANALYSIS CLUSTER

# DYCAM

(DYNAMIC CONSTRUCTION AND ASSEMBLY MODULE)

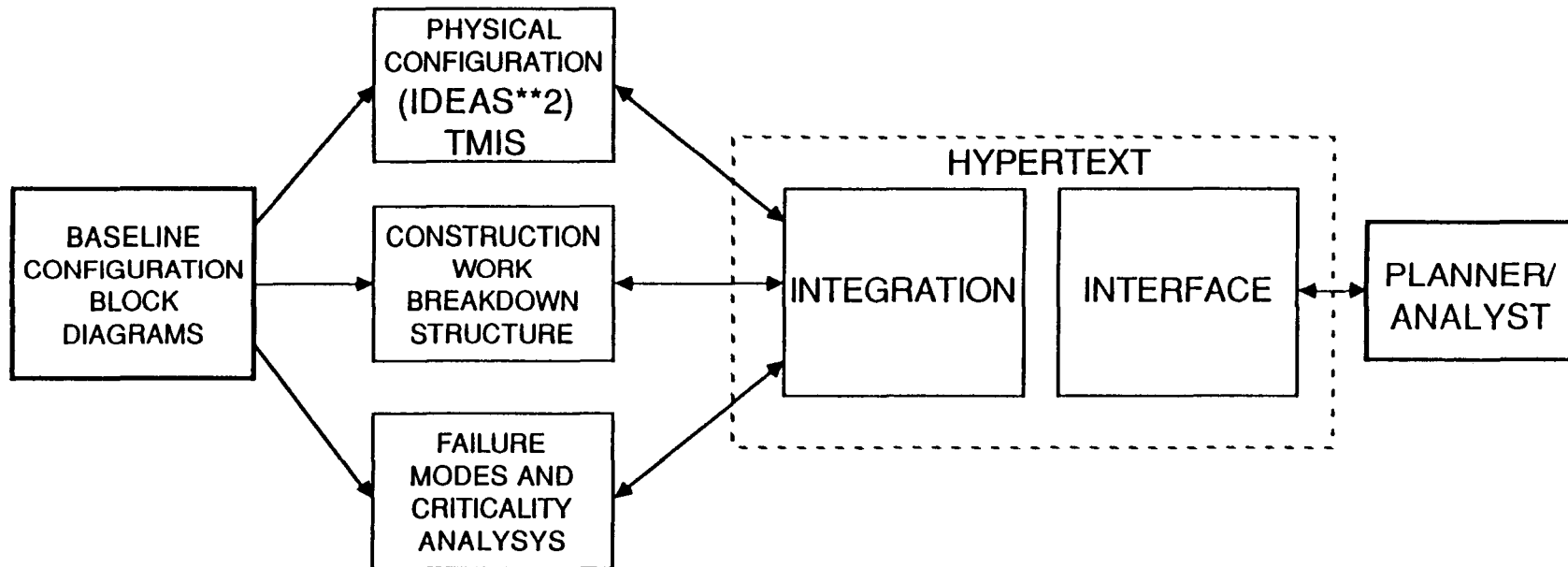

**CENTER FOR SPACE CONSTRUCTION  
SYSTEM ENGINEERING/ANALYSIS CLUSTER**

---

**D Y C A M**

**DYNAMIC CONSTRUCTION AND  
ASSEMBLY MODULE:  
PROPOSED SYSTEM REQUIREMENTS**

- **CONFIGURATION DRIVEN (controlled database)**
- **DISTRIBUTED COMPUTING ENVIRONMENT**
- **HYPertext ARCHITECTURE (graphic human interface)**
- **CAE FOR PLANNING**
- **COMPUTER AIDED ANALYSIS FOR  
CONSTRUCTION OPERATIONS MANAGEMENT**

# CENTER FOR SPACE CONSTRUCTION SYSTEM ENGINEERING/ANALYSIS CLUSTER

## IDEAS\*\*2

### INTEGRATED MULTIDISCIPLINARY ENGINEERING ANALYSIS CAPABILITY

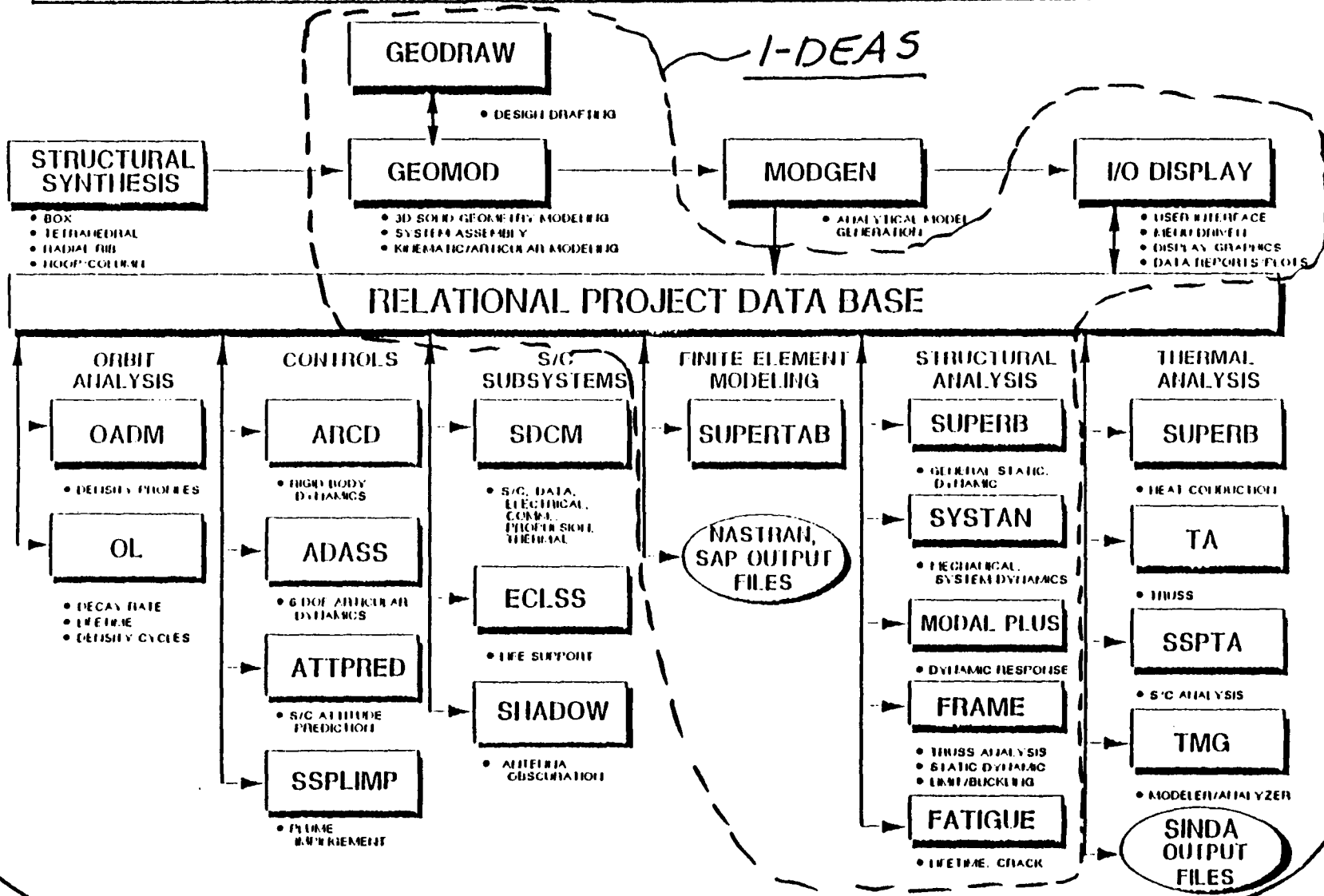

# CENTER FOR SPACE CONSTRUCTION SYSTEM ENGINEERING/ANALYSIS CLUSTER

## INITIAL NETWORK

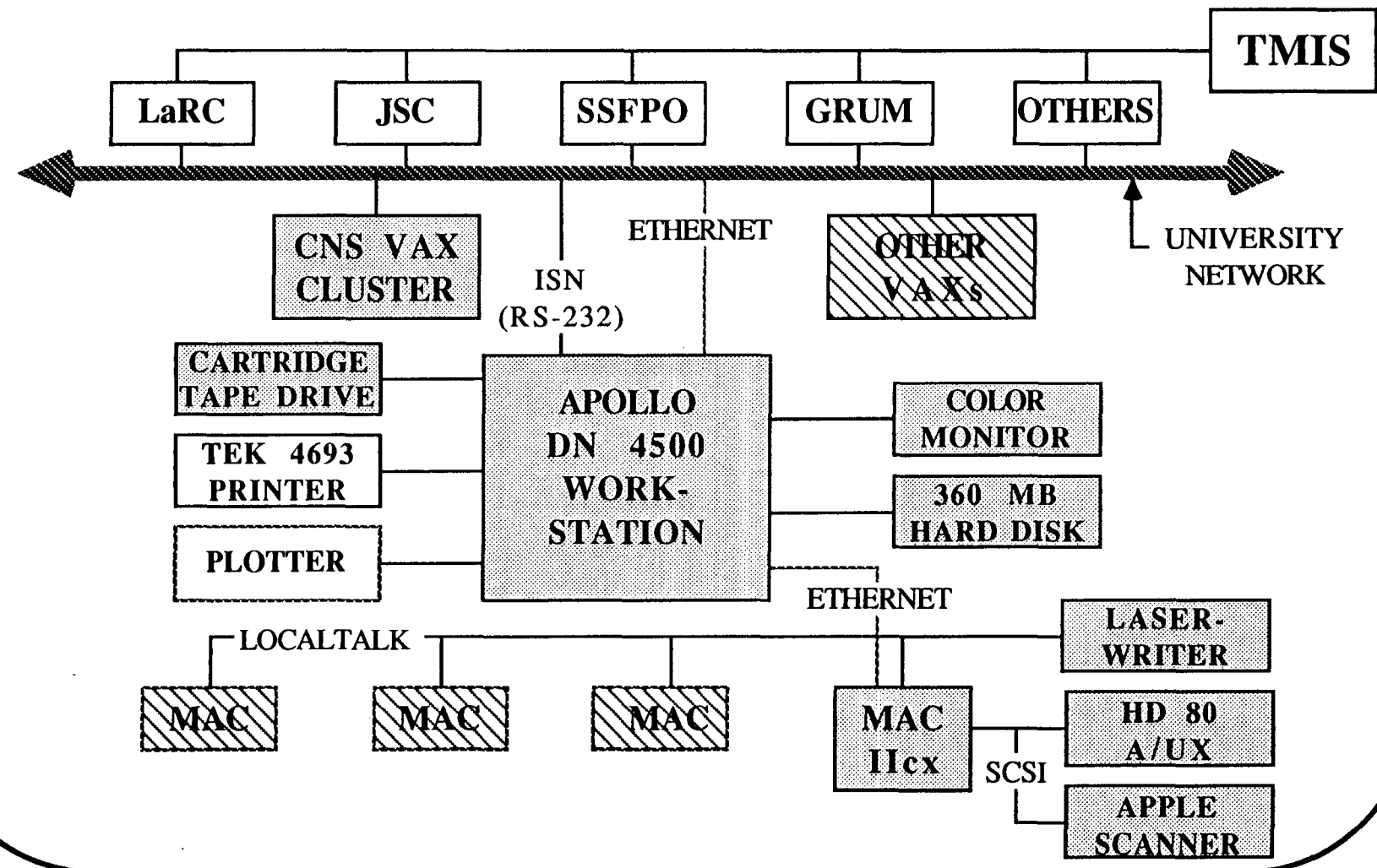



# CENTER FOR SPACE CONSTRUCTION SYSTEM ENGINEERING/ANALYSIS CLUSTER

## FUTURE NETWORK

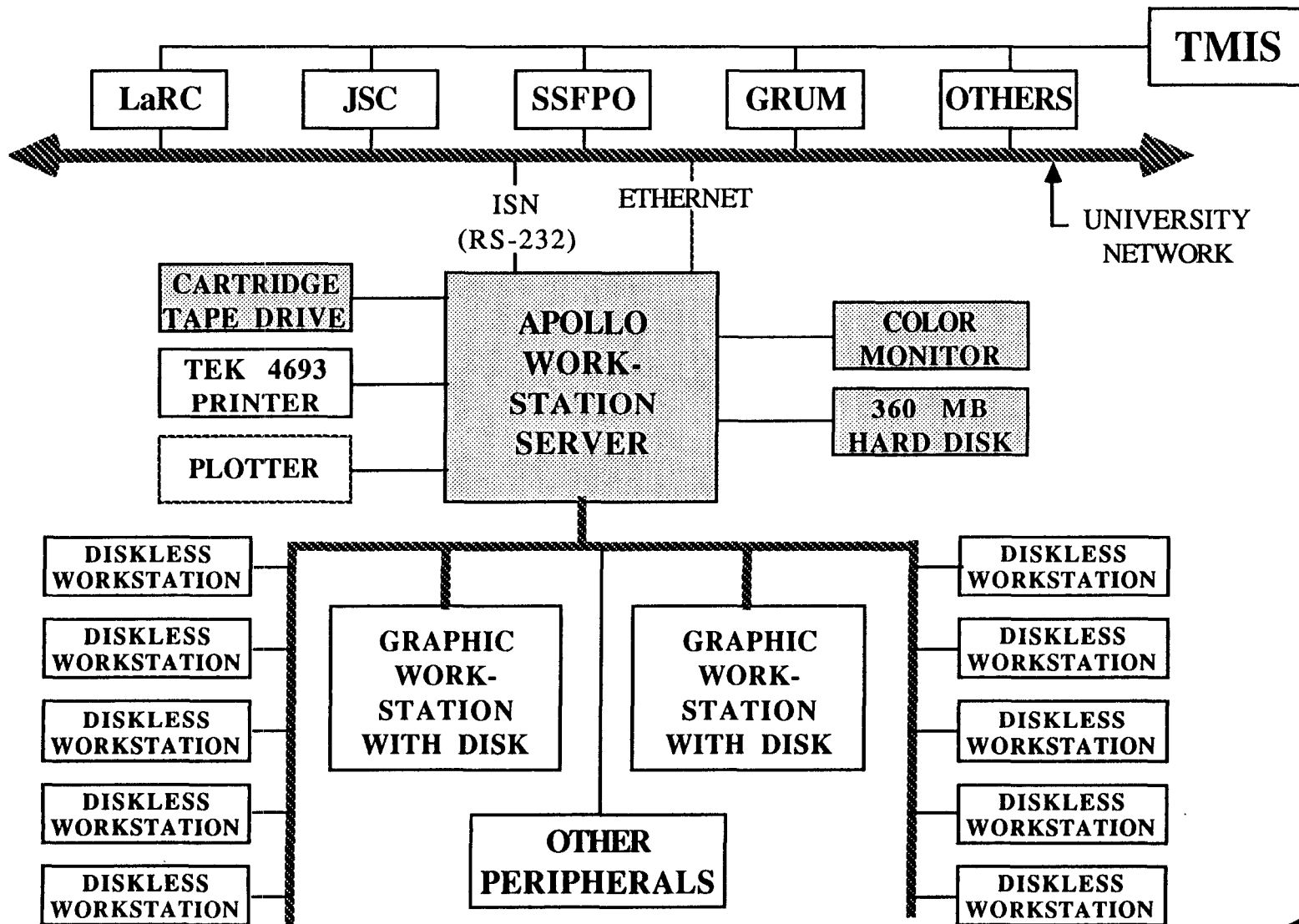

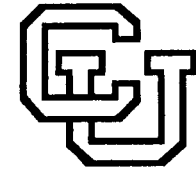

# The Industry Connection

**A Description of Work in Progress**

**Presented to the  
First Annual CSC Symposium  
Estes Park, Colorado  
1989 Oct 12**

**C.Uphoff, R. Coffey, M. Crouch  
Ball Space Systems Division  
Boulder, Colorado  
*and*  
M. Loucks  
Center for Space Construction  
University of Colorado at Boulder**

*unc*



# AGENDA



- **Overview** **C. Uphoff**
- **Optimal GTO Depot Studies** **R. Coffey**
- **Quick Response Mission Design Tools** **M. Crouch**
- **Lunar Base Supply & Mars Cycler Studies** **M. Loucks**



# Mission Design Tools

Part of the Total CSC Systems Analysis

**You Are Here**

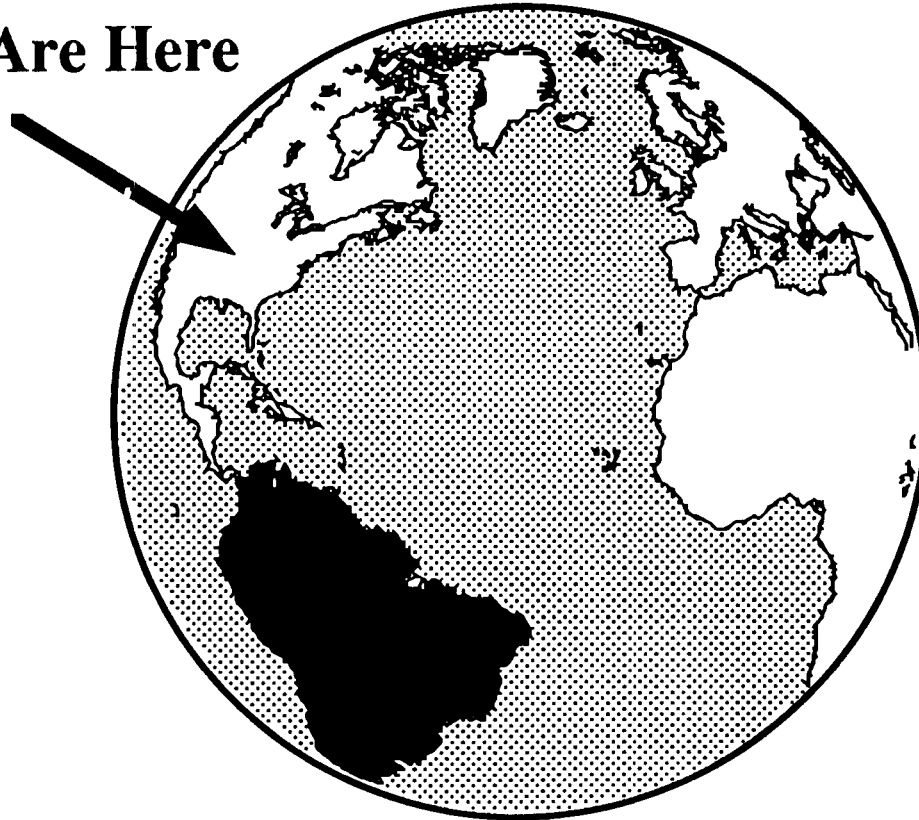

**Space is Almost  
Everywhere Else**

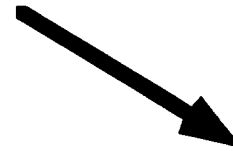

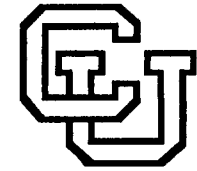

# Work in Progress Supports Broad Space Scenario

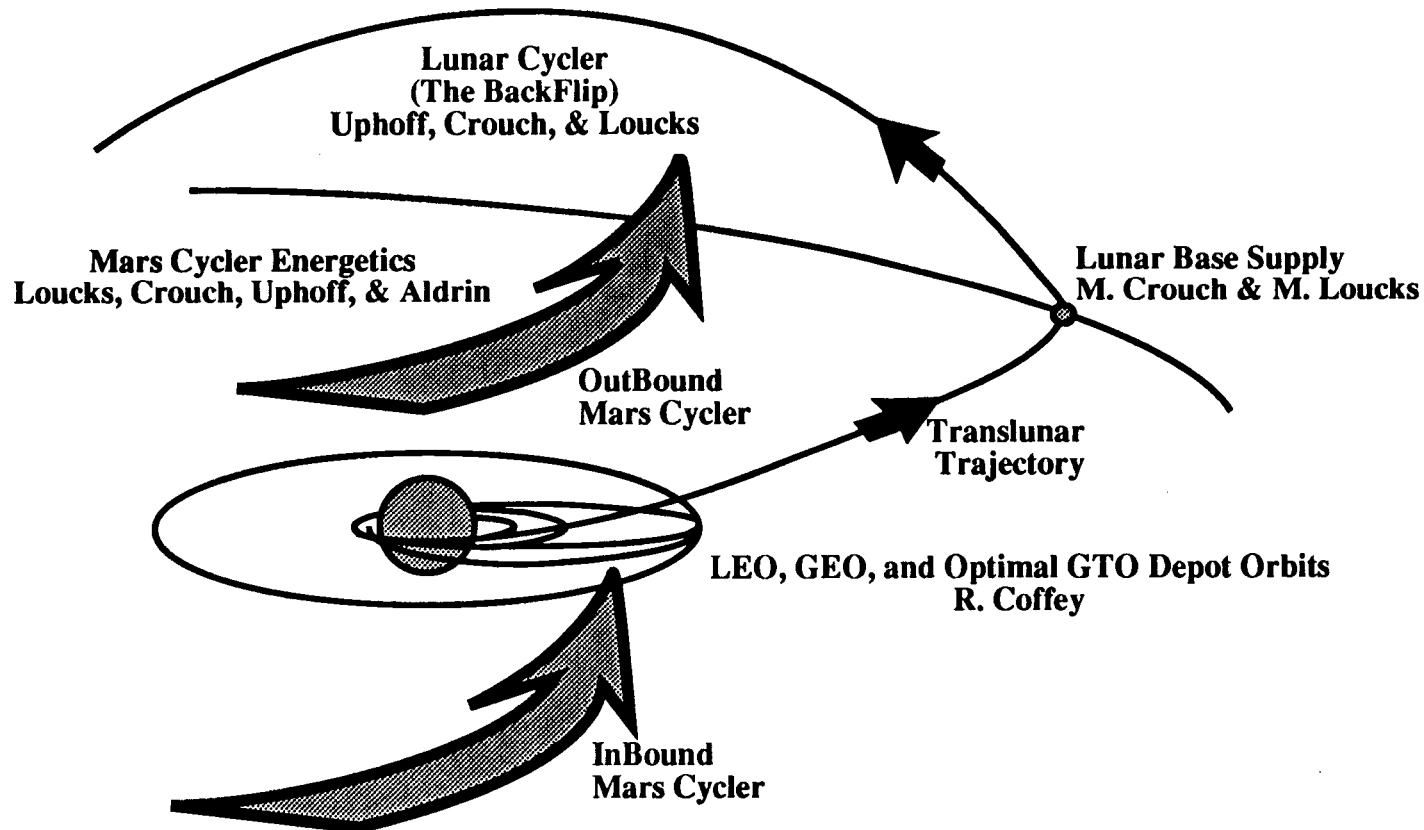



# OVERVIEW

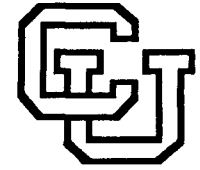

- **Ball/CSC Cooperation Mutually Beneficial**
- **The Ball Summer Intern Program**
- **CSC Charter Requires Total Systems Approach**
- **The Write Stuff - Space 90 Paper & Buzz Aldrin**
- **Informal Lecture Series - -**

**Computational Mission Analysis**

**and**

**Nitty Gritty Space Mission Design**

[REDACTED]  
100 594  
P. 8

Randall E. Coffey †  
Ball Aerospace Systems Division

**Abstract:**

This paper investigates the development and use of semi-analytic methods for propellant depot orbit selection in cyclic, coplanar, Keplerian GSO missions. The cyclic depot transfer strategy which allows for non-optimum (e.g. non-Hohmann) transfer, is constrained by resonance requirements allowing for descent rendezvous/refueling with fuel depots positioned during the ascent phase of the mission. The mission benefit using this transfer technique allows an improvement in propulsion system efficiency which can lead to ~ 43% reduction in initial launch mass when compared to traditional methods, but with the trade-off of longer mission timelines. A family of potential transfers is identified with an "optimum" selection not based on conventional  $\Delta V$  minimization. The results of this analysis include reduced transfer times and greater potential initial launch mass savings over previous work.

**INTRODUCTION**

The national mandate of human exploration of our Solar System in the first part of the 20th Century, outlined in the February, 1988 Presidential Directive on National Space Policy, will require the development of strategies and hardware providing for human travel into the solar system<sup>1</sup>. Four case studies<sup>2</sup> typify the evolution of human exploration of our Solar System. These missions include a Human expedition to Phobos, Human expeditions to Mars, a Lunar scientific observatory<sup>3</sup>, and an early Mars expedition via a Lunar outpost. All of these human initiatives into the Solar System will require cyclic deliveries of hardware, materials, humans, etc., to provide for on-orbit assembly, manned station resupply, or alternately the retrieval of high orbit payloads for return to low Earth orbit, or Earth itself. The ability of perform these types of cyclic missions has been tied to the development of orbital maneuvering vehicles which exploit new energy saving concepts such as aerobraking recapture<sup>4,5</sup>. However, with the development of rendezvous and fuel transfer techniques currently underway<sup>6</sup> an advanced cyclic transfer strategy using orbiting fuel depots shows a potential for greatly reducing the mission support mass. The development and application of an optimum transfer strategy based on cyclic transfer using orbiting fuel depots is presented in this paper.

---

† Senior Mission Analyst, Ball Aerospace Systems Division



# **LEO/GSO CYCLIC DEPOT TRANSFER**

**Randall E. Coffey**

**CSC Systems Cluster**



# SPACE EXPLORATION BENEFIT

- Mission models for near-term exploration will require cyclic transfer capabilities to:
  - a) deliver materials for on-orbit assembly of orbiting nodes
  - b) resupply orbiting science/support platforms with personnel and supplies
  - c) retrieval & return of high orbit payloads to LEO
- Cyclic transfers using conventional techniques {nodal restrictive bi-Hohmann} limit the usable payload on each mission due to massive amounts of round-trip transfer fuel at the beginning of the mission.
- Cyclic missions using depot transfer/rendezvous can provide significant reductions in fuel requirements by improving the propulsion efficiency, and hence reduce the overall mission cost.

# CYCLIC MISSION PROPULSION EFFICIENCY CAN BE IMPROVED USING DEPOT TRANSFER

0.5.

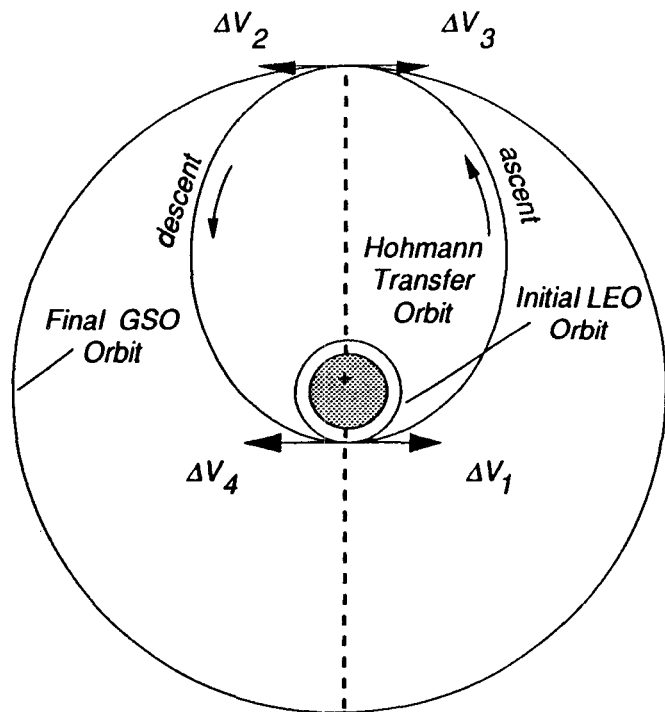

**Conventional Bi-Hohmann Cyclic Transfer**

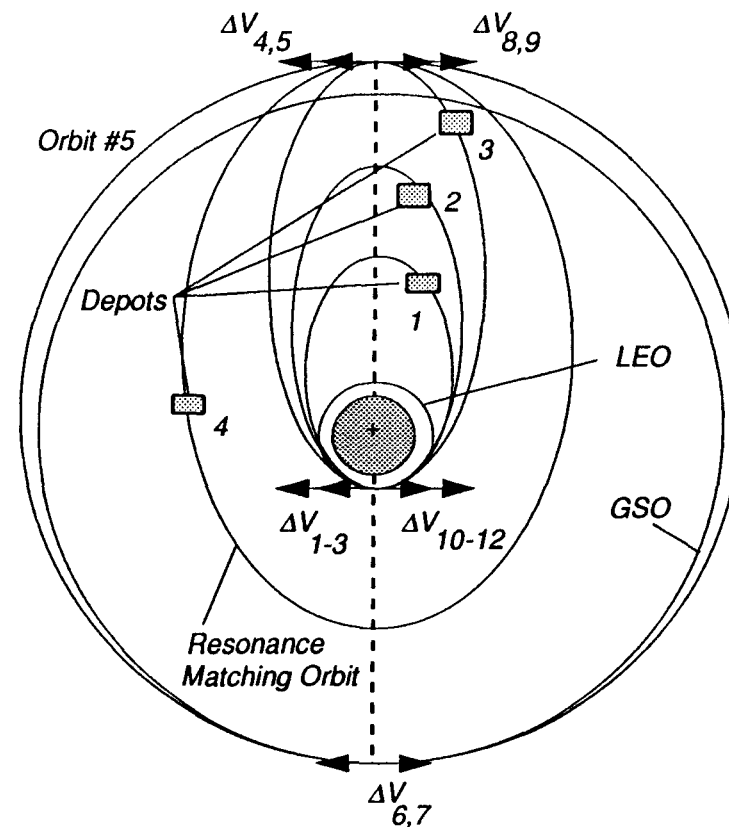

**Cyclic Transfer Using Depot Rendezvous**

# INITIAL DESCENT FUEL DEPOT RENDEZVOUS IS ACCOMPLISHED USING A RESONANCE MATCHING ORBIT

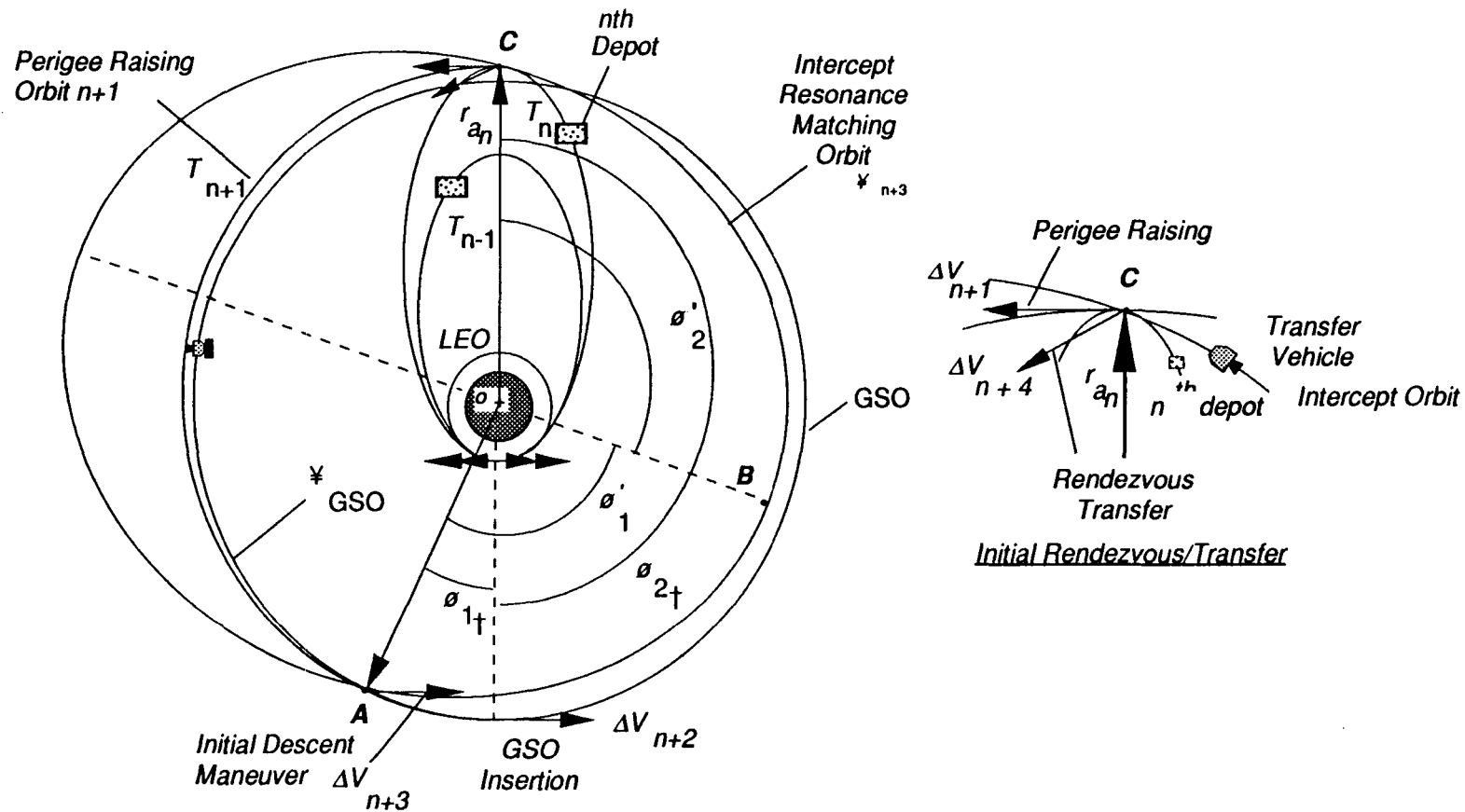

# EXAMPLE: CYCLIC DEPOT ORBIT HISTORY

{ Ni = 4.0 : 1.5 }

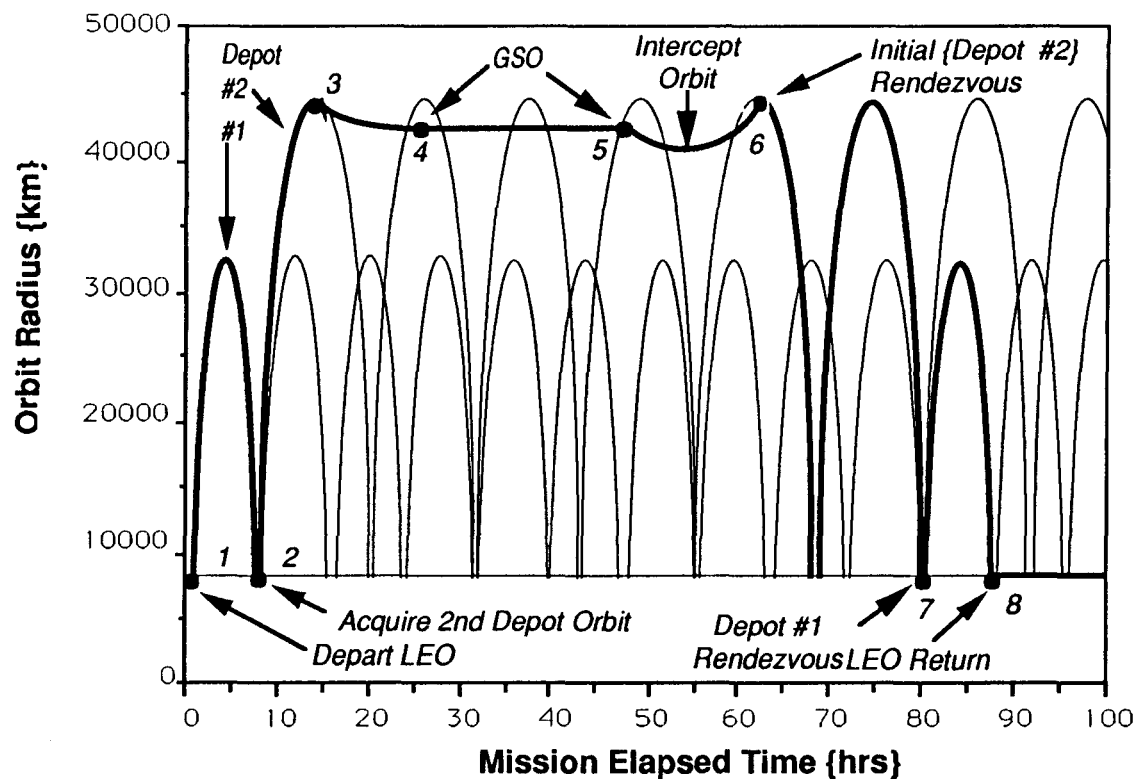

# CYCLIC DEPOT TRANSFER CAN PROVIDE SINGLE ELEMENT BENEFIT FOR SOME MISSIONS

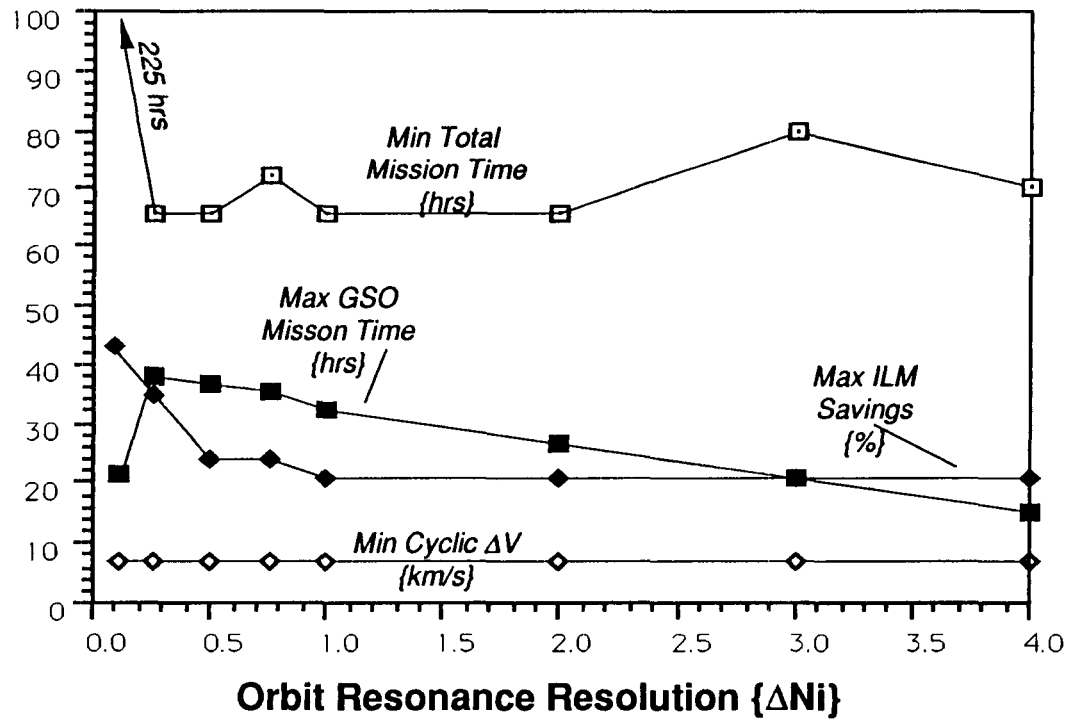

# DEPOT TRANSFER ATTRIBUTES CAN BE MATCHED TO INDIVIDUAL MISSION GOALS

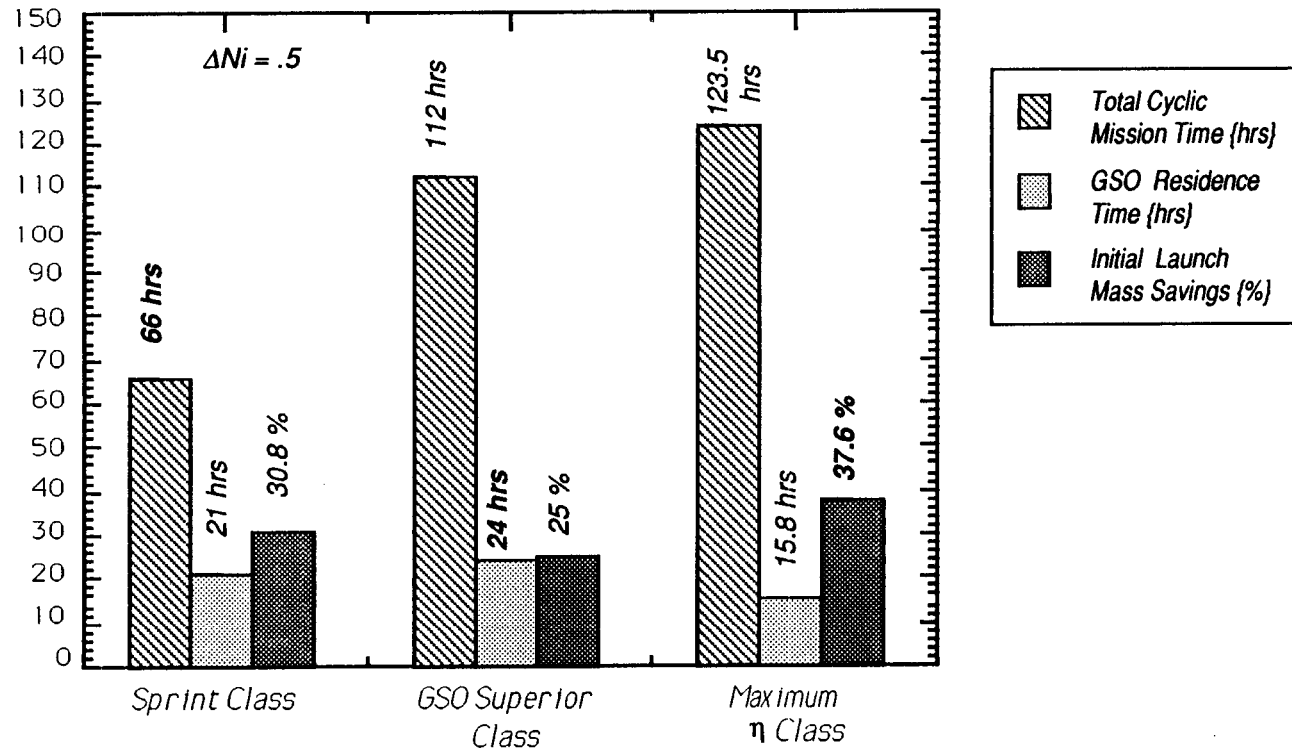

██████████  
5-5-90  
160695  
p. 13

Lunar Cycler Orbits  
with  
Semi-Monthly Transfer Windows

by

Chauncey Uphoff

Ball Space Systems Division

Boulder, Colorado

and

Mark Crouch & Michel Loucks

Center for Space Construction

University of Colorado

Boulder, Colorado

**Abstract:**

This paper is a presentation of a new type of cislunar transfer orbit that has encounters with the Moon twice per month. The use of this technique is suggested for Earth-to-Moon Cycler spacecraft that contain the heavy and expensive life support equipment for human transfer from low Earth orbit to the Moon and for logistical supply of lunar bases. The basis for the technique is a  $180^\circ$  near-circular Moon-to-Moon transfer orbit that is inclined to the Earth-Moon plane by an angle that is compatible with a low-inclination, near-minimal energy Earth-to-Moon transfer orbit. Also included are preliminary discussions of Cycler spacecraft design considerations and the logistics of operation for extensive manned operations on the Moon. Numerical studies are included to verify the usefulness of the technique in a realistic cislunar dynamic environment and estimates of navigation propellant requirements are given.

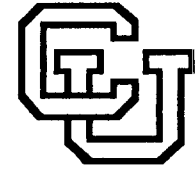

# **The Development of Quick-Response Mission Design and Analysis Tools**

**Chauncey Uphoff  
Ball Space Systems Division  
Boulder, Colorado**

**Mark Crouch & Mike Loucks  
Ball Summer Intern Program  
and  
Center for Space Construction  
University of Colorado**





# QUICK - RESPONSE TOOLS AND TECHNIQUES

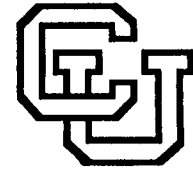

## Objectives

- **Software for the Preparation and Presentation of Mission Analysis Information**
- **Commercial Software**
- **In-House Software**
- **Macintosh II<sup>TM</sup>**
- **Response Time Critical**



# QUICK - RESPONSE TOOLS AND TECHNIQUES

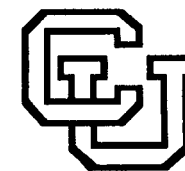

## Selections

- **Kozsak**
- **MAESTRO**
- **Preliminary Targeting Programs**
- **Presentation Software**
- **Macintosh II™**



# KOZSAK



## **Orbit Propagator for Close Orbiters in an Oblate Field**

- **Rapid Long - Term Propagator**
- **Mean Element Propagation**
- **Mean-to-Osculating Element Transformation**
- **Accuracy Good - Will Be Improved**
- **Applications: Frozen Orbits, Resonance Analysis**



# MAESTRO

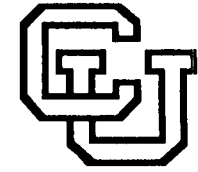

## MISSION ANALYSIS EVALUATION AND SPACE TRAJECTORY OPERATIONS PROGRAM

- **Developed for Goddard in 1973**
- **Mission Analysis and Operations**
- **Multiple Modes of Operation**
- **Wide Range of Applicability**
- **Under Conversion**



# Preliminary Targeting Programs

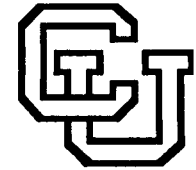

- **Interplanetary and Earth - Lunar**
- **Preliminary Trajectory Selection**
- **Provide Data for MAESTRO**
- **Output to Animation or Contouring**

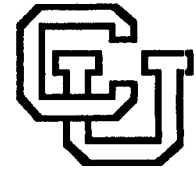

# **Lunar Cyclor Orbits with Semi-Monthly Transfer Windows**

**To Be Presented at SPACE '90  
Albuquerque, NM. April, 1990**

**Chauncey Uphoff & Mark Crouch  
Ball Space Systems Division  
Boulder, Colorado**

**Mike Loucks  
Center for Space Construction  
University of Colorado  
Boulder, Colorado**



# LUNAR CYCLER

## 14-DAY BACKFLIP

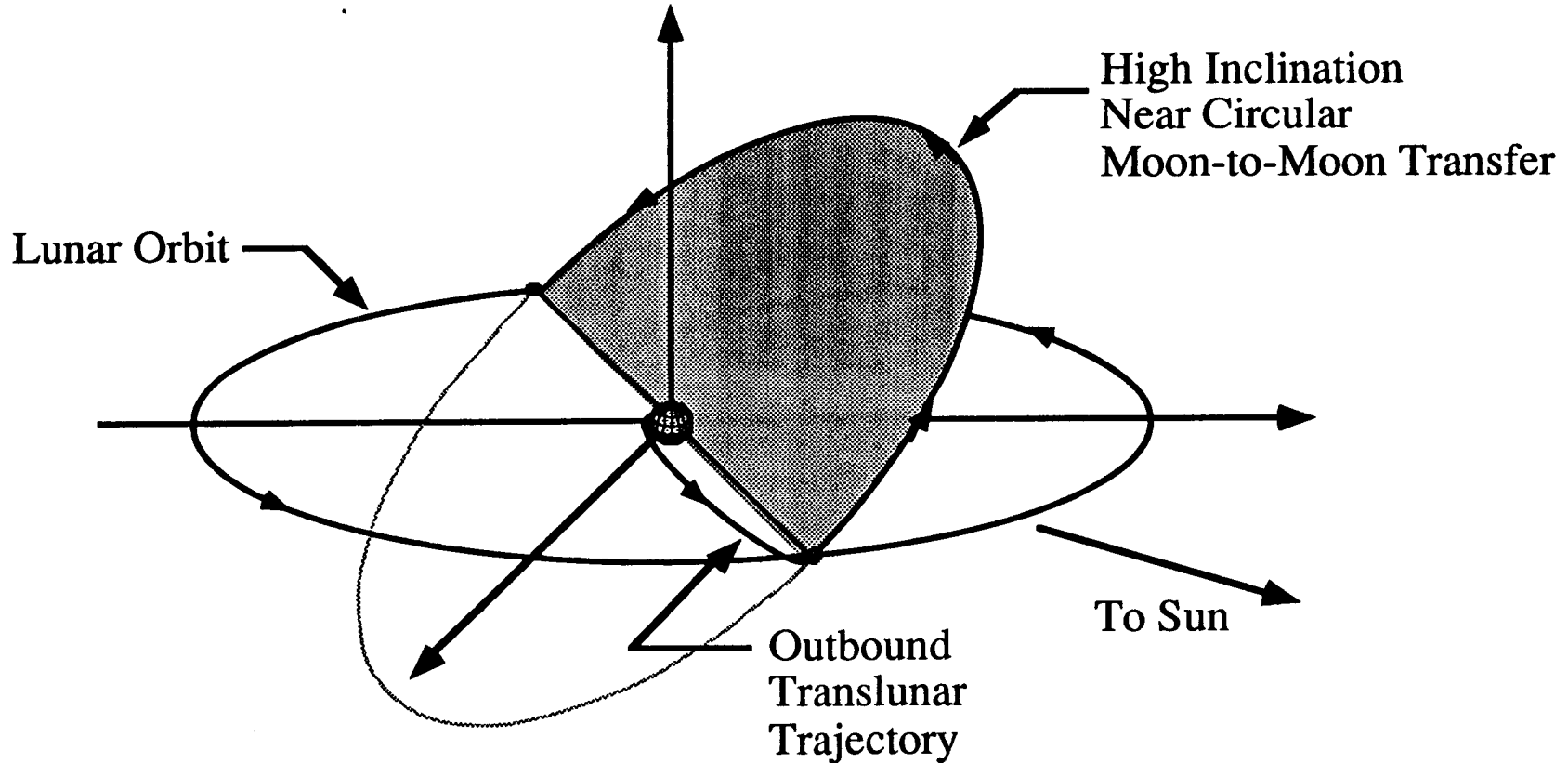



# LUNAR CYCLER

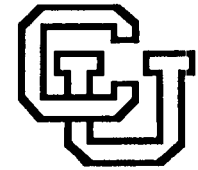

## INBOUND LEG

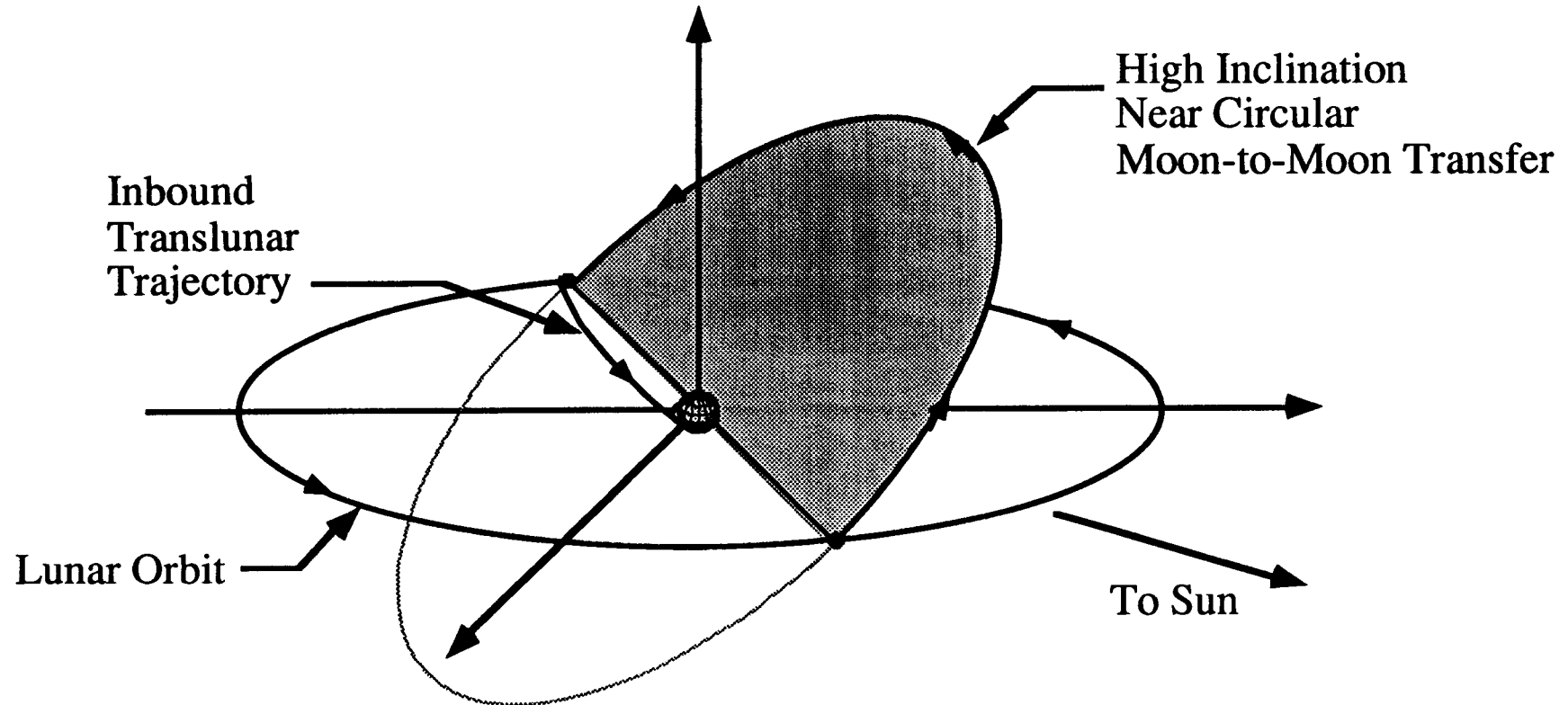





# MARS SPLIT- CYCLER MISSION CONCEPT

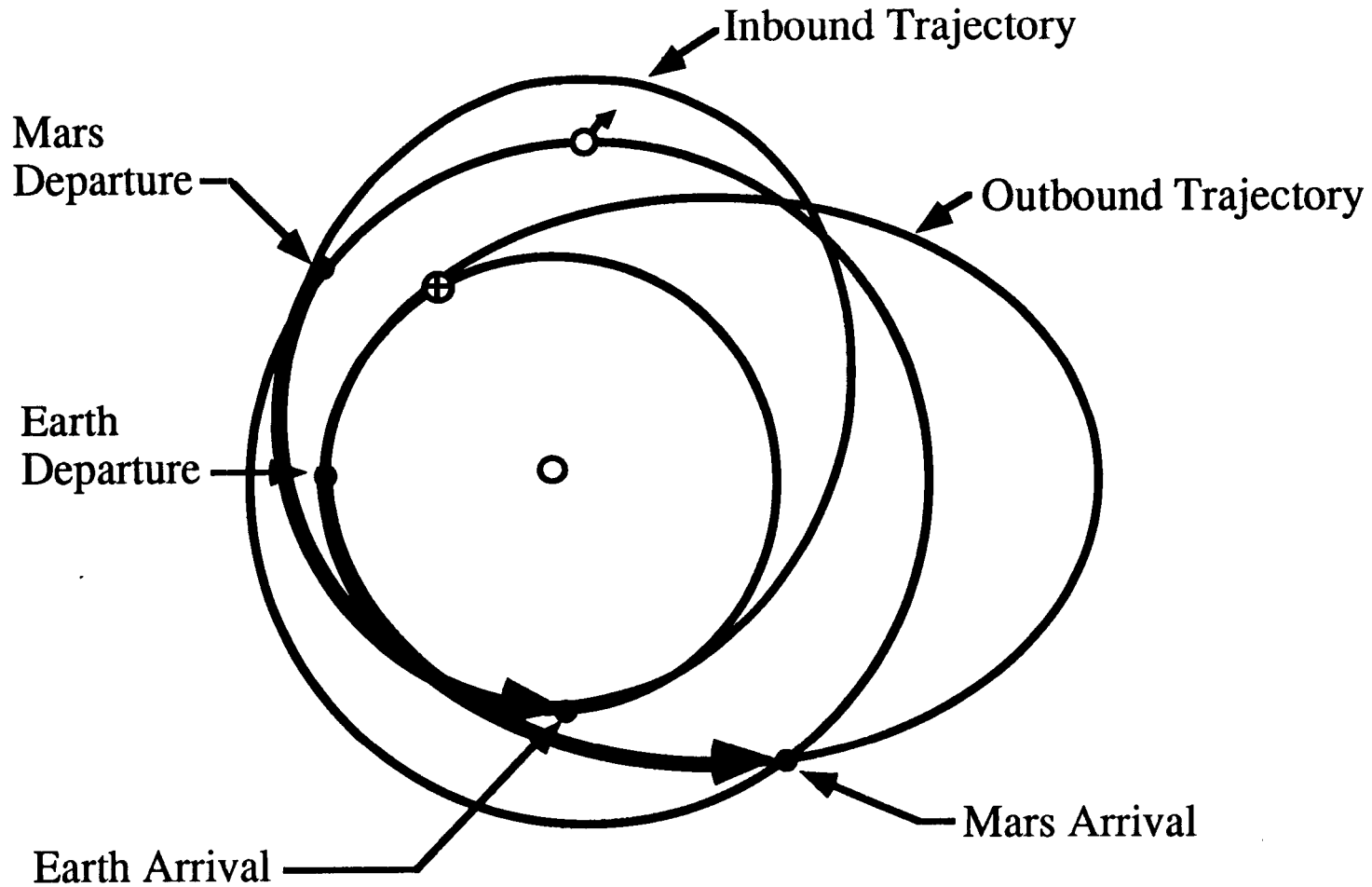
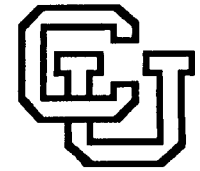



# MARS SPLIT-CYCLER SWING-BY PHASING

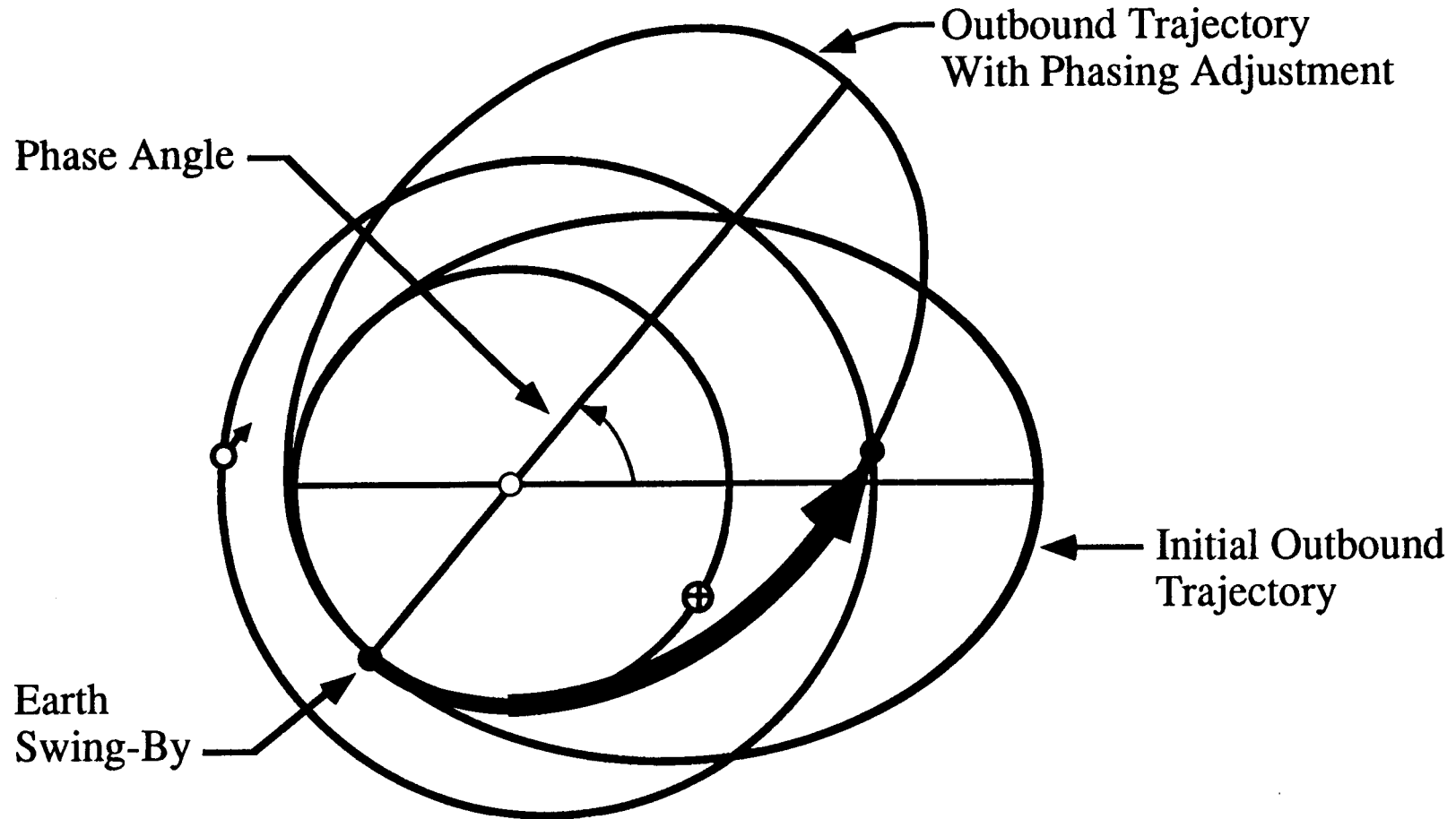
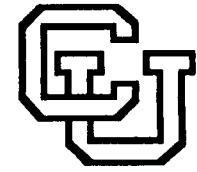



# QUICK - RESPONSE TOOLS AND TECHNIQUES

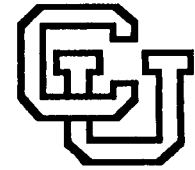

## Summary

- **Comprehensive Set of Tools Produced**
- **Emphasis on Analysis and Presentation**
- **Wide Applicability**
- **All Work Conducted on Macintosh II™**
- **Work to Continue in Association with CSC**

Constructor Selection System

Richard Johnson

226-31

160696

p. 10

**Abstract**

Future space construction missions will involve both human and machine constructors. Selection of the optimum constructor mix requires a model of constructor capabilities and requirements. The database for that model is developed via extrapolation from current literature. Optimization is done via minimization of total mission cost using a linear programming approach. This prototype is the first cut at producing a general tool for choosing a near-optimum constructor mix for any space construction mission. It illuminates some significant representational and data-gathering problems with the modelling approach.

# Constructor Selection System

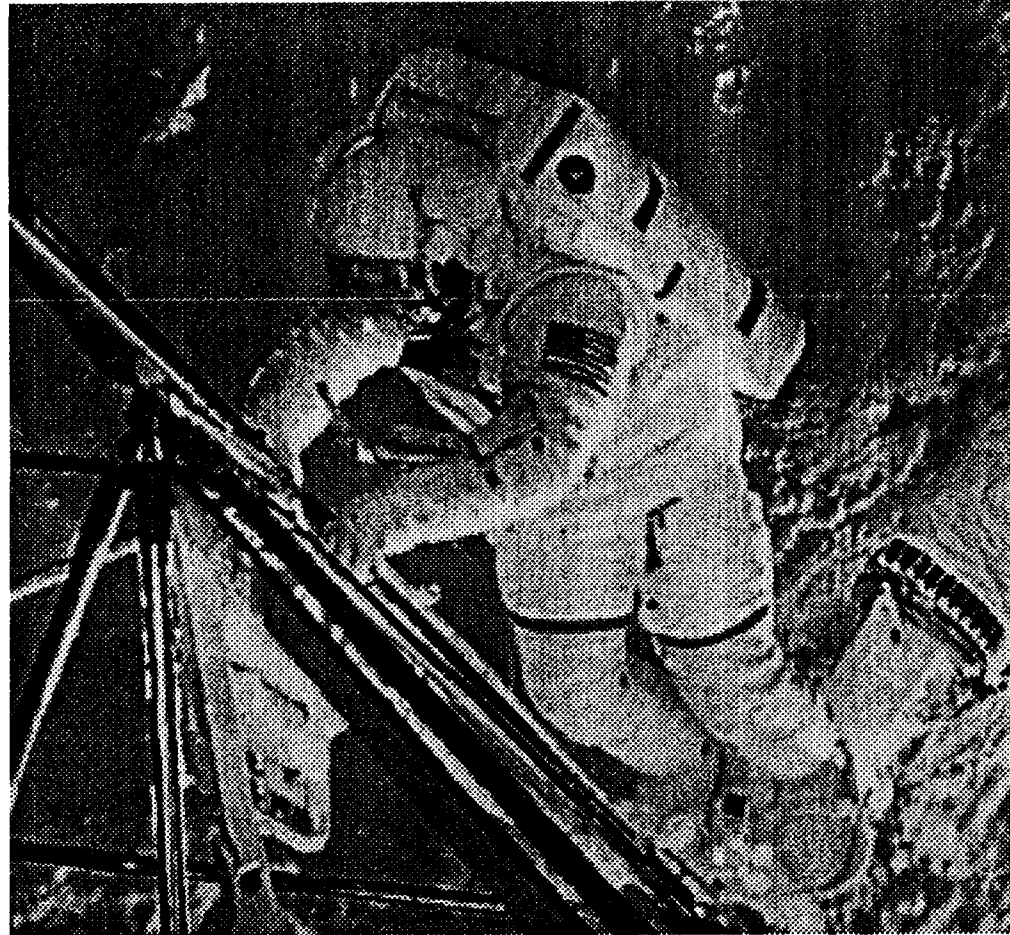

CSC Systems Cluster  
Constructor Selection  
10/12/89  
RJJ

# Overview

- The Model
- The Reference Mission
- The Constructors and Tasks
- The Results
- Future Directions

# Mission

## Overall Goal

Select the best constructor teams for an extended series of space construction missions.

## Prototype Model Objective

Provide a research tool for examining modelling approach

# Prototype Model Description

## Linear programming approach

Objective function:

$$\text{Minimize } C = \sum_{i=1}^m \sum_{j=1}^n X_{ij} C_i$$

Constraints:

Finish all the tasks

$$\sum_{i=1}^m X_i P_{ij} \geq \text{Total Work}$$

Don't overwork the constructors

$$\sum_{j=1}^n X_{ij} \leq \text{Time Available}_i$$

## Model Input Matrices

Constructor productivities – minutes/task unit

Constructor costs – \$/minute



# Reference Construction Mission

## Satellite Servicing Bay

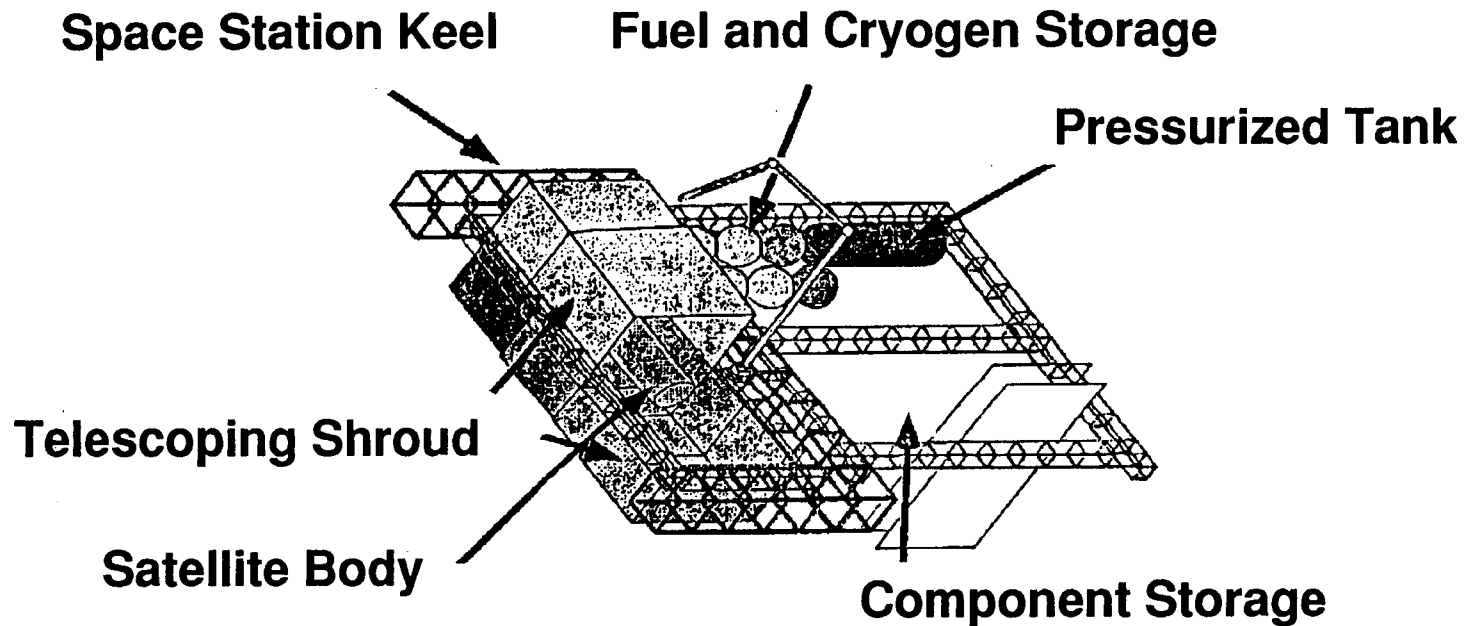

## Why a Reference Mission?

Provides a common knowledge base for diverse research  
Gives us something to construct

# Constructors

Self Deploying Truss (SDT)  
Self Deploying Solar Array (SDSA)  
Self Deploying Radiator (SDR)  
Extra-Vehicular Activity Astronaut using Space  
Transportation System suit (EVA/STS)  
Extra-Vehicular Activity Astronaut using new Space Station  
Freedom hard suit (EVA/SSF)  
Flight Telerobotic Servicer under STS control (FTS/STS)  
Flight Telerobotic Servicer under ground control (FTS/GC)  
Flight Telerobotic Servicer under SSF control (FTS/SSF)  
Remote Manipulator System under STS control (RMS/STS)  
Remote Manipulator System under SSF control (RMS/SSF)

# Tasks

## Unload

- Truss Parts
- Solar Array Parts
- Radiator Parts
- Shroud Parts
- Cans
- Palettes
- Can Support Parts

## Transport

- Truss
- Solar Array
- Radiator
- Shroud
- Cans
- Palettes

## Build

- Truss Bay
- Solar Array
- Radiator
- Shroud
- Cans
- Palettes
- Can Support

## Attach

- Truss
- Solar Array
- Radiator
- Shroud
- Cans
- Palettes
- Electrical/Optical/Fluid  
Connections

# Results

Currently limited to subset of reference mission

## Constructors

Self Deploying Truss (SDT)  
Extra-Vehicular Activity Astronaut using  
Space Transportation System suit  
(EVA/STS)  
Flight Telerobotic Servicer under STS  
control (FTS/STS)  
Remote Manipulator System under  
STS control (RMS/STS)

## Tasks

Unload Truss Parts  
Transport Truss  
Build Truss Bay

**Trivial output** – EVA Astronaut was only constructor used  
Limited mission has no larger context  
EVA Astronaut has no development costs  
Input costs were most likely not realistic

# Future Directions

## Start-up costs and times

Amortization in prototype can skew results  
Use more advanced modelling/search techniques

## Try Tabu

Scheduling optimization technique  
Bubble sort with memory  
Handles start-up costs and delay penalties

## Expansion of Model

Multiple-launch missions  
Time and task order (scheduling) constraints  
More useful optimization criteria (using empiric function)  
Multiple-mission space programs



-27-10  
160697  
P-10

# ADDRESSING THE PROBLEM OF INTERRUPTABILITY IN THE CONSTRUCTION OF LARGE SPACE STRUCTURES

R.A. Davidson\* and G.W.Morgenthaler†

Large scale space missions of the near future will depend upon successful multi-launch coordination and construction in the space environment. One of the main challenges is how to accomplish a valid global analysis of a construction project with the intent of improving safety, reducing overall mission cost, and total construction time. These three items are dependent on the interruptability of the project, which is the ability of the project to recover from unplanned interruptions; such as failure of the launch vehicle; sudden, on-orbit, crew illness; or damage from a space debris impact on the partially completed space structure.

A new method for addressing and analyzing this type of problem is being developed. The method is called Program Interruptability and Risk Evaluation Technique, or PIRET. PIRET has been developed in order to model and analyze potential interruptability concerns of the construction of the U.S. Space Station Freedom (SSF), although PIRET is applicable to any complex, multi-launch structural assembly.

This paper is a progress report on the continuing research of the NASA Center for Space Construction at the University of Colorado, Boulder into this area of space construction interruptability. The paper will define the problem of interruptability, will diagram the PIRET approach to space construction, will share results from a preliminary PIRET analysis of SSF, and will show that PIRET is a useful tool for modelling space construction interruptability.

---

\* Graduate student in the Center for Space Construction of the Aerospace Engineering Sciences Department at the University of Colorado, Boulder 80309-0429

† Associate Dean, College of Engineering and Applied Sciences and Professor, Aerospace Engineering Sciences Department and member, Center for Space Construction at the University of Colorado, Boulder 80309-0429

ADDRESSING THE PROBLEM  
OF INTERRUPTABILITY  
IN THE CONSTRUCTION  
OF LARGE SPACE STRUCTURES

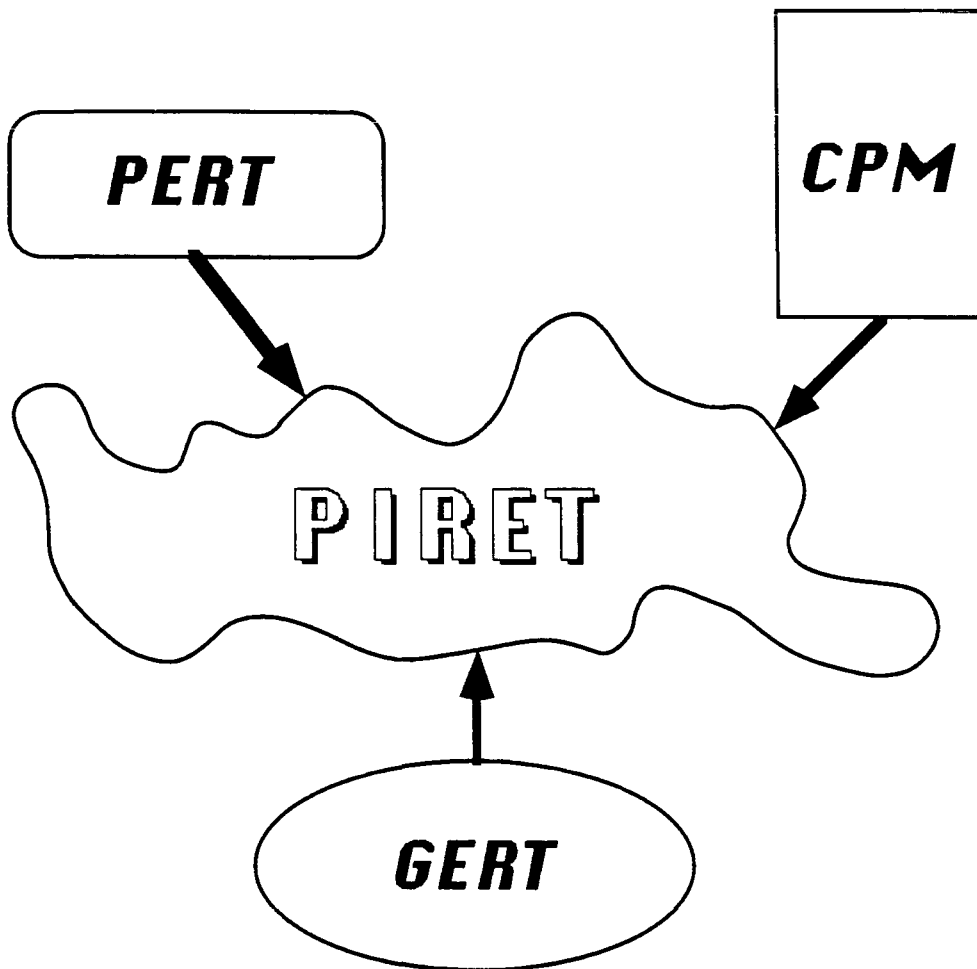

### Foundations of PIRET

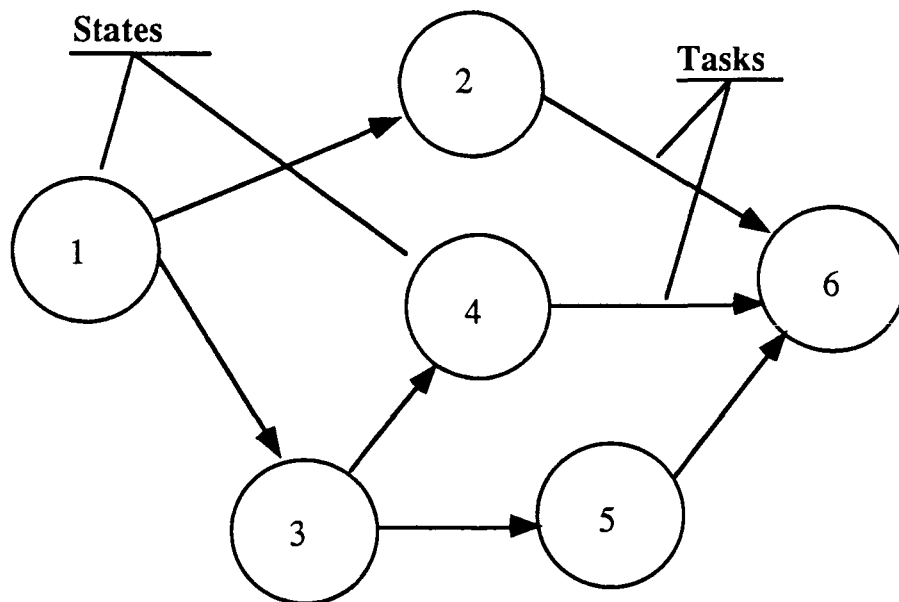

### Activity Network



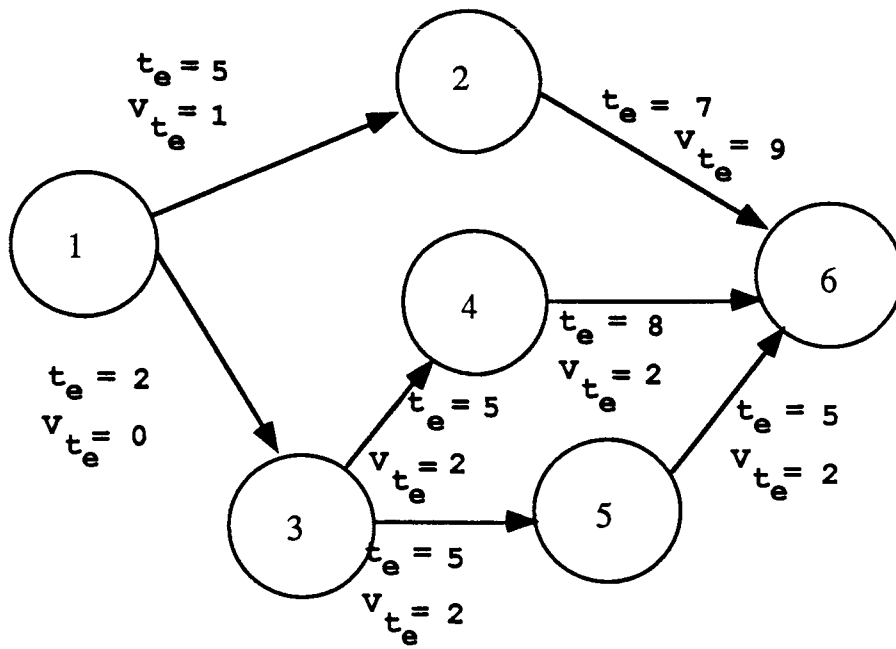

## PERT Network

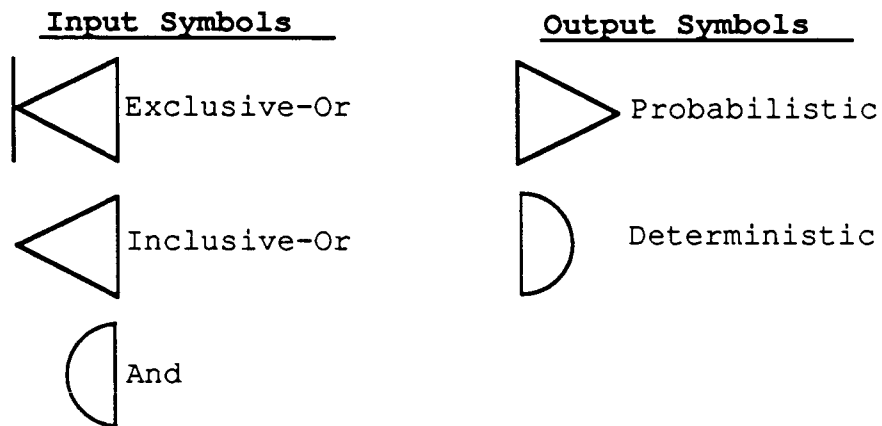

## GERT Symbols

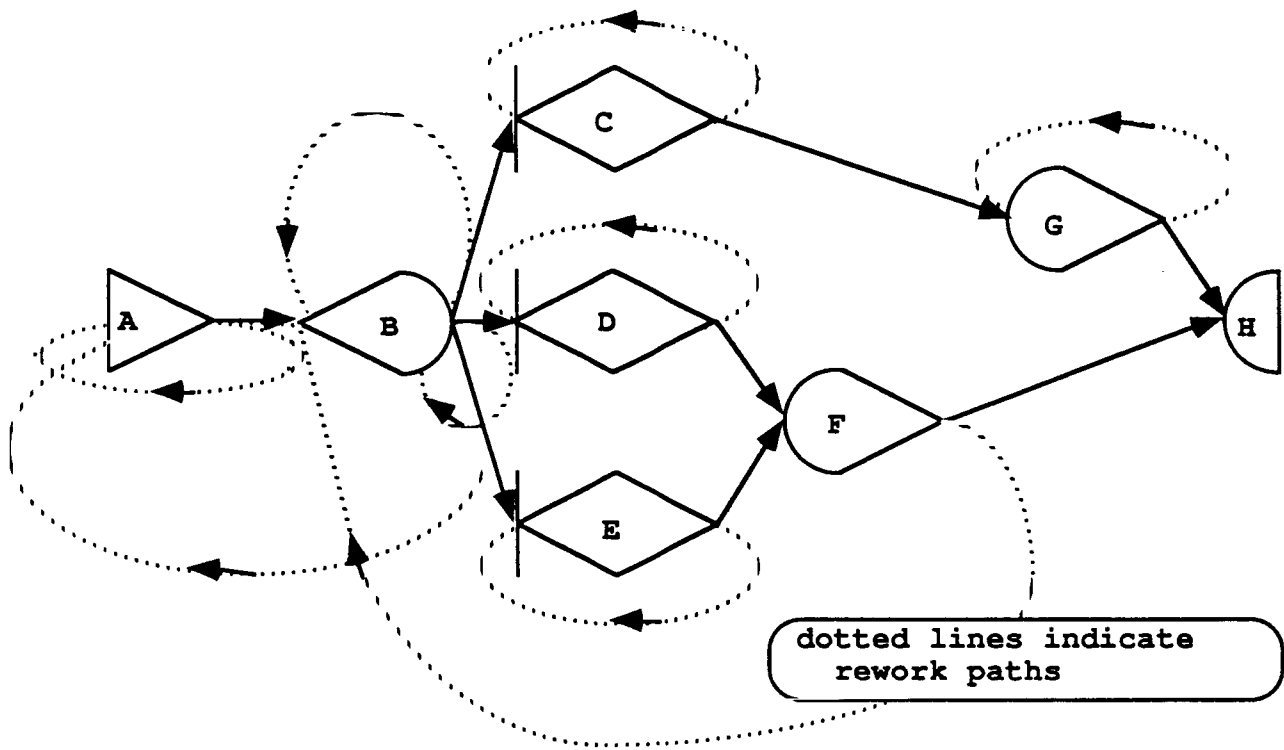

**Sample PIRET Network Diagram**

**Sample PIRET Task Definition Table**

Task	Completion	Time Distrib.		Cost Distrib.		Safety	Rework Path
	Prob.	$t_e$	$U t_e$	$\$e$	$U \$e$	Prob.	
A.B	0.99	25.0	3.2	1.2	0.2	0.995	A.B*A
B.C	0.97	23.8	5.4	0.9	0.13	0.9999	B.C*B
B.D	0.925	34.8	3.3	1.9	0.3	0.987	B.D*B
B.E	0.995	45.2	9.0	2.3	0.9	0.999	B.E*A
C.G	0.917	23.5	0.7	1.2	0.3	0.96	C.G*C
D.F	0.93	34.8	5.2	1.7	0.6	0.977	D.F*D
E.F	0.99	21.0	0.5	0.8	0.05	0.9999	E.F*E
F.H	0.95	23.9	4.9	0.9	0.1	0.998	F.H*B
G.H	0.99	22.1	0.9	0.8	0.1	0.999	G.H*G

For each construction task the following information is used:

- 1 ) Probability of successful task completion
- 2 ) Time probability distributions for task completion
- 3 ) Cost/Resource-use probability distributions for task completion
- 4 ) Contingency paths and rework relationships for task failure
- 5 ) Safety information such as probability of injury or loss of life

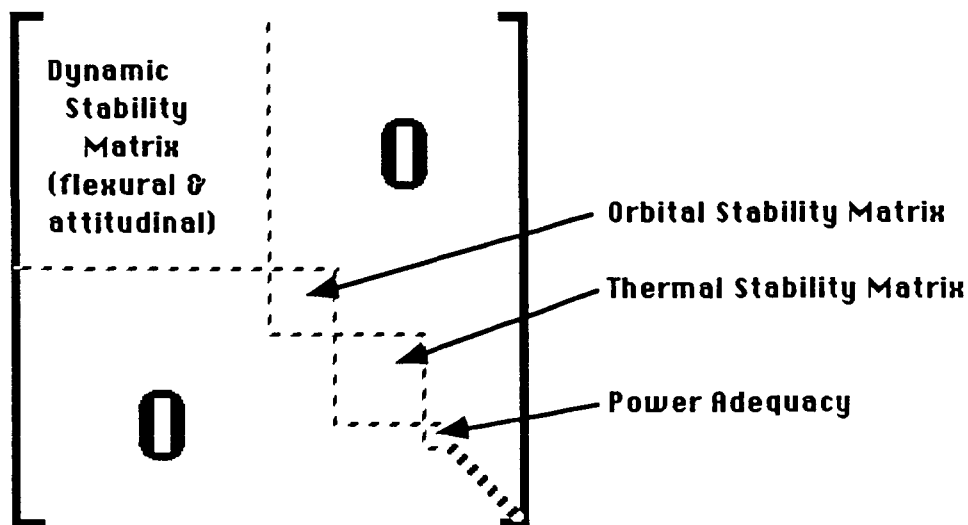

**PIRET State "Stability" Matrix**

**POSSIBLE DESIGN MODIFICATIONS  
FOR STABILITY ENHANCEMENT**

**Dynamic  
Instability**

**Thermal  
Instability**

**Power  
Inadequacy**

**Orbital  
Decay**

-----  
**Active stiffeners**

**Thermal sources**

**Power modules**

**Thrusters**

**Passive dampers**

**Thermal sinks**

**Propellant**

**Additional sensors**

**Additional actuators**

**Shuttle flight #**

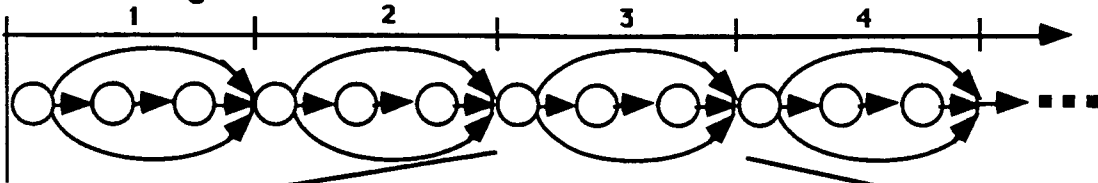

**Level 1: Shuttle mission i of planned launch sequence**

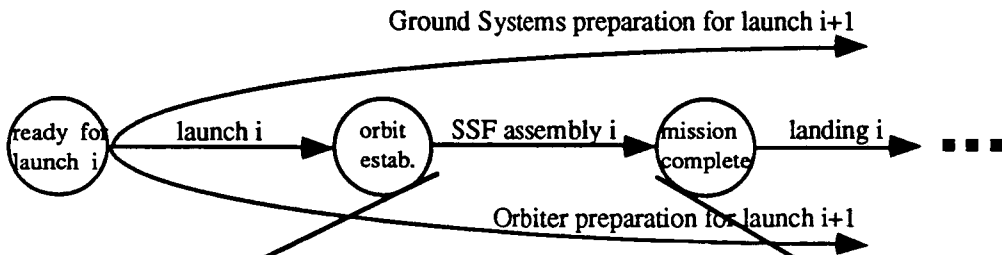

**Level 2: SSF assembly task definition for launch i**

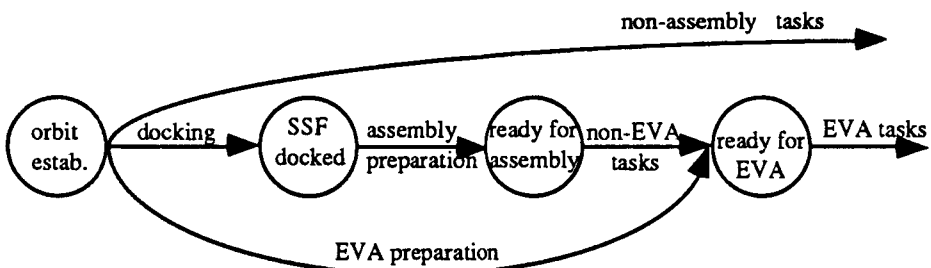

**Level 3: Further defining of Level 2 tasks**



## Problems with PIRET:

- 1) Acquisition of accurate data for PIRET model task definitions is typically difficult and slow, if the data is available at all.
- 2) The requirements of PIRET for numerical calculations is very high, especially if the "stability at each state must be determined.
- 3) There is no standard, off-the-shelf, computer package available for creating, managing, and analyzing PIRET models.

From PIRET modelling and analysis of large space structure construction the following objectives can be gained:

- 1) Identification of reasons and solutions to possible unacceptable probability distributions of outputs such as time and costs in order to make program adjustments and save actual time and resources.
- 2) Identification of high-risk periods of construction and interruptability hazards in order to improve safety before injury or major loss occurs.
- 3) Identification of possible problem areas and the necessary contingency plans designed to mitigate the problem of interruptability.
- 4) Guidance of construction design and scheduling to improve human safety, reduce risk of space structure loss, reduce expenditures, and improve construction time.

[REDACTED]

Numerical Simulation of Controlled Large Space Structures

513-18

by Ralph Quan

160599

p. 8

Large Space Structures do not have much damping, which necessitates the installation of a controller onto the structure. If the controller is improperly designed, the structure may become unstable and be destroyed. Since Large Space Structures are extremely expensive pieces of hardware, new controllers must not be tested first on the structure. They must first be tested in computer simulations.

Until now, the usual procedure for simulating controlled Large Space Structures is to compute a reduced order modal representation of the structure and then apply the controller. However, this procedure entails modal truncation error.

A new software package which is free from this error is currently under development within the Center for Space Construction. The more accurate finite element representation of the structure is used in the simulation, instead of the less accurate reduced order modal representation. This software also features an efficient matrix storage scheme, which effectively deals with the asymmetric system matrices which occur when control is added to the structure. Also, an integration algorithm has been chosen so that the simulation is a reliable indicator of system stability or instability.

The software package is fairly general in nature. Linearity of the finite element model and of the controller is the only assumption made. Actuator dynamics, sensor dynamics, noise, and disturbances can be handled by the package. In addition, output feedback of displacement, velocity, and/or acceleration signals can be simulated. Kalman state estimation has also been implemented.

This software has been tested on a finite element model of a real Large Space Structure: The Mini-Mast Truss. Mini-Mast is a testbed at NASA-Langley which is currently under development. A 714 degree of freedom finite element model was computed, and a 19 state controller was designed for it. Torque wheel dynamics were added to the model, and the entire closed loop system was simulated with the software package.





## Models for Simulating Controlled Large Space Structures:

### ● Modal Model

- Experimental (ERA)
- Iterative Solution for mode shapes and frequencies from the finite element model
  - Modal truncation
  - Frequency response functions indicate that the higher modes are important, especially for accelerometers.

### ● Finite Element Model

- Mass and Stiffness matrices are large, but sparse.
  - It is important to store as few zeros as possible, while minimizing the number of required computations.
  - Traditional matrix storage schemes such as the banded and skyline schemes have been used for structural analysis.
  - When performing closed loop simulations, many unstructured matrices appear. Linked lists provide a more efficient way of storing matrices.

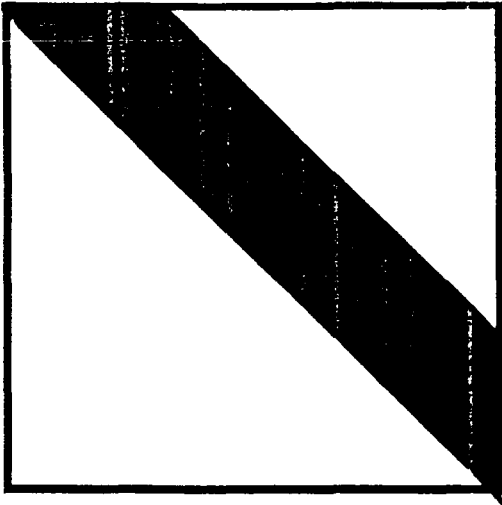

**Banded  
Stiffness Matrix**

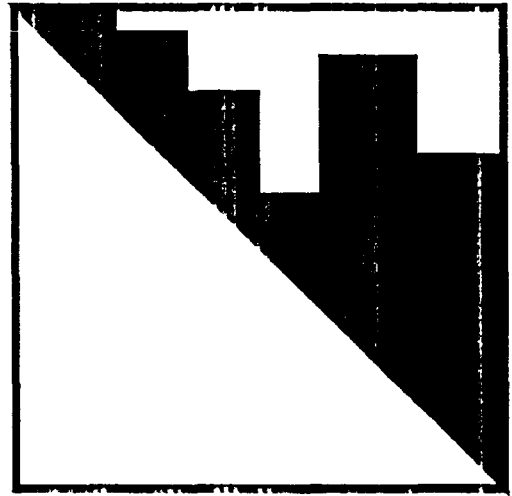

**Skyline (Profile)  
Stiffness Matrix**



**Output Matrix  
(No obvious patterns)**

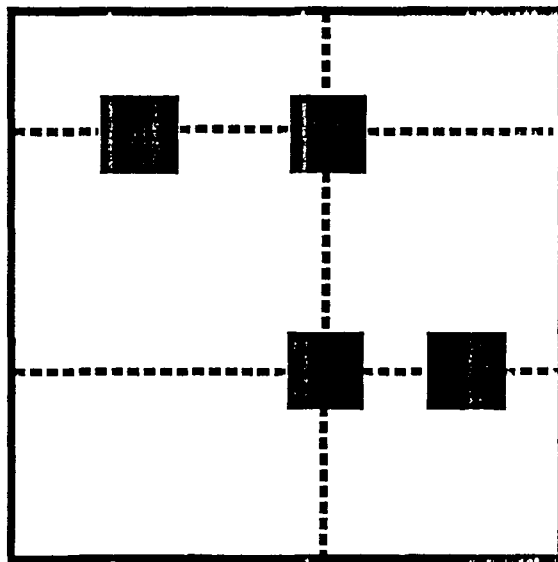

**Linked List Stored Matrix**

## Regions of Numerical Stability For Integration Algorithms:

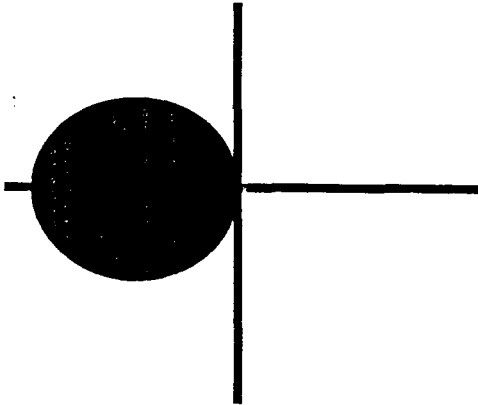

Explicit algorithms  
such as  
Runge-Kutta

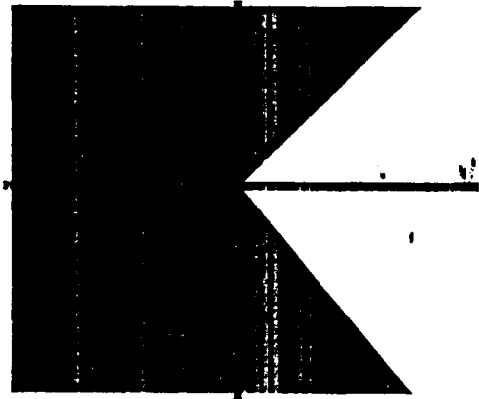

Some popular algorithms  
for simulating open loop  
structures

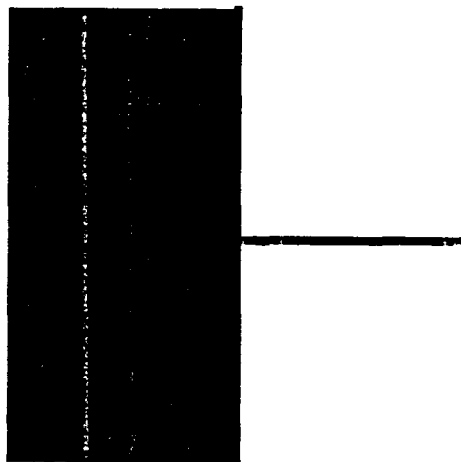

Algorithms such as Trapezoidal,  
or Midpoint Rule

## Closed Loop Simulation Architecture:

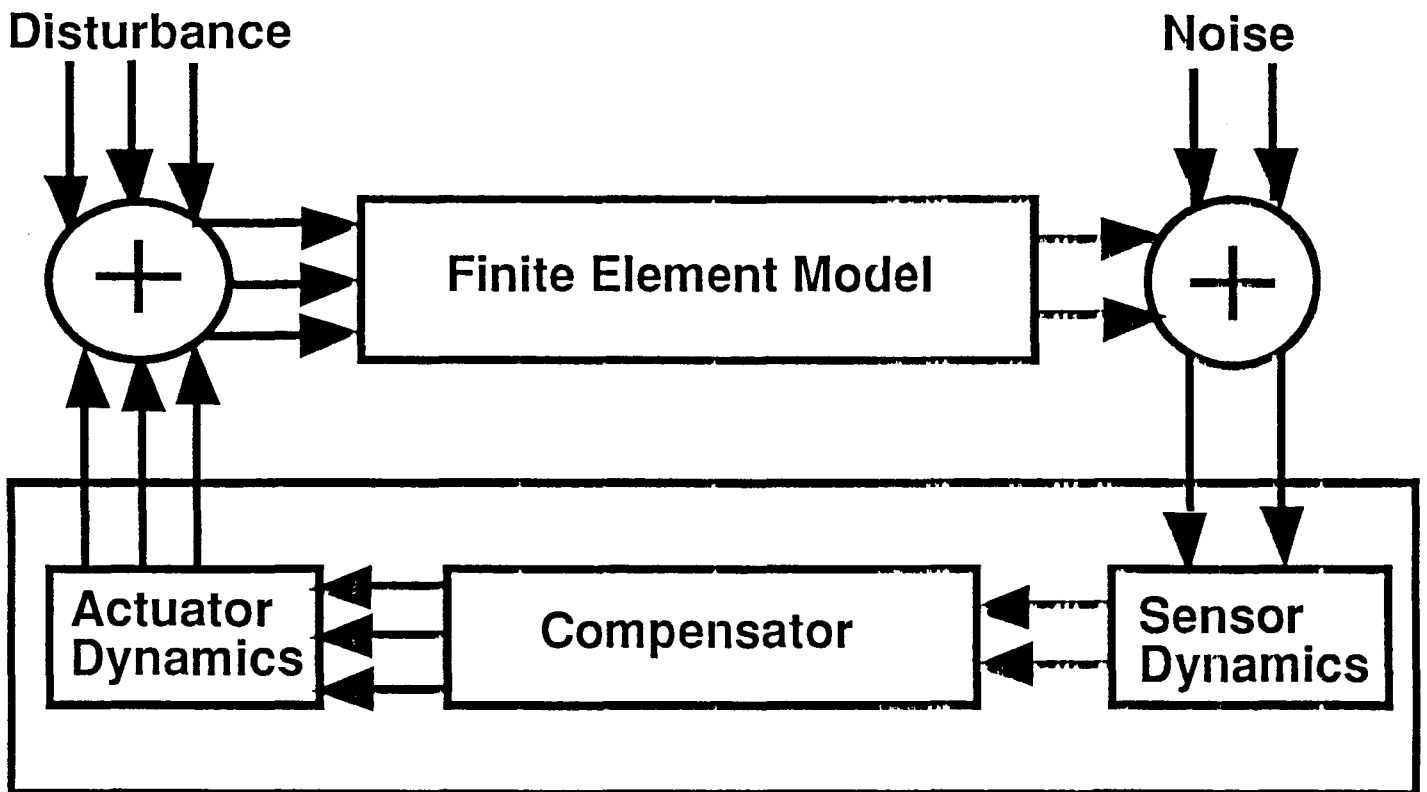

## Linear Finite Element Model:

$$M \ddot{q} + C \dot{q} + K q = F u + d$$

## Appended Linear System ( Actuator Dynamics, Compensator, and Sensor Dynamics)

$$\dot{x} = L11 x + L12 u + L13 yd + L14 yv + L15 ya$$

$$y = L21 x + L22 u$$

$$u = L31 x + 0 + L33 yd + L34 yv + L35 ya$$

- **Key Computation:**

$$A z = b$$

where **A** is a large, sparse, unsymmetric, and unstructured matrix.

**z** is a vector of all states in the closed loop system.

- **Summary of Key Points:**

- **Linked List Matrix Storage**
- **Numerical Stability  $\Leftrightarrow$  System Stability**
- **No Modal Truncation Error**
- **General Purpose Simulation Tool for:**
  - **Output Feedback**
    - **Displacement**
    - **Velocity**
    - **Acceleration**
  - **First Order State Estimation**

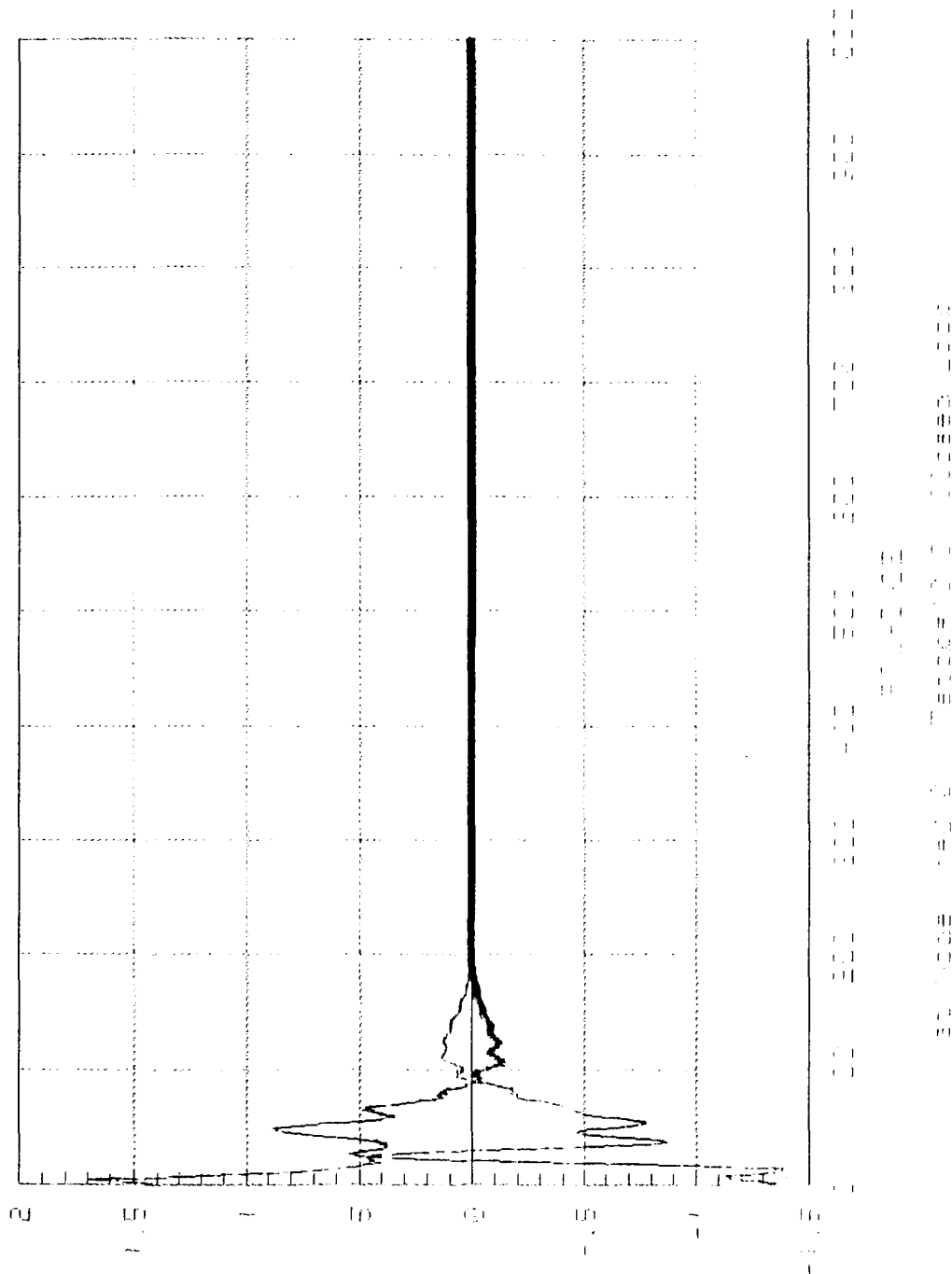

0.0 1.0 2.0 3.0 4.0 5.0 6.0 7.0 8.0 9.0 10.0

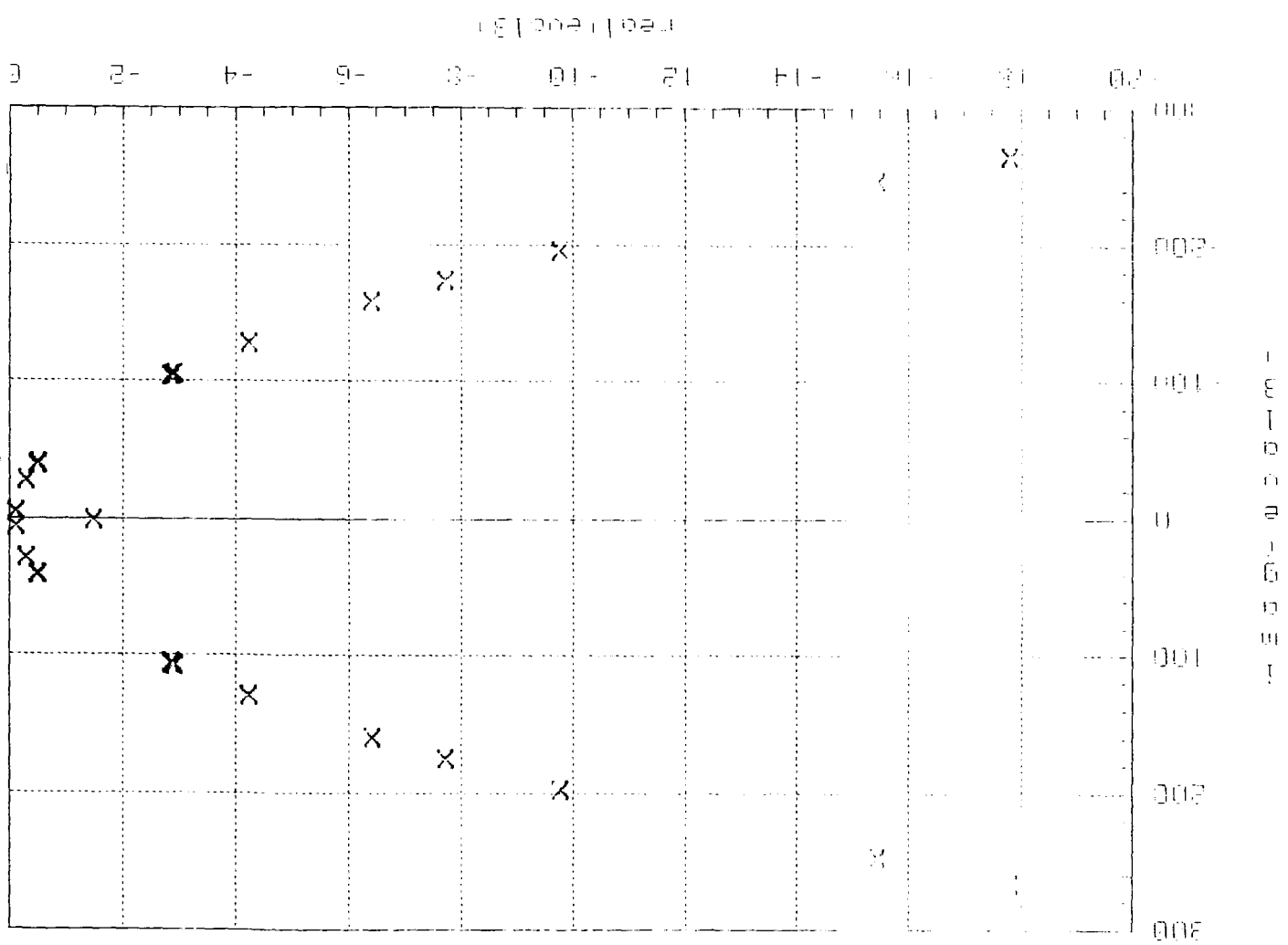

ORIGINAL PAGE IS  
OF POOR QUALITY