

(NASA-CR-192655) ARCJET
EXPLORATORY TESTS OF ARC OPTICAL
WINDOW DESIGN FOR THE AFE VEHICLE
Final Report, 14 Dec. 1990 - 6 Mar.
1991 (NASA) 86 p

N94-10930

Unclas

G3/09 0175560

Arcjet Exploratory Tests of ARC Optical Window Design for the AFE Vehicle,

December 14, 1990 to March 6, 1991

NCC2-653

Ellis E. Whiting, Imelda Terrazas-Salinas,
and Roger A. Craig
Eloret Institute

IN-09-CR

175560

Charles K. Sobeck, George L. Sarver III, Louis J. Salerno,
Wendell Love, Scott Maa and Al Covington
NASA, Ames Research Center

p. 86

April 1991

Abstract

Tests were made in the 20 MW arcjet facility at the NASA Ames Research Center (ARC) to determine the suitability of sapphire and fused silica as window materials for the AFE entry vehicle. Twenty nine (29) tests were made; 25 at a heating rate about 80% of that expected during the AFE entry and 4 at approximately the full, 100% AFE heating rate profile, that produces a temperature of about 2900 °F on the surface of the tiles that protect the vehicle. These tests show that a conductively cooled window design using mechanical thermal contacts and sapphire is probably not practical. Cooling the window using mechanical thermal contacts produces thermal stresses in the sapphire that cause the window to crack. An insulated design using sapphire, that cools the window as little as possible, appears promising although some spectral data in the vacuum-ultra-violet (vuv) will be lost due to the high temperature reached by the sapphire. The surface of the insulated sapphire windows, tested at the 100% AFE heating rate, showed some slight ablation ($T_{melt}=3722$ °F), and cracks appeared in two of three test windows. One small group of cracks were obviously caused by mechanical binding of the window in the assembly, which can be eliminated with improved design. Other cracks were long, straight, thin crystallographic cracks that have very little effect on the optical transmission of the window. Also, the windows did not fall apart along these crystallographic cracks when the windows were removed from their assemblies. Theoretical results from the thermal analysis computer program SINDA indicate that increasing the window thickness from 4 to 8 mm may enable surface ablation to be avoided. An insulated design using a fused silica window tested at the nominal AFE heating rate experienced severe ablation ($T_{soften}=3029$ °F), thus fused silica is not considered to be an acceptable window material.

Background

The first test of a sapphire window at ARC was a design proposed by the Martin Marietta Astronautics Group (MMAG). This design featured a sapphire window brazed to a metallic holder. The window broke during a test in the 20 MW arcjet at ARC on June 28, 1989. This failure and the lack of significant progress by April of 1990, led to the initiation of a test program at ARC to find an acceptable window design.

The design concept selected by ARC for testing was a two window or "storm window" concept that uses one window in the heat shield to withstand the heating load from the shock layer during entry and a second window, located about 2 inches behind the first window, to protect the detectors from the thermal load transmitted through or around the first window. This design protects the vehicle under any reasonable condition, including complete window failure, and survival as a safety issue is not a major concern. However, the window must also survive as an optical element that transmits optical radiation to meet the science requirements of the mission. Thus, other concerns arise that include the loss of transmission in an unpredictable manner due to cracking or melting of the window, and in a predictable manner due to the change in window transmission with temperature.

Cracking of a window is an inherently random and unpredictable process and, in most cases, its impact on the quality of the data can not be assessed with any reasonable degree of certainty. Thus, a rational goal, if not a requirement, is that the window not crack during the AFE entry. This criterion was adopted in early tests to designate whether a window "passed" or "failed" a test. "Pass" in this case is defined to mean that the window does not crack. This is not an adequate evaluation of the test results in all cases, but it was the initial definition of window survival used during preliminary testing of sapphire and was maintained for consistency.

Another strongly desired goal is to measure the radiation from the vuv atomic N lines near 174.5 nm (ref.'s 1 and 2). This goal places a requirement on the window was that it transmit optical radiation at this wavelength as the window heats up during the entry.

The transmissions of a 1.0 mm thick sample of sapphire and a 2.0 mm thick sample of fused silica were measured at 174.5 nm in the laboratory as a function of temperature. The results of these measurements are shown in figures 1 and 2. Clearly, above a

temperature of about 800 °C for sapphire and 500 °C for fused silica the transmissions fall very rapidly to zero. The time along the AFE trajectory at which the vuv radiation reaches its maximum value is shown in figure 3 to be about 100 seconds (figure 3 is reproduced here from figure 16 in ref. 2.) Taking data to the 100 second point in the trajectory is strongly desired, which means that the window must stay cool or be cooled. Keeping the temperature of a fused silica window below 500 °C along the trajectory seems very improbable, and probably eliminates fused silica as a possible window material. Whereas, keeping the temperature of a sapphire window below 800 °C may be possible.

Conductive cooling of the window was included in the storm window concept, even though cooling the edge of a hot window places the edge in tension and sapphire, being a very brittle material, is likely to break with edge cooling only. Theoretical calculations indicated that the stress associated with edge cooling would be reduced substantially by also cooling the window through its rear surface. This step requires that a contact surface be placed against a portion of the rear surface of the window which, of course, will block a portion of the optical field-of-view. However, the field-of-view of the AFE radiometers was determined by the accuracy of the spacecraft to point at the sun for the solar calibration. This accuracy resulted in the actual field-of-view of the radiometers being about a factor of two more than needed to measure the shock layer radiation. Thus, heat path elements that block no more than 50% of the field-of-view, were placed behind, and in contact with, the window to draw heat out of its rear surface.

The design of the outer window in the storm window concept and its window assembly are shown on the far right in figure 4. The window edge is beveled across most of the edge at an angle of 20° from the window axis.

The window assembly is composed of three tubes. The outer tube provides a uniform and fixed region around the window that simplifies the task of mounting the window in the AFE vehicle. The hole required in the tile of the AFE vehicle can, thus, be a simple cylinder. The metal ring around the window also protects the window in case the tile recedes or chips during the actual entry. The middle, or restraining tube, contacts the window along the window bevel and holds the window in place against the inner tube assembly.

The inner, or support tube, holds the window with a backplate and spring assembly, which covers 50% of the window area, and provides the main heat path for conductively cooling the window, either from the window edge or backface. The backplate and spring assembly provides good flexibility for varying the heat paths from the window by changing the thermal contacts at the edge and the backface of the window. The thermal contacts can be varied by

changing the spring loading that holds the backplate against the window, the surface coating of the backplate, the material used to make the parts and by the insertion of shims of various thickness and material between the springs and the inner tube.

Previous to the exploratory arcjet tests reported herein, two other groups of tests were performed at ARC in order to become acquainted with the properties of sapphire. The first group of tests is referred to here as preliminary laboratory tests and the second as exploratory torch tests. These tests are described briefly before discussing the arcjet tests.

Preliminary Laboratory Tests

Preliminary laboratory tests of sapphire were conducted from June to September 1990, while the windows and window assemblies described above were being made. In these tests free-standing sapphire samples were tested in:

1. A carbon oven that could heat the sapphire to about 2000 °F at a rate comparable to the rate of temperature increase (30 °F/sec) expected during the AFE entry trajectory.
2. A "hot plate" rig that could heat a sapphire disk to about 1000 °F, while it was being cooled at its edge.
3. A hydrogen-oxygen torch that could apply a rapid thermal shock to the sapphire and impose a heating rate of about 18 W/cm², i.e., about 40% of the nominal AFE peak heating rate.

The results of these preliminary tests are summarized below:

1. Off-the-shelf r-plane sapphire looks promising:
 - a. Repeated heating to 1000 °C caused no apparent problems.
 - b. Simple thermal gradients did not crack sapphire.
2. Edge cooling can break windows easily.
3. Axial cooling should reduce stresses caused by edge cooling.
4. Transmission at 174.5 nm acceptable below 800 °C.

In brief, these results indicated that sapphire is a possible window material but that more realistic tests of actual window assemblies needed to be performed in order to develop window design criteria.

Exploratory Torch Tests

The exploratory torch tests were conducted in the hydrogen-oxygen torch from November 1990 to February 1991. The purposes of these tests were to check out ideas and evolve design concepts as much as possible before arcjet tests were made. The design configurations of the window and window assemblies for these tests are shown in figure 4. The configuration on the right is the full assembly as described earlier and is referred to as the "conductively cooled" window assembly.

The configuration on the left in figure 4 is a nearly free-standing window, achieved by placing the window in a piece of refractory tile. The window in this case is oriented upside down to avoid an excessive gap at the edge of the window where it is beveled and prevent possible unknown flow impingement effects. The configuration in the center of the figure is referred to as an "insulated" window assembly and is a reasonable approximation to the free-standing window. The backplate in this case is replaced by a silfrax spacer, to insulate the window from the inner tube, and the springs are not used. However, some cooling of the window still occurs through the silfrax spacer and through the restraining tube.

The results from the exploratory torch tests are summarized below and a narrative description of these tests is attached as Appendix A. A separate description of the c-plane window tests is attached as Appendix B.

1. Crystal orientation is important:
 - a. r-plane and a-plane parallel to window surface are acceptable.
 - b. c-plane parallel to window surface is not acceptable.
2. Mechanical binding can break windows:
 - a. Must cushion contact points.
 - b. Must allow generous room for parts to expand.
3. Axial cooling does reduce cracking caused by edge cooling.
4. Free-standing, insulated and conductively cooled windows survived 40% AFE peak heating rate.

In brief, sapphire windows with the crystallographic r-plane or a-plane oriented in the plane of the window seem to be the most promising, the c-plane orientation not being acceptable from a thermal shock point-of-view. Mechanical binding must be avoided and axial cooling helps reduce window cracking due to stresses induced by edge cooling, as expected. The necessity of avoiding mechanical binding led to the use of a 0.040 inch thick layer of alumina refractory paper between the restraining tube and the window to cushion contact points, and to a slightly smaller window diameter (0.639 instead of 0.669 inches) to provide more room for the thermal expansion of the assembly components. The mechanical binding might also have been prevented by increasing the taper on the windows from 20° to 30° or 40°, but this change would have required a new assembly design.

Arcjet Exploratory Tests

The purpose of the arcjet exploratory tests, which is the principal subject of this report, was to evaluate the suitability of sapphire and fused silica as window materials in a more realistic AFE entry environment. The tests were made in the aerodynamic leg of the 20 MW arcjet facility at ARC (ref. 3) from December 14, 1990 to March 6, 1991. In all, 29 tests were made. They are summarized in table 1, and briefly described in Appendix C. The alumina paper cushion (see figure 4) between the window and the restraining tube was used in all of the arcjet tests.

The last column in table 1, labeled "RESULT," gives a "pass" or "fail" evaluation to the test based on the simple criterion mentioned earlier, i.e., "pass" means that the window did not crack. In three of the tests this evaluation is followed by a question mark because the criterion is not considered adequate for these cases. The reasons for this inadequacy are discussed later.

The test fixture that held the window assembly during the arcjet tests is shown in figure 5. It is covered with a 1.25 inch thick layer of FRCI-12 tile (ref. 4) that has been coated with the RCG coating (ref. 5). The window assembly is located at the center of the fixture and two heat transfer gages are installed, one on either side of the assembly.

The surface temperature of the tile during an arcjet test increases rapidly and the emitted radiation quickly comes into radiative equilibrium with the imposed heating rate due to the hot gases in the shock layer. The tile temperature is measured by eight type R thermocouples (Pt/Pt-13%Rh) mounted under, and in contact with, the RCG coating on the tile surface. However, many of the thermocouples failed upon repeated use of the test fixture. In some tests the tile temperature in table 1 is noted by "na" as none of the thermocouples were still operational when the test was

made. The temperatures shown in the table are not precise values, but are, roughly, the average peak temperatures given by the thermocouples that were working when the tests were made. Type K thermocouples (chromel/alumel) were also attached to the inner support tube for some tests and a pattern of 5 type R thermocouples were attached to the backface of some sapphire windows to measure window temperatures.

All of the data recorded during each test are available from the RTF Branch at ARC. They are archived under test series AHF131 and the data from each test is specified as AHF131xxx.Dat, where xxx represents the arcjet run number listed in column 3 in table 1, i.e., for test number 22 the data file is AHF131037.Dat.

The arcjet heating pulse was controlled by the arcjet engineers (Wendell Love and Huy Tran) and operators (Fred Bear and Frank Custer) to simulate either the 100% AFE heating rate expected along the AFE entry trajectory or 80% of this rate. This was not a simple process for a powerful facility, designed for steady state operation. However, the results were very good, and greatly improved the value of the arcjet tests. The method used by the operators for controlling the arcjet is described in detail in Appendix D and discussed briefly in ref. 6.

The anticipated AFE heating rate profile for the AFE baseline-VA maximum heating rate trajectory (ref. 7) is shown in figure 6. The peak heating rate is shown to be about 52 Btu/sec/ft². Also shown in this figure, are two measured heating rate profiles generated by the operators, one at 80% (test 7) and one at 100% (test 22) of the AFE heating rate. The experimental heating rate curves were generated using the expression shown in the figure, which assumes radiative equilibrium with the applied heating rate, and the temperature recorded by the tile thermocouple that gave the highest temperature.

Figure 6 illustrates that the operators are able to simulate the AFE heating rate pulse with considerable skill, particularly on the first, or increasing heating, half of the cycle. The heating rate during the second half of the cycle was somewhat higher than the anticipated heating rate during the AFE entry. This resulted in the integrated heating rate over the pulse in the arcjet being somewhat greater than that expected during the actual AFE entry trajectory. The arcjet tests, therefore, may be a slightly severe test of the window. However, the actual entry weight of the AFE vehicle may be greater than the 4100 lbs. assumed for the baseline-VA trajectory, which would increase the heating rate expected over that shown in figure 6.

The initial heating rates, when the argon and then the air flows were first turned on, were step-like heating pulses, as noted in figure 6. The effect of these initial heating pulses on the windows were a concern and extra tests, discussed below, were included in the schedule to allow them to be evaluated.

The 80% AFE heating rate pulse was used in order to extend the life of the test fixture and allow several tests to be made with the three test fixtures available. The facility engineers advised us that the test fixture would probably be severely damaged after a single test at the 100% AFE heating rate, and this proved to be the case. However, test fixture number 3 was only slightly damaged during test 28 and was used again for test 29, allowing four tests at the higher heating rate. Although the tests at the 80% AFE heating rate were at a significantly lower heating rate than desired, they enabled new ideas to be explored and windows to be screened at a considerably higher heating rate than was possible to achieve in the torch tests.

The 29 tests made in the arcjet were distributed among four general kinds of tests as follows:

- | | |
|--|----------|
| 1. Initial arcjet start-up heat pulse | 5 tests |
| 2. Conductively cooled sapphire window | 10 tests |
| 3. Insulated window | 7 tests |
| 4. Thermal model (SINDA) | 7 tests |

The first three of these have been mentioned earlier; the fourth category, thermal model, was included to gather data to evaluate the ability of the SINDA (Systems Improved Numerical Differencing Analyzer) computer code (ref. 8) to predict the temperatures measured in the arcjet. The physical properties of the material used in the window assemblies are listed in Appendix E. For each property the values are printed in the order temperature1, value1, temperature2, value2, etc. Note that the surface catalysity of sapphire is not given. Thus, calculations based on these properties are for a noncatalytic sapphire window, which may not be accurate as sapphire may be catalytic.

Catalysity can be included in the calculations in an approximate manner by multiplying the applied heating rate by a factor that accounts for the additional heating due to atomic recombination on the surface. A factor of 1.4 for this effect is recommended by the ceramic test engineers in the RTM Branch at ARC to model a "fully" catalytic material from measurements for a noncatalytic material such as RCG. This is a "rule of thumb" value based on several years experience.

1. Initial arcjet start-up tests

The initial arcjet start-up tests are noted in table 1 by the words "start-up" in the comments column. These tests showed that the step-like heating pulses, that occurred when the arcjet was first turned on, had no noticeable effect on the windows.

2. Conductively cooled sapphire window tests

The conductively cooled window tests are noted in table 1 by either a Ti (titanium) or Mo (molybdenum) in the column labeled "SPRING", except for tests 5 and 6. Tests 5 and 6 were start-up tests, even though they were in the conductively cooled window assembly. Also note, that all conductively cooled tests were made at the 80% AFE heating rate only.

A cooled window configuration was found (test 20) that survived the 80% AFE heating rate, in that it didn't crack. However, an examination of the window and window assembly after the test indicated that the window had gotten much hotter than the 800 °C desired for a cooled window. Also, the tests indicated that, even at the 80% AFE heating rate, the window is very sensitive to the degree of cooling and to the ratio of edge to backface cooling. A slight change in the heat path can cause the window to break or to become too hot.

In brief, these tests showed that a conductively cooled window of the ARC design is probably not a practical design. The ARC window assembly design has good flexibility for testing components, but the degree of thermal contact doesn't appear to be repeatable or uniform. For example, the temperature of the inner (support) tube behind the window should be axisymmetric. However, an analysis of the thermocouple data, attached as Appendix F, shows that this was not the case.

An alternative window assembly design, proposed by the Martin Marietta Astronautics Group (MMAG) (ref. 9), may be more practical and is being evaluated. In the MMAG design the backplate is bonded directly to the window and to the support tube in order to improve the thermal path between the window and the support tube. The MMAG assembly should conduct the heat from the window into the support tube far more uniformly and repeatably than the ARC assembly, but its ability to cool the window without breaking it has not yet been demonstrated.

3. Insulated window tests

The insulated window tests are noted in table 1 by "None" in the column labeled "SPRING" and by the absence of thermocouples (TC's) noted in the "COMMENTS" column. Tests 1, 2 and 3 were in the insulated window assembly but were actually start-up tests. Only seven tests (numbers 4, 21-24, 28 and 29) were insulated window tests. Three of these seven were at 80% and four at 100% of the AFE heating rate.

All three of the insulated windows tested at the 80% AFE heating rate survived. Two of these were sapphire windows and one was with a fused silica window.

None of the four windows (three sapphire and one fused silica) tested at the 100% AFE heating rate survived unscathed, although the three sapphire windows came through the tests in reasonably good condition. However, all three showed some signs of surface ablation and two of them cracked. Figure 7 is a photograph of a portion of the window from test 22, showing melt lines on the surface and two perpendicular crystallographic cracks.

The fused silica window showed severe ablation in the 100% AFE heating rate test and as a result fused silica is not considered to be an acceptable window material for the AFE mission.

The time from the start of the tests to the point where ablation of the sapphire windows occurred was about 140 seconds in the two tests where the windows cracked. This time was measured from a video tape record of the tests. The presence of ablation is clearly evident in the video by the appearance of a small cloudy spot that moves around on the window. This spot was not seen in any tests where ablation did not occur.

Ablation was also detected in tests 28 and 29 by shining a laser beam on the window and observing the reflected spot on a piece of white paper. The time at which the spot "exploded" (became widely dispersed) was also taken as the time when ablation occurred. This time was recorded orally on the sound track of the video tape, and was very nearly the same as the time when ablation was first seen in the video. Unfortunately, a video tape was not made of the sapphire window test in which the window did not crack (test 28). The recollection of the observer watching the laser spot during these tests is that the time when ablation occurred during test 28 was similar to the other two tests.

The cracking of the sapphire windows during the 100% AFE heating rate tests was of two kinds: crystallographic cracks, which occurred in both of the windows that cracked; and complex cracks near the edge of one window. The window (test 29) with the group of complex cracks was found to be tightly bound in the window assembly after the window assembly was removed from the arcjet. The appearance of complex cracks in the earlier torch tests was indicative of cracks caused by mechanical binding. Thus, this group of cracks is believed to have been caused by mechanical binding in the window assembly, which may have been due to a defective part in the assembly or to improper assembly of the assembly. This kind of binding can be prevented.

The crystallographic cracks that occurred were long, straight, thin cracks that appeared to follow particular crystal planes. There were two sets of such cracks, each set orthogonal

to the other. Prof. Dick Bradt (Dean of the Mackay School of Mines, University of Nevada at Reno) examined windows from the earlier torch tests, noticed such orthogonal cracks in r-plane windows and described them as crystallographic cracks. The three sapphire windows tested at the 100% AFE heating rate were all r-plane windows, one did not crack. The window that has the small group of complex cracks (test 29) also has a number of the crystallographic cracks. The other window (test 22) has only two such cracks and they are orthogonal, see figure 7. These two cracks appear to originate at a flaw on the edge of the window, which is not visible in the figure. Thus, crystallographic cracks appear to be influenced by both surface finish and by mechanical stress.

The window (test 22) with only the two crystallographic cracks did not come apart when removed from the window assembly and, in fact, remained intact during and after vibration testing at the flight qualification level. The window (test 29) with the small group of binding cracks did come apart when removed from the window assembly, but only along the complex cracks. It did not appear to break along any of the crystallographic cracks. Further, any noticeable optical interference from the crystallographic cracks is small. These effects lead one to believe that crystallographic cracks may not have any significant effect on the optical performance of the window.

A summary of the results from these tests is given below:

1. Sapphire and fused silica windows survived the 80% AFE heating rate tests.
2. Three sapphire windows were tested at the 100% AFE heating rate:
 - a. All showed some signs of surface ablation ($T_{\text{melt}}=3722^{\circ}\text{F}$).
 - b. Time from start of test to ablation was about 140 seconds.
 - c. Two windows cracked:
 - (1) Both had long, straight, thin crystallographic cracks:
 - (a) Cracks held together after removal from the assembly.
 - (b) Optical path essentially unchanged by these cracks.
 - (2) One had a small group of complex cracks near one side of the window; probably caused by mechanical binding in the assembly.
3. The fused silica window tested at the 100% AFE heating rate showed severe ablation ($T_{\text{soften}}=3029^{\circ}\text{F}$).

A question mark is placed after the pass/fail evaluation in the "RESULT" column in table 1, for the three tests (22, 28 and

29) made using sapphire windows and tested at the 100% AFE heating rate. All of these windows, as noted above, show some signs of ablation and two of them cracked. However, rating them as pass or fail on the basis of cracking only is not adequate. These tests indicate that an insulated sapphire window is a very promising candidate for the AFE mission and point the way toward a new series of tests that will define the criteria for a successful window design.

4. Thermal model (SINDA) tests

Seven tests were made to get temperature data on insulated sapphire windows for comparison with results from the thermal model. These tests are noted in table 1 with "TC's" in the column labeled "COMMENTS," where TC's is used as an abbreviation for thermocouples. The thermocouples were mounted on the backface of the window with one thermocouple at the center of the window and four others equally spaced around the window and about halfway between the edge and the center of the window.

The thermocouples on the first window to which thermocouples were attached (tests 11-13), were mounted with rather large and uneven spots of refractory cement. The data from these tests may have been influenced by these spots. The thermocouples on the remaining windows were mounted with great care by personnel from the ARC machine shop (Richard Piquette and Jim Vaccaro).

All thermal model tests were made at or near the 80% AFE heating rate. Also, all but one window tested had a thickness of 4 mm. The one exception was a window whose thickness was 6 mm. The purpose of this test was to test the ability of the thermal model to predict temperature trends with window thickness.

The window temperatures at the center of the backface from test 19 are shown in figure 8. The window in this case is a c-plane window which cracked during the test. However, neither the crack nor the crystal orientation is believed to affect the window temperature significantly. The prediction of the temperature at the center of the backface given by the thermal model is also shown in the figure. Unfortunately, the tile temperature for this test was not recorded because the thermocouples in the tile on the test fixture had failed earlier. The thermal model in this case is based on the heating rate given by the tile temperatures measured during test 7, which had the highest tile temperatures measured for the 80% AFE tests. The temperatures predicted by the thermal model, even with this highest heating rate, are shown in figure 8 to be lower than the measured values, by about 200 °F at the peak temperature.

This result, that the thermal model gives lower temperatures than the measured values, at least for sapphire, is also evident from tests at the 100% AFE heating rate, where the surface of the

sapphire window ablated. Figure 9 shows the temperatures predicted by the thermal model, at the center of the front face of the sapphire window, for test 22. Ablation began during this test approximately 140 seconds after the test began, thus the experimental temperature at this point is 3722 °F, the melting point of sapphire. The thermal model, however, only predicts a temperature of about 2750 °F at this point. This result casts serious doubt on the physical properties of sapphire that are used in the thermal model.

The physical properties of sapphire at temperatures above 2000 °F are not well known, particularly the surface catalysity and the emissivity. By arbitrarily increasing the heating rate, as an adjustment for catalysity, or lowering the emissivity the thermal model can give results that agree better with the experimental data. For example, by multiplying the heating rate by a factor of 1.6 the temperature of the window front face, shown by the solid curve in figure 9, is about 3700 °F at 140 seconds, in good agreement with the data. In contrast, setting the emissivity of sapphire above 2000 °F to the limiting value of zero, the predicted temperature at the 140 second point is still about 200 °F too low. Thus, lowering the emissivity at high temperatures can not, by itself, account for the difference between the experimental and predicted values. However, neither of the changes shown in figure 9 may be realistic, and some combination of them may be a better choice.

Test 26 was conducted to impose a step function heating pulse to the window, which is better defined and easier to control than that of a simulated trajectory heating profile. The arcjet for this test was brought up to 80% of the peak AFE heating rate with the window out of the air stream. Then the window was translated into the airstream, held there for about 60 seconds and translated out of the flow. The thermal shock and gradients imposed on the window as it entered the airstream did not appear to affect the window in any way. The measured and predicted temperatures at the center of the backface of the window are shown in figure 10. Again, the predicted temperatures from the thermal model are lower than the measured values. An analysis of this test is attached as Appendix G, which also shows that the temperature difference seen here can be accounted for by using a high value for the catalysity of sapphire.

Test 25 was made to assess the effect of window thickness on window temperature. The window for this test was 6 mm thick compared to 4 mm for all other tests, i.e., a 50% increase in thickness. The effect of window thickness on the window temperatures is shown in figure 11. Here the measured temperatures at the center of the backface of the window from tests 25 and 19 are compared. Although the test conditions are not exactly reproducible from test to test they are believed to be close enough to make such a comparison useful. These data show

that in this case increasing the window thickness from 4 mm to 6 mm caused the peak temperature to drop by about 340 °F and the time to the peak temperature to increase by about 20 seconds.

The predictions for tests 19 and 25 given by the thermal model are shown in figure 12. The predicted temperatures are again lower than the measured values, shown in figure 11, but the change in the peak temperature (-390 °F) and the change in the time to peak temperature (+45 seconds) are in reasonable agreement with the measured values.

The result above indicates that the temperature trends from the thermal model are fairly reliable even though the actual temperatures are somewhat low. This result can be used to estimate the effect that window thickness might have on window ablation.

The possibility of avoiding window ablation by using a thicker window is illustrated in figure 13. Here the front face temperatures given by the thermal model, using a modified heating rate for the AFE entry, are shown for 4 mm and 8 mm thick sapphire windows. The heating rate used in these calculations did not include the radiative heating portion of the total heating and multiplied the convective heating rate by a factor of 1.6. The radiative heating was not included because sapphire is nearly transparent to the shock layer radiation, and the factor of 1.6 was applied to the convective rate to be consistent with the result shown in figure 9.

The results from the thermal model, shown in figure 13, indicate that the maximum temperature reached by the 4 mm thick window is close to, and thus in reality may exceed, the melting temperature of sapphire. Doubling the window thickness to 8 mm, however, should lower the maximum temperature by nearly 400 °F. This result, if true, would reduce substantially, and might avoid completely, ablation.

Conclusions

1. Sapphire can withstand the severe AFE entry environment.
2. Conductively cooled sapphire windows that keep the temperature below 800 °C for 100 seconds may not be practical.
3. Insulated sapphire windows look promising but:
 - a. Some vuv data will be lost before the 100 second point because the sapphire will get very hot.
 - b. The window assembly must prevent mechanical binding of the window from occurring.
 - c. Some, apparently benign, crystallographic cracks may be present.
 - d. Methods for reducing or avoiding ablation need to be investigated, making the window thicker is an attractive possibility.
4. Insulated fused silica windows are not acceptable because of the severe ablation present at the 100% AFE heating rate.
5. The SINDA thermal model gives reasonable trends in the temperature of sapphire, but absolute temperatures are not in good agreement with experiment.

References

1. Giuseppe Palumbo: Shock Layer Vacuum uv Spectroscopy in an Arcjet Wind Tunnel. NASA TM-102258, 1989.
2. Ellis E. Whiting and Chul Park: Radiative Heating at the Stagnation Point of the AFE Vehicle. NASA TM-102829, 1990.
3. 20 MW arcjet facility reference???
4. Daniel B. Leiser, Marnell Smith and Howard E. Goldstein: Developments in Fibrous Refractory Composite Insulation. American Ceramic Society Bulletin, Vol. 60, No. 11, 1201-1204, November 1981.
5. Howard E. Goldstein, Daniel B. Leiser and V. Katvala: Reaction Cured Borosilicate Glass Coating for Low-Density Fibrous Silica Insulation. Borate Glasses; Structure Properties, Application; Materials Science Research, Vol. 12, 623-634, Plenum Press, NY, 1978.
6. Imelda Terrazas-Salinas and Roger A. Craig; Simulation of the AFE Mission Heating in an Arcjet Wind Tunnel. ISA Paper 89-0049, May 1989.
7. AFE Aerobrake Aerothermodynamic Data Book for Baseline V Trajectory, Vol. III; Baseline VA Heating Environments Along Pitch Plane. JSC-23623, October 1990.
8. SINDA computer code at Ames Research Center as used by Scott Maa.
9. RHARE Program Status Review for Robert Morris April 10, 1991. Copy in files saved by Charles Sobeck at ARC.

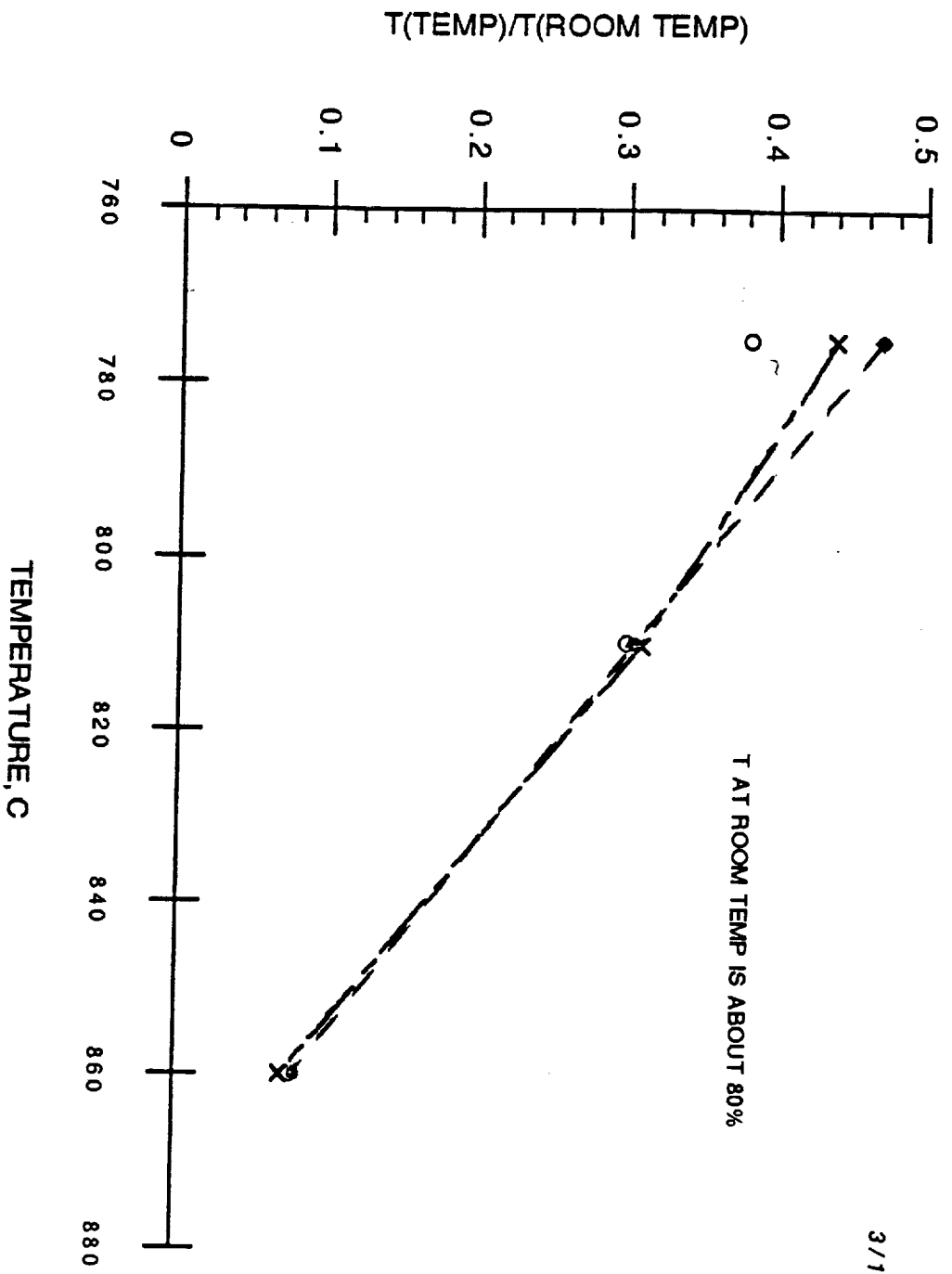

T AT ROOM TEMP IS ABOUT 80%

3/18/90

Figure 1. Transmission of 2 mm thick sapphire window at 174.5 nm as a function of temperature.

5/7/90

HBT Quartz T @ 1742A

Correcting for background
electronic zero.

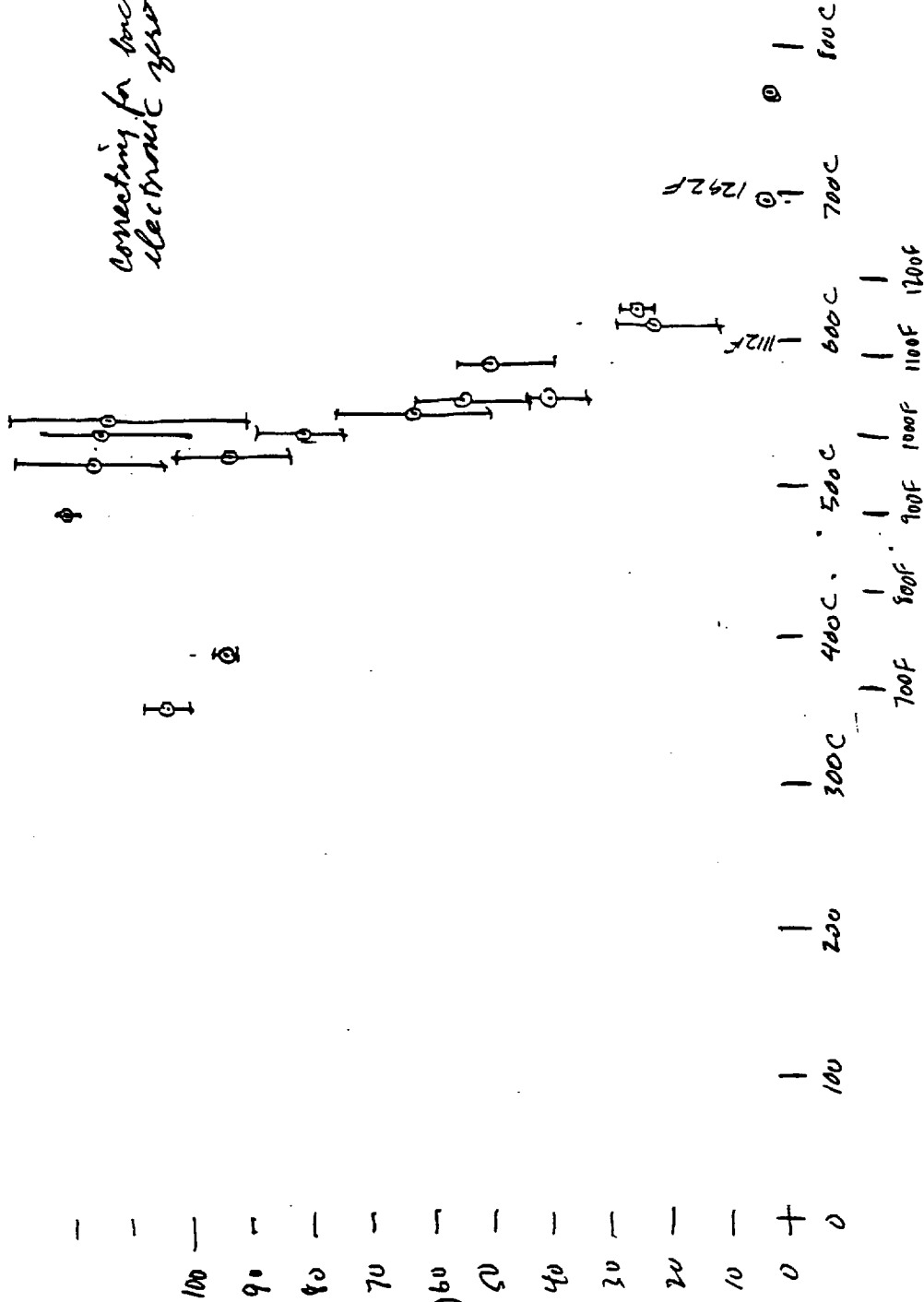

Figure 2. Transmission of 2.0 mm thick sample of fused silica at 174.2 nm as a function of temperature.

5/8/90

I/I_0

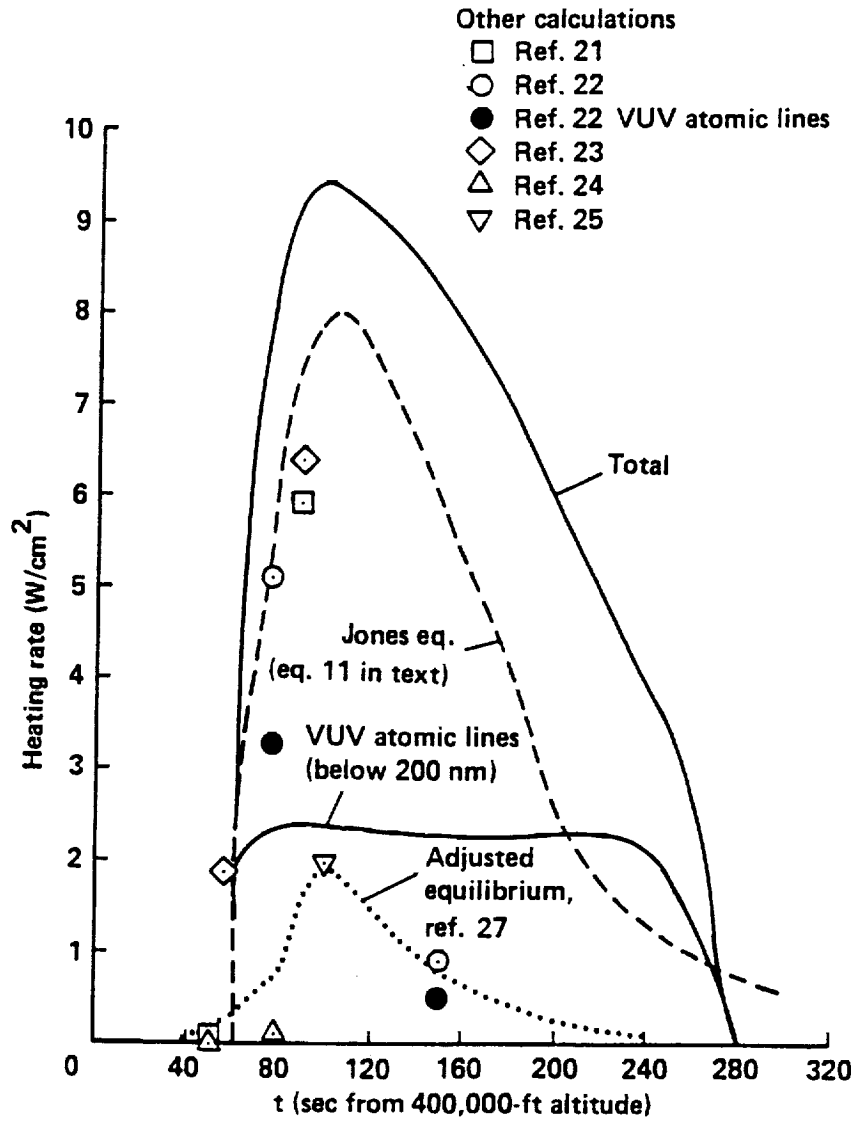
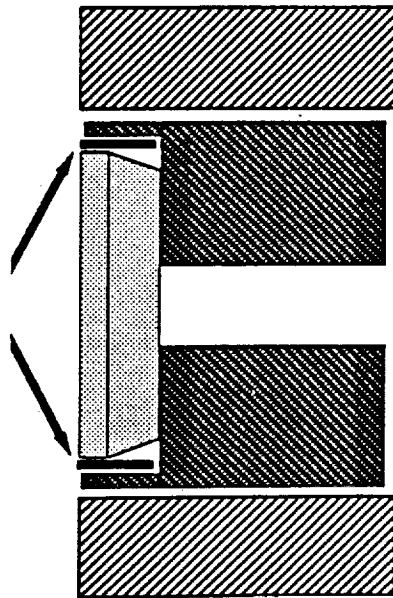

Figure 3 . Radiative heating rates at the stagnation point of the AFE vehicle, along the baseline-5 trajectory.

Gap Filler



FRCI-12 Tile

Silfrax Spacer

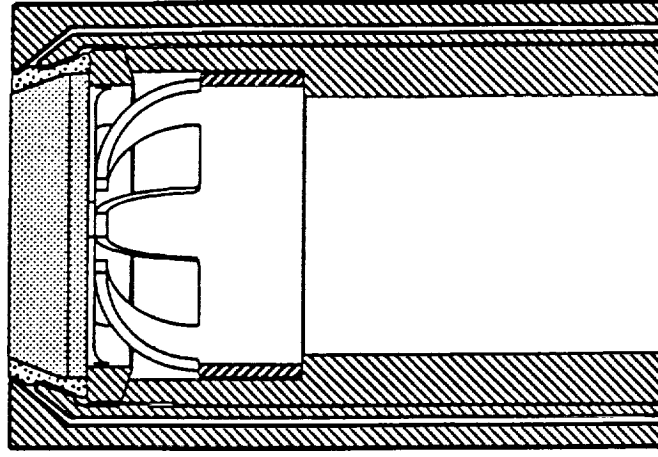
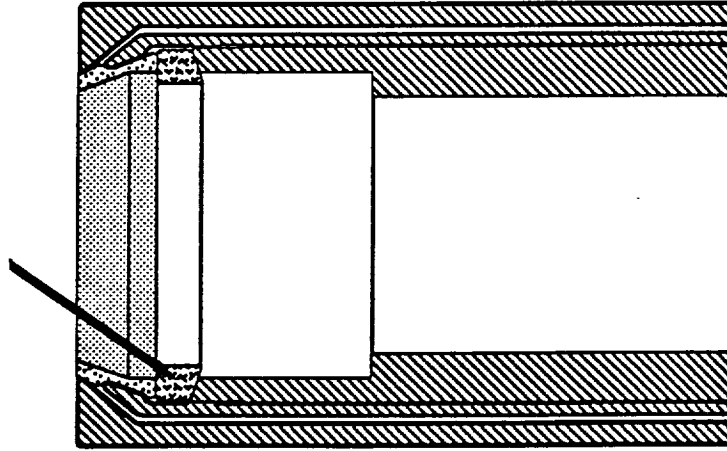

Free Standing

Insulated

Conductively
Cooled

Figure 4. Sketches of the ARC window assemblies tested in either the 20 arcjet and/or the hydrogen-oxygen torch at ARC.

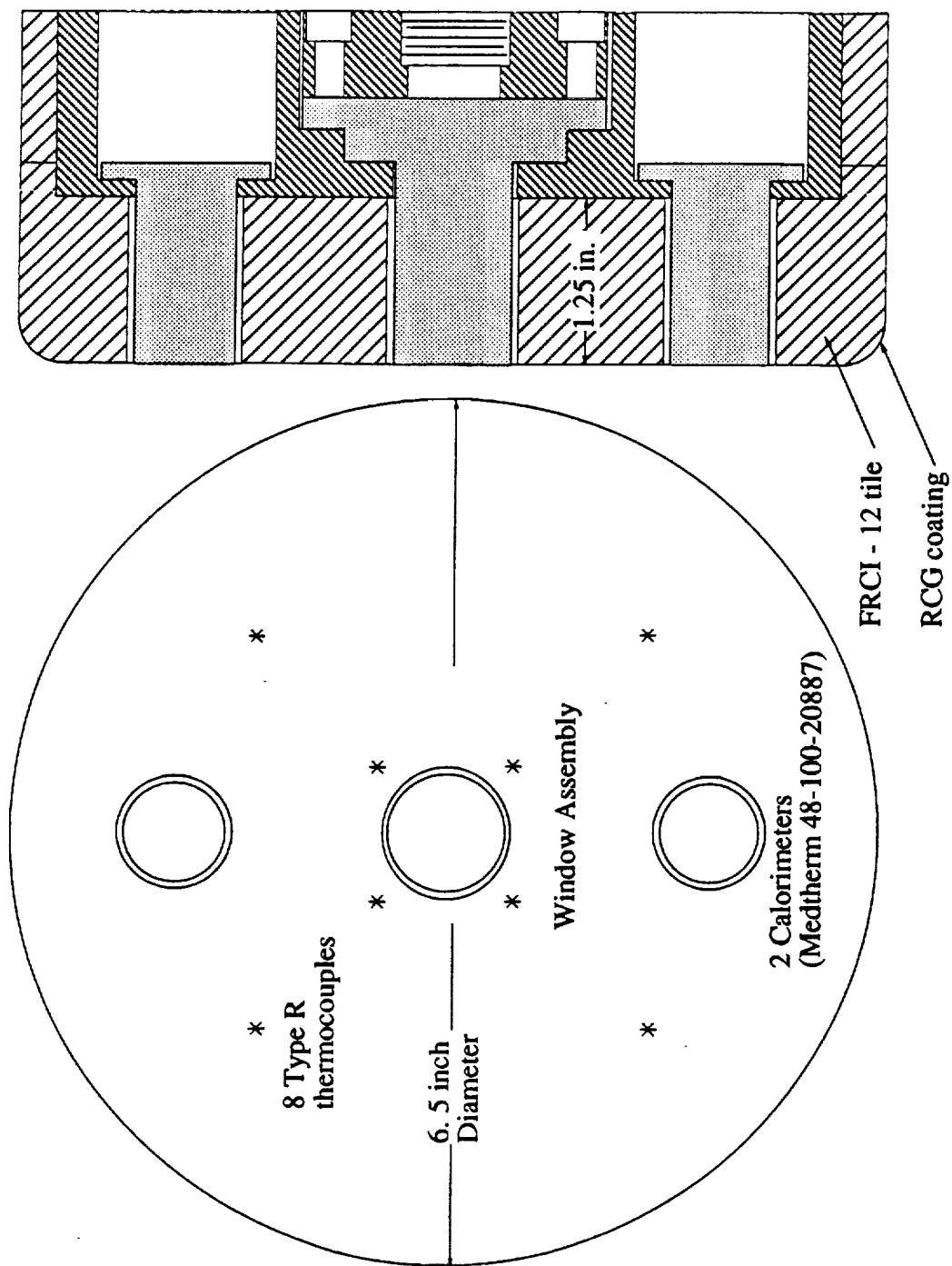

Figure 5. Test fixture used to support window assembly in the 20MW arcjet tests.

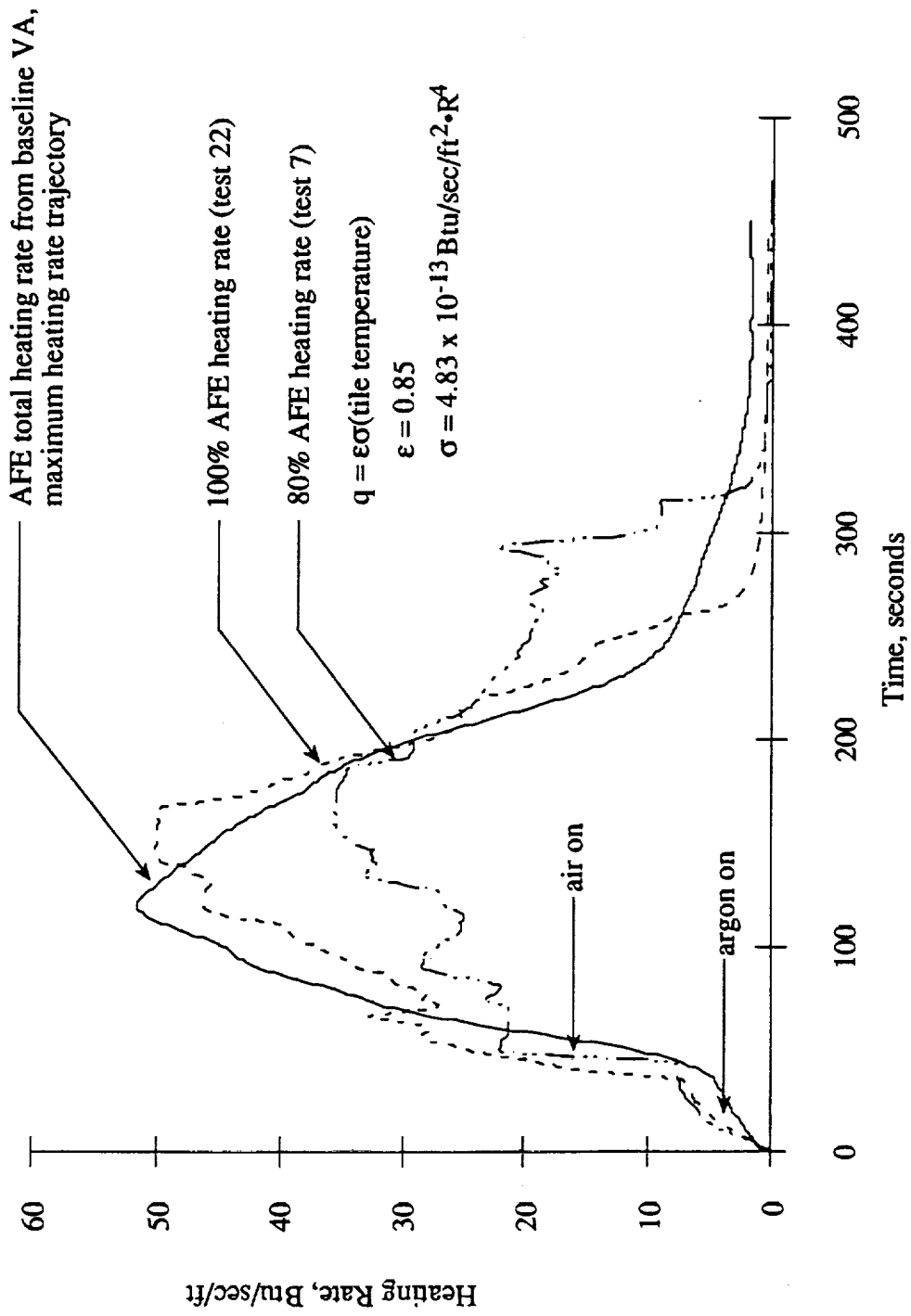

Figure 6. Expected AFE total heating rate profile and measured heating rates (from tile temperature) to simulate an 80% and a 100% AFE profile.



Surface melt (ablation) and 2 perpendicular long, straight, thin crystallographic cracks.

Figure 7. Photograph of sapphire window after test number 22, at the 100 AFE heating rate.

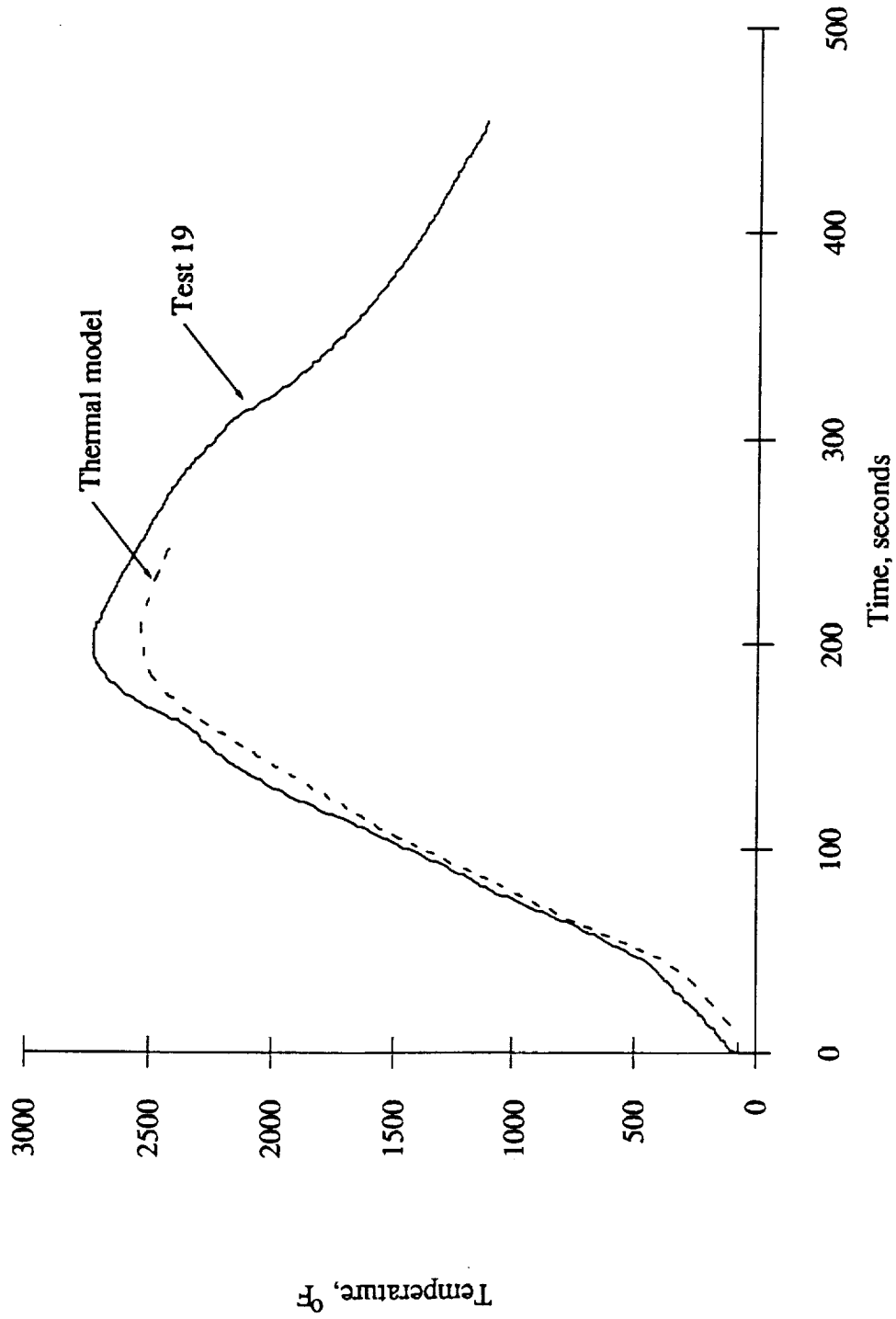

Figure 8. Comparison of measured and predicted temperatures at center of window backface; sapphire window; 80% AFE heating rate.

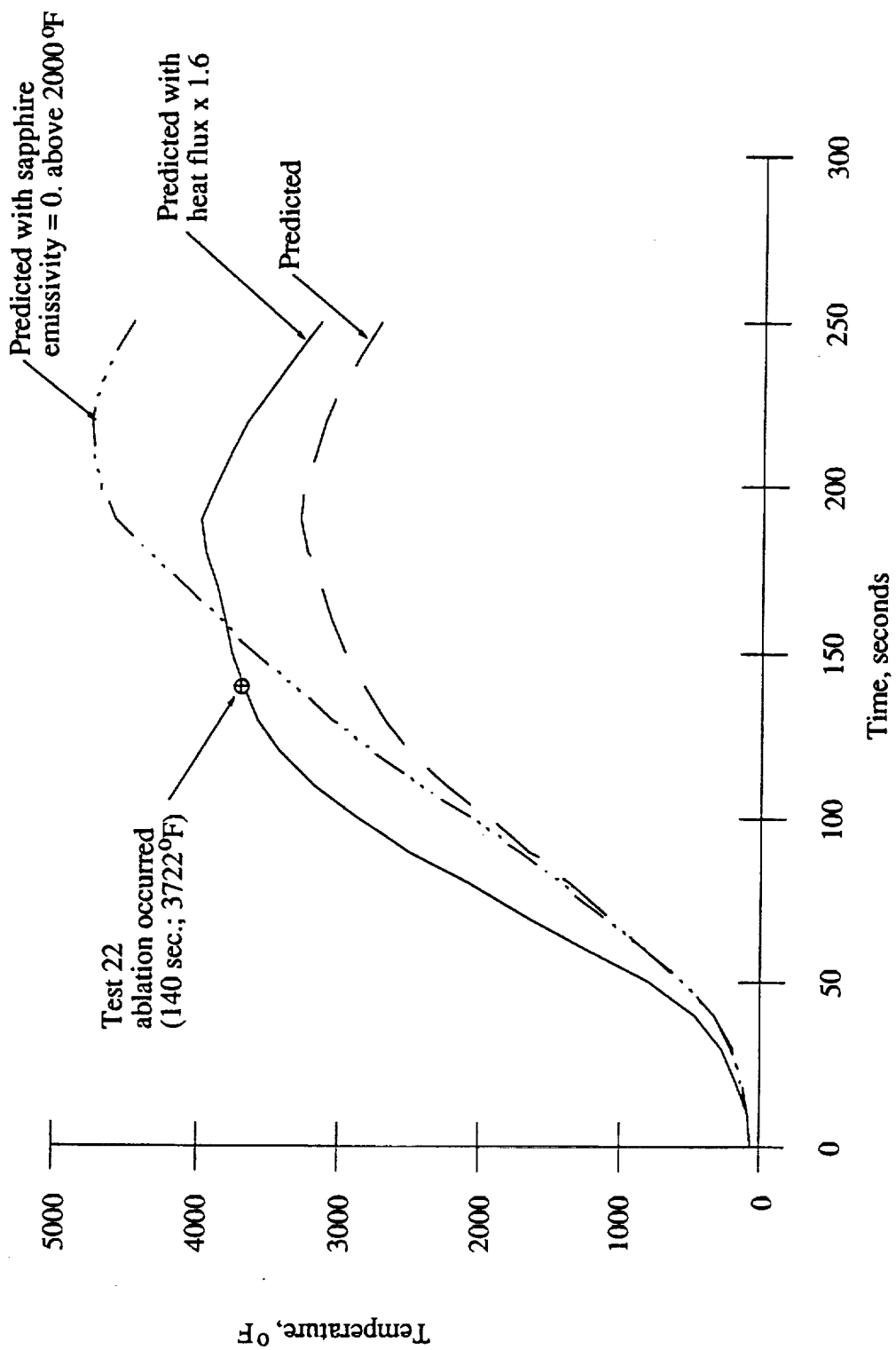

Figure 9. Comparison of predicted temperatures at the center of the front face of the window with the ablation point; sapphire window; 100% AFE heating.

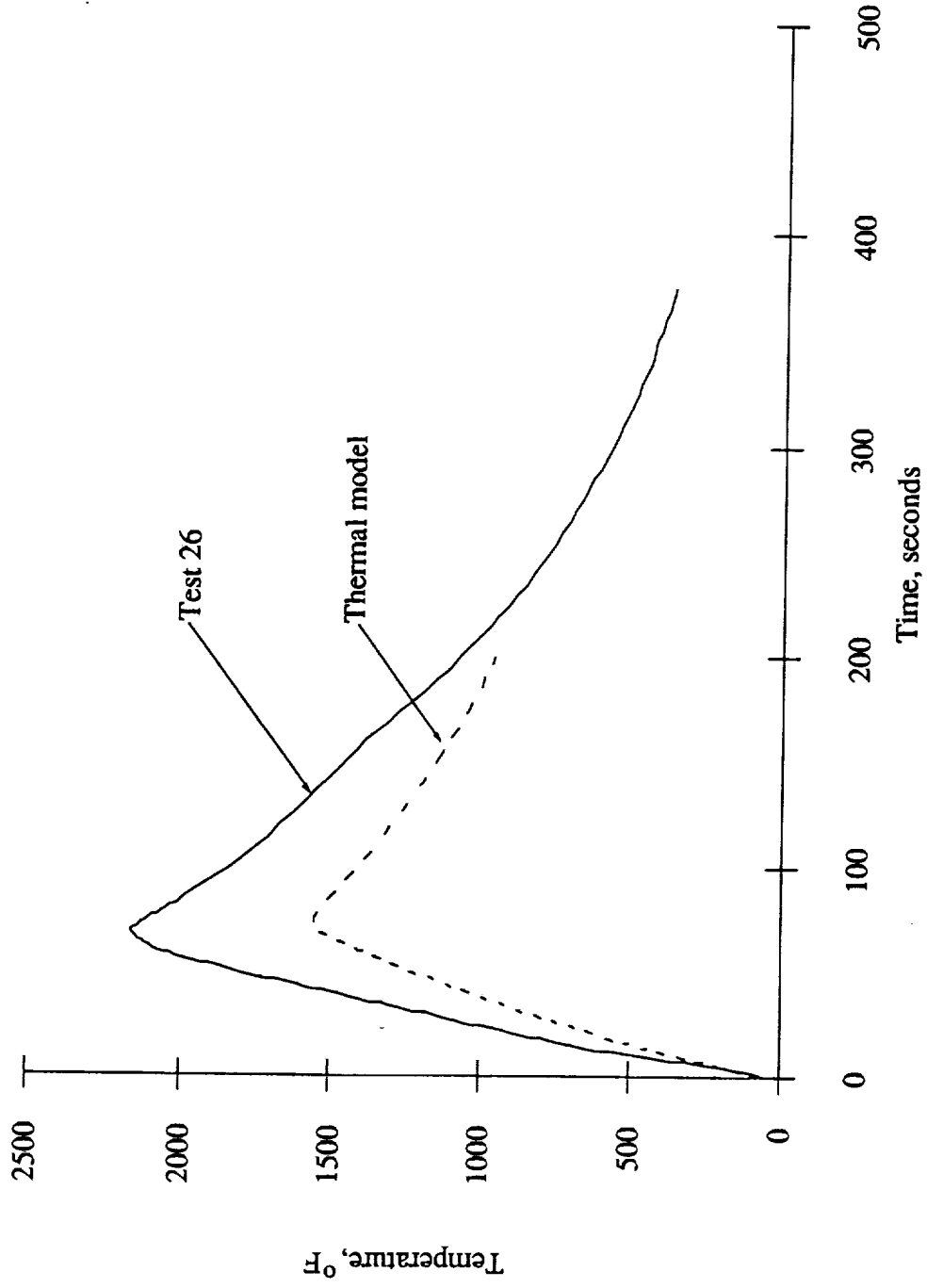

Figure 10. Comparison of measured and predicted temperatures at center of window backface; sapphire window; translated test; 80% AFE maximum heating.

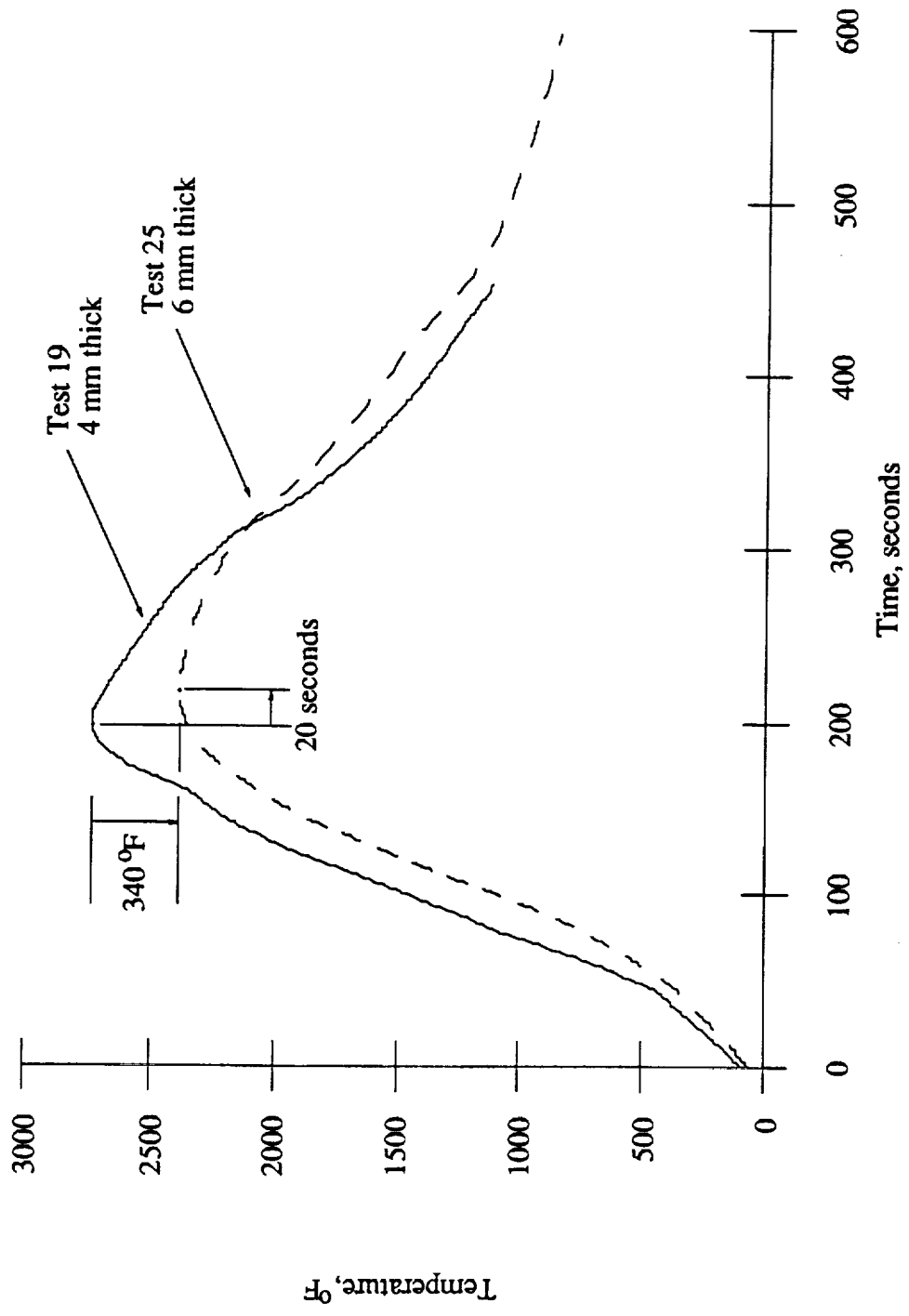

Figure 11. Measured temperature at center of window backface; sapphire window; 80% AFE heating rate.

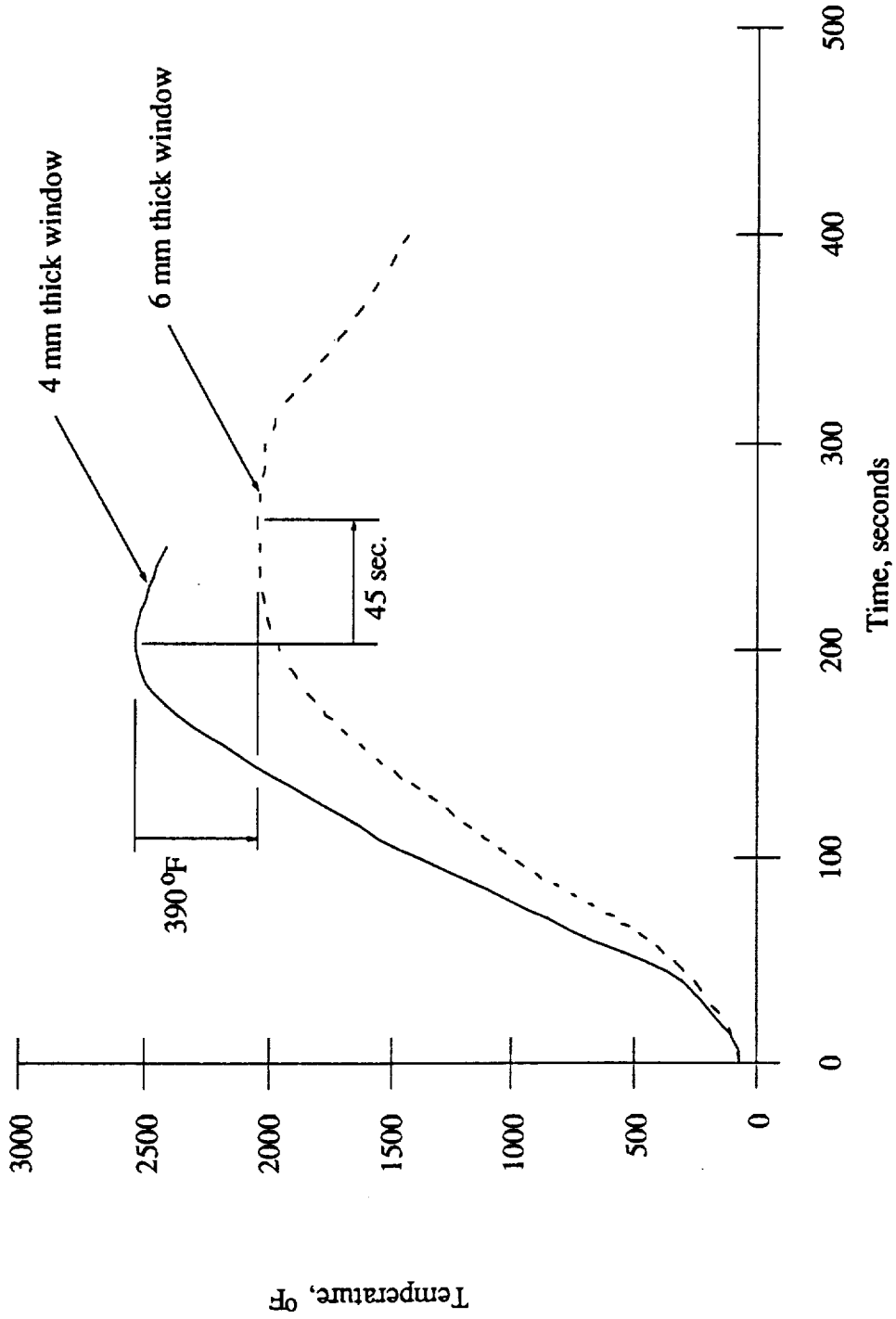

Figure 12. Calculated temperature at center of window backface; sapphire window; 80% AFE heating rate.

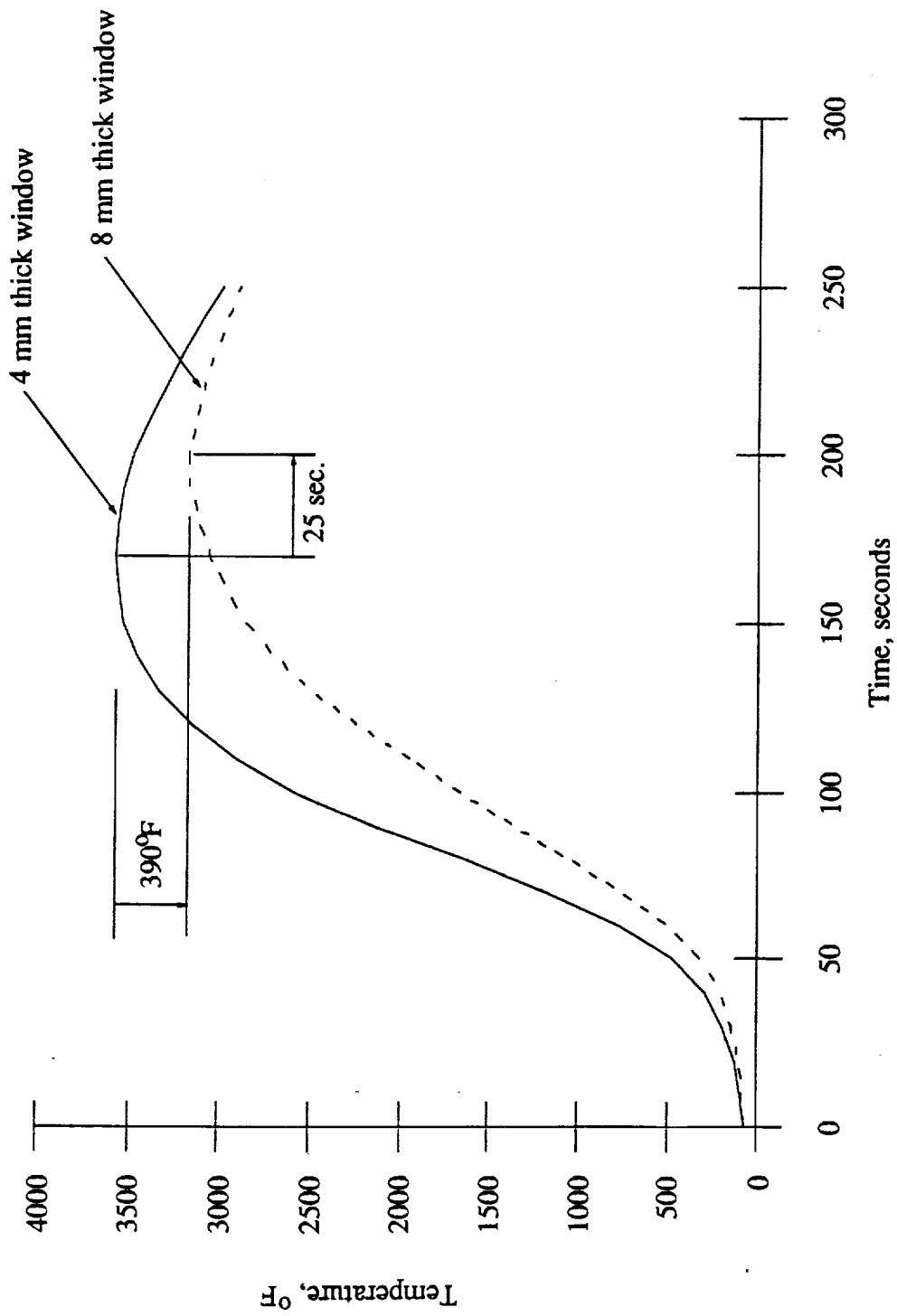

Figure 13. Predicted change in the maximum temperature at the center of the front face of a sapphire window during the AFE entry by changing the window thickness from 4 mm to 8 mm.

Appendix A

Final Torch Test Report

Louis J. Salerno

**AEROASSIST FLIGHT EXPERIMENT
Ames Research Center**

Final Torch Test Report

This report summarizes all torch testing performed at ARC related to the Ames window design. The windows were obtained from various sources. Sapphire windows were of Crystal Systems and Union Carbide manufacture, while the quartz windows were Heraeus Suprasil. Table 1 summarizes the testing described in this report.

A total of 22 windows were tested in 53 tests over 7 months, including 7 a-plane, 6 c-plane, 7 r-plane, and 2 quartz.

Several categories of tests were performed, with different objectives in mind. The test categories explored the importance of axis orientation, cooling efficiency and induced thermal stresses, thermal and mechanical isolation, and acquired data for analytical model validation.

It was concluded that, at the heating levels experienced in the torch, heat could be effectively removed from the window without inducing unacceptable thermal stresses. Higher heating rates, in the arc-jet, are necessary to determine if this conclusion could be extrapolated to the flight conditions. With this in mind, there is no further appreciable value in continuing torch testing of the ARC design.

A description of general information regarding the test setup, equipment used, etc. is provided, followed by more specific information pertinent to individual results.

INTRODUCTION

The torch testing was initiated to proof test a sapphire window assembly design and assess its performance in a complex heating environment prior to committing to arc-jet testing, however the test became an important discriminator of potential window configurations. Over 7 months, 53 tests were run with a variety of window materials and assembly configurations. Our understanding of the problem and potential solutions improved as more experience was gathered regarding material selection and test configuration, with the result that at this point, the torch is no longer useful for screening test articles.

A schematic of the torch test is shown in Figure 1. Conditions selected for testing were a nominal rate heat application as well as twice the nominal rate and a maximum rate. The nominal rate represented a tile surface temperature increase of 30° F/second up to a maximum temperature on the order of 2000° F.

Testing included both free-standing windows and various window assembly configurations. Each series of tests served a different purpose. The primary test configurations were the free-standing window and the conductively cooled cases. The free-standing window tests were performed to evaluate the suitability of the window material from an inherent survivability viewpoint. Tests performed with the complete assembly explored the parameters important for a window cooled by conductively removing heat from the back surface. (A window temperature below 800° C is necessary for transmission of the vacuum ultraviolet radiation.) Tests performed with other configurations assessed survivability of the window in a thermally insulated mode, and provided window backface temperature data from thermocouples cemented on the rear surface of the window to aid in the verification of analytical models.

Several windows had undergone screening, i.e. visual, binocular, and metallographic inspections by Code E prior to being delivered to the test cache. These inspections are described in detail, however, no correlation was ever established between pre-test window inspections and subsequent test results, and these inspections have now been discontinued.

The visual inspection consisted of examination with the naked eye under normal room lighting, both looking toward and away from the source of light. The windows were rotated and tilted through a variety of angles as they are examined. This procedure highlights the general condition of the window and brings attention to any irregularities. The windows were next examined using a low power binocular microscope at magnifications of 25x and 50x. Again, the windows were manipulated by hand and rotated and tilted through a variety of angles to enhance the visibility of imperfections. A final examination was made using a metallograph at a magnification of 100x. The metallograph incorporates a precision stage with X-Y movement and a framed image window. The sapphire was moved one image frame at a time until the entire surface had been scanned. Particular attention was given to previously identified imperfections. At each image frame location, the focus point of the metallograph was adjusted from one surface to the other and then back such that the interior of the window is examined. All cracks, voids, and significant surface imperfections were photographed and their position in the sapphire recorded.

TEST DESCRIPTION

Test apparatus included the following:

Hydrogen-oxygen torch
Pyrometer Instrument Co. Model 901 Optical Pyrometer
2 Cole-Parmer Model 8373-30 Chart Recorders
Instrumented Window Assembly Holder (Tile)
Heating Rate Control Carriage
Questar Telescope
Video Camera-Panasonic AFX8 S-VHS Omni Movie HQ

Test Settings:

Torch	Regulator	Flowmeter
Hydrogen	15 psi	140 lit/min
Oxygen	20 psi	100 lit/min

Chart Recorders--20mV amplitude, 5 cm/min speed

Test Article:

One of three test configurations was used. The configurations are shown in Figure 2. The free-standing configuration consists of the window mounted into a plug of FRCI-12 tile material. The space between the window and the plug is filled with a gap filler. The isolated configuration consists of the window installed in the assembly with a Silfrax spacer isolating the window from the inner tube. Alumina paper is employed between the window and the restraining tube. Finally, the cooled assembly is a full configuration with backplate and window spring.

Test Procedure:

Water on
Oxygen tank valve opened
Hydrogen tank valve opened
Oxygen regulator adjusted
Hydrogen regulator adjusted
Torch lit
Chart Recorders on
Test article moved into flame
At maximum temperature position, pyrometer read
Test article moved out of flame
Torch extinguished
Oxygen tank valve closed
Hydrogen tank valve closed
Water off
End of test

TEST RESULTS AND DISCUSSION

A total of 22 windows were tested in 53 tests over 7 months, including 7 a-plane, 6 c-plane, 7 r-plane, and 2 quartz.

Several categories of tests were performed, with different objectives in mind. The test categories explored the importance of axis orientation, cooling efficiency and induced thermal stresses, thermal and mechanical isolation, and acquired data for analytical model validation.

Axis Orientation

First, the effect of sapphire crystal axis orientation was investigated by testing windows with different orientations under the same conditions. The details of c-plane window testing has been covered in a previous report. Originally, it was our understanding that c-plane material would best serve our purpose, since available data indicated that c-plane material demonstrated the highest strength (fracture toughness) at room temperature of a-, c-, m-, or r-plane material. As the result of reviewing additional reference material, it was learned that at elevated temperatures, in the region of our interest, the c-plane actually exhibits a severe degradation in strength. At this point, a-plane material was ordered, shaped to our specifications. While awaiting delivery, window testing revealed that the c-plane material was unsuitable for our application, 2 of 3 windows having broken when tested in the free-standing mode (As a comparison, 7 of 7 a-plane windows later tested in the free-standing mode survived). Further testing of previously obtained material of unknown axis orientation (later determined to be r-plane) and discussion with outside researchers substantiated the unsuitability of c-plane material and pointed to r-plane material as a candidate. Although 2 of 7 r-plane windows failed when tested in the free-standing mode, the two failures occurred as the result of the windows being subjected to extreme off-axis heating applied to explore the material limits. In these cases, flow impingement on the edges caused the failures. It should be noted that this condition was not considered representative of flight. Other than these two, no r-plane window, either free-standing or in an assembly, ever failed regardless of the assembly configuration, leading to the selection of the r-plane material as the material of choice. This success spanned a total of 21 separate tests.

Both of the quartz windows survived the free-standing tests, a result which was anticipated.

Cooling

Next, the effect of cooling the window was investigated. The candidate windows were placed in an assembly containing a backplate flush with the rear window surface. The backplate was held in place by a spring which was mounted against a shoulder on the inner tube of the assembly, the objective being that the spring would ensure contact between the window and backplate, and would conduct heat away from the center of the window to balance against the heat being removed from the edges. The window would hopefully thus remain cool enough ($< 800^{\circ}\text{C}$) to transmit the vacuum ultraviolet. Variations on this configuration examined the effects of gold-coating the backplate, and of using different spring materials (titanium vs. molybdenum). Tests resulted in the survival of, over 6 tests, 2 of 3 a-plane and 1 of 1 r-plane windows, whereas 2 of 2 c-plane windows failed.

Thermal/Mechanical Isolation

The thermally/ mechanically isolated series of tests were performed to assess the survivability of uncooled windows in an assembly. This configuration represents a near-free-standing design which is believed to be flyable. Both r-plane windows tested survived. Of the a-plane windows tested, 3 of 5 windows tested failed, although the consensus is that these failures were caused by mechanical binding of the window. These failures, although not conclusive, raised concern regarding the suitability of a-plane material to perform in an uncooled environment, and emphasized the need to ensure mechanical clearances.

Analytical Model Validation

Finally, tests were performed to validate analytical models developed for prediction of window design performance. Windows were tested in both the full and thermally/mechanically isolated assemblies with thermocouples attached to the back surface. The inner tube was instrumented with six thermocouples to measure the circumferential uniformity of heat removal and to verify the total heat removed during the test. Based on the results of temperature profiles obtained, the conclusion was reached that heat could be efficiently extracted from the window with the ARC design (1350°F and 1800°F with and without the backplate, respectively).

CONCLUSIONS:

At the outset, c-plane windows were selected on the basis of available data indicating that the c-plane demonstrated the highest strength (fracture toughness) at room temperature. Discussion with other researchers suggested that at elevated temperatures in the region of our interest, the c-plane actually exhibits a degradation in strength. Our torch test experience supports the view that the a- and r-plane windows have superior strength with the r-plane being superior.

Quartz was proof-tested to verify inherent material survivability only. As was expected, this was straight-forward, and no further tests were performed.

Based on the number of failures experienced with the a-plane windows, and the 100% survival rate of the r-plane windows tested, the r-plane material has been selected as the material of choice.

It was concluded that, at the heating levels experienced in the torch, heat could be effectively removed from the window without inducing unacceptable thermal stresses. Higher heating rates, in the arc-jet, are necessary to determine if this conclusion could be extrapolated to the flight conditions. With this in mind, there is no further appreciable value in continuing torch testing of the ARC design.

SAPPHIRE WINDOW TORCH TESTS

WINDOW	MFG	DATE REC	PLANE	F - S		OA		TESTS						COMMENTS		
				F	S	F	S	T/M	ISO	ISO	ISO	BCK	PLT			
				F	D	M	F	D	M	F	D	M	F	D	M	
FS-01	??	6/22/90	R	P	P	P	P	P	F*							Multiple Tests
FS-02	??	6/22/90	R	P	P	P	P	P	P							Multiple Tests
FS-03	??	6/22/90	R	P	P	P	P	P	F*							*F-Failed due to
FS-04	??	6/22/90	R	P	P	P	P	P	P	P						flow impingement
FS-05	??	6/22/90	R	P	P	P	P	P	P	P						on edge
CSS-02	CS	9/5/90	C											F		
CSS-04	CS	9/5/90	C	P	P	P					F					
CSS-06	CS	9/5/90	C	F												
UCS-06	UC	9/5/90	C	F												
AA-01	CS	11/30/90	A	P	P	P				P				F		Fngrs not touching wndw
AA-02	CS	11/30/90	A	-	-	-				F						1/2 thck alum paper
AA-03	CS	11/30/90	A							F						
AA-04	CS	11/30/90	A	P	P	P				P	P					
AA-05	CS	11/30/90	A							F						
AC-01	CS	11/30/90	C											F		TC mounted on wndw
AC-02	CS	11/30/90	C							P						TC mounted on wndw
FA-01	CS	12/17/90	A													
FA-02	CS	12/17/90	A											P		
UR-01	CS	12/18/90	R													Turned down to 0.653"
UR-02	CS	12/18/90	R											P		Turned down to 0.653"
QN-01	HE	1/31/91	N/A	P	P	P										Nominal size quartz window
QN-02	HE	1/31/91	N/A	P	P	P										Nominal size quartz window-pol edge

CS-Crystal Systems UC-Union Carbide He-Heraeus

P-Pass F-Fail

TABLE 1. ARC TEST SUMMARY

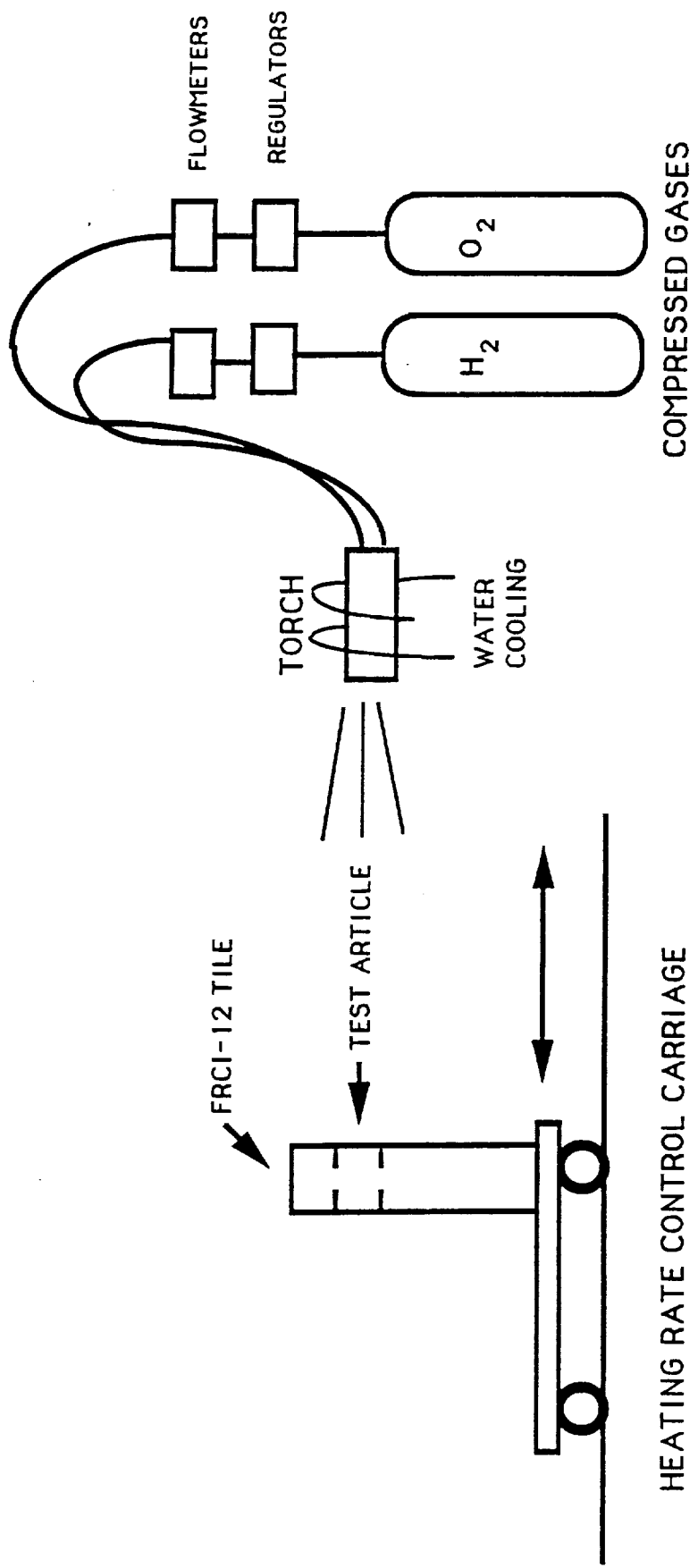
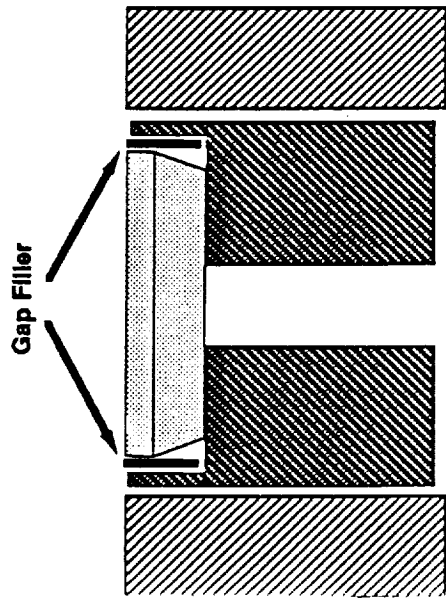
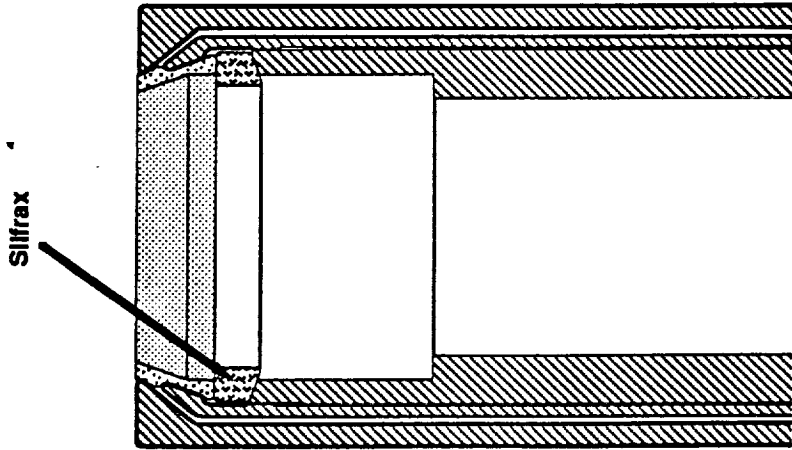

FIGURE 1. TORCH TEST SCHEMATIC



FRCI-12 Tile Assembly



ISOLATED ASSEMBLY

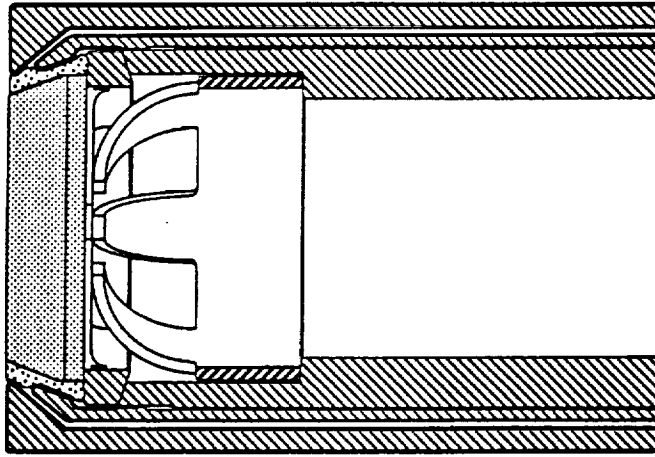

COOLED ASSEMBLY

FREE STANDING ASSEMBLY

FIGURE 2. TEST ARTICLE CONFIGURATION

Appendix B

Sapphire C-Plane Window Final Test Report

Louis J. Salerno

**AEROASSIST FLIGHT EXPERIMENT
Ames Research Center**

C-Plane Window Final Test Report

This report summarizes both free-standing and assembly torch testing of c-plane sapphire windows at ARC. The windows were obtained from various sources. Table 1 summarizes the testing described in this report.

Out of 17 c-plane windows ordered, 4 have been tested. In the free-standing condition, 3 of 4 c-plane windows have failed, resulting in this crystal orientation being dropped from further consideration.

A description of general information regarding the test setup, equipment used, etc. is provided, followed by more specific information pertinent to individual results.

INTRODUCTION

The purpose of torch testing was to proof test a sapphire window assembly design and assess its performance in a complex heating environment prior to committing to arc-jet testing. A schematic of the torch test is shown in Figure 1. Conditions selected for testing were a nominal rate heat application as well as twice the nominal rate and a maximum rate. The nominal rate represented a temperature increase of 30° F/second up to a maximum tile surface temperature on the order of 2000° F.

Both free-standing windows and windows mounted in either a complete assembly including backplate and spring, or an isolated assembly containing a Silfrax spacer in place of the backplate/spring combination were tested.

All windows had been pedigreed, i.e. had undergone visual, binocular, and metallographic inspections by Code E prior to being delivered to the test cache. These inspections will be described in detail, however, no correlation was ever established between pre-test window inspections and subsequent test results, and these inspections have now been discontinued.

The visual inspection consisted of examination with the naked eye under normal room lighting, both looking toward and away from the source of light. The windows were rotated and tilted through a variety of angles as they are examined. This procedure highlights the general condition of the window and brings attention to any irregularities. The windows were next examined using a low power binocular microscope at magnifications of 25x and 50x. Again, the windows were manipulated by hand and rotated and tilted through a variety of angles to enhance the visibility of imperfections. A final examination was made using a metallograph at a magnification of 100x. The metallograph incorporates a precision stage with X-Y movement and a framed image window. The sapphire was moved one image frame at a time until the entire surface had been scanned. Particular attention was given to previously identified imperfections. At each image frame location, the focus point of the metallograph was adjusted from one surface to the other and then back such that the interior of the window is examined. All cracks, voids, and significant surface imperfections were photographed and their position in the sapphire recorded.

TEST DESCRIPTION

Test apparatus included the following:

Hydrogen-oxygen torch
Pyrometer Instrument Co. Model 901 Optical Pyrometer
2 Cole-Parmer Model 8373-30 Chart Recorders
Instrumented Window Assembly Holder (Tile)
Heating Rate Control Carriage
Questar Telescope
Video Camera-Panasonic AFX8 S-VHS Omni Movie HQ

Test Settings:

Torch

	Regulator	Flowmeter
Hydrogen	15 psi	140 lit/min
Oxygen	20 psi	100 lit/min

Chart Recorders--20mV amplitude, 5 cm/min speed

Test Article:

One of three test configurations was used. The configurations are shown in Figure 2. The free-standing configuration consists of the window mounted into a plug of FRCI-12 tile material. The space between the window and the plug is filled with a gap filler. The isolated configuration consists of the window installed in the assembly with a Silfrax spacer isolating the window from the inner tube. Alumina paper is employed between the window and the restraining tube. Finally, the cooled assembly is a full configuration with gold backplate and window spring.

Test Procedure:

Water on

Oxygen tank valve opened

Hydrogen tank valve opened

Oxygen regulator adjusted

Hydrogen regulator adjusted

Torch lit

Chart Recorders on

Test article moved into flame

At maximum temperature position, pyrometer read

Test article moved out of flame

Torch extinguished

Oxygen tank valve closed

Hydrogen tank valve closed

Water off

End of test

TEST RESULTS AND DISCUSSION

The first c-plane window to be tested was CSS-02 installed in the cooled assembly, a window which had been obtained from Insaco and was of Crystal Systems manufacture. The window had undergone, visual, binocular, and metallographic inspection by ARC Code E.

The results of the inspection were that visually the surfaces appeared clean and that binocular inspection revealed no distinct features, however a metallographic inspection revealed circumferential and radial polishing scratches which appeared to be concentrated near the edges. There was no apparent depth to the scratches and the edges appeared to be almost entirely free of chips.

The test procedure involved moving the heating rate control carriage, including the attached window assembly mounted in the tile, toward the torch. A thermocouple mounted in the tile coating was monitored on a chart recorder. The carriage was moved such that the plotted temperature profile matched, as closely as possible, a pre-drawn guide curve.

Testing resulted in the window cracking well before the maximum temperature of 2210° F, measured on the tile, was reached. The crack displayed multiple branches, and appeared to spread as the test proceeded. The gold fingers of the backplate were darkened at the tips, suggesting good thermal contact. The inner tube of the assembly was instrumented with three

thermocouples. Only two of the three thermocouples were operating during the test, however they exhibited excellent tracking, suggesting a uniform circumferential temperature distribution.

Disassembly after testing revealed that the crack began at the edges of the window, indicating that either the edge was in tension, or that there were mechanical stresses. Several potentially contributing factors were identified (e.g. window bevel, mechanical binding, thermal gradients, etc.) Therefore, subsequent tests were directed toward resolving the important factors, and steps toward mitigating these factors were pursued.

The next test (Crystal Systems c-plane window CSS-06) subjected a window to testing at the nominal rate while mounted free-standing in a plug fitted into the tile. The maximum temperature of the tile as read with a pyrometer was 2650° F. This temperature is rather high, suggesting that it was an anomalous hot spot. (As a matter of consistency, the temperature reading taken by means of pyrometry is always taken at the 3:00 position on the tile.) As the window was moved out of the flame and began to cool, a crack developed. This crack was not multi-branched, but was instead simple in nature and is therefore felt to be due to thermal stresses.

To examine the possibility of a defective lot, Union Carbide window UCS-06 was inserted into the plug and tested at the nominal rate. Maximum temperature reached in this test was 2180° F, and at the conclusion of the test a crack was observed in the window, extending from one edge to the center, again, simple in nature.

Crystal Systems window CSS-04 was tested at the nominal, twice nominal, and maximum rates free-standing, surviving in each case. The window was then tested in the isolated assembly configuration. At the maximum temperature reached in the assembly of 2150° F, a multiple branch crack developed, reminiscent of the crack observed in CSS-02, and felt to be caused by mechanical binding of the window in the assembly. At this point, c-plane windows were eliminated from consideration. Two of three c-plane windows had broken in the free-standing configuration, whereas both a-plane and r-plane windows had survived all such free-standing tests.

CONCLUSIONS:

At the outset, c-plane windows were selected on the basis of data indicating that the c-plane demonstrated the highest strength (fracture toughness) at room temperature of a, c, m, or r-planes. After discussion with other investigators, it was learned that at elevated temperatures in the region of our interest, the c-plane actually exhibits a severe degradation in strength. Our test experience indicates that the a and r-plane windows exhibit superior strength with the r-plane being slightly superior to the a-plane. It should be pointed out that in a c-plane window, the c-plane is not a fracture plane in our application. The c-plane is parallel to the optical surface and is in a minimal stress orientation. The a, r, or m-plane is actually the plane where fracture is occurring.

As a result of empirical testing, c-plane sapphire has been eliminated as a candidate material. Results of a and r-plane tests constitute a separate report, however, these materials have demonstrated marked improvement over the performance of the c-plane material.

C-PLANE SAPPHIRE WINDOW TORCH TEST SUMMARY

WINDOW	MFG	TST DATE	PLANE	TESTS			COMMENTS
				Free- Standing	Isolated Assembly	Cooled Assembly	
CSS-02	CS	10/18/90	C				
CSS-04	CS	11/15/90	C	P	F		Also tested 11/19, 11/21
CSS-06	CS	10/30/90	C	F			
UCS-06	UC	11/11/90	C	F			Tested to examine possibility of a defective CS lot

P = Pass F = Fail
 CS - Crystal Systems UC - Union Carbide

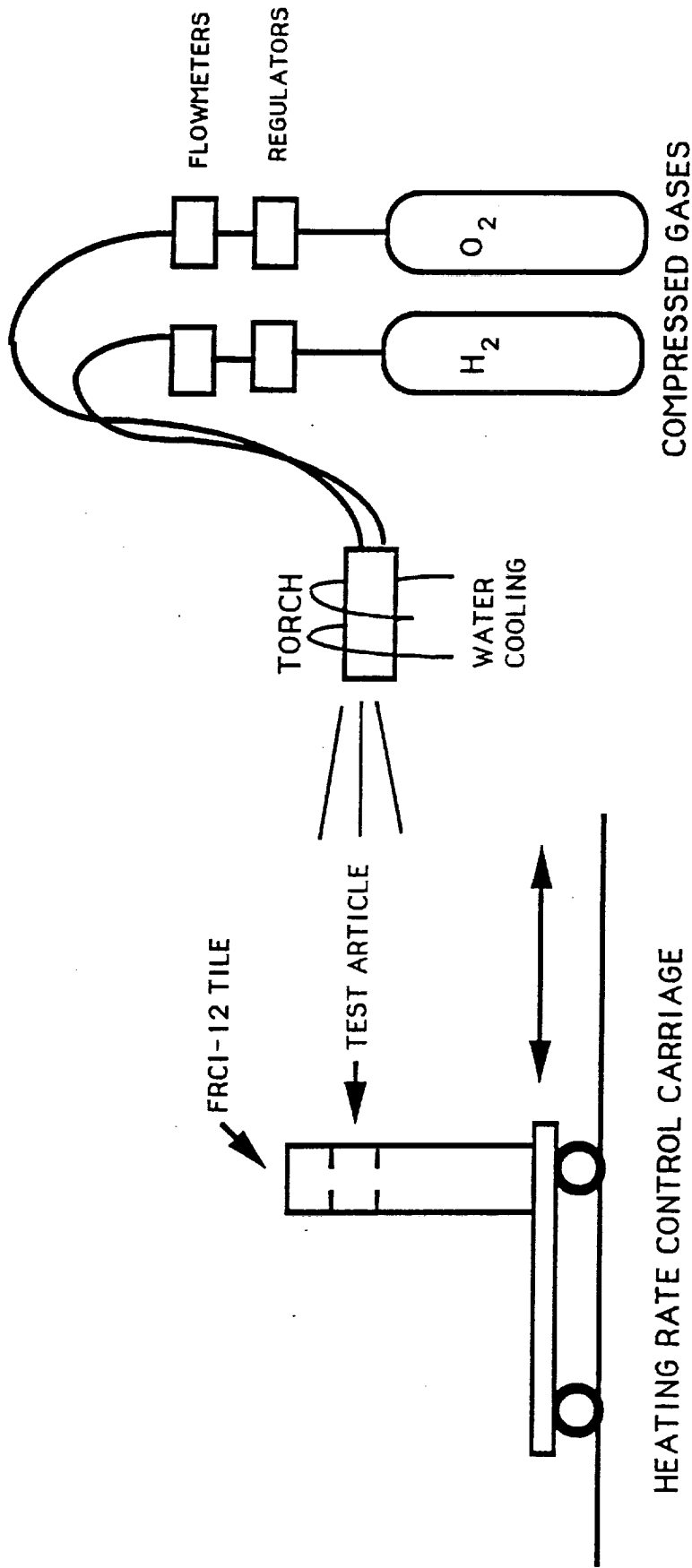

FIGURE 1. TORCH TEST SCHEMATIC

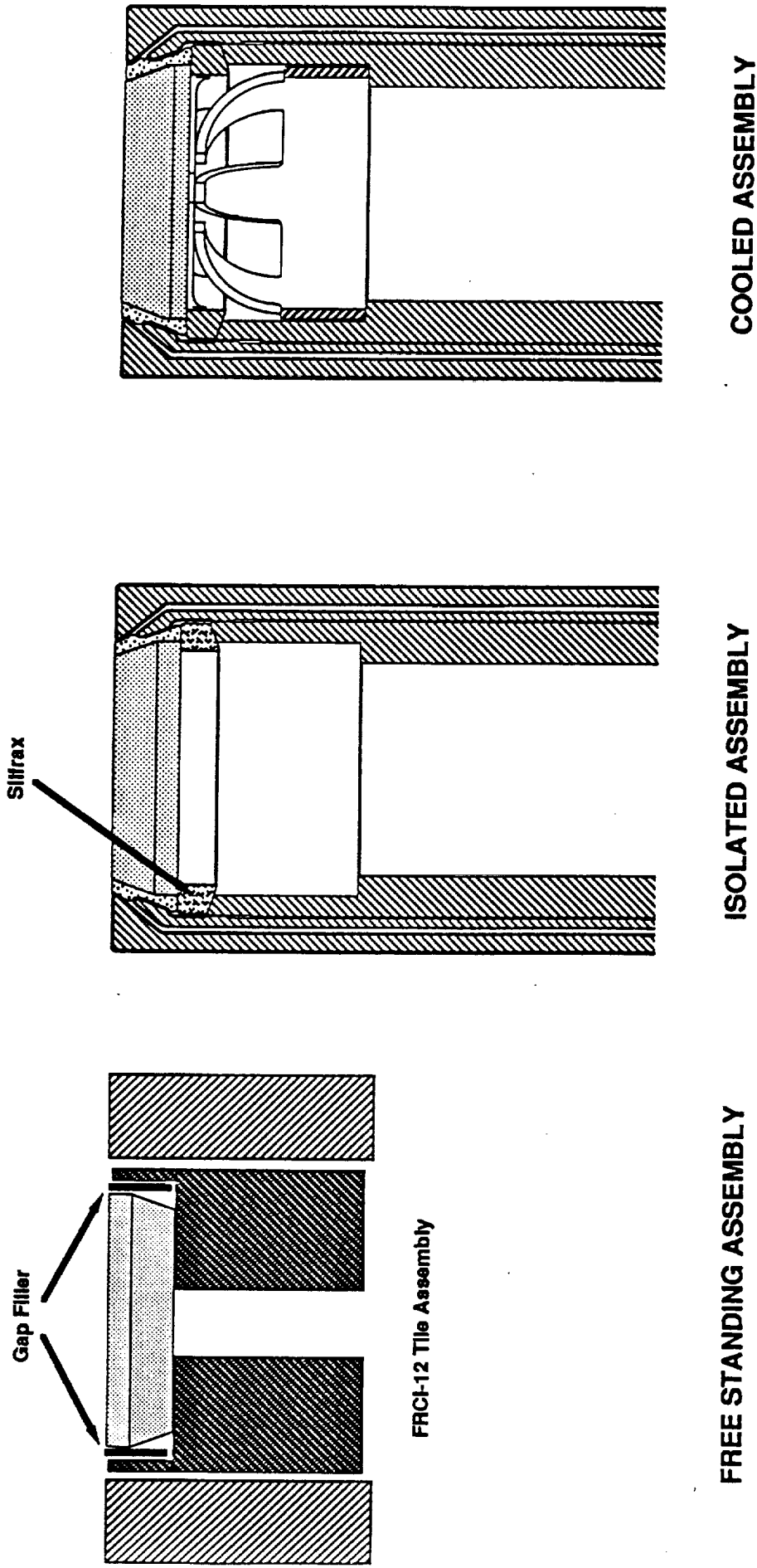

FIGURE 2. TEST ARTICLE CONFIGURATION

Appendix C

Comments About The Arcjet Tests Tabulated in Table 1

Comments for Table 1.

Test Nos. 1, 2, 3 and 4

This first group of arcjet tests were made with an insulated, small diameter, r-plane window (FS-04). This window was bevelled at ARC from one of the 5/8" diameter, off-the-shelf, cylindrical windows purchased in June 1990. It was too small to be used with the fingers and spring components in the ARC assembly. Thus, it was assembled with a Silfrax spacer behind the window edge. It was the first window in an assembly to survive the torch test. Four arcjet runs were made with this assembly at increasing heat loads using argon and then argon and air. The first three tests were to test the ability of sapphire to withstand the arcjet start-up heating pulse. The window survived all four tests. The fourth test was at the 80% AFE heating rate level and indicated that a flyable window design would probably be found.

Test Nos. 5, 6 and 7

The next group of tests were with an a-plane window (AA-04) in the full assembly which also had survived the torch test. The window was assembled with a titanium spring and light loading (contact force between spring and backplate) on the fingers. Three arcjet runs were made with increasing heat loads as with the previous series. The window cracked on the nominal (80% of AFE heating rate) test, as shown in the sketch. The crack pattern seems to avoid the window center, suggesting that too much heat was removed from the window edge compared to the backface of the window. Increase spring loading should increase the heat removal from the backface.

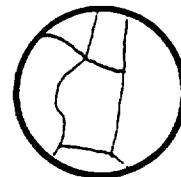

(These first two groups of tests, with increasing heat load, proved that the onset of heating due to the arcjet start-up impulse does not damage the window. Thus, all remaining tests eliminated the argon only and argon + air start-up tests and proceeded directly to the nominal and maximum test conditions that simulate the AFE trajectory.)

Test No. 8

This test was with an a-plane window (FA-02) assembled with a titanium spring and medium spring loading, as test 7 suggested. The window broke with multiple cracks, (as shown in the sketch), and was finely shattered on the rear surface next to the fingers. The window obviously became very hot, as the gold on the backplate melted, and fused the window to the backplate on cool down, as the gold solidified. The massive fine shattering and probably some of the cracking of the window likely occurred on cool down after the fusion took place, due to the difference in thermal expansion between the sapphire and the molybdenum backplate. The reason for the high window temperature is uncertain. However, when the window assembly was disassembled, the window was tightly wedged into the restraining tube. Thus, a possible explanation is that the window became wedged into the restraining tube during the torch test, which occurred prior to the arcjet test, and then was held clear of the support tube during the arcjet test. A smaller window diameter might have relieved this problem, but it may also be due to the small, 20° bevel on the window edge (see Figure 3). Also, this situation suggests that all window assemblies must be examined after each test, if possible.

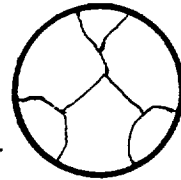

Test No. 9

This test was with a slightly smaller (0.653" diameter) r-plane window (UR-01), assembled with a titanium spring and medium spring loading. The window cracked and again, the cracks (as shown in the sketch), indicated that too much heat was removed from the edge of the window compared to that removed from its backface through the fingers.

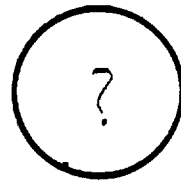

Test No. 10

This test was also with the 0.653" diameter r-plane window (UR-02), but the spring was changed from titanium to molybdenum, which has a higher heat conduction rate, and medium spring loading, in order to remove more heat from the window center. Multiple cracks again occurred in the window, avoiding the center. Cooling the edge of a window, compared to its center, places the edge in tension. Reducing the edge cooling, as opposed to increasing the center (backface) cooling, would be another way of lowering the stresses and perhaps, preventing the window from cracking. It would also, of course, reduce the total heat removed and thereby, raise the window temperature.

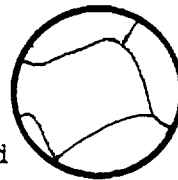

Test Nos. 11, 12 and 13

This group of tests was made with a c-plane window (AC-02), mounted with a Silfrax spacer instead of a backplate and spring, to provide an insulated window. The window was instrumented with 5 thermocouples cemented directly to the back surface. The purpose of these tests was to obtain window temperatures during the arcjet run for correlation with the thermal model. Three arcjet runs were made.

The thermocouples were attached to the window with rather large and uneven spots of refractory cement, and it is possible that this nonuniformity affected the temperature readings recorded.

Test No. 14

This test was with an r-plane window (UR-04), assembled with a molybdenum spring, and questionable spring loading. The spring loading was questionable because alumina paper was placed between the window and the backplate in an attempt to lower the window edge cooling. The window cracked with the same fine shattering pattern and fused to the gold-coated backplate as experienced in test 8. The high temperature of the window might have been caused by the spring pressure lifting the backplate slightly off of the inner tube or the alumina paper might have thermally isolated the window more than expected. The window experiences severe cracking whenever the gold melts and fuses the window to the backplate. Thus, the effect of removing the gold coating from the backplate must be assessed.

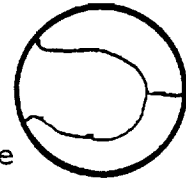

Test No. 15

This test was with another r-plane window (UR-05), assembled with a backplate from which the gold had been removed from the surface in contact with the window, leaving a bare molybdenum surface. A molybdenum spring was used in the assembly and the window/backplate combination was held from contact with the inner tube by high spring loading, which greatly reduced the heat flow from the window edges. The window cracked, but there was no fusion of the window to the backplate. The gold on other portions of the backplate did not migrate to the window interface area. The crack, as shown in the sketch, was the first simple crack seen in the arcjet, suggesting that the proper balance of heat removal is to take more heat from the center and less

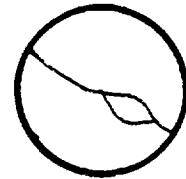

from the edges. However, if the window is to remain relatively cool, it is necessary to remove additional heat from both the edge and the center.

Test No. 16

This test was with an r-plane window (UR-03), assembled with a gold-plated backplate for better thermal contact with the window, (i.e., better center cooling). A molybdenum spring was used with low pressure to allow better window contact with the support tube (i.e., better edge cooling). The window cracked in several pieces, some of the cracks passing through the center, as shown in the sketch. The presence of a crack through the center may indicate that the ratio of edge to backface cooling is about right, but too much heat was extracted from the window. It is also possible that the window had edge flaws which encouraged crack formation or that this is evidence of the probabilistic nature of brittle material failure.

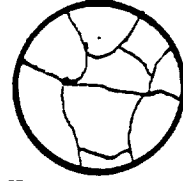

Test No. 17

This test was with an r-plane window (UR-06), assembled with an uncoated backplate to lower the heat conduction at the edge, and to prevent the window from fusing to the backplate if it gets hot, and with a molybdenum spring with high pressure, to maintain good heat extraction from the window center. The window broke with a small C-shaped crack in the center, as shown in the sketch. The crack did not reach the edge. This was the first instance in testing in which a crack did not originate or terminate at the window edge. This suggests that the edge cooling was low enough that the edge was no longer in tension, but that too much heat had been removed from the center. A survivable conductively cooled configuration might be attained by removing slightly less heat from the center.

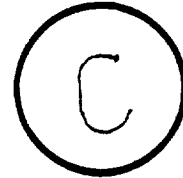

Test No. 18

This test was with an a-plane window (FA-01) because there were no more r-plane windows available at this time. It was mounted with an uncoated backplate, but with a titanium window spring with low pressure to reduce the heat extraction from the center. The window cracked, as shown in the sketch, but its cause could have been due to the use of an a-plane as opposed to an r-plane window, or because the edge of the window was not polished. This test will be re-run when new r-plane windows are available.

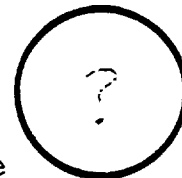

Test No. 19

This test was a c-plane window (UCS-06) ,
assembled with a silfrax spacer to give an insulated
window. Again, 5 thermocouples were cemented to
the window rear surface to test the analytical model. Great
care was used to ensure the best possible thermocouple
attachment technique. The results were similar to those from
test numbers 11-13, and indicate that the thermal model with
the present sapphire properties does not predict the window
temperature reliably within 100° C. This accuracy is not
adequate to determine the window transmission in the vacuum
ultraviolet to enable the AFE data to be correctly
interpreted. The use of a conductively cooled window is
beginning to look like a doubtful possibility.

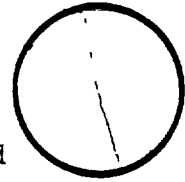

The measured backface temperatures were higher than
those predicted by the model. The reason for this is
uncertain. Possible explanations are that: (1) the window
is more catalytic than assumed, (2) the thermal conductivity
is higher than assumed, (3) the emissivity is lower than
assumed, (4) the heat path out of the window is not as good
as expected, or (5) the thermocouples were defective.
Unfortunately, the catalycity, thermal conductivity, and
emissivity of sapphire at high temperatures are poorly known.

Test No. 20

This was the last test of a conductively cooled window.
It was with an r-plane window (FR-01), assembled with an
uncoated molybdenum backplate and a titanium spring with low
pressure. This assembly was identical to the a-plane
assembly which failed previously (test 18). The window
survived, in that it did not break. However, a qualitative
evaluation of the assembly after disassembly was that it
appeared to get much hotter than expected. Thus, due to the
uncertainty regarding the window temperature and the relative
difficulty in attaining survival of a cooled window, the
conductively cooled concept was not tested further during
this test sequence.

(The remaining tests were conducted with the insulated window
approach, as it appeared to be the most promising path to achieving a
flyable window design. The arcjet tests completed had been at a nominal
peak heating rate of 38 W/cm², which is approximately 80% of the
anticipated peak flight rate of 48 W/cm². The only insulated window
tested without thermocouples attached was in test 4. This window, FS-
04, also had the smallest diameter tested (0.625 inches). It was,
however, an r-plane window, which may be stronger than an a-plane window

(see test 18). It was decided to test other insulated r-plane windows whose diameters were 0.653" at both the 80% and the maximum heating rate possible with the current model fixture. This maximum heating rate should be very close to the 100% AFE heating rate expected during the AFE entry.)

Test Nos. 21 and 22

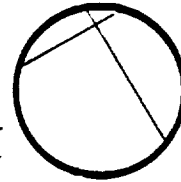

These tests were with an r-plane window (FR-04), assembled with a silfrax spacer. The window was first tested at the 80% AFE heating rate, and it survived. The assembly was then tested at the maximum heating rate possible in the present configuration, which was very close to the 100% AFE heating rate of 48 W/cm^2 . Two slight cracks occurred in the window, as shown in the sketch and in figure 3, and some slight ablation occurred on the window surface. The two cracks are at right angles to each other. In viewing the video recording made of the test, it appears that the ablation began about 140 seconds after the beginning of the test. The ablation definitely indicates that, in the arcjet, the window temperature is significantly higher than expected by the thermal model. Ablation, or surface melting, occurs at 3722° F , whereas the analytical prediction indicated a temperature of about 2750° F (see Figure 8).

Test Nos. 23 and 24

These tests were with a fused silica window (QN-02), which duplicated the previous two tests with sapphire, at both the 80% and 100% AFE heating rates. The window survived the 80% AFE heating rate but showed significant surface melt or ablation at the 100% AFE heating rate. The visual appearance of the window after this test was cloudy and with an obvious loss of transmittance. Based on these results, fused silica appears to be a poor candidate for the AFE window material if the window is not cooled considerably.

Test No. 25

The next test was with an r-plane window (AR+2-01) whose thickness was 2mm (50%) thicker than the standard 4mm thick windows that had been tested so far. The purpose of this test was to check the ability of the thermal model to give the correct trend of temperature change with window thickness. The window was instrumented with 5 thermocouples on the rear window surface. The window was tested at the 80% AFE heating rate, and survived. Thermocouple data, shown in

Figure 10, indicated that the peak window temperature was lowered, and the time that the peak temperature occurred was increased by about 10%. This trend is consistent with the thermal model trend shown in Figure 11.

Test Nos. 26 and 27

These tests were with a standard thickness r-plane window (FR-02), again instrumented with 5 thermocouples on the rear surface. The purpose of this test was to determine the effects of translation of the assembly into the flow stream after the arc had been established, to avoid the copper coating that occurs during the early portion of each run and to provide a simpler case for testing the thermal model. Two runs were performed. The first involved translating the assembly into the air flow after the flow was established, and the second was an 80% AFE heating rate profile. The thermal gradients developed in the window, as it entered the air flow, did not cause any apparent damage to the window. The thermocouple data taken during these runs also show that the measured temperature is higher than that predicted by the model (see Figure 9).

The final two arcjet tests were made to test the repeatability of the previous result with the insulated r-plane window at the maximum heating rate of about 48 W/cm^2 .

Test No. 28

The first such test was with an r-plane window (AR-01). The window ablated, but did not crack. The time from start of the test to ablation was estimated to be similar to that recorded during test 22. Unfortunately, the video camera was not run during the test and a direct measure of the time to ablation was not recorded.

Test No. 29

The last test was with an r-plane window (AR-05). The window ablated, and a small, multiple crack occurred near the edge of the window, as shown in the sketch. Again the ablation appears to begin at about 140 seconds after the test began. The window was found to be tightly bound in the restraining tube upon disassembly. The cracks might have been caused by mechanical binding produced by window expansion.

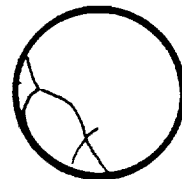

Appendix D

Simulated AFE Entry Trajectory in the ARC 20MW Arcjet

Wendell L. Love

Discussion Of The Procedures Followed For Conducting Arc Jet Testing On RHARE Window Assemblies

The fundamental purpose for performing arc jet tests on the RHARE window assembly is to determine how the assembly will perform in an aeroconvective heating environment which simulates the environment that will be encountered during the flight of the AFE vehicle. When considering the utilization of arc jet testing to evaluate flight environments, it needs to be kept in mind that an exact duplication of the complete flight environment for earth entry trajectories is rarely obtainable in ground based facilities. Although arc jet facilities can develop a reasonably good simulation of the aerothermal heating environment encountered during atmospheric entry, it is important to realize that there are limitations on the extent to which the simulation can be accomplished. In general, it will be necessary to make compromises in one or more of the parameters that characterize the flight environment. In the case of the AFE flight trajectory, the energy vs density characteristic of the "flight atmosphere", as represented by the test stream, tends to be somewhat outside of the operating envelope of the current arc jet facilities. In particular, peak heating in flight occurs under conditions of higher stream enthalpy and lower stream density than can readily be obtained with the arc jet. Consequently, to develop the equivalent peak heating on an AFE test article, it is generally necessary to operate with a higher surface pressure than would be experienced in flight.

Additional testing requirements were imposed for the RHARE window tests. To fully explain these and to better understand the rationale that was followed in order to establish the test conditions and procedures for the present test series, it may be useful to review some of the historical background surrounding the testing of window assemblies in the arc jet facilities. The initial arc jet test series on RHARE window assemblies was conducted during the period from May to July 1989. The requirements that were specified for this series were the following: (a) The test assembly was to be exposed to a convective heating environment that had the same heating rate vs time "profile" as that predicted for the AFE flight vehicle. (b) The heating rate must start from a zero level and change smoothly to the maximum and then back to zero without any significant step jumps or other abrupt transients. (c) The test configuration and test approach must have the potential for reaching a tile surface temperature of 2900 deg F.

The first two requirements presented a major problem. With the existing arc jet facilities, it is impossible to operate in such a way that the heating rate to a test article in the stream can be made to start from zero and increase smoothly from very low levels up to some maximum value. In order to accommodate these requirements, an approach was devised in which the test article was gradually traversed into the test stream from the side in such a manner that the heating rate, as measured by a calorimeter at the center of the test article, was made to gradually increase from a zero level up to the desired maximum. By using this approach it was possible to generate a heating rate profile, as measured by the centerline calorimeter, that matched the desired flight profile reasonably well. However, there were a number of negative features that accompanied this approach.

One readily apparent drawback to this approach is the fact that, while the heating rate at the center of the test article can be adjusted to a desired value by controlling the degree of insertion into the stream, the heating rates to the other parts of the test article will be at different levels. Only after the test article reaches the stream centerline and the flow geometry becomes symmetrical will the heating rate over the entire face of the model become uniform.

These effects are illustrated in Figures 1A and 2A, which give the heating rate and the temperature profiles that are generated by this test approach. It is apparent from examining the resultant profile that, for the most part, the heating rate as measured by the centerline calorimeter develops a very acceptable approximation to the flight case heating profile. On the other hand, the tile surface temperatures exhibit graphic evidence of the non-symmetrical heating effect. The temperature on the side of the model that first enters the stream is considerably hotter than the trailing edge until the model finally reaches the centerline. The same effect is generated as the model exits the stream and, if anything, the temperature gradient developed at this point appears to be even larger than for the heat-up portion of the profile.

After examining the results that were generated by this test approach, two criticisms were put forth: (a) A pronounced transient is produced as the model traverses the final distance to the stream centerline location; and (b) A significant temperature gradient across the model is created during the period of time that the model traverses from the edge of the stream to the centerline of the stream and back. The effects on the overall test model generated by these features were judged unacceptable. For these reasons, a series of arc jet tests were conducted in the latter part of October 1990 to explore possible methods for improving the test approach and to reduce or eliminate the undesirable features described above. The results of these exploratory

tests were described to the RHARE program people in a presentation given on November 19, 1990 and were summarized in a written memo distributed about December 5, 1990.

Before discussing the current test series, it may be appropriate at this point to describe in more detail the technique employed in the arc jet facility to generate the heating rate versus time relationship that constitutes the simulated flight trajectory heating rate profile. The technique is based on matching the actual heating rate output from a calorimeter in the model against the desired heating rate profile that has been drawn on the chart of an x-y plotter. The output signal from the calorimeter is fed to the y axis input of the x-y plotter and the x axis is controlled by a time base signal. Initially the centerline calorimeter is used as the reference for heating rate until one is satisfied that the test approach has been sufficiently perfected. Then another calorimeter in the test article, whose output has been correlated with that of the centerline calorimeter over the complete heating profile, is used as the test reference and a window assembly is installed at the center of the test article. To conduct a test, the arc heater operator controls the operation of the facility in such a way as to modulate the heating rate experienced by the reference calorimeter and thus cause its output to follow the desired profile drawn on the graph paper. Figures 5A through 10A are examples of the x-y plotter tracings used in conducting some of the current tests.

The test approach used for the current test series evolved from the results from the exploratory tests. The new test approach incorporated two significant modifications to the approach used earlier. First of all, the technique of trying to modulate heat flux by the translation of the model was abandoned. Instead, the arc was ignited with the test model already positioned at the stream centerline. Modulation of heat flux was accomplished solely through the control of the power level to the arc heater and the gas flow through the arc. Secondly, use was made of the argon start-up condition of the arc in order to produce as low a level of initial heating rate to the model as possible. The argon start-up condition is a normal part of the arc facility operation but arc start-up is rarely done with a stagnation flow model in the stream and it is almost never used as a viable test condition. In this situation, however, it enabled the test model to experience a heating rate that is about one third of the lowest possible level obtainable with air present in the arc stream. Finally, changes were made to the air flow system for the arc heater in order to gain finer control of very low air flow rates and thereby permit a more gradual introduction of the air into the test stream.

Run 007 represents the end result of the approach that evolved from the exploratory tests and the resulting heating

rate and temperature profiles for this run are shown in Figures 3A, 4A, and 5A. Figure 5A is a copy of the x-y plotter tracing of the output signal from the centerline calorimeter in the test article and Figures 3A and 4A are plots of the heating rate and surface temperature values that were recorded by the facility data acquisition system and are the counterparts of Figures 1A and 2A from the earlier tests. While at first glance the heating rate and temperature profiles for the current series may appear quite similar to the earlier series, there are some significant differences. For one thing, the target heating rate profiles were different for the two series. For the earlier series, the target heating profile was an exact representation of the computed flight profile. For the current series, the flight profile was approximated by a simple pyramid shape consisting of an increasing ramp, a 10 second constant period, and a decreasing ramp. The overall time of the simplified profile was kept the same as the actual profile which meant that the increasing rate was somewhat less than the actual flight case and the decreasing rate somewhat greater. For the purpose of screening windows, this deviation from the flight case was not considered significant and it greatly simplified the test set up effort.

The other differences in the profiles are a direct consequence of the differences in the test approaches. With the model located on stream centerline for the current tests, the initial arc startup produces a step increase in heating rate which is reflected in the step increase in surface temperature. In addition, the onset of air flow is accompanied by a step increase in heating. On the other hand, it was possible to eliminate the heating transient experienced during the earlier tests that developed as the test article approached centerline during the traverse portion of the profile. And, most significantly, the temperature gradient across the model that was experienced because of the stream traversing operation is eliminated in the current series because the model is always on centerline throughout the test.

Run 007, as illustrated by Figure 5A, represents the "perfected" version of the current series test approach in the sense that all the adjustments and presettings of the arc heater had been fine tuned to get the smoothest possible profile. Run 014, as illustrated by Figure 6A, shows the comparable heating profile that results when the reference calorimeter was shifted from the centerline location to the "Top" calorimeter, located on the "East" side of the model. It can be noted that the output scale had to be adjusted somewhat in order to arrive at the same arc heater conditions for the peak heating point. Figure 6A also shows the penciled-in notes that were made during the run to identify when various changes in the arc heater settings were being

made and to help correlate event changes in this run with other runs.

The detailed sequence of arc heater control operations carried out by the facility operator to generate the "perfected " heating rate profile is as follows:

Set-up Instructions

- Position model at stream centerline
- Pre-set air supply pressure, P_1 , to 300 on the panel gauge
- Check air valve controller to note where valve just starts to open

Run Sequence For Operator

- Start arc and x-y plotter, adjust current to 600 amps, (arc heater operating on argon startup flow only)
- When plotter pen approaches profile curve, crack open air valve as gently as possible to obtain minimum air flow
- Increase air valve opening while following curve until valve reaches 40% open (arc pressure about 10 psia)
- Switch to current control, increase current to 1300 amps while following curve
- Return to air flow control, increase valve opening while following curve to peak heating point (about 60 % open, arc pressure about 15 psia) then decrease back to 40%
- Reverse the settings used for the increasing part of curve to follow the decreasing portion of the heating rate curve

Once the above sequence had been established and the facility operator was given an opportunity to go through the sequence several times, the degree of repeatability between test runs was surprisingly good. This is demonstrated in Figure 7A which shows the actual plotter tracings for three successive test runs which were all recorded on a single x-y plotter graph.

It is also significant to note the fact that the arc facility itself is a very repeatable device in the sense that a given combination of arc heater settings will always produce the same set of conditions in the test stream. In other words, if the arc heater is operated repeatedly at a specified set of operating conditions, the heating rate and pressure environment developed in the test stream will repeat to good accuracy. This was demonstrated during the test series by the fact that those points in the run sequence which provided verifiable repeat settings such as the argon startup condition, the minimum air condition and the peak heating condition would always result in the same response from the calorimeter and the same surface temperature on the model. If, in fact, these parameters did not repeat for any

test it was a signal to look for some anomaly in the model or instrumentation that would explain the deviation. This characteristic of the arc heater proved useful in a number of instances in which the signal from the reference calorimeter was either lost or else it failed to respond properly for some reason. In these cases it was possible to complete the test profile by merely following the specified sequence of arc heater settings outlined above.

The test conditions and the test runs described so far were all at what the RHARE program people refer to as the 80% AFE flight condition. This condition resulted in a surface temperature on the test model of about 2500 deg F at the peak of the heating profile. On a few occasions the resultant surface temperature was somewhat lower than this if the prior test history of the test article was such that little or no copper had been deposited on the surface as a result of operating with argon flow only. All test runs up to and including Run 036 followed the same heating profiles as Runs 007 and 014, which is referred to as the 80% condition in the main report.

The projected flight environment for the AFE vehicle indicates that, under certain conditions, the surface heating may reach magnitudes such that the tile surface temperatures will approach 2900 deg F. This condition is referred to in this report as the 100% AFE condition and several tests were performed which attempted to develop heating profiles that would result in surface temperatures of 2900 deg F. In order to have a reference calorimeter which would function to these levels it was necessary to procure a special unit with a range of 250 BTU/sq ft-sec to replace the existing unit whose range was 100. It should be pointed out that the "100%" AFE condition relative to the "80%" AFE condition does not translate into an increase of 25% in heating rate in order to go from the 80% to the 100% condition. If one takes the 80% condition to be equivalent to a surface temperature of 2500 deg F (as described above) and the 100% condition to be equivalent to 2900 deg F, the percentage increase in degrees Fahrenheit is only 16% but the percentage increase in heating rate to the tile surface necessary to achieve this amounts to 66%. To accomplish this, it is necessary to operate the arc heater at an increased power level of sufficient magnitude to increase the heating rate on the reference calorimeter by 66%.

Run 037 was the initial attempt to perform the high heating rate profile of the 100% condition. The x-y plotter profile for this run is shown in Figure 8A. The test procedure followed was basically similar to the one described above except that the arc heater was taken to higher power levels. The peak condition for the lower(80%) condition was achieved with a power input to the arc heater of just under 2

MW. The peak power reached on Run 037 was 9.1 MW which amounts to an increase in power level of more than 4 times.

It was discovered during Run 037 that the target temperature of 2900 deg F on the model surface could not be obtained. This was somewhat of a paradox since extrapolations based on the 80% condition suggested that the target temperature of 2900 deg F should be obtainable. Indeed the extrapolations suggested that a power level of about 5 MW would be adequate to develop a heating rate on the test model of about 60% to 70% higher than the established "80% condition" and that this should be sufficient to obtain the desired temperature. During the test however, it was observed that the heating rate seemed to experience a sort of "plateau" as the power level reached the vicinity of 6 MW. Increasing the arc power further to 9 MW did not result in much additional increase in the reference heating rate or in the model surface temperature. The maximum temperature obtained was in the neighborhood of 2800 deg F.

It is the opinion of one of the arc jet engineers (W. Love) that the difficulty in reaching higher temperatures is a consequence of the size of the test article relative to the diameter of the test stream. It is felt that as the power level and mass flow through the arc heater was increased, the frontal shock on the test model tended to move away from the model surface as a consequence of the edges of the shock projecting out through the edge of the test stream. The result was a reduced heating rate to the model surface that was below the level which should have resulted had the test stream been of larger diameter.

It was observed on the following test, Run 038, that the higher range reference calorimeter appeared to be operating correctly since it was used as the reference on this test to reproduce the established 80% profile. Figure 9A shows that the calorimeter trace matches the target profile very well. The validity of the calorimeter response was further substantiated by the fact that the established arc heater settings were repeated at the peak heating point.

Several other test runs were made at the high heating rate condition. The plotter tracing for one of these is shown in Figure 10A. On this and subsequent high heating rate runs, the time to complete the profile was shortened by about 60 seconds in order to reduce the amount of damage to the test article. The target profile was also adjusted to reflect the maximum heating rate level achieved during Run 037. The same basic results were obtained on this run as on the first high heating rate run including the fact that no significant increase in heating rate was developed above a power level of about 6 MW. The implication that can be drawn from this is that smaller test models will have to be used to reach model surface temperatures of 2900 deg F.

Figure 1A

ARC JET SIMULATED AFE TRAJECTORY - PHASE I /1989

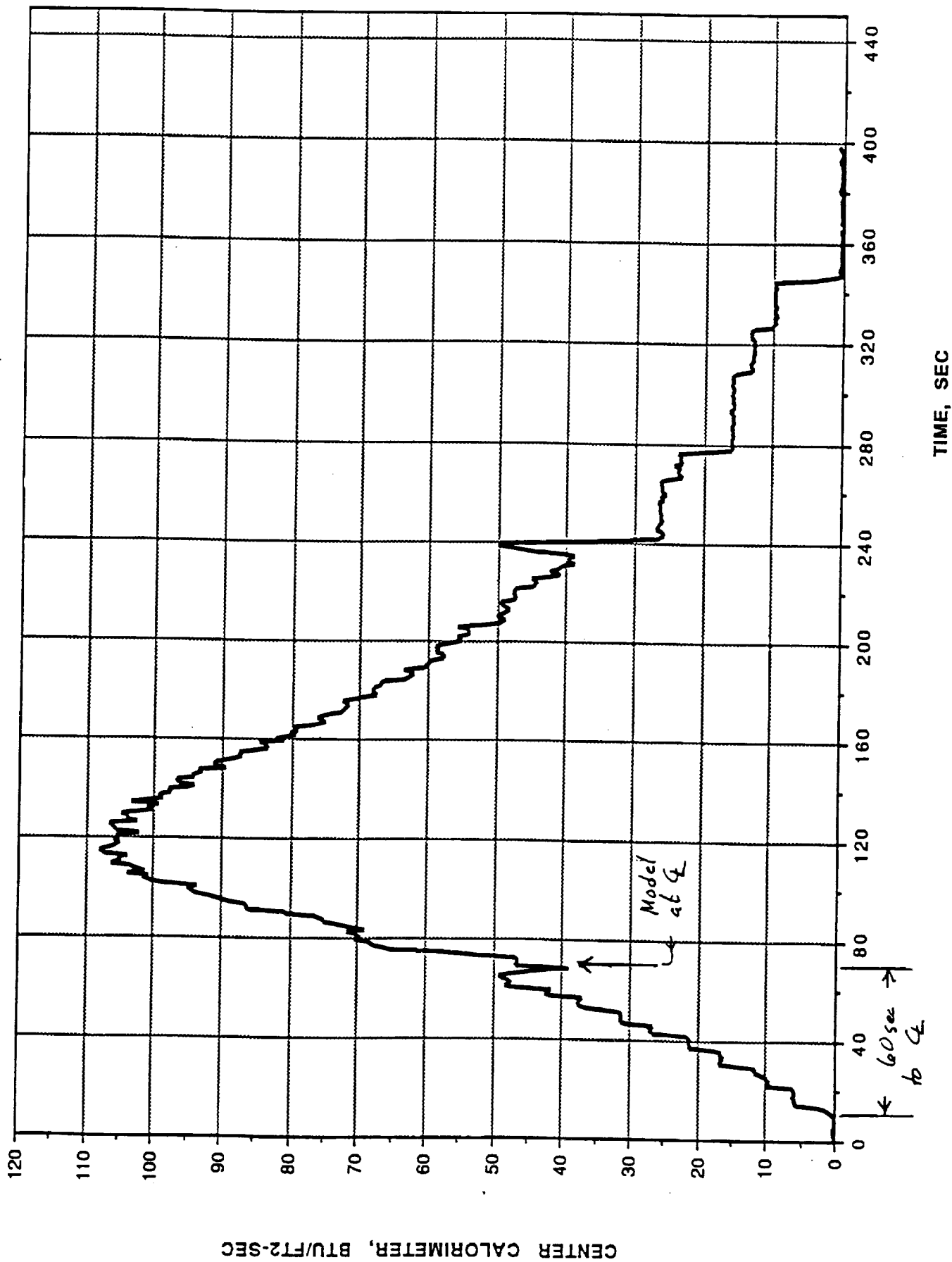

ARC JET SIMULATED AFE TRAJECTORY - PHASE I /1989

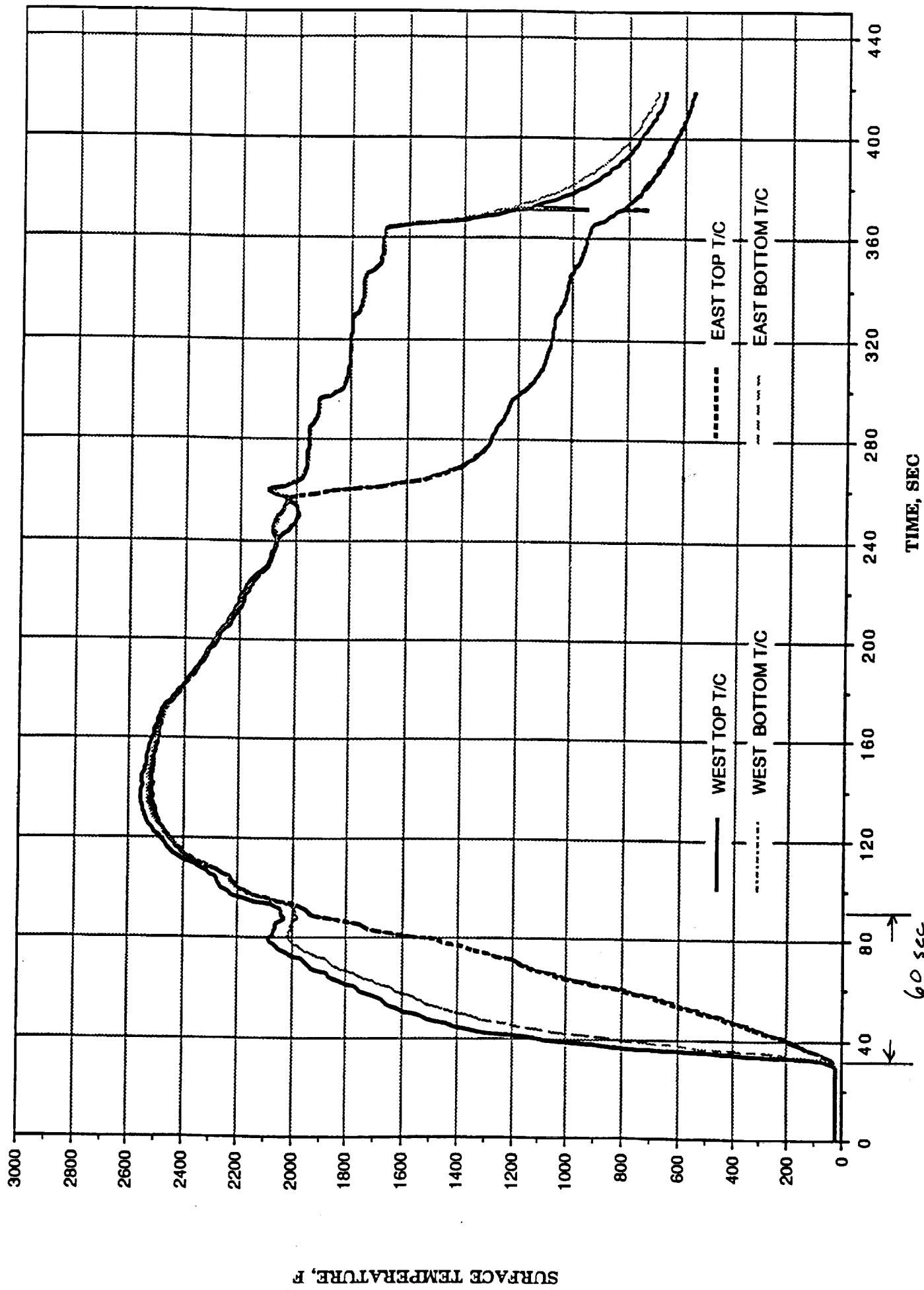

60 sec
to ϕ

Figure 2A

Figure 3A ARC JET SIMULATED AFE TRAJECTORY - MODEL AT CENTERLINE BEFOR ARC ON RUN 007

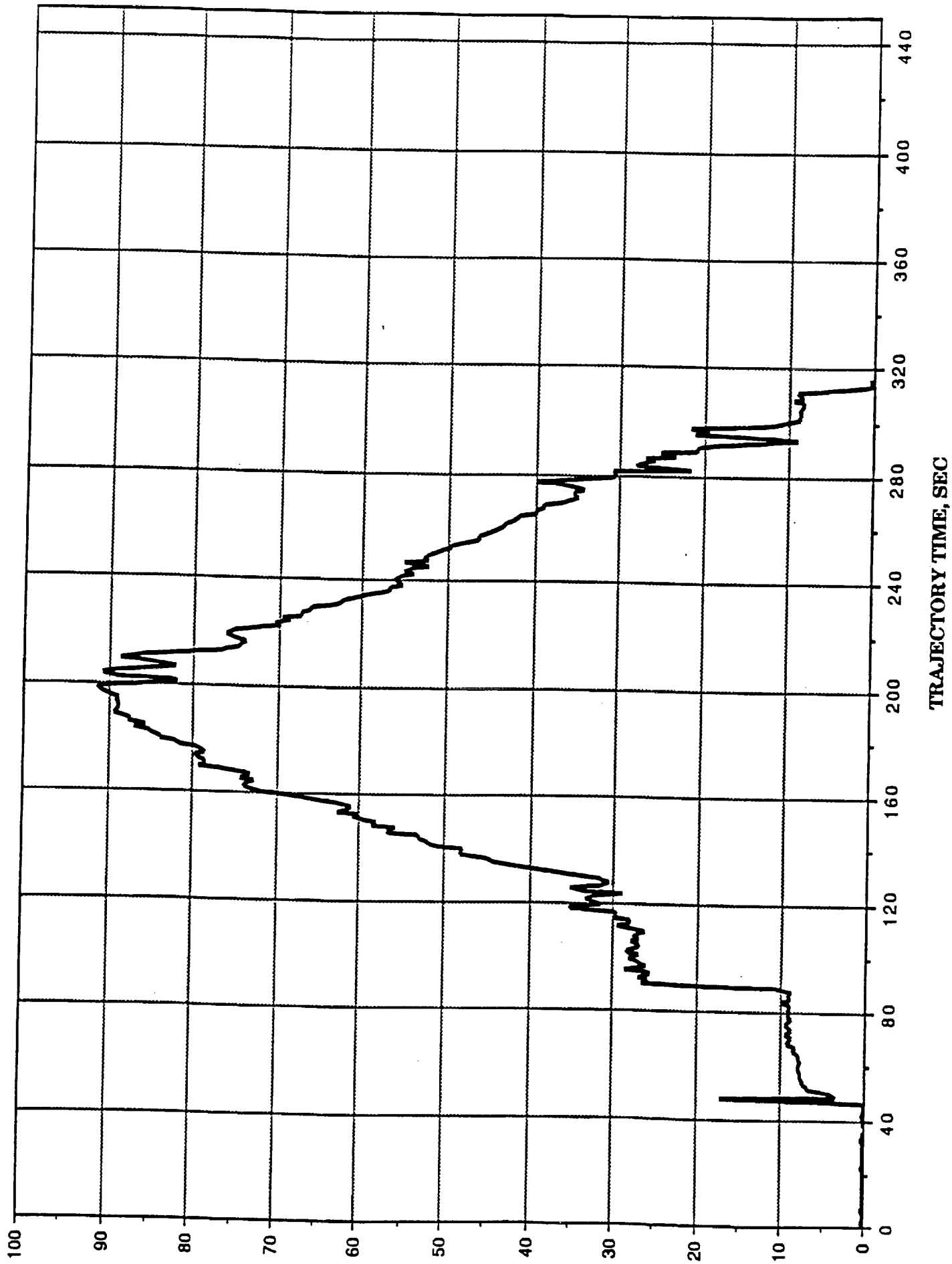

Figure 4A ARC JET SIMULATED AFE TRAJECTORY - MODEL AT CENTERLINE BEFORE ARC ON RUN 007

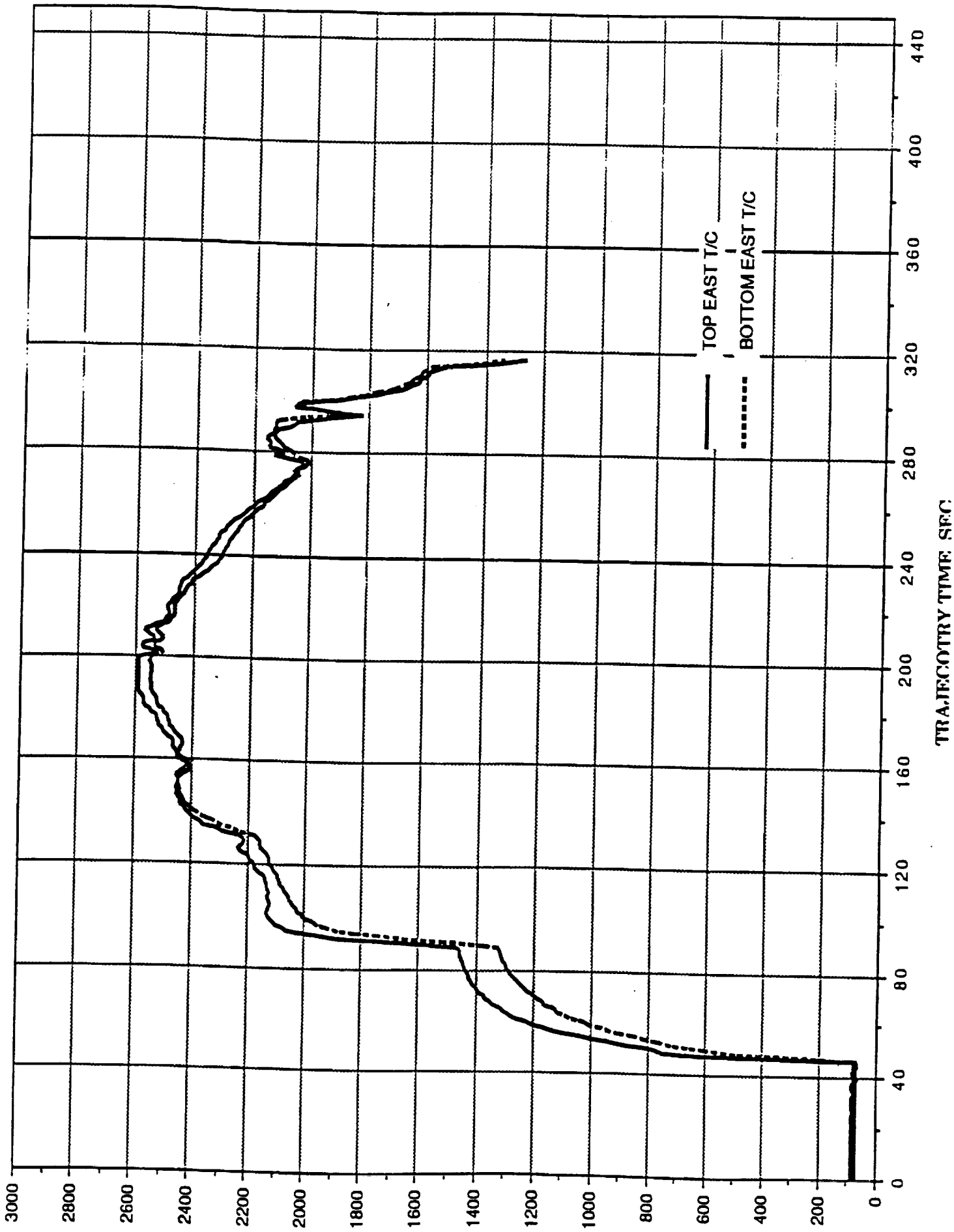

Figure 5A

ORIGINAL PAGE IS
OF POOR QUALITY

10/31/90

AHF 131

Run 007

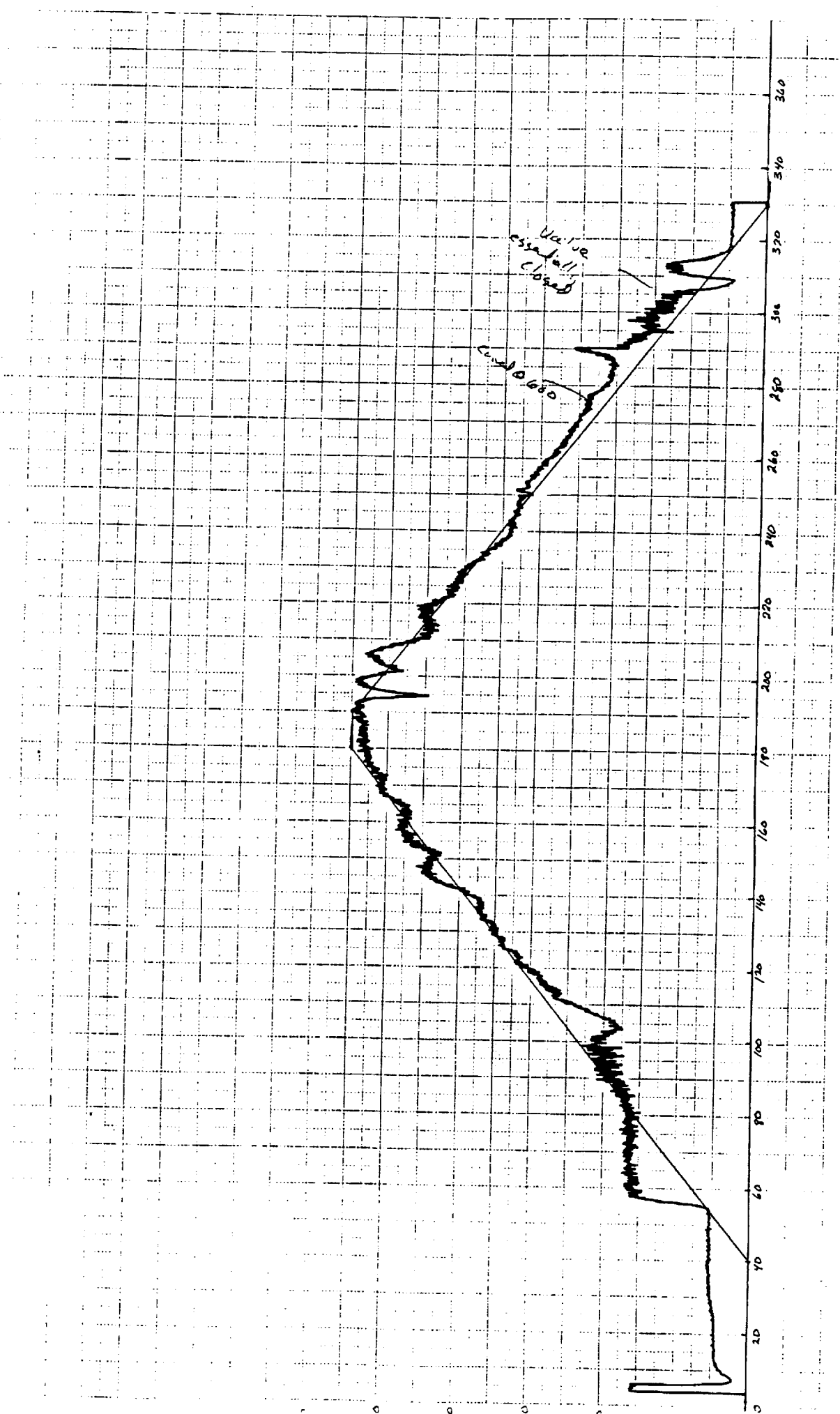

Figure 6A

ORIGINAL PAGE IS
OF POOR QUALITY

AHF 131 Trajectory #4 Following Topca1 (East)
Run 014
12/13/90
Calorimeter

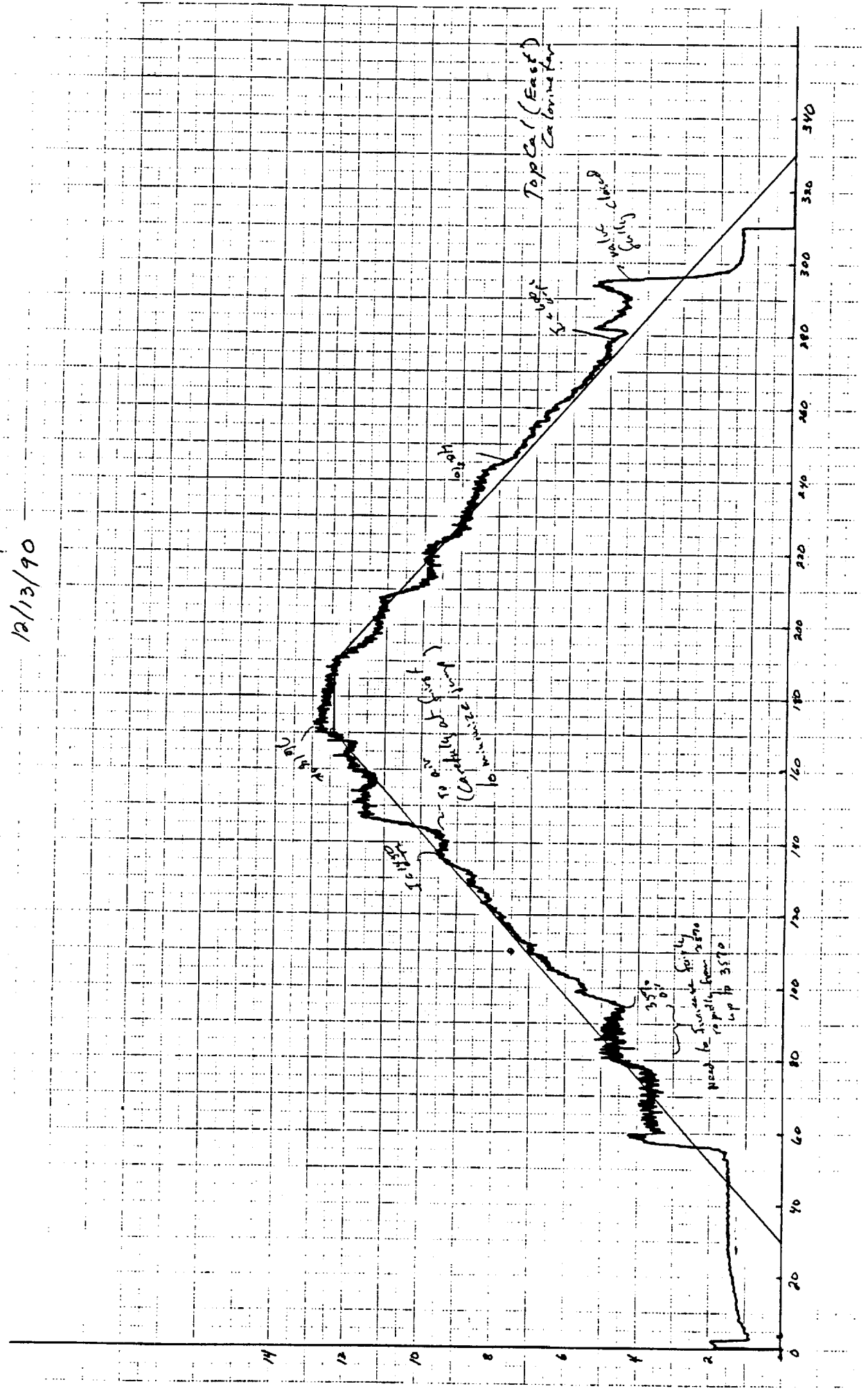
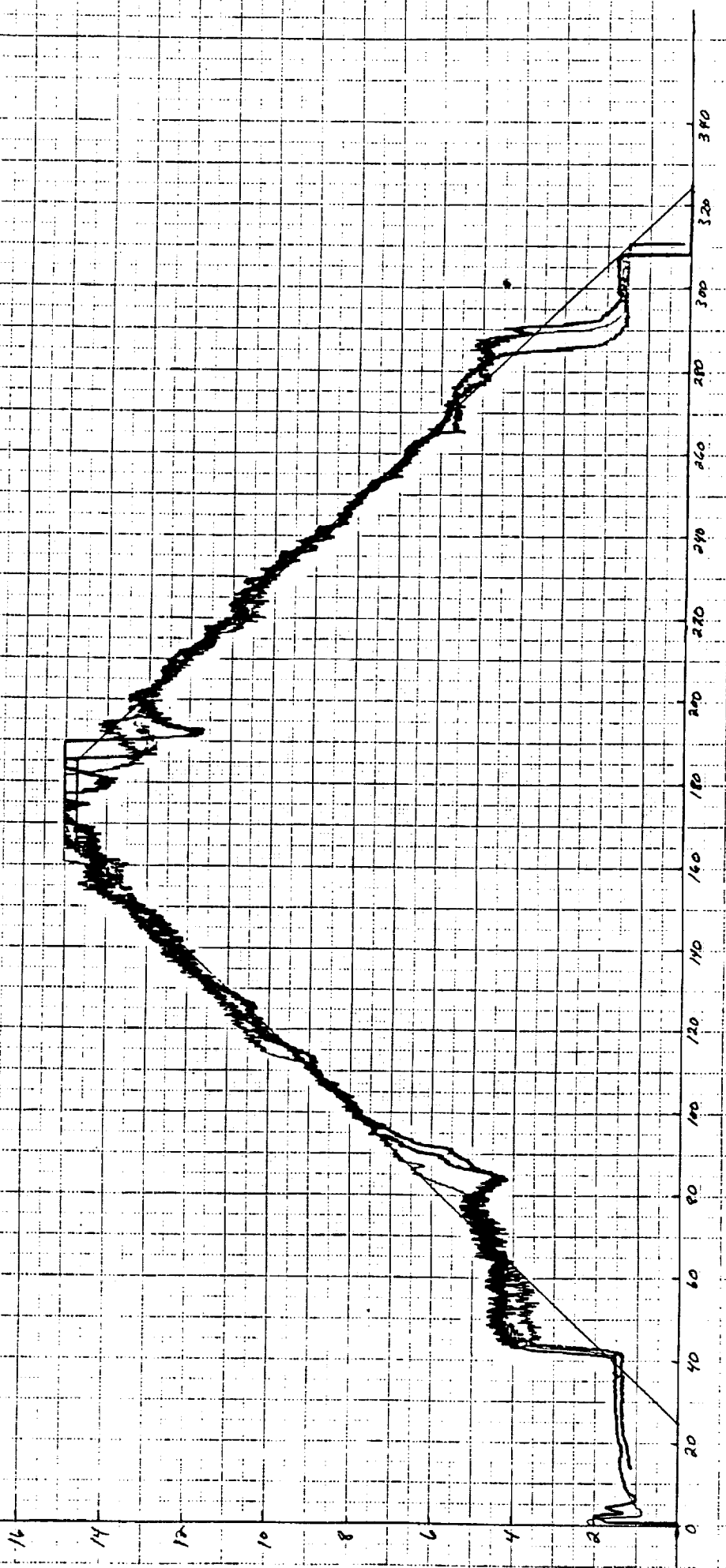

Figure 7A

ORIGINAL PAGE IS
OF POOR QUALITY

AHF 131

— Run 026 11/9/91 Topical output; Practice window assembly
 — Run 027 1/9/91 Practice #2 same assembly
 — Run 028 1/9/91 Practice #3 same assembly



ture on

ORIGINAL PAGE IS
OF POOR QUALITY

A.H.F-131
Run 037
2/21/91

Free Standing
r-plane for
maximum conditions
(Same window
as Run 36)

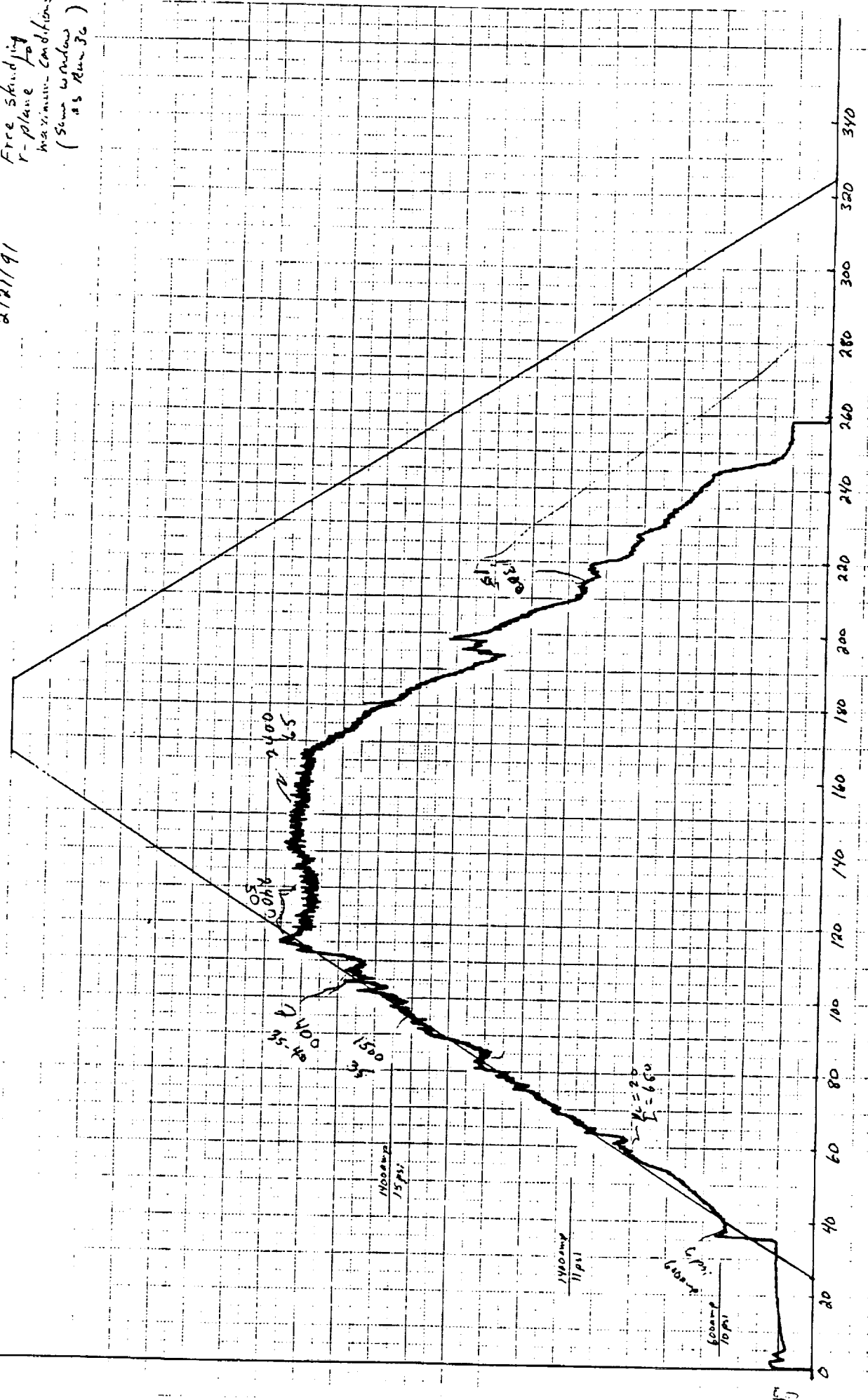

ORIGINAL PAGE IS
OF POOR QUALITY

AMF 131

Run 038

8/22/91 Free Standing Granite (Nominal trajectory)

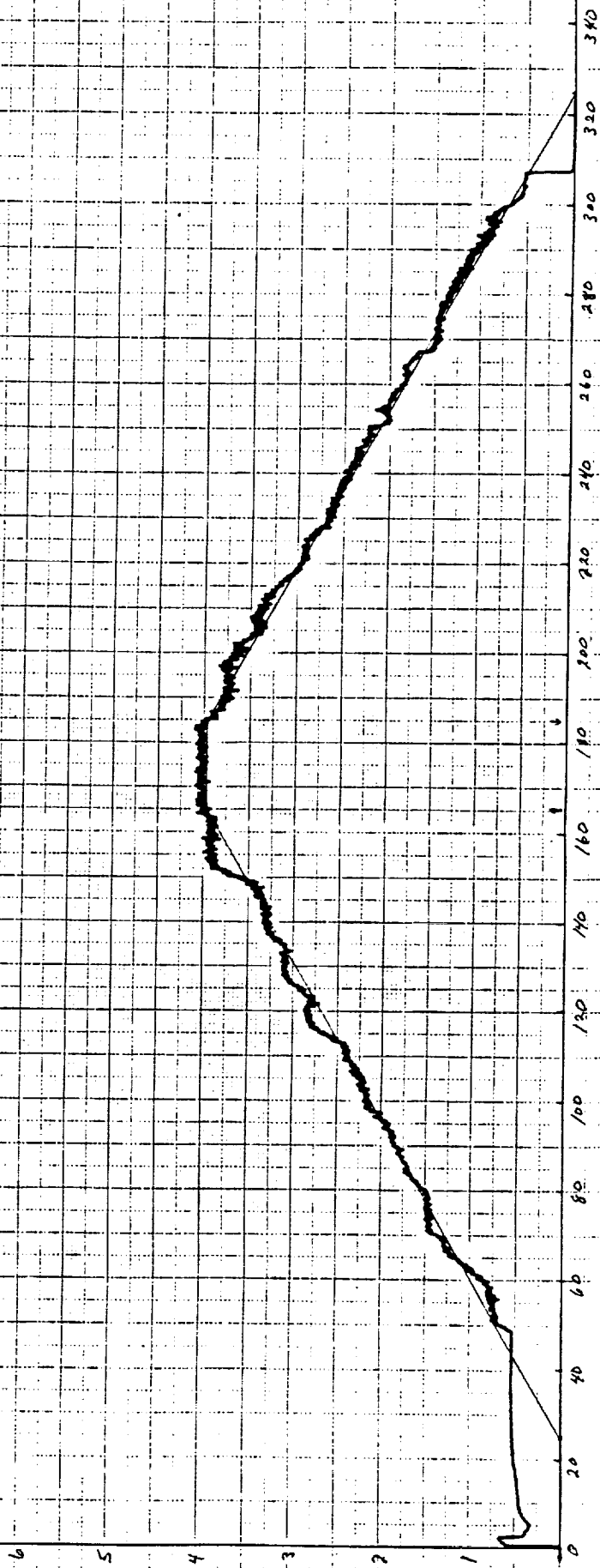

Figure 9A

Figure 10A

ORIGINAL PAGE IS
OF POOR QUALITY

AHF 131

River 039

8/22/91 Free standing granitic sediment, max conditions, thermopage 2500 unit

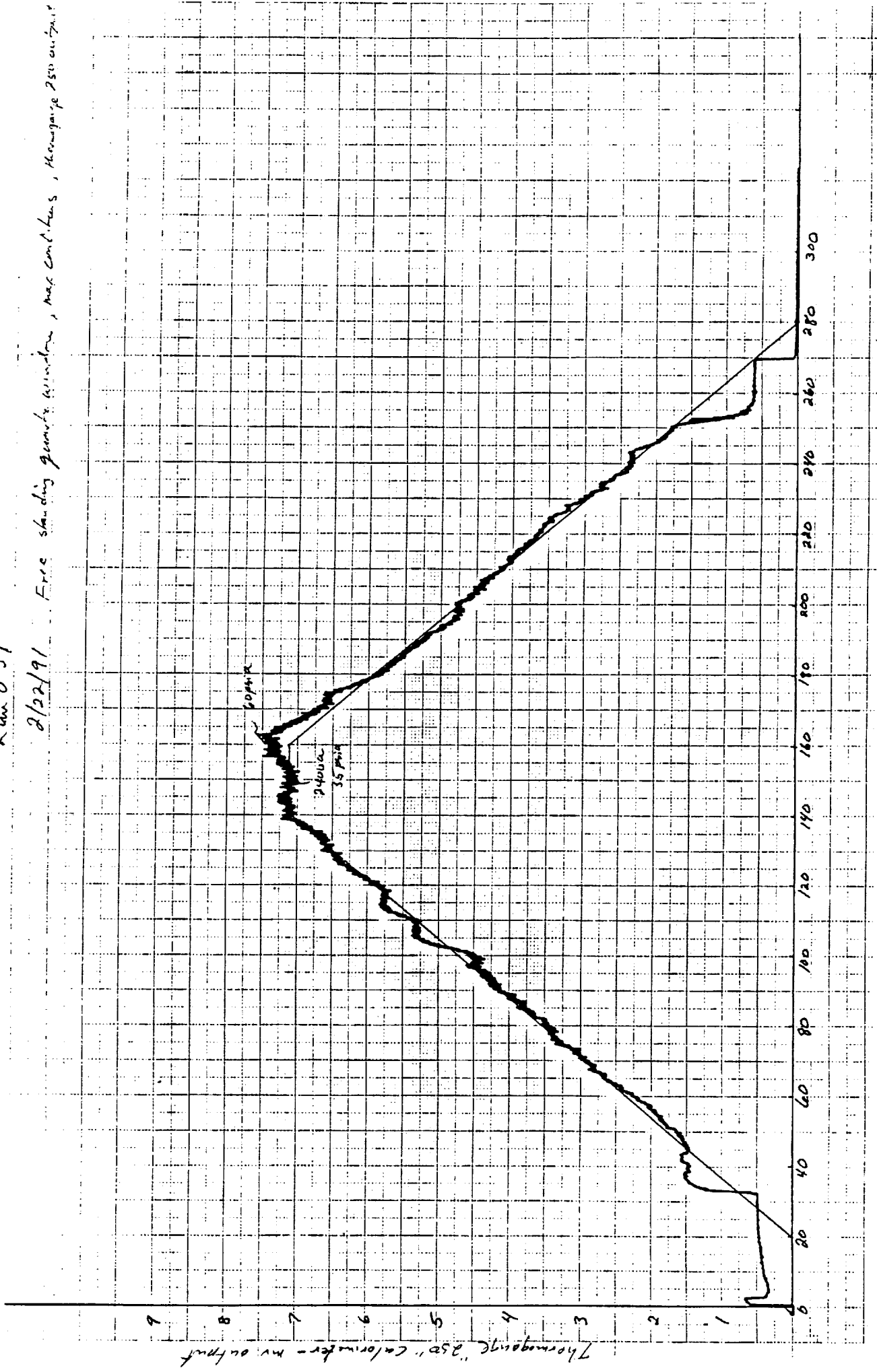

Appendix E

Materials Properties Used In SINDA Computer Program

In the following tabulation the material properties are listed in sequential pairs. The first number in each pair is the temperature and the second is the value of the property, i.e., temperature1, value1, temperature2, value2, temperature3, etc.

SAPPHIRE HEAT CAPACITY, BTU/IN**3/F

32.,.02494,212.,.03108,392.,.03513,572.,.03762,752.,.03918
1112.,.04128,1472.,.04265,1832.,.04323,2732.,.04323
3092.,.04396,3632.,.04516

QUARTZ HEAT CAPACITY, BTU/IN**3/F

80.,.014,260.,.0171,440.,.0186,620.,.0196,980.,.0209
1700.,.0226

STAINLESS STEEL HEAT CAPACITY, BTU/IN**3/F

70.,.0308,530.,.0355,971.,.0384,1342.,.0409,1842.,.0442
2240.,.0468

NIOBIUM HEAT CAPACITY, BTU/IN**3/F

32.,.0199,571.,.021,1111.,.0216,1651.,.0227,2191.,.0239

MOLYBDENUM HEAT CAPACITY, BTU/IN**3/F

80.,.0194,620.,.0233,1160.,.0249,2060.,.0274

TITANIUM HEAT CAPACITY, BTU/IN**3/F

122.,.0244,554.,.0247,842.,.0256,1238.,.0266,1688.,.0286

SILFREX HEAT CAPACITY, BTU/IN**3/F

0.,.0062,2000.,.0062

SAPPHIRE THERMAL CONDUCTIVITY, BTU/SEC/IN/F (TPRC)

32.,6.94E-4,80.3,6.16E-4,170.3,5.09E-4,260.3,4.33E-4
350.3,3.73E-4,440.3,3.24E-4,620.3,2.52E-4,800.3,2.06E-4
980.3,1.74E-4,1160.,1.54E-4,1340.,1.41E-4,2240.,.736E-4

QUARTZ THERMAL CONDUCTIVITY, BTU/SEC/IN/F

80.,.185E-4,260.,.202E-4,620.,.234E-4,980.,.289E-4
1340.,.384E-4,1700.,.535E-4

STAINLESS STEEL THERMAL CONDUCTIVITY, BTU/SEC/IN/F

32.,.2.18E-4,212.,.2.32E-4,752.,.2.55E-4,1112.,.3.01E-4
1472.,.3.47E-4,1832.,.4.17E-4

NIObIUM THERMAL CONDUCTIVITY, BTU/SEC/IN/F

80.,.7.16E-4,440.,.7.58E-4,800.,.7.99E-4,1160.,.8.39E-4
1520.,.8.8E-4,2060.,.9.4E-4

MOLYBDENUM THERMAL CONDUCTIVITY, BTU/SEC/IN/F

80.,.1.84E-3,440.,.1.73E-3,800.,.1.63E-3,1160.,.1.53E-3
1520.,.1.44E-3,2060.,.1.33E-3

CERAMIC CLOTH THERMAL CONDUCTIVITY, BTU/SEC/IN/F

392.,.169E-5,752.,.185E-5,1112.,.218E-5,1472.,.287E-5
1832.,.356E-5

TITANIUM THERMAL CONDUCTIVITY, BTU/SEC/IN/F

80.,.2.94E-4,440.,.2.64E-4,980.,.2.64E-4,1700.,.2.94E-4

AIR CONDUCTIVITY, BTU/SEC/IN/F

32.,.322E-6,391.,.495E-6,751.,.653E-6,1111.,.806E-6
1471.,.935E-6,2011.,.111E-5

SILFREX CONDUCTIVITY, BTU/SEC/IN/F

500.,.2.315E-6,1000.,.2.701E-6,1500.,.3.279E-6,2000.,.5.015E-6

ALUMINA PAPER CONDUCTIVITY, BTU/SEC/IN/F

500.,.772E-6,1000.,1.35E-6,1500.,1.929E-6,2000.,2.701E-6
2500.,3.665E-6,3000.,4.823E-6

TIME ARRAY, SEC

0.,9.9,20.,30.,40.1,50.,60.4,70.1,79.8,90.6,100.3,110.
119.7,130.3,140.2,149.9,159.8,170.5,180.4,190.1,199.7,209.5
220.2,229.9,239.5,250.5

CONVECTIVE HEATING RATE, BTU/SEC/IN**2

.0004,.0148,.0324,.0426,.0988,.158,.1973,.222,.2167,.2559
.2653,.2957,.2935,.2876,.2947,.3015,.2995,.3053,.3408,.325
.257,.2238,.2007,.1463,.1131,.0888

RADIATION HEATING RATE, BTU/SEC/IN**2

0.,0.,.00347,.00764,.0229,.0347,.04306,.0493,.050,.0493
.04514,.03264,.01875,.01458,.00972,.00556,.00139,.00069
0.,0.,0.,0.

SAPPHIRE EMISSIVITY

0.,0.62,200.,0.64,500.,0.58,1000.,0.42,1500.,0.31
2000.,0.27,2400.,0.25,4000.,0.25

SAPPHIRE-METAL EFFECTIVE EMISSIVITY

0.,.3827,200.,.3902,500.,.3671,1000.,.2958,1500.,.2366
2000.,.2126

Appendix F

General Thoughts and Insights on RHARE Arc-jet Test Data

Cooled vs. Uncooled Windows

Charlie Sobeck
March, 1991

General Thoughts and Insights on RHARE Arc-jet Test Data

Cooled vs. Uncooled Windows

Charlie Sobeck
March, 1991

Although we have generally concluded that the RHARE window cannot survive the anticipated flight environment while being conductively cooled, none-the-less, I felt a cursory review of these data was required. The following are my thoughts on the data after a contemplative half-day on the subject.

To begin with, the question that immediately begged an answer was "Was the attempt at cooling the window effective?" Earlier, in the torch test, we had measured the window backface temperature both with and without cooling, and found approximately 500°F difference between the two. But in the arc-jet facility we never measured the backface temperature of a cooled window (our goal had been to find a window which would survive, rather than to assess the effectiveness of the conductive cooling). Therefore I had to rely upon the measurements of the tube temperatures in order to assess the effectiveness of the cooling. I plotted figure 1 to illustrate the effect of window cooling on the tube temperatures. As expected, when applying cooling to the window, the tube temperatures increased. I attribute this to the increased heat load applied to the tube through the window. Both the temperature and temperature difference between the fore- and aft-tube increased, indicating that the additional heat load was being applied at the front of the tube.

Although, all my conclusions are qualitative here, I believe that a quantitative assessment of this data would be useful. It should be possible, using Scott Maa's thermal model, to estimate the heat load to the tube under these two conditions. The difference between these values would be the heat removed from the window (I assume that the arc-jet conditions are comparable, an assumption that appears reasonable based on my review of the data. The data from which figure 1 was derived were from runs 25 and 26.), and this would be a lower limit for the heat input to the window. Should we ever determine the actual heat load to the window, it would be interesting to see to what levels it could reasonably be reduced.

In runs 26, 27 and 28, the tube temperatures of an isolated window were measured with very good agreement, lending confidence that these data were reasonable representative for such a configuration. But what of the data for the cooled configuration? During the course of testing, we tried several different cooled window configurations in an attempt to balance the thermal stresses. One might therefore reasonably expect that the tube temperatures would vary somewhat with the changing configurations.

To test this expectation I then superimposed all the tube temperatures measured during a cooled window run, adjusting the time offset of the data such that all the curves peaked at the same time. The result was the confused mess found in figure 2. This figure shows considerably less order than I had expected (even on a color monitor it's a mess). This lack of order, however, may be enlightening. There were six thermocouples installed in the tube, two layers of three thermocouple each, equally spaced circumferentially. In figure 1 it is clear that each layer of thermocouples in the isolated window configuration, is self-consistent. This is true in all the other isolated window runs as well. However, in the case of the cooled configurations this is dramatically *not* true! Figure 3 is presented as an

example (albeit a worst-case). I will return to this issue shortly, but in the meantime, to be chronological; Disappointed in the reality of figure 2, I re-plotted the figure, eliminating the data from the aft-tube thermocouples. Surely this would be less confusing. Hardly. Figure 4 is the result. It is better, but not by much. To make sense out of this data I eventually had to generate figure 5 which plots the fore-tube data averaged by arc-jet run. This eliminates the circumferential asymmetry in the data, and I believe reasonably reflects the variability due to the different cooling configurations. As expected, there is significant variability. That is, over the course of the testing we extracted more or less heat in any given run. As one would further expect, the trend here is that we extracted more heat in the early runs and less in later ones. Figure 6 is the same data, with the isolated window configuration results superimposed. As you would expect, this represents a limiting case.

In figures 7 and 8, I repeated the process for the aft-tube temperature measurements. There is much less data from this tier of thermocouples, most of the thermocouples must have failed early in the arc-jet testing. But generally the data agrees with the fore-tube measurements. (Interestingly, run 30 shows a lower aft-tube temperature than the isolated case, although the fore-tube temperature was somewhat higher. Perhaps there was better thermal contact between the window assembly and the brass backplate of the test fixture during this run.) Because there is at most only one aft-tier thermocouple functioning during the cooled window tests, it is not possible to explore the circumferential asymmetry at this level.

In my perusal of the data, I found that the choice of spring material (either titanium or molybdenum) had surprisingly little impact on the apparent amount of heat extracted from the window (contrary to my expectation). Rather, the tube temperatures were more strongly influenced by the backplate to tube interface, a good contact pulling heat strongly, alumina paper reducing it, and an air gap reducing it further. Run 31 is an anomaly to this rule. This run had good contact at this interface, and yet showed very low fore-tube temperatures. Unfortunately, although the calorimeter data shows no apparent deviations during the run, neither aft-tube, nor tile surface temperature data is available from the run. I have no explanation.

But let me return to the asymmetry. From the data, I have to conclude that the asymmetry is truly there. It appears, to some degree, in all the cooled window runs. As a result, I have to give greater credence to the Martin Marietta claim that our mechanical thermal links are not sufficiently reliable. We did not instrument the window backface, so have no direct measurement of the temperature variation across the window face, but figure 3 shows a fore-tube temperature variation of greater than 150°F, and I believe that it would be reasonable to expect even greater differences in the window itself.

There is surely more to learn from the data (especially by adding the translated test data into the equation), and the data presented here is but a small subset of the data we actually acquired. But it is a good object lesson, and I hope that I have managed to ferret out some of the more interesting points. I would like to thank Imelda for showing me how to use KaleidaGraph, without the speed of which, I would never have had the time to wade through all the data. I am grateful to Roger also, for the Mac at home which allowed me to process this data in the evening (data processing, I've found, does not interfere with the watching of today's television shows). Finally, I found Lou's arc-jet test matrix an enormous help in identifying the various runs, their relation to each other and the configuration under test.

Figure 1

Window Tube Temperatures

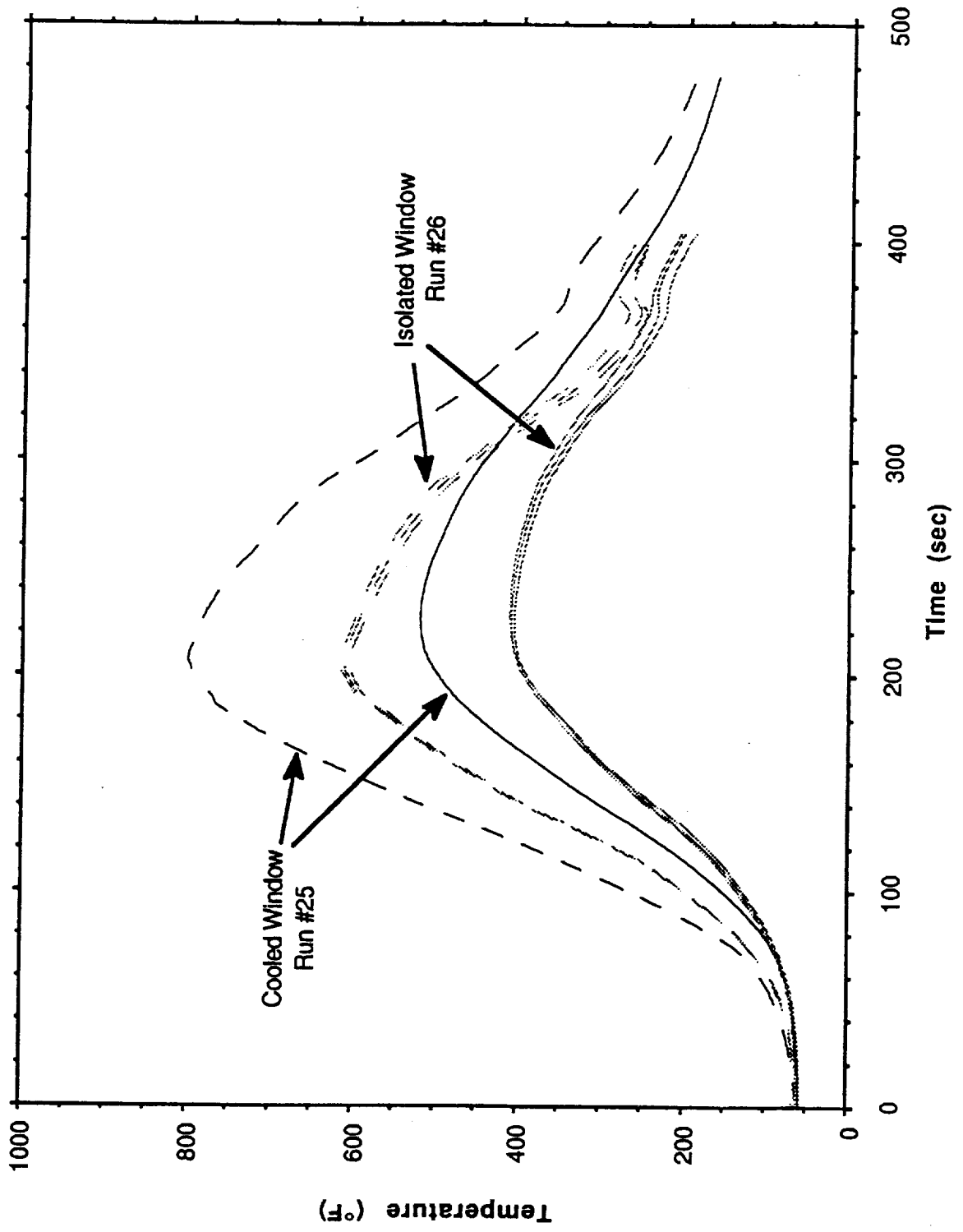

Figure 2

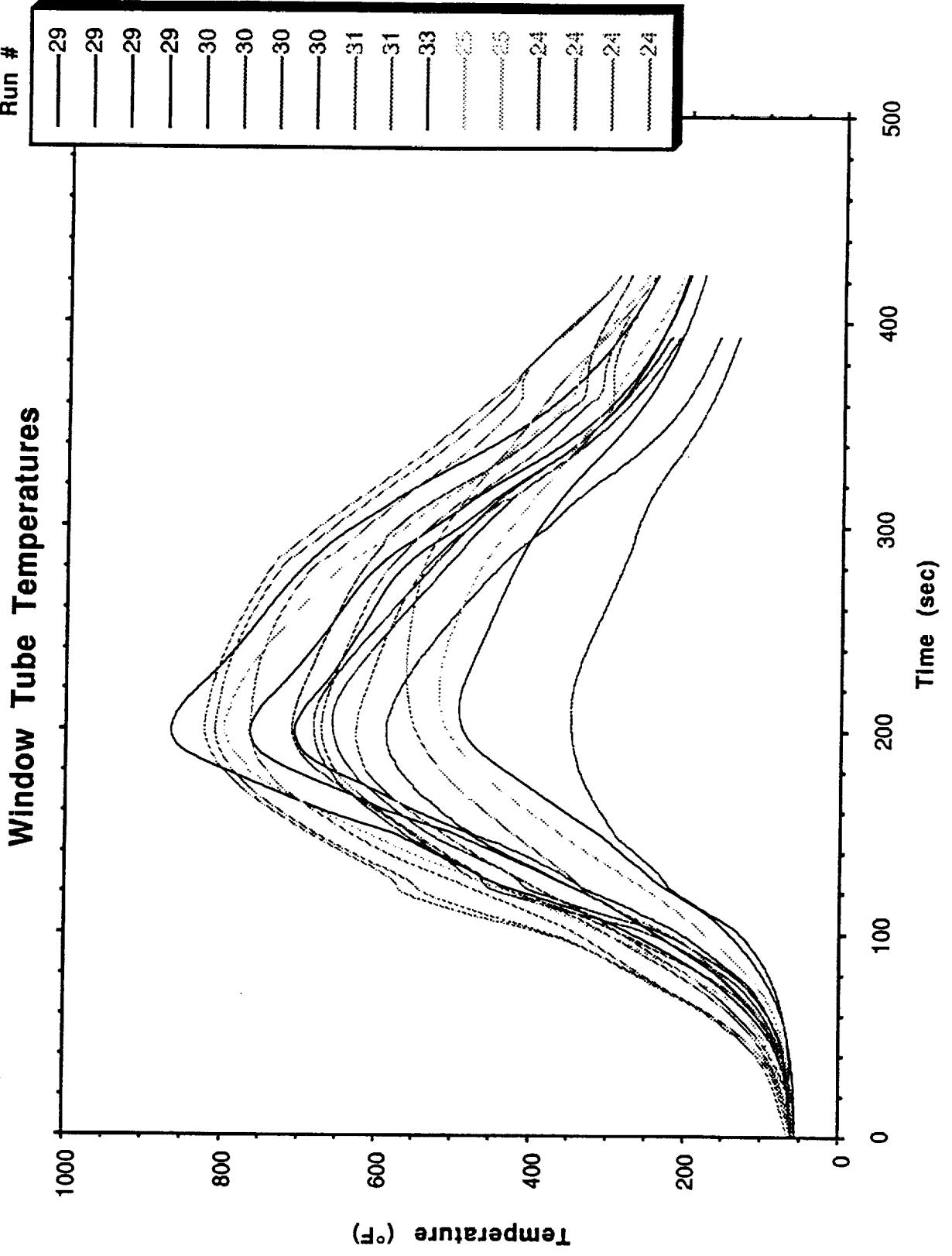

Figure 3

Window Tube Temperatures
Test: 131 Run: 029

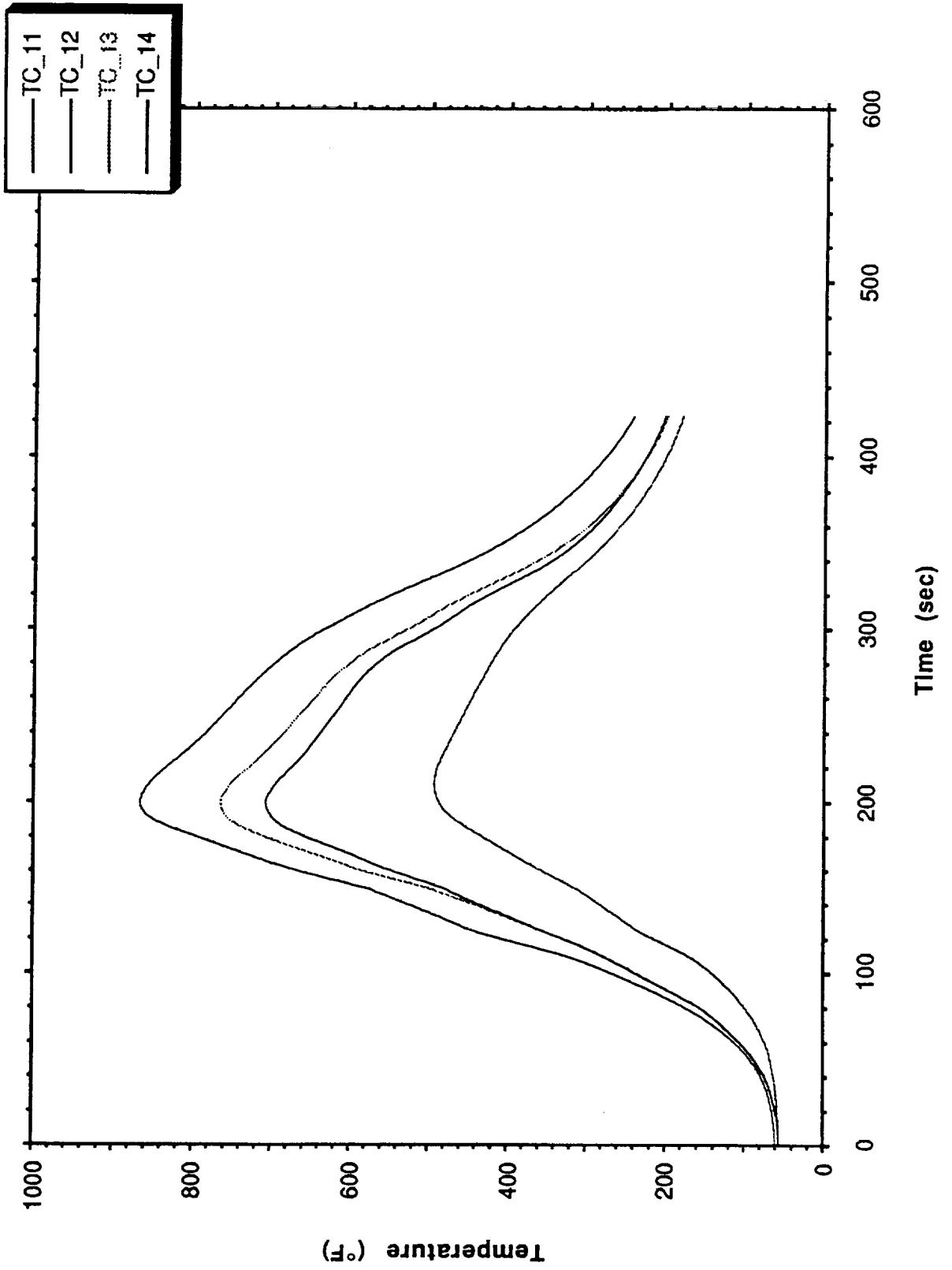

Figure 4

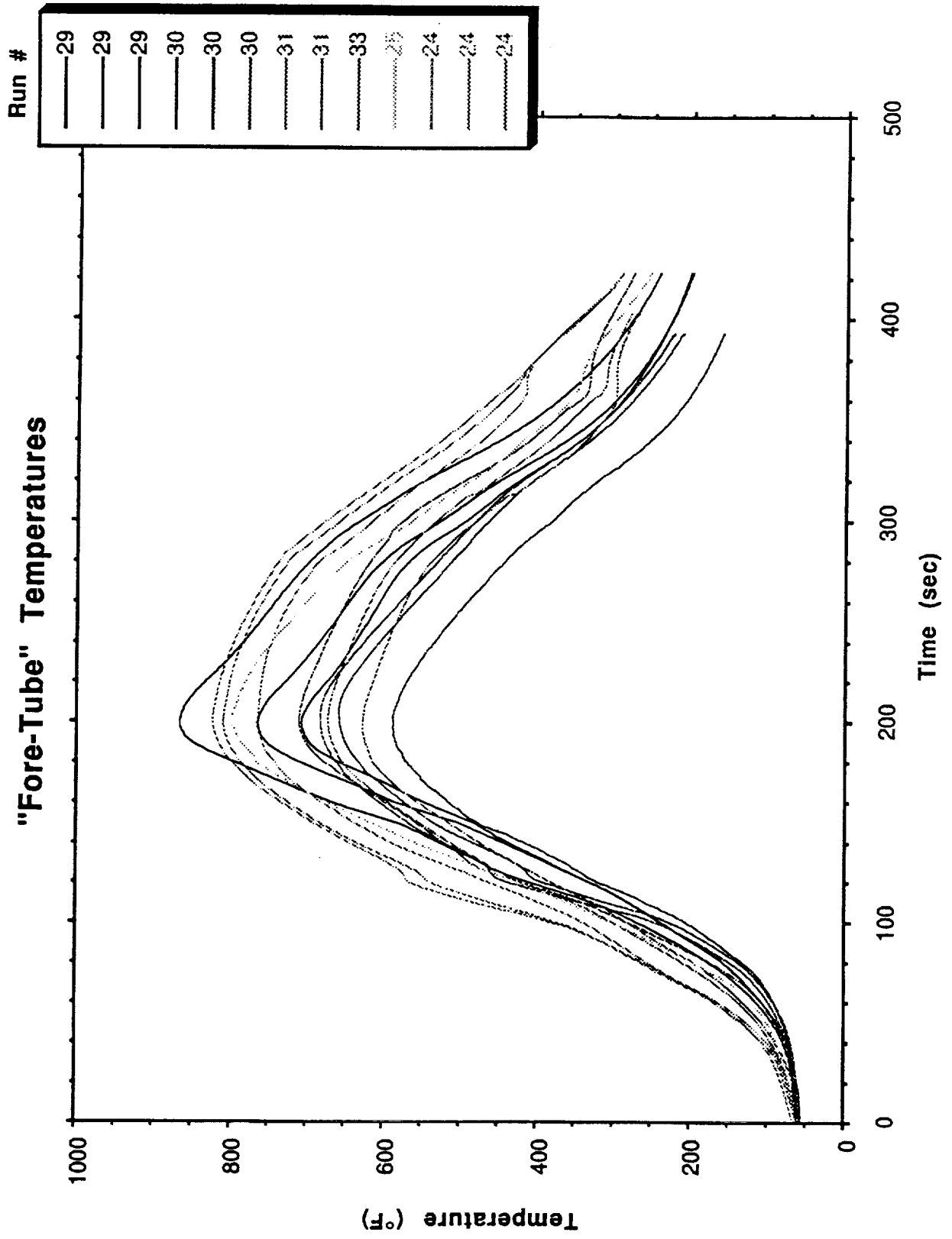

Figure 5

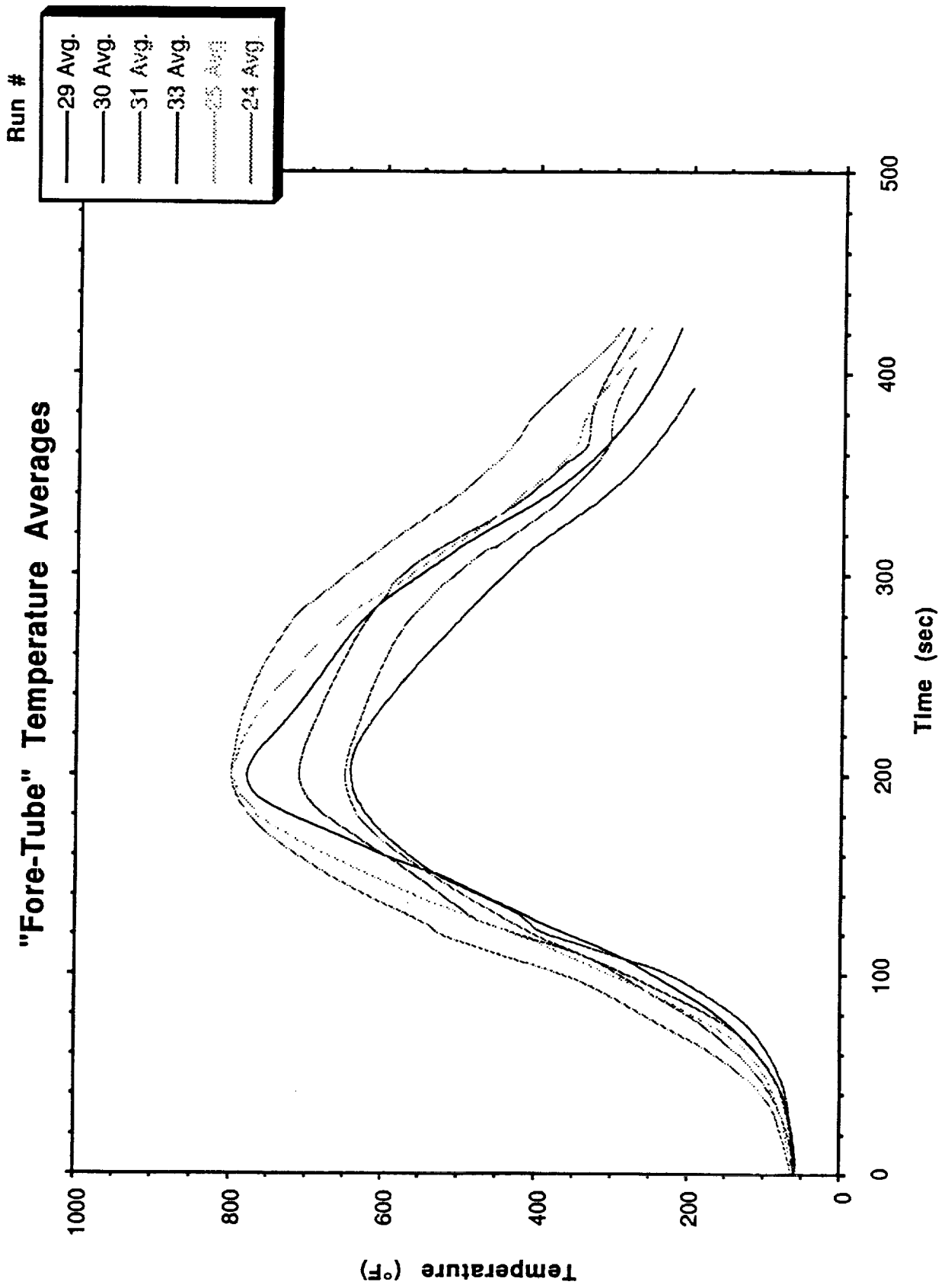

Figure 6

"Fore-Tube" Temperature Averages
Cooled Runs vs. Isolated Window Average

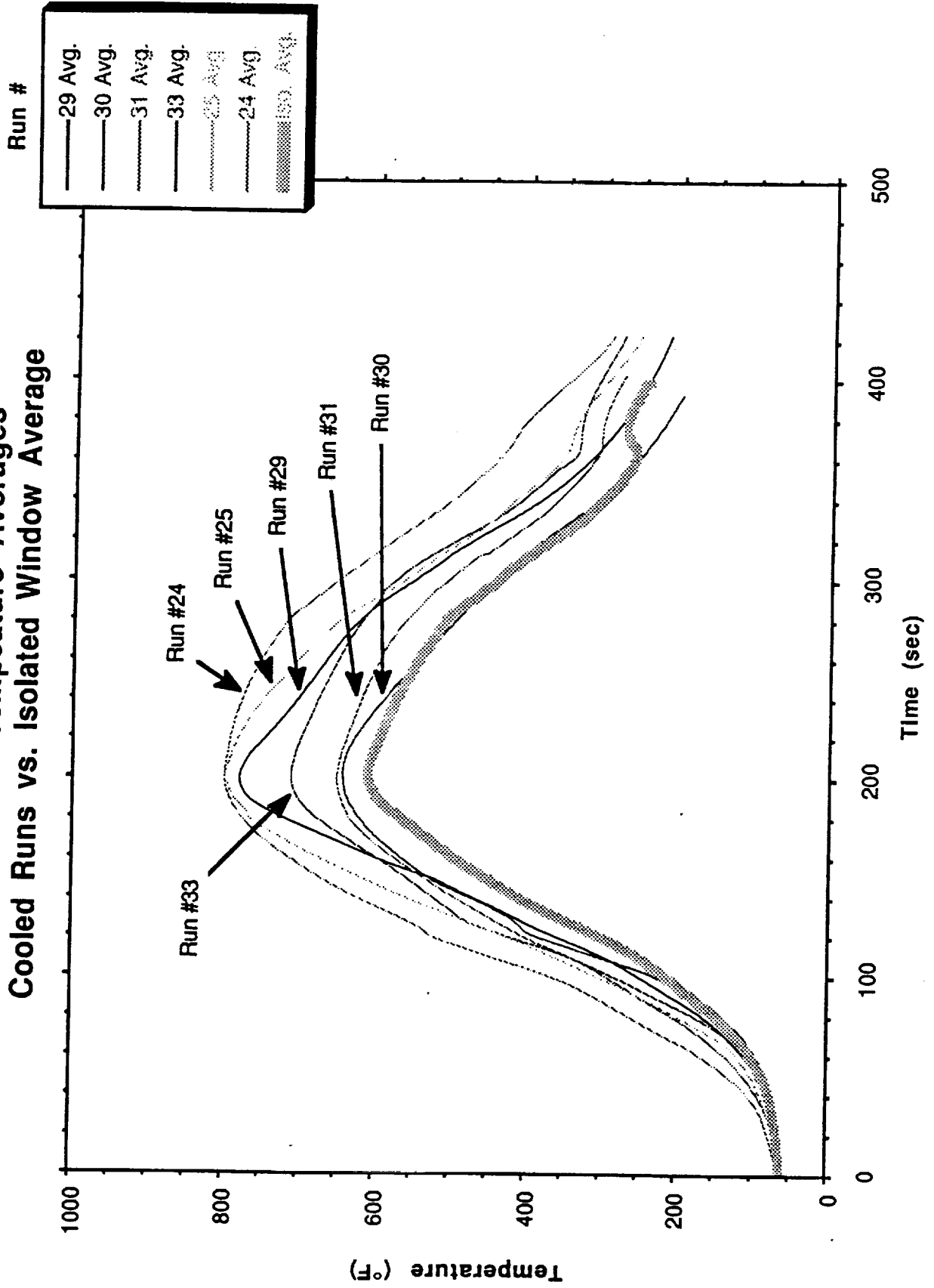

Figure 7

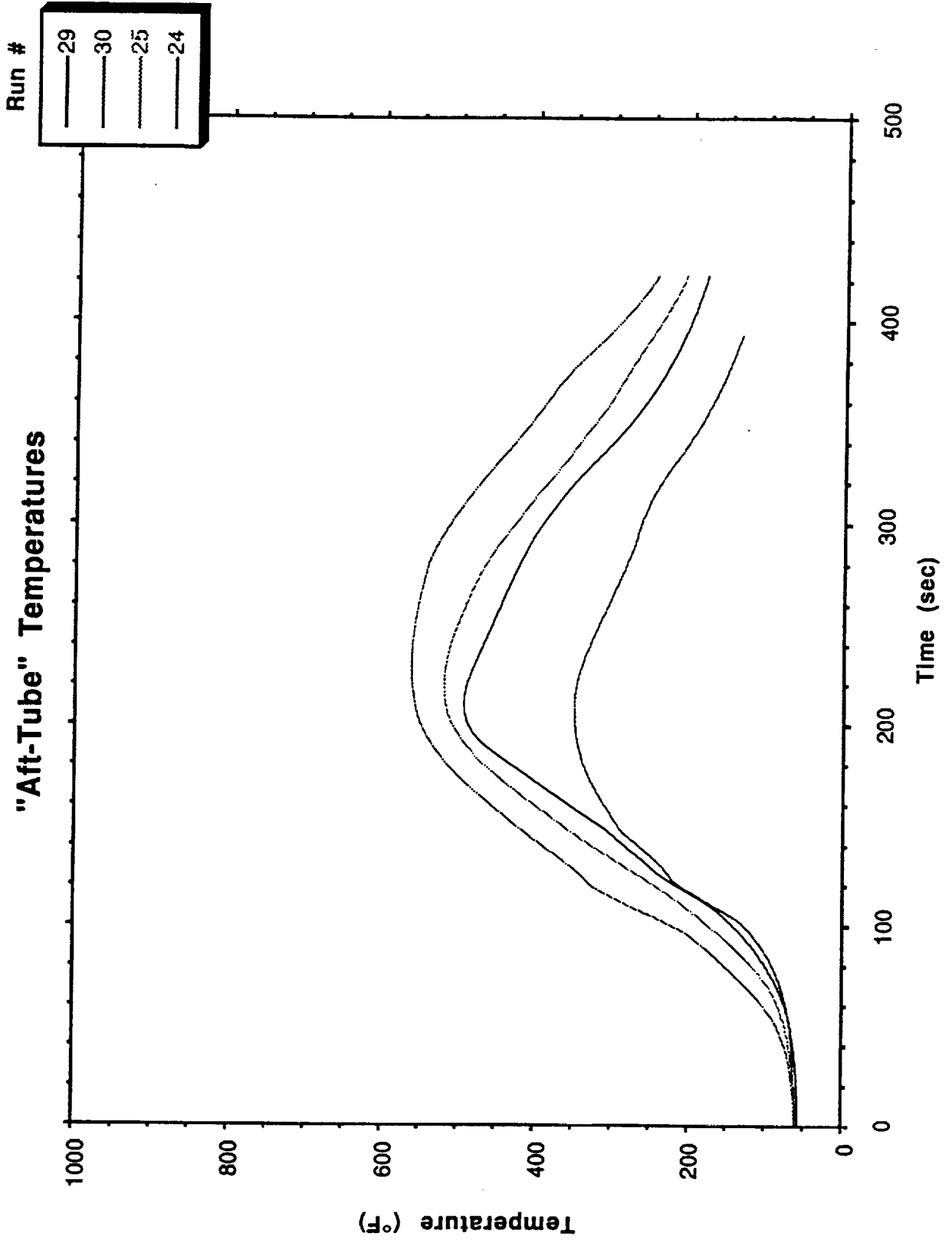
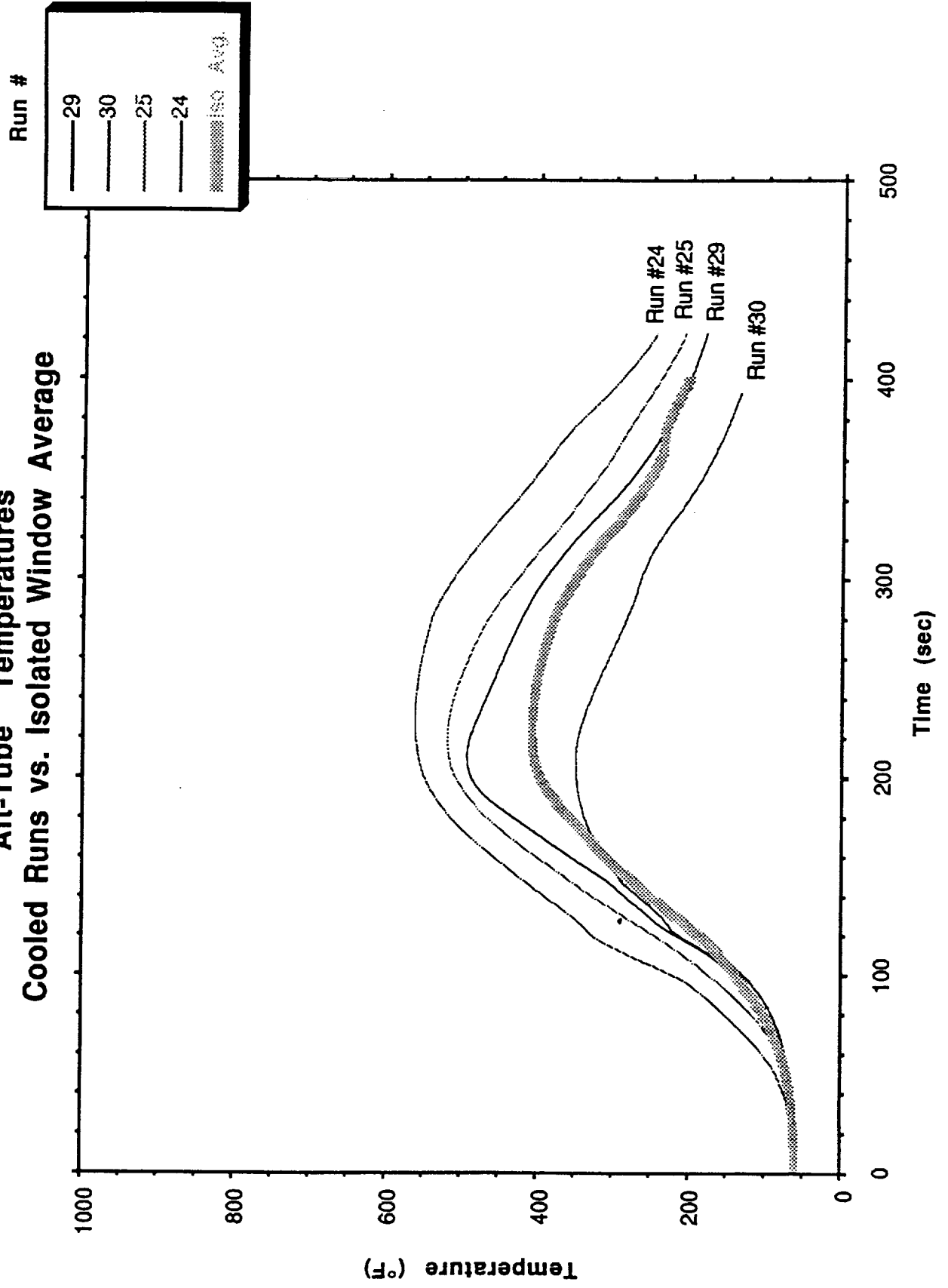

Figure 8

"Aft-Tube" Temperatures
Cooled Runs vs. Isolated Window Average



Appendix G

Analysis of Test 26 for Catalysity of Sapphire

Al Covington