

EXACT RECONSTRUCTION ANALYSIS/SYNTHESIS FILTER BANKS WITH TIME-VARYING FILTERS

J. L. Arrowood Jr. and M. J. T. Smith

School of Electrical Engineering
 Georgia Institute of Technology
 Atlanta, GA 30332

ABSTRACT

This paper examines some of the analysis/synthesis issues associated with FIR time-varying filter banks where the filter bank coefficients are allowed to change in response to the input signal. Several issues are identified as being important in order to realize performance gains from time-varying filter banks in image coding applications. These issues relate to the behavior of the filters as transition from one set of filter banks to another occurs.

Lattice structure formulations for the time varying filter bank problem are introduced and discussed in terms of their properties and transition characteristics.

1. INTRODUCTION

Subband coding is of great interest within the signal processing research community and is being studied from many different perspectives. Several important components are involved and are receiving attention. The two most notable are the analysis/synthesis system, which performs the frequency band splitting, and the encoding section, where the bands are quantized and coded. Most of the analysis/synthesis work has been focused on filter banks where the analysis and synthesis filters are fixed for the duration of the system's operation. In ICASSP92, time-varying filter banks were introduced in which the analysis and synthesis filters were allowed to change as a function of time [1].

Implementing these time-varying systems is not the trivial problem of just switching between two sets of filters on both the analysis and synthesis sides of the filter bank structure. The transition between two (or more) sets of perfect reconstruction filter banks provides a challenging reconstruction problem, since in general distortion is introduced by this process. The solution to this time-varying reconstruction problem presented in [1] involves designing multiple sets of synthesis filters that are applied while the analysis filter bank alternates between two sets of filters on the analysis side of the structure [1]. It was demonstrated that exact reconstruction could be achieved in this situation if the filters were designed properly. This was accomplished by using time domain reconstruction equations to design a set of transition synthesis filters that compensate for dis-

tortion during the switch from one set of analysis filters to another.

In [2], the application of FIR time-varying filter banks to coding images was considered. The problem addressed was the well-known inability of conventional filter banks to accurately preserve edge characteristics at low coding rates. In particular, when images are coded at low bit rates, ringing distortion at object edges is often observed. This is due to the step response characteristics of the analysis/synthesis filters and is a consequence of their having good magnitude response properties. If filters with monotonic step response characteristics are used (which precludes their having good magnitude response characteristics) aliasing distortion becomes very visible. Time-varying filter banks have the ability to simultaneously reduce the aliasing distortion and ringing distortion at low bit rates. As discussed in [2], this can be done by switching back and forth between analysis filters with different spectral and temporal (step response) characteristics such that in regions where no major transitions occur, the filter set with good magnitude response characteristics is used. When transition regions or object edges are encountered, the system switches to the filter set with good step response properties.

The time-domain formulation of the problem [1] is such that each switch in analysis filters requires that many synthesis filters be applied sequentially. If we consider the case with 16-tap filters and assume that we are free to switch back and forth between analysis filters without restriction, 256 synthesis filters are necessary to exactly reconstruct the input, all of which are interdependent. To reduce the severity of this problem, constraints were imposed on the frequency in which the filters could be alternated. Even with this, 46 synthesis filters were needed to guarantee exact reconstruction. The large number of synthesis filters can make it difficult to design the system since all filters are designed together.

The lattice formulation which is introduced in the next section utilizes a structure that guarantees exact reconstruction in the presence of changing filter coefficients. This approach has the advantage of avoiding the problem of having to maintain large sets of synthesis reconstruction filters. However, these transition areas can be troublesome for coding applications, and care must be taken as to what method is used when switching between sets of coefficients as discussed in the subsequent sections.

This work is supported in part by the National Science Foundation under contract MIP-9116113 and the National Aeronautics and Space Administration.

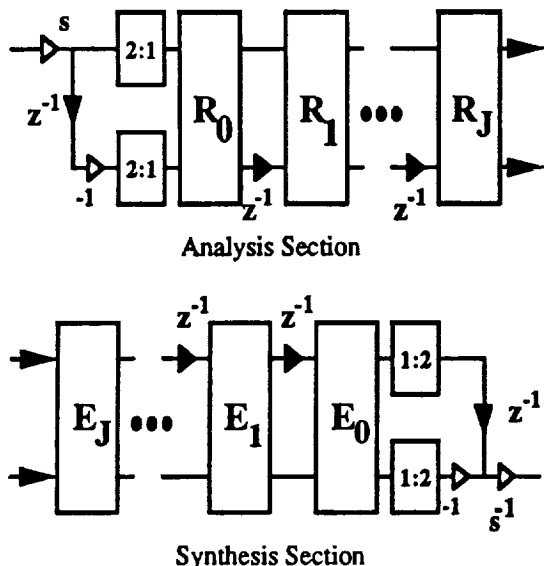

Figure 1: Efficient lattice implementation.

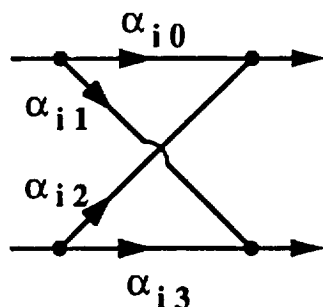

Figure 2: Implementation of R_i .

2. TIME-VARYING, LATTICE-BASED FIR FILTER BANKS

The lattice structure for two channel conventional FIR filter banks can achieve exact reconstruction in the absence of coding [3]. This structure can be applied to time-varying filter banks as well. In the following derivation, we consider the general case as well as some more specific cases for example. Figure 1 shows the general structure needed to set up the lattice based FIR filter bank. For each of the lattice stages the following holds:

$$R_i = \begin{bmatrix} \alpha_{i0} & \alpha_{i2} \\ \alpha_{i1} & \alpha_{i3} \end{bmatrix}$$

$$E_i = R_i^{-1}$$

Figure 2 shows how this matrix is implemented to form the lattice. The difference in the lattice shown here and the one commonly presented in literature is that the actual inverse of R_i is used for E_i , instead of the transpose. This maintains the perfect reconstruction property when the lattices

are being exchanged to form the time-varying structure by ensuring that the following always holds:

$$R_i \times E_i = I$$

where I is the identity matrix. The overall structure can be made time-varying at this juncture simply by allowing any or all of the matrices, R_i , to change as a function of time. As long as the corresponding E_i also changes at the appropriate time in the synthesis section, the overall structure remains perfectly reconstructing.

It is important that the switch in the synthesis section take place at the correct time given a change in the analysis portion of the structure. First, the implementation in Figure 1 specifies the number of lattice stages at $J+1$, leading to filters of length $N = 2 \times (J+1)$ being produced. Furthermore, this implementation requires that if the matrix R_i is switched out with a new matrix, r_i at time n_0 , one needs to change the lattice matrix E_i to e_i (the inverse of r_i) at the time $n_0 + (J-i)$. The delay is necessary due to the delays found between lattice matrices. Changing out synthesis lattices with respect to analysis lattices in this fashion will maintain the PR (perfect reconstruction) property of the system, while allowing the filters "built" by the subsequent implementation of the lattices to change.

For the case where the matrices are unitary, and real coefficients are used, a more efficient implementation can be used. Here the matrices R_i are given by:

$$R_i = \begin{bmatrix} 1 & \alpha_i \\ -\alpha_i & 1 \end{bmatrix}$$

The paraunitary nature of the filter bank forces the impulse response coefficients of the filter bank to be related as:

$$h_1[n] = (-1)^n h_0[(N-1)-n]$$

$$g_0[n] = h_0[(N-1)-n]$$

$$g_1[n] = h_1[(N-1)-n]$$

where N is the length of the filters created and g_0 and g_1 are the corresponding synthesis filters. It should be mentioned here that the above equations hold only for regions where the filters are stationary—transition filters will not necessarily maintain the above properties. Note also that the length of each of the filters is $2(J+1)$ and that all four filters are expressible uniquely in terms of $\alpha_0, \dots, \alpha_J$.

From the discussion above, it is easy to gather that a different set of four filters can be implemented simply by specifying a new set of $J+1$ lattice coefficients. If these new coefficients are specified as β_0, \dots, β_J , one needs only to develop a reasonable method for changing from the α 's to the β 's and vice versa in order to implement a time-varying filter bank that can switch between two sets of analysis/synthesis filters.

The transition between the two sets must be done with care, since it is important that the impulse response of the transition filters provide a relatively smooth change in going from one set to the other. The type of method used should depend on the type of filters being interchanged. Obviously, filter sets that are similar in nature, and thus have similar coefficients, are easier to switch between than filters that are markedly different. One method for switching between the

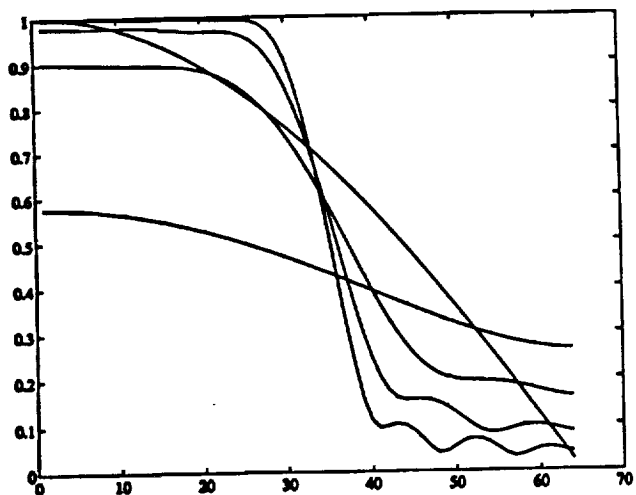

Figure 3: Lattice transitional filters produced when the cascade method is used.

two that provides decent results comes from the paraitary property of the lattice itself. Assume, for example, that the transition is being made between the filter set based on the α 's to the one based on the β 's. The first step, at time n_0 , would be to "turn off" α_j through α_1 , replacing each coefficient with a zero, while at the same time replacing α_0 with β_0 . The remaining β 's are "turned on" in a cascade fashion, with β_1 being turned on at time n_1 , then β_2 at time n_2 and so on, until all of the lattice stages are functioning with the new coefficients. This simple procedure will keep the transitions somewhat smooth, for many cases. This same procedure will work in the opposite direction, when the coefficients are switched from the β 's to the α 's. Figure 3 shows some of the transition filters produced when the system goes from a broad to a sharp filter using the cascade method described above. For Figure 4, a change is made between the same two sets of coefficient, except that all of the coefficients were swapped out simultaneously, with the result being the poor transition filters that are seen. Thus, care should be taken when implementing the time-varying structure using the lattice approach, since the transition filters may not automatically turn out to be desirable.

A comparison can also be made with respect to the time-domain formulation versus the lattice structure in terms of the transition filter quality. Figure 5 displays several of the transition filters that must be used, and therefore stored, in the synthesis side of the filter bank implemented using the methods discussed in [1]. Figure 6 shows what happens in the same region for the lattice structure, with the difference being that the lattice structure only requires the methodical swapping out of two sets of coefficients.

3. APPLICATION TO SUBBAND IMAGE CODING

The time-varying FIR analysis/synthesis system can be used in a subband image coder to reduce the effects of aliasing

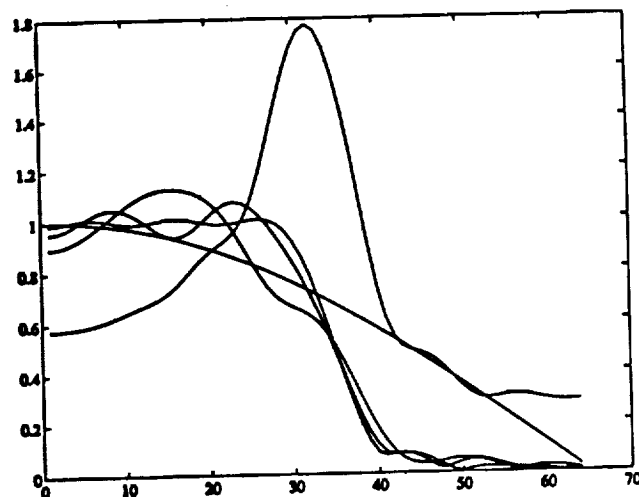

Figure 4: Lattice transitional filters produced without using a cascade.

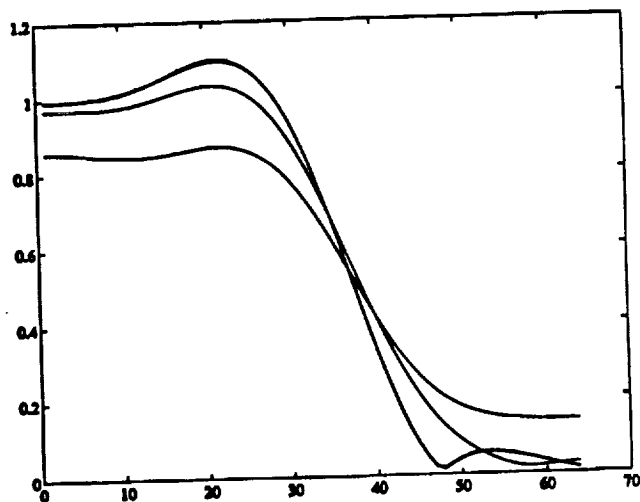

Figure 5: Time-domain formulation synthesis transition filters.

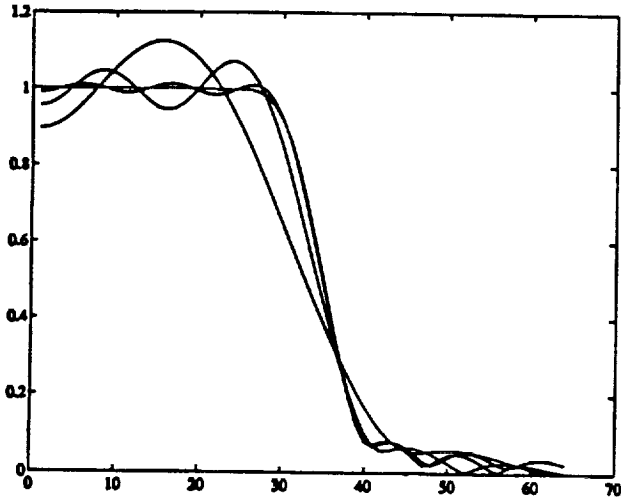

Figure 6: Lattice implementation synthesis transition filters.

and ringing distortion. The approach considered here involves a separable implementation of the analysis/synthesis system in which the rows are split first with the filter bank and then the columns of the result are split to form four subband images. The band splitting can be continued until the desired number of subband images is obtained. As with conventional subband coders, the bits are allocated according to the importance of each individual subband. For natural images, the low frequency subband images are most important and the high frequency ones are less important. Thus at low rates, information in the high frequency bands is often lost completely.

As an example of the possibilities of the time-varying structure, consider the image example found in Figure 7. For this figure the top portion was used as input to both a standard, non-time-varying system and to a time-varying system based on the time-domain formulation. The subband outputs were quantized. The low frequency channel was represented with 5 bit uniform quantization. The high frequency channel represented with only 3 bits. Clearly, the ringing, evidenced by the varying bands of shading, is reduced in the time-varying case with respect to the output of the standard filter bank.

4. CLOSING COMMENTS

The idea of time-varying filter banks is still very new and much remains to be understood before the full potential of this approach is realized. An important aspect of the problem which has not been studied sufficiently at this time is the design of an adaptation strategy that reflects both the analysis and transition synthesis filter characteristics. In homogeneous regions of the input image, filter banks with good magnitude response characteristics are known to work well and should be used. When an object edge is encountered, analysis and synthesis filters with good step response characteristics are desirable to avoid ringing distortion. The

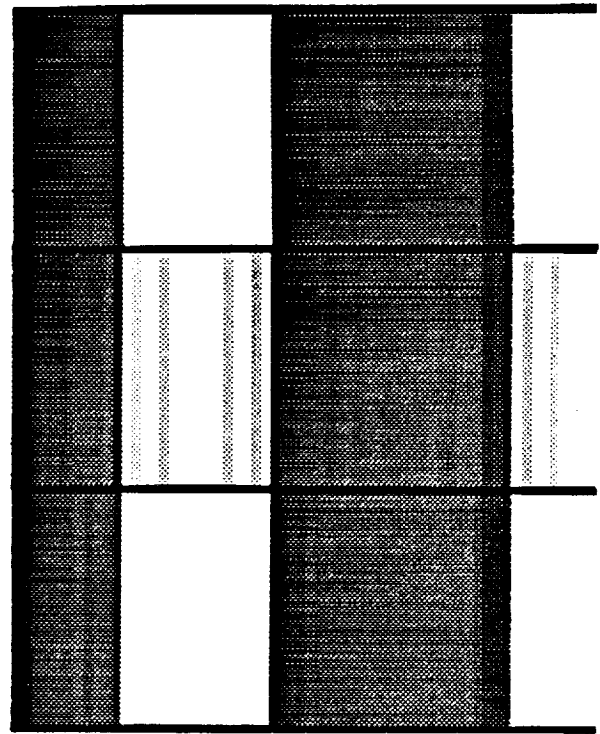

Figure 7: Image comparison for standard versus time-varying filter bank systems.

problem is that after a change in analysis filters, a sequence of synthesis filters follows. Unlike the analysis filter sets which are changed directly to match step and magnitude responses to the input, this flexibility is not present in selecting the synthesis filter sets. It is expected that better results are possible with an adaptation strategy and design procedure that allow both analysis and synthesis filter characteristics to be optimized to the input signal. These issues are currently being examined. Some examples of coded images will be presented at the conference that reflect our latest efforts in this direction.

5. REFERENCES

- [1] K. Nayebi, M. J. T. Smith and T. P. Barnwell, "Analysis-Synthesis Systems Based on Time Varying Filter Banks," *ICASSP* March 1992, pages 617-620.
- [2] J. L. Arrowood and M. J. T. Smith, "Gibbs Phenomenon Suppression Using FIR Time-Varying Filter Banks," *IEEE DSP Workshop*, September 13-16, 1992, Utica, Illinois.
- [3] P. P. Vaidyanathan, *Multirate Systems and Filter Banks*, Prentice Hall, Englewood Cliffs, NJ, 1993.