

N 9 4 - 2 2 3 5 9

**ROBUST UNSTRUCTURED GRID
GENERATION WITH VGRID**

**SHAHYAR PIRZADEH
ViGYAN, INC.**

Outline

- Objective and scope of present work
- Methodology
- Applications
- Concluding remarks

Scope of Present Work

- Objective:
to develop a **robust, user oriented** unstructured grid-generation technique for **fast** generation of Euler/viscous grids around 2D/3D **complex** configurations
- Approach:
 - **Advancing-Front** method for generation of Euler grids (established technique)
 - **Advancing-Layers** method for generation of viscous grids (work in progress)

Advancing-Front Method

- Salient features:
 - grid quality
 - robustness
 - self-sufficiency for grid point distribution
 - established methodology (especially in 3D)
- Recent developments resulting in substantial enhancement of AFM :
 - structured background grids with source elements
(AIAA Journal, Feb. 1993)
 - grid restart capability
 - local remeshing } grid post-processing
(AIAA paper 92-0445)

Advancing Front Method

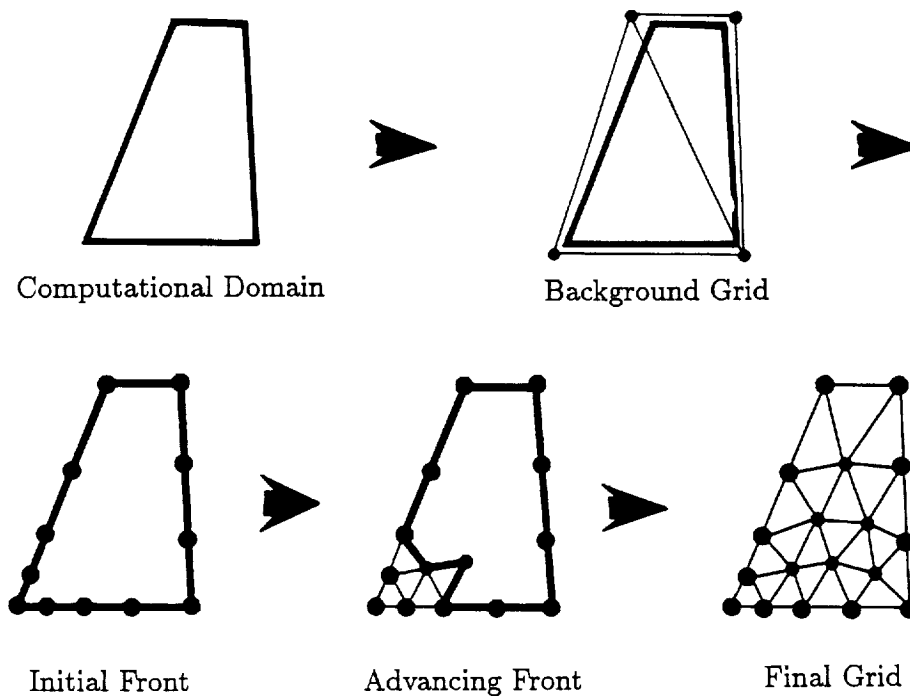

Background Grids

- A secondary mesh containing grid characteristic information
 - need not conform to the domain boundaries
 - integral to the AFM
- Background grids should
 - be simple to construct
 - provide smooth and controlled variation of grid spacings in the field
 - be flexible to modifications

Unstructured Background Grids

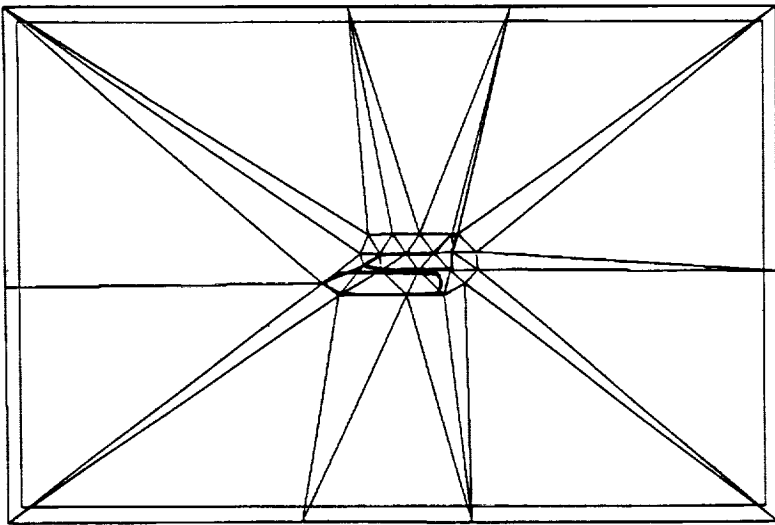

2-D

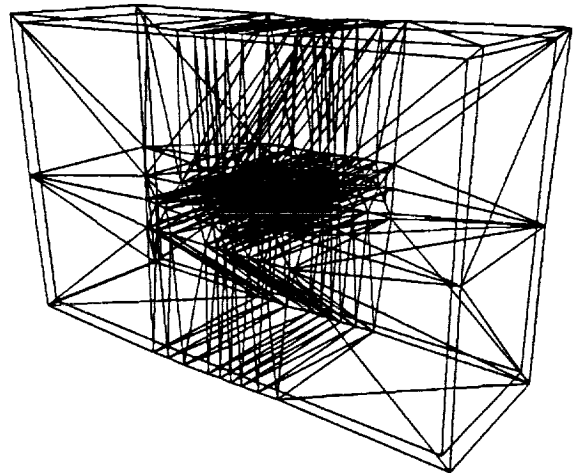

3-D

Structured Background Grids

- Simple uniform Cartesian grids; easy to construct
- Source elements with prescribed spacing parameters: nodal and linear elements
- Provides smooth grid distribution, flexible control, and ease of grid modification

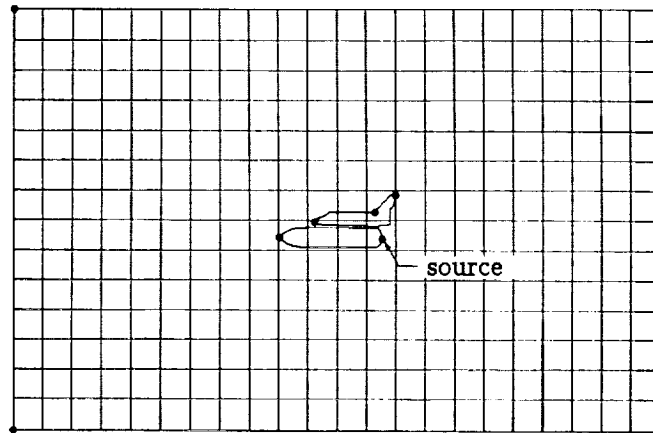

Distribution of Spacing Parameters

- Determined by a process similar to diffusion of 'heat' from discrete heat sources in a conducting medium
- Modeled by solving a Poisson equation, $\nabla^2 S = G$
- Resulting discretized algebraic equations solved with an iterative method
- The solution provides 'pseudo-isotherms' varying smoothly from high- to low-potential regions

Background Grid for a NACA 0012 Airfoil

Unstructured

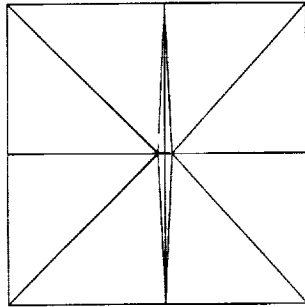

Structured

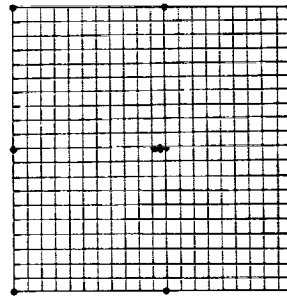

far field

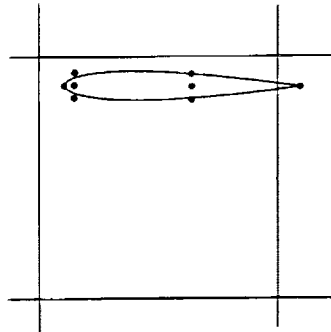
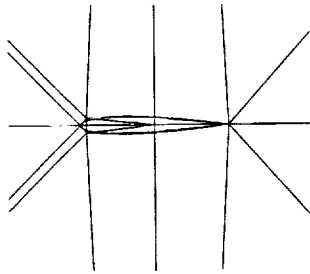

near field

Unstructured Grid around a NACA 0012 Airfoil

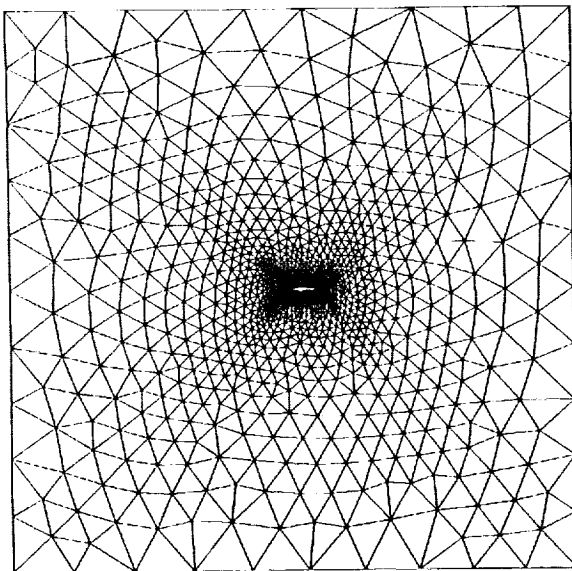

using unstructured
background grid

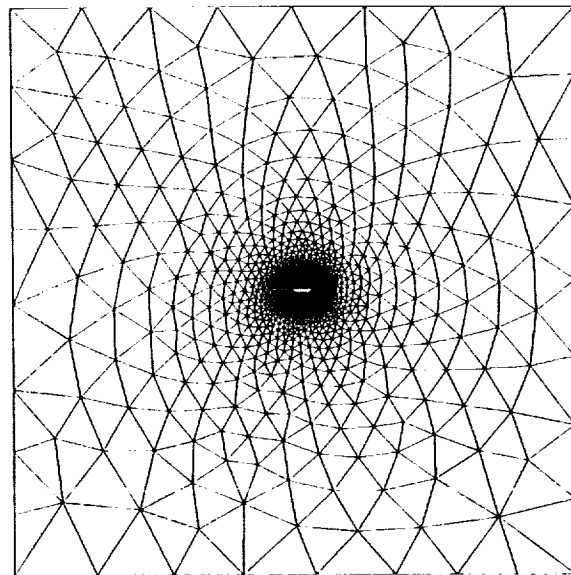

using structured
background grid

Directional Control of Source Intensity

(Nodal Elements)

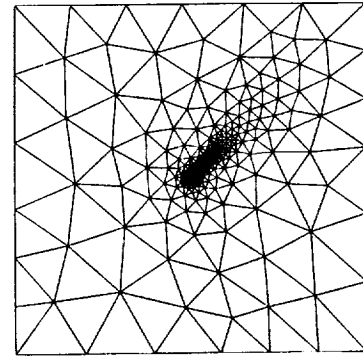
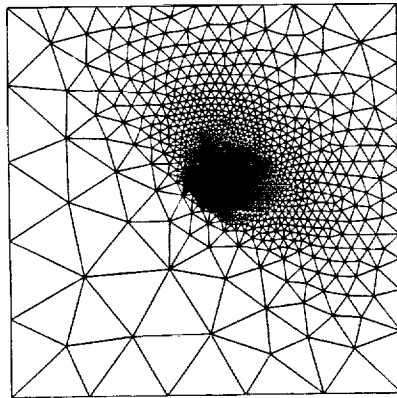
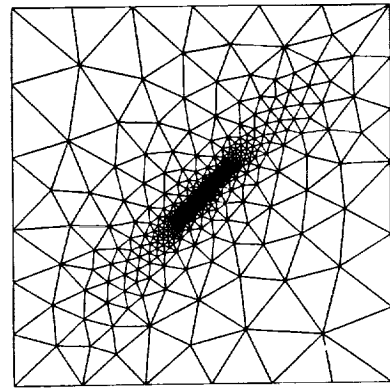

Directional Control of Source Intensity

(Linear Elements)

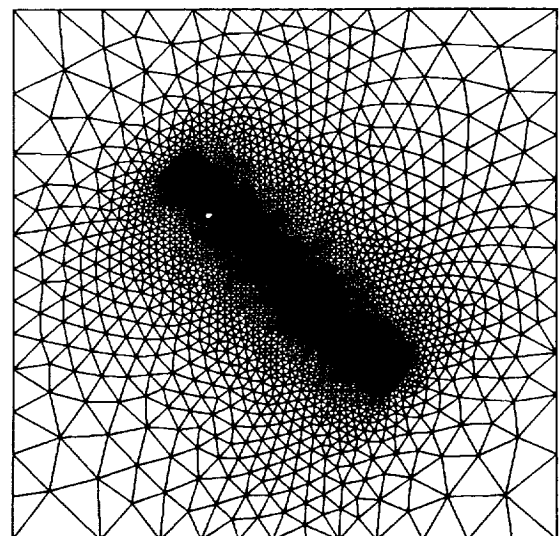
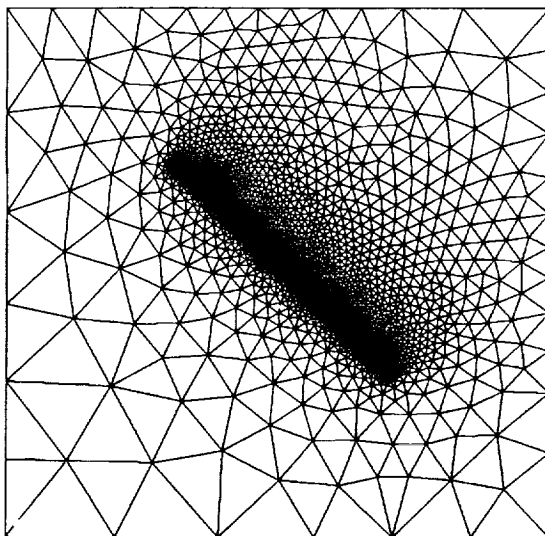

Source Elements on a Generic Multi-Element Wing

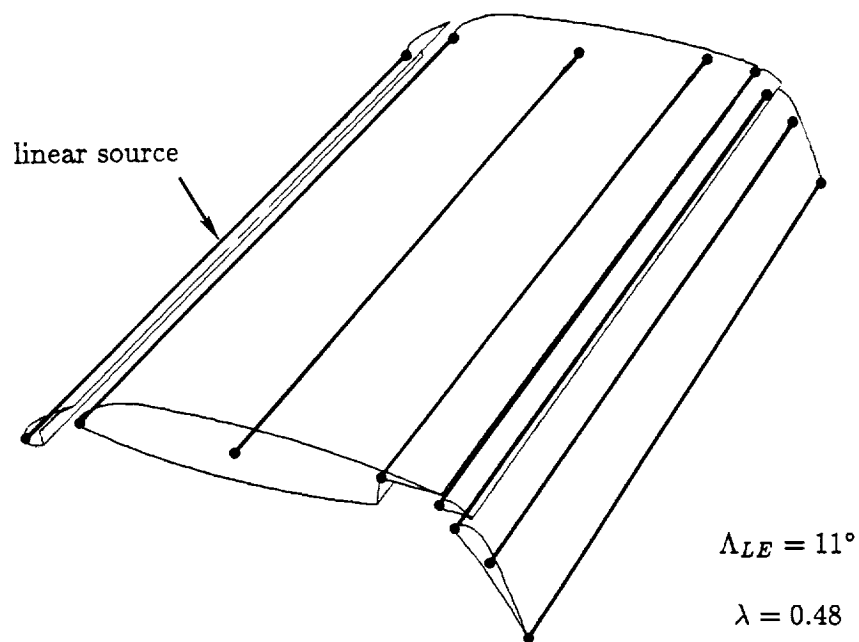

Surface Triangulation on a Generic Multi-Element Wing (wing lower surface)

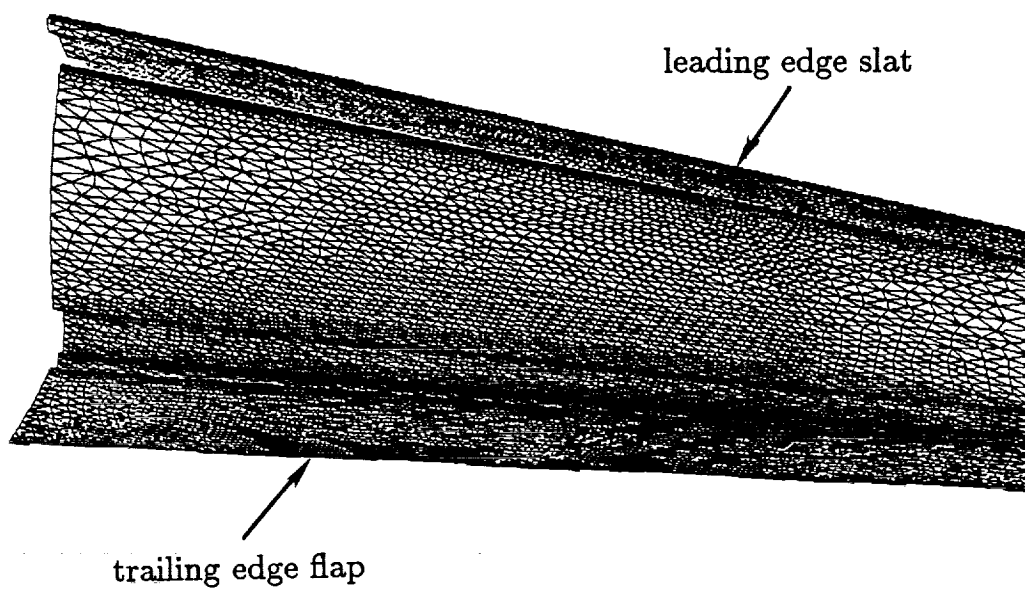

Surface Triangulation on a Generic Multi-Element Wing

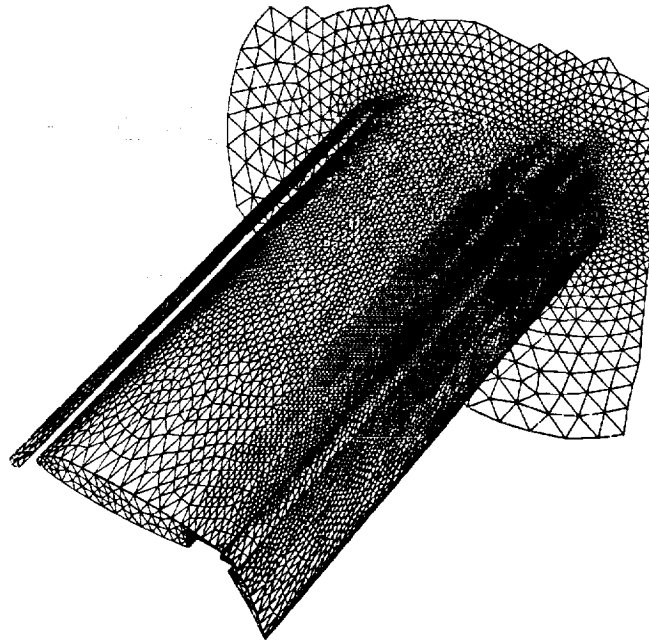

A Wing/Pylon/Store Configuration

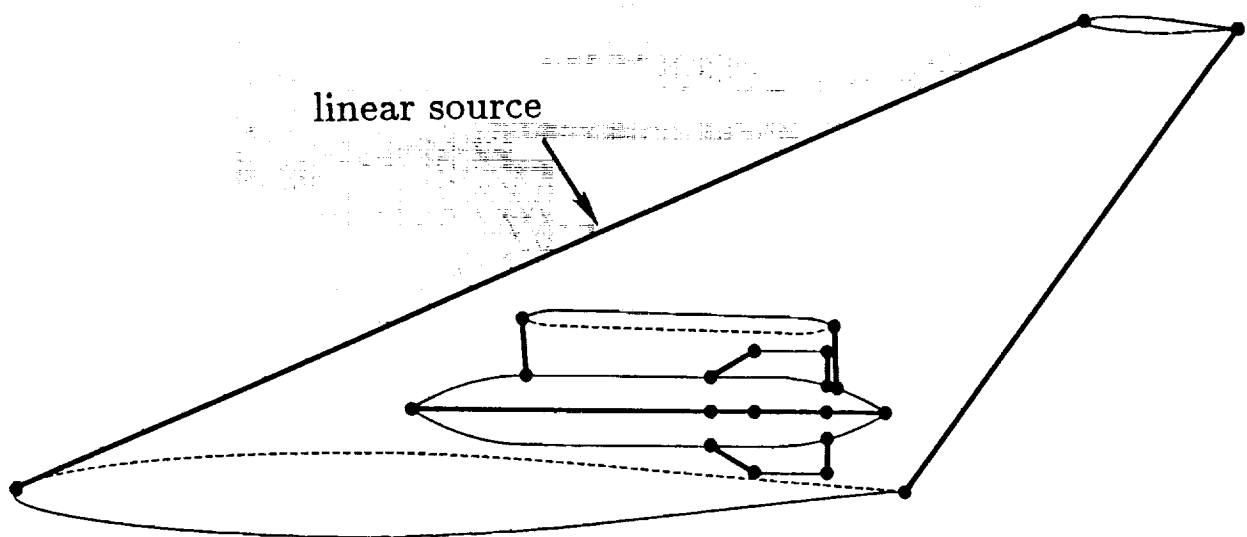

Details of Surface Grid on a
Wing/Pylon/Store Configuration

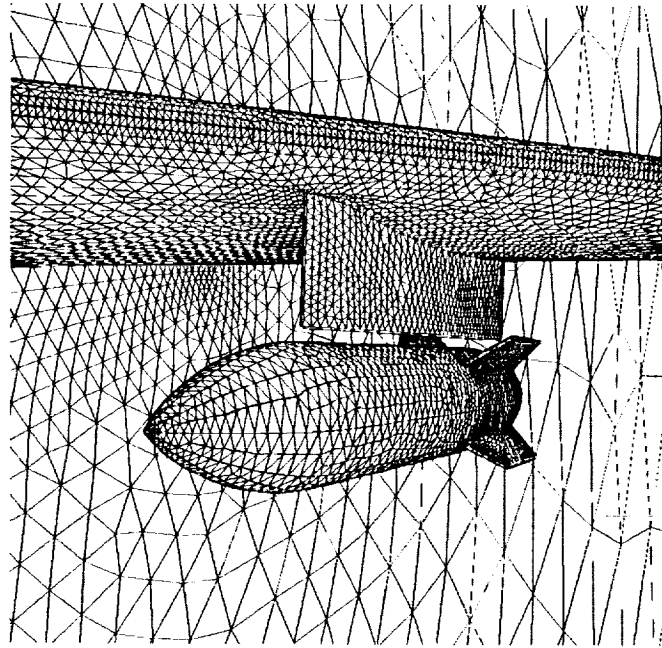

Details of Surface Grid on a
Wing/Pylon/Store Configuration

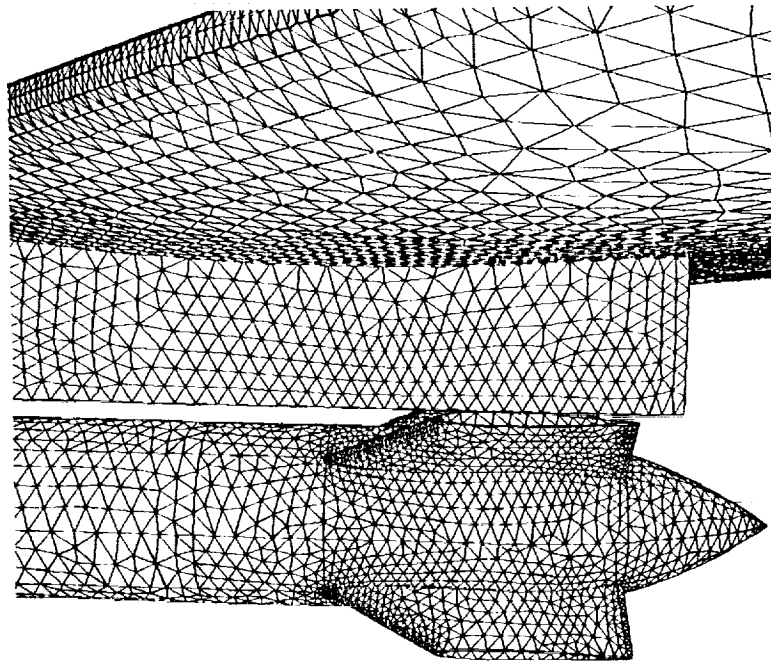

A Boeing Joined-Wing Aircraft Configuration

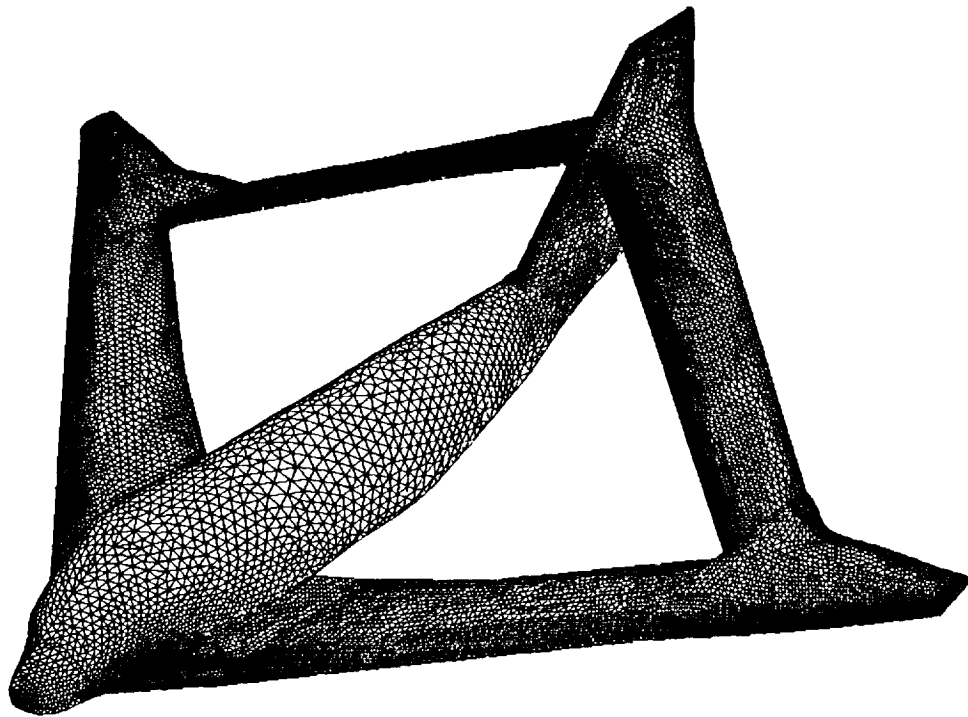

Grid Restarting

- Grid generated in a marching fashion in AFM
 - only information on the current front needed for further advancement
 - process may be stopped and restarted without carrying previously generated grid
- Procedure based on a recurrent local/global renumbering resulting in:
 - substantial reduction in memory requirement
 - capability of generating large grids on small machines
 - substantial increase in productivity of the method

Partial Restarted Grids Around a B747 Configuration

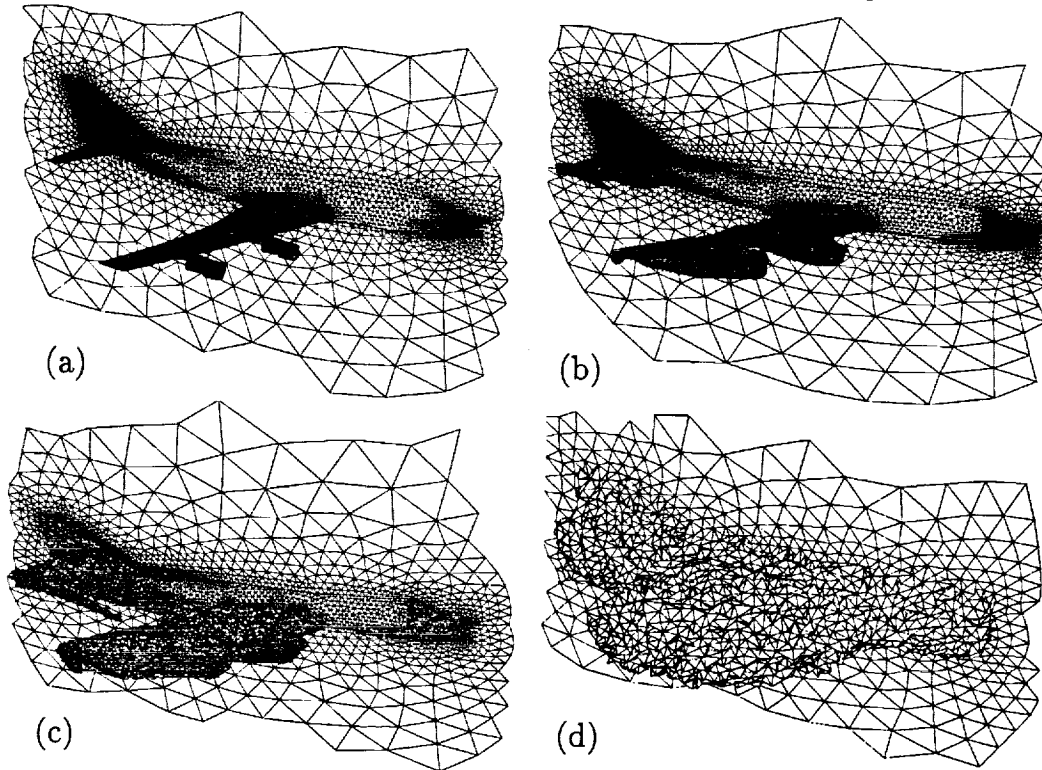

Local Remeshing

- Irregularity of unstructured grids \Rightarrow arbitrary cell groupings
- A cell grouping, being independent of surrounding mesh, may be
 - removed, creating pockets and new fronts in the grid
 - remeshed with no effect on rest of the grid
- Local remeshing and restart capability have resulted in a useful 3D grid post-processing tool \Rightarrow program **Postgrid**

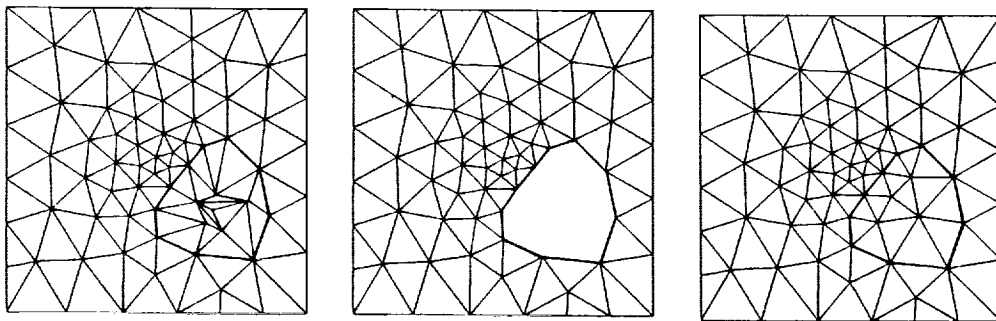

Unstructured Viscous Grid Generation

- Problem still unresolved, especially in 3D
- Generation of highly stretched cells proven to be non-trivial
- Issues to be considered:
 - automation
 - self-sufficiency for grid point distribution
 - grid quality
 - flexibility and ease of grid control
 - capability of handling difficult regions such as sharp corners, singular points, wakes, gaps between close surfaces, etc. without users' interaction

Advancing Layers for Generation of Viscous Grids

- An extension of Advancing-Front method to generate highly stretched cells
 - grid advances in the field one layer at a time
 - benefits from generality and flexibility of AFM
 - method is automatic, fast, self-sufficient, and robust
 - provides smooth and structured-looking viscous grids
 - practically, no limit to the extent of cell aspect ratio
 - minimal user's input data (uses same surface mesh and B.G.)
 - resolves many of shortcomings of the semi-structured methods
- Has been shown in 2D with good results (NASA CR 191449, 1993)
- Work in progress in 3D

Viscous Grid around a Multi-element Airfoil

Partial grid

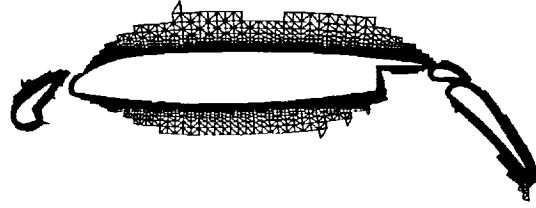

complete grid

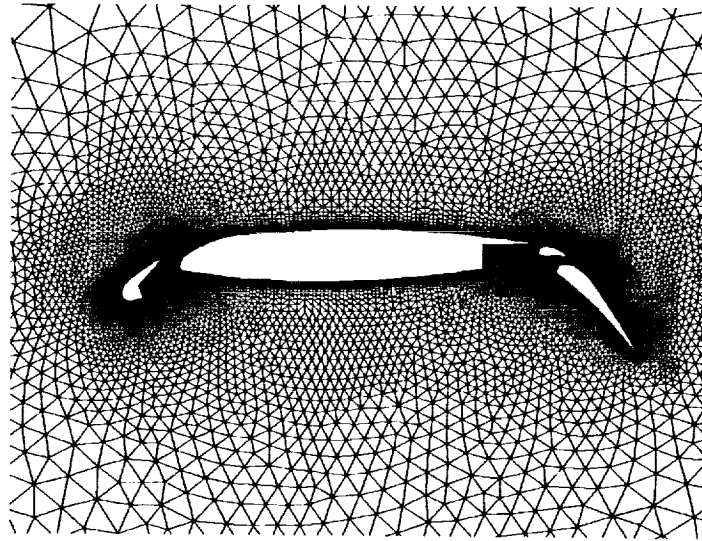

Viscous Grid around a Multi-element Airfoil (by Advancing Layers / Advancing Front Methods)

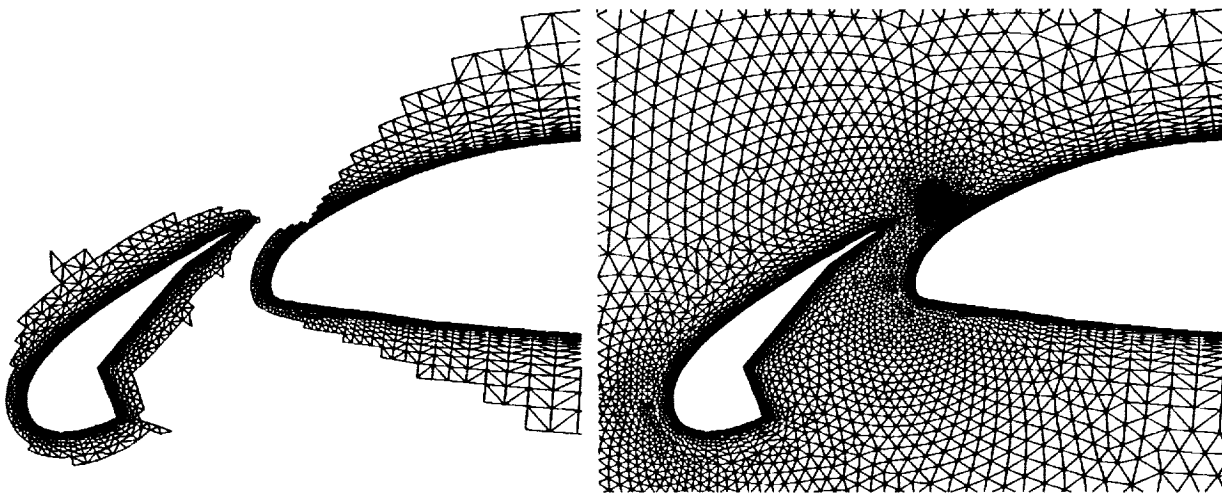

Partial grid

complete grid

Viscous Grid around a Multi-element Airfoil
(by Advancing Layers / Advancing Front Methods)

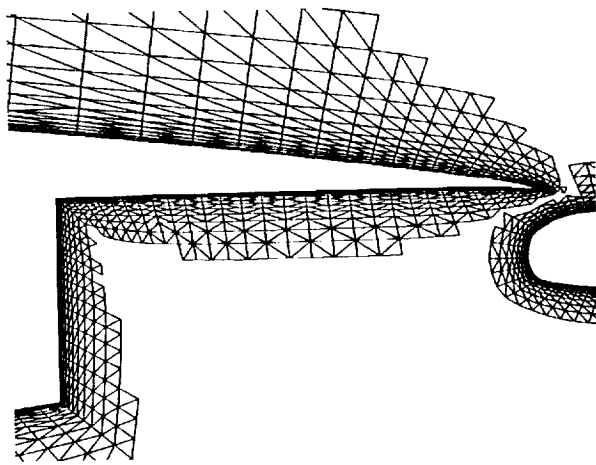

Partial grid

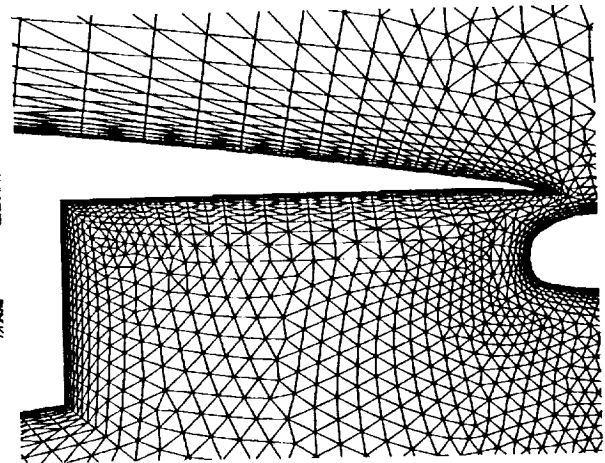

complete grid

Viscous Grid around a Multi-element Airfoil
(by Advancing Layers / Advancing Front Methods)

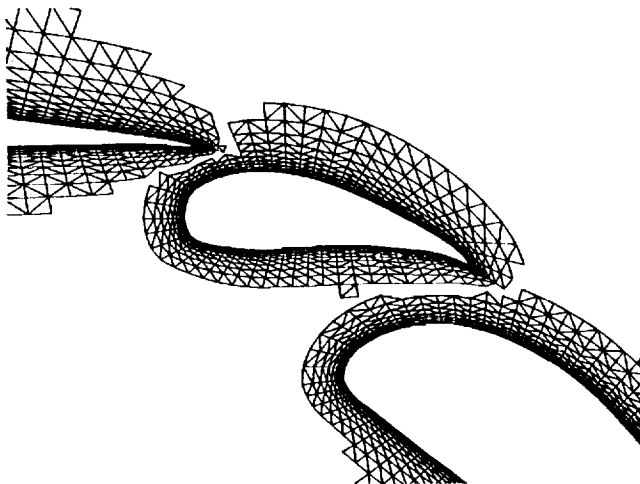

Partial grid

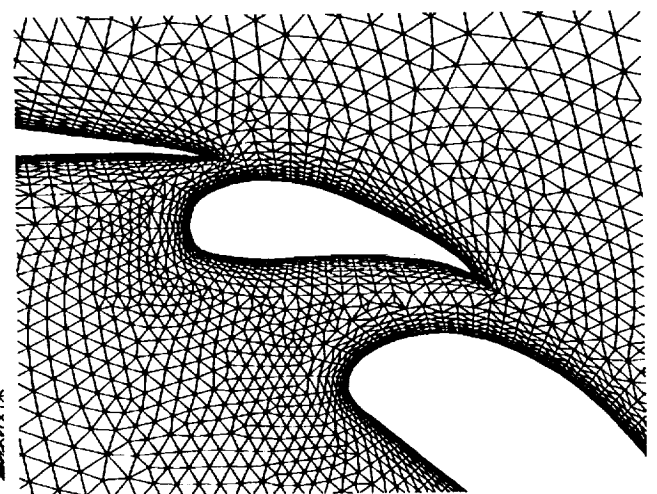

complete grid

Surface Pressure on a Douglas Multi-element Airfoil

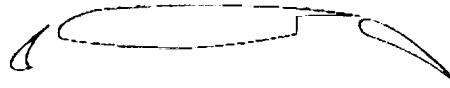

$M_\infty = 0.2$
 $Re = 9 \times 10^6$
 $\alpha = 16.30^\circ$

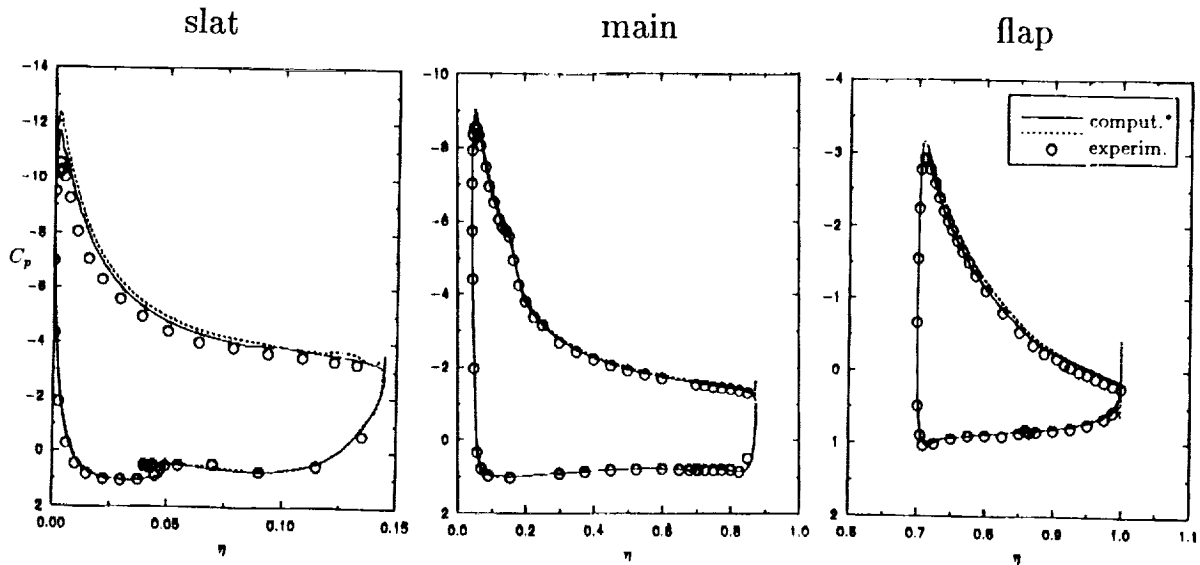

Concluding Remarks

- Routine generation of Euler grids around complex configurations now possible with VGRID as currently used by many users from NASA and industry
- Continuous enhancement of the technique is performed in response to the users' requirements and feedback
- The new method of 'Advancing Layers' has produced good unstructured viscous grids in 2D (extension to 3D in progress)
- Plan: a single robust code for generation of both Euler and viscous unstructured tetrahedral grids