

Simulation of a Passive Millimeter Wave Sensor 254737**William W. Kahlbaum**
Lockheed Engineering and Science Corporation P-18**ABSTRACT**

The visual display expected to be generated by a Passive Millimeter Wave (PMMW) camera and sensor system has been simulated on a Silicon Graphics IRIS workstation at the NASA Langley Research Center (LaRC). The low resolution of the sensor has been simulated by graphically manipulating the scene as it is being drawn by the IRIS in real time. Camera field of view, sensor resolution, and sensor update rate are the controllable parameters. Physical effects such as lens model, radome effects, and noise have not been included at this time. An approximate dynamic model of the atmospheric phenomenology has been included which generates the gray-scale intensity values in real time for the simulated image. The gray-scale values are proportional to temperature. A snapshot capability which captures individual image frames during real-time operation has been included. These images were used to validate the approximate phenomenology model against a more rigorous physical model.

Introduction

- **Graphics techniques used to create Passive Millimeter Wave (PMMW) display**
- **Interface with the atmospheric phenomenology model**
- **Solutions to problems which were encountered**

Simulated Passive Millimeter Wave Display

- **Low Resolution Corresponds to Anticipated Sensor Element Density**
- **Gray Scale Corresponds to Temperature Value**

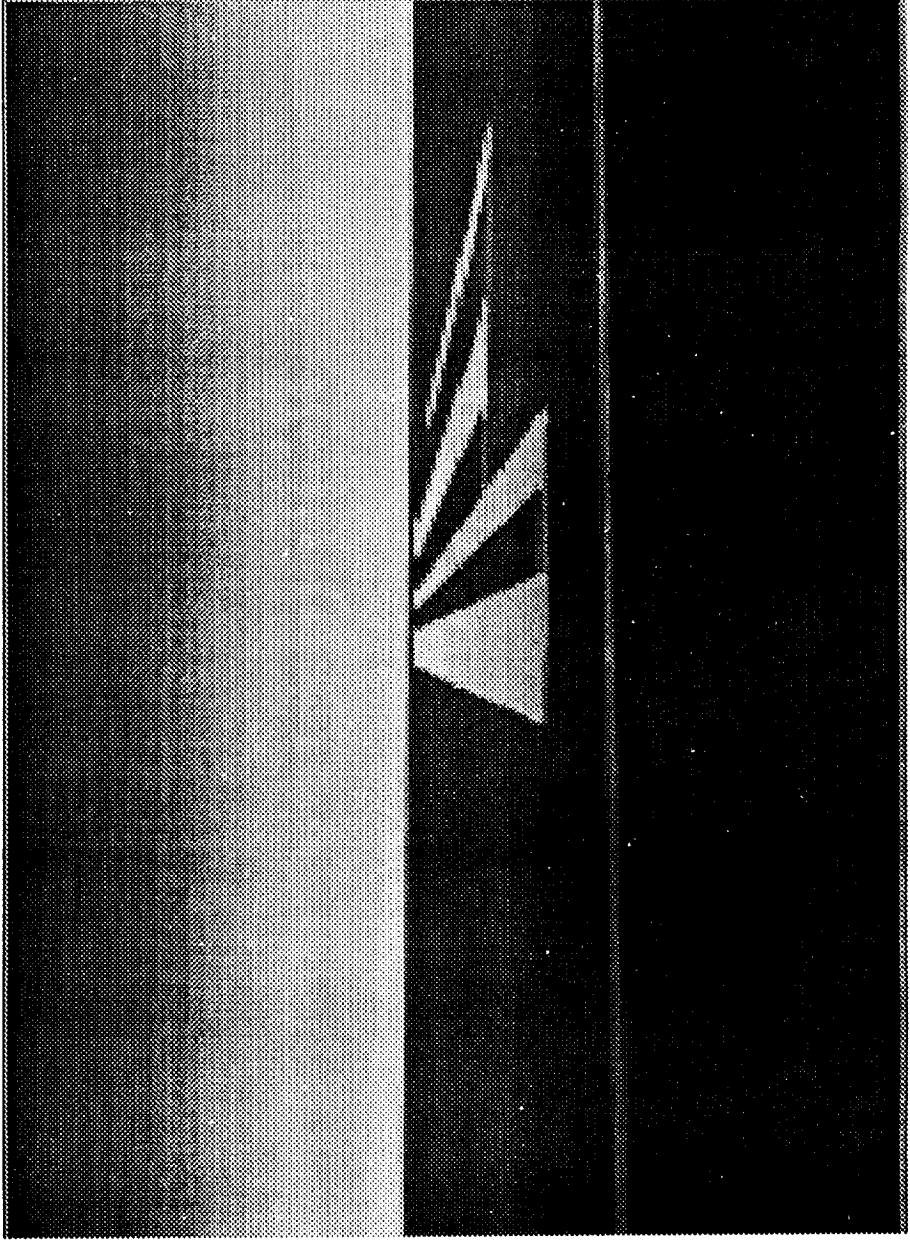

Controllable Parameters

- **Sensor field of view**
- **Sensor resolution**
- **Sensor update rate**

Variation of Resolution with Constant Field of View

- 30 X 24 degree Field of View
- 0.1 degrees/pixel
- 30 X 24 degree Field of View
- 0.34 degrees/pixel

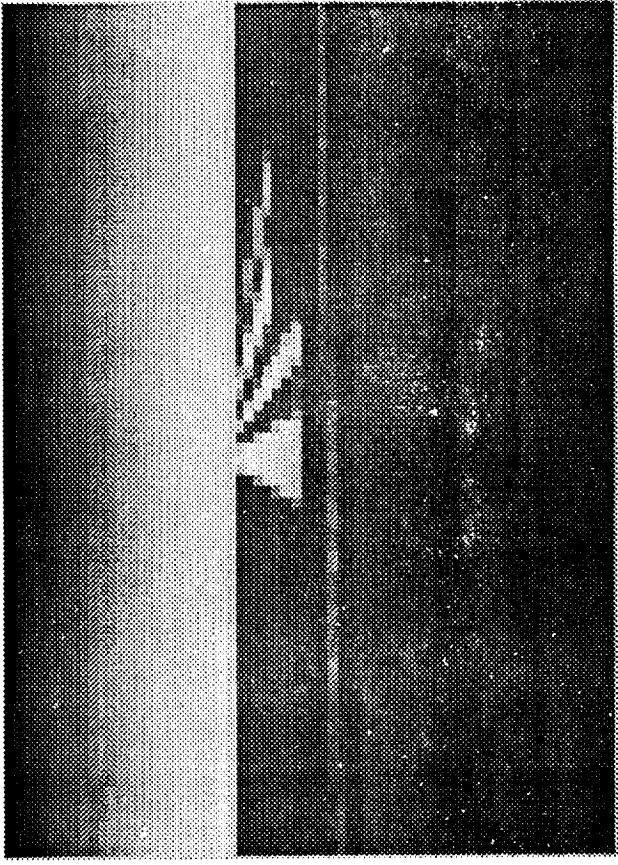
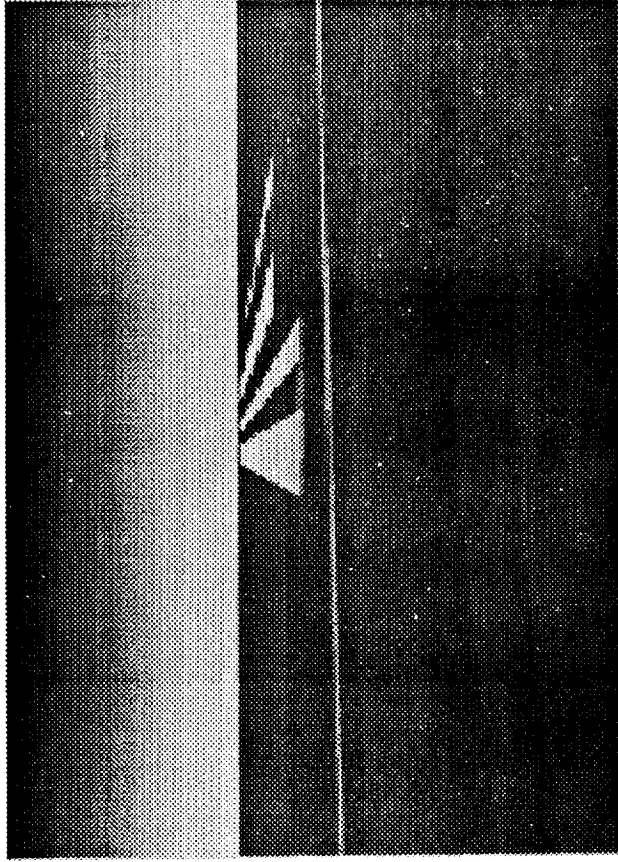

Variation of Field of View with Constant Resolution

- 30 X 24 degree Field of View
- 0.1 degrees/pixel
- 5 X 5 degree Field of View
- 0.1 degrees/pixel

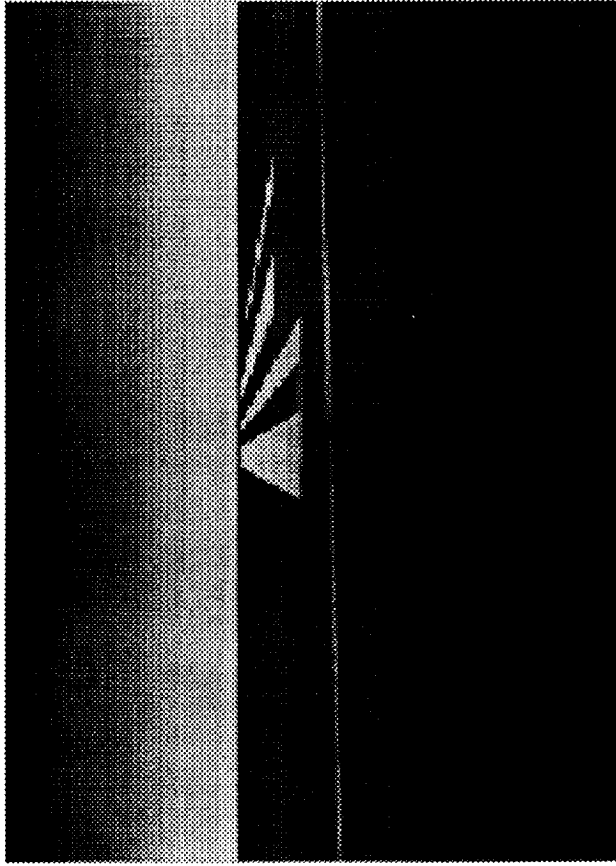

Resolution

- Image drawn in original drawing area at normal screen resolution
- Image copied to full field area with zoom
- Full field area may or may not cover entire screen, depending on the field of view
- Update rate controlled by changing the animation update rate of the IRIS

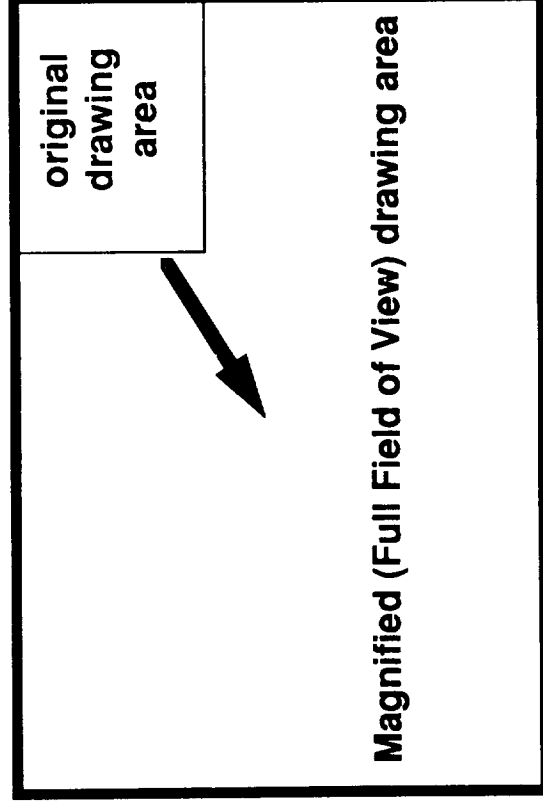

Polygonal Data Base

Sky and Terrain

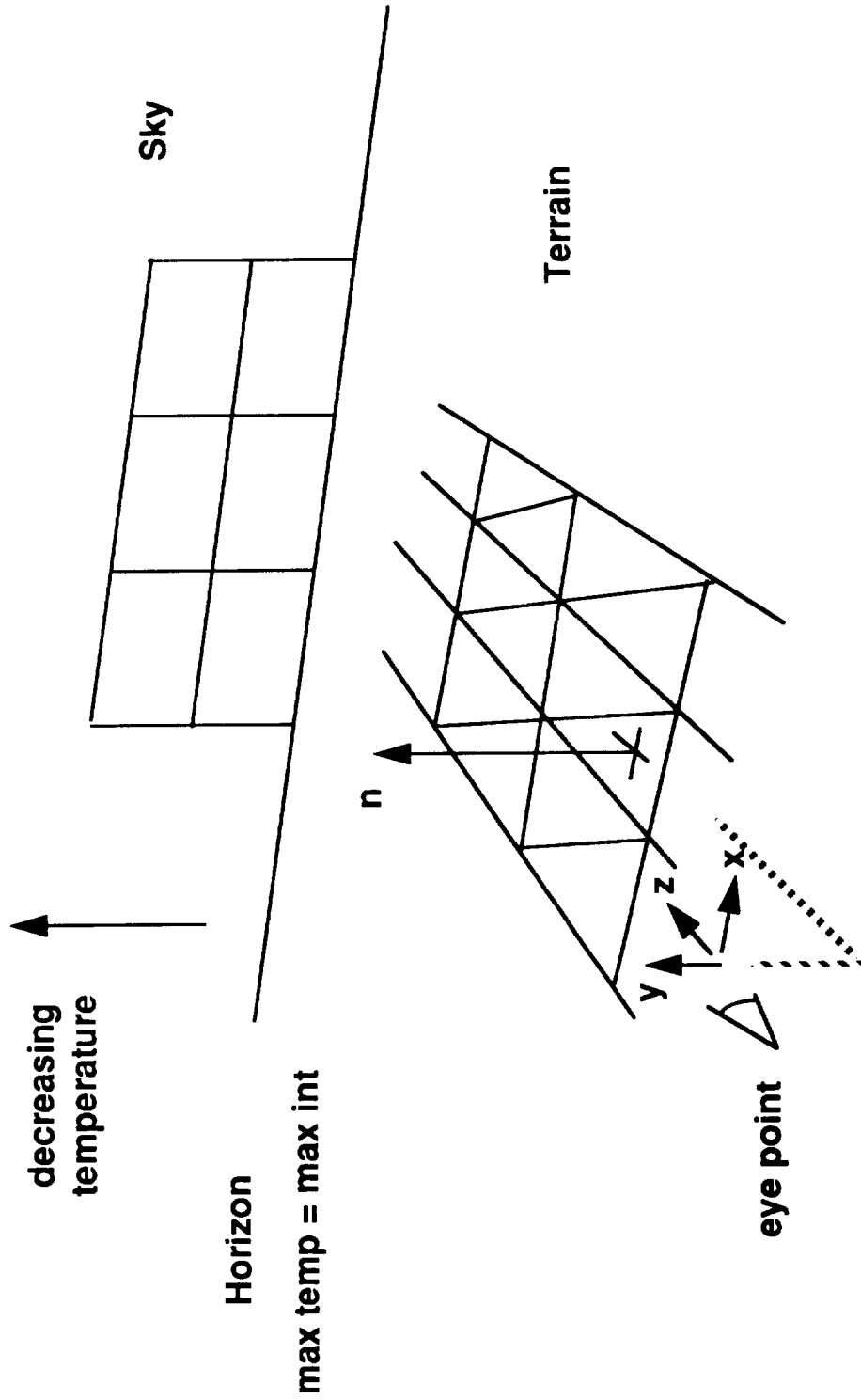

Data Base Tree Structure

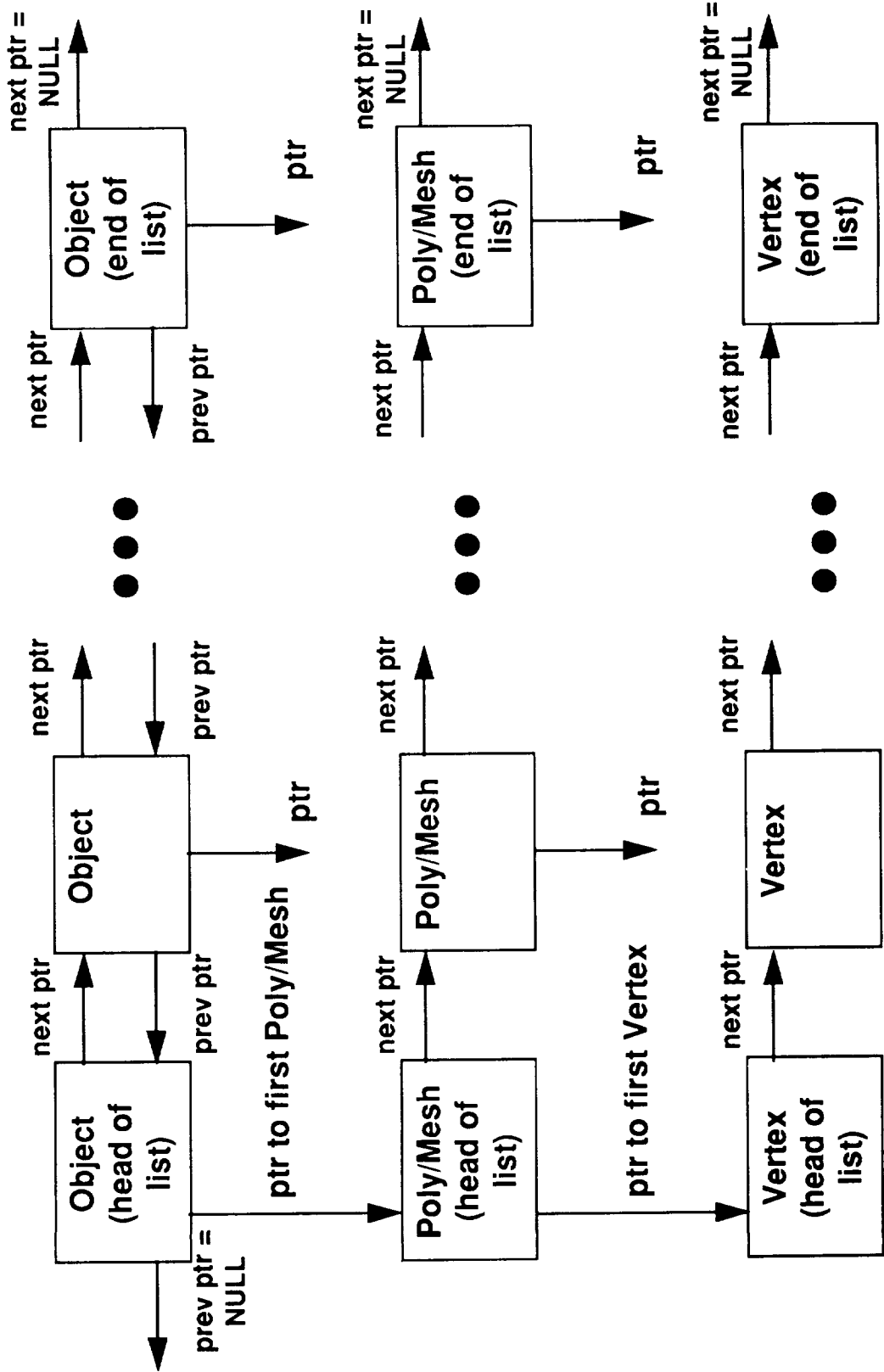

Simulation Models

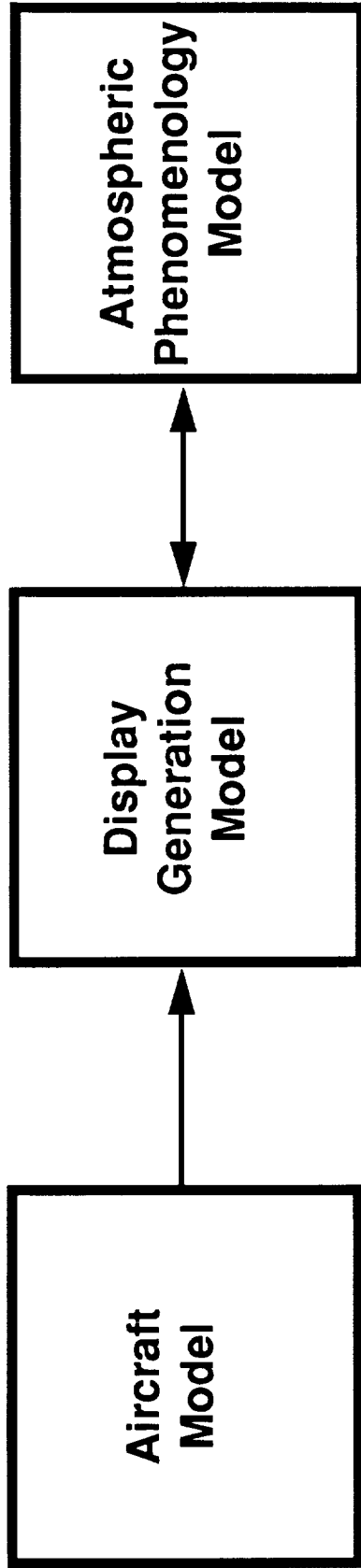

Real-Time Program Flow Diagram

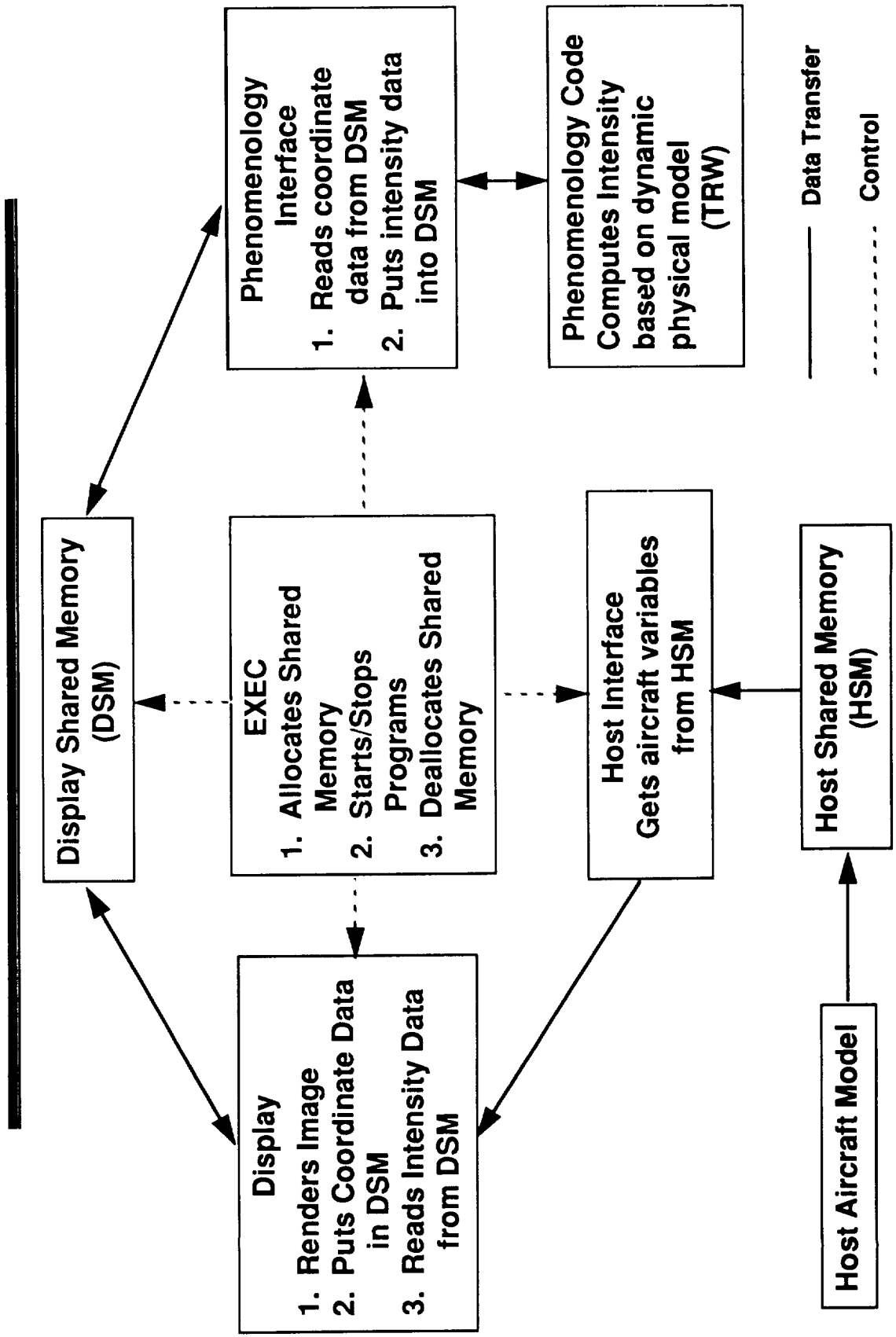

Task Summary

- **Four tasks running on IRIS 480 Reality Engine**
- **Each task (EXEC, Display, Host Interface, Phenomenology) is running on a separate CPU**
- **Update rate is 30 Hz for all field of view and resolution combination**

Snapshots

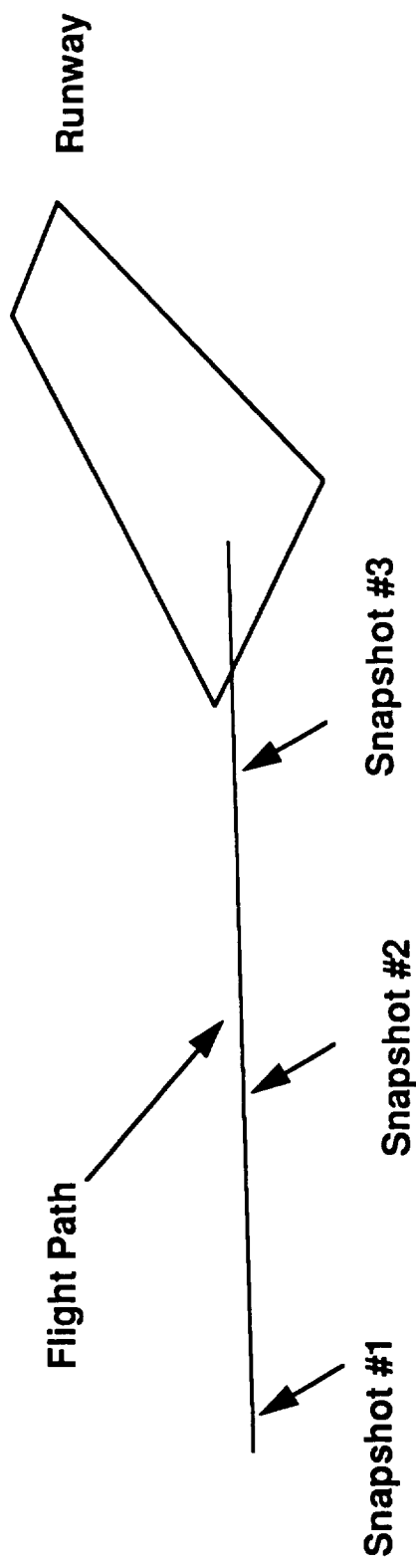

- Captured snapshot frames during real-time flight
- View snapshots using offline program
- Analyze Intensity Profiles and generate graphs
- Intensity Profiles were used for validation of model
- Captured sequence of images used by Dr. Kasturi at Penn State

Validation of Real-Time PMMW Model

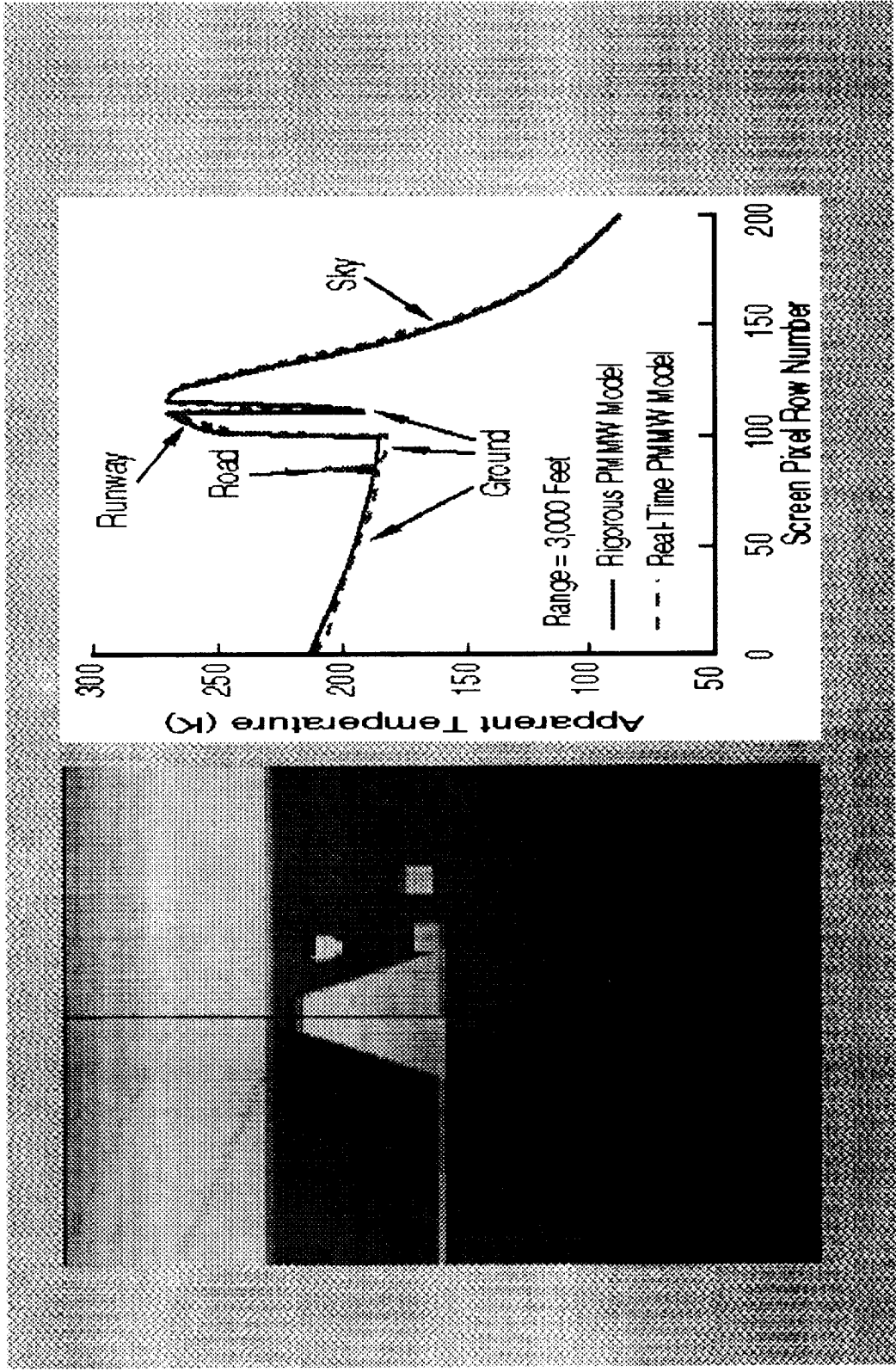

Clipping Planes

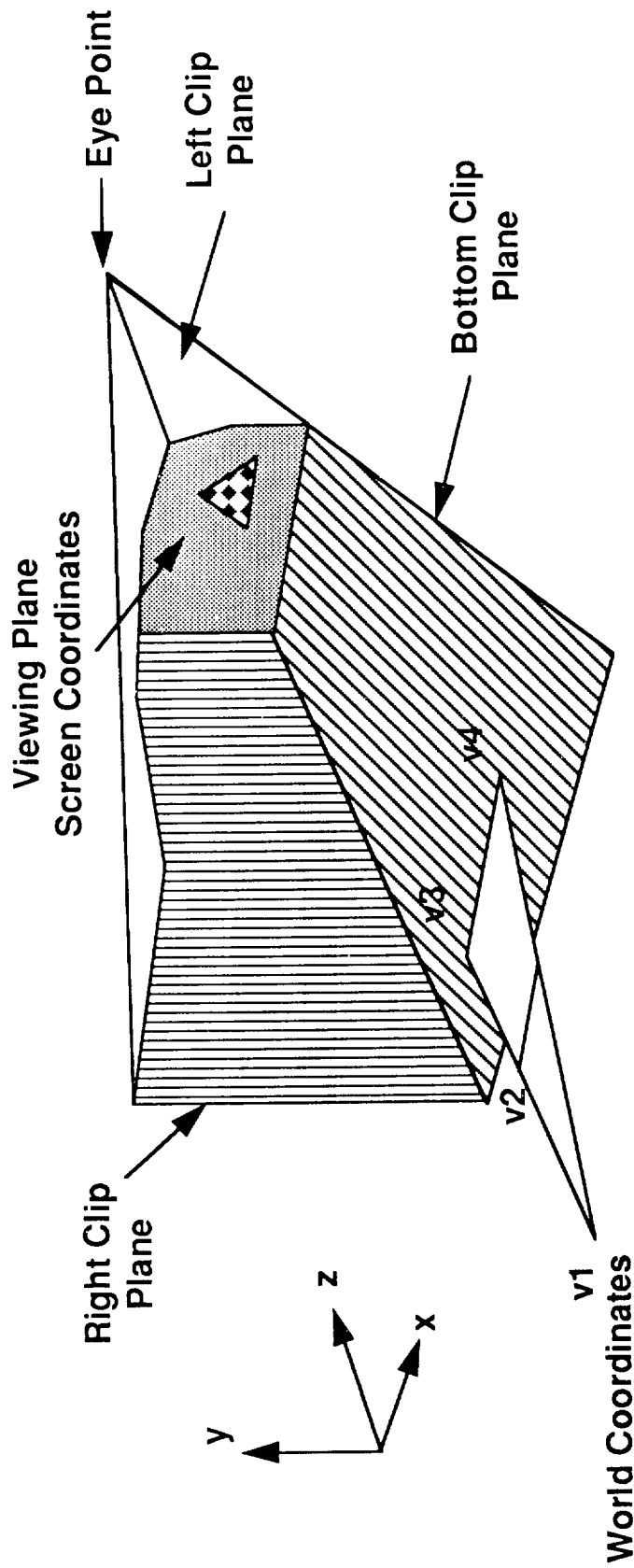

- Intensities are computed by the phenomenology at vertices in world coordinates
- Gouraud shading performs a bilinear interpolation between vertices but it is done in Viewing Plane coordinates
- This is a good approximation as long as polygon is inside the field of view

Solutions to the Shading Problem

- **Clipping polygons and interpolating intensities in 3 dimensional world coordinates prior to rendering image with Gouroud shading**
- **Increasing the number of polygons in the data base**

Recent Embellishments and Future Plans

- **Revised Display task to use MultiGen data bases**
 - Ease of modifying data base
 - More control over sorting and culling of data base
 - Ease of control of moving objects
 - Future addition of Levels of Detail
- **Investigate partitioning of Display task to relieve CPU bottleneck**
- **Addition of Shadows**

Summary

- **Described the graphical techniques used in the PMMW Sensor Simulation**
- **Described the interface with the dynamic phenomenology model**
- **Discussed problems and solutions**