

1994021781

442570

N94-26284

# **Berthing of Space Station Freedom Using the Shuttle Remote Manipulator System**

**Paul Cooper  
NASA Langley Research Center  
Hampton, Virginia**

**and**

**Martha E. Demeo  
VIGYAN  
Hampton, Virginia**

# **Berthing of Space Station Freedom Using the Shuttle Remote Manipulator System**

by

**Paul A. Cooper**

**NASA, Langley Research Center**

and

**Martha E. Demeo**

**VIGYAN, Inc.**

**Presented March 17, 1993**

at

**Selected Topics in Robotics for Space Exploration  
Workshop**

**NASA Langley Research Center**

**Hampton, Virginia**

## **ABSTRACT**

A large-angle, flexible, multi-body, dynamic modeling capability was developed to help validate analytical simulations of the dynamic motion and control forces which occur while berthing of Space Station Freedom to the Shuttle Orbiter during early assembly flights. The paper describes the dynamics and control of the station, the attached Shuttle Remote Manipulator System, and the Orbiter during a berthing maneuver. Emphasis is placed on the modeling of the Shuttle Remote Manipulator System in the multi-body simulation. The influence of the elastic behavior of the station and of the Remote Manipulator System on the attitude control of the station/Orbiter system during the maneuver is investigated.

## **STUDY PURPOSE AND PROCEDURE**

**STUDY PURPOSE:** Provide independent data to help JSC validate Space Station Freedom Program on-orbit assembly simulation analyses.

**STUDY PROCEDURE:** Perform time simulations of the berthing of an Intermediate-build configuration of Space Station Freedom to the orbiter.

A dynamic simulation of the berthing process is fairly complex since it involves the interaction of large, highly flexible components during a large motion maneuver while in orbit, where the components are subject to active control forces and gyroscopic, drag, and gravity gradient forces and moments. The complexities of the Space Station Freedom (SSF) assembly analytical simulator are such that it was advisable to develop independently a comparable tool to help validate the simulator. This paper is concerned with a description of a large-angle, multi-body, dynamic modeling capability developed to help validate the SSF program analytical berthing simulator which will be used to analyze each assembly flight.

The berthing simulations are used to calculate the dynamic motion and control forces that occur while berthing early build configurations of SSF to the Orbiter during assembly flights when attitude control of the stack resides with the station control systems. The sixth assembly flight is the first flight that will use the station control systems rather than the Orbiter Digital Auto Pilot to maintain the attitude of the stack. Berthing during this sixth flight was selected as the validation simulation since the control systems of both the station and the Shuttle Remote Manipulator System (SRMS) are active during this maneuver.

## **MOTIVATION FOR SELECTION OF THE SIMULATION SCENARIOS**

Wanted to simulate a SSF assembly sequence  
which would exercise the:

- SSF RCS attitude command system
  - SSF ~~CMG~~ attitude and momentum  
management system
  - Orbiter SRMS control system
  - Orbiter SRMS brake system
  - Orbiter SRMS flexible body
  - SSF flexible body
  - Environmental conditions during a typical orbit
- => Selected with JSC the berthing of SSF- Stage 5  
to the Orbiter (MB-6 flight).

The simulation scenarios were selected to capture the critical components of the space station assembly operation when attitude control of the stack resides with the SSF. The specific features which were to be exercised are outlined above. Since the MB-6 flight was the first flight to capture all of these features, it was chosen by JSC and LaRC to be the study scenario.

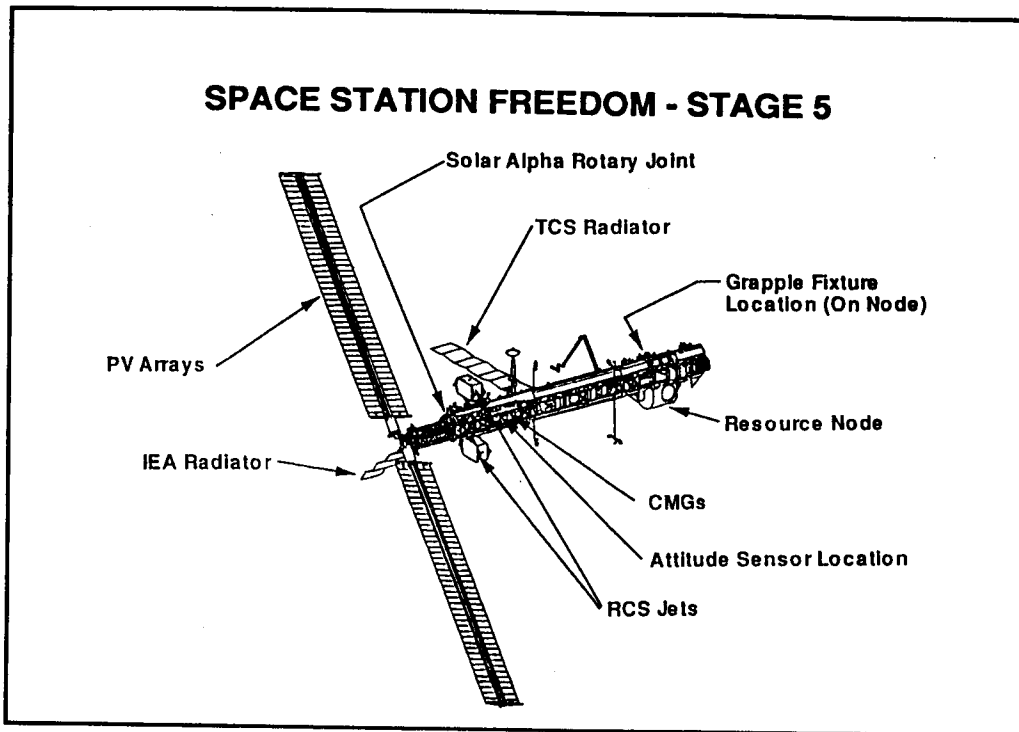

The figure shows the Space Station Freedom - Stage 5 configuration. The location of the avionics platform containing sensors which provide attitude and attitude rate information is indicated. The attitude can be controlled by firing jets, located on the top and bottom of the inboard station framework, at a constant force level of 25 lbs per jet, or by a set of four double-gimbaled CMGs, each with a capacity of 3500 ft-lb-sec, located on a platform close to the avionics platform. Also shown is the resource node, a pressurized shell attached to the station framework inboard of the alpha joint, to which a grapple fixture is mounted.

## SSF/ORBITER APPROXIMATE DIMENSIONS

FLIGHT MB-6: ORBITER BERTHED TO SC-5 STATION  
(UNITS = FEET)

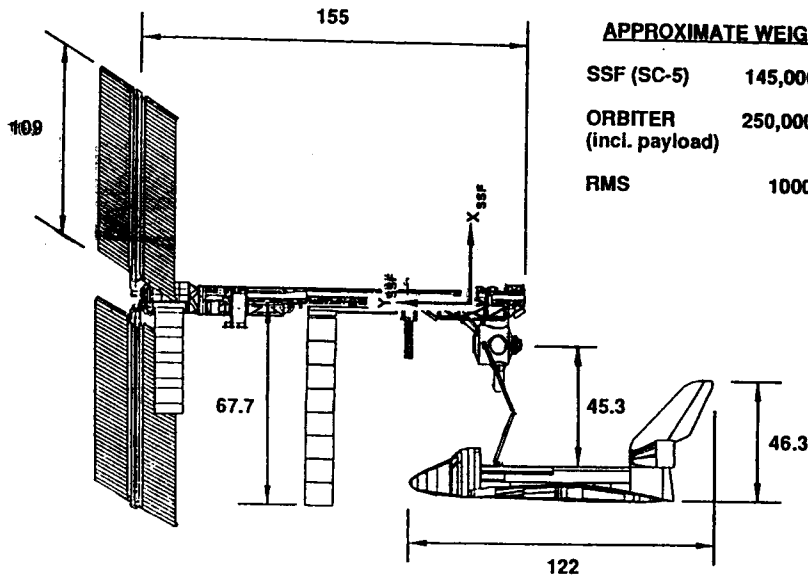

The figure shows the relative size and location of the stage 5 station, the Orbiter, and the extended SRMS at the beginning of the simulation. At this assembly stage, the SSF is over 150 feet in length. It has a weight of 145,000 lbs and the Orbiter, with the lab module in the cargo bay, has a weight of 250,000 lbs. The SRMS has a weight of only 1,000 lbs.

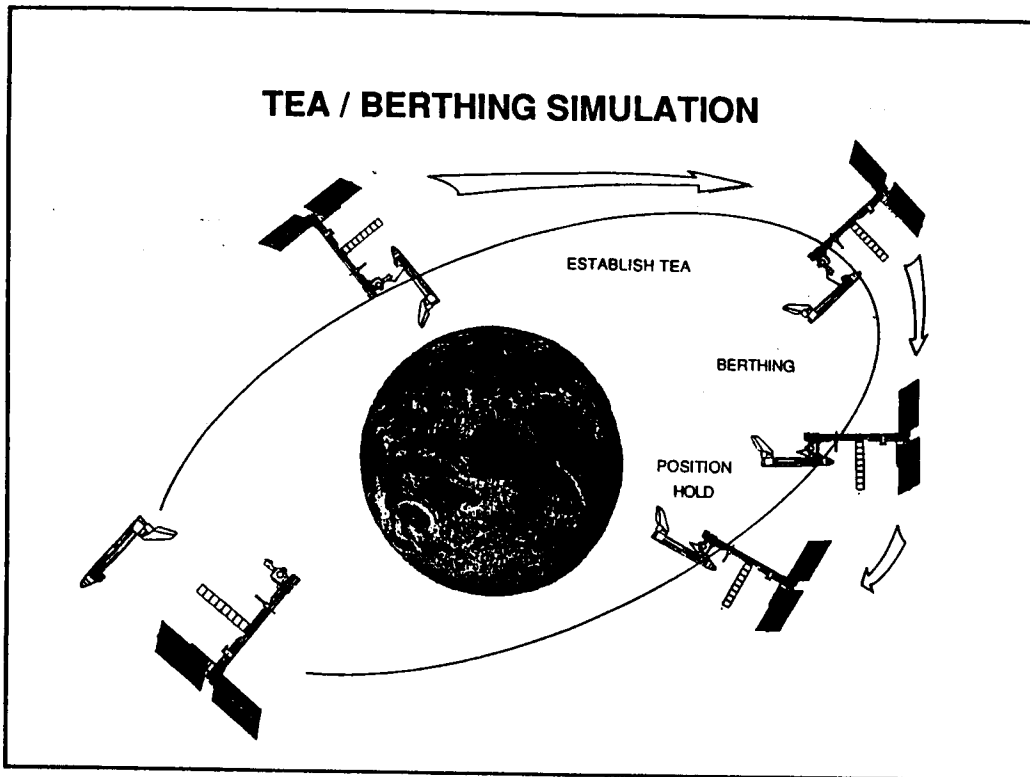

The scenario under investigation is the stage 5 assembly sequence depicted in the Figure. For the purposes of this study, this scenario is broken down into two simulations: 1) simulation of the Torque Equilibrium Attitude (TEA) maneuver and 2) simulation of the berthing of stage 5 to the orbiter.

Before the first simulation begins, the photovoltaic (PV) arrays are feathered and the alpha joint is locked to minimize plume loads from the Orbiter jets during the final approach of the Orbiter before grappling occurs. The alpha joint remains locked during the entire berthing maneuver. The Orbiter approaches the station along the direction opposite the orbital velocity vector and flies in tandem with the station maintaining a distance of about 30 feet from the V guides in the cargo bay to the trunnion pins on the berthing adapter. The SRMS end effector grapples the station by snaring the grapple fixture located on the resource node. This is the start of the first simulation. The SRMS joint brakes are applied and the RCS jets are fired to move the station from a GG attitude to a computed Torque Equilibrium Attitude (TEA). Once TEA has been established, the second simulation begins. The brakes on the SRMS are released, the station RCS jets are inhibited from firing, and the attitude of the stack is now maintained by the station CMG momentum management system. Berthing is accomplished by the SRMS joint motors which draw the station and the Orbiter together.

## ESTABLISHMENT OF INITIAL TORQUE EQUILIBRIUM ATTITUDE (TEA)

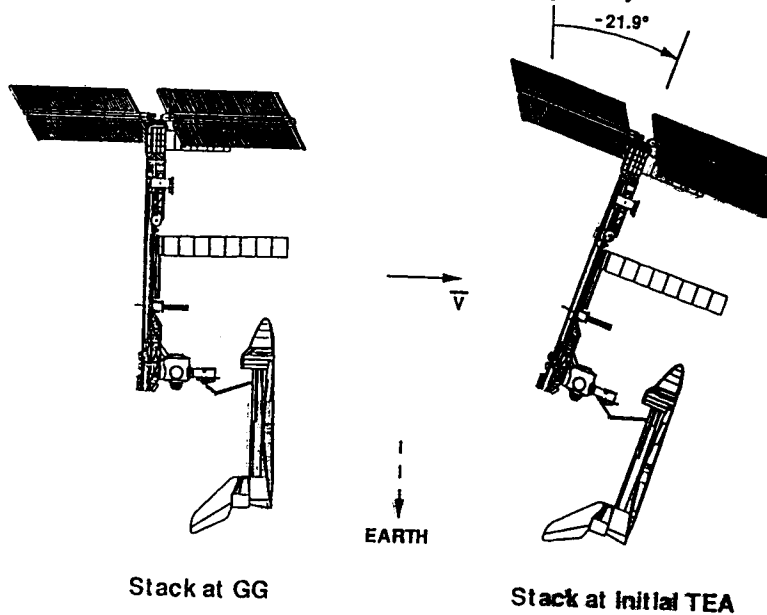

The torque equilibrium attitude (TEA) is the average attitude which must be held during an orbit so that the net angular momentum accumulated over one orbit, in the presence of gravity gradient, aerodynamic and orbital gyroscopic disturbances, is zero. The figure shows a schematic of the stack configuration at Gravity Gradient (GG) and at the initial TEA.



**FIRST SIMULATION:  
ESTABLISH TORQUE EQUILIBRIUM ATTITUDE**

Use station RCS jets to move stack from attitude at grapple to a computed TEA.

- Station RCS control system active, responding to commanded attitude.
- Brakes with friction modelled are applied to all six SRMS joints.
- Flexible representation of the SRMS long booms.
- Flexible representation of SSF (36 mode model).
- Orbital mechanics including aerodynamic and gravity gradient moments.

The specific components exercised during the simulation of TEA maneuver are outlined here. The SSF Reaction Control System (RCS) is used to maneuver the stack to its TEA. During this maneuver, the SRMS brakes are applied. The SSF is modelled as a flexible body as are the upper and lower long booms of the SRMS. Aerodynamic and gravity gradients forces and torques are included.

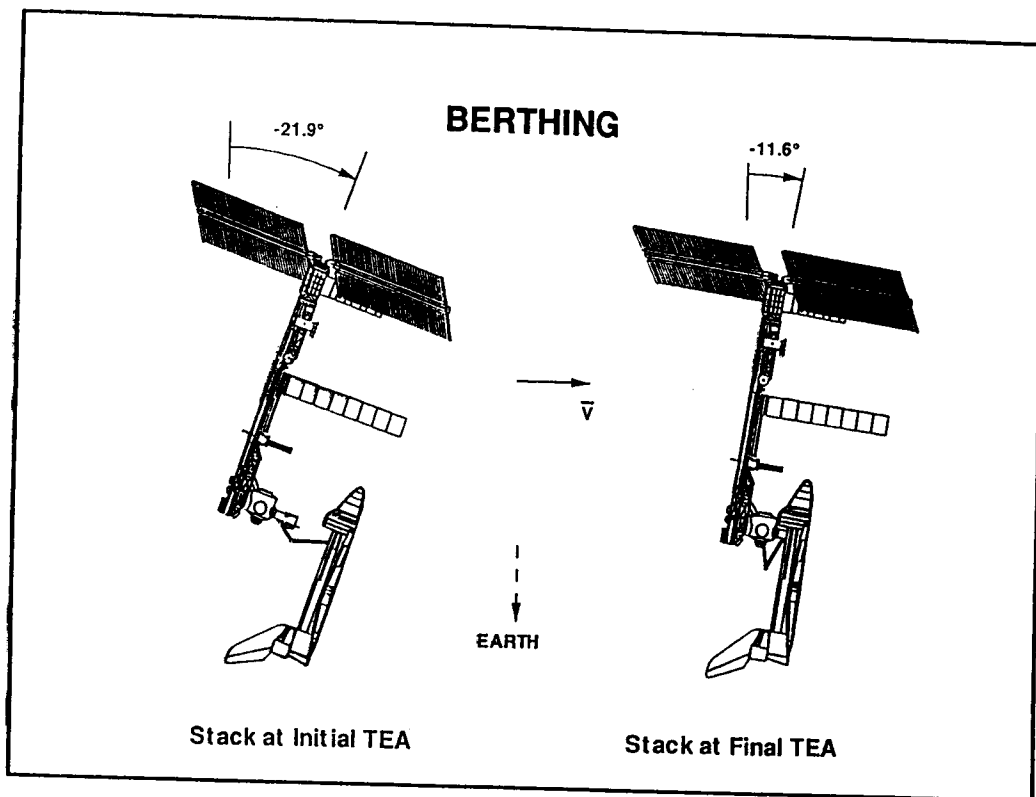

During the second simulation, the TEA changes since the inertia of the stack changes as the station is berthed to the Orbiter. The change in the TEA pitch angle during this simulation is shown in the Figure.

**SECOND SIMULATION:  
USE SRMS TO BERTH STATION TO ORBITER**

- Station CMG control system active.
- Flexible representation of the SRMS long booms.
- Flexible representation of SSF (13 mode model).
- Orbital mechanics including aerodynamic and gravity gradient moments.
- Mass matrix and estimated TEA recomputed every second.
- SRMS operational modes exercised:
  - Automatic mode
  - Manual Augmented mode
  - Position Hold mode

The specific components exercised during the simulation of the berthing maneuver are outlined here. The SSF Control Moment Gyros (CMGs) are used to maintain the attitude of the Orbiter/SRMS/station stack. As in the TEA maneuver, the SSF and long booms of the SRMS are modelled as flexible bodies and the aerodynamic and gravity gradients forces and torques are included. The SRMS control system is active and is used to command the SRMS to berth the station to the Orbiter using Manual Augmented and Automatic Mode maneuvers. The changes in the TEA are estimated using a mass property estimator which computes the composite inertia of the stack as a function of SRMS end effector position and attitude.

## SC-5 FE MODEL

PV Arrays Feathered

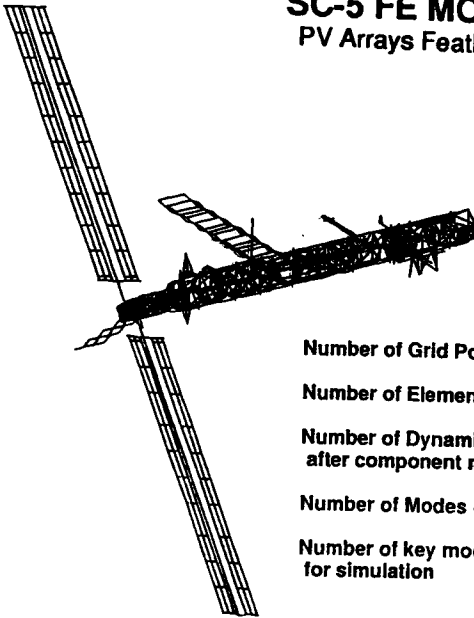

Number of Grid Points	=	2442
Number of Elements	=	2851
Number of Dynamic DOF after component mode reduction	=	781
Number of Modes < 5 Hz	=	181
Number of key modes selected for simulation	=	36 (1st sim) 13 (2nd sim)

The original finite element model of SSF consisted of almost 15,000 degrees of freedom (DOF). After component mode reduction, the number of DOF was reduced to 781. Mode shapes and frequencies up to 5Hz were calculated.

The space station structural dynamics were represented during the TEA simulation by a set of 36 natural modes which range in frequency from 0.1 Hz to close to five Hz. The modes were selected to provide an accurate representation of the flexible response at the station sensor location caused by forces applied at the RCS jet locations. The modes were obtained for the model fixed at the grapple fixture point.

## SSF ATTITUDE CONTROLLER DESIGN

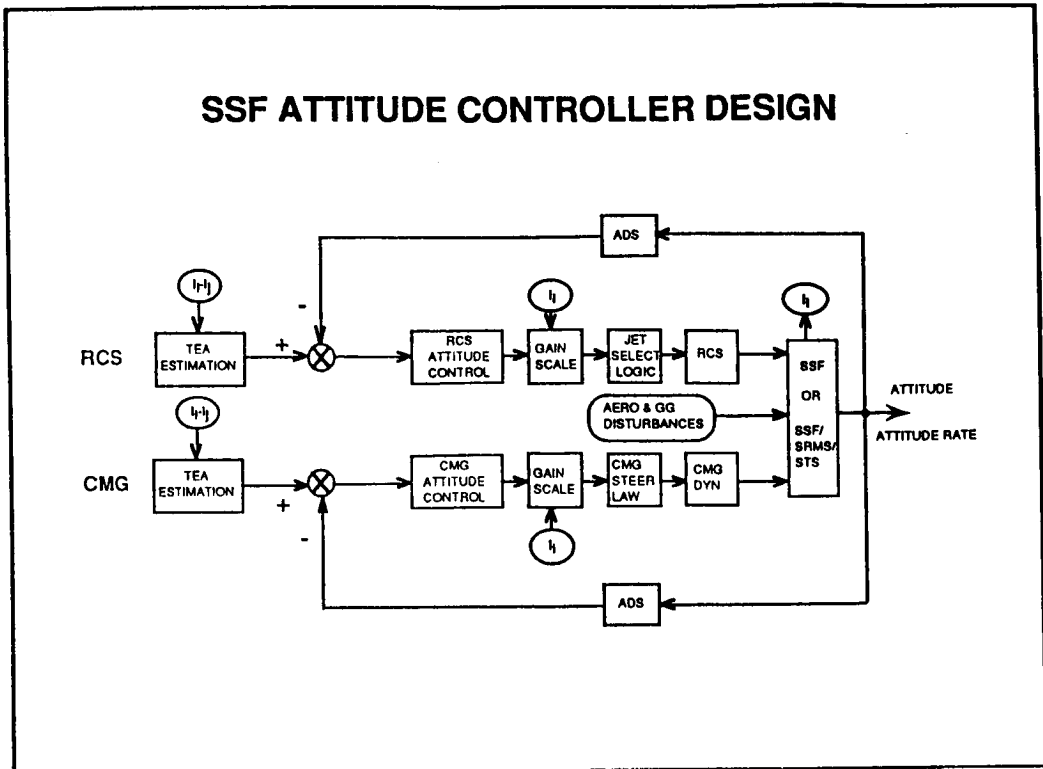

A simplified block diagram of the RCS and CMG control systems is shown. The attitude determination system (ADS), which measures the attitude and feeds this information back to the controller, is assumed to be accurate within the controller bandwidth so that a transfer function of unity is assumed for the ADS for the current simulations. The control system is designed for use in all configurations of the station covering a large range of inertias during the 3-year assembly process. To accommodate this wide range of system parameters, a mass estimator is provided to determine the on-orbit inertias and to adjust the control gains for acceptable performance. Normally the gains will not change significantly for a given flight configuration since the inertia matrix will remain nearly constant until the next assembly flight; however, during the berthing process, the system inertia matrix is continuously changing so that the gains are also continuously changing. A mass estimation program based on knowledge of the SRMS end effector location has been written to provide an updated system inertia matrix as berthing progresses. There are two bending filters (low pass filters designed to remove higher frequency components of the feedback position and rate signals) in the control design.

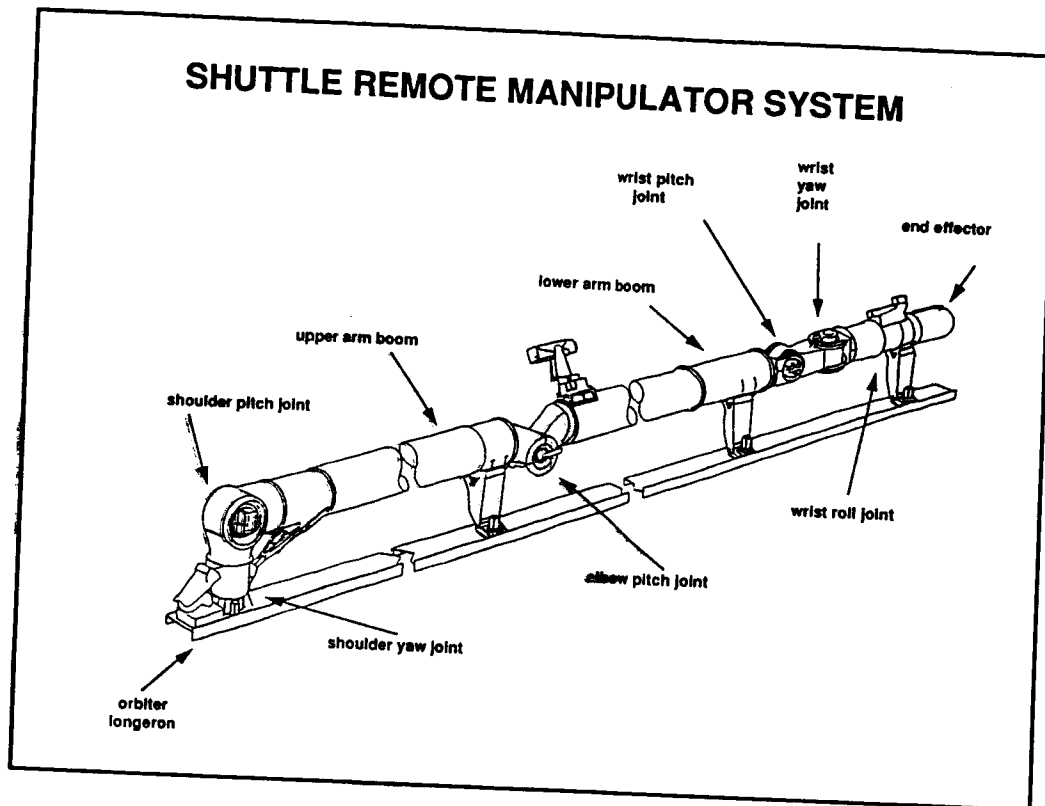

The Shuttle Remote Manipulator System is a six-joint anthropomorphic arm which was originally designed to deploy payloads weighing up to 65,000 lbs. and retrieve payloads weighing up to 35,000 lbs. The 50 foot arm is mounted to the port longeron of the Orbiter cargo bay by means of a Manipulator Positioning Mechanism (MPM). This is the so-called swing-out joint which is used to rotate and lock the arm (19.48°) outboard for adequate clearance during arm/payload operations. From this attachment point, the arm is comprised of two single degree-of-freedom (DOF) shoulder joints, a 21 foot long upper boom, a single DOF elbow joint, a 23 foot long lower boom, 3 single DOF wrist joints and a snare type end effector capable of mating with a payload mounted grapple fixture.

## MOTOR SERVO CONTROLLER FOR EACH SRMS JOINT

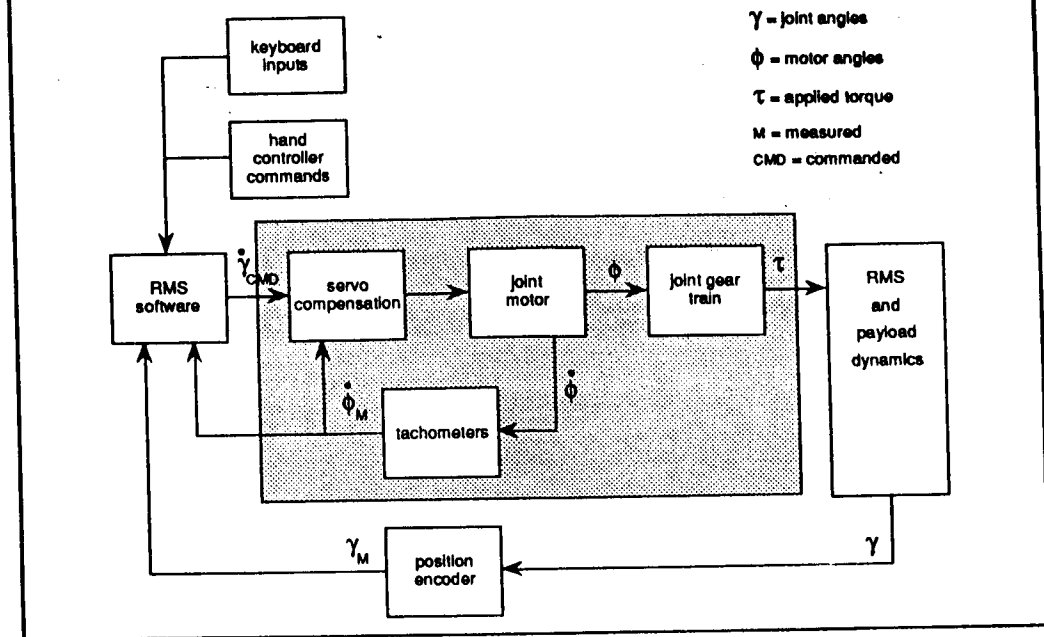

Each of the six SRMS joints is comprised of a reversible dc drive motor, a mechanical joint brake, an inductosyn tachometer, an epicyclic gear train and an electro-optical encoder and servo compensation as shown. The SRMS is telerobotically controlled from the aft cockpit of the Orbiter by way of translational and rotational hand controllers and control panel command inputs. Joint rate commands are sent from software algorithms resident in the Orbiter General Purpose Computer (GPC) to the joint servos by way of the Manipulator Control Interface Unit (MCIU) (not shown). The joint gear train applies the required torque to the SRMS/payload system. The encoders and tachometers provide measurement of the joint position and rate, respectively.

## DETAILED SERVO MODEL

DRAPER RMS SIMULATION / JULY 1988

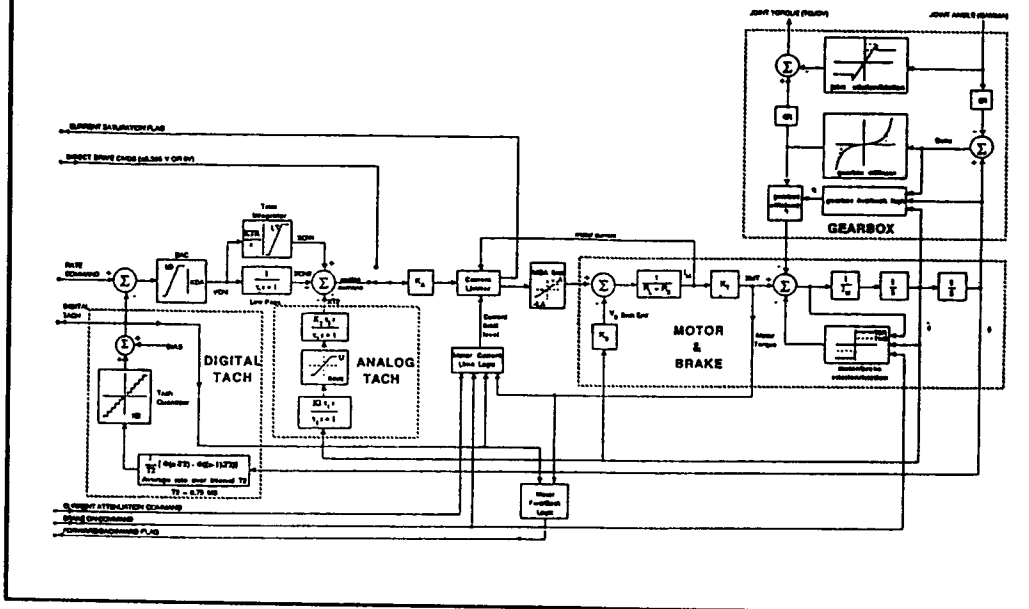

This is a detailed block diagram of the servo system modelled in the assembly simulator. The servo math model was adapted from an existing high fidelity simulation tool of the SRMS called the DRS, Draper RMS Simulation.

As shown, a digital joint rate command (in counts) is received from the GPC by way of the MCIU. This input rate demand is compared with the actual motor rate from a digital tachometer feedback to form an error signal. This error is then converted to an analog voltage signal and processed in through a trim integrator and a low pass filter. The purpose of the integrator is to provide a high gain at low frequencies needed to break motor and gear train stiction and to overcome small errors. The output of these analog electronics are summed with negative feedback of the analog tachometer signal. This continuous part of the tachometer is run through a high pass filter which serves to provide stability. In contrast, the purpose of the digital tachometer is to improve tracking accuracy. The analog voltage signal is then sent to the Motor Drive Amplifier (MDA) and a current limiter which results in attenuation of the voltage applied to the joint motor. The resulting motor rate is then passed to the gearbox to generate the required output torque.

Nonlinear friction losses are modeled on both the motor or input side of the gearbox and on the output or joint side of the gearbox. The output friction models include both the joint friction and the gearbox friction.



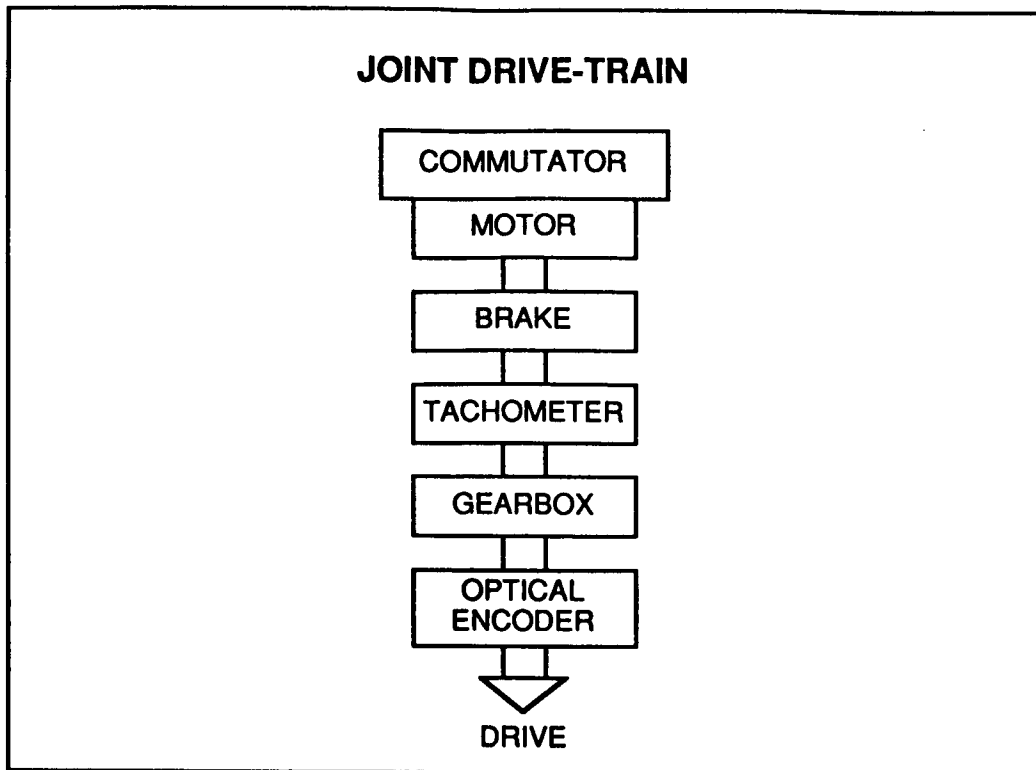

Shown is a schematic of the SRMS joint drive-train. The optical encoder is physically mounted on the joint side of the gearbox and the tachometer is mounted on the motor side of the gearbox. The friction and freeplay which occurs in the drive-train have been modelled in the simulation.

## NONLINEAR SERVO MODELS

Gearbox Stiffness

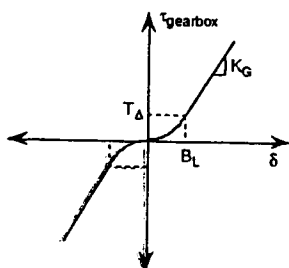

where,  
 $T_\Delta$  = gearbox transition torque (ft-lbs)  
 $B_L$  = gearbox transition angle (rad)  
 $K_G$  = gearbox linear stiffness (ft-lbs / rad)

Joint Friction/Stiction

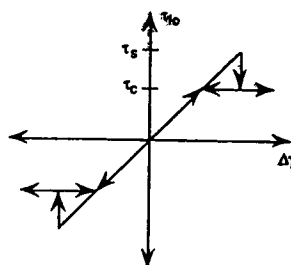

where,  
 $\Delta\gamma$  = difference in actual joint angle (deg)  
 $\tau_c$  = coulomb torque level (ft-lbs)  
 $\tau_s$  = stiction torque level (ft-lbs)

*"the old hairbrush model"*

The nonlinear gearbox model is represented by an asymptotic linear compliance and a quadratic stiffness relation at low torque levels. This stiffness is computed as a function of the backlash angle of the gearbox as shown.

For the joint friction/stiction model, the friction torque is computed as a function of the joint angle as shown. When the actual joint angle is less than a stiction (static friction) reference angle, friction torque acts like a spring restraint. In this region, a steady torque produces a small rotational displacement. When an applied torque is removed, the joint returns to an equilibrium position. If the displacement exceeds the stiction reference angle, the friction torque drops to a coulomb torque level. While the joint rate remains positive, the friction torque is constant. If the rate becomes negative, the friction reference angle is reset and the model reverts to its spring-like behavior about the new reference point. This is the so-called "old hairbrush" model used in the DRS.

## NONLINEAR SERVO MODELS (cont'd)

### Motor/brake Friction

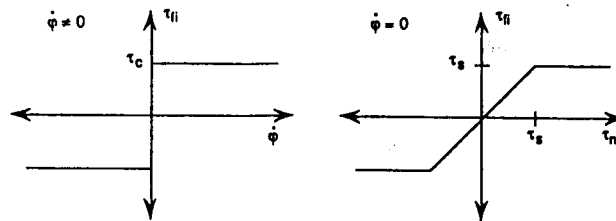

where,  
 $\dot{\phi}$  = motor rate (rad/sec)  
 $\tau_c$  = coulomb torque level (ft-lbs)  
 $\tau_s$  = stiction torque level (ft-lbs)

The SRMS motor/brake friction/stiction is modelled as shown. When the joint is moving, the friction torque is equal to the coulomb (sliding) friction value. When the joint is not moving and the torque is larger than the stiction level, the friction torque is set to the stiction level. If the torque is less than the stiction level, just enough stiction is applied to the joint to make the net torque output zero.

## MUTLIBODY REPRESENTATION

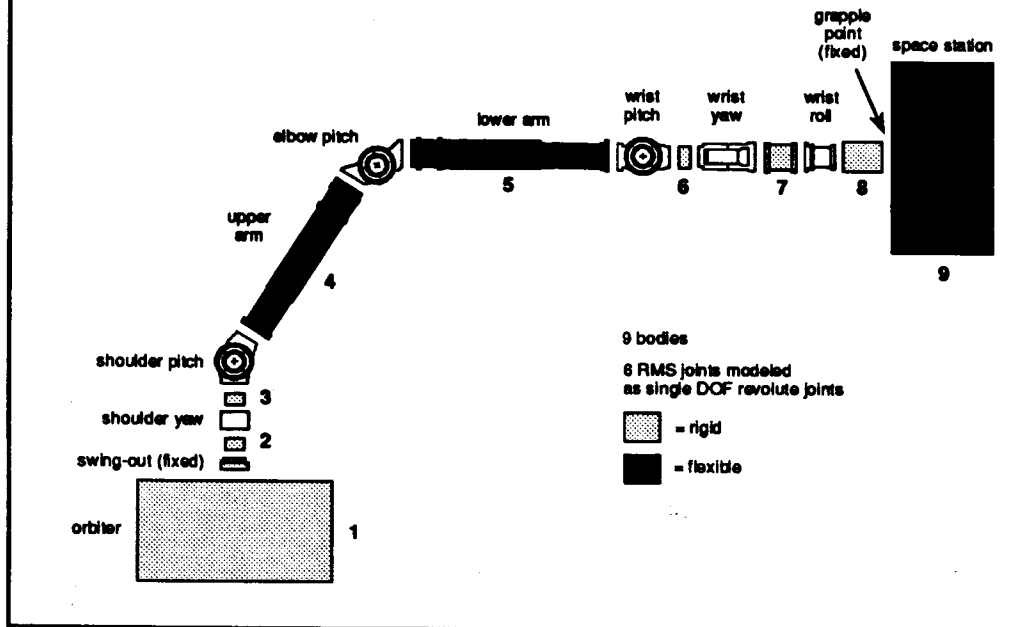

Nine bodies are used to model the complete multibody system as shown. The nine bodies include the orbiter, the seven links of the SRMS, and the SSF. Three components, the two long booms of the SRMS and SSF, are modeled as flexible bodies. Eight joints are defined to connect each of the bodies in the system. The swing-out joint at the base of the SRMS and the connection between the end-effector and payload are modeled as bracket (rigid) joints. The remaining six joints are modeled as single degree-of-freedom revolute joints, which accommodate the six degrees-of-freedom of the SRMS.

## SIMULATION ARCHITECTURE

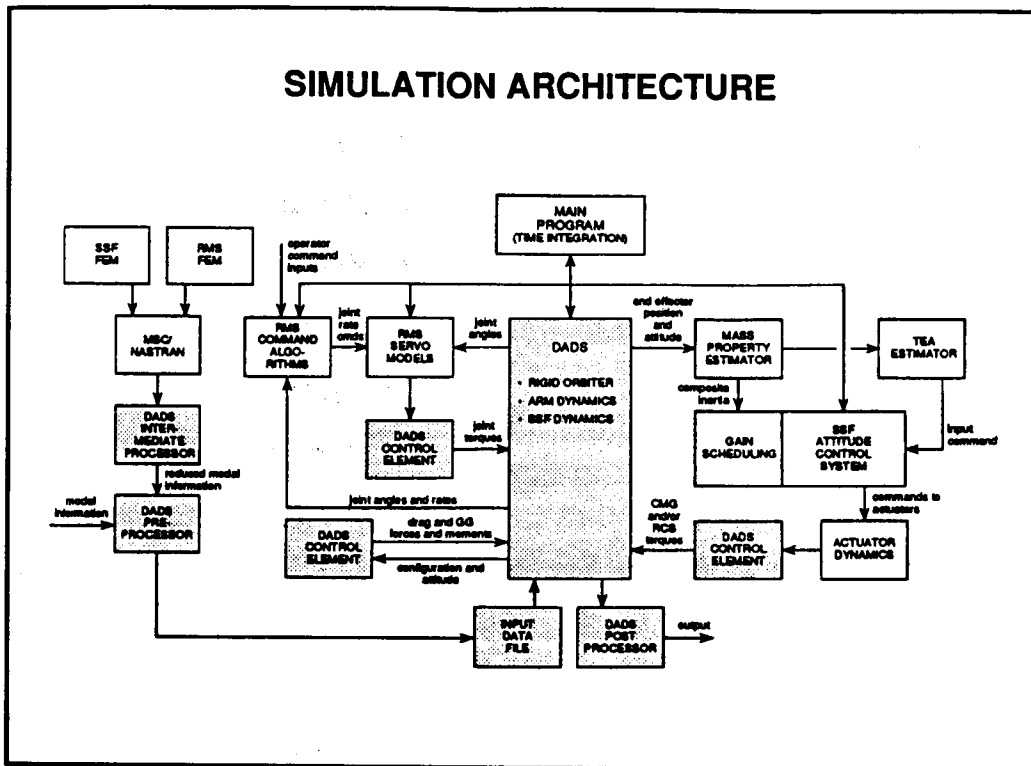

The detailed architecture of the computational tool is shown. It consists of four major parts; multibody dynamics code DADS (Dynamic Analysis and Design System), the SRMS controller, the SSF ACS, and the MAIN program. The DADS code is used to generate equations of motion of the system, including the SRMS arm, the orbiter, and SSF. Each of these modules has its own integration routines and integrate its state equations at its respective integration step sizes. In order to synchronize the simulation process of different sampling rates, the MAIN routine was added to control the timing and program execution flow.

For the SRMS controller, joint angles and rates from DADS, along with operator command inputs, are fed into the SRMS command algorithm to compute joint rate commands. The SRMS controller model calculates driving torques, based on the joint rate commands, which are then applied back to DADS through control elements. For the ACS, the DADS code provides the attitude and attitude rate of the stack to the ACS. Along with the commanded attitude, the ACS computes attitude errors and rate errors that are used to compute required commanded torques to be applied to the system. At the same time, the mass property estimator is used to estimate the inertia of the composite system. This estimated information is used to compute proper gain scheduling in the ACS and to update the commanded attitude. Depending on the type of actuator used, the commanded torques are converted to either RCS forces or to CMG torques which are fed back to DADS using control elements. Environmental disturbances from aerodynamics moments and gravity gradient torques, recomputed on the estimated inertia change, are also applied to the system through control elements.

## **SIMULATION RESULTS**

**All sims performed using an SGI 4D/440 workstation**

### **ESTABLISH TORQUE EQUILIBRIUM ATTITUDE**

**36 mode representation of SSF**

**4 mode representation of SRMS**

**TEA was established in 20 minutes real-time**

### **BERTHING**

**13 mode representation of SSF**

**4 mode representation of SRMS**

**Berthing to within 2 feet was completed in 14 minutes real-time.**

For the TEA maneuver, the time integration was performed with a time step of 0.001 seconds and the computations took approximately 72 hours of dedicated CPU time on an SGI 4D/440 workstation. The station structural dynamics were represented using 36 normal modes. A comparison was made with a simulation using ten normal modes to represent the station dynamics. The response differences were within the accuracy of the computation and thus the ten-mode model was deemed to be sufficient in representing the dynamics of the station. A conservative proportional damping level of 0.2 percent of critical damping was assumed for each mode.

For the Berthing maneuver, the time integration was performed with a time step of 0.002 seconds and the station dynamics were represented using a 13 mode model. The maneuver was completed in 14 minutes.

## ATTITUDE CHANGE DURING TEA MANEUVER

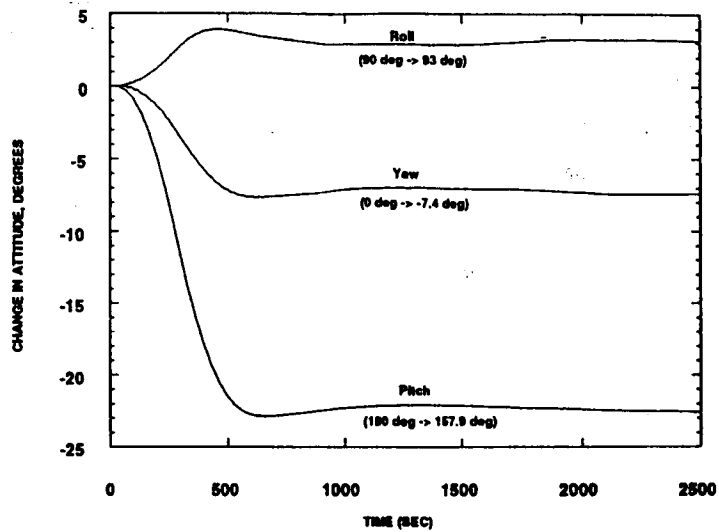

The TEA maneuver required an attitude change from a gravity-gradient position to an attitude orientation of pitch, yaw and roll of  $-22.1^\circ$ ,  $-7.4^\circ$  and  $3^\circ$ , respectively. The resulting attitude-change time history is shown. The TEA of the stack was successfully established within 1200 seconds, a little more than a quarter of an hour.

## RCS JET FIRINGS DURING TEA MANEUVER

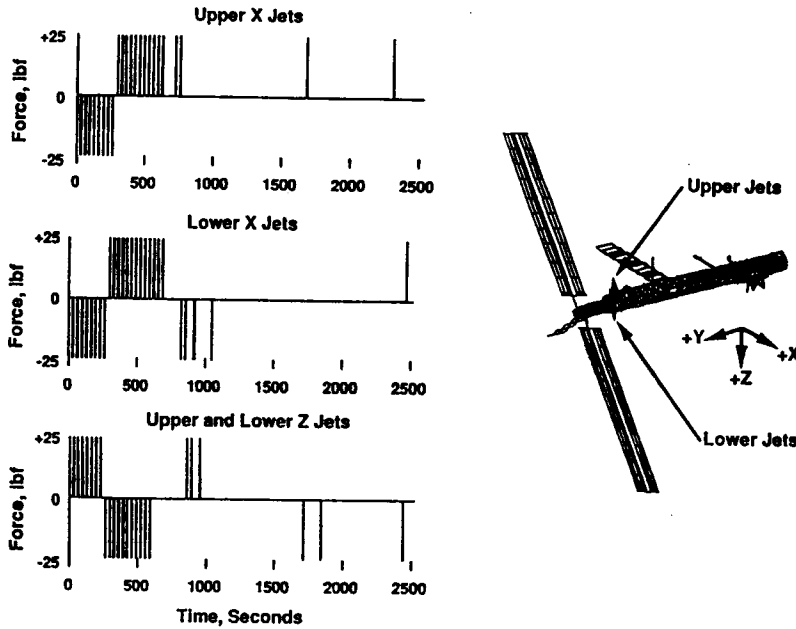

The actual jet firing times for the upper and lower x-axis and z-axis jet clusters are shown. The RCS commanded torque is realized through the jet selection logic as firing pulses of approximately 0.2 to 1 second in duration. The RCS jets are inhibited from firing more often than once every 33 seconds to reduce structural dynamic response.



## CHANGE IN POR MAGNITUDE DURING TEA MANEUVER

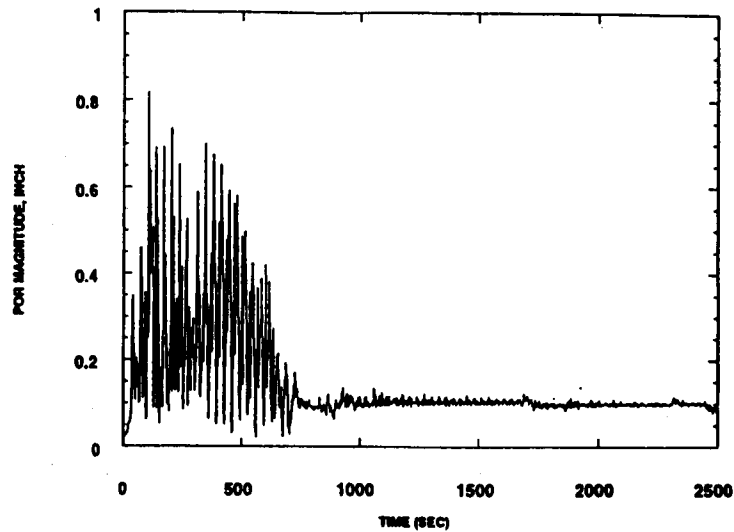

Shown is a plot of the relative magnitude of the position of the Point of Resolution (POR) (located at the SRMS end-effector) with the brakes engaged. The SRMS joints were slightly overloaded when the jets were fired to establish TEA and two of the wrist joints exhibited some brake slip during the first 750 seconds of the simulation. The largest position change computed during the jet firings was less than one inch and the resultant slip after the jet firings were completed was less than 0.2 inches. The total position change is a combination of brake slip, arm flexibility and joint flexibility in the six-joint drive-trains.

## POR LOCATION FOR BERTHING SCENARIO

### Orbiter Body Axis System (OBAS) Coordinates

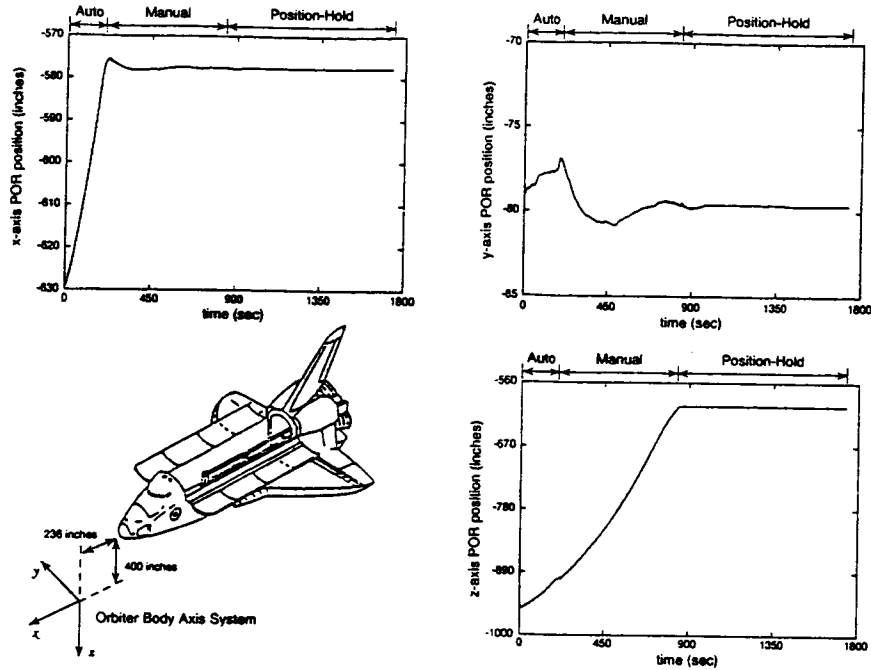

Results from the berthing simulation are shown. The SRMS POR is commanded to move along a three-point berthing trajectory. From the initial grapple point, position 1, the SRMS is commanded to move 4.5 feet in the x and z-axis directions and 2 inches in the y-axis direction using an Operator Commanded Auto Sequence (OCAS) maneuver. From position 2, the SRMS is immediately commanded to move 25 feet vertically to position 3 using Manual Augmented Loaded mode z-axis translational hand controller inputs. Position 3, which is two feet from a full berthed position, is reached in approximately 800 sec. At this time, the Position Hold function is automatically enabled by the SRMS command algorithms to maintain its commanded position and attitude. Very little residual vibratory motion is observed following completion of the berthing maneuver.

This simulation was conducted using translational and rotational end-effector rate limits of 0.14 ft/sec and 0.14 °/sec (coarse mode).

## ATTITUDE CHANGE DURING BERTHING MANEUVER

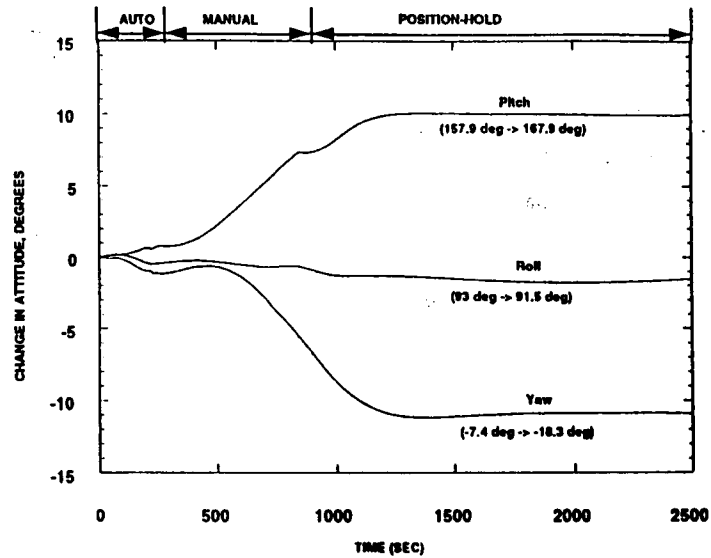

Euler Angle Sequence is Pitch, Yaw, Roll

The inertia of the stack, and thus the TEA, changes continuously during the berthing maneuver. The instantaneous mass of the stack is computed every second and used to modify the gains of the CMG momentum management control system. This information is also used to compute the current TEA which is subsequently applied to the CMG control system as an updated commanded attitude change. The change in attitude of the stack during the berthing maneuver is shown. The final Pitch, Yaw and Roll attitude of the stack is designated.

## **SIMULATION OBSERVATIONS**

### **ESTABLISH TORQUE EQUILIBRIUM ATTITUDE**

**Minor SRMS brake slip occurs (continuous firing unacceptable).**  
**Influence of structural response on control is small.**  
**Structural response and loads are small.**  
**RCS control functioned well.**

### **BERTHING**

**CMGs saturate if maneuver starts with unblased CMGs.**  
**SRMS Position Hold mode shows tendency toward instability (SRMS upgrades not implemented).**  
**Influence of structural response on control is negligible.**  
**Periodic update of stack inertia is required (trace of I matrix changes by as much as 10% during berthing).**

The following observations may be made about the simulated TEA and berthing maneuvers. The SSF RCS successfully established a TEA for the stack with only a small amount of SRMS brake slip. During the berthing maneuver, the CMGs were able to track the changing TEA while the orbiter and station were pulled together by the SRMS when given an initial bias.

Although not shown, the Position Hold mode did exhibit a tendency for instability when left on for an extended period of time. This may be attributable to the known instability of Position Hold with massive payloads. An enhancement to Position Hold mode along with two other SRMS upgrades are presently being implemented by JSC to facilitate assembly operations.

In both simulated maneuvers, the elastic behavior of the station and of the SRMS was found to have only a minor influence on the attitude control of the stack and the control loads caused only minor internal structural loads and structural response.