

NASA Conference Publication 3253

# Second Annual International Space University Alumni Conference

(NASA-CP-3253) THE SECOND ANNUAL  
INTERNATIONAL SPACE UNIVERSITY  
ALUMNI CONFERENCE (NASA, Marshall  
Space Flight Center) 151 p

N94-31425  
--THRU--  
N94-31438  
Unclas

H1/12 0005284

*Proceedings of a workshop held in  
Huntsville, Alabama  
August 6, 1993*

**NASA**

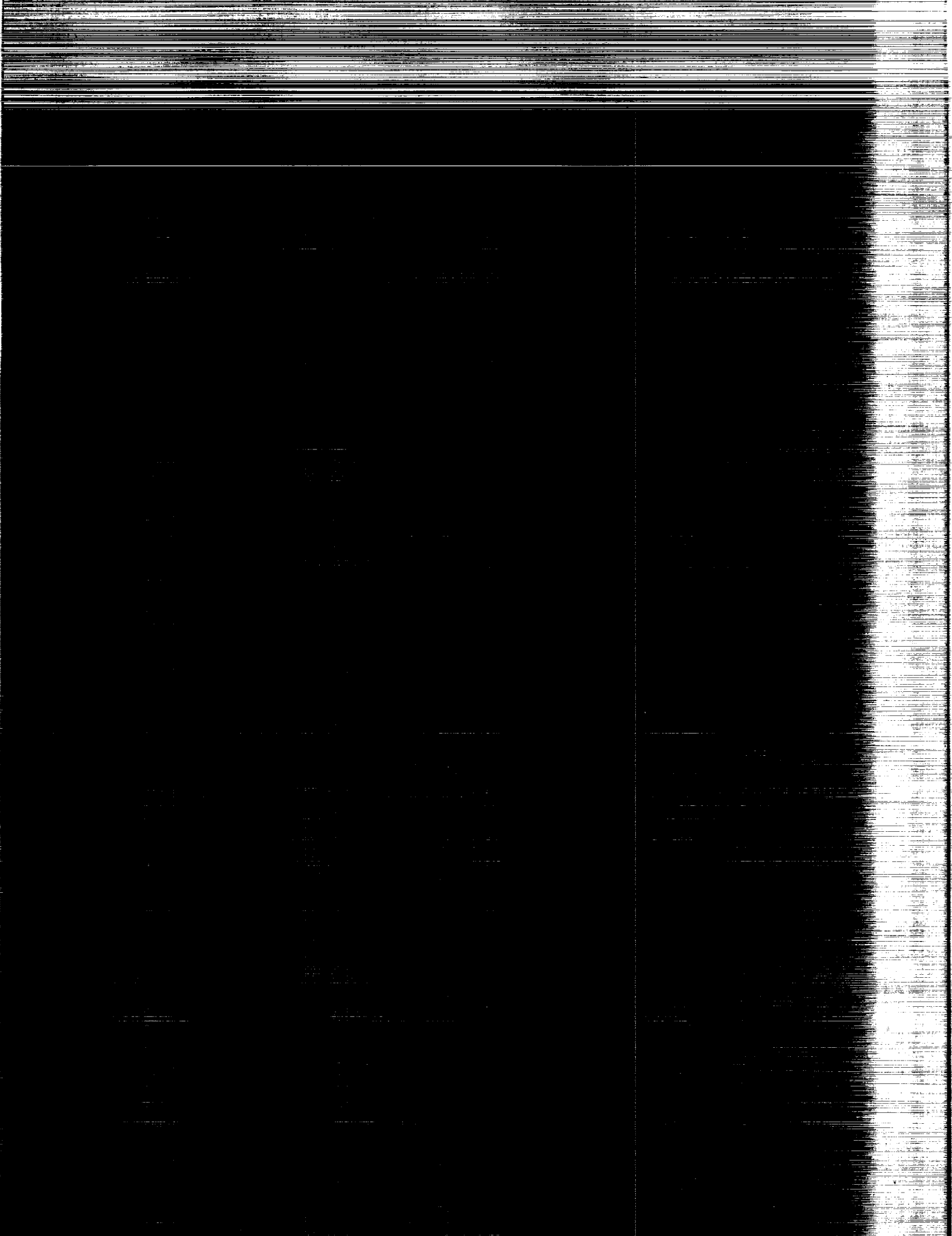

*NASA Conference Publication 3253*

# **Second Annual International Space University Alumni Conference**

*Compiled by L. Johnson, and P. Robinson  
George C. Marshall Space Flight Center  
Marshall Space Flight Center, Alabama*

Proceedings of a workshop sponsored by the  
International Space University  
Cambridge MA, and held at  
George C. Marshall Space Flight Center  
Marshall Space Flight Center, Alabama  
August 6, 1993

**NASA**

National Aeronautics and  
Space Administration

Office of Management

Scientific and Technical  
Information Program

**1994**

## **Preface**

The Second Annual International Space University Alumni Conference was held at the University of Alabama in Huntsville on August 6, 1993. The conference was chaired by Dr. Paul Robinson and Lance Bush. Dr. Lin Hartung helped in the organization and Les Johnson coordinated the publication of the conference proceedings.

The Alumni Conference is intended to give graduates of the International Space University's multi-disciplinary space education program a forum through which they may present and exchange technical ideas, and keep abreast of the wide variety of work in which the ever-growing body of alumni is engaged. We believe this diversity is reflected in the subject matter of the papers presented in this collection.

In this document we have tried to preserve the order of the presentations given at the conference. The first papers have special relevance to the student design projects which are an integral part of the International Space University summer program. There were two design projects in 1993: the design of an International Lunar Farside Observatory and Science Station (ILFOSS), and the development of a Global Emergency Observation and Warning (GEOWARN) system.

The NASA George C. Marshall Space Flight Center was a sponsor of the 1993 ISU Summer Session and provided significant technical expertise to the program as well as assistance in the publication of these proceedings.

We would like to thank all those who participated in the conference and who helped in its success.

Paul A. Robinson

Les Johnson

## CONFERENCE AGENDA

Opening Remarks	Dr. Paul Robinson, Conference Chair
<b>Design Project Session</b>	
Mitigation of Adverse Environmental Effects on Lunar-Based Astronomical Instruments	Les Johnson (91, USA)
Solar Lunar Power	Sheila Bailey (89, USA)
The ACTS Mobile Terminal	Catherine Girardey (89, FRA)
Moon Docs Among the Moon Rocks	Dr. Ron Schaefer (88, USA)
Moon Base Habitability Aspects	Max Leoncini (91, ITA)
Multi-Wavelength Search for Protoplanetary Disks	Ralph Neuhauser (88, GER)
Break	
The Legal Regime of Astronauts	Carlo Golda (91, ITA)
Evaluating Success Levels of Mega-Projects	Mohan Kumaraswamy (88, SRI)
SCDI: The First Brazilian Satellite	Oscar Dias (90, BRZ)
Stereo Vision Using Local Spatial Frequency	Mark Maimone (89, USA)
Lunch	
Hubles Satellite Communications Networks	Peter Robinson (92, AUS)
Ariane: Europe's Space Transportation for theWorld	Juan de Dalmau (89, FRA)
Dynamics and Control of Evolving Space Platforms with Application to the Proposed Space Station	Afzal Suleman (92, CAN)
Application of Wavelets in Image and Speech Processing	Stephane Maes (91, BEL)
Thermal Management in Future Spacecraft and Space Station	Kamiel Rezkallah (90, CAN)
Presentation on the MSS Curriculum Planning Working Group	Dr. George Haskell
Break	
<b>Host Nation Session</b>	US Alumni
Multisatellite Constellation Architecture Optimization	Mark Matossian (88, USA)
Biosphere Presentation	Taber McCallum (88, USA)
The Founding and Development of ISU	Doug Messier (91, USA)
Space Station Freedom Redesign	Eric Dahlstrom (91, USA)
Closing Remarks	Dr. Paul Robinson



## TABLE OF CONTENTS

	Page
Mitigation of Adverse Environmental Effects on Lunar-Based Astronomical Instruments (Les Johnson and Kurtis L. Dietz, NASA/Marshall Space Flight Center; and T.W. Armstrong and B.L. Colborn, Science Applications International Corp.) .....	1
Solar Lunar Power (Sheila G. Bailey, NASA Lewis Research Center, and Geoffrey A. Landis, Sverdrup Technology) .....	8
Channel and Terminal Description of the ACTS Mobile Terminal (B.S. Abbe, M.J. Agan, C.C. Girardey, and T.C. Jedrey, Jet Propulsion Laboratory) .....	26
The Nomad Explorer Assembly Assist Vehicle: An Architecture for Rapid Global Extraterrestrial Base Infrastructure Establishment (Madhu Thangavelu, University of Southern California) .....	34
Multiwavelength Search for Protoplanetary Disks (Ralph Neuhäuser, Max-Planck Institut für Extraterrestrische Physik, and Theodor Schmidt-Kaler, Astronomisches Institut, Ruhr-Universität Bochum) .....	57
Legal Regime of Human Activities in Outer Space Law (Carlo Golda) .....	66
Evaluating Success Levels of Mega-Projects (Mohan M. Kumaraswamy, University of Hong Kong) .....	76
Hubless Satellite Communications Networks (Peter Alan Robinson, Telstra Corp. Ltd.) .....	92
A Study of the Space Station <i>Freedom</i> Response to the Disturbance Environment (A. Suleman, V.J. Modi, and V.B. Venkayya, Wright-Patterson Air Force Base) .....	96
Application of the Wavelet Transform for Speech Processing (Stéphane Maes, Rutgers University) .....	112
An Innovative Approach to Space Education (Christine Marton, Canadian Alumni of the International Space University, Alain B. Berinstain, University of Ottawa, and John Criswick, York University) .....	121
Multisatellite Constellation Configuration Selection for Multiregional Highly Elliptical Orbit Constellations (Mark G. Matossian, University of Colorado) .....	126
ISU in an Era of Partial Reconvergence (Douglas M. Messier, George Washington University) .....	137

PRECEDING PAGE BLANK NOT FILMED





Mitigation of adverse environmental effects on lunar-based astronomical instruments

Les Johnson and Kurtis L. Dietz

NASA/Marshall Space Flight Center,  
Huntsville Alabama 35812, U.S.A.

T.W. Armstrong and B.L. Colborn

Science Applications International Corporation  
Prospect, Tennessee 38477, U.S.A.

**ABSTRACT**

The galactic cosmic-ray flux incident on the Moon was examined for its potential adverse impact on the performance of the large lunar telescope (LLT) proposed as a part of NASA's Space Exploration Initiative (SEI). Noise produced by the cosmic-ray flux in the charge coupled devices (CCD's) to be used as the primary photodetector in the telescope was estimated. It was calculated that approximately 2.5 m of regolith would provide the shielding necessary to reduce the noise to an acceptable level.

Dust is an omnipresent environmental concern for any human-assisted or robotic scientific instruments deployed on the Moon. The degree to which dust poses an operational risk to the telescope was examined. Three potential methods for reducing this risk were identified: locating scientific instruments at remote locations; utilizing a prepared, dust-free site for all rocket activities; and covering the optics during high-risk times.

**INTRODUCTION**

Several astronomical instruments are being considered for deployment on the Moon as part of the SEI. The Marshall Space Flight Center (MSFC) is examining the feasibility of placing a 16-m diameter optical telescope on the Moon in the next century as a potential follow-on to the Hubble space telescope (HST).<sup>1</sup> The LLT will utilize segmented optics and operate in the ultraviolet-visible-infrared portions of the electromagnetic spectrum.

Lunar-based astronomical instruments such as the LLT will be exposed to a solar and galactic cosmic ray (GCR) environment which is much more severe than that present on the Earth or in low-Earth orbit (LEO). The Moon is located outside the Earth's protective atmospheric envelope which acts as a thick shield for highly energetic cosmic-ray particles from space. The Moon also lacks the benefit of the Earth's geomagnetic field, which serves to deflect all but the most energetic cosmic rays away from the planet's surface. Cosmic rays, which are highly energetic and very penetrating, are of significant concern due to their potential impact on the lifetime of and the noise produced in the CCD's likely to be used in lunar-based astronomical instruments.<sup>2</sup>

The dust- and regolith-covered lunar surface will also pose an environmental risk to the telescope and other optical instruments. Human activity will disturb the dust to varying degrees: simple walking can kick up dust that will settle many meters from where it is lofted, while rockets descending to the surface can give small particles ballistic trajectories with sufficient velocity to reach the other side of the Moon! If such dust is permitted to land uninhibited on exposed optical surfaces, the result can be significant degradation of telescope performance.

## THE COSMIC-RAY ENVIRONMENT

GCR's are composed primarily of hydrogen and helium ions (protons and alpha particles), although other ions are also present (Fig. 1).<sup>3</sup> These high-energy, highly penetrating ions, and the secondary particles they generate by nuclear collisions, can deposit energy by ionization in passing through a CCD array and release free electrons, which is read by the CCD as noise. During the projected lifetime of these lunar-based instruments, a significant number of nuclear interactions may also be produced within the CCD, causing displacement damage and degradation of performance that can lead to the need for CCD replacement.

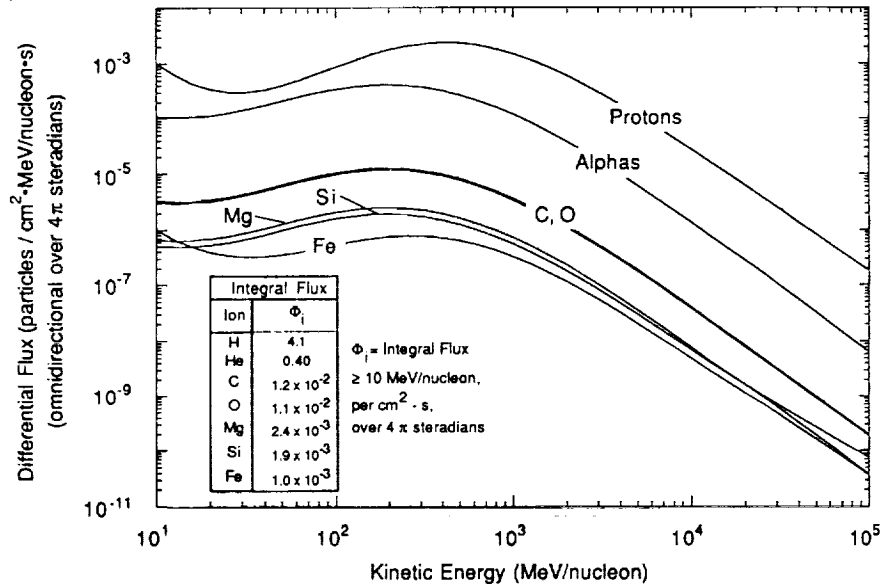

Fig. 1. Galactic cosmic-ray spectra at solar minimum, based on data compilation by Adams.

An additional component of the cosmic-ray flux incident on the Moon is the radiation of solar origin. Although the Sun is constantly emitting low-energy solar wind particles, the flux is small until the advent of a solar flare, during which the particle emission can increase by orders of magnitude. However, these relatively low-energy solar cosmic-ray particles are much more easily shielded than the penetrating galactic cosmic rays and are typically present for such a relatively short period of time that they are not considered to be a major problem.

The feasibility of using lunar regolith to shield CCD's and reduce the galactic cosmic-ray induced noise to acceptable levels was investigated. Calculations using detailed Monte Carlo radiation transport codes that take into account secondary particle production were performed to determine the radiation environment as a function of depth in lunar regolith. The predicted depth-dependent fluxes are shown in Fig. 2.<sup>4</sup> For CCD noise assessments, it is the ionization produced by the charged particle flux that is important. The probability of a noise event from a nuclear collision by the neutral particles (neutrons and gamma rays) is relatively small due to the small thickness of the CCD's. Figure 2 also shows that the most abundant charged particle in the lunar cosmic-ray environment is electrons, whereas protons dominate the background for satellite observatories in LEO and muons are the most prevalent particle type in the sea-level cosmic-ray background on Earth. Thus, electrons would be the most appropriate particle for irradiations in laboratory tests of CCD noise for lunar applications. The CCD radiation damage by displacement in a shielded lunar environment will be dominated by neutrons.

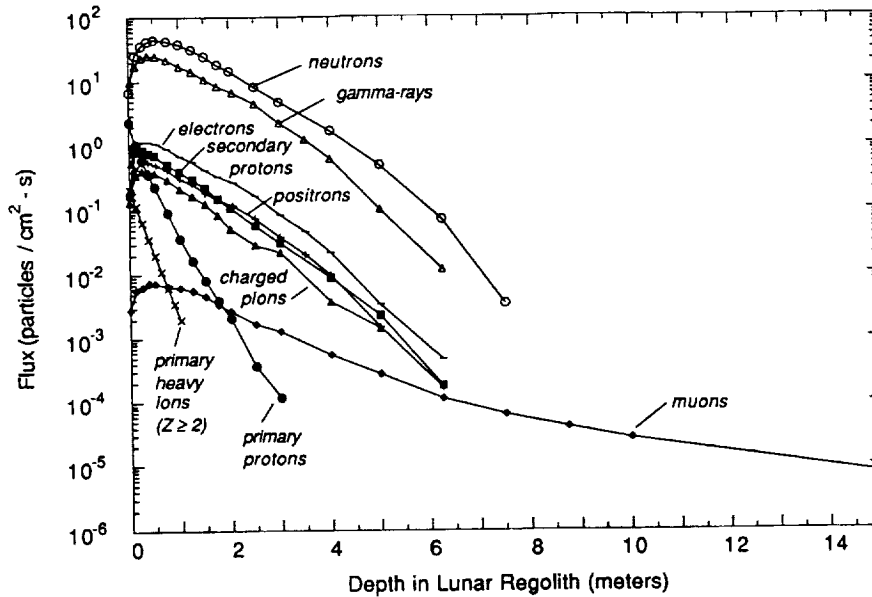

Fig. 2. Predicted radiation environment below lunar surface due to cosmic-ray bombardment.

The shielding needed to reduce the cosmic-ray background to acceptable noise levels for CCD's was parameterized in terms of pixel size and exposure time (Fig. 3). For nominal criteria based on Earth astronomy procedures (1-h exposures and a noise event probability of  $<10^{-3}$  per pixel), and assuming a CCD pixel size based on current technology (10 microns by 10 microns), a shielding thickness of about 2.5 m of lunar regolith is obtained. For the baseline LLT design, a buried instrument chamber utilizing this regolith shielding (illustrated in Fig. 4) was selected.<sup>5</sup> The actual shielding needed may well be less than for these particular parameter assumptions; however, more definitive estimates depend on several evolving factors, such as CCD characteristics (pixel sizes, detection sensitivity) and operational considerations (appropriate exposure times). Also, noise reduction techniques, such as signal processing to discriminate between signal versus noise based on spatial and amplitude features, may be able to further reduce the shielding needed. The lunar radiation environment results calculated here will allow revised CCD noise assessments to be performed as these factors become better defined in the future.

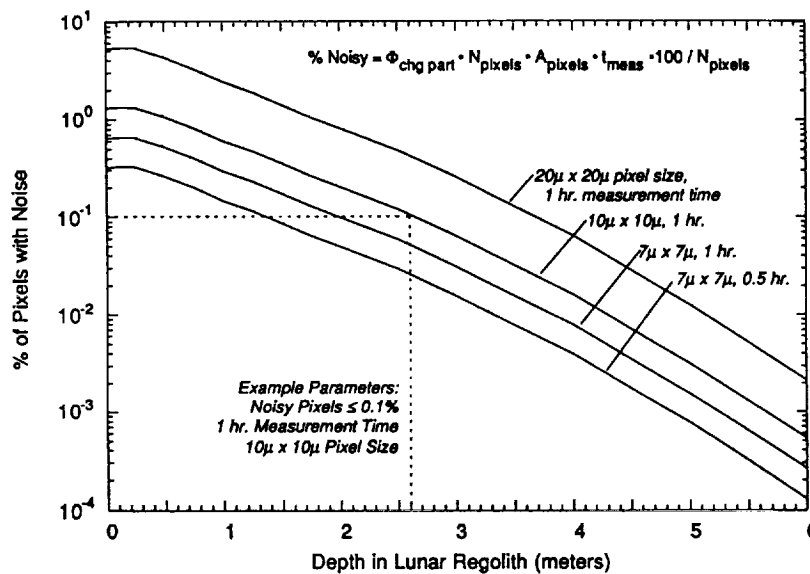

Fig. 3. Lunar regolith shielding needed to reduce CCD noise from cosmic rays.

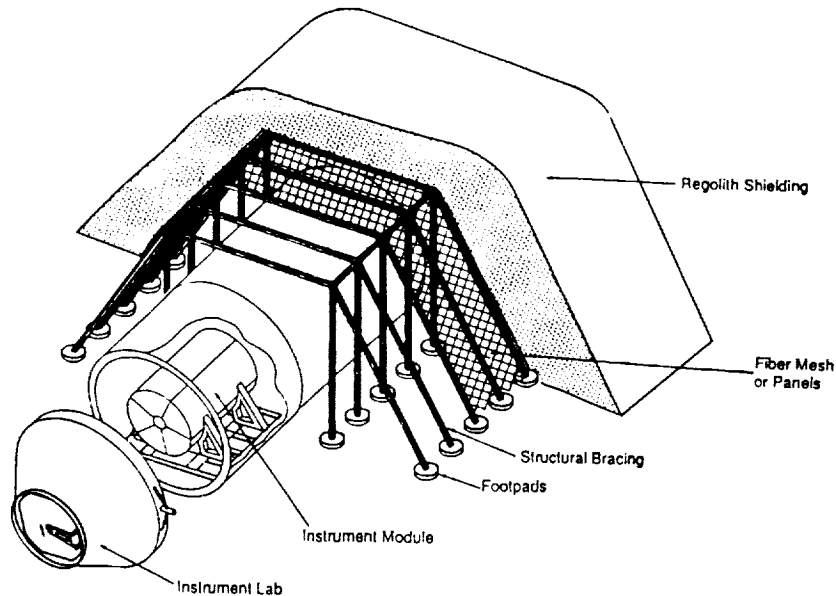

Fig. 4. LLT regolith-covered instrument laboratory concept.

### THE DUST ENVIRONMENT

While the unpopulated Moon provides an excellent platform for large, high-resolution astronomical instruments, the presence of humans there may have a significant negative impact on both the instruments and the observations to be made with them. The Apollo missions have shown that human activity can easily disturb lunar dust and, due to the low lunar gravity and negligible atmosphere, can launch even the smallest grains in ballistic paths that stretch far across the lunar surface.<sup>6</sup> The lofted dust may thus be transferred onto the telescope, obscuring the sensitive optics, scattering light resulting in distorted observations, and potentially interfering with the mechanical devices that slew and guide the telescope.

Figure 5 illustrates the range that a ballistic particle may travel on the Moon as a function of its initial velocity. Human endeavors on the Moon will loft dust particles with velocities comparable to those given in Table I and labeled in Fig. 5.<sup>7</sup> All human activity, from launching rockets to simply walking on the lunar surface, will spread dust to considerable distances.

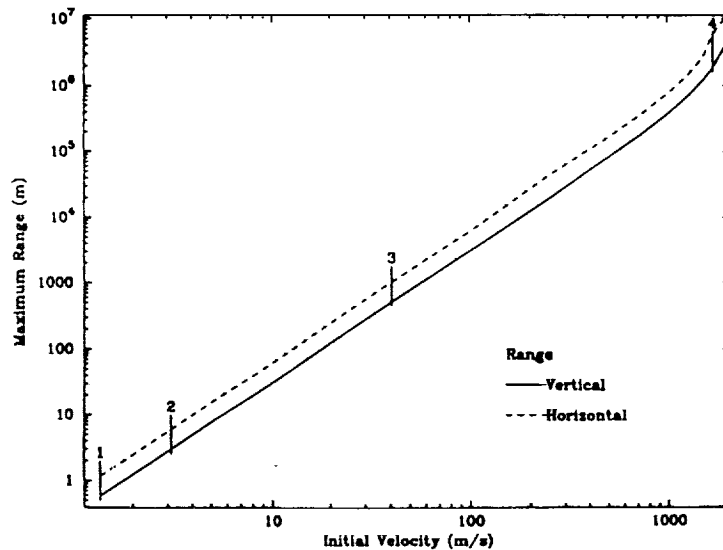

Fig. 5. Plot of the maximum horizontal and vertical range of a lunar particle as a function of its initial speed. The four labeled vertical ticks are those points listed in Table I.

Table I. Speeds of some typical human activities and the maximum horizontal and vertical ranges of particles ejected at these speeds on the Moon.

Activity	Maximum Range (m)		Horizontal
	Speed	Vertical	
1. Driving a vehicle at 5 km/h	1.38	0.59	1.17
2. Dropping a tool from 3 m	3.12	3.00	6.00
3. Throwing a major league fastball	40.7	511	1,023
4. Landing a rocket (rocket exhaust speed)	1,700	1,740,000	5,460,000

The data shown in Table I and Fig. 5 indicate that the most common lunar surface activities will scatter dust no further than approximately 1 km from its lofting point. The data also show that the dust raised by the descent or ascent of a typical rocket can travel as far as the other side of the Moon, leaving no lunar location completely free of the settling dust. Since dust cannot simply be avoided, the quantity accumulated at different locations was assessed in order to determine what distance from a human settlement a telescope must be placed to provide a tolerable dust environment for its optics and mechanisms.

The distribution of dust raised from a nominal rocket landing was estimated based on astronauts' measurements of the crater created by the Apollo 14 lunar lander. These measurements are listed in Table II.<sup>8</sup> From the calculated dust distribution, the obscuration (i.e., the fraction of a surface's area covered by dust) caused by the settling particles was estimated from geometric considerations. The resulting obscuration as a function of horizontal distance from the landing site is plotted in Fig. 6. As a reference, the allowed contamination level for the IRAS and EOS optical instruments is also shown.<sup>9</sup> In order to prevent significant obscuration of the LLT optics by a single rocket landing, the telescope should be located more than 1 km from the rocket landing site. Since several such landings and launches will occur during the lifetime of the LLT, it would seem that the telescope should be moved even farther from the lunar base. However, the need for power and other logistical support from the base will require that the telescope be placed within a few kilometers of it and the landing site. This scenario will require some method of reducing the amount of dust reaching the telescope's optics.

Table II. Data from Apollo 14 landing site.

Crater Diameter	4 m
Crater Depth	10 cm
Crater Volume	1.23 m <sup>3</sup>
Approximate Rocket Velocity	1.0 to 1.7 km/s
Assumed Dust Diameter	20 microns

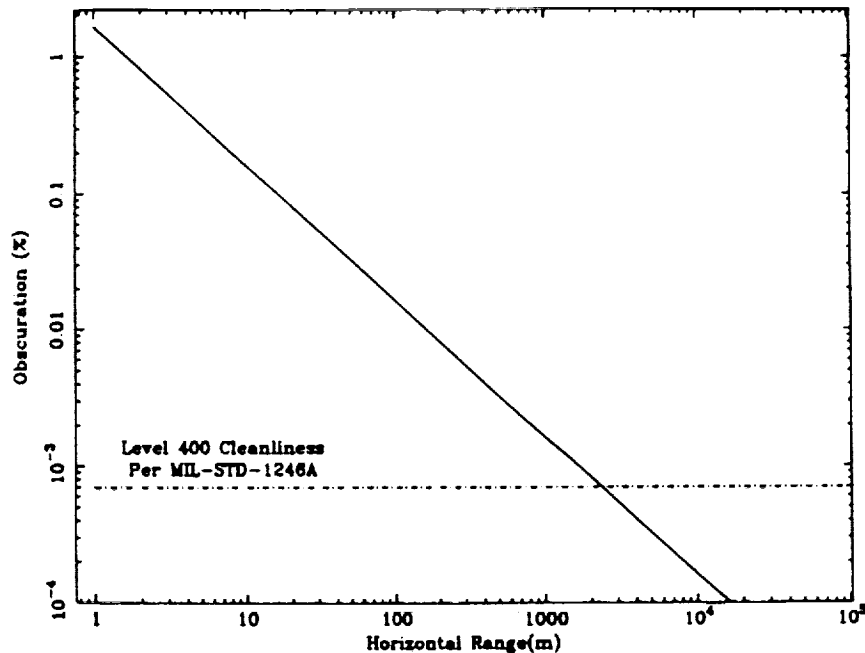

Fig. 6. Plot of the obscuration of a clean surface by dust as a function of distance from the landing site of an Apollo 14-class rocket.

One possible method of reducing dust contamination is to cover the optics during rocket launches and landings, which are the only times that dust from the lunar base is likely to reach the telescope. This would allow the LLT to be located approximately 1 km from the base and would not significantly affect its observing time, since launches and landings will occur relatively infrequently (approximately once per year, probably during daylight hours when no observations are planned). It was estimated that the dust raised by rocket exhaust will remain aloft for less than 1 h. Similar covers proposed as thermal shields may also provide the added benefit of dust protection.<sup>10</sup> However, it should be noted that erecting a large dust cover could significantly increase the mass and transportation cost of the telescope.

Another potential dust-reduction method is to prepare a hard, dust-free site for rocket launches and landings. Such a prepared site would protect not only the LLT, but other scientific instruments as well. However, as the human presence on the Moon expands, it is likely that other projects will require remote, and thus unprepared, landing sites that would be a source of potential dust contamination to the optics of the LLT.

It is recommended that a combination of the techniques mentioned above be used to reduce the threat dust presents to the operation of the telescope. Locating the telescope 1 to 10 km from the base, utilizing a prepared landing site whenever possible, and covering the optics with a thermal shield designed to also serve as a dust cover should reduce the overall risk of dust contamination for the LLT optics. A trade study is suggested to quantify the risk to the optics when only a subset of these proposed techniques be used.

## CONCLUSIONS

Reductions in the noise level produced when solar and galactic cosmic rays impinge the LLT CCD arrays can be achieved with a moderate amount of regolith shielding (approximately 2.5 m). The shielding serves to attenuate the highly energetic galactic cosmic rays and reduce the number of

secondary particles created by their interaction with the shielding itself. Advances in CCD design and signal processing might provide better noise-rejection and thus reduce the amount of shielding required. Reducing the amount of disturbed lunar dust falling onto the optics of the telescope is not so easily achieved. A combination of locating the telescope at least 1 km from the human outpost, providing a hardened rocket launch/landing pad, and covering the exposed optics should be considered.

### REFERENCES

1. Nein, M., Davis, B., et al., "Introduction," NASA/MSFC Large Lunar Telescope: 16-m Aperture UV/Visible/IR Telescope Report, Huntsville, Alabama, 1991.
2. Woodgate, B.E., "Visible and Ultraviolet Detectors for High Earth Orbit and Lunar Observatories," Proceedings of the Next Generation Space Telescope Workshop, 1989.
3. Adams, J.H., "Cosmic Ray Effects on Microelectronics, Part IV," Naval Research Laboratory Memorandum Report 5901, 1986.
4. Armstrong, T.W., and Colborn, B.L., "Cosmic Ray Secondary Particle Environment Analysis for Large Lunar Telescope Instruments," Science Applications International Corporation Report No. SAIC-TN-912, 1991.
5. Gerry, M., MSFC Internal Communications, 1991.
6. Aldrin, E.A., Armstrong, N.A., and Collins, M., "Crew Observations," Apollo 11 Preliminary Science Report, NASA SP-214, pp. 35-39, NASA, Washington, DC, 1969.
7. Wright, F.E., et al., "The Lunar Surface: Introduction, Section 10: Lunar Ballistics," The Solar System IV: The Moon, Meteorites, and Comets, B.M. Middlehurst and G.P. Kuiper, eds., pp. 36-43, The University of Chicago Press, Chicago, 1963.
8. Mitchell, J.K., et al., "Soil Mechanics Experiment," Apollo 14 Preliminary Science Report, NASA SP-272, pp. 87-108, NASA, Washington, DC, 1971.
9. Hansen, P.A., and Maag, C.R., "Development of Contamination Requirements for Spaceborne Optical Instruments," Optical System Contamination: Effects, Measurements, and Control, SPIE vol. 777, pp. 127-137, SPIE, Bellingham, Washington, 1987.
10. Nein, M., Davis, B., et al., "Thermal Analysis," NASA/MSFC Large Lunar Telescope: A 16-m UV/Visible/IR Telescope Midterm Review Report, pp. 71-79, Huntsville, Alabama, 1990.

## Solar Lunar Power

Sheila G. Bailey

Photovoltaic Branch, NASA Lewis Research Center,  
Cleveland, OH 44135

Geoffrey A. Landis

Sverdrup Technology, NASA Lewis Research Center,  
Cleveland, OH 44135

### ABSTRACT

Current and projected technology is assessed for photovoltaic power for a lunar base. The following topics are discussed: requirements for power during the lunar day and night; solar cell efficiencies, specific power, temperature sensitivity, and availability; storage options for the lunar night; array and system integration; the potential for *in situ* production of photovoltaic arrays and storage medium.

### 1. INTRODUCTION

Recent evaluation of the power requirements for an initial lunar outpost based on a 4 person crew including a 45 day stay on the lunar surface required 10.8 kW daytime and 9.7 kW nighttime during the crewed phase and 2.0 kW daytime and 2.8 kW nighttime for the uncrewed phase of ~ 4 months.<sup>1</sup> This analysis assumed 8 kW for crew systems, 1.8 kW for avionics, and 1.0 kW for laboratory science experiments. The power requirement profile for a lunar base will not be uniform. To optimally make use of available energy, discretionary energy-intensive activities would be carried out primarily during the daytime. However, some activities, such as life-support, cannot be cut back during the night, and may even require greater energy expenditure at night than during the day (*e.g.*, lighting, including possible requirements for greenhouse lights if a closed life support system is required, science activities such as astronomy). Our analysis will be based on a power requirement of 25 kW of electric power. The driving factor for the selected technology is the mass, due to the high cost of transportation to the lunar surface.

The initial piloted landing will require the availability of power very shortly after the landing, preferably with a minimum of EVA activity required to deploy the power system. Fig. 1 shows one such concept, where flexible arrays are rolled out from reels on the lander and affixed to the ground. The arrays are angled toward the east and west to provide power for both sunrise and sunset conditions as well as midday. The power system may also be on an unmanned supply vehicle and deployed automatically in advance of the piloted mission.

### 2. PHOTOVOLTAIC TECHNOLOGY

There are three approaches to large area photovoltaic arrays in space. The conventional approach, used on all existing satellites, is to make flat-plate arrays from individual crystalline solar cells. The material currently most widely used is silicon (Si); Gallium Arsenide (GaAs) solar cells, with improved efficiency, are also being flown, and Indium Phosphide (InP) solar cells, with a higher tolerance to radiation damage, are being developed for possible use in the future.

An alternative approach is to use solar concentrators with extremely high efficiency solar cells. Such an approach has yielded the highest conversion efficiencies achieved to date, over 30% AM0 using



a tandem GaAs/GaSb solar cell. The first spaceflight experiments with such high-efficiency concentrator solar arrays are now in progress.

A third approach is to use thin-film, integrally connected solar cells, adapting new technology which has been developed for use in low-cost terrestrial solar arrays. Materials used for such arrays include amorphous silicon, CdTe, and copper indium diselenide. This approach has the potential for low weight arrays, the possibility for low cost, and have been demonstrated to have extremely high tolerance to radiation, but is unlikely to achieve the high efficiencies found in single-crystal technologies. Nevertheless, recent advances in efficiency (Fig. 2) have been striking. This array technology has not yet been demonstrated in space, although individual solar cells have been tested in space, confirming the high tolerance to radiation.

Research is ongoing to increase the efficiency, lower the cost, and increase the specific power for all three of the approaches discussed.

### 3. SINGLE-CRYSTAL CELLS

Table 1 summarizes the AM0 efficiencies achieved in the laboratory of a variety of single junction solar cells. The current generation of space solar cells<sup>2</sup> consists of silicon cells. GaAs cells, somewhat more efficient than silicon cells, are beginning to be flown on certain advanced satellites where high efficiency is a major criterion. GaAs on Germanium (Ge) will be flown on the Earth Observing Satellite AM scheduled for launch in 1997.

While currently flying silicon solar cells only have an efficiency of about 14%, in the last decade tremendous advances have been made in silicon solar cell efficiency. Advanced silicon solar cells have been manufactured by the University of New South Wales and by Stanford University with efficiency approaching 21% AM0<sup>3</sup>. These solar cell designs are not yet space qualified, however, and preliminary tests indicate that they are not tolerant to radiation damage. Future designs ultra-thin, light-trapping cell designs may have the advantage of being both highly efficient and radiation tolerant<sup>4</sup>. A 100  $\mu\text{m}$  Si cell was recently reported to have achieved an efficiency of 18.0 %<sup>5</sup>.

The state of the art silicon space solar cell is a large area (8 x 8) cm cell, 0.2 mm thick, covered with a 0.125 mm thick ceria stabilized glass microsheet. This cell, 10  $\Omega\text{-cm}$  base resistivity, with dual anti-reflective coating and a back surface field, has an average efficiency of 14.2% at 28°C, beginning of life (BOL). These cells are currently under production for Space Station Freedom<sup>2</sup>.

The inherent higher efficiency potential for III-V solar materials such as GaAs and InP has promoted research leading to the production of research solar cells routinely in excess of 20%<sup>6</sup>. The desire to reduce cost and breakage has also led to production of III-V cells on other substrates<sup>7</sup>. The current cost of 2 inch semiconductor grade wafers for solar cell production is \$3.00 for silicon, \$65.00 for germanium (Ge), \$100.00 for GaAs, and \$200.00 for Indium phosphide (InP). The cost variations in the latter three are a reflection of supply/demand and not an intrinsic production difference. Current costs for GaAs/GaAs and GaAs/Ge cells are 3-5 times the cost/watt of the SSF solar cell. Cell manufacturing is moving toward thin (< 5  $\mu\text{m}$ ) high efficiency structures on low cost substrates. It is not unrealistic to envision the costs of future high efficiency cells approaching silicon cell costs. Cell cost however is only one component of the cost of an array. The mission profile could dictate requirements such that the higher efficiency array, and hence, less area, would be cost effective for the power system. For instance, replacing the silicon cell on SSF with a 22% efficient solar cell would provide a lower array cost and a considerable weight savings.

A recently-developed alternative single-crystal solar cell technology is indium phosphide (InP). InP solar cells potentially have an efficiency equivalent to that of GaAs, but with vastly superior

tolerance to radiation. A difficulty with InP, however, is the cost of the material. Several methods of growing InP on low cost substrates are currently under development. Missions requiring long lifetimes or high radiation orbits have led to the development of InP cells. The superior radiation resistance of InP cells is illustrated in Fig. 3. The mission chosen for the purpose of illustration is the earth observing satellite (EOS) orbit, which has approximately the same equivalent radiation fluence as the moon. Fig. 4 compares the total radiation fluence, neglecting solar flare events, for five years in a SSF orbit (334 km, 30°), EOS orbit (700 km, 100°), LIPS orbit (1100 km, 60°), and geosynchronous (GEO) orbit (35794 km, 0°). The lunar radiation environment is provided for comparison and will be discussed later.

A small module of InP solar cells on the LIPS satellite has shown no degradation after five years in space. Several thousand InP solar cells were produced by the Japanese and a thousand were used to power a lunar orbiter on board the ISAS scientific satellite "MUSES-A", launched in January, 1990.

Efficiencies listed in Table 1 for InP/Si and InP/GaAs are beginning efforts to produce a less expensive solar cell by growing the InP structure on a less expensive substrate. Efforts are also in progress to remove the thin (< 4  $\mu\text{m}$ ) InP solar cell structure from the substrate by mechanical techniques (CLEFT) and preferentially etched epitaxial liftoff<sup>8</sup>. Both of these techniques also apply to other III-V structures and hold great promise for future crystalline thin film solar cells.

#### 4. CONCENTRATOR AND CASCADE CELLS

Table 2 lists the current status of two- and three-junction solar cells. These are small area cells which can be used in a variety of concentrator systems. Demonstrated efficiencies of over 30% have been achieved. In missions requiring minimum array area, concentrator arrays provide a promising alternative to planar structures. Concentrators also provide extra protection from the radiation environment. The pointing requirements for the mini-dome fresnel concentrator<sup>9</sup> are  $\pm 2^\circ$ , which is an order of magnitude less stringent than required by a solar dynamic concentrating system. Utilizing an optical secondary, the mini-dome concentrator tolerance can be relaxed to  $\pm 3.5^\circ$ .

Cascade cell development has proceeded in both a mechanically stacked arrangement in which a lower bandgap solar cell is placed underneath an infrared transparent higher bandgap cell, and also in a monolithic structure in which the cells are often interconnected by tunnel junctions. The simplicity of simply stacking the cells is offset with the added wiring complexity. Future progress can be anticipated in both of these approaches, leading to a future 40% efficient tandem structure.

#### 5. THIN-FILM SOLAR CELLS

An alternative to the conventional single-crystal solar cell is the thin-film solar cell. Thin-film solar cells are made from thin (1 to 5 micron) semiconductor layers deposited on an inert substrate or superstrate material. The semiconductors have a high-absorption constant; the high absorption constant allows essentially complete absorption of the light within the first micron or so of the material. Recently thin-film solar cells have been the topic of a considerable research effort for low-cost terrestrial electricity production. Initial research efforts focussed on amorphous silicon (a-Si); recently copper indium selenide ( $\text{CuInSe}_2$ ) and cadmium telluride (CdTe) have shown extremely good experimental results. Fig. 2 shows the recent progress in efficiency of copper indium selenide and cadmium telluride cells.

For technologically well-developed materials, such as Si and GaAs, achieved efficiencies are very close to the theoretical predicted limits. For thin-film materials, achieved efficiencies fall well below these values. There are two reasons for this disparity. First, Si and GaAs have received the benefit of extensive materials development for the electronics industry and are technologically very well understood materials; thin-film materials have been comparatively little researched. Second, because

thin-film materials are polycrystalline or amorphous, there are additional sources of efficiency loss due to the effects of structural disorder and grain boundaries. It is not known whether the ultimate efficiencies of these materials can ever approach those of the single crystals.

In general, all of the thin-film solar cell types have exceptionally high radiation tolerance compared to conventional single-crystal cells. A review of radiation damage effects in thin film cells can be found in reference<sup>10</sup>.

In summary, the advantages of thin-film solar cells are: high radiation tolerance; high specific power; potentially in the kilowatt/kilogram range; large area solar cells with integral series interconnections; the potential for thin, flexible blankets; and low cost. The disadvantages of thin-film solar cells are: lower efficiency; lack of space experience; and the fact that they are not currently produced on lightweight substrates.

Reviews of thin-film solar cell research for terrestrial applications can be found in Refs. 11 and 12. Reviews of applications for space can be found in Refs. 13-15.

Experimental measurements on thin film solar cells are almost always quoted for a solar spectrum filtered by passage through the atmosphere (Air Mass 1.5, or "AM1.5" spectrum). Very few measurements have been made of cells under the space (Air Mass Zero, or "AM0") spectrum. Efficiency measured under space sunlight is lower than that under terrestrial sunlight because most of the added energy available in space is in the infrared and ultraviolet regions, to which solar cells are generally not very responsive. The conversion factor from AM1.5 to AM0 efficiency is typically a decrease in efficiency by 15 to 20 percent for cells with bandgaps in the range of interest, varying with the spectral response of the solar cell in question. For an amorphous Si cell, for example, conversion of AM1.5 efficiency to AM0 is by a multiplicative factor of 0.80<sup>16</sup>. For a copper indium gallium selenide (CuInGaSe<sub>2</sub>) cell, an efficiency of 11.1% AM1.5 was measured as 10.0% AM0; resulting in a multiplicative factor of 0.90<sup>17</sup>.

While thin-film technologies have not yet been demonstrated in space, there is a very large (by space standards) manufacturing base on the Earth: tens of megawatts per year for a-Si, a rapidly increasing capability of perhaps one megawatt per year for copper indium selenide, and several hundred kilowatts per year for cadmium telluride.

The active regions of thin-film cells are typically a few microns, compared to several hundred microns thickness required for conventional silicon solar cells. The technology could potentially be extremely lightweight, if the cells can be deposited on lightweight substrates (or superstrates). However, current technology development programs are directed at glass substrates, inexpensive and rugged but not lightweight. There is little or no research on alternative, lightweight substrates. Some recent experimental work has been done on deposition of CuInSe<sub>2</sub> onto lightweight substrates. Researchers at Boeing have manufactured 4 cm<sup>2</sup> CuInSe<sub>2</sub> cells on 50 micron thick flexible glass substrates<sup>18</sup>. Kapur and Basol at International Solar Electric Corporation, under SBIR contract to NASA Lewis, are also investigating CuInSe<sub>2</sub> cells on thin substrates, including thin glass sheets, and have reported some significant results in work done on foils<sup>19</sup>. Technology to manufacture amorphous silicon solar cells on lightweight thin substrates has been demonstrated by several organizations, including ECD<sup>17</sup> and Iowa Thin Film Technology Corporation<sup>20</sup>. Sanyo Corporation has recently announced commercial production of amorphous silicon solar cells on flexible substrates under the trade name "Amorton," with a quoted specific power of 275 W/kg, AM1.5, corresponding to about 220 W/kg at AM0.

Flexible substrate a-Si arrays are not being made with fully space-qualified materials, and to date have not been tested under space conditions. There is some interest in lightweight, high specific-power

a-Si arrays for space <sup>21</sup>; a recent review article <sup>22</sup> discusses production capability in the United States for a-Si spacecraft arrays.

An important technology for the production of future high-efficiency thin film arrays is the ability of thin films to be produced in multi-bandgap "cascade" structures. This could potentially allow efficiencies of 15 to 20%, with the light weight and high radiation tolerance characteristic of thin film cells <sup>17</sup>. The best currently demonstrated thin-film cascade, reported by Siemens Solar<sup>23</sup>, uses an amorphous silicon top cell on a CuInSe<sub>2</sub> bottom cell. The achieved efficiency is 12.5% AM0 (estimated from AM1.5 measurement). In this cell the two elements were deposited on separate substrates, and the two elements coupled with transparent encapsulant. For higher specific power, it would be desirable to eliminate the intermediate layer by depositing the a-Si cell directly on the CuInSe<sub>2</sub>.

The potentially light weight of thin-film materials allow new strategies for solar power satellite design. Landis and Cull<sup>24</sup> have proposed using the potentially extremely light thin-film solar cell technology for reducing the mass of a solar power satellite by integrating the solar cells and a solid-state receiver. Such a technique could, potentially, decrease the mass of a solar power satellite by a factor of ten to a hundred. This approach requires considerable additional study before it could reach the stage of being ready for engineering design.

## 6. COST AND PRODUCTION READINESS

Despite revolutionary decreases in the cost of terrestrial solar cells, solar arrays for space applications have not decreased in cost significantly over the past twenty years. Space solar arrays currently cost on the order of \$1000 per watt, while terrestrial array costs are as low as \$2 per (peak) watt, with costs of under \$1/watt quoted as actual manufacturing costs for the generation of manufacturing plants currently under construction, assuming that the demand exists to run these plants at full capacity. For cost-competitive electricity, it is clear that a satellite solar power array would have to be much more like terrestrial array than the type of array currently used in space.

Space array costs are high because there is only a weak incentive to try to reduce them. Even at \$1000/watt, for example, the 6 kW array of an Intelsat-VI satellite represents only a small portion of the \$250M cost of building and launching the satellite.

Some of the cost difference between terrestrial and space arrays is due to the fact that space arrays use more efficient cells, have more stringent weight requirements, and have many more inspection steps to assure reliability. However, a significant portion of the cost of a solar array is the cost of interconnecting the cells. 2 cm by 4 cm cells are still in use on satellite arrays, considerably smaller than the 10 cm square and larger cells used in terrestrial arrays. In this respect the solar arrays for Space Station Freedom, using 8x8 cm cells and a simplified rear-side printed-circuit interconnect, is a considerable advance. Use of thin-film cells, with the interconnections made on large-area sheets at the same time as the cell manufacture, could also represent a means for considerably reducing this expense.

Over the last ten years, the terrestrial photovoltaic industry has made great advances in production capability, with single-crystal silicon, polycrystalline silicon, and amorphous silicon all having well over a megawatt per year of production capability, and with several factories recently announced to produce both cadmium telluride and copper indium selenide on a multi-megawatt scale. Figure 5 shows the historical trend of world shipments of photovoltaic generating capacity. While the production capability is large and growing, the cumulative production of solar panels in the last twenty years only totals slightly over 300 MW(p), or roughly the power capacity of a single fossil-fuel powered electric plant. Note also that solar cell production quantities are quoted in terms of peak megawatts, the power which would be produced with the sun directly overhead. Actual power production, on the Earth's surface, is considerably lower, due to night and cloud coverage.

(On the same graph, the world usage of solar cells for space, well under one megawatt per year, would not even be visible.)

## 7. ARRAY TEMPERATURE

A solar array on the moon will operate at significantly higher temperature than arrays in near-Earth space. Solar array operating temperatures are determined by an energy balance equation, where the incident energy minus the energy converted into useful power is radiated thermally according to the fourth-power of temperature as specified by the Stefan-Boltzmann radiation law. The lunar soil is a quite good thermal insulator, and thus the solar array will be able to radiate to space only from one side. The operating temperature on the moon can thus be estimated from operating temperatures in high orbit by assuming that the solid angle available for radiation is cut in two. The maximum operating temperature on the moon will be increased by about 19%. Since typical operating temperatures for geosynchronous orbit arrays are  $\sim 305^\circ\text{K}$ , this yields a maximum operating temperature of  $90^\circ\text{C}$  (decreasing slightly if the cell efficiency increases). This is very close to the temperatures reached by the lunar surface at local noon.<sup>25</sup> Average daytime power will be somewhat lower.

These numbers are roughly consistent with those measured by instrument packages left on the moon during Apollo. For example, the Apollo 11 PSEP package reached a maximum temperature of  $88^\circ\text{C}$  at lunar noon.<sup>26</sup> Similarly, the Apollo 12 Surface Magnetometer reached a maximum external temperature of about  $78^\circ\text{C}$ .<sup>27</sup> Fig. 6 shows a graph of measured instrument temperature versus time for one lunar day.<sup>27</sup> The average daytime temperature is lower than the noon maximum, but still considerable higher than nominal.

The large areas required for the solar array make it unlikely that cooling techniques will be usable. Since solar cell performance decreases with increasing temperature, a consideration in the selection of the solar cell type is to select a solar cell material which is not highly sensitive to temperature. The temperature dependence is primarily dependant on the bandgap of the material, with lower temperature sensitivity for wide-bandgap materials, such as GaAs or amorphous silicon. If the bandgap can be increased, as by going to a ternary III-V compound such as AlGaAs, the temperature sensitivity is decreased yet further, although at some cost in decreased efficiency at standard temperature. Cascade (or "tandem") cells also have high temperature sensitivity, typically equal to the sum of the sensitivities of the individual component cells, and are thus less desirable for lunar use, although of higher baseline performance at standard temperature.

The temperature variation of power ( $1/P \partial P/\partial T$ ) for gallium arsenide cells is about  $0.25\%/^\circ\text{C}$ .<sup>28,29</sup> For cell operation at  $90^\circ\text{C}$ , the power would be derated by about 17% due to temperature. Amorphous silicon would be comparable or slightly better. For silicon, the temperature variation is about  $0.33\%/^\circ\text{C}$ ,<sup>28</sup> leading to about 23% loss, with  $\text{CuInSe}_2$  expected to be about the same.

For the single crystal solar cell technologies, GaAs and Si, the temperature extremes are not expected to present lifetime problems if adequate design safeguards against thermal cycling are taken. For thin-film technologies, long-term operation at high temperatures and vacuum thermal cycling stability have not yet been demonstrated, and reliability will have to be verified before such arrays can be used on the moon.

## 8. RADIATION ENVIRONMENT

The moon has no permanent magnetic field; hence there are no trapped radiation belts. The major source of natural particle radiation for an array on the lunar surface is solar flares which consist predominately of protons. Solar flares occur sporadically with varying magnitudes over an eleven year

cycle. The effect of solar flare protons has been calculated statistically. A comparison of a five year total equivalent 1 MeV electron fluence for a lunar SSF solar cell versus an earth orbit SSF solar cell (5 mil (125 $\mu$ m) coverglass) is shown in Fig. 4. During the lunar night, when the moon is between the sun and the array, the array will be protected from solar flare protons. This has the effect of reducing the flux by a factor of two and has been taken into consideration for Fig. 4.

## 9. STORAGE TECHNOLOGY

Solar power is an abundant resource during the lunar day. The 354 hour lunar night, however, poses a large obstacle to implementation of an all solar-powered lunar facility. Power storage concepts include conventional options such as batteries or fuel cells; less common storage technologies such as inductive or capacitive storage, possibly using superconductive elements; and physical storage concepts such as flywheels and compressed gas<sup>30</sup>. Present technology storage capability is about 25 W-hr/kg for Ni-H batteries. Levels of ~80 W-hr/kg are expected for composite flywheels, and 300 W-hr/kg for regenerative fuel cells with conventional reactant storage. Up to 1000 W-hr/kg is expected for advanced RFCs if the conventional pressurized gas reactant storage is replaced with cryogenic storage<sup>31</sup>. Storage efficiencies (ratio of energy in during charging to energy out at night) is typically on the order of 60-70% for existing systems. Values of 80% should be achievable.

Finally, a lunar base could utilize a hybrid power system, with an isotope power supply to provide a baseline power level both during the day and night, and a photovoltaic power supply for peak power during the day.

## 10. SYSTEM INTEGRATION

We will not consider the balance of system, or power conditioning and management system, in any detail, but simply assume that the balance of system mass (excluding the storage system) is equal to three times the actual array mass. This assumption is based on the space-station *Freedom* power system design, where a 75 kW power system is assumed. A rough breakdown of the power system mass for *Freedom* is shown in table 3. We believe that this is likely to be a conservative estimate, and that advances in power system components, experience with large space power systems learned from the *Freedom* system, and careful attention to system mass may be able to reduce this mass considerably.

We also note that, for existing ultra light-weight array designs (e.g., APSA<sup>32</sup>), the structural elements of the array are roughly equal in weight to the solar cell blanket. This structural mass has been factored into the array masses shown, however, we should note that a good analysis of the structural mass required on the moon will have to wait until details of structure, tracking (if used), and deployment mechanisms have been selected. An array designed for the 1/6 g environment of the moon may be considerably different from typical arrays designed for free-fall deployment.

Table 4 shows a conceptual design for a baseline photovoltaic-powered lunar base, with a mass breakdown of the primary elements.

Three cases are shown: present-technology baseline case, with thin silicon cells and Ni-H batteries, conservative next-generation technology, with advanced thin, 20% efficiency GaAs solar cells and regenerative fuel cells for storage, and advanced technology thin-film cells with advanced fuel cell technology and cryogenic reactant storage. The total mass is calculated for a 100kW daytime power requirement and 50% night power, with the assumption of 80% storage efficiency (energy out/energy in). This efficiency is somewhat higher than is achievable using current technologies.

From these figures it is clear that storage technology, and not photovoltaic technology, dominates the total mass of the power system.

A solar array for the moon can be configured either as a sun-tracking array or as a fixed array. On the equator, a tracking array has higher total energy production than a fixed horizontal array of the same size by a factor of  $\pi/2$ , or about 57% more energy. The advantage increases as the base is moved further away from the equator. This advantage is likely outweighed, however, by the added structural mass, complexity, and deployment difficulty of the tracking system. The tracking array has an important additional advantage: the power profile is nearly flat, while the fixed horizontal array has a power profile proportional to the cosine of the solar angle, peaking at solar noon. These are shown in figure 6. Since this means that a fixed horizontal array will produce zero output at sunrise and sunset, the amount of time that power must be provided by the storage system is significantly increased. Since the power storage mass dominates the system mass, an array which does not produce baseline power immediately after sunrise is not acceptable.

To increase the power at sunrise (and sunset) yet still eliminate the complexity of a tracking array, the array can be peaked as shown in figure 7. We set the requirement that the power be provided by the array rather than by the storage system immediately starting at sunrise and continuing until sunset. The required angle to provide this power profile is discussed in the next section.

### 11. OPTIMUM ARRAY ANGLE

Consider an array consisting of two identical panels, each tilted an angle  $a$  from the horizontal, respectively toward sunrise and sunset. If the rated array power at normal incidence is  $A$ , and  $q$  is the sun angle with  $q=0$  defined as solar noon, the power for the tilted array is:

$$P = A \cos(a)\cos(q) \quad \text{for } |q| < p/2 - a, \quad (1a)$$

$$P = (A/2)\cos(a)\cos(q) + (A/2)\sin(a)\sin(q) \quad \text{for } (p/2 - a) < |q| < p/2, \quad (1b)$$

and 
$$P = 0 \quad \text{for } |q| > p/2. \quad (1c)$$

Thus, the average power over the daytime is:

$$P_{ave} = [\cos(a) + 1] / p \quad (2)$$

which, as should be expected, has a maximum value of  $2/p$  for  $a = 0$ , a horizontal array. (For comparison, for a tracking array  $P_{ave} = 1$ ). The power at sunrise equals the power at sunset,

$$P_{sunrise} = \sin(a)/2. \quad (3)$$

Consider energy storage with an efficiency  $h$  (energy out/energy in) and power fraction  $f$  (power required at night divided by power required during the day). Then the average power generated during the day  $P_{gen}$  must be larger than the daytime load by a factor  $k$ :

$$P_{gen} = (1 + f/h) P_{day} \int k P_{day} \quad (4)$$

where we have defined  $k = (1 + f/h)$ . To minimize the storage, we require that the array power at sunrise equal the daytime load  $P_{day}$ , *i.e.*, immediately at sunrise no power is drawn from the storage system. This then gives us an equation for the minimum array tilt angle  $a$ :

$$\sin a = 2 (\cos a + 1)/(p k) \quad (5).$$

The solution to this equation is:

$$a = \cos^{-1} [(k^2 - 4/p^2)/(k^2 + 4/p^2)] \quad (6).$$

As an example, suppose night and day power requirements are equal, and the energy storage efficiency is 100%. Then the sunrise power must be exactly half the average (daytime) power, and the minimum angle  $a$  is:

$$a = \cos^{-1} [(p^2 - 1)/(p^2 + 1)] = 35.3^\circ \quad (7).$$

From equation 2, the array considered provides 58% of the power per unit area of a tracking array. This is shown in figure 3, which compares the power versus time profile for a peaked array at  $35.3^\circ$  with the power profile of a tracking array and a fixed horizontal array.

For a more realistic example, suppose the required night power is half the daytime power, and the storage efficiency is 85%. Then  $f/h = 0.588$ , and the optimum angle  $a = 43.7^\circ$ . This is still 55% of the power per unit area of a tracking array. As can be seen, the required angle increases as  $f/h$  decreases.

## 12. ALTERNATIVE CONCEPTS FOR LUNAR NIGHT POWER

The dominance of storage mass over the photovoltaic array mass for the lunar night is so large that it may be worth considering alternate methods of storage or of powering the base over the night. A general survey of such methods is considered in reference 30. The methods proposed consist generally of alternative methods of power storage, which will not be discussed here, and methods of continuous solar power generation over the night. Of the continuous power generation methods, we discuss here one concept for illuminating the solar arrays continuously.

One proposal is to use beamed power to run the base during the night. As a specific example, the solar arrays could be illuminated from the Earth by laser. For an array of 50 kW required night power, using stationary reflectors on the moon to concentrate light onto the arrays, 2.2 MW of Earth-based lasers operating at a wavelength of 0.5 microns would be sufficient to run the base if the solar cells selected were an AlGaAs alloy of bandgap 2.0 eV. Assuming two meter diameter lenses (which may be fresnel lenses or holographic optical elements), the beam spread at the moon is diffraction limited and illuminates a spot a hundred times larger than the array, allowing considerable growth in power required before the ground-based lasers need to be upgraded. To eliminate single point failure, many ground lasers could be used. While the technology for making high-power continuous wave lasers at wavelengths as short as 0.5 microns is not now commercially available, the technology is rapidly advancing, and may very well be available by the time a moonbase is emplaced.

## 13. IN-SITU PRODUCTION

For an expanded lunar facility, it may be practical to manufacture power sources from in-situ resources. Cells made from InP, GaAs, CuInSe<sub>2</sub>, and CdTe are ruled out for lunar production due to material scarcity. Silicon, however, is abundant, as well as array structural materials aluminum, titanium, steel, and glass. While hydrogen, carbon, and halogens are required for existing Si refining and purification processes, an aluminothermic process sequence for production and refining of Si from lunar anorthite is possible which reuses all reactants. Production of both amorphous (a-Si:H) and single-crystal cells on the moon is possible<sup>33</sup>.

The production sequence for a-Si:H cells is comparatively simple. The required thickness of amorphous silicon is very small, allowing high specific power and a low requirement for refined Si.



Disadvantages are the comparatively low efficiency, light-induced degradation; and the requirement that the refined silicon be converted into silane for use.

Single crystal silicon, the workhorse of the current spacecraft solar array industry, has higher efficiencies but greater material usage. The production sequence is energy intensive; however, most of the requirement is heat, which could be provided by inexpensive solar furnace.

Likewise, power storage capability may be manufactured from available materials. While hydrogen is not easily available to use as reactant in hydrogen/oxygen fuel cells, oxygen will be a major product of any lunar industrial facility. Lunar derived steel and fiberglass will also be available to make tanks for (non-cryogenic) reactant storage. Alternately, flywheels could be manufactured from lunar-manufactured glass fiber, with specific energy of perhaps 20 W-hr/kg. This is somewhat lower than is possible with advanced composites (e.g., Kevlar™), but will require little non-local material usage. The lunar vacuum, low gravity, and plentiful availability of regolith for failure protection make flywheel storage a viable alternative for night storage.

## 14. CONCLUSIONS

Use of photovoltaics for the primary power system for a lunar base presents several issues for consideration. A reference photovoltaic power system for a lunar base has been outlined, and the effect of anticipated technology advances discussed. The primary consideration for power system mass is the requirement for 14 days of storage for operation of the base over the lunar night. It will be important to minimize the power requirement during the night using techniques, for example, such as separating and storing the waste carbon dioxide for regeneration during the day when surplus power is available. Hydrogen/oxygen fuel cells, preferably using cryogenic storage of the reactants, are a critical technology to reducing the mass of the storage system. In order to minimize daytime storage requirements by transitioning from stored power to use of directly generated power as quickly as possible after sunrise, an array design which is peaked toward the east and west was proposed.

Current photovoltaic technology is adequate for such a base, and anticipated advances such as thin-film solar cell development will reduce the array mass to a minor fraction of the total power system mass. Photovoltaic arrays will be required to operate at peak temperatures of up to 90°C, and to withstand nighttime thermal cycling at very low temperatures.

Finally, other proposals for power over the lunar night were briefly reviewed, and various possibilities for use of in-situ resources for manufacturing elements of power and power storage equipment were discussed.

## 15. REFERENCES

1. R. L. Cataldo and J. M. Bozek, "Power Requirements for the First Lunar Outpost (FLO)", *Tenth Symposium on Space Nuclear Power and Propulsion*, Jan. 10-14, 1993.
2. D.J. Flood and H. Brandhorst Jr., in *Current Topics in Photovoltaics*, Volume 2 (T.J. Coutts and J.D. Meakin, eds.), Academic Press Inc., pp. 143-202, 1987.
3. J. Zhao, A. Wang, and M. Green. *Proc. 21st IEEE Photovoltaic Specialists Conference*, (IEEE, NY), pp.333-335, 1990.
4. G.A. Landis, *Space Power*, Vol. 29, No. 2/3, pp. 257-266, 1990.
5. H. Washio, T. Katsu, Y. Tonomura, T. Hisamatsu, T. Saga, T. Matsutani, A. Suzuki, Y. Yamamoto, and S. Matsuda, "Development of High Efficiency Thin Silicon Space Solar Cells", to be published in the *Proceedings of the 23rd IEEE PVSC Conference*, 1993.
6. S.P. Tobin *et al.*, *Proc. 21st IEEE Photovoltaic Specialists Conference*, (IEEE, NY), pp. 158-162, 1990.
7. G.C. Datum and S.A. Billets, *Proc. 22nd IEEE Photovoltaic Specialists Conference*, (IEEE, NY), pp. 1422-1428, 1992.

8. D.M. Wilt *et al.*, *Proc. 21st IEEE Photovoltaic Specialists Conference*, (IEEE, NY), pp. 111-114, 1990.
9. M.F. Piszczor *et al.*, *Proc. 22nd IEEE Photovoltaic Specialists Conference*, (IEEE, NY), pp. 1485-1490, 1991.
10. J. Woodyard and G.A. Landis, *Radiation Tolerance of Thin Film Solar Cells*, NASA TM-103715, 1991; *Solar Cells*, Vol. 31, No. 4, pp. 297-329, 1991.
11. B.L. Stafford, W. Luft, B. von Roedern, and W.L. Wallace, *Proc. 21st IEEE Photovoltaic Specialists Conference*, (IEEE, NY), pp. 1409-1415, 1990.
12. K. Zweibel, H.S. Ullal, and R.L. Mitchell, *Proc. 21st IEEE Photovoltaic Specialists Conference*, (IEEE, NY), pp. 458-466, 1990.
13. K. Zweibel, *Proc. 23rd Intersociety Energy Conversion Engineering Conference*, Volume 3, pp. 97-101, 1988.
14. G.A. Landis, *Space Photovoltaic Research and Technology 1989*, NASA CP-3107, pp. 180-203, 1991.
15. G.A. Landis and A.F. Hepp, *Proc. European Space Power Conference*, Publication ESA-SP-320, pp.517-522, 1991.
16. J.J. Hanek *et al.*, *Space Photovoltaic Research and Technology 1986*, NASA CP-2475, pp. 99-110, 1987, .
17. W.E. Devaney, J.M. Stewart and W.S. Chen, *Proc. 21st IEEE Photovoltaic Specialists Conference*, (IEEE, NY),pp. 535-540, 1990.
18. R.P. Gale *et al.*, *Proc. 21st IEEE Photovoltaic Specialists Conference*, (IEEE, NY), pp. 53-57, 1990.
19. J.H. Armstrong, M.S. Misra, V.K. Kapur, and B.M. Basol, *XI Space Photovoltaic Research and Technology Conference*, NASA CP-3121, pp. 19-1 to 19-8, May 7-9 1991.
20. F. Jeffery, "Flexible, Lightweight Amorphous Silicon Solar Cells Tuned for AM0 Spectrum," *Phase I Report for NASA Lewis Research Center*, Iowa Thin Film Technologies, Inc., 1990.
21. J.H. Hanak *et al.*, *Space Photovoltaic Research and Technology 1988*, NASA CP-3030, pp. 162-163, 1989.
22. J. Kaschmitter and J.J. Hanak, *XI Space Photovoltaic Research and Technology Conference 1991*, NASA Lewis Research Center, NASA CP-3121, pp. 21-1 to 21-10, 1991.
23. K. Mitchell, C. Eberspacher, J. Ermer and D. Pier, *Proc. 20th IEEE Photovoltaic Specialists Conference*, (IEEE, NY), pp. 1384-1389, 1988.
24. G.A. Landis and R. Cull, "Power From Space 1991", Paris, France, Aug. 1991; see also *Vision-21 Conference Proceedings*, NASA CP-10059, pp. 494-500, April 1990.
25. R.A. Robie, B.S. Hemingway, and W.H. Wilson, "Specific Heat of Lunar Surface Materials from 90 to 350 Degrees Kelvin," *Science*, Volume 167, pp. 749-750, 30 January 1970.
26. G.V. Latham *et al.*, "Passive Seismic Experiment," *Apollo 11 Preliminary Science Report*, NASA Publication SP-214, p. 144, 1969.
27. P. Dyal, C.W. Parkin, and C.P. Sonett, "Lunar Surface Magnetometer Experiment," *Apollo 12 Preliminary Science Report*, NASA Publication SP-235, pp. 55-73, 1970.
28. J.C.C. Fan, "Theoretical Temperature Dependence of Solar Cell Parameters," *Solar Cells*, Vol 17, pp. 309-315, 1986.
29. I. Weinberg, C.K. Swartz, R.E. Hart, Jr., and R.L. Statler, "Radiation and Temperature Effects in Gallium Arsenide, Indium Phosphide, and Silicon Solar Cells" (NASA Tech. Memorandum TM-89870), *Proc. 19th IEEE Photovoltaic Specialists Conf.*, IEEE, NY, 1987.
30. G.A. Landis, "Solar Power for the Lunar Night" (NASA Tech. Memorandum 102127), *Space Manufacturing 7: Space Resources to Improve Life on Earth*, 144-151, AIAA, Washington, D.C., 1989.
31. L.L. Kohout, "Cryogenic Reactant Storage for Lunar Base Regenerative Fuels" (NASA Tech. Memorandum 101980), *International Conf. on Space Power*, Cleveland, OH, June 5-7, 1989.
32. R.W. Francis, W.A. Somerville, and D.J. Flood, "Issues and Opportunities in Space Photovoltaics," *Proc. 20th IEEE Photovoltaic Specialists Conf.*, 8-20, IEEE, NY, 1988.
33. G.A. Landis and M.A. Perino, "Lunar Production of Solar Cells" (NASA Tech. Memorandum 102102), *Space Manufacturing 7: Space Resources to Improve Life on Earth*, 144-151, AIAA, Washington, D.C., 1989.

Cell Type	Area(cm <sup>2</sup> )	Laboratory Efficiency % at 25°C	Projected Efficiency % at 25°C
8 mil Si	64	14.6	17
2 mil Si	8	13.5	16
Advanced Si	4	20.8	21
GaAs	4	21.8	23
GaAs/Ge	4	20.5	23
InP	4	19.9	22
InP/Si	4	7.0	19
InP/GaAs	4	13.7	21
Ge	4	9.0	10
GaSb	.234	6.9 (52X)	8 (52X)

**Table 1. Status of Single Junction Solar Cells  
(AM0 Record Efficiencies to Date)**

## I. Monolithic (Two Junction)

### A. One Sun :

Top Cell/Bottom Cell	Area(cm <sup>2</sup> )	Laboratory Eff. % at 25°C	Projected Eff. % at 25°C
AlGaAs/GaAs n/p n/p (two terminal)	.5	23.0	26
GaInP/GaAs n/p n/p (two terminal)	.25	23.6	26

### B. Concentrator

Top Cell/Bottom Cell	Area(cm <sup>2</sup> )	Laboratory Eff. % at 25°C	Projected Eff. % at 25°C
GaAs/Ge p/n p/n (two terminal)	.136	23.4 (9 suns)	33.5 (100 suns)
InP/Ga <sub>0.47</sub> In <sub>0.53</sub> As n/p p/n (three terminal)	.065	28.8 (40.3 suns)	30.0 (100 suns)

## II. Mechanically Stacked (Two Junction)

### A. One Sun :

Top Cell/Bottom Cell	Area(cm <sup>2</sup> )	Laboratory Eff. % at 25°C	Projected Eff. % at 25°C
GaAs/CuInSe <sub>2</sub> n/p n/p (four terminal)	.5	23.1	33.5 (100 suns)

### B. Concentrator:

Top Cell/Bottom Cell	Area(cm <sup>2</sup> )	Laboratory Eff. % at 25°C	Projected Eff. % at 25°C
GaAs/GaSb p/n p/n (four terminal)	.05	30.8 (100 suns)	33.0 (100 suns)

## III. Monolithic/Mechanically Stacked (Three Junction)

### A. One Sun:

Top Cell/Bottom Cell	Area(cm <sup>2</sup> )	Laboratory Eff. % at 25°C	Projected Eff. % at 25°C
AlGaAs/GaAs/InGaAsP n/p n/p n/p (two terminal)	.5	25.2	30.0

**Table 2. Status of Two- and Three- Junction Tandem Solar Cells  
(AM0 Record Efficiencies to Date)**

<i>Element</i>	<i>Mass (kg)</i>	<i>Fraction (%)</i>
PV Blanket	890	24.0
mast	330	8.8
gimbal	540	14.5
electrical equip.	610	16.6
thermal control	730	19.6
<u>misc. integration</u>	<u>610</u>	<u>16.5</u>
<i>total</i>	<i>3710</i>	
<i>not including:</i>		
Batteries:	1300	
Charge/disc. unit	290	

*Array is a quarter of system mass  
array plus structure is half of system mass*

**Table 3. Space Station Freedom Photovoltaic Power System Mass Breakdown per module (28 kW power produced; 18.75 kW av. user power)**

Solar Array	cell type	thickness (μm)	efficiency (%)	spec. power (W/kg)	array mass (kg)	total mass (kg)
Present technology	Si	62	13.5	130	312.5	1250
Next-generation	GaAs	6	18.5	300	135	538
Advanced	Cascade	12	25	450	90	363
In-situ resource	a-Si	2	10	100	405	1625
Storage	type			specific energy (W-hr/kg)		mass (kg)
Present technology	Ni-H batteries			14		600,000
Next-generation	RFC, conv. storage			300		27,500
Advanced	RFC, cryo storage			1000		7,765
In-situ resource	composite flywheel			20		420,000

*mass is calculated for a 25 kW daytime power requirement and 50% night power, with the assumption of 80% storage efficiency.*

**Table 4. 25 kW Photovoltaic Power System for a Lunar Base (Including Balance of System mass = 3 times the array mass)**

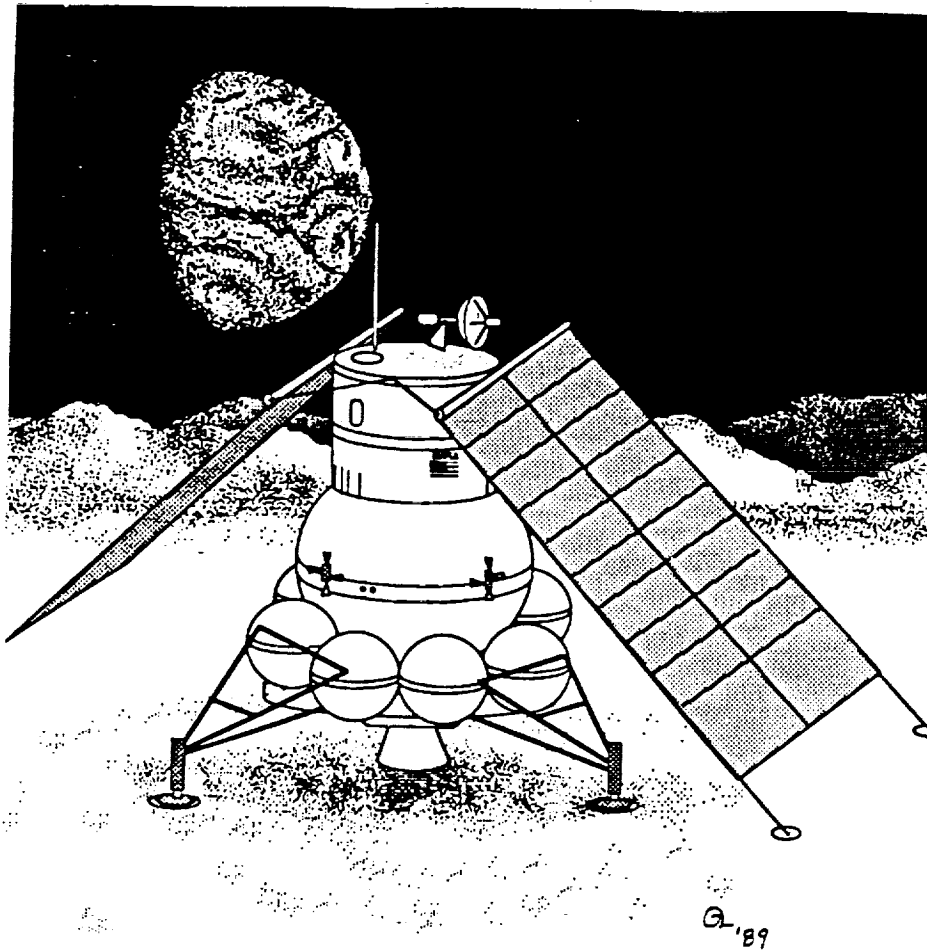

Fig. 1. Artist's conception of a fast-deployment roll-out solar array from the lunar lander.

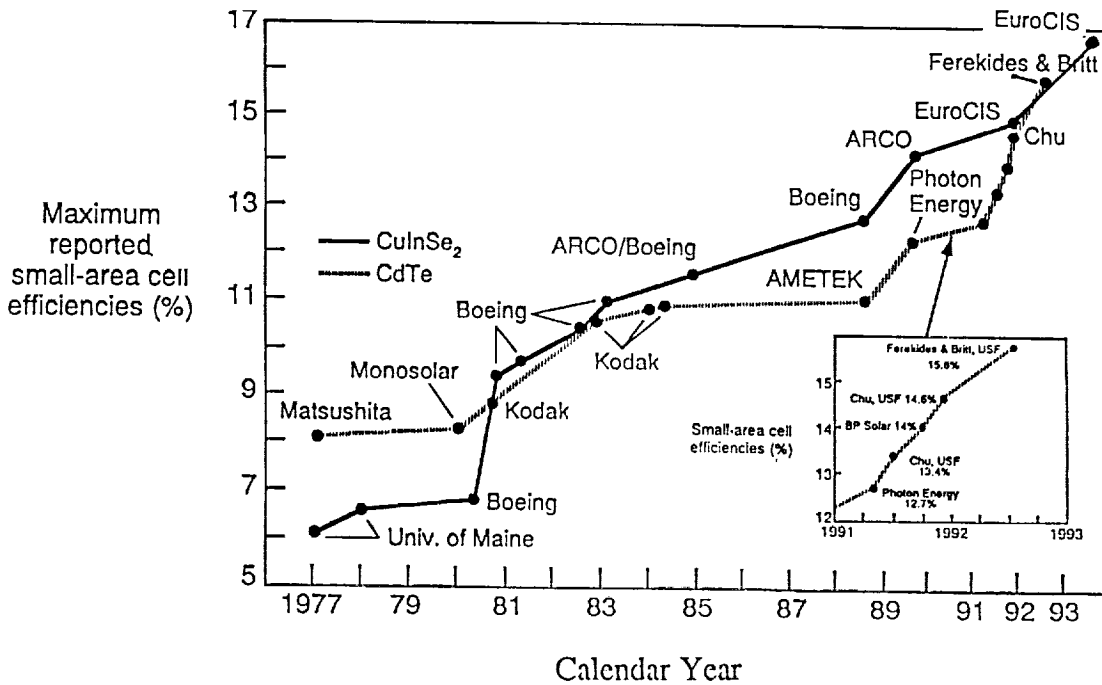

Fig. 2. Reported Air-Mass 1.5 efficiencies of small-area thin-film solar cells  
 Solid line: Copper indium diselenide cells  
 Dashed line: Cadmium telluride cells  
 (Data courtesy of NREL. Note: Arco Solar is now Siemens Solar Inc.)

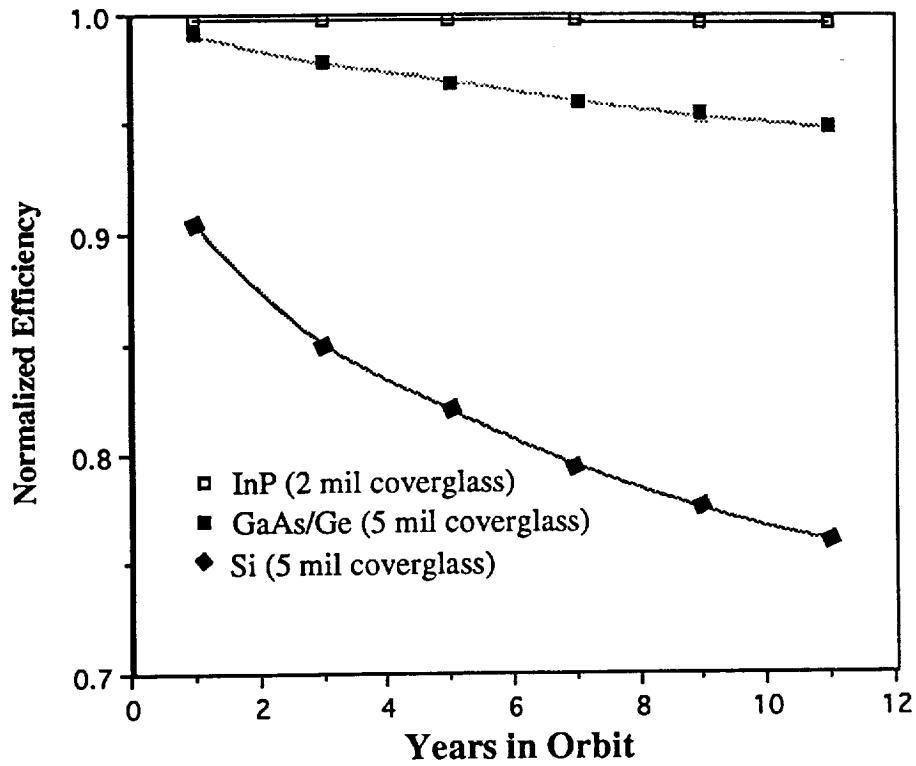

Fig. 3. Normalized Efficiency as a function of the number of years in a 705 km polar orbit

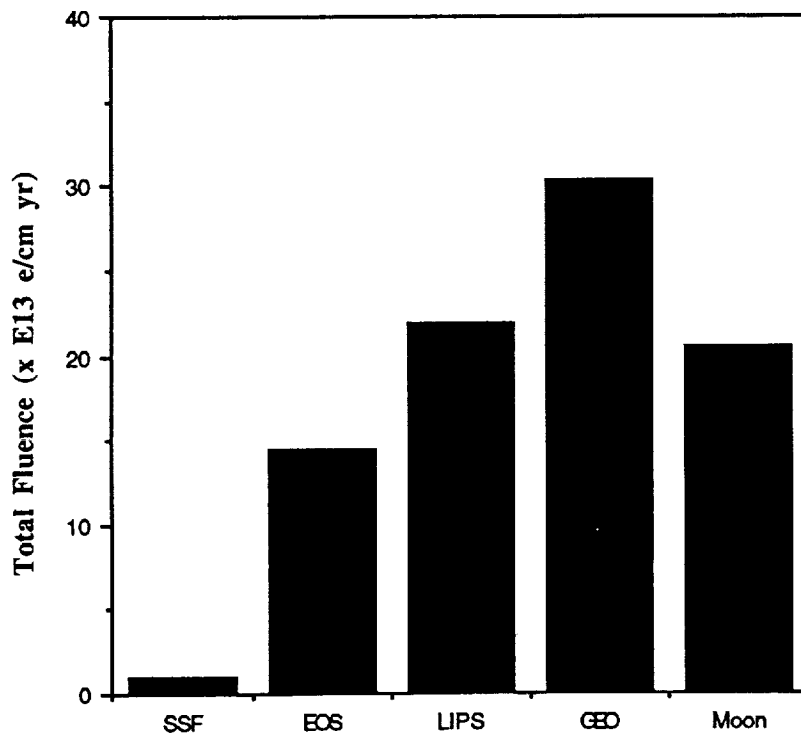
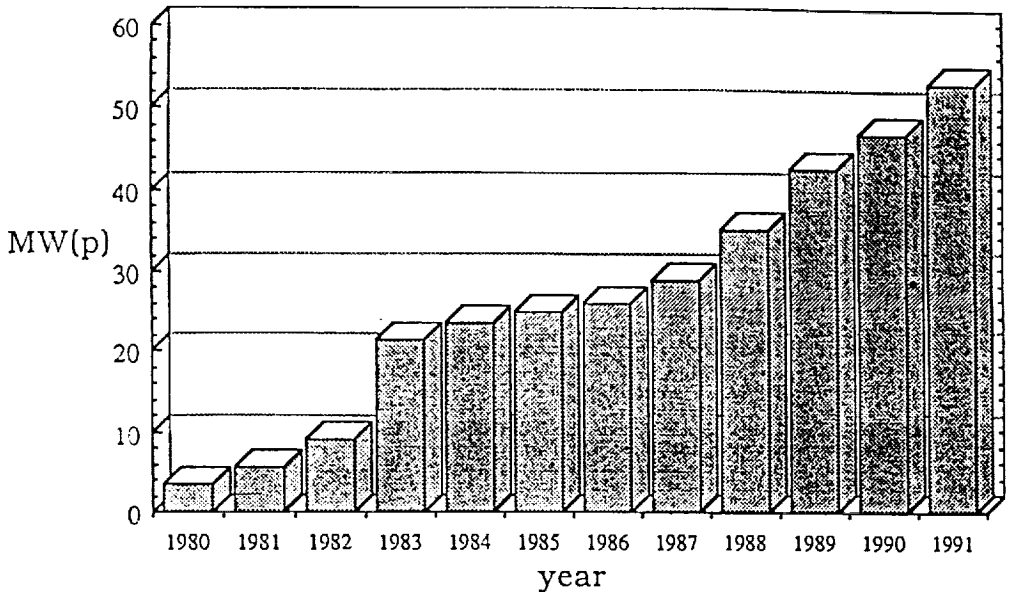
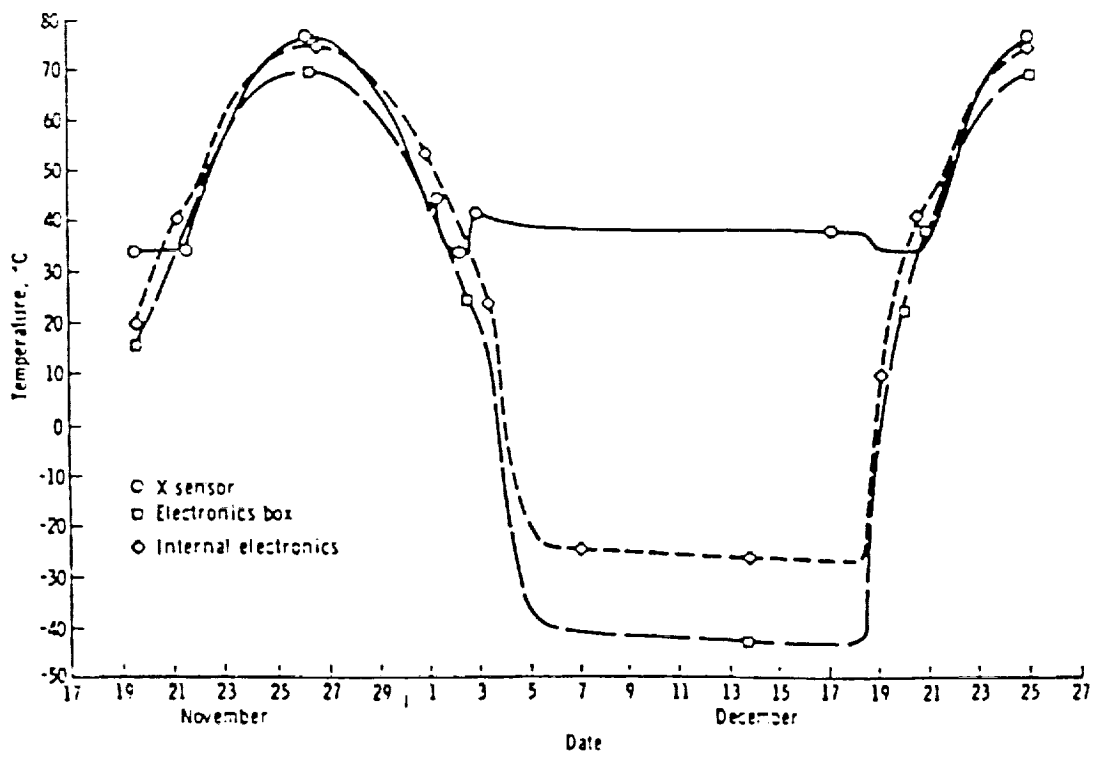

Fig. 4. Five Year Total Fluence, neglecting solar flare events for SSF, EOS, LIPS, & GEO, experienced by a SSF solar cell



**Fig. 5. World Photovoltaics Shipments, 1980-1991.**

Growth in production capability of the world photovoltaics industry in Megawatts (peak) from 1980 through 1991. Includes solar cell applications in consumer electronics (watches, calculators) as well as utility and remote power applications. On this scale, the portion of production used for space applications (less than 1 MW) is not visible.



**Fig. 6. Temperature versus time for Apollo 12 scientific package (note that night temperature is stabilized with a heating unit).**



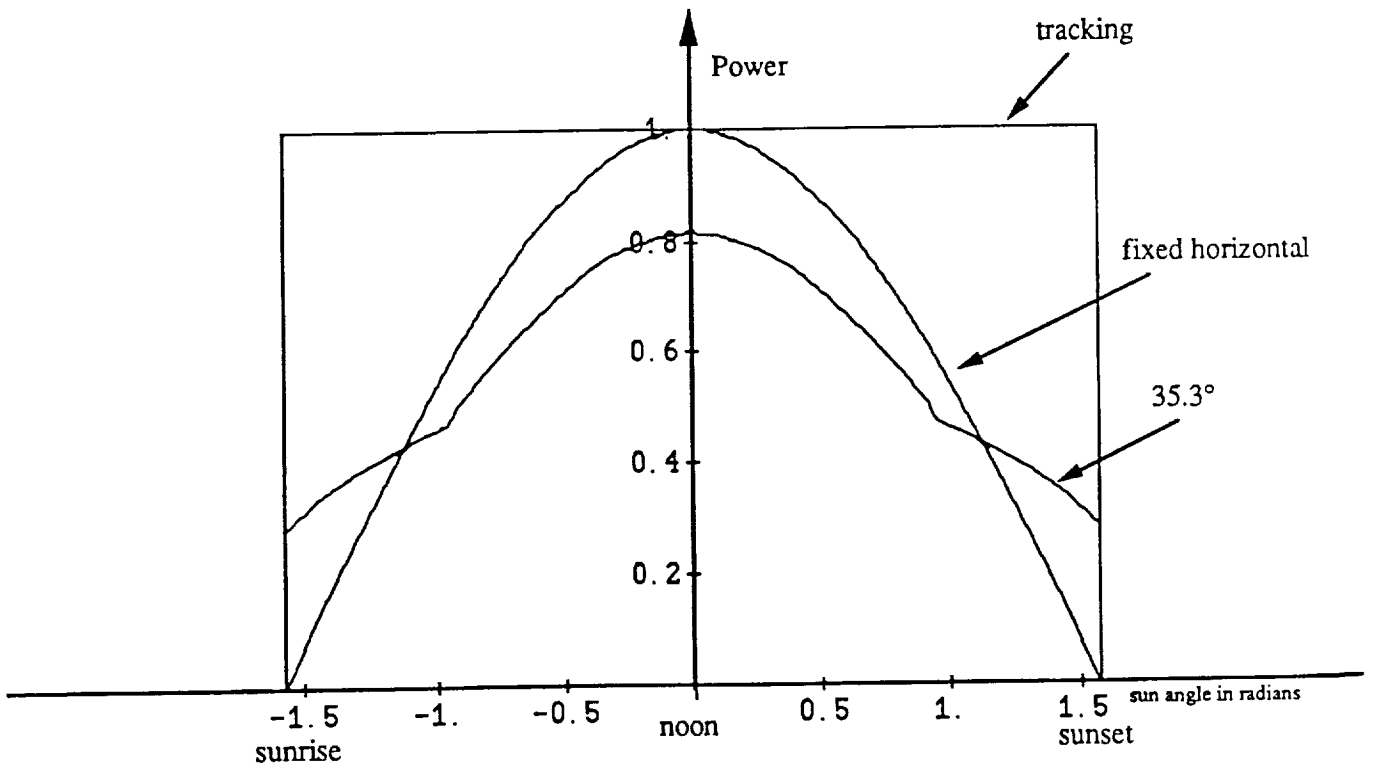

Fig. 7. Array output versus time for tracking array, fixed horizontal array, and double-tilted array at a tilt angle of  $35.3^\circ$ .

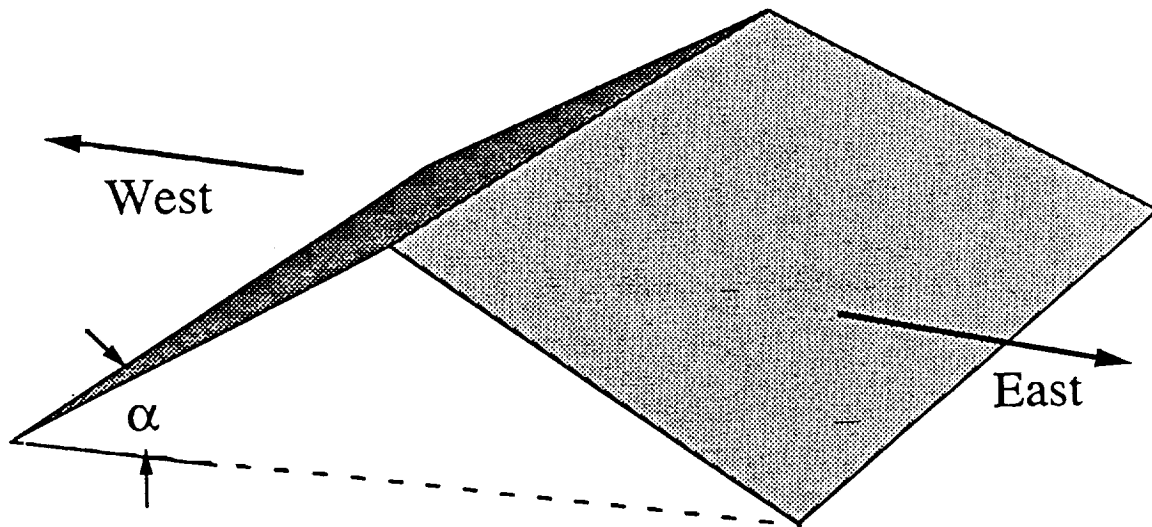

Fig. 8. Optimum two-tilt array for minimizing storage

**CHANNEL AND TERMINAL DESCRIPTION OF THE ACTS MOBILE TERMINAL**

B.S. Abbe, M.J. Agan, C.C. Girardey\*, T.C. Jedrey

Jet Propulsion Laboratory, California Institute of Technology  
4800 Oak Grove Drive  
Mail Stop 238-420  
Pasadena, California 91109  
Phone: (818) 354- 3426 FAX: (818) 354-6825

**ABSTRACT**

The Advanced Communications Technology Satellite (ACTS) Mobile Terminal (AMT) is a proof-of-concept K/Ka-band mobile satellite communications terminal under development by NASA at the Jet Propulsion Laboratory. Currently the AMT is undergoing system integration and test in preparation for a July 1993 ACTS launch and the subsequent commencement of mobile experiments in the fall of 1993. The AMT objectives are presented, followed by a discussion of the AMT communications channel, and mobile terminal design and performance.

**1. AMT OBJECTIVES**

The AMT is a part of a larger ACTS program which has as its goal to pave the way for the next generation of communications satellite technology and services. The ACTS program is developing high risk technologies so as to reduce risk and thus stimulate commercial use by U.S. companies. The AMT is a mobile digital communications terminal that is being developed by the Jet Propulsion Laboratory (JPL) for NASA in an effort to advance the technology and system concepts necessary for a commercially viable mobile satellite communications system at K/Ka-band frequencies.

The AMT, as depicted in Figure 1, will demonstrate speech and data transmissions in the Ka-band mobile satellite communications channel. Ka-band is particularly promising for mobile communications because of the large amount of available spectrum and the amenability to small high gain antennas. The AMT is being developed as a mobile satellite communications platform by NASA to aid the development of aeronautical mobile, maritime mobile, land mobile, micro-terminal, and personal communications. Additionally, the AMT will be used to characterize the Ka-band mobile communications channel through a series of propagation experiments.

**2. AMT SYSTEM ARCHITECTURE**

The AMT will utilize the geosynchronous ACTS satellite in bent-pipe mode. The key ACTS technologies that the AMT will exploit include high gain spot-beam antennas and a 30 GHz uplink and a 20 GHz downlink. ACTS is scheduled to be launched into geosynchronous equatorial orbit at 100° W in July 1993. It will carry a four year supply of expendables, and has been approved for a two-year experiment cycle starting in September 1993. Funding for two additional years of experiments is pending.

The AMT uses a frequency division multiple access (FDMA) architecture. The fixed station transmits an unmodulated pilot which is used by the mobile terminal for antenna tracking, as a frequency reference for Doppler precompensation and in measuring rain attenuation. The system can run at data rates of 2.4, 4.8, 9.6 and 64 kbps.

---

\* Visiting member of JPL technical staff from ESA-ESOC  
Paper presented at and published by IMSC '93, Pasadena 16-18 June 1993

### **3. AMT COMMUNICATIONS CHANNEL**

#### **3.1 Rain Attenuation**

One of the challenges of operating at 20 and 30 GHz is that these frequencies are susceptible to rain attenuation. In preparation for ACTS launch some propagation experiments at these frequencies have been performed by Virginia Polytechnic Institute and State University (VPI) using the European Space Agency's (ESA) Olympus satellite. The experience gained with Olympus has resulted in a valuable data base of 20/30 GHz propagation data.

VPI built fixed site ground-based terminals to receive the 12, 20 and 30 GHz Olympus beacons. Due to the respective locations of Olympus (19° West) and the ground-based receivers (VA), the beacons were visible at a 14° path elevation angle. VPI conducted measurement campaigns in 1990, 1991, and 1992, and has established statistics on signal attenuation, including rain attenuation. The statistics published to date are for the period January-May 1991 [2]. Yearly statistics are not available yet.

A comparison of the VPI empirical rain attenuation data has been made with the rain attenuation predicted by theory [3]. A statistical rain attenuation model (Manning's model) using the parameters of the Olympus satellite and the Blacksburg ground location was used to generate the theoretical attenuation statistics. The predicted statistics based on Manning's model are for an average year.

Although the comparison of both the predicted and empirical data sets can only be indicative, mainly because the statistics have been established for different lengths of time, the comparison is still a valuable attempt to validate Manning's model with actual data, as it is the only experimental data available to date.

Both sets of data, predicted and empirical data sets, are analyzed in detail in [2] and [3]. The worst month case statistics derived by VPI were obtained for March and May 1991. The data demonstrates that for 94% of a month time (worst month case), the rain attenuation did not exceed 3 dB at 30 GHz and 1dB at 20 GHz. 97% of the time the rain attenuation did not exceed 5 dB at 30 GHz and 2.5 dB at 20 GHz. 98% of the time the rain attenuation did not exceed 8 dB at 30 GHz and 3.6 dB at 20 GHz. These data points indicate how rapidly the attenuation level increases with the link availability. Manning's yearly model predicts attenuations that are lower by 3.5 dB and 1.6 dB respectively, for a link availability of 98%.

The empirical VPI data obtained for the five month period, January-May 1991, which intuitively shows less attenuation than the worst-month data, matches the yearly Manning model better. At lower attenuation levels (less than 5 dB) the empirically derived rain attenuation is more severe than predicted, and at larger attenuation levels, it is less severe.

ACTS is located at 100° West longitude; its ground-based terminals will operate at an elevation angle of at least 30°. Rain attenuation will therefore be less severe than for Olympus, due to the shorter propagation path through the atmosphere. The simulation based on Manning's model has been run for ACTS, at various locations representing the different climates and rain conditions in the US. The data demonstrates that, for a link availability of 98% of an average year, the attenuation will theoretically not exceed 1.2 dB at 30 GHz, and 1 dB at 20 GHz.

#### **3.2 Shadowing**

A mobile satellite system like the AMT is affected by shadowing and multipath propagation due to roadside obstacles and terrain conditions. The degree of shadowing depends on the intersecting path length with roadside obstacles. Many parameters affect the intersecting path, like path elevation angle, azimuth direction to the satellite, nature and geometry of the obstacle (tree, utility pole), obstacles set back from the road, lane and direction driven, size and type of road driven (rolling/flat, straight/road bends), etc. Also, the antenna pattern, the environment, rural/suburban, the season, and the frequency, affect the degree of shadowing.

No data is currently available on Ka-band shadowing effects. However, research and experiments on shadowing have been conducted at UHF(870 GHz) and L-band (1.5 GHz)[4]. These measurements have been used to quantify the influence of the system variables on the degree of shadowing and to assess the statistics of shadowing as a function of these variables.

Although the measurements have not been carried out at Ka-band, a few important conclusions can be drawn from the L-band data that are of importance for the AMT experiment. The statistics presented here were obtained at L-band, and as such, define the lower shadowing limit at Ka-band.

1) An increase/decrease of 20° in the path elevation angle (40° - 60°), will significantly reduce/increase respectively the degree of shadowing, by 7.5 dB at the 2% link outage probability level [4].

2) Driving on the lane which is the farther away from the roadside obstacle can reduce shadowing significantly. The farther away the vehicle is from the obstacle, the shorter will be the intersecting path with the obstacle, thereby reducing the degree of shadowing. Also, the wider the road is, the larger will be the improvement. The data analyzed here demonstrated at the 1% probability level, a 2.5 dB reduction on a wide road with trees, and a 4 dB reduction on a narrow road with utility poles [3].

3) Fades were calculated up to 10 to 15 dB and 1 to 8 dB at the 1% and 10% probabilities, respectively [4]. These results were obtained with a low-gain antenna system using ETS-V (elevation angle 51°). Fades for the "high gain antenna mode", were calculated up to 25 dB at the 1% probability level.

### **3.3 Doppler, frequency offset, and Doppler rate**

A significant impairment to AMT communications is the frequency offset introduced by the various oscillator instabilities throughout the link and the Doppler and Doppler rate introduced by vehicle motion. Typical vehicular induced Doppler frequency offsets and Doppler rates can approach 3 kHz and 370 Hz/sec respectively if they are not compensated for. Oscillator instabilities can raise the total frequency offset to 10 kHz or greater depending on how often the system oscillators are calibrated.

### **3.4 Phase Noise**

The phase noise of the AMT communications channel, though not an inherent problem of Ka-band communications, is a serious impairment that the AMT must overcome. The ACTS communication payload, having been designed for high rate transmissions, possesses very low phase noise (-108 dBc/Hz) at frequency offsets of 1 MHz. It has, however, a high phase noise specification closer to the carrier (-52 dBc/Hz at 1 kHz) which is problematic for low bit rate communications like the AMT. The AMT modulation scheme must be designed such to minimize the degradation due to this phase noise.

## **4. AMT DESIGN AND PERFORMANCE**

A block diagram of the AMT is presented in Figure 2. Descriptions of each of the subsystems follow. A key feature of the AMT that is interwoven among several of the subsystems is the rain compensation algorithm (RCA) [6]. The basic premise of the RCA is that by lowering the data rate from 9.6 kbps to 4.8 or 2.4 kbps in the advent of a rain event, the link margin can be increased by approximately 3 dB and 6 dB, respectively. The RCA is a novel algorithm by which the AMT is able to dynamically adjust the data rate to help mitigate the effects of rain attenuation. The RCA utilizes pilot power measurements at the mobile terminal and satellite beacon power measurements at the fixed terminal to determine rain attenuation. The rain attenuation information is communicated to both terminals through the AMT communications protocol [7] and a conflict free decision as to whether the data rate should be lowered or raised is made.

The link budgets for both the forward and return links are presented in Table 1, and include actual measured subsystem performance to the extent possible. A photograph of the mobile terminal is shown in Figure 3.

#### **4.1 Speech Codec**

The speech codec converts input analog speech signals to a compressed digital representation at data rates of 2.4, 4.8 and 9.6 kbps, with monotonically improving voice quality. The 2.4 kbps compression algorithm is the government standard LPC-10, the 4.8 kbps algorithm is the proposed CELP government standard, and at 9.6 kbps an MRELP algorithm is adopted. Data rate switches are performed upon command from the TC based on RCA information or upon user command. Data rate switching is performed with no user intervention and "on-the-fly" to have minimal impact on the continuity of the link. Finally, the codec is capable of interfacing to the Public Switched Telephone Network (PSTN). For example, the user at the mobile terminal can place a call to a telephone anywhere in CONUS.

#### **4.2 Terminal Controller**

The terminal controller is the brain of the terminal. It contains the algorithms that translate the communications protocol into the operational procedures and interfaces among the terminal subsystems. For example, it executes the timing and handshake procedures for the interaction among the speech coder, modem, user interface, and any external device (data source or sink) during link setup, relinquishment, or data rate change. The TC also contains the RCA routines and is responsible for executing them. The TC also has control over the operation of the IF and RF electronics and maintains high-level control over the antenna platform. The TC in addition is responsible for providing the user with a system monitoring capability and supports an interface to the data acquisition system (DAS). Finally, the TC will support the test functions required during experimentation, such as bit stream generation, correlation and bit error counting.

#### **4.3 Modem**

The baseline AMT modem will implement a simple but robust DPSK scheme with rate 1/2 convolutional coding and interleaving. The driver here is to minimize the impact of the phase noise of ACTS on the performance of the modulation scheme. The performance of the modem at a data rate of 9.6 kbps is a bit error rate (BER) of  $10^{-3}$  at an  $E_b/N_o$  of 6.6 dB in AWGN with frequency offsets and including modem implementation losses. The modem has been designed to handle frequency offsets of +/- 10.0 kHz without additional degradation. Simulations have determined that up to 1.0 dB of degradation due to ACTS phase noise could be experienced. Alternate pseudo-coherent BPSK modulation schemes wherein link synchronization information is imbedded into the data channel were explored for possible  $E_b/N_o$  performance gains, but the performance was found to be seriously degraded in the presence of phase noise. In addition to the 2.4, 4.8 and 9.6 kbps rates the modem will be designed to handle up to 64 kbps for the demonstration of high quality digital audio and slow scan compressed video on the forward link. Essential to the modem design is a built-in robustness to deep, short-term shadowing. The modem will "free-wheel", i.e., not lose synchronization through a signal outage caused by road-side trees and will reacquire the data rapidly after such a drop-out.

#### **4.4 IF Converter**

The IF up/down converter translates between 3.373 and a lower 70 MHz IF at the output/input of the modem. A key function of the IF converter is pilot tracking and Doppler pre-compensation. The down-converted pilot is tracked in a phase-locked loop and used as a frequency reference in the mobile terminal. The tracked pilot is also processed in analog hardware and mixed with the up-converted data signal from the modem to pre-shift it to offset the Doppler on the return link. The IF converter provides the TC and antenna subsystem with pilot signal strength for RCA and antenna pointing operation respectively. Finally the pilot in-phase and quadrature components are provided to the DAS for link characterization.

#### **4.5 RF Converter**

Preceding (or following) the antenna the RF up (down) converter will convert an IF around 3.373 GHz to (from) 30 (20) GHz for transmit (receive) purposes. The choice of the 3.373 GHz IF band is dictated by compatibility with the fixed station RF hardware to be used at NASA LeRC during demonstration. For the passive reflector antenna, the RF up-converter will also provide the antenna with sufficient power on the transmit signal through the use of a TWTA.

#### **4.6 Antennas**

The vehicle antenna is a critical Ka-band technology item in the AMT. Two types of antennas are being developed. The first is a "passive" elliptical reflector-type antenna to be used in conjunction with a separate TWTA or a solid state power amplifier (SSPA), and the second is an "active" array antenna with MMIC HPA's and LNA's integrated onto the array. Both antennas have their distinct advantages. The reflector is simpler and less risky and when a transmit power of 1.5 W or less is required does not need the somewhat bulky TWTA. For higher data rate applications when a higher transmit power is required the reflector can be used with the TWTA. The active array, despite being more complex and risky to develop, exploits MMIC technology to overcome some of the losses in the Ka-band hardware. The integration of the amplifiers also leads to a smaller more conformal antenna assembly. The antenna will have a minimum EIRP of 22 dBW, G/T of -8 dB/K, and bandwidth of 300 MHz. Testing of the reflector antenna has found the actual minimum G/T to be -6 dB/K. The reflector will reside inside an ellipsoidal water-repelling radome of outside diameter 9" (at the base) and maximum height 3.5".

The antenna pointing system enables the antenna to track the satellite for all practical vehicle maneuvers. Either of the two antennas will be mated to a simple yet robust mechanical steering system. A scheme wherein the antenna will be smoothly dithered about its boresight by about a degree at a rate of 2 Hz will be used. The pilot signal strength measured through this dithering process will be used to compliment the inertial information derived from a simple turn rate sensor. The combination will maintain the antenna aimed at the satellite even if the satellite is shadowed for up to ten seconds. This mechanical pointing scheme is one of the benefits of migration to Ka-band. The considerably smaller mass and higher gain achievable relative to L-band make the mechanical dithering scheme feasible and obviate the need for additional RF components to support electronic pointing. The necessary processing will reside in the antenna controller.

#### **4.7 Data Acquisition System**

The DAS performs continuous measurement and recording of a wide array of propagation, communication link, and terminal parameters (e.g., pilot and data signal conditions, noise levels, antenna direction, vehicle velocity and heading, etc.). The DAS also provides real-time displays of these parameters to aid the experimenters in the field.

### **5. CONCLUSIONS**

The ACTS mobile terminal is a proof-of-concept K/Ka-band mobile satellite communications terminal that has been developed by JPL for NASA. The terminal has been designed and the technology developed to explore the potential of a future commercial satellite system at these frequencies. The key technical challenges are to: 1) develop tracking, high-gain vehicular antennas, 2) design power efficient communications schemes, 3) compensate for high rain attenuation, 4) overcome high Doppler shifts and frequency uncertainties.

The AMT is currently undergoing system integration and test in preparation for a two year experimentation period starting in September 1993. U.S. industry has expressed significant interest in experimenting with the AMT as evidenced by the many planned experiments which are detailed in [8]. In addition a smaller derivative system is planned for broadband aeronautical experiments [9]. The goal of stimulating

commercial use of K/Ka-band for mobile satellite communications is being achieved and hopefully the end result will be a commercial satellite system at these frequencies.

## 6. REFERENCES

- [1] "ACTS Mobile Terminal Modem Functional Requirements Document", JPL Document AMT-017, Rev 1.0, November 20, 1991.
- [2] VIRGINIA POLYTECHNIC INSTITUTE AND STATE UNIVERSITY, Bradley Department of Electrical Engineering, Blacksburg, Virginia 24061, "Communications and Propagation Experiments Using The Olympus Spacecraft - Analysis of Olympus Propagation Data for the Period January to May 1991", November 1992.
- [3] C. Girardey, "The AMT Communication Channel", internal JPL document, AMT No. 48, 1993.
- [4] J. Goldhirsh and W. J. Vogel, "Propagation Effects for Land Mobile Satellite Systems: Overview of Experimental and Modeling Results", NASA Reference Publication 1274, February 1992.
- [5] Khaled Dessouky and Thomas Jedrey, JPL, "The ACTS Mobile Terminal", Proceedings 14th AIAA Conference, March 22-26, 1992, Washington, DC.
- [6] E. H. Satorius, "Rain Compensation Algorithm for the ACTS Mobile Terminal System", JPL IOM no. AMT:331.5-92-094, internal document, Sept. 15, 1992.
- [7] N. Lay and K Dessouky, "A Communication Protocol for Mobile Satellite Systems Affected by Rain Attenuation", IEEE J. Selected Areas in Commun., vol. 10, no. 6, August 1992.
- [8] B. Abbe, et al., "AMTS/AMT Experiments", IMSC 1993.
- [9] B. Abbe, et al., "ACTS Broadband Aeronautical Experiment", ACTS Conference 1992.

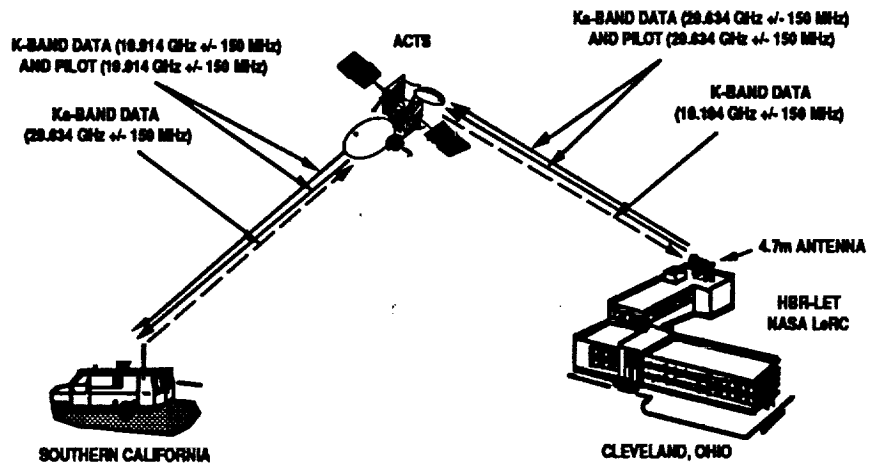

Figure 1 The AMT Experimental Setup

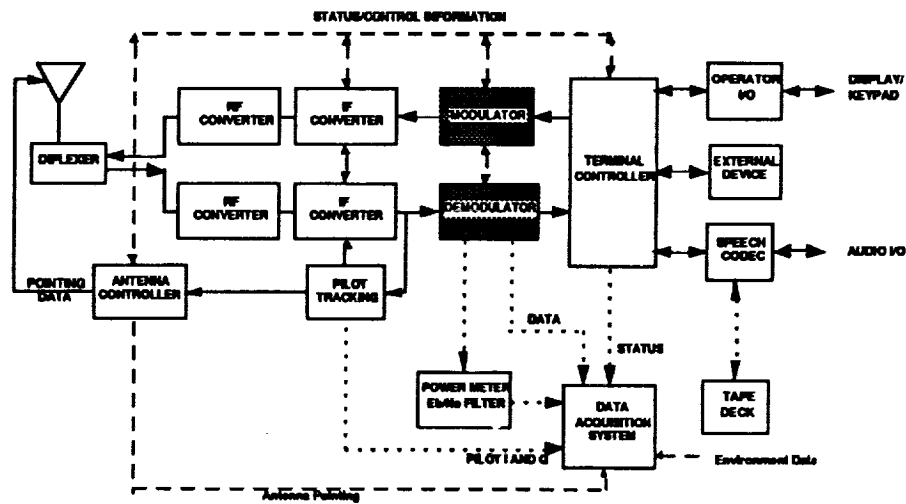

Figure 2 Block Diagram of the ACTS Mobile Terminal

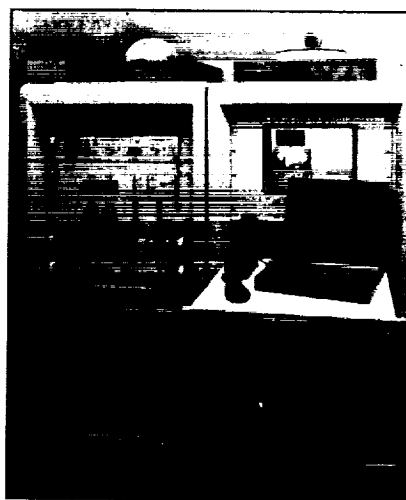

Figure 3 ACTS Mobile Terminal Photograph (Mobile Terminal)



Table 1 AMT Link Budgets

RETURN (AMT-TO-ACTS-TO-HUB) LINK BUDGET

UPLINK: AMT-TO-ACTS

TRANSMITTER PARAMETERS	
EIRP, DBW (NOMINAL)	22.00
POINTING LOSS, DB	-0.50
RADOME LOSS, DB	-0.40
PATH PARAMETERS	
SPACE LOSS, DB	-213.34
(FREQ., GHZ/MHZ)	29.63
RANGE, KM)	37408.00
ATMOSPHERIC ATTN, DB	-0.44
RECEIVER PARAMETERS	
POLARIZATION LOSS, DB	-0.50
G/T, DB/K	19.56
POINTING LOSS, DB	-0.32
BANDWIDTH, MHZ	900.00
RECV'D C/NO, DB.HZ	54.66
TRANSPONDER SNR IN, DB	-34.88
LIM. SUPPRESSION	-1.05
TRANSPONDER SNR IN, DB	-35.93

DOWNLINK: ACTS-TO-HUB

TRANSMITTER PARAMETERS	
EIRP, DBW	30.06
POINTING LOSS, DB	-0.22
PATH PARAMETERS	
SPACE LOSS, DB	-210.03
(FREQ., GHZ/MHZ)	19.91
RANGE, KM)	38000.00
ATMOSPHERIC ATTN, DB	-0.50
RECEIVER PARAMETERS	
POLARIZATION LOSS, DB	-0.13
ANT. DIRECTIVITY (MIN.), DBI	
SYSTEM TEMP., K	
G/T, DB/K	27.00
POINTING LOSS, DB	-0.50
DOWNLINK C/NO, DB.HZ	74.78
OVERALL C/NO, DB.HZ	53.58
REQ'D EB/NO (AWGN-SIMULATION), DB	6.00
MODEM IMPLEMENT. LOSS, DB	0.60
REQUIRED EB/NO, DB	6.60
LOSS DUE TO ACTS PHASE NOISE, DB	1.00
FADE ALLOWANCE (OVERALL), DB	3.00
DATA RATE, BPS	9600.00
REQ'D EFFECTIVE C/NO, DB.HZ	50.42
HARDWARE PERFORMANCE MARGIN, DB	3.16

FORWARD (HUB-TO-ACTS-TO-AMT) LINK BUDGET

UPLINK: HUB-TO-ACTS

TRANSMITTER PARAMETERS	
EIRP, DBW	37.00
POINTING LOSS, DB	-0.80
PATH PARAMETERS	
SPACE LOSS, DB	-213.48
(FREQ., GHZ/MHZ)	29.63
RANGE, KM)	38000.00
ATMOSPHERIC ATTN, DB	-0.36
RECEIVER PARAMETERS	
POLARIZATION LOSS, DB	-0.13
G/T, DB/K	21.25
POINTING LOSS, DB	-0.22
BANDWIDTH, MHZ	900.00
RECV'D C/NO, DB.HZ	71.86
TRANSPONDER SNR IN, DB	-17.68
EFF. LIM. SUPPRESSION, DB	-1.00
HARD LIM. EFF. SNR OUT, DB	-18.68

DOWNLINK: ACTS-TO-AMT

TRANSMITTER PARAMETERS	
EIRP, DBW	45.04
POINTING LOSS, DB	-0.32
PATH PARAMETERS	
SPACE LOSS, DB	-209.89
(FREQ., GHZ/MHZ)	19.91
RANGE, KM)	37408.00
ATMOSPHERIC ATTN, DB	-0.32
RECEIVER PARAMETERS	
POLARIZATION LOSS, DB	-0.50
RADOME LOSS, DB	-0.20
ANT. DIRECTIVITY (MIN.), DBI	18.90
SYS. TEMP. (REF TO REFLECTOR), K @	320.00
G/T, DB/K	-6.15
POINTING LOSS, DB	-0.50
DOWNLINK C/NO, DB.HZ	55.76
OVERALL C/NO, DB.HZ	55.63
REQ'D EB/NO (AWGN-SIMULATION), DB	6.00
MODEM IMPLEMENT. LOSS, DB	0.60
REQUIRED EB/NO, DB	6.60
LOSS DUE TO ACTS PHASE NOISE, DB	1.00
FADE ALLOWANCE (OVERALL), DB	3.00
DATA RATE, BPS	9600.00
REQ'D EFFECTIVE C/NO, DB.HZ	50.42
HARDWARE PERFORMANCE MARGIN, DB	5.21

The Nomad Explorer Assembly Assist Vehicle : An Architecture For Rapid Global  
Extraterrestrial Base Infrastructure Establishment

Madhu Thangavelu\*

Research Associate, Institute of Aerospace Systems Architecture and Technology,  
School of Architecture and the School of Engineering, University of Southern  
California, Los Angeles, CA 90089-1191.

AAA•VISIONEERING, 207 S. Hoover Street, Los Angeles, CA 90004-6158.

### **ABSTRACT**

Traditional concepts on lunar bases describe scenarios where components of the bases are landed on the lunar surface, one at a time, and then put together to form a complete stationary lunar habitat. Recently, some concepts have described the advantages of operating a mobile or "roving" lunar base. Such a base vastly improves the exploration range from a primary lunar base. Roving bases would also allow the crew to first deploy, test, operationally certify, and then regularly maintain, service and evolve long life-cycle facilities like observatories or other science payload platforms that are operated far apart from each other across the extraterrestrial surface. The Nomad Explorer is such a mobile lunar base. This paper describes the architectural program of the Nomad Explorer, its advantages over a stationary lunar base and some of the embedded system concepts which help the roving base to speedily establish a global extraterrestrial infrastructure. A number of modular autonomous logistics landers will carry deployable or erectable payloads, service and logistically resupply the Nomad Explorer at regular intercepts along the traverse. Starting with the deployment of science experiments and telecommunication networks, and the manned emplacement of a variety of remote outposts using a unique EVA Bell system that enhances manned EVA, the Nomad Explorer architecture suggests the capability for a rapid global development of the extraterrestrial body. The Moon and Mars are candidates for this "mission oriented" strategy. The lunar case is emphasized in this paper.

### **2. NOMENCLATURE**

AMCL- Autonomous Modular Common Lander  
DIPS - Dynamic Isotope Power System  
ETO - Earth to Orbit  
EVA - Extra Vehicular Activity  
ECLSS- Environmental Control and Life Support System  
GNC - Guidance, Navigation and Control

---

\*Consultant, Space Systems Division, Rockwell International, Downey, CA 90241.  
An earlier version of this concept was presented at the World Space Congress,  
Washington D.C. Aug 28 - Sep 5, 1992

LOI - Lunar Orbit Insertion  
MOSAP- Mobile Surface Applications Traverse Vehicle  
POS - Point Of Start  
RFC - Regenerative Fuel Cell  
RMS - Remote Manipulator System  
TLI - Translunar Injection  
VLTV - Very Long Range Traverse Vehicle

### **3. INTRODUCTION**

Permanent lunar base establishment will entail detailed terrain exploration, sampling and analyses. Current studies expect all the site analyses to be performed robotically. Though unmanned precursors and remote sensing satellites would provide valuable information on possible sites for lunar base location, in order to "live off the land", as President Bush directed, detailed manned exploration and formal site analyses of selected candidate sites will be required. Since site selection is a critical task, initial manned missions will have to "site-hop" before settling on the prime candidate site or sites. Global mobility then becomes imperative in the initial manned mission. Following this initial activity, long duration facilities like optical / ultraviolet interferometry observatories emplaced on the extraterrestrial surface will require regular on-site manned supervision for maintenance, refurbishment, and for steady evolutionary enhancement of capability. As these science and observatory platforms would be spread out over rather large stretches of extraterrestrial surfaces, again global mobility would greatly enhance such activity. And finally, these remote autonomous science outposts, observatories, technology testbeds and pilot manufacturing plants would have to be in constant communication with the Earth. As most of these facilities are stationary, extraterrestrial fiber optic networks linking them all together offers promise. Again, the mobile rover strategy would make it viable to lay fiber optic cables across the extraterrestrial surface, interlinking all of these outposts and providing simple, reliable yet very high quality telecommunication with the Earth.

Examining the program requirements which have already been developed by NASA(1), it might be possible to design a single manned mission assisted by an autonomous logistics lander system that would conduct all the required tasks as well as establish a global infrastructure of remote science outposts, observatories, technology testbeds for long duration missions and pilot indigenous materials manufacturing plants, and all of the necessary telecommunication networks to support such activity, all of which activities could be simultaneously manifested in a combined manned/unmanned mission architecture.

### **4. DEVELOPMENT OF THE NOMAD EXPLORER STRATEGY**

Starting from the need to establish, service and progressively evolve a series of highly versatile observatories for deep space, planetary, solar and Earth observation, The Nomad Explorer mission is tailored expressly to meet this highly specific objective in a

rapid, timely and economic manner. Immediate high quality return on investment is an aim of this mission.

NASA exploration studies indicate the need for manned rovers to assist in the development of extraterrestrial bases. Three classes of rovers have been identified and studied. Point design concepts have also been proposed in all three categories(1). Studies include the short range rover for around-the-base activity with a range of 50-100km, the long range vehicle with an operating range of 1000km and finally, the very long range traverse vehicle(VLTV) capable of covering 3000-10,000km on a single traverse. The mobile surface application traverse vehicle(MOSAP) is a vehicle that NASA has proposed for this purpose(2). Capable of all the exploratory functions and normal EVA that is carried out from a conventional stationary base, the VLTV, by virtue of its long range and enhanced manned crew systems capability, is in essence, a "roving lunar base"(3). Unlike a stationary base, from which detailed manned terrain exploration is limited by the range of the rovers, this mobile concept for a primary exploration-oriented base offers unlimited range for exploratory traverses(Fig.1). It is an extension of the program requirements of this very long range traverse vehicle that leads to the possibility of the Nomad Explorer strategy for lunar base/observatory establishment.

The Nomad Explorer Strategy is a synthesis of two major system architectures. They are :

#### **4.1. The Nomad Explorer Vehicle**

The Nomad Explorer vehicle is derived from the MOSAP vehicle developed by NASA. Several other studies done by NASA contractors on long range rovers are also available. Very long range traverses are possible using this vehicle. The architecture of this vehicle is adaptable to both manned or autonomous unmanned operations. The configuration studied in this paper portrays a manned Nomad Explorer vehicle. See Schematic in Fig.2.

#### **4.2. The Autonomous Modular Common Lander System**

The Autonomous Modular Common Lander(AMCL) is a common vehicle that can deliver both crew or cargo depending on the modular configuration employed. Logistics, consumables, and erectable/deployable science outpost components that are launched from Earth are delivered to the lunar surface using the AMCL system. The concept is derived from the lunar lander(3) and the Common Lander Study(4) which NASA has developed. The AMCL is outfitted with modular payload on the Earth, landed autonomously on the lunar/Mars surface, intercepted by the Nomad Explorer and the payload unloaded and deployed or transferred to the roving vehicle. The modular capability allows the lander to be sized for any mission, ranging from 5MT to 25MT depending on the requirements during the traverse of the Nomad Explorer vehicle.(fig.2)

The Nomad Explorer strategy is aimed at establishing a global scientific and telecommunication network, even during the initial "trail blazing" permanent base selection run. The Nomad Explorer, besides being a VLTV, is also conceived as a manned EVA and assembly assist vehicle.

Exploratory activity like soil sampling, soil mechanics, locating natural formations that enable habitation like lava tubes(5) is followed by the deployment of science outposts and habitation facilities during the course of the same mission. This vehicle, during the course of its very long traverse, will intercept autonomously landed payloads("modular common lander" payloads ?) along the traverse route, assemble the payloads or deploy them, check them out at the site, certify them for operations, doing all of these functions using the crew of the vehicle. During the later stages of the extraterrestrial base evolution, the strategy could be used for maintenance, repair activity and evolutionary enhancement of these remotely based highly sensitive scientific experiments like optical interferometry observatories(6) /pilot plants for manufacturing lunar indigenous materials and components (7) /telecommunications relay platforms etc.

#### **4.3. The Nomad Explorer Global Extraterrestrial Basing Strategy is as follows:**

- 1. Precursory high resolution mapping of the entire lunar/Mars surface using polar orbiting satellites.**
- 2. Analysis of terrain information, followed by determination of alternate likely candidate sites for lunar/Mars base location. Alternate rover traverse routes established with the aim of maximizing scientific returns(8) along the route while conducting detailed terrain surveys for locating alternate sites for a permanent base. A lunar polar traverse might be considered to explore trapped volatiles.(9)**
- 3. One or more Nomad Explorer VLTVs launched from ETO, coupled with lunar lander tankage in LEO, and landed on the lunar surface at the predetermined point of start of traverse.**
- 4. Lunar lander with crew accompany Nomad Explorer to the point of start(POS) of traverse.**
- 5. Crew transfer to Nomad Explorer and begin traverse. First telecommunication Earth link established at POS.**
- 6. Modular autonomous landers deliver modular payload along traverse route. Alternate base sites surveyed. Crew intercept payload, retrieve consumables/logistics modules, prepare and carry out assembly and deployment of science experiments and telecommunication relay stations, using manned EVA enabling systems which are part of the Nomad Explorer vehicle architecture.**
- 7. Nomad Explorer completes traverse. Establish global fiber-optic telecommunication network. Install scientific outposts. Conduct detailed geologic surveys and prospecting. Determine location for a permanent lunar settlement\*.**
- \*8. If more than one Nomad Explorer is landed, parallel activity would further speed up the base site selection and global infrastructure development. If required, the teams could assist each other by congregating at a particular site of interest, for exploration,**

for need of added manpower, or for establishing a permanent manned lunar base at a most suitable location.

9. At end of traverse, moth ball Nomad Explorer into energy conserving "hibernation mode" or set up vehicle for remote traverse operations. Permanent base site established.

10. Crew transfer to Earth return vehicle that has been autonomously landed at end of traverse. Crew depart for Earth. Mission complete. Permanent base establishment activities commence.

11. Nomad Explorer crew return to vehicle on future missions and proceed on traverses at prescribed intervals to repair, maintain or evolve remote outpost elements.

The Nomad Explorer Strategy for lunar basing is depicted in Fig.3

## **5. THE NOMAD EXPLORER VEHICLE SYSTEMS ARCHITECTURE**

The Nomad Explorer is a VLTV with an essentially unlimited operating range which depends entirely on the number of logistic resupply missions that are flown to it during the course of the mission. Assisted by the AMCL system, the Nomad Explorer carries only enough consumables, logistics and spares required by it between regular intercepts of the AMCL; much like the optimum pitstops and refueling operations carried out in automobile racing. A 10,000KM traverse could be used as an example to demonstrate the proposed capability of the Nomad Explorer. Duration of traverse could be six months to a year with the possibility of a complete crew changeout during the middle of the mission. Two regenerative fuel cell(RFC) power plants with a total peak output in the range of 50kW are required for powering the drive train and all of the manned and unmanned systems. Advanced photovoltaic arrays would assist the rover systems during the lunar day cycle. Mission architecture dictated a crew of four for optimum performance and the manned systems and life support are provided for four crew. A simple exploded schematic in fig.4 shows the basic systems of the manned Nomad Explorer.

The main features of the Nomad Explorer are as follows:

### **5.1. Habitation**

The pressurized volume of the vehicle is about 300cum.

This volume contains long term accommodation facilities for four crew, work and conferencing areas, a command and control center and ample storage space. Besides a galley, hygiene and waste management facilities, the long term accommodations include a health maintenance facility and a recreation space.

### **5.2. Environmental Control Life Support System(ECLSS)**

The ECLSS will handle the needs of four crew. Cryogenic nitrogen, Oxygen, Hydrogen and water are available from RFC operations. Though complete closure of the ECLSS is not envisaged, it may be possible to operate with a 90% efficiency(1).

Space station Freedom will provide the basis for the Nomad Explorer ECLSS.(10,11,12,13)

### **5.3. The EVA Bell**

The EVA Bell for enhancing manned EVA is a prominent feature of the vehicle and is described later in detail. The invention allows the astronaut crew to perform EVA in a more comfortable manner by providing a shirtsleeve environment around the payload to be assembled and deployed during the earlier mission or, serviced, repaired or enhanced during later extraterrestrial base evolutionary activity.(Fig.6)

### **5.4. The Utility Belt**

An utility belt is strapped around the perimeter of the vehicle. This belt has modular racks which carry "plug on" modules for logistics, consumables and waste management that are replenished by replacement modules arriving on autonomous landers which the vehicle intercepts from time to time along the traverse. The belt also carries tools and accessories for EVA. Two small unpressurized rovers for "around-the-base" traverses are also part of the EVA accessories. These rovers have a range of about 100km and are powered by fuel cells and advanced photovoltaics.

### **5.5. The Remote Manipulator System**

Two remote manipulator systems that are capable of assisting manned EVA, loading and unloading cargo, and providing anchoring or scaffolding support during assembly/deployment operations, run along two tracks on the top and bottom through the entire length of the utility belt. High resolution cameras mounted on this track as well as in other strategic points provide video support during the traverse as well as during assembly operations.

### **5.6. Traction System**

Traction could be provided using several options. The Nomad Explorer configuration in fig.5 depicts independently powered and steerable large variable diameter wheels which are unfurled and deployed after landing. Fig.7 schematic shows a telescopic traction system that is capable of adjusting the height of the Nomad Explorer chassis for enhancing traverse as well as assembly operations.

### **5.7. Radiation Protection**

Radiation protection is provided by skillful placement of system hardware on the vehicle so that they provide sufficient mass for protection. Tankage might be employed to enhance radiation protection(14). Regolith bags could be packed and laid in areas that require additional protection during solar particle events which might occur during the traverse.

### **5.8. Guidance, Navigation and Control System**

Guidance, navigation and control(GNC) of the vehicle is achieved through appropriate systems. Visual feedback could be direct or augmented by video support. Real-time telecommunication is possible through a 3m Earth pointing antenna and a chain of

surface-based relays or low orbiting satellites that could be employed for contact when line of sight communications is not possible. Electronically steered planar array antennas could be employed to maintain contact with low orbiting satellites or stationary extraterrestrial relay stations while the rover is in motion, even over rugged terrain. Fiber optics/free space laser communication and related technologies could enhance Nomad Explorer operations.

### **5.9. Power System**

Advanced Regenerative Fuel Cell(RFC) technology, advanced photovoltaics, as well as nuclear technology are suggested for the Nomad Explorer power system. The nuclear power option using the Dynamic Isotope Power System(DIPS) needs further study(1). Shielding requirements need to be considered for nuclear power systems. A set of RFC batteries could power the Nomad Explorer between AMCL intercepts. At each intercept of the AMCL, these RFCs could be recharged. In addition, advanced photovoltaic arrays could be employed to provide support to the RFCs. In generating about 50 kW of power,(25kW for drive train and 25kW for the manned systems including the ECLSS), the heat rejection system would have to handle about 16kW. High efficiency heat rejection systems are required. Dust contamination of radiator surfaces will require study and appropriate design. Recent developments in "power beaming", a technique whereby a microwave/laser beam from an external source is used to transmit power to the vehicle during traverse operations could substantially improve the performance of the Nomad Explorer by reducing the payload associated with power generation and storage equipment. (15,16,17,18)

### **5.10. Mass and Payload Configuration**

All these systems are designed to fit within a HLLV(Energiya or revived Saturn V-B technology) payload shroud that is 30m tall and 10m in diameter. The payload mass at launch is about 35MT+propulsion, tankage and structure for TLI, LOI and lunar landing. This mass is above the NASA lunar lander capability of 25MT. Though this Nomad Explorer study suggests that larger landers are required for the mission, it would be possible to scale down the vehicle and still preserve the mission architectural strategy for a smaller vehicle. The unmanned version of the Nomad Explorer is such a small vehicle. Substantially smaller(5-7MT), the robotic Nomad Explorer would employ the same mission strategy. However, reliability and the capability to handle contingencies require demonstration. A possible manned Nomad Explorer configuration is depicted in fig.5.

In the next section, the paper will discuss certain special features of the Nomad Explorer vehicle which were developed to enhance mission capabilities.

## **6. THE PROBLEM WITH CONVENTIONAL EXTRA VEHICULAR ACTIVITY**

Conventional EVA is a most time consuming, hard and inefficient yet essential part of human activities in space or on the extraterrestrial surface. Complex and lengthy preparatory procedures are part of EVA. Present studies aimed at establishing



extraterrestrial bases will require substantial EVA during buildup operations. Long hours of continuous EVA are expected during the early development phase of these projects. It is well known that present day designs for space suits are simply inadequate for these operations(19). When inflated to the optimum operating pressure of about 8psi, the suit becomes very stiff and quite difficult to flex at the required joints. The astronaut then has to work against this suit pressure stiffness as well as the forces which are required of the task to be performed. Loss of dexterity is the result and almost every component in a payload package to be assembled or deployed has to be designed to adapt to the limitations imposed by this loss of dexterity(Fig.6). In past EVA missions, astronauts and cosmonauts have complained about the difficulty of working in the EVA suit. Lunar dust is notorious for degrading astronaut as well as vehicle performance(20,21). Compounded by the fact that future missions are expected to be more complex and substantially longer in duration, it is imperative that alternate methods for conducting EVA be studied. Hard suits, where the fabric is substituted for a metallic shell with articulation mechanisms at the essential joints have been studied but they have their limitations too. Compact modules with appropriate life support and remote manipulator systems(the so called "man-in-a-can" concepts)have also been suggested as an alternate means for enhancing long duration EVA. Fully robotic systems have yet to prove their ability to handle contingencies, and until then, manned EVA will continue to play the leading role in assembly operations in space and on the extraterrestrial surface. It is also possible that hybrid concepts employing both robotic and manned systems may prove to be more effective, using a mutual support strategy, during extravehicular buildup activity.

## **7. RATIONALE FOR AN ALTERNATIVE MANNED EVA SYSTEM**

The EVA Bell concept proposed in this paper is a concept for enhancing manned EVA operations on the extraterrestrial surface. The rationale for this concept are as follows:

1. Conventional EVA is an extremely inefficient way of utilizing astronaut capabilities. EVA time is expensive and must be used more efficiently.
2. Conventional EVA requires that components to be assembled/deployed be designed to respond to the limitations of the EVA suited astronauts. Such a strategy limits efficient design and operation and therefore should not be a design driver.
3. Extraterrestrial base development will surely involve much more complex and arduous EVA tasks that will heavily tax the physical and mental capabilities of the best astronauts. Though the conventional EVA suits may be ample for some of the envisaged activity, alternate concepts for EVA are required to handle different and diverse EVA scenarios, which are a natural implication of the plethora of necessary EVA tasks required that will eventually lead to a final establishment and operation of the base.
4. "Back to stay" missions entail long duration missions, and most importantly, long life cycle facilities. These facilities will require servicing, repair activity as well as associated evolutionary enhancement and modification procedures. EVA must be simplified in order to help the crew repeat these functions with ease.

5. Dust contamination from the extraterrestrial surface has and will continue to pose a serious threat to successful assembly and maintenance operations(20,21). EVA concepts are needed that will effectively combat this problem during assembly/repair operations.
6. It may not be possible to tackle all EVA scenarios using the same strategy.(i.e. use of only the conventional EVA suit). Therefore, at the planning stage, it is prudent to have as many alternate concepts for manned EVA as possible, so that tasks may be designed for efficient execution.
7. Many payloads to be deployed and maintained remotely on an early lunar base could be designed to be quite small in their physical dimensions.(e.g. remote data relay stations, small science experimental platforms, photovoltaic arrays, optical interferometry array components).
8. It should be possible to provide an EVA environment for the assembly/repair/maintenance crew which is less taxing and more comfortable. Concepts are required which would enable the astronaut crew to perform more precise and delicate tasks on the site without the strain imposed by EVA suit constraints.
9. A rapid and highly flexible global extraterrestrial telecommunication/scientific experimental station network infrastructure establishment may be possible if a manned and robotic hybrid architecture is adopted during the primary phase of buildup activities.

It is on the basis of these premises that the Nomad Explorer architecture for rapid lunar/Mars global infrastructure development and the EVA Bell concept for enhancing manned EVA is developed.

## **8. THE EVA BELL SYSTEM ARCHITECTURE**

In its simplest manifest, the idea is to separate the astronaut from the suit and try to provide as close to a shirtsleeve environment as possible during EVA. In order to accomplish this, we will provide a pressurized shack, referred to as the "Bell"(programatically similar in many ways to the diving bell used underwater), at the place where the EVA is to performed.(Fig.6) Obviously then, this Bell becomes an integral part of the Nomad Explorer !

Though only one configuration of the EVA Bell is addressed in this paper, several other ways exist in which to provide this protective enclosure around the payload and the astronauts during assembly activities. They are being studied at the institute.

The Bell works in the following manner:

1. The Nomad Explorer drives to the EVA/Assembly site. The payload to be deployed could have been landed at the site separately,(Common lander concept ?)or carried in the vehicle.
2. The surface is approximately leveled by the RMS on the vehicle. A surface seal fabric is unrolled on the smoothed out terrain. (This fabric could be part of each common lander payload.)

3. The payload/experiment to be assembled/deployed is then unloaded on top of the prepared surface seal fabric.
4. The Nomad Explorer then aligns itself with the prepared surface seal and gently lowers the Bell so that the complete payload is covered by it with space around the payload to spare. The volume inside the Bell is about 150cum.
5. The Bell is lowered till it uniformly contacts the surface seal fabric all around the payload. The Bell is then secured to the surface seal fabric in such a way as to produce a nominal pressure seal between the inside of the Bell and the extraterrestrial surface. Studies are under way that examine several ways of establishing this pressure seal.
6. The Bell is then pressurized.(8psi nominal.)
7. After assuring that the seal is operational and that the nominal leakage rates are not exceeded, an airlock into the Bell allows the astronaut crew to access it from inside the Nomad Explorer.
8. The assembly/deployment activity is performed by the crew wearing minimal EVA garments.(An emergency pressure suit?). After test and checkout of the experiment/setup or system(eg.optical IF, VLBI components, relay stations, remote monitoring equipment), the crew get back into the vehicle.
9. The Bell is depressurized, retracted and the Nomad Explorer is on its way to the next assembly assist /experiment setup/maintenance/repair site.
10. In the case of a repair or regular facility maintenance mission, the same procedures listed above are employed except that the mission will be simpler because the surface seal fabric is already in place from the primary mission. It would be much easier now to deploy the EVA Bell over the facility and complete the mission.

This sequence of operations is illustrated in Fig. 7.

## **9. CHALLENGES POSED BY THE EVA BELL SYSTEM**

1. How do we mitigate counter pressure ? At 8psi, a 4 x 6m Bell footprint would produce a total uplift of nearly 300,000 lbs. !!. However, we have a substantial surface contact perimeter of 20m to devise an anchoring mechanism. External as well as internal anchoring mechanisms for the EVA Bell are being explored.
1. How do we make sure of the seal ? We will require a 100% reliability on the seal mechanism if a shirtsleeve environment is the goal.
3. How large a Bell can we practically build and operate? It has to be compatible with payloads that we intend to assemble and deploy, of course!.
4. The surface seal fabric will have to be left in place after the assembly activity.
5. The payload cannot contact the surface during the assembly operation.

## **10. ADVANTAGES OF THE EVA BELL SYSTEM**

1. Shirtsleeve environment for assembly/deployment activity. No prebreathing or associated EVA preparations are required.
2. The fully enclosed EVA Bell system provides a completely dust contamination-free environment during assembly and checkout of sensitive experimental equipment.

3. Lacking post landing serviceability, conventional missions carrying sensitive scientific equipment need to be designed to accommodate the shock of lunar lander impact. This translates directly as additional mass or design for shock absorption. Alignment, and recalibration of equipment could pose a problem. The EVA Bell strategy provides a way to circumvent this problem.
4. If the 8psi pressure is too much to handle, then the crew could still work inside of the Bell wearing a pressure suit just enough to combat the differential pressure between the Bell and the suit. For e.g. if the Bell can withstand up to 4psi, then the crew needs roughly another 4psi inside the suit. Such a decrease in suit pressure will make the suit less stiff during operation and enable more comfortable EVA. This method of operation is also very safe in the event of a Bell pressure seal failure. New, more maneuverable and comfortable pressure suits could be designed to use with the Bell.
5. All of the multilayer insulation used in the conventional EVA garment for radiation and micrometeoritic protection are eliminated from the suit which then retains only the pressure garment.

## **11. ADVANTAGES OF THE NOMAD EXPLORER STRATEGY**

1. The Nomad Explorer strategy completely eliminates the need for conventional buildup equipment and infrastructure. All the heavy machinery and associated equipment, roads, launch and landing pad facilities associated with previous studies are not required during the initial stages of development.
2. Nomad Explorer technology is mature and does not require heavy investment to realize. NASA has studied long range vehicles like MOSAP in enough detail to be able to build and test Nomad Explorer prototypes.
3. Prototypes based on existing vehicles used for special terrestrial purposes (like the MX Missile transporter and other advanced recreational vehicles) could also be modified and studied in order to design and build the Nomad Explorer economically.
4. The Autonomous Modular Common Lander (AMCL) is not a new concept. NASA has been working on several lunar landers including the "common lander" and Artemis using existing RL-10B or equivalent engine technology. Modular clustering of engines and tankage need more study in order to realize the AMCL concept. Innovative ways of landing bulk payload that is not so sensitive to higher than average terminal impact velocities (5-10m/s) need further study (22).
5. If the AMCL system is employed to land modular payload containing experiments, logistics and consumables at various locations along a predetermined traverse route, then the Nomad Explorer could assemble and deploy the payload at regular intercepts along the path. Such a strategy will provide unlimited range for the Nomad Explorer.
6. The autonomous common lander approach would bring to the Nomad Explorer architecture a powerful design flexibility. During the course of the traverse, if unforeseen events require different logistics, science or consumable payloads, the landers could be outfitted and flown to intercept the Nomad Explorer with the required mission specific hardware at short notice.
7. During the course of the Nomad Explorer global traverse, if a globally accessible fiber-optic cable could be laid by the vehicle along the traverse, then it may be possible

to eliminate the need for the deployment and maintenance in orbit of a constellation of telecommunication satellites.

8. This flexible open-ended mission architecture can be tailored as the mission proceeds. The if-then philosophy is best suited for exploration oriented missions and can be used to alter the traverse to best suit the exploration and extraterrestrial base site selection as well as the science mission goals.

9. The EVA Bell on the Nomad Explorer will provide a less stressful environment for astronaut crew on long duration EVA missions. The crew will have more freedom to alter traverse routes on the basis of their own exploration results, making the mission more exciting and eventful for both astronaut crew as well as mission control.

10. This ultra-dynamic strategy will also hold the fascination of the public because of the continuously changing terrain vistas, the regular rendezvous with the AMCL system, the number of mission goals which are rapidly met, and the spontaneous nature of the tasks that may have to be performed by the crew during this mission.

11. In this way a speedy global infrastructure may be established on the lunar/Mars surface.

12. The strategy offers tremendous potential for international collaboration. The use of the Energiya HLLV for Nomad Explorer deployment is a possible example.

13. The Nomad Explorer Strategy is a clear and precise "mission oriented" project. The mission objective is the rapid deployment of a highly versatile series of observatories on the moon for deep space, planetary, solar and Earth Observation that are evolved progressively during subsequent missions.

14. A very high quality cislunar telecommunication network is an essential part of the Nomad Explorer architecture. Fiber optics and free space lasers are employed in a round-the-clock communication network architecture which maximizes scientific return and promotes 24 hour use of the facilities by the international community.

## **12. TECHNOLOGY FOR THE NOMAD EXPLORER STRATEGY**

The Nomad Explorer vehicle and the Autonomous Modular Common Lander System employ state-of-the-art and mature technologies. NASA has been working on similar concepts and sufficient data exists within the U.S. which could be used to build and test prototypes.

The Nomad Explorer vehicle requires a heavy lift launch vehicle(HLLV). HLLVs are required in order to minimize otherwise costly and risky on-orbit assembly and rendezvous procedures for which the infrastructure is not in place yet(23,24). Reviving the Saturn V-B and incorporating new modifications to the twenty year old technology could result in a work horse launcher that NASA needs and that is essential for any permanent manned presence on the moon or Mars(29).The Russian Energiya is a typical example of an operational HLLV that could provide primary deployment support for the Nomad Explorer operations(25).

Communications technology has come a long way since Apollo. Fiber-optics and free-space laser communication systems can provide dependable and very high bit rate

communications for the Nomad Explorer strategy. Furthermore, if the Nomad Explorer is used to lay a fiber-optic network as the traverse proceeds, eventually it might be possible to have a global extraterrestrial communication system that would eliminate the need for a constellation of satellites in unstable orbits(in the lunar case) and poor life times. Optical line-of-sight free-space laser communications without atmospheric disturbances and associated attenuation is possible on the lunar surface. Laying such extraterrestrial fiber optic cable/free-space links require serious study. Preliminary studies indicate that fiber optics is a feasible option for the moon.(26)

### **13. THE NOMAD EXPLORER BUDGET**

Project Apollo cost \$100 billion in 1990 dollars(27,28). Much of the technology base had to be built up from scratch. Though much of the hardware and infrastructure associated with the project is no longer with us, much wealth in hardware and experience from the project remains dormant within NASA and the space industry. In addition, NASA and the space industry have already done much study on long range rovers and landers. MOLAB and MOSAP are some of the long range rovers which have been studied in depth. Several designs have also been developed by NASA for lunar landers. Artemis, lunar lander and the Common Lander some of the NASA studies under way. The Nomad Explorer strategy will rejuvenate NASA and the manned spaceflight hardware builders of the world by tapping into research that is already underway. Using Apollo as the gauge for the Nomad Explorer, it should be possible to return to the moon using the Nomad Explorer and the Autonomous Modular Common Lander for about the same price tag.

### **14. CONCLUSIONS**

The Nomad Explorer Strategy for Extraterrestrial Base Evolution is an alternate strategy for global extraterrestrial infrastructure establishment. Capable of all the functions normally conducted from a stationary base, a mobile base like the Nomad Explorer, when coupled with an autonomous payload/logistics lander system like the AMCL system, has unlimited exploration range as well as a highly tailorable mission plan. Maximum flexibility is the chief attribute of this "open architecture". The "if-then" capability allows the mission to be tailored as it proceeds while maintaining close contact with mission control. Autonomous modular common landers carry mission specific hardware as dictated by the crew.

The Nomad Explorer mission objective is highly defined : To establish, service and progressively evolve a highly versatile series of observatories for deep space, planetary, solar and Earth Observation. Immediate and high quality return on investment is envisaged.

The EVA Bell, a new system concept for enhancing manned EVA in the Nomad Explorer vehicle will help to assist assembly and deployment of science experiments

and pilot projects while the vehicle traverses from site to site, examining them in detail for establishing a permanent manned base.

An extraterrestrial fiber-optic/free-space global telecommunication infrastructure may be laid during the course of the exploratory traverse which will eventually eliminate the need for expensive operation and maintenance of a constellation of telecommunication satellites which would otherwise be required as complex extraterrestrial projects evolve. Rapid extraterrestrial development that will hold the interest and excitement of the public as the mission proceeds from site to site is the consequence of using such a mobile strategy. The various systems constituting this architecture require further study and analyses.

## **15. ACKNOWLEDGMENTS**

This study was done as a task for the extraterrestrial surface transportation group at Rockwell International, Space Systems Division, Downey, CA. Thanks are due to Ed Repic, Project Manager for the Space Exploration Initiative, Steve Kent who supervised my work, John Pulley, manager of surface transportation group, and all the others including Todd Wise and Ron Jones who helped to critique the concept. Thanks are due also to the participants of the Institute of Aerospace Systems Architecture and Technology at the University of Southern California who are embarked on a brave new voyage, exploring and charting new territory in the field of Aerospace System Architectures.

## **16. REFERENCES**

1. NASA(1989). Exploration Studies Technical Report TM 4170, Volume III: Planetary Surface Systems. NASA Office of Exploration. b. NASA(1988)Exploration Studies Technical Report TM 4075, NASA Office of Exploration, FY 1988. Volumes 1 & 2. c. Eagle Engineering(1988). Lunar Reports. NASA contract NAS9-17878. Eagle Engineering Inc., Webster, Texas. d.3. Landis, G.A.(1989). Solar Power for the Lunar Night. NASA TM102127. 9th Biennial SSI Princeton Conference on Space. e. Thangavelu, M.(1991). The Very Long Range Traverse Vehicle: Option for Primary Lunar Base Establishment. Space Systems Division, Rockwell International, Downey, CA. f. Landis, G.A.(1989). A Proposal for a Sun Following Moon Base. Journal of the British Interplanetary Society.
2. Alred, John.(1989).Lunar Outpost. Systems Definition Branch, Advanced Programs Office, NASA Johnson Space Center.
3. Cohen, Aaron, et al.(1989). Report of the 90 Day Study on Human Exploration of the Moon and Mars. NASA Johnson Space Center, Houston, Texas. b. National Research Council.(1990). Human Exploration of Space. A Review of NASA's 90 Day Study and Alternatives. National Academy Press, Washington D.C.
4. Common Lander Study (1991). NASA JSC. NASA Office of Exploration.
5. Horz, Fredrich.(1985) Lava Tubes: Potential Shelters for Habitats. Lunar Bases and Space Activities in the 21st Century. Ed. Mendell W.W. Lunar and Planetary Institute, Houston.

6. Burke, F.B.(1985). Astronomical Interferometry on the Moon. Lunar Bases and Space Activities in the 21st century. Ed. Mendell W.W. Lunar and Planetary Institute.
7. Haskin, L.A.,(1985) Toward a Spartan Scenario for Use of Lunar Materials. Lunar Bases and Space Activities in the 21st century. Ed. Mendell W.W. Lunar and Planetary Institute.
8. Cintala, M.J., Spudis, P.D., Hawke, B.R.(1985) Advanced Geologic Exploration Supported by a Lunar Base: A Traverse Across The Imbrium-Procellarum Region of the Moon. Lunar Bases and Space Activities in the 21st century. Ed. Mendell W.W. Lunar and Planetary Institute.
9. Burke,J.D.(1985) Merits of A Lunar Polar Base Location. Lunar Bases and Space Activities in the 21st century.  
Ed. Mendell W.W. Lunar and Planetary Institute.
10. Humphries, R.(1991). Life Support and Internal Thermal Control System Design for Space Station Freedom. NASA MSFC, Huntsville, USA. 4th European Symposium on Space Environmental Control Systems. ESA SP-324
11. Rummel, J.D., Averner, M.(1991) Regenerative Life Support: The Initial CELSS Reference Configuration. Life Sciences Division, NASA Hq. Regenerative Life Support Systems and Processes. Society of Automotive Engineers. SP-873, paper#911420.
12. Schwartzkopf, S.H., Brown, M.F.(1991) Evolutionary Development of A Lunar CELSS. Regenerative Life Support Systems and Processes. Society of Automotive Engineers. SP-873, paper# 911422.
13. Hypes, W.D. and Hall, J.B.(1988). ECLS Systems for a Lunar Base- A Baseline and some Alternate Concepts. SAE 881058. 18th Intersociety Conf. on Environmental Systems, San Francisco, CA.
14. Griffin,B. & Appleby, M.(1991). The Pressurized Lunar Rover. Radiation Analysis using the Boeing Radiation Exposure Model(BREM). Advanced Civil Space Systems Division, Boeing Co.
15. Stone, C.(1991). ALPS: Advanced Lunar Power System. Space Systems Division, Rockwell International,Downey Ca.
- 16.E.P. Coomes, J.E. Dagle, J.A. Wise(1992). Design Study of A Laser Beam Powered Lunar Exploration Vehicle. Pacific Northwest Laboratory. IAF-92-0742.
17. Brown, W.C.(1969) "Experiments involving a Microwave Beam to Power and Position a Helicopter", IEEE Transactions, Aerospace Electronics Systems., Vol.AES-5
18. Glaser, P.E.(1974) Feasibility Study of A Satellite Power Station, NASA CR-2357.
- 19.Kuznetz, L.H.(1990). Space Suits and Life Support Systems for the Exploration of Mars. NASA Ames R.C.
- 20.Wise,Todd(1991). Dust Contamination Control. IDEEA Conference,Houston, Texas.
- 21.Glaser,Peter(1991). Dust Contamination and Control. IDEEA Conference, Houston, Texas.



22. Thangavelu, M.(1991). The Multicellular Airbag Landing System. A concept for landing extraterrestrial payloads. Space Systems Division, Rockwell International, Downey, CA.
23. Stafford, T.P.(1991). America at the Threshold: Report of the Synthesis Group on America's Space Exploration Initiative. Washington, DC.
24. Augustine, N.(1991) Report of the Commission for the Future of the Space Program.
25. Gobanov, B.I.(1989). Energia - A New Versatile Rocket Space Transportation System, IAF-89-202.
26. Lutes, G.F(1991). Communicating On The Moon Via Fiber Optics. Lunar Fiber Optic Link Study. NASA JPL. California Institute of Technology. NAS7-918.
27. Crawley, Ed(1988). Aerospace Systems Analysis and Costing. Lecture to the International Space University at MIT, Boston
28. Sellers, W.O. and Keaton, P.W.(1985). The Budgetary Feasibility of a Lunar Base. Lunar Bases and Space Activities in the 21st Century. Ed. Mendell W.W. Lunar and Planetary Institute, Houston.
29. Frieling, T.J(1993). Return To The Moon To Stay : Logistical Considerations For SEI Lunar Missions Using Earth Orbit Rendezvous. Bainbridge College, Georgia.

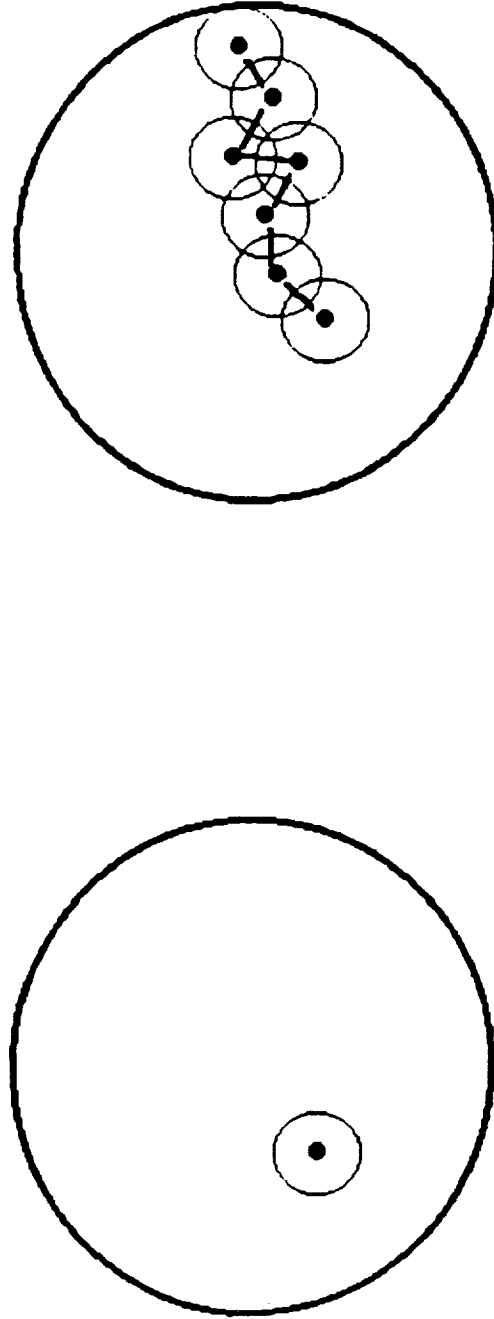

**STATIONARY EXTRATERRESTRIAL BASE**  
• LIMITED EXPLORATION RANGE

**MOBILE EXTRATERRESTRIAL BASE**  
• UNLIMITED EXPLORATION RANGE

**Fig. 1**

**SCHEMATIC OF NOMAD EXPLORER**

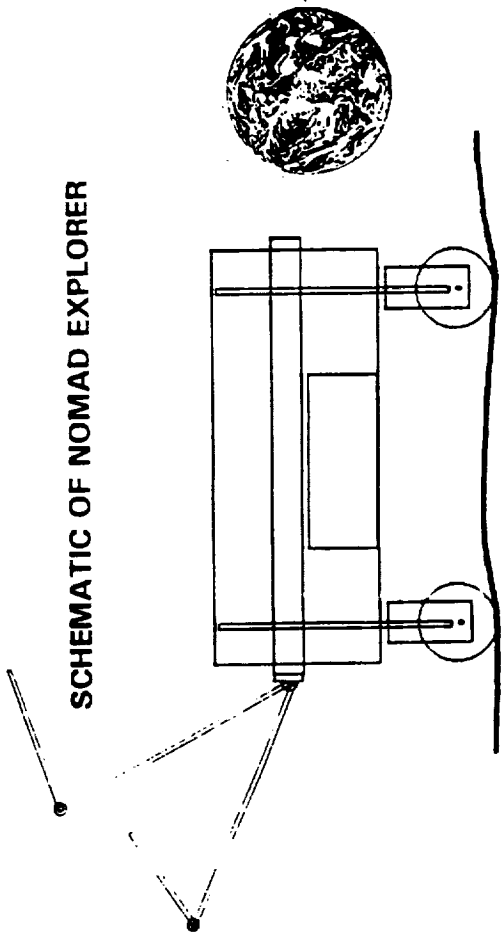

**SALIENT FEATURES**

1. VERY LONG RANGE TRAVERSE VEHICLE
2. CREW OF THREE, SIX MONTHS, 10,000 KM.
3. MANNED ASSEMBLY ASSIST VEHICLE.
4. BELL ATTACHMENT FOR ENHANCING MANNED EVA.
5. NUCLEAR POWER.
6. LOGISTICALLY RESUPPLIED BY MODULAR REPLACEABLE UNITS DELIVERED BY THE AUTONOMOUS LANDER.

**MISSION**

1. "SITE-HOP" TO LOCATE BEST SITE FOR PERMANENTLY MANNED LUNAR BASE.
2. DURING TRAVERSE, ESTABLISH SCIENCE OUTPOSTS ALONG THE WAY, DEPLOY EXPERIMENTS, AND ESTABLISH EXTRATERRESTRIAL GLOBAL TELECOMMUNICATION INFRASTRUCTURE USING FIBER OPTICS AND LASER TECHNOLOGY.

**SCHEMATIC OF AUTONOMOUS MODULAR COMMON LANDER**

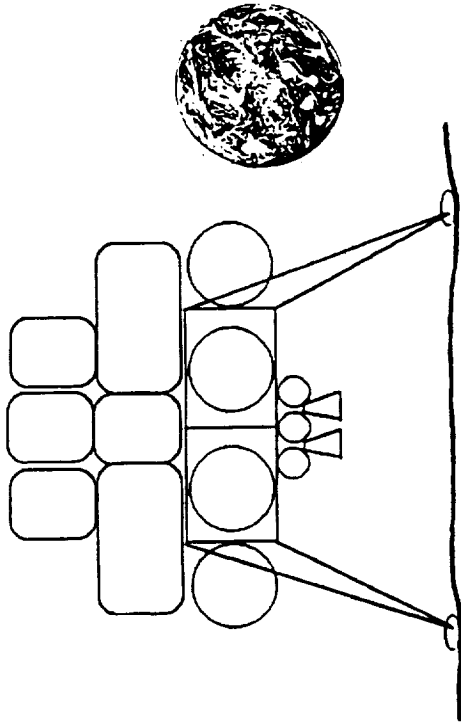

**SALIENT FEATURES**

1. AUTONOMOUS LANDING CAPABILITY
2. MODULAR STRUCTURAL/PROPULSION DESIGN
3. COMMON CARRIER FOR NOMAD EXPLORER CREW TRANSPORT, LOGISTICS, ERECTABLE OR DEPLOYABLE SCIENCE PAYLOADS
4. PAYLOAD CAPABILITY - 5,10,15,20,25 MT DEPENDING ON MODULAR CONFIGURATION

**MISSION**

1. PROVIDE CREW TRANSPORT, LOGISTICS SUPPORT FOR THE NOMAD EXPLORER
2. CARRY SCIENCE/OTHER PAYLOADS TO BE DEPLOYED/ERECTED BY CREW OF NOMAD EXPLORER.

**Fig.2**

THE NOMAD EXPLORER MISSION PLAN

Fig.3

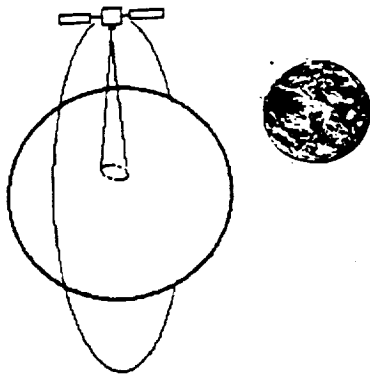

1. HIGH RESOLUTION IMAGING OF EXTRATERRESTRIAL SURFACE. DETAILED GLOBAL MAPS PREPARED.

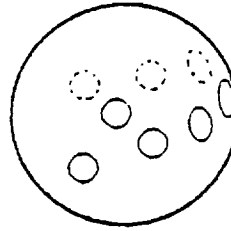

2. SEVERAL CANDIDATE BASE SITES IDENTIFIED. BOTH ON LUNAR NEAR SIDE AND FAR SIDE.

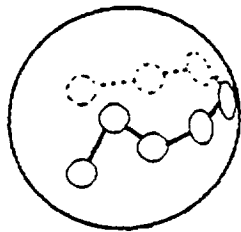

3. ALTERNATE NOMAD EXPLORER TRAVERSE ROUTES EXAMINED. FINAL TRAVERSE ROUTE IDENTIFIED.

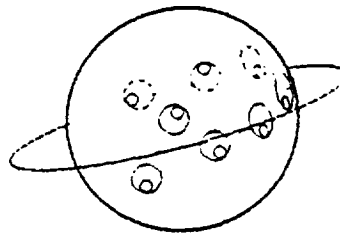

4. AUTONOMOUS LANDER (AMCL) DELIVERS LOGISTICS TO CANDIDATE SITES.

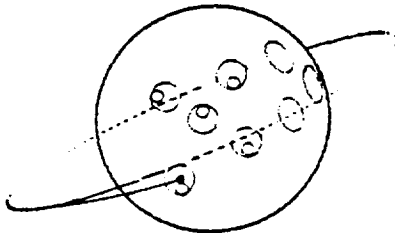

5. NOMAD EXPLORER LANDED AT POINT OF START OF TRAVERSE. ALL SYSTEMS CHECKED OUT FROM EARTH. CREW LANDS NEXT TO VEHICLE IN AMCL CONFIGURED FOR CREW TRANSPORT. TRANSFERS TO NOMAD EXPLORER.

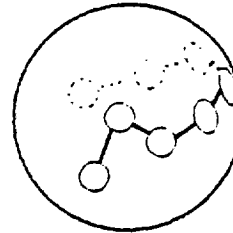

6. DETAILED MANNED EXPLORATION OF NATURAL TERRAIN FORMATIONS (LAVA TUBES, RILLES ETC.) SOIL MECHANICS AND OTHER "HANDS-ON" EXPERIMENTS CONDUCTED. TELECOMMUNICATION LINK DEPLOYED AS MISSION PROCEEDS.

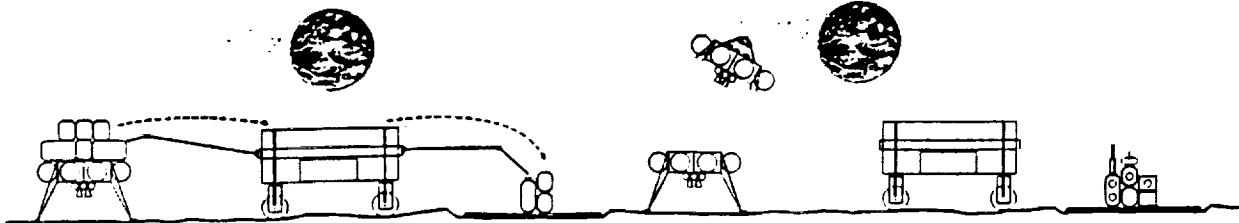

7. AS MISSION PROCEEDS, NOMAD EXPLORER REGULARLY RENDEZVOUS WITH AMCLs CARRYING SITE SPECIFIC PAYLOADS OF SCIENCE EXPERIMENTS AND RELATED HARDWARE. NOMAD EXPLORER INTERCEPTS AMCLs, ASSEMBLES AND DEPLOYS SCIENCE PACKAGES. LOGISTICS REPLENISHED. IF MISSION DURATION EXCEEDS SAFE STAY TIMES, SECOND FULL CREW REPLACEMENT ARRIVES DURING MIDDLE OF MISSION AND THE FIRST FULL CREW RETURN TO EARTH IN AMCL.

8. NOMAD EXPLORER COMPLETES TRAVERSE. VEHICLE SWITCHED TO "HIBERNATION MODE" TILL NEXT MISSION. CREW RETURN TO EARTH IN AMCL THAT IS READY AND WAITING AT END OF TRAVERSE.

# THE NOMAD EXPLORER

## SCHEMATIC OF SYSTEMS

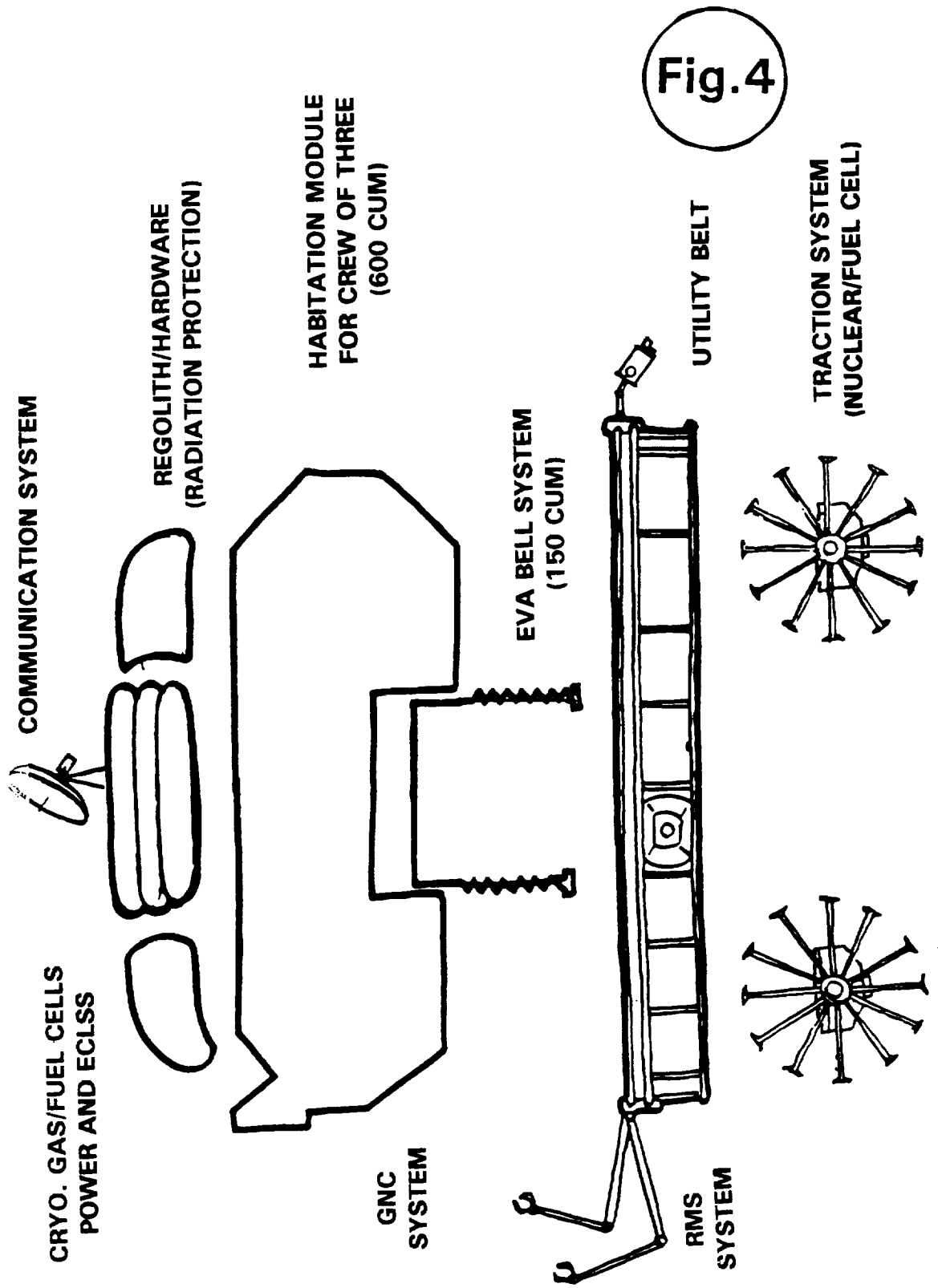
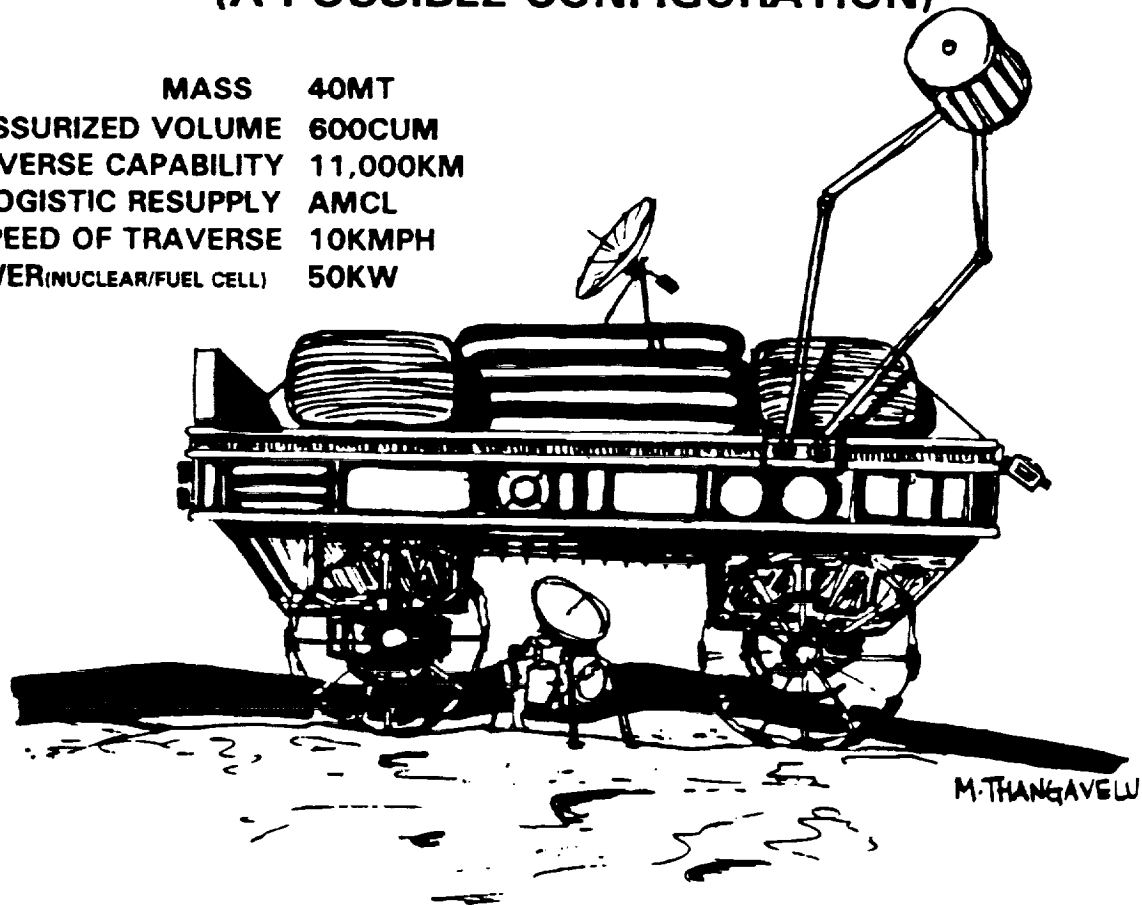

**Fig. 4**

Fig.5

# THE NOMAD EXPLORER (A POSSIBLE CONFIGURATION)

MASS	40MT
PRESSURIZED VOLUME	600CUM
TRAVERSE CAPABILITY	11,000KM
LOGISTIC RESUPPLY	AMCL
SPEED OF TRAVERSE	10KMPH
POWER(NUCLEAR/FUEL CELL)	50KW



## LONGITUDINAL SECTION

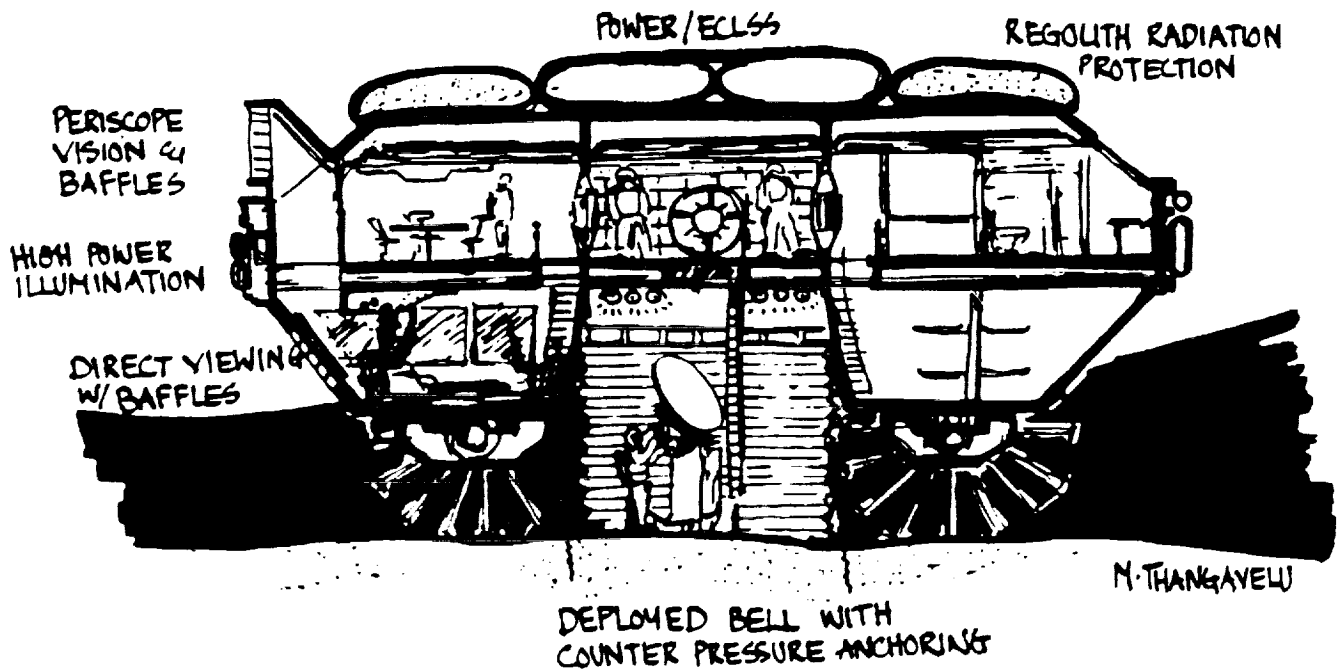

**Fig.6**

**CONVENTIONAL EVA PROBLEMS**

- COMPLEX, LENGTHY PREPARATION
- ASTRONAUT FATIGUE
- CLUMSY & POOR DEXTERITY
- DUST CONTAMINATION
- SHORT DURATION LIMITS

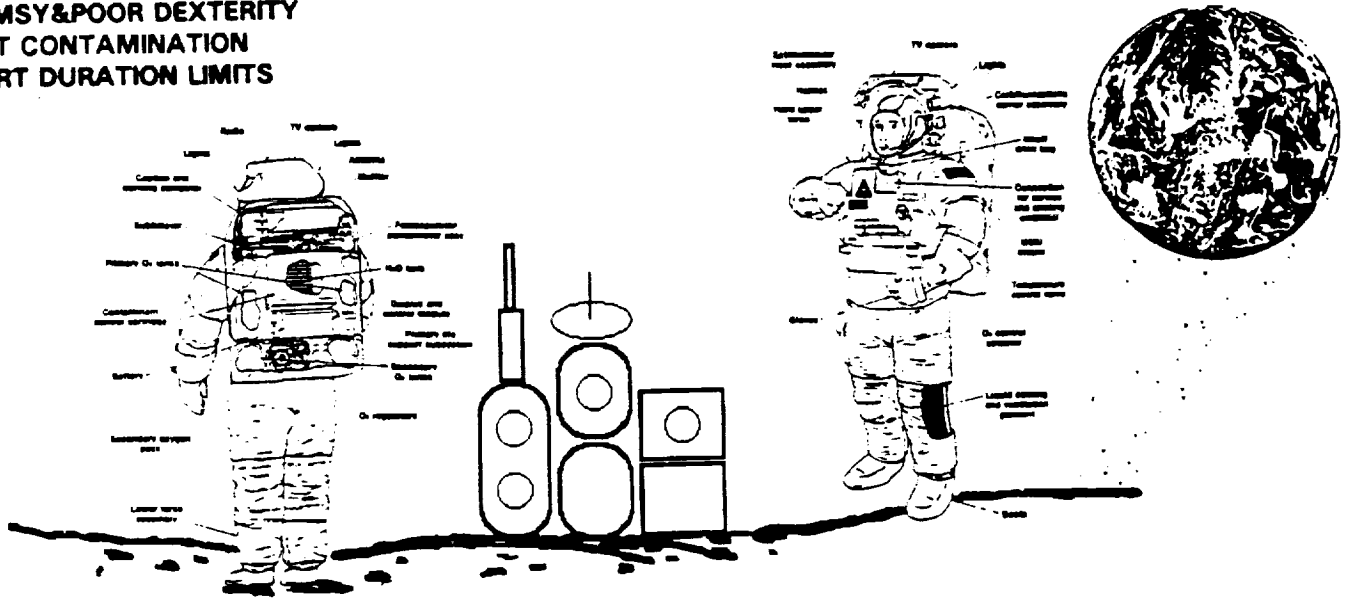

**NOMAD EXPLORER BELL SYSTEM ADVANTAGES**

- MINIMAL PREPARATION
- SHIRT SLEEVE ENVIRONMENT
- DUST FREE ENVIRONMENT
- LONG DURATION EVA

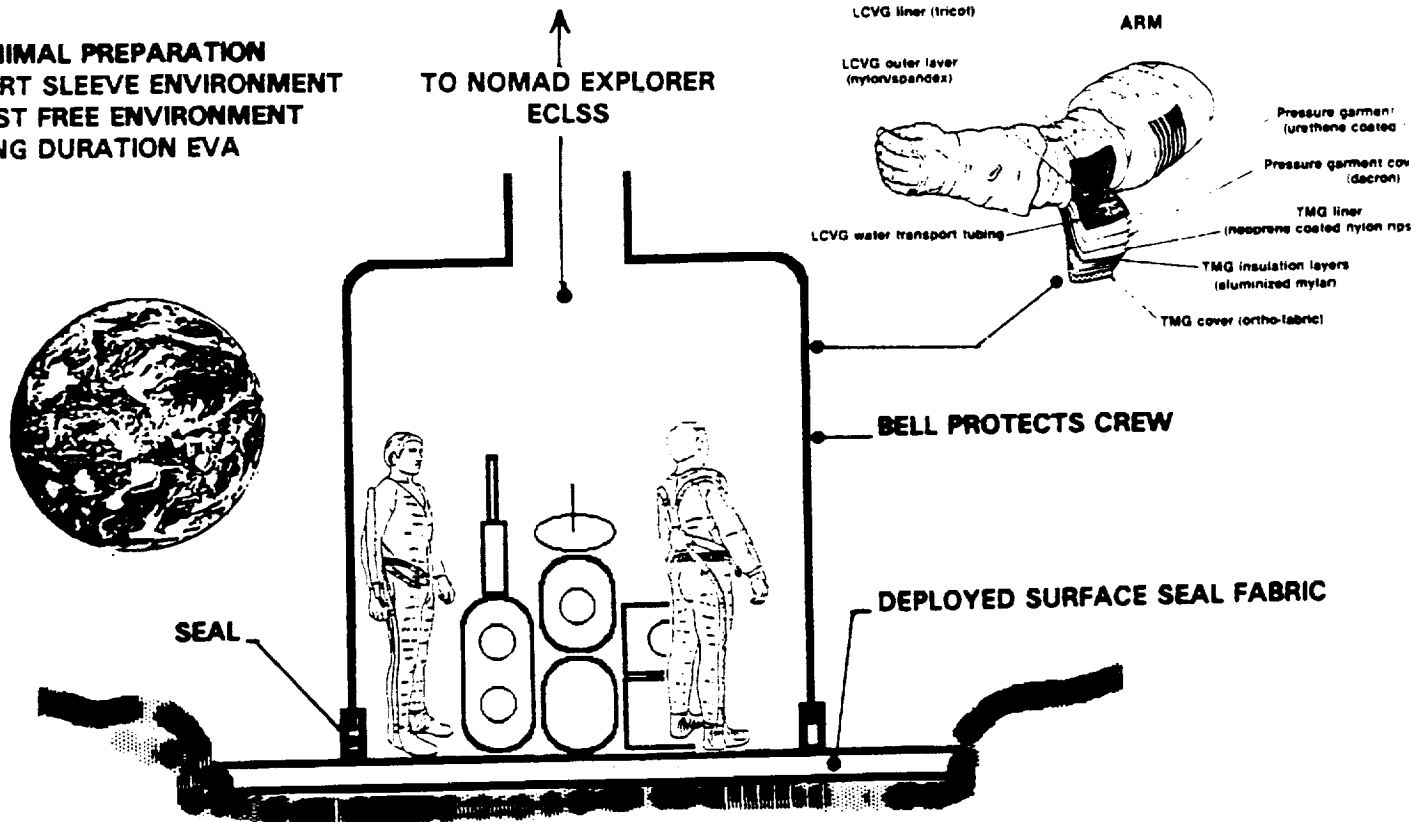

**NOMAD EXPLORER PAYLOAD ASSEMBLY ASSIST SEQUENCE**

**Fig. 7**

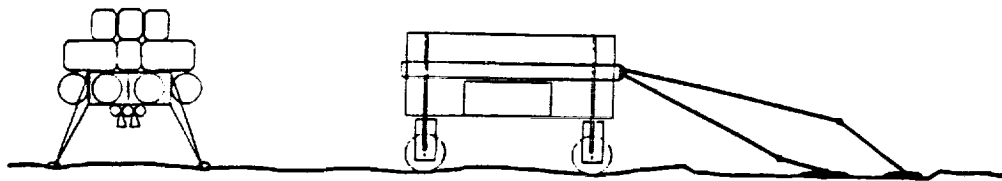

- 1. NOMAD EXPLORER INTERCEPTS AND PARKS CLOSE TO AUTONOMOUS MODULAR COMMON LANDER (AMCL) WHICH CARRIES LOGISTICS AND SITE SPECIFIC SCIENCE PAYLOADS. MODULAR LOGISTICS RETRIEVED. SUPPLIES REPLENISHED. DEPLETED LOGISTICS MODULES/WASTE DISCARDED.**
- 2. NOMAD EXPLORER PREPARES TERRAIN FOR PAYLOAD ASSEMBLY/DEPLOYMENT.**

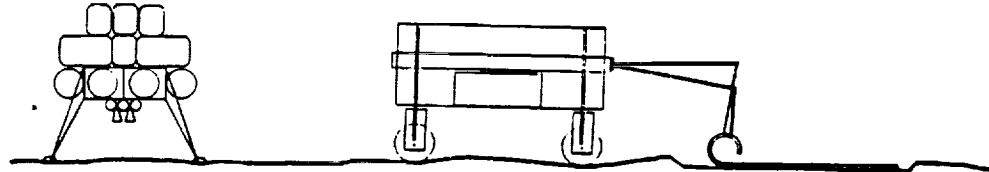

- 3. NOMAD EXPLORER LAYS SURFACE SEAL FABRIC OVER PREPARED TERRAIN. THIS FABRIC WILL HELP TO CONTAIN THE PRESSURE INSIDE THE DEPLOYED EVA BELL.**

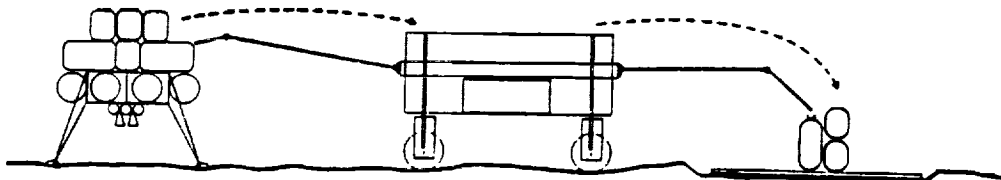

- 4. NOMAD EXPLORER UNLOADS PAYLOAD FROM AMCL OVER THE SURFACE SEAL FABRIC AT THE PAYLOAD ASSEMBLY SITE.**



- 5. NOMAD EXPLORER IS ELEVATED, SLOWLY MOVES TO PREPARED SITE AND ALIGNS EVA BELL OVER THE PAYLOAD AND THE SURFACE SEAL FABRIC.**

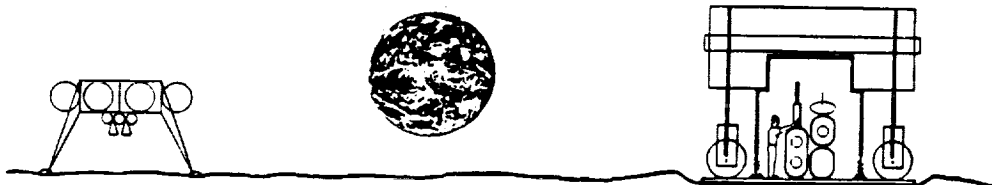

- 6. NOMAD EXPLORER DEPLOYS EVA BELL WHICH PROVIDES CREW A SHIRT-SLEEVE ENVIRONMENT FOR MANNED EVA. CREW ASSEMBLE, CHECK OUT, CERTIFY PAYLOAD INSIDE DUST FREE, THERMAL, MICROMETEORITIC, AND RADIATION PROTECTED AND PRESSURIZED EVA BELL.**

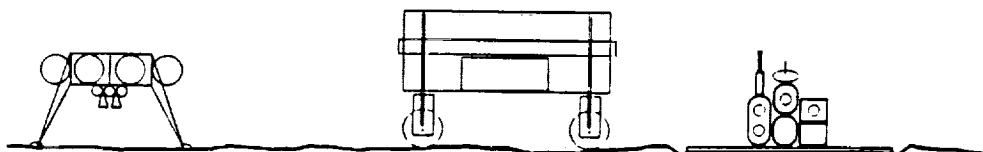

- 7. ASSEMBLY COMPLETE. EVA BELL RETRACTED. NOMAD EXPLORER MOVES AWAY FROM PAYLOAD ASSEMBLY. PAYLOAD IS OPERATIONAL. PROCEEDS TO NEXT SITE.**



Ralph Neuhäuser <sup>a</sup>  
Theodor Schmidt-Kaler <sup>b</sup>

(a) Max-Planck-Institut für Extraterrestrische Physik, 85740 Garching, Germany  
(b) Astronomisches Institut, Ruhr-Universität Bochum, 44801 Bochum, Germany

### ABSTRACT

For almost one hundred T Tauri stars, infrared emission of circumstellar dust has been observed. This dust is interpreted to be part of a protoplanetary disk orbiting the central star. T Tauri stars are young stellar objects and evolve into solar type stars. Planets are believed to form in these disks. The spectral energy distribution of a disk depends on its temperature profile. Different disk regions emit at different wavelengths. The disk-star boundary layer is hot and emits  $H\alpha$ . Inner disk regions at around 1 AU with a temperature of a few hundred Kelvin can be probed in near infrared wavelength regimes. Outer disk regions at around 100 AU distance from the star are colder and emit far infrared and sub-millimeter radiation. Also, X-ray emission from the stellar surface can reveal information on disk properties. Emission from stellar surface and boundary layer may be shielded by circumstellar gas and dust. T Tauri stars with low  $H\alpha$  emission, i.e. no boundary layer, show stronger X-ray emission than classical T Tauri stars, because the inner disk regions of weak emission-line T Tauri stars may be clear of material. In this paper, first ROSAT all sky survey results on the X-ray emission of T Tauri stars and correlations between X-ray luminosity and properties of T Tauri disks are presented. Due to atmospheric absorption, X-ray and most infrared observations cannot be carried out on Earth, but from Earth orbiting satellites (e.g. IRAS, ROSAT, ISO) or from lunar based observatories, which would have special advantages such as a stable environment.

### 1. INTRODUCTION

One of the questions most interesting to all humankind has always been, whether there is life other than on Earth. Life is possible on planets only. There seems to be no life on other planets in our planetary system. Planets outside our own planetary system could not be observed so far, because they are too distant, too small, too dark, and too close to the (possibly bright) star they circle, i.e. planets are too faint for direct observation.

Stars form in collapsing interstellar clouds<sup>1</sup>. Planetary systems form in circumstellar dust and gas disks. Dust settles in the equatorial plane and grows due to sticking, colliding, and merging. Dust coagulation leads to the formation of solid bodies kilometers in size. Due to radial migration, gas drag, and gravitational interaction<sup>2</sup>, these so-called planetesimals either coalesce or cease to grow. They get fewer in number and larger in size. Eventually, only a few planetesimals are left over, the planets. This process (from the initial collapse of an interstellar cloud to the formation of planets) lasts approximately up to a few  $10^7$  years.

Since the mid 1980ies, protoplanetary disks are observed around young, low-mass, pre-main sequence stars, so-called T Tauri stars. For a sample of some 100 T Tauri stars in the Taurus-Auriga star forming region, the spectral energy distribution has been observed. Particularly, far infrared, millimeter, and sub-millimeter emission observed indicates the existence of cold circumstellar dust<sup>3</sup>. Planetary systems like the one we live in are believed to form in such disks. In Taurus-Auriga, star and planet formation seems to be an ongoing process. Due to its low distance of 140 pc, Taurus-Auriga is one of the best studied regions of star formation.

T Tauri stars are named after their prototype T Tauri and defined mainly by their spectrum<sup>4,5</sup>:  $H\alpha$  emission and Lithium (and Ca) absorption lines. They show variable luminosity and are very young (up to a few million years). T Tauri masses range from a few tenth to three solar masses. In the Hertzsprung-Russell diagram, T Tauri stars lie above the main sequence, because they are still contracting down the Hayashi tracks, T Tauri stars are low-mass, pre-main sequence stars. There are two sub-groups, classical and weak-emission line T Tauri stars. Classical T Tauri stars (CTTS) show strong  $H\alpha$  emission, while weak-emission line T Tauri stars (WTTS) have  $H\alpha$  equivalent width smaller than 10 Angstrom. Many classical T Tauri stars seem to be surrounded by disks, while most weak-line T Tauri stars don't (naked). T Tauri stars eventually evolve into solar-type stars possibly with planets.

We discuss recent observations and interpretations of the spectral energy distribution of T Tauri stars (chapter 2), summarize results on actual disk observations including new statistical analyses (chapter 3), and report on new X-ray observations of T Tauri stars with the Röntgen Satellite ROSAT (chapter 4). X-rays of late-type stars like T Tauri stars (spectral type G, K, or M) are of coronal origin and due to magnetic activity on the surface of the stars. CTTS and WTTS show both different X-ray fluxes and different X-ray spectra. This may be due to different X-ray absorption by circumstellar material. Since this paper was given at the International Space University's (ISU) second Alumni Conference during ISU's summer session in Huntsville, USA, where an International Lunar Far-Side Observatory design project was carried out, possible observation from a lunar based observatory will be discussed in the last chapter.

## 2. SPECTRAL ENERGY DISTRIBUTION OF T TAURI STARS

T Tauri stars can be observed in many different wavelengths: Optical (star itself), X-rays (stellar corona and surface), ultraviolet (hot boundary layer between disk and stellar surface), near and mid infrared (cold circumstellar gas, few 1000 Kelvin), far infrared (hot circumstellar dust close to the star, few 100 K), and sub-millimeter (sub-mm) and millimeter (mm) emission (cold dust in a few to some 100 AU distance from the star, down to a few 10 K). Different wavelengths originate from material at different temperatures, i.e. at different distances from the star that heats the material. Different wavelengths probe different regions of a disk.

Observations in many wavelengths give the spectral energy distribution (SED) of star and disk. The SED depends on the temperature profile of a disk, i.e. on the radial dependence of the disk temperature. From any given point (i.e. any given temperature) on the surface of the disk, a spectrum is emitted. The spectral energy distribution of the disk as a whole consists of these spectra. Assuming blackbody radiation of a disk element (at distance  $r$  and polar angle  $\phi$ ) at temperature  $T$  with frequency  $\nu$ , Planck constant  $h$ , and Boltzmann constant  $k$ , the Planck function runs as

$$B_\nu(T(r, \phi)) = \frac{2h\nu^3}{c^2} \left( \exp \frac{h\nu}{kT} - 1 \right)^{-1} \quad (1)$$

With angle  $\delta$  between line of sight and disk plane, the luminosity of the disk between inner and outer disk radii  $r_i$  and  $r_o$  is

$$L_\nu = 4\pi \cos \delta \int_0^{2\pi} \int_{r_i}^{r_o} \nu B_\nu(T) \cdot (1 - \exp(-\tau)) r dr d\phi \quad (2)$$

with  $\tau$  as optical depth (depending on frequency):  $\tau = \kappa \cdot \sigma / \cos \delta$  with surface density  $\sigma$  and opacity  $\kappa$ .

Isolated dust grains at distance  $r$  from star have a temperature  $T(r) \sim r^{-1/2}$ . For a dust grain on the surface of a self-luminous, axi-symmetric disk, the temperature runs as

$$T = \left( \frac{3 G M_c \dot{M}}{8 \pi \sigma r^3} \right)^{1/4} \sim r^{-3/4} \quad (3)$$

with gravitational constant  $G$ , mass of central object  $M_c$ , mass accretion rate  $\dot{M}$ .

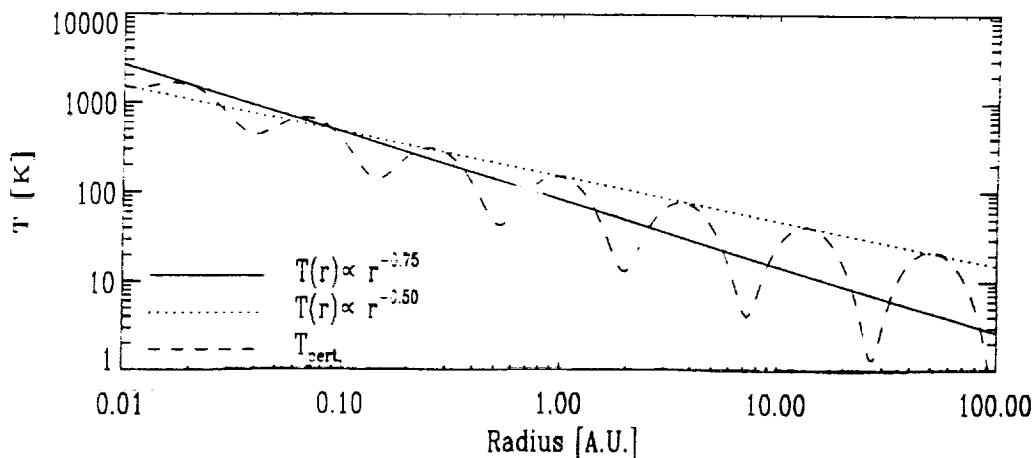

Fig.1: Theoretical temperature profiles of a disk (Sterzik<sup>6</sup>)

The temperature index  $q$  is defined as

$$T \sim r^{-q} \quad (4)$$

Given a temperature profile (Fig.1) with  $q$  between 1/2 and 3/4, one can model the spectral energy distribution<sup>6,7</sup> (Fig.2). Also, the other way round, after having measured a disk's SED, one can calculate the temperature index  $q$ , i.e. the temperature profile of the disk. The flatness of the SED is given by  $q$  and is connected with the infrared spectral index (and yields the temperature profile using equations 3 and 4):

$$\text{IR-Spectral index} = \alpha_{IR} = \frac{d \log L_\nu}{d \log \nu} = 4 - \frac{2}{q} \quad (5)$$

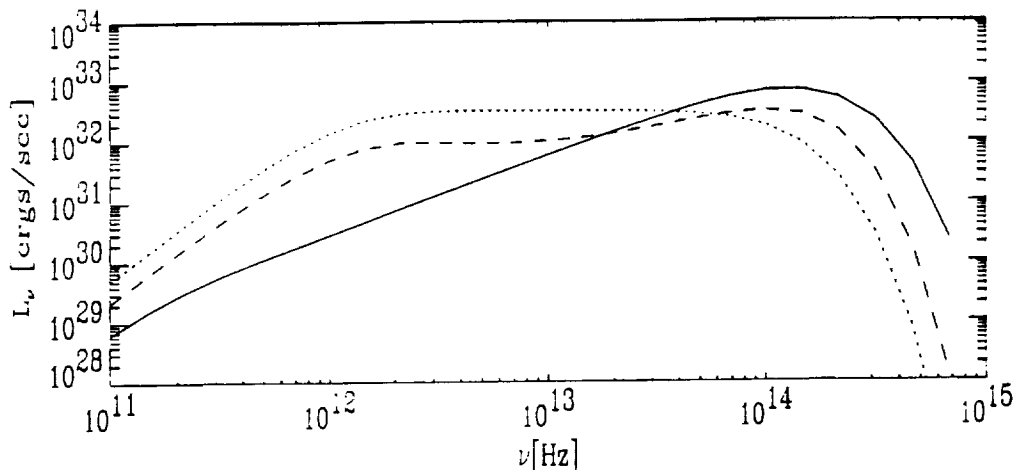

**Fig.2: Theoretical SEDs for different temperature profiles (Sterzik<sup>6</sup>)**

The SED flatness  $q$  should by theory be 3/4. But, for most disks observed so far, the temperature index  $q$  lies between 1/2 and 3/4, i.e. spectra are often too flat<sup>3</sup>. A possible solution according to which disks are flared, i.e. disks that are much thicker at outer disk radii than at inner disk portions<sup>8</sup>, is not favored any more, because disks would have to be much more flared than theoretical constraints allow to fit with observed disk flatness. A new solution recently published<sup>9</sup>, suggests disks surrounded by remnant dusty nebulae and re-radiation of star light down to the disk resulting in flat spectra. This solution seems to be able to solve the flat spectra problem.

Having observed the SED of a disk, i.e. the luminosity of a disk, one can calculate mass and outer radius of a disk. For typical T Tauri disks, one gets masses between 0.001 and 0.1 solar masses and radii of around 100 AU. This is in good agreement with theoretical assumptions for the protosolar nebula.

If one would distribute material of this mass spherically around the star (assuming a plausible  $r^{-2}$  distribution), the absorption would be very high, one could not see the star anymore. Assuming the collapse model of star formation and given the angular momentum problem, the material must be distributed in a flat disk.

Forbidden line emission (e.g. O I) is seen only in one direction. though stellar wind is ejected in both direction up and down. One side is absorbed by disk, unless the line of sight lies in the plane of the disk.

Wings in  $H\alpha$  emission line profiles show evidence of accretion with decreasing rate for older stars. Accretion of material onto the star leads to hot spots on the stellar surface that rotate around the star. This results in luminosity variations being observed as light curves<sup>10</sup>. Enhanced accretion can lead to outflow enhancement (shocks), e.g. so-called FU Orionis phenomena.

The resolution of disk observations is not sufficient to resolve the disk. There is no direct evidence for disks. Only for one T Tauri star (HL Tau), interferometric observation of a disk-shaped feature around the star was attempted with some success<sup>11</sup>, but for other stars, interferometric observations were unsuccessfully.

The evolutionary picture of classical T Tauri stars evolving into weak-line T Tauri stars is consistent with the existence of disks. Indeed, weak-line T Tauri stars seem on average to be older than classical T Tauri stars, though absolute age determination is difficult. A classical T Tauri star with disk forms from a collapsing cloud, disk and star surface interact resulting in a very hot boundary layer, which emits UV radiation (strong  $H\alpha$  emission). Later, the disk accretes partly onto the star and/or planetesimals form. The disk dissipates after some time (millions of years) resulting in a star without hot boundary layer, i.e. with weak UV emission: weak-line T Tauri star. Weak-line T Tauri stars are sometimes called naked T Tauri stars (NTTS<sup>12</sup>), because most of them are not surrounded by disks.

### 3. OBSERVED T TAURI DISK PROPERTIES

The 1.3  $mm$  continuum emission of 86 T Tauri stars in the well known Taurus-Auriga star forming region have been observed<sup>3</sup>. Since continuum emission and line width are not correlated, free-free emission by ionized gas can be excluded as reason for this 1.3  $mm$  emission. Instead, the observed far infrared flux is caused by stellar photons that were absorbed by dust grains and re-radiated in the far infrared. Therefore, there is dust and gas in the circumstellar vicinity around the T Tauri stars observed. As explained above, this dust is believed to be distributed in a flat disk in the equatorial plane of the star. The 1.3  $mm$  flux contributes one point to the SED of the star-disk system, important mainly to determine the flatness of the SED, i.e. temperature profile and other properties of the disk.

From equations given in chapter 2 and a few more assumptions, one can get the following properties of the disks observed<sup>3</sup>:

- Spectral energy distribution flatness  $q$
- Distance  $r_1$  from the star (in units of distance between Sun and Earth,  $AU$ ), the border between optical thick and optical thin regions of the disk
- Temperature  $T_1$  (in Kelvin) at distance 1  $AU$  from the star
- Mass  $M_d$  of the disk (in units of solar mass  $M_\odot$ )

Table 1 gives all these properties of those 34 T Tauri stars, for which a disk has been observed<sup>3</sup>. Also given in table 1, are stellar masses  $M_*$  in solar masses and the type of the star, i.e. WTTS or CTTS (one star in neither a WTTS nor a CTTS, but an Ae star, i.e. a star of spectral type A with emission line).

These data have been evaluated both by Beckwith et al.<sup>3</sup> and by Morfill and Sterzik<sup>7</sup>, some of the most important results are:

- Approximately one half of the CTTS observed do have disks. Almost no WTTS are surrounded by 1.3  $mm$  emitting material, i.e. most WTTS are naked. Their disks are already dissipated (if they have had disks at all during earlier stages). If they have had disks, planetesimals may have already formed around these WTTS. As yet, bodies as large as planetesimals can not be detected or observed directly.
- Disk masses do not depend on disk sizes if outer disk radii lie between 20  $AU$  and 300  $AU$ .
- Disk temperature at 1  $AU$  depends on 60  $\mu m$  flux, but does not depend on  $q$ .
- For almost all disks,  $q$  does not lie in the range predicted by theory (around 3/4), but between 1/2 and 3/4. Many disks are too flat ( $q$  around 1/2), especially those with high temperatures.
- Disk mass and stellar age are not correlated, thus, a disk does not dissipate before the star has reached an age of around  $10^7$  years.
- The radial distribution of dust surface density is consistent with a  $\sigma \sim r^{-1.5}$  law, disk masses are small.
- Disks are quite cold with temperatures between 63  $K$  and 388  $K$  (at 1  $AU$ ). Temperature and age are not correlated.

Star	other designation	type	$M_*/M_\odot$	$q$	$T_1/K$	$M_d/M_\odot$	$r_1/AU$
FN Tau	Haro 6-2	CTTS	0.27	0.54	156	0.004	3
DE Tau	MHa 259-8	CTTS	0.44	0.57	133	0.007	4
RY Tau		CTTS	1.69	0.51	360	0.039	20
T Tau		CTTS	1.91	0.51	390	0.016	7
DG Tau	MHa 259-10	CTTS	0.56	0.51	308	0.041	15
IQ Tau	Lk H $\alpha$ 265	WTTS	0.54	0.64	128	0.040	15
UX Tau A		WTTS	1.49	0.52	169	0.009	5
DK Tau	MHa 259-12	CTTS	0.65	0.62	188	0.005	3
HK Tau	Haro 6-12	CTTS	0.55	0.46	150	0.005	3
HL Tau	Haro 6-14	CTTS	0.55	0.49	307	0.10	25
V710 Tau	Lk H $\alpha$ 266	CTTS	0.42	0.64	112	0.038	12
UZ Tau	UZ Tau f/p	CTTS	0.44	0.62	173	0.054	14
GG Tau	MHa 257-2	CTTS	0.65	0.55	180	0.29	
DL Tau	MHa 259-13	CTTS	0.56	0.59	158	0.087	24
CI Tau	MHa 259-20	CTTS	0.70	0.58	156	0.063	20
DM Tau	MHa 257-6	CTTS	0.62	0.51	108	0.034	13
AA Tau	MHa 259-17	CTTS	0.67	0.55	135	0.021	9
DN Tau	MHa 259-18	CTTS	0.62	0.58	123	0.027	11
HP Tau	Lk H $\alpha$ 258	CTTS	1.43	0.50	203	0.005	4
DO Tau	MHa 259-15	CTTS	0.72	0.54	203	0.018	9
DP Tau	MHa 259-19	CTTS	0.60	0.61	144	0.003	2
GO Tau	MHa 259-24	CTTS	0.67	0.60	93	0.057	17
DQ Tau	MHa 257-7	CTTS	0.67	0.59	141	0.025	9
DR Tau	MHa 257-8	CTTS	0.55	0.62	227	0.028	11
DS Tau	MHa 259-2	CTTS	1.29	0.66	100	0.010	6
UY Aur		CTTS	0.65	0.55	243	0.004	2
GM Aur	MHa 259-1	CTTS	0.72	0.51	152	0.060	19
V773 Tau	HD 283447	CTTS	1.74	0.75	207	0.010	6
V892 Tau	Elias 1	Ae	1.03	0.49	388	0.013	7
V819 Tau	WK X-Ray 1	WTTS	0.72	0.65	68	0.032	13
FT Tau	Haro 6-6	CTTS		0.55	139	0.034	13
Haro 6-13		CTTS	0.55	0.54	200	0.014	5
FY Tau	Haro 6-17	CTTS		0.70	156	0.003	2
FZ Tau	Haro 6-18	CTTS		0.66	152	0.004	3

There are five disks with low far infrared excess, i.e. no emission of dust at high temperature, i.e. no material at a few  $AU$  distance from the star, i.e. a gap in the inner disk. Such a gap clearing can be interpreted as planetesimal formation. But, a perturbed temperature profile can also account for the missing FIR excess<sup>13</sup>.

An additional statistical analysis of the Beckwith sample has been performed recently<sup>14</sup>. We summarize a few results. A correlation analysis was done with the Statistical Analysis System (SAS) program. The Pearson correlation coefficient  $\rho$  tests linear correlation of two parameters. If  $\rho$  is positive, the parameters studied are positive linear correlated, if  $\rho$  is negative, the parameters are negative linear correlated. But the significance of the correlation can not be concluded from  $\rho$ . Let  $p$  be the probability for mistakenly denying the hypothesis the parameters studied were not correlated, then, if  $p$  is very close to 0, the correlation is very significant.

Disk mass  $M_d$  and distance  $r_1$ , the border between optical thick and thin region in the disk, are positive linear correlated with  $\rho = 0.96$  and  $p < 10^{-4}$ , i.e. the correlation is very significant. See figure 3 for a display of the correlation. A linear regression gives

$$\frac{r_1}{AU} = (2.95 \pm 0.49) + (256 \pm 13) \frac{M_d}{M_\odot} \quad (6)$$

We conclude that, the more massive a disk is, the larger is the optical thick part of the disk.

Also, square root of disk mass and  $r_1$  are significantly positive linear correlated with  $\rho = 0.98$ . A linear regression gives

$$\frac{r_1}{AU} = 70 \sqrt{\frac{M_d}{M_\odot}} AU \quad (7)$$

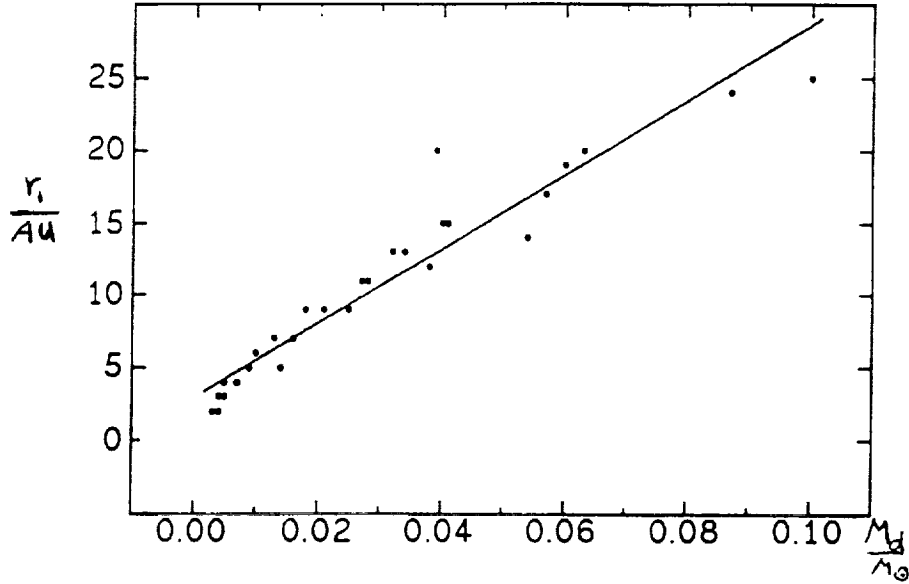

Fig.3: Correlation between  $r_1$  and  $M_d$  (Neuhäuser<sup>14</sup>)

We have also found a positive linear correlation between stellar mass  $M_*$  and disk temperature  $T_1$  at distance 1 AU with  $\rho = 0.46$  and  $p = 0.01$ . As displayed in figure 4, this correlation does not seem to be significant, though the small  $p$ -value formally indicates significance. A linear regression gives

$$\frac{T_1}{K} = (115 \pm 29) + (91 \pm 33) \frac{M_*}{M_\odot} \quad (8)$$

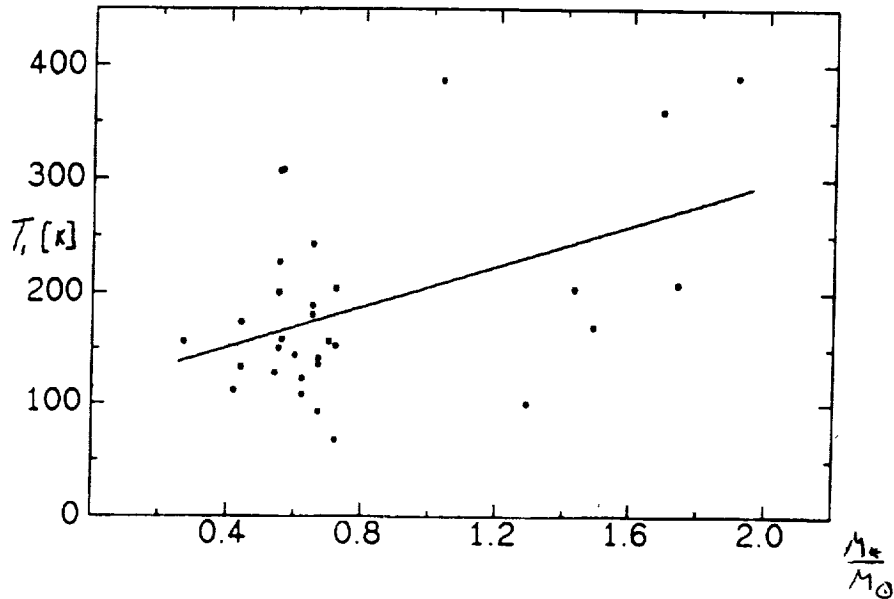

Fig.4: Correlation between  $T_1$  and  $M_*$  (Neuhäuser<sup>14</sup>)

In case of the protosolar disk, the stellar mass is known to be  $1 M_\odot$ , i.e. we get  $T_1 = (206 \pm 43)K$  for disk temperature at 1 AU. This is in good agreement with theoretical models using, e.g., 280 K as temperature at 1 AU (Kyoto model of protosolar disk<sup>15,16</sup>).

#### 4. X-RAY EMISSION OF T TAURI STARS

T Tauri stars are still quite young and very active. Strong magnetic activity results in coronal loops and X-ray emission. Flares were observed, too. X-ray flux during the T Tauri phase is by a few orders of magnitude larger than X-ray flux of the present Sun.

X-ray emission of T Tauri stars was for the first time measured with the *Einstein* observatory. Many weak-line T Tauri stars show X-ray emission, but only a very few classical T Tauri stars according to the limited sample that was observed by the *Einstein* observatory<sup>17</sup>. Ground-based optical follow-up observation of unidentified *Einstein* X-ray sources resulted in the discovery of some 30 new weak-line T Tauri stars that were not found with previous  $H\alpha$  surveys because their UV emission is too small.

During the ROSAT all sky survey, virtually all T Tauri stars were observed in the 0.1 to 2.4 keV range. Detection rates are in agreement with previous *Einstein* observatory observations: 54% of all weak-line T Tauri stars and only 12% of the classical T Tauri stars are strong enough to be detected with X-rays. Classical T Tauri stars and weak-line T Tauri stars also show different X-ray fluxes. This can be due to the fact that WTTS are older than CTTS and rotate faster (therefore more magnetic activity on the stellar surface). Another reason can be different absorption.

X-ray flux of T Tauri stars seems to be correlated with  $H\alpha$  equivalent width: decreasing flux with increasing UV emission. This can be explained if the  $H\alpha$  emitting region absorbs X-rays, i.e. classical and weak-line T Tauri stars may emit similar X-ray spectra and fluxes, but different X-ray emission is observed because of different absorption. Absorption should have different effects on X-rays of different energies. Indeed, a new result of ROSAT observation is that CTTS and WTTS have different X-ray hardness ratios. This can in principle be due to either intrinsically different spectra or to different absorption. For T Tauri stars most authors assume a one temperature spectrum (1 keV). If WTTS and CTTS are coeval, their X-ray spectra should not be different. Absorption can be caused by the interstellar medium, the intercloud gas, and circumstellar material. ROSAT observes in three energy channels: soft (0.1-0.4 keV), hard 1 (0.5-0.9 keV), and hard 2 (0.9-2.1 keV) (also, hard: 0.5 - 2.1 keV). Let  $Z_s, Z_h, Z_{h1}, Z_{h2}$  be the count rates observed in the different energy bands soft, hard, hard 1, and hard 2, respectively, then for hardness ratios 1 and 2:

$$HR 1 = \frac{Z_h - Z_s}{Z_h + Z_s} \quad \text{and} \quad HR 2 = \frac{Z_{h2} - Z_{h1}}{Z_{h2} + Z_{h1}} \quad (9)$$

For further discussion and interpretation of different hardness ratios, it is important to know what fraction of the absorption of stellar X-rays is caused by interstellar medium, intercloud gas, and circumstellar material. By comparing results for Taurus-Auriga with other star forming regions like ScoCen (without intercloud gas), Lupus, and Perseus (more distant than Tau-Aur), we find evidence that intercloud absorption is not the main reason for different hardness ratios, because WTTS and CTTS show different hardness ratios even in ScoCen, where all intercloud gas was blown away by a recent supernova shock front. Also, by statistical reasons, we can exclude interstellar medium as the main absorbing material. CTTS seem to cluster along dark filaments, while WTTS are distributed all over the Taurus-Auriga star forming cloud complex. In all star forming regions studied, we find average hardness ratios of CTTS and WTTS to be very different. Therefore, given the different spatial distributions of CTTS and WTTS, it is for statistical reasons very unlikely that absorption of interstellar medium resulted in these differences.

Another argument for excluding different X-ray spectra as reason for different X-ray hardness ratios is the following. Assuming similar X-ray spectra, the only reason for different hardness ratios is different absorption. The harder the observed X-ray emission is, the more absorbed the X-rays are. Theoretically modeling the energy dependent effect of more material in the line of sight on absorption of X-rays gives the shift in hardness ratios 1 and 2 that results due to more absorption. We can therefore weight  $HR 1$  and  $HR 2$  according to their significance as tracer for more or less absorption in order to get the effective hardness. The weighted hardness should be correlated with visual extinction observed in the line of sight. We do have found this correlation. Detailed studies of X-ray emission of known T Tauri stars in the Taurus-Auriga star forming region will be published soon<sup>18</sup>.

Being the only possible cause for absorption remaining, we find absorption by circumstellar material to be the main reason for different hardness ratios of CTTS and WTTS. This material consists of the boundary layer (hot gas) between star and dust and gas disk and/or the remnant star formation nebula. Therefore, X-ray hardness ratios can be interpreted as indirect evidence for the existence of circumstellar material.

Since absorption of X-rays of classical T Tauri stars happens mainly within the boundary layer (UV) and only stars with disks have a hot boundary layer, weak X-ray flux may be taken as indication for a disk. Weak-line T Tauri stars have no disk, i.e. no boundary layer. i.e. strong X-ray flux is observed. Whether the X-ray emission of a CTTS can be detected, may depend more or less only on the angle between the line of sight and the plane of the disks. If this angle lies in the range of around 30 to 60 degree, we do not have to look through stellar wind or disk, therefore, X-ray are less absorbed. But not all CTTS with an angle  $\delta$  in the above range should be expected to be detectable in X-rays, because accretion of material onto the star may be along tubes that are aligned along the magnetic field lines. Hot gas in these tubes can absorb X-rays.

## 5. LUNAR OBSERVATORY OBSERVATIONS

Disks mainly emit in infrared and UV wavelengths that are not accessible for ground-based observatories (due to atmospheric absorption). Infrared observation was done by the Infrared Astronomical Satellite (IRAS) and will be done by the Infrared Space Observatory (ISO). UV observation is done by the Extreme Ultraviolet Explorer (EUVE). X-ray observation was done by the *Einstein* observatory and is still to be done by ROSAT. Direct imaging of protoplanetary disks is attempted with Hubble Space Telescope (HST), though HST can resolve only disks larger than typical T Tauri disks.

Lunar based observatories would have similar advantages as orbiting satellites have, and additionally several more (relevant for optical, IR, UV, and X):

- Near perfect vacuum
- High seismic stability
- Slow rotation (i.e. very long exposures possible)
- No fluid sheath or liquid core (rotation modeling with high accuracy)
- Stable thermal environment (sun-shielding easy)
- Earth-Moon-Interferometry (e.g. optical)
- Low gravity (large structures with no debris floating)
- Remote operation possible and cheap

Another very interesting observation would be low-frequency Earth-Moon interferometry in the millimeter wavelength regime in order to resolve the structure of disks.

## 6. ACKNOWLEDGEMENTS

The new statistical analysis of the Beckwith sample we report on was part of a Diplom thesis by R.N. supervised by both T.S.K. and Johannes Feitzinger, who deserves many thanks. Results reported in chapter 4 are first results of a PhD by R.N. being supervised by Gregor Morfill, R.N. wishes to thank Michael Sterzik, Jürgen Schmitt, and Peter Kahapka for helping to evaluate the ROSAT all sky survey. We have made use of the SIMBAD and IRAS databases as well as of the Munich Image Data Analysis System (MIDAS) and the Extended Scientific Analysis System (EXSAS). R.N.'s contribution were supported by scholarships of the Hanns-Seidel-Stiftung in conjunction with the Federal Ministry for Science and Technology of Germany.



## 7. REFERENCES

1. F.H. Shu, F.C. Adams, S. Lizano, "Star formation in molecular clouds: Observation and theory", *Ann. Rev. Astron. Astrophys.*, **25**, pp 23, 1987
2. Neuhäuser, R. and Feitzinger, J.V., "Radial Migration of Planetesimals", *Astrophys. and Space Science special issue, proceedings of the conference on "Planetary systems: Formation, evolution, and detection" held Dec. 1992 in Pasadena, USA*, ed. by Burke, Rahe, and Roettger, in press, 1993
3. S.V.W. Beckwith, A.I. Sargent, R.S. Chini, R. Güsten, "A survey for circumstellar disks around young stellar objects", *A.J.*, **99**, pp 924, March 1990
4. I. Appenzeller and R. Mundt, "T Tauri stars", *Astron. Astrophys. Ann. Rev.*, **27**, pp 293, 1989
5. C. Bertout, "T Tauri stars: Wild as dust", *Astron. Astrophys. Ann. Rev.*, **27**, pp 351, 1989
6. M.F. Sterzik, "Strukturierungsprozesse in protoplanetaren Akkretionsscheiben", PhD thesis, Garching, Feb. 1993
7. G.E. Morfill and M.F. Sterzik, "Protoplanetary disks: Observations and physical processes", *ESA Proc. 24th ESLAB Symp.*, pp 219, Nov. 1990
8. S.J. Kenyon and L. Hartmann, "Spectral energy distribution of T Tauri stars: Disk flaring and limits on accretion", *ApJ*, **323**, pp 714, Dec. 1987
9. A. Natta, "The temperature profile of T Tauri disks", *ApJ*, in press, Aug. 1993
10. J. Bouvier, submitted, 1993
11. S.V.W. Beckwith, A.I. Sargent, N.Z. Scoville, C.R. Masson, B. Zuckerman, T.G. Phillips, "Small-scale structure of the circumstellar gas of HL Tau and R Monocerotis", *ApJ*, **309**, pp 755, Oct. 1986
12. F.M. Walter, A. Brown, R.D. Mathieu, P.C. Myers, F.J. Vrba, "X-ray sources in regions of star formations. III. Naked T Tauri stars associated with the Taurus-Auriga complex", *A.J.*, **96**, pp 297, July 1988
13. A.P. Boss and H.W. Yorke, "An alternative to unseen companions to T Tauri stars", *ApJ*, **411**, L99, July 1993
14. R. Neuhäuser, "Radialwanderung von Planetesimalen in der protoplanetaren Planetenentstehungsscheibe", Diplom theses, Bochum, July 1992
15. C. Hayashi, "Structure of the solar nebular, growth and decay of magnetic fields and effect of magnetic and turbulent viscosity on the nebula", *Progr. Theor. Phys. Suppl.*, **70**, pp 35, 1981
16. T. Nakano, "Formation of planets around stars of various masses - I. Formulation and a star of one solar mass", *Mon. Not. R. astr. Soc.*, **224**, pp 107, 1987
17. E.D. Feigelson, J.M. Jackson, R.D. Mathieu, P.C. Myers, F.M. Walter, "An X-ray survey for pre-main-sequence stars in the Taurus-Auriga and Perseus molecular clouds", *A.J.*, **94**, pp 1251, Nov. 1987
18. R. Neuhäuser, M.F. Sterzik, J.H.M.M. Schmitt, "ROSAT survey observation of T Tauri stars in Taurus-Auriga-Perseus", in preparation, 1993

## Legal regime of human activities in outer space law

Carlo Golda

ABSTRACT

Current developments in space activities increasingly involve the presence of humans on board of space crafts and, in the near future, on the Moon, on Mars, on board Space Stations, etc. With respect to these challenges, the political and legal issues connected to the status of astronauts are largely unclear and require a new doctrinal attention. In the same way, many legal and political questions remain open in the structure of future space crews: the need for international standards in the definition and training of astronauts, etc.; but, first of all, an international uniform legal definition of astronauts. Moreover, the legal structure for human life and operations in outer space can be a new and relevant paradigm for the definition of similar rules in all the situations and environments in which humans are involved in extreme frontiers. The present article starts from an overview on the existing legal and political definitions of "astronauts", moving to the search of a more useful definition. This is followed by an analysis of the concrete problems created by human space activities, and the legal and political responses to them (the need for a code of conduct; the structure of the crew and the existing rules in the U.S. and ex-U.S.S.R.; the new legal theories on the argument; the definition and structure of a code of conduct; the next legal problems in fields such as privacy law, communications law, business law, criminal law, etc.).

1. INTRODUCTION

Since 1961, which marked the onset of human space flights with Yuri Gagarin, and until today, no more than 200 individuals the world over can boast the title of astronaut. Almost all of these are either US or ex-Soviet citizens and most are career military officers<sup>1</sup>. On the other hand, a period of significant changes in human space flight has already begun. First of all the "Freedom" space station program (continuing, although behind schedule) will lead to the establishment of communities in space, on board special vehicles of a totally new type and, more importantly, of greater size<sup>2</sup>.

Additionally, ten years of experience with the American S.T.S. (the Space Shuttle) have demonstrated that, although not without difficulty, it is possible to exploit extra-atmospheric space commercially for activities that require man's physical presence (scientific experiments, manufacture of special chemical and biomedical substances, satellite repair, etc.). Then one should consider that both cost and domestic/foreign policy issues have led to an increasing internationalization of activities in space, with the consequence of an increasingly varied and multifaceted composition of flight crews, both in the West and in the ex- communist countries.

Lastly, it should be underscored how an easier and, within limits, more "economical" access to extra-atmospheric space has motivated private organizations (led by the large multinational corporations) to gain access to space for a variety of motives, preferably with their own personnel included as crew members<sup>3</sup>.

2. WHO IS AN ASTRONAUT

Consequently, the time has come for jurists to focus on man, the astronaut, in order to confront the mass of legal issues apparently generated by human space flight. This need, which is felt by Americans in particular, was recently addressed by international diplomacy by the COPUOS<sup>4</sup> legal sub-committee. On this issue, the situation today is still quite confused, so much so that not even a univocal legal definition

of the term "astronaut" has been agreed upon<sup>5</sup>. The international law sources, which in some way and for various ends recall the concept of "man operating in space", provide vastly different indications.

First of all, art. 5 of the Outer Space Treaty<sup>6</sup> as well as the title and preamble of the Rescue Agreement<sup>7</sup> utilize the term "astronaut", art. 8 of the Outer Space Treaty utilizes the term "personnel", articles 1 and 4 of the Rescue Agreement refer to "crew", art. 12 of the Outer Space Treaty mentions "representative", articles 3 and 5 of the Liability Convention<sup>8</sup> mention "persons aboard a space object", and, finally, art. 5 of the Outer Space Treaty proposes the classical definition of "envoys of mankind".

### 2.1. Astronauts as "envoys of mankind"

First of all it is appropriate to discuss the validity of this latest definition that, repeated and used on several occasions in the political and diplomatic arenas, is apparently an expression of the most widely accepted classification of personnel operating in outer space<sup>9</sup>. In reality, and beyond its rhetorical value, the definition "envoys of mankind" is totally devoid of any juridical utility and today is obsolete, just as the Rescue Agreement itself<sup>10</sup>. This treaty, ratified in 1968, was the product of a world comprising only two space powers engaged in a cold war and involved in infrequent and very costly space activities. Therefore the Western and Communist blocks felt a need, including a military one, for reciprocal reassurance that any men and equipment that might fall into "enemy" hands would be returned<sup>11</sup>.

In essence the intent was to guarantee a sort of diplomatic immunity to the astronauts (the boundaries of which were all but well defined), sanctioned by the foremost supranational authority in light of the benefits, indeed international, that derive from human activities in space and in light of the risks that crews voluntarily agree to take. The dissolution of the communist empire, on one hand, and the extreme ambiguity of the cited definition, on the other hand, compel us to reject it in the context of this paper, even though the Rescue Agreement has been ratified by more than 80 countries. If anything, the latter datum can assist in directing the hermeneutic research of the emerging principles of international public law in the matter of research and rescue during space activities.

### 2.2. Astronauts as "persons on board a space object"

If we examine all of the previously cited definitions, the most juridically useful one is apparently that of astronauts as "group of persons on board a space object<sup>12</sup>". This definition must be accepted as the one least likely to be criticized since it is directly traceable to the principles of navigation law of the Scialoja School. If indeed all human activities in extra-atmospheric space must take place within a truly autarkic vehicle and if every role or function of man in space can in all cases be traced to the supporting vehicle and its navigation, then the above mentioned definition seems the most fitting because it makes it possible to use (and quote) all the doctrinal and normative efforts devoted so far to similar cases in maritime law, including ancient and aeronautical law. Furthermore, it is also necessary to point out that the proposed definition is independent of the substantial and diverse activities that can be conducted in space (piloting, experiments, etc.) as well as of the duration of space flights, the composition of the crew, etc. Obviously, E.V.A.<sup>13</sup> (i.e. space walks) must be included within the expression "on board...". It cannot be ruled out that, in the near future, the definition of choice will become inadequate to cover the spectrum of human extraterrestrial activities. In particular it may become necessary to distinguish between astronauts and the normal passengers of extra-atmospheric flights. However we can affirm that such a distinction would effect certain aspects of international private law (in the areas of trade, compensation, etc.) more than international public law and that, as of today, a development of such magnitude cannot be anticipated. More important is the issue concerning human settlements on the surface of other planets<sup>14</sup>.

Obviously, the definition proposed must be integrated to include persons who, already members of a crew

of astronauts, would then remain on a celestial body, whether or not becoming separated from the rest of the crew<sup>15</sup>. In this respect the definition contained in the Moon Treaty (the last of the space-related treaties) could be used. Art. 10 of this treaty defines astronauts as "any person on the Moon.....". This concept integrates perfectly with that of "person on board a space object" as the first expresses the static phase while the second expresses the dynamic phase of human activities in space. Furthermore, this definition does not exclude the preceding one and allows both concepts to apply at the same time, referring each time either to one or the other, depending on the juridical nature and the characteristics of the problems to be confronted.

### 2.3. Current situation with international norms

Moving on to review the current regulatory evolution of the issue of the juridical qualification of astronauts, it is necessary to note that two documents have already been presented to the U.N. in 1987 (more precisely the C.O.P.U.O.S. Subcommittee), both of which concern the matter under scrutiny. The first document regards accidents and critical situations in space flight, the other the legal status of the crew and rescue operations. The first is the working document (No. A/AC-105/C-2/L 159 dated 27/3/87) presented by the United Kingdom to promote the broadening of international cooperation in the event of an accident or critical situation on board an inhabited space station. The second working document (No. A/AC-105/C-2L 161 dated 1/4/87) was presented by Czechoslovakia to bring the issue of the juridical status of the crew of a space object and the matter of rescue operations of such a crew to the attention of the COPUOS juridical subcommittee<sup>16</sup>.

## 3. THE SPECIFIC PROBLEMS POSED BY HUMAN ACTIVITY IN SPACE

Having exhausted the discussion on the general picture of international public law concerning the actual definition of "astronaut", it becomes necessary to investigate the specific problems posed by the expansion of human activities in space. The debate over the definition can be actually circumvented by a homogeneous juridical discipline under various profiles of law (private, penal, etc.) capable of leading to an "a posteriori" definition of the astronaut concept. Given the vastness of the issues before us, it is helpful to identify some of the specific questions that will and, at least in part, already face us.

### 3.1. The Code of Conduct

It seems that the issue of a "Code of Conduct" for astronauts is the most urgent one, also given the premises. Actually, strong internationalization of space activities will increasingly involve the selection of heterogeneous crews impossible to govern by applying specific national laws or the usual conflict norms of international private law<sup>17</sup>.

#### 3.1.1 The crew's roles

Prior to a discussion on the "code of conduct" there is the question of the definition of the roles of the individual crew members of a spacecraft. In fact, the roles of the individual astronauts constitute a technical and juridical framework for the ensuing behavioral norms, as the latter must necessarily blend in with the technical role entrusted to each astronaut. The order of the stated ideas is then confirmed in practice by today's activities in space. Both the US and the ex-USSR have indeed devised international norms (at times involving simple administrative acts) in order to differentiate between the various roles, functions and authorities among the crews. The definition contained in the NASA documents is particularly useful and clear<sup>18</sup>. Within a crew, the American Space Agency identifies the roles of captain, pilot, mission specialist and payload specialist<sup>19</sup>.

- - The *Captain* on board is a NASA career astronaut. During the flight he is entrusted with the absolute power to order all actions that he deems necessary to ensure discipline and the safety of the spacecraft and the astronauts. To achieve this end the captain may avail himself of all means at his

disposal, including physical coercion. The captain's authority extends over all persons on board, regardless of their nationality, and also includes transferees from other vehicles, even only temporary ones, including personnel involved in Extra Vehicular Activities. In addition, in the event of a descent on a celestial body, the captain assumes all duties of the leader of the landing party, regardless of whether or not he is concretely involved in the activities on the surface of the celestial body.

- - The *Pilot* is also a career astronaut and his duties are of an exquisitely technical nature (even though he remains under the authority of the captain even as far as piloting the spacecraft is concerned). Most important is the role of Second in Command that the pilot assumes every time the captain is otherwise occupied and/or prevented from carrying out his duties.
- - The *Mission Specialist* is equally a "professional" astronaut deeply involved with achieving the results of the individual mission. Consequently, the mission specialist is involved in planning the mission and is responsible for coordinating the use of the spacecraft and the payload.
- - The *Payload Specialist* is the only crew member who is not necessarily a career astronaut. He generally is not part of the flight crew (and may be a national of a country other than the US) and can even come from the private sector (industry, universities, etc.), rather than space agencies<sup>20</sup>. The payload specialist does not take part in any extra-vehicular activity and his duties are limited to activating all of the instruments that pertain to the payload as well as obtaining the scientific and experimental results for which the latter was planned.

### 3.1.2. New doctrinal tendencies in defining crew roles

In light of the fact that flight crews in the ex-USSR are structured in a similar way, it is immediately apparent that crews have been designed on the basis of a limited number of members with a tendentially homogeneous level of training. The future of space colonization, on the other hand, will carry with it the need for increasingly large crews (communities) with various backgrounds (physicians, scientists, etc.) whose level of preparedness for permanence in space may not be homogeneous and in any case whose level of inner conflict (due to ethnic, religious, personality or other reasons) could be higher. However, for the most part it will be impossible for the captain to exercise his authority in person and the chain of command will necessarily involve some degree of subdivision to administer particularly vast and complex vehicles.

Over the last few years, the best doctrine, American in particular, has raised the issue of delegating the powers of the captain and, consequently, of the different organization of the crew, focussing in particular on the differences between the S.T.S. and the Space Station<sup>21</sup>. The most significant and original fruit of this speculation has been the statement of two possible approaches to the problem: the "Spacecraft Commander Approach" and the "Delegation Approach"<sup>22</sup>. In essence, this latter approach stems from the premise that it is impossible, on the part of the captain, to personally manage the life of the vehicle and crew, and, as a solution, proposes the creation of Personnel Specialists. These would be individuals assigned to the Space Station for a certain period of time where they would carry out the tasks delegated to them by the captain to ensure order and discipline, provide for the safety and the well-being of the personnel on board, solve controversies within the crew and protect crew members and equipment on board the Space Station. Their curriculum must include training in psychology, law, public relations, medicine, etc., however without excessive specialization and they may also be other than NASA career astronauts and have only part-time duties on board. The proponents of this theory cite an historical precedent for this role identified as the "consul" figure in the "Codice Amalfitano" (Amalfi Code) a person who, on board, acted as a judge to quell disputes among the crew members<sup>23</sup>. The captain would maintain the "ultimate responsibility" in governing the vehicle as well as for the order, safety, well-being and integrity of the spacecraft and its passengers. Finally, the captain would maintain the right to

order the use of force, however with the possibility of delegating such use to one or more Personnel Specialists.

Although the approach illustrated briefly above is certainly original and presents some valid items, we feel that it is unacceptable despite being supported authoritatively and diffusely in American doctrine. Indeed, the creation of a figure such as the Personnel Specialist presents a number of uncertainties. First of all there is the fact that the captain is deprived of certain control and intervention faculties (for the most part typical of military command) on the life of his crew, with the substantial risk that he may be increasingly perceived as detached from the life of his crew members, more a controller than a chief. Furthermore, at the juridical level the captain would retain the ultimate responsibility for decisions made by others, the curriculum and abilities of whom he could not directly ascertain in numbers that may be substantial enough to create a real and true counterpower, especially on board large and very large spacecraft. This would actually pose a great threat to order, discipline and safety on board. We fail to understand, in the event of errors or abuse on the part of Personnel Specialists, how the captain could be called to answer in person, especially in the more serious cases, without artificially creating a sort of objective responsibility against him, totally incompatible with the subtlety and difficulty of his duties<sup>24</sup>. Having ruled out that they would only be American citizens (if nothing else for obvious political reasons), it is clear that personnel specialists could not belong to a single, well-defined, ethnic or religious group, lest they lose their credibility in front of the other crew members with a different origin and culture. It is unrealistic today to imagine the existence of such individuals.

Finally, and still at the juridical level, the supporters of this theory have failed to explain where Personnel Specialists should be placed in the chain of command on board of the spacecraft, whether under normal circumstances or during emergencies. In particular, there is a risk that these individuals, somehow authorized to supervise and refer on the psychic health of the crew, could constitute a sort of internal lobby and dispose of the power to influence and to move accusations against any individual that is totally disproportionate and incompatible with any guarantee of the astronaut's freedom. Furthermore, in the event of an emergency, it is unclear whether they would be the immediate subordinates of the captain or of the second in command/pilot, or if they would indeed maintain an independent capacity to intervene. In this case, the proposed model would seem to lead to a "community" management of life on board that would be particularly harmful to the efficiency of the vehicle and unfit for space activities, at least those that can be hypothesized today<sup>25</sup>.

The "Spacecraft Commander Approach" is substantially different. Based on a more traditional paramilitary model of the crew (as illustrated above) and supported by current international (art. 8 of the Outer Space Treaty) and national (US) regulations (42 U.S.C. par. 2473, first section of the US Code) this model contemplates the total subordination of each crew member to the captain, without any regard to individual roles or nationality<sup>26</sup>. In the case of non-American astronauts, these would in any case be subject to both American law and the laws of the countries they are nationals of, on the basis of diplomatic agreements made on a case by case basis<sup>27</sup>. Obviously, hierarchic subordination becomes even more rigid in the case of a military crew and it is precisely to the military origins of NASA personnel (at least during the Sixties) that supporters of the delegation of powers doctrine refer to prove the outdatedness of the approach just illustrated. In particular, the most valid criticism is based on the captain's physical impossibility of supervising every function "without becoming a space bureaucrat" on one hand and without creating command vacuums on the other. In effect, this objection is well taken where it states that "the Spacecraft Commander Approach" could be beneficial for small traveling communities, for a limited amount of time, formed by homogeneous members (the Shuttle is a typical example), whereas it would be inadequate for larger communities. Actually, we believe that the latter approach is absolutely preferable for a variety of reasons. First of all, it has strong foundations in historical maritime and aeronautical law. Whether military or civilian, the hierarchical distribution of roles on board "autarkic sailing vehicles" has always postulated the existence of a sole person responsible

for the life of the vehicle as well as the crew, with the consequent attribution to the same of at times limitless powers. Moreover, selection of this model makes it possible to fully exploit all of the doctrinal and jurisprudential developments that have occurred to date in the field of maritime law, and in uniform international norms in particular, which, in this field, are considerably vast, especially at the level of general principles. Then, the problem of the captain's actual ability to carry out all of the functions assigned to him and the problem of the risk of abuse, facilitated by the magnitude of the powers assigned to the him, can be solved without recourse to delegation of power within the crew (as would occur by establishing Personnel Specialists) by delegating said powers outside the crew.

In essence, it would be necessary to establish a regime by virtue of which the captain, at least during non-emergency situations on board, would be subjected to higher Ground Control Authorities, on the basis of the suggestions or, if necessary, orders of which he would act to regulate life on board. Such a system was effectively tested in the past through the "aeronautical director", and the commercial flight management system in particular, where most decisions concerning non-emergency flight are made by ground controllers and, for the most part, even the captain's decisions on board are made on the basis of precise and extremely detailed operations manuals that contemplate practically all possible flight situations. A similar system can be hypothesized for the relationship between Ground Control Authorities and the captain of a spacecraft, with the additional advantage that such a vehicle could be managed entirely through automatic and radio controls from earth, making it possible to exclude the captain should he no longer prove sufficiently reliable.

At the political level of international law, such a command chain would be the most favorably accepted by all Countries involved in an international mission, as it would allow for true international control over the life of the vehicle and its crew and, more importantly, it would situate the discussion and decisions involving the primary theoretical and juridical issues well before the beginning of the mission.

### 3.1.3. Concrete definition and structure of a Code of Conduct

Having exhausted the review of hierarchy within the crew it is possible to analyze the issue of a "code of conduct". Even today this regulation of the astronauts' life is already a problem that will become a most impelling one in the near future<sup>28</sup>. In fact, crew internationalization, their increasingly varied composition and the size of the vehicles and duration of permanence in space will increasingly configure human activities there as those of a traveling community, in part isolated, and on an almost totally autarkic vehicle. In this framework, the code of conduct must become a sort of international "general law" for all human activities in space, containing reference norms that, perhaps modified on a case by case basis, can guarantee a real and true legal regime of astronaut life.

With reference to the most recent doctrinal elaborations (I.S.U. 91), we can very briefly state that the code of conduct should be inspired by current international law on the matter of space activities and by the new requirements that will surface as space stations are commissioned and lengthy interplanetary voyages are undertaken. Therefore it will probably have to avoid norms of substantial and procedural penal law, since this branch of the law is the strict domain of individual countries (this would also hasten the acceptance of the Code of Conduct by the various Governments involved in space activities)<sup>29</sup>. The main issues that the code of conduct should regulate are the jurisdiction and definition of the roles and positions on board the spacecraft. Then, at the formal level, the code of conduct should be assembled as a series of uniform international law norms, whenever possible avoiding conflicting norms that would be difficult to apply, either diplomatically or juridically<sup>30</sup>.

As far as jurisdiction is concerned, suffice it to state that, beyond applicable conventions<sup>31</sup>, jurisdiction for a violation of the norms of the code of conduct should be maintained by the country of origin of the

perpetrator of the violation (in case of crimes requiring complete penal proceedings for an evaluation, after return of the astronaut to his country of origin), while so-called "simple insubordination" may be disciplined directly by the captain of the spacecraft. As far as the different roles on board the spacecraft and the related chain of command are concerned, with reference to earlier statements, the division of roles among Captain, Pilot (and First Officer), Mission Specialist and Payload Specialist are acceptable. In particular, the duties and powers of the captain should be defined as follows:

The captain is the highest ranking authority on board and/or on the surface of a planet. His powers include that of using or ordering the use of physical force against crew members, but only in case of an immediate and absolute necessity, to guarantee the safety of the vehicle<sup>32</sup>. The captain may consult with his first officer or all of the crew as far as life on board is concerned and must in any case consult with the first officer before administering punishments and taking steps against any member of the crew. Emergency situations are those in which there is an immediate and obvious risk of damage or destruction of the spacecraft or its equipment, as well as those in which the physical health of the crew is even simply at risk.

#### 3.1.4. New juridical problems

Beyond the structure of the code, as examined above, there are issues of substantial law concerning the life and activities of the astronauts. For the sake of this discussion it is necessary to propose a particular definition of astronaut, capable of distinguishing the latter from a possible passenger of space flights, to underscore the technical and juridical peculiarities of space work, separate from the contractual relationship of mere transportation which, in the future, could be the setting of the juridical positions of passengers. In this sense, accepting the recommendations of the best international doctrine<sup>33</sup>, a "crew" is defined as "persons conducting professional activities during a space flight". Having clarified this issue, let us now identify the areas of the most urgent intervention.

First of all, at the civil law level there are personal rights<sup>34</sup>. With reference to the situation on earth, the astronaut lives and works in an environment the limited space and continuing forced cohabitation of which emphasize the need of ensuring some form of *privacy*<sup>35</sup>. The right to *privacy*, one of the issues that has developed the most in the field of personal rights over the last few years, is yet to be established in terms of extra-atmospheric activities. It implies the possibility for astronauts to practice their religion, to take their personal objects with them, to organize and use their own "personal" space within the spacecraft, to have the freedom to organize, albeit minimally, their work and rest schedules. Within the privacy sphere there is the issue of communications and information, with features that are markedly different from earth.

Astronauts must be guaranteed a possibility to communicate individually with Earth, whether with the ground control structures (GCA, etc.) or their families and employers as well as the reciprocal right to receive all the information that they may wish to receive, at least in the family and personal safety areas. Then, in particular, it will be necessary to reach a compromise between the possibility for the individual to use private radio frequencies (even if at given time intervals) and the need for the entire life of the space vehicles to be under control and also in order to ensure military and scientific secrecy. Another privacy issue is the limits to investigations of the life of men in space (both physically and psychically) and to the transmission of news concerning any individual on the part of other crew members<sup>36</sup>.

Other pressing issues surface in the sphere of work and welfare law. There is definite proof that, in the absence of gravity, the human body experiences physical damage of significant entity (lack of calcium in the bones, cardiocirculatory problems, alteration of reflexes, etc.). This damage cannot be prevented beyond a certain limit and implies the right of astronauts to a special safeguard, both medical and



compensatory. Moreover, internationalization of crews in the current situation where each country provides individually for recruiting and training personnel (at times with differences between military and civilian personnel) creates an astronaut coverage problem. Therefore it will be necessary to establish homogeneous standards for recruiting, qualifying, training and determining the attitude for flight and lengthy sojourns in space, granting licenses and professional certification in this field.

Still in the astronautical field, but with implications that involve all the other fields of law, there is the problem of the right to safety. This right will have to constitute the basis of every juridical elaboration concerning the legal regime of astronauts and extend to all processes involving transportation, sojourn in space, scientific experiments, handling of dangerous substances, definition of parameters for clothing (intra and extra-vehicular), etc. Once again, special attention must be paid to radio communications in order to ensure the use of protected emergency frequencies (along the lines of existing aviation law)<sup>37</sup>. Then it will be necessary to provide a safeguard of the intellectual property rights that derive from human scientific activities in space in order to protect and encourage investments on the part of private companies and individual countries in this area, on one hand, and to insure the exploitation and dignity of the work of the men on the other. These men, individually, accept the risks and discomfort without which similar scientific experiments could not take place<sup>38</sup>.

Finally, in the perspective of astronauts from many different backgrounds (national and international space agencies, military, commercial enterprises, research institutes, etc.) it will be necessary to guarantee uniformness of economical treatment in the wider sense of the term, establishing a single or very homogeneous labor contract (at least for extended flights), that could possibly be included in the code of conduct<sup>39</sup>. From the perspective of civil liability of the astronaut it will be necessary to provide a transfer mechanism of the individual astronauts' liability and, secondly, the liability of the countries of which they are nationals. This would ensure a sort of "immunity" to the astronaut that could compensate the hardship, including physical hardship, in which they work, and at the same time avoid depriving the subject who has suffered a loss of an equitable reimbursement for the damages sustained. At the penal level it will be necessary to deeply rethink the limits of guilt with regard to the astronauts' new and special living conditions. In particular it will be necessary to establish precise limits to the extension of criminal behavior to include a greater number of "involuntary" actions that could be perpetrated in space<sup>40</sup>.

A different approach must be adopted for concepts such as total, partial and mental infirmity. Finally, for behavior defined as "simple insubordination", it will be necessary to establish a sanctioning system capable of ensuring respect of the norms on the part of the individual astronauts, also out of fear of punishment, but without involving sanctions that would deprive the crew of the contribution of the single members whose role is often technically irreplaceable. These sanctions must therefore be essentially economic in nature and/or effect the professional career perspectives of the astronaut<sup>41</sup>.

#### 4. REFERENCES

1 The record for the longest time in space belongs to the Russian L. Kizine with 375 days, 16 hours and 19 minutes of space flight.

2 See A. Farand "La Station Spatiale et son regime juridique", Min. des Aff. Ext. - Dir. Gen. des Aff. Jurid. Ottawa, 1989; Anajiom, Goldman, Meeks Space and Society: Challenges and Choices, Am. Astronautical Soc, Publ., 1984.

3 See I.S.U. "International Mars Mission Design Project", Toulouse, 1991, pp. 32 et seq. where the initial theoretical basis for the creation of an international organization dedicated to future space activities was laid. Young A.J., "Law and Policy in the Sp. St. Era", Utrecht, 1989, M. Nijhoff Pub., pp. 98 et seq., where the profile of space activity internationalization and privatization, although partial, is examined in greater depth.

4 C.O.P.U.O.S. Committee for the Peaceful Use of Outer Space, a permanent UN Committee established in 1959 by Resolution 1472 (14) adopted on 12/12/59 "International Cooperation in the Peaceful Use of Outer Space", by the UN General Assembly

5 Among the various authors who have addressed this problem, see: G. LAFFERANDERIE, "Pour une charte de l'Astronaute", *Annual of Air and Space Law*, vol. XII, 1987, pp. 263 et seq., McGill Univ., Montreal; K.H. BOCKSTIEGEL, "Draft for a convention on Manned Space Flight", in *ZLW* 40. Jg. 1/1991, pp. 5 et seq.; Goldman, "International Space Law 1957-1979", Part II, pp. 74 et seq.

6 Treaty on Principles Governing the Activities of States in the Exploration and Use of Outer Space Including the Moon and Other Celestial Bodies (the Outer Space Treaty, 1967).

7 Agreement on the Rescue of Astronauts, the Return of Astronauts and the Return of Objects Launched into Outer Space (the Rescue Agreement, 1968).

8 Convention on International Liability for Damage Caused by Space Objects (The Liability Convention, 1973).

9 See the Outer Space Treaty, art. 5: "States Parties to the Treaty shall regard astronauts as envoys of mankind in outer space...."

10 See Goldman, cit. p. 76

11 This is the framework in which some of the COPUOS member nations signed the Agreement, however reserving the right of granting political asilum to foreign astronauts that were to make such a request.

12 See in this respect: N.M MATTE, "Space Activities and Emerging International Law", Centre for Research of Air & Space Law, McGill Univ., Montreal 1986; SZALSO, "Air Crew and Space Crew - A modest Analysis of Analogies from Air and Space-law rules", document presented at the seminar of the International Institute of Space Law, Oct. 9-15, 1983, Budapest; DE SAUSSURE, *Astronauts and Seamen - A legal Comparison*, 10, *J. Of Space L.* 165 (1982); and others.

13 E.V.A. = Extra Vehicular Activities: all activities performed by the astronauts outside the spacecraft (i.e. walking in space or on celestial bodies).

14 International consensus is increasing on the "Agreement Governing teh Activities of States on the Moon and Other Celestial Bodies" (The Moon Treaty, 1979) containing the general principles that pertain to human extraterrestrial settlements, in accord with the Outer Space Treaty.

15 In this sense also I.S.U., cit., p. 48.

16 As of today, none of these documents has been developed. The end of the cold war and of the resulting political bipolarism should allow for both of these diplomatic proposals to be resurrected.

17 See, in this respect, I.S.U. cit., p. 49; LAFFERANDERIE, cit., p 271 et seq.; FARAND, cit., p 13 et seq.; BOCKSTIEGEL, cit., p 5 and 6.

18 Presidential Executive Order 1977 establishing the Space Shuttle Program; U.S. Code of Federal Regulations, Title 14 - Chapter V - N.A.S.A. - part. 12/4; N.A.S.A. - NMI 7100-8-1987.

19 See S.F. MARCHI., "Authority of the Space Station Commander: the need for delegation", in *Glendale Law Review*, Vol. 6, n. 1, 1984, Glendale Univ., page 73 et seq.; LAFFERANDERIE, cit., pp. 270-271; I.S.U., cit., p. 50 et seq.

20 For example, the first Italian astronaut, Franco Maierba, is an engineer, not a pilot, employed by a private industry.

21 S.T.S. = Space Transportation System: official name of the "Shuttle". (Presidential Executive Order 1977 establishing the Space Shuttle program; US Code of Federal Regulations, Title 14 - Chapter V - NASA - part. 12/4; NASA - NMI 7100-8-1987); Space Station = "Freedom" Space Station: an orbital structure under development by the US, the European Countries (through ESA) and Japan, with the aim of creating a large permanently inhabited settlement in earth orbit.

22 See MARCH, cit., p. 74; I.S.U., cit., p. 48; FARAND, cit., p 18-21, etc.

23 The Amalfi Tables contain an ancient Mediterranean Code, dated 1131; see GILMORE & BLACK, *The Law of Admiralty* (2nd Ed., 1975) p. 5 note 14.

24 Among others, ROBINSON, "NASA's Space Station and the Need for Quantifiable Components of a Responsive Legal Regime", 6 *Int'l Law* 292, 297-300 (1972) discussing the risk factors of human relations within a space crew; NOTE, "Dispute resolution in Space", 7 *Hastings Int'l & Comp. L. Rev.* (1984).

25 This is the sense behind the criticism of the "Delegation Approach", es. in I.S.U., cit., p. 50.

26 For a complete definition and analysis of the Sp. Comm. App. see: GORONE, "The Sp. Shuttle: Some of its features and legal implication", 6 *Annals of Air & Space Law* 381, 389-90 (1981); MOSSINGHOFF and SLOUP, "Legal Issues Inherent in Sp. Shuttle Operation", 6 *J. Space L.* 47, 67 (1978).

27 Although regarding other juridical issues, this hypothesis was already contemplated for the Shuttle flights by MOSSINGHOFF, "The Space Shuttle era: International and Domestic Legal Aspects", 72 *Proceedings of the Am. Soc. Int. Law* 249, 257- 58 (1981). 28 The issue of a "Code of Conduct" for astronauts for years has been at the center of the best doctrine. For example, see I.S.U., cit., p. 48 et seq.; YOUNG, cit., p 135 et seq.; BOCKSTIEGEL, cit., p. 6; Maj. Gen. T.B. BRUTON, USAF Judge Advocate General, "The status of Criminal Jurisdiction in Outer space", within the *Proceedings of the 24th Conference of the Inter-American Bar Ass. Panama, February 1984* (no page no.), etc.

29 This is the direction in which international doctrine appear to be moving, especially until the end of political bipolarism, given the considerable differences that exist in the definition of crime and sentencing between communist and non- communist regimes.

30 See I.S.U., cit., p. 35 et seq.; YOUNG, cit., p. 67 et seq.

31 Art. 8 of the Outer Space Treaty

32 See, in this respect, YOUNG, cit., p 152-53, MATTE, cit., pp 342 et seq.

33 See, in this respect, YOUNG, cit., p 152-53, MATTE, cit., pp 342 et seq

34 In particular, LAFFERRANDERIE, cit., p 269 et seq.; BOCKSTIEGEL, cit., p 6

35 See I.S.U., cit., p 115 et seq.

36 See P. SMITH, "Space Stations Intended Law and Policy", 312-61 (1979).

37 Even during a past Apollo mission there occurred problems with interference, loss of radio contact, etc., that ceased after the use of the "Hot Line" between Washington and Moscow (See LAFFERRANDERIE, cit., p. 272).

38 See YOUNG, cit., pp. 164 et seq.; HOOVER, "Law and Security in Outer Space from the Viewpoint of Private Industry", 11 *J. Space L.* 115, 122 (1983); B. LUZENBERG & G.J. MOSSINGHOFF, "Intellectual Property and Space Activities", 13 *J. Space L.* 8, 13 (1985); see also on the issue of discovery and patent rights, among others T.M. FOLEY, "U.S. Proposal would restrict European, Japanese Station use", in *Aviation Week & Space Technology*, 16/2/87, p. 23; and R. OÖSTERLINK, "Les inventions de l-Agence et leur protection", *ESA Bulletin n. 27*, Aug. 81, pp. 22-26.

39 FARAND, cit., pp. 23 et seq.; YOUNG, cit., pp. 146 et seq.; MATTE N.M., "Aerospace Law From Scientific Exploration to Commercial Utilization", (1977, The Carswell Co. Ltd.) pp 162- 163, (note 24).

40 See BLUTH, "Consciousness Alteration in Space", Paper presented at the Fourth Princeton/Am inst. of Aeronautics and Astronautics (AIAA) Conference on Space Manufacturing Facilities, Princeton, N.J. 14-17/5/79; AKINS, "Psychological and Psychophysiological Effects on Long Duration Space Flight", in *Update on Space* 64-81 (Bluth & McNeal ed., 1981).

41 This is the direction apparently taken by the US in applying art. 8 of the Outer Space Treaty, reference to which is made by 2 sections of the US Code (42 U.S.C. 2473); 18 U.S.C. 799); in any case see McDOUGAL, LARSWELL, VLASIS "Law and Public Order in Space", 1973, pp. 668-74.

## Evaluating Success levels of mega-projects

Mohan M. Kumaraswamy

University of Hong Kong, Department of Civil  
& Structural Engineering,  
Pokfulam Road, Hong Kong.

SYNOPSIS

Today's mega-projects transcend the traditional trajectories traced within national and technological limitations. Powers unleashed by internationalization of initiatives, in for example space exploration and environmental protection, are arguably only temporarily suppressed by narrower national, economic and professional disagreements as to how best they should be harnessed.

While the world gets its act together there is time to develop the technologies of such supra-mega-project management that will synergise truly diverse resources and smoothly mesh their interfaces. Such mega-projects and their management need to be realistically evaluated, when implementing such improvements.

This paper examines current approaches to evaluating mega-projects and questions the validity of extrapolations to the supra-mega-projects of the future. Alternatives to improve such evaluations are proposed and described.

1. MEGAPROJECTS OF TODAY..... AND TOMORROW1.1 From projects to mega-projects

First focusing on projects, most simplified definitions portray a project as an amalgamation of inter-related non-routine non-recurrent activities aimed at specific objective(s) and with definite start and finish points in time. Distinctions between project and general management stress the limitation of resources, specificity of goal(s) and the short sharp imperatives facing temporary project teams as against the longer term almost self-perpetuating and relatively routine roles of general managers maintaining streamlined operations in steady state scenarios.

To distinguish mega-projects from projects is less simple; and admittedly a matter of choice: whether to use criteria based on money value/ cost; or on impact to the community and/or environment; or on the number of people deployed; or key parameters involved such as hectares of land, cubic meters of earth or concrete, kilometers of road or tunnel; or a combination of the foregoing.

1.2 Examples of mega-projects

Traces of past megaprojects continue to fascinate us as for

example in the great pyramids of Egypt, the Great Wall of China, mega-irrigation works and other edifices of ancient civilisations.

Voyages of discovery were megaprojects whether across the uncharted seas, into unexplored forests of yore, into the depths of the Ocean or into Space. What springs to mind today may be the mega-undertakings such as the Space Station, Moon Base or Mission to Mars. It is useful to consider these in the context of some contemporary or imminent examples on Earth itself; each of which had/ has/ will have a mega-impact on its people and environment:

(a) the proposed Three Gorges Project is on the 6300 km. long Yangtze river which has a drainage area of 1.3 million sq. km and a 'mean annual runoff of 1 trillion cu m<sup>1</sup>. The proposed concrete gravity dam requiring 15.27 million cu m. of concrete will be 2546 m long and 175 m high at the crest. The reservoir capacity will be 39.3 billion cu m. and the two hydropower plants will have a total installed capacity of 17,680 MW.

On the other hand 23,793 hectares of farmland, 13 towns, 140 townships and 1500 villages will be affected by the reservoir and the population to be moved may well be over 1.1 million.

The cost was estimated at 57 billion yuan (about US\$ 10 billion) based on 1990 prices, the net economic benefit at 13.2 billion yuan, the Economic Rate of return at 14.5%, the Financial Rate of Return at 11%; and the Payback Period at 20.6 years which is about 2 1/2 years after estimated total completion.

(b) The Channel Tunnel will soon change the character of earth-bound traffic between the UK and the rest of Europe. However the approximately US\$ 13 Billion project is already 60% over budget and over one year behind schedule.

Furthermore the US\$ 1.8 billion claim by the consortium of contractors recently resulted in a deadlock in Paris<sup>2</sup> which perhaps exemplifies that the problems of megaprojects are not very different from smaller ones except that the repercussions can be that much greater. The potential for problems is perhaps heightened by the interactions between the many powerful personalities of the multi-project participants; but then the opportunities for bigger and better solutions is also hopefully heightened on synergistic grounds.

(c) The proposed new airport in Hong Kong vividly illustrates the problems of multi-stake-holder interests in mega-projects. The program estimated at approximately US\$20 Billion, has been split into 10 'Core' projects. Some of these are underway; while others may be modified in order to meet the self-imposed deadline of 1997; and also as a compromise in the on-going prestige battle between Britain and China on broader issues.

This megaproject includes transportation links to the airport that is being built mostly on land reclaimed from the sea. The 'Core' projects include long span bridges and road and rail

links and interchanges which are 'big' projects in themselves.

(d) It is worth comparing the foregoing with the \$ 2.7 billion new Denver International Airport megaproject in USA. At its ultimate capacity it will exceed the combined capacities of the worlds two largest airports at present<sup>3</sup>.

(e) The Mahaweli irrigation and hydropower program in Sri Lanka launched in the late 1970's sought to compress into the life span of one parliament, a previously phased out program that would have spanned 30 years and cost over US \$ 1 billion. Foreign funds from many countries were injected to fuel this acceleration. It was not difficult to achieve (on paper) the required rates of return, by for example changing some designated crop areas from paddy to higher return yielding cash crops. The relative merits of the nature and magnitude of the foreign inputs are still being questioned by those who point out to the stifling of the domestic construction industry, for example.

Even the foregoing small sample of contemporary mega-projects indicates the nature of the emerging agendas to be addressed; for example of the increasing size, scope and linkages of mega-projects; and of the delicate interface management needed between the many powerful and sometimes culturally and technologically diverse project participants. Issues to be resolved sometimes include those arising from divergent value systems and from real or imagined impacts on the environment.

### 1.3 The need for evaluation

The foregoing random scan of a few mega-projects, illustrates the need for evaluating every project against relevant criteria. The stakes are so high and the variables so many that ground-rules need to be established, targets set and evaluated against from the outset for many reasons; including the efficient allocation of scarce resources, for example.

President Clinton recently directed NASA to redesign Space Station 'Freedom' to make it more efficient and effective and capable of producing greater returns on investment. No doubt NASA has translated these into a set of detailed 'evaluatable' targets. The imperatives for proper evaluation are just that much more compelling on mega-projects which can have mega-impact on so many living things; and even those who are still unborn.

## 2. EVALUATION

### 2.1 What is evaluation?

Unfortunately the word evaluation has been used in various contexts and with different connotations. It can for example mean different things to economists, engineers or human resource managers. This paper which espouses a multi-disciplinary approach to evaluation, takes evaluation to cover both ongoing and completed project reviews. It excludes pre-project appraisals of

feasibility but must necessarily relate to the setting and validation of objectives at that stage.

In comparison, Imboden defined<sup>4</sup> evaluation as the 'ex-post analysis of an executed project' and project appraisal as the 'ex-ante analysis of a proposed project'. The Overseas Development Administration of UK defines it similarly<sup>5</sup>; while using 'monitoring' for reviews of ongoing projects. Here mid-project evaluation is taken to include a more detailed performance analysis against targets, than may be implied by monitoring. On the other hand Corrie extends the scope of evaluation to include planning and feasibility studies<sup>6</sup>.

This paper also distinguishes evaluations from audits which may merely test compliance with management controls and regulations. Evaluation implies testing performance against pre-determined targets; that may or may not be adjusted for changed circumstances. More fundamentally, evaluation refers to the process of determining the merits, worth or value of things; or to the result of that process<sup>7</sup>. It is implied that the reference is to the net value; so that both value and cost aspects are assessed.

## 2.2 Why evaluate?

Briefly, project evaluators may seek (a) to assess performance on on-going or completed projects; in order to reward or reprimand participants; (b) to improve future performance (by lessons learnt from failures); (c) to improve future target setting (eg: incorporating weightings for project circumstances so as to yield more realistic targets).

Top management, shareholders, governments or the community itself (in the case of mega-projects) would also want to know what went wrong and why, how bad it really was and how things could be improved. For example they may want to know the exact impact on project success of for instance the mirror defect in the Hubble Space Telescope or the jammed high gain antenna in the Galileo mission.

While there are already many stakeholders in a smaller project, those with interests in a mega-project multiply tremendously. eg: those affected by the environmental impact or whose tax payments may have contributed to the funding.

## 2.3 How to evaluate?

Will a systematised approach to evaluation of mega-projects provide the necessary answers? What of the grey areas that may need qualitative judgements? How does one evaluate the ability of the project team to hit the 'moving targets' that often result from changing project priorities and circumstances eg: sudden price restrictions; mid-stream scope expansions; or intermediate time targets, for sectional completion or meeting other milestones.

Except in major disasters like the 'Challenger' or a breached dam, it is usually the time and cost targets that are over-run, as in the case of the Sydney Opera House; since the performance specifications can often be met by incurring more time and money. It is difficult to be excellent, fast and economical all at once, but that is the essence of a good project and of its management.

#### 2.4 Differentiating project success from that of its management

Drastic changes in conditions affecting a project can result in project failure; and successful management can sometimes only mitigate the efforts of such failures. At the other extreme unrealistically 'easy' targets and very favourable conditions can precipitate project success in spite of management mishaps.

The evaluator(s) should therefore be clear what/ who is being evaluated; whether it is the project, its management or both. Effectiveness (in achieving results) must be distinguished from efficiency (in optimising resource usage in achieving such results).

The consequent distinction between 'impact' or 'outcome' evaluation (of results) and 'implementation' evaluation of process (and management) is self - explanatory.

The formulation of suitable targets against which to measure success must therefore take account of such distinctions.

### 3. CRITERIA AND INDICATORS OF SUCCESS

#### 3.1 Establishing criteria of success

Since every project is unique and the major stake -holders may have special priorities, it is essential to jointly establish the criteria by which success will ultimately be judged. Securing the agreement of multiple stake holders of a mega-project may well prove a formidable project by itself. Incorporating such agreed criteria in the project brief is therefore a primary management task.

Criteria of project success which were traditionally based on the cost-time-quality tripod, have grown in both number and sophistication. Health, safety and environmental criteria, as well as stake-holder satisfaction criteria are also often (consciously or otherwise) considered when evaluating the success level of a project or its management. For example Ashley et al listed in 1987 six criteria most frequently used to measure construction project success as: budget performance; schedule performance; functionality; client satisfaction; contractor satisfaction and project manager/ team satisfaction<sup>8</sup>.

As for increased sophistication; the cost criterion for instance may not be confined to initial capital cost; but may well



include life-cycle cost; elemental (sectional) costs; cash flow profile factors etc for management or implementation evaluation and economic rates of return incorporating social benefits as well, for impact or outcome evaluation. Thus life-cycle cost, elemental costs etc. may be sub-criteria within the overall cost criterion. Return on capital is an example of a criterion relating to the overall project success itself.

The relative significance of each criterion (and sub-criterion) would necessarily vary with the project priorities on different projects. Cost may be paramount in some, while timing or prestige / performance levels may be of the essence on others.

The multiple criteria against which projects are to be evaluated often result in varying degrees of success/ failure against each criterion and sub-criterion. Figure 1 illustrates a model proposed by the author to illustrate a profile of performance against each such criterion (a,b, c....) and sub-criterion (a1, a2, ...b1, b2, ... etc)<sup>9</sup>.

Appropriate measures to be used for each such criterion and sub-criterion need to be defined and suitable scales established for such measurement. Measurement can be by suitable 'indicators'<sup>9</sup>

### 3.2 Formulating indicators of success

Indicators are needed here: (a) as proxies for measurement where direct measurement is difficult; (b) as short-hand symbols to measure vast quantities of data; (c) as short-cuts to a quick first approximation of the status of a project or its management; (d) to present such status through measurements against relevant criteria for example on the above-mentioned project performance profiles.

Examples of such basic primary indicators can be cost/kg of payload launched or cost/ m<sup>3</sup> of usable space, in a Space mission; or cost/m<sup>2</sup> of building, cost/ m<sup>3</sup> of water stored or cost/MW of power generated etc. A combination of primary indicators may be designed to represent one criterion if necessary ie if one indicator is deemed inadequate by itself. Each primary indicator in turn can be analysed into secondary (and tertiary) indicators related to relevant criteria, for example in elemental cost break-downs.

### 3.3 Using indicators in evaluation

'Norm' values of such indicators as derived from a databank could convey the industry standard under average circumstances. These can be weighted by factors (based on 'weighting indicators') to adjust for special project conditions and client priorities. Evaluators would then compare actual performance against such weighted 'norms'.

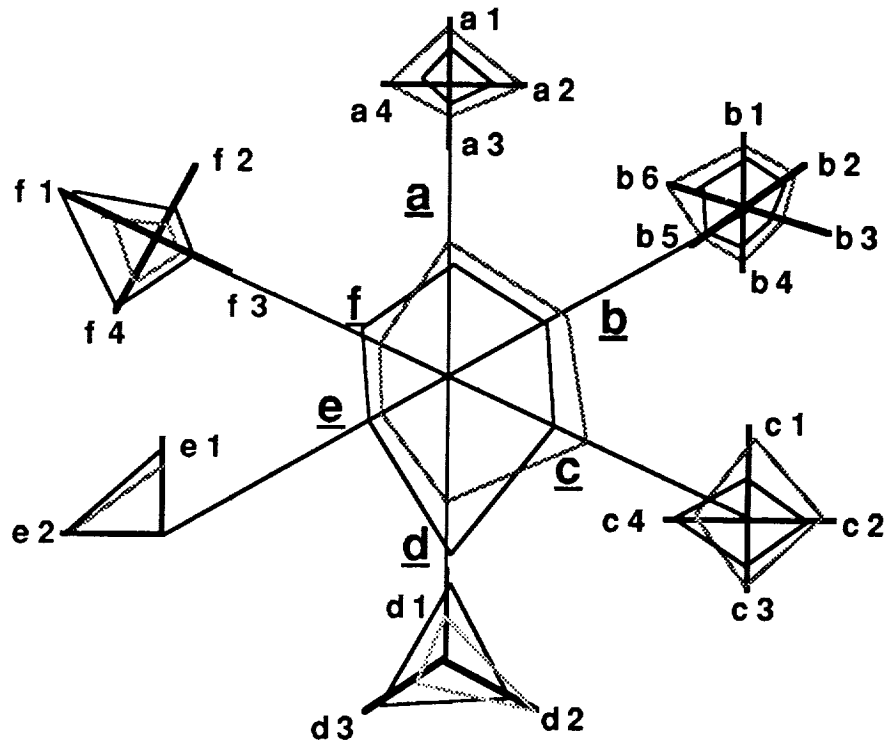

**KEY**

Targetted Profile   
 Achieved Profile

**NOTE**

The further a point is from the origin along any criterion (or sub-criterion) axis: the better is the performance against that criterion (or sub-criterion).

**EXAMPLE OF A PROJECT PERFORMANCE PROFILE**

FIGURE 1

Figure 2 illustrates how deviations from the norms, say in certain primary indicators, would alert the evaluator to investigate relevant areas further; by checking out the secondary (and tertiary) indicators therein. Thus the evaluator is directed through a structured search for the root causes of under-performance<sup>9</sup>.

However two caveats are noted. Firstly apparently 'normal' primary indicators may mask a 'delinquent' secondary indicator which is over-compensated by over-performance against a parallel secondary indicator. Secondly parallel qualitative assessments are essential to place apparent 'good' or 'bad' variances in context.

### 3.4 Examples from international mega-project evaluation

International funding agencies such as USAID, the overseas Development Administration (ODA) and other bilateral aid agencies have used indicators - based evaluation systems to measure the success levels of their programs in other countries. Figures 3 and 4 illustrate the evaluation frameworks used for such systems. Different cultures, diverse value systems, divergent views and conflicting claims would have proved the worth of such a systematized approach to evaluation in such situations. Similar scenarios would arise in the multinational mega-projects of the present and future.

## 4. PROBLEMS AND PROSPECTS OF MEGA-PROJECT EVALUATION

### 4.1 The changing nature of mega-projects

While projects were always about change, the mega-projects of today reflect the ultra high rates of change that technology has facilitated. The multiplicity of participants and the effects of the project increasingly transcend national boundaries; as in joint venture in space exploration and environmental control. Technology advances much faster than the frameworks needed to manage it, generating human and environmental stresses and strains.

Since mega-projects may take longer than the average projects, the success criteria are more susceptible to revision eg. with the change of governments or other project stakeholders. Multi-attribute evaluation becomes more complex with such shifting goal-posts. Even on a macro scale Purchasing Power Parity and various forms of Quality of Life indices are supplanting GNP. Environmental impact indicators are another growth industry. A mega-project evaluator needs to quantify social costs and benefits as well.

The author found specialist software designed for integrating a series of pairwise comparisons to be useful in reducing the residual subjectivity of some such basically qualitative assessments<sup>9</sup>. It is also useful to make allowances for possible distortions by effects such as the 'Halo' effect, the 'Hawthorne' effect, the 'Placebo' effect or the 'Harvard fallacy'<sup>7</sup>

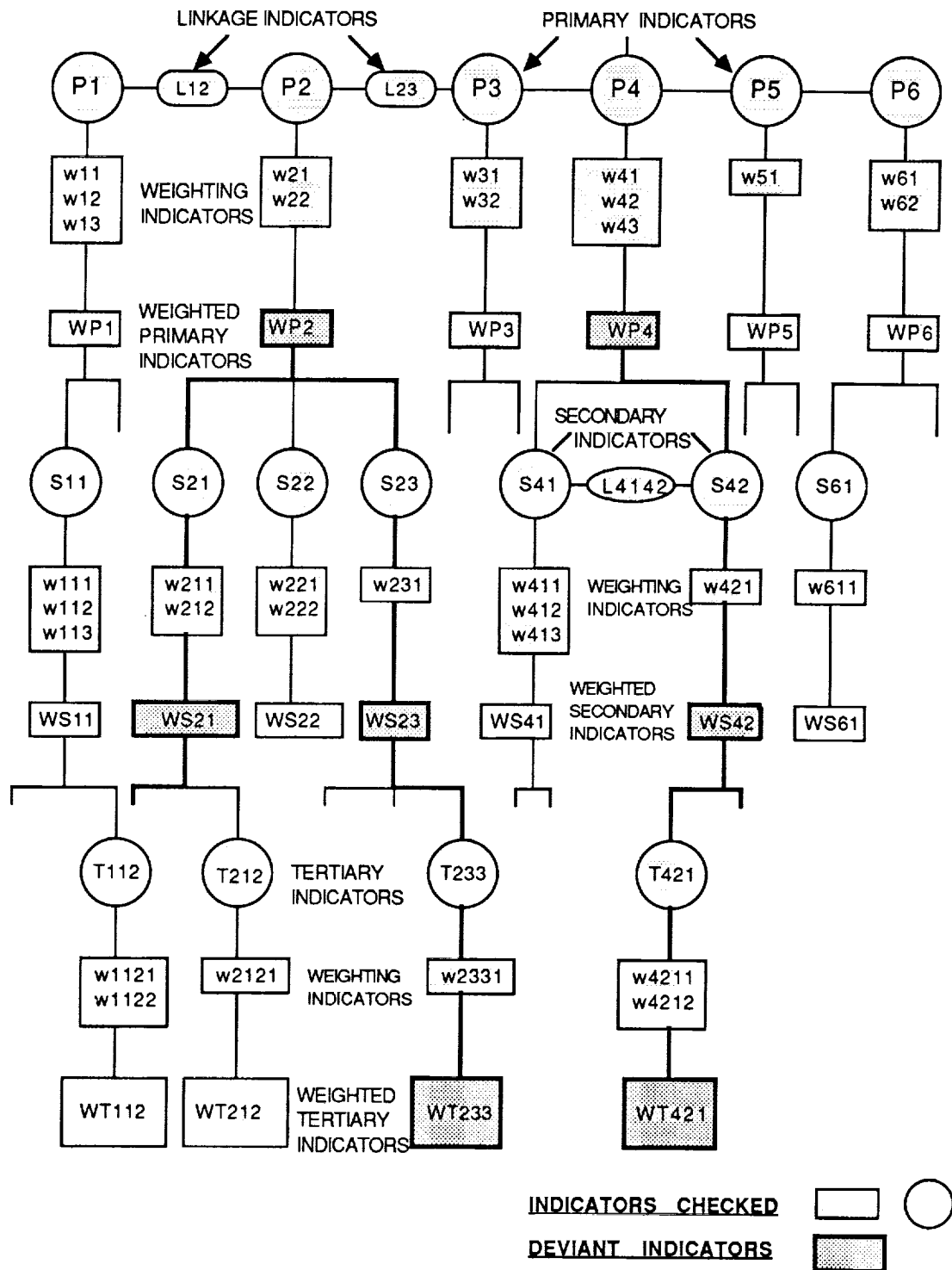

**SELECTING FROM A TYPICAL FAMILY OF INDICATORS**

**FIGURE 2**

<b>Narrative Summary</b>	<b>Objectively verifiable indicators</b>	<b>Targets</b>	<b>Means of verification</b>	<b>Major assumptions</b>
<b>Goal</b>				
<b>Objective</b>				
<b>Target</b>				
<b>Output</b>				
<b>Input</b>				

**LOGICAL FRAMEWORK MATRIX USED BY USAID<sup>10</sup>**

**FIGURE 3**

<b>Project structure</b>	<b>Indicators of Achievement</b>	<b>How indicators can be quantified or assessed</b>	<b>Important Assumptions</b>
<b>Wider (ie sector or national) objectives</b>			
<b>Immediate objectives</b>			
<b>Outputs</b>			
<b>Inputs</b>			

**PROJECT FRAMEWORK USED BY THE ODA  
(OVERSEAS DEVELOPMENT ADMINISTRATION OF UK)<sup>11</sup>**

**FIGURE 4**

C-2

The matrix or hybrid project matrix structures typical of projects may be inadequate to convey the mechanisms of mega-project operations. Additional dimensions are introduced by the multiple stake-holders.

For example the consortium of contractors on the Channel tunnel is composed of 5 major British and 5 major French contractors. The Eurotunnel client is similarly diverse. Joint ventures in Aerospace have exposed project participants to even wider ranges of diversity. Build, Operate and Transfer (BOT) type contracts (and their variations) for major infrastructure projects bring together an array of stake-holders with an apparent multiplicity of objectives, from various countries and cultures.

Thus a third dimension (at the very least) is needed in the organisational picture to accommodate the multiple organisations, each of which have their own functional hierarchies; from each of which in turn, project participants will be drawn. The participants therefore have linkages (however weak) to their parent organisations as well as to their functional disciplines. The nature of each industry (and specific factors such as mobility therein) would determine the relative strengths of such linkages. Evaluators of mega-projects need to make allowances for such linkages and loyalties; and to be aware of the particular management structures, styles and operative information flow mechanisms.

#### 4.2 Integrating evaluation mechanisms into management systems

Another characteristic of most mega-projects is that the special priorities and conditions governing them are that much more different from the average. While every project is unique, and therefore diverges from each other in most respects, such divergences are magnified many fold in mega-projects. However the assimilation and analysis of databanks of relevant information from 'similar' projects is an important step in placing the project in context.

Project planning is another critical function in such mega-projects. The multi-attribute success criteria of multiple stake-holders is hopefully translated into meaningful management targets.

It is an obvious advantage to build in monitoring, evaluation and control (remedial) systems to integrate with the management systems. For instance the management information system disseminating information required to run the job can be designed to retrieve reports for review. The Quality Assurance or Safety systems could have similar built in evaluation mechanisms.

'Bechtel' which manages many mega-projects has installed systems where the 'Controls' function incorporating progress and cost control personnel, is separated from the 'Management' function; perhaps so that an independent assessment is facilitated. However the actual information gathering could be integrated to prevent duplication; apart from specific

investigations from time to time which are necessary to vary the procedures so as to minimise cheating; to cater to specific situations and to evaluate from fresh angles.

#### 4.3 Integrating progress, cost and quality management systems

Progress and cost control systems have been advantageously integrated under 'earned value' analysis where cost and schedule variances are generated. The U.S. Departments of Defence and Energy for example have used 'cost/schedule control system criteria' (C/SCSC) to interrelate work scope definition, schedule, estimate/budget, physical performance and actual expenditure<sup>12</sup>.

'Cost trending' is a similar procedure used for example, in the Airport Core Programme in Hong Kong where project cost, scope and programming are continuously monitored and hopefully controlled.

Recent international emphasis on quality, 'galvanised' contractors, consultants and even large client organisations to seek accreditation under ISO 9000 or the relevant local standards such as BS5750. Quality now has to be 'designed, in' 'built in' and 'assured' rather than checked or inspected for after the event. One of the key advantages of installing internal systems geared to such accreditation is the opportunity to incorporate recording and reporting sub-systems that can also service the monitoring and evaluation functions. The discipline instilled in maintaining these provisions, helps overcome previous resistance to such procedures.

Another relatively recent concept is that of using 'feedforward' mechanisms that alert management to deviations in inputs; rather than relying only on feedback from output variances.

#### 4.4 Trends in mega-projects; and related criteria and indicators of evaluation

Jargon such as 'out-sourcing' 'down-loading' and 'down-sizing' operations, convey the moves towards sub-contracting out specific activities to specialists while whittling down one's own operations to core activities and interface management. 'Joint-venturing' and 'partnering' are other manifestations of similar trends. Claims of interface interference by the many interacting parties can thus prove crucial.

This leads to criteria and indicators such as numbers and values of claims, related to numbers of such interfaces and values of such work packages.

Some clients and consultants even use (official or unofficial) indicators of the 'claims - consciousness' of contractors, in order to weight tenders accordingly. Of course such indicators should themselves be weighted by the circumstances (of justification or otherwise) of the original claims. Diverse

sources of information contribute to construct such indicators. eg: the number of referrals to arbitration; the number of rejections therefrom; comparisons with other contractors.

Disputes themselves are not settled only by litigation or arbitration but by mediation, conciliation etc. Alternative dispute Resolution (ADR) underlines the philosophy of such new approaches; just as alternative procurement systems are spawning many variations of contracting for design, supply and construction services. For instance alternative contracting is now challenging the traditional lowest - bid system even in public-sector construction in USA<sup>13</sup>. Even payments are linked to the statistical quality of work, for example on some New Jersey DOT sponsored highway construction projects. Statistical indicators of concrete or asphalt strength, thickness, smoothness and riding quality can enhance contractors payments up to 103% of contract value. The trade-off is in less maintenance and future repairs.

Impact evaluation would continue to rely heavily on variance indicators to assess deviations from set targets, while implementation evaluation also uses indicators of resource utilisation or resource idling rates. The evaluation of social and environmental costs and benefits in computing Economic Rates of Return for example, are areas where evaluation expertise needs refinement.

The effectiveness of technology transfer is a sensitive area in mega-projects that straddle national boundaries. The evaluation of cross-benefits that accrue to, and costs incurred by joint-venture partners is another crucial area where criteria and indicators used are often inadequate to track the longer term impacts and trace the wider repercussions of participation in such mega-projects. The Asia & Pacific Centre for Transfer of Technology (of ESCAP) formulated a system of evaluating technology content using sets of indicators related to 4 different aspects of technology<sup>14</sup>.

Trends appear to favour the increasing 'size' of mega-projects; as the benefits of comparative advantages (for instance of different operations in different nations) and of synergistic linkages gradually overcome traditional apprehensions. 'Drivers' are also derived from providing opportunities to regions in temporary recession or decline for example; while resistance arises for instance from heightened environmental apprehensions aroused by mega-impact projects.

However the need to tackle environmental, Space exploration and even ocean exploitation endeavours on a broader basis, justify the overall push towards globalisation. This will perhaps herald the supra-mega-projects of the future.

Such trends highlight the needs not only to develop technologies of supra-mega -project management, but also for their realistic evaluation, so as to continue improving that management.



#### 4.5 Concluding observations

'Trade-offs' are often warranted where for example high performance against one criterion is sacrificed to enable exceptional performance against others which are of higher priority, as for example illustrated in Figure 5. While such 'trade-offs' are easier appreciated and accommodated on small projects with less stake-holders, they become the source of conflict in multi-participant mega-projects. Even if agreed, unless it is explicitly so, these could lead to conflicts and unfair future evaluations. The moral is the enhanced importance of a detailed project brief in mega-projects; and also the criticality of the conceptualisation phase where such trade-offs are best incorporated; rather than making adjustments mid-stream in the project when the costs of disruption can be tremendous.

The multi-dimensional character of mega-projects arise from the usually multi-disciplinary, multi-cultural multiple stake-holders and warrant multi-attribute evaluations which can become somewhat complex, and more so in view of the foregoing trade-offs, that may continue in the dynamic project environment.

The purpose of this paper is to focus on the evaluation of mega-projects and to highlight the need for a systematisation of approaches based on multi-dimensional criteria (and sub-criteria) and appropriate indicators for measuring against such criteria and sub-criteria. Data banks of previous project parameters are useful to assess and weight 'norm values' of such indicators so as to facilitate more realistic expectations. Their usefulness presupposes classification according to appropriate categories and sub-categories. The multiplicity of such variables (criteria, indicators and weighting factors) and the ranges of possible values led the author to propose (a) a modular structure and (b) a knowledge-based front-end to facilitate the efficient use of such a system. It's viability<sup>9</sup> was demonstrated in a pilot construction project evaluation system<sup>9</sup>.

The evaluation system should not grow so complex as to 'hide the wood for the trees'. Furthermore the rewards from evaluation as in improved performance on on-going and future projects should exceed the costs of the evaluation itself. Such objectives are easier to ensure through the foregoing systematisation of broad approaches to evaluation. A given broad core approach can be selected to suit a particular category of projects; and then modified according to particular project priorities and contextual conditions<sup>9</sup>.

The integration of evaluation mechanisms into the planning, operational and information sub-systems further facilitates efficient evaluations. The next question that surfaces relates to the effectiveness and efficiency of the evaluation itself; possibly leading on to the evaluation of the evaluations and evaluators themselves.

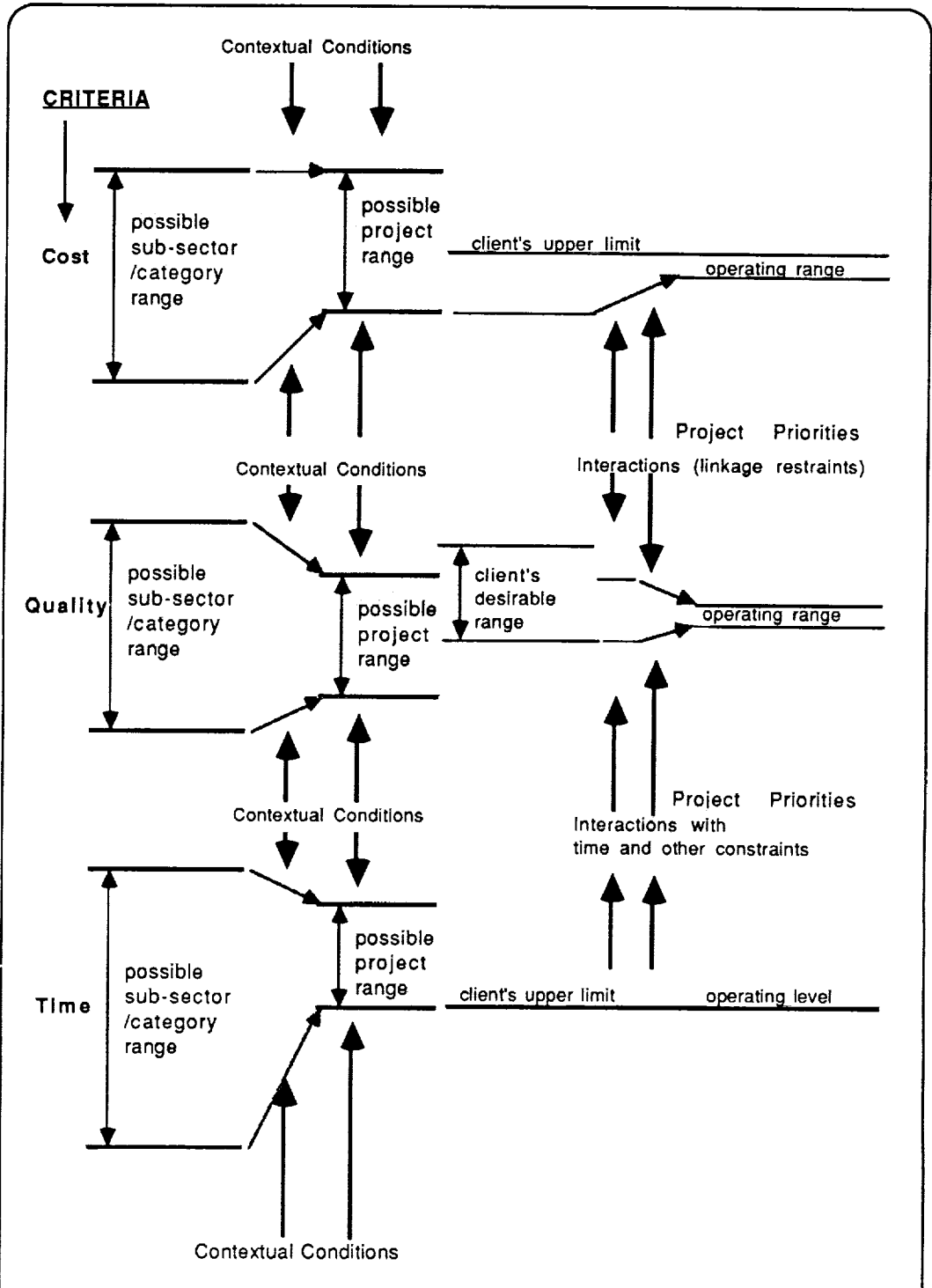

**EXAMPLE OF THE NARROWING RANGES OF PERFORMANCE CRITERIA DUE TO CONTEXTUAL CONSTRAINTS AND PRIORITY INTERACTIONS**

**FIGURE 5**

## REFERENCES

1. Zhao chan-shao, "Brief Presentation on the Three Gorges Project (General Report)", One -Day symposium on the Three Gorges project, Hong Kong, March 1993.
2. N. Doyle, "Claim talks crisis hits Chunnel deadline", Construction Today, ICE, UK, April 1993.
3. G.S. Evans, R.L. Haury & G.M. Stricklin, "The Denver Airport: Managing a Megaproject", Civil Engineering Journal, ASCE, USA, May 1993.
4. N. Imboden, "A management approach to project appraisal and evaluation" Development Centre for the Organisation for Economic Co-operation and Development, 1978.
5. Overseas Development Administration, "Guidelines for the preparation of evaluation studies", ODA, UK, May 1988.
6. R.K. Corrie, "Project Evaluation", Thomas Telford, 1991
7. M. Scriven, "Evaluation Thesaurus", Sage Publications 4th Edition, 1991.
8. D.B. Ashley, C. S. Lurie and E. J. Jaselkikis "Determinants of Construction Project Success", Project Management Journal, Volume XVIII, No2, June 1987.
9. M.M. Kumaraswamy "Evaluating the management of construction projects", Ph.D Thesis, Loughborough University of Technology, U.K., 1991.
10. USAID, 'Project Assistance Handbook 3', United States Agency for International Development, 1975.
11. Cracknell, B. E. and Rednall, J.E. "Defining Objectives and Measuring Performance in Aid Projects and Programmes" EV384, ODA, August 1986.
12. A.E. Kerridge and C.H. Vervalin, (Ed) "Engineering & Construction Project Management", Gulf Publishing company, 1986.
13. P. Tarricone, "Deliverance", Civil Engineering Journal, ASCE, USA, Feb. 1993.
14. Asia & Pacific Centre for Transfer of Technology (of the ESCAP) "Technology Content Assessment -Vol. 12 - A framework for Technology based development planning", ESCAP, Bangalore, India, 1989.

Peter Alan Robinson

Telstra Corporation Ltd  
231 Elizabeth Street, Sydney 2000, Australia

### ABSTRACT

Frequency Comb Multiple Access (FCMA) is a new combined modulation and multiple access method which will allow cheap hubless Very Small Aperture Terminal (VSAT) networks to be constructed. Theoretical results show bandwidth efficiency and power efficiency improvements over other modulation and multiple access methods. Costs of the VSAT network are reduced dramatically since a hub station is not required.

### 2. INTRODUCTION

VSAT networks have become increasingly important in the satellite communications arena over the last decade<sup>1</sup>. Predominantly, VSATs have been arranged in hubbed satellite communications networks: either single-hop to or from a hub station or double-hop systems. FCMA is a new combined modulation and multiple access technique which lends itself to a meshed, hubless satellite communications network configuration. FCMA has been investigated in several papers<sup>2345</sup>. This paper briefly describes VSAT network configurations, FCMA and why FCMA is a suitable modulation method for hubless satellite communications networks.

### 3. VSAT NETWORK CONFIGURATIONS

VSAT networks have typically been arranged in a star configuration as shown in the figure below. In this configuration a number of VSATs communicate through or via a hub station.

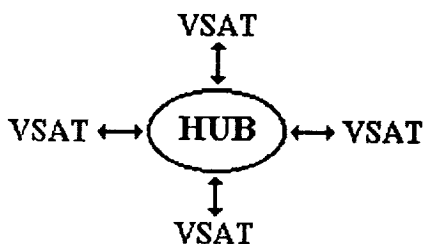

In a single-hop system the VSATs communicate with the hub station only. For example: a hub station could be located at company headquarters and VSATs at each company outlet. Information is only communicated between the VSATs and the hub station and not

between VSATs. Another example is satellite television. In this case information is transferred solely from the hub station to the VSATs.

In a double-hop system VSATs communicate with each other via the hub station. In a network such as this a VSAT sends data to the hub station which then sends information to a second VSAT. The second VSAT sends information back to the first VSAT via the hub station. An example of this type of network is a satellite telephone service.

In a meshed VSAT network there is no hub station as shown below. Many of the applications which have used double-hop networks can be used with a meshed network.

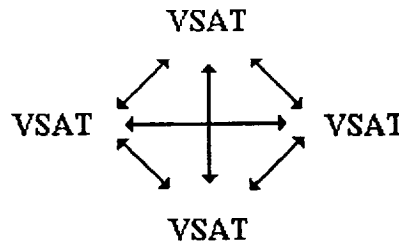

Previously, meshed networks have not been a viable option as VSATs are power limited and hence link budgets could not be met. VSATs are power limited because they use small dish antennas and low-power transmitters to reduce cost. Hughes Network Systems have developed a meshed telephony network using frequency division multiple access (FDMA). Because FDMA is not as power efficient as FCMA, the Hughes system requires larger antennas to meet link budget requirements than would be required for an FCMA system. The only other modulation method which lends itself well to use in a meshed environment, direct sequence code division multiple access (DS-CDMA), is bandwidth inefficient. FCMA can meet link budget requirements and is bandwidth efficient.

Meshed VSAT networks are cheaper than star VSAT networks because no hub is required. This reduced cost will allow new applications of VSAT networks to evolve.

#### 4. FREQUENCY COMB MULTIPLE ACCESS

FCMA symbols are transmitted as a set of  $w$  frequencies called a signature. Each receiver has  $2^k$  signatures in its received signal set where the data transmission rate is  $k$  bits per symbol. When a VSAT transmits data to another VSAT, it transmits signatures which belong solely to the recipient VSAT.

The diagram below shows a basic FCMA transmitter - receiver block diagram. Input data is mapped to the received signal set of the VSAT which is to be the recipient of the message. The signature frequencies are then created by a  $w$ -tone FSK modulator. The signal is then up-converted, amplified, transmitted to a satellite, retransmitted by the satellite and finally received and down-converted by the receiving VSAT. Signatures are

detected by a combination of a matched filter and a detector. The detector decides which signature has been received by a criteria of magnitude and phase. The received signature is mapped to a data sequence which is then outputted.

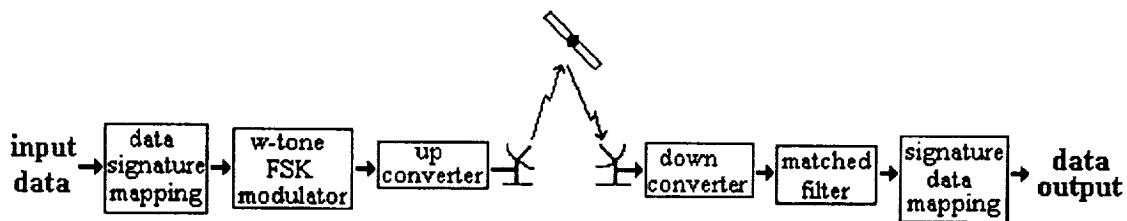

## 5. FCMA AND HUBLESS VSAT NETWORKS

In an FCMA system the number of frequencies which can be used for signatures is finite: 256 being common. If the number of frequencies per signature is five ( $w=5$ ), if there are sixteen signatures per signature set ( $k=4$ ), and if there are 256 frequencies available then only three users can be accommodated without overlap ( $3 \times 5 \times 2^4 = 240$ ). So that many users can be accommodated, overlap of one frequency per signature is allowed. This overlap of signatures between users causes inter-user interference. When more users are transmitting, there is more inter-user interference causing more data errors. Hence, as the number of simultaneous-users increases, there is a graceful degradation of service. This is required as without a hub controlling the network, there must be some way to ensure service can still be provided even in times of peak usage.

FCMA is able to meet link-budget requirements where other modulation methods can't because it uses powerful encoding methods. The encoding methods which can be used with FCMA require a multi-signal, mutually orthogonal signal set. This criterion is generally not available with other modulation methods. Hence, the power efficiency of FCMA allows it to be used in a hubless network.

## 6. CONCLUSION

Frequency Comb Multiple Access is a combined modulation and multiple access method which is well suited to use in hubless satellite communications networks. Due to powerful encoding methods, it enables VSATs to communicate in a single hop without need for a hub. A graceful degradation of service is inherent in this multiple access technique.

Since a hub station is not required, the satellite communications network is cheaper than other VSAT networks. This will allow new and innovative applications of VSAT networks.

## 7. ACKNOWLEDGMENTS

The permission of Telstra Corporation Ltd to publish this paper is much appreciated. The views and opinions expressed in this paper are those of the author, and do not necessarily imply Telstra policy or future services offerings. The author would like to thank Roksana Boreli and Geoff Richardson for reviewing this paper.

## 8. REFERENCES

1. T. T. Ha, Digital satellite communications, Second Edition, p586, McGraw Hill, USA, 1990.
2. T. Stevenson and K. W. Yates, *A new multiple access technique for packet satellite communications*, International Symposium on Signals, Systems and Electronics, Erlanger 1989.
3. R. A. Z Simington, *New frequency domain techniques for DSP based VSAT modems*, Proceedings of the IREECON 1991, pp428-429, 1991.
4. K. W. Yates et al, *A new combined modulation and multiple access scheme for VSATs*, 9th International Conference on Digital Satellite Communications, pp399-406, 1992.
5. R. Boreli, K. W. Yates, *FCMA Error Probability in AWGN and Multiple Access Noise*, International Conference on Communication, 1993.

# A STUDY OF THE SPACE STATION '*FREEDOM*' RESPONSE TO THE DISTURBANCE ENVIRONMENT

A. Suleman,\* V.J. Modi,\*\* and V.B. Venkayya \*\*\*

Flight Dynamics Directorate  
Wright Laboratory, WL/FIBR  
Wright-Patterson AFB OH 45433-6553

## ABSTRACT

A relatively general formulation for studying the dynamics and control of an arbitrary spacecraft with interconnected flexible bodies has been developed<sup>1</sup>. This self-contained and comprehensive numerical algorithm using system modes is applicable to a large class of spacecraft configurations of contemporary and future interests. Here, versatility of the approach is demonstrated through the dynamics and control studies aimed at the evolving Space Station *Freedom*.

## 1. INTRODUCTION

The next generation of communications satellites, Space Shuttle based experiments, proposed Space Station *Freedom*, and many others belong to a class of systems which are large and flexible, and their analysis is amenable only to numerical simulation requiring efficient algorithms. A challenge faced by engineers is to simulate the dynamics and control of such systems using accurate mathematical models.

Given the large size of these orbiting systems and the expected growth from the initial operational configuration, the structural flexibility will be a key parameter governing their dynamical behaviour. The presence of environmental and operational disturbances will only add to the complexity of the problem. Hence thorough understanding of interactions between librational dynamics, flexibility, inertia and orbital parameters as well as initial disturbances is of importance.

With this as background, the paper presents a rather self-contained and comprehensive numerical algorithm for simulating dynamical behaviour of large space structures. Here, its versatility is demonstrated through the dynamics and control studies aimed at the evolving Space Station *Freedom* (Figure 1).

---

\* NRC Research Associate

\*\* Professor, University of B.C., Vancouver, Canada

\*\*\* Principal Scientist



## 2. MULTIBODY DYNAMICS FORMULATION

Having recognized the importance of flexibility, particularly with reference to large evolving space structures, there have been considerable effort aimed at general multibody formulations applicable to a wide class of flexible systems. The models considered vary significantly; however, the underlying objective is to obtain dynamic equations of motion for a system of arbitrarily connected flexible members in a branched or closed loop topological form.

The amount of time and effort involved in derivation of the equations of motion are indeed significant. The resulting kinetic and kinematic expressions as well as the governing equations of motion are quite lengthy even in matrix notation. The Lagrangian formulation has the following distinctive features:

- (a) it is applicable to an arbitrary number of beam, plate, membrane and rigid body members, in any desired orbit, interconnected to form an open branch-type topology (Figure 2);
- (b) rigid joints between the flexible members permit arbitrary large angle rotation and linear translation between the structural components;
- (c) the formulation accounts for the gravity gradient potential, the effects of transient system inertias and shift in the centre of mass;
- (d) the flexible character of the system is described by three-dimensional system modal functions obtained using the finite element method;
- (e) symbolic manipulation is used to synthesize the equations of motion thus providing a general and efficient modelling capability with optimum allocation of computer resources;
- (f) the governing equations are programmed in a modular fashion to isolate the effects of appendage slewing and translation, librational dynamics, structural flexibility and orbital parameters;
- (g) operational disturbances (Space Shuttle docking, crew motion and maintenance operation maneuvers) have been implemented in this dynamic simulation tool. Other disturbances can easily be incorporated through generalized forces and initial conditions;
- (h) both the nonlinear and linear forms of the equations of motion have been formulated to permit assessment of a wide variety of control strategies, both linear and nonlinear.

The governing equations of motion can be obtained from

$$\frac{d}{dt} \left( \frac{\partial T}{\partial \dot{\bar{q}}} \right) - \frac{\partial T}{\partial \bar{q}} + \frac{\partial U}{\partial \bar{q}} = \bar{F}_q,$$

where  $\bar{q}$  and  $\bar{F}_q$  represent the generalized coordinates and associated forces, respec-

tively. The above equations can be rewritten in vector form as

$$\mathbf{M}(\bar{q}) \bar{q}'' = \begin{Bmatrix} \bar{Q}_\theta \\ \bar{Q}_p \end{Bmatrix},$$

where:

$$\begin{aligned} \bar{Q}_\theta = & \frac{d}{dt} \left( \frac{\partial \bar{\omega}^T}{\partial \dot{\bar{\theta}}} \right) \mathbf{I} \bar{\omega} - \frac{\partial \bar{\omega}}{\partial \dot{\bar{\theta}}} \frac{d}{dt} \mathbf{I} \bar{\omega} - \frac{\partial \bar{\omega}^T}{\partial \dot{\bar{\theta}}} \mathbf{I} \frac{d\bar{\omega}}{dt} - \frac{d}{dt} \left( \frac{\partial \bar{\omega}^T}{\partial \dot{\bar{\theta}}} \right) \bar{H} \\ & - \frac{\partial \bar{\omega}^T}{\partial \dot{\bar{\theta}}} \frac{d\bar{H}}{dt} + \frac{\partial \bar{\omega}^T}{\partial \bar{\theta}} \mathbf{I} \bar{\omega} + \frac{\partial \bar{\omega}^T}{\partial \bar{\theta}} \bar{H} + \frac{\partial U}{\partial \bar{\theta}}; \end{aligned}$$

$$\begin{aligned} \bar{Q}_p = & - \frac{d}{dt} \left( \frac{\partial \sum T_i}{\partial \dot{\bar{p}}} \right) - \frac{d}{dt} \left( \frac{\partial \bar{H}}{\partial \dot{\bar{p}}} \right)^T \bar{\omega} - \left( \frac{\partial \bar{H}}{\partial \dot{\bar{p}}} \right)^T \frac{d\bar{\omega}}{dt} \\ & + \frac{\partial \sum T_i}{\partial \bar{p}} + \frac{1}{2} \bar{\omega}^T \frac{\partial \mathbf{I}}{\partial \bar{p}} \bar{\omega} + \left( \frac{\partial \bar{H}}{\partial \bar{p}} \right) \bar{\omega} + \frac{\partial U}{\partial \bar{p}}. \end{aligned}$$

Here  $\mathbf{M}(\bar{q})$  represents the nonlinear mass matrix, while  $\bar{Q}_\theta$  and  $\bar{Q}_p$  correspond to the nonlinear stiffness, gyroscopic and forcing terms for the librational and vibrational degrees of freedom, respectively.  $\bar{H}$  is the angular momentum with respect to the orbital frame;  $\bar{\omega}$ , the librational velocity vector;  $\mathbf{I}$ , the inertia matrix; and  $\sum T_i$ ; the total kinetic energy due to the structural flexibility. The vector  $\bar{q}$  is comprised of two vectors,  $\bar{\theta}$  and  $\bar{p}$ , where  $\bar{\theta} = \{\psi, \phi, \lambda\}$  for the librational degrees of freedom and  $\bar{p} = \{p_1, p_2, \dots, p_n\}$  for the vibrational degrees of freedom.

### 3. ATTITUDE CONTROL METHODOLOGY

Nonlinear control has received considerable attention in the past decade, particularly in the robotics applications. Linear control techniques based on either the Bellman's principle of optimality or on the Pontryagin's maximum principle, fail to provide reliable and accurate results, particularly when the nonlinearities of the system become important. To overcome this limitation, Freund<sup>2</sup> proposed the use of the state feedback to decouple the nonlinear system in such a way that an arbitrary placement of poles becomes possible.

Inverse control, based on the Feedback Linearization Technique (FLT), was first investigated by Bejczy<sup>3</sup> and used by Singh and Schy<sup>4</sup> for control of a rigid arm robot. Spong and Vidyasagar<sup>5</sup> also used the FLT to formulate a control procedure for rigid manipulators. Given a dynamical model of the system, the controller first utilizes the feedback to linearize the system followed by a linear compensator to achieve the desired output. Here, the FLT is applied to the FMC of the Space Station to achieve attitude control in the presence of structural flexibility.

### 3.1 Feedback Linearization Technique

This procedure has been applied with success in many control problems dealing with rigid systems. A particular application is in the trajectory tracking of a given structure where the dynamics involves only the rigid modes. For example, consider a system described by a set of equations in the form

$$\mathbf{M}(\bar{\theta}, t)\ddot{\bar{\theta}} + \bar{F}(\bar{\theta}, \dot{\bar{\theta}}, t) = \bar{Q}_{\bar{\theta}}(\dot{\bar{\theta}}, \bar{\theta}, t), \quad (1)$$

where the generalized coordinate vector accounts only for the rigid degrees of freedom. The objective is to seek a nonlinear feedback control  $\bar{Q}_{\bar{\theta}}(\dot{\bar{\theta}}, \bar{\theta}, t)$ , which when substituted in the above equation leads to a linear closed loop system. It has been shown<sup>6</sup> that, the resulting system becomes asymptotically stable around the nominal trajectory if the driving control efforts are given by

$$\bar{Q}_{\bar{\theta}} = \mathbf{M}(\bar{\theta}, t)\bar{v} + \bar{F}(\bar{\theta}, \dot{\bar{\theta}}, t),$$

where

$$\ddot{\bar{\theta}}_d + \mathbf{K}_v(\dot{\bar{\theta}}_d - \dot{\bar{\theta}}) + \mathbf{K}_p(\bar{\theta}_d - \bar{\theta}) = \bar{v}, \quad (2)$$

and  $\bar{\theta}_d$ ,  $\dot{\bar{\theta}}_d$  and  $\ddot{\bar{\theta}}_d$  correspond to the desired trajectory characteristics. Here  $\mathbf{K}_p$  and  $\mathbf{K}_v$  are the  $3 \times 3$  matrices of position and velocity feedback gains, respectively. They are so chosen as to insure stable behaviour of the tracking error,  $\bar{e} = \bar{\theta} - \bar{\theta}_d$ , given by

$$\ddot{\bar{e}} + \mathbf{K}_v\dot{\bar{e}} + \mathbf{K}_p\bar{e} = \mathbf{0}. \quad (3)$$

A suitable choice for  $\mathbf{K}_p$  and  $\mathbf{K}_v$  is

$$\mathbf{K}_p = \text{diag}\{\chi_1^2, \dots, \chi_n^2\}; \mathbf{K}_v = \text{diag}\{2\chi_1, \dots, 2\chi_n\},$$

where  $\chi_i$  and  $\zeta$  represent the controller frequency and damping ratio, respectively. This results in a globally decoupled system with each generalized coordinate responding as a second-order damped oscillator. The natural frequencies  $\chi_i$  determine the speed of response of the corresponding generalized coordinates. A larger value of  $\chi_i$  gives rise to a faster response of the  $i$ th degree of freedom.

Recently, Karray and Modi<sup>7</sup> have extended the FLT to include structural flexibility for a model of an orbiting manipulator system. The basic idea here is to design a controller capable of transforming the rigid part of the dynamics into a canonical, decoupled state space model. This, obviously, implies a completely controllable system. Note, here the state of the system is not transformed through a diffeomorphic mapping; rather it is the control effort that makes the rigid part of the system behave as if it were completely linear. Also it is important to notice that if the system were not in the form similar to that in Eq. (1), then a diffeomorphic transformation and a special form of the control effort are needed for reducing the system to the canonical form.

Now, if the observable states are chosen to be the components of the rigid mode subvector  $\bar{\theta}$ , then by selecting a suitable control vector  $\bar{Q}_\theta$ , the linearized equations of motion become

$$\ddot{\bar{\theta}}(\psi, \phi, \lambda) = \bar{v},$$

where:

$$\bar{Q}_{\bar{\theta}} = \tilde{M}\bar{v} + \tilde{F},$$

with

$$\tilde{M} = [M_{\theta,\theta} - M_{p,\theta}^T M_{p,p}^{-1} M_{p,\theta}]; \quad \tilde{F} = [\bar{F}_\theta - M_{p,\theta}^T M_{p,p}^{-1} \bar{F}_p];$$

and  $\bar{v}$  takes the form given in Eq. (2). The control effort can be expressed as the sum of two parts,  $\bar{Q}_{\theta_1}$  (primary) and  $\bar{Q}_{\theta_2}$  (secondary):

$$\bar{Q}_{\theta_1} = \tilde{M}\ddot{\bar{\theta}}_d + \tilde{F}; \quad \bar{Q}_{\theta_2} = \tilde{M}(K_v\dot{\bar{e}} + K_d\bar{e}).$$

The primary controller is so designed as to compensate for the nonlinear effects corresponding to rigid part of the system. In practice, the system properties and the dynamical model are usually not precisely known. To account for modelling uncertainties, i.e. to impart robust character, a secondary controller  $\bar{Q}_\theta$  is introduced. The function of the primary controller is to offset the nonlinear effects inherent in the attitude degrees of freedom; whereas the secondary controller ensures robust behaviour of the error. The question of flexible modes which interact with the rigid ones through  $M_{\theta,p}$  still remains as they are needed for computation of the control effort  $Q_\theta$ . Two different control schemes are proposed to that end: one leads to a Quasi-Open Loop Control (QOLC) procedure; while the other is termed the Quasi-Closed Loop Control scheme.

### 3.2 Quasi-Open Loop Control

The central idea here is to evaluate flexibility generalized coordinates through an off-line procedure, i.e., dynamics of the  $\bar{p}$  is computed independent of  $\bar{\theta}$  (Figure 3a). However, it is still governed by the desired trajectory specified for the rigid degrees of freedom as characterized by  $\ddot{\bar{\theta}}_d$ ,  $\dot{\bar{\theta}}_d$  and  $\bar{\theta}_d$ . Thus the dynamics of  $\bar{p}$  evolves according to

$$\ddot{\bar{p}} = -M_{p,p}^{-1} \{M_{p,\theta} \bar{v} + \bar{F}_p(\bar{\theta}_d, \dot{\bar{\theta}}_d, \bar{p}, \dot{\bar{p}})\}.$$

Integration of this set of equations, which can be carried out off-line, permits the designer to assess the evolving behaviour of  $\bar{p}$  and  $\dot{\bar{p}}$ , and compute the control effort  $\bar{Q}_\theta$  with the tracking error vector governed by Eq. (3). Of course, this implies the dynamics of the flexible generalized coordinates to be stable for the control study. It is important to recognize that the choice of  $\bar{v}$  as in Eq. (2), instead of being simply  $\ddot{\bar{\theta}}_d$ , gives the system a more robust behaviour, similar to that attained with a proportional plus derivative controller.

### 3.3 Quasi-Closed Loop Control

Here, responses in the rigid and flexible degrees of freedom are computed simultaneously according to the following dynamical relations:

$$\ddot{\bar{\theta}} = \bar{v}$$

$$\ddot{\bar{p}} = -\mathbf{M}_{p,p}^{-1} \{ \mathbf{M}_{p,\theta} \bar{v} + \bar{F}_p(\bar{\theta}, \dot{\bar{\theta}}, \bar{p}, \dot{\bar{p}}) \}.$$

Now  $\bar{F}_p$  is a function of  $\bar{\theta}$  and  $\dot{\bar{\theta}}$  instead of being governed by  $\bar{\theta}_d$  and  $\dot{\bar{\theta}}_d$  (Figure 3b). The disadvantage of the scheme is the relatively large computational effort as compared to QOLC. However, the QCLC is less sensitive to system uncertainties.

#### **4. RESPONSE TO OPERATIONAL DISTURBANCES**

A study of the First Milestone Configuration (FMC) was undertaken to assess effects of operational disturbances on the system response. Objective was to predict acceleration levels imposed on the station during the operational maneuvers leading to unacceptable dynamics in terms of pitch, roll and yaw response; vibrational displacements, velocities and acceleration profiles at various locations on the Space Station; and torque demands by the controller.

##### **4.1 Nominal Configuration**

The first forty system modes (including the six rigid body modes) for the First Milestone Configuration (FMC) were obtained to represent the structural flexibility of the continuous system.

The frequency spectrum provides the free vibration frequencies and associated system modes. The mode characterization helps appreciate the relative contributions of different parts of the Station to each system modal frequency.

In general, modal displacements fall into the following three categories:

- (a) **Solar Array Deformation Modes**: these are the modes in which the solar arrays deform significantly in and out of the X-Y plane as cantilever plates and the remainder of the Station responds only slightly so as to maintain the dynamic equilibrium. Modes which are dominated by the twisting motion of the array plates are also included in this category.
- (b) **Radiator Modes**: These are associated with the PV radiator deformations, which has designed to have a fundamental bending frequency of 0.1 Hz.
- (c) **Stinger/RCS Boom Coupled Modes**: these components are designed to have a fundamental bending frequency of 0.5 Hz, so they appear in combination in the system modes.
- (c) **Overall System Modes**: in general, these modes involve an overall motion of the Station, with solar array and radiator deformations coupled with response of the main truss in and out of the X-Y and X-Z planes.

For the earlier proposed FMC, the appendage response in bending dominated the first six elastic modes ( $f_7 - f_{12}$ ) with frequencies in the range of 0.1 - 0.5 Hz (Figure 4). Of these, the first three modes ( $f_7, f_8, f_9$ ) pertain to the PV array and radiator while  $f_{10} - f_{12}$  correspond to the RCS boom and stinger assembly. It is of interest to recognize that the torsional motion of the main truss is represented by  $f_9$  while the corresponding bending in Z and Y directions correspond to  $f_{21} = 2.30$  Hz and  $f_{22} = 2.35$  Hz, respectively. Note, the stinger and RCS boom motions are coupled as both have a fundamental frequency of 0.5 Hz. On the other hand, the PV arrays and radiators have their fundamental component frequency of 0.1 Hz as cantilevers. The solar array deformation modes display pure torsional motion in symmetric and asymmetric modes at  $f_{16}$  and  $f_{17}$  (1.14 Hz) with higher harmonics represented by  $f_{24}, f_{25}$  (2.4 Hz) and  $f_{31}, f_{32}$  (5.97 Hz).

## 4.2 Solar Array Sun Tracking

The Space Station attitude orientation will be in the Local Vertical-Local Horizontal (LVLH) mode, with its main truss along the local horizontal and the solar arrays perpendicular to the orbital plane. The arrays are provided with the rotational capability, about the alpha and beta joints, in order to track the sun for optimum exposure. Another design objective, which will require rotation of the solar panels, is to maintain a "feathered" flight configuration in order to reduce the aerodynamic drag. Obviously, changes in the orientation of the solar panels due to these maneuvers will affect structural flexibility characteristics of the Space Station and the associated frequency spectrum. The rotational rates of the solar panels are relatively slow, such that a quasi-static condition prevails during the maneuver.

For a 90° rotation of the solar panels about the  $\alpha$ -joint (Figure 5a), the frequency spectrum undergoes significant changes, particularly at modes 16, 18, 19, 25, 27, 29 and 33, with variations as large as 35% in mode 16. Analysing the modal displacements, mode 27 starts with the solar arrays undergoing torsional motion, and as the maneuver progresses, the deformations become predominant in bending. Similar changes in the behaviour were observed in other modes as well. For instance, mode 18 exhibited main truss bending about Y-axis coupled with solar array bending at the start of the maneuver, and by the end, the structural response was characterized entirely by the torsional motion of the arrays. Also of interest is the interchange of modal energy among the modes and between the components in the same mode. For mode 29, large bending displacements of the solar panels coupled with slight bending of the radiator, stinger and RCS boom were observed in the nominal configuration. By the end of the maneuver, the radiator exhibits large modal displacements with a small motion of the solar arrays.

This information is utilized in the multibody dynamics simulations such that the modes are updated, so as to maintain an accurate representation of the flexibility of the system during the maneuver. The simulation is carried out for 0.25 orbit

(25 minutes), with a total array rotation of  $90^\circ$  at an angular velocity  $\dot{\Theta}$ . The modes are updated at  $15^\circ$  intervals and the nonlinear controller gains are based on  $\chi = 10^{-2} \text{ rad/s}$  and  $\zeta = 1$ .

Figure 5b shows the dynamical response of the FMC. The control effort to maintain the Station in the LVLH orientation is minimal, with the peak  $Q_\psi = 1.4 \text{ Nm}$  and  $Q_\lambda = Q_\phi = 0.5 \text{ Nm}$ . Since the controller is commanded to drive the system to the LVLH orientation, which is not a Torque Equilibrium Attitude (TEA) position ( $\psi_e = 1.5^\circ, \lambda_e = \phi_e = 0^\circ$ ), the control effort in the pitch degree of freedom continues to persist at an average level of  $1 \text{ Nm}$ .

Of interest is the transfer of energy between the be seen that a transfer of energy is taking place. At perigee, the beginning of the maneuver, the solar panel tip deflection is larger than the PV radiator ( $3 \times 10^{-4}$  and  $3 \times 10^{-5} \text{ m}$ , respectively). At the end of the maneuver, when the spacecraft has completed 0.25 orbits, the PV radiator appears to contain most of the modal energy, with the tip displacement considerably higher than that of the solar panel. The main truss displacement at the modules location increases during the maneuver, while the microgravity levels stay well within the allowable limit of  $1.0 \mu g$ .

The effect of aerodynamic torque was also considered. The torque model accounts for the diurnal bulge at twice the orbital rate. Now, the TEA shifts from  $\psi_e = 1.5^\circ, \lambda_e = \phi_e = 0^\circ$ , to  $\psi_e = 13^\circ, \lambda_e = 9^\circ$  and  $\phi_e = 7^\circ$ . This change in equilibrium reflected in an increase in the control effort (from  $Q_\psi = 1 \text{ Nm}, Q_\lambda = Q_\phi = 0 \text{ Nm}$  to  $Q_\psi = 4.5 \text{ Nm}, Q_\lambda = 1.5 \text{ Nm}$ , and  $Q_\phi = 1.4 \text{ Nm}$ ). The solar panels and secondary members do not exhibit any significant change in behaviour, with similar responses as before in displacement and acceleration.

To summarize, rotation of the solar panels for tracking the sun, even in the presence of aerodynamic drag, is not likely to affect the microgravity experiments. Furthermore, the control effort required to maintain the spacecraft in the LVLH orientation is rather minimal.

### 4.3 MSS Operational Maneuvers

The Mobile Servicing System (MSS) manipulator arm, among other tasks, will be used to position payloads along the Space Station's main truss. Here it is proposed to investigate a maneuver designed specifically for this purpose. Consider the case where a disabled satellite has been retrieved by the Space Shuttle and delivered to the Space Station docking bay, and it is to be transferred to the maintenance depot for repair. To accomplish this task, the manipulator is commanded to perform a series of slewing and translational maneuvers. The maneuver consists of three distinct steps: (i) a  $90^\circ$  slewing motion in the plane of the solar panels, divided into four  $22.5^\circ$  increments. Each increment follows a sine-on-ramp profile; (ii) a translation of  $22.5 \text{ m}$  along the main truss, divided into five steps; and finally (iii) a  $90^\circ$  rotation to position the satellite at the the root of the solar panels, with the slewing motion

composed of  $4 \times 22.5^\circ$  steps.

The manipulator is modelled by a single arm 15 meters in length, and uniformly distributed mass of 3,200 kgs, carrying a 3,200 Kgs payload at the end.

The maneuver has been discretized into ten time steps ( $t_1 \rightarrow t_{10}$ ). During this task, the frequency spectrum undergoes significant frequency excursions in modes 11, 20, 23, 24 and 25, with changes in frequency as large as 30% in mode 20 (Figure 6a). Furthermore, the associated modal displacements also exhibited considerable changes during the maneuver as well. For example, mode 25 displays a transfer of modal energy, in this case from the manipulator arm to the PV radiator. Mode 11 started by having the strain energy stored in bending of the solar panels and PV radiator, at time step  $t_5$  the RCS boom and stinger displayed predominant modal motion, and by the end of the maneuver  $t_{10}$  the elastic energy reverted back to the PV radiator and solar arrays. Mode 20 displayed a very interesting behaviour; at the beginning of the maneuver, the motion of the main truss, at its free end, was suppressed by the presence of the robot arm, which acts effectively as an added inertia on an anti-node of a free-free beam. When the arm reaches a modal node in the main truss ( $t_6$ ), the main truss motion shows large modal displacements since the mass damper is unable to influence the main truss motion.

The ensuing dynamic response simulation is presented in Figure 6b. The various maneuvers are well demarked in the plots. It can be observed that the slewing maneuvers exert considerable disturbance to the Station environment compared to the translation maneuvers. The complete positioning task lasts 0.225 orbit (22.5 minutes). The inplane slewing of the MSS arm exerts a moment about the local vertical; this torque is transmitted to the Space Station, which in turn is counteracted by the CMGs with a corresponding peak control effort in the yaw degree of freedom ( $Q_\lambda = 1014.5 \text{ Nm}$ ). The MSS arm displays a maximum transverse tip displacement of  $3 \times 10^{-4} \text{ m}$  with corresponding acceleration of  $5\mu g$ . The acceleration levels around the modules on the main truss were found to be quite high ( $10 \mu g$ ).

Simulations were also carried out for a 1,000 kgs payload. It was observed that the control efforts and acceleration levels at various Station location decreased considerably (50%).

## 5. CONCLUDING REMARKS

Applicability and versatility of a general Lagrangian formulation are illustrated through the analysis of the First Milestone Configuration of the proposed Space Station. Predicting the dynamic response of the Space Station to disturbances encountered during normal operation are an important step in the process of defining design loads for the main truss structure, as well as for the modules and secondary components. The control effort profile to maintain the LVLH attitude orientation of the Station, the displacement and acceleration response time histories for several



locations were presented for each case and the peak response values were tabulated for comparison. The dynamic analysis results indicate that the solar array sun track maneuvers caused accelerations on the order of  $0.1 \mu\text{g}$ , and the MSS positioning operation resulted in peak acceleration of  $10 \mu\text{g}$  at the laboratory module attachment point on the main truss.

## 6. REFERENCES

1. Suleman, A., *Dynamics and Control of Evolving Space Platforms: A Formulation with Applications*, Ph.D. Thesis, University of British Columbia, Vancouver, Canada, August 1992.
2. Freund, E., "The Structure of Decoupled Nonlinear Systems", *International Journal of Control*, Vol. 21, No. 3, 1975, pp. 443-450.
3. Bejczy, A.K., *Robot Arm Dynamics and Control*, JPL TM 33-669, California Institute of Technology, Pasadena, California, 1974.
4. Singh, S.N., and Schy, A.A., "Invertibility and Robust Nonlinear Control of Robotic Systems", *Proceedings of the 23rd Conference on Decision and Control*, Las Vega, Nevada, December 1984, pp. 1058-1063.
5. Spong, M.W., and Vidyasagar, M., "Robust Linear Compensator Design for Nonlinear Robotic Control", *Proceedings of IEEE Conference on Decision and Control*, Fort Lauderdale, Florida, December 1985, pp. 1767-1772.
6. Hunt, L.R., Su, R., and Meyer, G., "Global Transformations of Nonlinear Systems", *IEEE Transactions of Automatic Control*, Vol. AC-28, 1983, pp. 24-31.
7. Karray, F., Modi, V.J., and Chan, J.K., "Nonlinear Modelling and Dynamic Feedback of the Flexible Remote Manipulator System", *Proceedings of the 1991 American Control Conference*, Boston, USA, Editor: A.G. Ulsoy, Vol. 3, pp. 1909-1912.

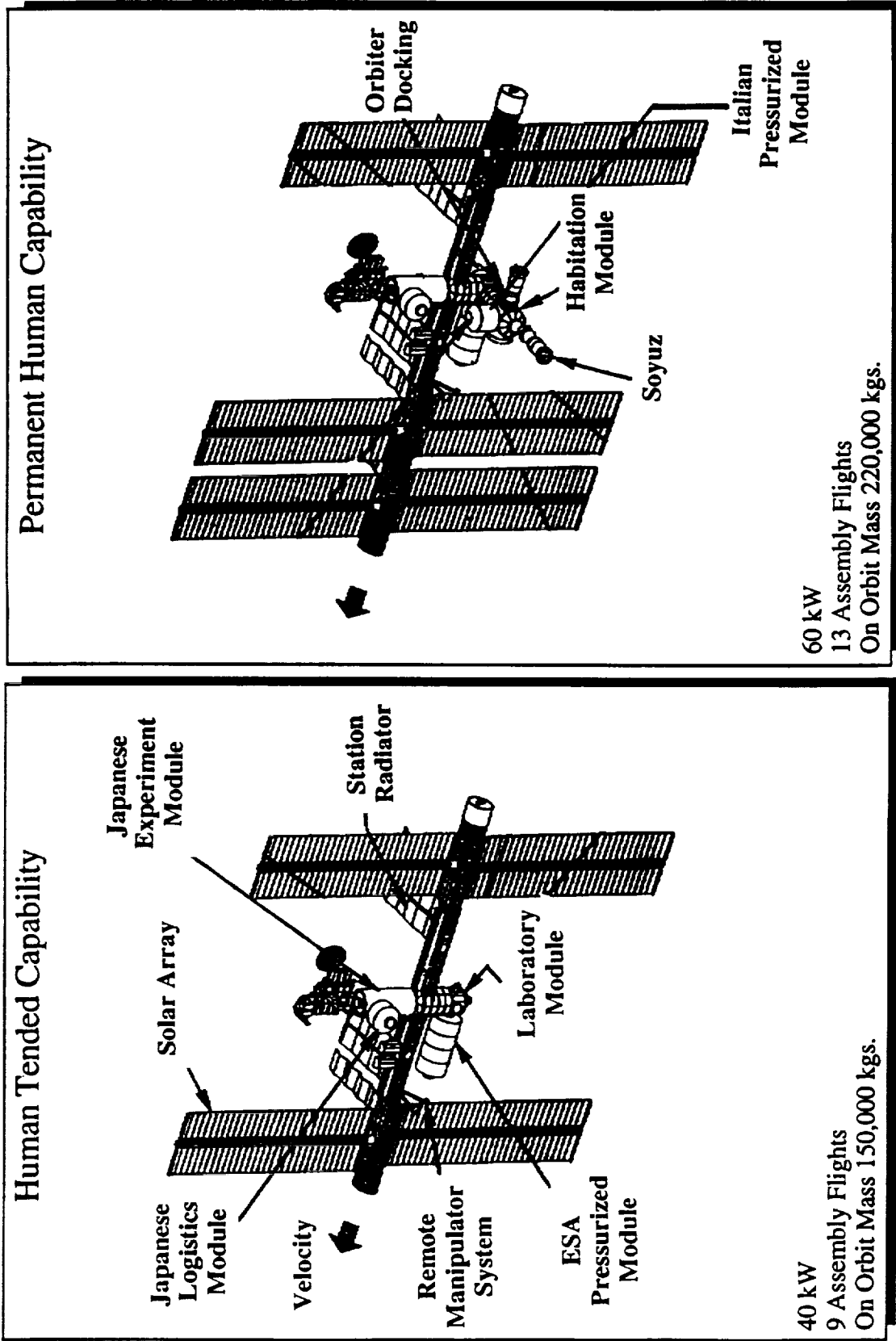

**Figure 1** Proposed Space Station *Freedom* redesigned configurations as of June 1993 showing the Human Tended and the Permanent Human Capabilities.

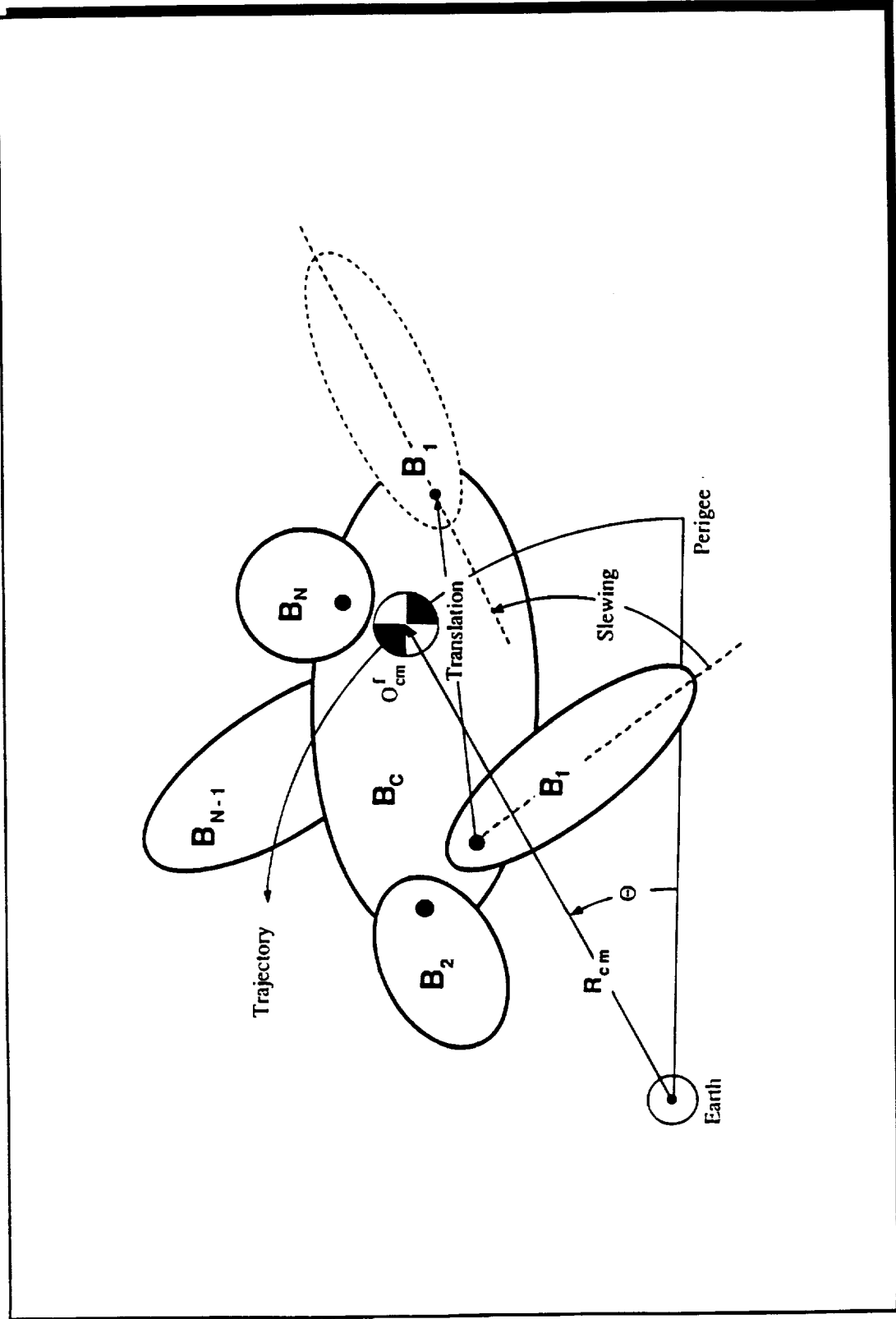
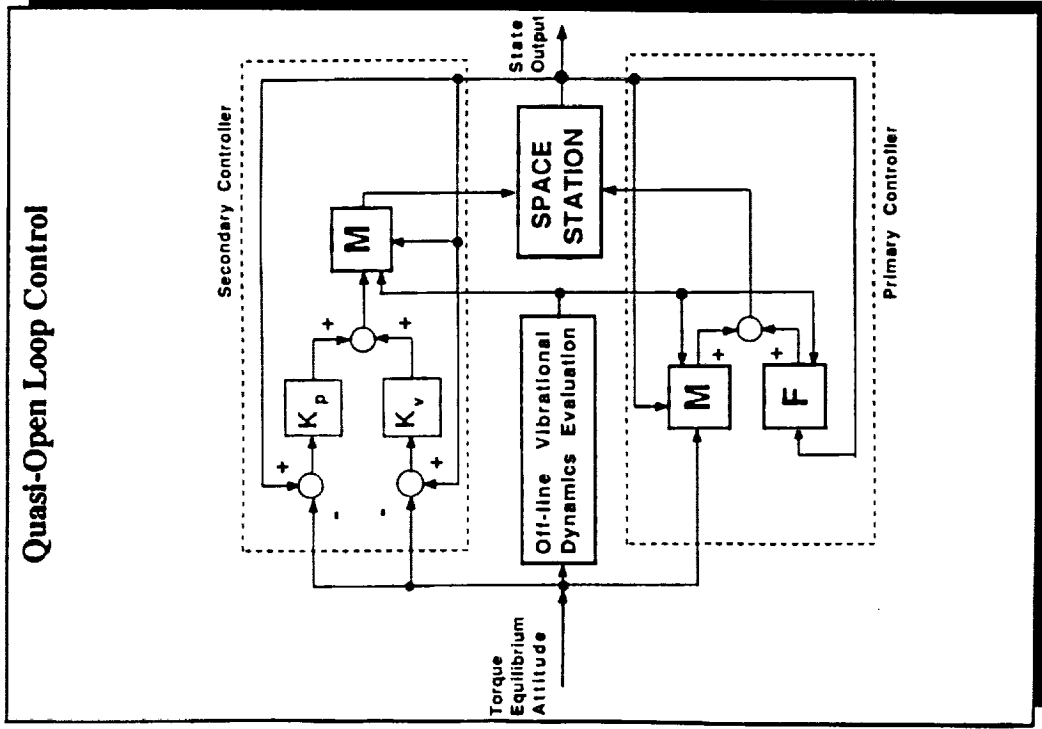
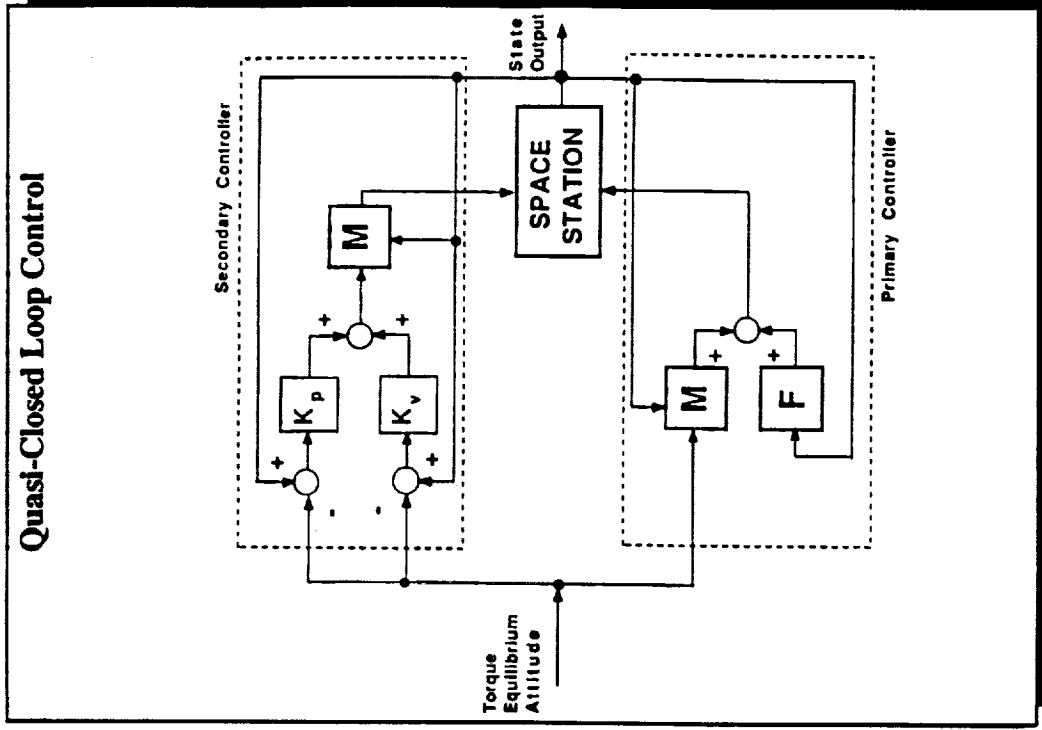
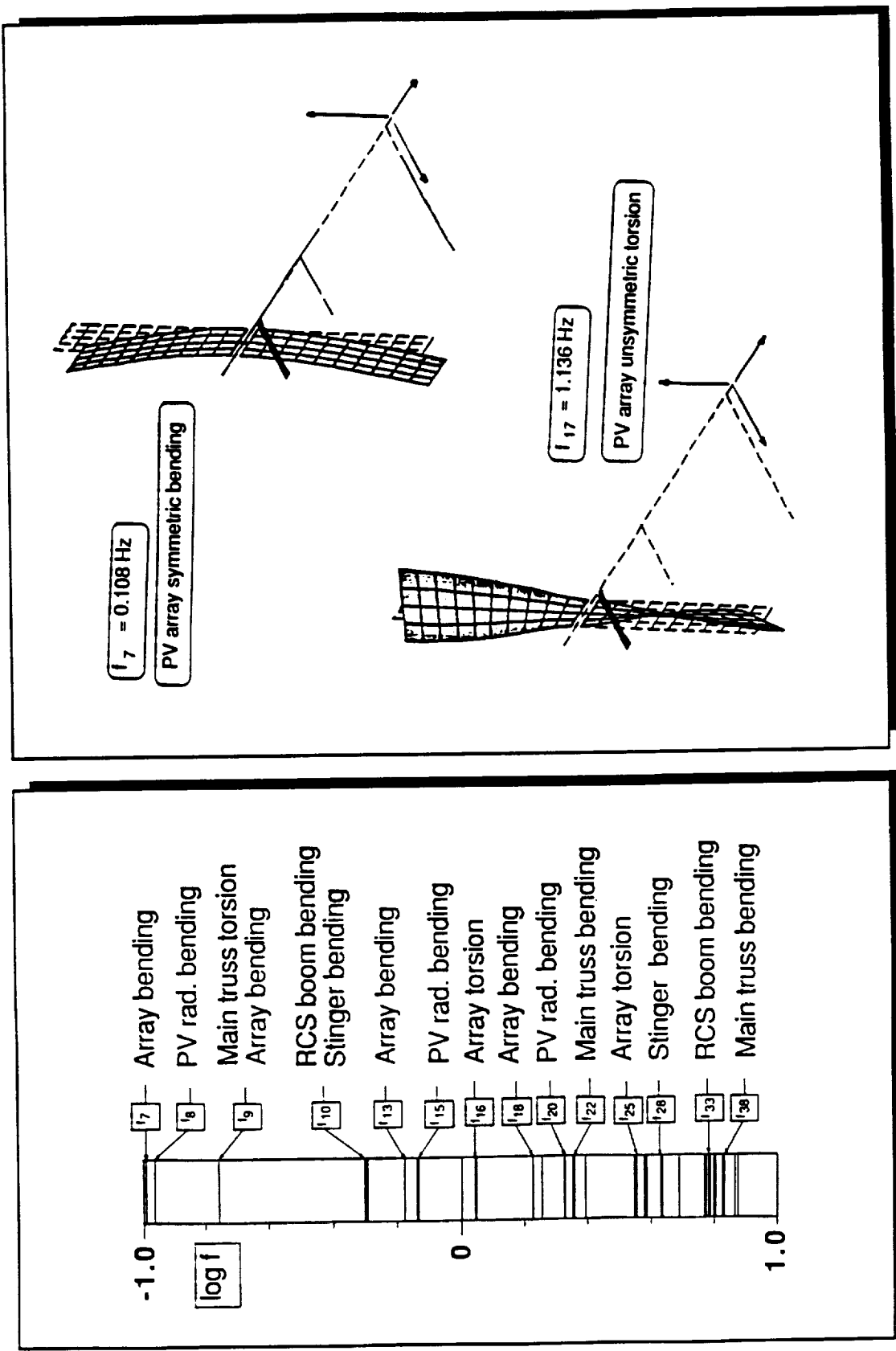

Figure 2 A schematic diagram of the multibody space structure in an open tree configuration.



**Figure 3** Block diagram for the nonlinear attitude control strategy using the Feedback Linearization Technique: (a) Quasi-Open Loop Technique; and (b) Quasi-Closed Loop Technique.



**Figure 4** Frequency spectrum and mode shapes for the First Milestone Configuration of the Space Station showing a closely spaced and overlapping character.

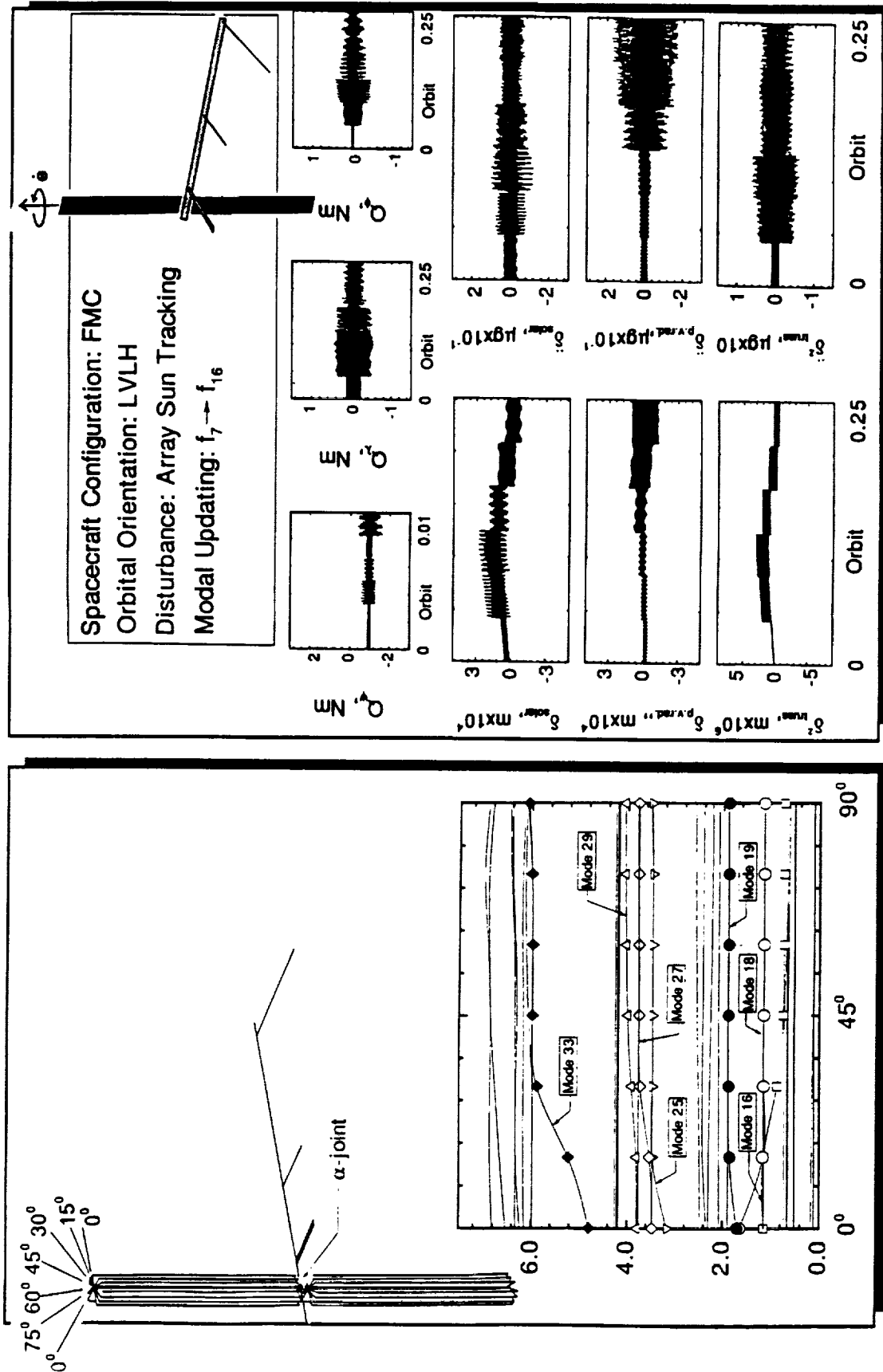

**Figure 5** The Space Station response to the solar panels rotation to track the sun for optimum exposure: (a) the frequency spectrum showing the updated modal information at 15 degree intervals to maintain an accurate representation of the system geometry and deformation; and (b) the control effort, and the displacement and acceleration time histories for critical locations on the Space Station.

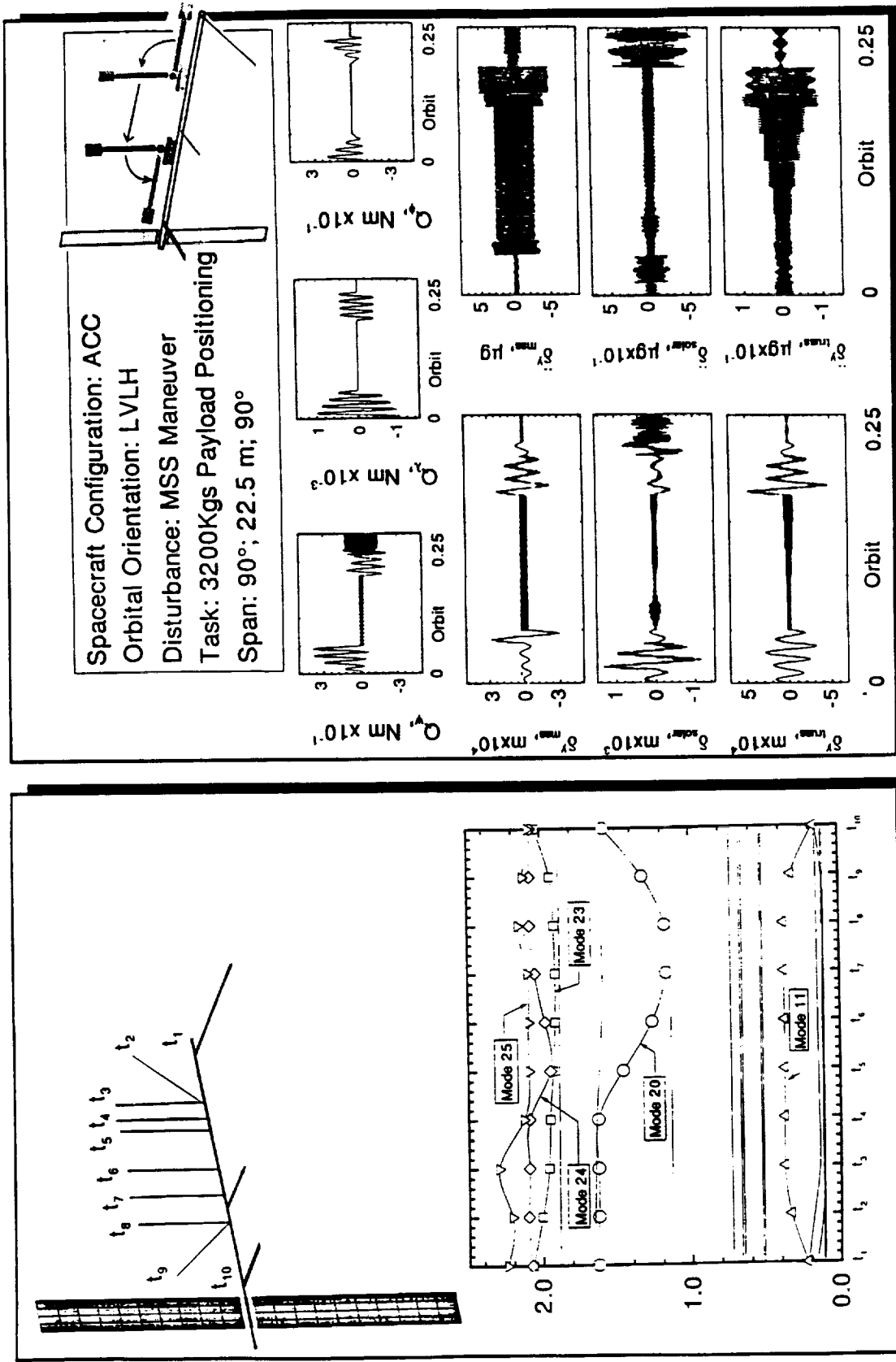

**Figure 6** The dynamical response of the Space Station in the presence of the MSS payload positioning maneuver: (a) the spectrum depicting the frequency excursions during the maneuver at 10 time steps; and (b) the control effort, and the displacement and acceleration time histories for the tip of the MSS and solar panels and the location of the laboratory module on the main truss during the maneuver.

## Application of the wavelet transform for speech processing.

Stéphane Maes  
(ISU'91-ISU'93-BEL)

Rutgers University,  
Center for Computer Aids for Industrial Productivity (CAIP),  
P.O. Box 1390, Piscataway, NJ 08855-1390, USA.

### ABSTRACT

Speaker identification and word spotting will shortly play a key role in space applications. This paper presents an approach based on the wavelet transform. In the context of the "Modulation Model" <sup>1</sup>, enables to extract the speech features which are used as input for the classification process.

### 1. INTRODUCTION

Speech processing has always played an important role in telecommunications. The primary goal is to transmit, or store, efficiently speech signals. It quickly appeared that synthesizer-coders are among the most efficient <sup>2</sup>. Therefore, huge efforts have been made to develop speech production models and to come up with features sets and models which completely characterize a signal of speech. This paper describes a technique based on the wavelet transform which allows on line extraction of such a set of parameters. Those parameters proved well adapted for speaker identification and word spotting, in clean as well as in a noisy environment.

Those excellent results open new perspectives for security systems and for voice controlled devices, which have huge potential for space activities. Robust voice control systems alleviate a good many ordinary task. They increase the reaction speed and efficiency of operators involved in tricky maneuvers. Voice commands increase also the number of degrees of freedom which can be simultaneously modified, by freeing the operator's hands even by allowing the operator to move freely in the control room. This requires the use of microphone array with directionality controlled by a speaker identification system, in order to follow the right operator in a noisy and even crowded room. Coupled with virtual reality (VR) techniques, voice control systems provide powerful and more user friendly interfaces for remote control of robotics tasks.

### 2. MODULATION MODEL

Speech results from the excitation of the vocal tracks at a fundamental frequency called the pitch <sup>1,2,3</sup>. The resulting signal produced by the vibration of the vocal tracks and composed by a fundamental component and some of its harmonics is modified (filtered) during its transmission from the vocal tracks till the lips. The transfer function which characterize this modification takes into account the length of the path, the shape of the vocal channel (inner mouth, tongue, glottal constriction,...) and the presence of resonators (e.g. nasal pits,...). The pitch and the transfer function are time dependent.

Based on those speech production considerations, the "modulation model" <sup>1</sup> considers that speech signals can be written as linear combination of principal components, each being characterized by an instantaneous amplitude ( $A_i(t)$ ) and an instantaneous phase ( $\phi_i(t)$ ):

$$s(t) = \sum_{i=1}^N A_i(t) \cos(\phi_i(t)) + \eta(t) \quad (1)$$

where  $\eta(t)$  denotes the model error due to the finite summation plus additional noise.

In order to perform efficient speaker identification or word spotting, it is mandatory to extract adequate features of the speech signal prior to any classification process based on them (see Figure 1). Until now, the LPC derived cepstrum ( linear prediction coefficients ) approach gives the best results. This can be understood in the context of the "modulation model". In fact, LPC considers the speech as a piece wise



stationary signal approximated by a linear combination of principal components, with instantaneous amplitude:

$$A_i(t) = a_0 e^{-\sigma_i t} \quad (2)$$

and instantaneous phase:

$$\phi_i(t) = \omega_i t + \theta_i \quad (3)$$

In the absence of noise, it can be proven<sup>4</sup> that the cepstra  $c_n(t)$  behave as new signals with  $A_i(t)$  and  $\theta_i(t)$  forced respectively to  $\frac{1}{n} e^{-\sigma_i(t)n}$  and 0:

$$c_n(t) = \frac{1}{n} \sum_{i=1}^N e^{-\sigma_i(t)n} \cos(\omega_i(t)n) \quad (4)$$

The cepstrum approach is sensitive to noise and contains only a partial amplitude information (e.g. the bandwidth  $\sigma$ ). Improvements are expected if more general techniques are used to determine the  $A_i(t)$  and  $\phi_i(t)$  without the kind of restrictions imposed by the LPC analysis.

Most of the techniques (e.g. em Hilbert transform, Wigner-Ville, Choi-Williams) which have been proposed so far to separate the different components and extract their instantaneous amplitudes and frequencies are time consuming, difficult to implement and nonlinear which implies also a high sensitivity to noise<sup>5</sup>.

### 3. THE WAVELET TRANSFORM

Window Fourier transform (or Gabor transform) and wavelet transform are efficient alternatives.

The window Fourier transform consists into a Fourier transform of the signal pre multiplied by a well chosen window:

$$g_{(b,\omega)}(x) = e^{j\omega(x-b)} g(x-b) \quad (5)$$

$$G_f(b, \omega) = \langle g_{(b,\omega)} | f \rangle \quad (6)$$

It satisfies the identity reconstruction:

$$f(x) = \frac{1}{2\pi \langle g|h \rangle} \int_{-\infty}^{+\infty} \int_{-\infty}^{+\infty} G_f(b, \omega) h_{(b,\omega)}(x) d\omega db \quad (7)$$

The time-frequency support of such an analysis remains the same at each frequency level. This leads to problems whenever the signal exists on a wide range of scales, which is usually the case for speech.

The wavelet transform is defined by the following equations:

$$g_{(b,a)}(x) = \frac{1}{a} g\left(\frac{x-b}{a}\right) \quad (8)$$

$$W_f(b, a) = \langle g_{(b,a)} | f \rangle \quad (9)$$

It satisfies the identity reconstruction:

$$f(x) = \frac{1}{C_{(g,h)}} \int_0^{+\infty} \frac{da}{a} \int_{-\infty}^{+\infty} db W_f(b,a) h_{(b,a)}(x) \quad (10)$$

provided that the admissibility condition is satisfied:

$$0 < C_{g,h} = \int_0^{+\infty} \frac{\hat{g}(\omega)\hat{h}(\omega)}{\omega} d\omega < +\infty \quad (11)$$

There are two different ways to visualize the wavelet transform, as illustrated in Figure 2. Firstly, it is the correlation value between the signal and dilated and translated versions of a band pass function: the wavelet. Secondly, it can also be considered as the output of a filter bank where each filter has a dilated version of the wavelet as impulse response. Due to the dilation process, the time-frequency support depends on the frequency location: low frequency events are studied on large time intervals (with narrow frequency support), while high frequency contents are studied on narrow time intervals (with large frequency support). See Figure 3.

Both the Gabor and the wavelet transforms provide perfect reconstruction formula, which, in the case of the wavelet transform, defines the perfect reconstruction synthesis filter bank.

Also as those transformations of one dimensional functions are defined in two dimensional spaces, they are over complete. Therefore, they can be sampled<sup>5</sup>. Critically sampled wavelet transforms constitute particular cases of subband coding decompositions, a well known signal processing technique. In subband coding, a signal is successively split up into two subbands. One is roughly the low frequency content of the input signal (i.e. it is obtained with a low pass filter) and the other is the detail signal needed to reconstruct the original signal. The different subbands are downsampled by a factor two. The decomposition is iterated on the low frequency subband. The reconstruction filter bank is designed to recombine the two subbands and to cancel the aliasing errors introduced by the downsampling operation. Any other type of subband coding decomposition can be related to an hybrid wavelet transform where additional operators are applied on the wavelets<sup>6,9,10</sup>.

To allow on line quasi-continuous wavelet transforms, a fast wavelet transform algorithm has been developed. It is shown in Figure 4. It is based on an extension of the classical subband coding approach to a quasi-continuous situation and is particularly well adapted to parallel and hardware implementations. It consists in a projection upon an intermediate set of functions called scaling functions, followed by a decomposition of the scaling function into the wavelet functions, instead of a direct projection upon the set of wavelets<sup>7,10</sup>.

## **4. PARAMETER EXTRACTION**

### **4.1. The ridge skeleton algorithm**

Once the wavelet transform is computed, different algorithms can be used to extract the speech features  $A_1(t)$  and  $\phi_1(t)$ . The first technique is known as the ridge-skeleton approach. It is based on the steepest descent method approximations which single out the dominant contributions to the wavelet transform, to which it associates curves into the time/scale plane (i.e. the ridges). An example is presented in figure 5. When all the hypotheses, needed to perform these approximations, are satisfied, the ridges provide the phase modulation laws of the components while the restriction of the wavelet transform to the ridges (i.e. the skeleton) enable us to evaluate the amplitude modulation laws. Unfortunately, these hypotheses are not always satisfied and, in that case, only sophisticated perturbation techniques sometimes give correct results<sup>8</sup>.

### **4.2. The fusion and squeezing processes**

We have proposed the fusion approach based on the filter bank concept. The signal is split up into different frequency subbands. The temporal evolution of some properties of these subbands can easily be monitored. The subbands which have the same temporal behavior are recombined with the synthesis filter bank. Its outputs are the principal components of the original signal. This is sketched in Figure 6. As criterion for recombination, and in order to provide a practical time-frequency representation, we have introduced a squeezing process. It consists into building a measure function ( $\mu(b,\omega)$ ), defined into the time/frequency plane. It is, at a given time location, a function of the frequency, which is obtained by adding together the wavelet transform (or only its modulus, or a linear combination of the wavelet transform and its modulus) of all the different subbands which have a contribution at this frequency. A typical squeezed plane is presented in Figure 7.

$$\omega(b,a) = \partial_b \phi_{\omega_f}(b,a) \quad (12)$$

$\phi_{\omega_f}(b,a)$ : phase of the wavelet transform.

$$\Omega = [\omega - \delta_\omega, \omega + \delta_\omega] \quad (13)$$

$c(a)$  is a weighting factor.

$$\mu(b,\omega) = \int_{\omega(b,a) \in \Omega} (|W_f(b,a)| + W_f(b,a)) c(a) da \quad (14)$$

This method uses the whole information present into the time/scale plane, without any approximation. Into the squeezed plane, if we take only the modulus of the wavelet transform, otherwise, into the synchrosqueezed plane, the instantaneous frequencies of the principal components can be tracked by dynamic programming techniques<sup>7</sup>.

The squeezed and synchrosqueezed plane presents the phase modulation of the different components. Once those components are identified, they can easily be reconstructed with the following strategy which consists into a simple addition. This is what we call the fusion algorithm:

$$\int_0^{+\infty} \frac{da}{a} W_f(b,a) = f(b) A_g \quad (15)$$

$$A_g = \int_0^{+\infty} \frac{du}{u} \hat{g}(u) \quad (16)$$

Those components have a known angular modulation. Therefore it is easy to extract the amplitude modulation of each component.

The wavelet approach (as well as the Gabor approach) is almost completely linear, and the only non linearity results from the measure computation, which is an averaging process, followed by dynamic programming. This guarantees good robustness to noise. In fact for a Signal to Noise Ratio: SNR=10dB, it is still possible to obtain a very good extraction of the pitch and of the first three formants. This has to be compared with the threshold of 20dB of the other classical formant extractors.

Figure 8 and figure 9 present the synchrosqueezed plane obtained for two speech signal in a noisy environment. The different formants are clearly visible.

Some inaccuracies might also occur for the higher frequencies due to a wide frequency support which prevents different components from being resolved by the wavelets. However, this can be easily solved with wavelet packets, based on a similar approach, where the wavelets are scale adapted.

## 5. CLASSIFICATION

This feature extraction is a front-end for the classification process. Different techniques<sup>2</sup> exist for feature classification of speech. The most efficient ones are (presented in the case of speaker identification):

- Dynamic Time Warping. The time dependent set of feature stretched and deformed by a mapping function, in order to match each speaker in the data base. The identified speaker is the one who has the mapping function with the lowest cost (Figure 10).
- Hidden Markov Models. Each speaker is characterized by a set of "states" and probability of transition between those states (Figure 11). The probability to obtain the observed feature set is computed for each model and the one with the highest probability is considered as the identified speaker.
- Vector Quantization: A dictionary of dominant feature pattern is produced for each speaker. The observed feature set is coded with each dictionary. The most efficient code identifies the speaker.
- Autoregressive Vector Models. Each speaker is characterized by an autoregressive model. The probability to obtain the observed feature set is computed for each model and the one with the highest probability is considered as the identified speaker.
- Neural Networks and Neural Tree Networks. Neural networks perform direct classification by splitting up with hyperplanes, an hyperspace into different volumes. Each volume (sometimes more than one) is associated to a different speaker. Neural Tree Networks allow to increase the database without having to retrain the whole system. The classification is hierarchical. It starts with a very simple neural networks and each time that two speakers have to share the same volume in the hyperspace, a new simple neural network is used to discriminate between them.

Excellent speaker identification results have been obtained<sup>1,4</sup>. The error rate is lower than 2% with databases of more than one hundred speakers. The system is totally text and language independent. For example, it is possible to train the system in one language (e.g. Thai) and to test it in another (e.g. French). Channel distortion are under investigation in order to increase the robustness to noise.

## 6. ACKNOWLEDGMENTS

Stephanie Maes is research assistant of the Belgian National Fund for Scientific Research (FNRS) at the Université Catholique de Louvain, Louvain-la-Neuve, Belgium: Laboratoire de Télécommunications et Télédétection (TELE) and Unité de Physique Théorique et Mathématique (FYMA). The author wishes to thank professor Ingrid Daubechies (ATT Bell Labs) for her useful help and support.

## 7. REFERENCES

1. K.T. Assaleh, R.J. Mammone, M.G. Rahim, J.L. Flanagan, "Speech recognition using the modulation model", Proc. ICASSP, 1993.
2. L. Rabiner, Biing-Hwang Juang, Fundamental of speech recognition, Prentice-Hall, 1993.
3. S. Furui, Digital Speech Processing. Synthesis and Recognition, Marcel Decker, 1987.
4. K.T. Assaleh, K.R. Farrell, R.J. Mammone, "Speaker recognition using modulation model parameters and neural network classifiers", submitted to IEEE Trans. on Speech and Audio, 1993.
5. I. Daubechies, Ten Lectures on Wavelets, SIAM, 1992.
6. S. Maes, "Adaptive Optimal Decompositions with Hybrid DCT-Subband Coding", Proc. IEEE -SP, Time-Frequency and Time-Analysis, (The IEEE Signal Processing Society, 1992), pp. 479.
7. S. Maes, "An Application of Wavelets to the Characterization of Formant Parameters in Speech.", ATT Bell Labs seminary, Holmdel, May 7, 1993.
8. N. delprat, E. Escudoc, P. Guillemain, R. Kronland-Martinet, Ph. Tchamitchan, B. Torresani, "Asymptotic Wavelet and Gabor Ananlysis: extraction of instantaneous frequencies", IEEE Trans. Inf. Theory, vol 32, n<sup>o</sup>2, part 2, pp. 644-664, March 1992.
9. S. Maes, "Hints on the Relationships between Subband Coding, Wavelet and Vaguelette Decompositions and Cosine Sine Altered Transformations", Proc. EUSIPCO, Elsevier, 1992.
10. S. Maes, "Hybrid Subband Coding Decompositions", ATT Bell Labs seminary, Murray Hill, May 18, 1993.

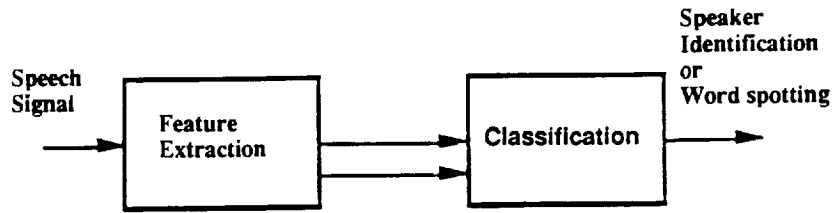

Figure 1: For speaker identification or word spotting, features have to be extracted prior to any classification process.

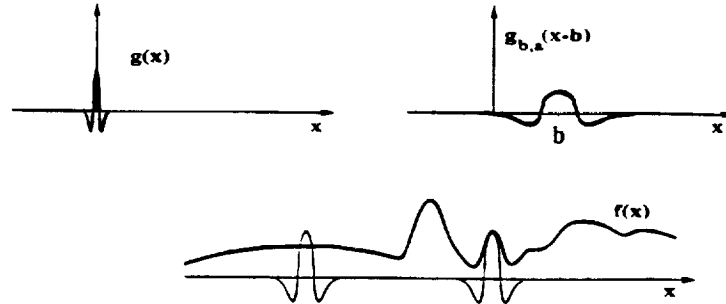

Figure 2: The wavelet transform, can be considered as the correlation value between the signal and a set of dilated and translated version of the "original" wavelet. Because of the admissibility condition, this transform peaks when signal and wavelet looks alike and it is negligible everywhere else.

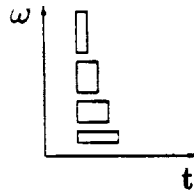

Figure 3: The time frequency support of a wavelet analysis changes with the frequency location.

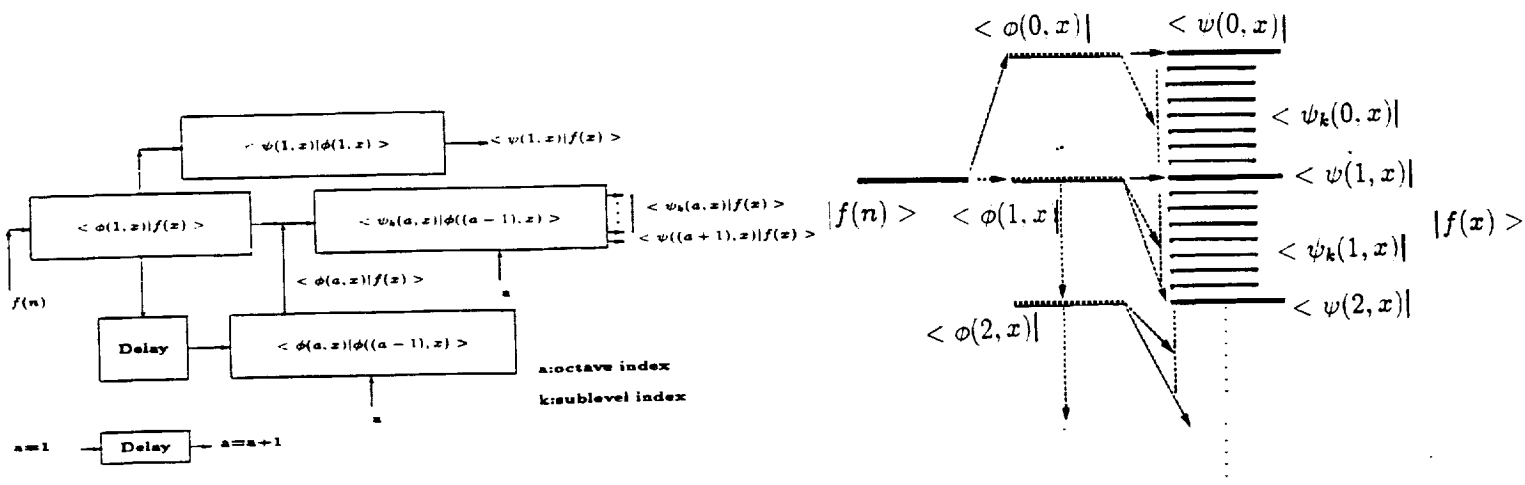

Figure 4: It describes the "indirect" computation of the wavelet transform. It is extremely fast because it can be implemented with a few filter banks.

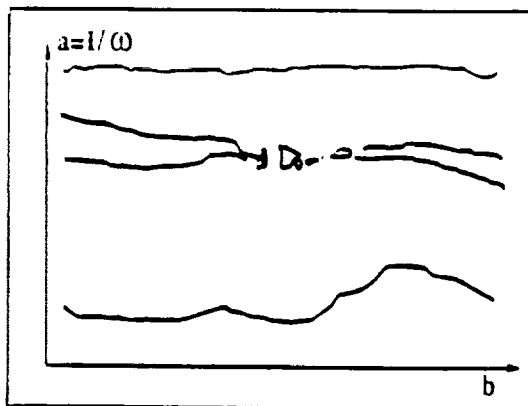
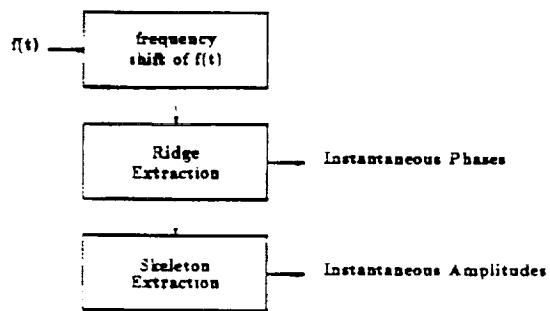

Figure 5: It describes the ridge-skeleton process and presents a typical ridge in the time/scale plane.

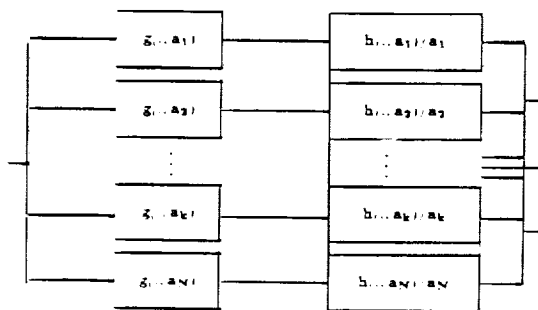

Figure 6: The fusion process. Every subband which presents the same temporal behavior are recombined. The output are the different components of the signal.: the formants.

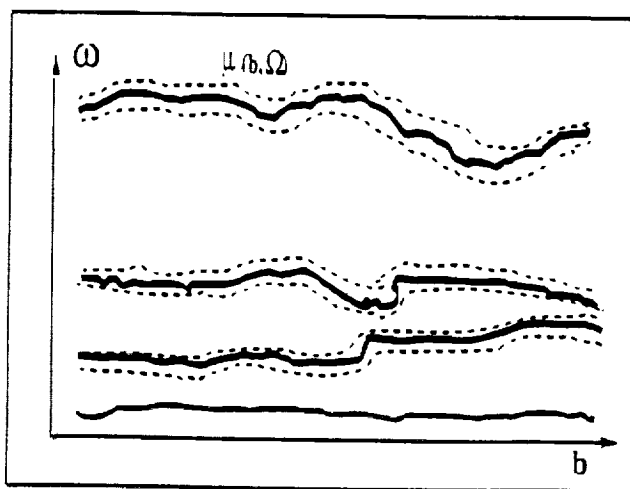

Figure 7: A typical synchrosqueezed plane. The peak values define the central frequency while the bandwidth is easily determined by relative threshold.

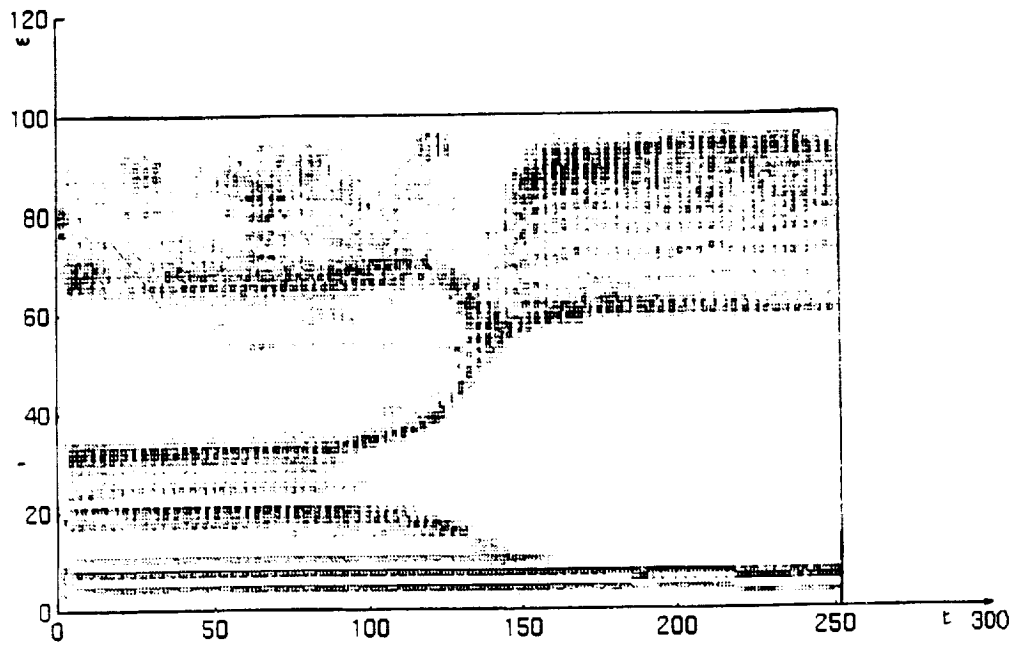

Figure 8: The synchrosqueezed plane obtained for the transition in "aaii" (French pronunciation) said by a male voice, with a SNR=15dB, pink noise. The frequency scale is linear from 0 to 4000Hz. The time interval is roughly 0.5 s.

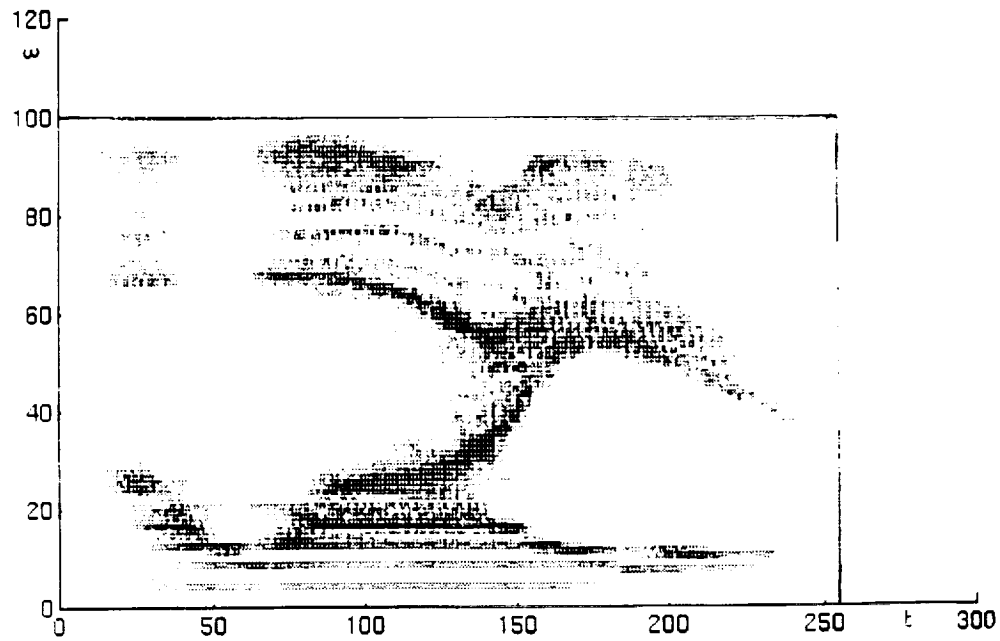

Figure 9: The synchrosqueezed plane obtained for "how are you?" said by a male voice, with a SNR=15dB, pink noise. The frequency scale is linear from 0 to 4000Hz. The time interval is roughly 0.5 s.

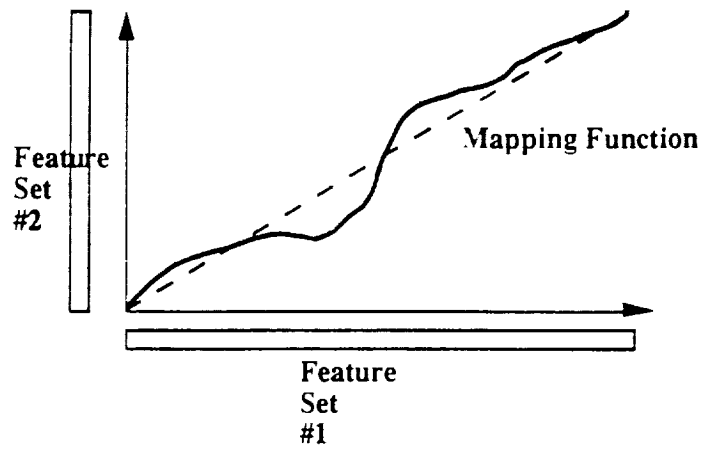

Figure 10: It illustrates the definition of the mapping function for the Dynamic Time Warping approach.

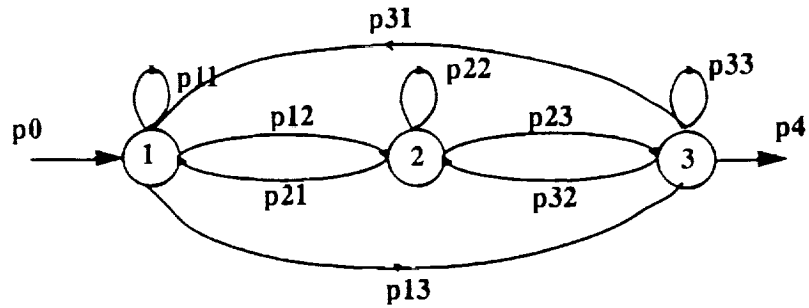

Figure 11: It illustrates the Hidden Markov Model approach.  $p_{ij}$  denotes the probability to have a transition from the state  $i$  to the state  $j$ , knowing that the system is in the state  $i$ .

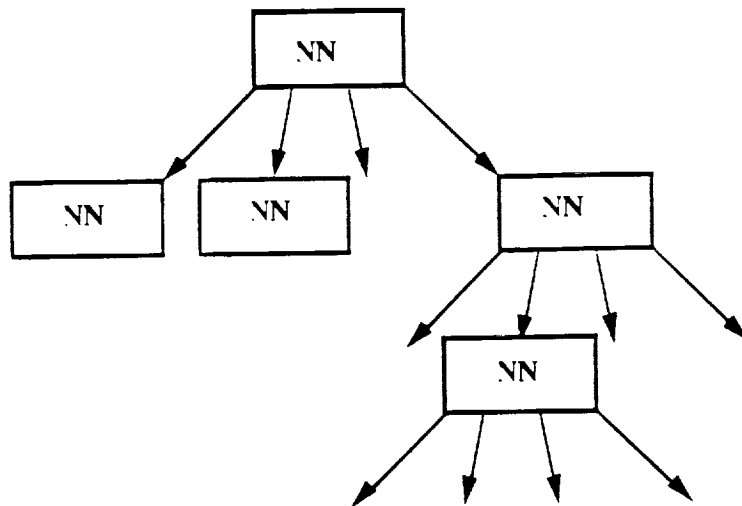

Figure 12: It illustrates the concept of Neural Tree Networks.



AN INNOVATIVE APPROACH TO SPACE EDUCATION

Christine Marton

Canadian Alumni of the International Space University

Alain B. Berinstain

University of Ottawa, Department of Chemistry

John Criswick

York University, Space and Terrestrial Physic Laboratory,  
Institute for Space and Terrestrial Science

ABSTRACT

At present, Canada does not have enough scientists to be competitive in the global economy, which is rapidly changing from a reliance on natural resources and industry, to information and technology. Space is the final frontier and it is a multi-disciplinary endeavour. It requires a knowledge of science and math, as well as non-science areas such as architecture and law. Thus, it can attract a large number of students with a diverse range of interests and career goals. This paper presents an overview of the space education program designed by Canadian Alumni of the International Space University (CAISU) to encourage students to pursue studies and careers in science and technology and to improve science literacy in Canada.

2. WHAT IS CAISU?

Canadian Alumni of the International Space University (CAISU) is the association of Canadian alumni of the International Space University (ISU). Its members number over sixty and are widely distributed across Canada and the world. The organization is run by a board of directors and a number of members donate their time and resources to help in the organization's activities. CAISU was formed in 1990 and incorporated as a non-profit corporation by Consumer and Corporate Affairs Canada under the Canada Corporations Act.

3. WHAT IS ISU?

The International Space University is a non-profit organization with headquarters in Cambridge, Massachusetts. It was created in 1987 and for each year since 1988 it has operated a ten week summer session. Approximately 130 students attend each year and come from all parts of the world. The summer session includes core and advanced lectures and seminars in a variety of space related subjects from law and art to science and engineering. A well organized design project gives students practical experience in

project management and working with people from other cultures and backgrounds. ISU intends to evolve from a summer session campus to a full time Master of Space Studies degree program starting in 1995.

#### 4. CAISU SPACE EDUCATION MANDATE

CAISU serves two purposes. First, it is an alumni organization in that its members are Canadian citizens who have attended the International Space University. Secondly, CAISU is interested in furthering space education and research in Canada. At present, CAISU organizes an annual space education and careers conference. In 1991 the conference was held in Montreal, in cooperation with the International Astronautical Federation. In 1992 the conference has held in Ottawa, in collaboration with the Canadian Aeronautics and Space Institute (CASI). The conference has been the major educational endeavour of CAISU to-date, and last year attracted over 200 students from Ontario and Quebec. CAISU members are also active giving talks at other conferences and to students in high schools and universities across the country.

In order to broaden the scope of its space education mandate to participate more actively with students at both the university and K-13 levels, CAISU is currently developing a closer working relationship with the Canadian government, particularly with the Canadian Space Agency.

The goals of the CAISU Space Education Program are twofold: to encourage students beginning high school to take science courses and pursue a career in science and technology, and to provide interested Canadians, particularly students and educators, with access to electronic mail communication and a space database.

The CAISU space education programs consists of two major components, a Speakers Bureau and an electronic communications network and space database, hereby referred to as CAISU.Net.

#### 5. THE SPEAKERS BUREAU

The Speakers Bureau will consist of CAISU members willing to donate their time and expertise on space to schools and universities who request speakers to give presentations on space-related topics. Presentations will include printed material for distribution, slides, overheads, and demonstration materials. All areas of space studies will be covered, e.g. space law, space life sciences, astronomy, aerospace engineering, space art and architecture, and materials processing.

CAISU speakers will also be involved in giving talks on the Canadian space program, on behalf of the Canadian Space Agency. At present, the space agency has a strong education mandate from the federal government, however, it lacks the staff to implement it. Canada is a geographically vast country with a scattered population base. CAISU members come from all parts of Canada and therefore are able to give talks in different areas of the country. The Speakers Bureau will make use of printed material and posters already available from the Canadian Space Agency and Canadian aerospace companies.

## 6. CAISU.NET

The proposed CAISU.Net will be a Macintosh computer-driven communication network accessed by modem. It will offer free electronic mail access to CAISU members, enabling them to collaborate on research endeavours. It will link students and teachers in different parts of Canada, allowing them to establish electronic mail penpals with students in other countries with Internet access. Service will also include a source of space related bulletins such as those issued daily by NASA , a source of space related data such as may be available from CSA and NASA to the public domain (Geo-Ref, Voyager Images etc.), and access to an international database of space knowledge stored on CD-ROM.

CAISU.Net will also provide a space expert information line for students and teachers. Eventually, it is hoped that the computer network will be extended in capability to include telescience projects. One project could involve students downloading live space images into the classroom, collected from a controllable telescope. Another application of this technology would be to control a simulated Mars rover which would transmit back images of a simulated Mars landscape.

## 7. CAISU.NET INFRASTRUCTURE

Before this system can be made available to the general public, the technology must be developed and tested. Setting up the infrastructure which would electronically connect the entire CAISU community is the first step. Two hardware configurations have been considered. According to the first configuration, the central CAISU.Net node will be a Macintosh Centris 650 with 8 megabytes of RAM, a 500 megabyte hard disk, a CD-ROM drive and QuickTime video hardware. It will have a data modem to provide external access and network hardware for the Internet connection. The system will be run by a small team of CAISU volunteers, each with specific tasks like account management, list management and interfacing to ISU.Net. In fact CAISU and its members will also be providing additional hardware support to this project. It is proposed that the system will be connected into the Space Agency network domain by a 56kbps Bell leased line.

The Macintosh Centris 650 is a mid-range computer with very good computing capabilities. It is a new model which is built around the Motorola 68040 chip; it can perform all operations available to the higher-end Macintosh Quadra but at a more affordable price. It is clear that in the near future (less than 2 years), this processor will become the new minimum configuration for Macintosh line of computers. Selecting a 68040-based machine allows for future expandability in a very fast changing world of computers.

The configuration includes a UNIX-based operating system and a large storage system for data to be shared in the CAISU.Net community, which will include K-13 students. UNIX has become an industry-standard for internet-style communication. The data modem will provide added external access, and the QuickTime interface board and video hardware will allow us minimum visual data transfer capability to carry out our first experiments in telescience. Since the UNIX station described above must be dedicated to internet communication for efficient operation, an additional workstation is necessary to carry out daily operations and programming necessary for the development and upkeep of the entire network. A Macintosh IIvx will adequately serve this purpose. For efficient data communication, a data modem will be a necessary addition. We note that by no means is this configuration a top-of-the-line solution. It is adequate and expandable.

It is possible as a secondary option to utilize the lower end Macintosh model such as the Mac II vx 5/400/CD as the UNIX station, coupled with a Macintosh LC III as the workstation. The IIvx can, at a later date, be upgraded to a Centris 650, but the LC III has limited upgrade capabilities. Clearly this system will address immediate needs with a working system. We feel that though this is a viable alternative, it limits us to somewhat older technology and a less powerful configuration.

## 8. RELATIONSHIP TO ISU.NET

As part of its plan to remain an international university, ISU will set up a global campus network with a Central Campus located in Strasbourg, France and Affiliate Campuses distributed around the world. The campus sites will be connected together and to the rest of the world through an electronic network called ISU.Net.

A part of ISU.Net currently exists as a communications and information server. It provides the principle means for keeping ISU alumni, faculty, staff and supporters in touch. ISU.Net is also part of each summer session and includes a large network of computers for use by students, staff and faculty and an Internet link connecting the session to the rest of the world. The planning and preparation for ISU.Net is an ongoing process and workshops organized by ISU are held two to three times each year. We wish to embark on a more active participation in ISU.Net.

CAISU recently received a computer donation from the Institute for Space and Terrestrial Sciences in the form of an Apollo UNIX Workstation. This computer is the first node in the CAISU.Net, providing Toronto-area alumni with access to the Internet and ISU.NET. This approach may be used in other cities where there are large groupings of members. Connecting into Bell Canada's DataPac network is another option. Having access to the Internet will enhance opportunities for CAISU to become involved in joint projects with other alumni abroad, for example ISU colleagues in Russia or China. Internet communication allows, at no extra cost, to make this one of the principal means of communication in any such project.

## 9. WHY AN APPLE MACINTOSH SYSTEM?

No system exists which is perfect for all applications. Computing power, price, flexibility, compatibility, and availability of software are all things which need to be taken into consideration when choosing which platform to work on. Macintosh now offers a wide range of machines which deliver a wide range of computing power. Apple has, in the last few years, taken a very aggressive approach to their pricing to bring their machines into a more affordable range for home, business, and technical use. The Macintosh line of computers is known for its flexibility and compatibility between software programs, and more recently, even across platforms. Software is available for practically all applications which are available on any other platforms.

ISU is, for the most part, an Apple Macintosh based university. For its summer sessions and ongoing efforts it has received support from Apple in the USA, France, Canada and Japan. A network of Macintoshes are set up at each session giving students access to electronic mail and to the production of documents, animations and graphics. ISU has also

received support from Apple for developing ISU.Net. CAISU is presently seeking support from Apple Canada Education Foundation, in the form of Apple equipment and software.

#### 10. CONCLUSIONS

The proposed CAISU Space Education Program seeks to improve science literacy among young Canadians by providing speakers on space science and the Canadian space program, and by offering both teachers and students free electronic mail capability and access to an international database on space. It will increase CAISU membership access to the Internet, permitting alumni to collaborate on space research projects. The CAISU space education program is a cost effective approach to nurturing the desire in young minds to pursue studies and careers in space.

#### 11. ACKNOWLEDGEMENTS

CAISU wishes to thank the Institute for Space and Terrestrial Science for its kind donation of an Apollo Workstation. As well, CAISU would like to thank the Canadian Foundation for the International Space University (CFISU) for its ongoing financial support.

## **Multisatellite Constellation Configuration Selection for Multiregional Highly Elliptical Orbit Constellations**

Mark G. Matossian

University of Colorado, Colorado Center for Astrodynamics Research  
Boulder, Colorado 80309-0431

### **ABSTRACT**

The Archimedes Project is a joint effort of the European Space Agency (ESA) and the National Space Development Agency of Japan (NASDA). The primary goal of the Archimedes project is to perform a technical feasibility analysis and preliminary design of a highly inclined multisatellite constellation for direct broadcast and mobile communications services for Europe, Japan and much of North America. This report addresses one aspect of this project, specifically an analysis of continuous satellite coverage using multiregional highly elliptical orbits (M-HEOs). The analysis methodology and ensuing software tool, named SPIFF, were developed specifically for this project by the author during the summer of 1992 under the STA/NSF Summer Institute in Japan Program at Tsukuba Space Center.

## **2.0 INTRODUCTION: THE ARCHIMEDES PROJECT**

### **2.1 Archimedes and 1992 World Administrative Radio Conference**

The Archimedes project is an outgrowth of the 1992 World Administrative Radio Conference (WARC-92) that allocated worldwide frequency bands for a variety of services to be phased in over a period of years. Included in these bandwidth assignments were allotments for direct satellite radio broadcasting (DBS-R), mobile communications, navigation and other services. With the significant progress in clarifying bandwidth use from WARC-92, the Archimedes project was initiated to investigate the technical aspects of providing DBS-R services.

### **2.2 Coverage areas and elevation angle**

Archimedes originally began at ESA with examination of highly elliptical Molniya (12 hr. period) and Tundra (24 hr. period) orbits for European coverage. The program has now expanded to include other non-geosynchronous orbits such as M-HEOs to serve several markets, and the participation of NASDA.

## Multiregional Highly Elliptical Orbit Constellations

Satellite services now under consideration include DBS-R, mobile communications, navigation and possibly meteorological services. The coverage areas have expanded to include Japan, most of the contiguous US, and the US/Canada border area. (90% of the Canadian population is located within a few hundred kilometers of the US border.) This multi-regional scenario reduces user costs by expanding market opportunities and improving economies of scale. Analysis was done for both 30° and 40° elevation angle continuous satellite coverage in each coverage zone.

### 2.3 Multiregional-highly elliptical orbit constellations

The goal of this analysis was to determine the configurations of multi-satellite HEO constellations capable of providing continuous coverage to the European, Japan and North American coverage zones mentioned above. Typically, a constellation consisted of P orbital planes of Q satellites/plane for a total of  $N=P*Q$  satellites. Furthermore, a harmonic phase distribution factor, M, is necessary to describe the initial distribution of the satellites within a plane and in relation to the neighboring planes. The harmonic factor is discussed in greater detail in the Multisatellite Constellation Analysis section below.

In each orbital plane, a highly elliptical orbit with a low perigee was selected (altitude=1000 km.) to keep the energy of the orbit relatively low but with sufficient altitude to largely avoid drag effects. The argument of perigee was selected to be 270° to place the satellite at apogee over the Northern Hemisphere coverage areas. Likewise, an inclination of 63.4° is necessary to avoid precession of the argument of perigee. The selection of the longitude of the ascending node for each orbital plane was selected so that each plane was equally separated from neighboring planes ( $360°/P$ ). This assured that apogee for at least one of the planes would be centered over a coverage area, in this case Europe. Periods of 3, 4, 6 and 8 hours (even factors of 24 hours) were examined so that the ground track would repeat. Low apogee 3 and 4 hour period orbits were quickly determined to require too many satellites and the analysis focused on 6 and 8 hour orbits. The selection of the period then enabled the radius of apogee and the eccentricity to be determined.

## 3.0 MULTISATELLITE CONSTELLATION ANALYSIS STRATEGY

### 3.1 Introduction

Constellation analysis has been conducted at least as far back as 1961 in the area of continuous zonal coverage.<sup>1</sup> In the 1970's, John Walker<sup>2</sup> and G. V. Mozhaev<sup>3</sup> developed innovative algorithms for continuous global coverage. In

## Multiregional Highly Elliptical Orbit Constellations

1980<sup>4</sup>, the late Arthur Ballard extended and generalized the work of Walker for the U.S. NAVSTAR/GPS program.

For the Archimedes analysis it was helpful to use elements of Ballard's analytical approach, however improvements and corrections to Ballard's work was necessary. Still, significant differences remained, such as the employment of elliptical trajectories and discrete zonal coverage, that required the development of a new algorithm. Nonetheless, credit is due to Walker, Ballard, et al. for inspiration in the modeling strategy employed for this study that is embedded in the SPIFF software.

### 3.2 Coordinate systems

SPIFF works in an Earth-Centered Earth-Fixed (ECEF) coordinate system. The published algorithms mentioned above use an Earth-Centered Inertial (ECI) coordinate system since their goal is global Earth coverage - independent of points fixed on the Earth's surface. The requirement for discrete zonal coverage resulted in the use of an ECEF system. Essentially, the Earth is held fixed and the entire constellation is rotated around it through manipulation of the longitudes of the ascending nodes of the orbital planes.

As a result, SPIFF is a coverage zone based algorithm. Satellite coverage analysis is often based on what a specific satellite can "see", however the driving requirement for Archimedes was actually that coverage areas had line of sight visibility of any satellite at greater than a user-specified elevation angle. This results in a subtle difference in the question that the algorithm answers. Instead of asking whether the satellites have line-of-sight to all parts of each of the coverage zones, the question is reversed to, "Can anyone, anywhere in the coverage zone, always have line of sight to at least one satellite at greater than a <user specified> elevation angle?" Thus SPIFF drives the simulation from the users' perspective.

### 3.3 An overview of the sequence of calculations

After the usual initialization procedures, SPIFF reads in the user's specifications for the run from a data file. In addition to specifying limits for P, Q and N, the user may assign several variables that control the resolution of the analysis, orbital periods to be considered, the coverage areas, and the minimum elevation angle therein. Next the program performs some preparatory calculations on the geometry of the coverage areas and the some of the orbital elements of the constellations to be considered.



## Multiregional Highly Elliptical Orbit Constellations

SPIFF now enters into a series of nested loops to test all the possible orbits as specified by the user. After P and Q have been specified, a loop for the harmonic factor, m, is entered and the candidate constellation is calculated.

Once the constellation has been determined, a nested ascending node offset loop is entered to test for the different constellation ECEF positions in terms of longitude of the ascending node. Recall that the orbit is repetitive since the periods are factors of 24 hours and the small J2 effect on precession of the ascending node for a highly elliptical orbit may be accommodated through a slight period adjustment in the orbit.

Now a 24 hour time propagation loop is begun. the satellites are assigned their longitude of ascending node according to their initial distribution, the ascending node offset, and Earth rotation. This converts the orbital elements, an ECI-based system, to ECEF coordinates since the orbital elements interface with the inertial and fixed coordinate systems through the ascending node. Note that the right ascension of the ascending node is an ECI term fixed to the former position of the First Point in Aries, whereas the longitude of the ascending node is an ECEF argument. Time zero corresponds to vernal equinox when the two coordinate systems' axes are collinear.

The phase distribution can also now be determined. One of the modifications from Ballard's and Walker's work is that their phase distribution for circular orbits must be converted to true anomaly of an elliptical orbit. This can be accomplished several ways and SPIFF uses the phase distribution for a circular orbit as a percentage of the period (adjusted for 360 degrees). The resulting time separation value is first converted to mean anomaly through a recursive method and then to true anomaly.

Finally, SPIFF enters another nested loop for checking the coverage of each zone. First there is a check for single satellite coverage of the entire zone. Failing that, there is a check for multisatellite coverage. To check for multisatellite coverage, points on the circumference of the circular coverage zone and the center of the zone are checked for elevation angles to satellites in view.

Full coverage for 24 hours assures that the constellation will have continuous coverage. This is because the selected periods repeat at least once every 24 hours and the ascending node precession is neutralized through orbital maneuvers.

### 3.4 Constellation harmonics

As mentioned above, the SPIFF code cycles through a user specified range for P and Q. However, within the designation of a constellation of P planes and Q satellites/plane, there can be many permutations. Ballard introduced a

## Multiregional Highly Elliptical Orbit Constellations

harmonic factor  $M$  that is used as a multiplier with the right ascension to derive the initial phase angle of a circular orbiting satellite.<sup>5</sup> The longitude of the ascending node at time=0 and the time separation of the satellites can then be derived. It is very important at this stage to check against duplication of constellation configurations derived from different  $M$  values as the Ballard algorithm, though compact, is rife with duplication resulting in excessive run times. The algorithm in SPIFF was modified to eliminate duplicated permutations. The user may specify a range for  $P$  &  $Q$ , a step size for each, and a maximum number of satellites to be considered in a candidate constellation.

### 3.5 Coverage zone definition

The three coverage areas are represented in the SPIFF program by four circular coverage zones shown below in figure 3.5.1.

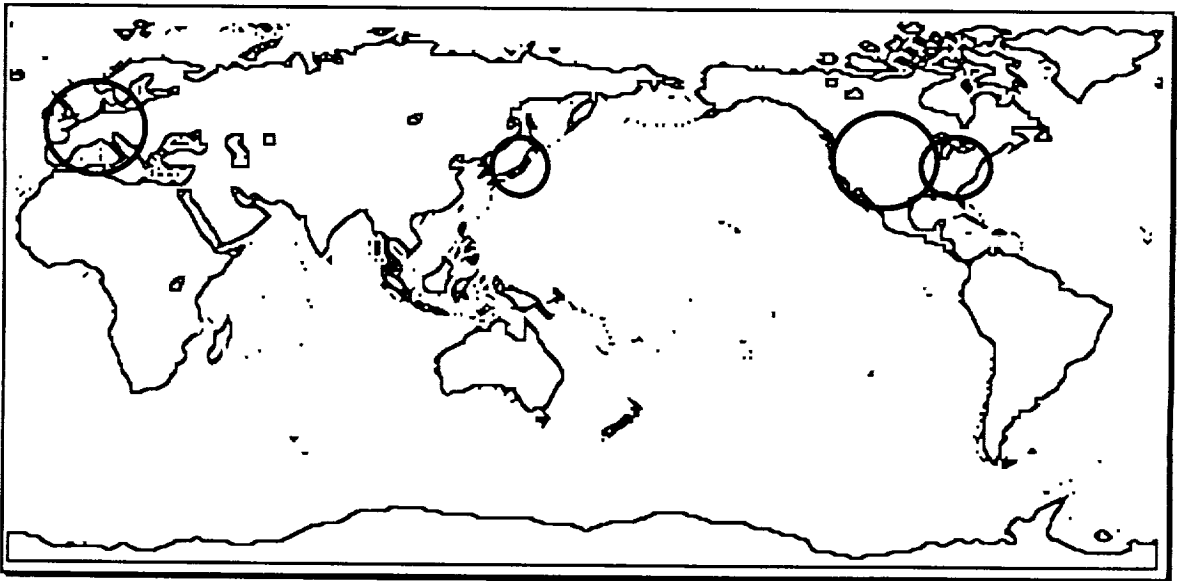

Figure 3.5.1 Circular coverage zones

The circular coverage zones may be easily described by a vector and an angle arc: the vector from the center of the Earth to the center of the coverage circle on the surface of the Earth fixes the location of the coverage zone; and the arc on the surface of the Earth from the center of the circle to the circumference of the circle. Please refer to figure 3.5.2.

## Multiregional Highly Elliptical Orbit Constellations

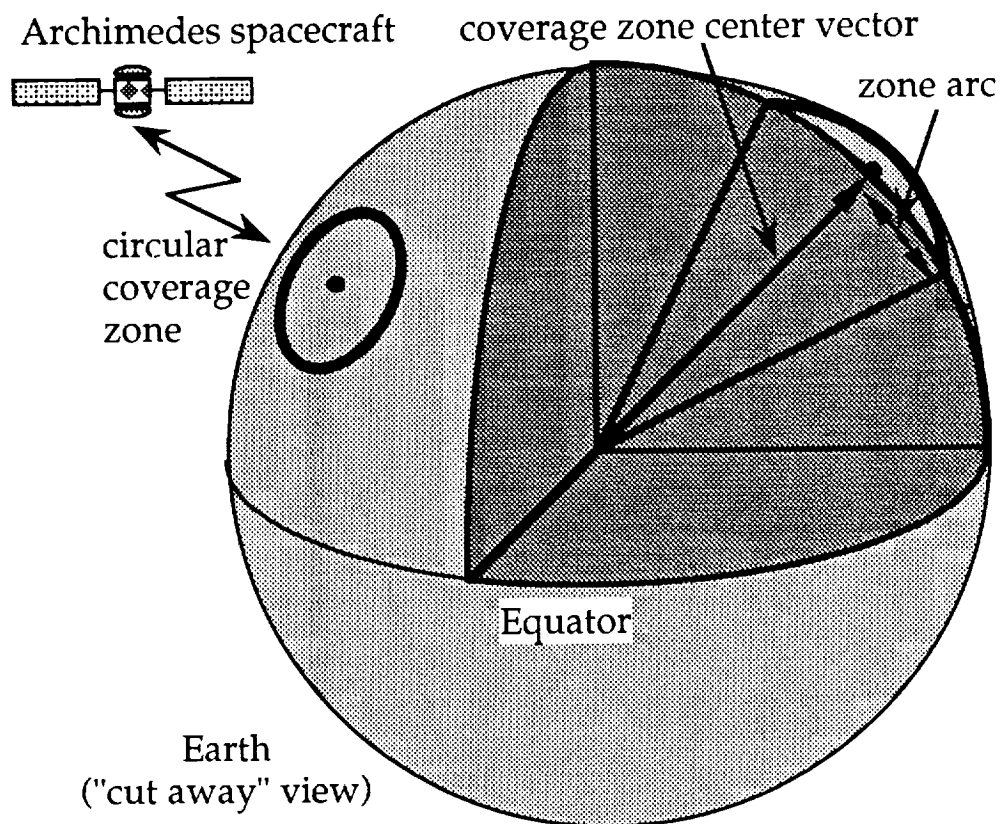

Figure 3.5.2 Coverage zone cross section

### 3.6 Coverage check

Checking for single or multisatellite coverage is accomplished by simple vector manipulation. For a point on the surface of the Earth to have proper satellite coverage, the satellite must be in a cone extending outward from the Earth from that point and at an angle with the tangential plane equal to the minimum elevation angle. Please refer to figure 3.6.1. For full zonal coverage by a single satellite, the satellite must be located within a cone that is the locus of all the coverage cones from the circumference of the circular zone. In the event that single satellite coverage is not possible, multisatellite coverage of a zone is checked by assuring that individual coverage cones on the circumference of the circle, as well as the circle center, each contain a satellite.

## Multiregional Highly Elliptical Orbit Constellations

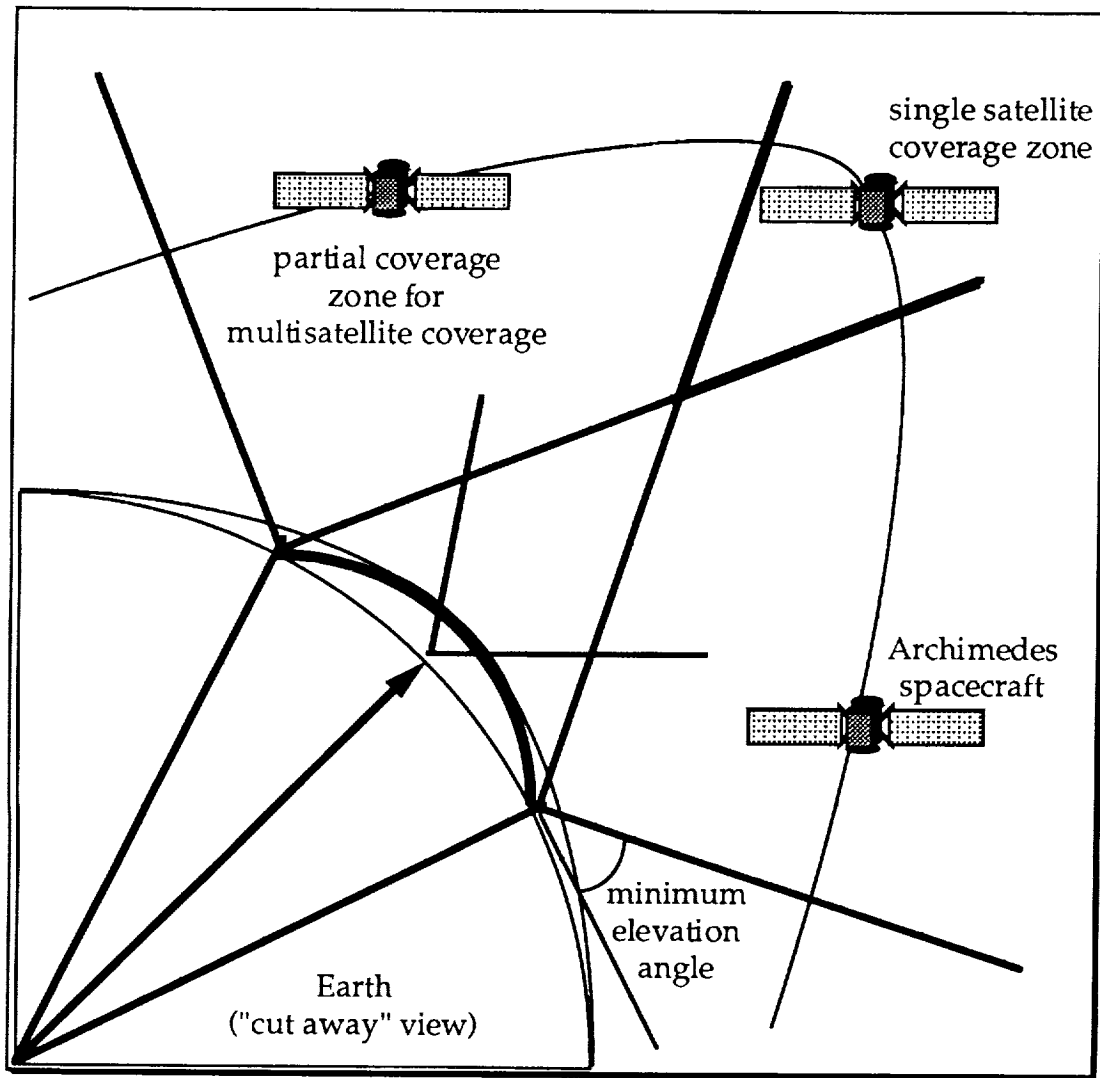

Figure 3.6.1 Full and partial coverage cones

## 4.0 RESULTS

### 4.1 Data

Several runs of the SPIFF program were made under specific conditions to test for candidate Archimedes systems. Constellations of up to  $P=6$  planes and maximum value of  $N=P*Q=10$  was specified. The zones were specified as shown in table 4.1.1.

## Multiregional Highly Elliptical Orbit Constellations

Table 4.1.1 Coverage zones' centers and arc lengths (degrees)

	Europe	Japan	W. US/CAN	E. US/CAN
Longitude	10	138	253	278
Latitude	50	38	40	40
Arc length	15	11	17	12

The minimum elevation angles considered were 30 and 40 degrees, and the orbit was tested for 6 and 8 hour periods for different runs. These results can be seen in tables 4.1.2 and 4.1.3.

Table 4.1.2 40° elevation angle results

Elev. Angle	Period	P	Q	N	M
40°	6 hr.	-	-	-	-
40	8	5	2	10	4.5
40	8	6	1	6	3.0

At the stringent conditions (40 degree minimum elevation angle and 6 hr. period), there were no constellations that could provide continuous coverage. However, there were two constellations in 8 hour orbits capable of providing continuous coverage: a 10 satellite constellation of 5/2/4.5 (P/Q/M) and another requiring only 6 satellites in a 6/1/3 configuration.

Table 4.1.3 30° elevation angle results

Elev. Angle	Period	P	Q	N	M
30°	6 hr.	5	2	10	4.5
30	8	5	1	5	2.0
30	8	5	2	10	2.5
30	8	5	2	10	4.5
30	8	6	1	6	3.0

When the minimum elevation angle requirement is opened up to 30 degrees, it is revealed that there is a 6 hour period constellation that could provide continuous coverage with 5 planes of 2 satellites/plane. In the 8 hour period case, we see that there are several acceptable constellations.

# Multiregional Highly Elliptical Orbit Constellations

## 4.2 CONCLUSIONS

The number of planes (P), the number of satellites (N), and the line-of-site elevation angle are important criteria for rating constellations. High values of P and N are undesirable due to operational complexity and cost.

Elevation angle is an important consideration for communications due to signal interference. In order to successfully communicate at lower elevation angles, the power density flux of a signal from a satellite must be stronger. The achievement of high power level transmissions typically results in higher spacecraft weights and is undesirable, hence the emphasis on high minimum elevation angles for communications.

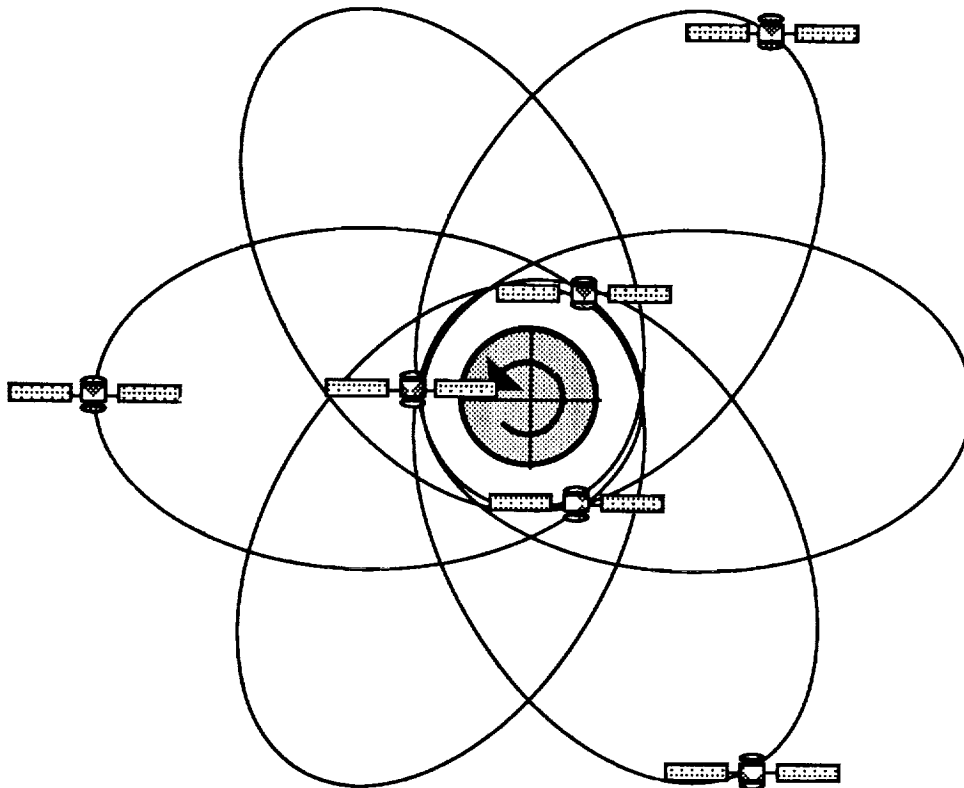

Figure 4.2.1 A constellation option that satisfies the 40° elevation angle & 8 hour period constraints with a P=6/Q=1/M=3 configuration (polar view).

The 8 hour/40 degree elevation angle results show that it is possible to achieve relatively high elevation angles. The balance between having fewer satellites as an initial cost in the 6/1/3 case vs. 5/2/4.5 must be weighed against the additional operational costs of having more planes.

## Multiregional Highly Elliptical Orbit Constellations

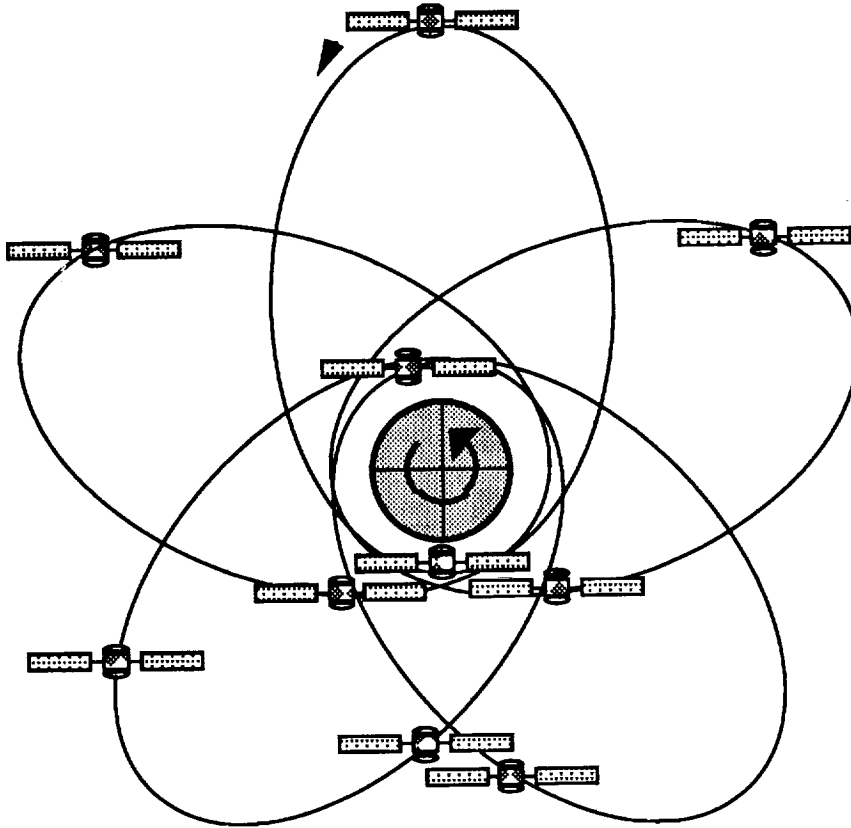

Figure 4.2.2 A second constellation option that satisfies the  $40^\circ$  elevation angle & 8 hour period constraints with a  $P=5/Q=2/M=4.5$  configuration (polar view).

At lower elevation angles, the 6 hour period is attractive for its shorter time delay in communication due to its lower apogee, but will have larger  $J_2$  effects to expend propellant counteracting and thus shortening its operational lifetime. The 8 hour case reveals an interesting result that there is a  $5/1/5$  solution with both a low number of planes and a low total number of satellites. This would be an especially attractive configuration if the low minimum elevation angle results in acceptable power flux density requirements on the spacecraft design.

It should be noted that these results conflict with those previously published in the ESA Bulletin<sup>6</sup> by Solari and Viola. These differences need to be reconciled. I was, however, able to duplicate their results in the course of developing an independent program for checking the coverage zone satellite hand-off that neglected Earth rotation. When Earth rotation was added to this program, the results matched those of SPIFF.

# Multiregional Highly Elliptical Orbit Constellations

## 5.0 ACKNOWLEDGEMENTS

This research was performed at NASDA's Tsukuba Space Center in Tsukuba city, Ibaraki-ken, Japan, under the auspices of the STA/NSF Summer Institute in Japan Program during the summer of 1992. The author gratefully acknowledges the generous support of the following organizations for their support of this work: The National Space Development Agency of Japan (NASDA), The Science and Technology Agency of Japan (STA), and the United States National Science Foundation (NSF).

## 6.0 REFERENCES

1. R. D. Luders, "Satellite Networks For Continuous Zonal Coverage," *American Rocket Society Journal*, vol. 31, pp. 184-197, Feb. 1961.
2. J. G. Walker, "Circular Orbit Patterns Providing Continuous Whole Earth Coverage," Royal Aircraft Establishment, Technical Report 70211 (UDC 629.195:521.6), November 1970.  
J. G. Walker, "Continuous Whole Earth Coverage By Circular Orbit Satellite Patterns," presented at the IEE Satellite Systems for Mobile Communications Conference, 13-15 March 1973, paper 95.  
J. G. Walker, "Continuous Whole Earth Coverage By Circular Orbit Satellite Patterns," Royal Aircraft Establishment, Technical Report 77044 (UDC 629.195:527), 24 March 1977.
3. G. V. Mozhaev, "The Problem of Continuous Whole Earth Coverage and Kinematically Regular Satellite Networks, I," *Cosmic Research*, volume 10, (UDC 629.191), November-December 1972, translation in CSCRA7 (Consultants Bureau, New York), volume 10, number 6, pp. 729-882, 1972.  
G. V. Mozhaev, "The Problem of Continuous Whole Earth Coverage and Kinematically Regular Satellite Networks, II," *Cosmic Research*, volume 11, (UDC 629.191), January-February 1972, translation in CSCRA7 (Consultants Bureau, New York), volume 11, number 1, pp. 1-152, 1973.
4. A. H. Ballard, "Rosette Constellations of Earth Satellites," *IEEE Transaction on Aerospace and Electronic Systems*, vol. AES-16, no. 5, pp. 656-673.
5. *ibid.*
6. G. Solari and R. Viola, "M-HEO: The Optimal Satellite System for the Most Highly-Populated Regions of the Northern Hemisphere," *ESA Bulletin*, volume 70, 1992, pp. 81-88.



ISU in an era of partial reconvergence

Douglas M. Messier

George Washington University, Space Policy Institute,  
Gelman Hall, Washington, D.C. 20037

Knowledge, as Socrates would have it, is the "only one good" and is universal in value; but knowledge, as Bacon would have it, is also "power" and power is particularized: Those with the power may not want to share it. Which to serve, the universal truth or the particularized power.

-- Educator Clark Kerr1

1. ABSTRACT

The International Space University was founded in 1987 to provide young space professionals with an international, multi-disciplinary approach to space education. The organization has held six 10-week summer sessions at which students from throughout the world have studied space. In 1995, ISU plans to begin a one-year Ph.D.-level program in space studies.

This paper examines the educational goals of ISU in the context of current education trends. It discusses how trends toward internationalism and interdisciplinary studies are reshaping both education and the aerospace field. The tensions that exist between ISU's conflicting goals are discussed in the context of these prevailing currents.

2. INTRODUCTION

There's an old saying that timing is everything. ISU's timing was especially fortuitous; the university's founding and development corresponded with a number of substantial political, economic, and technological trends that are transforming both aerospace field and higher education. The main trends common to both of these areas is a move toward internationalism coupled with an increasing emphasis on interdisciplinary education. The changes are bringing about many benefits but also a great deal of tension as the old is gradually replaced by the new. ISU's public relations often makes it appear that the school is unique and is doing things that no one has ever done before. The reality is the university is not setting trends so much as being at the forefront of them, and applying methods and tools used by others in a new manner and a new field (space). The leaders of the university has been very shrewd in judging these trends and exploiting them.

3. EDUCATION AND INTERNATIONALISM

The multicultural and multinational characteristics embodied

within ISU are not new; they go back to classical times. However, the definition of higher education, and the relationship between the university and internationalism, have undergone major changes over the past 2,500 years. The world might be entering a new era in which education will become even more internationalized.

Educator Clark Kerr divides the history of higher education into three phases: convergence, divergence, and partial reconvergence.

The first phase, convergence, dates back to Classical times. This phase was marked by the establishment of institutions open to all who were included within a particular civilization. "Scholars and students were drawn from within the entire orbit of the civilization of the time and placed without reference to nationality, and they studied what they wanted to without intended external guidance or constraints by nation-states."<sup>2</sup> This era was, of course, subject to the constraints of the prevailing religious and political doctrines. Three key attributes involved a single curriculum, a single scholarly language (Latin), and one religion each (Muslim and Christianity).

Kerr dates the period of divergence back to the Reformation, which gave rise to nation-states and divided the Western university world into Catholic and Protestant sectors. A number of academic models proliferated as nation-states created their own university systems. These systems were designed to help create governments in: building institutions; promoting common languages, cultures, and national histories; training people to participate in economies; providing for national defense needs; and accomplishing other national goals. Universities thus became an integral part of training people to become leading citizens of their nations.

The systems remain splintered today. For example, the European Community has implemented the European Course Credit Transfer System to facilitate the recognition of university degrees and courses across national boundaries. Students who completed academic work in one country have often found it difficult to receive credit at institutions in another nation.

Writing in 1991, Kerr said that the world has entered a "confused period of partial reconvergence" that heralds "a second great transformation" in education. This era has been marked by the integration of Europe and the entrance of the former Soviet Union and China back into the international education world. Coupled with other economic and social trends and new information technologies, education and academic research is increasingly being done across national borders.<sup>3</sup>

### 3.1 Educational Examples

International commerce has been a major driver of internationalism, and academia has responded to help meet the needs. INSEAD -- the European Institute of Business Administration -- was founded

at the start of European integration in 1958 to meet the needs of the European business community. The school, located in Fountainbleau, France, offers a one-year MBA program that includes a broad multi-national, multi-disciplinary curriculum. INSEAD typically includes about 300 students from about 30 nations, as well as an international faculty from approximately 15 nations.<sup>4</sup> Thus, the program is very similar in scale and scope to what ISU plans for its master in space studies degree in the central campus. What ISU will likely create is an INSEAD for space.

The EC has been at the forefront of efforts to break down the pattern of divergence. The community's ERASMUS program, initiated in 1987, funds a variety of initiatives. Under the program, a university student from one EC nation can study abroad in another one. Further, ERASMUS funds a variety of joint educational programs between universities in different nations.<sup>5</sup>

Another trend is interdisciplinary approaches. This has resulted from the increasing interconnection of many elements of the world; it creates for managers and leaders to see the bigger picture. A number of top engineering schools have initiated interdisciplinary educational programs. The Massachusetts Institute of Technology (MIT) offers a joint engineering/management degree that is aimed at teaching engineers a broad approach to these fields. The program, which is done in conjunction with 11 major manufacturers, includes intensive classroom training as well as practical experience through internships.<sup>6</sup>

### 3.2 Tensions

The trends toward international and interdisciplinary approaches have not been without problems. At the heart of partial reconvergence lies a tension between, on the one hand, the universal nature of the search for truth and knowledge, and on the other hand, the power that is at the root of this knowledge.

Two of the several "laws of motion" currently propelling institutions of higher learning around the world are (a) the future internationalization of education of learning, and (b) the intensification of the interest of independent nation states in the conscious use of these institutions for their own selected purposes.<sup>7</sup>

Despite the increase of internationalism, economic competition continues to put pressure on national leaders to improve education as a way of bolstering competitiveness. Military tensions have forced leaders to stifle the free flow of knowledge. All of this creates an undercurrent against internationalism.

A major challenge remains: how to demonstrate to the "average citizen" the benefits of a public university's involvement in world affairs. This is no easy task, particularly given the difficult economic times. Universities, particularly public ones, are experiencing

social and political pressures to focus on local, state and national issues. In the coming century, the challenge for American higher education will be to persuade our constituents of the necessity--and value--of adopting and nurturing a major international focus.<sup>8</sup>

#### 4. ISU AND PARTIAL RECONVERGENCE

ISU is dedicated to reaching full convergence. It is an institution that is open to all people of the world, regardless of citizenship or political persuasion. And it aims to foster increased cooperation among all countries of the world in space education and exploration while avoiding any strong connection with military activities. The knowledge that is gained in space exploration would be available to all, and the more advanced space powers would share it with those less advanced.

Yet, in a larger sense ISU is still operating within the partial reconvergence framework described by Kerr. Space exploration is in a similar period of transition. The major space programs were founded based on Cold War competition. The end of the Cold War has coincided with other developments that include a leveling of technological capabilities, increased costs, and economic problems to encourage unprecedented efforts in international cooperation. At the same time these internationalist trends have run into counter forces aimed at maintaining domestic industries and competitiveness. ISU must strike a delicate balance: encourage internationalism while not posing too much of a threat to the status quo. Otherwise, the space agencies and other organizations that support the organization would simply stop providing money and personnel, and ISU would collapse.

The constraints of partial reconvergence can be seen in a less than subtle manner at ISU. Under the ideal of convergence, the ISU would be dedicated to discovering essential truths and knowledge unfettered by the demands of a particular group. However, two forces are at work within ISU that have led to a state of partial reconvergence.

The first force is ISU's own ideology. The university's three founders -- Peter Diamandis, Todd Hawley, and Bob Richards -- as well as many of their collaborators came from the ranks of space advocacy organizations. Diamandis founded the Students for the Exploration and Development of Space (SEDS) while an undergraduate at MIT. SEDS promotes space among young college students. Hawley was involved in running the Young Astronauts Council, which promoted space among children. The founders are disciples of Gerard K. O'Neill and Arthur Clarke--futurists who believe it is mankind's destiny to explore and eventually settle space on a large scale. The founders spoke seriously of eventually having the permanent campus in orbit.

ISU is the grandchild of SEDS, and it possesses many of its predecessors genes. Under full convergence, education is to be

free to search for essential truths unfettered by outside demands. ISU is dedicated less to this ideal of education than to social engineering on an ambitious scale. The idea was less to create a university than to win over disciples who would work to further human presence in space. Diamandis described the philosophy with a near evangelical fervor.

What drew (the founders) together was something we called the benign conspiracy.....The concept was that we were all working to subvert the minds of all the people in future positions of power out there, subvert them or convert them into people who supported and wanted to develop space. To take you as someone is coming in who might like space and so forth but through the ISU experience to help you see the same benefits and the good of international and multidisciplinary studies, and so that when you're successful in wherever you go, when it comes time 30 years from now, Doug, I can pick up the phone and say, Doug, it's time. We have got to make this thing happen. And the benign conspiracy, through ISU and through SEDS earlier, to get the contacts and the capability someday to influence the world at a critical moment, at a cusp point....It is not an entity onto itself, it is a mechanism for facilitating space development. It's a machine, it's a living entity as best we could design it.

In my mind, the means is more important than the ends.....If in the end, you tell me that ISU did not accelerate the development of space one iota, I've failed. ISU is a waste. If you tell me that a permanent university is never formed, but it accelerated the development of space because it pulled people together, it developed concepts, then its been a total success.<sup>9</sup>

Most alumni describe ISU as an intense social experience, giving generally lower marks to the academic aspects. The emphasis the university places on social and cultural activities is good in that it helps to break down a lot of barriers. The intensity of the experience assists in creating deep friendships and a network of contacts around the world. This international "ISU family" could have a substantial impact on how space exploration is conducted if its members rise to high positions of power. Further, many alumni have also expressed satisfaction with the university's multi-disciplinary, multi-national approach. The students have undertaken design projects that take an international approach to space.

The second force at work within ISU is the relationship between the university and its main sponsors, which include major space agencies and corporations. Although it is difficult to generalize, most of these organizations are involved in ISU for more practical reasons instead of philosophical ones. They want the employees they send to ISU to come back with experience in

working into an international, multi-disciplinary setting. The sponsors also use ISU to promote their programs through lectures and also design projects that advocate particular initiatives. The university also gives the sponsors a chance to evaluate young space talent. These are all useful activities for a university to undertake.

#### 4.1 Academic Constraints

At the same time, however, ISU's ideology and its relationship with the main sponsors has seriously retarded the academic program in some respects. The university is more interested in serving in an advocacy role--promoting a set of goals and objectives -- than in analyzing whether these objectives make any sense. ISU is so keen on space development that the institution has lacked the necessary distance from the subject matter that is necessary for critical analysis. ISU does do very well in exposing students to many different disciplines, thus improving the scope of their knowledge. But, much of the information is presented in a conference-like setting, and respect for all beliefs and concepts is stressed. The evaluative aspects are weak.

For a school that prides itself on a multi-disciplinary approach, ISU's view of space's role in society appears slightly myopic. The summer sessions succeed, to varying degrees, in making connections between disciplines, such as relating engineering to policy and law. However, ISU's vision is largely focused on space, and does a generally poor job of putting space into the larger context of human existence. ISU's general view is that space exploration is the most important thing mankind can undertake; this is an extraordinary claim for anyone to make about any undertaking, and one that deserves some critical analysis. The reality is that few people outside the space field view things in these terms, and they are correct in taking this view. Some aspects of space, such as telecommunications and remote sensing, are ubiquitous aspects of modern life; other aspects such as human exploration are luxuries.

The connection between ISU and its main sponsors has had some detrimental impacts on the program. The university has no real financial independence, and it is heavily dependent on support from governments and private industries. Thus, it is an organization that seeks to challenge the status quo while relying on those same traditional organizations for its existence. The other element of this equation is that both ISU and the sponsors are interested in promoting space activities. As a result, the academic program has suffered at times. Some lectures are substantive, while others appear to be little more than exercises in public relations and "selling" of initiatives.

The idea of an underground guerrilla movement -- a Fifth Column -- working to subvert the world is a bit scary. If these words were spoken by a religious fanatic, a terrorist or a radical

political leader, they would sound downright chilling. An honest educational effort should not include conspiracies of any sort, nor should it involve any overt political agenda. Further, inclusion in the "ISU family" should not be seen as the main criteria for success; otherwise, a space Mafia will be created that will only further its own interests.

## 4.2 Transitions

A major redefinition of ISU's main goals is looming. The university is preparing to transition to a full-time degree program. ISU will be running a one-year, Ph.D.-level program beginning in 1995. The aim of the school is ambitious: to become THE training center for future leaders in the space sector. ISU officials would like to see their program as a pre-requisite for a person who wants to advance his or her career.

The transition is likely to lead to a much different ISU. First, the academic standards are higher than the master's-level summer session. In order to be successful, ISU will have to create a serious program. The program also will be aimed to a large degree at professional audience. The expectation is that companies will sponsor them as a way of obtaining better employees.

Further, the program will likely allow some students to take the program in stages, possibly over two or three years. This means a modification of ISU's main goal of having a small number of students get together in an intense experience. The social and networking aspects of the program will continue to be important, but they will be more diffused. As a result, the coming transition could be marked by a tension between serving the university's original promotional goals and creating a more sober-minded program aimed at meeting the needs of a market niche.

## 5. CONCLUSIONS

ISU's program includes many positive aspects. The emphasis on international and multi-disciplinary studies involves the application of major educational trends to a new field of space. The program's approach, which mixes social and academic elements, has served to break down many barriers between people of different nationalities and disciplines. It represents a unique laboratory where young space professionals can get together to learn.

The period of partial convergence is characterized by a conflict between an emphasis on internationalism and strong pressure on nations to use educational institutions for their own purposes. The situation with ISU is similar in scope, although it is not nation-states and their demands that are creating the tensions. Instead, the tensions exist because of a conflict between ISU's desire to promote space and the need for an academic institution to have some critical distance from the subject matter it covers. Another aspect of the conflict revolves around the relationship between ISU and its main sponsors.

It should be stated that it's not a matter of doing one thing or the other exclusively. Conflict always exists in education between the demands of specific groups. Institutions of higher learning serve a number of different functions, and the real challenge is to find an appropriate balance between the elements. Education is similar to a stool held up by three legs. One leg embodies the requirement to give students practical skills they can use in their professional careers. Students will not spend \$20,000 to \$30,000 for the MSS program without this assurance. The second leg involves providing government and industry with a skilled labor force, and conducting research work for these sectors. ISU cannot survive without the financial support of these institutions. The third leg involves honest academic inquiry that searches out essential truths.

Interviews with alumni show that many of them are satisfied with the career experience and the international contacts gained at ISU. Further, ISU's sponsors appear generally pleased with the benefits they are receiving from their support of the university. Seven organizations bid for ISU's central campus, and another 18 have signed on as affiliate campus as part of the university's global campus system. The program is not without its substantial problems, and much improvement in quality is needed if ISU is to run better summer sessions and grant a credible degree in its full-year MSS program. The key aspect of international and multi-disciplinary education is that anyone can do it; however, doing it well is another matter.

It is the third leg -- academic inquiry -- that needs to be strengthened. Academic should not embody promotion and evangelical proselytizing but rather a sober-minded search for the truth that embodies critical analysis. ISU has often crossed the line in this regard, presenting space as being more important than it is in reality. Part of the academic content has been more to promote particular ideas/projects/space agencies/companies than to provide any real analysis. Yet, ISU could not have been established if its founders had not been very enthusiastic about both space and the need to further internationalize it. This excitement helps make the ISU sessions so interesting.

The question of whom ISU serves is a key one as the institution transitions from a summer session effort to a full-time program. Will ISU continue its advocacy role, remaining true to the founders' vision? Or will it lose a lot of its ideology, becoming just another institution that will produce better bureaucrats for ESA, NASA, and Rockwell International? ISU must work to find an appropriate balance so that its various educational elements complement each other.

## 6. ACKNOWLEDGMENTS

This paper was drawn from a master's thesis titled, "The Founding and Development of the International Space University."



The thesis is part of a master's degree in science, technology and public policy at The George Washington University, Washington, D.C. Many thanks go to John Logsdon, director of the Space Policy Institute, for all of his assistance. Special thanks to David Bearden for providing valuable comments.

## 7. REFERENCES

1. Clark Kerr, "International Learning and National Purpose in Higher Education," *American Behavioral Scientist*, September/October 1991, p. 18.
2. *Ibid*, p. 17.
3. *Ibid*.
4. *The Official Guide To MBA Programs*, Graduate Management Admission Council, Warner Books, 1986, p. 225.
5. Willie Wielemans, "Erasmus Assessing ERASMUS," *Comparative Education*, Vol. 2, No. 2, 1991, pp. 168-69.
6. William J. Cook, "Made In America Comes Back," *U.S. News & World Report*, 23 March 1992, pp. 81-2.
7. Kerr, p. 17.
8. Manuel Pacheco, "Knowing No Boundaries: The University As World Citizen," *Educational Record*, Spring 1992, p. 23.
9. Interview with Peter Diamandis, 7 December 1992.

# REPORT DOCUMENTATION PAGE

Form Approved  
OMB No. 0704-0188

Public reporting burden for this collection of information is estimated to average 1 hour per response, including the time for reviewing instructions, searching existing data sources, gathering and maintaining the data needed, and completing and reviewing the collection of information. Send comments regarding this burden estimate or any other aspect of this collection of information, including suggestions for reducing this burden, to Washington Headquarters Services, Directorate for Information Operations and Reports, 1215 Jefferson Davis Highway, Suite 1204, Arlington, VA 22202-4302, and to the Office of Management and Budget, Paperwork Reduction Project (0704-0188), Washington, DC 20503.

1. AGENCY USE ONLY (Leave blank)		2. REPORT DATE February 1994	3. REPORT TYPE AND DATES COVERED Conference Publication	
4. TITLE AND SUBTITLE Second Annual International Space University Alumni Conference			5. FUNDING NUMBERS	
6. AUTHOR(S) L. Johnson and P. Robinson, compilers				
7. PERFORMING ORGANIZATION NAME(S) AND ADDRESS(ES) George C. Marshall Space Flight Center Marshall Space Flight Center, Alabama 35812			8. PERFORMING ORGANIZATION REPORT NUMBER M-738	
9. SPONSORING / MONITORING AGENCY NAME(S) AND ADDRESS(ES) National Aeronautics and Space Administration Washington, DC 20546			10. SPONSORING / MONITORING AGENCY REPORT NUMBER NASA CP-3253	
11. SUPPLEMENTARY NOTES Proceeding of a conference sponsored by The International Space University 955 Massachusetts Avenue Cambridge, MA 02139				
12a. DISTRIBUTION / AVAILABILITY STATEMENT Unclassified—Unlimited Subject Category: 12			12b. DISTRIBUTION CODE	
13. ABSTRACT (Maximum 200 words) The papers presented at the conference reflect the multidisciplinary nature of the International Space University (ISU) and its alumni. The first papers presented hold special relevance to the design projects, and cover such topics as lunar-based astronomical instrumentation, solar lunar power generation, habitation on the moon, and the legal issues governing multinational astronauts conducting research in space. The next set of papers cover various technical issues such as project success assessment, satellite networks and space station dynamics, thus reflecting the diverse backgrounds of the ISU alumni.				
14. SUBJECT TERMS space exploration, lunar development, space astronomy, spacecraft design			15. NUMBER OF PAGES 155	
			16. PRICE CODE A08	
17. SECURITY CLASSIFICATION OF REPORT Unclassified	18. SECURITY CLASSIFICATION OF THIS PAGE Unclassified	19. SECURITY CLASSIFICATION OF ABSTRACT Unclassified	20. LIMITATION OF ABSTRACT Unlimited	