

**NASA Technical Memorandum 104607**

# **Creative Inventive Design and Research**

**James J. Kerley**

**JUNE 1994**

(NASA-TM-104607) CREATIVE  
INVENTIVE DESIGN AND RESEARCH  
(NASA, Goddard Space Flight Center)  
162 p

N94-33719

Unclas

G3/31 0012658





**NASA Technical Memorandum 104607**

# **Creative Inventive Design and Research**

**James J. Kerley**  
*NASA Goddard Space Flight Center*  
*Greenbelt, Maryland*



**National Aeronautics and  
Space Administration**

**Goddard Space Flight Center**  
Greenbelt, Maryland 20771

1994

**This publication is available from the NASA Center for AeroSpace Information,  
800 Elkridge Landing Road, Linthicum Heights, MD 21090-2934, (301) 621-0390.**

## CONTENTS

<u>Section</u>	<u>Page</u>
1.0 INTRODUCTION . . . . .	1-1
2.0 THE STATE OF THE ART--INNOVATION TODAY . . . . .	2-1
2.1 Commentaries about Modern Innovative Education . . . . .	2-1
2.2 Psychology, Medical Studies, and Their Relation to Creative Thought . . . . .	2-6
2.3 The Natural Process of Thinking, Induction, and Deduction . . . . .	2-9
3.0 THE RELATIONSHIPS BETWEEN CLINICAL PSYCHOLOGY AND THE PHILOSOPHY OF ENGINEERING . . . . .	3-1
3.1 Hemispheric Studies in Psychology and Medicine . . . . .	3-1
3.2 Abstraction . . . . .	3-7
3.3 Percepts and Concepts . . . . .	3-9
3.4 Wallace's Discussion of the Powers of the Intellect and Body . . . . .	3-11
4.0 APPLICATION OF THEORY . . . . .	4-1
4.1 Arithmetic . . . . .	4-1
4.2 Parametric Equations . . . . .	4-1
4.3 Geometry . . . . .	4-4
5.0 INDUCTIVE--DEDUCTIVE LOGIC . . . . .	5-1
5.1 Problems to Solve in Deductive and Inductive Thinking . . . . .	5-1
6.0 HEURISTICS . . . . .	6-1
6.1 Problem Solving by the Method of Heuristics . . . . .	6-1
7.0 A PRELIMINARY STEP TO RETRODUCTION--A 12-YEAR-OLD BOY BUILDS A SHOP . . . . .	7-1
8.0 ENGINEERING APPROACH TO RETRODUCTION--THE BEAM . . . . .	8-1
8.1 The System of Retroduction Is Introduced by the Design of a Beam . . . . .	8-2
9.0 RETRODUCTIVE INVENTION . . . . .	9-1

CONTENTS (Continued)

<u>Section</u>	<u>Page</u>
9.1     Retroduction Used to Demonstrate the Process of Invention in a Mesh Isolation System of a Sensitive Tube . . . . .	9-1
10.0    A PIONEER INVENTION--RETRODUCTION . . . . .	10-1
10.1    Using Retroduction to Solve a Multi-phase Pioneer Invention That Has Been the Leader in Its Field Over the Past 25 Years . . . . .	10-1
11.0    EARLY AMERICAN INVENTORS . . . . .	11-1
11.1    John Deere and the Plow . . . . .	11-1
11.2    McCormick and His Reaper . . . . .	11-1
11.3    John Robert Stevens and the "T" Rail . . . . .	11-4
11.4    Swivel Trucks for Railroad Cars . . . . .	11-4
11.5    Railroad Safety Standards . . . . .	11-4
11.6    McCay and the Clipper Ship . . . . .	11-8
11.7    Inventions in Iron and Steel . . . . .	11-8
11.8    Oil Discoveries . . . . .	11-8
11.9    Early Submarine . . . . .	11-8
11.10   Machine Tools . . . . .	11-8
12.0    BASIC RESEARCH . . . . .	12-1
12.1    John Jacob Astor Starts a Business in New York . . . . .	12-1
12.2    Retroduction Demonstrates the Development of Principles as Well as Causes . . . . .	12-9
13.0    REFERENCES . . . . .	13-1
APPENDIX A--QUESTIONNAIRE ON INDUCTION AND DEDUCTION . . . . .	A-1
APPENDIX B--CONCEPTS AND EFFECTS OF DAMPING IN ISOLATORS . . . . .	B-1
APPENDIX C--RETRODUCTION . . . . .	C-1

ILLUSTRATIONS

<u>Figure</u>		<u>Page</u>
1	Left Hemisphere and Right Hemisphere Thinking . . . . .	3-2
2	Inductive-Deductive Thinking . . . . .	3-4
3	Man Contacts the Outside World . . . . .	3-5
4	The Mental Powers of Man . . . . .	3-6
5	Percepts & Concepts - Abstraction . . . . .	3-8
6	Percepts & Concepts . . . . .	3-10
7	The Powers of Man . . . . .	3-12
8	Multiplication of Fractions . . . . .	4-2
9	Parametric Equations . . . . .	4-3
10	Geometric Figures . . . . .	4-5
11A	Pattern Studies . . . . .	4-7
11B	Pattern Studies . . . . .	4-8
12	Given . . . . .	5-1
13	Find . . . . .	5-1
14	The Solution . . . . .	5-1
15	What Would Happen If? . . . . .	5-2
16	Now It Is Obvious . . . . .	5-2
17	Another Solution . . . . .	5-2
18	A Similar Approach . . . . .	5-2
19	Another Solution . . . . .	5-2
20	Move 3 Coins at One Time Another Solution . . . . .	5-2
21	Rotate Until 2 Is on the Bottom Move 2 Coins at One Time . . . . .	5-3
22	Inductive-Deductive Logic . . . . .	5-5

ILLUSTRATIONS (Continued)

<u>Figure</u>		<u>Page</u>
23	Solution to House Problem . . . . .	5-6
24	Inductive-Deductive Logic . . . . .	5-8
25	The Nonmathematical Example of a Man Wishing to Cross a Creek . . . . .	6-3
26	Travel from "A" to "B" . . . . .	6-5
27	Heuristic Approach . . . . .	6-6
28	Building a Shop . . . . .	7-2
29	Handbook Design . . . . .	8-1
30	Retroductive (Ballpark) Design . . . . .	8-3
31	Retroductive Design . . . . .	8-8
32	Isolator Figure . . . . .	9-2
33	Isolator Invention . . . . .	9-3
34	The Plow . . . . .	11-2
35	The Reaper . . . . .	11-3
36	Railroad Tracks . . . . .	11-5
37	The Truck . . . . .	11-6
38	Safety . . . . .	11-7
39	Clipper Ship . . . . .	11-9
40	Steel and Mining . . . . .	11-10
41	Oil . . . . .	11-11
42	Submarine . . . . .	11-12
43	Machine Tools . . . . .	11-14
44	Starting a New Business . . . . .	12-2
45	Principles . . . . .	12-4



ILLUSTRATIONS (Continued)

<u>Figure</u>		<u>Page</u>
46	Business Opportunities . . . . .	12-6
47	Hat Business . . . . .	12-8

APPENDIX B

1	Overall Problem of Designing Damping into a System .	B-2
2	Sandwich Damping in Panels, Frames, and Curved Mounts . . . . .	B-3
3	Dynamic Motion of Curved, Mounted Panels . . . . .	B-3
4	Internal Stress Condition of Curved Sandwich Panels . . . . .	B-4
5	Bumpers to Reduce Deflections . . . . .	B-4
6	Special Forms of Sandwich Mounts . . . . .	B-4
7	Dynamic Motion of Best Mount . . . . .	B-4
8	Cable Sandwiched Between Two Pieces of Plastic . . .	B-5
9	Dynamic Response Curves of Rubber, Plain, and Cable Mounts . . . . .	B-5
10	First and Most Recent Use of All-Cable Mounts . . . .	B-6
11	Use of Corner Angle with Cable to Control Frequency and Damping . . . . .	B-7
12	Vibration in Two Different Planes Noting the Same Natural Frequency and the Same Damping . . . . .	B-7
13	Deflections of Rubber and Steel Cable (Cord) . . . .	B-8
14	Different Deflections Caused by Different Preform . .	B-8
15	Angle Rotation and Damping During Vibration . . . .	B-8
16	Load Deflection Curve for Soft Cable System . . . .	B-9
17	Applications of Cable Systems . . . . .	B-9
18	Mounting of 5000-lb Horn and Frame with Cables . . .	B-10

ILLUSTRATIONS (Continued)

<u>Figure</u>		<u>Page</u>
19	Cable Opening During Bending . . . . .	B-10
20	Single-cable Mounting System . . . . .	B-10
21	Isolating with Heavy Preload . . . . .	B-10
22	Response Function of Isolation with 15-g Preload . . . . .	B-11
23	Heavily Damped Coupling Systems . . . . .	B-11
24	Application of Coupling with Good Damping . . . . .	B-12
25	Coupling Systems with Damping . . . . .	B-12
26	Coupling System with Damping . . . . .	B-12
27	Compound Cable Systems . . . . .	B-12
28	Compound Cable Systems . . . . .	B-13
29	Shocks from 30 g's to 100 g's on Cable Systems . . . . .	B-13
30	Isolation Through Damping of Electric Hammer . . . . .	B-13
31	Damping Isolation Through Wire Mesh . . . . .	B-13
32	Damping and Stiffness as a Design Tool . . . . .	B-14

APPENDIX C

1	Chart of Philosophical History . . . . .	C-21
---	--	------

## CREATIVE INVENTIVE DESIGN AND RESEARCH

### 1.0 INTRODUCTION

The National Science Foundation along with the engineering universities and societies have joined in a mutual effort to define the design process with particular emphasis on creative design. This work has taken a high priority in American research as it becomes obvious to most engineers in many fields that American design is taking a second place in the world market.

This paper is a summary of a course currently given at the Goddard Space Flight Center for graduate engineers entitled "Creative Inventive Design and Research". This course strikes at the heart of the problem as it describes the thinking process itself before it goes deeper into the design process as a structured method for performing creative design. Many problem examples and figures are presented in a form that should make clear to all students what this process is and how it can be used.

Discussion of the process of thinking is supplemented by an explanation of how the course is taught to engineers and scientists. The approach to creative design is a combination of analysis, synthesis, and actual practice. All of these techniques are essential if a student is to genuinely understand the creative process in design.



## 2.0 THE STATE OF THE ART--INNOVATION TODAY

Is the creativity crisis a real problem or a fictitious problem? It is best to quote from those in responsible positions for they know the status, importance, and results of this void in our American culture. The void exists not only in engineering but also in business, medicine, and the other professions as well.

### 2.1 COMMENTARIES ABOUT MODERN INNOVATIVE EDUCATION

In Reference 17, Keith R. Richburg on September 25, 1925 wrote an article entitled "College Graduates Depicted as Uncreative, Too Indebted." He is quoted:

Students too frequently sit passively in class, take safe courses, are discouraged from risky or interdisciplinary research projects and are discouraged from challenging the ideas presented to them....

In Reference 6, Emily T. Smith, Stephanie Yanchinski, and Margaret Sabin are quoted in Business Week on September 30, 1985 in an article "Are You Creative?" as saying:

This year more than 20,000 executives will attend workshops that they hope will help them invent new products, conceive new strategies, and become better managers....

Business executives are taught to be inventive because there is a void in creative thinking in American business today that is recognized and industry is going to do something about it.

In Reference 12, on January 29, 1985 Carol Innerst is quoted from an article entitled "Corporate Programs Indict U.S. Educational System":

\$130 billion spent annually on public education. Corporations are spending some \$40 billion annually to train and educate their employees....

This does not include the amount of money that the government is spending to train its employees.

In Reference 53, in June 1980 Robert C. Haavind stated in High Technology:

So many of our national problems would be solved by a revival of the innovative spirit that built this great nation. It is amazing that this effort has been shoved to a back burner....

In Reference 3, Richard W. Samson in October 1985 stated in an article entitled "Entering the Mind-Work Age: Will You Be Ready?" that the engineer and scientist will be required to think and do

creative work. Training is needed today to prepare engineers for this new type of thinking that is coming up.

In Reference 34, the thoughts of Paul Gray, president of M.I.T., were noted on March 31, 1980 in an article entitled "Where Are the Edisons? They Are an Endangered Species, Warns M.I.T.'s Paul Gray":

The list of American innovators is long and impressive. But are we running out of original thinkers? Paul Edward Gray who will become the 14th president of Massachusetts Institute of Technology on July 1, worries that we are.

In Reference 55, on February 11, 1985 Ezra Bowen wrote an article in Time entitled "Education Schooling for Survival":

America's business has become its own educational provider. Says Del Lippert, vice president for education services at Digital Equipment Corp. It's a matter of survival....

In Reference 52, Lars Soderholm wrote an article entitled "Readers Claim Management Hampers Design Effort" for his fellow engineers:

Most had contempt for the 'high flash for low cash' design concepts and the superficial trivia that marks many consumer items. It was evident that the shortcomings of American-made mass-produced products made even U.S. designers uncomfortable.

They pointed out in their letters that the 'international look' described as 'straight-forward, clean and lean' had its beginning areas with traditional shortages of raw materials and energy. As a result their products emphasize substance and permanency rather than 'frills'. It was also suggested there is little 'native' design left and that U.S. designers are just as capable of effective design but instead usually ending going in whatever direction their sales manager pushes them....

It is expedient at this point to leave the business world and break the remarks down into:

1. comments by management
2. comments on general education
3. comments on engineering education

In Reference 36, Bob Kelly in Assembly Engineering stated:

There may be some very good (or is it bad) reasons why employees shy away from using their creative talents. Here are just a few of the most prevalent:

An anti-creativity atmosphere exists in the company  
When an idea fails to produce the results expected, the creator is punished

Creativity threatens the insecure  
There is no good way to communicate ideas.

In Reference 27, Dr. Frederick Herzberg in Industry Week of November 16, 1981 stated in his article "Group Dynamics at the Roundtable":

Human-relations strategies masking lack of experience.  
Personality masking lack of ethical courage.  
Teamwork masking loss of opportunity for individual responsibility.  
Quantity masking neglect of quality.  
Growth of make-ready industries masking inaction.

In many companies and the government the management that promoted group dynamics did not realize that this very action put a roadblock in the way of creative innovative design and management.

In Reference 14, Geoffrey C. Ward in Science Digest, September 1982, is quoted from his article, "Making Thinking Your Business":

'My business is thinking' Edison often said, and on the wall of every room at this Menlo Park headquarters was the same quotation from the British artist Sir Joshua Reynolds: 'There is no expedient to which a man will not resort to avoid the real labor of thinking....'

In Reference 15, Thomas Love recorded the following on June 10, 1979 in his article "Revival of 'Yankee Ingenuity', Called Answer to U.S. Woes":

It's common knowledge that the famous old 'Yankee ingenuity' is winding down, Gilbert V. Levin, President of Rockville's Biospherics Inc. said.

In Reference 13, James F. Lardner wrote an article in August 1982 in Industry Week entitled "Why U.S. Manufacturers Miss Out on New Technology":

- (a) Senior management then evaluates the proposals independently and over an extended period. This obscures whatever potential a technology may have for the organization as a whole.
- (b) Senior managers in recent years have been focused on financial and marketing strategy and on behavioral science--and has ignored technology--there is a lack of comfort with technological change at a senior level.
- (c) Senior management who could suspend or modify the economic screening procedure does not do so because the technology involved is not understood. And the managers and technicians in the subgroups who do understand it do not have the authority to act.

The following comments on general education demonstrate that the education which professional engineers, lawyers, and doctors, etc. get before coming to college is practically devoid of creative thinking.

In Reference 1, Elsa Walsh stated on October 20, 1986 in an article entitled "Pupils Taught to Review Thought Process" that the inductive creative process of thinking is starting to come back in a small number of schools.

In Reference 2, Elsa Walsh stated on October 20, 1986 in her article entitled "Education's '3 Rs' Become Four: Schools Put Stress on Reasoning", that education was returning to reasoning which would include both the logical sciences and the creative sciences.

In Reference 19, Michael A. Wallach in the American Scientist of January 2, 1976 in an article entitled "Tests Tell Us Little About Talent":

Above intermediate score levels, academic skills assessments are found to show so little criterion validity as to be questionable based on which to make consequential decisions about students' futures....

If the testing does not predict success or achievement in later life, what is taught? Is the student prepared to take tests to be successful in his profession?

In Reference 20, James E. Stice in Engineering Education in February 1979 stated in "Grades and Test Scores: Do They Predict Adult Achievement?":

Intellectual aptitude could not be related to actual accomplishments in social leadership, the arts, science, music writing, speech and drama....

This is more evidence that the schools are not teaching the young people to be fully educated, particularly in the creative arts and professions.

In Reference 38, David C. McClelland wrote an article entitled "Testing for Competence Rather Than for 'Intelligence'" in which he stated:

So what about grades? How valid are they as predictors? Researchers have in fact had great difficulty demonstrating that grades in school are related to any other behaviors of importance-other than doing well on aptitude tests. Yet the general public-including many psychologists and most college officials-simply has been unable to believe or accept this fact....



These references express the opinion that grades and the study required to make those grades will not predict success or failure in the professions. In addition, modern education does not prepare the students for the real world because it trains the students to be deductive with convergent thinking but it does not train them to be creative with inductive or innovative thinking.

The following references will demonstrate these same principles as applied to engineering and they will go further to demonstrate the application of thinking and training to the left (major) and the right (minor) hemispheres of the brain.

In Reference 42, the work of Irene Peden is recorded in an article entitled "Education May Suppress Creativity, Imagination" in Machine Design:

Engineering educators are beginning to take a hard look at ways to apply findings of research concerning left vs right hemispheres of the brain. According to the University of Washington's Irene Peden, basic differences between left and right halves suggest the need for new approaches to the training of engineers and for supervising them in industry. For example, present teaching methods stress math and technical bases that foster left-brain development. Downplayed-or outright suppressed-are aspects stimulating the right half, the area which gives rise to creativity and imagination. Thus conventional engineering curricula can prove unattractive to many talented students.

In Reference 44, Fred Landis stated in Mechanical Engineering in October 1984 in an article entitled "Let's Improve the Learning of Mechanical Engineering":

Almost everybody is concerned with better teaching but only a few worry about effective learning...Unfortunately, some textbook writers do not take the educational low road. They have not learned from the comments made by August Foppl, one of the founders of modern Strength of Materials, more than seventy years ago: 'The writers of textbooks often think more about the critics who may review their work than about their students. To satisfy the critics, the authors try to present their work in general terms and in as rigorous a form as possible....'

In Reference 30, Carol Innerst in the Washington Times of July 23, 1985 stated in an article entitled "Visual, Spatial Skills Fall 'Alarmingly' in Students":

The average score for public, parochial and private school seniors taking the test in 1980 was 9.1 correct answers out of a possible 16. The average score in 1985 slid to 7.1....

The spatial skills are a clear indication of the creative mind.

In Reference 33, Ronald L. Eshleman in the Shock and Vibration Digest is quoted in an article entitled "Mathematics in Engineering Education":

My opinion is that educators have been trapped by the beauty and apparent exactness of mathematics. Deterministic solutions look good on paper, and, if instructors haven't been exposed to other approaches, such solutions are easy to use and to elaborate. The result has been a trend in which basic textbooks on mechanical vibration have become more mathematically oriented in the past 20 years.....

This introduction to the course "Creative Inventive Design" is to show the students that most of them have had poor training in inductive creative thought. It is pointed out that the mad rush to cram in so many courses hit a peak and the students were then required to drop laboratory, design, and drafting courses. The argument was that the student could get this training on the job. But what was missed was the fact that these types of courses were given not so much to teach the student how to draw a straight line as to develop their inductive skills not provided in the myriad courses offered in modern education. This was observed from the references quoted. Each year many schools pick up on this problem and offer inductive creative skill courses. The greatest witness for this fact were Reference 6 and Reference 12, where it was pointed out that this year 20,000 executives would be given courses in how to be inventive and creative. The fact that \$40 billion dollars was spent by industry on educating employees was a clear indication of what industry would like the schools to teach.

## 2.2 PSYCHOLOGY, MEDICAL STUDIES, AND THEIR RELATION TO CREATIVE THOUGHT

Dr. James Rimualdi of Carnegie-Mellon University has probably done more than any person in engineering education to tie down the hemispheric studies of the brain and relate them to creative thought. In Reference 10, Dr. Rimualdi is quoted from his class notes that he uses to teach this work at Carnegie-Mellon ("The Creativity - Intelligence Distinction and Its Significance for Professional Education"):

- (1) He points out the work of Wallach,<sup>19</sup> McClelland,<sup>38</sup> and others to show that grades do not necessarily lead to success or achievement in later life.
- (2) He shows that the work of Galin, et al.,<sup>9</sup> Douglas,<sup>16</sup> Sperry,<sup>115</sup> and Nebes<sup>116</sup> provides medical and psychological evidence that the left and right hemispheres of the brain have different tasks.
- (3) He synthesizes much of this work by noting that the left, or major hemisphere, is primarily (a) verbal, (b) analytic,

and (c) linear. He then points out that the right, or minor hemisphere, is primarily (a) holistic, (b) nonverbal, (c) global, (d) proficient in visuoconstructive tasks, and (e) creative. This is only the beginning of his synthesis, but it should be pointed out that he has been a pioneer in the field of the synthesis of hemispheric studies as applied to teaching engineering in the university.

- (4) He makes a special reference to Nebesll6 that the right, or minor hemisphere, of the brain is more efficient in perceiving the relationship between part or parts of a stimulus and the overall configuration. He explains it as an arc to the whole circle. This point is one of the major keys to invention and basic research.
- (5) Dr. Rimualdi makes a special point to show how the minor hemisphere has the ability to see three-dimensional pictures from two-dimensional pictures. The University of Maryland has specialized in this study over the past several years.
- (6) He points out that the minor hemisphere is able to infer the structure and organization of our environments without having to submit the whole sensory array to a detailed analysis. This is another key to solving creative problems.
- (7) He notes that the minor, or right hemisphere, is seen to organize and treat data in terms of the complex wholes, being in effect a synthesizer with a predisposition for viewing the total rather than the individual parts.
- (8) Dr. Rimualdi assessed the importance of his finding in the following passage:

The true impact of these findings, moreover, becomes apparent when one removes one's focus from clinical details and considers the global implications of such results in our view of how one learns; how one solves problems and how one assimilates and processes stimuli. The findings are of such fundamental importance and significance that the action suggests a new paradigm within which one could formulate new models of education....
- (9) It is clear that Dr. Rimualdi is aware of the inadequacy of current testing in ascertaining the lack of creative education, and he demonstrates that this creative talent is indicated or measured primarily in the minor or right hemisphere of the brain.
- (10) He points out that Osborn's book Applied Imagination<sup>71</sup> approaches the issue of creativity on the basis that everyone has imagination and that practice with the appropriate techniques will increase the proliferation of ideas.

Osborn highlights the importance of visual imagery. He points to the forthcoming hemispheric studies as two classes in thinking: (a) judicial mind which analyzes, compares, and chooses and (b) creative mind which visualizes, foresees, and generates ideas.

- (11) Dr. Rimualdi points out the extensive development of techniques for teaching creativity. He dispels the old belief that it is strictly an inherited trait, restricted to a small, gifted proportion of the population.
- (12) Douglas<sup>16</sup> shows the psychological association by Guilford distinguished between convergent and divergent thinking. These different modes of thought parallel the description of major and minor hemispheric specialization of the brain.
- (13) Dr. Rimualdi points out the natural use of analogy and figures of speech in creative thought.

It would be good to list some of the works that have been done in the past decade to supplement the early studies that we have mentioned.

- (1) Andrew W. Young<sup>5</sup> has written a book entitled Function of the Right Cerebral Hemisphere. He includes over 600 references to studies performed in this field. His point at the end of this long study is that there is something beyond brain that everyone is seeking to find.
- (2) Joseph Peter Longo Jr.<sup>7</sup> points out in this article "Holistic Thinking (Modal Boundary)" the use of this work in the Defense Intelligence College.
- (3) Linda Garmon<sup>23a</sup> points to the work of the late Norman Geschwind in his brain studies. Geschwind was a brilliant theoretician, not an experimentalist.
- (4) Doreen Kimura<sup>23b</sup> in the same issue of Psychology Today as Linda Garmon's article points out the difference between the female and the male brain.
- (5) Maya Pines<sup>24</sup> in her article "Baby, You're Incredible" shows that the basic concept of abstraction (so necessary for brain study) is not started at age 6 or 7 but rather soon after the infant is born.
- (6) Howard Gardner<sup>26</sup> demonstrates in his article "The Music of the Hemispheres" that the left hemisphere differs from the right hemisphere in the playing and writing of music. Writing or creative music is with the right hemisphere, primarily.

- (7) Dr. Frederick Herzberg<sup>27</sup> notes in his article "Group Dynamics at the Roundtable" that the psychology used for years called group dynamics is invalid and has turned the people practicing it away from creative thought.
- (8) Henry Mintzberg,<sup>40</sup> in his article in Harvard Business Review, suggests that planning is the left hemisphere and that managing is in the right hemisphere.
- (9) Irene Peden<sup>42</sup> points out that education may suppress creativity because the training of the hemispheres of the brain could act as a block in creative learning.

Many other references were presented to the classes which pointed out numerous fields of study including medicine and music. It would take an entire book to list all of the studies that were performed along with their findings. These few references serve to demonstrate to the students that this work is current and germane to creative inventive work and research. To enumerate all of these findings would be nothing more than a compilation of different ideas. However, they are included here to show how important this work is to the study of creative engineering and to show how important the study of Dr. Rimualdi has been in presenting a synthesis with definite conclusions. All of these data show a consistent pattern which cannot be ignored by modern educators.

### 2.3 THE NATURAL PROCESS OF THINKING, INDUCTION, AND DEDUCTION

At this stage the students were shown the natural process of thinking. It is synthesis of inductive (right hemisphere) and deductive (left hemisphere) thinking. The process is presented with diagrams to be sure that the students knew the hemispheric distinction.

A version of this process was presented at an Engineering Colloquium<sup>29</sup> at Goddard Space Flight Center. Much of the work was paraphrased from the "Natural Process of Thinking."<sup>117</sup>

The student was shown that a thorough understanding of the inductive-deductive type of thinking was most necessary as a step to understanding creative inventive design and research. This work is so important that it is presented here in its entirety.

#### "Creative Inventive Design and Research"

Invention is generally perceived to be something left to chance or happenstance. Not so! I intend to show that there is a structured methodical approach to invention which is based on the natural process of thinking. In other words, anyone can do it - if they can think and understand how they think! That's a tremendous concept! The same applies to research.

It is creativity that has been lacking in the training of engineers, doctors, business majors, etc. Traditionally, past solutions have been studied in depth, but new or different answers have not been sought.

Although Carnegie-Mellon, Thayer School at Dartmouth, the University of Florida, and the Goddard Space Flight Center have recently offered courses in creative design, most schools do not do so. Therefore, training in the creative realm has been forced on industry, amounting to billions of dollars annually.

Those of us who are studying the problem of creativity and innovation are concentrating on the thinking process itself rather than the type of courses given. We have taken the thought process for granted so long that few questioned it until we had to take a more thorough look at artificial intelligence. How can we define artificial intelligence if we don't thoroughly understand human intelligence?

At Goddard our study has concentrated on the inductive-deductive processes of thinking. What are these processes of thinking? The inductive-deductive philosophy of education insists upon balance - learning the material first by employing one process and then learning the other process. THE GREATEST BENEFIT OF THIS BALANCED EDUCATION IS THE HIGH DEGREE OF UNDERSTANDING OR MEANING WHICH RESULTS. Retention is greatly improved. Minor benefits are fairly evident.

Any in-depth study of induction and deduction must be preceded by several pertinent considerations. NEITHER OF THESE PROCESSES IS ANY BETTER THAN THE OTHER. One is only different from the other, and neither operates exclusively. They interact together. If the thought process is followed through, INDUCTION LEADS TO DEDUCTION.

Now let's provide some definitions. Deduction is fairly easy to understand. The engineer defines it as "going from the general to the particular". It is convergently logical, a step-by-step process, which moves the thinking in an orderly fashion toward a single point or aim.

Knowing that the general equation for the area of a rectangle is the length times the width (the general equation), if the length is 9 inches and the width is 4 inches, then the area is 9 inches times 4 inches or 36 square inches (the particular). This is a simple example of typical engineering courses where the general equation is derived by the professor and the student's job is to take the general equation and come to a particular solution.

But now we come to induction. This is a more difficult concept to grasp. It is defined as "going from the particular to the general". This concept can also be visualized as going from the part to the whole. Compared to deduction, induction is holistic or divergently

logical, at times leading to a fluency of ideas and sometimes to a number of answers. (Not all successful inventions of a chair have to be the same.) Induction is orderly like deduction, but this order is that of the thinker or inventor. The simple, most important characteristic of induction is that it is holistic. This means that the whole is seen as made up of its parts, and that simultaneously, the organic or functional relationships between the parts and the whole are emphasized. An inductive engineer never puts a component into a spacecraft without seeking immediately the reaction that this component will have on the parts next to it, how that component will affect the whole flight, how that component will affect the assembly, what the manufacturing problems will be, what testing may have to be done to insure reliability, etc. The inductive thinker or engineer always thinks of the whole as made of the parts and how these parts relate to each other. He also considers every part as an integral part of the whole. Pattern is a key word of the inductive thinker. He observes, seeks, recognizes, and matches patterns consistently.

It might be helpful to compare how the average engineer (home from work) would solve a problem deductively and inductively. Let's, for sake of simplicity, take the case of the broken down clothes dryer. The dryer is made up of a motor, which turns a belt, which drives the drum. The drum is mounted on a bearing and the bearing is attached to the back housing. The rotating drum dries the clothes as there is a heater under the drum.

There is no such thing as a purely deductive thinker. But, if there were, this is the way he would approach the problem. He opens the back of the dryer and looks in. His thoughts probably go something like this: "Everything appears to be in place, at least according to this diagram...wonder why it won't work. Wait a minute, wait a minute, there's bolt in the bottom of the machine, a loose bolt...that's probably the answer...it came loose and fell out. Let's see now, where could it have come from? The plans don't show. That's funny, I don't see any place that a bolt can fit...now it just must be a bolt that fell in by mistake...I don't really know what's wrong with this thing. Guess I'll just have to call a repair man." He sends for the repair man.

The purely inductive thinker doesn't bother with the directions. He just opens up the back and looks in. His thoughts are probably like this: "Well, let's see...what makes what work in here? I know the heater is working...but to dry the clothes, the drum has to rotate and it just isn't right now. Why not? Now the motor supplies the power which turns the belt; that seems to be ok...then the belt drives the drum while the drum is mounted to the bearing. That's not working. The trouble is there...the drum can't turn... how can I make the drum rotate? The drum seems to be a little out of line...the only thing that could cause this would be the bearing...this bearing seems to be a little out of line...let me grab it...ah, it is loose and rotating...let me line up the

drum. The drum is lined up and belts have their tension. Hey, there's a missing bolt here that attaches the bearing to the housing...there it is on the bottom of the dryer. Let me screw it through the bearing into the housing. That does it...the drum is in line...the belts are tight." The dryer is working...problem solved.

This example shows that the inductive thinker chases down the causes or reasons of all the parts or particulars until he arrives at the final cause or the whole, or the general. He is looking for essential parts of a thing - that which makes it what it is.

You may be wondering whether you are primarily inductive or deductive. There are certain rules to remember. An engineer may be inductive in some ways and deductive in other ways. He could be born deductive and train himself to be inductive in his profession. The same is true of some engineers who were born inductive but through great discipline trained themselves to be deductive. There are some thinkers who were born with a balance between induction and deduction. They could have trained themselves to be primarily one or the other depending on their position.

One clue to a deductive mind is that it uses rote memory to remember. The inductive thinker is constantly looking for patterns and this training helps his associative memory. Usually an imaginative man is inductive, if this imaginative memory is disciplined. He could be simply guessing. The inductive engineer is constantly looking for ballpark answers. He knows how to ask questions. The inductive engineer uses analogies to solve problems. He sees the association of ideas and designs.

We shall look now into the work of psychologists, medical doctors, and philosophers to put this mystery of induction and deduction together.

At this point the students would like to know whether they are primarily inductive (creative) or deductive (convergent logical). A list of questions for engineers which will give them a good idea about their position and provide clues that they can use to become more inductive if they are deductive is presented in Appendix A.



### 3.0 THE RELATIONSHIPS BETWEEN CLINICAL PSYCHOLOGY AND THE PHILOSOPHY OF ENGINEERING

Most engineers and scientists have spent little time studying psychology and/or philosophy. In the class, most of the philosophical and psychological terms presented were new to them. It was necessary to do three things:

- (1) Review the terms and definitions from time to time.
- (2) Show the reasoning processes of psychology and philosophy.
- (3) Outline and summarize the results where possible.

#### 3.1 HEMISPHERIC STUDIES IN PSYCHOLOGY AND MEDICINE

Figure 1 is a graphic outline of the left hemisphere and the right hemisphere of the brain. From the left hemisphere note that the modern sciences and engineering are strong in singular aim, logical thinking, convergent thinking, and deductive mathematical analysis. Not generally taught today are the creative parts of the right hemisphere: matching patterns, synthesizing, fluency of ideas, and the holistic or functional relationship between the parts and the whole.

In the class work it was necessary to follow a constructive manner of thinking and demonstrate how these psychological studies were associated with the philosophy of engineering. In order to do this, certain steps were taken to show the students that the philosopher looks at the same problem as the psychologist but that he uses a different method. To present the philosophical approach, the works of Wallace<sup>61</sup> and Croce/Birch<sup>62</sup> were followed.

Wallace's, text From a Realist Point of View<sup>61</sup> was paraphrased first to demonstrate this phase of the inventive process. Clinical psychology was best described by Hilgard, et al.<sup>161</sup> in the following quotation:

EXPERIMENTAL AND PHYSIOLOGICAL PSYCHOLOGY - The term 'experimental' is really a misnomer, because psychologists in other areas of specialization carry out experiments too. But this category usually consists of those psychologists who use experimental methods to study how people react to sensory stimuli, perceive the world around them, learn and remember, respond emotionally, and are motivated to action, whether by hunger or the desire to succeed in life....

The psychologist experiments with people by using either natural or artificial stimuli in order to arrive at a conclusion about human understanding and behavior.

**LEFT SIDE**

**RIGHT SIDE**

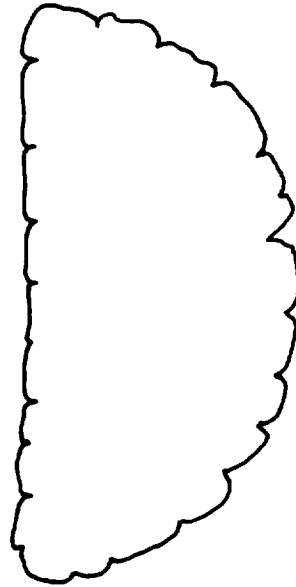
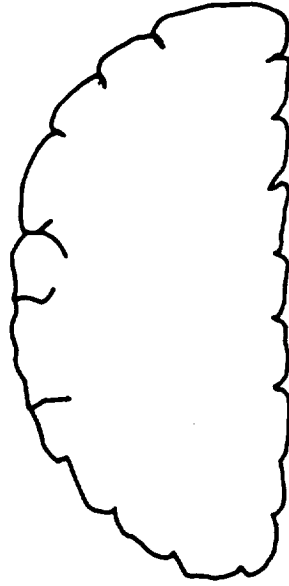

**DEDUCTION**

**INDUCTION**

**SPEECH**

**SINGULAR AIM**

**LOGICAL THINKING**

**CONVERGENT THINKING**

**MAIN LANGUAGE CENTER**

**DEDUCTIVE MATHEMATICAL  
ANALYSIS**

**MATCHING PATTERNS**

**SYNTHESIZER**

**FLUENCY OF IDEAS**

**DIVERGENT LOGICAL THINKING**

**HOLISTIC, GLOBAL**

**RELATIONSHIP BETWEEN  
PART & WHOLE**

**CREATIVE**

**FIGURE 1**

**LEFT HEMISPHERE AND RIGHT HEMISPHERE THINKING**

The philosopher, on the other hand, in his study of the philosophy of science looks upon his work as the development of the methodology of science, especially its logical structure and its impact on the concept of truth and knowledge. (Class notes of Anthony Birch, 1986.)

The philosopher looks at man to find out his very nature, that is, what makes him what he is. He looks within himself to see what the powers of man are, how they react with his other powers, and how these same powers react to the outside stimuli. He talks with others who have performed the same studies. Figure 2 shows the method the philosopher uses to approach thinking from the inductive or deductive point of view. This has been explained earlier. To be noted here is that inductive thinking leads to deduction. The induction of noticing that grass is green leads to the deduction of why the grass is green.

In the fields of science and engineering the philosopher takes nothing for granted. He starts from scratch. Figure 3 shows how man approaches the "outside world" from the philosophic point of view. Man has external senses which pick up all that can be seen, heard, etc. Once this signal gets to the eye or ear, it travels to the brain and puts an image or signal on the internal senses. It has to register somewhere because the sense organ (the eye, for example) cannot hold this impression. It remains in the eye until the eye looks somewhere else. The eye and ear are termed the sensation. The internal signal is termed the percept. Then, within the man, the intellect acts on these internal senses and forms concepts or meaning. In summary, all thinking starts from the outside and first goes through the external senses. Then it is interiorized in the internal senses. Finally, a true concept of the observed object is formed in the intellect.

Figure 4 shows exactly how this is done. All thinking begins with the outer senses through sensation. Outer senses include touch, taste, sight, hearing, and smell. The inventor, in particular, has to constantly go back to his outer senses to be sure of that with which he is really working. The engineer learns what these senses are and can enhance them by the use of instruments, such as a thermometer.

The outer senses send the signal to the inner senses to form a perception. First, the imagination forms an image in the brain or intellect. Later this image can be recalled through the memory. If a man walks into a dark room and grabs something on the table that feels like a fish and smells like a fish, he uses his central sense to conclude that it is a fish. The external senses have no means of conferring signals to each other. The internal senses combine the outer senses through this central interior sense. A value is put on the inner senses. This value is called the "cognitive sense". If the odor is repugnant, an immediate value is placed on the senses.

GRASS (SUBJECT)                      IS                      GREEN (PREDICATE)

GRASS                      WHY IS GRASS GREEN?  
(MIDDLE TERM)                      GREEN

LIVING PLANTS WITH  
CHLOROPHYLL                      ARE                      GREEN

GRASS                      HAS                      CHLOROPHYLL

THEREFORE

GRASS                      IS                      GREEN

**FIGURE 2**  
**INDUCTIVE DEDUCTIVE THINKING**

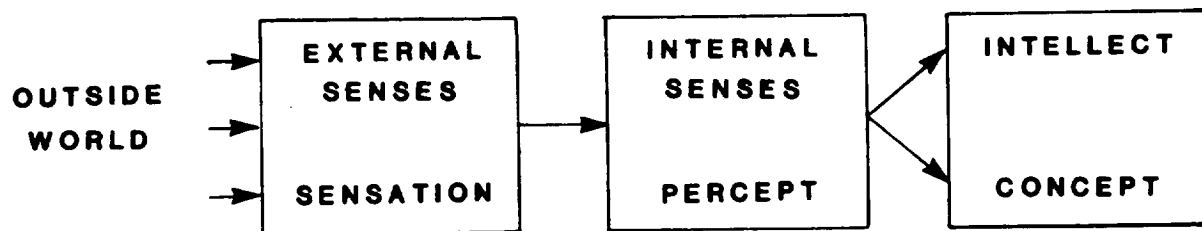

**FIGURE 3**  
**MAN CONTACTS THE OUTSIDE WORLD**

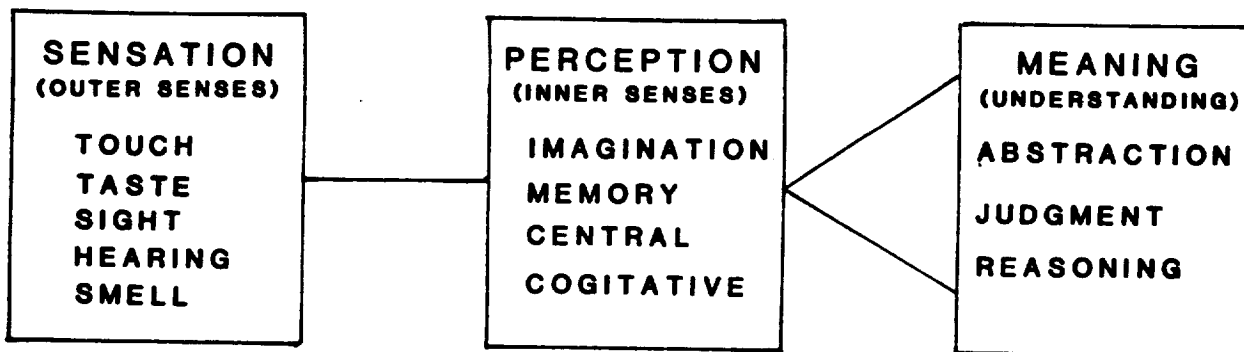

**FIGURE 4**  
**THE MENTAL POWERS OF MAN**

The imagination can form fanciful new images. With the percept of a bird and that of a horse, the imagination can form a mental image of a flying horse. It could be a flying red or purple horse. Wallace states:

Through the inner senses, it should be noted, the knower becomes aware not only of the objects of sense experience but also of space, time, and motion, and in general of the perceptual field in which he situates these objects.

The percept is a very important factor in human knowing, and thus one must be precise in delineating what it does and what it does not contain. Its essential characteristic is that it represents a singular concrete object as apprehended in past or present sense experience. Example of percepts would be 'this blade of grass' or 'this bouncing ball.'

The last step of meaning or understanding is the intellect. Before breaching this subject it is important to remember that this step of meaning or understanding is the cornerstone to invention and basic research. The engineer should know these terms in order to be a successful inventor or research specialist. Edison used these terms without knowing how to define them. These older engineers and inventors all had a good indication that these terms existed but they just couldn't spell them out. These will be pointed out later. Most engineers today use some of these terms. Very few use them all or know what they mean.

The advantages of knowing the terms will be that they will be a help to the engineer. Such knowledge gives the engineer a better understanding not only of what he is doing but also how and why he is doing it. Knowing what, how, and why gives a deeper understanding of every job every day. The time to solve the everyday jobs is shortened. Knowing the terms provides the ability to solve problems that others think impossible. Creative design is easily recognized and studied. Experience is needed for creative, inventive design and research. When the terms are understood, every design is a creative experience and the time to learn is cut down considerably.

### 3.2 ABSTRACTION

The first and most important step is to learn what an abstraction is. Abstraction is the first step to understanding. It is good to start with Figure 5 in which examples of percepts and concepts (abstractions) are illustrated. A comparison of points associated with percepts (inner powers of the senses) and concepts (abstractions) is given on the top of the list of Figure 5. These include imagination, memory, and cogitative under percepts and abstraction, judgement, and reasoning under concepts. The most important concept

<u>PERCEPT</u>	<u>CONCEPT</u>
IMAGINATION MEMORY COGITATIVE	ABSTRACTION JUDGMENT REASONING
INDIVIDUAL	UNIVERSAL
<u>SCREWDRIVER</u> HANDLE SHANK SPECIAL HEAD	THAT WHICH TURNS A SCREW
APPEARANCE	UNDERLYING NATURE
SINGULAR	ALL
SOMETIMES IMAGES	NEVER AN IMAGE
RIGHT TRIANGLE 	A TRIANGLE IS A THREE-SIDED FIGURE
MAN 2 LEGS 2 ARMS BACK 2 EYES BRAIN	MAN RATIONAL ANIMAL

FIGURE 5  
PERCEPTS & CONCEPTS - ABSTRACTION



is abstraction. On the next row it is clear that percepts are individual and concepts (abstractions) are universal.

### 3.3 PERCEPTS AND CONCEPTS

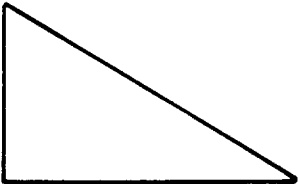
Next comes the percept and concept of screwdriver. It has a handle, a shank, and a special head to turn a screw, all included in the single observable screwdriver. The concept has to be universal and include all screwdrivers. It has to take all of the individual percepts and form a universal definition or concept called the abstraction. This universal is defined as "that which turns a screw". A dime or a fingernail could turn a screw. When it comes to forming a concept or abstraction of all of the screwdrivers throughout the world, it is necessary to put aside all vivid descriptions of individual screwdrivers. What is needed under concept is a definition which would describe the underlying nature of every screwdriver. This is "screwdriverness". It could also be, "That which turns a screw."

The next row in Figure 5 gives a better insight into the percept and the concept (abstraction). The percept is the appearance as it comes from the senses. The concept or abstraction is the underlying nature.

The next row lists the fact that the percept is singular as the senses can only see one thing at a time. The concept, however, includes all screwdrivers under study.

In the next row, it is shown that the percept usually consists of an image. The concept is never an image. Note "that which turns a screw" is not an image of any individual screwdriver.

A concrete example is that of a right triangle which is drawn as the percept. The universal triangle is not a picture of an individual triangle but that of the concept: "a three-sided figure". This is a universal, described according to the nature of all triangles.

The next percept listed is man: 2 legs, 2 arms, back, 2 eyes, brain, etc. This image describes the individual man. But the concept (abstraction) of all those features listed under percept is "rational animal". Legs, arms, eyes, etc. are common to animals and man. The "rational" is included to show that man is an animal who thinks. This includes all men.

Figure 6 is a simplified example of percepts and concepts. The driver notices other drivers. He gets an individual image of the bully driver forcing him off the road. He gets an individual picture of the fast driver as a jackrabbit, and so on for the tailgater, the speed demon, and the slowpoke. These are all individual percepts of the man who does individual things with a car.

THE BULLY TRIES TO PASS  
BY FORCING OTHERS.

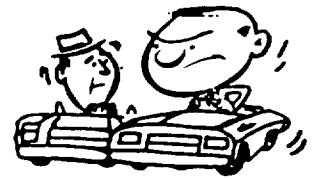

THE JACKRABBIT DRIVES  
IN LEAPS AND BOUNDS.

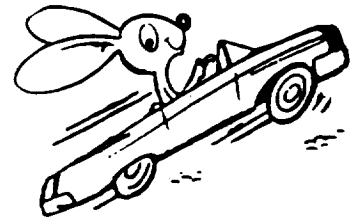

THE TAILGATER RIDES  
'ON THE BUMPER' OF OTHER CARS.

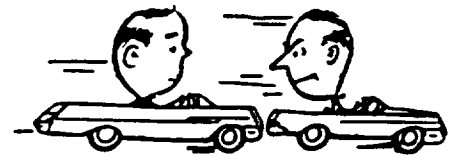

THE SPEED-DEMON  
IGNORES SPEED LIMITS.



THE SLOWPOKE DOES NOT  
KEEP PACE WITH TRAFFIC.

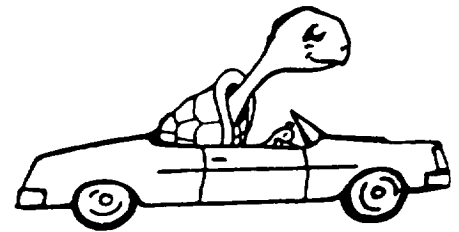

DRIVING A CAR SOMETIMES BRINGS OUT THE WORST IN PEOPLE.  
PERSONALITY TRAITS THAT ARE HARDLY NOTICED AT WORK  
OFTEN BECOME SERIOUS PROBLEMS WHEN A DRIVER GETS  
BEHIND A WHEEL.

FIGURE 6  
PERCEPTS & CONCEPTS

The concept of this same driver would have to include the abstraction of a driver with poor driving characteristics. It could be further characterized by the universal definition listed on Figure 6.

The students studying to be inventors or research engineers should see the importance of percepts and concepts (abstractions) at this point. As an example: an engineer may see a woman carrying an oval wicker basket on her arm. This is a percept as it comes to him from his outer senses. He immediately abstracts from this particular basket the essential notes: a light-weight container with a handle to fit over the arm for carrying small, portable items. He now has a concept of what this basket is all about. He then visualizes other ways of doing the same thing from this concept. He could see a leather container with a handle and maybe a strap to go over the shoulder. He could visualize a cloth or plastic container. He may see a method for keeping the contents dry such as a zippered top of waterproof material. He may see a special top to the wicker basket to hold things inside with a small opening to drop them in, such as a wicker basket for a fisherman. From the general abstraction he can form many percepts with his imagination.

The essential point to get across to the student is that forming the concept first by abstraction sets the stage for the imagination to form many different percepts. This study also conveys to the students the point that the mind or intellect goes readily, and many times very fast, from percept to concept and back again. And if the inventor looks further, he may go back to his original external senses to get further measurements which could lead to another perception, which in turn would modify the concept. Understanding what this means can give the student confidence in his inventive or research work.

Up to this point most of the development of creative thinking is put under the psychological terms of induction and deduction and the philosophical terms of percepts and concepts. But it was originally demonstrated from Figure 1 that all of the psychological powers demonstrated by the hemispheric studies could be classified under the philosophical classification of induction and deduction. Since induction and deduction in philosophy can be related to percepts and concepts, it can be concluded that there is a direct tie between the work of the psychologists and that of the philosophers. More of these connections will be brought out later.

### 3.4 WALLACE'S DISCUSSION OF THE POWERS OF THE INTELLECT AND BODY

William Wallace<sup>61</sup> continues to explain the powers of man. Some of them are listed in Figure 7. Note that sensation, perception, and meaning are listed as previously explained. Next is listed the faculty of personal decisions or the will of man. Edison claimed that the will was the greatest part of invention. The difficulty

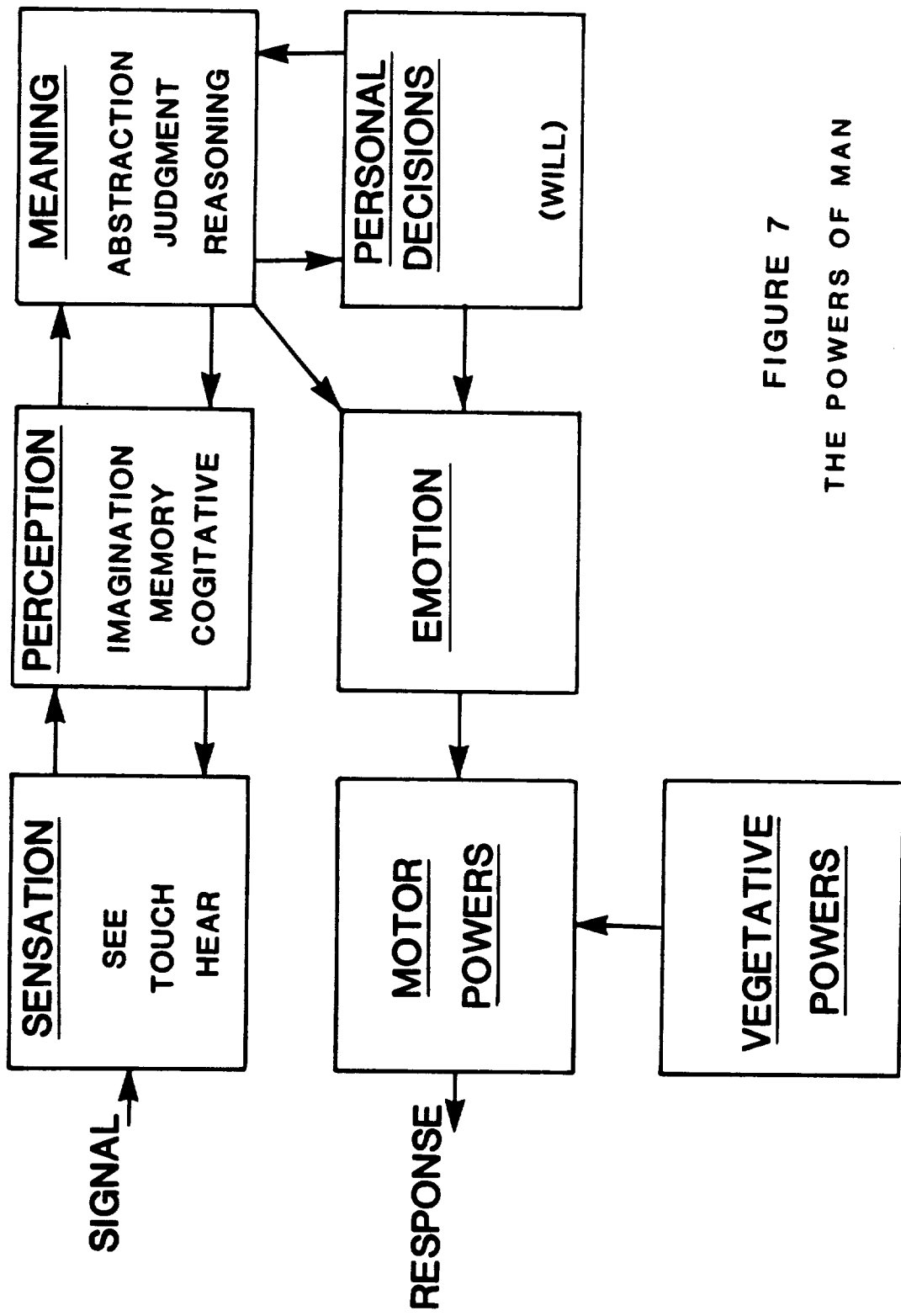

FIGURE 7  
THE POWERS OF MAN

of the work, and in most cases the little pay or recompense, makes it imperative that an engineer use strong will power to continue his work. Many works are used in this development to observe this power in the great inventors of the past - such people as Eastman and McCormick.

Next in Figure 7 is listed emotion. Once the mind is made up with the will, the emotions are needed to continue the interest in the project. There is much written on this subject, particularly the motivations that encourage many engineers to take up this type of work.

The motor powers give action to the will with the emotions. Man has the ability to follow through from his thinking to his will and emotions to work toward the desired end. The vegetative powers give life to the body.

It must be remembered that these individual powers do not work independently of the other powers in the individual. They are broken down with blocks so that the differentiation can be addressed and studied. Thus emotion should be studied with will and also separately to see how the two work together and often clash. Then the intellect should be shown to control the emotions and will to produce the desired end.

The relationship of concepts has been particularly true in the discussion of perception and meaning. These connections are made with arrows to show some of the paths of contact and interaction. Later, other powers such as kinesthetics (a form of sense perception) will be discussed. Many engineers considered this power to be quite useful in the field of invention. Dr. A. D. Moore in his work Invention, Discovery and Creativity<sup>64</sup> considers this power to be the most important in the field of invention. He has much evidence to support his claim. This work and the work of others will be discussed later.



## 4.0 APPLICATION OF THEORY

### 4.1 ARITHMETIC

At this point the students need to see concrete examples of the types of thinking used in engineering. So little time is spent on inductive thinking in the present engineering schools that it is necessary to start out with simple subjects that the students are familiar with and show them both the inductive and deductive way of approaching the subject. The first example is that of arithmetic.

The general rule that they must remember is that induction is going from the particular to the general, while deduction is going from the general to the particular.

Note the multiplication of fractions presented in Figure 8. The problem is to multiply  $1/2$  by  $1/4$ . It can be read as  $1/2$  or  $1/4$ . Induction states that the problem is started from the particular and then goes to the general. The particular in this case was chosen as a straight line. The length of the line was 1 unit. See Figure 8. The line is broken down into  $1/2$ 's,  $1/4$ 's, and  $1/8$ 's. They are drawn on the sheet to show the particular unit of induction. The problem calls for taking  $1/2$  of  $1/4$ . Thus  $1/4$  is located first as shown. Then  $1/2$  of this particular spacing is seen inductively as  $1/8$ . There was no general equation from which to start. The solution is inductive. The problem started by taking a concrete example of a line  $1/4$  unit long. Later, items in addition to a line can be broken down into  $1/2$ 's, etc.

The deductive solution to this problem is to start with the general equation and come up with the particular solution. This is illustrated as:

$$\begin{array}{l} \text{MULTIPLY NUMERATORS} \\ \hline \text{MULTIPLY DENOMINATORS} \end{array} \quad = \frac{1}{2} \times \frac{1}{4} = \frac{1 \times 1}{2 \times 4} = \frac{1}{8}$$

### 4.2 PARAMETRIC EQUATIONS

The second example is the solution of parametric equations both deductively and inductively. Figure 9 shows a sidewalk on the left side of the sketch. It is marked "S". To the right of the sidewalk are marked the fence posts "F". To the left of the sidewalk are marked the telegraph poles "T". The object is to show the functional relationships between sidewalk, fence, and telegraph poles.

Inductively (going from the particular picture to the general equation), simply look at the picture and notice that there are

## MULTIPLICATION OF FRACTIONS

$$\frac{1}{2} \times \frac{1}{4} = ?$$

(NOTE: CAN ALSO BE  
READ 1/2 OF 1/4)

### INDUCTIVE METHOD:

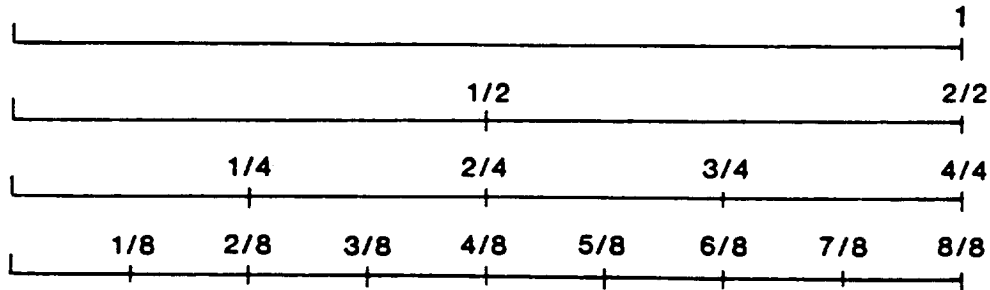

ONE HALF OF  $1/4 = 1/8$   
 $1/2 \times 1/4 = 1/8$

$$\frac{1}{2} \times \frac{1}{4} = \frac{1}{8}$$

### DEDUCTIVE METHOD:

$\frac{\text{MULTIPLY NUMERATORS}}{\text{MULTIPLY DENOMINATORS}} = \frac{\text{REDUCE ANSWER}}{\text{IF POSSIBLE}}$

$$\frac{1}{2} \times \frac{1}{4} = \frac{1 \times 1}{2 \times 4} = \frac{1}{8}$$

$$\frac{1}{2} \times \frac{1}{4} = \frac{1}{8}$$

FIGURE 8

MULTIPLICATION OF FRACTIONS



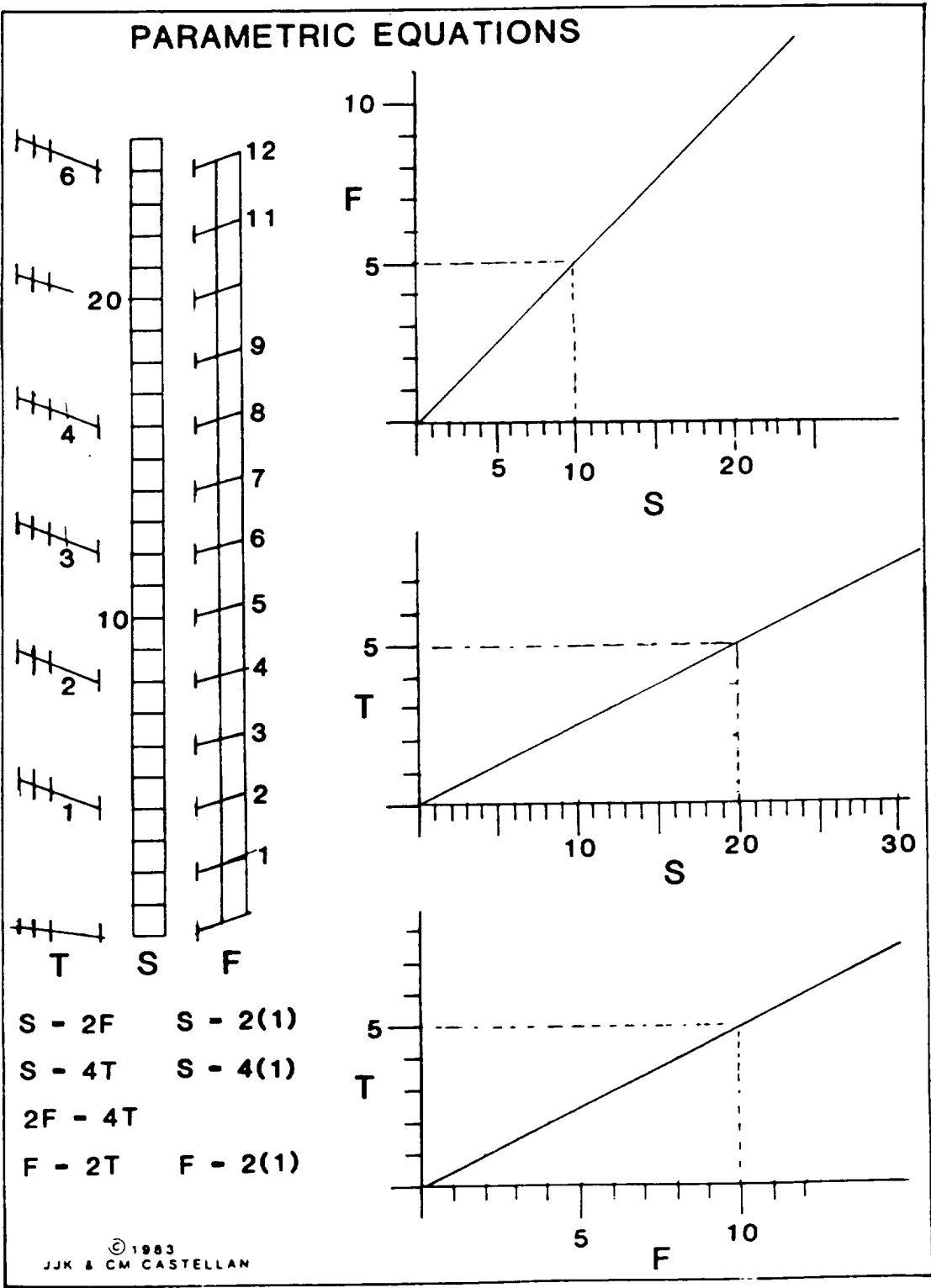

**FIGURE 9**  
**PARAMETRIC EQUATIONS**

two pieces of sidewalk for every one fence post. From this particular observation the general equation is drawn up:  $S = 2F$ . The next part of the problem is to note that there are four pieces of sidewalk for each telegraph pole. From this particular observation is derived the general equation  $S = 4T$ . Finally, the parametric equation or relationship of telegraph poles to fence posts is derived. There are two fence posts for each telegraph pole. This inductive observation leads to the general equation  $F = 2T$ .

Deductively, without a sketch, the relationship of sidewalk to fence posts is given as  $S = 2F$ . The relationship of sidewalk to telegraph poles is given by the general equation  $S = 4T$ . To find the parametric relationship between telegraph poles and fence posts simply eliminate  $S$  between the two equations and observe that:

$$S = 2F \quad S = 4T \quad 2F = 4T \text{ or reduced to } F = 2T.$$

By plotting the relationship, it is possible to use both induction and deduction to show the relationship. The plots on the right of Figure 9 serve this purpose. The curves are drawn inductively, but the equations are marked on the graph deductively.

### 4.3 GEOMETRY

There are times when induction and deduction are used together to solve problems. In Figure 10, "Geometric Figures", the object is to prove that the angle (2 theta) is related to the angle theta. Or, if the angle theta is given, the angle drawn through the center of the circle would have to be (2 theta).

The first step is inductive. The student has no general equation with which to start. He simply notes that  $R_1 = R_2$ , as the radii of a circle are all equal. From deduction it can be seen that the angle B is equal to the angle B at the other end of the triangle. It is observed inductively by symmetry or deductively by the rule of the isocetes triangle. As problems get more involved and complicated it is good to be able to solve a problem both inductively and deductively to give a better understanding of the problem and to give confidence in the solution of other similar problems.

Next it is noted that the two angles B and A both equal 180 degrees. Deductively this is a rule for all triangles. From the general rule that the sum of the angles of a triangle must equal 180 degrees comes the particular note that this figure is a triangle and thus the sum of the angles must be 180 degrees.

Next it is noted deductively that the angle  $A + C = 180$  degrees. The angles of a straight line must equal 180 degrees. We thus have two equations:  $A + 2B = 180$  degrees and  $A + C = 180$  degrees. Simply eliminate the 180 degrees from the two equations by equating one to the other:  $A + 2B = A + C$ . This reduces to  $2B = C$ , which

# GEOMETRIC FIGURES

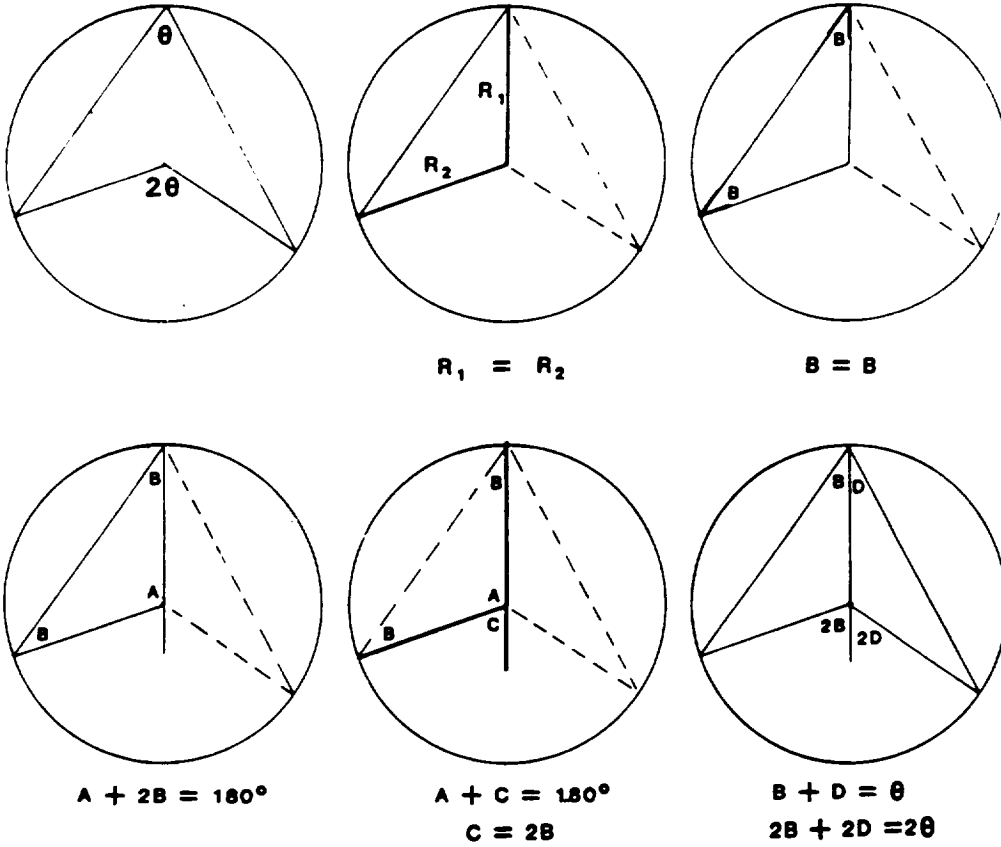
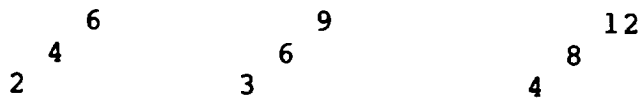

FIGURE 10  
GEOMETRIC FIGURES

can be written as  $B = C/2$ . Since the left side and the right side of the circle are similar by induction, it is proved that if B is given, then the lower angle is equal to  $2B$ . If the upper angle on the right is D, then the lower angle is  $2D$ . But  $B + D$  equals theta, and  $2B + 2D$  equals  $(2 \text{ theta})$ . Proved.

One of the greatest forms of creative inductive drills is the study of patterns. There is little direct deductive logic to the solution of these types of problems, unless the problem solver has seen the same type of problem before. There are, however, certain methods which can be used to solve such problems.

One of the first examples is shown in the series of Figure 11A 2,4,6,3,6,9,4,8,12... Plotting the numbers as if they were on a scale produces the pattern as indicated:



By inductively (just looking) at the series in this form, it can be seen that the next number is 5 because the bottom lines are 2, 3, and 4. In the second column the same can be said of 4,6,8 where the next number is 10. Once the pattern is found inductively, the rest of the solution is deductive because deduction goes from the general to the particular.

Another solution to the above problem is to observe that the 2 tables, the 3 tables, and the 4 tables are plotted. The 5 table is next.

On Figure 11B the inductive pattern is to lay the alphabet out in a row and then draw lines between the listed letters. The discovery of the method is inductive because it goes from the individual letters to the general pattern or conclusion. Once the pattern is found inductively, the rest of the letters are found deductively because deduction goes from the general to the particular.

(38)

GIVEN:

FINISH THE FOLLOWING PATTERNS.

- 1, 2, 3, 4, 5, 6 \_\_
- 2, 4, 6, 8, 10, 12, \_\_
- 2, 4, 6, 3, 6, 9, 4, 8, 12, \_\_
- 20, 18, 16, 14, 12, \_\_
- 1, 4, 16, 25, 49, \_\_
- 8, 15, 24, 35, \_\_
- 24, 0, 35, 3, 48, 8, \_\_
- A, Z, Y, B, C, X, W, D, \_\_
- A, D, C, B, K, N, \_\_
- P, A, Q, B, R, C, S, D, \_\_

FIND:

WHAT ARE THE KEYS TO THE PATTERNS?

In these problems it is necessary to find the patterns that make up the series. Once the pattern is found, the problem becomes obvious. When it is obvious it becomes a deductive process and the rest of the pattern follows the deductive process found by the inductive searching for the right pattern.

This is best illustrated with a few examples which follow:

1, 2, 3, 4, 5, 6...

The pattern is to see that the interval is "1". Thus the next number is 7 because the pattern or interval is known.

2, 4, 6, 3, 6, 9, 4, 8, 12...

First note that the numbers are in patterns of three. Now look within the patterns of three for the pattern there. These can be plotted graphically to vividly show what is happening.

	6	9	12	largest
4		6	8	larger
2	3	4		small

Now notice the interval between patterns:

		5
	4	
3		
2		

Next notice the pattern for the changing of numbers within the series of three. The first series has an interval of "2". The second series has an interval of "3". The third series has an interval of "4". Thus there is a unit step up every time a new series of three is started. It is possible now, to find the next number in the series. It is up "1" from 4 or 5. Thus 5 starts the next series of three.

**FIGURE 11A**  
**PATTERN STUDIES**

(38) Continued...

24, 0, 35, 3, 48, 8...

Again, it can be noted from induction that the numbers are close to squares, or a square of a number minus one. "24" =  $5^2 - 1$ . Next note that the pattern is in groups of two:

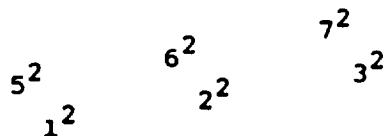

Notice that the top numbers in the patterns of two always goes up one unit. Thus the next number should be  $8^2 - 1 = 63$ . The next number goes down the same as any series of two, the interval "4". Thus the number after 63 should be  $4^2 - 1 = 15$

A, Z, Y, B, C, X, W, D...

This pattern can best be seen by tracing the intervals with straight lines:

A Z Y B C X W D

Pick out the letters from the lower and the upper part of the alphabet:

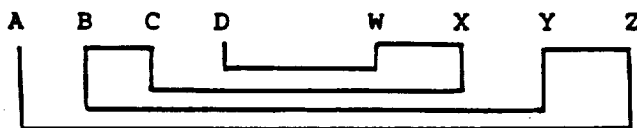

It is evident by induction that the next letter is "E".

A, D, C, B, K, N...

This pattern is seen by putting lines between the letters:



The inductive pattern immediately points to the next letter as "M". Then the next letter after that is "L".

P, A, Q, B, R, C, S, D...

This pattern is seen by joining the letters with lines:

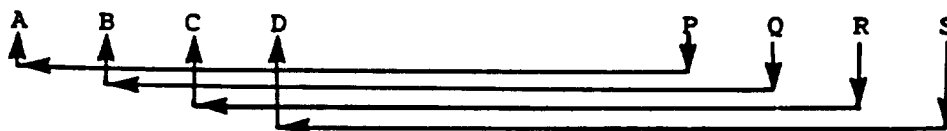

The next letter is "T".

FIGURE 11B

PATTERN STUDIES

## 5.0 INDUCTIVE--DEDUCTIVE LOGIC

### 5.1 PROBLEMS TO SOLVE IN DEDUCTIVE AND INDUCTIVE THINKING

In this section the student is called upon to exercise his problem-solving ability with inductive-deductive thinking. It has been previously emphasized that most of the engineering sciences have stressed deductive logic - given the general equation, find the particular answer. In a beam problem, the stress =  $Mc/I$ . Given "M", "C", and "I", simply find the stress by substituting in the general equation. Another example is the deductive logic of why grass was green. Living plants with chlorophyll are green. Grass has chlorophyll. Therefore grass is green.

Inductive-deductive logic is used when the general equation is not known, even for part of the problem. There may be many steps in a design problem. Some deductive equations are known but others are not. This training teaches the student how to go about solving a problem when he hits the unknown equation or if he does not know which way to go.

In the books Logic<sup>68</sup> and Logic Solutions,<sup>69</sup> the many methods for this type of study are illustrated. First, let's consider a problem. No. 4 from Reference 68:

The object is to make                      look like this                      in one move.

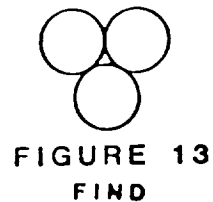
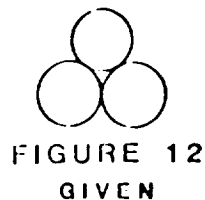

The most obvious solution is to make the following move:

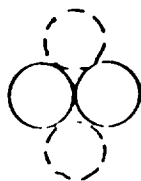

FIGURE 14  
THE SOLUTION

The inventor or research man keeps asking himself if that is the best solution. What next? The inventor may not know where to go but he asks himself the following questions:

- (1) What could I possibly do that I haven't done already?
- (2) I have already moved the top coin once.
- (3) I can move the lower right one but I don't know what it will do if that move is made. I'll move it and see what happens.

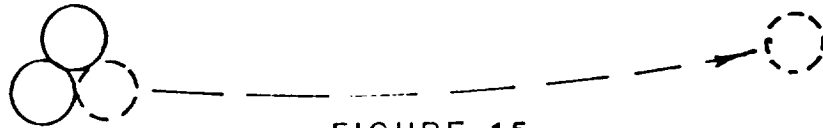

FIGURE 15  
WHAT WOULD HAPPEN IF?

The inventor always keeps in mind his final goal:

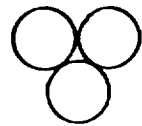

FIGURE 16  
NOW IT IS OBVIOUS

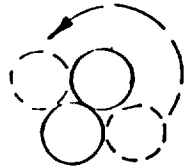

FIGURE 17  
ANOTHER SOLUTION

This immediately suggests to the inventor that he could also use the last coin that he has not yet moved.



FIGURE 18  
A SIMILAR APPROACH

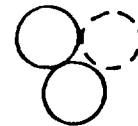
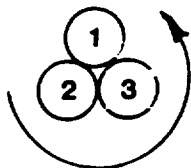
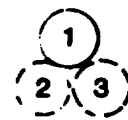

FIGURE 19  
ANOTHER SOLUTION

The inventor never quits. He asks himself if there isn't another possible way that it could be done. He looks at the specifications and notices that it says "one move" and not "one coin at a time". So he says: "Why can't I move three coins at one time with three fingers?"



MOVE 3 COINS  
AT ONE TIME



ANOTHER SOLUTION

FIGURE 20



It now becomes apparent to the inventor that he could keep rotating the three coins at one time until both 1 and 3 appear at the bottom. Thus there are two more solutions.

With some mechanisms it is necessary to rotate and move parts in different directions to make them fit and operate. In this problem it is evident that there are three more solutions in which the coins are rotated in the opposite direction.

The inventor then questions himself. "Why not move two coins at one time?" This is one possible solution.



FIGURE 21

It is now possible to find the many variations of moving 2 coins at a time. This is a rather simple problem. It is made simple to illustrate the principles used by the inventor to solve problems. What are some of these principles?

- (1) Use the hands where possible.
- (2) Make sketches where possible.
- (3) Make models where necessary. In the above problem take three coins from the pocket and use them.
- (4) Do something. Just don't look at the problem.
- (5) Constantly look where one solution could lead to another. Practice the habit. When an engineer sees a truss in a building, he should ask himself how many ways that job could be done. When something fails the engineer should ask himself to find as many ways as possible it could have failed and then think up as many ways that could be used to make it work.
- (6) Don't ever think that your work is positively done. You can never be sure that you have the perfect solution. There may be no perfect solution. Many inventions cover the same problem. Ask questions of others working with you. Show them your first solution and ask them if they can improve on it.
- (7) Keep re-reading the specifications and know where you are going.

Problem No. 3168:

If one man can build  $\frac{1}{2}$  of a house in 1 day and another man  $\frac{1}{3}$  of a house in 1 day, how long will it take them to build 1 house, if they work together on the project? (See Figures 22 and 23).

- (1) You know what is given. You know what is to be found. To get the solution, you have to ask the proper questions.
- (2) The first question is: "Is there a simple deductive equation that will solve the problem in one or two steps?"  
Reply: "There may be, but I don't know what it is." You don't have a deductive solution. You have to turn to an inductive solution.
- (3) Question: "How can I find out how much they can build together?" Inductively you know that you can find out how much each man can do in one day. Then, deductively, you can add their individual efforts.
- (4) Inductively you can see that a man who builds 1 house in 2 days will build  $\frac{1}{2}$  of a house in 1 day.
- (5) The same inductive reasoning tells you that the other man who builds a house in 3 days will then build  $\frac{1}{3}$  of a house in 1 day.
- (6) You can see that the amount of 1 house that both of them working together can build in 1 day is  $\frac{1}{2}$  of a house +  $\frac{1}{3}$  of a house. Deduction is needed to sum up the  $\frac{1}{2} + \frac{1}{3}$ .  $\frac{1}{2} + \frac{1}{3} = \frac{3}{6} + \frac{2}{6} = \frac{5}{6}$ . Both of them working together can build  $\frac{5}{6}$  of a house in 1 day.
- (7) You may not remember how to work out the next step. You know that they can build  $\frac{5}{6}$  of a house in 1 day but you may not know how to convert that to the length of time it takes them to build 1 house. Form an analogous problem or situation where the answer is obvious by induction. For example, take the case where both men can finish 1 house in 4 days. Each man can finish 1 house in 4 days or  $\frac{1}{4}$  of a house in 1 day. Working together they can finish  $\frac{1}{4} + \frac{1}{4} = \frac{1}{2}$  of a house in 1 day. It is obvious by induction that the men can finish 1 house in 2 days if they can work together and finish  $\frac{1}{2}$  of a house in 1 day. (Sometimes it is necessary to form several analogous problems.)
- (8) The next step is to find the deductive method that will lead to the proper answer - both of them finishing 1 house. Just invert the  $\frac{1}{2}$  house per day to days to finish 1 house. The solution was to go from houses/day to days/house. The value  $\frac{1}{2}$  was inverted to give 2.

**GIVEN:**

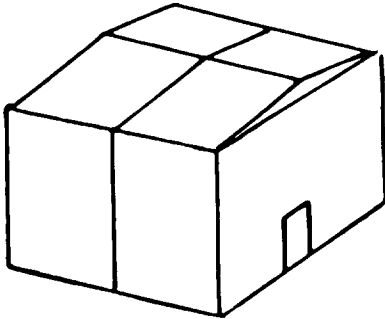

**ONE MAN BUILDS  
A HOUSE IN 2 DAYS.**

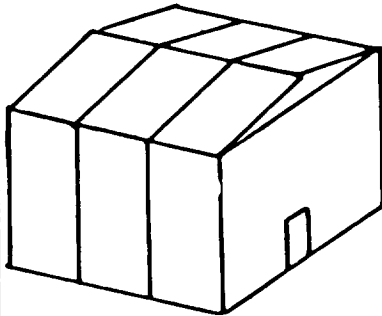

**ANOTHER MAN BUILDS  
A HOUSE IN 3 DAYS.**

**FIND:**

**HOW LONG WILL IT TAKE THEM TO BUILD  
ONE HOUSE WORKING TOGETHER?**

**FIGURE 22**

**INDUCTIVE-DEDUCTIVE LOGIC**

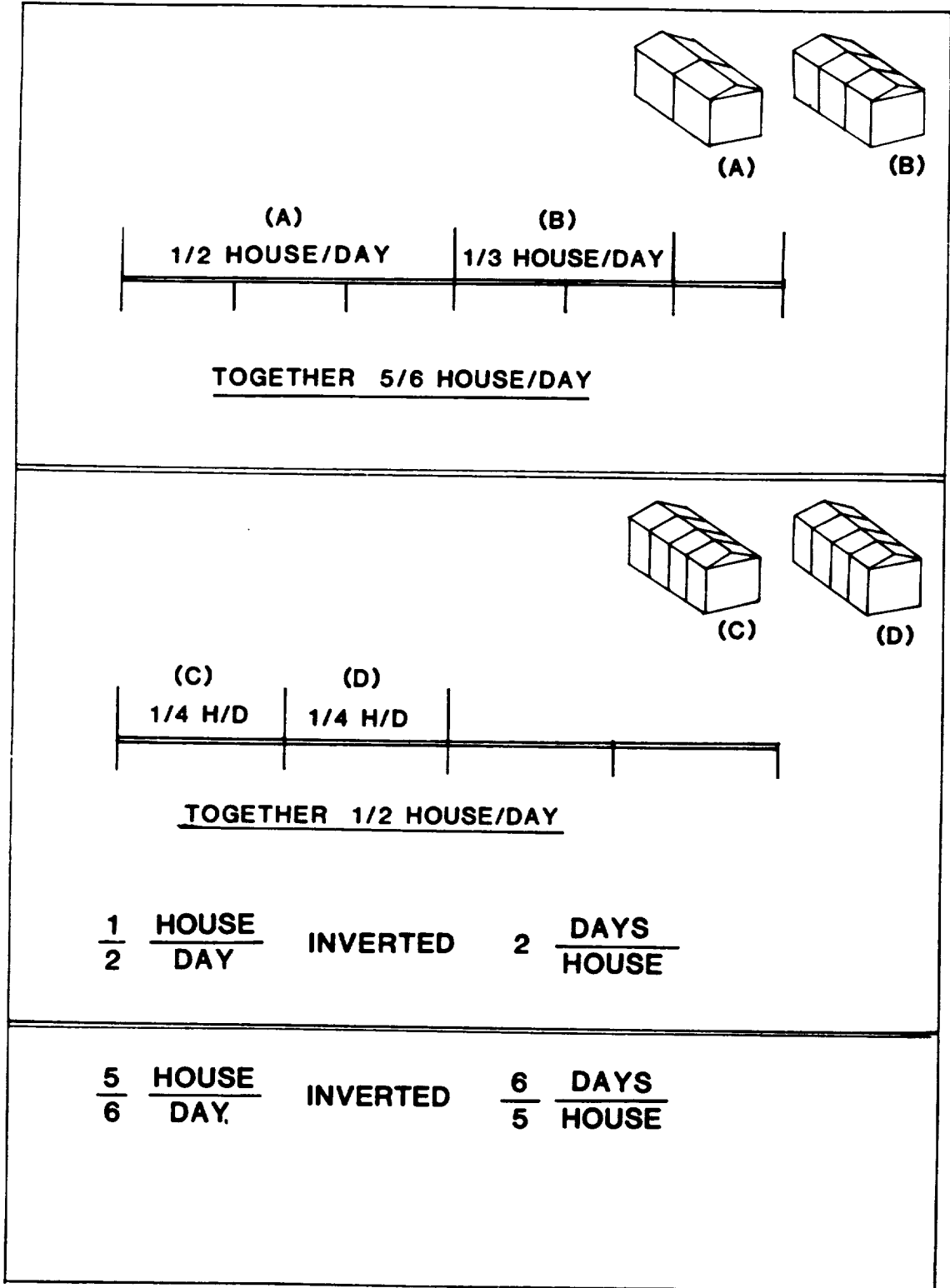

**FIGURE 23**  
**SOLUTION TO HOUSE PROBLEM**

- (9) Now go back to the original problem. If they can finish  $\frac{5}{6}$  of a house in 1 day it will take them  $\frac{6}{5}$  days to finish 1 house. This is  $1 \frac{1}{5}$  days.

This problem was discussed in detail to illustrate the thinking process. Once the system is learned, a little more difficult problem can be worked without any trouble. (Do it mentally for practice.)

If three men can build a house in 20 days, 40 days, and 80 days respectively, how long will it take them to build 5 houses?

In 1 day the three men will build  $\frac{1}{20}$  of a house,  $\frac{1}{40}$  of a house, plus  $\frac{1}{80}$  of a house. Together they will finish  $\frac{7}{80}$  of a house in 1 day. This will mean that it will take them  $\frac{80}{7}$  days to finish 1 house. It will take them  $\frac{80}{7} \times 5 = \frac{400}{7}$  days to finish 5 houses.  $\frac{400}{7} = 57 \frac{1}{7}$  days to finish 5 houses.

Once this system of thinking is learned it not only is fast but it improves the ability of the engineer to do mental arithmetic and enables him to work and check long and detailed problems in his head. This is a distinct advantage in design, particularly preliminary design where a certain path of action can be followed through quickly. It helps to get ballpark answers to complex problems.

Figure 24 illustrates imagination, analogy, and three-dimensional visualization. John is pointing to a picture on the wall and states: "Brothers and sisters I have none but that man's father is my father's son." John is talking about that man's father even though he may not know who it is he points to. The imagination along with the idea of analogy will form another picture above the one shown. The only thing known now is that one is the father and the other is the son.

From the problem he states that the imaginary picture on top is defined as his father's son. This means that the imaginary picture on top is John. The picture below is his son. John has no brothers or sisters. Engineers in many cases form analogies with pictures that help them visualize problems. These are simple examples but they illustrate the thinking process. They also give a good source for the training of young engineers.

The book Logic has many problems that offer examples of the mental processes of induction and deduction. Most of them point out clearly that the inductive process and the deductive process are used together to solve engineering problems. Practice will tell the engineer when to use each one and how.

This problem is solved inductively

with a sketch. When the puzzle says,

"That man's father..." make a sketch of the father.

(20)

GIVEN:

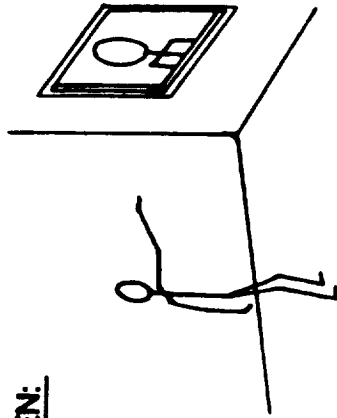

WHILE POINTING TO A PICTURE ON THE WALL, JOHN SAYS: "BROTHERS AND SISTERS I HAVE NONE BUT THAT MAN'S FATHER IS MY FATHER'S SON."

FIND:  
WHAT IS THE RELATIONSHIP BETWEEN JOHN AND THE MAN IN THE PICTURE?

FIGURE 24

INDUCTIVE-DEDUCTIVE LOGIC

The puzzle states that the man on top is John's father's son.

Since John doesn't have any brothers and sisters, the man on top is

John. If the picture on top is John, the picture under him is his

son. Thus John is pointing to his son.

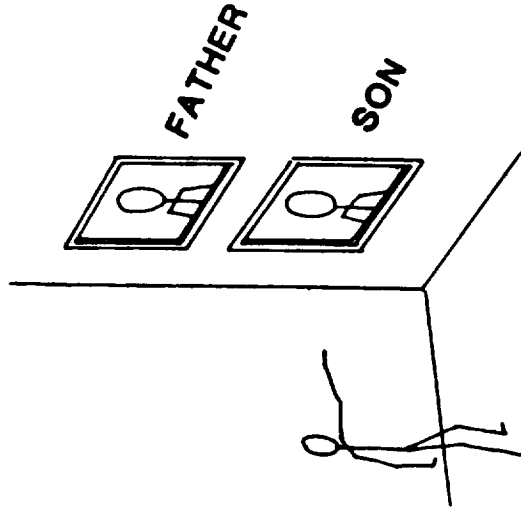

## 6.0 HEURISTICS

### 6.1 PROBLEM SOLVING BY THE METHOD OF HEURISTICS

Heuristics is another form of inductive thinking. Thus it is holistic, seeks patterns, is creative, and leads to a fluency of ideas. Heuristics goes from the particular to the general. From previous inductive problems, it should be noted that it also depends on analogy for solutions. Simple problems can be used to explain the system.

Poyla in his book How to Solve It<sup>56</sup> gives several examples of heuristic thinking.

(1) Observe  $1 + 8 + 27 + 64 = 100$

(2) This immediately suggests  $1^3 + 2^3 + 3^3 + 4^3 = 100$

This is a particular solution. What general equation could this lead to? Induction must lead to deduction or the general equation. Look at the numbers carefully and notice that it simply means that the summation of a series of numbers cubed from 1 to n are equal to the summation of n numbers altogether squared. It is generally expressed:

(3)  $1^3 + 2^3 + 3^3 + \dots + n^3 = \text{summation of } 1 + 2 + 3 + \dots + n, \text{ the summation squared.}$

This type of problem worries many students because they are so used to deductive problems where they are given a general equation and then expected to come up with a particular solution. They are not used to seeing the particular problem first and then have to find the general solution. Several other problems will illustrate this point.

Take a non-mathematical problem about a man who wishes to cross a creek.<sup>56</sup> In prehistoric days a man and his wife and child needed food as his local land was drying out. He decided to migrate to another land. He packed up and started out. He finally saw a land with much green vegetation in the distance. He headed that way. He ran into a swiftly flowing creek and he was stopped. The current was too fast to go across by raft. He had remembered other creeks he crossed by crawling over a tree that had fallen over the creek. He walked up and down the creek but he found none of these trees. He knew that he had to make a tree fall over the creek. He grabbed a twig and noticed that a twig that was leaning toward the creek would fall over faster. He knew that he had to make the tree fall down. He found a leaning tree and started to chip the wood away from the back side. Soon he found that he wasn't getting enough force behind the stone, so he attached the stone to a stick. By that time he was getting big chips to fall. Eventually the tree fell down. He and his family crossed the

creek to a better land. There is a graphic diagram of this heuristic action in Figure 25.

Notice how this system works. He started out to do one thing, namely, find a new land. This led to the creek problem. This led to the ax problem. Then he solved these problems in the reverse order, that is, he formed the ax, then he cut down the tree, and last of all he and his family crossed the creek. In heuristics, the last thing looked at is the first thing solved. All of these types of problem form a pattern. Heuristics is not only an inductive way of thinking but it is a structured way of thinking inductively.

Another example is that of a boy who comes to his father and states that his kite is caught up in a tree. What goes through the father's mind?

- (1) I have to cut the string on the kite to let it down. In this way I will not tangle up the string further. The string can be pulled through the limbs and kite can be taken down carefully.
- (2) I have to get myself into a position up in the tree near the kite where I can firmly plant my feet and have two free hands to cut the kite free. I could be sitting on a limb.
- (3) I have to climb the tree safely.
- (4) I have to get off the ground and up to the first limb.
- (5) I have to put the proper clothes on for climbing.

The system of heuristics takes the last item and solves it first. The father goes into the back room and dresses in his old clothes. He gets a ladder on which to climb up to the first limb. He goes up to the first limb, then goes up the tree limb by limb. He makes sure that he always has two contacts on the tree at one time, as one limb may break and he needs the second contact to hold him without falling. He then gets near the kite and into a position where both feet are firmly planted. He then grabs the kite and cuts the string with a pen knife. If he can sail the kite through an opening in the tree, he does so. If not, he drops the kite straight down and keeps dropping it as he climbs down.

Notice that he took the reverse order that he used to analyze what he had to do. Then he came to the ladder and climbed down, put the ladder away, and changed his clothes.

Note that these types of problems are not innovative but they are structured. They have a form of solution which is consistent. Some problems may make two steps and others 20 steps but the person solving the problem starts with the thing that the father wants to do and works back to the first step that he has to take in order to get the final solution.



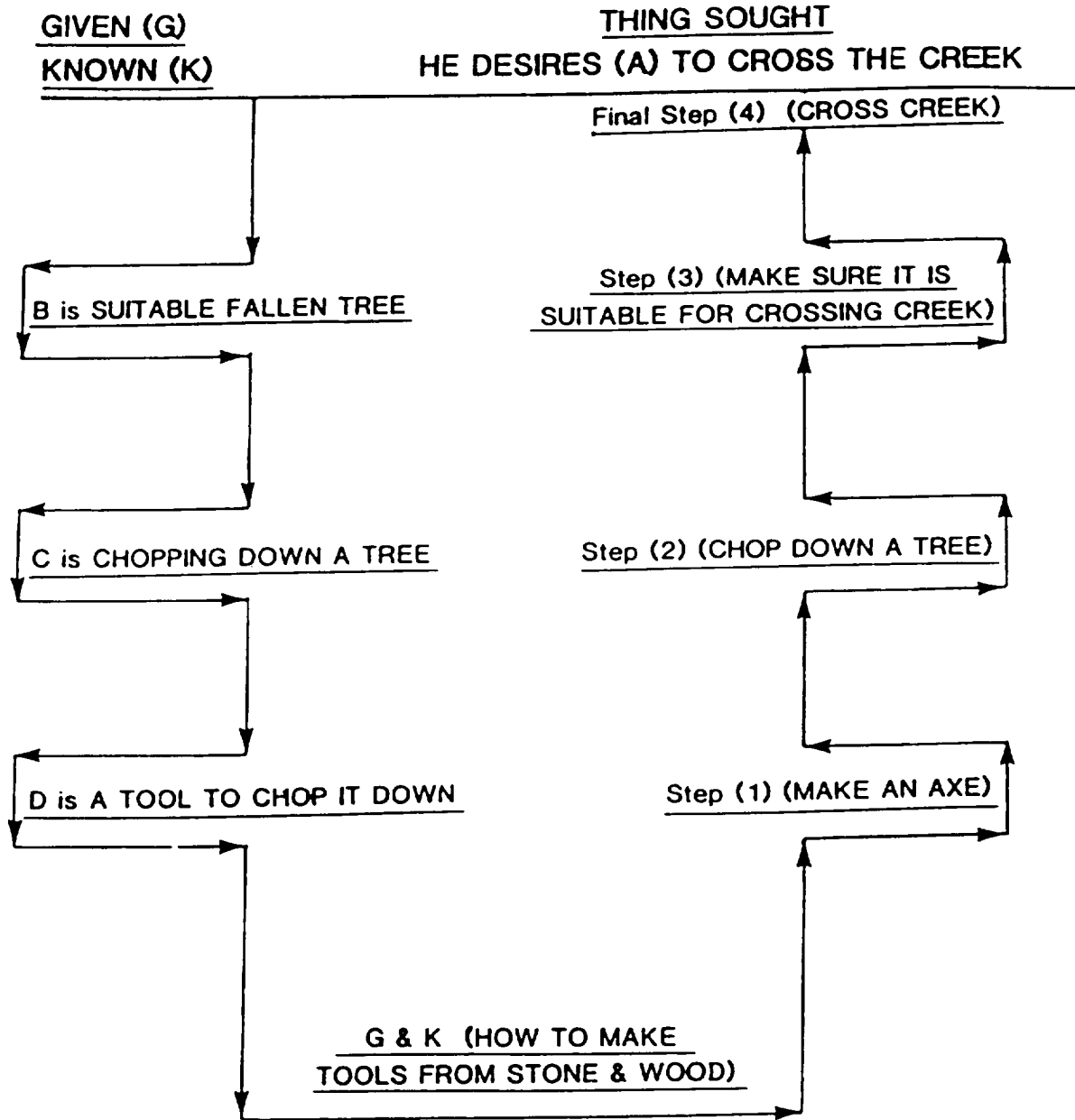

THE NONMATHEMATICAL EXAMPLE  
OF A MAN WISHING TO CROSS A CREEK

FIGURE 25

Another illustration is a simple, two-step problem. Figure 26 is a sketch of a room in which a spider is located at point "A". The spider wants to get to point "B" by the shortest possible route. Figure 27 shows the simple two-step thinking. The student lays the walls down flat. He then draws a straight line from "A" to "B". He just follows that path for the shortest possible route.

There are many problems in which the answer is not obvious but a short construction step will make the problem inductively possible.

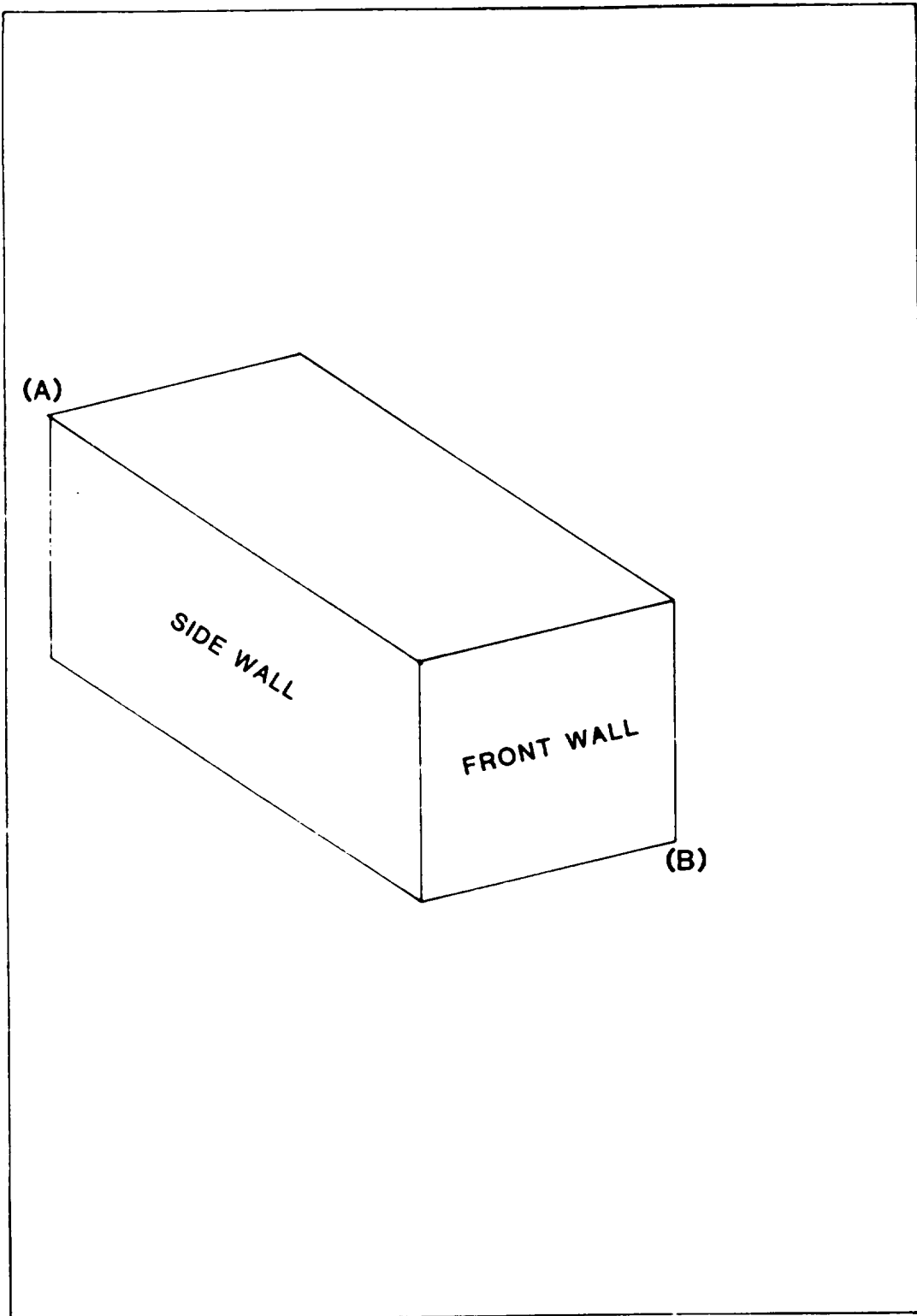

**FIGURE 26**  
**TRAVEL FROM "A" TO "B"**

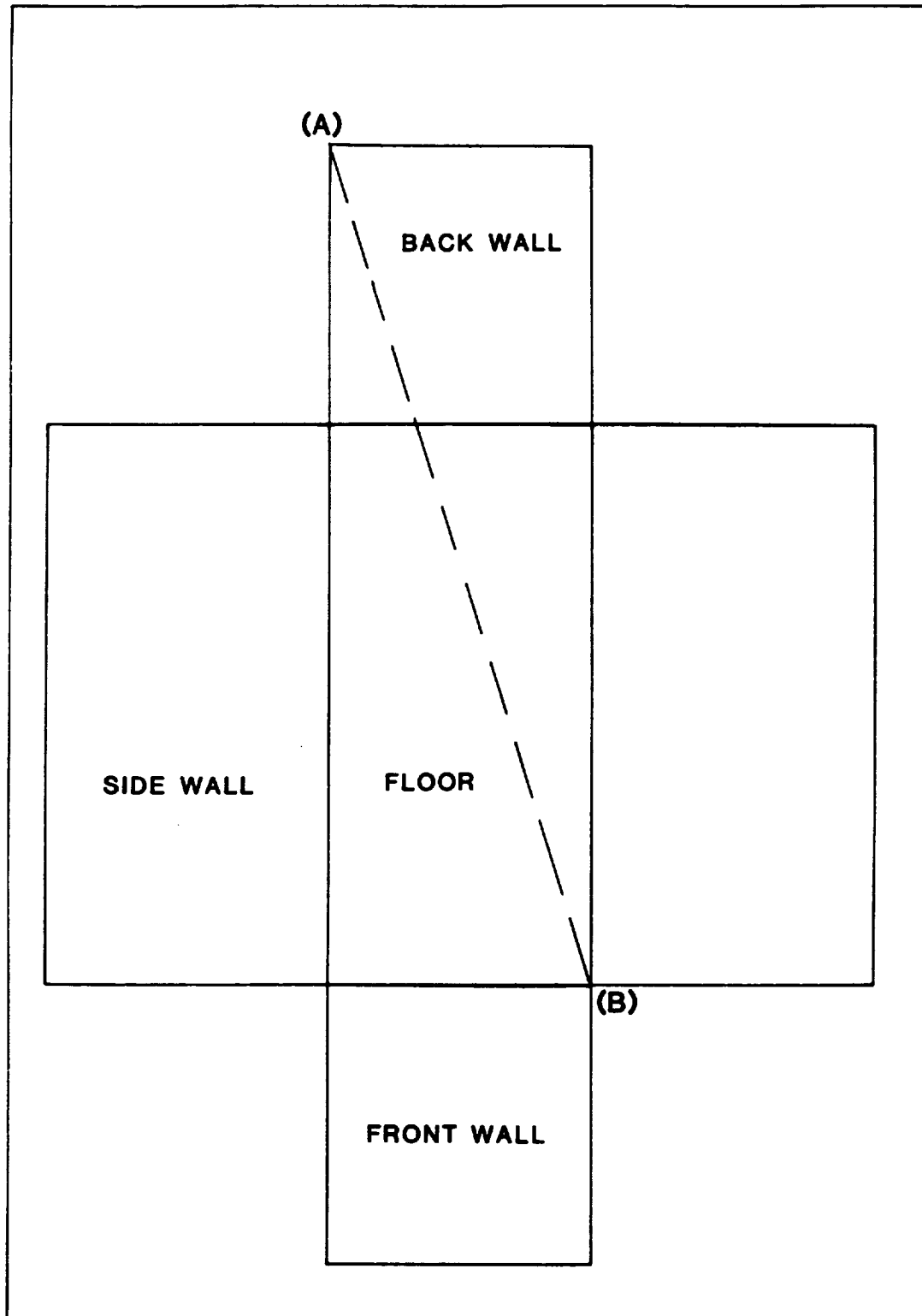

**FIGURE 27**  
**HEURISTIC APPROACH**

## 7.0 A PRELIMINARY STEP TO RETRODUCTION--A 12-YEAR-OLD BOY BUILDS A SHOP

A twelve year old boy wants to build a shop in the basement. He has to convince his father that a shop is feasible. He has to demonstrate that once started he will finish the job. Therefore, he has to ask himself many questions - questions which his father is bound to ask him later.

Turn to Figure 28. On the left column are questions that he will ask of himself as he analyzes the problem of building a shop. To analyze means to take it apart and find out what the individual parts are.

The first question that he asks himself is: "What tools are necessary?" A question implies knowledge in part and ignorance in part. The boy knew that he needed tools. He knew something about tools or he would not want to build a shop. But he had to know more to give his father ample evidence that he knew what went into a shop. So he temporarily answers part of the question by looking at other shops and sighting what they have in their shops. Then he goes to the library and looks over the past issues of Popular Mechanics and similar magazines. The dotted arrows after the first question indicate that the boy had to have knowledge in part and that he could find out more about that question by looking up other sources of information. He had to have knowledge in part to know where to look for further information.

The next question is: "Where should he put the shop in the basement?" He answers the question temporarily by going down in the basement and looking around. He avoids the furnace and washing machine and notes that the best location could be the left or right front of the basement.

Then he asks himself the question: "How shall I electrify the basement?" This question could have come from previous knowledge by temporarily answering question 1. Often answering one question will lead to another question. The boy knows something of his father's friends and knows that one is an electrician. As a temporary answer he would suggest to his father that he let his father's friend do the job or the friend might tell the young man how to do it.

The next question is: "How shall he arrange the tools?" He knows that the tool arrangement will depend upon what he plans to build in the shop. If he is working with wood there are certain basic tools that he needs. If he is working with metal there are other tools that he needs. If he is interested in doing electrical repairs he is talking about a completely different arrangement. Most shops need a drill. So some of his temporary answers will be: (1) swing room for drill, (2) safety, (3) proper lighting for the job, and (4) shelves and storage space.

12 YEAR OLD BOY AND SHOP.

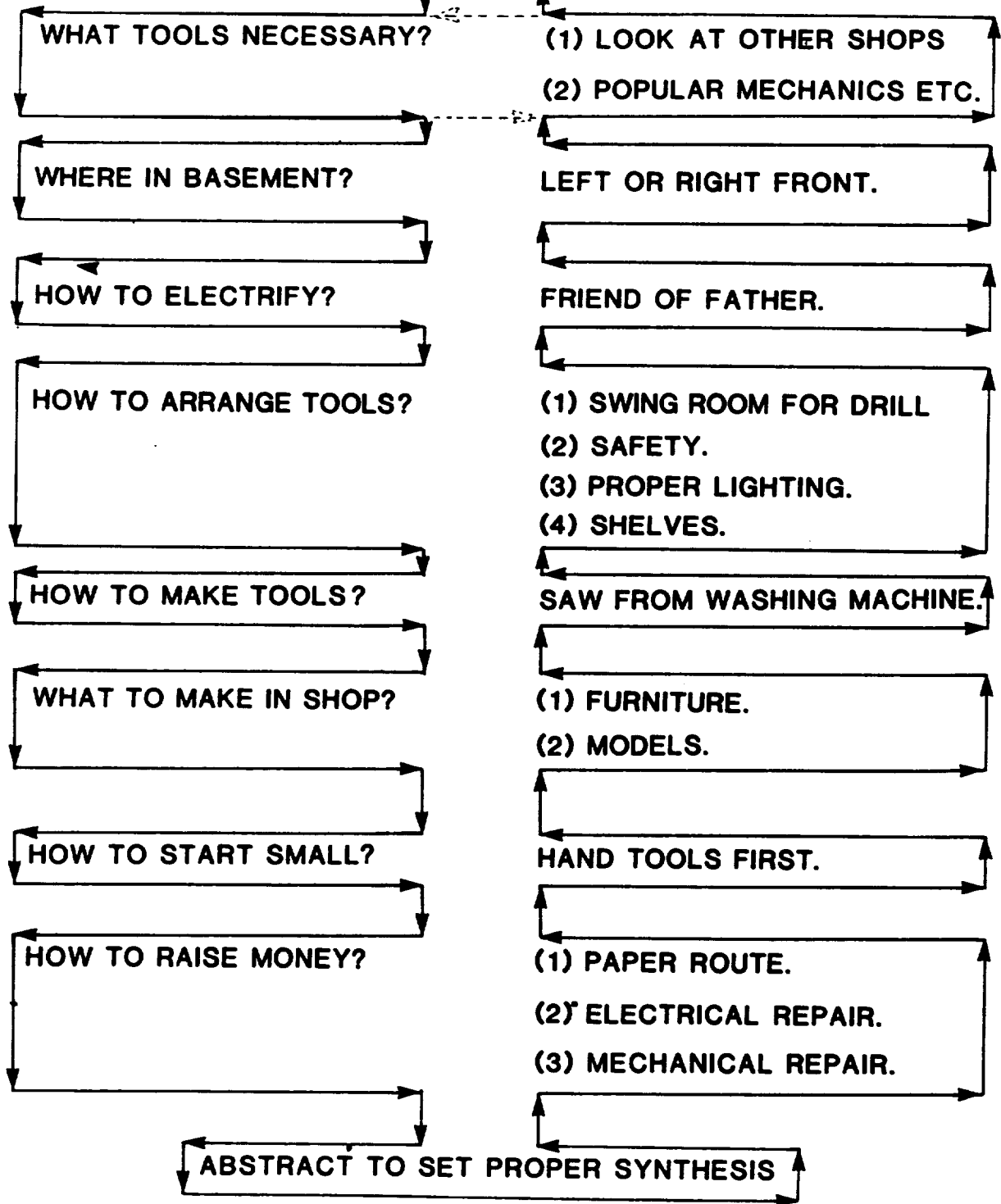

FIGURE 28

BUILDING A SHOP

He knows that he is limited in how much money he can spend. He knows that he has to put together certain tools. As an example, he can make a saw from a washing machine.

Now he is forced to ask himself the question: "What shall I make in the shop?" If he is interested in working with wood he may pick furniture and models as a temporary answer, both natural products for a young man.

Then he begins to realize that this shop could run into a lot of money and he feels that he can handle the job by starting with a few tools and then building up later on. His question is: "How shall I start small?" The answer, of course, is to start out with small hand tools, then build up.

He then comes to the question that his father is bound to bring up: "How am I to raise the money to start the shop?" He knows from his friends that he could: (1) take a paper route, (2) go into electrical repairs, or (3) go in for mechanical repairs.

Now he wants to put this whole thing together. This is a form of synthesis. He approaches his father for permission to build a shop. His father starts to ask him questions and he learns that his son had looked into this problem very carefully. Now is the time for the father to work with his son and abstract the essential notes needed to start a shop from all of the answers. All of the answers have a part to play. Some of the questions can be eliminated. The father and the son agree that the young man would rather work with wood than metal. And he would like to start with wood models. They decide to go this way which would eliminate the problems with metal and electrical repair tools. Next they have to agree on the order they would like to follow to build the shop. Almost immediately the subject of money comes up and the son sees a paper route as a good source of money. Next he knows that this money problem would make it imperative for him to start with hand tools. His father can advance him some money to get started, until the paper route makes money. They decide to start with a simple bench and an old bookcase for storage. They then decide to use a simple extension for electricity to start out, as the initial demand for electricity would very small. When more power is needed they can go to the father's friend. They look around the basement and decide that the left front is the best place to start the shop because it could offer more room for safety, storage, and further expansion. The son will start by making wood models on a simple bench with hand tools and he will take a paper route to earn money to improve his shop.

This is the part of abstraction in engineering design. It has to draw from all of the points the essential notes to get the final result - to build a shop in the basement.

Thus the system of retroduction looks at all of the questions and draws from them their essential notes. What is essential? Then the system poses another question: "How much money is necessary?" The young man then poses new questions not listed yet. Then he rearranges the order of the existing questions to get to the proper answer to the first question, namely, the money problem. He then looks to the next question and follows the list until he has the shop completed. All the way through this study he: (1) forms new questions, (2) rearranges the order of the original questions, (3) eliminates some questions, and (4) every step along the way he abstracts from the remaining questions the essential notes that are left.

He can make an estimate, at times, of some of the questions and come up with a ballpark answer. This ballpark answer would help him form new questions and make different arrangements of the importance of the remaining questions. To reach his final goal (the shop), he has to be ready to adjust his thinking to fit the circumstances at the time and give a little and take a little. He has to learn how to be a good expediter.



## 8.0 ENGINEERING APPROACH TO RETRODUCTION--THE BEAM

Engineering design adds another dimension to retroduction. This is best illustrated with the design of a beam in a house that is being built in a remote area, a vacation home for instance.

The typical approach to a design of a beam is to take the load and compute the bending moment on the beam. The handbook is then used to find the beam that will take the bending moment. The selection depends on the analysis. The engineer may have a beam similar to a job done previously, and he may subject this beam to a simple test to see if it will do the job. If it is not strong enough, a larger beam is chosen and tested, or a mathematical analysis is done to determine the proper size from a previous test. Even after the test, a mathematical analysis must be performed to ensure that the beam will meet all requirements, such as deflections, stresses, etc.

Figure 29 is a graph of both of these methods. If the handbook method is used and the beam is too weak, a larger beam is chosen. If deflection is a criterion as in Figure 29, the deflection is calculated as shown. If the designer is not sure of his calculations, he can buy a beam and test it to check his calculations. If the mathematical analysis is too high, the mathematical analysis will have to conform to the tests. Stress concentration factors and other variables could cause this discrepancy.

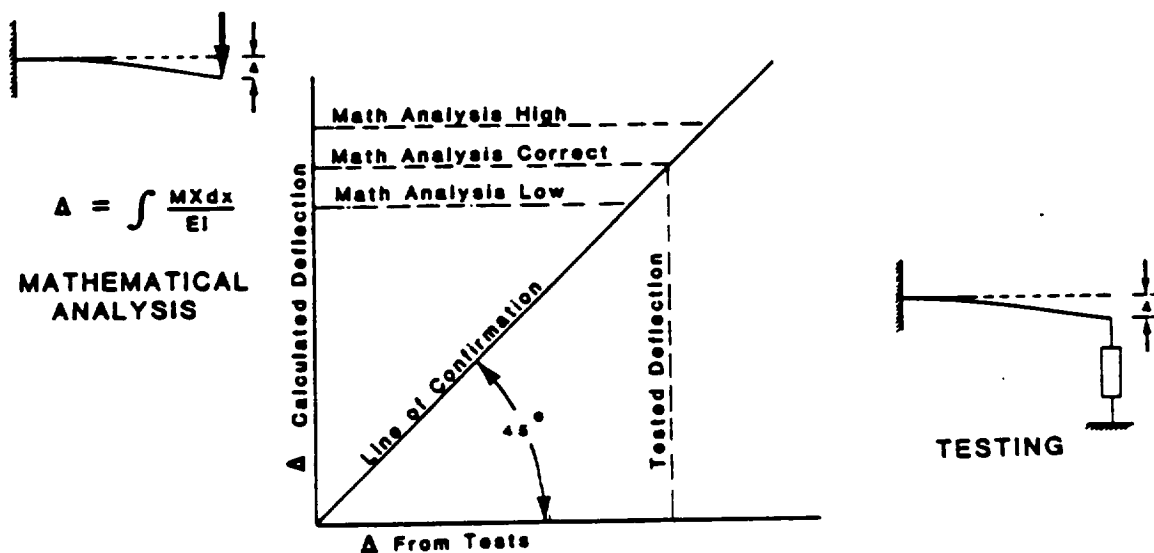

**FIGURE 29 HANDBOOK DESIGN**

But what is to be done when no catalog is available for picking the desired beam or when the designer has no idea where he should begin? This calls for a new approach to the problem. The question usually asked is: "How was the beam selected in the first place?" If the loads are the same as past loads, the moments the same as past designs, and the deflections about the same as past requirements, a beam can be picked from the handbooks from experience.

In many modern designs, however, the circumstances are new, and a beam must be chosen when past experience does not exist. The only written requirements are that the beam meet a certain deflection. The stress condition is secondary, but it must be checked analytically. Retroduction is a method for finding the right beam in the first place. Retroduction is a dialectic method. "Dialectic" is a logical or rational method of analysis and can be defined as the art or practice of examining opinions or ideas logically, often by the method of question and answer. Dialectics as the logic of questioning organizes the line of inquiry so that conclusions are reached or put in a form that can be either tested by observation and experimentation or verified by mathematical analysis. From the beginning, it must be understood that this document discusses two types of analysis. One is mathematical analysis (well-known) and logical analysis in which opinions are discussed to arrive at a starting point for selecting the proper beam. Some engineers call this their ballpark design. The first requirement is that the beam under the loading conditions stipulated meet a certain deflection requirement. Even though dialectics is a method of questioning and answering, it must be understood that these questions are prefaced by a number of items both given and known. Given by this design problem are the following:

- (1) The length of the span is given.
- (2) The loading on the beam is given.
- (3) The limit of deflection is given.
- (4) A tight time schedule is given.
- (5) The beam is in a house in a remote area.

Known from past experience are the following:

- (1) The stresses in the beam can be calculated.
- (2) Methods for computing deflections are known.
- (3) The time element listed under GIVEN will affect most of the points on the analysis.
- (4) The limitations in cost will affect everything.
- (5) Building in a remote area will affect cost because the proper labor may not be available.

#### 8.1 THE SYSTEM OF RETRODUCTION IS INTRODUCED BY THE DESIGN OF A BEAM

The next step is to study Figure 30, "Retroductive Design". In this figure the GIVEN and KNOWN items appear at the bottom, and

THING SOUGHT - BEAM DESIGN

- (1) DOES THE BEAM HAVE TO BE WOOD?
- (2) CAN IT BE A COMPOSITE BEAM SUCH AS REINFORCED CONCRETE?
- (3) CAN THE GIVEN MOMENT BE CUT DOWN BY CHANGING THE POSITION OF THE SUPPORT?
- (4) CAN THE ENDS OF THE BEAM BE RESTRAINED TO DECREASE THE MOMENT?
- (5) COULD A PIECE OF STEEL BE NAILED UNDER THE BEAM?
- (6) COULD SOLID BRIDGING PROPERLY SPACED AND INSTALLED INCREASE THE BENDING RESISTANCE AND LOWER THE DEFLECTION?
- (7) CAN CABLE BE PRESTRESSED AND ATTACHED TO THE BEAM?
- (8) IF THE DEFLECTION IS CAUSED BY VIBRATION, CAN THE DEFLECTION BE LOWERED BY: (A) MAKING THE BEAM STIFFER; (B) USE A HEAVILY DAMPED MATERIAL; (C) DETUNE THE BEAM THROUGH DESIGN.
- (9) CAN A NEW TYPE OF PATENTED STEEL OR WOOD BEAM BE USED?

BEAM DESIGNED

- (1) NO. WOOD DOES NOT HAVE TO BE USED BUT A CHANGE MAY RAISE COST BY USING EXPENSIVE MATERIAL - EXPENSIVE METHODS OF MANUFACTURING OR EXPENSIVE MEANS OF INSTALLATION.
- (2) IN HOUSE CONSTRUCTION WOOD BEAMS ARE USUALLY LESS EXPENSIVE THAN COMPOSITES, BUT IT MAY BE NECESSARY TO MEET COST AND DEFLECTION REQUIREMENTS.
- (3) A CANTILEVER AT ONE OR BOTH ENDS COULD REDUCE THE MOMENT BUT IT MAY CAUSE DEFLECTION PROBLEMS UNDER VIBRATION.
- (4) IF THE LONG BEAM IS MOUNTED OVER THE MAIN STEEL BEAM IN THE HOUSE, THERE ARE USUALLY OTHER BEAMS COMING FROM THE OTHER SIDE OR A CONTINUOUS BEAM COULD BE MOUNTED OVER THE SUPPORT. AVAILABILITY AND TIME ARE OTHER FACTORS TO CONSIDER.
- (5) THE STEEL COULD BE USED TO CUT DEFLECTION BUT IT IS MORE EXPENSIVE THAN A STRAIGHT WOOD BEAM, BUT IT MAY BE NECESSARY.
- (6) SOLID BRIDGING IS INDEED STIFFER IF BIG HOLES LIKE HEATING DUCTS ARE NOT CUT THROUGH THE BEAM.
- (7) CABLE CAN BE USED BUT IT IS EXPENSIVE TO INSTALL.
- (8) VIBRATION MAY NOT BE CRITICAL BUT IF IT IS THEN ONE OR MORE OF THE SUGGESTIONS SHOULD BE APPLIED.
- (9) ALL OF THE 'PATENTED SPECIALS' HAVE A CATALOG LISTING THE PERFORMANCE VERSUS THE COST. OTHER QUESTIONS MUST BE ANSWERED SUCH AS WHO IS GOING TO MAKE IT AND WHO IS GOING TO INSTALL IT.

GIVEN

- (1) THE LENGTH OF THE SPAN IS GIVEN.
- (2) THE LOADING ON THE BEAM IS GIVEN.
- (3) THE LIMITING DEFLECTION IS GIVEN.
- (4) A TIGHT TIME SCHEDULE IS GIVEN.
- (5) THE BEAM IS IN A HOUSE IN A REMOTE AREA.

KNOWN

- (1) THE STRESSES IN THE BEAM CAN BE CALCULATED.
- (2) METHODS FOR COMPUTING DEFLECTIONS KNOWN.
- (3) THE TIME ELEMENT LISTED ABOVE IN 'GIVEN' WILL EFFECT MOST OF THE POINTS IN THE ANALYSIS.
- (4) THE LIMITATION IN COST WILL EFFECT EVERYTHING.
- (5) BUILDING IN A REMOTE AREA WILL EFFECT COST AS THE PROPER LABOR MAY NOT BE AVAILABLE.

FIGURE 30

RETRODUCTIVE (BALL PARK) DESIGN

the dialectic questions appear on the left of Figure 30. Bear in mind that these questions on beams must consider the given and known items at the bottom because these items are known before the design starts and they give direction to the dialectic questions.

The next step is to answer each question as it is listed on the right side of Figure 30. These dialectic questions can be answered by either the designer or a group of designers, or they could appear in a handbook on design. In some cases, answers to these questions can be found under many aspects of a library system, particularly in our present engineering age where so much is computerized. Let us follow some of the questions to conclusion.

At the top left of Figure 30 is the thing sought, "Beam Design". Drop down to the first question. "Does the beam have to be wood?" Go over to the right, and under item 1, read the general answer to the question, not an answer to the particular beam to be used here. After reading the temporary answer to question 1, the eye is directed back to question 2 on the left: "Can it be a composite beam such as reinforced concrete?" The answer to this question (in general) is on the right. This procedure is followed all the way down through question 9.

The answers to the questions always consider the GIVEN and KNOWN. These items always follow certain principles. A "principle" is that from anything follows. As example is the principle that no material should be used in house construction that could be toxic to the future owner. It may not be a law but it is a principle. A principle may or may not be a rule. But when principles are used the thinker will come to a logical and clear answer.

In answering the questions on the left, the following principles must be kept in mind. These are the four causes that ALWAYS lead to the solution of this design problem or any other research or design problem. Of these principles the most important cause is the "final cause", which is always the first thing sought (you want a beam) and the last thing found (you have found a beam). In this case, the final cause is a beam to fit into the house construction with GIVEN items in mind.

The second principle to consider is the "material cause": "What is it made of?" Remember that the first question on the list of Figure 30 was: "Does the beam have to be wood?" However, this question could not have been answered without knowing the final cause. You have to always remind yourself where you are going. Many designers have a universal failing of looking so closely at the details that they forget exactly where they are going. This is particularly true when it comes to tolerances and degrees of accuracy.

Remember that principles are not chosen to strangle thinking but merely to give order to the thinking and keep the designer aware

of the overall goal as well as the individual parts that make up that order. The next cause to consider is the "efficient cause" or who designed it, who installed it, or who manufactured it. Today with quality control at a premium, the efficient cause is very critical to design engineers. You have to know who is to complete your job while you have the design on the board.

The last cause to consider is the "formal cause", which is the method or form in which the beam is designed to solve the final cause. The form is actually in the mind of the designer as he considers all the ways that he has to put things together to give him his final cause.

Note that the analysis takes every point on the left which makes up the parts of the beam design that could be questionable. This is analysis: taking something apart to see how it works or goes together. So the questions list all of the probable solutions or parts to the answer. Some questions lead to other questions. Nailing a piece of steel under the beam suggests the use of steel cable to make it stiffer. On the right are general answers to each question. This may not be the answer for this particular beam but it is the general answer for any beam. Note how other questions are formed. The steel suggested the use of cable which was another question. Questions lead to questions. Much of this information has been computerized or catalogued for everyday use. This is done in many design books such as Engineering Design: A Systematic Approach,<sup>74</sup> The Way Things Work,<sup>73</sup> Engineers Inventors and Workers,<sup>72</sup> Geo-metric Vibration Analysis,<sup>75</sup> Creative Synthesis in Design,<sup>76</sup> How Do They Do That?,<sup>77</sup> The Art of Successful Invention,<sup>107</sup> Introduction to Creative Design,<sup>110</sup> The Design of Design,<sup>59</sup> and Invention Discovery and Creativity.<sup>64</sup>

The questions are prepared from personal experience, computerized listings, and handbooks from which general answers can be found or referenced. (It must be pointed out here that all beam designs do not go to all of this trouble, but the beam could be a critical beam in the space shuttle.) The designer can always cut the questions short if he is caught for time or if the answer is obvious. Now assume that the dialectic questions are prepared and practical answers are given. Let us also assume that the material cause, the formal cause, and the efficient cause are answered in a general way though not a particular way.

Now the analysis has been completed. The next step is to synthesize all of these questions and come up with a ballpark answer. This requires the designer to abstract all the questions and answers. (If abstraction is not thoroughly understood, it is suggested that the reader go over Section 3.2 briefly before continuing.) The students who take this course have to be constantly reminded of the true definition of abstraction.

This abstraction must consider the following: Elimination of the general questions that do not apply to this particular problem. The limited cost will put out questions 2, 7, and 9 because the cost alone will make these concepts prohibitive. (They could apply to another beam in another place. They are brought up to stimulate thought and assure the designer that he has considered every angle that he can possibly think of in his design.) Item 5 is temporarily eliminated but kept in the back of the mind as something to be done if all else fails. (The designer always leaves himself a way out. He never designs himself into a hole.) The fact that the house is in a remote area will eliminate questions 2, 7, and 9.

Note the quality of abstraction used here. In order to get at the essential notes, so necessary for abstraction, the non-essentials are eliminated first.

The items left are 1,3,4, and 6. It is the job of retrodution to put them in their proper order and thus arrive at the final cause: the beam. Question 1 suggests that wood be used. Settle on that first and then all of the other questions can be answered, assuming that wood is the material to be used. If that decision doesn't work out, then another material such as reinforced concrete can be substituted. Thus item 1 is temporarily wood. Questions 3,4, and 6 remain. Look at question 3: "Can the given moment be cut down by changing the position of the supports?" There is no doubt that bringing the foundation wall in will lower the moment on the beam. This will cut down on the deflection.

Question 4 suggests that the wall and beams be firmly nailed to the foundation to cut down the moment on the beam, and subsequently the deflection. Properly attached, this will lower the moment and deflection. But if the foundation wall (Question 4) is moved in, the nailing down of the beam to the wall will not have as much effect on stiffening the beam as it would have if the foundation wall were all the way out. A compromise must be reached here. This is where deductive analysis takes over. The two variables can be optimized by analysis. There are many computer programs that solve this problem with ease. In most cases hand analysis is sufficient.

Question 6 suggests the use of solid bridging to decrease the stress and deflection on the beam. Solid bridging will decrease the deflection on the beam under many design considerations. If heating ducts have to go through the joist beams, it will destroy this benefit. This is why retrodution is good for the designer because it takes into account not only the structural considerations but also all of the other problems associated with the structural problem. If the outside wall is to be moved in, another question should be asked: "What effect will a cantilever have on heating the room in a cold winter?"

The order for answering the questions is set by synthesis. Question 1 comes first. Question 6 comes next. Questions 3 and 4 vary from installation to installation or they could be optimized for each case.

If all of the requirements are answered but it is found that there is too much deflection, then questions 5 or 7 can be used to give additional support to the beam. Their order had been established by abstraction when the questions were first synthesized. (put together)

The questions on the left take the problem apart. This is analysis. The answers on the right put the beam together. This is synthesis.

Designs are made up of many parts and similar questions can be prepared for these parts as well. Most answers are routine but when original design or inventive work is called for the designer has to use this retroductive system (or one similar to it) to make sure that he has asked himself all of the questions that have to be answered for his particular design. His analysis on the left may point out additional questions. His synthesis on the right may point out additional questions. The handbook designer sticks strictly to his handbook. The results are evident to the man on the street who tries to gain access to the top of the engine to add oil but finds out that he has to disconnect the sway bar to get to the oil cap. Or the man who has to back his engine off the engine mounts to replace the water pump. You name it!

Figure 31 is a graphic description of everything that has been discussed to explain the system of retroduction. Note the upper left and the upper right. The first thing sought is the proper beam. The last thing achieved (the final cause) was the desired beam. Note the questions listed on the left. Notice the temporary answers to the questions. Note that the questions have to answer the final cause, the material cause, the efficient cause, and the formal cause. Note that on the extreme left is listed the analysis or the taking apart of the design piece by piece in question form. Next notice how abstraction is used to start the synthesis which is to put the questions together in a ballpark answer. The list at the bottom of the page gives the order to take to form a good abstraction.

First, non-essential questions are eliminated. Second, the remaining questions are abstracted and put into their final order for a ballpark answer. Next, the final design can be done by analysis or by a combination of testing and analysis. If the two parts of the beam have to be bolted together and the deflection is critical, tests may have to be performed on a model to note the effect of friction on the parts before the analysis can continue. Thus the

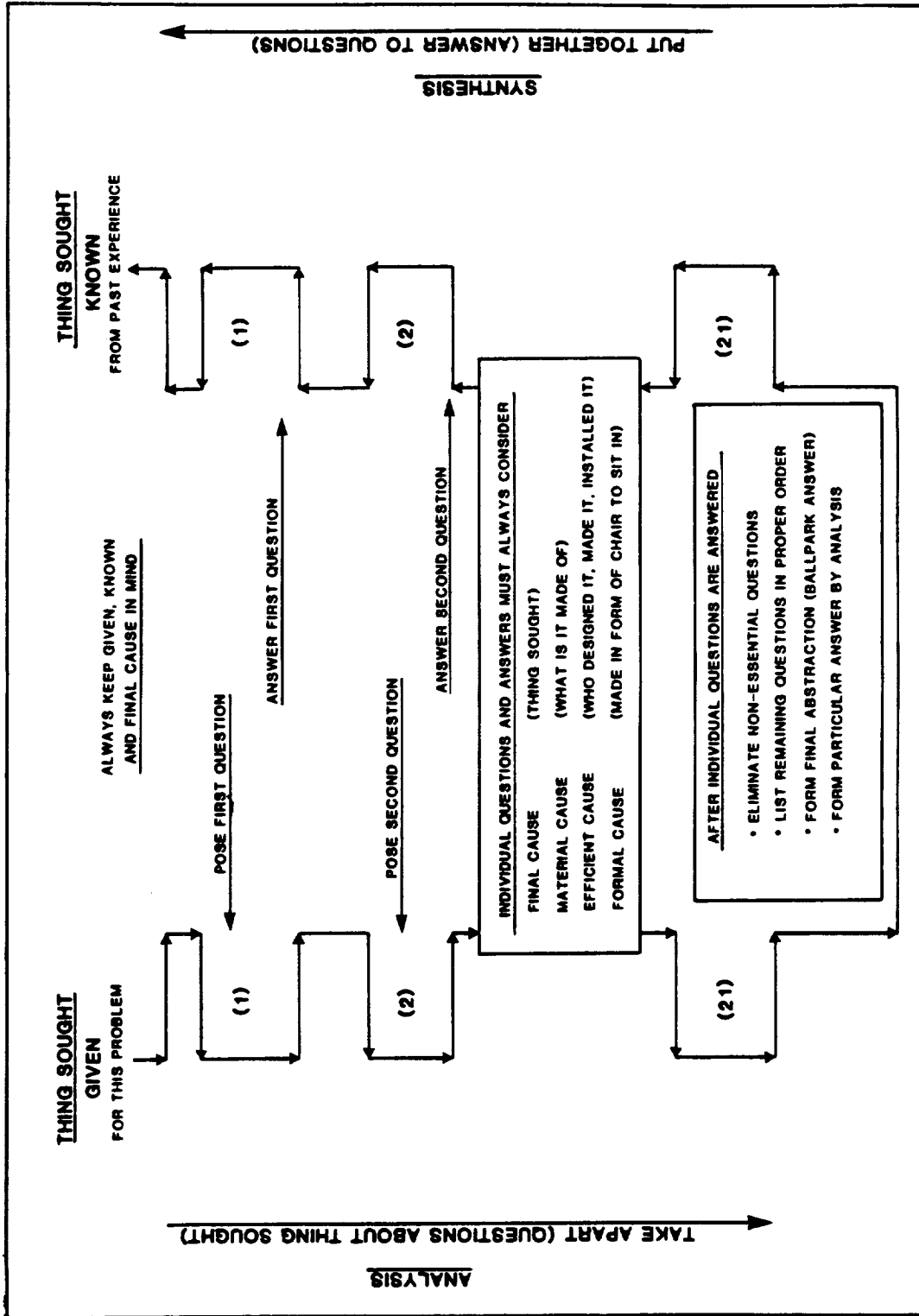

FIGURE 31

RETRODUCTIVE DESIGN



final step is deduction and not induction, but induction has placed the designer in the right ballpark where he is able to use his deduction.



## 9.0 RETRODUCTIVE INVENTION

In the third section the student learned about abstraction. Then they learned about induction in mathematics and logic. Next they were introduced to structured inductive thinking in heuristics. Then they could see from the young man building a shop that the structured thinking could involve abstraction and dialectic questions. Finally, they could see engineering design as a combination of analysis, synthesis, dialectic questions, and abstraction.

Invention adds another dimension to retroduction. This is best explained by going through two different kinds of invention. One type of invention is the normal type in which a patent is given because the inventor takes material and puts it together in a new and useful way. The second type of invention is a patent granted because the inventor had produced a completely new concept which had no previous reference in the patent office. Then from this pioneer invention many inventions follow and a whole new industry starts up.

### 9.1 RETRODUCTION USED TO DEMONSTRATE THE PROCESS OF INVENTION IN A MESH ISOLATION SYSTEM OF A SENSITIVE TUBE

Retroduction will be illustrated for both types of inventions. The first invention is that of a mesh isolation system illustrated in Figure 32 and Figure 33.

The basic difference between design and invention is that there are additional principles to follow in invention. These principles vary with different types of inventions. In vibration isolation, it is well known that there are three kinds of isolation. The first is mass impedance where mass is used to isolate vibration. Most of the old cast iron machine tools were heavy to isolate the equipment from vibration. The second type of isolation is known as detuning. The engines of most automobiles are mounted on unstable rubber so that the torsion load on the engine can be isolated by the rubber in shear. The rubber will give a low natural frequency but the compression load is quite high. Volvo mounted a block of rubber and a heavy steel block on the back of the engine to isolate the engine noise from the rest of the car. The third principle of vibration is damping. The hydraulic shocks on the car use the shocks to isolate the road motion by damping. The brakes in the car are used to stop the car by friction damping.

The inventor knows the principles that he must follow if he is to get isolation. He must use mass, detuning, or damping to cut down on the vibration. Principles have already been defined as that from which all else must follow. Thus, to get isolation, one of these principles must be followed by forming hardware which will give these reactions: mass, detuning, or damping.

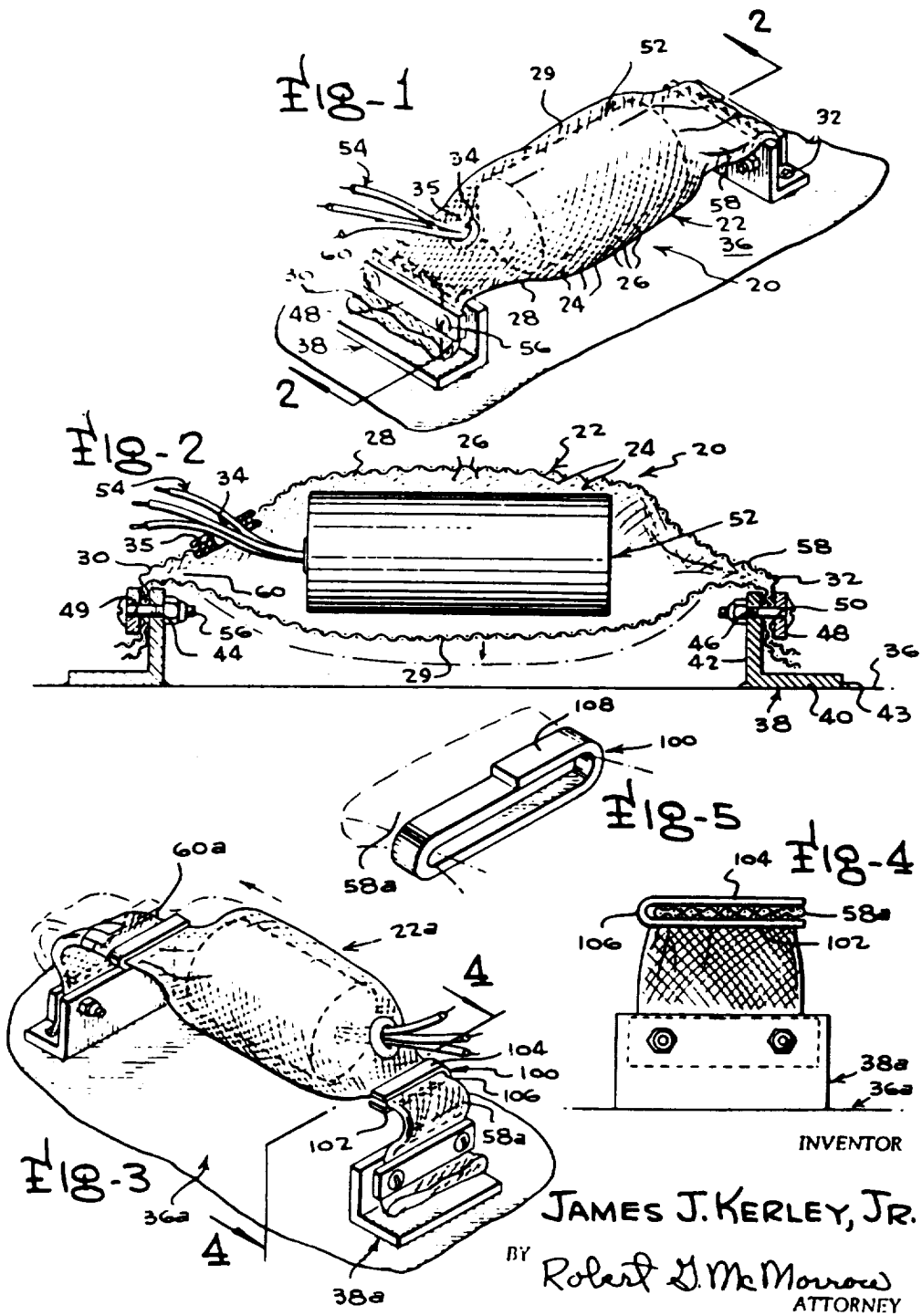

INVENTOR

JAMES J. KERLEY, JR.

BY Robert J. McMorrow ATTORNEY

FIGURE 32  
ISOLATOR FIGURE

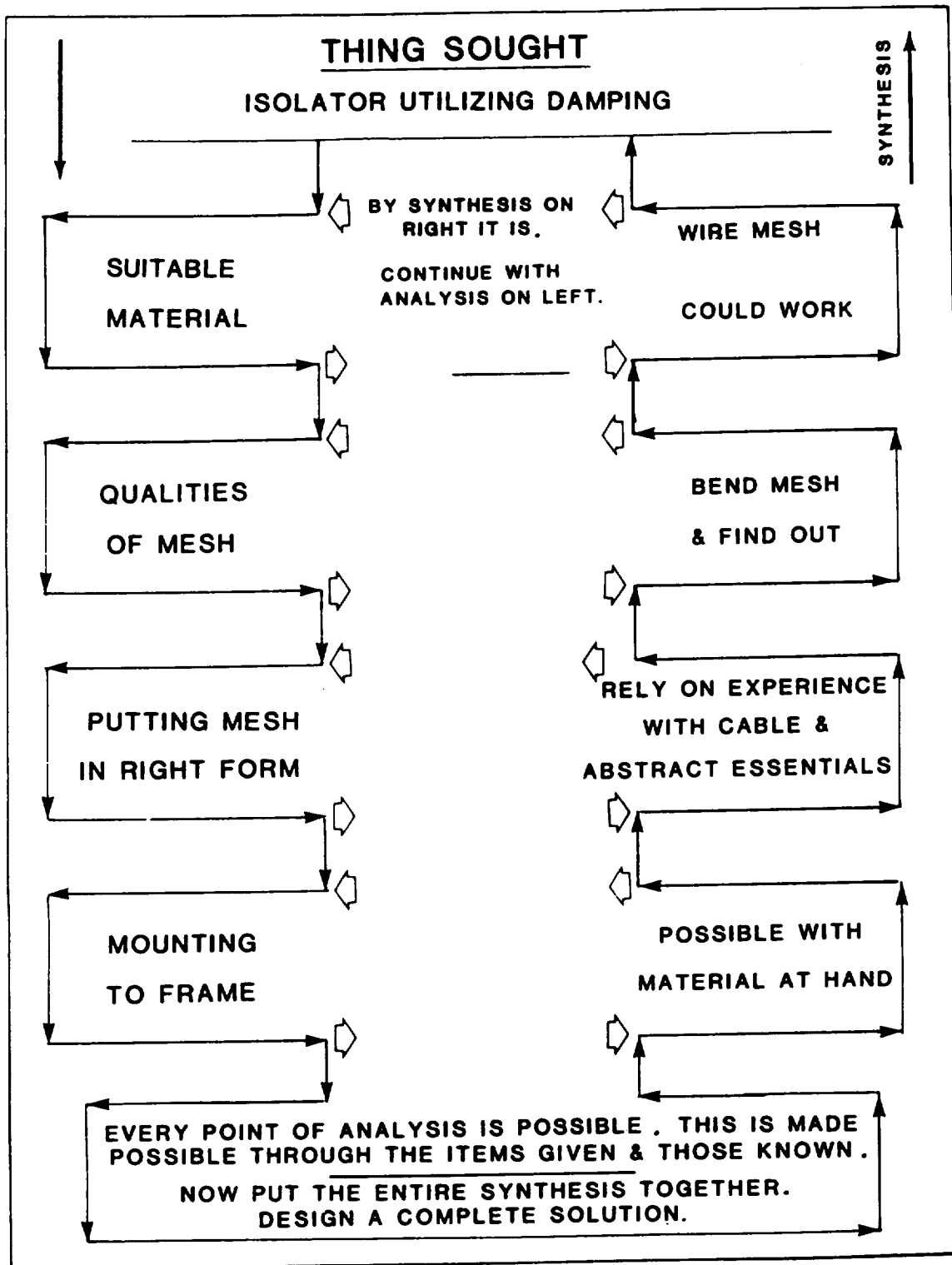

**FIGURE 33**  
**ISOLATOR INVENTION**

The invention pictured in Figure 32 is an electronic tube that replaced the one which had failed previously during vibration testing. The original tube was mounted on a sounding rocket that was to be shipped to White Sands, New Mexico the next day. It was 11:00 at night and little time was left to make a fix.

The engineer sat down at the bench with the tube in his hand. He knew his final cause all too well - to isolate the tube from excessive vibration. He knew the principles of isolation and had to rule out using mass to isolate as that would be too heavy in flight. He could not detune the tube and check it out in a short length of time. He knew that he had to get damping to isolate the tube. In Figure 33 note that the first question he had to ask himself was about the material cause. Was it a suitable material? He saw some shielding mesh made from steel wire. From his previous experience with steel cable he knew that wire rubbing against other wires offered excellent damping. So he knew that he had material that could work.

He then could answer the second question about the qualities of mesh. But he had to get the formal cause answered. What form could he put the mesh in to get the individual wires to rub against each other during vibration? But he realized that he had another formal cause to answer. How could he get the mesh to hold the tube? The mesh was flat and rolled up. He took a piece and noticed that it changed its diameter easily. He put his finger inside the mesh and formed a circular channel. Then he put the tube into the circular channel. Then he cut a hole in the connector end of the mesh to put on the socket and wires to hold the tube. See the top two pictures on Figure 32. But he still had not worked out a way to get the mesh to move during vibration. Not only did the tube have to move but it had to move under control so that the damping would take effect.

While working with the mesh and the tube, the efficient cause was very important. There was no time to machine any part nor was there time to use expensive or time-consuming techniques. He then bent the mesh in many forms so that it would have to bend during vibration. Finally, he came upon the technique shown in the lower part of Figure 32. The ends of the mesh at both ends of the tube were bent in a semi-circular pattern so that no matter what motion the tube would take, the wire mesh would bend and thus the wires would rub against each other and give good damping. The efficient cause was to do it by hand and design it in such a way that precision was not a requirement. To keep it together he invented a strip of metal that he clamped to the end of the tube and again to the angular base. Both of these items were easy to make from an efficient cause point of view. The formal cause was settled and the form of the bend controlled the damping.

The next problem was to solve the formal and efficient cause of how to mount the assembly to the sounding rocket. That was solved by making two small angles which were clamped to the mesh on one end and mounted to the sounding rocket with epoxy on the other end. The vibration test was performed and the tube performed well throughout the test. The flight was successful.

Another point is brought out in invention, and that is the close relationship between the formal and efficient cause. When the inventor wanted to get the mesh in the proper form so that it would bend, he knew that he had little to work with from an efficient cause point of view. The shops were closed and he himself had little talent. He had to make something simple with no close tolerances. This took the most time for thinking. This is the ability to expedite to get things done with little money and little time. It is a characteristic of all good inventors. Even in a large expensive project where invention is needed, the inventor will often make a model of the invention and see with the model if what he wants to do can, in fact, be made. More will be demonstrated about the close relationship between the formal and the efficient cause in the invention problem to follow.





## 10.0 A PIONEER INVENTION--RETRODUCTION

Note from Figure 33 that the principles are the same for a complex pioneer invention as they were for a simple invention like the mesh isolator. Certain items or specifications are given and certain things are known as a matter of engineering education. Then dialectic questions are made as a form of analysis. They are temporarily answered on the right. Then all of the questions and answers are abstracted to come up with a synthesis or ballpark answer. This can lead to an invention.

In the case of vibration isolation, it is known that there are only three types of isolation possible. These items were discussed in the past invention. The same will hold true for the pioneer invention. Thus any further pursuit of this problem with the same boundary conditions should be through damping techniques.

### 10.1 USING RETRODUCTION TO SOLVE A MULTI-PHASE PIONEER INVENTION THAT HAS BEEN THE LEADER IN ITS FIELD OVER THE PAST 25 YEARS

The mesh isolator was a particular problem. It had a unique solution for a unique use. The new problem is quite different. The problem was to design an isolator which would take weights from one ounce to many thousands of pounds. It had to take items that would measure in centimeters to items that would measure in meters. Instead of a simple single-loading condition of the mesh isolator, this new patent should be able to take one of the most severe specifications applicable to vibration - that is 10 G sine from 20 Hertz to 20 G at 28 Hertz sine with a movement of one octave per minute. Then the isolator has to take 20 G from 28 Hertz to 2,000 Hertz. This is a most serious vibration specification. The principles of isolation are known. But the most difficult part of this type of invention is where to start.

Figure 1\* gives a good example of how the inventor looks at the whole field with the techniques of analogy and synthesis. From this picture it is evident that the following dialectic questions in the analysis can be asked. Is vibration similar in cars, aircraft, and missiles? How can the structure be broken down for isolation? What part can be isolated first? Which is the least expensive way to attack this problem? What effects does vibration have on the structure? Can the structure fail? Can the structure malfunction through impact? Can noise and vibration destroy the structure?

This paper was presented at the 1984 Vibration Workshop - Air Force Wright Aeronautical Laboratories.

\*See Appendix B for all figures in Section 10.1.

Figure 1 is further analyzed for dialectic questions. Start with the internal limitations. What will the cost be to get started - to test - to analyze the tests - to make changes necessary for good design? What is the time limit on the job? Is the invention to be used in a product that must go into production in a matter of months? Is the time schedule open for a year or two? What is the organization that the inventor must work in or is he by himself? If he is by himself, how is he to organize his own work? Is the inventor under contract so that he has to come up with interim reports, etc.? What about his supervisors - are they sympathetic to thorough work or are they after a quick fix and run? How is safety to be considered in the invention process as well as the invention after it is completed? What about the material cause? What material should be used at first? Will the invention add or take away from the noise in the atmosphere? A good isolator will cut down the noise. Is the inventor expected to use the work of others to foster his work or is he expected to be ethical? What is the state of the art in isolation today? What hardware is used?

Then when the inventor starts out he has to go over the following questions. What forms of analysis will he use? How will he test it? Where will he get his references? Can he make models and prototypes?

These are just 24 dialectic questions that the inventor should ask himself to start his invention. Turn back to Figure 33 and note that the mesh isolator needed only six questions to answer. As the inventor goes along, he has to give temporary answers to each of these questions where he can. If he cannot answer all of the questions, he has to make conjectures and substitute his own opinion or he would never get started. Money has always been the toughest question to ask. Most companies would never guarantee that the inventor could have sufficient money to complete the invention, even though the investment would be small. He is usually lucky if he receives enough money to get the project off the ground. Then he has to go through another accounting review. If he shows promise, he will get more money if there is enough available money in the research funds.

The above invention was performed in the design section of a large corporation where the inventor made the parts himself with his technician. He tested the parts in the vibration laboratory which was part of the applied engineering department. He managed to conduct his testing on the machines between major assignments. He made all of his models with quick disconnects and put his lab on wheels. All major projects had testing time allocated ahead of time. If he heard a break in the item being tested he would roll his portable lab into the laboratory. While the broken part was removed from the machine, he mounted his experiment on the machine until the next major project came along. There are many ways to

keep overhead expenses down. Notice that the above explanations already give temporary answers so necessary for the synthesis.

Turn to Figure 1. The inventor has to make his first decision. He has four areas to start. He can begin with isolation of the entire payload or the entire automobile. That is very expensive and time-consuming. He would like to step down and take the frame but that requires manufacturing costs and space. The next step down is the panel that mounts the sensitive equipment. He can start there because the cost is low, parts are easy to make, and he is able to try something and get almost immediate results.

He is immediately setting up principles that would help any inventor. It is better to come up with some small conclusion that he knows well, rather than have a vague idea of the entire structure. When he learns from the small structure he will be able to apply it to larger structures. Another principle is that the inventor should do as many things for himself as he possibly can. He should make parts that are easily tested so that he can verify his results immediately. He should see from the mesh isolator in Figure 33 that simple inventions for small singular parts may be done in one step. But in inventions as complicated and involved as this new problem presents, he will never be able to complete it in one step. Therefore, he has to set steps or plateaus along the way at which he can stop and come to a temporary solution, looking for a final step which may take many months and years.

The first decision was to settle for the panel and design one that would meet the very stringent specifications given him. For most inventions that first decision or the first few steps are the most important made in the long invention process. Early in the inventive process it is necessary that a clue be found that indicates the inventor is going in the right direction. The wrong decision made early could miss one of these important points. The smallest parts, such as the tube or the electronics, were not chosen because they would end in particular solutions and not a general universal solution. In other words, relays could be isolated to pass their specifications but this type of solution would fit little else.

An aluminum box 12 inch by 12 inch by 12 inch was riveted together and mounted on the testing machine to see what the vibration response would be. It was observed that the box was like a bell with many harmonics. The inventor knew that he had to get damping somewhere so he looked at the inventions of the time for the best damping material. He found commercial panels with aluminum on the outside and rubber on the inside. Such panels were dead to vibration when excited. The aluminum-rubber combination had the characteristic of heavy damping when forces were excited perpendicular to the panel but poor damping if the forces were introduced parallel to the panel. The inventor glued up his own panels and made a 12 inch box similar to the one that he had already made. He put this box on the vibration shaker and compared it to the box with no

damping. It did a great job of stopping the vibration but it was entirely too heavy.

The next step was to take the first 12 inch box of straight aluminum and mount the panel with damping inside the box. This interior panel is shown in Figure 2. The box was still too heavy and the vibrations were still getting through in the edge plane. The inventor knew that he had to get motion in all three planes in order to get isolation. Motion would bend the panels with damping material and this bending motion would bring about isolation.

The next step was to use the all-aluminum box and mount an all-aluminum panel inside. However, the all-aluminum panel had the edges mounted on heavy damped curved panels (rubber between two pieces of aluminum) on the edges as in the lower part of Figure 2. The curved edge panels or isolators would now bend in all three directions as indicated in Figures 3 and 4. Note that the isolators or edge panels would bend in all three directions, giving isolation. Two problems were not solved. Edge vibration was solved for low frequencies, but it was not solved for isolation in the higher frequencies. Even though edge vibration was curtailed, it was not reduced sufficiently for good isolation.

To get more flexibility and more isolation the rubber was put on the outside and the metal on the inside. This step improved the isolation considerably. A problem still existed in the high frequency of the edge plane. It was still too stiff.

A new problem was created. With the rubber on the outside and the metal on the inside the isolators moved a good deal more but in some cases they moved too far and would bang into the outside edge. Bumpers were installed as illustrated in Figure 5. In some cases they worked well but in others the bumpers acted like a slingshot to increase the motion.

It is good to stop here to investigate the intellect of the inventor to see where he found the information to ask the proper questions. His questions lead to directions and trials used to solve critical problems. The first thing that he looked for was the material cause. He knew that he had to have damping. Thus he looked for material that would give good damping, such as rubber. But he knew that the rubber alone was not stiff enough to carry heavy weights. He then came to a combination of the formal and the material cause. The new material was aluminum with rubber and the form taken was that of bending in order to bring about the damping and subsequent isolation. When various problems arose he kept looking to the formal cause to try different forms to put his isolators in to give him the proper isolation. In the overall construction he started in the form of a box, then a panel, and last a curved panel which turned into an isolator.

The efficient cause or the way it was made and installed came into play when he started gluing the rubber to the metal. Ordinarily a simple glue would work but in vibration isolation the damping causes heat and the heat changes the characteristics of the glue and rubber. The technique took a while to develop. Another difficulty was to get the metal to bend into a quarter circle when the rubber was glued to the metal. Finally, the metal was bend first, dies were made, and the material was glued under pressure in final form. Note how closely the three types of causes--material, formal, and efficient--work with each other to form an invention. The inventor saw the need for motion. He needed the proper material in the right place (material and formal cause). But he had to figure out a way to do what he wanted to do. In the early stages of invention this was most difficult and it took expert hand work. Even the modification of the motion by the use of bumpers demanded a knowledge of the three causes. The bumpers could not be too stiff, but how stiff? What should they be made of? What form should they be put in? How were they to be made? The sketches show the many ways that the inventor was thinking.

Even though the quarter circle was good for isolation, it was not enough motion in the low frequency range with high inputs. In addition, the edge isolation was still a problem. The formal cause was put to use and the isolators were made in the forms of Figure 6. The isolators in the lower row of pictures had difficulty because they banged against the side of the panel. The center row was used to compare the first with the last step. The top row proved to be the best form of isolation to date. The motion is shown in Figure 7. Again, the efficient cause was difficult to master. The double bend took a more complicated die to glue up the aluminum and rubber. Any separation of the rubber from the metal would lead to immediate failure.

It now became apparent that there were two related and simultaneous problems. A lot of motion was needed in all three planes in order to get isolation. But with motion the aluminum in the center would bend back and forth and fatigue. The object was to find a metal which could take the loads and still bend back and forth without breaking. The material cause was the first to be studied because if that were solved it would simplify the problem. Wire was used instead of sheet metal. The wire was better but it would fatigue in time. Finally stainless steel cable was tried. It was glued between two pieces of rubber and put in the quarter round form. See Figure 8. The new material (stainless steel cable) satisfied the material cause. The cable bending back and forth satisfied the formal cause - the rubbing of the strands of cable while bending caused damping, and better isolation existed. The cable could go back and forth many times without breaking. However this made the efficient cause most difficult. Gluing the strips of cable between the rubber demanded a thorough study of the process of gluing. However, with this form, isolation was most complete. See Figure 9 which is a graph of the transmissibility of output

divided by input. Because of the good damping and strength characteristics with good fatigue life, the following points were accomplished:

- (1) All three planes had good isolation.
- (2) High damping existed at resonance and little or no damping occurred at high frequencies. Damping at high frequency could cause noise problems but it did not occur with this combination.
- (3) The isolator was good for both shock and vibration.
- (4) Preliminary tests demonstrated that the isolation was good in the presence of high steady-state loads.

There was still a nagging problem that needed an answer. The material cause of the rubber caused it to become very soft as heat was added and very hard at low temperature, even to the point of becoming brittle and snapping into two pieces. Other materials such as teflon and saran were used with problems of gluing and other bad characteristics too numerous to mention here. The material cause had to be abandoned and the answer found in the formal cause. The rubber had to go. It had been determined previously that the cable itself had good damping characteristics as the rubbing of the strands of cable together cause sufficient damping to control the motion. But how was it possible to get the cable to hold a form when the rubber was removed - the rubber which gave the cable a medium to control it.

Over the period of six months a whole series of cables were put in different forms to look for some type of stability. After all, holding a piece of cable between two hands illustrates the instability that exists if you try to bend the cable. Finally the first configuration was formed and is illustrated in Figure 10. This configuration was used in many military aircraft. However it would not take high loads or severe shock loads. Other configurations were attempted and the best is shown in Figure 11. Much of this problem was solved by using rope and balsa or heavy string and balsa wood. A model could be made in less than an hour and gave a good solution for the formal cause. This is just another case where models and analogies were used to solve very complex problems.

While working with this configuration it was found that the position of the cables could be varied as shown in Figure 11 and this variation would change the spring constant and the natural frequency. It was now possible to have an isolator that would have the same natural frequency in all three planes. See Figure 12.

One of the most important results of this configuration is illustrated in Figure 32. Note that the natural frequency can be doubled simply by adjusting the cables. The night before a flight it might be found that a certain frequency was dangerous for flight. The isolation system could be immediately adjusted to avoid that

frequency. Note also that the area under the curve is a measure of the damping and the damping can be controlled by the stiffness. Also note that the greater the amplitude, the stiffer the cable became. This made the isolator good for shock loads as it would snub up itself without coming to an abrupt stop. Also notice that there is considerable damping with high amplitude low frequencies and little or no damping at high frequency low amplitude loads. This is most desirable for field operation.

The next step was to have an isolation system that would isolate from shock and vibration in the presence of steady-state loads. Rubber had the characteristic of stiffening up the natural frequency during the steady-state loads, thus cutting back severely on isolation. The isolator in Figure 11 and Figure 20 did not have this characteristic as was demonstrated by the load deflection curve in Figure 32. Thus an airplane can be pulling 7 G while isolating from vibration. The same is true with the space shuttle which could be going through the early heavy steady-state loads while isolating. The same is true during reentry. Models have been made and this characteristic has been put to use with many applications. This is particularly true when mounting gyros.

If the cable can isolate in the presence of high steady-state loads, then the cables offer a good system to act as a coupling. The desirable characteristics for this coupling is that the cable can take care of out-of-alignment problems. It can prevent vibration from getting from the engine to the drivers. It can also prevent the driver vibrations from feeding back to the engine. Figure 23 shows several forms of this type of coupling.

It is evident that the pioneer type of invention leads to many solutions. And many of these secondary inventions were made with little or no change in the original form. The material cause is solved and most of the efficient causes were solved. The only difficult cause left was the formal cause. Note that the many inventions shown in this development were nothing more than changing the formal cause. One of best examples of this new form was illustrated in Figure 20.

There is one other related invention that has done well in America and abroad. It is illustrated in Figure 30. With the ability to take steady-state loads on top of vibration, an electric or pneumatic hammer can be isolated. The operator can push harder on the ground through the isolation system without feeling the vibrations in his hands. But this action does not hinder the amount of energy that gets to the ground. Rather, it increases the energy on the hammer and the work can be done in a shorter period of time.

From the above description it is evident that a pioneer invention takes more time and it goes through many steps to get to a good final form. Then when the final form is reached it is evident that many different forms of the invention can solve various kinds of problems.



## 11.0 EARLY AMERICAN INVENTORS

The early part of the last century saw the beginning of the great inventive period in America. For example, in a fifty-year period, America changed from a nation that imported many foods to a nation that was the seventh largest exporter of food in the world.

Americans wanted to go West but food, transportation, and other business interests made the development slow. A series of inventions solved this problem and it is interesting from an historical point of view to stand back and study what went on inside the minds of many of the great inventors to see if they followed the process of retrodution that we have previously outlined. The students are able to see here a method for using a study of engineering of the past to project that thinking to the future.

### 11.1 JOHN DEERE AND THE PLOW

When the pioneers went west into the central farmlands they found out that the soil was primarily clay and not the sandy loam of New England. The cast iron plows of New England would not work in the Ohio mud. The mud would cling to the plow and slow down the cutting action. Many inventors made different forms for the plow. This was to satisfy the formal cause which states that the metal be made in a certain form to perform a certain final cause, which was to plow the land. Notice the various forms in the lower left of Figure 34. The dilectic questions that they asked were addressed to the formal cause. But John Deere had a different approach. He went after the material cause. He was a blacksmith who made steel saw blades. He decided to make a plow of steel instead of cast iron. He noticed that his plow made of saw blades performed a scouring action on the clay and the clay would slide off. He attacked the material cause. He solved the problem by asking questions about the material cause. Practically every covered wagon going west had a John Deere plow.

### 11.2 MCCORMICK AND HIS REAPER

Now that the fields were growing grain and corn in great abundance, it was necessary to move it to the industrial East to sell it. There was a problem. The farmers could not cut the wheat fast enough to save it from the fall rains. One man with a scythe could cut one acre of wheat per day. Many tried for an invention to solve this problem. The best solution was developed by Cyrus McCormick and his reaper. Figure 35 is a sketch of the first workable reaper. He knew that he needed a scissors action to cut the grain. He knew that the efficient cause had to be solved along with the formal cause. It had to operate correctly with the power of the wheels. From a practical point of view this would solve the efficient cause. And it had to be manufactured in the right form in order to cut the wheat. Study Figure 35 and notice how McCormick solved this problem. He drove a belt off the wheel



Pat Lyon, famous smith, had his prototype in John Deere, of Grand Detour, Ill., who made the first steel plow.

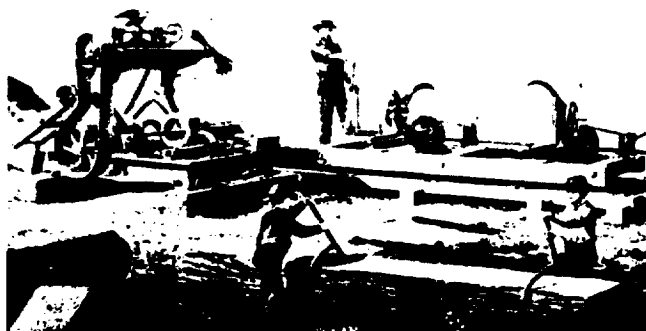

Steel was self-scouring in the sticky, black soil, but the only steel in Grand Detour was in circular saw blades.

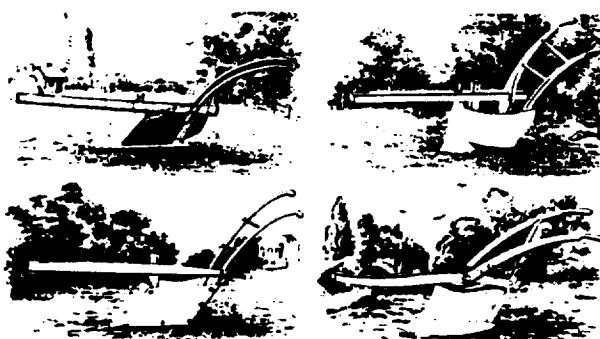

Thomas Jefferson designed the classic American plow, but never patented it. After him, during the next fifty years, plow patent applications poured into the Patent Office.

## 2. JOHN DEERE'S PLOW OF SAW-STEEL

Thomas Jefferson, the first American to make a study of the plow, discovered the importance of making the plow's cutting edge a straight line. He sought no patent. The first patent on a plow was granted in 1793 to Charles Newbold of New Jersey, who spent his entire fortune of thirty thousand dollars developing an efficient plow of cast iron; but the neighboring farmers decided against it. Iron would poison the ground, they said.

Twenty years after Newbold lost his money experimenting with plows no one would buy, Jethro Wood invented another iron plow, the nineteenth to be patented in America, based on Jefferson's theories. Wood sold every plow he could make, but he was hounded by infringers.

Jethro Wood's plow worked well enough in the sandy earth of the East, but the soil of the West—of Illinois, Indiana, and Wisconsin—was far different. Farmers complained that they seemed to be trying to plow a mixture of tar, mud, and molasses. To plow a clean, fast furrow, the earth must fall away in a smooth curl from the moldboard. This was called *scouring*. The sticky mud of Illinois soil refused to scour, and clung in great gobs to iron plows. Men thought the problem could be solved by making slight changes in the shape of one part or another of the plow; and every variety of design was patented out of as many different combinations of wood and iron.

In 1833, a young blacksmith, John Deere of Grand Detour, Illinois, came to the conclusion that the fault lay in the iron itself, not in the iron's shape. One day, on a visit to a sawmill, Deere noticed how a discarded steel blade shone where it had been polished by friction. He wondered whether steel would also clean itself when cutting earth. He made a plow out of a discarded circular blade, using a wooden mallet to avoid denting the surface. With this new steel plow, he cut a dozen smooth straight furrows in Lewis Crandall's field without having to stop once. His neighbors took the plow and kept going down the field just to be sure they weren't seeing things. He sold his first plows for ten dollars each.

John Deere moved to Moline where he started a factory. Twenty years after he made his first steel plow, the great push of settlers to Oregon and California was under way, and a John Deere plow could be found in almost every wagon train.

When the furrows of soil slid smoothly past the steel, the plowshare vibrated with a humming sound, and John Deere became famous for his "singing plow."

### FIGURE 34

### THE PLOW



Cyrus H. McCormick

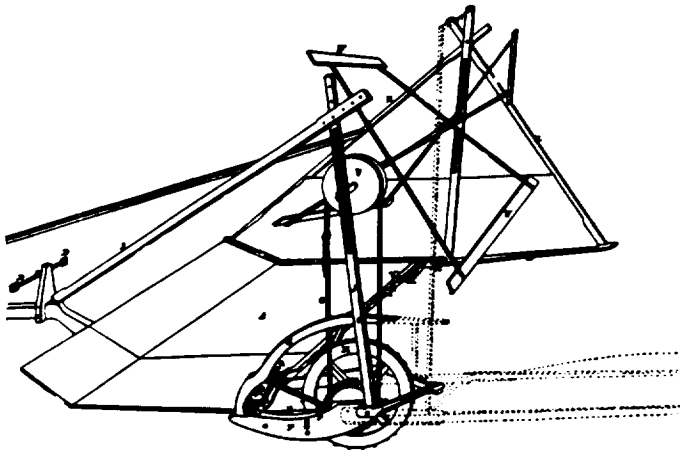

McCormick patented his reaper in 1834. Over 20 other reapers had been patented in the U. S. before. McCormick's was the best.

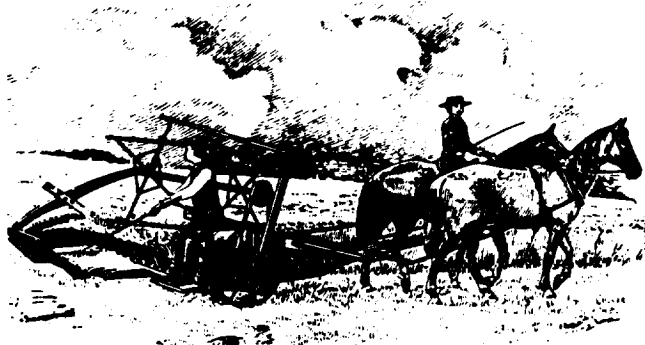

McCormick's reaper of 1847 showed many improvements. McCormick's production genius enabled him to make 4,000 reapers in 1856.

#### 4. McCORMICK AND HIS RIVALS

Cyrus McCormick was born in 1809 three days after the birth of Lincoln. The McCormick family were prosperous farmers. The father, Robert, was himself an inventor with his own smithy. His son, Cyrus, grew up familiar with the tools of his time, at home in the blacksmith shop on his father's farm.

Robert McCormick's great failure was a mechanical reaper which he finally gave up as hopeless. Cyrus McCormick, who had always identified himself with his father, was impelled to prove that in this respect, at least, he was more a man than his father. He took over the reaper as his responsibility.

He was a young man with narrow interests and few friends. He held himself aloof from almost everyone, but not because he courted anonymity; a man who dresses with almost dandyish elegance is a man who wants to be noticed.

His younger brothers and sisters used to tease him for being so straitlaced, but secretly they were in awe of him. When he became a millionaire before he was forty, they made no secret of their awe, and he, in return, was very generous.

In 1831, when he was twenty-two, he gave the first public demonstration of his reaper and cut six acres of oats at Steele's Tavern in one day. Four horses pulled the machine which was doing the work of six men. Two of the McCormick slaves, "Old Joe" Anderson and Anthony, had to hold the horses because the clatter of the machine was frightening. Neighbors who had seen earlier performances of the father's reaper admitted that it was "a right curious sort of thing" but "nobody ever believed it would come to much."

The fact that went unappreciated was that horsepower was being substituted for human labor. From that point of view, a reaper is a device which converts the pulling power of a horse into the intelligence, judgment, experience, and strength necessary to harvest a field of standing grain.

The first reaper did not cut too evenly, and some of the grain was damaged. McCormick continually improved his machine and in 1834 secured a patent, but made no attempt to market a machine with which he was still dissatisfied.

Essentially the reaper substituted a number of cutting shears for the swinging blade of the scythe. A horse walked down a field pulling a two-wheeled chariot which had an axle about six feet long. Connected to the chariot was a flat iron bar parallel to the axle, a few inches above the ground. Protruding from the front of the bar were a number of broad, flat steel fingers which separated the grain stalks into

### FIGURE 35

### THE REAPER

shaft. This belt turned a shaft that rotated the blades, just like a lawn mower, to cut the wheat. The amazing feat of McCormick is that he had to have the blades line up all of the time or they would jam or not cut at all - just like a dull pair of scissors. McCormick did this with no machine tools or without any of the modern techniques for tolerances. It took him ten years, and was truly a remarkable invention. He adjusted his reaper to the height of the grain by adjusting the height of the lower blade.

John Deere invented his plow about 1833. McCormick invented his reaper about 1841, eight years later. The next item needed was a method for moving the wheat to the eastern markets. The Erie Canal was too far away.

### 11.3 JOHN ROBERT STEVENS AND THE "T" RAIL

The next series of inventions were those of the practical railroad. The British railroad was under construction with elaborate bridges, rails and granite road beds. When America started to build railroads they had long distances to travel over many difficult hills. Stevens in America invented the "T" rail which saved considerably. Then they could not supply enough granite blocks for road beds so they used crushed rock. It not only saved money but it gave a much smoother ride as well. The British bridges were quite elaborate, but America had neither the money nor the time to construct such bridges. Many of the early rail systems were built with wooden truss bridges. Figure 36 shows some of these early inventions.

### 11.4 SWIVEL TRUCKS FOR RAILROAD CARS

Figure 37 illustrates the next rail development. The original cars looked like stage coaches. Then they needed longer cars to carry freight. The long cars had difficulty on the curves. The truck was invented and shown in Figure 37. This opened the West to heavy freight. This was a use of the formal cause. The wheels were put in that form to take the curves with heavy loads.

### 11.5 RAILROAD SAFETY STANDARDS

The next problem was the tendency of the locomotive boilers to blow up. Quality control was not at its best in 1835. To protect the passengers, a car loaded with cotton bales was inserted between the locomotive and the travelers. See Figure 38. The material cause was the fact that cotton absorbed a lot of energy. The formal cause was to put the car between the locomotive and the people.

Stevens and his fellow inventors came along when they were needed. Their inventions were structured to fit the times. It was not just luck or happenstance. It was the logical development of resources to meet the needed goals: the final cause. The inventors

4. THE ROAD AND ROBERT STEVENS

Some of the most basic inventions in American railroading were never patented. The T-rail, now in universal use, was invented by John Stevens' son, Robert, in 1830 while on his way to England for the South Amboy and Camden Railroad to order locomotives and track. To pass the time on the *Hibernia*, he began to whittle models of rail that would be practical, strong, and easy to build in America.

The original rails, as delivered to Robert Stevens, ran to sixteen-foot lengths, and were three and a half inches high. The head, on which the wheel bore, was two and one-eighth inches broad. The base of the track was three and a half inches wide. Standard practice abroad and here was to lay the wooden rails on square granite blocks sunk into the earth. However, once he began to lay track, he found himself moving ahead faster than Sing Sing could furnish him with granite. Unwilling to wait, he had his men square off logs and lay them crosswise on an improvised roadbed of broken rock. These were the original wooden ties. When Robert Stevens gingerly piloted the locomotive himself over the new section, he found the road far more elastic and comfortable than anything he had ridden before. The T-rail, the hook-headed spike, the balance valve, and the fishtail for rail joints were all inventions of Robert Stevens, and none of them were ever patented. He was too busy thinking of the details of the next job.

Within ten years, Stevens' method of laying track became standard the world over.

American and English engineering practices diverged very sharply from the beginning. The English built double lines, while the Americans built single lines with sidings for passing. The English built beautifully designed, substantial stone bridges, viaducts and tunnels. The Americans simply laid track—up hill, down dale, through virgin forests. If a stream or river had to be bridged, wooden trusses were used, hewn from the nearest spot. Furthermore, because of the invention of the swivel truck, American lines were able to make curves twice as sharp as the English would tolerate. In America, a 500-foot radius curve was not at all uncommon. This saved expensive track. Thus the Americans were able to lay twice as much mileage as the English for a far smaller capital investment per mile. The difference, of course, was paid by the passengers in terms of swaying, jolting, and queasiness.

John Stevens' sons, Robert, Edwin, and John Cox, all lived and worked in their robust father's tradition. The English railroad pioneer inventor, Stephenson, was very much like Stevens, and he, too, had a worthy son as colleague and successor. The two railroading families met in 1850 in friendly rivalry in another field. Several of the Stevens sons, with some other young bloods, founded the New York Yacht Club, and as a syndicate built the racing schooner, *America*. They sailed the *America* across the Atlantic where Yacht Club Commodore Stevens issued a sporting challenge to all England to a race for any trophy or a wager up to ten thousand guineas.

At first there were no takers because the *America* was obviously unbeatable, and the *London Times* cried: "Fie! For shame on England!" Then Stephenson stepped up with his yacht *Titania*, game to lose but willing to race. Seven other schooners and eight cutters followed Stephenson's example. During the race, Queen Victoria's quartermaster watched the finish line. Her Majesty asked him who was first, who was second and what was the order. He snapped shut his spyglass, saying, "*America* first—no second!"

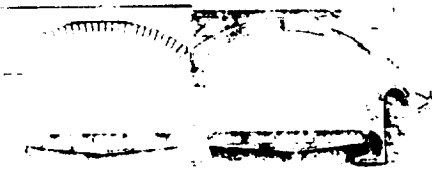

The English adhered to the most refined practices of bridge and road engineering.

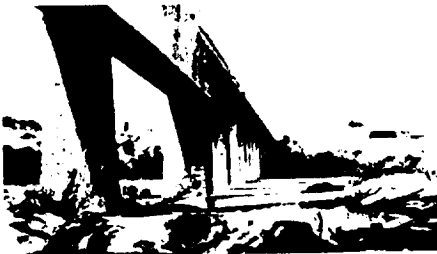

The Americans built trestles and bridges from whatever materials were handy.

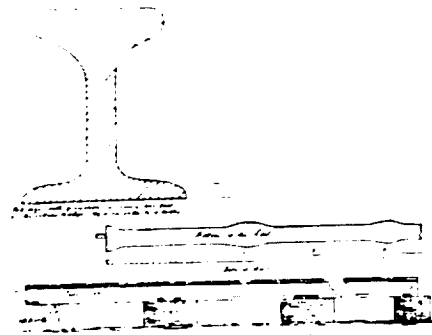

*The first T-rail was sketched by Robert Stevens while on board ship for England.*

The first T-rail was sketched by Robert Stevens while on board ship for England.

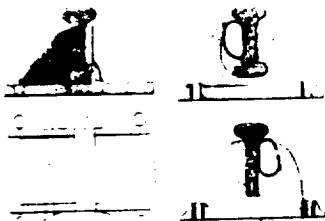

English track was complicated and expensive. Stevens simply spiked his T-rails to ties.

FIGURE 36  
RAILROAD TRACKS

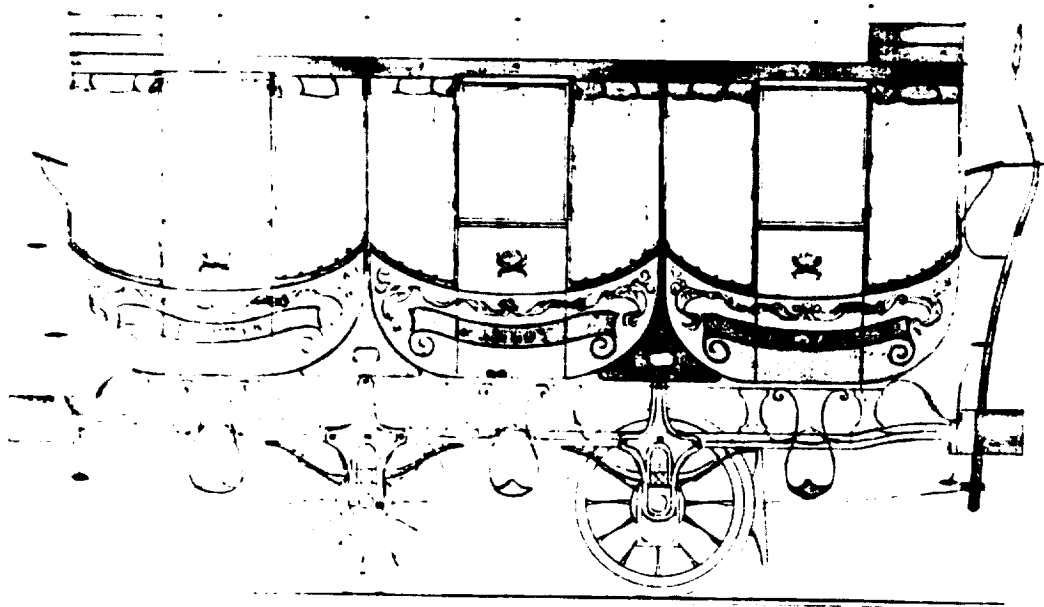

Before 1840, coaches imitated styles set by the only precedent that was known—stagecoaches and carriages of the time.

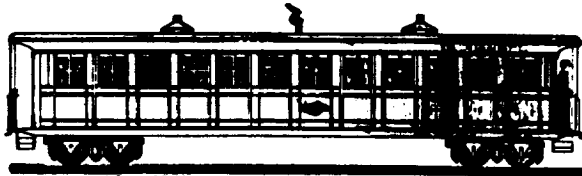

After 1840, the "standard American car" remained in use until Pullman's innovations in the '70's.

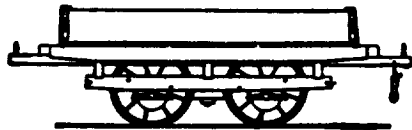

The first freight cars in the United States were simple platforms mounted on four wheels.

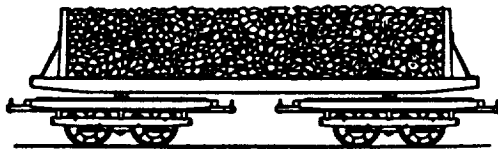

The next stage was to mount long platforms on two primitive cars used as swivel trucks.

### 3. CARRIAGES AND COACHES

The earliest American carriage was of the stagecoach type, just as in England, but once again American design began to depart radically to suit its own needs. With the invention of the double truck, longer cars were possible. As the first step away from the stagecoach on tracks, three carriages were mounted in tandem on a single bed to insure greater stability from the trebled weight. This design was an intermediate step to the typical long American coach. Here was an idealistic description of an American coach in the forties.

"In cold weather, a small stove is placed near the center of the carriage, the smoke pipe of which passes out through the roof; and a good lamp is placed at each end for illumination through the night. The vehicle is thus perfectly lighted and warmed. The seats are cushioned, and their backs, consisting of a simple padded board about six inches broad, are so supported that the passenger may at his pleasure turn them either way, so as to turn his face or back to the engine. For the convenience of ladies who desire to be apart, a small room is some-

FIGURE 37

THE TRUCK



The interior of an early B. & O. car was dirty, smoky, crowded, noisy, and half as wide as this picture indicates.

times attached at the end of the carriage, admission to which is forbidden to gentlemen."

But in actual practice:

"This morning, at nine o'clock, I took passage on a railroad from Boston for Providence. Five or six other cars were attached to the locomotive, and uglier boxes I do not wish to travel in. They were made to stow away some thirty human beings who sit cheek by jowl, the best they can. Two poor fellows who were not in the habit of making their toilet squeezed me into a corner, while the hot sun drew from their garments a villainous compound

of smells made up of salt fish, tar, and molasses. By and by, just twelve—only twelve—bouncing factory girls were introduced who were going on a party of pleasure to Newport. 'Make room for the ladies,' bawled the superintendent. 'Come, gentlemen, jump on the top, plenty of room there!' 'I'm afraid of the bridge knocking my brains out,' said a passenger. For my part, I flatly told him that since I had belonged to the corps of the Silver Greys, I had lost my gallantry and did not intend to move. The whole twelve were introduced and made themselves at home sucking lemons and eating green apples. . . ."

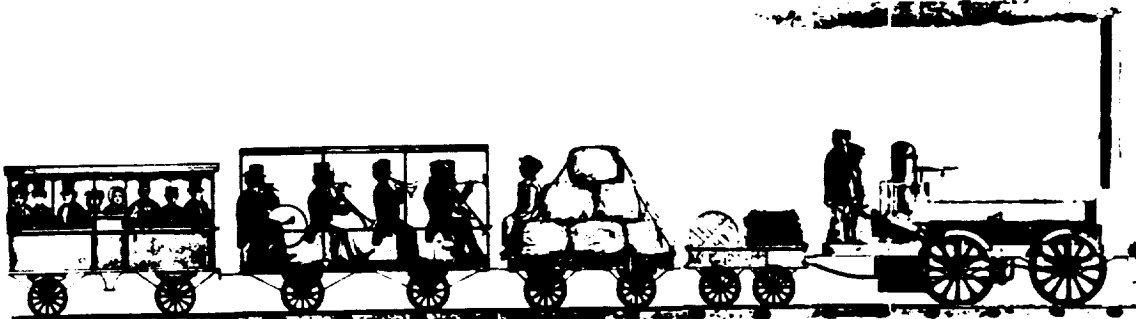

Boiler explosions were frequent on the early railroads. Here the passengers are protected by bales of cotton.

FIGURE 38

SAFETY

used the natural resources around them to fill the need by turning to the causes for possible answers and then to experimentation to reach the final invention: the desired and needed end.

In many of these cases the toughest problem was not the basic invention but the development of patents that were needed to make the invention work efficiently and reliably.

#### 11.6 MCCAY AND THE CLIPPER SHIP

Now that the grain was growing and McCormick's reaper was cutting it down and getting it to the railroads, the grain was going East. But there was too much wheat for the eastern markets. The next item needed was a merchant marine to ship the grain all over the world. McCay in the 1840's designed and built a new type of ship called the clipper ship. This new design was faster than any other ship on the seven seas. This ship was somewhat unstable at times but in the hands of a good crew it kept the sea lanes open for many years while carrying the American grain. The largest clipper ship ever made was called The Great Republic and it is shown in Figure 39.

#### 11.7 INVENTIONS IN IRON AND STEEL

Around 1840 industry was booming. The next need was energy. The industry needed coal and steel. Figure 40 gives an introduction to the many examples of inventions that resulted from the expansion of these sources of energy.

#### 11.8 OIL DISCOVERIES

The need for energy increased as industry and cities grew. Drake struck his first oil well in Titusville, Pennsylvania in 1850. From that day on a new business grew from many inventions needed to get the oil from the ground to storage tanks, to pipe lines, and eventual use. Many new types of lamps and burners were needed and these items all demanded many inventions to get them working. People had a need. The inventors used the resources around them and worked with the causes to produce the inventions needed for the times. See Figure 41.

#### 11.9 EARLY SUBMARINE

With the onset of the Civil War there was rush for new inventions of war. Figure 42 shows a submarine that was propelled by hand. This type of submarine killed more submariners than the enemy.

#### 11.10 MACHINE TOOLS

Now that the thesis has been presented to demonstrate that invention was a natural process of following through on the need of the people working with the materials at hand, it is natural to ask



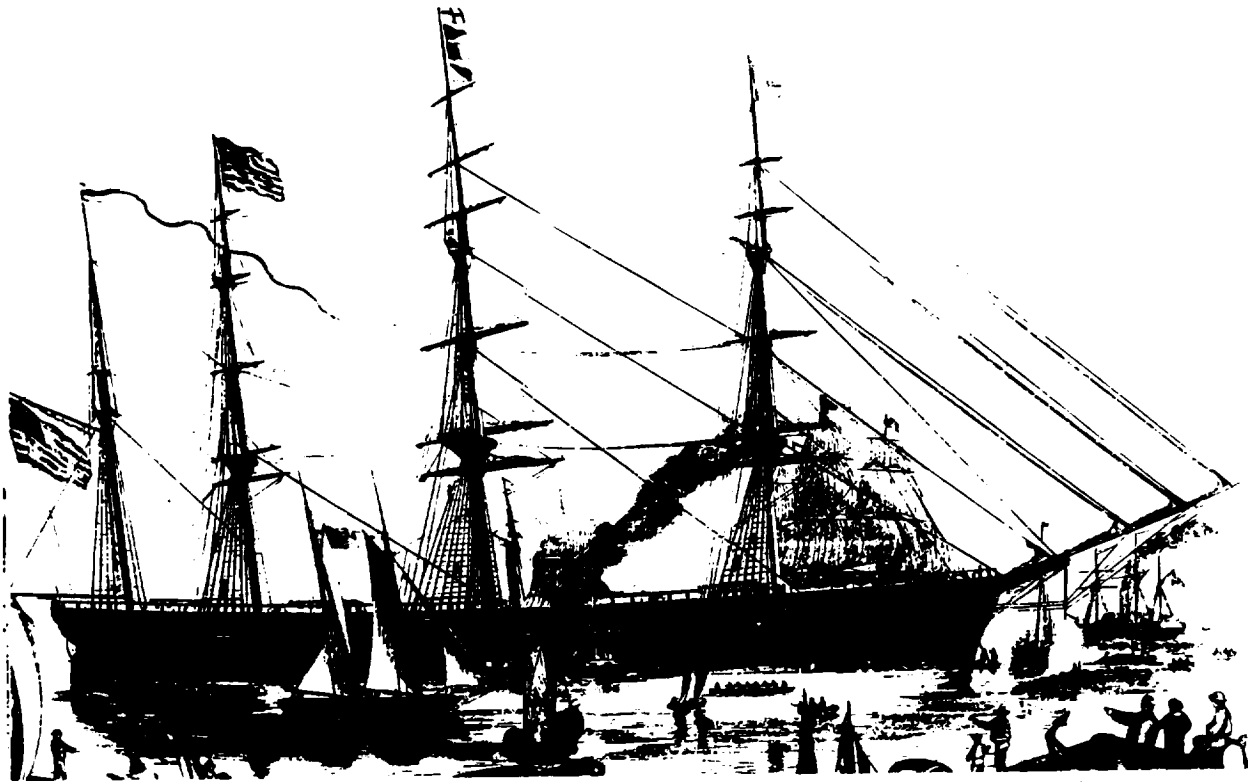

The biggest clipper ever built was the *Great Republic*, launched at Boston in 1853. Her 3,357 tons were twice that

of the average clipper. Her foremast was four feet in diameter and 130 feet tall. She burned before she sailed.

### 3. THE CLIPPER ERA

Lauchlan McKay, in addition to building ships, was one of the supreme shipmasters of his time. He was in command of the *Sovereign of the Seas*, the longest and sharpest-ended vessel then built, and went out to San Francisco making a record voyage. Off the coast of Chile the vessel was dismasted in a storm, but Lauchlan McKay rerigged her at sea and kept her going. Having delivered a cargo of gold miners, Lauchlan McKay put in at Honolulu, took aboard a cargo of 8,000 barrels of whale oil and some bone, and sailed for home again. On this passage, too, the ship sprang a fore-topmast, which McKay repaired at sea, and she eventually arrived at Sandy Hook in eighty-two days out from Honolulu.

On this trip the *Sovereign* sailed 5,391 nautical miles in twenty-two days. In 1853 the *Sovereign* sailed from New York to Liverpool, crossing from pier to anchorage in thirteen days, twenty-two hours. The next ship under Lauchlan McKay's command was his brother's greatest vessel, the *Great Republic*, which never went to sea: The ship burned and sank in the harbor when they were making ready to sail to Liverpool.

Captain Lauchlan McKay went as builder's repre-

sentative aboard the *Lightning* on her maiden voyage from Boston to Liverpool in 1854, when she made a day's run of 436 nautical miles. Lauchlan McKay was also the skipper of the English clippers sent on the Australia run. At the end of the clipper era, he returned to shipbuilding in Canada, where his firm launched twenty-nine vessels of all classes.

The clipper era passed, but Americans had finally learned to build ships according to scientific principles, and this was the era's great achievement.

A former master of a clipper ship, when asked if the clippers were really superior to other vessels, replied that a clipper was never still. The ships "ghosted" along in the lightest airs. Certainly a great part of the clipper's performance was due to the masterly handling by skippers out to make records by driving their crews to the limit. Very few Americans sailed before the mast on the clippers, because by that time the wages paid by American shippers were so low and life at sea so hard that the American seaman, who had been such a source of pride to America in the early years of the century, would no longer have any part of the sea. The clipper crews were generally tough derelicts, packet-rats, or shanghai'd foreigners who were made to work for the pitifully small salaries offered by American shippers. As lovely as the ships were, Americans knew that the

FIGURE 39  
CLIPPER SHIP



An 18th-century iron forge, by the English artist, Richard Earlom



Coal mining was begun in earnest during the 1840's to feed America's burgeoning smelters and steel mills.



Before then, charcoal was preferred as fuel for the manufacture of iron and steel, but coke made better steel.



The Nashua (N. H.) Iron Company produced forged iron for machine shops, ships, and railroads. Their "perfect

machinery enables them to produce Locomotive Tyres so accurately as not to require any turning or boring."

**FIGURE 40**  
**STEEL & MINING**

FORGE, PAN, AND DERRICK: OIL

Pennsylvania. Unfortunately he was a few miles away from the region that was later to be known as "Oil County" and lost twenty thousand dollars digging worthless holes.

What Ferris was doing in New York. Samuel M. Kier was doing in Pittsburgh. He had discovered oil coming up from one of his salt wells on the Allegheny River in 1849. He sent a sample to Professor Booth of the University of Pennsylvania, who told him that the oil seemed to be largely composed of naphtha which ought to make a good solvent for gutta percha. The gutta percha manufacturers were not interested, so Professor Booth then advised Kier to refine his oil and get a suitable lamp designed. Having paid for advice, Kier had the good sense to follow it. From 1850 on, he was able to sell all the oil he could get from his own salt works.

Ferris' example suggested to George H. Bissell and Jonathan G. Eveleth of New York the novel idea of drilling directly for oil instead of using the by-product from salt wells. The same derrick that stood over every salt well could be used for oil. Even the drilling process ought to be the same. They took in as partner and field superintendent, Colonel E. L. Drake.

In May, 1858, Drake went to Titusville on Oil Creek, selected a site, and began to drill. He struck water in such volume that his workers were flooded. Drake's ingenuity saved the situation. On the spot he invented the modern method of driving iron pipe, one length after another, down into the hole, keeping out the water, the quicksand, and the clay. He struck oil in small quantities, but the ferocious mountain winter set in and stopped operations. The following year Drake started over again and went to Kier for advice.

Kier suggested Uncle Billy Smith as the man to drill deep salt wells. Uncle Billy and his sons began work towards the end of May, 1859. Using Drake's method of sinking pipe, they continued drilling and by August had gone almost seventy feet through rock. On the twenty-eighth, they were about to stop for the night, when the pipe began to fill.

"Look at this," Uncle Billy said to Colonel Drake. "What is it?" Drake asked.

"It's your fortune coming!" said Uncle Billy.

The next day, Drake installed a spring pump and eight barrels were pumped into old fish cans and any other receptacles that were at hand. Within two months the well was yielding twenty-two barrels a day.

The news of the strike spread as rapidly as the word of gold had spread from California. The word *kerosene* which had been a trade name for a different substance, was popularly applied to petroleum. Everyone began drilling everywhere, and most of them found oil. Within two years strikes ran to two thousand barrels a day.



Drake started drilling for oil in May, 1858. His men struck water in such volume that they were flooded.



The derrick used in the drilling of oil wells, such as Drake's, was exactly the same as had previously been used for brine

FIGURE 41

OIL

CONFEDERATE SUBMARINES

Fort Sumter. but the submarine was caught in the hole its torpedo tore apart and sank with its victim.

Still a fourth Confederate experiment was a semi-submersible—operated by a steam engine. The *David* could submerge until its deck was hidden, and all that then protruded above water was the hatchway and a small smokestack. It was really a fast little launch with a long spar like a bowsprit on which was mounted an explosive charge. The tactic was to ram the torpedo against the enemy's hull, then backwater and escape if possible.

The Federal Navy, too, had a torpedo boat which, in 1864, sank the *Albatross*. The Federal torpedo boat was a steam launch that depended on its speed and maneuverability to evade enemy fire. After the war and for a considerable period longer, it was assumed that submarines were unusable and, in the future, the torpedo bearer would be a light, fast, expendable boat. Fifteen years after the close of the war the *United States Naval Encyclopedia* said, under the section on torpedo boats:

"As submarine boats have apparently been given up, it is probable that for harbor defense there is nothing cheaper and surer than light boats with the spar torpedo. These would also be useful at sea if carried by large vessels and lowered in action.

"For coast defense, torpedo rams . . . would seem to be best. When torpedoes can be discharged from guns or tubes under water, torpedo ships for cruising upon the high seas will doubtless come into favor."

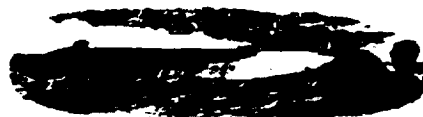

De Villeroz's submarine was being built according to plans made by Fulton. It was seized by the Federal forces in 1861 and was never brought to completion.

Cross section of the *Hunley* (below) was drawn during the war by a Northern artist who was inspired by exaggerated reports of the submarine menace. He correctly showed that the driving mechanism was hand-operated, though there is no connection between the crank and the propeller—a fact which does not seem to bother any of those concerned. The original of this charming drawing is over six feet long and is brilliantly colored. It is in the Submarine Library of the Electric Boat Company, in New London, Connecticut.

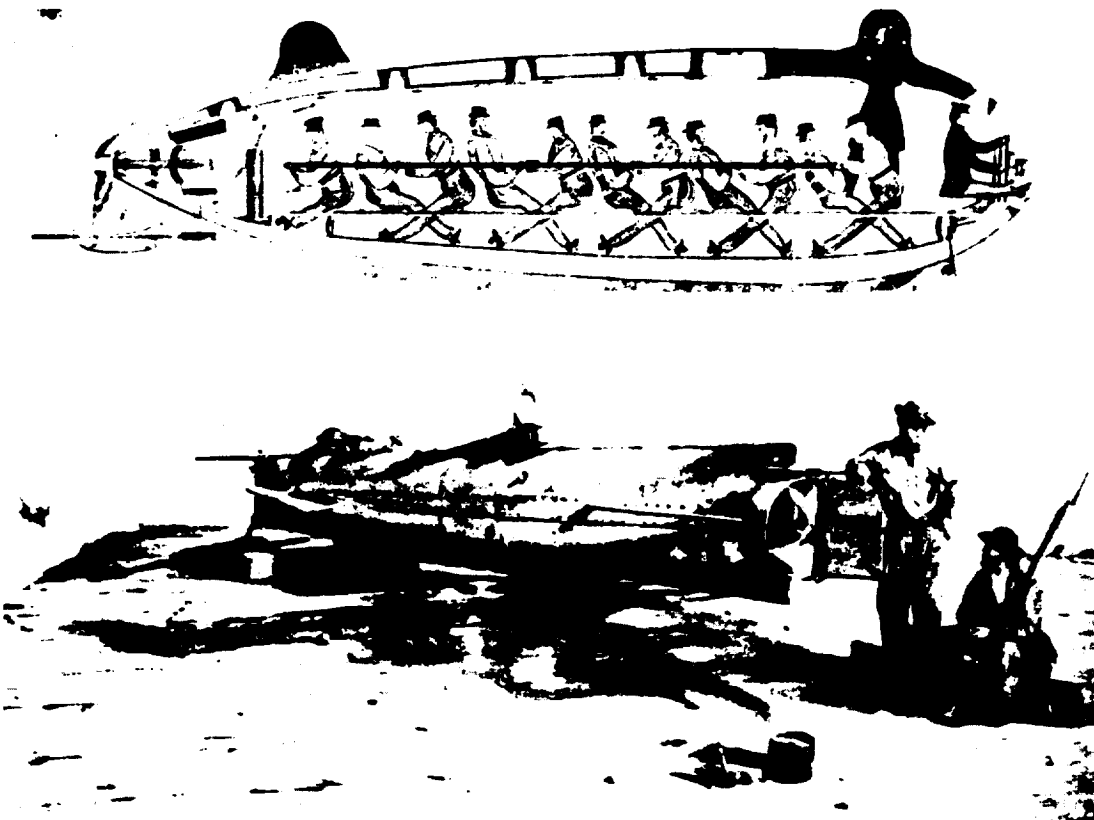

The *Hunley* killed more Confederate volunteers than Union sailors. She sank four times during trials and was

destroyed along with the only ship she attacked. She was built of sheet iron and the propeller was hand-driven.

FIGURE 42  
SUBMARINE

how this could be done with so many ideas and inventions. Figure 43 shows the natural development which could handle most of these problems. This was the development of the machine tool business. Now the people could get multiple production. Then came quality control where one worn out item could be replaced. Next grew one of the greatest forms of American ingenuity, the tool and die business. This was both an art and a science and remains so to this day. This tool business started about 1840 and saw great development in the next twenty years. All of these references and pictures came from Reference 65, Mitchell A. Wilson, Science and Invention: A Pictorial History (New York: Simon and Shuster, 1960). It would be well for every engineer interested in invention and scientific research to read this book and note the consistent patterns of thought that have always existed in this type of work.

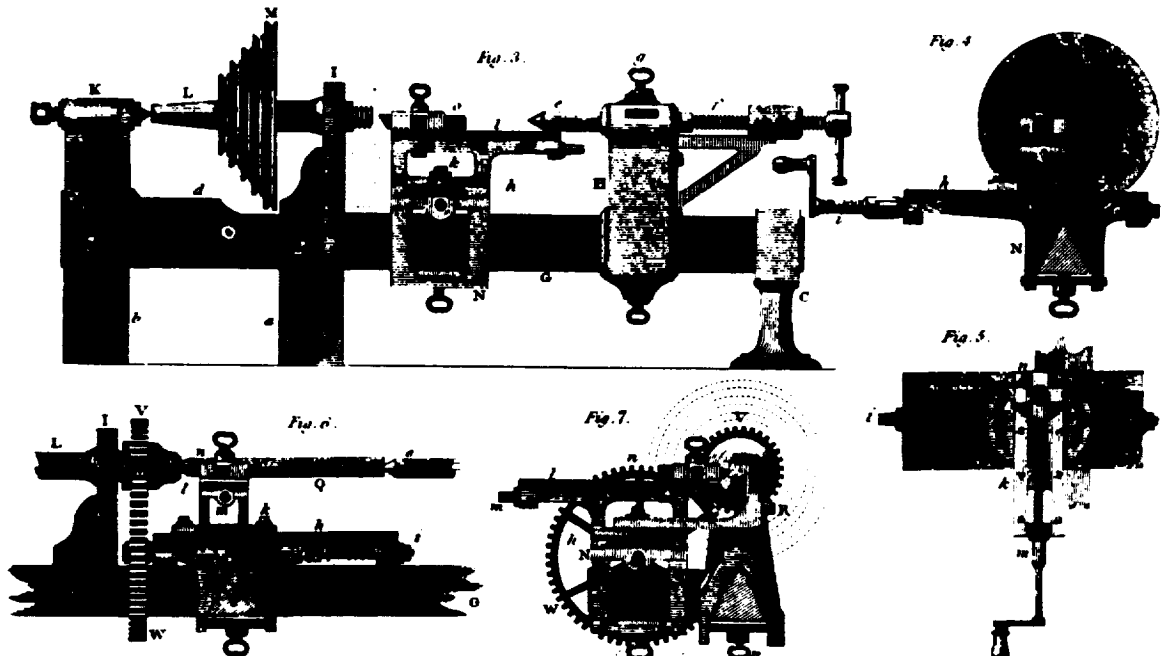

Maudslay's lathe was the prototype of all later forms. David Wilkinson, of Pawtucket, R. I., also designed a slide-rest, with less success.

### 3. THE LATHE, THE PLANER AND THE MILLING MACHINE

The steam engine revealed the need for metal shaping machinery of greater delicacy than the hammer, chisel, and file. The need was met by an English inventor whose stature in his own field was as great as Watt's in steam. This machine designer, Henry Maudslay, was truly an artist. His nearest American counterpart was his contemporary, David Wilkinson of Pawtucket, Rhode Island. Maudslay and Wilkinson attacked the same basic problem—from different levels of skill, with different national resources to draw on, and for very different purposes.

The potter's wheel was a flat circular platform that rotated at a fairly uniform speed. On the rotating surface, a mound of soft clay could be shaped by the potter's hands into a symmetrical shape. If he held his fingers tightly against the clay, a certain amount of clay would be removed evenly all around as the wheel turned. The ancients shaped wooden poles in somewhat the same way. The driving wheel was turned on its side, and rotated a wooden bar. The wood worker, holding a chisel in his hands, placed the edge against the spinning surface. The circular cut made was dependent on the firmness of his grip.

No machinist's hand was steady enough or strong enough to hold a scraping tool against a turning piece of iron for more than a few minutes at a time. Nor could he maintain a constant pressure. Yet the Industrial Revolution was impossible until a way could be found to hold a cutting tool against metal so that machines of iron could be built. The solution to this problem was one of the greatest inventions of the nineteenth century.

Describing the principle of Maudslay's invention, his disciple, James Nasmyth, wrote in 1841: "Up to within the past thirty years, nearly every part of a machine had to be made and finished to its required form by mere manual labor . . . Then a sudden demand for machinery of unwonted accuracy arose . . . and but for the introduction of the principle which I am about to describe, we could never have attained to one-thousandth part of the bright object . . . which has since been so wonderfully realized.

"The principle to which I allude consists of a *substitution of a mechanical contrivance in place of the human hand* for holding, applying, and directing the motions of a cutting tool . . ."

This contrivance was called the slide-rest. It was a moving metal carriage, in which a cutting tool was rigidly clamped. This tool holder was clamped to the lathe and, by means of accurately threaded screws, could be made to move both along the length of the

FIGURE 43  
MACHINE TOOLS

## 12.0 BASIC RESEARCH

Review Figure 31. In all of these basic problems, whether they be design, invention, or basic research, it should be noted that they follow the system of retrodution as illustrated in Figure 31. Something is sought - a shop in the basement, a beam in a house, an isolator, or a study in the vibration of bolts. First something is sought. Then dialectic questions are asked listed as (1), (2), etc. Then temporary answers are given for each question. The questions are based on the material cause, the formal cause, and the efficient cause of the problem. After all of the questions are asked and the questions that can be answered are answered, the designer or inventor then abstracts from all of the questions and answers the essential notes. He eliminates the questions that do not have to be answered immediately. Then he puts an order to the way the questions are to be answered. In long inventions and basic research, the solution is taken in steps. These are plateaus along the way on which particular answers or ballpark can be reached to help lead the designer or inventor to his final answer. The pioneer invention was a good example of the step by step solution.

Basic research follows the same pattern with one exception. In basic research the principles that the solution must follow will not all be known. In vibration isolation the principles were well-known but such is not the case in the problem to follow.

### 12.1 JOHN JACOB ASTOR STARTS A BUSINESS IN NEW YORK

The basic research is set in 1850 when John Jacob Astor wanted to go into business in New York. The question was what business should he go into and why. He had been quite successful in the fur trading business out west but he saw that the future in business for that time was in New York. So he went to New York to go into business. He first of all had to set up principles to follow. He didn't know what those principles should be so he set up a system of retrodution to find those principles. The thinking is shown in Figure 44.

The first question was: "Shall I invest my own money?" He had a temporary answer. He could mortgage the house or he could take on a full-time job while starting his own business.

He had to ask himself the first principle of all business. He knew from the fur business that it was the profits and not sales that made a business. If the profits do not go along with the sales, when a slight slump comes along, the man in business starts to go into the hole. It is necessary to have profits to compensate for the death or loss of a key employee. Furthermore, he could use the profits to improve his product and come up with improvement patents.

**PRINCIPLES FOR STARTING A NEW BUSINESS**

**NEW YORK CITY, 1850**

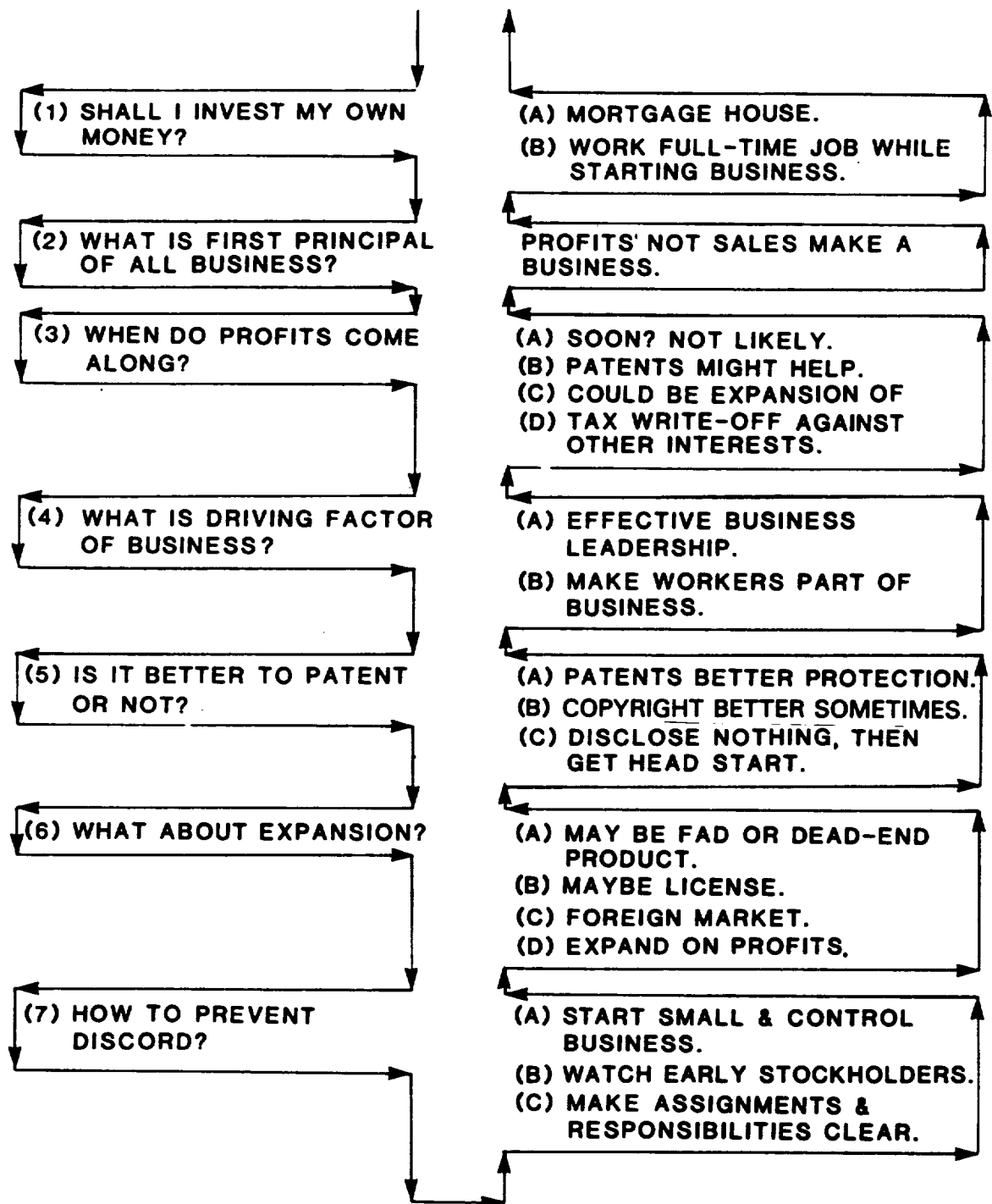

**FIGURE 44**

**STARTING A NEW BUSINESS**



He knew that he had to set the time scale so that he could know when he needed so much cash and when he had to expand, etc. He had temporary answers: patents might help, could be an expansion of another business such as his trapping business, or may tie in with another company that could write off his early losses against taxes.

He had to get leaders early in the game and he had to know what to look for; he asked what are the driving factors in business. The first answer is effective business leadership. The second answer is to make the workers part of the business. It could be a stock plan or bonus plan.

The question of patents comes up and he had to be able to answer this decision early. The answers are that good patents with a good patent lawyer give good protection. In some cases it could be better to copyright rather than patent. It depends upon the type of invention and the time the patent or copyright is expected to be effective. He could do what many chemical plants do. He could keep his new work a secret and get a head start in the field.

The next question is about expansion. This should be thought about early in the business. He had to be ready for it when the decision came along and he wanted principles to follow. He knew that his product could be a fad or a dead-end product. Maybe he could license his rights in whole or in part to someone else already in the business and concentrate his efforts going after another product or a byproduct of the current invention. He should think of the foreign market early. Astor was in the foreign market by selling most of his furs overseas, and he knew that the only sensible way to expand is on profits.

His last question is how to prevent discord. These problems should be considered before he gets going. Some of the rules are as follows. Start small and control the business. Watch the early stockholders. Some stockholders are buying stock with the assumption that the business will expand fast and the value of their stock will rise right away. If it does not expand as fast as they expect, they will dump their stock and this could hurt the reputation of a new company. The last principle is to make assignments and responsibilities clear. Early in the business if things go slowly, some of the workers may go over the manager's head to the stockholders and cause a split in the company stability. The control of the business must be made clear right from the beginning.

Figure 45 shows the result of abstraction from all of the questions and the temporary answers of Figure 44, the essential notes. Some of these principles include:

- (1) Business should be small at first.
- (2) Business should expand on profits.
- (3) Try new patents - which was a good rule about 1850.

**THE PRINCIPLES ESTABLISHED FROM PREVIOUS  
ANALYSIS & SYNTHESIS**

- (1) BUSINESS SHOULD BE SMALL AT FIRST IN ORDER TO CONTROL IT EFFICIENTLY. NOT TO BORROW AT FIRST AS INTEREST COULD KILL YOUNG BUSINESS.
- (2) BUSINESS SHOULD EXPAND ON ITS OWN PROFITS.
- (3) TRY NEW PATENTS, DON'T COMPETE WITH EXISTING BUSINESS.
- (4) NO POLITICAL ENTANGLEMENTS TO START OUT. POLITICAL FAVORS HARD TO PAY OFF.
- (5) MARKET STUDY NECESSARY BY OWNER OR CONTRACTED OUT.
- (6) WORKERS SHOULD BE GIVEN A SHARE OF THE BUSINESS.
- (7) START OUT BY WORKING FULL TIME AND STARTING BUSINESS ON THE SIDE.
- (8) SHOULDN'T TRY TO EXPAND TOO FAST. CONTROL ADVERTISING.
- (9) TRY TO GET ORDERS SO THAT TOOLING AND OVERHEAD CAN BE MET WITHOUT BORROWING.
- (10) AVOID SALE OF COMMON STOCK AS CONTROL IS LOST THIS WAY.
- (11) GET ENDORSEMENTS FROM RESPONSIBLE TECHNICAL ORGANIZATIONS.
- (12) TAXES SHOULD BE STUDIED CAREFULLY. LOOK FOR TAX SHELTERS.

**NEXT, A NEW ANALYSIS AND SYNTHESIS IS NECESSARY WITH DIALECTIC QUESTIONS TO FIND THE EXACT TYPE OF BUSINESS THAT SHOULD BE ATTEMPTED.**

**FIGURE 45  
PRINCIPLES**

- (4) Stay out of politics in the beginning as it could work against the business with a change of administration.
- (5) Before a product is picked, a market study should be performed.
- (6) Workers should be made part of the business.
- (7) He could work part-time at another job while the business is getting started.
- (8) He should not try to expand too fast. He could lose control of the organization that way.
- (9) Get orders so that tooling can be paid for without borrowing.
- (10) Keep a close eye on the common stock to control the business.
- (11) If the product is a technical product, it is important to get endorsements from responsible technical organizations.
- (12) Keep a close eye on taxes and assessments.

Now that the principles were established, he had to decide what particular business he wanted to go into. This is outlined in Figure 46. In 1850 he saw the possibilities of the ice business, food business, clothing business, a general delivery store, stables, and undertaking.

He now must take the principles that he has set and apply them to each type of business that he wants to go into.

- (1) **THE ICE BUSINESS.** He could have to get a lot of equipment to start out. He would also run into some heavy competition right from the beginning.
- (2) **FOOD BUSINESS - DISTRIBUTORS.** There are many distributors already set up. He needs a good reputation and this would also take time. The initial outlay for real estate and equipment is high. It takes time to build personnel who are reliable and skilled.
- (3) **CLOTHING BUSINESS.** It could be started with a small outlay at first. He would need little room and not too many employees to start. There are many possibilities at first in men's clothes, women's clothes, and children's clothes.
- (4) **GENERAL DELIVERY STORE.** It is expensive to start because he has to stock a complete store from many sources. It is expensive and time-consuming to meet the right distributors in the business. It takes experience from the top down to make a profit as there is skill needed in every product sold.
- (5) **STABLES.** The original cost is moderate. However, he needs a lot of real estate. This business particularly needs good political connections to get started.

## WHAT BUSINESS? - 1850 - NEW YORK CITY

### CONSIDER PREVIOUS PRINCIPLES

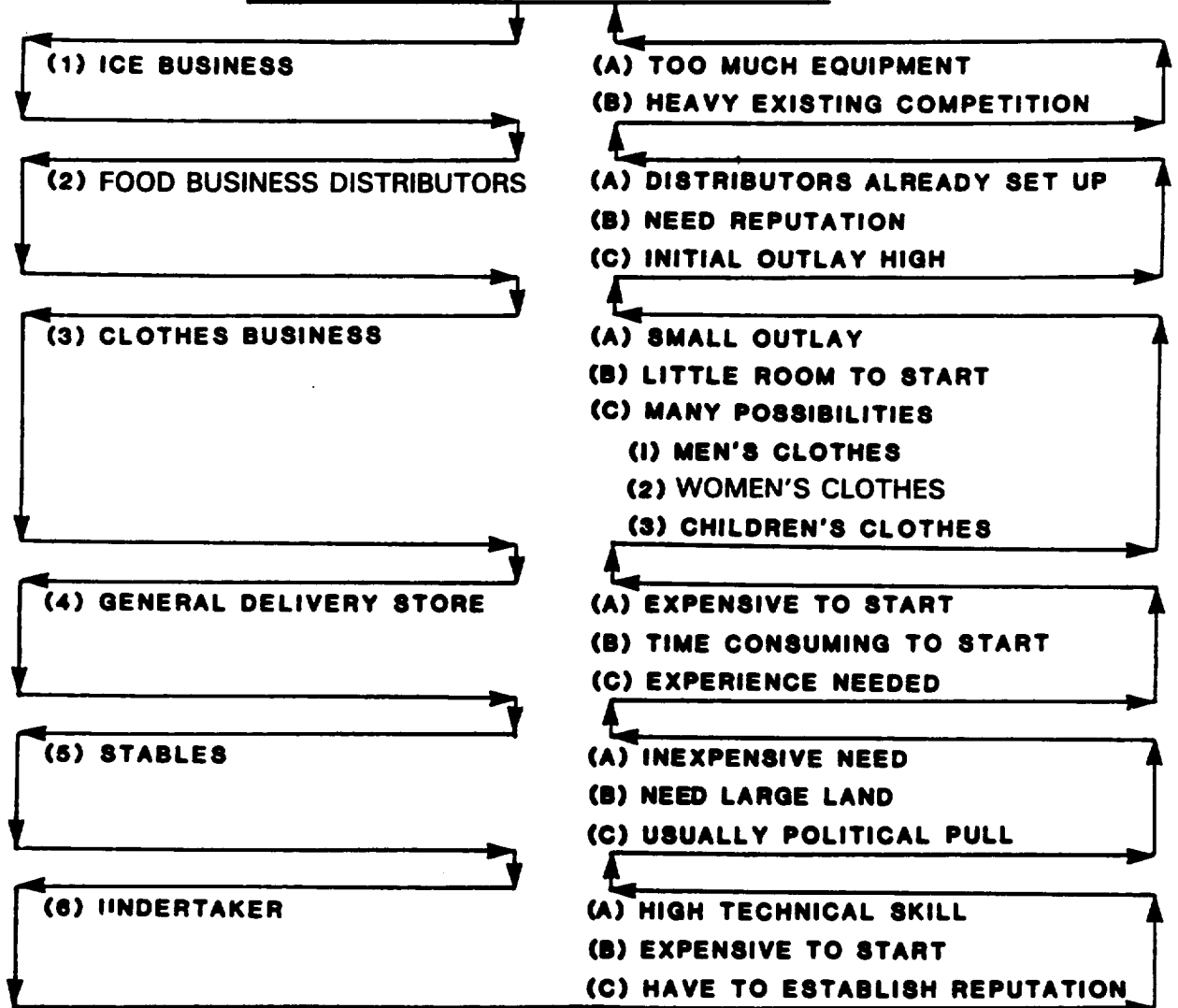

ABSTRACT FROM ALL OF THE QUESTIONS AND ANSWERS THE PROPER BUSINESS TO START CONSIDERING THE ESTABLISHED PRINCIPLES JOHN JACOB ASTOR DECIDED THAT WOMEN'S CLOTHES WOULD BE BEST. THE NEXT DECISION WOULD BE WHAT TYPE OF WOMEN'S CLOTHES?

**FIGURE 46**  
**BUSINESS OPPORTUNITIES**

- (6) **UNDERTAKING.** This business, above all others, needs good technical skills to get started. He would have to take somebody in the business with him for this skill. He needs a lot of expensive equipment that would have to be charged to overhead. Many other businesses need the money for goods which could be sold. Undertakers need a reputation to get the business. Starting out is tough.

The businesses that Astor would consider are analyzed with temporary answers given for each business. He is now ready to abstract a path to take from this analysis. He goes back to the original principles of Figure 45 and it becomes obvious to him that the business to go into would be the clothing business. More than any other business, it follows the essential notes. Thus he decided to go into the clothing business. The next decision he had to make was the kind of clothing business. Study Figure 47.

He noticed that women followed a certain pattern when buying their clothes. They were very conscious of style. They wanted to be up-to-date with all their clothes. So Astor sat in Grand Central Park and observed the sales of all types of women's clothes. He had his principles reduced to the following seven items: (1) good profit, (2) heavy sales, (3) what brings customers back?, (4) initial outlay low, (5) how to be informed, (6) getting a good store position, and (7) what about style?

- (1) **GOOD PROFITS.** It is equally divided between dresses, hats, and shoes.
- (2) **HEAVY SALES.** Dresses and hats lead the list. Shoes were covered in many cases and fashion was not important.
- (3) **WHAT KEEPS BRINGING CUSTOMERS BACK?** To head the list is style. Next comes the store position in New York. Fashion stores were usually in a certain part of the city. Next is the fact that stylish ladies buy in certain shops. They attract other ladies. Then as well as now, advertising has a great deal to do with the sales.
- (4) **INITIAL OUTLAY LOW.** This is true for hats and shoes, particularly hats where there is no necessity to have a large variety to start.
- (5) **HOW TO BE INFORMED.** In those days marketing surveys were not made. Astor himself ran his own marketing study and informed himself about what sold best. He did it with personal observation and he read the ads in the papers.
- (6) **GETTING A GOOD STORE POSITION.** Hats take little room to start. Shoes would probably take a little more and dresses would take up a lot of room, particularly large, full skirts.

NEW GOAL — SELL WOMEN'S CLOTHES

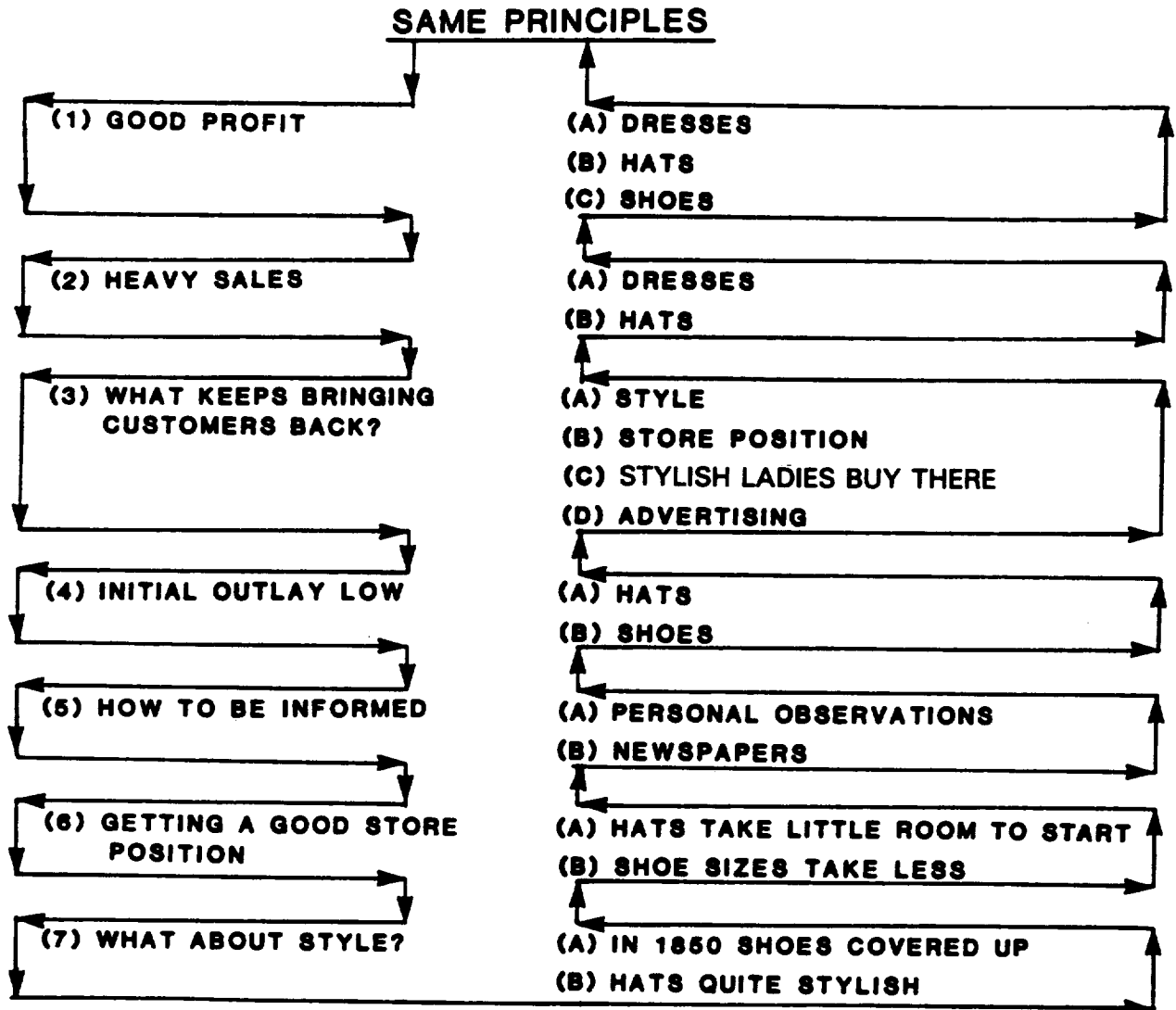

ASTOR MADE THESE OBSERVATIONS AND STARTED IN HAT BUSINESS.

FIGURE 47  
HAT BUSINESS

- (7) WHAT ABOUT STYLE? Shoes were out because they were hidden. Hats and dresses were about even except dresses had a wider variety of styling and demanded more room.

Abstracting all of these variables led Astor to the conclusion that he should be selling women's hats.

## 12.2 RETRODUCTION DEMONSTRATES THE DEVELOPMENT OF PRINCIPLES AS WELL AS CAUSES

In review, the typical form of retroduction was used, except the principles had to be established first. The conclusion was not reached with one jump, however. Certain ballparks were reached first. From ballparks the principles were reached, the business area established, and finally the particular business established from the previous ballparks. Not only was the business picked out but the principles for running the business were established. In this research there were three steps. In some businesses there are many steps along the way as first one path is chosen and that path leads to another. In the end, a final conclusion of where to go into business is made.





### 13.0 REFERENCES

1. Elsa Walsh. "Pupils Taught to Review Thought Process." The Washington Post. August 20, 1981.
2. Elsa Walsh. "Education's '3 Rs' Become Four; Schools Put Stress on Reasoning." The Washington Post. August 20, 1981.
3. Richard W. Samson. "Entering the Mind-Work Age: Will You Be Ready?" The Washington Post. October 1985.
4. "The 'Innovation Recession'" Time. October 2, 1978.
5. Andrew W. Young. Functions of the Right Cerebral Hemisphere. New York: Academic Press, 1983.
6. "Are You Creative?" Business Week. September 30, 1985.
7. Joseph Peter Longo, Jr. "Holistic Thinking (Modal Boundary)." Defense Intelligence College, 1984.
8. Louis B. Lundborg. "Creativity by Seminar?" Industry Week. November 10, 1980.
9. D. Galin and R. Ornstein. "Lateral Specialization of Cognitive Mode: An EEG Study." Psychophysiology. 1972.
10. James Rimualdi. "The Creativity - Intelligence Distinction and Its Significance to Professional Education." Class Notes, 1983.
11. Lars Solerholm. "Engineers' Return on Investment." Design News. January 26, 1976.
12. Carol Innerst. "Corporate Programs Indict U.S. Educational System." The Washington Times. January 29, 1985.
13. James F. Lardner. "Why U.S. Manufacturers Miss Out on New Technology." Industry Week. August 23, 1982.
14. Geoffrey C. Ward. "Making Thinking Your Business." Science Digest. September 1982.
15. Thomas Love. "Revival of 'Yankee Ingenuity' Called Answer to U.S. Woes." The Washington Star. June 10, 1979.
16. John H. Douglas. "The Genius of Everyman." Science News. April 23, 1977, and April 30, 1977.
17. Keith B. Richburg. "College Graduates Depicted as Uncreative, Too Indebted." The Washington Post. September 17, 1985.

18. Patrick Young. "Foreigners Outpacing Americans in Number of U.S. Patents Issued." The Washington Times. August 6, 1984.
19. Michael A. Wallach. "Tests Tell Us Little About Talent." American Scientist. January/February 1986.
20. James E. Stice. "Grades and Test Scores: Do They Predict Adult Achievement?" Engineering Education. February 1979.
21. Robert J. Sternberg and Janet E. Davidson. "The Mind of the Puzzler." Psychology Today. June 1982.
22. James J. Kerley. "Creative Inventive Design and Research." Class notes of course at Goddard Space Flight Center (part 1).
- 23a. Linda Garmon. "Of Hemispheres, Handedness and More." Psychology Today. November 1985.
- 23b. Doreen Kimura. "Male Brain, Female Brain: The Hidden Difference." Psychology Today. November 1985.
24. Maya Pines. "Baby, You're Incredible." Psychology Today. February 1982.
25. James P. Rimualdi. "The Teaching of Creative Engineering Design." CIT Engineering News, 1983.
26. Howard Gardner. "The Music of the Hemispheres." Psychology Today. June 1982.
27. Frederick Herzberg. "Group Dynamics at the Roundtable." Industry Week. November 16, 1981.
28. Thomas Aquinas. "Summa Contra Gentiles." London: Burns & Oates, 1905.
29. James J. Kerley. "New Structured Approach to Invention, Research and Management." Engineering Colloquium. February 18, 1986.
30. Carol Innerst. "Visual, Spatial Skills Fall 'Alarmingly' in Students." The Washington Times. July 23, 1985.
31. James Kerley. "Employee Suggestion Program." January 21, 1985.
32. Howard Gardner. "The Mind's New Science: A History of the Cognitive Revolution." The Washington Times. November 5, 1985.
33. R. L. Eshleman. "Mathematics in Engineering Education." The Shock and Vibration Digest. November 1981.

34. Paul Gray. "Where Are the Edisons? They Are an Endangered Species, Warns M.I.T.'s Paul Gray." People. March 31, 1980.
35. "The 'Innovation Recession'." Time. October 2, 1978.
36. Bob Kelly. "Shackled Creativity." Assembly Engineering. August 1978.
37. James Rimualdi. "The Teaching of Creative Engineering Design." Class Notes.
38. David C. McClelland. "Testing for Competence Rather than for 'Intelligence'." Princeton: Educational Testing Service, 1971.
39. Allen L. Hammond. "The Other American Revolutions." Science. February 1985.
40. Henry Mintzberg. "Planning on the Left Side and Managing on the Right." Harvard Business Review. July-August 1976.
41. Andrea Croce. "The Human Power to Find Meaning." The Natural Process Of Thinking. I.O. Digital, 1984.
42. Irene Peden. "Education May Suppress Creativity, Imagination." University of Washington, 1983.
43. Anthony Birch. "Greeks, (Inductive, Deductive) FOUR CAUSES Efficient, Material, Formal and Final." Educational Chart, 1986. Unpublished.
44. Fred Landis. "Let's Improve the Learning of Mechanical Engineering." Mechanical Engineering. October 1984.
45. Bob Kelly. "Shackled Creativity." Assembly Engineering. August 1978.
46. James J. Kerley. "Philosophy of Engineering Design." 1982. Unpublished.
47. Jeff Meer. "Learning by Design." Psychology Today. May 1984.
48. Thomas Aquinas. Summa Theologica. New York: Benziger Brothers, Inc., 1920.
49. Morris Bailey. "Why Is U.S. Technology Lagging?" The Washington Star. December 2, 1979.
50. Roy Dreistadt. "Want to Invent Something? Then Try Using Analogy." Science Digest. May 1970.

51. Lars Soderholm. "Building on the Ideas of Others." Design News. August 21, 1978.
52. Lars Soderholm. "Readers Claim Management Hampers Design Efforts." Design News. November 21, 1977.
53. Robert C. Haavind. "Top Priority for the U.S.: Revive Innovation." High Technology. June 1980.
54. C. W. Nelson and G. E. Zinsmeister. "Putting Engineering Education to Work." Mechanical Engineering. October 1981.
55. Ezra Bowen. "Education Schooling for Survival." Time. February 11, 1985.
56. George Polya. How to Solve It. Princeton: Princeton University Press, 1945.
57. Eugene Raudsepp. How Creative Are You? Perigee, 1981.
58. Roger Von Oech. A Whack on the Side of the Head. Menlo Park, California: Creative Think, 1983.
59. Gordon L. Glegg. The Design of Design. Cambridge: Cambridge University Press, 1969.
60. Andrew W. Young. Functions of the Right Cerebral Hemisphere. London: Academic Press, 1983.
61. William A. Wallace. From a Realist Point of View. Lanham: University Press of America, 1983.
62. A. Croce. A Logic of Scientific Discovery Based on Aristotelian Dialectic. An Arbor: University Microfilms International, 1983.
63. Bernard S. J. Wuellner. Summary of Scholastic Principles. Chicago: Loyola University Press, 1956.
64. A. D. Moore. Invention Discovery and Creativity. Garden City, N.Y.: Anchor Books, 1969.
65. Mitchell A. Wilson. Science and Invention a Pictorial History. New York: Simon and Schuster, 1960.
66. James J. Kerley. Technical Notes on Cable Isolation. Washington, D.C., 1960.
67. Artificial Intelligence, Expert Systems in Manufacturing. Wheaton, Illinois: Hitchcock Publishing Co.
68. James J. Kerley. Logic.

69. James J. Kerley. Logic Solutions.
70. Samm S. Baker. "S-T-R-E-T-C-H Your Mental Muscles." Science Digest. 1970.
71. Alex F. Osborn. Applied Imagination. New York: Charles Scribner's Sons, 1963.
72. Peter W. Kingsford. Engineers, Inventors and Workers. New York: St. Martin's Press, 1964.
73. The Way Things Work. New York: Simon and Schuster, 1967.
74. Matousek. Engineering Design: A Systematic Approach. New York: John Wiley & Sons, Inc., 1957.
75. R. J. Barra. Geo-Metric Vibration Analysis. Baltimore: RMS Publishing Co., 1977.
76. John R. M. Alger and Carl V. Hays. Creative Synthesis in Design. Englewood Cliffs, New Jersey: Prentice-Hall Inc., 1964.
77. Caroline Sutton. How Do They Do That? New York: Hilltown Press Inc., 1967.
78. Sid J. Segalowitz. Two Sides of the Brain. Englewood Cliffs, New Jersey: Prentice-Hall Inc., 1983.
79. Arthur B. Van Gundy. Training Your Creative Mind. Englewood Cliffs, New Jersey: Prentice-Hall Inc., 1982.
80. Roger Von Oech. A Kick in the Seat of the Pants. New York: Harper and Row, 1986.
81. Wallace. "Nature as Animating: The Soul in the Human Sciences." The Thomist. October 4, 1985.
82. Michael Fidlow. How to Strengthen Your Memory. New York: Gramercy Publishing Co., 1961.
83. S. J. Lindsworsky. The Training of the Wall. Milwaukee: Bruce Publishing Co., 1929.
84. Frances A. Yates. The Art of Memory. Chicago: University of Chicago Press, 1966.
85. Ian M. L. Hunter. Memory. Baltimore: Penguin Books Ltd., 1957.

86. Thomas S. Kuhn. The Structure of Scientific Revolutions. Chicago: University of Chicago Press, 1970.
87. Robert Edward Brennan. Thomistic Psychology. New York: MacMillan Co., 1960.
88. Richard M. Weaver. "Ideas Have Consequences." Chicago: University of Chicago Press, 1948.
89. Alex Osborn. Your Creative Power. New York: Charles Scribner's Sons, 1954.
90. Robert Edward Brennan. History of Psychology. New York: MacMillan Co., 1945.
91. Vincent Edward Smith. The Science of Nature: An Introduction. Milwaukee: Bruce Publishing Co., 1965.
92. Vincent Edward Smith. Science and Philosophy. Milwaukee: Bruce Publishing Co., 1955.
93. Opan Moore. Why Johnny Can't Learn. Milford, Michigan: MM Mott Media, 1975.
94. Mortimer J. Adler. Aristotle For Everybody. New York: MacMillan Publishing Co., 1978.
95. Arthur Danto and Sidney Morgenbesser. Philosophy Of Science. Cleveland: World Publishing Co., 1960.
96. Robert Thomason. The Psychology of Thinking. Middlesex: Penguin Books Ltd., 1966.
97. P. R. Whitfield. Creativity in Industry. Middlesex: Penguin Books Ltd., 1975.
98. W. I. B. Beveridge. The Art of Scientific Investigation. New York: Vintage Books, 1950.
99. Vincent Edward Smith. Science and Philosophy. Milwaukee: Bruce Publishing Co., 1965.
100. Pierre Duhem. The Aim and Structure of Physical Theory. Princeton: Princeton University Press, 1962.
101. John R. M. Alger and Carl V. Hays. Creative Synthesis in Design. Englewood Cliffs, New Jersey: Prentice-Hall Inc., 1964.
102. Robert Lay Hallock. Inventing for Fun and Profit. New York: Harmony Books, 1978.

103. Guy S. Metraux and Francois Crouzet. The Evolution of Science. New York: Mentor Books, 1963.
104. M. A. Caldin. The Power And Limits of Science. London: Chapman & Hall Ltd., 1949.
105. Raymond F. Yates. Yates' Guide to Successful Inventing. New York: Funk & Wagnalls, 1949.
106. Melvin Powers and Robert S. Starrett. A Practical Guide to Better Concentration. Hollywood: Wilshire Book Co., 1962.
107. Edward B. Shlesinger, Jr. The Art of Successful Inventing. Washington, D.C.: Kelly, Hafner Associates, Inc., 1973.
108. Ronald W. Clark. The Scientific Breakthrough. New York: G.P. Putnam's Sons, 1974.
109. Vincent E. Smith. The Logic of Science. New York: St. John's University Press, 1964.
110. Edel. Introduction to Creative Design. Englewood Cliffs, New Jersey: Prentice-Hall Inc., 1967.
111. O. P. Kane and William Humbert. The Dignity of Science. Washington, D.C.: Thomist Press, 1961.
112. Arthur D. Fearon. Concerning Knowledge How to Know Reality a Noetic Synthesis of Reality. San Francisco, 1964.
113. Joseph C. Keeley. Making Inventions Pay. New York: McGraw-Hill Book Co., 1950.
114. John R. Dixon. Design Engineering: Inventiveness, Analysis and Decision Making. New York: McGraw Hill Book Co., 1966.
115. R. W. Sperry. Lateral Specialization in the Surgically Separated Hemispheres. Neuro Science.
116. R. D. Nebes. Hemispheric Specialization in Commissurotomed Man. Psychological Bulletin, Vol. 81, No. 1, January 1974.
117. James J. Kerley. "The Natural Process of Thinking." Alexandria, Virginia: I.D. Digital.
118. Sergius Kayius. On Studying Singing. New York: Dover, 1960.
119. Opal Moore. Why Johnny Can't Learn. Milford, Michigan: MM Mott Media.
- 120a. Robert Thomson. The Psychology of Thinking. Penguin Books Ltd., 1966.

- 120b. Melvin Powers and Robert S. Starrett. A Practical Guide to Better Concentration. Wilshire Book Co., 1962.
121. Thomas K. Finley. Mental Dynamics. Englewood Cliffs, New Jersey: Prentice-Hall Inc.
122. Walter G. Oleksy. The Power of Concentration. Allen, Texas: Argus Communications.
123. Arthur D. Fearon. The Two Sciences of Psychology. San Francisco: Abbey Press, 1955.
124. William James. Talks to Teachers. New York: W. W. Norton & Co., Inc., 1958.
125. Harry Maddox. How to Study. Pan Books Ltd., 1965.
126. Anthony Standen. Science Is a Sacred Cow. E. P. Dutton & Co., Inc., 1950.
127. S. J. Kluberstanz. "The Philosophy of Human Nature." Class Notes.
128. S. J. Hull and R. Ernest. The Formation of Character. Herder Book Co.
129. Pierre, Conway, Principles of Education. Thomist Press.
130. Robert H. Thouless. Straight and Crooked Thinking. London: Pan Books Ltd., 1966.
131. James Kerley, Jr. "How Does the Computer Fit Into Drafting? Engineering Design? Engineering Research?" Robotic World. 1984.
132. Richard Bodkin. Logic for All. Chicago: Henry Regnery Co., 1955.
133. Arthur D. Fearon. How to Think - How to Analyze - Associate Memorize - Reason. San Francisco: Fearon Publishers, 1955.
134. Raymond J. McCall. Basic Logic. New York: Barnes & Noble Inc., 1963.
135. Kenneth Dougherty. Logic: An Introduction to Aristotelian Formal Logic. Peekskill, New York: Graymoor Press, 1956.
136. Daniel J. Sullivan. Fundamentals of Logic. New York: McGraw-Hill Book Co. Inc., 1963.



137. A. A. Luce. Teach Yourself Logic. London: English Universities Press Ltd., 1958.
138. Kurt Hanks. Motivating People. Allen, Texas: Argus Communications, 1982.
139. Philip Kaplan. Puzzle Me This. New York: Harper and Row, 1968.
140. H. E. Dudeney. Amusements in Mathematics. New York: Dover Publications Inc., 1958.
141. Julio A. Mira. Mathematical Teasers. Barnes & Noble Inc., 1970.
142. C. R. Wylie, Jr. 101 Puzzles in Thought and Logic. New York: Dover Publications, Inc., 1957.
143. Martin Gardner. More Mathematical Puzzles of Sam Lloyd. New York: Dover Publications, Inc., 1960.
144. James F. Fixx. Games for the Super-Intelligent. New York: Popular Library, 1972.
145. J. A. Hunter. Mathematical Brain-Teasers. New York: Dover Publications Inc., 1965.
146. Jerome S. Meyer. The Provocative Puzzler. New York: Scholastic Book Service, 1969.
147. Gerard Mosler. Can You Solve It? New York: Scholastic Book Service, 1965.
148. L. H. Longley-Cook. Fun With Brain Puzzlers. Greenwich, Connecticut: Fawcett Publications, Inc., 1965.
149. Jessica Davidson and William G. Martin. Mind-Boggling Brain Benders. Englewood Cliffs, New Jersey: Prentice-Hall, Inc., 1969.
150. Eric Doubleday. Test Your Wits. New York: Ace Books, 1969.
151. L. H. Longley-Cook. Work This One Out. Fawcett Publications, Inc., 1960.
152. Jack Luzzatto. Fun & Games with a Pencil. New York: Bantam Books Inc., 1968.
153. Teasers & Tests. New York: Funk and Wagnalls, 1968.
154. Gerald L. Kaufman. The Book of Modern Puzzles. New York: Dover Publications, Inc., 1954.

155. H. E. Dudeney. The Canterbury Puzzles. Dover Publications Inc., 1958.
156. Hubert Phillips. My Best Puzzles in Logic and Reasoning. New York: Dover Publications, Inc., 1960.
157. Sam Lloyd. Mathematical Puzzles of Sam Lloyd. New York: Dover Publications, Inc., 1959.
158. Jerome S. Meyer. Fun With Mathematics. Greenwich, Connecticut: Fawcett Publications, Inc., 1958.
159. Jerome S. Meyer. Puzzle Quiz and Stunt Fun. New York: Dover Publications, Inc., 1972.
160. Henry Ernest Dudeney. 536 Puzzles & Curious Problems. New York: Charles Scribner's Sons, 1967.
161. Ernest Hilgard, Rita Atkinson, and Richard Atkinson. Introduction to Psychology. New York: Hartcourt Brace & Jovanovich, 1979.

APPENDIX A

QUESTIONNAIRE ON INDUCTION AND DEDUCTION

TESTS - IN WHICH AREAS ARE YOU PRIMARILY INDUCTIVE OR DEDUCTIVE?

- (1) Do you have trouble visualizing three-dimensional figures from two-dimensional drawings or sketches?
  - (A) The ability to visualize three-dimensional figures from two-dimensional drawings is a function of induction. This does not mean that you are not inductive because you may have seldom tried to use this faculty. But if you have tried to use this function from time to time and failed, you are probably deductive in this particular talent.
- (2) Do you have trouble finding the essential parts of a design problem?
  - (A) This is one characteristic of an inductive thinker; he always sees the parts as part-of-the-whole. He trains himself to look for the whole all of the time. He then sees the essential parts of the design.
- (3) Do you sketch the parts before the assembly or the assembly before the parts?
  - (A) One characteristic of the inductive thinker is that he has to see the whole as soon as possible. He draws the assembly with as few parts as possible. This could be a three-dimensional sketch or a good three-dimensional model. Even as he draws the parts he always sees them as parts-of-the-whole.
- (4) When you see a new design problem do you immediately relate it to past design problems, even though they may be in different fields such as automotive and aircraft?
  - (A) This ability to relate one design to another is an example of seeing the essential parts-of-the-whole of one job and relating them to the essential parts-of-the-whole of another job. This comparison may be an analogy or two parts that agree in part and differ in part. Many inventors see analogies in just about everything that they look at and study. This is another indication of the characteristics of induction.
- (5) What studies are you interested in? Name those which are not in the field of math, science or engineering.
  - (A) For an engineer to have an interest in psychology, literature, music or art is a good sign of an inductive mind. It is good to state here that you may not have been born with

these interests but through your will power you may have acquired these interests. This is one case where a person born with a primarily deductive mind can train himself to be inductive. This is also a way for a person who is purely deductive to learn to be inductive.

- (6) When working with an engineering design do you look for patterns that could explain parts of the problem?
- (A) One key in the ability to see the parts only as parts-of-the-whole is to look constantly for patterns of motion, position, and particularly causes. (What causes what to move what? etc?) These patterns are sometimes seen with analogy. Again, you could be born with this ability or through the will you could acquire this ability.
- (7) Did you ever eat a meal while working out a difficult problem?
- (A) Edison once said that invention was 95% will power and 5% ability. But he should have gone further to say that the will power must be used for mental discipline and concentration and even the concentration could be so strong that a meal could be consumed while the mind was still working on the design problem. This mental discipline is aided in invention by analogies, patterns, figures of speech, past experiences, etc. These abilities are inductive.
- (8) When you get into a library can you browse for hours without realizing how much time you are spending?
- (A) The inductive thinker is always looking for patterns and analogies in everything. He is also looking for completely new patterns. The library is one of the first steps that he uses to see what has been done in the past. Remember though that this type of browsing requires a pattern and the ability to trace down a clue through causes and analogies, etc. This inductive power can be learned.
- (9) When working out the essential details to a job do you sometimes get bored and let some of them slip?
- (A) One characteristic of most inductive thinkers is that they are satisfied when they find what they are looking for. They may care little whether others see it or not. Thus they may not use their will power to take the time to detail it and write it up so that others would have the benefits of their findings.

This is one reason why it is difficult, sometimes, to tell inductive from deductive thinkers. A good inductive creative thinker at birth could lose his ability if it is not practiced. The will power is most important here. The inductive

designer may have disciplined himself to always finish the job to the last detail.

(10) When you get a difficult design problem does the answer come to you when you least expect it such as waking up in the morning or riding on a train or plane?

(A) One characteristic of people who use intensive concentration and mental discipline is that they find it difficult to get their minds away from the design job. When they sleep and then awaken they are usually more relaxed and in that state the job comes back to them, but in that relaxed state they still have their inductive ability and they see the parts only as parts-of-the-whole. The inductive mind which thinks in three-dimensional images, forms the whole from the parts.

This could be the invention. It may not be the best answer but it is an answer and it may give a clue to the inventor that will lead him to a better invention. Answering one question may lead to a better formed question which could lead to a better invention.

Again, the will is most important but even with well trained will power the mind must be further trained to see these patterns and three-dimensional pictures.

(11) Do you look for impossible jobs that have never been solved?

(A) Once an inventive mind learns to solve difficult problems, the confidence to seek more difficult ones is natural. Anyone with this attitude and who has it realistically (not as an emotional outlet) is an inductive thinker.

(12) Do you become discouraged when you cannot get an exact answer to a design problem?

(A) The deductive mind seeks exact answers to everything. It is logical and seeks to find the one and only answer. An approximate answer will never satisfy this deductive designer.

The inductive thinker, on the other hand, seeks exactness in a design only as the nature of the design demands. Once he has the essential design according to his needs, he feels satisfied and may not even finish the details. Only if the details are necessary does he finish them. A sketch or a model could be sufficient.

(13) Are you willing to accept the suggestions of your associates?

(A) The deductive mind seeks answers in exact formulas and exact procedures. Once he sets out on a problem, he wants to follow that pattern to the end. The inductive mind, on the

other hand, is always looking for new ideas and it has no qualms about changing course and going after a new solution if it is better than the one he is working on.

- (14) Does your boss think that your designs and ideas are predictable?
- (A) If your designs are always predictable you are probably in a deductive rut. It is easy to get into that rut because it is less effort and you can defend yourself better that way. It takes an inductive mind to gamble with a new idea for a better design.
- (15) Are equations and computer programs more important to you than the causes that go to make up the problem and solve it?
- (A) If you look at an equation or computer program as the ultimate in design instead of the causes of how the items form the equations then you are primarily a deductive thinker. A close look at the mathematical equations that make up an analysis demonstrates that there are many assumptions. The causes come first and the assumptions are the limits set by the causes.
- (16) Have you held back a solution knowing that it could be laughed at?
- (A) The deductive thinker follows a well-known set pattern or a typical computer program. He is seldom laughed at. The inductive thinker is always looking for a new way to do something and sooner or later some of his suggestions will be laughed at and even the designer himself, when he studies his designs will sometimes see one of his own designs quite humorous.
- (17) When seeking a design solution do you keep to yourself or do you ask questions?
- (A) Most of the time the deductive thinker keeps to himself and he follows a set pattern for a design solution. The inductive designer goes to any means to find an answer. He may do library reference work; he may use the phone to get information; he consults his associates constantly. If he sees a better form of analysis he uses it. If a computer program gives him a lift he uses that. He never keeps to himself until he has to use his synthesis to put all of this information together. This is a form of abstraction and the designer has to do it by himself. Inductive design is primarily a whole series of proposed questions and analyses followed by a synthesis which draws all of this work together.

(18) Do you like algebra more than geometry?

(A) Algebra is primarily a deductive study. Geometry (if studied properly) is primarily an inductive study. The inductive thinker prefers geometry. Algebra is primarily a deductive study and is preferred by the deductive thinker.

(19) Are high grades a priority with you?

(A) Most deductive thinkers look to perfect grades as the ultimate in their studies. The inductive thinker is more interested in causes, patterns and analogies which relate to the problem. The inductive thinker is known to have led his class in a subject going into the final examination, only to pick up an interesting book the night before the final and read it through the night. He did not do well on the final.

Many successful inductive designers do not have good grades. It takes a lot of will power for the inductive thinker to sit down and study for examinations. But this is one way that he is able to discipline himself to be both deductive and inductive together.

The whole concept of a complete inventive mind is to have a balance in both induction and deduction. There is no reason why an inductive thinker cannot learn to be deductive or is there any reason why a deductive thinker cannot learn to be inductive.

One of the ideals in a design team is to balance the primarily inductive thinkers with the deductive thinkers.

(20) Do you find ways to check your work as you go?

(A) The inductive thinker is always trying to find a better way to design something. In his analysis and synthesis he is most concerned that he find a ballpark answer as soon as possible. These ballpark answers give him many ways to check his work as he is looking for a final solution.

(21) Do you use analogies to solve problems?

(A) The inductive thinker usually uses analogies to solve some problems. An analogy is another type of problem that agrees in part with the present design problem, and it also disagrees in part. It cannot disagree on the essentials. His approach is through causes and patterns. Patterns are best seen through the patterns of similar problems. Thus a vibration problem in the automotive field could be studied by looking for similar patterns in the rail business. This is often done.

- (22) Are you noted for finding unusual solutions to your design problems?
- (A) This is undoubtedly an inductive characteristic. Not all of the designs are unusual, but it is seen to be a general characteristic of inductive thinking.
- (23) Do you think that the liberal arts are a good start for engineering?
- (A) Most young engineers see no need for this type of training but the inductive designer needs to see what is going on in other studies related to engineering. Thus he should take some course work in some of the following: psychology, philosophy, law, the arts or music.
- (24) Do you make up words when you can't find one to fit your meaning?
- (A) The deductive designer would not dare turn to word creation but the mind of the inductive thinker usually goes faster than the mind of the deductive thinker, and he may not have time to look up a word when he is putting his ideas on paper. Thus he may make up a word or two just to finish his idea. He then comes back later to edit and recompose his work.
- (25) Can you memorize easily?
- (A) The deductive thinker uses rote memory and he memorizes a poem readily. The inductive thinker uses association of ideas to memorize. The memorizing of a poem may be very difficult for the inductive thinker. Rote memory is another good way for an inductive thinker to learn how to be deductive.
- (26) When solving a problem and a certain line of analysis is coming to a dead end, do you have any trouble looking into another method of analysis?
- (A) The deductive thinker with a formulated method of solution may hit a dead end. He has no trouble turning to another deductive method of analysis.
- The inductive thinker could do this as well but he has the additional ability to form a new method of analysis where he could at least get a ballpark solution. This ballpark solution could possibly lead him to another form of deductive analysis.
- (27) Does your desk or work bench have a place for everything and everything in place?



- (A) Both the deductive and inductive thinker need order and control to come to a conclusion. The order of the deductive thinker is indicated by his work-place where handbooks, references and computer programs give him what he wants when he wants it for his particular line of work. He has a set way of doing all problems.

The inductive thinker's workshop may have the same references and computers but he usually has in addition to this: (1) a good drafting board where he can sketch out solutions; (2) textbooks which lead to approximate solutions or methods, and; (3) books from other analytical fields which could give leads into possible solutions; (4) a file of magazine articles from all fields; (5) historical text and reference books showing how it was done in the past; (6) a series of books on how things work; and (7) perhaps a model or two with photographs which point to past difficult design jobs of his own and his associates.

- (28) When working with machines do you try to find out how they really work or do you work with them just to finish the job without giving it a thought?
- (A) The inductive thinker would just have to see how it worked even though it was not part of his assignment.
- (29) Can you solve more than one problem at a time?
- (A) The deductive thinker desires to solve just one problem at a time logically seeing it step by step from beginning to end. The inductive thinker is curious enough to attempt to solve more than one problem at a time. Sometimes he uses one problem to help in the solution of another. A simple problem shows the way to solve a complex problem. This is one of the characteristics of an inductive thinker. He is able to see the essence of the problem and reduce it to simple principles. With these simple principles he may work out a problem in his head as a check.
- (30) Is simplicity of design one of your strong points?
- (A) The deductive designer wants a typical answer. It has to look like something in the field. The inductive designer is never satisfied with his design. He just has to keep trying to simplify it further and further. This is the start of many inventions.
- (31) Do you constantly check your design work with ballpark answers?
- (A) Ballpark answers are the key to good inductive design. The inductive thinker gets into the ballpark first and then

narrows his design down deductively. This is probably the best way to illustrate how a designer is not all inductive or deductive. The good designer has a balanced mind where he can use both his deductive and his inductive powers when they are needed in the appropriate place. The good inductive designer narrows the design down with his inductive ballpark designs. Then he turns to deduction to finish off his complete design. He starts with induction and ends with deduction. This takes considerable training on the part of the inductive designer.

- (32) Do you think that you could specialize in most phases of engineering?
- (A) The deductive engineer likes to stick to one branch and specialize in that particular field. The inductive engineer with imagination, analogy, association of ideas and creative desires can easily adapt himself to many branches of engineering.
- (33) When you have to solve a problem is nothing too difficult for you?
- (A) The inductive mind is willing to tackle any problem anywhere by his association of ideas and high general knowledge of many fields. He may not solve it but he is willing to try.
- (34) Have you always liked to make things, particularly models?
- (A) The deductive thinker may see this as nonsense. The inductive engineer, through the use of his hands and analogy is always tempted to make a small model of his problem to see it better and to be sure that he did not make a mistake. The deductive thinker, probably does not know how to make a model. He should try to develop this inductive skill.
- (35) Could you work around the clock tonight to solve a critical problem?
- (A) The will power is more important here, but induction can help the will through analogy and imagination to see a possible ballpark solution. If the solution is seen over the horizon, it is much easier for the will to drive to the end. The inductive thinker can work all night long visualizing a possible solution.

Again, it is well here to see the importance of developing the will along with the inductive powers of the intellect. Left alone, these inductive powers could easily deteriorate. Many deductive thinkers today are poor inductively because

they did not use their will to develop these inductive powers. It is never too late to continue the training of these inductive powers, through the will.

(36) In your studies does novelty attract you immediately?

(A) The inductive thinker takes novelty and puts it to a good end. The novelty can come from association of ideas and it helps at a later date to solve difficult problems. The purely deductive thinker ignores it as he has no use for it.

(37) Can you walk into a confused situation and bring order back?

(A) If you bring back order by following a prescribed system it is probably deductive. But if you bring back order by turning to a new approach based on sound judgment from causes and analogies, then this new approach is inductive.

This is one of the best examples of why a person should develop both his deductive and inductive skills. He should use his deductive skills first, as far as he is able, but upon confronting a difficult situation he may be required to turn to his inductive skills.

(38) When something breaks down do you look for the directions first or do you look to see how it works first?

(A) The drawings or directions are important to both inductive and deductive thinkers. There is a difference. The deductive thinker uses the directions as a rote step by step procedure for getting it working again. The inductive thinker uses the directions and drawings to find the causes of how it works and then how to fix it.

(39) When you can't get exact answers, do you start with ballpark answers?

(A) The deductive thinker does not do this very often. The inductive thinker is constantly looking for ballpark answers. In the end he turns to deduction to finish the job.

(40) When solving a problem with a certain form of analysis and that method is heading for a stone wall, do you have any trouble turning to another form of analysis?

(A) The inductive thinker will see that the analysis is coming to a dead end long before the deductive engineer because he is using ballpark methods along with his analysis. And, as he sees one method closing off, he is ready to turn to another method immediately.

- (41) Do you have any trouble learning languages?
- (A) Most languages are learned by rote memory and are easily learned by the deductive thinker. Japanese may be an exception. Some languages are partially inductive as they are learned by rote along with association of ideas. The inductive thinker, generally has trouble learning languages.
- (42) Whenever you see something new, do you immediately look to see the essential parts that make it work the way that it should?
- (A) This is truly a sign of an inductive thinker. He has to see how it works. The deductive thinker is not as curious, unless he has a need to know.
- (43) Are you accused of asking so-called "stupid" questions when solving a problem?
- (A) Sometimes the so-called "stupid" questions will turn up a method of analysis or a piece of hardware or a lead to a solution. The deductive designer seldom sees this. The inductive thinker through questions is looking for a clue through analogies, patterns and causes. Asking questions of non-engineers and technicians are a sure way to spot an inductive thinker. The deductive thinker should learn how to ask questions.
- (44) When working out the design problems, are there times when you just know that a solution is right around the corner even though you cannot sketch it or put it into an equation?
- (A) This is another characteristic of the inductive designer. He may have a phantasm or a memory jog, even though it may be by association of ideas and past design jobs, he may just "know" that he saw something like that before. By jogging his associative memory he could bring back the original design job. Also, the inductive designer constantly looks for patterns. From the development of the pattern he may see an answer in sight. And what are some of these patterns? They are of motion, forces, costs, causes, etc.
- (45) When solving a problem do you ask the least likely technician or junior engineer for a possible idea?
- (A) The deductive designer looks for handbooks and equations. The inductive designer looks for any possible help. Where

could he find a better clue of how things work than from the technician who makes similar objects and uses them as a part of his daily work?

- (46) When solving a design problem, even though you do not see an immediate solution, do you pick up clues to the answer almost immediately?
- (A) Due to the association of ideas, the inductive thinker picks up clues almost immediately. The deductive thinker works primarily with rote memory and not association of ideas. He may not pick up a clue like the inductive engineer.
- (47) Even though you specialize in one branch of engineering, do you read and show interest in other branches of engineering?
- (A) The deductive engineer stays pretty close to the field he majored in. The inductive engineer has his interest in every phase of engineering, as far as he can go and understand it. This association helps him in the solution of design problems. The designer never knows where an idea will come from, but a likely source is another branch of engineering.
- (48) Are you good at true and false as well as multiple choice questions?
- (A) The deductive thinker is good at true and false, as well as multiple choice questions. The inductive thinker usually has difficulty with true and false questions as design problems are not always that black and white. There is one big jump from the school to the job. The young designer finds out that design jobs are not the straight-forward deductive problems given in the classroom.
- (49) Do you make models to better understand your design problem?
- (A) The designer who makes models - even crude cardboard and balsa models is probably inductive because he is using his sense of touch to give him a better understanding of the design problem:
- (a) Geometry to see that things fit.
  - (b) Motion to see that things move as they should without interference.
  - (c) Relative stiffness to study the response of static and dynamic forces on the structure.

- (d) Vibration models to study model response and feedback problems.
  - (e) The model verifies the free body forces and responses.
- (50) Do you make sketches of parts of the problems to help you understand it as you bring about a solution to your design problem?
- (A) Sketching is one of the best signs of the inductive thinker. You have to visualize motion, forces, dynamics, geometry through sketches. One of the first things that a deductive thinker should learn is sketching. It will lead him right into balanced thinking as he adds the inductive skills to his deductive skills.
- (51) Even though you solve a problem do you still remain curious about other aspects of the problem? Do you ask yourself what would happen if such-and-such a variable were changed?
- (A) The deductive designer logically comes to the end and stops. The inductive designer is never done. He asks himself "what if that part broke first?" "What would happen?" He has just spent many mental hours fighting his way to a solution and he makes these mental changes to see patterns that should develop in future design problems. He is also trying to relate this job to other jobs that he is working on at present. He also knows that he could have made a mistake or that he may have forgotten something. By going over these hypothetical questions he may find out something that he missed.
- (52) When you were young, did you ask so many questions that you drove your mother and friends wild?
- (A) Question asking is normal for all children but the inductive child asks so many questions that he drives everyone wild.
- (53) When you were young, did you take things apart just to see how they worked?
- (A) Every child does, but the inductive child takes just about everything apart, and even puts some of them together again.
- (54) What is one of the key elements to observe in a designer?
- (A) It is the ability of a designer to expedite. The expediter is a man who gets things done, no matter what the obstacle. The inductive mind with the association of ideas and the open exchange with all those around him will use his will power to find more than one way to get the job done. Then he will get it done, and not by the formula.

# APPENDIX B

## CONCEPTS AND EFFECTS OF DAMPING IN ISOLATORS

James Kerley  
NASA/Goddard Space Flight Center  
Greenbelt, Maryland 20771

### ABSTRACT

The hallmark of engineering has always been creative, inventive design. This paper presents a series of innovative designs and inventions that has led to the solution of many aerospace vibration and shock problems through damping techniques. In particular, the design of damped airborne structures has presented a need for such creative innovation. The primary concern has been to discover just what concepts were necessary for good structural damping. Once these concepts were determined and converted into basic principles, the design of hardware followed.

### INTRODUCTION

The concepts of damping in isolators were first arrived at through work with sandwich panels. The sandwich panels were formed into isolators and then bent into a form to give three-dimensional isolation. The solid metal in the sandwich was eliminated, and sandwich panels of steel wire and plastics were formed. The steel wire was replaced with cable in the plastic, and finally, the cable by itself was used as a medium of structural damping and isolation in three planes.

The concepts converted into basic principles were (1) heavy damping at low frequency with no damping at high frequency, (2) the structural damping medium to be formed in such a way to give isolation in all three planes, (3) the ability to take shock, vibration, and steady-state loads simultaneously without changing damping characteristics, and (4) designing the damped structure so that it could be analyzed and tested to ensure reliable performance in the service environment.

Based on these principles, the following hardware and techniques were developed in support of aerospace program requirements:

- Shipping containers
- Alignment cables for precision mechanisms
- Isolation of small components such as relays and flight instruments
- Isolation for heavy-flight equipment
- Coupling devices
- Universal joints

- Use of wire mesh to replace cable
- Isolation of 160-dB, 5000-lb horn
- Compound damping devices to get better isolation from shock and vibration in a high steady-state environment

## DISCUSSION

As shown in Figure 1, in solving problems in the design of isolation systems, the designer must consider the entire vibration field. The isolation problems of an automobile are less difficult to solve than those of a spacecraft. The isolation of an automobile begins with the frame, and this fact solves many problems. An automobile does not have to fly upside down as does a spacecraft. The designer must use a different approach in the isolation of a spacecraft since its entire frame cannot be isolated. Therefore, it was decided to try first to isolate a complete compartment.

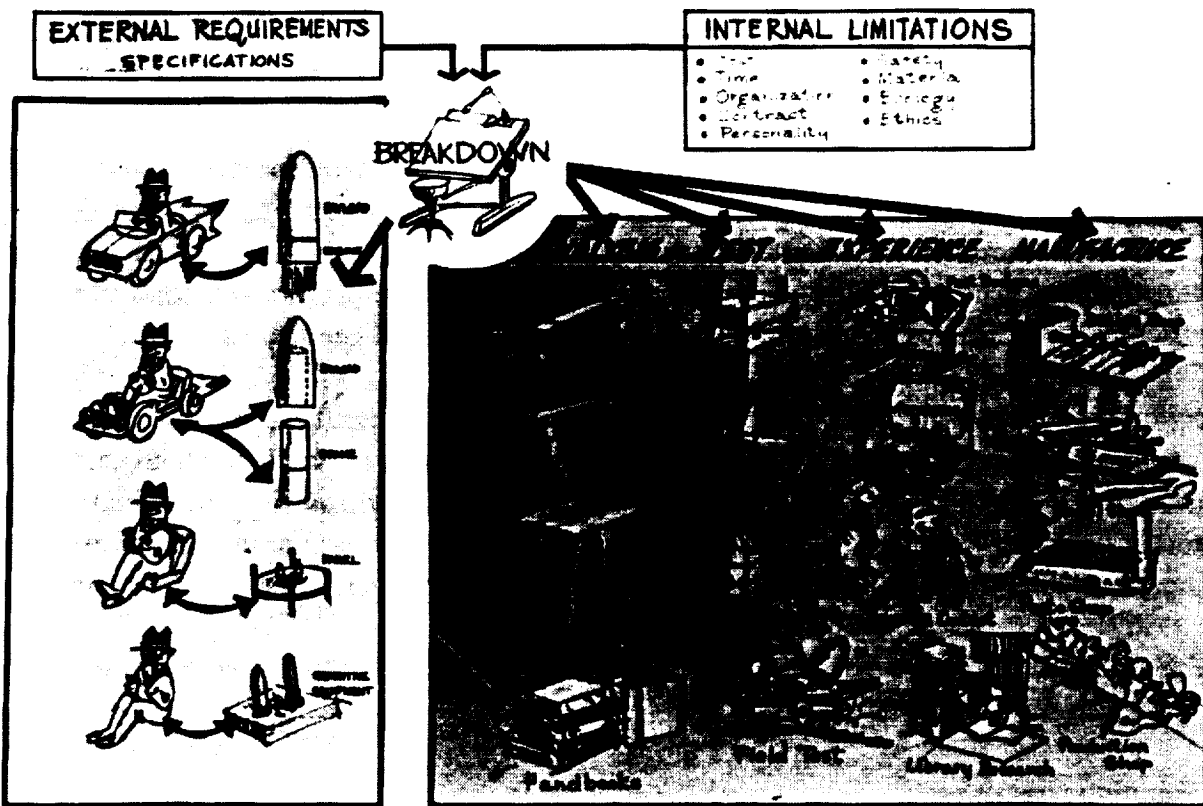

Figure 1. Overall problem of designing damping into a system.

The first attempt at isolation is shown at the top of Figure 2. Commercially available were sandwich panels composed of aluminum on the outside and plastic on the inside. A box structure was made of this configuration. The damping was good, but it was further improved by fabricating our own panels that were aluminum on the inside and a plastic called saran on the outside. Although the damping was very good, it was obviously too heavy for space flight. The next step was to form



a straight aluminum box and make a central panel of sandwich construction (aluminum on the inside and saran on the outside). This isolation was good except in the edge planes, and it was difficult to mount anything on the saran. Thus, the configuration was changed to that shown at the bottom of Figure 2, which shows a straight aluminum panel with equipment mounted on it. At the edges of the panel were quarter-round sandwich bent panels with aluminum in the center and saran on the outside.

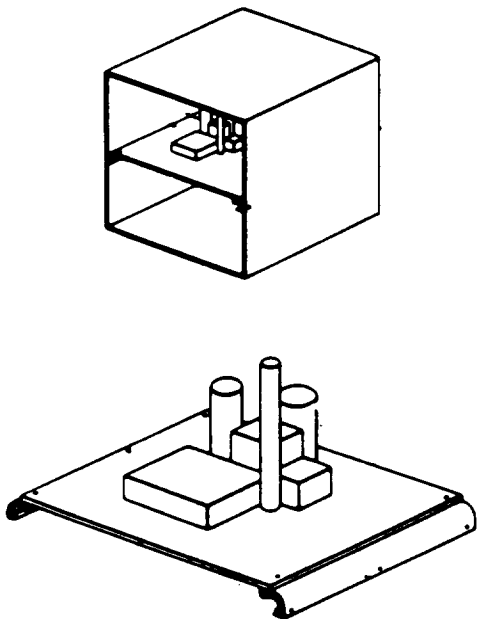

Figure 2. Sandwich damping in panels, frames, and curved mounts.

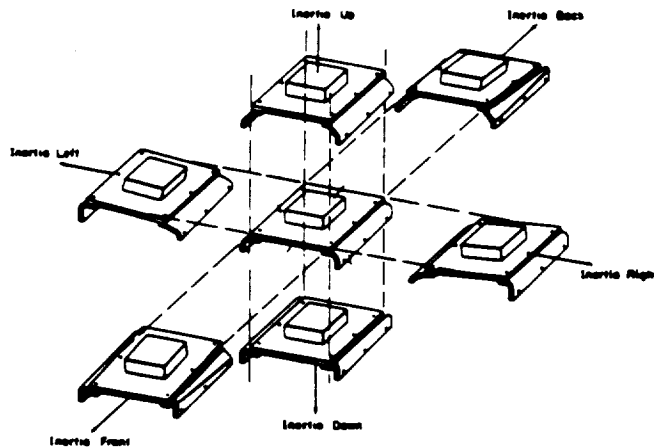

Figure 3. Dynamic motion of curved, mounted panels.

The motion of this system is indicated in Figure 3 by the lines drawn up and down, front and back, and sideways. The quarter-round sandwich-core material was always in bending, allowing for good isolation. However, two problems existed: the metal would fatigue, and vibration was still evident in the edge plane of the panel.

The internal stresses caused by this type of motion are shown in Figure 4. It is evident from these figures that the stress concentration at the end of the aluminum was quite high. To reduce this extreme motion at the edges, bumpers were constructed to show this motion down. They are shown in Figure 5.

The motion was still too severe; therefore, other forms of sandwich core were constructed to get good isolation in all three planes and reduce the metal fatigue. The center row of Figure 6 shows all the quarter-round forms. On the left is the typical metal in the middle. Next is the metal on the inside and saran on the outside. Following this was the metal on the outside and saran on the inside. Last was the sandwich construction of metal on the outsides and saran on the inside. All of these types of sandwich-core materials were made in different forms: quarter round, question mark, and "W" formations. The question mark form was eliminated because it banged against the side too easily. The quarter round ended up where it started with the saran on the outside and the aluminum inside. Of the four "W" forms, the best was the saran on the outside and the aluminum inside.

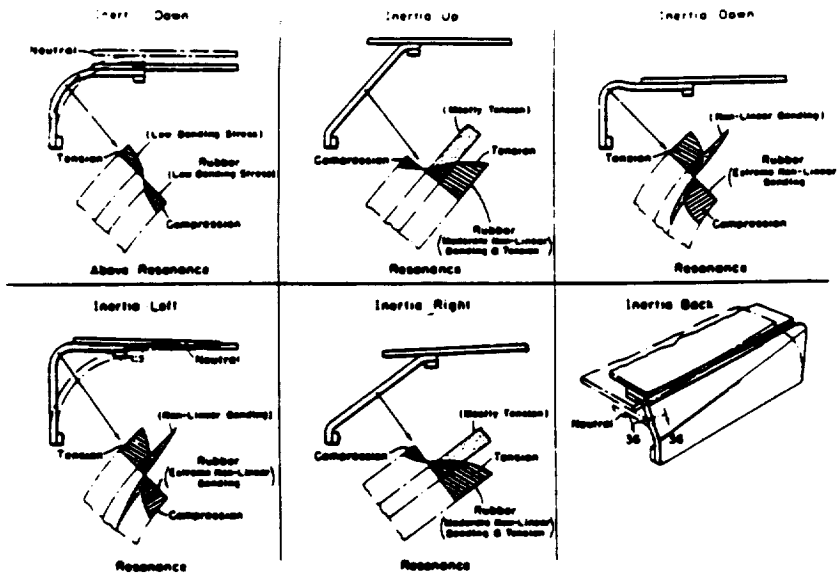

Figure 4. Internal stress condition of curved sandwich panels.

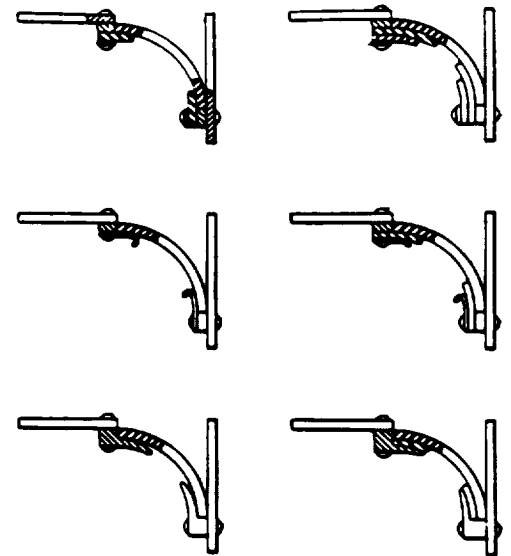

Figure 5. Bumpers to reduce deflections.

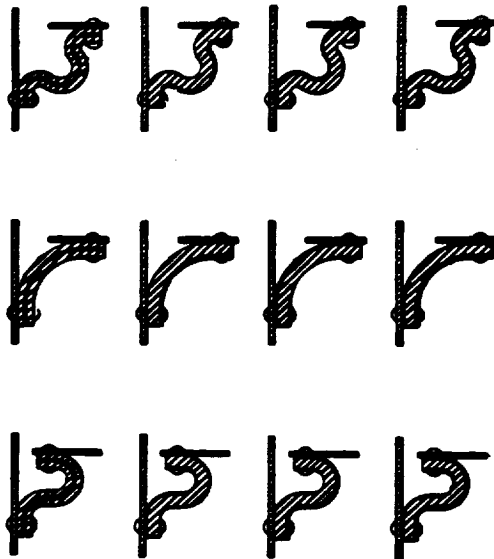

Figure 6. Special forms of sandwich mounts.

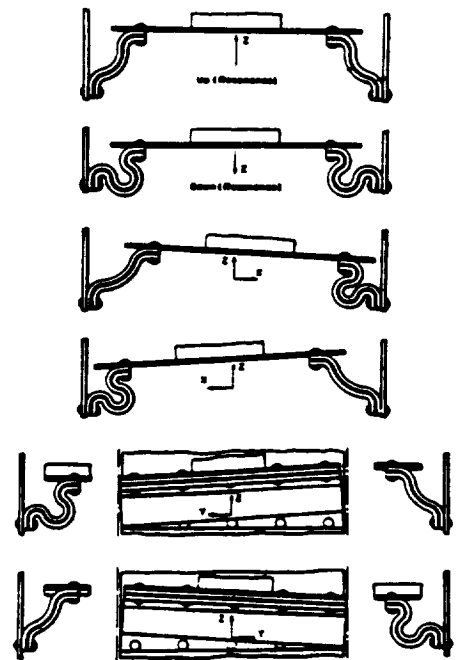

Figure 7. Dynamic motion of best mount.

This final solution was tested and is shown in Figure 7. The fatigue life was increased as the "W" form relieved the stress concentration at the edges. However, there were still problems because the metal would fatigue in the center.

It must be kept in mind that these were all good shock and vibration systems. The purpose of this study was to find a universal solution to any shock and vibration problem that could arise. The advantage of these first systems is that they could be bent up, glued together, and made overnight for a quick isolation job, particularly where a heavy-shock load was present.

To solve the fatigue problem, the metal was cut in the center into strips and was glued between two pieces of saran. Although this isolation worked well, it eventually developed fatigue problems. High-strength wire was substituted for the metal strips, but they would eventually fatigue. A piece of cable was chosen by chance; although not expecting it to work well, it was known that it could handle the fatigue problem. The cable was glued between two pieces of saran and mounted on the panel. It was immediately obvious that this was the motion that was under control (see the bottom of Figure 8).

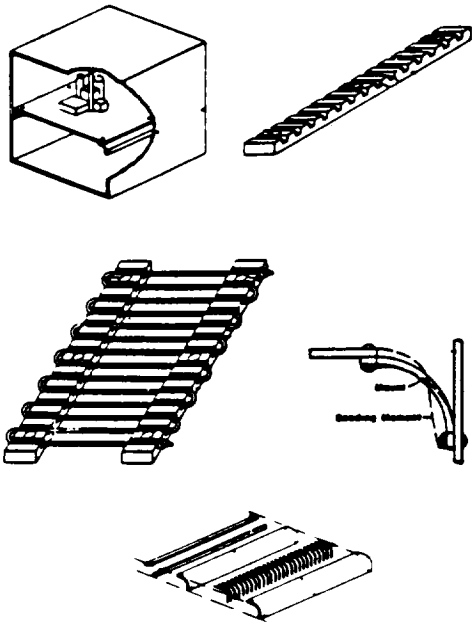

Figure 8. Cable sandwiched between two pieces of plastic.

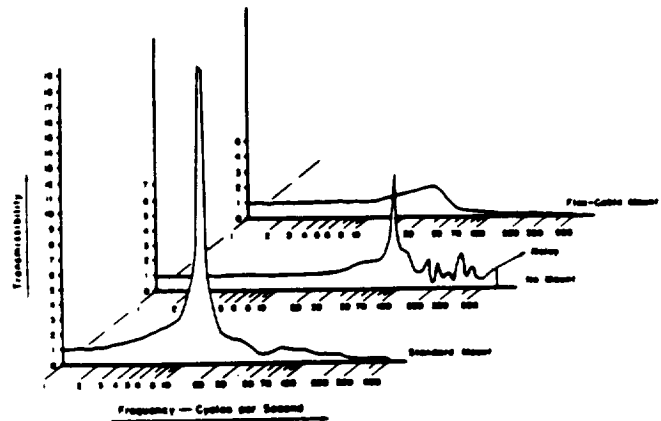

Figure 9. Dynamic response curves of rubber, plain, and cable mounts.

Because it was difficult to cut the individual cables, a frame was made to hold the cables as shown and was mounted at the end of the panels. The isolation is shown in Figure 9. In the front is the transmissibility function of a standard mount. Standard mounts worked well except at resonance where they would bottom out and cause a tremendous shock to the entire structure. The center transmissibility curve shows a frame without isolators with many resonant points. In the back is the saran cable isolation system. The transmissibility was 2 to 3 at resonance, and then it diminished gradually without rising again. The specification called for 4 g's from 20 to 35 Hz and 20 g's from 35 to 2000 Hz sine testing.

The foregoing system demonstrated the following:

- All three planes had good isolation.
- High damping existed at resonance and little or no damping at high frequencies.
- The isolator was good for both shock and vibration loads.
- Preliminary tests demonstrated that the isolation was good in the presence of high steady-state loads.

There were some problems that still had to be solved. The saran was too stiff at low frequencies and too limber at high frequencies. It was also subject to deterioration under many chemical contacts. Fabrication continued to caused problems. Many different types of plastics were used: natural rubber, Teflon, etc. It was known then that the only good universal solution was to make the isolators of cable without the saran.

For many months, many forms of all-cable isolators were made, but they failed one after the other, usually because they would be stable in two planes but would become unstable in the third plane. Finally, it was observed that the only system would be a cable system that had uniform geometry in all planes except in the front and back. This is illustrated in Figure 10.

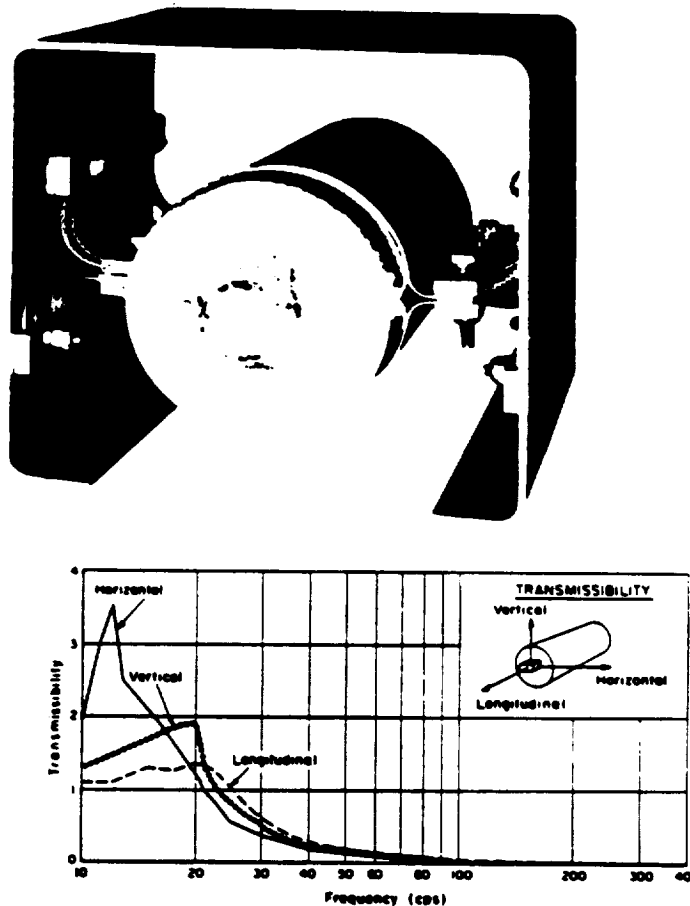

Figure 10. First and most recent use of all-cable mounts.

Quarter-round cable mounts were mounted top and bottom on both ends of the mounting panel. This was a symmetrical mounting system that provided good isolation in all three planes. The transmissibility response functions are plotted below the picture. This was the first all-cable isolator used in flight, and it mounted on a true air-speed indicator. It worked well during flight and was used in both spacecraft and airplanes. It is interesting to note that Aeroflex Laboratories, Inc., Plainview, Long Island, New York, has recently revived this invention, and they are using it for shelf mounting where difficult shock and vibration loads exist. It is cheaper to use cable isolators than to weld the shelves. This approach is published in the October 10, 1983, issue of "Design News."

Calculating the response with different weights and different specifications became a difficult task. Every job became a major design project. It was decided that a more uniform isolation system would have to be made of all cables and should be easily adapted to any shock, vibration, load, or difficult environment that could be found in space use.

After many trials with different forms of cable, a system was found that performed the job. It is shown in Figure 11. The upper left "A" shows a perspective of the overall system, and "B" is the end view showing the versatility of the system. The cables could be straight, or they could be stiffened to give a higher frequency, right on the spot. "C" shows the opposite as the cables can be compressed to give a low-frequency response. "D" shows the way the mounts could be constructed to give this versatility.

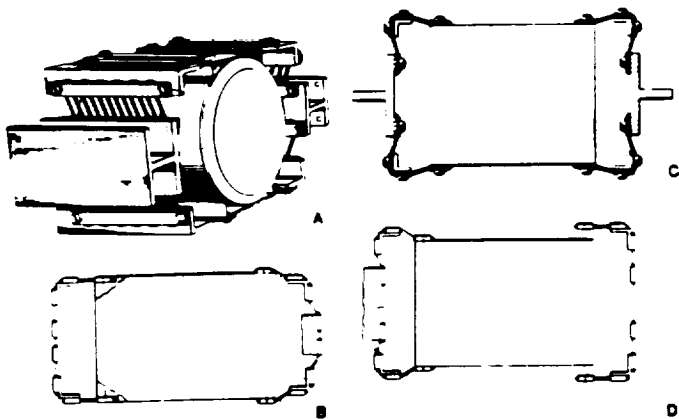

Figure 11. Use of corner angle with cable to control frequency and damping.

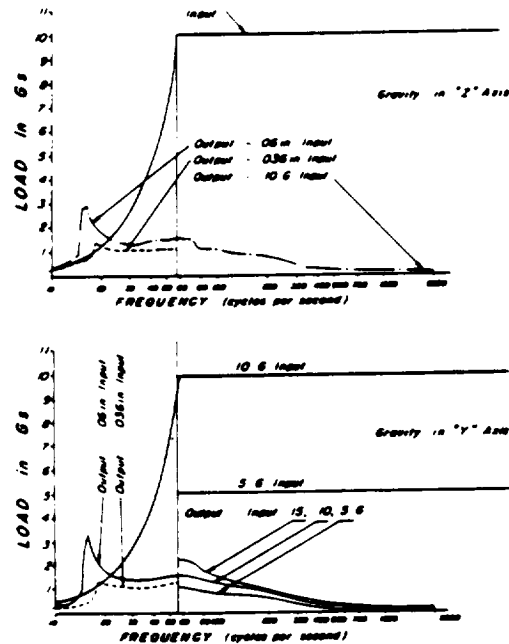

Figure 12. Vibration in two different planes noting the same natural frequency and the same damping.

By adjusting the cables in and out, it was possible to give the same amount of damping and the same natural frequency in all three planes. This is illustrated by the transmissibility curves shown in Figure 12. The natural frequency in two planes is about 16 Hz, and the magnification factor "Q" is about 3 in both planes. For the first time in the history of isolation, there was a damped spring system that had the same response in "Q," which meant the same damping and the same natural frequency in all three planes. This meant that no matter in what plane the structure was pushed, it would respond the same way. This simplified the mathematics and made day-by-day work an easy task to accomplish. It solved many problems such as rate gyros that had to respond the same in all three planes. This was the first isolation system which was a true "design tool."

Figure 13 shows a comparison of rubber response with cable response. The rubber responds differently in tension, compression, and shear. The cable mount always bring about a shearing action that causes the cable to bend. Thus, it is possible to have the same response in all three planes.

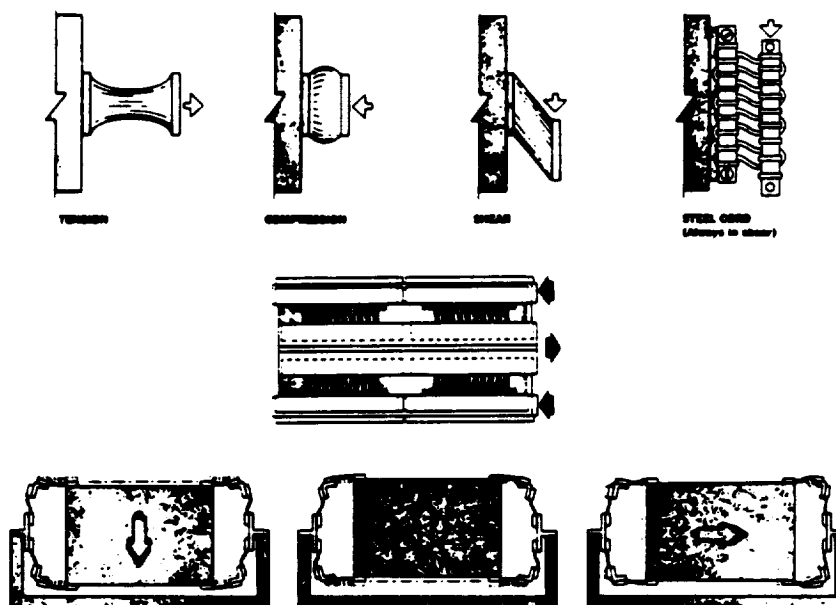

Figure 13. Deflections of rubber and steel cable (cord).

Figure 14 shows the first form of versatility for this type of configuration. With the cables pushed out as they are shown in "A," they are quite limber and have a low natural frequency and a considerable amount of damping. When the cables are pulled in as shown in "C," they become quite stiff with much less damping. This is a design tool since it is possible to adjust the natural frequency a full octave the night before testing. A few shims will adjust the cables and give the right natural frequency right on the flight line.

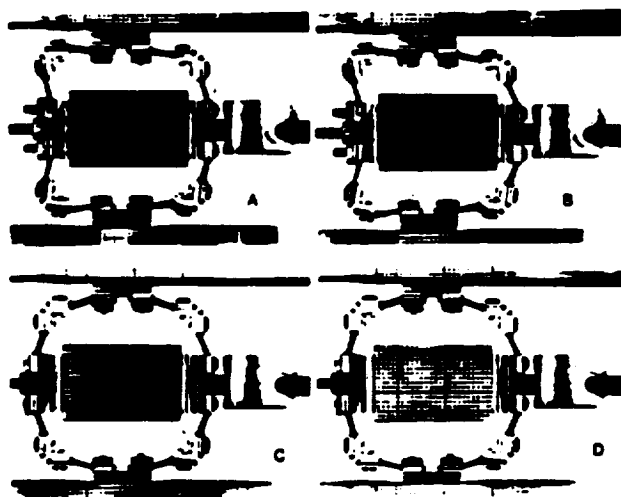

Figure 14. Different deflections caused by different preform.

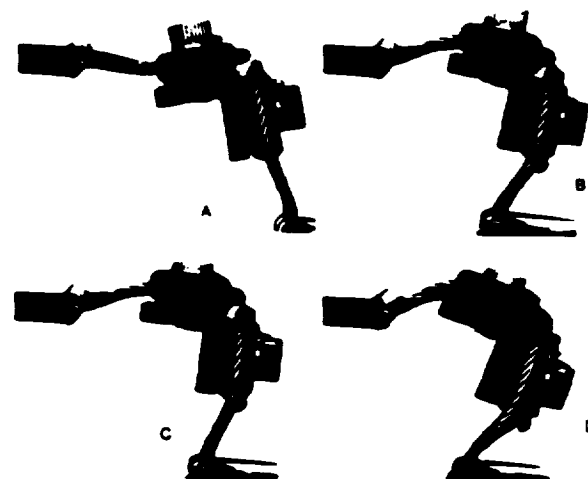

Figure 15. Angle rotation and damping during vibration.

Not illustrated here are the many cases in which the isolator can be made stiff in two planes and limber in the third plane. In this way, any motion in the stiff plane will be diverted into the third plane. This is controlled motion isolation. This is necessary when the designer is called in to isolate a black box already installed in a missile or airplane, and the motion is limited to one plane only. It can be isolated.

Figure 15 is an example of macrophotography used to study the motion of cable during isolation. Note the large rotation of the angle with motion to the cable. Many strands of cable rub against many more strands, and the damping controls the motion.

Figure 16 shows a typical hysteresis curve of the average isolation system. This response is nonlinear with respect to both stiffness and damping, but it is repeatable and consistent. The natural frequency can be predicted within  $\pm 5$  percent.

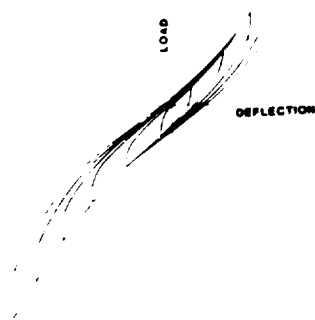

Figure 16. Load deflection curve for soft cable system.

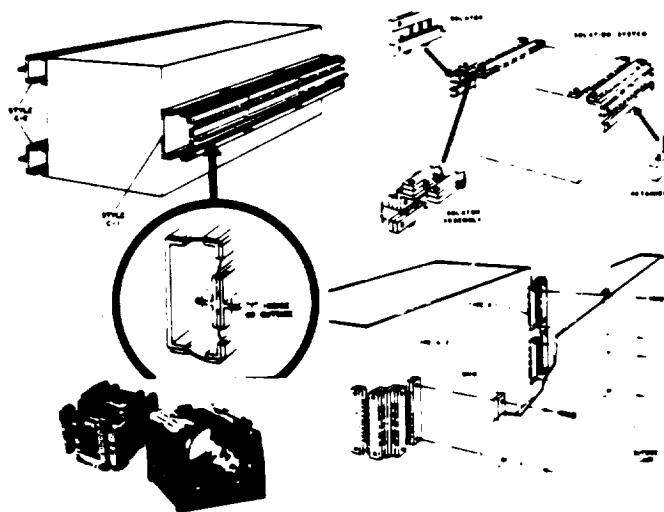

Figure 17. Applications of cable systems.

Figure 17 shows some of the installations of the systems that performed well in flight. The upper left shows rack-mounting systems. The upper right shows the top and bottom mounting system. The lower right shows side mounting. The lower left shows a field installation of a gyro and a radar altimeter for flight use. All performed well.

Figure 18 is a picture of the Goddard Space Flight Center (GSFC) noise horn weighing 5000 pounds. The frame weighs 5000 pounds, and both are mounted on Aeroflex cable isolators (see arrow).

Many ways were studied to increase the damping in the cable. Figure 19 shows a series of macrophotographs of cable under bending conditions. It was noted how the cable strands opened during this bending and ways were sought to prevent it. It was discovered that a slight twist to the cable while stringing it caused the outer strands to close and the independent wire rope core (IWRC) to expand. This action would force cables against cables and make more contact points. With more contact points, the damping increased considerably. Too much pretwist would cause the IWRC to pop out.



Figure 18. Mounting of 5000-lb horn and frame with cables.

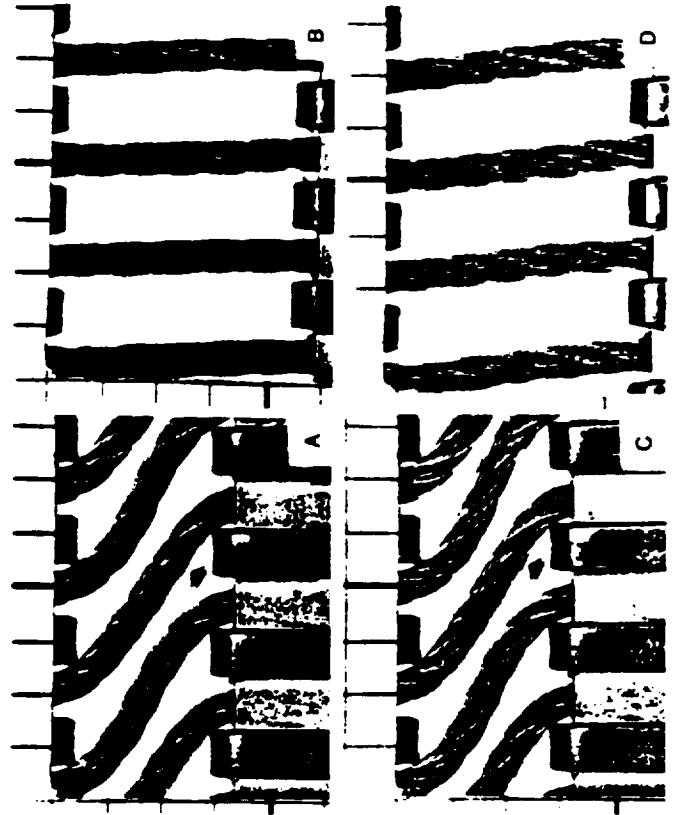

Figure 19. Cable opening during bending.

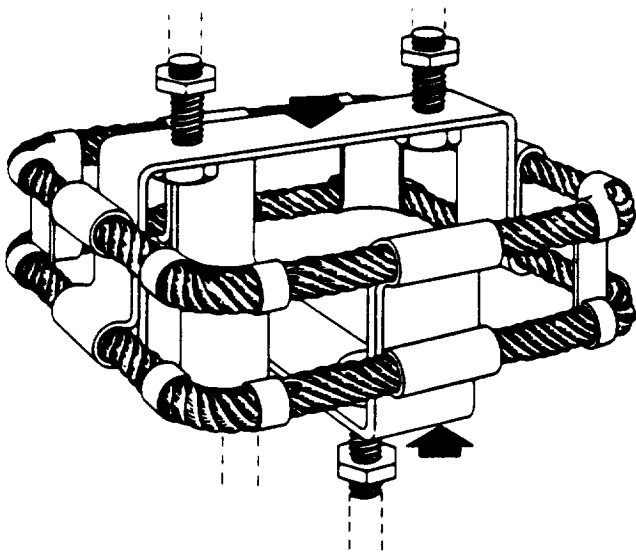

Figure 20. Single-cable mounting system.

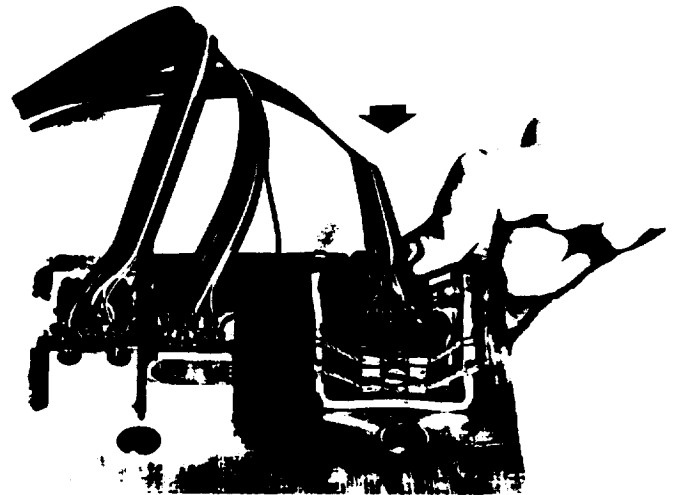

Figure 21. Isolating with heavy preload.

For economy and efficiency, it was considered necessary to make a mount that would be easily installed anywhere. This new invention is shown in Figure 20. Note that the typical angles are still there. There are four corners to prestress the cables either in or out, etc. It is made of stamped metal for economy, and it is easily mounted under, over, or at the side of any piece of equipment.



Figure 21 shows an application of this mount. Relays were causing a problem at GSFC, and a method of isolation had to be worked out to prevent the chatter. Note that the finger is pushing down on the isolator while it is going through vibration. This push simulates the steady-state load that exists when a fast rocket takes off.

The response curves are shown in Figure 22. Note that the natural frequency without steady-state loads is approximately 23 Hz. With the 15-g load, the natural frequency jumped up to 28 Hz. There is only a slight change in the natural frequency with the addition of a severe steady-state load. Also note that the "Q" or magnification factor at resonance is less because more cables are rubbing against themselves to create better damping. This system performed quite well.

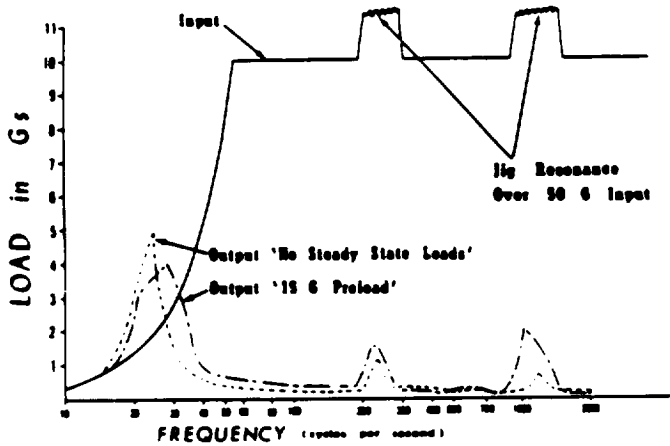

Figure 22. Response function of isolation with 15-g preload.

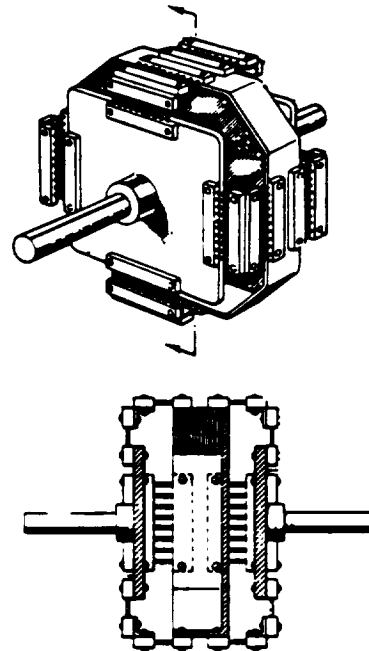

Figure 23. Heavily damped coupling systems.

Now that it could be established that the cable isolators could work just as well with or without steady-state loads applied at the same time, it became apparent that they could be used in coupling devices. Figure 23 shows such a coupling system of cable. This system not only corrects for misalignment but also isolates from shock and vibration any load that tries to get through the coupling. Note that there is a floating element in the center of the coupling. This floating element allows a greater degree of rotation, and it offers an additional barrier to vibration.

Another example is the use of Aeroflex isolators (Figure 24) to act as a coupling of the Launch Phase Simulator at GSFC. This coupling brings out a smooth motion where a metal coupling caused constant jerking.

Another use of couplings is shown in Figure 25. The upper coupling is quite flexible. It will take a lot of misalignment, but it will not take heavy loads. The lower couplings are not as well isolated, but they take much higher torque forces.



Figure 24. Application of coupling with good damping.

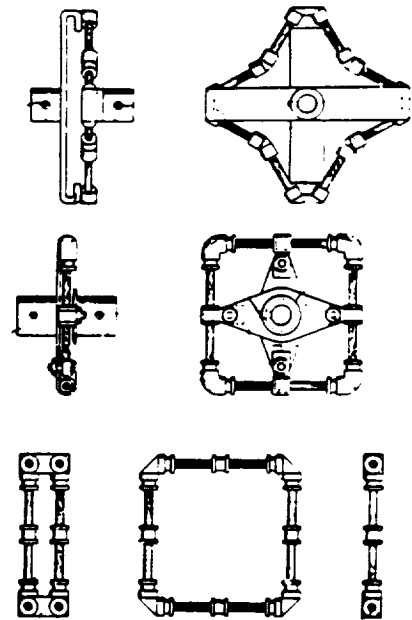

Figure 25. Coupling systems with damping

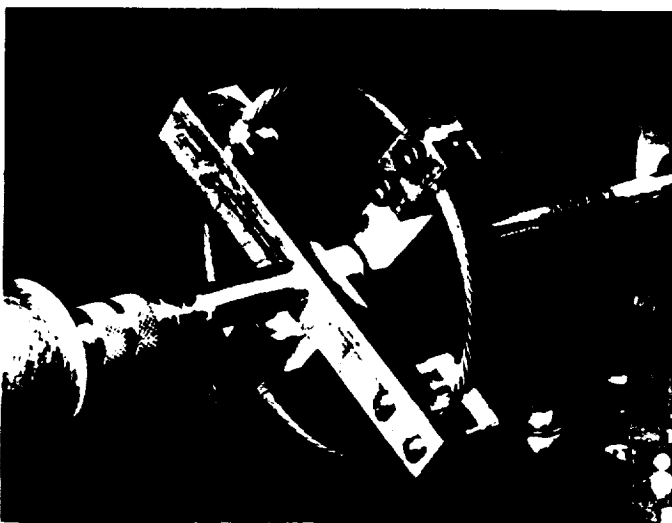

Figure 26. Coupling system with damping

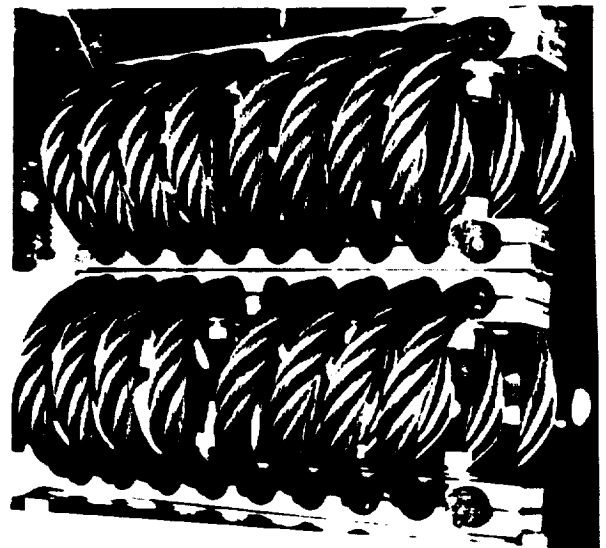

Figure 27. Compound cable systems.

Another coupling designed for GSFC is shown in Figure 26. This is the simplest of all the designs but must be designed by an engineer. This coupling is different from the rest in that it used a centering device.

Another need arose when it was discovered that compound systems were necessary for additional isolation. The compound isolation systems would lower the natural frequency and increase the damping. The one shown in Figure 27 is on the Launch Phase Simulator at GSFC.

Figure 28 shows another use of a compound system. The device is a g-negation device that is mounted in a spacecraft which goes into free fall to study component actions. After the free fall, it must be stopped without damaging the spacecraft. The cable compound system gave a simple single-degree-of-freedom well-damped motion.



Figure 28. Compound cable systems.

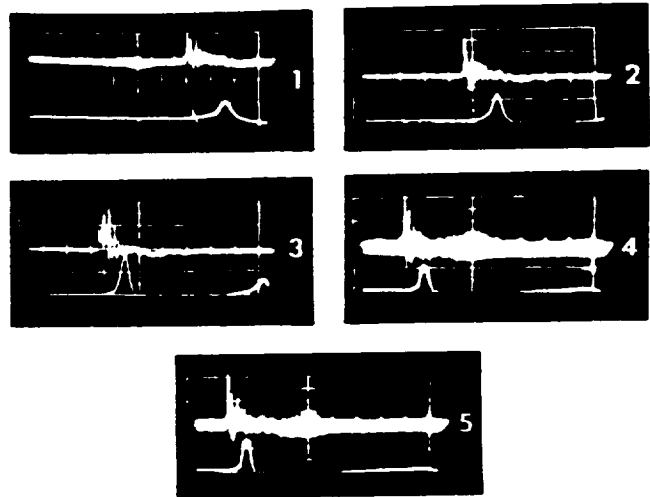

Figure 29. Shocks from 30 g's to 100 g's on cable systems.

Shock loads with the cable isolation system are shown in Figure 29. These shocks range from 30 g's in part 1 to over 100 g's in part 5. The scale on the oscilloscope has been changed to accommodate the signal. Note that the only response was a single-cycle, well-damped response. There is no bottoming out or any secondary responses.

Once it had been established that shocks could be mitigated, it was obvious that the shocks from an electric or pneumatic hammer could be isolated from the handle. Figure 30 shows such an installation. After a few years of use, the operators of these hammers complain of nerve loss in the wrists.

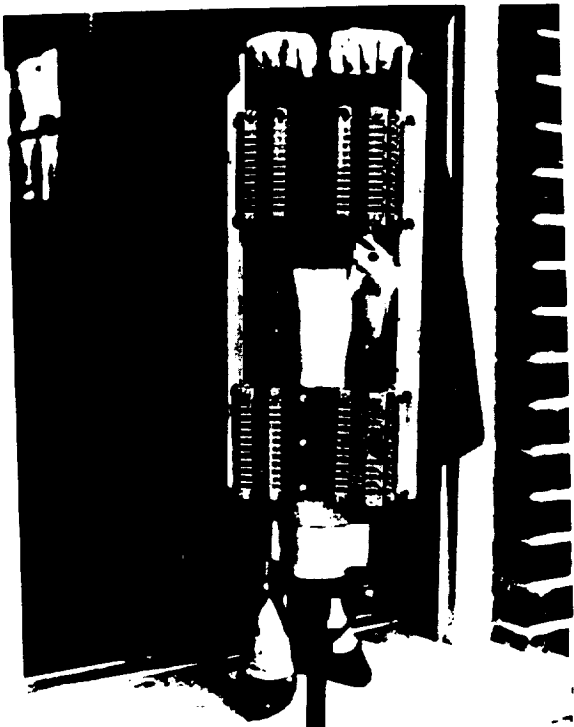

Figure 30. Isolation through damping of electric hammer.

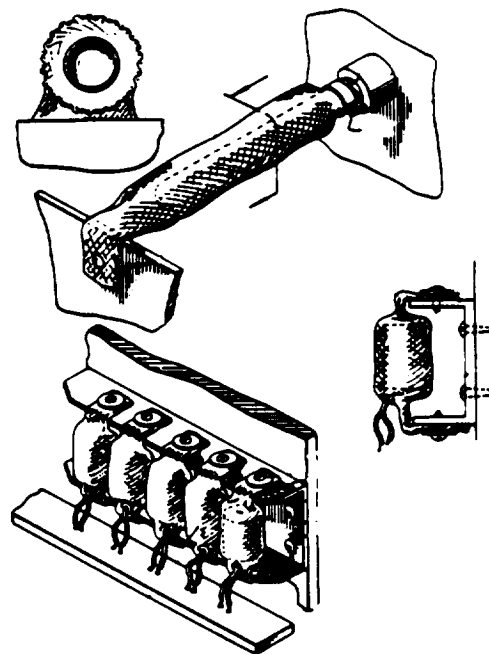

Figure 31. Damping isolation through wire mesh.

This isolation system takes the shock off the wrists. Furthermore, by pushing down on the handle (to simulate steady-state loads on top of shock), the chisel point is kept closer to the cement and drills through a concrete slab twice as fast as it would if the hammer were held loosely and allowed to bounce. This could be applied to gun mounts, drilling rigs for mines, or oil rigs.

When a sensitive piece of equipment to be flown the next day had to be isolated during the night, there was no time to build a cable isolator. A piece of wire mesh was opened up, the instrument placed inside, the ends crimped to simulate the motion of a cable isolator, and then was mounted on a small frame (see Figure 31). The principles of operation were that the wires were rubbing against each other as they would in a cable system. The wire mesh was formed in such manner to preload the mounted system. It worked well in flight. Figure 31 shows that any form of wire can be used (not necessarily cable). If wire rubs against wire, the resulting system gives restrained motion in all three planes.

Figure 32 is a sketch of the design tool of cable isolation systems. These curves represent the installations of Figures 11 through 17 and Figures 19 and 22. If the cable is kept in the neutral position, the damping curve is drawn from the original hysteresis curve as shown in Figure 16. If the cable is pulled tight, the hard curves are superimposed on the average system. If the natural frequency is raised, there is less damping because there is less motion and less rubbing of wire against wire. If the system is made more limber, the soft curves apply as shown in Figure 32. If there is more damping, the natural frequency goes down. The natural frequency of a system can be doubled by changing the form of the cable. It is easy to see now what a design tool the cable systems are. The cables can be stacked one isolator on top of the other as shown in Figure 17. Thus, if the designer desires the same natural frequency with more damping, he simply adds another layer of cables. They are all bolted together.

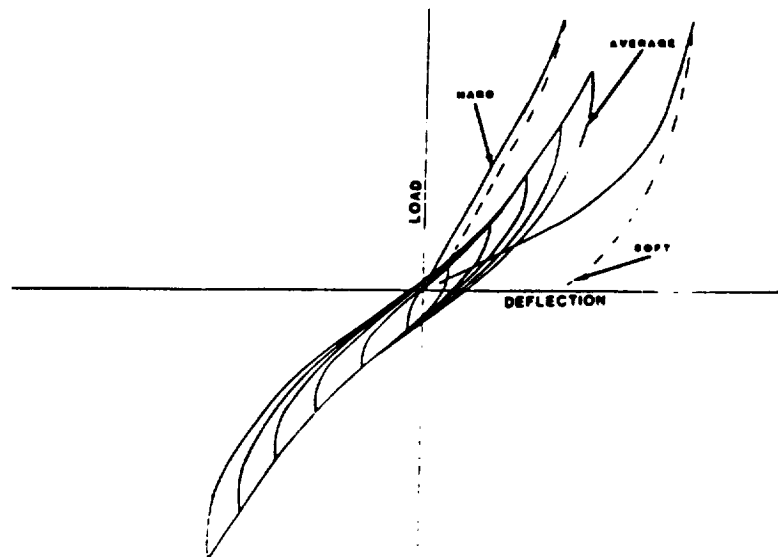

Figure 32. Damping and stiffness as a design tool.

## APPENDIX C--RETRODUCTION

### PART 1: THE LOGIC OF INVENTION

Andrea C. Birch

#### I. Introduction

Since much of the philosophical work on the subject of the creative process of the mind is stated in terms that relate to scientific discovery rather than engineering invention, it might be useful to make two simple distinctions before we begin to look at the problem of invention.

First, the verb "to invent" means to think out or produce a new device, a new process, etc. It implies originating and devising something new by bringing things together in an original way to create that new device or process. The classic example is: Thomas Edison invented the light bulb. To invent does not imply uncovering something already existing. In contrast, "to discover" means to find out or to learn the existence of. It does imply a finding out about something already in existence, for example, Walter Reed discovered the cause of malaria and Isaac Newton discovered the law of gravitation. The discovery and invention processes use the same procedure and the words are often used interchangeably. In the field of engineering it seems more correct to speak in terms of the logic of invention, of bringing things together to create something new.

Second, as in discussing the logic of discovery, the logic of invention requires a further distinction between two possible interpretations of the word "invention". On the one hand, invention can refer to an inventing, that is, shaping or initial formulation of a conjecture or possible solution leading to a new device or process. On the other hand, invention can mean something invented, that is, the achieved, appraised, justified, and accepted solution, device, or process. In discussing invention, we will be concerned with this term in the first sense, namely, as a process leading to a possible solution or working model. Of course, this process can lead to a justified and proven solution or device, and the achievement can also be referred to as an invention. Our task, however, is to determine the grounds for saying that invention as the process leading to the achievement is infused with rational elements and has a logical structure that can be communicated.

#### II. The Problem

The major problem arising when one tries to talk about the logic of invention is that there is a strong academic and popular bias against the possibility of a rule-based or even a rational process of invention.

Since the 1930's the most influential philosophers of science (Karl Popper and logical positivists such as Rudolf Carnap, Carl Hempel, and Herbert Feigl) have eliminated the issue of discovery and invention as a legitimate subject for philosophical investigation. They assigned discovery and invention to the realm of the mysterious, the nonrational, and the inexplicable. As Popper states in his work The Logic of Discovery (which denies the subject of his title), the initial act of inventing does not require logical analysis and, in fact, is not susceptible to it.<sup>1</sup>

While arguing that there is no special logic of discovery or invention, many philosophers of science do maintain that the discovery or invention process is amenable to psychological and historical description. They argue that discovery is a process that can only be studied psychologically because it is idiosyncratic to each creative individual. They view discovery and invention as almost mystical flashes of insight that are momentary and quite unintelligible.

This position has actually affected the meaning of invention. A genuine invention is seen, by definition, to be something that appears suddenly by a mysterious process which is not reconstructible as reasoning. This emphasis destroys even the possibility of developing a logic of invention. It would follow that there cannot be a logic, or rational program, or methodology of invention. That definition embroils the philosopher who attempts to study invention in what Wartofsky calls a "dilemma of explanation".<sup>2</sup> If the explanation succeeds by explaining discovery logically in the narrow sense of an algorithmic system of rules, then it is not dealing with real, creative invention. If the explanation fails, then invention remains unexplained. Creative invention is inexplicable, and the philosopher has nothing to analyze. Genuine creative invention can only be described by the psychologist, although it is never actually understood.

The way out of this dilemma is twofold. First, the methodology of discovery need not be equated with logic in the narrow sense of an algorithmic system of rules which subjects discovery to the logico-mathematical criterion of rationality. As Reichenbach and Achinstein knew, and as any careful study of actual cases of invention will indicate, reasoning and rationality are important components in the discovery of new theories and the generation of problem solutions.<sup>3</sup> Moreover, it is simply absurd to equate creative with irrational and to assume that every invention arrived at through a reasoned argument forsakes its claim to be creative. Creativity does not vanish even in examples of invention that are matters of algorithmic calculation. As Gutting points out, even when the process of justification of an hypothesis or possible solution is considered logical in the narrow sense, it still requires creativity and imagination to formulate the deductive proof.<sup>4</sup>

Secondly, philosophers cannot conclude that all psychologists view the invention process as nonrational. Granted, some psychologists continue to describe invention solely in terms of a flash of insight or the "Aha!" experience which often accompanies the process. Meanwhile, an increasing number of psychologists, neurologists, and cyberneticists are finding that not all rational activities involve conscious behavior, but that does not make them nonrational. Work in cognitive psychology and in the area of artificial intelligence has already applied jargon concerning computation, problem solving, and reasoning to subconscious processes. Philosophers such as Wartofsky and Toulmin have indicated that rational scientific judgment is not necessarily inferential. The absence of obvious inferential steps need not evoke the label of nonrational.<sup>5</sup>

Furthermore, philosophers of science cannot conclude from the work of psychologists that the invention process is irrational, although that term is not always applied carefully. The term should be used with care. It can mean lacking the power of reason or contrary to reason. The term irrational is an ambiguous word when used to describe the complexities of invention processes which, though subtle and perhaps unconscious, are not contrary to reason. In the same sense, this reasoning could be applied to a discussion of discovery.<sup>6</sup>

In conclusion, the psychology of invention and the logic of invention are both legitimate, but separate, areas of study. In contrast to the standard interpretation that removes invention as an appropriate topic for philosophy, the issues of invention, discovery, innovation, hypothesis generation, and problem solving give philosophers a great deal to analyze. Since the process of invention deals with the psychological connections between thoughts, these connections can be subjected to descriptive treatment and psychological explanation. Since reasoning occurs as the inventor thinks of new ideas, philosophy can concern itself with the rational reconstruction of that reasoning.

So far we have tried to extricate the issue of invention from the restrictions of merely psychological description and from the terminology that many philosophers associate with it (nonrational, irrational, mysterious, unanalyzable). We now turn to the related issue of historical description of invention.

Historians have contributed to the "momentary psychological experience" conception of discovery and invention by recording and accepting what researchers have said when they speak of their discoveries or inventions in terms of natural hypotheses, mystic presentiments, or happy guesses.<sup>7</sup> Scientists repeat the famous stories about the discoveries of Kekule and Poincaré. Popper and the positivists have used such incidents to attack inductivism (induction is not needed to generate scientific ideas) and a logic of discovery or invention (no normative or prescriptive account

can be given of hypotheses generation). Nickles summarizes this position:

It follows that, so far as these philosophers can determine, all "methods" (or madneses) by which people seek to solve problems are equally good -- anything goes....So if you are struggling with a problem, these philosophers should (on their view) tell you, citing the cases of Kekule, etc., that as good a way as any to solve it is to doze off before a fire, board one tram after another, start pecking randomly at the typewriter, sit under an apple tree....<sup>8</sup>

Part of the problem has been a lack of reliable data on the thought processes and other activities which occur when scientists and engineers arrive at their discoveries and inventions. Note the statement made by the Council of Scholars of the Library of Congress:

What we lack most are more sophisticated descriptions that may lead someday to better theories, descriptions of what is going on when science is freshly produced. We need to look at what artists and other creators actually do and try to decipher the mystery by observing the concrete....Libraries need to collect materials which will permit thicker descriptions of creative moments: laboratory notes, computer printouts, transcripts of conversations in the heat of battle, and all other traces, thumb prints, smudges, and blood stains.<sup>9</sup>

Granted, it is difficult to get case studies and develop explanations of discovery and invention. But when an intelligible description eludes the philosopher of science, he should take care not to lapse into metaphor that precludes the possibility of analyzing the discovery and invention process.

Despite these problems, historians and philosophers of science have produced some important work on scientific discoveries. In the past two dozen years increased interest in historical case studies has contributed to the resurgence of discussion of the issue of discovery and invention. Philosophers seem to be unconsciously adhering to Reichenbach's belief that a rational reconstruction of cases of bona fide discovery is possible.<sup>10</sup> Hanson's Patterns of Discovery, published in 1958, and Koestler's The Sleepwalkers, published in 1959, focused philosophers' interest in the history of science and on the process of discovery. The issue of the relation of history of science to philosophy of science, debated by Thomas Kuhn, Popper, Imre Lakatos, and Paul Feyerabend, while not concentrating on the generation of ideas, further created a climate in which discovery and invention could be analyzed.



Historical description and the study of historical cases have made philosophers aware of the reality of the discovery and invention process within scientific and engineering activity and its relevance to philosophy. Philosophers can no longer ignore discovery and invention and leave it solely to the domain of either psychological or historical description.

### III. The Solution: Toward a Logic of Invention

Contemporary philosophers of science fail to recognize three concepts which have deep historical roots in the philosophical tradition and that can illuminate the path toward a valid logic of invention. The three concepts, all of which have their original source in the writings of Aristotle (Greek philosopher, fourth century B.C.). are: retroduction, the four causes, and abstraction.<sup>11</sup> We will briefly discuss each in turn.

#### A. Retroduction

We can best begin to appreciate the role of retroduction in the invention or discovery process when we contrast it to the hypothetico-deductive method. The hypothetico-deductive method has emerged as the official methodology of science according to contemporary philosophers of science. Followers of both logical positivism and Karl Popper view scientific theory within a hypothetico-deductive system. According to the hypothetico-deductive method, the scientist begins with an hypothesis and deduces testable consequences from it. However, hypothetico-deductive methodology is inadequate to explain the realities of science. Specifically, the hypothetico-deductive method exhibits two problems. First, this method begins with the formulation of hypotheses which act as starting points in a deductive argument or demonstration. Yet hypothetico-deductive methodologists provide no theory as to how the scientist arrives at his hypothesis in the first place. The second problem is that the method can never yield certitude (we will deal with this problem under our discussion of the four causes).

The hypothetico-deductive methodologist disregards the process of arriving at an abstraction or a ballpark solution which can act as the starting point of the deduction. This would be comparable to ignoring the dialectical questions of the analytical branch of the retroductive method which led to temporary answers. The hypothetico-deductive methodologist overlooks the initial stages of synthesis through which the inventor organizes the questions and answers and puts together a ballpark solution from which the deduction can proceed. The hypothetico-deductive methodologist acts as though he does not care where the initial hypotheses or starting solutions originate. Arriving at temporary answers and ballpark solutions, however, is not a haphazard procedure. If it were, and if there were no criteria by which to judge some temporary solutions better than others, it would take a very long time for an engineer or scientist to complete his research. In fact, engineers and

scientists work with the givens and knowns of their experience to focus their discursive step-by-step process so as to move from what is known to a knowledge of the unknown. This description of the step-by-step process the mind goes through in thinking to solutions is the definition of reasoning provided by Aquinas (thirteenth century) based on his studies of Aristotle.

According to the hypothetico-deductive method, once consequences are deduced, the scientist can test them. In this, the hypothetico-deductive method is similar to the procedure that is followed once the thing sought is found through the synthetic branch of the method of retroduction. The thing sought which constitutes a deductive conclusion can be tested by known methods, such as induction, experimentation, or mathematical calculation. After the inventor devised the mesh isolator, he was able to test it in actual flight. See Part 9.1 of the main text above.

So the point of criticism directed against the hypothetico-deductive method is that it does not go back far enough to explain the struggles, images, and experiences that lead the scientist or engineer, in a dialectical, logical, and rational way, to formulate original hypotheses, temporary answers, and ballpark solutions. The hypothetico-deductive methodologists exhibit the problem discussed in the foregoing Section II ("The Solution"). They do not see that the initial stages of discovery and invention are infused with rationality and, although the steps are not always consciously made, they can be logically reconstructed and communicated by the method of retroduction.

Retroduction has its original source in the works of Aristotle. He used the word "reduction" and considered that method to be a valid type of argumentation along with the two other more extensively discussed types, induction and deduction. Aristotle linked reduction to the method of Greek geometrical analysis and to the dialectical method. The method of geometrical analysis as elaborated by Pappus (third century, A.D.) is a powerful method for discovering the solution to mathematical problems. Dialectic is the practice of examining ideas logically by the method of question and answer so as to arrive at probable solutions.

Five points help to characterize Aristotle's method of reduction. First, reduction starts with an original assumption or thing sought. The inventor works with certain givens and knowns that relate to the problem and keeps his eye on the goal of finding a solution that can answer all the significant questions he has raised and can meet all the criteria for the final thing sought. Second, it involves a search for probable premises that constitute temporary solutions. Third, the temporary solutions are easier to prove or solve, simpler to achieve, more readily testable, or more probable than the conclusion or final thing sought. Fourth, the process of arriving at premises or temporary solutions from the thing sought involves analysis. The process of putting together a

ballpark solution and deducing consequences that result to something specific and capable of being tested in final form is called synthesis. Analysis is always followed by synthesis. Fifth, the direction of the process leading to finding temporary solutions is different from the order of the essential questions and answers which result in a specific conclusion expressing the thing sought.

Acknowledging his debt to Aristotle, Charles Sanders Peirce (nineteenth century American philosopher), coined the word "retroduction". He also used the words "abduction", "presumption", and "hypothesis" to describe the form of reasoning by which hypotheses are adopted. Peirce struggled all his life to establish the proposition that all reasoning is either abduction (retroduction), deduction, or induction. For him, abduction is a preparatory process. It provides a weak argument leading only to conjecture (temporary answers and ballpark solutions) and cannot perform the verifying function of other methods such as experimental testing or mathematical calculation. Abduction only suggests that something may be, but it is the sole form of reasoning which supplies new ideas. It constitutes the logic of discovery.

Following Peirce, Norwood Russell Hanson (twentieth century) argues that the logic of discovery has a special form distinct from deduction or inductive inference. It has the form of retroductive inference from phenomena or a problem requiring a solution to an explanatory hypothesis or the thing sought. Hanson adopts Peirce's description of the form of retroductive inference: some surprising phenomenon P is observed or some problem requiring a solution is identified. Phenomenon P would be explicable as a matter of course if H were true or the problem could be solved by the ballpark solution that satisfies all the general temporary answers. Hence, there is reason to think H is true or to accept the ballpark solution in a final specific form as the thing sought.

Hanson was the forerunner of the current interest in the philosophy of discovery and invention. His work helped to stimulate philosophical concern for the history of science and the discovery process. Philosophers remain indebted to him for focusing attention on the logic of discovery and for recognizing the contributions of Aristotle. Arguing that the hypothetico-deductive thinkers "get the issue twisted [by] putting hypotheses where the surprising phenomena should be," Hanson remarks that "Aristotle, as usual, carves out the important trail here."<sup>12</sup>

## B. The Four Causes

In addition to laying the groundwork for an understanding of retroduction, Aristotle introduces a second concept (the four causes) that is ignored by many contemporary philosophers of science. According to Aristotle, the four causes answer the following questions about anything: What is it made of? (material cause); Who made it? (efficient cause); What is it? (formal cause); For what

end is it made? (final cause). The causes are important to the process of inventing a solution to a problem because they point the way to definite, concrete answers. For example, in the beam design problem (see main text) the temporary answers arrived at through analysis, although general in some way, all involve knowing concrete inner mechanisms or causes. To answer the question, "Does the beam have to be wood?", requires knowing at least that the beam has to have an inner nature that expresses the material cause. It has to be made of something appropriate for a beam (e.g., it could not be made of paper). In the same way, formulating a ballpark solution to the problem and deducing a final beam design that can be made and tested in the actual structure requires knowing the appropriate causes.

This may seem obvious, but it is important to point out because many contemporary philosophers of science deny the possibility of causes. They see themselves as heirs to David Hume's empiricism (See Figure 1). As a result, they apply skepticism, the logical outcome of empiricism, to their limited understanding of the scientific method. They tend to ignore modern science's roots in the ancient Greek and scholastic study of retroduction, the four causes, and abstraction and thus deny the possibility of scientific knowledge. More specifically, the second problem with the hypothetico-deductive method of contemporary philosophers of science presents itself in this context. You will recall that the first problem with that method (discussed above under point A) is that it provides no theory as to how a researcher or inventor arrives at working hypotheses or ballpark solutions that can be expressed in a final form capable of being tested or verified in an actual situation. The second problem with the hypothetico-deductive method is that it denies the possibility of certitude, that is, the possibility that the inner nature of things can be known through the four causes. The reason for this is that hypothetico-deductive methodologists cast their conditional argument in a form that is close to the fallacy of affirming the consequent. Let us explain briefly.

A statement such as "if p, then q; and q therefore p" exhibits the fallacy of affirming the consequent. For example, "if it is raining, then the ground is wet; and the ground is wet, therefore it is raining". There could be many other reasons besides rain to explain why the ground is wet. When hypothetico-deductive methodologists attempt to express a solution to a problem they use a similar form of argument: "if p, then q; and q<sub>1</sub>, q<sub>2</sub>, q<sub>3</sub>...q<sub>n</sub>, therefore probably p". Through observing or measuring many instances of q they say that they increase the probability that p is true. As Carnap argues, one can have various degrees of confirmation that hypothesis p is true, but one can never know a solution for certain either through the four causes or any other means. The orientation of hypothetico-deductive methodologists tends to undermine the possibility of scientific knowledge, discoveries that constitute true explanations, and concrete inventions that provide valuable solutions to problems.

Aristotle's emphasis on the four causes expressed his faith that the world is capable of being explained, that answers are possible, and that the human mind can penetrate the inner mechanism of things.

### C. Abstraction

A third concept that Aristotle introduces to show that the human mind is able to move through a step-by-step process toward discoveries and inventions is abstraction. According to Aristotle, abstractions are essences or universals arrived at through mentally taking things apart which are not necessarily separated in the actual world. The mind, in effect, can pull out, through inductive experience of the sensible world, the essential characteristics of things. For example, through analysis the inventor can ask many questions and arrive at many general separate answers. Before he puts his answers together to make a concrete specific thing such as a mesh isolator that can be tested in flight, he can mentally or through a model form a ballpark solution by putting his general answers together in the appropriate order. From that abstraction, mental concept, definition, or general solution he can deduce an answer in a final form that can be tested. The particular thing found and made must meet the general essential criteria established by the abstraction.

With the concepts of retrodution, the four causes, and abstraction the major features are in place for a viable logic of invention. The process of invention need not be a rule-directed enterprise in the negative sense as criticized by Hubert Dreyfus and Stuart Dreyfus in their recent work Mind Over Machine (1986). Rather, the process of invention directed by the method of retrodution can make use of the way the mind works. Inventors move dialectically through questions and answers. They utilize strategies that permit them to work with the givens and knowns of their experience, and infuse the analytic branch of retrodution with inductive tests or mathematical calculations to arrive at temporary answers. Based on their experience and their data, they organize their general answers and formulate abstractions that can function as ballpark solutions from which they deduce a specific solution in final form that meets the criteria of the abstraction and can be tested. In other words, they find the thing sought, utilize their knowledge of causes, and work with the confidence that a final solution is possible.

The process of invention is not haphazard and irrational, but it is not a simple process. Inventions cannot be made by following a simple rule book. A commitment to a logic of invention signifies that the human being is capable of more than the positivists and hypothetico-deductive methodologists would suggest. The problems of the world are not dark and impenetrable, but rather are realities awaiting explanation. Solutions are waiting to be discovered. Inventions are waiting to be made. The logical process of invention lies within the grasp of all willing to make the effort to use the method of retrodution.

## NOTES

1. Karl Popper, The Logic of Scientific Discovery (New York: Harper and Row, 1968), pp. 31-32.
2. Marx Wartofsky, "Scientific Judgment: Creativity and Discovery in Scientific Thought," In Scientific Discovery: Case Studies (Boston: D. Reidel, 1980), p. 8.
3. Hans Reichenbach, Experience and Prediction, (Chicago: University of Chicago Press, 1983); Peter Achinstein, "History of Philosophy of Science: A Reply to Cohen," In The Structure of Scientific Theories (Urbana: University of Illinois Press, 1974, enlarged 1977); and Peter Achinstein, Law and Explanation (Oxford University Press, 1971).
4. Gary Gutting, "The Logic of Invention," In Scientific Discovery, Logic, and Rationality (Boston: D. Reidel, 1980), pp. 224-225.
5. Wartofsky, "Scientific Judgment"; and Stephen Toulmin, Human Understanding, Vol. 1. (Princeton: Princeton University Press, 1972).
6. Thomas Nickles, "Introductory Essay: Scientific Discovery and the Future of Philosophy of Science," In Scientific Discovery, Logic, and Rationality (Boston: D. Reidel, 1980).
7. Martin Curd, "The Logic of Discovery: An Analysis of Three Approaches," In Scientific Discovery, Logic, and Rationality (Boston: D. Reidel, 1980) p. 210.
8. Nickles, "Introductory Essay," p. 29.
9. James Hutson, ed., Creativity: A Continuing Inventory of Knowledge (Washington, D.C.: Library of Congress, 1981), p. 15.
10. Curd, p. 210.
11. See Andrea Croce (Birch), A Logic of Scientific Discovery Based on Aristotelian Dialectic (Ann Arbor: University Microfilms International, 1983).
12. Norwood Russell Hanson, "The Logic of Discovery," The Journal of Philosophy, Vol. 55 (1958), p. 1089.

## APPENDIX C--RETRODUCTION

### PART 2: AN HISTORICAL PERSPECTIVE ON MODERN PHILOSOPHY OF SCIENCE AND CRITICAL COMMENTARY OF POSITIVISM

Anthony D. Birch

#### I. Overview

Study Figure 1. The purpose of the chart is to show key ideological developments relating to the history of science and philosophy. The chart shows how philosophy has branched from its early beginnings (when philosophy and science were one) into two main streams: modern science and modern philosophy. In this sense, the scholastics and medieval philosophy are the pivotal point.

The basic point of the chart is that the fundamental ideas about nature and science were carried forward from Greek origins, through the Middle Ages, and then adopted by such key figures as Kepler, Galileo, and Newton. These same basic principles (we contend) continue to be used by scientists and engineers today. Let us hasten to add that this view of the flow of ideas which stresses an intimate connection between Galileo and his scholastic and Greek forebearers is probably not widely accepted by historians and philosophers of science. The more traditional view is that Galileo broke sharply with the dogmatism of the scholastics and developed an entirely new methodology of scientific investigation. We believe, however, that the recent work of William Wallace on Galileo's early notebooks has demonstrated Galileo's firm commitment to Greek and Aristotelian ideals and principles of science.

While science began to develop as an independent field, philosophy, as a discipline now separate from the scientific investigation of the natural world, continued to develop its own way. It diverged from and finally broke with the scholastic tradition and sought new formulations of truth. Descartes is usually cited as the breaking point -- the "Father of Modern Philosophy". In the eighteenth century, two major branches of philosophy developed, indicated on the chart as those originated by Hume and Kant. These two branches still exist today and may be referred to broadly as the Anglo-American empiricist tradition and the continental tradition. The difficulty in the history of the philosophy of science (which now perforce existed as a separate discipline) occurred when philosophers closer to our own time once again asked about the truths of natural philosophy (science). Because some modern philosophers tended to believe that the answers to the epistemological problems of science could only be found in modern philosophical history, they tended to formulate their answers and base their investigations on recent developments in science and their own rather brief history (no further back than Descartes). The main stream of the actual practice of science was lost to them. Because

most educators and scientists today are taught in the tradition of empiricism, the original roots of science, the method of hypotheses, and the four causes have been lost.

Here again our claim must sound strange to the contemporary ear, for to many people, empiricism is science. Certainly science is empirical, but we are referring to intellectual history, the philosophic roots of science, and the ideas about science. The history of science and the history of ideas surrounding it have, we claim, become confused. There is, in fact, a radical divergence between science and many popular ideas about science. Today the streams flowing on the left side of the chart are perceived by many to be the same stream. That is, many believe that science and the true scientific attitude were born of the radical empiricism of Hume and follow the logic of Russell and the positivists. Our own conception is that there exists in today's popular psyche a profound connection between the ideology of radical empiricism and the notion of what scientific inquiry is all about. Popular notions that cause and effect our constructs of the human mind, namely, that all the sciences can be reduced to physics or mathematics, that science is ethically neutral, that the mind can be reduced to the brain, and that things do not exist for identifiable purposes are evidence of this. This is at odds with the actual methods, procedures, and activities of scientists, although we readily admit that scientists themselves may not verbally assent to our alternate description of their methods. Because of the human capacity for dissimulation, intentional and otherwise, there can exist a divergence between the method of speech and the method of hand.

The connection between radical empiricism (and by extension, skepticism) has been fostered and nurtured by writings in the philosophy of science which:

1. Claim to report the activities of science.
2. Imply that the most adequate description of the scientific method is supplied by philosophers of science rather than the lessons of history or scientists themselves.
3. Imply that where descriptions of actual methods may fail or be found inaccurate in the real world, the prescriptive methodology supplied by the philosopher should be applied. That is, if the philosopher is not painting an accurate description of how science actually works in the laboratory, it is inconsequential because his intention is to provide a description of the method that should work in science and the claims that science should make.

Our intention here is to broadly outline our position, not to prove it. Substantial elements of the proof exist in writings by Wallace, and in the actual work performed by present day scientists and engineers.



## II. Following the Chart

This section provides an outline of some of the branches in the chart and gives a brief description of the philosophies developed by key individuals.

### Greeks

Some early Greek philosophers were concerned with discovering the primeval substance of the universe. The notion that there is a substance underlying everything that exists is, of course, one of the basic ideas of science. Other early Greek philosophers were concerned with the logical connection between the claims of rival philosophies and in describing the apparent differences between perception and the requirements of reason. Truth must be rational and consistent, whether or not it is to be found in the sensory world.

Plato is considered the father of the theoretical basis of the scientific method. He described how hypotheses were to be formulated, tested, and resolved (although this was done through reason, not empiricism). Plato was the first to describe four modes of causation (material, formal, final, and efficient).

Aristotle, however, made the four causes the cornerstone of his philosophy. His philosophy gave powerful formulation to the idea that knowledge required a search for causes within the confines of reason. Aristotle made extensive use of the idea that things (natural and man-made) exist for a purpose, and that a thing may be judged on the basis of how well it is suited to its purpose. Aristotle sought to describe a natural world in which things existed for reasons, where cause and effect were taken for granted. The events occurring in the natural world were not considered in isolation, as disconnected moments in time.

Things for Aristotle had natures in themselves. The nature of a thing was not a construct of the human mind. When a flower blooms or a rock falls, that is because of the intrinsic nature of the flower or the rock. The unfolding of these events and the causes that lead to them are not constructs of the mind. It is the task of the mind and the natural ability of the mind to understand these natures. This conception of nature (and man's place in it) is markedly different from some modern conceptions in which it is asserted that the mind can only attempt to understand itself in its attempt to understand a thing (Kant).

### Scholastics

Aquinas and other medieval philosophers utilized the basic principles developed by Aristotle.

## Galileo and Newton

The root of modern misunderstanding about science may be traced back to this beginning. Reason: Aristotle's way of thinking was "overthrown" during the Renaissance. His numerous works on all matters of physical sciences (meteorology, biology, physics) were shown to be in error. Many of Aristotle's empirical claims were simply not true. Aristotle was depicted as a fool by Galileo and others.

Galileo emphasized the importance of mathematical proportionality in discovering the rules of nature. Galileo also emphasized the importance of experiment and empirical investigation. These principles and methods, Galileo claimed, formed the basis of a new science, replacing the Aristotelian model. Meanwhile (we claim) Galileo continued to use many of the same principles that he played down in print. If nothing else, he was motivated by the desire to seek causes and certainly entertained the Aristotelian notion of truth. In the history of our modern problem, we have already reached an example of behavior that is repeated over and over again: the innovator overthrows the teachings of the establishment, but continues to use many of the same principles and ideas inherent in that establishment ideology.

Newton also emphasized the importance of mathematics and formal systems. Both Newton and Galileo studied the scholastic teachings and the works of Aristotle. Both tended to ignore or play down the importance of final causality in their investigations. The importance of formal (mathematical or logical), material (physical properties), and efficient (antecedent conditions) causes were emphasized. Followers of Newton tended to deal exclusively with very limited and specialized fields in science. This established the trend toward reductionism (belief that all sciences could be reduced to a simple set of scientific propositions in the "fundamental" science, i.e., physics, mathematics, or logic).

Unfortunately, the notes left by Galileo and the writings of Newton provide only cryptic explanations of how hypotheses were formulated in science. This is a contributing cause to the current difficulty in philosophy of science in understanding the formulation of hypotheses.

The principles and methods developed by Galileo and Newton continue to provide the fundamental structure of scientific investigation to the present day.

## Descartes

In general, it may be said that modern philosophy is characterized by a movement inward, away from the outside world of the senses.

As a rationalist, Descartes believed that the mind could intuit truths. It was through the intellect or mind and not through the

senses that ultimate truth was known. Descartes' criterion for certain knowledge was that ideas be clear and distinct. These elemental truths were innate in the mind.

Descartes was a mechanist. He believed all matter, including the human body, followed predictable mechanical laws. Mathematics was considered by Descartes to be the paradigm of science or certain knowledge. All other claims to knowledge made in the name of other sciences should be as precise, positive, and as subject to proof as mathematics.

### Hume

David Hume attempted to refute the notion of causality altogether. While Galileo and Newton were content to remove one of Aristotle's four causes, Hume insisted that all must go. The causal connection between any two events could not be proven, Hume claimed. (Most of his argumentation is pitched against efficient causality.)

Hume wrote convincingly on the problem of induction. Hume asserted that because the sun rose yesterday does not mean that we could have any legitimate expectation that it would rise tomorrow. The apparent causal connection between events in the world could not be proved. The best one could do was to tabulate occurrences.

Historically, this is a crucial point in the development of the modern dilemma in the philosophy of science. Hume's philosophy meant that one could still do scientific investigation -- but that one was not actually proving causal connections, only probability or likelihood. As we know, science rests on induction, but if the viability of induction as a tool for knowledge has been called into question, what does this mean for science? Clearly, the notion of science itself must change. We believe that from this point onward in the Anglo-American tradition, philosophic notions of science did in fact change. To most scientists, the natural world of Aristotle was lost, and the natural powers of the mind to seek out and know nature were consigned to the realm of myth.

The logical extension of a radical empiricism such as Hume's is skepticism (the belief that ultimately we can know nothing). This is indicated on the chart by an arrow toward the left which lines up vertically with the line for modern science. The purpose is to indicate graphically an association between a philosophic notion and a popular notion that science and scientists should be allied with a skeptical approach to problem solving. True, scientists are skeptical, but are there no real limits to their doubts?

### Russell

With Bertrand Russell and the analytic school, thought returned to the empiricist roots of British philosophy. Russell made the attempt to reduce (see Newton above) mathematics to logic. Again,

the idea that only direct experience and formal logic had any meaning becomes part of the official philosophic ideology. By this time, the notion that Aristotle had contributed anything to the basis of modern science could not even be considered by most scientists. Science was based on new principles of knowledge. Metaphysics was to be discarded as idle speculation. Whatever could not be rooted in science nor proven empirically was to be disregarded. New standards of truth based on the logic of verification, as described by philosophers of science, were to be developed.

### Positivism

This is discussed separately under Section III below.

### Analysis

Analysis is a broad term, encompassing most of what is done in current philosophy. Part of its concern is to dissect precise meanings of words and concepts in language to uncover the truth or principles inherent in them.

In the philosophy of science, there has been a few glimmers of change in the concept of how science actually develops knowledge. Some philosophers (Harre) have essentially rediscovered (without reading Aristotle) that there are natural kinds (natures which inhere in things) and scientific truths based on final causes.

### Kant

Returning to the right side of the chart, we see the continental branch of philosophy. Kant sought to balance the relationship between reason and experience. He mediated between the potential dogmatism of the rationalists and the potential skepticism of the empiricists. He tried to reach a philosophic balance between reason and experience. However, Kant felt that human reason was limited and inevitably led to self-contradiction if it tried to go too far. Knowledge of the ultimate nature of natural things was limited by categories of perception.

### Hegel

As a reaction to Kant's formulation of the strictures of reason and limitations of the human mind, the German Idealists developed an exceedingly complex notion of reality based on a new conception of dialectical structures which existed in both nature and in the human mind.

### III. Positivism

During the late 1920's and early 1930's, a particular group of scientists and philosophers formed in Vienna. The goal of these thinkers, whom we now call the Vienna circle (or, generically,

logical positivists) was to produce a philosophy which would be as accurate and predictable as the physical sciences. Through a study of the methods and attitudes of scientists, it was felt that practical notions of perception, knowledge, and truth could be developed. This goal led, quite naturally, to extensive writings centering on how perception, knowledge, and truth must already be (or should be) understood within the scientific community. From these beginnings the modern industry of writing about the philosophy of science was born.

### Influence

The positivists' view of the scientific method has been one of the most formative intellectual influences of the twentieth century. The principles involved in its formulation pervade the structures of our educational institutions. The methodology it prescribes has influenced research activities in science and procedures in engineering. Its vocabulary and philosophic claims have become incorporated into the consciousness of modern practitioners of many arts and sciences far afield from the original physical sciences which served as the basis for the generation of the positivist world view.

What we shall refer to as positivist writings cover most of the mainstream of modern writings in Western philosophy about science and methodology, particularly those stemming from the works from the Vienna Circle in the 1930's and those within the British analytic tradition. This is admittedly a large umbrella, and we acknowledge that "positivist" might be argued to be the incorrect appellation for any particular philosopher or writing we might name. Whatever the name, however, our claim is that there is an identifiable set of views about science perpetuated by major writers in the field.

### Specific Claim

Our claim is that these writings, such as the one examined here, have to some extent misrepresented the actual activities and methods of science.

In general, the positivist writers have described the claims, methods, procedures, and attitudes of the scientist in a way that can only serve to support and validate the positivist world view. The actual methods of practicing scientists, particularly the method of formulation of hypotheses and the procedure for inquiry, differ substantially. What has made the positivist writings so influential outside the sphere of abstract philosophy is that they have the beneficent aura of a report on the actual practices of scientists rather than the mark of a philosophic treatise with a list of claims. We argue that writers such as Ernest Nagel have created a false picture of the methods and claims of science. Although

logical positivism is dead as a philosophic movement, this false picture is still accepted as substantially correct by some influential writers, educators, and scientists today.

Excerpts from Scientific Method by Morris R. Cohen and Ernest Nagel with comments.

The following excerpts are presented in the order in which they appear in the article. Context and background are omitted. The purpose here is to analyze specific claims and specific sentences in the article, showing how we believe these claims to be flawed. No attempt is made to evaluate the article as a whole or to mention the claims which we feel are correct in the article.

Excerpt 1

The "facts" for which every inquiry reaches out are propositions for whose truth there is considerable evidence...what we believe to be the facts clearly depends upon the stage of our inquiry. There is therefore no sharp line dividing fact from guesses or hypotheses. During any inquiry the status of a proposition may change from that of hypothesis to that fact, or from that of fact to that of hypothesis.

Nagel is elaborating on the "take nothing for granted" attitude of the scientist. But is it really the case that we doubt whether the earth is oblate spheroid or that the coefficient of expansion of steel is  $0.65 \times 10^{-5}$  or that the electron has a unit charge when we investigate a scientific or engineering problem? Are there not some concrete facts upon which we base our inquiry? Surely there are definite scientific facts which may not be doubted, which may not become hypotheses. Nagel is overstating the case apparently in an attempt to emphasize that the scientist is open-minded. Taken to its logical limit, this seemingly harmless passage actually has the implication that there is literally no truth. The passage demonstrates how easily hyperbole may be mistaken for reporting.

Stylistically, the passage is consistent with the entire format of the article. Nagel does not preface his remarks by saying, "I believe that a typical scientist thinks..." (that any fact may become an hypothesis). Nagel does not say, "I claim the method of science to follow the following principles..." Nagel simply states the principles as though he were reporting rather than interpreting. We do not claim there is anything wrong intrinsically with this style as long as it is recognized for what it is.

Excerpt 2

The method of science would be impossible if the hypotheses which are suggested solutions could not be elaborated to reveal what they imply. The full meaning of a hypothesis is to be discovered in its implications.

Hypotheses are suggested to an inquirer by something in the subject matter under investigation, and by his previous knowledge of other subject matters. No rules can be offered for obtaining fruitful hypotheses, any more than rules can be given for discovering significant problems...The number of hypotheses which may occur to an inquirer is without limit, and is a function of the character of his imagination.

Here Nagel offers three statements about hypotheses which are true, followed by two which are open to question. Are there literally no rules in the formation of hypotheses? Nagel has already stated that hypotheses are suggested by something in the subject matter. Clearly, not just any hypothesis will do (e.g., the boiling point of water must have changed since yesterday). Hypotheses are more than guesses or flights of the imagination. If flights of the imagination were counted as legitimate hypotheses, scientific journals would be filled with mere fantasy. We think it reasonable that, at the very minimum, it is easy for the skilled scientist to distinguish good hypotheses from poor ones without having to pick one at random and consider all of its consequences. A reasoned understanding of one's field is more likely to produce good hypotheses. Nagel would probably agree with this last assertion. More work is being done on how hypotheses are made through a logical creative process (although discussion of same cannot be pursued here.)

### Excerpt 3

No hypothesis which states a general proposition can be demonstrated as absolutely true. We have seen that all inquiry which deals with matters of fact employs probable inference. The task of such investigations is to select the hypothesis which is the most probable on the factual evidence; and it is the task of further inquiry to find other factual evidence which will increase or decrease the probability of such a theory.

Nagel seems to claim that there is no such thing as truth, that there is only probability. In the final analysis, everything is uncertain, even the shape of the earth. Nagel seems to imply one would be required to subscribe to this view if one were to be a scientist. He evidently relies on two main principles of the positivist view:

1. Truth is probable. We can never arrive at definitive answers.
2. In order to verify an hypotheses, one must follow the principles of formal logic.

Nagel and the positivists in general seem content with this view of truth. A view or opinion about the nature of truth is presented

as though it were a fact. The nature of truth in science is, of course, one of the fundamental problems in the philosophy of science and continues to be debated at present.

To our knowledge, at no point does Nagel supply the evidence that the structures of formal logic are adequate to describe the inferences of science (this was subsequently attempted by many philosophers -- to little avail). Investigators have difficulty understanding why Nagel does not tell how inductive processes operate in science or why he does not make clear that formal and mathematical interpretations of material phenomena must be superimposed. In addition, there is difficulty as to why he does not make clear that the connection between mathematics, logic, and natural phenomena is philosophically problematic. In short, Nagel tends to avoid philosophical discussion by stating what he believes the essence of scientific method to be.

#### IV. New Directions

Rediscovering the historical roots of modern science is an important phase in solving the dilemmas in modern philosophy of science. If some of the original concepts of Aristotelian science can be applied to current thinking about science and engineering, this will likely dissolve old problems while at the same time illuminating new ones. Efforts in this direction have already begun. (See Appendix B and main text.) There has been and will continue to be a great deal of basic work which will assist in forging a coherent vision of science.



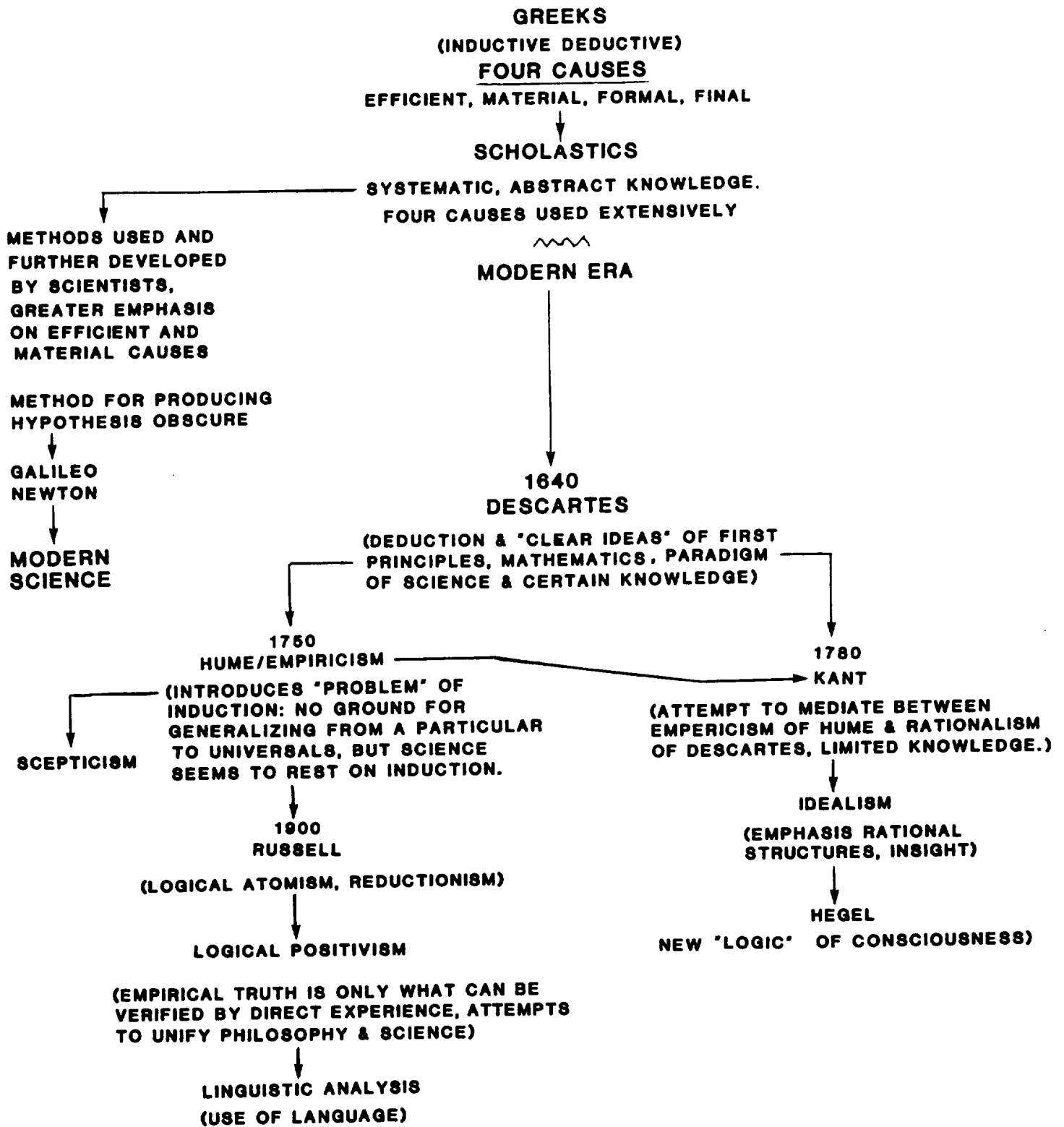

THE PROBLEM: BECAUSE THE ANGLO-AMERICAN PHILOSOPHIC SCIENTIFIC AND EDUCATIONAL COMMUNITY HAS BEEN INFLUENCED BY THE EMPIRICIST TRADITION, IT FAILS TO RECOGNIZE THAT SCIENCE UTILIZES THE FOUR CAUSES AND A METHOD OF RETRODUCTION (WHICH INCORPORATES INDUCTION AND DEDUCTION) AS A PROCEDURE FOR OBTAINING HYPOTHESES. THIS HAS LED TO A POPULAR AND ACADEMIC MISUNDERSTANDING OF THINKING AND THE NATURE OF THE CREATIVE PROCESS IN SCIENCE, ENGINEERING, MATHEMATICS, AND EDUCATION.

FIGURE 1 CHART OF PHILOSOPHICAL HISTORY

# REPORT DOCUMENTATION PAGE

*Form Approved*  
OMB No. 0704-0188

Public reporting burden for this collection of information is estimated to average 1 hour per response, including the time for reviewing instructions, searching existing data sources, gathering and maintaining the data needed, and completing and reviewing the collection of information. Send comments regarding this burden estimate or any other aspect of this collection of information, including suggestions for reducing this burden, to Washington Headquarters Services, Directorate for Information Operations and Reports, 1215 Jefferson Davis Highway, Suite 1204, Arlington, VA 22202-4302, and to the Office of Management and Budget, Paperwork Reduction Project (0704-0188), Washington, DC 20503.

<b>1. AGENCY USE ONLY (Leave blank)</b>	<b>2. REPORT DATE</b> June 1994	<b>3. REPORT TYPE AND DATES COVERED</b> Technical Memorandum	
<b>4. TITLE AND SUBTITLE</b>  Creative Inventive Design and Research		<b>5. FUNDING NUMBERS</b>  754	
<b>6. AUTHOR(S)</b>  James J. Kerley			
<b>7. PERFORMING ORGANIZATION NAME(S) AND ADDRESS(ES)</b>  Goddard Space Flight Center Greenbelt, Maryland 20771		<b>8. PERFORMING ORGANIZATION REPORT NUMBER</b>  94B00088	
<b>9. SPONSORING/MONITORING AGENCY NAME(S) AND ADDRESS(ES)</b>  National Aeronautics and Space Administration Washington, D.C. 20546-0001		<b>10. SPONSORING/MONITORING AGENCY REPORT NUMBER</b>  TM-104607	
<b>11. SUPPLEMENTARY NOTES</b>			
<b>12a. DISTRIBUTION/AVAILABILITY STATEMENT</b> Unclassified-Unlimited Subject Category 31 Report available from the NASA Center for AeroSpace Information, 800 Elkridge Landing Road, Linthicum Heights, MD 21090; (301) 621-0390.		<b>12b. DISTRIBUTION CODE</b>	
<b>13. ABSTRACT (Maximum 200 words)</b>  This paper is a summary of a course given at the Goddard Space Flight Center for graduate engineers entitled "Creative Inventive Design and Research." This course strikes at the heart of the problem as it describes the thinking process itself before it goes deeper into the design process as a structured method for performing creative design. Many problem examples and figures are presented in a form that should make clear to all students what this process is and how it can be used.			
<b>14. SUBJECT TERMS</b>		<b>15. NUMBER OF PAGES</b> 83	
		<b>16. PRICE CODE</b>	
<b>17. SECURITY CLASSIFICATION OF REPORT</b> Unclassified	<b>18. SECURITY CLASSIFICATION OF THIS PAGE</b> Unclassified	<b>19. SECURITY CLASSIFICATION OF ABSTRACT</b> Unclassified	<b>20. LIMITATION OF ABSTRACT</b> Unlimited



National Aeronautics and  
Space Administration

Goddard Space Flight Center  
Greenbelt, Maryland 20771

Official Business  
Penalty for Private Use, \$300

SPECIAL FOURTH-CLASS RATE  
POSTAGE & FEES PAID  
NASA  
PERMIT No. G27



POSTMASTER: If Undeliverable (Section 158,  
Postal Manual) Do Not Return

---