

1995104159

303117

N95-10571

Determining F-Factor Using Ground-Based
Doppler Radar: Validation and Results.

D. Elmore, D. Albo,

and R. Goodrich,

National Center for Atmospheric Research

F-Factor Determination Using Ground-Based Doppler Radar: Validation and Results

K. L. Elmore, E. D. Albo, and R. K. Goodrich

Research Applications Program,
National Center for Atmospheric Research

Using a two-dimensional linear least-squares method applied to Doppler radar data, we test the viability of determining F-factor remotely. The ultimate application of such an algorithm will be supplying real-time F-factor maps, derived from ground-based Doppler radars to air traffic control personnel and pilots. Data from NASA deployments to the MIT/Lincoln Lab TDWR testbed radar in Orlando in 1991 and 1992 along with NASA deployments to the NCAR TDWR testbed radar in Denver are examined. Preliminary analyses show that the two-dimensional method correlates reasonably well with *in situ* measurements. Several effects, independent of the method used, act to reduce the correlation to less than 1. These include time differences between radar and aircraft data, vertical misalignment between the aircraft and the radar beam, different spatial resolution scales between aircraft and radar data, inhomogeneous radar beam filling, noise in radar data that eludes filtering and phase lag between time and space due to low pass filtering of the aircraft data. In the final assessment, it appears that a shear-based F-factor algorithm is preferable to the currently implemented TDWR algorithms which lack any local shear estimates.

Problem: Develop a windshear hazard index, based on ground-based Doppler radar data, that qualitatively describes the expected aircraft performance loss along a given flight path.

Define the performance parameter as F , where

$$F = \frac{1}{g} \frac{\partial V}{\partial t} - \frac{w}{GS}$$

where: g is acceleration due to gravity
 V is the aircraft longitudinal wind component
 w is the vertical wind component
 GS is the aircraft ground speed.

Summer '92: NASA flies instrumented 737 through Denver and Orlando microbursts close to radar beam height. Compare *in situ* aircraft data to shear estimates using TDWR testbed radar. We estimate F by

$$F = \frac{1}{g} U_r GS - \frac{w}{GS}$$

where U_r is radial shear. U_r is estimated by a two dimensional least squares fit of the radial doppler velocity. We estimate w by

$$w = -2 U_r Z$$

where Z is the height of the beam. We are assuming local symmetry of the microburst. This estimate for w is used at all points where we detect divergence ($U_r > 0$).

Using weighted least squares, solve
and get

$$U_r = \frac{\sum i U_{i,j} W_{i,j}}{\Delta r \sum i^2 W_{i,j}}$$
$$U_s = \frac{\sum \Delta S_{i,j} U_{i,j} W_{i,j}}{\sum (\Delta S_{i,j})^2 W_{i,j}}$$

where

$U_{i,j}$ = radial velocity at i, j ,

$\Delta S_{i,j} = r_i \phi_j$ and

$W_{i,j}$ = weight.

We estimate the horizontal F factor by

$$F_h = \frac{1}{g} \frac{\partial V}{\partial t} \approx \frac{1}{g} \cdot U_I \cdot GS$$

and the vertical F factor by

$$F_v = -\frac{W}{GS} \approx \frac{2U_I Z}{GS}$$

when we detect divergence and

$$F_v = \frac{U_I Z}{GS}$$

when we detect convergence.

Total F is approximated by

$$F = F_h + F_v.$$

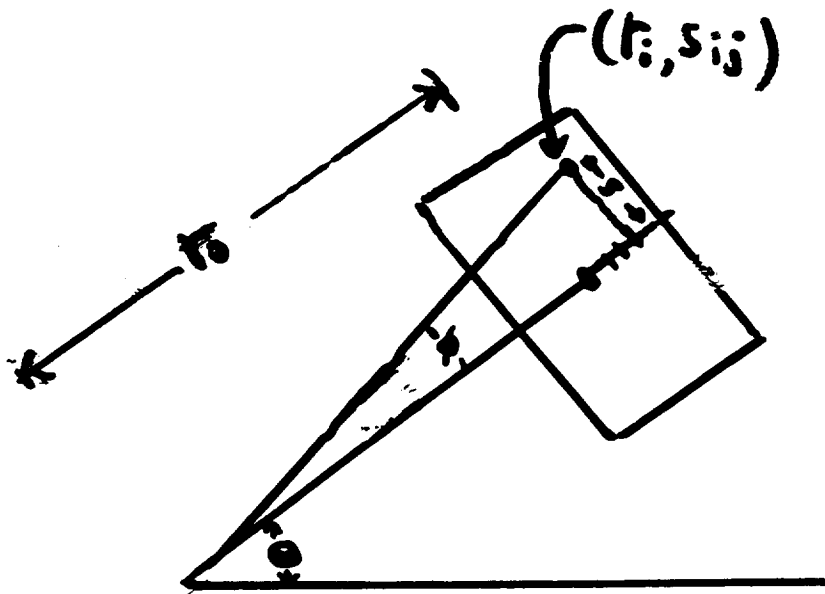

$$s = r\phi$$

$$s_{ij} \equiv r_i \phi_j$$

$$r_i = r_0 + i\Delta r$$

$$\phi_j = j\Delta\phi$$

$u(r, \theta) \neq$ radial velocity

fit locally

$$\tilde{u}(r, s) = u_0 + u_r(r - r_0) + u_s(s - s_0)$$

85th Percentile

Flight Path

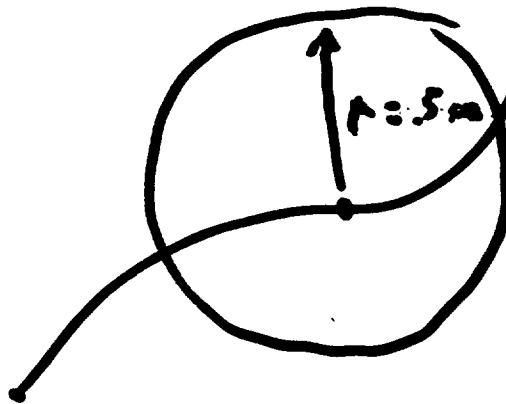

Radial Velocity

TIME 90 OF 19 21 33 20

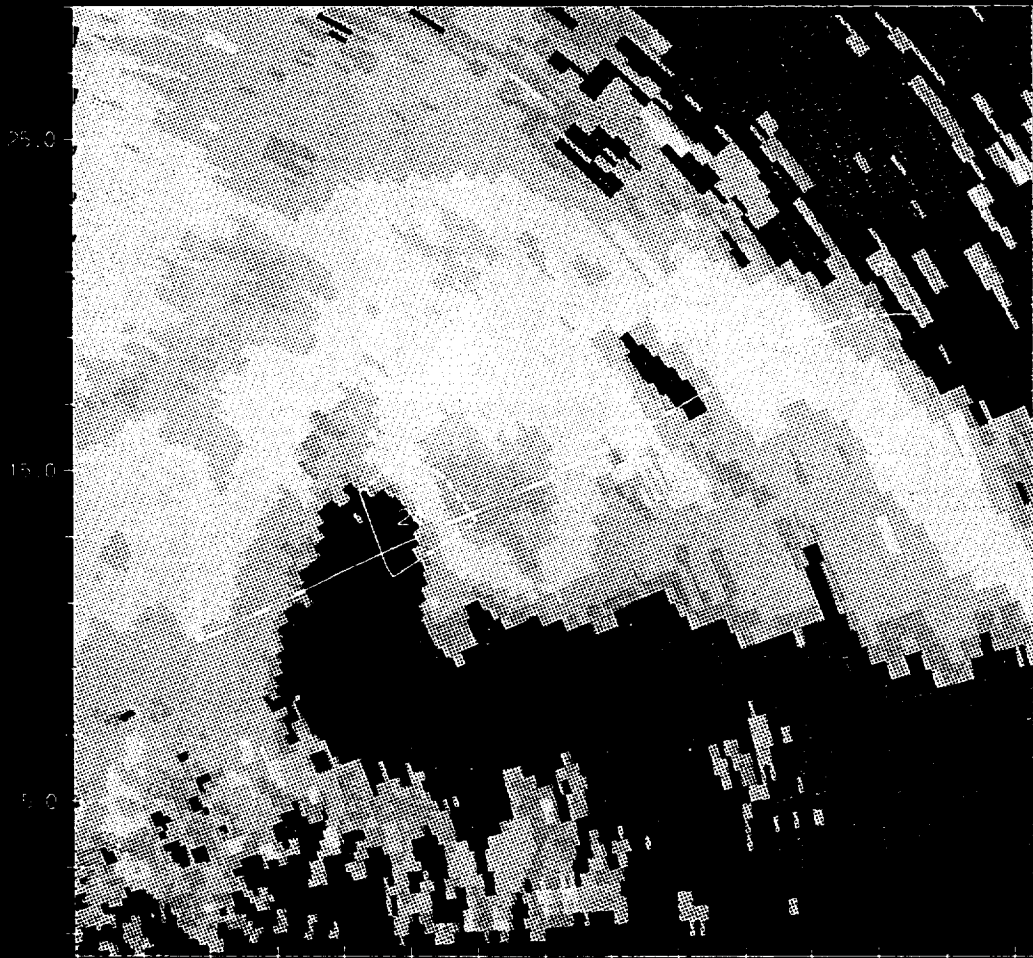

15.0 25.0 35.0
-292:191616181210 9 7 6 4 3 2 1 0 1 2 3 4 5 6 7 8 9 10 11 12 13 14 15 16 17 18 19 20 21

ORIGINAL POINTS

TIME 92 08 19 21 33 20

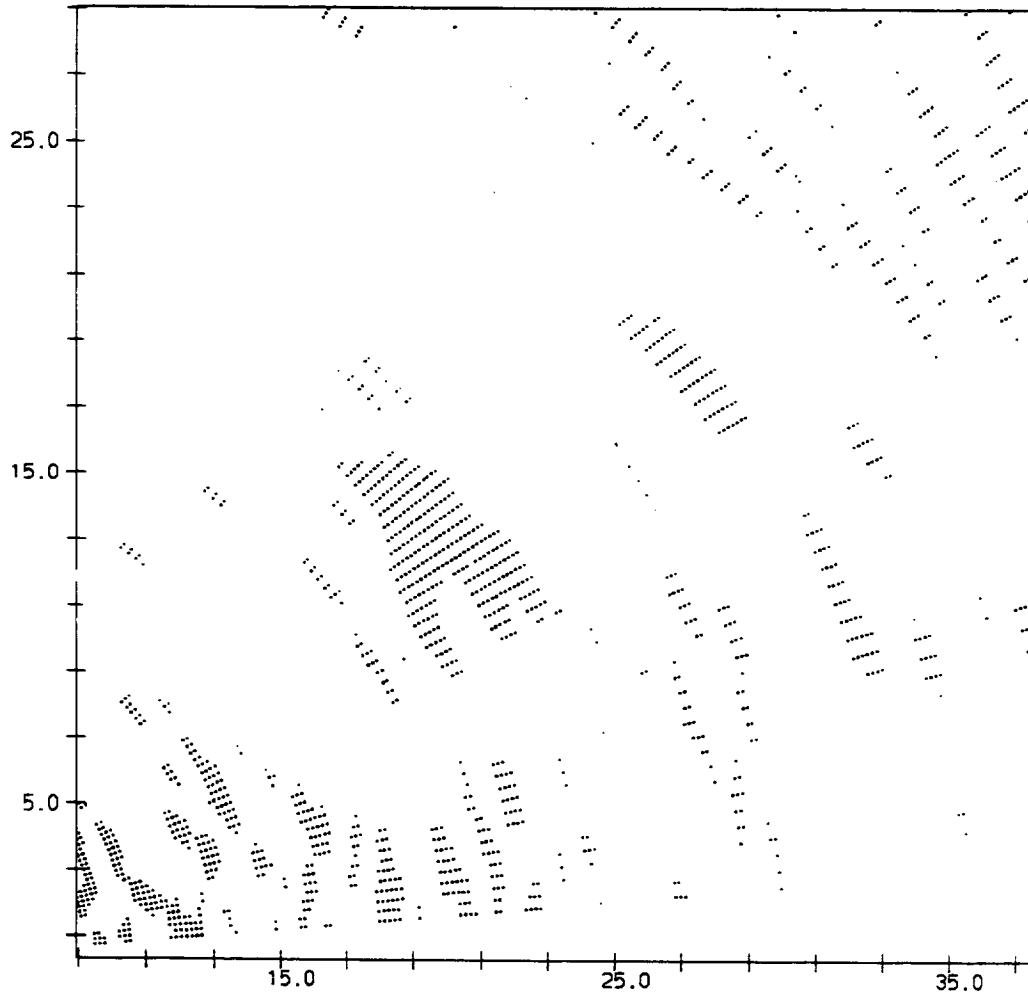

$u_r \approx 0.002$

Segments

TIME 92 08 19 21 33 20

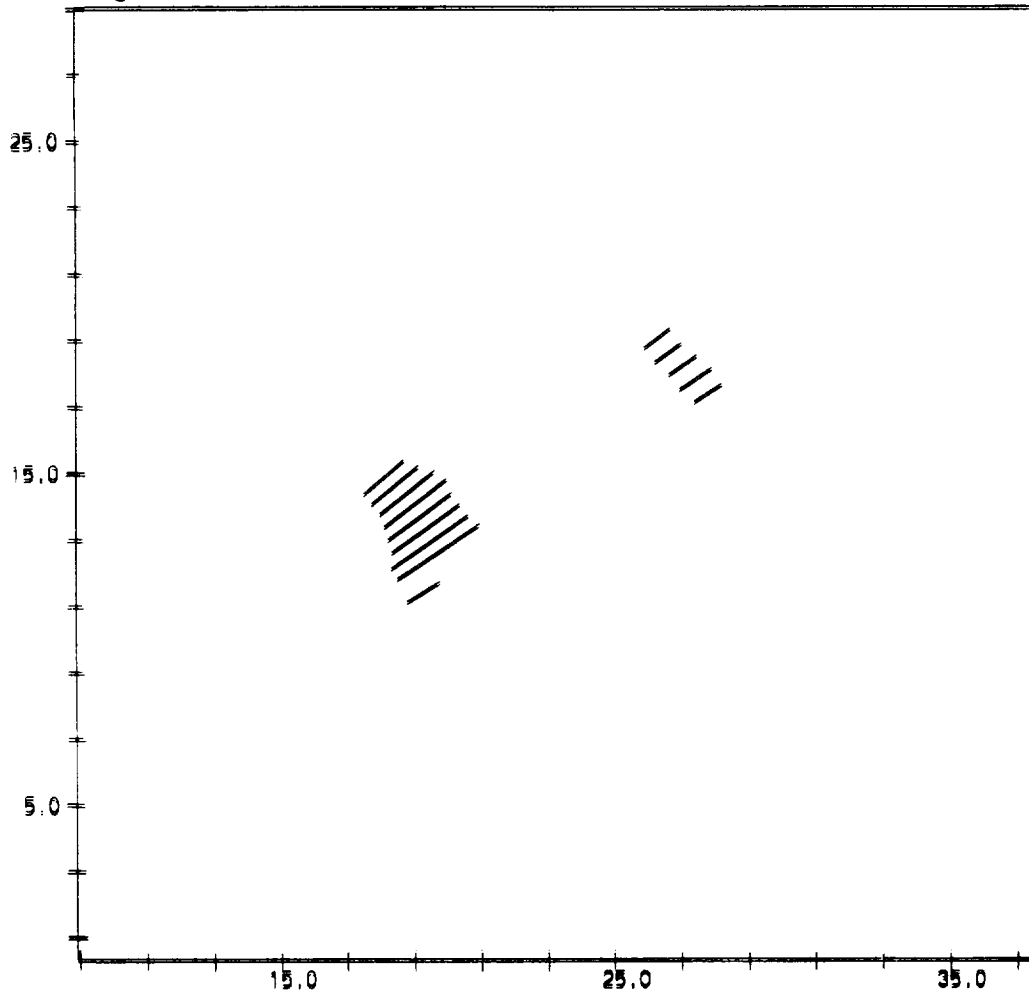

Filtered FEATURES

TIME =92 08 19 21 33 20

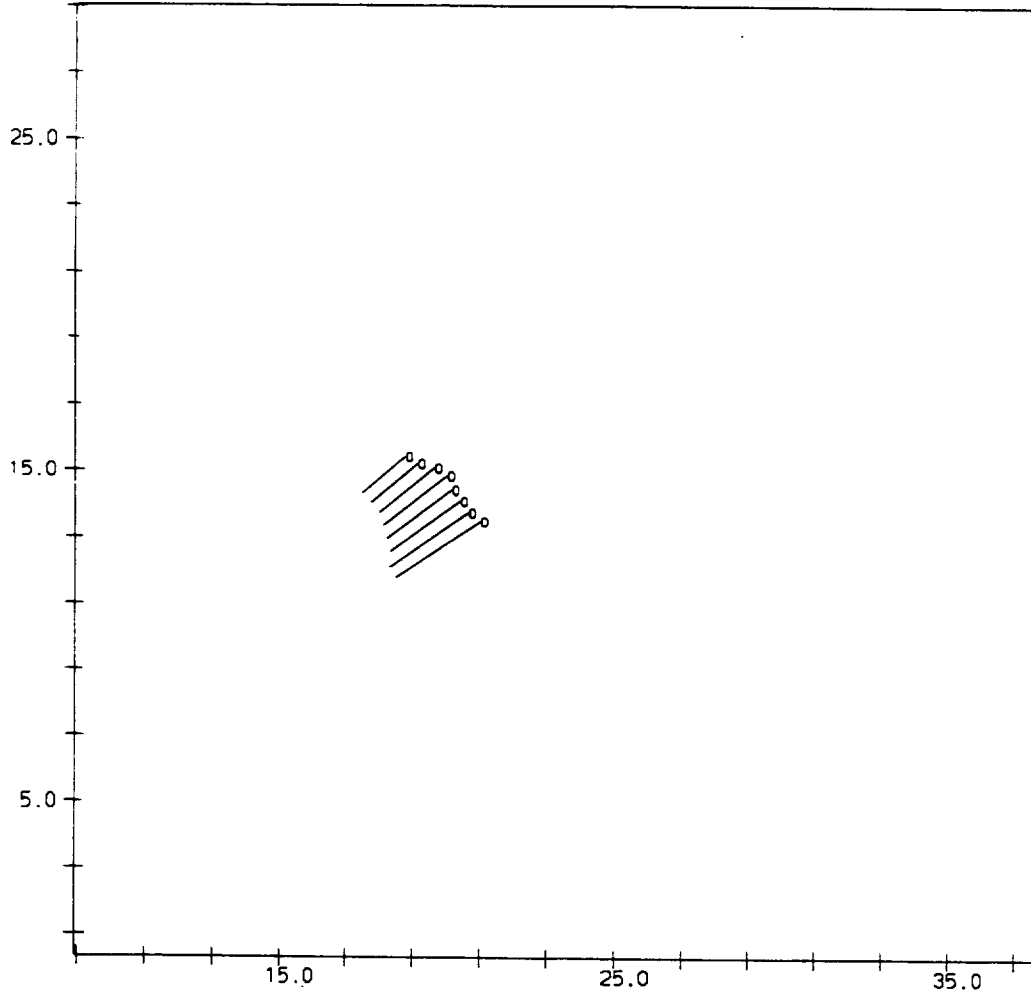

MAD SHAPES

TIME 92 08 19 21 33 20

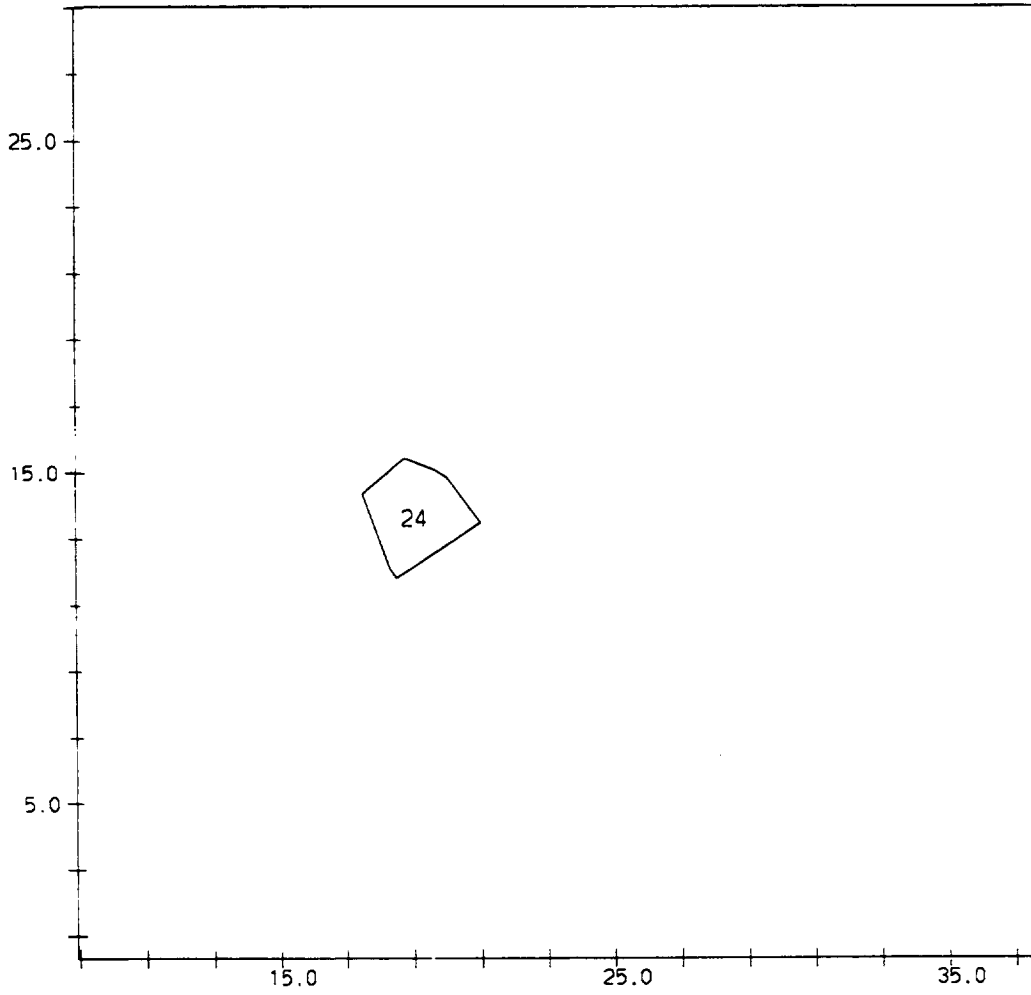

Factors Affecting Individual Path Correlations

Time differences between aircraft penetration and radar data collection.

Vertical mismatch between aircraft flight path and radar beam; aircraft either above or below the beam.

Aircraft distance from beam (too close or too far from radar).

Spatial resolution scale differences; the aircraft resolves smaller scales than the radar.

Inhomogeneous radar beam filling; scatterers may not be evenly distributed throughout the beam illumination volume.

Small scale noise within radar data that eludes median filtering.

Phase lag between time and space of aircraft data due to low-pass filtering.

Radial Velocity

TIME =92 07 24 01 25 17

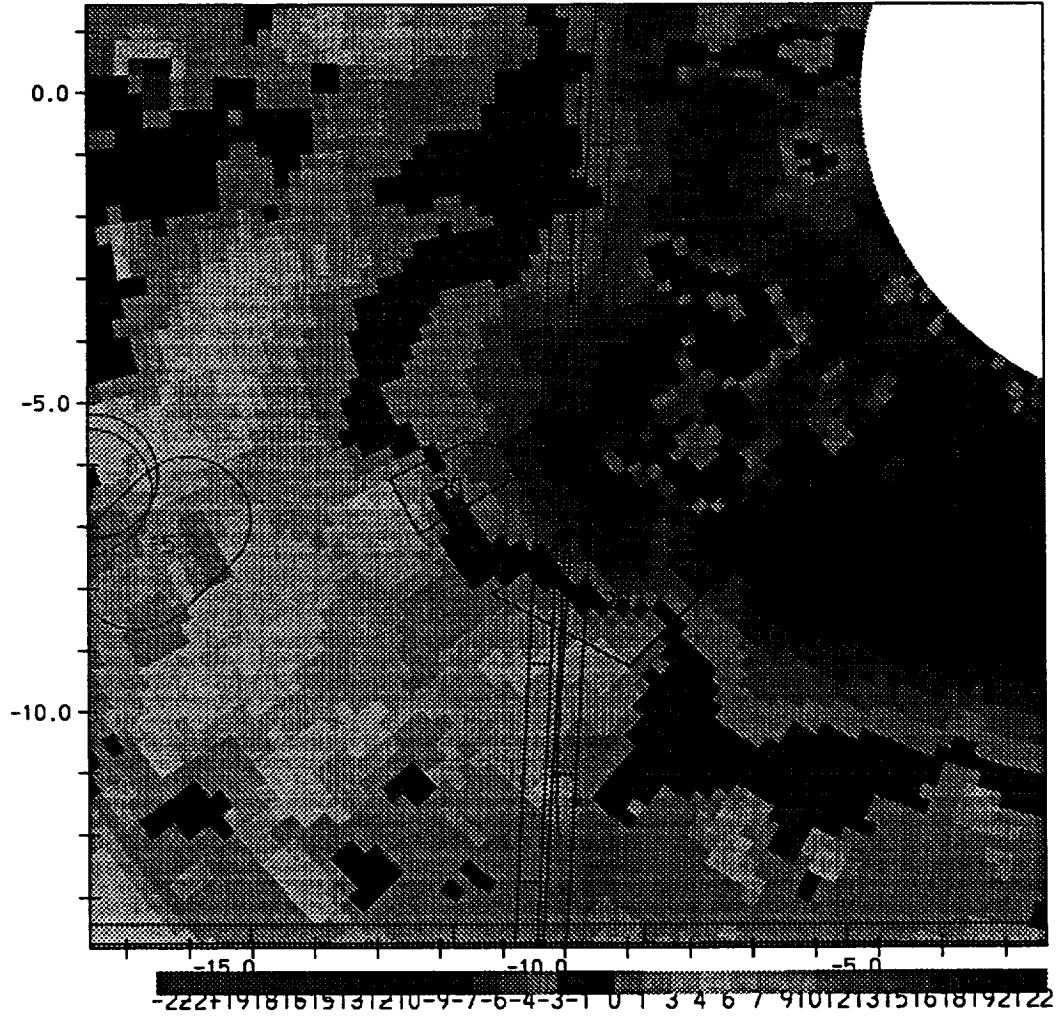

b462 Flight Path

TIME =92 07 24 01 27 16

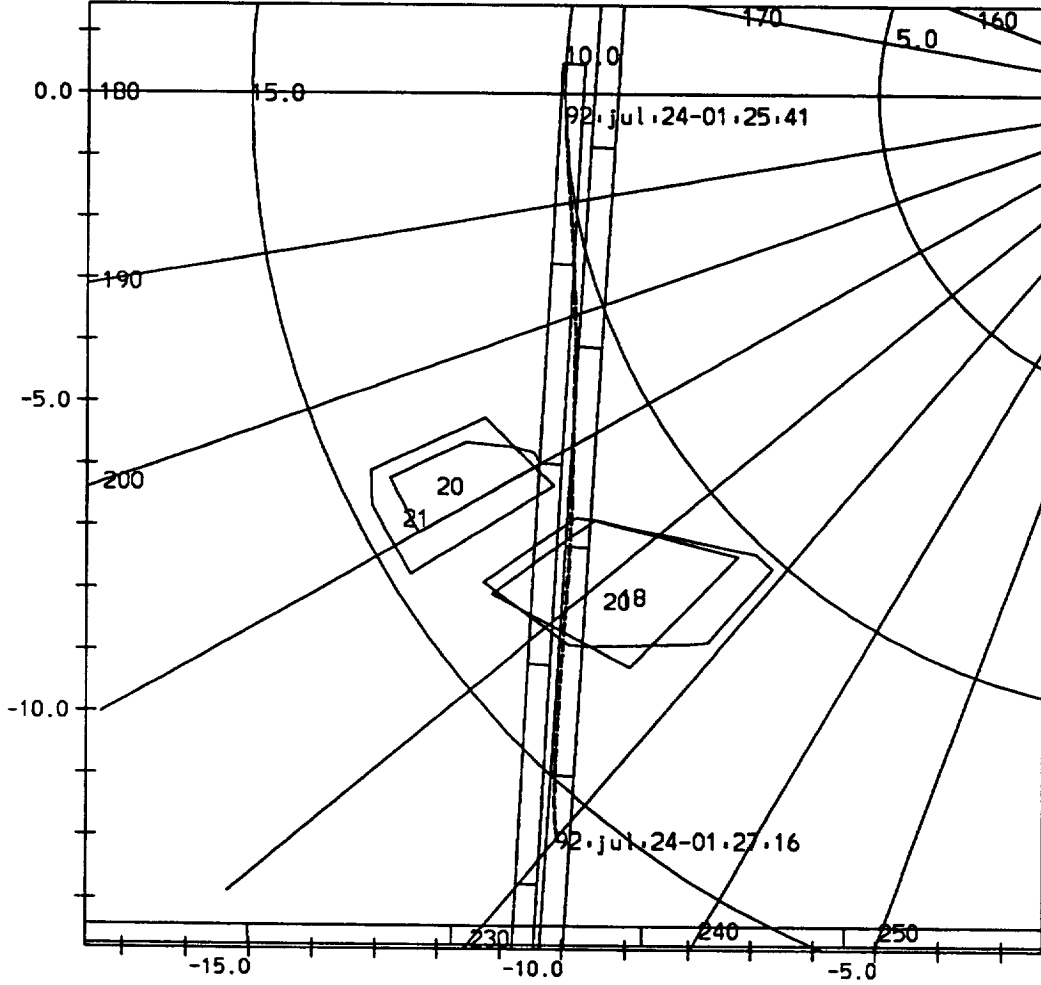

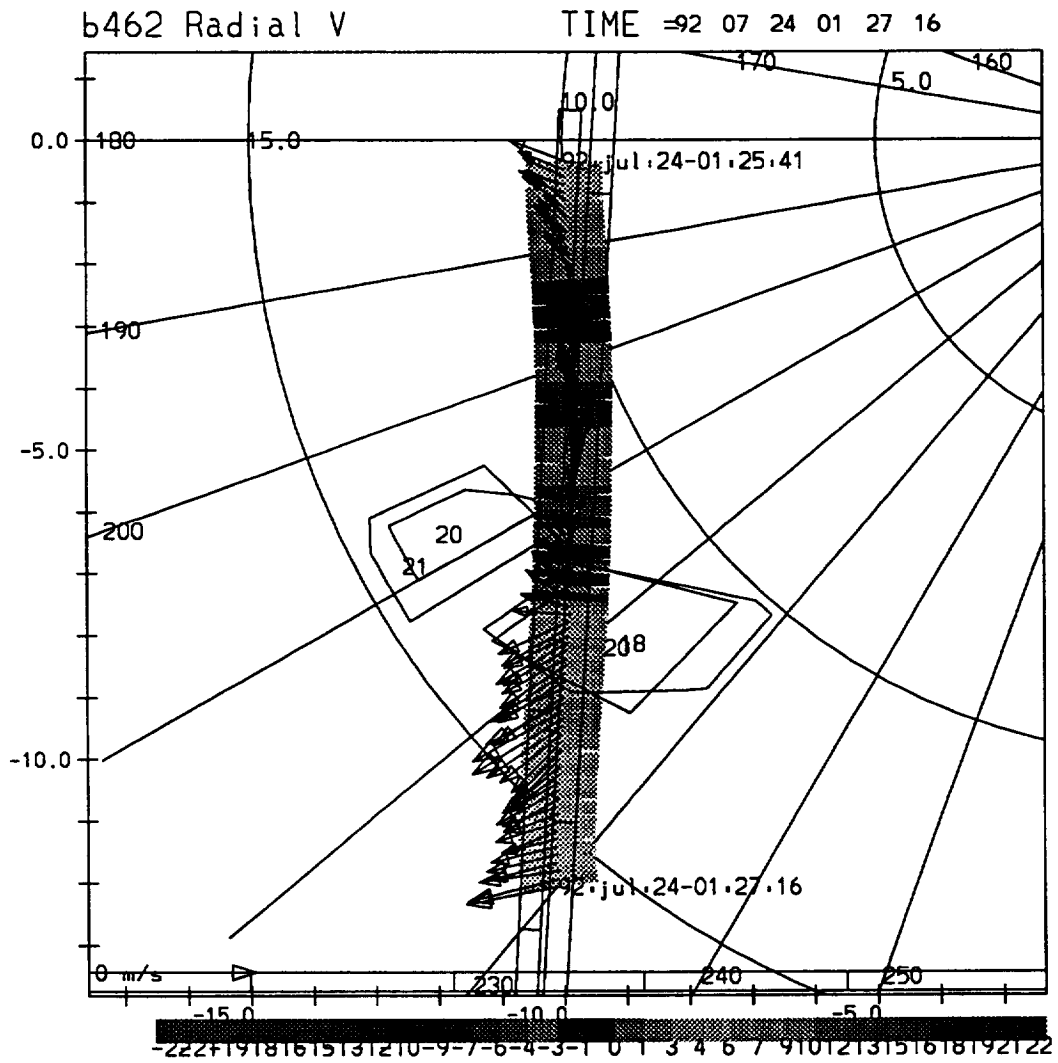

b462 Radar Data

TIME =92 07 24 01 27 16

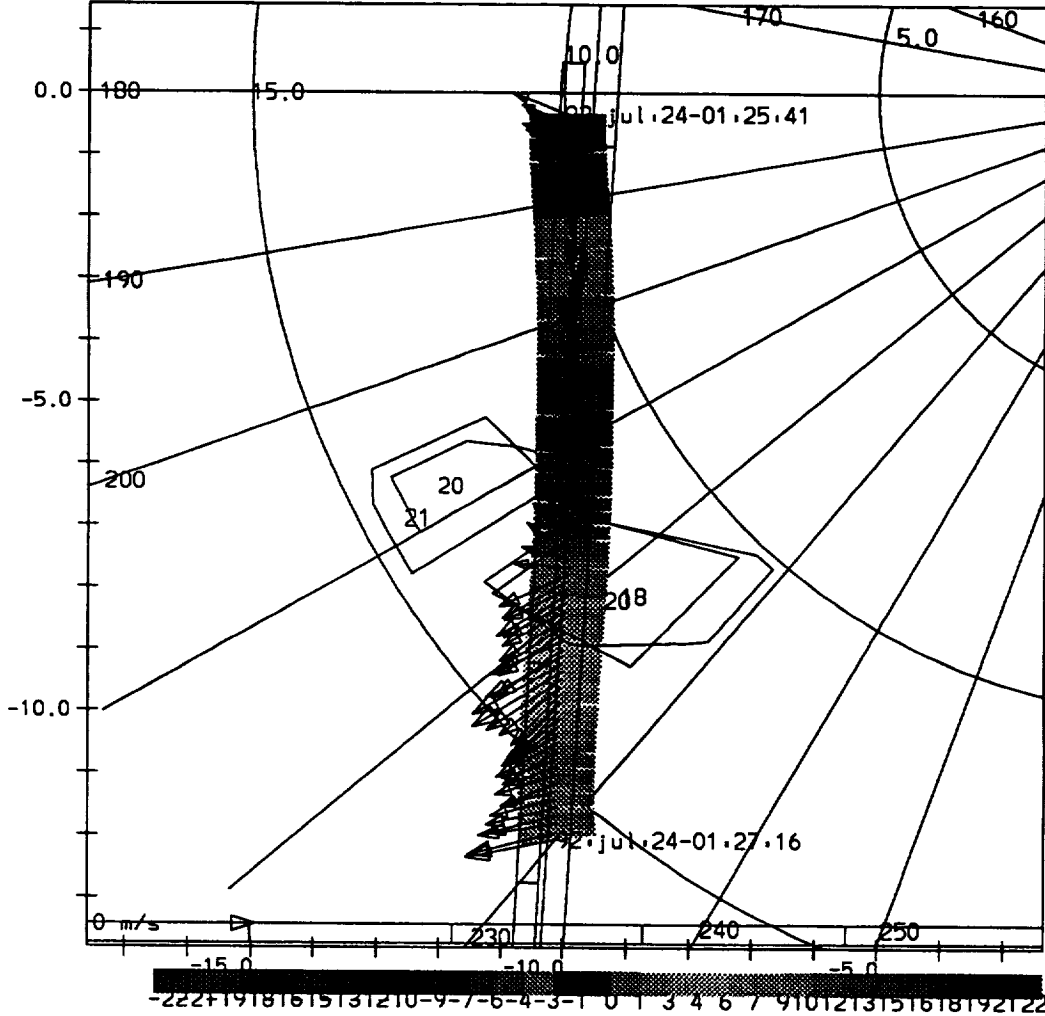

Elev Stats:b462

Aircraft

Radar

Min Radar

Max Radar

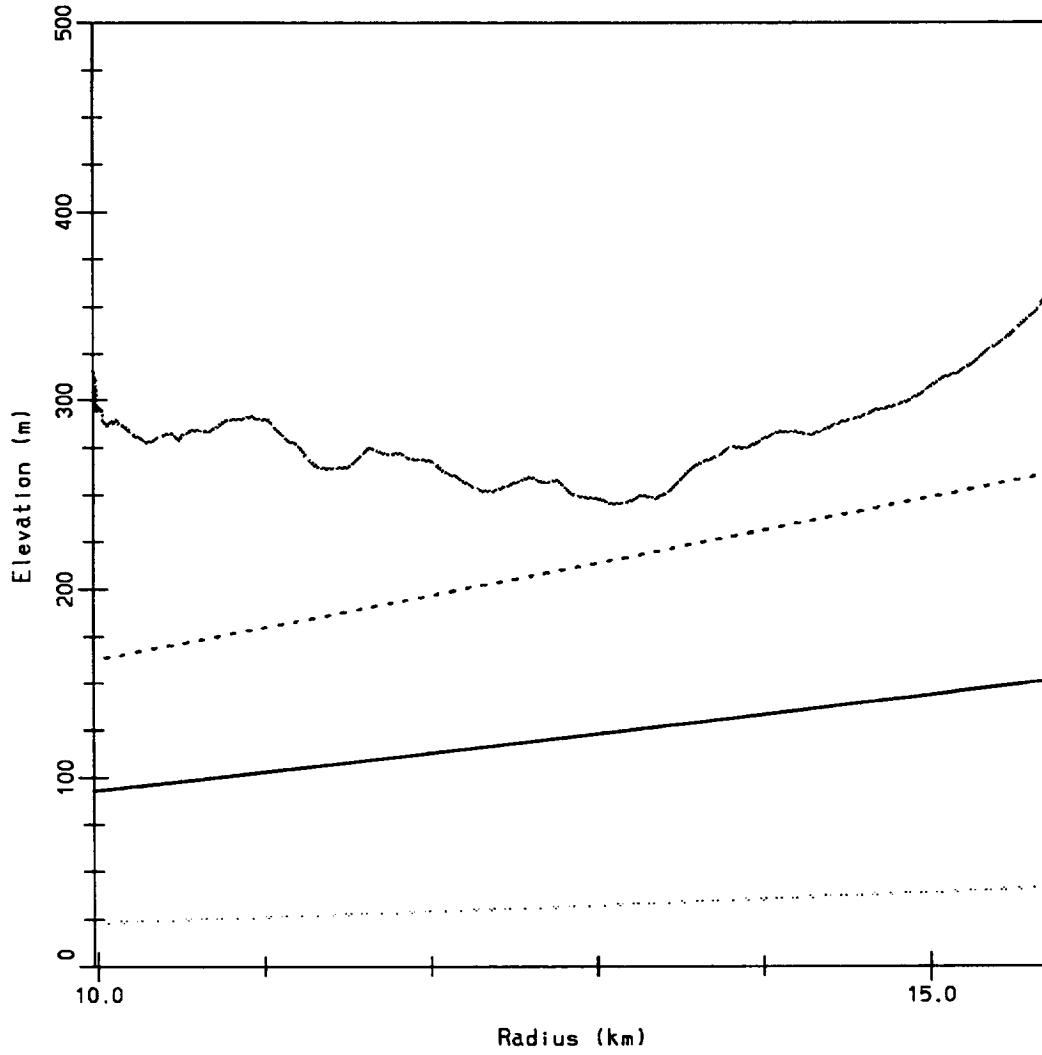

Velocity Stats:b462

85th pct Truth

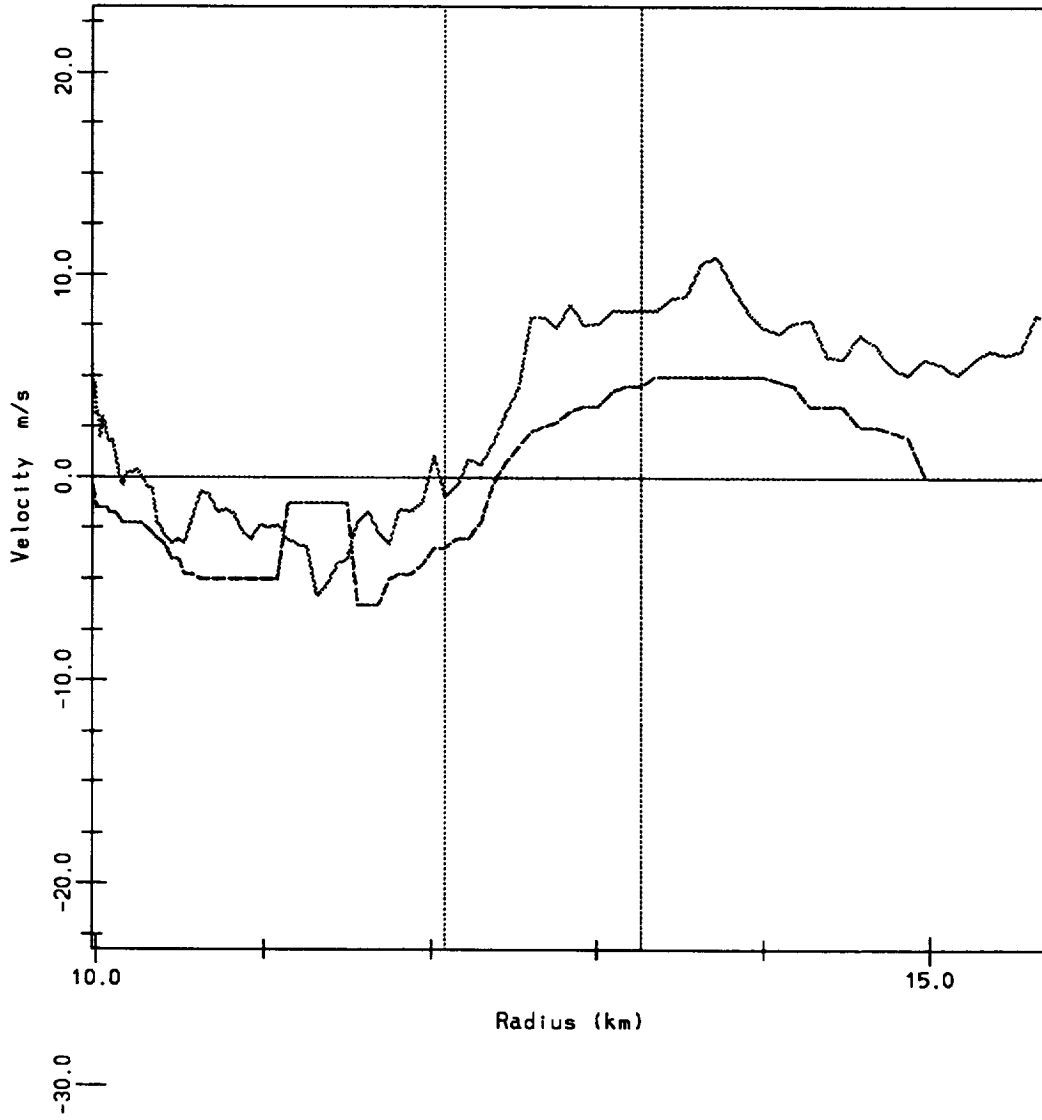

F_Factor Stats.b462

85th pct Truth

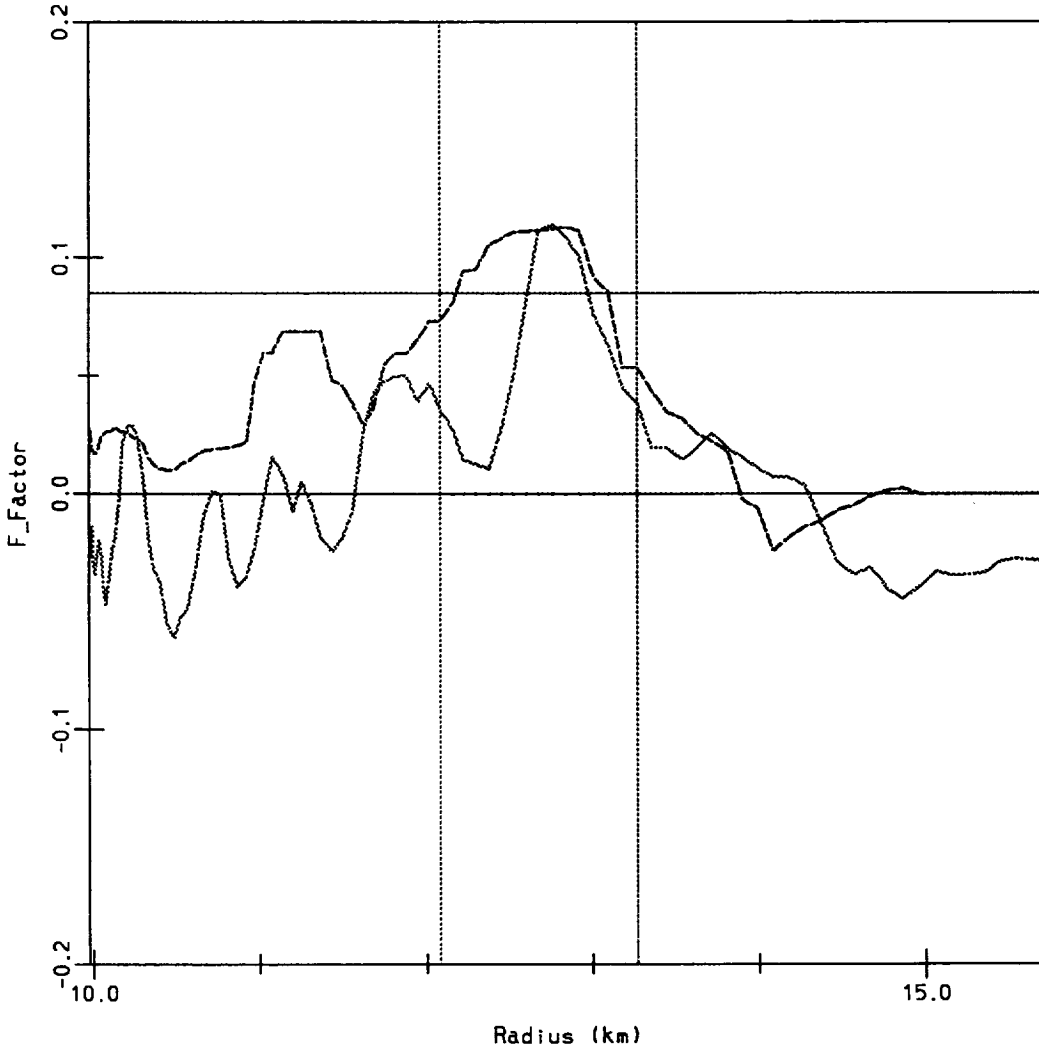

f_horiz Stats:b462

85th pct Truth

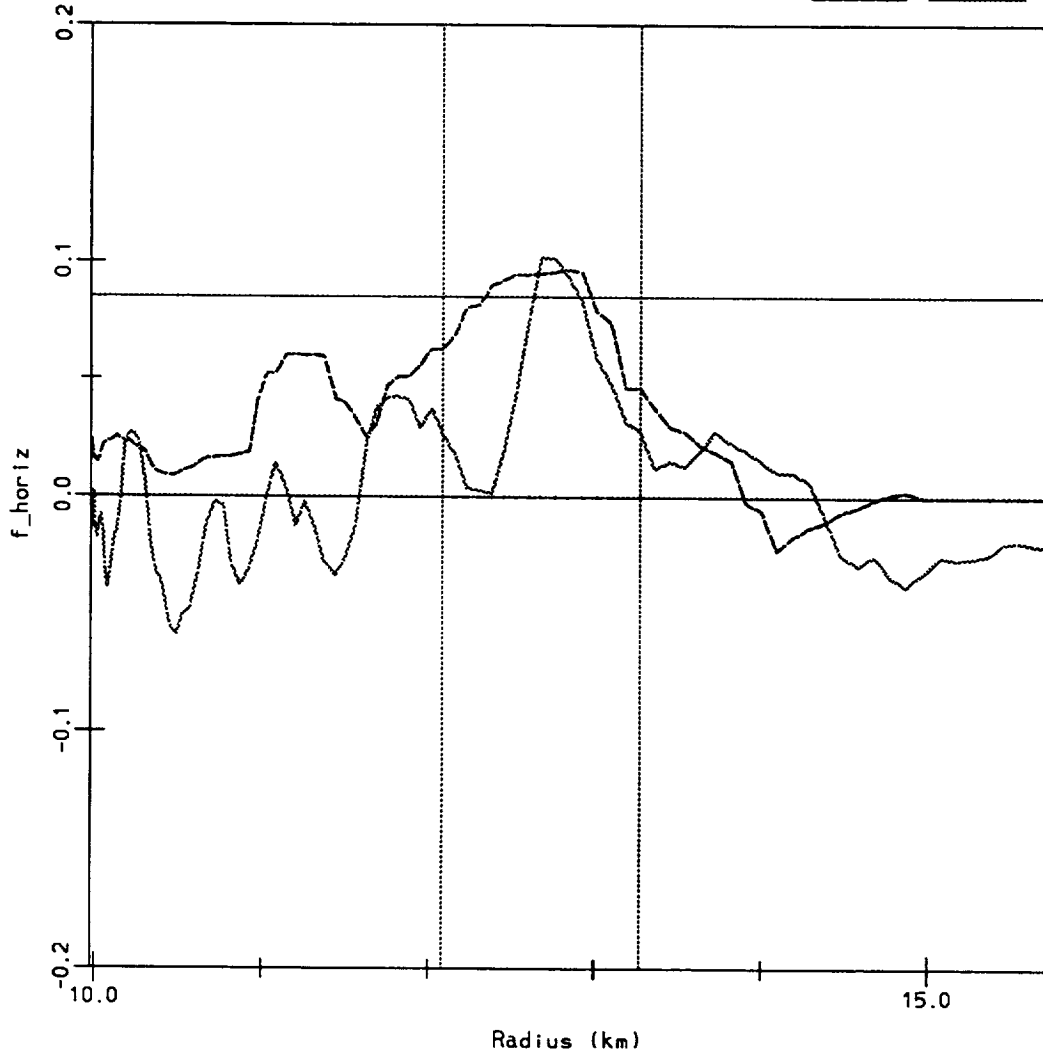

Vertical_F Stats.b462

85th pct Truth

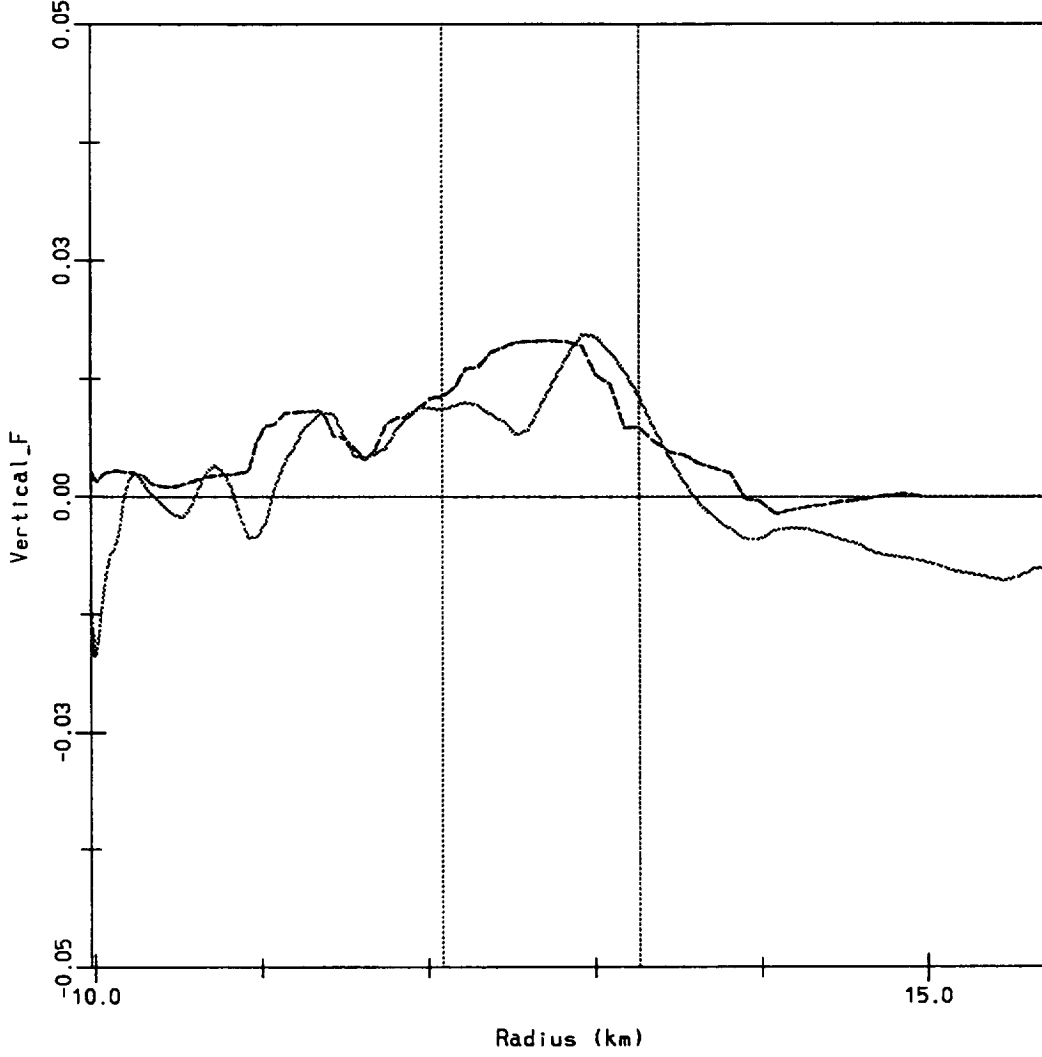

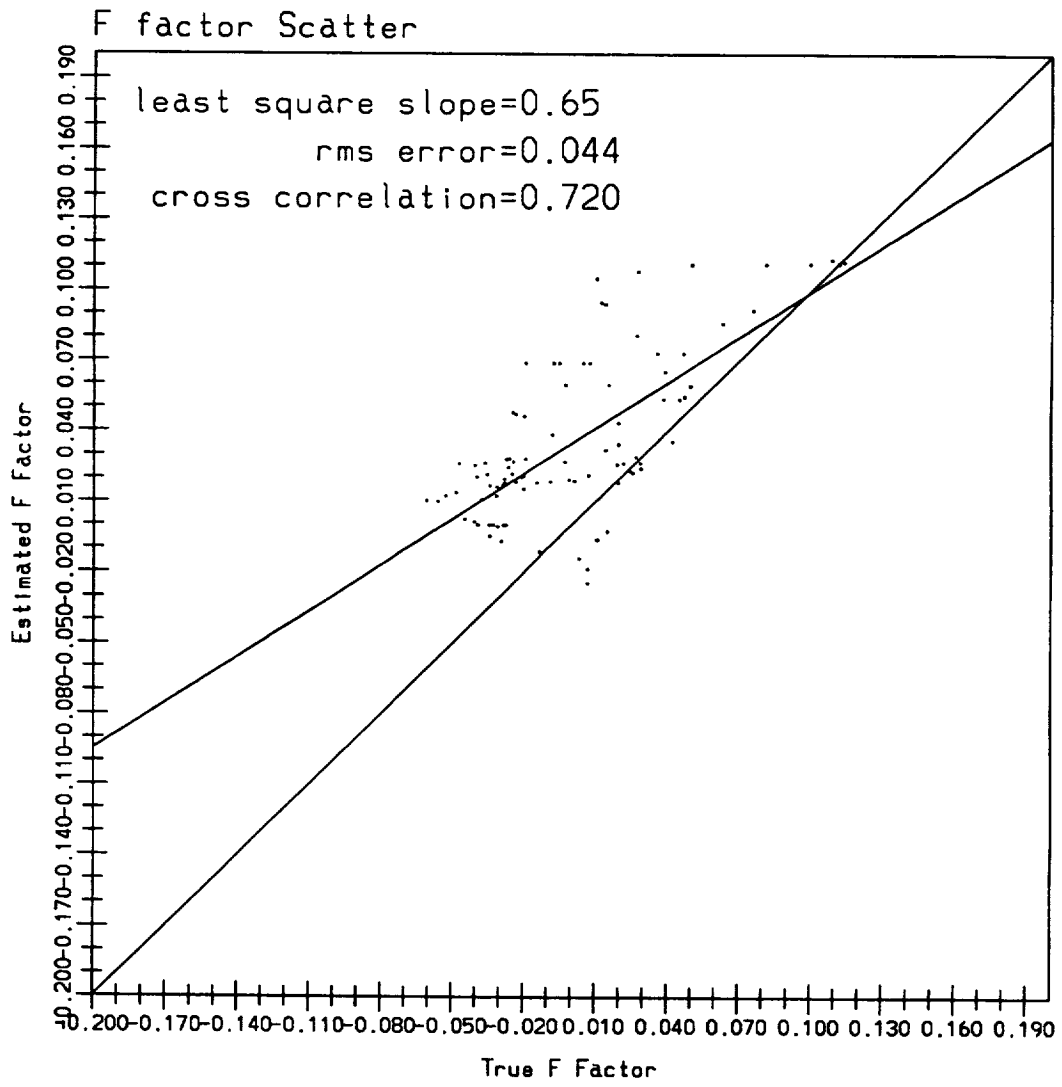

F_Factor Stats.b462

85th pct Truth

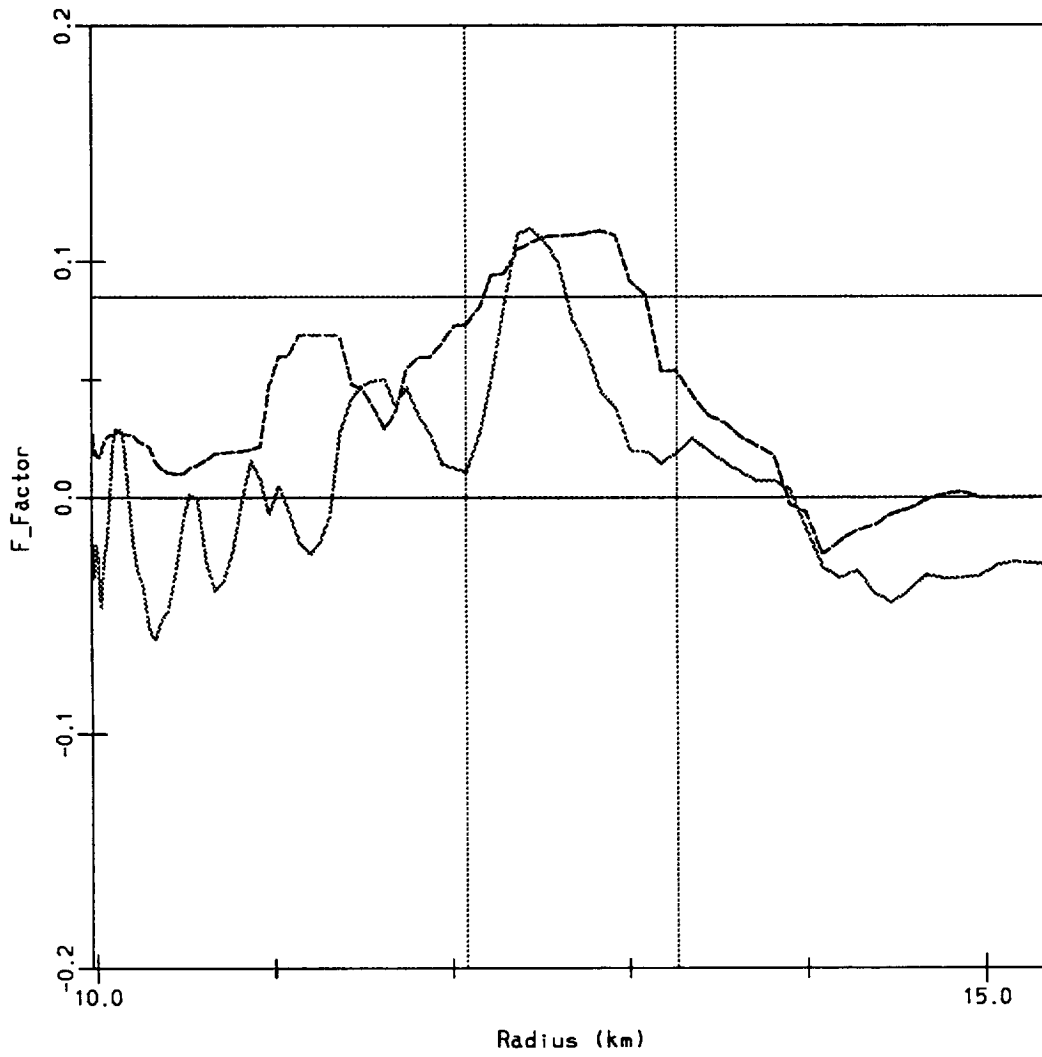

f_horiz Stats.b462

85th pct Truth

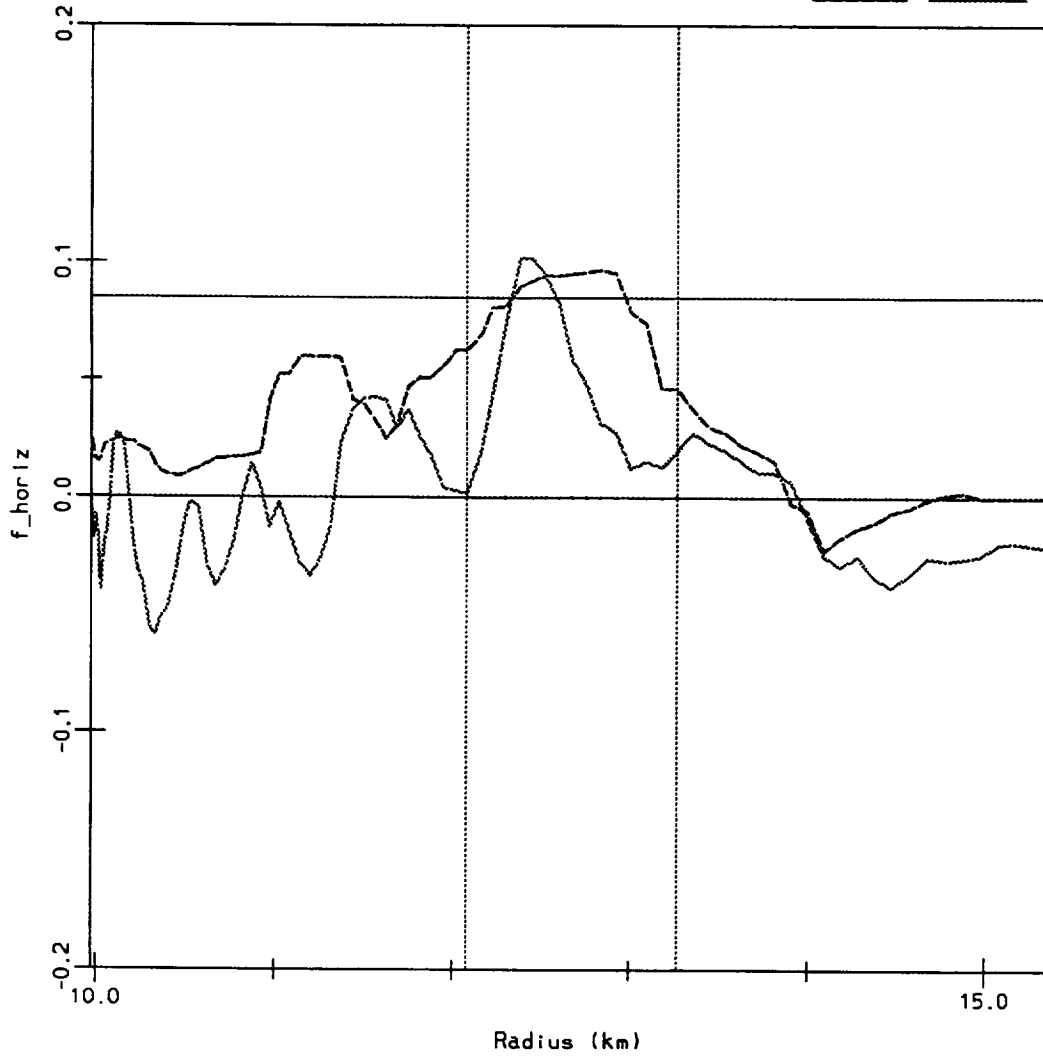

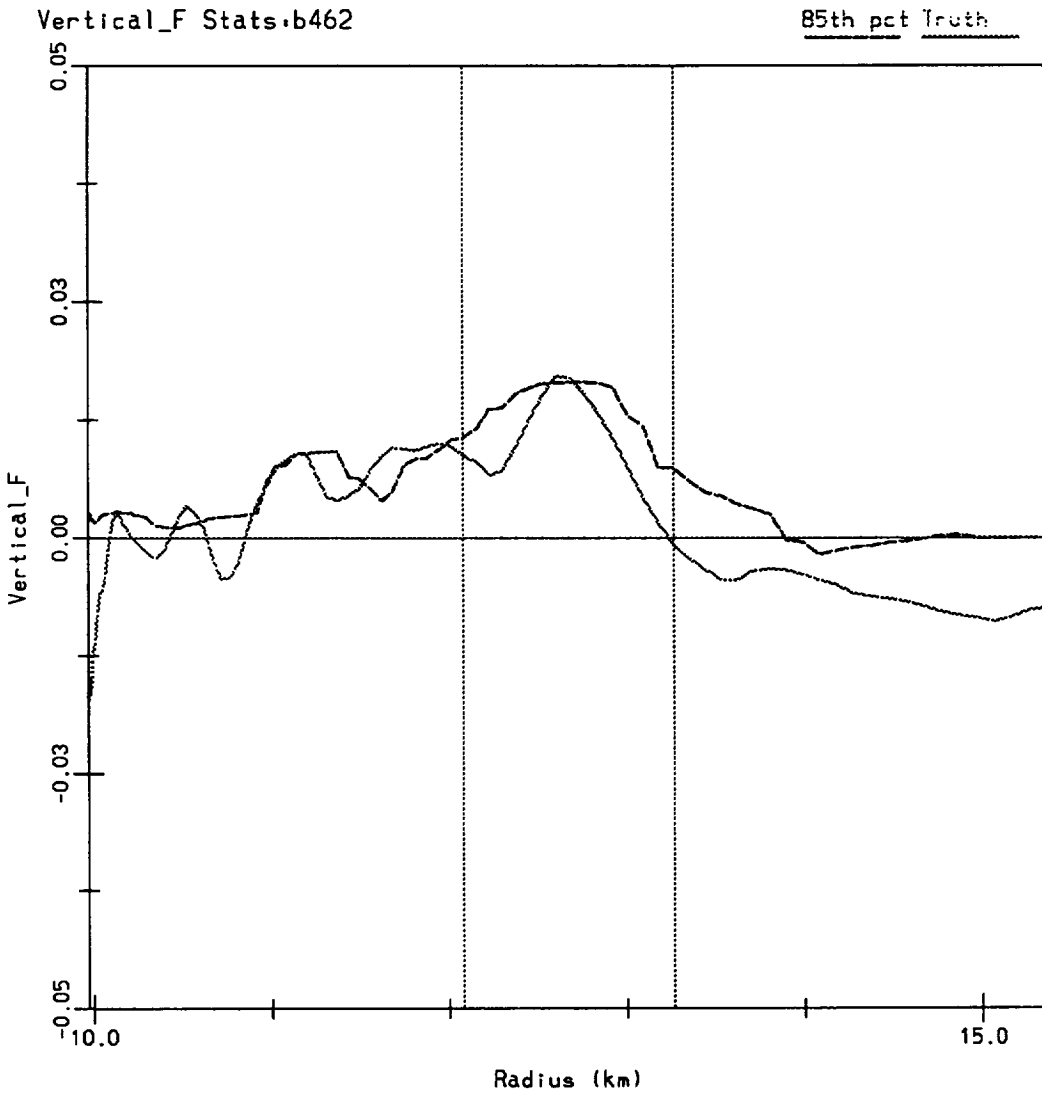

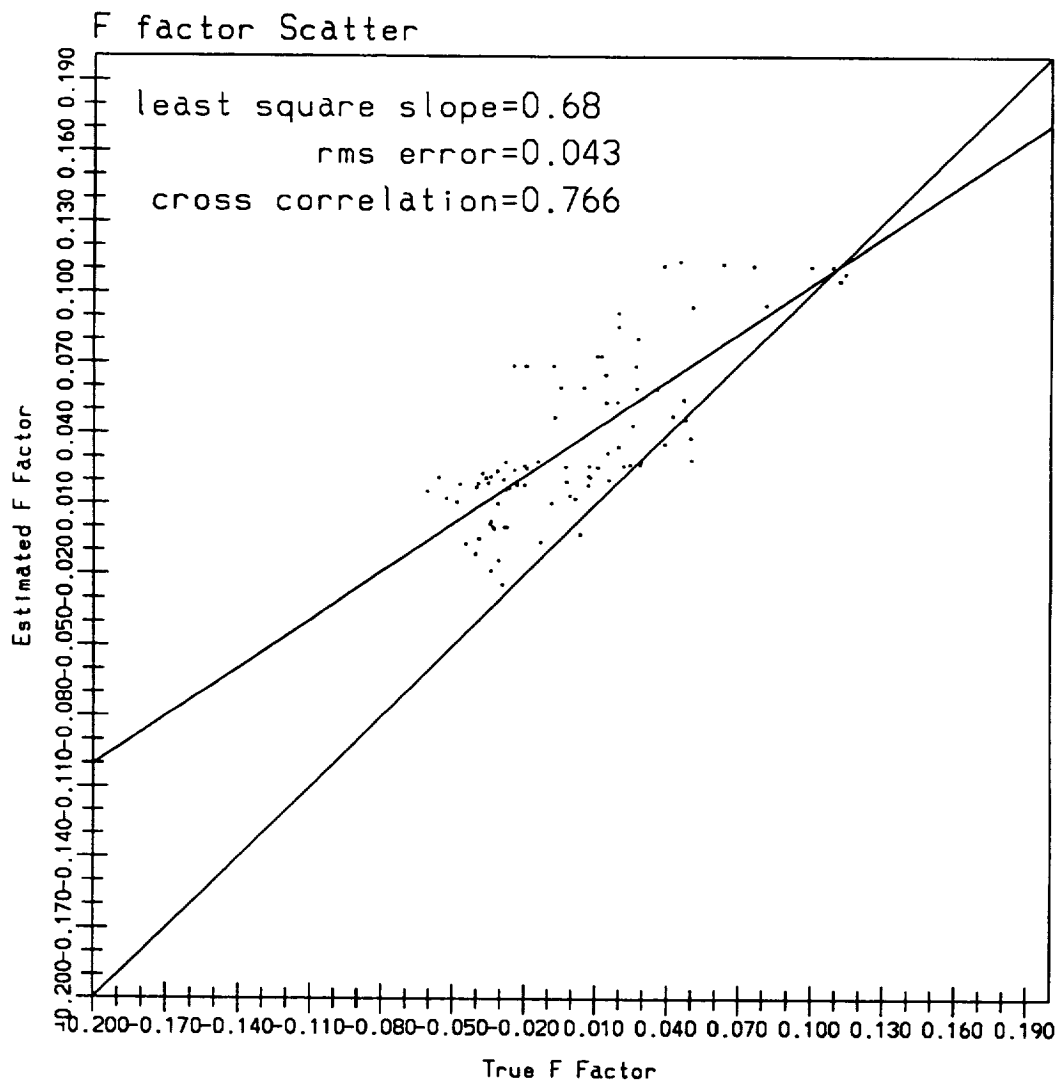

Radial Velocity

TIME =92 08 17 22 37 33

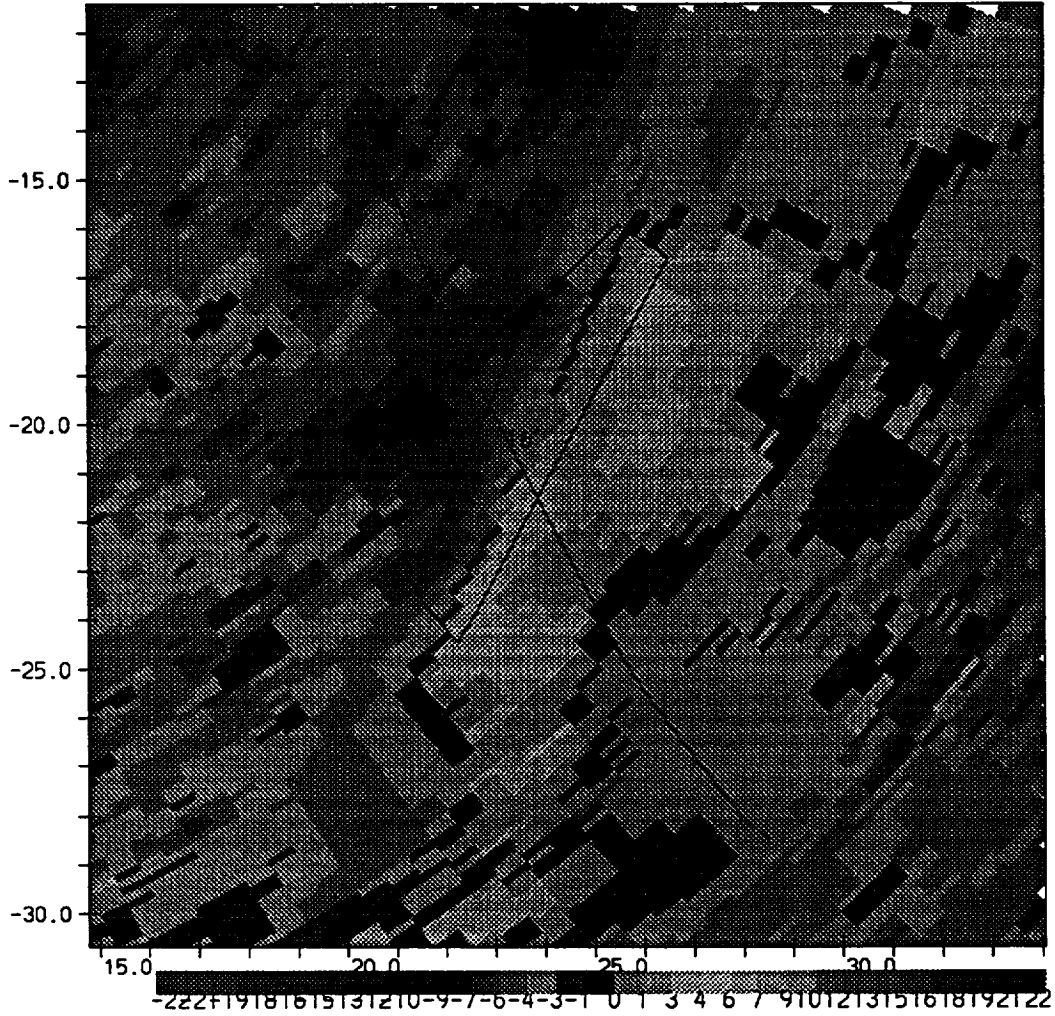

b555 Flight Path

TIME =92 08 17 22 39 09

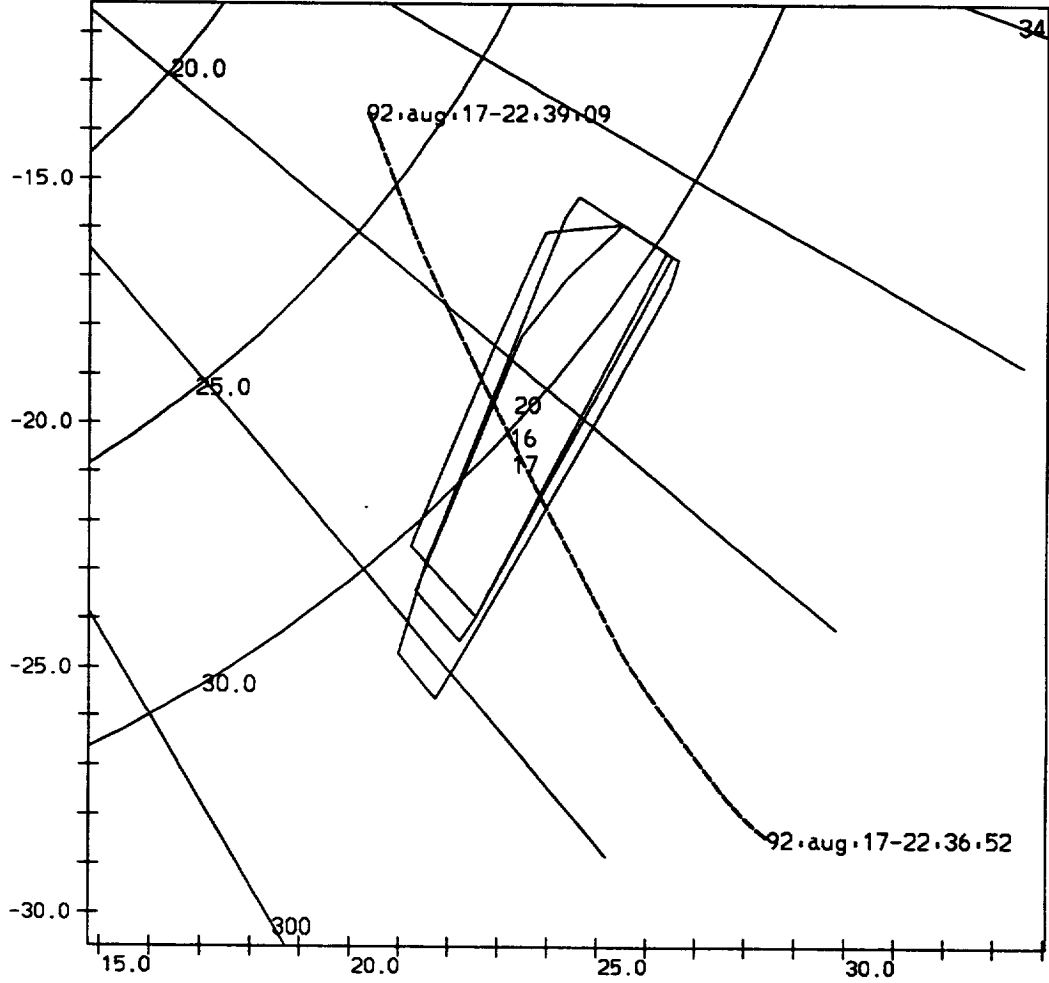

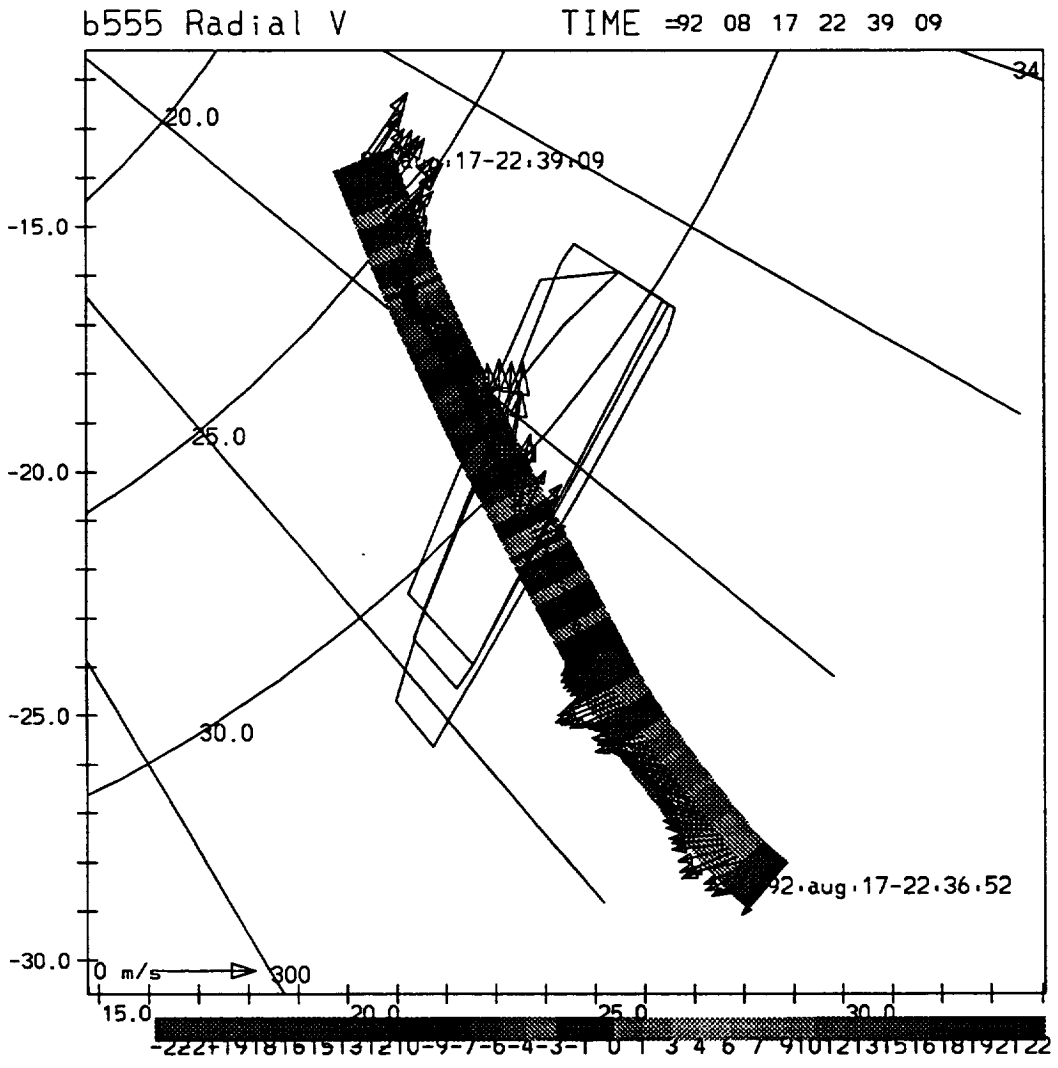

b555 Radar Data

TIME =92 08 17 22 39 09

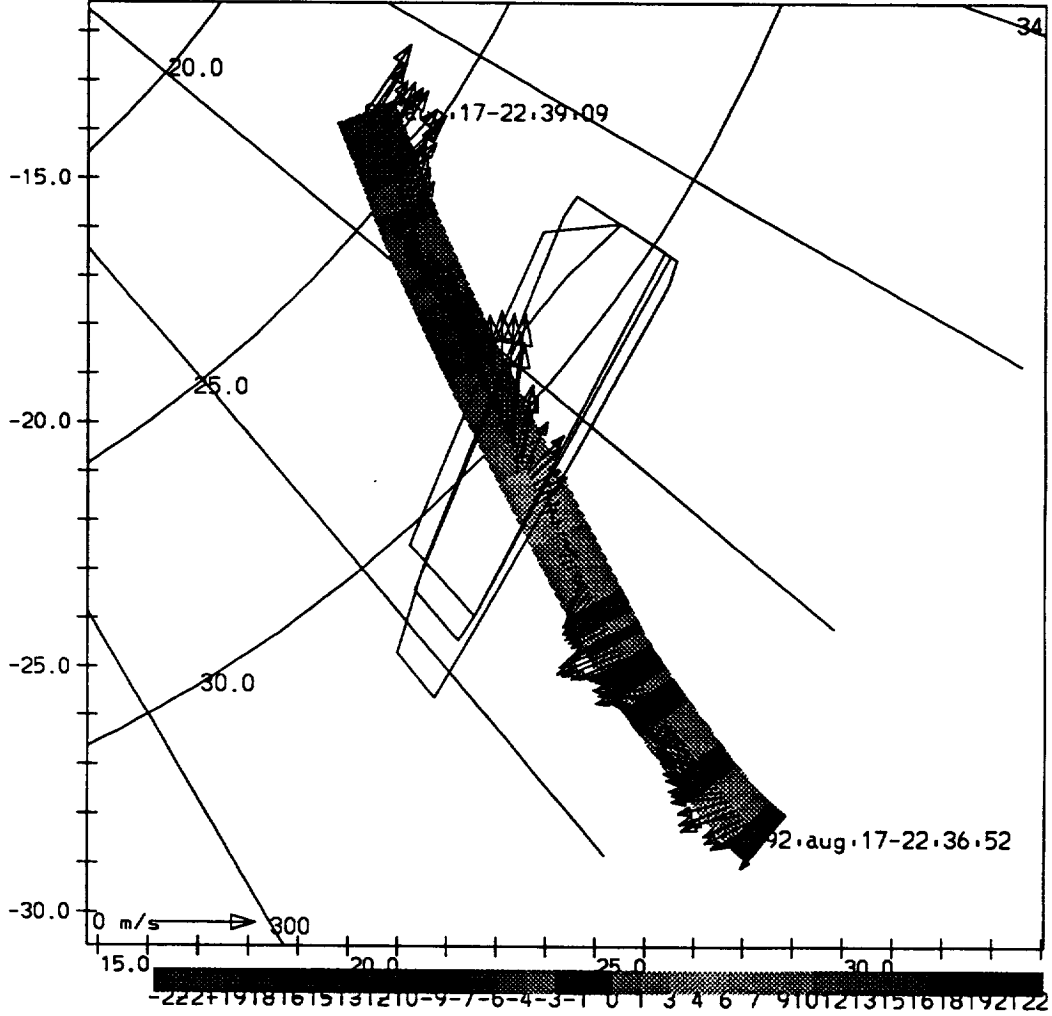

Velocity Stats.b555

85th pct Truth

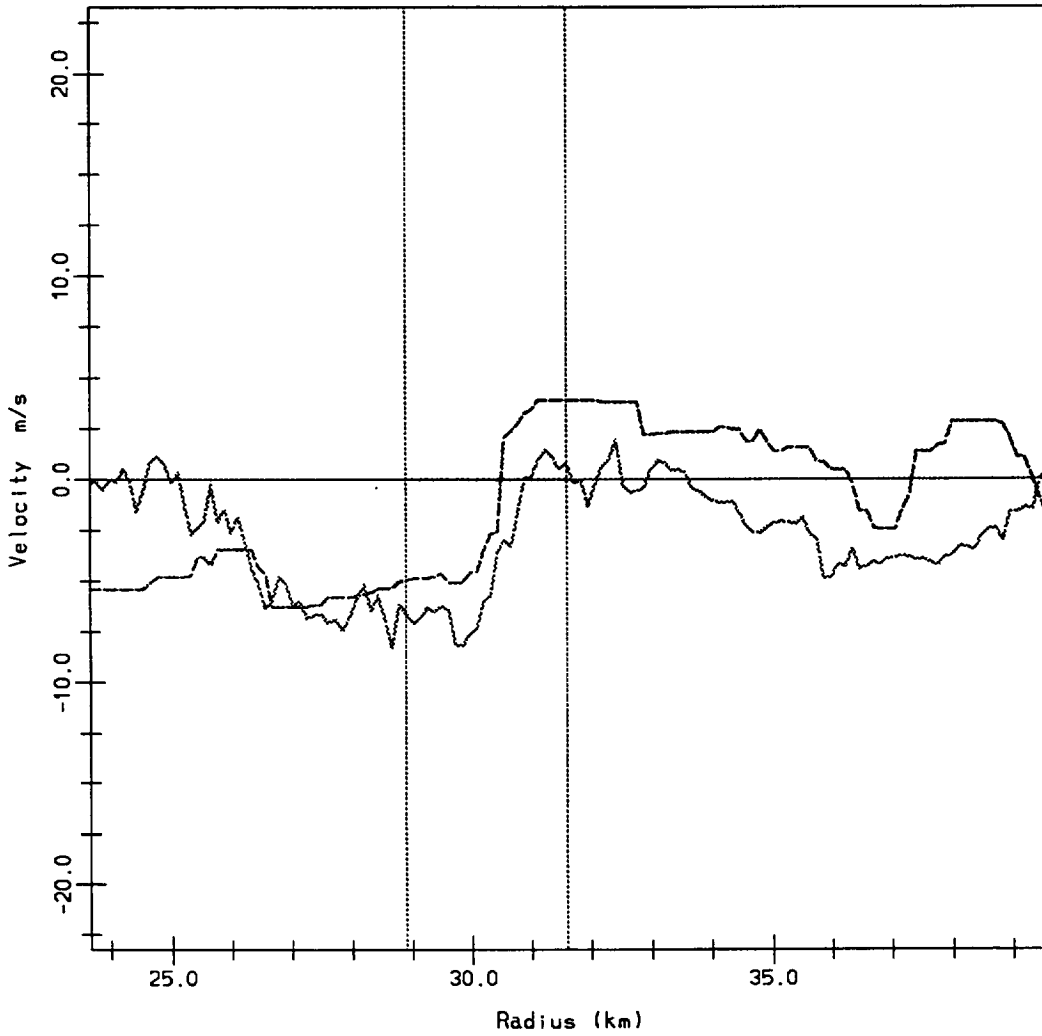

F_Factor Stats.b555

85th pct Truth

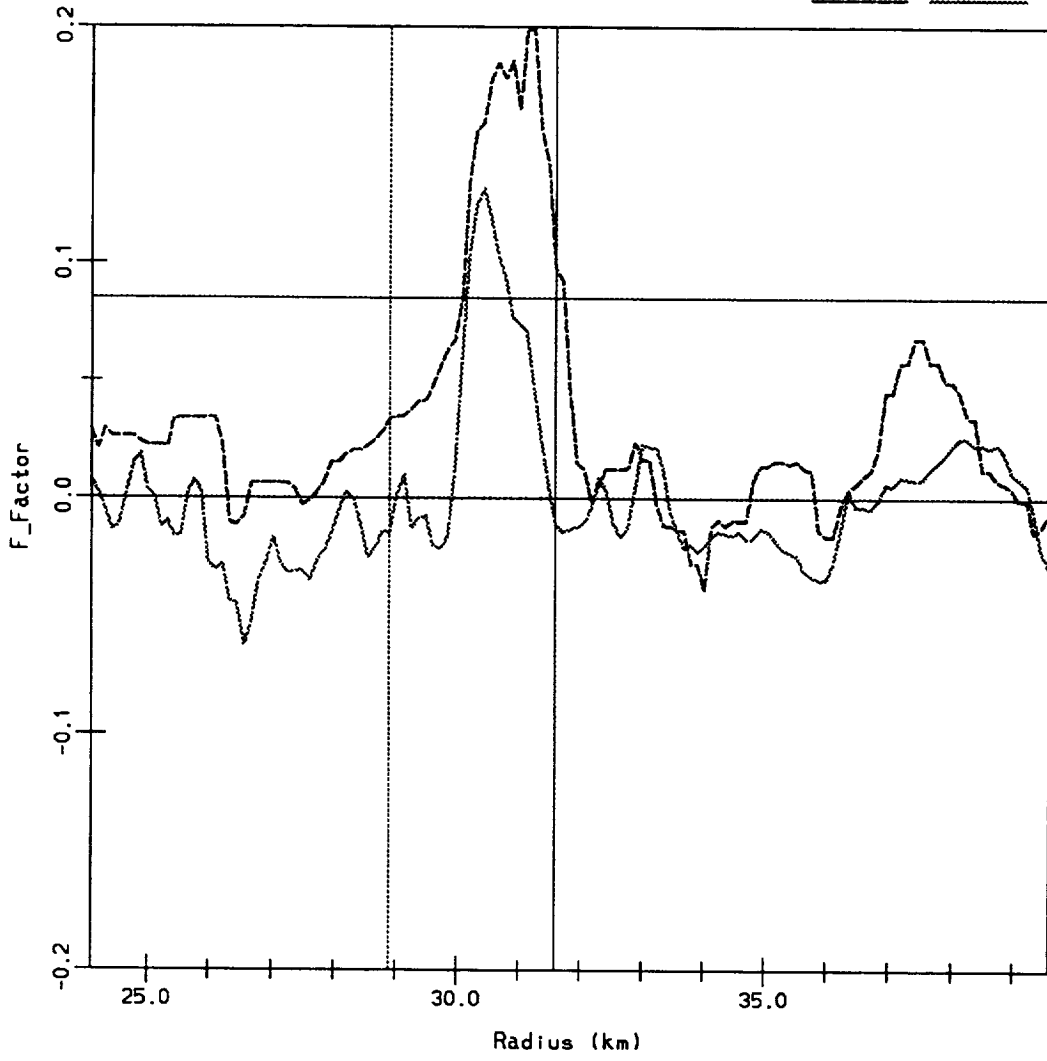

f_horiz Stats.b555

85th pct Truth

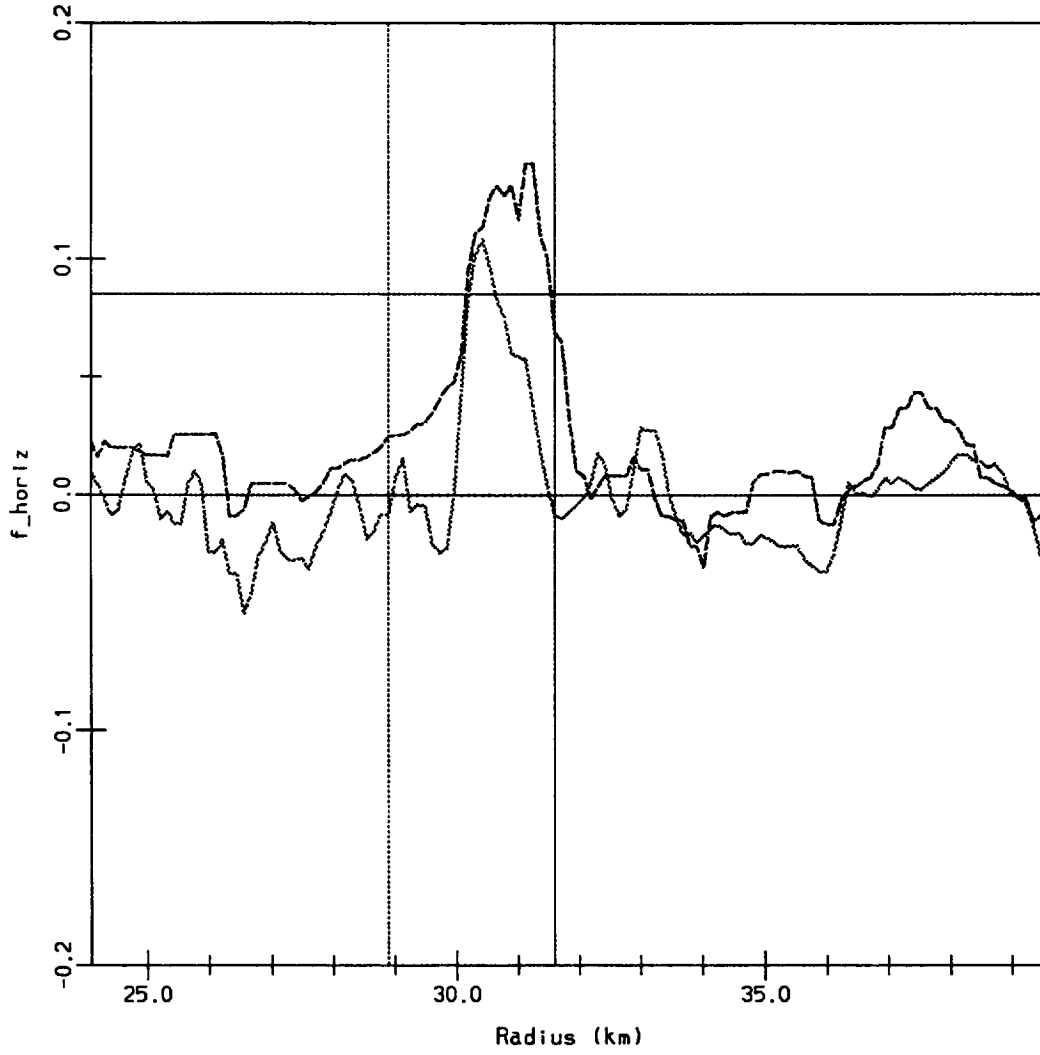

Vertical_F Stats.b555

85th pct Truth

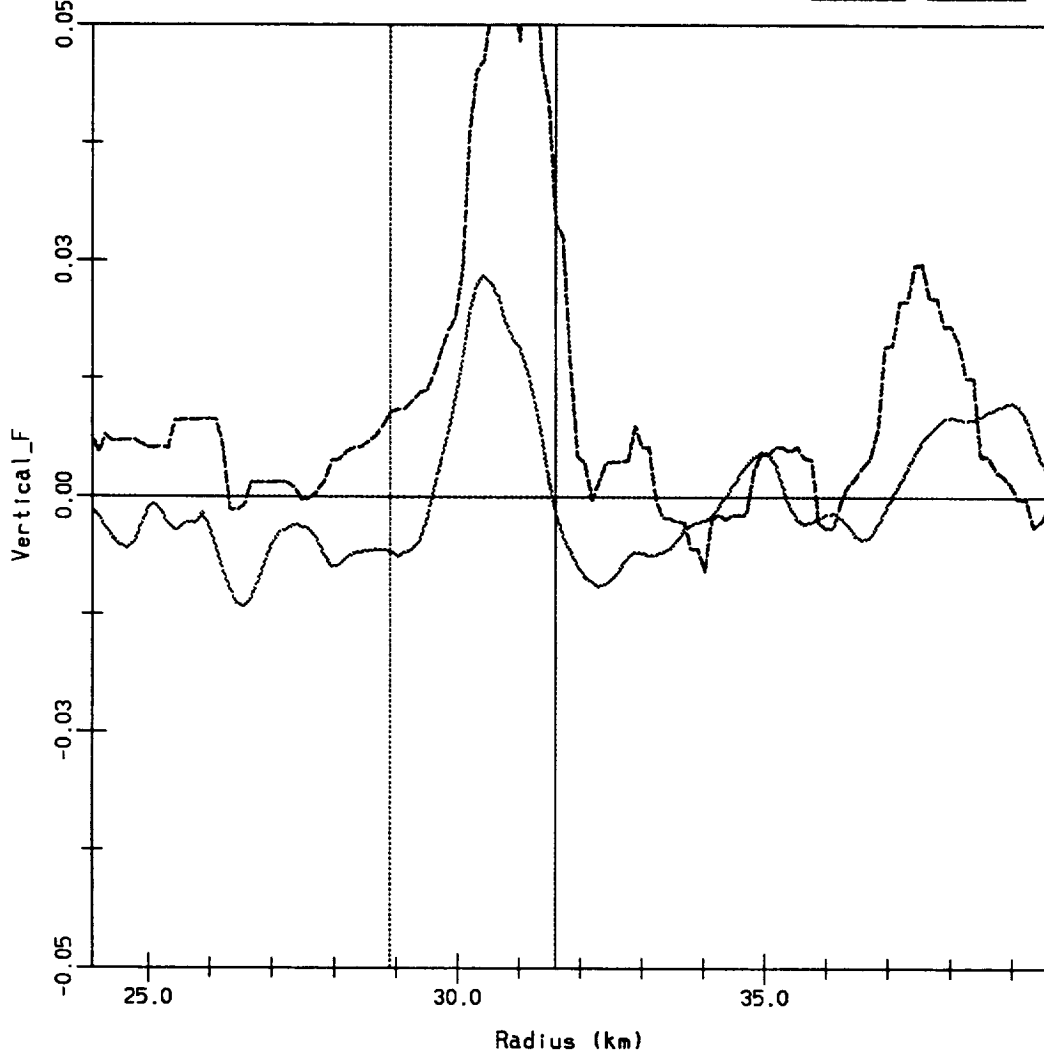

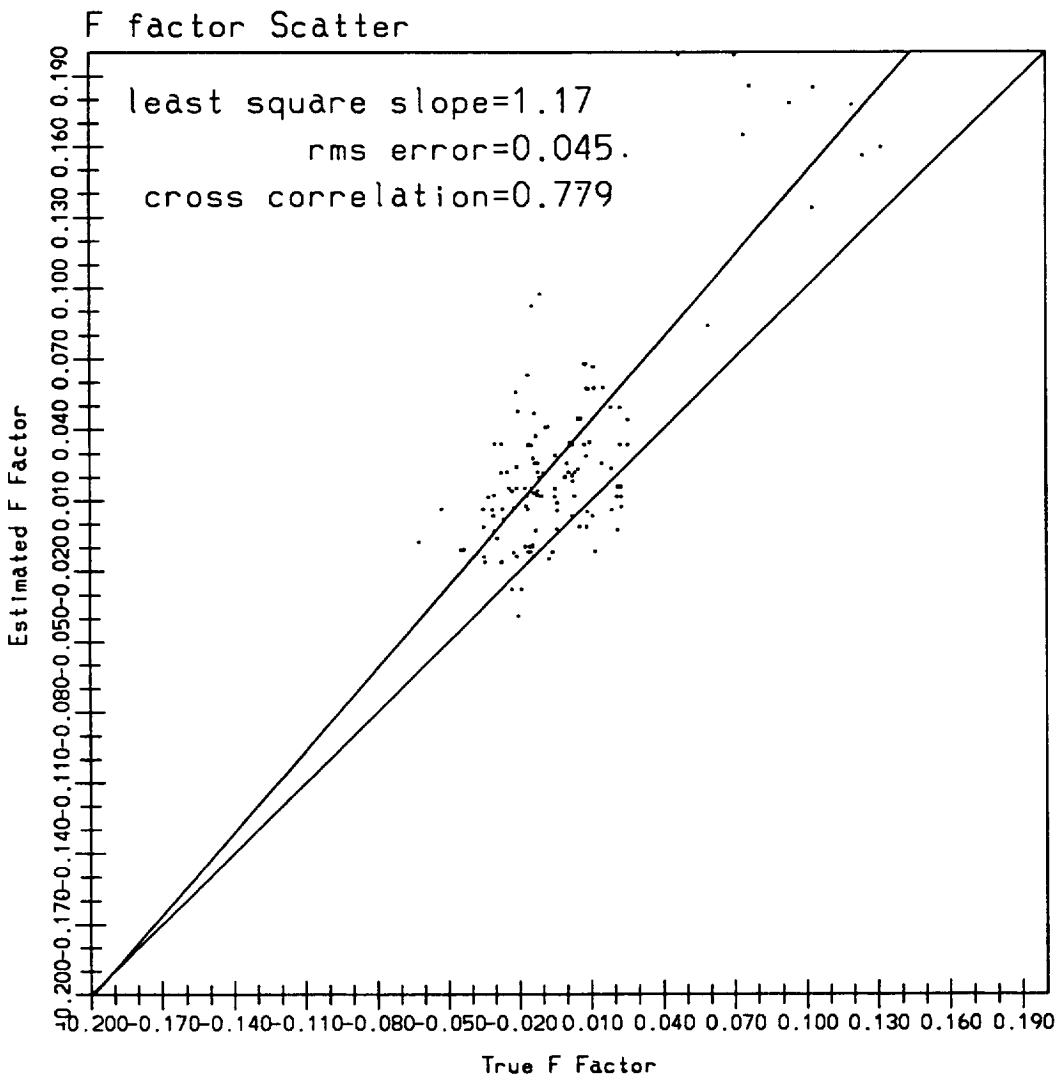

F_Factor Stats.b555

85th pct Truth

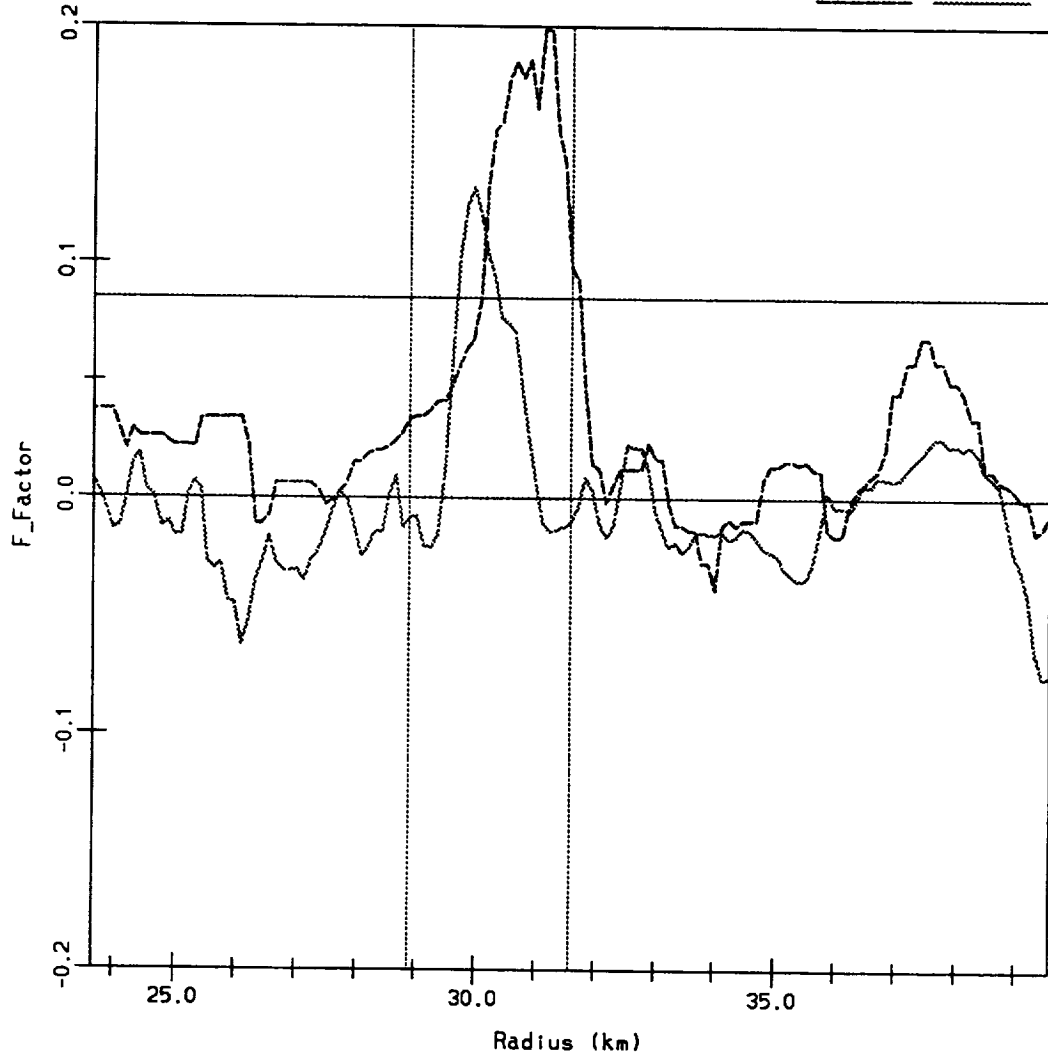

f_horiz Stats.b555

B5th pct Truth

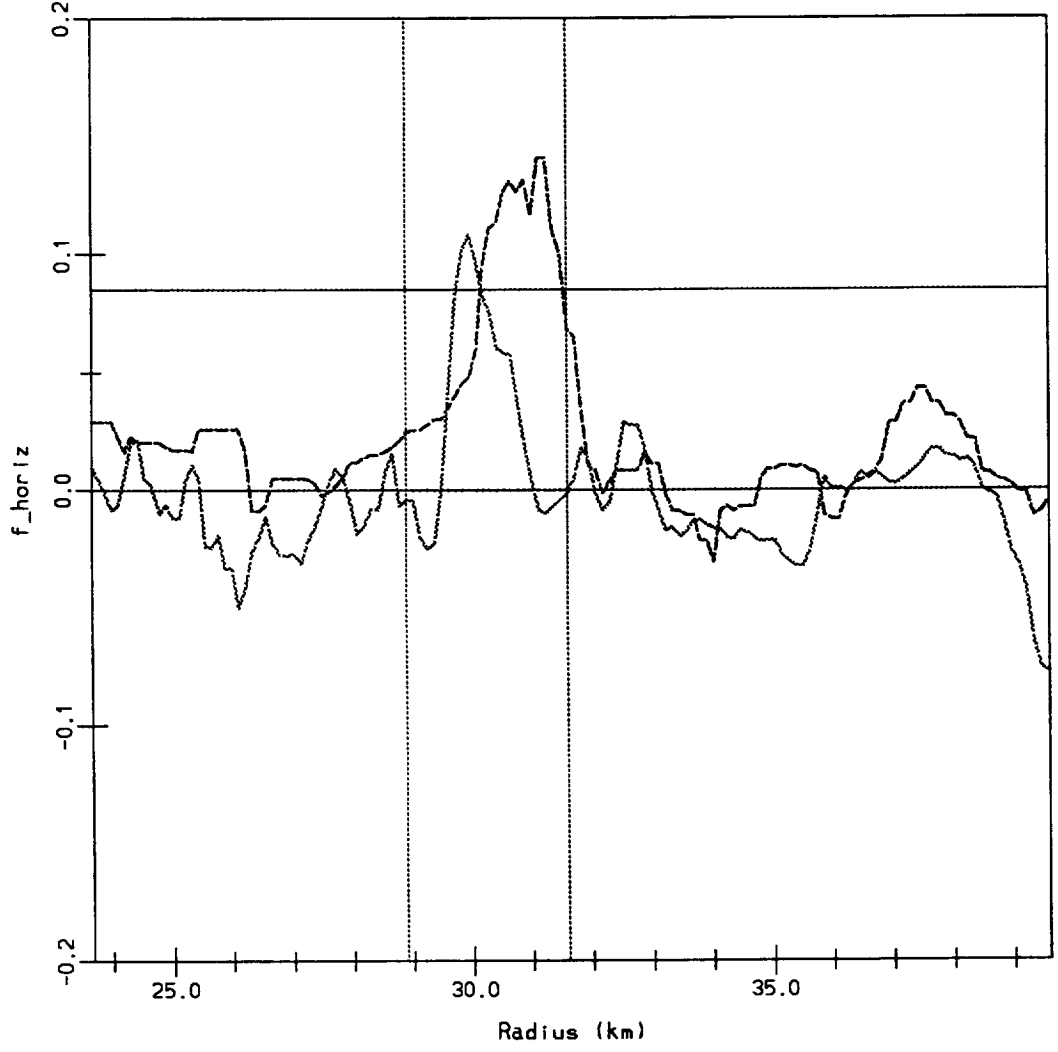

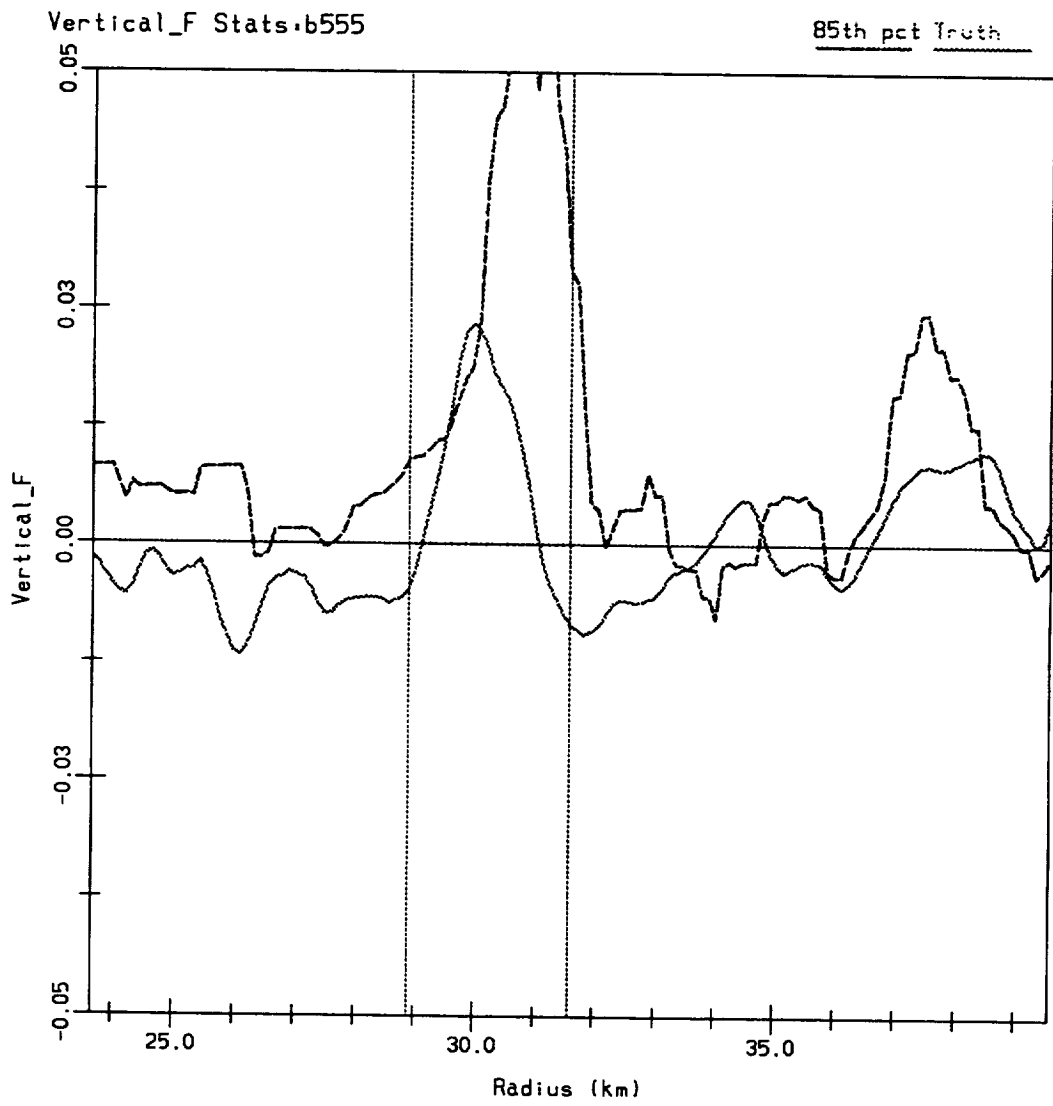

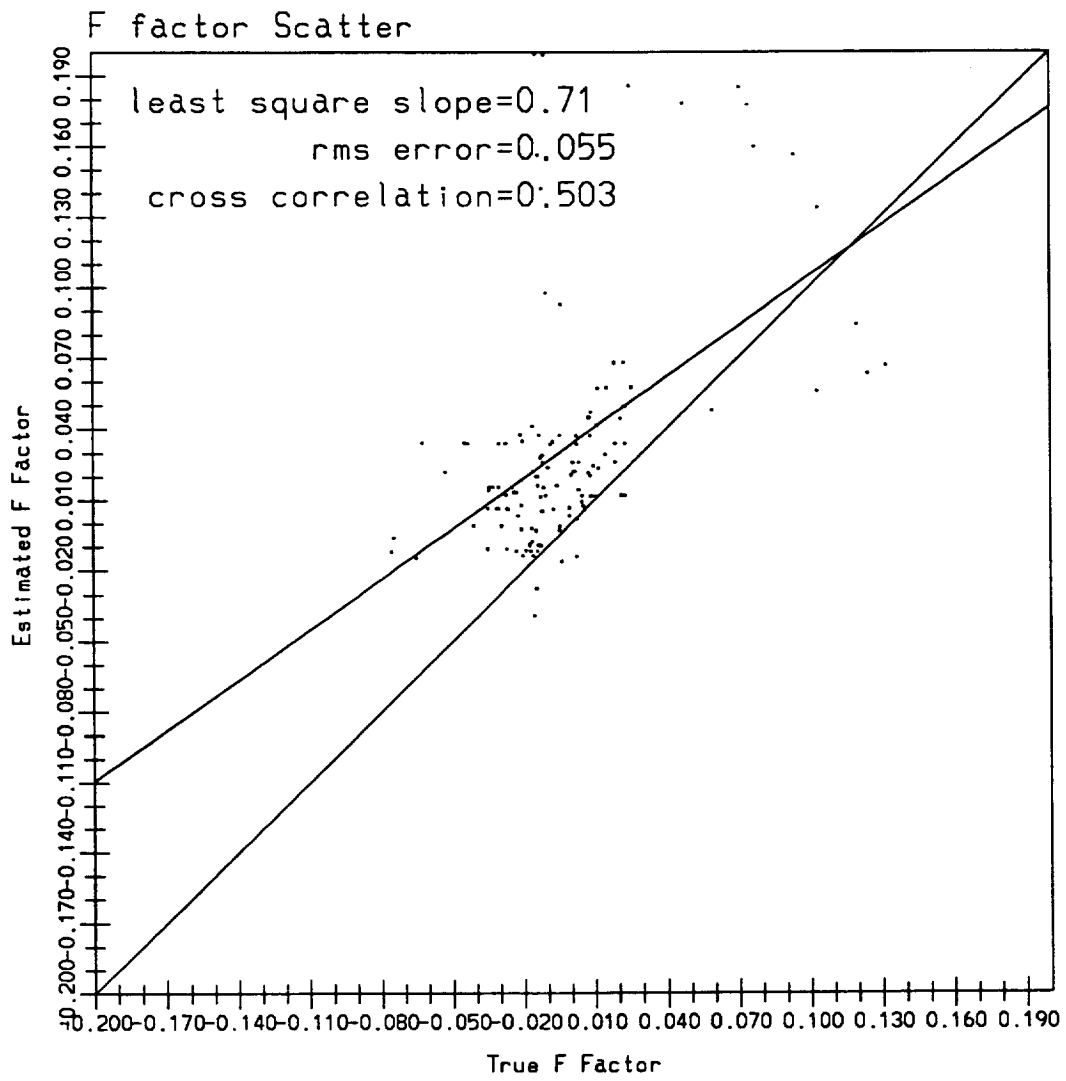

B456 (lagged)

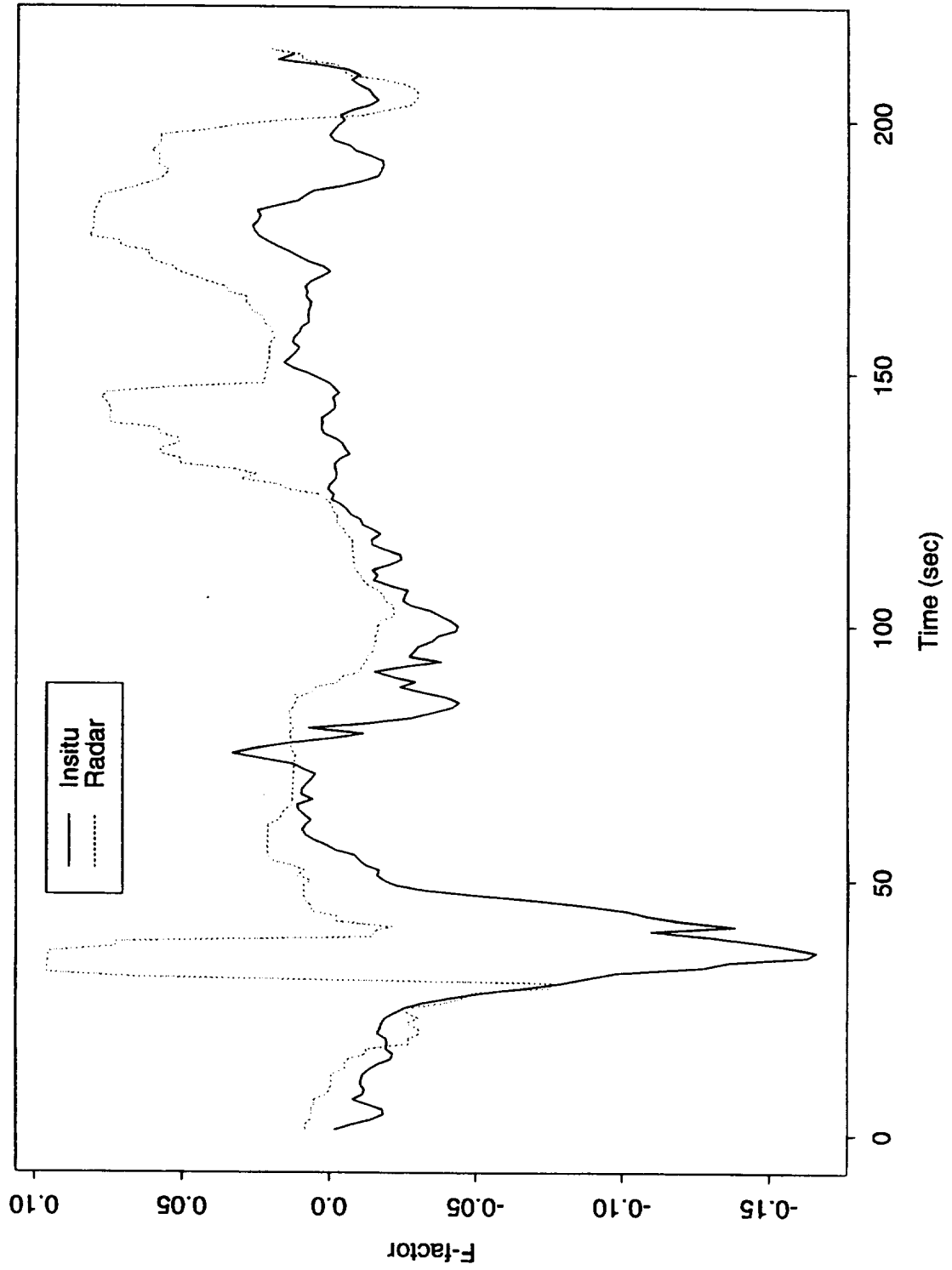

B456 (lagged, splined)

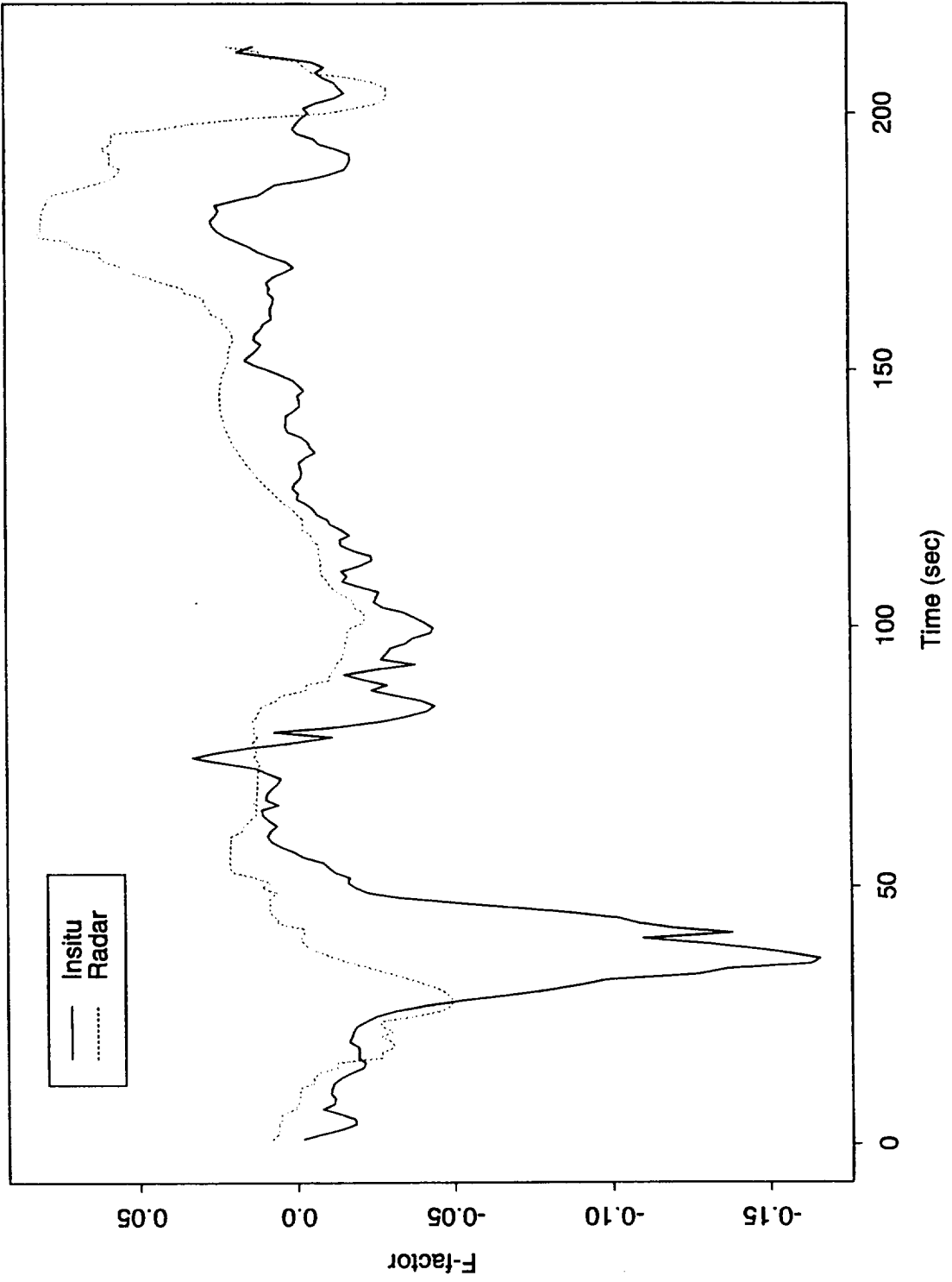

Additional Points

Clean up the current data set; trim off regions where the aircraft path is not representative of radar beam path.

Threshold (categorize) data and compare only those cases where either aircraft or radar-derived F exceeds 0.085 (or any other threshold).

Examine F comparisons only within shapes.

Current implementation does not constitute an operational algorithm; various problems peculiar to Doppler radars must be addressed for operational implementation.

A method of translating F factor to hazard severity needs to be created.

Conclusions

Path-specific statistics show that a least squares-based method faithfully reproduces significant shears experienced by penetrating aircraft.

Microburst wind shears display local linear symmetry.

A shear-based microburst detection algorithm identifies only areas containing a quantifiable performance loss.

F contains potentially more information because it uses shear; the currently implemented algorithms discard all local shear estimates.

We believe that a shear-based F-factor algorithm is preferable to the present TDWR headwind loss-based algorithm (These findings are similar to that being proposed for ITWS).

