

NASA Conference Publication 10143, Volume 2

# Fourth High Alpha Conference NASA Dryden Flight Research Center July 12-14, 1994



(NASA-CP-10143-Vol-2) FOURTH HIGH  
ALPHA CONFERENCE, VOLUME 2 (NASA.  
Dryden Flight Research Center)  
235 p

N95-14239  
--THRU--  
N95-14250  
Unclas



G3/02 0016088

# **Propulsion and Inlet Dynamics and Thrust Vectoring**

6pg

NASA Conference Publication 10143, Volume 2

1995/07825

323973

**Fourth High Alpha Conference  
NASA Dryden Flight Research Center  
Edwards, California  
July 12–14, 1994**



National Aeronautics and  
Space Administration  
Office of Management  
Scientific and Technical  
Information Program  
1994

## **Foreword**

High-angle-of-attack flight research and development has matured in the past 5 years. We have seen four different aircraft investigate the different methods of stability, control, and effectiveness of high-angle-of-attack flight. Of these four vehicles, three use thrust vectoring to achieve their goals. Production aircraft, such as the F-22, are now using thrust vectoring. The use of forebody vortex control has been and is being investigated in flight, as well as in ground facilities. Considerable research, development, and validation of ground predictive tools, including computational fluid dynamics, wind tunnels, and simulations, have taken place to enable better, faster, cheaper development of new aircraft and modification of current aircraft.

The goal of the Fourth High Alpha Conference, held at the NASA Dryden Flight Research Center on July 12–14, 1994, was to focus on the flight validation of high-angle-of-attack technologies and provide an in-depth review of the latest high-angle-of-attack activities. Areas that were covered include high-angle-of-attack aerodynamics, propulsion and inlet dynamics, thrust vectoring, control laws and handling qualities, tactical utility, and forebody controls.

This document is a compilation of presentations given at the Fourth High Alpha Conference. The presentations included in this document are included as supplied by the presenters with no modifications. This conference, along with its predecessors, was sponsored by the NASA High Alpha Technology Program Steering Committee.

Fourth NASA High Alpha Conference  
NASA Dryden Flight Research Center  
July 12-14, 1994

**Table of Contents—Volume 2:**

**Propulsion and Inlet Dynamics and Thrust Vectoring**

F-18 High Alpha Research Vehicle: Lessons Learned, Albion H. Bowers, Victoria A. Regenie, and Bradley C. Flick, NASA Dryden Flight Research Center, Edwards, CA

Design and Development of an F/A-18 Inlet Distortion Rake: A Cost and Time Saving Solution, Andrew J. Yuhas and Ronald J. Ray, NASA Dryden Flight Research Center, Edwards, CA, Richard R. Burley, NASA Lewis Research Center, Cleveland, OH, and William G. Steenken, Leon Lechtenberg, and Don Thornton, General Electric Aircraft Engines, Evendale, OH

Installed F/A-18 Inlet Flow Calculations at High Angles of Attack and Moderate Sideslip, S. D. Podleski, NYMA, Inc., Brook Park, OH

Propulsion Analysis of the F-16 Multi-Axis Thrust Vectoring Aircraft, Capt. Jeff Vickers, USAF, 416 Flight Test Squadron, Edwards AFB, CA

X-31 Post-Stall Envelope Expansion and Tactical Utility Testing, Dave Canter, USN, Naval Air Warfare Center, NAS Patuxent, MD

Aerodynamic Development and Effectiveness Evaluation of the X-31 Thrust Vectoring System, Hans-Ulrich Georg, Deutsche Aerospace AG, Germany

X-31 Quasi-Tailless Flight Demonstration, Peter Huber, Deutsche Aerospace AG, Germany, and Harvey Schellenger, Rockwell International North American Aircraft, Los Angeles, CA

**Control Laws and Handling Qualities**

High Alpha Handling Qualities and Agility Flight Research on the F/A-18 High Alpha Research Vehicle, Keith D. Wichman, Joseph W. Pahle, and R. Joe Wilson, NASA Dryden Flight Research Center, Edwards, CA, and Patrick J. Connelly and John W. Kelly, PRC Inc., Edwards, CA, and Marilyn E. Ogburn, NASA Langley Research Center, Hampton, VA

X-31 High Angle of Attack Control System Performance, Peter Huber, Deutsche Aerospace AG, Military Aircraft LME, Edwards, CA, and Patricia Seamount, NASA Dryden Flight Research Center, Edwards, CA

## **Control Laws and Handling Qualities (cont'd.)**

**Flight Test Results of the F-18 Aircraft Modified With the Axisymmetric Vectoring Exhaust Nozzle, Paul D. Anna, Lockheed Fort Worth Company, Fort Worth, TX, and David S. Kidman, USAF 416th Flight Test Squadron, Edwards AFB, CA**

**Flight Validation of Ground-Based Assessment for Control Power Requirements at High Angles of Attack, Marilyn E. Ogburn , Holly M. Ross, and John V. Foster, NASA Langley Research Center, Hampton, VA, Joseph W. Pahle, NASA Dryden Flight Research Center, Edwards, CA, Lt. Charles A. Sternberg, USN, and Capt. Ricardo Traven, CAF, Naval Air Warfare Center, Patuxent River, MD, and Troy D. Abbott, Virginia Polytechnic Institute and State University, Blacksburg, VA**

**High Angle of Attack Flying Qualities Criteria for Longitudinal Rate Command Systems, David J. Wilson and Kevin D. Citurs, McDonnell Douglas Aerospace, St. Louis, MO, and John B. Davidson, NASA Langley Research Center, Hampton, VA**

**NASA1-HARV Control Law Evaluation Using Flight Test Data, Pat Murphy, Frederick J. Lallman, Aaron J. Ostroff, John B. Davidson, Barton J. Bacon, Eugene A. Morellis, and Michael G. Tison, NASA Langley Research Center, Hampton, VA and Keith D. Hoffler, VIGYAN, Inc., Hampton, VA and Michael D. Messina, Lockheed Engineering and Sciences Company, Hampton, VA**

**VISTA/F-16 Multi-Axis Thrust Vectoring (MATV) Control Law Design and Evaluation, W. D. Zwerneman and B. G. Eller, Lockheed Fort Worth Company, Fort Worth, TX**

**Multi-Application Controls, Dale F. Enns and Dan J. Bugajski, Honeywell Technology Center, Minneapolis, MN and John Carter and Bob Antoniewicz, NASA Dryden Flight Research Center, Edwards, CA**

**Combat Agility Management System (CAMS), Andrew Skow and William M. Porada, Eidetics Aircraft, Inc., Torrance, CA**



# F-18 High Alpha Research Vehicle: Lessons Learned

Albion H. Bowers, Victoria A. Regenie and Bradley C. Flick  
NASA Dryden Flight Research Center

Fourth NASA High Alpha Conference

1693

325976

19951678296

N95-14240

16087

P-15

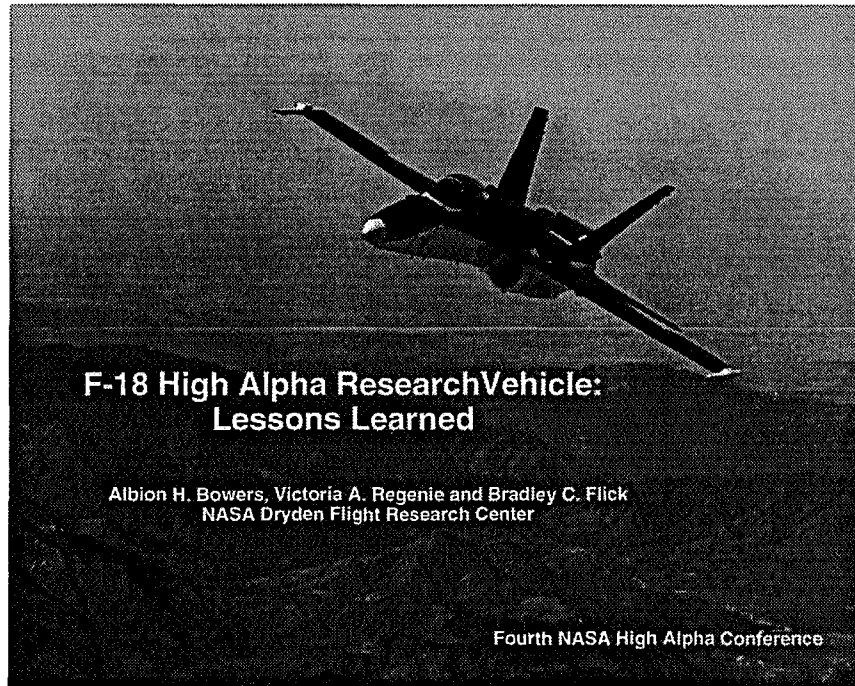

The F-18 High Alpha Research Vehicle has proven to be a useful research tool with many unique capabilities. Many of these capabilities are to assist in characterizing flight at high angles of attack, while some provide significant research in their own right. Of these, the thrust vectoring system, the unique ability to rapidly reprogram flight controls, the reprogrammable mission computer, and a reprogrammable On Board Excitation System have allowed an increased utility and versatility of the research being conducted. Because of this multi-faceted approach to research in the high angle of attack regime, the capabilities of the F-18 High Alpha Research Vehicle were designed to cover as many high alpha technology bases as the program would allow. These areas include aerodynamics, controls, handling qualities, and propulsion. To achieve these goals, new capabilities were developed to enable this research to occur. Some were outstandingly successful; others were not.



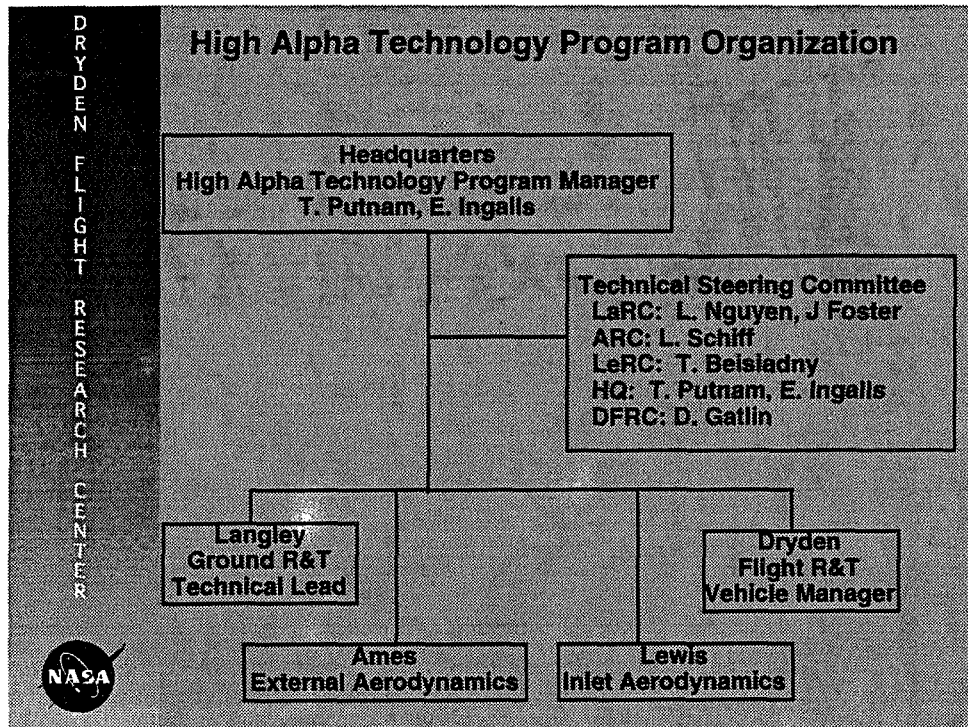

To better address the need for improved high angle of attack capability, NASA formed a High Alpha Technology Program (HATP). This program emphasized the need to provide a complete database of all available tools now used. To do this, close cooperation among all the NASA aeronautical centers was required.

Early in the development of a program, it was found that the Steering Committee was a most valuable asset to the project and the program as a whole. The steering committee was composed of a representative of each Center involved (plus a NASA Headquarters representative). Leaders of diverse disciplines were called upon to be members of the steering committee. The job of the steering committee was to provide vision for the HATP. In this way, the technical people at the Project levels did not need to worry about long range advocacy. Technical individuals could influence the direction of the program through their representatives, but the planning of the program was made at the highest level with input from the various projects to produce the most cohesive package of CFD to wind tunnel to flight database available.

## F-18 High Alpha Research Vehicle Aircraft

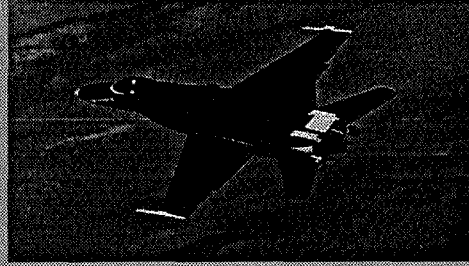

- Modified F-18 aircraft
- Separate instrumentation system
- Modified flight control computers
  - Research Flight Control System (RFCS)
- Thrust Vectoring Control System (TVCS)
- Onboard Excitation System (OBES)



The focal point of this program was selected to be a highly modified F-18 airframe. This aircraft was originally known as Full Scale Development (FSD) Ship 6, but now bears the NASA call sign 840 or also the NASA F-18 High Alpha Research Vehicle (HARV). The decision to use an F-18 aircraft was rooted in the knowledge that the F-18 (or F/A-18 as the production aircraft are known) was the finest high angle of attack airframe testbed available. The aircraft was extensively modified to include thrust vectoring, a unique instrumentation system, highly modified aircraft systems, additional emergency systems, and a special flight control computer.

The TVCS was designed as a set of add-on vanes that were never meant for a production type system. As such, they were heavy, crude and unsophisticated. They were simply a boiler-plate research system with which to gather the data. Despite this they were effective, easily maintained, and robust. Since the time they were designed and installed, thrust vectoring has become much more sophisticated. We have since begun calling our implementation the first generation of thrust vectoring systems. First generation being represented by the X-31 Enhanced Fighter Maneuverability aircraft, with an integrated vane approach and second generation being represented by the F-16 Multi-Axis Thrust Vectoring (MATV) aircraft with axi-symmetric nozzle vectoring.

## Research Technologies: Aerodynamics

- **Direct Comparisons:**
  - Computational Fluid Dynamics
  - Small- and large-scale wind tunnel
  - Flight
- **On- and Off-Surface Flow Visualization**
  - Smoke
  - Tufts and dye
- **Aerodynamic Parameter Identification**
- **Airdata**
  - Innovative high alpha probes
  - Flush Air Data System (FADS)
- **Pressure Surveys**
  - Low rate surface pressures
  - Tail buffet
  - Vortex rake surveys



Aerodynamic research has included static pressures, unsteady pressures, on and off surface flow visualization, as well as innovative parameter identification techniques. Static pressures have been taken around the forebody, leading edge extensions (LEX), wings, a vertical tail and the fuselage. Unsteady pressures and accelerometer data are being used to characterize the unsteady aerodynamic flow field over the verticals. A special traversing wake rake was made to investigate the off-surface vortex flow field over the LEX. All of these pressures are being used to characterize the flows at high angles of attack. An aerodynamics related piece of research is being done in the area of parameter identification. Three innovative techniques are being used to generate maneuvers at high angles of attack which are being analyzed using traditional techniques.

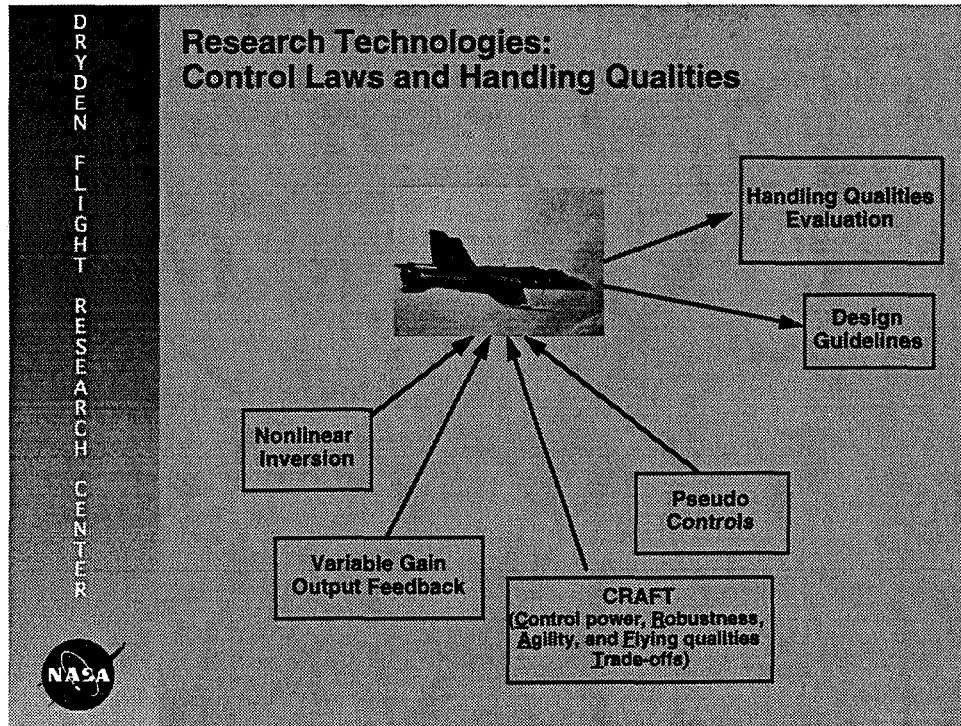

Controls research is being conducted by having several different control laws being independently designed for the aircraft. Of the five different control law sets designed for the aircraft, all which will be flown and evaluated. The digital flight control computers on-board the aircraft allow rapid reconfiguration. With each research control law set flown on the aircraft, the baseline aircraft control laws are retained for normal operation of the aircraft. This parallel control law set have allowed more rapid verification and validation of software than would have been possible. The baseline set of control laws allowed the research control laws to undergo a less complete, thorough and exhaustive verification and validation allowing for more rapid changes.

Handling qualities research is concentrating on the unique control effector aspects of the aircraft. Thrust vectoring allows control in corners of the envelop that do not lend themselves easily to conventional aerodynamic controls. Evaluation of handling qualities at high angles of attack are developing guidelines for criteria to be used for future generations of high performance fighter type aircraft.

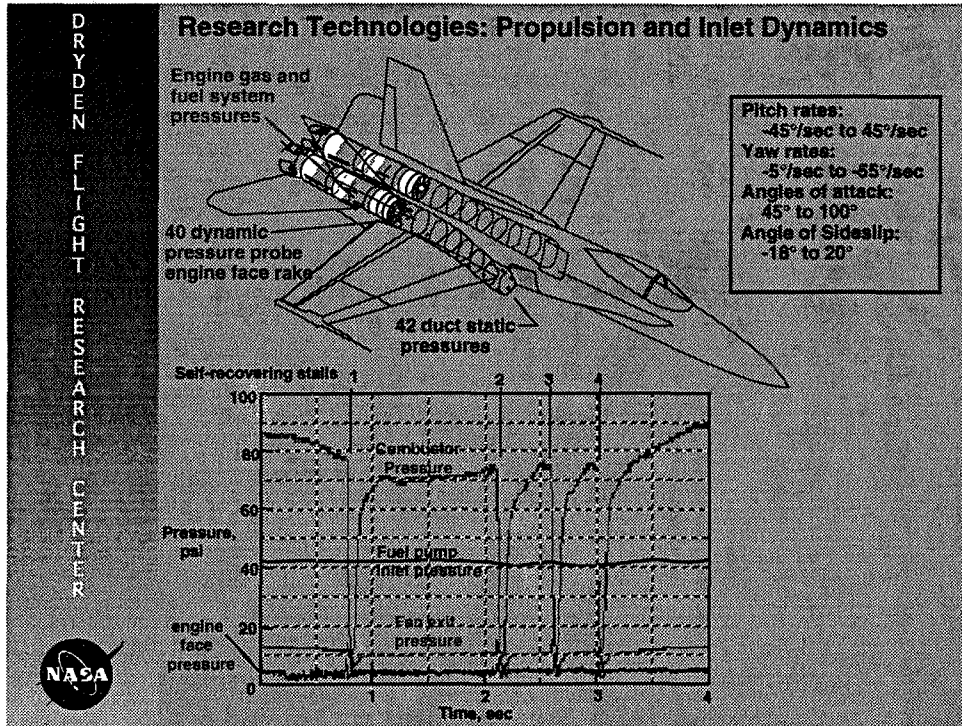

Propulsion research has been expanded using the F-18 High Alpha Research Vehicle because of the aircraft's ability to explore corners of the envelope that have been unobtainable with any repeatability or what had been transient at best. Special instrumentation to characterize the distortion and flow in the inlet, measure the thrust loss at high angles of attack, and baseline various thrust measurement systems are being flown on the aircraft.

## Operations and Planning

- Systems Approach
- Advanced Planning
- Configuration Control Board (CCB)
  - interdisciplinary communication
  - organizational planning function
  - operations, research and projects
- In-House Capabilities
  - software
  - hardware
- Planned Back-up Systems
  - Spin Recovery Chute (SRC)
  - Emergency Power Systems (EPS)
- Integrated Test Plans
  - cold loads
  - hot loads
  - combined system tests
  - structural mode interactions
  - ground vibration tests
  - functional checks
- Changes/Upgrades
  - instrumentation requirements
  - configuration changes
- External Requirements
  - programmatic advocacy
  - technical
  - remember your customer!



Many actions were found to assist the project greatly in its inception. Certain planning groups were instrumental, not only for program inception, but throughout the program. Other actions were much more simple, and while easily stated, made a significant impact to later operational aspects of the flight phase. Certain other actions were painful to the project, but were found to have long term payoffs far in excess of their setbacks. Along with estimates for changes, be sure to define, well in advance, deletion of envelope expansion hardware, e.g., Spin Recovery Chute (SRC) and Emergency Power Systems (EPS).

This goes hand-in-hand with planning in advance as much as possible. While this is a simple statement to make, it is very difficult to execute. In many cases, it is difficult to visualize the complexity of the complete system, especially when one is concentrating on the discipline at hand. The more advanced planning one is able to complete, the more quickly and smoothly the test project can advance.

At the project level, strong interdisciplinary communication was a must. A part of this was a configuration control board (CCB) process that worked.

As the system approaches flight testing, ground testing is performed. During this ground testing, be sure to include enough time for contingencies. Thrust vectoring is a difficult problem, causing a level of engine to airframe integration that has not been experienced before. The flight test plan is only that, a plan. Contingencies inevitably arise, forcing quick rethinking of individual flight plans. Use the data of opportunity as the situation arises.

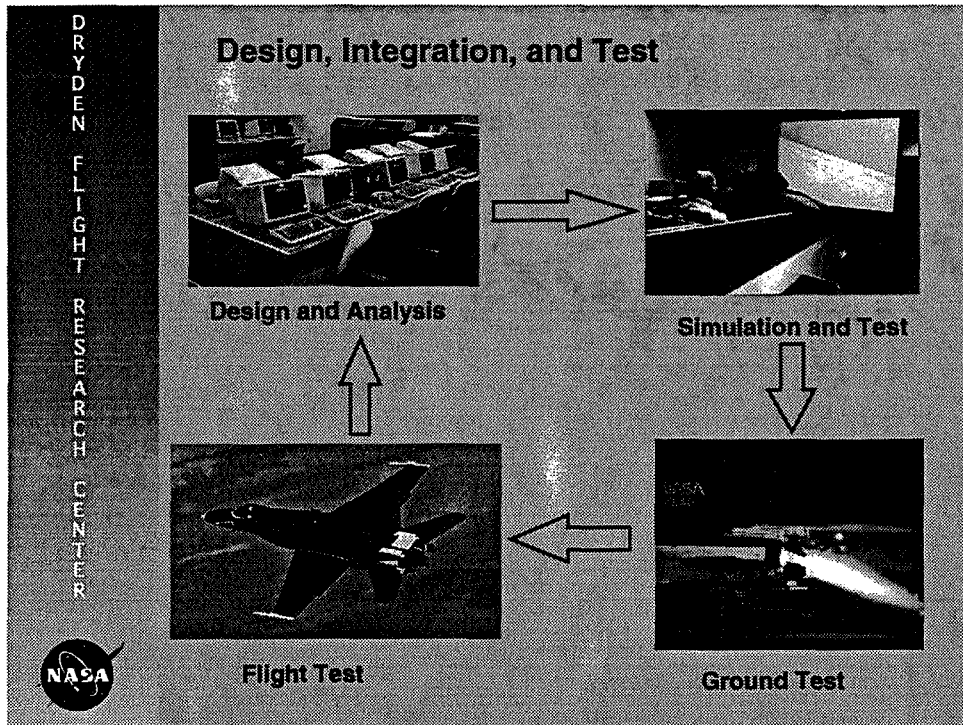

Major modifications, even if expected to be used for limited time periods, require design to facilitate physical access to as many systems as possible for maintainability. Elegant engineering solutions are not necessary, but maintainability is required. Significant schedule slips for simple failures can be expected if access is not designed into systems. Remember the cause and effect during modification of any system. Keep the entire aircraft in mind and use a systems approach as much as possible.

Along with maintainability, testability is required. The ability to test systems in the aircraft must be designed into the complete system and into each component of each system as early as possible. This greatly simplifies any troubleshooting later in the schedule.

In-house support for each system must be maintained in order to capitalize on the accessibility, maintainability and testability of these systems. This extends to the specialized systems installed, like instrumentation, or modifications like the TVCS. Also the hardware and software that might be used 'off-the-shelf' should be able to be modified in-house as late requirements arise. All these little pieces could become major stumbling blocks should a necessary change be required but is unavailable.



## Flight Test Techniques

- RAV Needles

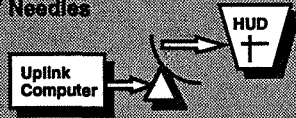

- On-Board Excitation System

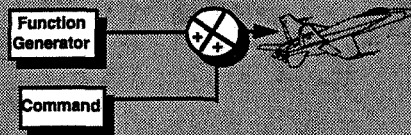

- Simulation

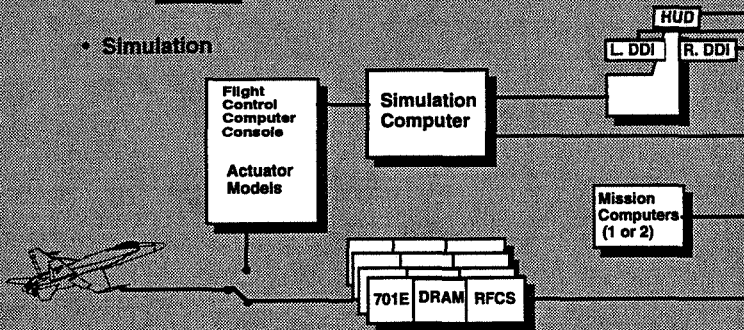

Consideration should also be given to flight test techniques. If the simulation is accurate, it can prove to be a most valuable tool for assessing the workload of a particular maneuver. New maneuvers can be designed for handling qualities, or control law evaluation, or performance in this way as well. Excellent examples abound in the HARV project, such as High Alpha Nosedown Guidelines (HANG), or the various handling qualities work performed in the HARV flight tests.

One flight test technique that was planned on from very early on in the program was the On Board Excitation System (OBES). This was a piece of software located in the RFCS that allowed independent excitation of individual flight control surfaces. While its original intent was to provide for structural excitation for aeroservoelastic clearance, later uses included inner-loop control law parameter identification, aerodynamic derivative extraction maneuvers, and to vary static stability recovery characteristics (HANG).

A Remotely Augmented Vehicle (RAV) capability was incorporated on the aircraft. This allowed guidance to be uplinked to the pilot to assist in the flying of a maneuver or initial condition. Consequently, unusual or very precise and complex maneuvers could be flown more easily.

A great help in early development work was the hardware-in-loop (HIL) simulation. Having the hardware available to test software releases early, and to perform verification and validation on, assisted in solving problems with software/hardware. This was long before such software or hardware were on the aircraft. This prevented costly and extensive downtime in the flight schedule.





## Range Capabilities

- Two Radars
- Chase Capabilities
- Quick Instrumentation Data Systems (QUIDS)
- Control Room Presentations

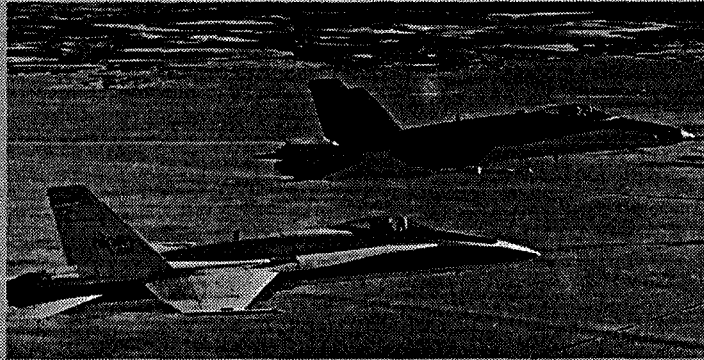

Special requirements extended well beyond those of the HARV aircraft. A Quick Instrumentation Data System was used for the chase aircraft so that special maneuvers where the chase could maneuver as a target for the HARV aircraft. This QIDS data was telemetered to the control room, and in concert with two radars, formed the ability to evaluate maneuver set-ups and minimize loss of data. Special displays were also developed for the control room so that research engineers could quickly evaluate the quality of a particular maneuver.

The number of instrumented channels and the high data rate at which the data was to be gathered necessitated the use of two instrumentation systems in the telemetry stream, and a third instrumentation stream was recorded on board the HARV aircraft. With the QIDS system being flown on a chase, this resulted in yet another data stream. The ability to quickly and easily accommodate requirements such as these contributed greatly to the success the HARV has enjoyed.

However, beware of possible instrumentation overkill. It is very easy to continue adding more and more capability, without exploring the possibility of using an existing sensor on the aircraft.

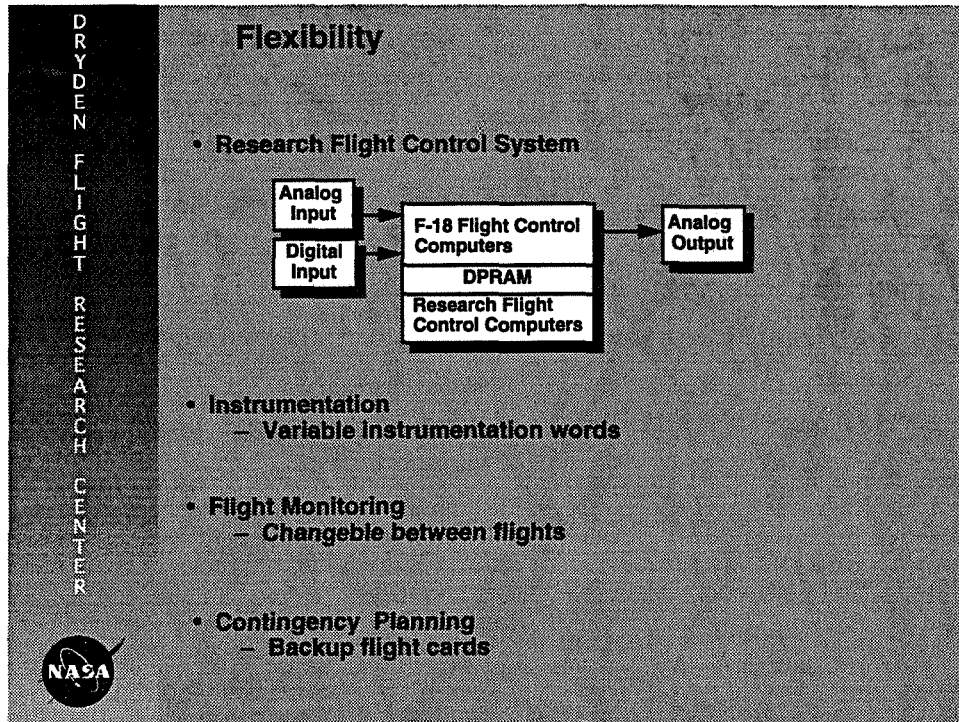

A research flight control system, where only control laws were operated, was of great value to be able to execute the program goals in a timely fashion. Part of that asset was assisted by having built in testability as well. This meant that many changes could be effected only with simple software changes. In all cases, it was desired to add more analog Input/Output (I/O). Sufficient I/O was always beyond the grasp of the project. No sooner was the design fixed, when new requirements would spring up driving the need for yet more I/O. Any flexibility that can be designed into the system is of great advantage at all levels (simulation, aircraft systems, instrumentation, control room capabilities, uplink systems, etc).

For a research effort, more data out of the flight control system (FCS) would have been highly desirable. Control law development and inner-loop parameter identification of control laws would have been highly desirable. The limited number of channels that were designed were rapidly overwhelmed by the later desires of research in the controls group, especially with the later control law designs.

Before embarking on an ambitious research data instrumentation system, be sure that the range data processing is capable of supporting displays, strip charts and timely data availability. Many fast response research instrumentation systems (such as used to measure and quantify data for engine/inlet stalls) have a bit rate that will tax most range telemetry systems. Also be aware of possible constraints operationally with the range, as rapidly reconfigured aircraft may not be supportable as the range may not be as rapidly reconfigured to keep up. Schedule changes to minimize changes, if possible. However, back to back control law comparisons, or other requirements, may require rapid range support changes.



## Technology Transfer

- Industry Tour
- High Alpha Conferences
- Reports
- Joint Programs
- Personal Contacts

Last, and most imperative, is technology transfer. The HATP has sponsored a set of conferences and workshops. These are excellent methods for disseminating information to the respective industry groups. The HARV and HATP have also performed an industry tour, to encourage participation in the program. These have proved to be the most effective means of distributing the complete databases to interested parties.



## Concluding Remarks

- **Successful and effective research tool for high alpha flight**
- **Effectiveness and timeliness aided by innovations in:**
  - **Operations and Planning**
    - » **Steering Committee**
    - » **early planning**
    - » **CCB**
  - **Mechanical Systems**
    - » **TVCS**
    - » **back-up systems**
    - » **separate instrumentation**
  - **Hardware / Software**
    - » **flexibility**
    - » **design in testability and maintainability**

The NASA F-18 High Alpha Research Vehicle project, as a part of the NASA high Alpha Technology Program, proved to be a most effective tool to perform research in the high alpha regime. Research has been accomplished in aerodynamics, controls, and propulsion.

The effectiveness and timeliness of the project was greatly aided by innovative thinking and execution in three areas. These three areas that assisted in making the project as successful as it has been were operations and planning, in mechanical systems, and hardware and software.

The F-18 High Alpha Research Vehicle has proven to be a flexible, capable research tool to investigate the high angle of attack regime with particular emphasis in the areas of aerodynamics, propulsion, control law research, and handling qualities. Many of these capabilities were essential to the performance of the project, and to the assistance to the program.

## REFERENCES

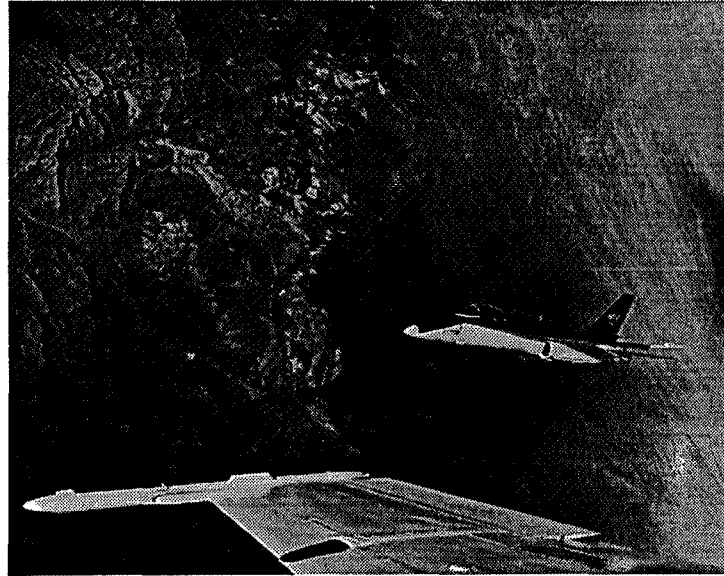

Shaw, Robert: "Fighter Combat," Naval Institute Press, 1985.

Chambers, Joseph R.: "High-Angle-of-Attack Technology: Progress and Challenges," NASA CP 3149, Part I, Vol. I, 1992.

Gilbert, William P., and Gatlin, Donald H.: "Review of the NASA High-Alpha Technology Program," NASA CP 3149, Part I, Vol. I, 1992.

Kempel, Robert: "F-18 High Alpha Research Vehicle Description," NASA Contractor Report, 1993.

Regenie, Victoria, Gatlin, Donald, Kempel, Robert, and Matheny, Neil: "The F-18 High alpha Research Vehicle: A High-Angle-of-Attack Testbed Aircraft," NASA TM 104253, 1992.

Ogburn, Marilyn E.; Foster, John V.; Nguyen, Laut T.; Breneman, Kevin P.; McNamara, William G.; Clark, Christopher M.; Rude, Dennis D.; Draper, Marjorie G.; Wood, Craig A.; and Hynes, Marshall S.: "High-Angle-Of-Attack Nose-Down Pitch Control Requirements for Relaxed Static Stability Combat Aircraft," NASA CP 3149, Part II, Vol. I, 1992.

Pahle, Joseph W.; and Wilson, Joe: "Preliminary Flight-Test Results with Multi-Axis Thrust Vectoring," NASA CP 3137, 1992.

Wilson, R. Joe; and Pahle, Joseph W.: "Results of High Yaw Rate Expansion Flights," NASA CP 3137, 1992.

Klein, Vladislav: "Aerodynamic Characteristics of High Angle of Attack Research Vehicle (HARV) Determined from Flight Data," NASA CP 3149, 1992.

Bowers, Albion H.; Noffz, Gregory K.; Grafton, Sue B.; Mason, Mary L.; Peron, Lee R.: "Multiaxis Thrust Vectoring Using Axisymmetric Nozzles and Postexit Vanes on an F/A-18 Configuration Vehicle," NASA TM 101741, 1991.

323977 1995107827

16090  
P-17

**Design and Development of an F/A-18 Inlet Distortion Rake:  
A Cost and Time Saving Solution**

An innovative inlet total-pressure distortion measurement rake has been designed and developed for the F/A-18 A/B/C/D aircraft inlet. The design was conceived by NASA and General Electric Aircraft Engines (Evendale, Ohio). This rake has been flight qualified and flown in the F-18 High Alpha Research Vehicle (HARV) at NASA Dryden Flight Research Center. The rake's eight-legged, one-piece wagon wheel design was developed at a reduced cost and offers reduced installation time compared with traditional designs. The rake features 40 dual measurement ports for both low- and high-frequency pressure measurements with the high-frequency transducer mounted at the port. The high-frequency transducer offers direct absolute pressure measurements from low frequency to the highest frequency of interest, thereby allowing the rake to be used during highly dynamic aircraft maneuvers. Outstanding structural characteristics are inherent to the design through its construction and use of lightweight materials.

DRYDEN  
FLIGHT  
RESEARCH  
CENTER



**Design and Development of  
an F/A-18 Inlet Distortion Rake:  
a Cost and Time Saving Solution**

**Andrew J. Yuhas and Ronald J. Ray**  
NASA Dryden Flight Research Center  
Edwards, California

**Richard R. Burley**  
NASA Lewis Research Center  
Cleveland, Ohio

**William G. Steenken,  
Leon Lechtenberg,  
and Don Thornton**  
General Electric Aircraft Engines  
Evendale, Ohio

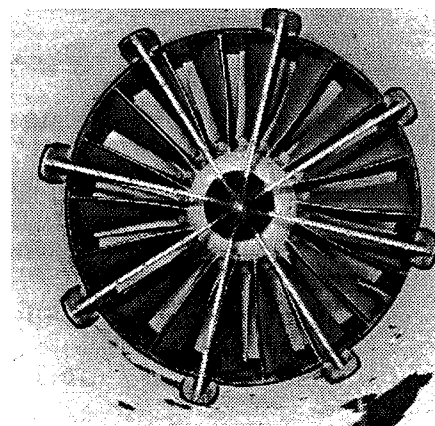

**4th NASA High Alpha Conference**  
Propulsion and Inlet Dynamics and Thrust Vectoring Section  
NASA Dryden Flight Research Center

July 12-14, 1994

94-172

## Outline

This presentation overviews the objective, description, installation, and qualification testing of the HARV inlet rake system. Comparisons of cost and installation time between this design and a previous design are made. The report describes the pressure transducer selection, along with all stages of flight qualification testing, from laboratory testing to flight test. The presentation ends with a summary of concluding remarks.

## Outline

- Objective
- Rake description
- Rake installation
- Pressure transducer selection
- Flight qualification testing
- Concluding remarks

## Objective

The design, development, and installation of an inlet total-pressure distortion rake can be expensive and time consuming. The goal of the F-18 HARV inlet research program is to evaluate the inlet characteristics of high-performance aircraft during both stabilized and highly dynamic maneuvers at high angles of attack. The F-18 HARV inlet research program required a low-cost, quickly installed, low-maintenance solution for a total-pressure inlet distortion measurement system.

Design requirements were established for the rake system. The most important requirement was to provide as much commonality as practical with the planned HARV inlet wind-tunnel test at the NASA Lewis Research Center and with previous F/A-18 inlet testing. Commonality considerations with past and present testing include, but are not limited to, instrumentation setup, rake positioning, and probe configuration. In addition, it was desirable to follow established industry guidelines wherever possible, especially those established by the Society of Automotive Engineers. Meeting aerodynamic and structural requirements was also an important consideration.

## Objective

**Design and develop an inlet total-pressure distortion measurement rake**

- **Investigate high angle-of-attack inlet flow characteristics during dynamic aircraft maneuvers**
- **Offer reduced cost and installation time**
- **Maintain commonality**
- **Adhere to technical guidelines**
- **Meet aerodynamic and structural considerations**

DRYDEN  
FLIGHT  
RESEARCH  
CENTER





## F-18 High Alpha Research Vehicle

The F-18 HARV is a one-of-a-kind research aircraft located at NASA Dryden Flight Research Center. This preproduction, single-seat fighter-attack aircraft has been uniquely modified to perform extensive flight testing in the high-angle-of-attack region. These modifications include a thrust-vectoring control system that uses three paddles per engine nozzle to deflect the jet exhaust. The aircraft has two General Electric F404-GE-400 turbofan engines. The inlet rake was installed in the right inlet (aft looking forward).

The aerodynamic design flight envelope coincides with the normal operating envelope of the HARV aircraft and was chosen to allow unrestricted flight with the inlet rake installed. Inlet research test points are primarily focused at the low-speed portion of the envelope between Mach numbers ( $M$ ) 0.3 to 0.4. The worst-case dynamic pressure condition is  $M = 0.7$  at sea level conditions in which the free-stream total pressure is 20.4 psia and the hot day total temperature is 618 °R.

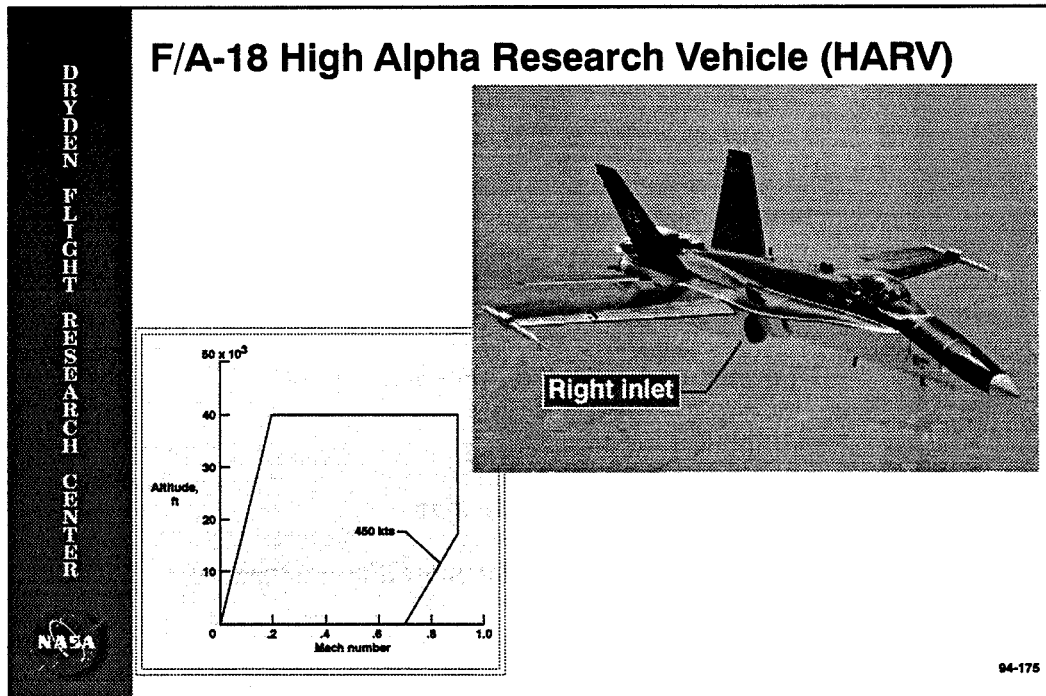

## Original F/A-18 Cantilevered Inlet Rake

An evaluation of the rake used in the original F/A-18 inlet compatibility program, flown in the mid-1970's on the second preproduction F/A-18A, indicated current costs more than \$1.5 million and installation time of a year or more. Driving both these factors was the complexity of using eight individual cantilever rakes. Those designs had to be developed, tested, and installed independently. Installation in the HARV would require the aft portion of the inlet duct to be extensively reinforced. To meet the complex inlet rake structural requirements, the bulkhead on aircraft #2 was specifically designed to accommodate the inlet rake mounting requirements. It was quickly apparent that this was not a viable approach for the HARV project. During an early design conception meeting NASA and General Electric personnel conceived an alternative approach in which all eight rake legs would be joined at the center of the inlet with a hub similar to that of a wagon wheel to simplify design.

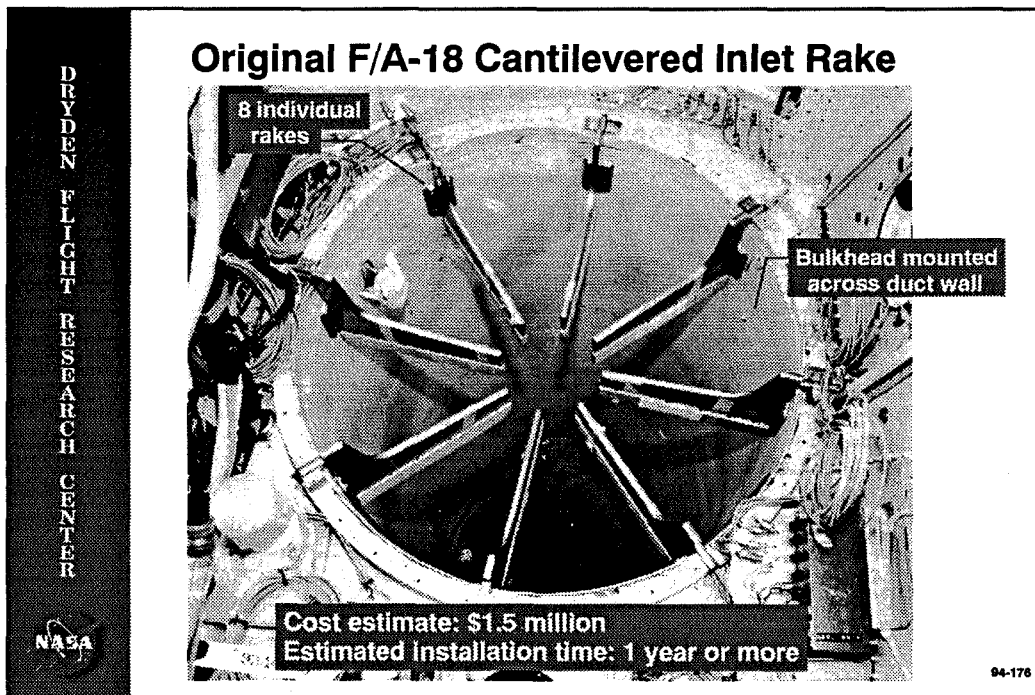

## HARV Rake Front and Side Views

The HARV rake is much like a wagon wheel, with the streamlined centerbody acting as the hub, the eight aerodynamic rake bodies as the spokes, and the inlet duct as the rim. The load-bearing structure is a welded steel unit that joins the rake bodies and the central hub into a single piece, which is supported by integral foot pads and bolted to the aircraft inlet duct flange. Each of the eight rake legs contains five probes located on the centroids of five equal areas of the flow area. The body comprises a steel frame with a bonded elastomer. The elastomer, which acts as an excellent damping material, allowed the overall weight to be reduced and the rake struts to be aerodynamically shaped easily (in comparison with an all-metal body). The weight of the entire rake assembly is approximately 15 lb. No physical contact is made between the engine and the rake system. A detailed description of the rake hub, rake body cross-section, measurement port, footpad, and mounting installation follows.

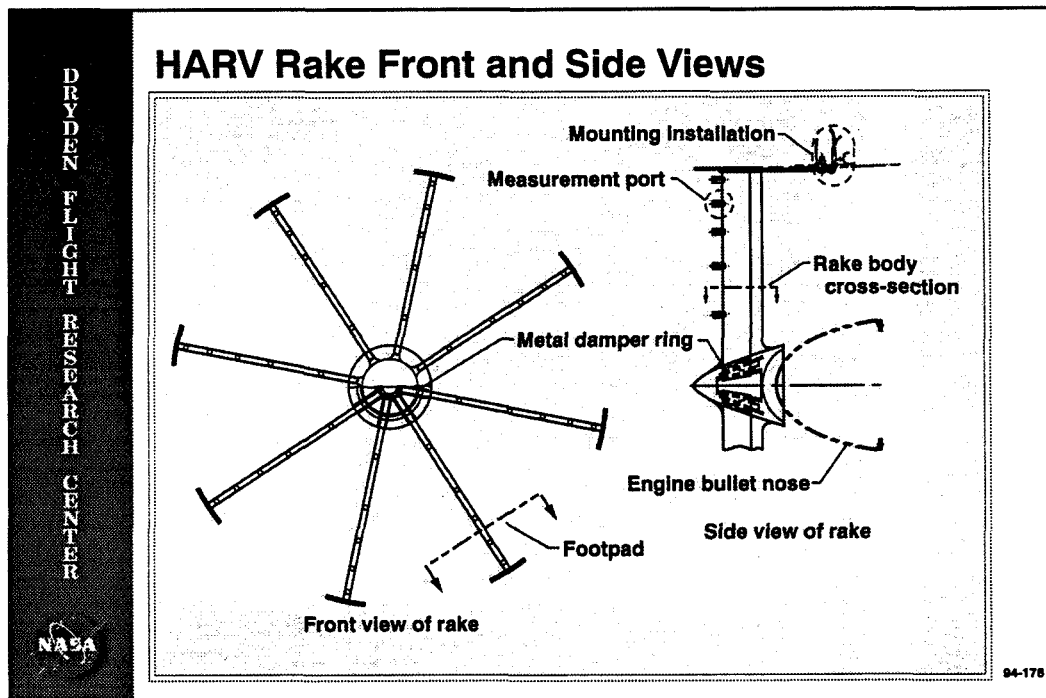

## Rake Hub

All of the rake bodies are gathered in a central hub and welded to an inner ring. The hub also contains an isolated metal damper ring potted in the polyurethane centerbody. This allows the damping material to dissipate vibration energy more effectively than an all-metal body would. The same polyurethane material forms the streamlining of centerbody.

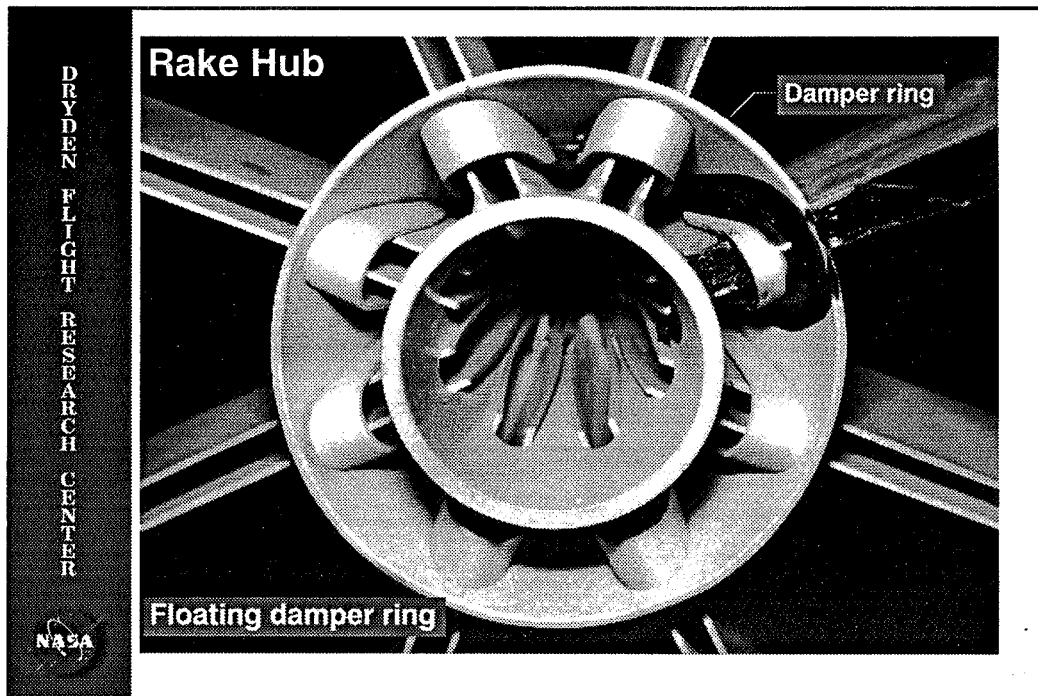

## Rake Body Cross-Section

The rake bodies (or spokes) are made by forming sheet metal into the leading edge and sides of the airfoil shape. The sheet metal is left open at the trailing edge. This allows the installation of the sensor and lead-out tubes. The rake bodies are filled the elastomer, and the trailing edges of the rake bodies are aerodynamically formed with the elastomer. The rake body is 2.5-in. long with maximum thickness of about 0.39 in.

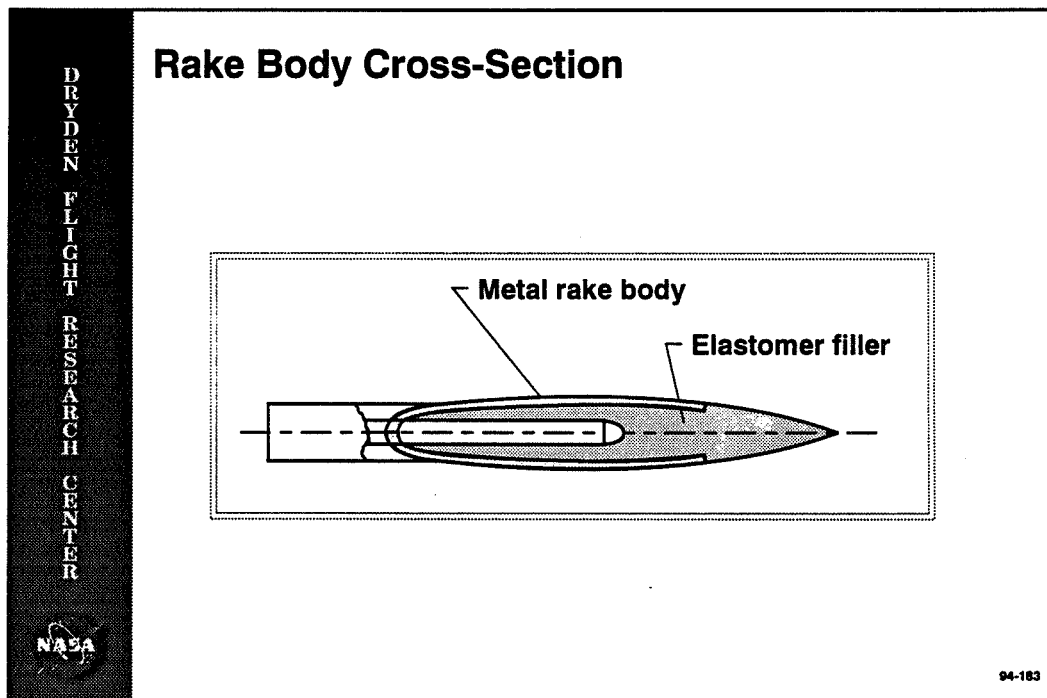

## Rake Measurement Port

The rake sensors are shielded total-pressure measuring sensors consisting of a high-frequency response pressure transducer and a 1/16-in. diameter low-frequency response pressure tube. The stagnation shield configuration was tested to show its ability to measure the true total input pressure at flow angles of  $\pm 25^\circ$  in yaw and  $+15^\circ$  and  $-25^\circ$  in pitch (positive angle is toward engine centerline). The probes are aligned within  $2^\circ$  of the anticipated steady-flow streamlines. The innermost probe is the only one that had to be angled ( $5.5^\circ$ ) with respect to the rake body. The high-response transducers are installed in carrier tubes. The tubes have a counterbore to receive the transducers. Installation is accomplished by feeding the electrical leads through the carrier tube from the sensor end, coating the back of the transducer with an adhesive, and inserting the transducer into the counterbore. Next, the transducer is covered with heat-shrinkable tubing. This arrangement gives a secure mounting for the transducers but allows replacement while the rake is still in the aircraft. Transducer replacement was demonstrated with the replacement of seven transducers requiring less than 2 days once the engine was removed.

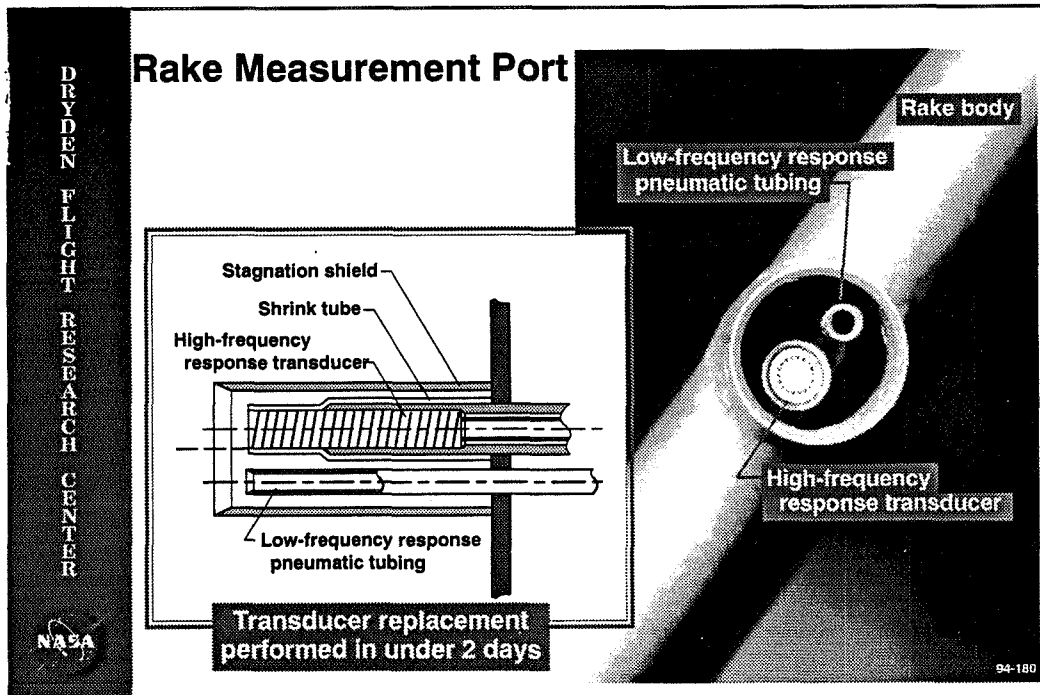

## Rake Footpad

The rake bodies are welded to the foot pads. The footpads allow the duct flange to support the rake without inducing any bending load in the sheet metal wall of the duct. The lead-out tubes are carried between the toes of the footpad.

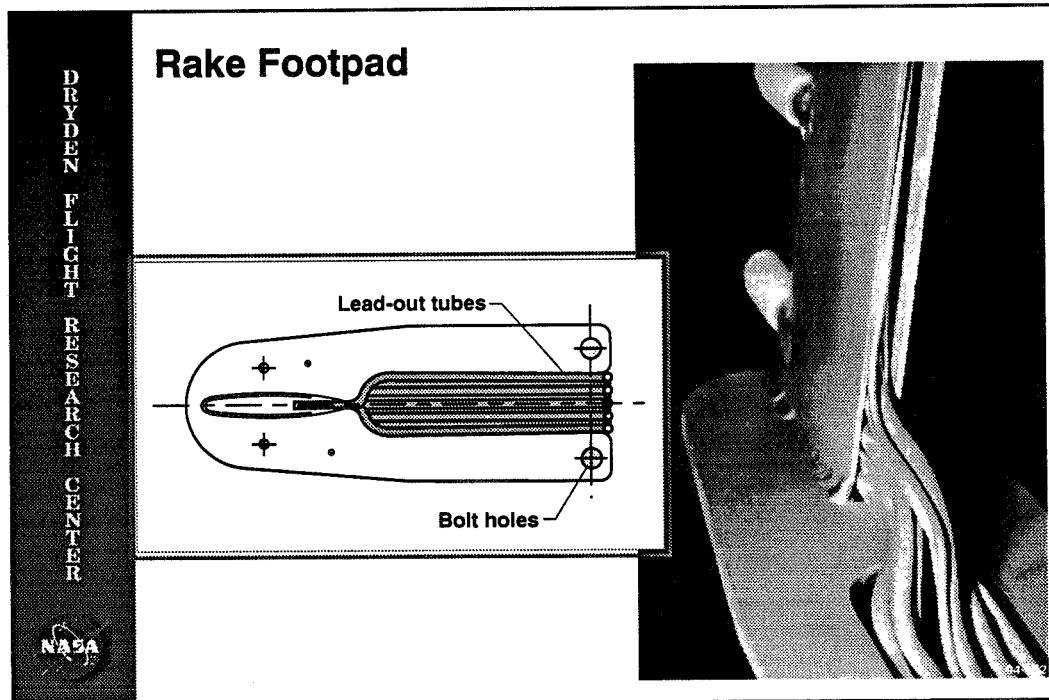

## Rake Mounting Installation

Installation of the rake was accomplished after the right engine and K-seal had been removed. The minimal modifications that were required on the airframe consisted of 16 bolt holes drilled in the inlet duct flange aft of the rear bulkhead. Backup washers were placed at each hole on the outside of the duct and epoxied in place to provide a solid and flat surface for seating the nuts of the rake mounting bolts. The rake was placed in the duct, and an even fit for each rake strut was achieved by placing shims between the metal footpad and the inlet duct wall. The rake was then installed with an adhesive injected between the foot pads and the shims. The foot pads were bolted in place and the adhesive cured giving the assembly a firm, elastomer-damped mounting. The K-seal was contoured to allow the rake tubes to pass freely under it. The seal was then bolted in place on the aft duct flange, and the electrical leads and the pneumatic tubes were routed to their respective connector locations.

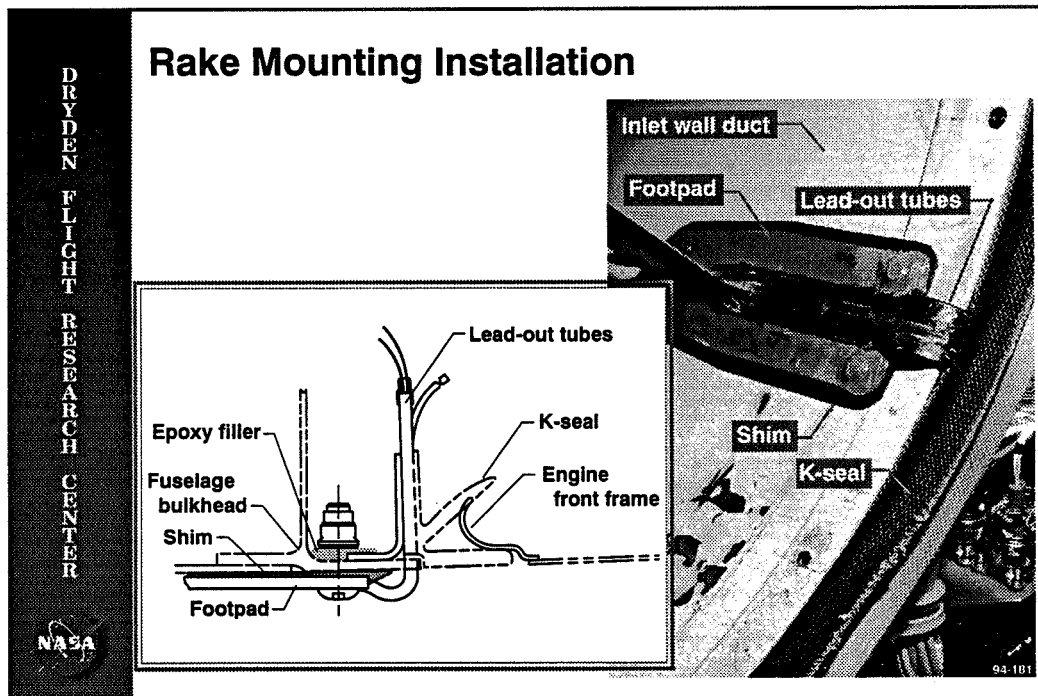



## Installed HARV Inlet Rake

The NASA/General Electric design greatly simplifies installation and aircraft modifications required for an inlet rake system. General Electric has designed, developed, and built one prototype and two flight-worthy rakes for less than \$500,000. One flight-worthy rake had an entire set of high-response transducers included in the cost. The rework to the airframe, installation of the rake assembly, modification to the K-seal, and installation of the seal ready for lead routing was accomplished in two and a half 8-hour shifts. This installation time shows a significant reduction in aircraft down time compared with more traditional designs.

DRYDEN  
FLIGHT  
RESEARCH  
CENTER

### Installed HARV Inlet Rake

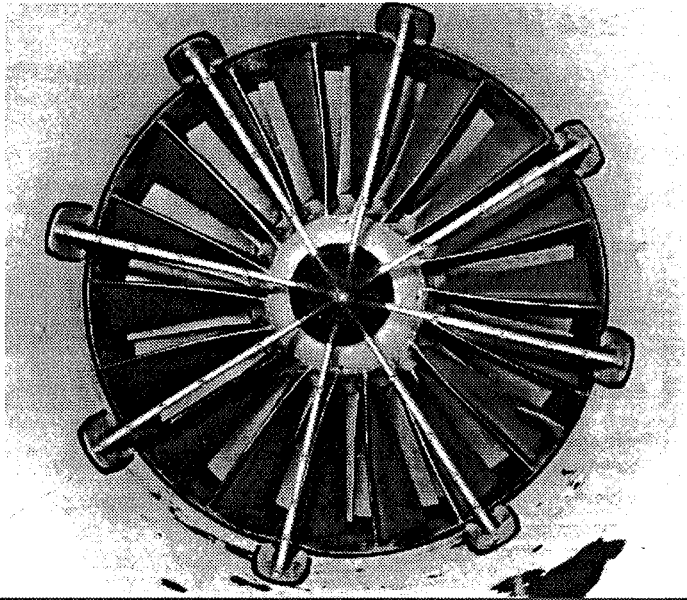

**Cost: less than \$500,000    Installation time: under 3 days**



94-184

## **Pressure Transducer Selection**

The pressure transducer requirement was to develop an instrumentation setup that would allow for accurately measuring the pressure level and the time-dependent component of the pressure during highly dynamic maneuvers. Minimization of two known uncertainties that affect the ability to measure an accurate pressure level during a dynamic maneuver were addressed: (1) pneumatic lag and (2) thermal zero shift. The pneumatic lag describes the condition in which the pressure signal is delayed, in reference to time, to the transducer at the end of the tubing and, therefore, affects low-response accuracy. The thermal zero shift affects the ability of the transducer to accurately measure the pressure level at varying inlet temperature conditions. Thermal zero shift describes the calibration shift of the zero voltage condition experienced as a pressure transducer sensing element varies with temperature.

The high-response probe used a temperature-compensated pressure transducer with an absolute pressure range of 0 to 20 psia. The transducer was selected because of its ability to minimize thermal zero drift through passive temperature compensation. To further increase the accuracy of the transducer measurement, a series of pressure calibrations were performed over the entire required pressure and temperature range, up to 20 psia and at  $-65$ ,  $-30$ ,  $0$ ,  $75$ , and  $150$  °F. These calibrations, along with the measured engine inlet temperature, would allow for any remaining zero thermal drift to be removed during postflight data processing. The low-response measurements will be used to verify the pressure levels of the high-response measurements at stabilized conditions. This high-response transducer setup will allow for the accurate measurement of high-frequency pressure levels during highly dynamic maneuvers and also meets the system accuracy requirements.

The low-frequency response probe uses a differential transducer with a reference pressure. This transducer unit was thermally stabilized to increase accuracy by minimizing thermal zero drift. This was accomplished by wrapping the transducer unit in temperature-controlled thermal blanket. Another transducer feature that was used to increase accuracy was its ability to perform in-flight calibrations. This allows for any calibration bias error to be removed during postflight data processing. The in-flight calibration is accomplished by applying the reference pressure to both sides of the differential transducer.

## Pressure Transducer Selection

**Challenge: Measure inlet pressures during highly dynamic aircraft maneuvers by minimizing pneumatic lag and thermal zero shift**

- **High-frequency response instrumentation**
  - Absolute pressure range of 0–20 psia
  - Passive temperature compensation
  - Laboratory calibrations at temperatures from –65 to 150 °F
- **Low-frequency response instrumentation**
  - Differential transducers with reference pressure
  - Thermal blanked transducers
  - In-flight calibration capability

## Flight Qualification—Test Phases

The flight qualification testing was broken into three phases: (1) laboratory, (2) ground, and (3) flight. The laboratory phase determines the baseline structural and vibrational characteristics of the rake. This phase consists of NASTRAN computer modeling of the rake structure, along with ping testing and vibrational shake table testing of a prototype rake. The baseline results from the laboratory tests were used for comparison with the results from the remaining phases: installed ground and flight testing. Ground testing consisted of a ping test being performed on the inlet rake installed in the HARV. Then, the installed rake was ground tested on the HARV with the aircraft tied down. The right engine was operated through its full range with a slow acceleration from idle power to full maximum afterburning and a slow acceleration back to idle power. This procedure allows predominant frequencies to be identified over the entire fan rotor speed range. Flight testing for the rake consisted of flight maneuvers to give maximum unsteady loads ( $\alpha = 60^\circ$  at 20,000 ft), maximum temperature, and pressure ( $M = 0.7$  on the deck), and maximum combination of temperature, pressure, and unsteady loads ( $M = 0.9$  at 18,000 ft) within the HARV flight envelope. The latter two points were at the limits of the HARV flight envelope. The first point was flown to a high-angle-of-attack condition, while the latter two obtained maximum  $g$ -limit loading.

### Flight Qualification – Test Phases

- Laboratory testing
  - NASTRAN modeling
  - Ping testing
  - Vibrational shake table testing
- Ground testing
  - Ping testing
  - Engine operation over entire fan rotor speed range
- Flight testing
  - Flight maneuvers with combinations of maximum unsteady loads, temperature, and pressure

## **Flight Qualification—Results**

The rake structure was demonstrated to be highly damped and was successfully flight qualified for the entire HARV flight envelope. The spectra of the rake vibrations experienced during laboratory testing remained consistent with the ground and flight test results. The maximum stress levels observed were less than 30 percent of limits (30,000 lbf/in<sup>2</sup>, peak to peak). The stress levels observed during high- $\alpha$  flight were 26 percent of limits and less than 10 percent of limits during maximum- $g$  flight. The highest stress levels observed were 30 percent of limits during aircraft takeoff. Based on the laboratory, ground, and flight test results, the rake is now fully cleared for conducting flight research within the entire HARV flight envelope with no restrictions. The inlet rake system has flown over 60 successful research flights.

### **Flight Qualification – Results**

- **Highly damped structure**
- **Successfully cleared for entire design envelope**
- **Flight and ground testing verified expected frequency response predicted by laboratory testing**
- **All stress levels observed were less than 30 percent of limits**
- **Flown in over 60 research flights**

## Concluding Remarks

An improved cost- and installation-time-saving inlet distortion pressure rake was successfully designed, built, and validated for flight testing on the F/A-18 HARV research aircraft. The cost for one prototype and two flight-worthy rakes along with required development testing was under \$500,000. The innovative design consists of a one-piece, wagon wheel approach that resulted in ease of installation with minimal aircraft modifications. The demonstrated installation time was under 3 days. Design features include lightweight, high-strength, low structural resonance, low flow blockage, and easy transducer removal and replacement. Instrumentation selection allowed for direct pressure measurement during highly dynamic aircraft maneuvers. A prototype of the new rake was environmentally tested in a laboratory where it passed all vibration structural requirements. Ground test verified the expected frequency response predicted from laboratory test. Flight qualification was completed and the rake is now cleared for flight testing on the HARV aircraft with over 60 flights performed. All stress levels observed during ground and flight qualification were less than 30 percent of limits.

### Concluding Remarks

- NASA/GEAE inlet rake design demonstrated improved cost and installation-time savings
- Cost for entire design and development of two flight-worthy rakes was under \$500K
- Rake installation in under 3 days
- Direct pressure measurements during dynamic aircraft maneuvers
- Flight qualification successfully completed (60+ flights)
- Structural stress levels were less than 30 percent of limits
- Ease of transducer replacement demonstrated

015

# Installed F/A-18 Inlet Flow Calculations at High Angles of Attack and Moderate Sideslip

S. D. Podleski, NYMA, Inc., Brook Park, OH

# PURPOSE OF PARC3D CALCULATIONS

## **PURPOSE**

*Support Wind-Tunnel Tests at NASA/Lewis Research Center*

*Support Flight Tests at NASA/Dryden*

*Explore Capabilities of PARC3D and Grid Generation*





# OUTLINE OF PRESENTATION

## OUTLINE

*Purpose*

*Grid Generation and Flow Solver*

*Grid Structure*

*Geometry*

*Particle Traces*

*Total Pressure Contours*

*Comparisons With Flight-test*

*Ongoing Work*

*Future Work*

*Video Tape*



# **FLOW SOLVER AND GRID GENERATOR**

Short description of the PARC3D flow solver and  
GRIDGEN3D grid generator.

## **FLOW CODE**

### ***Parc3d***

*full 3-D Reynolds-averaged Navier-Stokes equations*

*strong conservation form*

*Beam and Warming factorization*

*multiple grid blocks*

## **GRID GENERATION**

### ***Gridgen3d system***

*developed by General Dynamics and Wright Patterson AFB*

*Gridblock, Gridgen2d, Gridgen3d, Gridvue*

*algebraic and elliptic surface and volume grid generation*



# PARC3D GRID BLOCK STRUCTURE

This figures show the grid block geometry of the F/A-18 HARV half model. There is a total of 30 blocks totaling over 2.4 million grid points. Each block is required by the PARC3D code to overlap by at least one cell to enable trilinear interpolation between blocks.

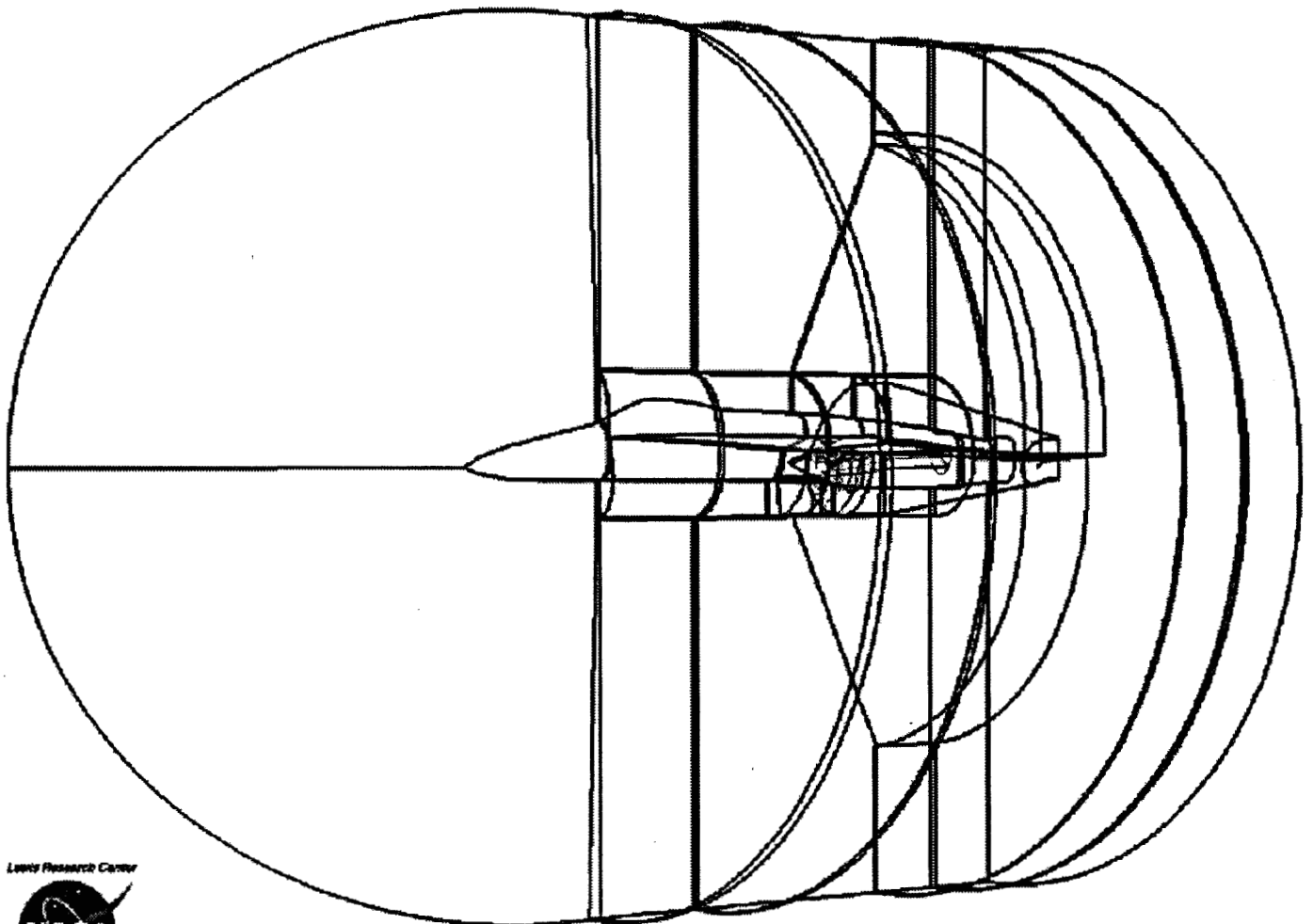

**Grid Block Structure**



## FLOW FIELD AND SURFACE GRIDS

---

This figure shows the grid along the symmetry plane and on the aircraft surface. The red coloured grid denotes the blocks where viscous calculations are made and the green coloured grid are blocks where Euler calculations are made.

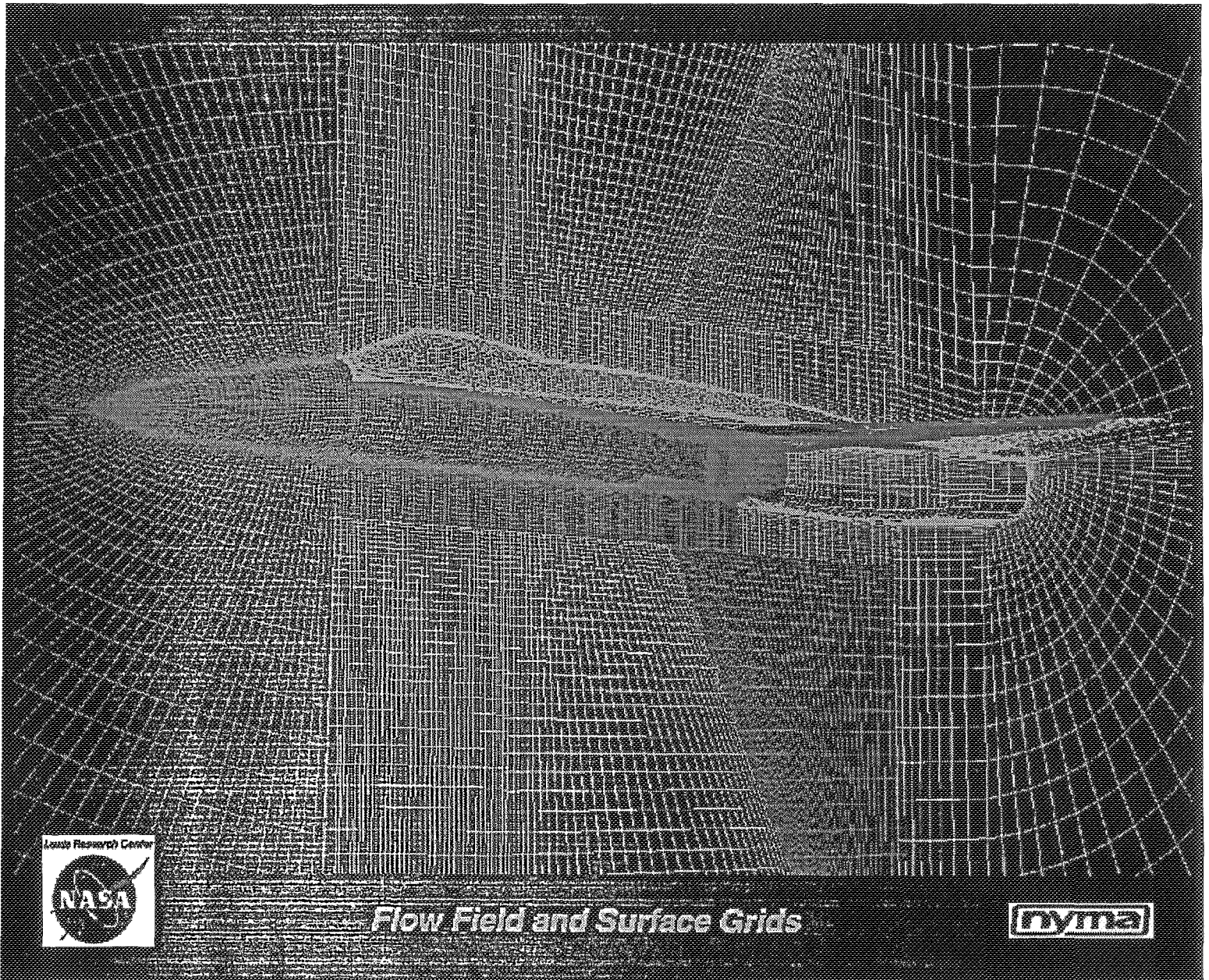

## PARC3 GEOMETRY IN VICINITY OF INLET

This is a close up of the area near the inlet. Several features are shown: the ramp/splitter plate, the diverter and slot, the overlapping lip and leading edge flap grid, the upper diverter (cove block).

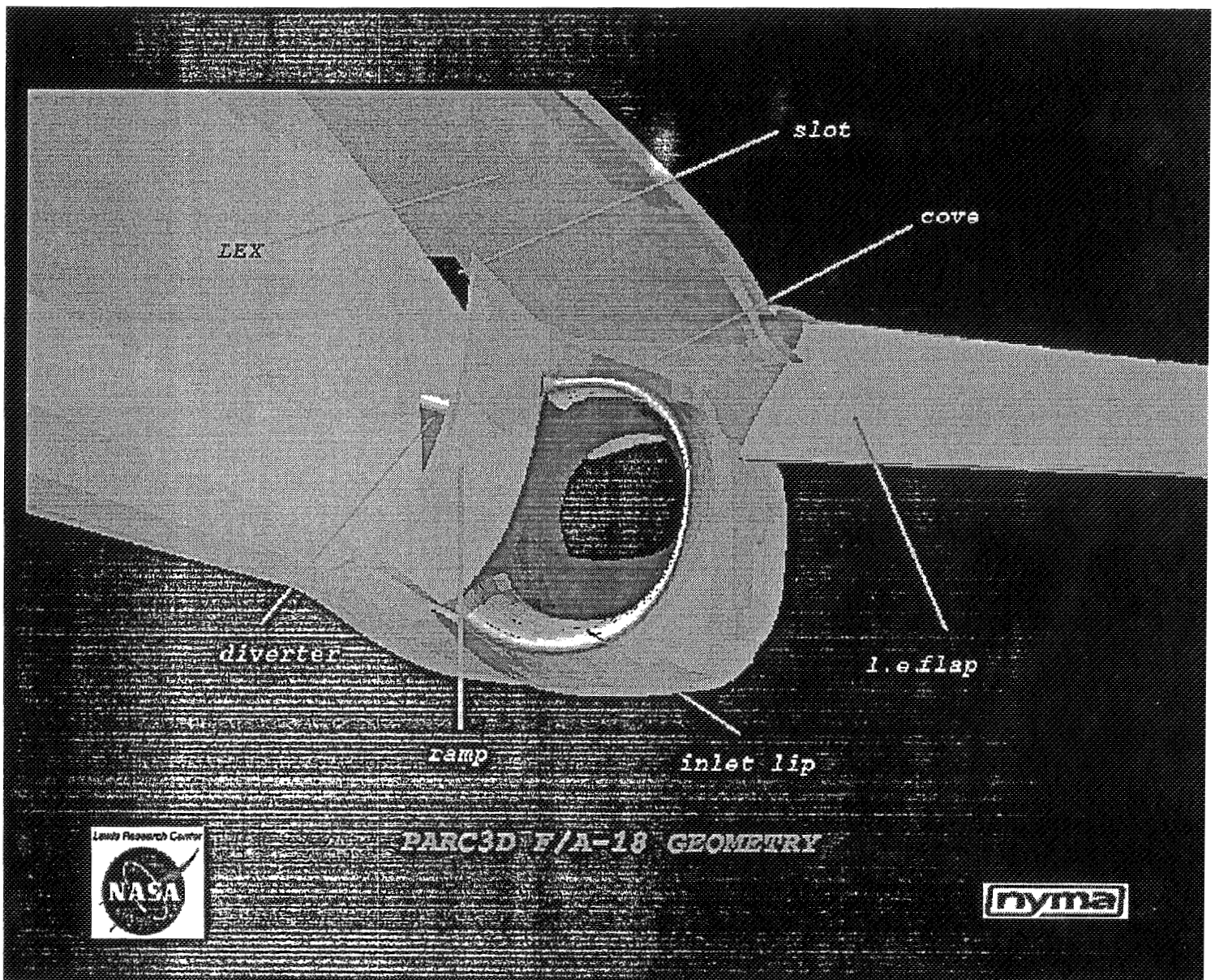

## LEEWARD PARTICLE TRACES

This figure shows the particle traces generated by PLOT3D highlighting the main flow features. For this flow condition, Mach number of 0.2,  $\alpha=60^\circ$  and  $\beta=10^\circ$ , a stagnation-like flow exists below the LEX. Two sets of vortices exist: one near the LEX apex and another about midway downstream to the inlet. Both vortices have a component to flow towards the nose of the aircraft until they are swept over the LEX and into the wake. One vortex moving towards the inlet is split by the ramp where one component is ingested by the inlet and the other is swallowed by the diverter and dumped into the wake.

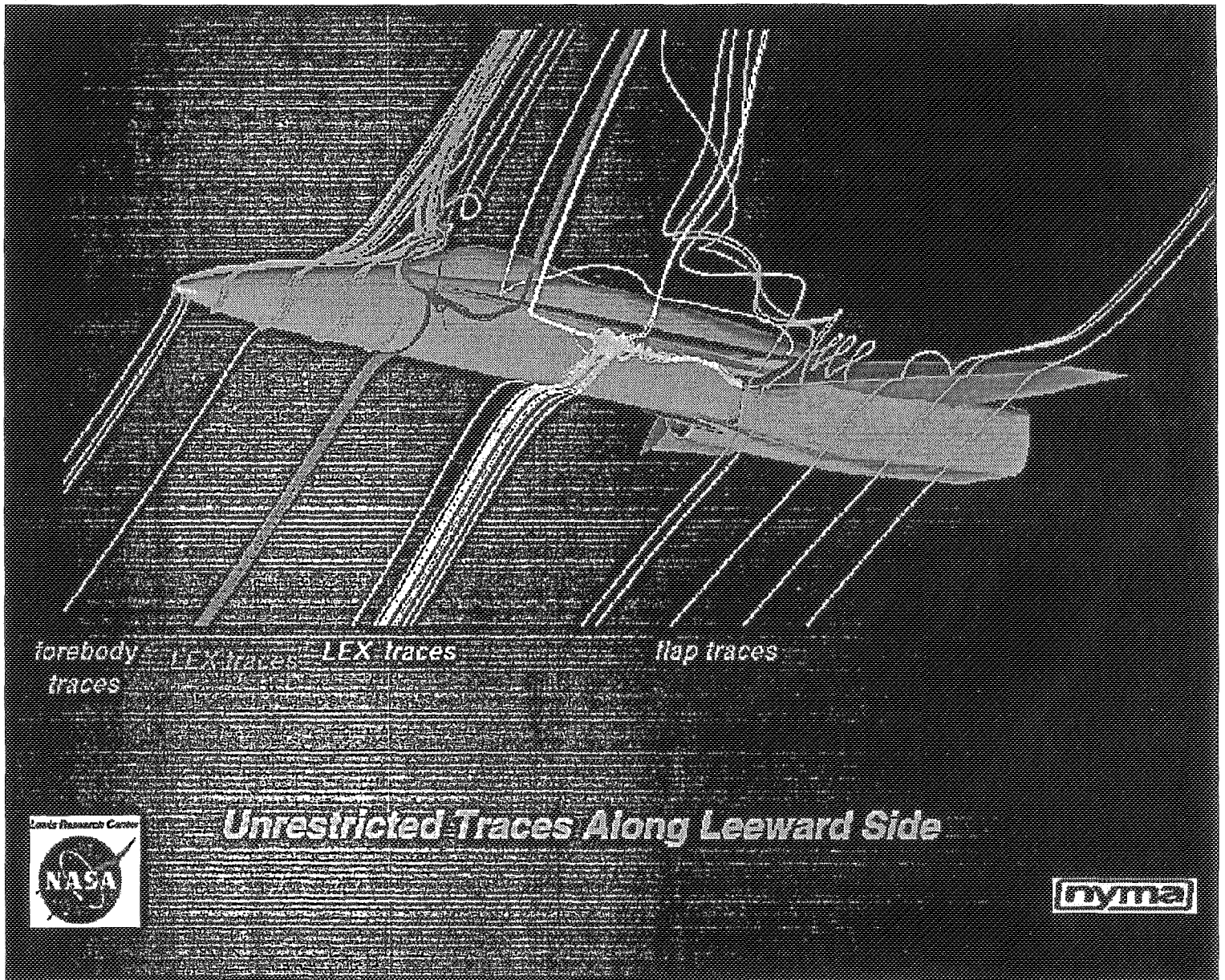

# LIMITING STREAMLINES NEAR THE LEEWARD INLET

This figure shows the PLOT3D generated surface oil flow near the leeward inlet. Most of the fuselage and wing blocks have been removed for clarity. The main flow features of interest are the separation lines along the ramp and inside the inlet and the stagnation line on the cowl. The flow conditions are  $\alpha=60^\circ$ ,  $\beta=10^\circ$  and a Mach number of 0.2.

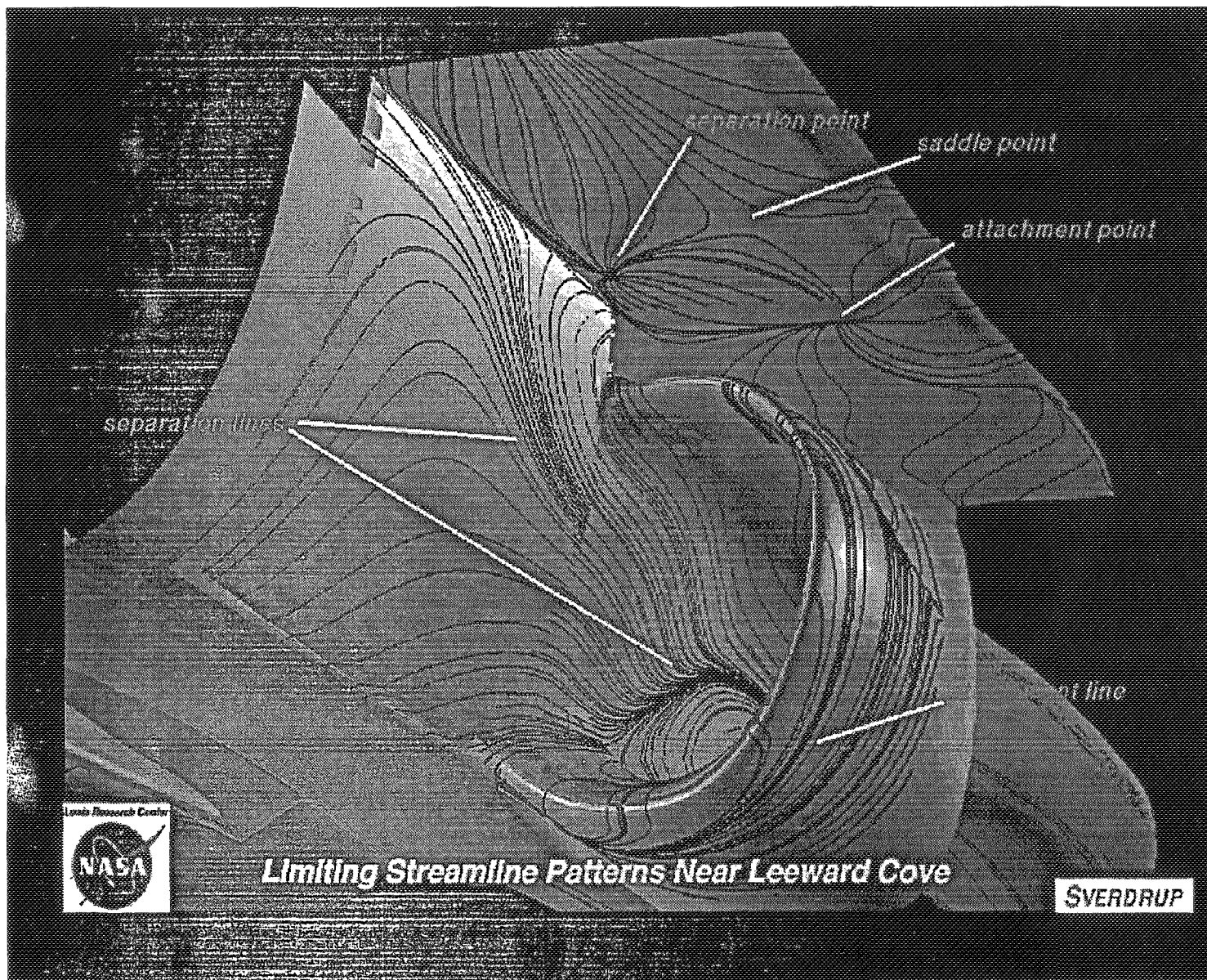

# OIL FLOW TRACES AT $\alpha=30^\circ$ , $\beta=10^\circ$ and $M=0.3$

This figure shows the FAST-generated surface oil flow on the leeward side of the aircraft.

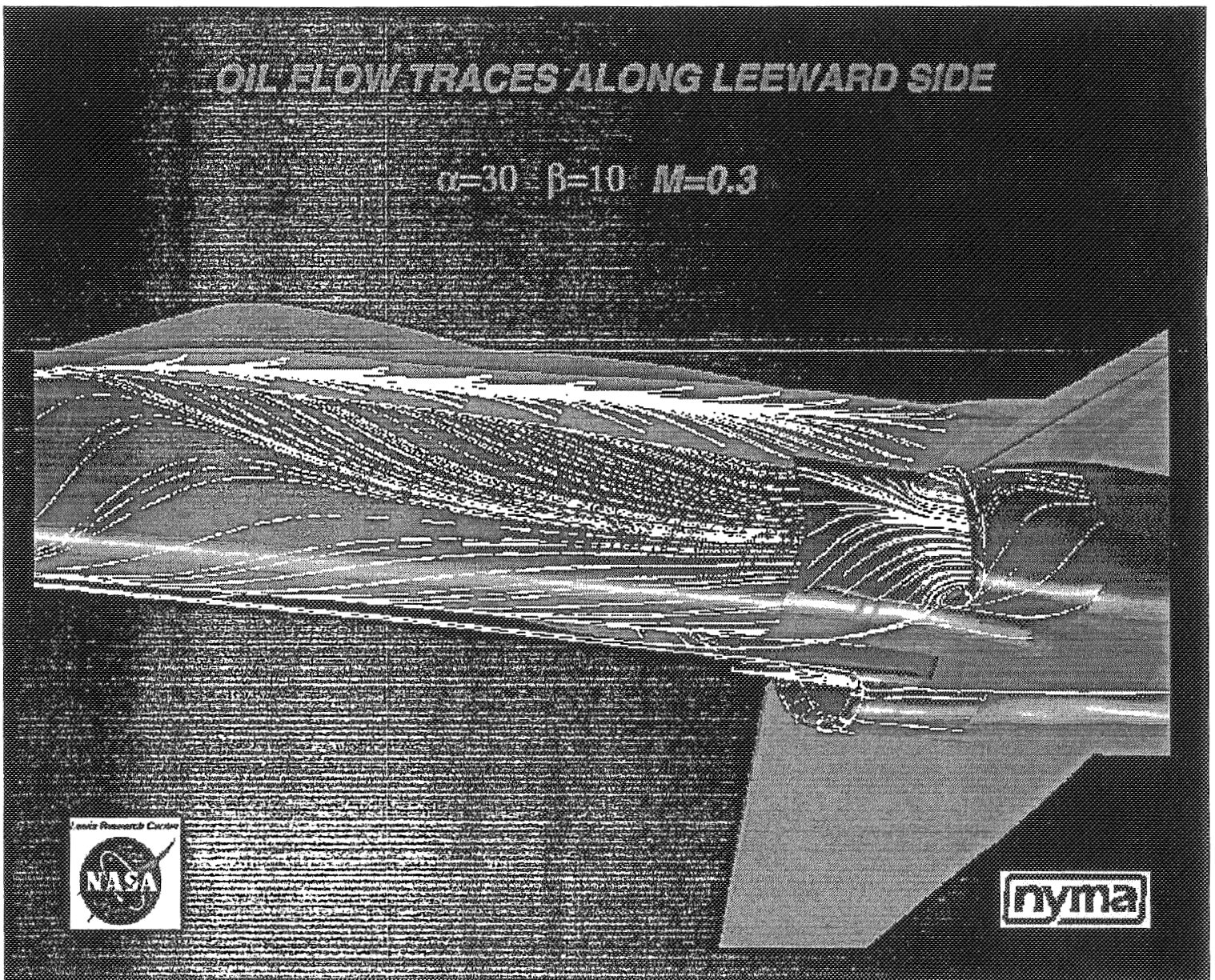



## OIL FLOW TRACES AT $\alpha=30^\circ$ , $\beta=10^\circ$ and $M=0.4$

This figure shows the FAST-generated surface oil flow on the leeward side of the aircraft at an angle of attack of 30 deg., a sideslip angle of 10 deg. and Mach number of 0.4.

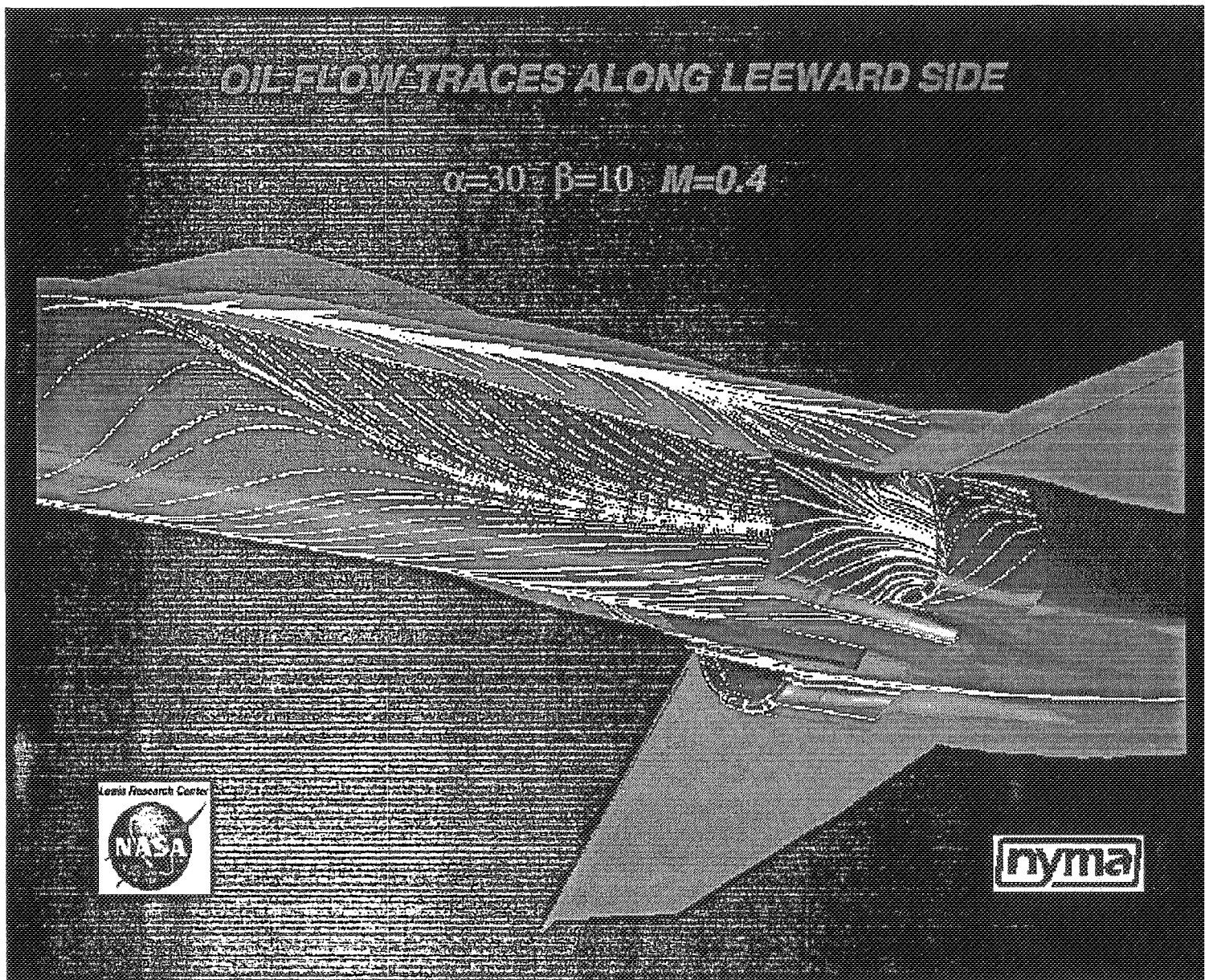

## OIL FLOW TRACES AT $\alpha=50^\circ$ , $\beta=10^\circ$ and $M=0.3$

Here, with the aircraft flying at 50 deg. angle of attack, 10 deg. of sideslip and a Mach number of 0.3, the FAST generated surface oil flow shows a more complex pattern with some of the flow moving towards the aircraft nose.

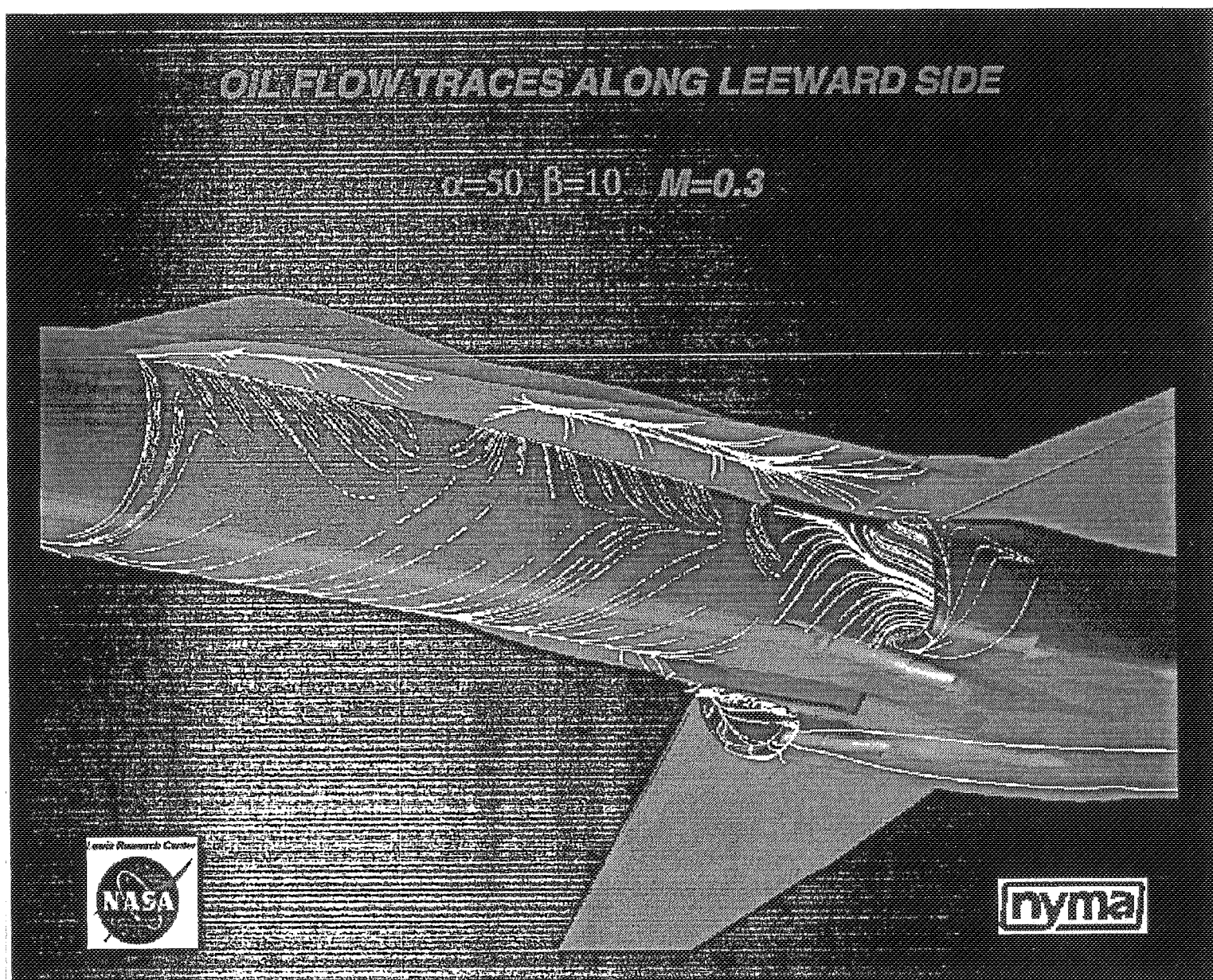

## OIL FLOW TRACES AT $\alpha=60^\circ$ , $\beta=5^\circ$ and $M=0.3$

Here, with the aircraft flying at 60 deg. angle of attack, 5 deg. of sideslip and a Mach number of 0.3, the FAST generated surface oil flow shows a more complex pattern with some of the flow moving towards the aircraft nose.



## LIMITING STREAMLINES INSIDE LEEWARD INLET

---

This figure shows the PLOT3D-generated surface oil flow inside the leeward inlet. A vortex (blue line) lifts off the focus located near the 2 o'clock position on the lip and it travels downward along the lip until it meets the separation vortex (yellow line) generated by the lip. Flight conditions are at  $\alpha=60^\circ$ ,  $\beta=10^\circ$ , and Mach number of 0.2.

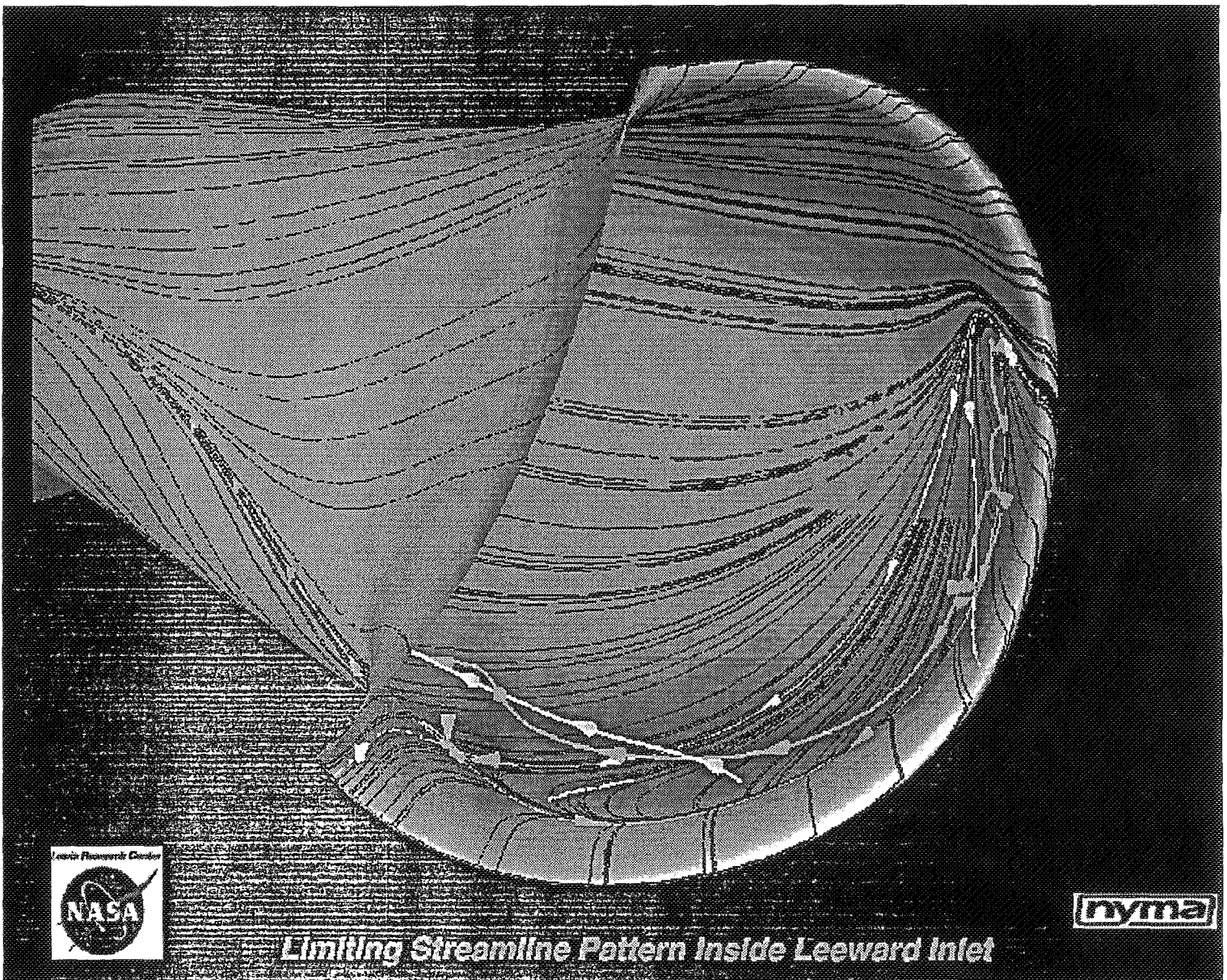

## LIMITING STREAMLINES INSIDE LEEWARD INLET

---

This figure gives a downstream view of the leeward inlet. The final location of the separation vortex is the low pressure region of the total pressure contours at the aerodynamic interface.

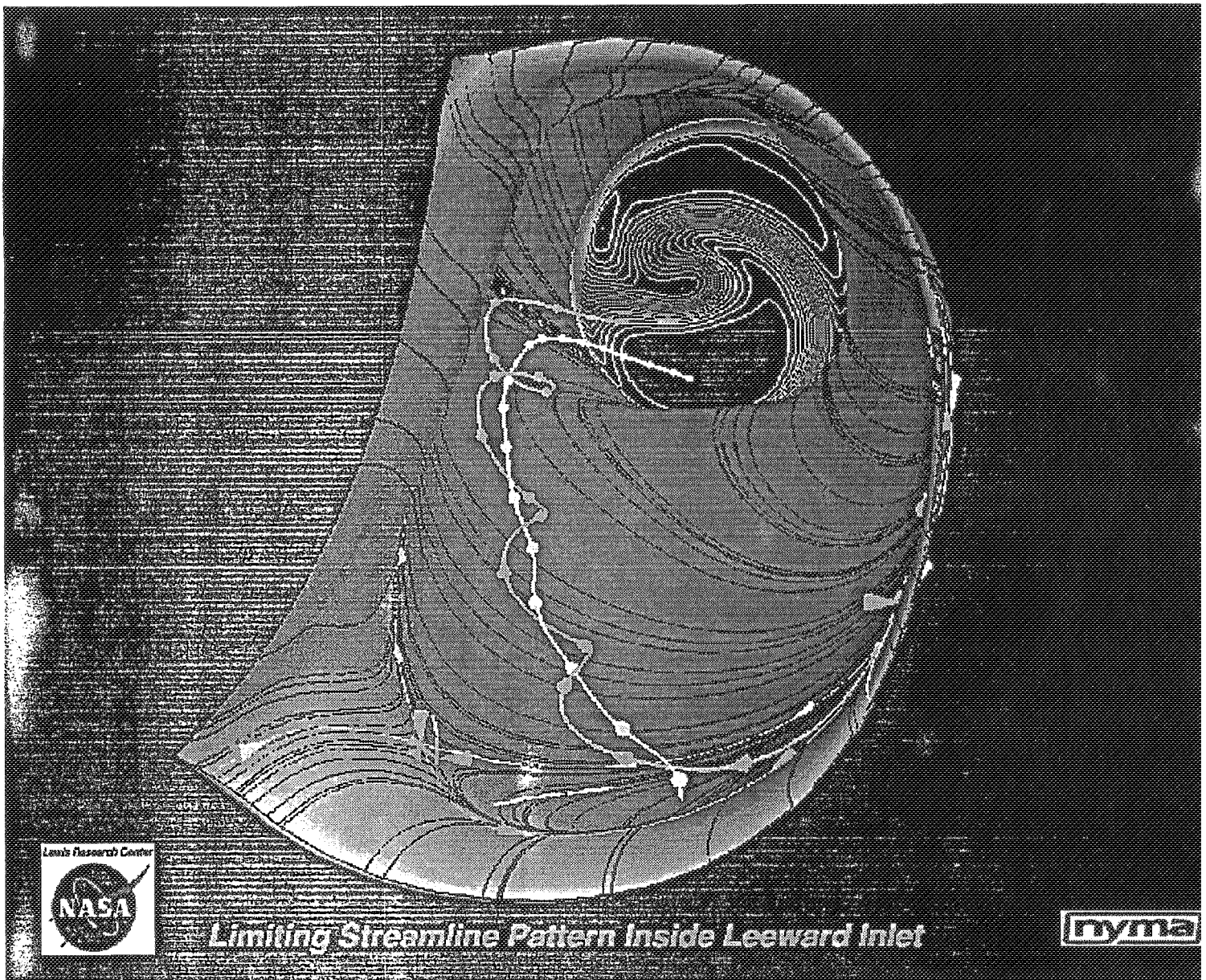

# PRESSURE CONTOURS AND VELOCITY VECTORS

## OF LEEWARD INLET AT VARIOUS $\alpha$ , $\beta$ and M

This figure shows the total pressure contours and cross-flow velocity vectors at the aerodynamic interface.

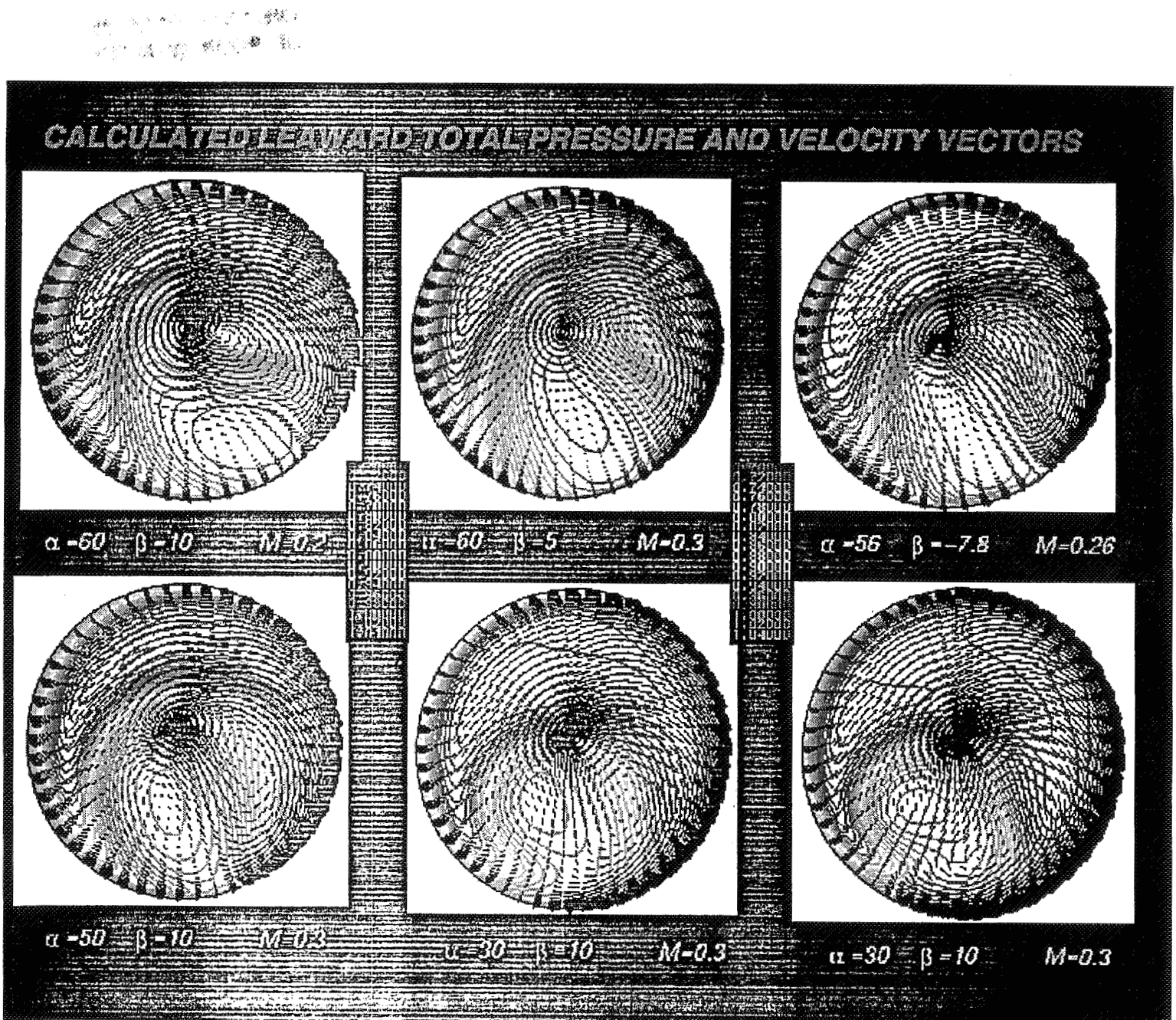

# PRESSURE CONTOURS AND VELOCITY VECTORS

## OF WINDWARD INLET AT VARIOUS $\alpha$ , $\beta$ and M

This figure shows the total pressure contours and cross-flow velocity vectors at the aerodynamic interface.

ORIGINAL PAGE IS  
OF POOR QUALITY

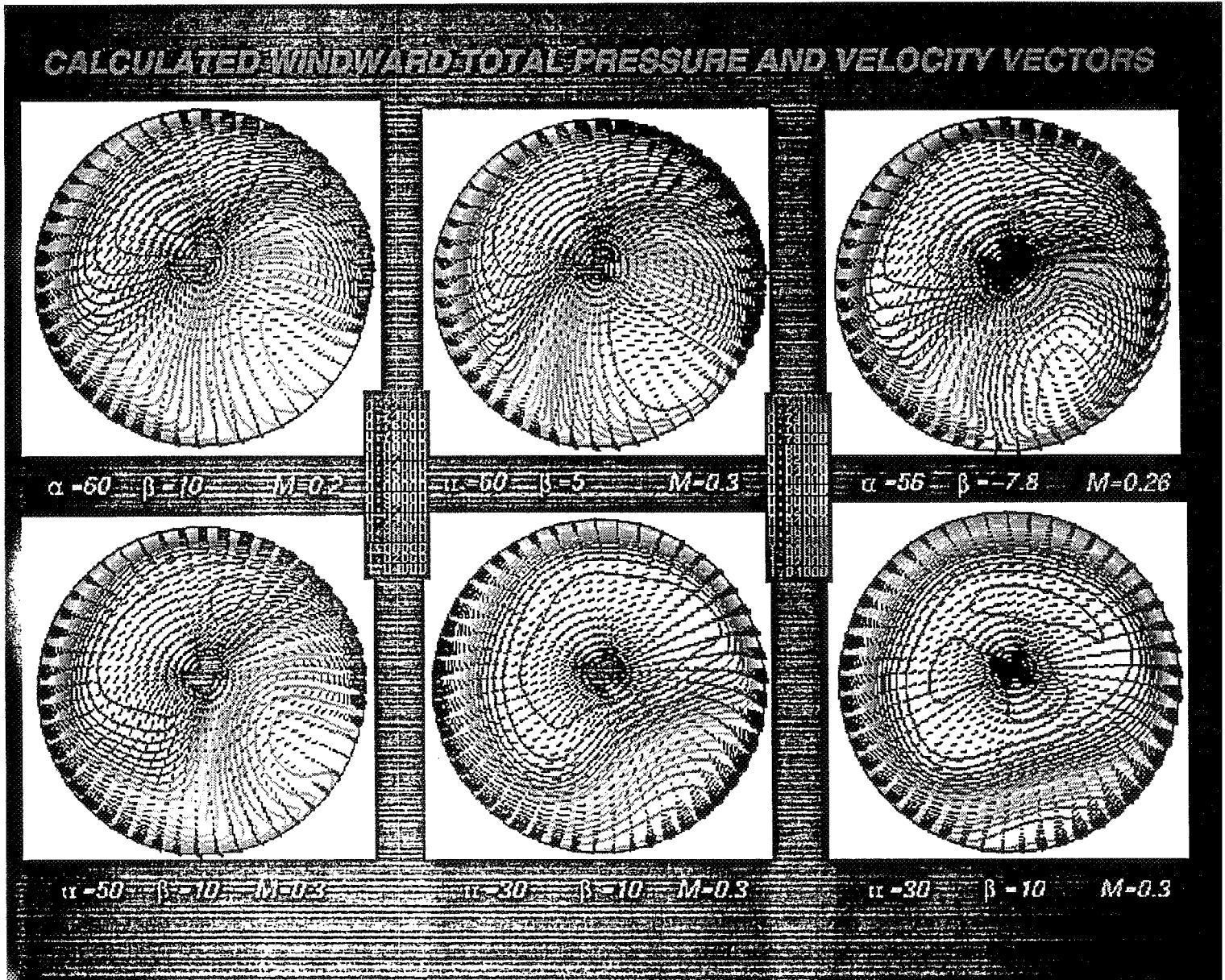

# COMPARISON OF LEEWARD INLET PERFORMANCE BETWEEN

## PARC3D AND FLIGHT TEST

This figure compares inlet performance between calculations and flight test data at comparable conditions. The PARC3D calculations were done at  $\alpha = 30^\circ$  and  $\beta = 10^\circ$ .

### COMPARISON OF TOTAL PRESSURE CONTOURS

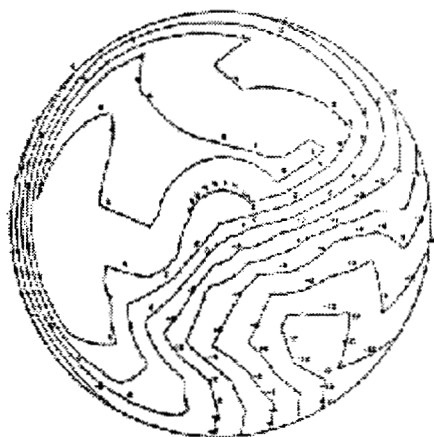

1981 Northrup Flight Test (Leeward)

Prec=95%

D2 = .186

m=145

$\alpha=34.5$  deg.

$\beta=5.03$  deg.

M=0.4



PARC3D (Leeward)

Prec=95%

D2 = .23

m=144

ORIGINAL PAGE IS  
OF POOR QUALITY

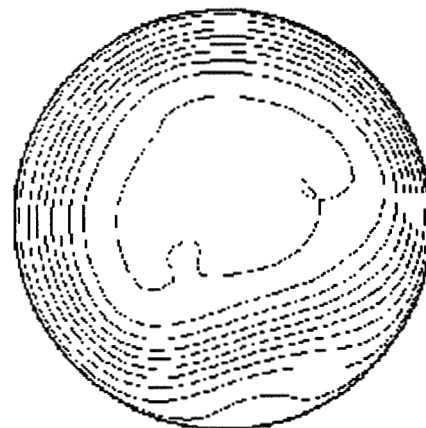

PARC3D (Windward)

Prec=96%

D2 = .20

m=144

$\alpha=30$  deg.

$\beta=10$  deg.

M=0.4



# COMPARISON OF LEEWARD INLET PERFORMANCE BETWEEN

## PARC3D AND FLIGHT TEST

This figure compares inlet performance between calculations and flight test data at comparable conditions. The PARC3D calculations were done at  $\alpha = 60^\circ$  and  $\beta = 5^\circ$ .

### COMPARISON OF TOTAL PRESSURE CONTOURS

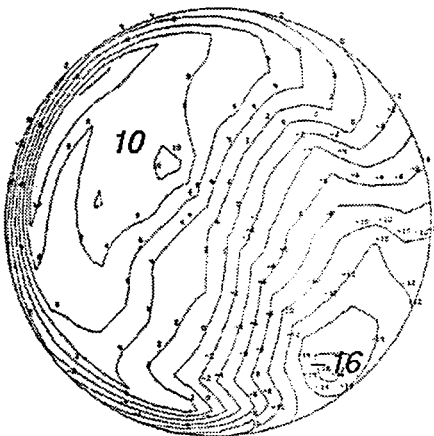

1981 Northrup Flight Test (Leeward)

Prec=94%

D2 =.295

m=145

$\alpha=60$  deg.  
 $\beta=4.33$  deg.  
 $M=0.295$

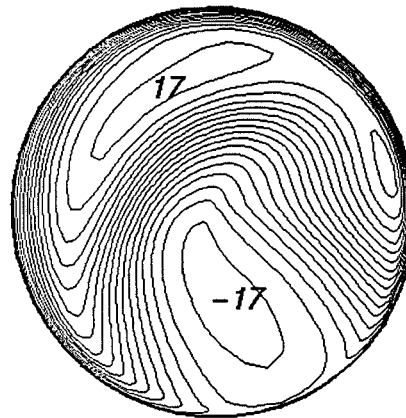

PARC3D (Leeward)

Prec=88%

D2 =.33

m=145

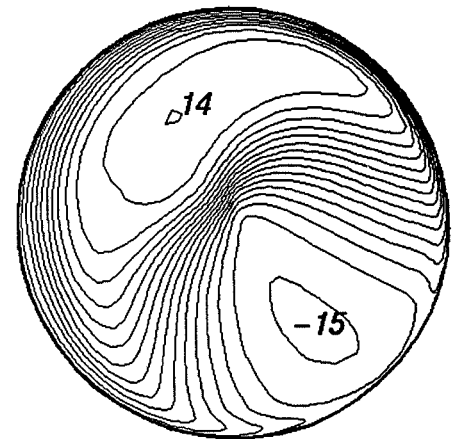

PARC3D (Windward)

Prec=90%

D2 =.31

m=144

$\alpha=60$  deg.  
 $\beta=5$  deg.  
 $M=0.30$

# EFFECT OF TURBULENCE MODEL ON INLET PERFORMANCE

---

Various turbulence models were

## EFFECT OF TURBULENCE MODEL ON INLET TOTAL PRESSURE

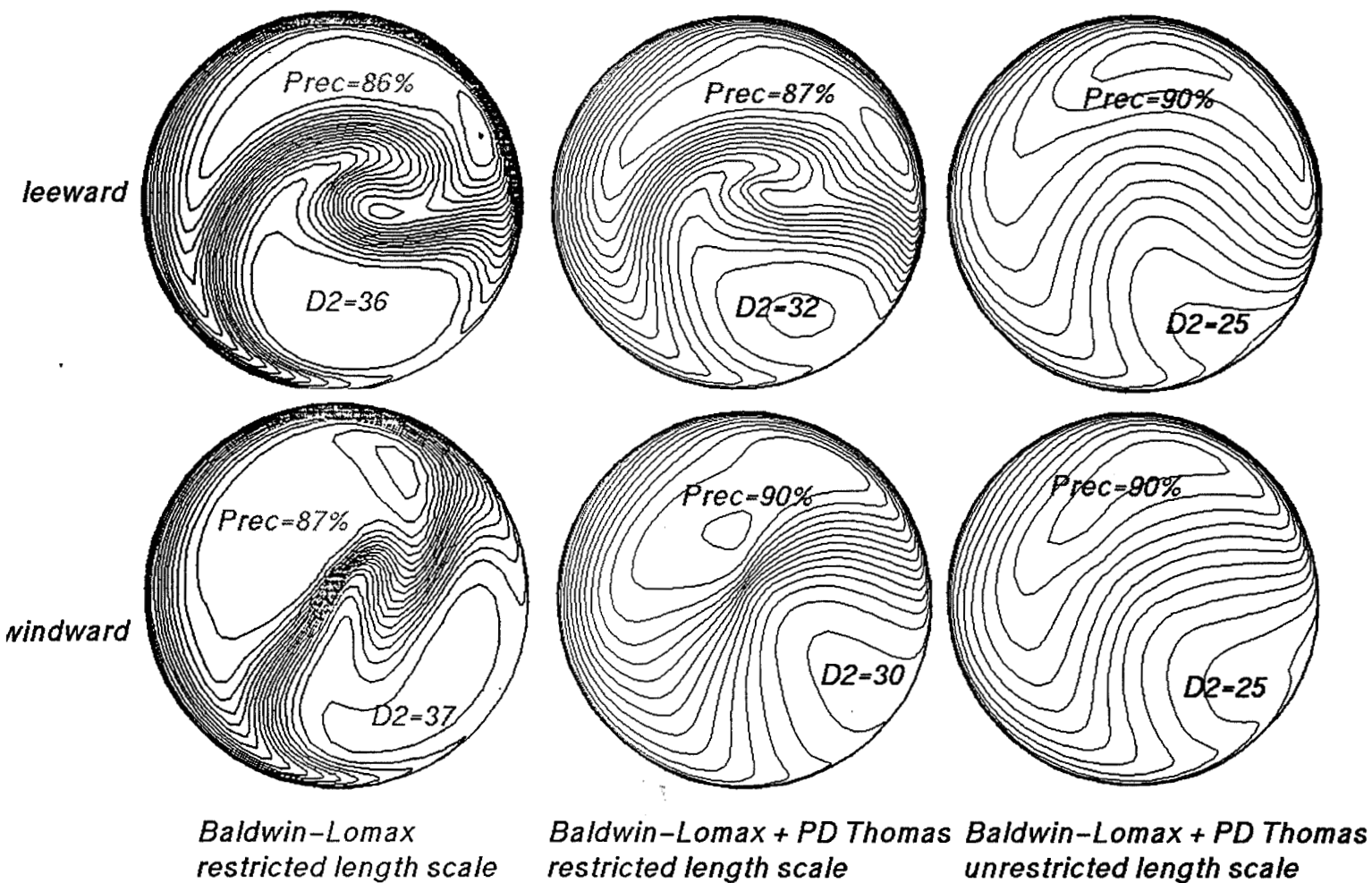

# EFFECT OF TURBULENCE MODEL LENGTH SCALE

This figure shows the effect of length scale of the Baldwin-Lomax turbulence model on the distortion ( $D2=(P_{max}-P_{min})/P_{ave}$ ) total pressure recovery and contours. Restricted length scale denotes that the search for a length scale has been restricted by the PARC3D user to a given number of grid points.

## **EFFECT OF TURBULENCE LENGTH SCALE ON LEEWARD INLET**

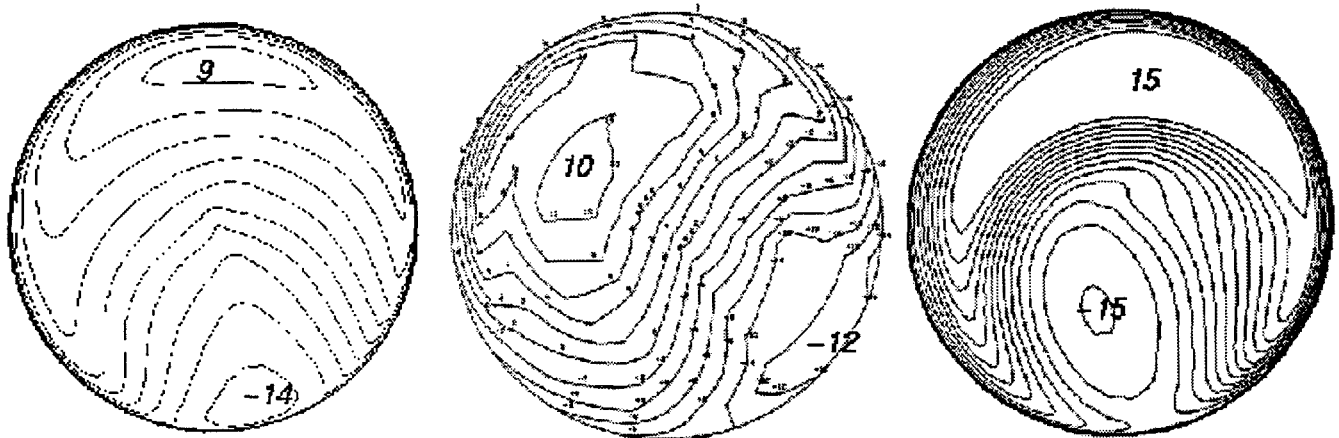

*Unrestricted Length Scale*

*Prec-91%*

*D2 = .22*

*m-145*

**$\alpha=50$  deg.**

**$\beta=10$  deg.**

**$M=0.3$**

*1981 Northrup Flight Test*

*Prec-93.5%*

*D2 = .262*

*m-144*

**$\alpha=50$  deg.**

**$\beta=5.66$  deg.**

**$M=0.29$**

*Restricted Length Scale*

*Prec-90%*

*D2 = .29*

*m-145*

**$\alpha=50$  deg.**

**$\beta=10$  deg.**

**$M=0.3$**

# EFFECT OF TURBULENCE MODEL LENGTH SCALE

This shows the results of length scale on the windward inlet.  
No flight test data was available at this condition.

## **EFFECT OF TURBULENCE LENGTH SCALE ON WINDWARD INLET**

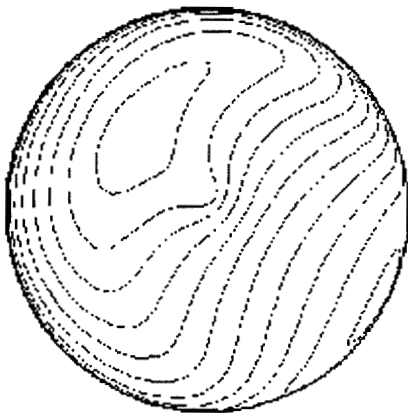

*Unrestricted Length Scale*

*Prec-91%*

*D2 -.22*

*m-143*

**$\alpha=50$  deg.**

**$\beta=-10$  deg.**

**$M=0.3$**

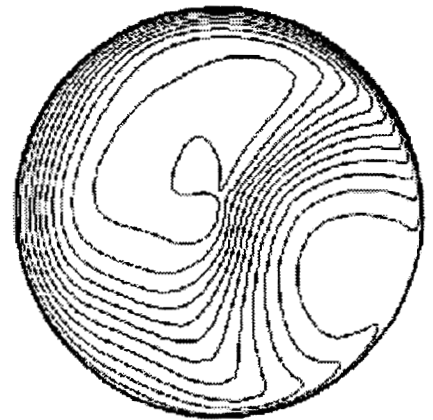

*Restricted Length Scale*

*Prec-92%*

*D2 -.25*

*m-145*

**$\alpha=50$  deg.**

**$\beta=-10$  deg.**

**$M=0.3$**

*1981 Northrup Flight Test*

*(N/A)*

# EFFECT OF TURBULENCE MODEL LENGTH SCALE

The effect of turbulence model length scale is shown for a case that corresponds to a flight test case is shown below for the leeward inlet.

## **EFFECT OF TURBULENCE LENGTH SCALE ON LEEWARD INLET**

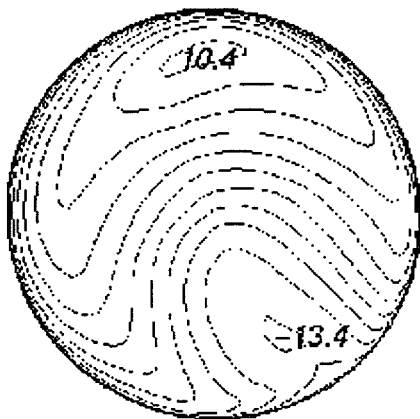

*Unrestricted Length Scale*

*Prec-90%*

*D2 = .24*

*m = 145*

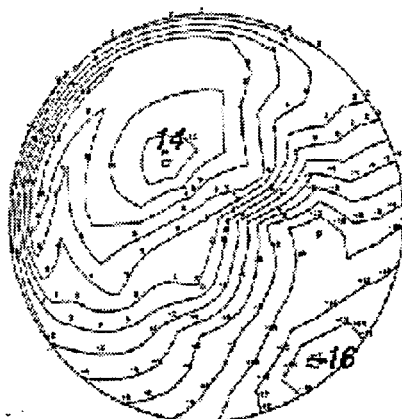

*1981 Northrup Flight Test*

*Prec-92.7%*

*D2 = .307*

*m = 143*

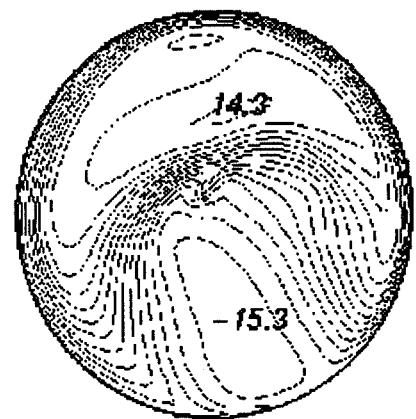

*Restricted Length Scale*

*Prec-90%*

*D2 = .29*

*m = 143*

**$\alpha = 56$  deg.**

**$\beta = 7.8$  deg.**

**$M = 0.26$**

## EFFECT OF TURBULENCE MODEL LENGTH SCALE

The effect of turbulence model length scale is shown for a case that corresponds to a flight test case is shown below for the windward inlet which was flown at different sideslip angle than calculated.

### **EFFECT OF TURBULENCE LENGTH SCALE ON WINDWARD INLET**

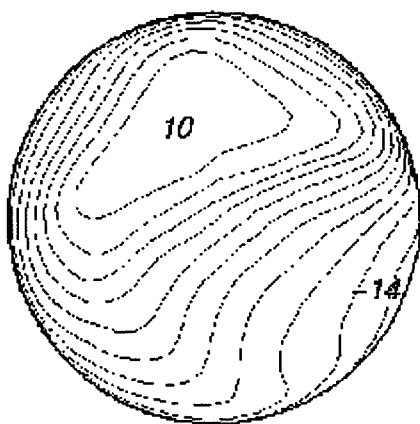

*Unrestricted Length Scale*

*Prec-92%*

*D2 - .23*

*m - 143*

**$\alpha=56$  deg.**

**$\beta=-7.8$  deg.**

**$M=0.26$**



*1981 Northrup Flight Test*

*Prec-92%*

*D2 - .253*

*m - 143*

**$\alpha=61$  deg.**

**$\beta=-12$  deg.**

**$M=0.27$**

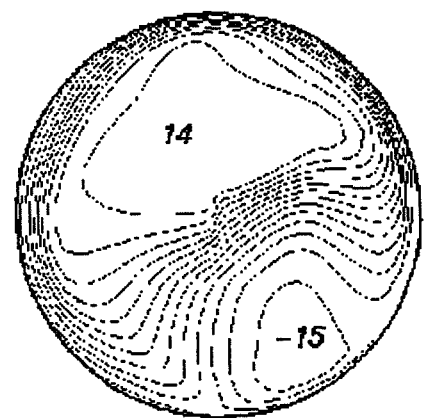

*Restricted Length Scale*

*Prec-92%*

*D2 - .28*

*m - 144*

**$\alpha=56$  deg.**

**$\beta=-7.8$  deg.**

**$M=0.26$**

# PARC3D CALCULATIONS INCLUDING VORTEX GENERATORS

This figure shows the grid geometry used in calculating the effect of the vortex generators on inlet performance. A fine grid overlapping the coarser inlet grid was needed to allow interpolation between the vortex generator and inlet grids.

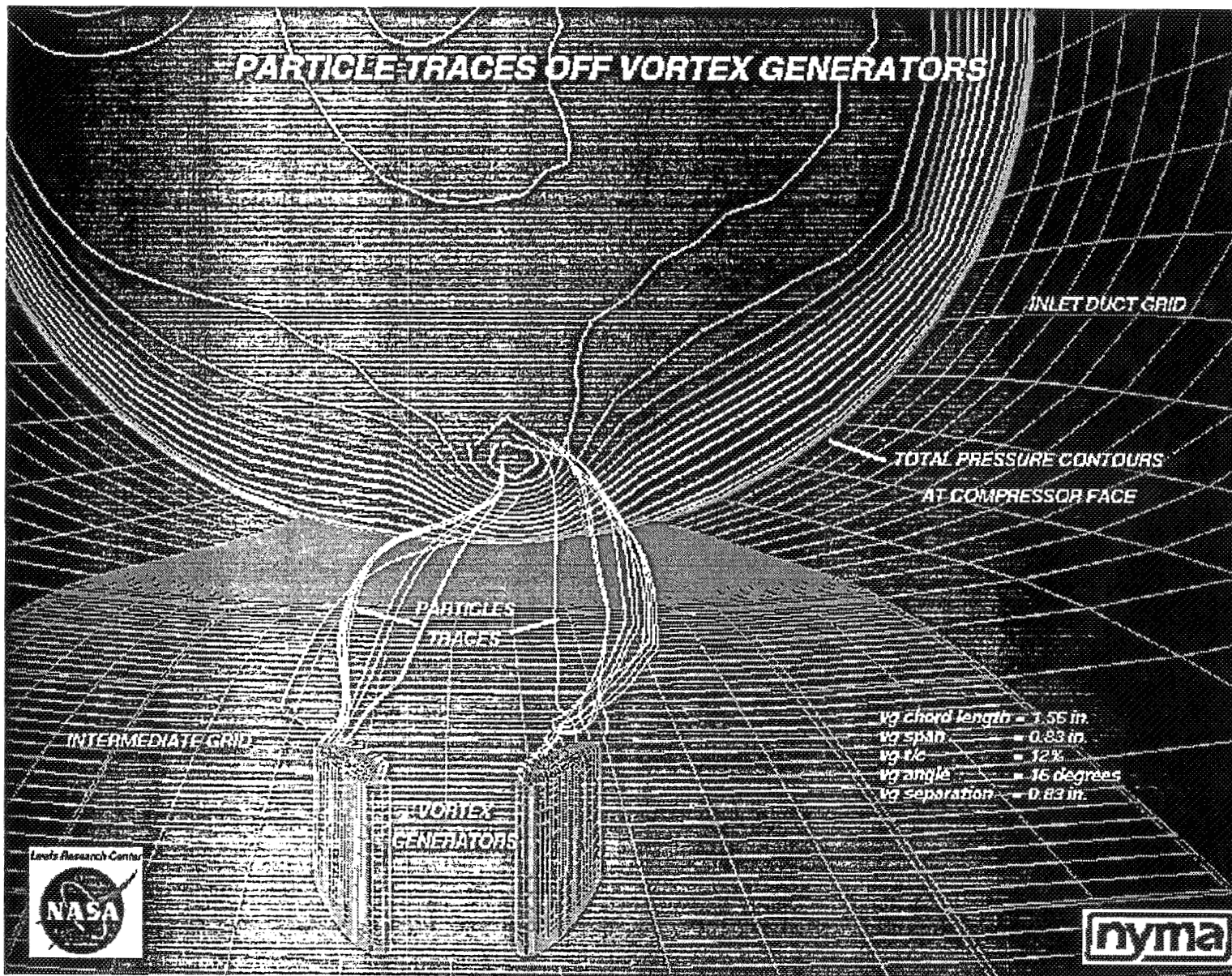

# COMPARISON OF CFD WITH FLIGHT TEST ON THE EFFECT VORTEX GENERATORS ON TOTAL PRESSURE CONTOURS

This figure shows the effect of the vortex generators on total pressure recovery and flow distortion at the aerodynamic interface.

## EFFECT OF VORTEX GENERATORS ON PARC3D AND FLIGHT TEST TOTAL PRESSURE CONTOURS

VG's IN

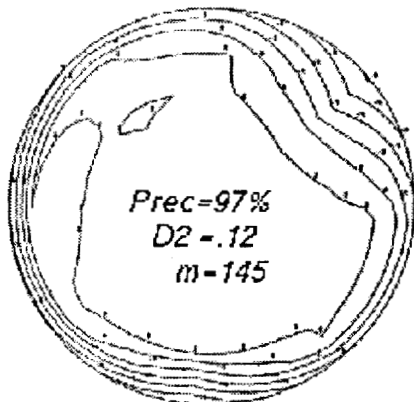

$$M/\alpha/\beta = .8/3.8/0$$

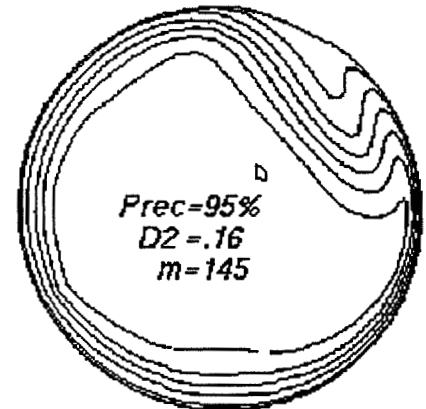

VG's OUT

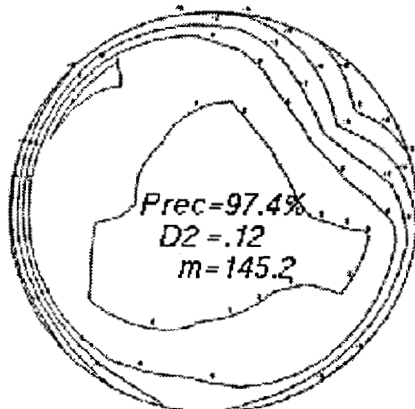

$$M/\alpha/\beta = .798/3.8/0.4$$

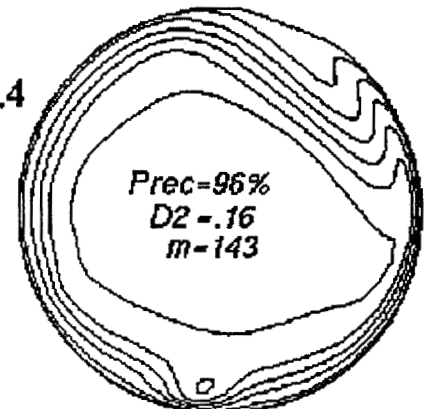

FLIGHT TEST

(dynamic distortion at peak fan sensitivity)

PARC3D

(asymptotic solution)

Lewis Research Center





## ONGOING WORK

A study of grid density will determine the effect of grid spacing on the strength of vortices shed by the vortex generators. The grid spacing of the inlet will also be varied to determine its effect on the inlet performance

### **ONGOING WORK**

*Effect of grid density of vortex generator performance*

*Inclusion of wind tunnel walls to PARC3D model*

*Effect of turbulence model parameters on inlet performance*



## FUTURE WORK

Items to be investigated in the next year.

### *FUTURE WORK*

*Comparison with NASA/Dryden flight test data*

*Addition of Baldwin–Barth turbulence model*

*Possible use of unsteady version of NPARC*

*Addition of mathematical vortex generator model to NPARC*

*Comparison of GE total pressure contour program with FAST*



**PAPER NOT AVAILABLE FOR PREPRINT**

**Propulsion Analysis of the F-16 Multi-Axis Thrust Vectoring Aircraft, Capt. Jeff Vickers,  
USAF, 416 Flight Test Squadron, Edwards AFB, CA**

20pg

1995107828  
323979

N95-14242

16091  
P-19

**X-31** High Alpha Conference

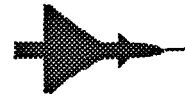

***X-31 Post-Stall Envelope Expansion  
and  
Tactical Utility Testing***

July 13, 1994

Dave Canter

NAWC-AD Patuxent River, MD

5805JEDC6

Good morning. I'm Dave Canter and I'm from the Naval Air Warfare Center's Aircraft Division at Pax River, MD.

I was a member the X-31 international test organization at NASA Dryden during calendar years 92 and 93.

# **X-31**

## High Alpha Conference

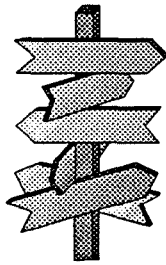
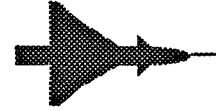

*Lessons Learned*

**Non-Technical  
Technical**

*Tactical Utility Results*

5805JEDC10

I will discuss some of the lessons that were learned along the way and end with some of the results achieved during tactical utility testing.

# X-31

High Alpha Conference

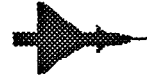

## ***Organizational Lessons Learned***

- ▶ Test Team Building
- ▶ Streamlined Flight Clearance Process
- ▶ Consistent Leadership

5805JEDC8

The first lesson is that test team building takes a lot of time. The X-31 test team is made up of a very diverse mix of government agencies and contractors from the US and from Germany. It took approximately six months of working together before we became a cohesive team where there was a bond of trust between the government and contractor engineers. Trust was critical to creating positive working relationships and to put an end to redundant efforts that had been going on as government engineers worked to verify the results achieved by the contractors. The only way to build a cohesive team is through working together over an extended period of time. To get the organizational bugs worked out, we think its a good idea to get your team physically co-located at least 3 months prior to the start of flying.

2nd point: NASA has a streamlined flight clearance process, referred to as a Tech Brief, where the test team briefs representatives from engineering, flight ops, and management on planned testing. If all questions are satisfactorily answered at the Tech Brief, permission is received to commence testing. This approach is much faster than requiring a formal written document to be reviewed by a long chain of individuals.

3rd point: The ITO was blessed with consistent leadership. When a chief engineer from one of the team member organizations left the program, they were replaced by someone from within the organization. This continuity in leadership meant that our way of doing business did not have to change through the course of testing.

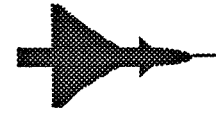

## ***Logistical Lessons Learned***

- ▶ 90% of Test Team On-Site
- ▶ Collocated Assets
- ▶ Six Project Pilots Not Too Many

5805JEDC7

The program also had some logistical factors working in its favor. Approximately 90 % of the test team was on-site at Dryden. Early on, the flight hardware in the loop simulator was moved from Rockwell's Downey facility up to Dryden. The majority of the test team was located in one building, NASA's Integrated Test Facility or ITF. Along with the engineers, the ITF was home to half of the X-31 test pilots, the simulator, and the jets. This setup greatly improved communications and efficiency. It was amazingly easy to try things out on the simulator or to go into the hangar and do on-aircraft testing.

For the majority of the last two years, the ITO used six test pilots - basically one from each of the major organizations involved. Early on, there were fears that it wouldn't be possible to keep that many pilots proficient for high AOA envelope expansion. This was not a problem, because the pilots were all very experienced, they were able to get proficiency flying in other types of aircraft, and they could get as much simulator time as they needed.

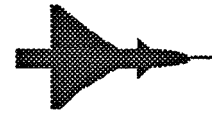

## ***Technical Lessons Learned***

### **High AOA Aerodynamics**

- ▶ **Wind Tunnel Does *Not* Give Complete Picture**
- ▶ **Small Differences Have Large Impact**
- ▶ **Precise Air Data Required for Flight Control Laws**

5805JEDC9

Now, I'll switch to some of the technical lessons learned. Depending on which projects you've been involved with, some of these will not be new to you. In the area of high AOA aerodynamics, we saw that there were many nuances that were not discovered in the wind tunnel. The primary effect that was not identified was the strength of the symmetric vortices coming off the nose of the aircraft.

We also saw that very small changes to the aircraft's nose dramatically changed the plane's stability and control at high AOAs. These small changes to the aircraft's nose would be very difficult to duplicate on a small-scale wind tunnel model. When we started flying above 50° AOA, the aircraft underwent sideforce kicks which the pilots called lurches.



# X-31 High Alpha Conference

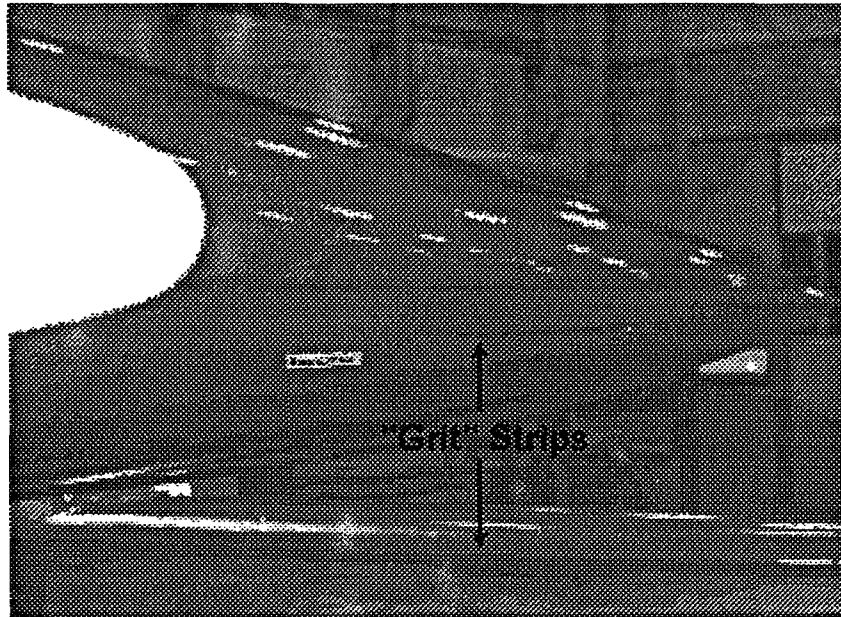
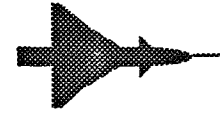

EDC15

We added narrow 1/4 inch wide strips of grit - small grains about the size of bird seed, to the aircraft's noseboom and radome. These grit strips reduced the randomness of lurches, and we were able to finish 1 g envelope expansion to the design AOA limit of 70°. When we started elevated g entries to post-stall, which the X-31 defines as AOAs above 30°, we had an unintentional departure from controlled flight at 58° AOA during a split-s maneuver. Analysis determined that the departure was caused by a very large yaw asymmetry which overcame the available thrust vectoring control power. It was realized that the grit strips alone were not a powerful enough effector of the forebody aerodynamics.

# **X-31** High Alpha Conference

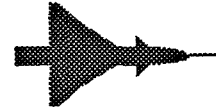

5805JEDC16

Based on previous high AOA research and new wind tunnel testing with the X-31 model, we added 6/10 in wide by 20 in long strakes to the nose and also blunted the nose tip from essentially a zero radius of curvature to a radius of curvature of 3/4 of an inch. The strakes were added to force symmetric transition of the forebody vortices and the nose tip was blunted to give lower yaw asymmetries. These changes to the nose made a major improvement to the aerodynamics of the aircraft.

# **X-31** High Alpha Conference

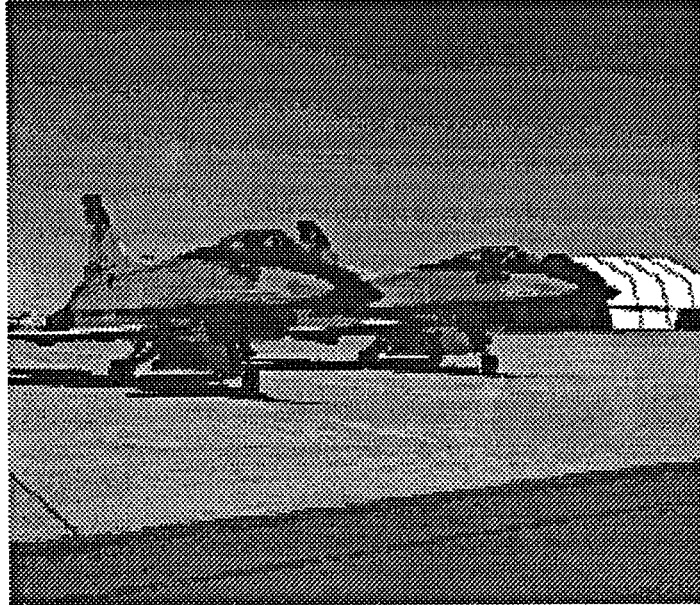
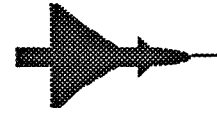

5805JEDC17

Despite the fact that the X-31's were built with the same external dimensions, aircraft 2 had considerably stronger yaw asymmetries than aircraft one. This led to aircraft two being referred to as the "evil twin". By testing aircraft two with several lengths of extended nose strakes, we found that we were able to get it to fly like aircraft one by lengthening the strakes by 8 1/2 inches. Longer nose strakes than this proved undesirable because they created a de-stabilizing nose-up pitching moment. Since the longer nose strakes were added to aircraft two, it is no longer an "evil twin".

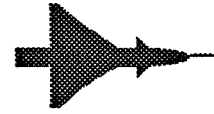

## ***Technical Lessons Learned***

### **High AOA Aerodynamics**

- ▶ **Wind Tunnel Does *Not* Give Complete Picture**
- ▶ **Small Differences Have Large Impact**
- ▶ **Precise Air Data Required for Flight Control Laws**

5805JEDC18

Due to the low basic stability of the aircraft at high AOA, it had a low tolerance for sideslip buildup. That made sideslip a very important feedback to the flight control system. The source of sideslip was the inertial navigation unit, or INU. Below 30° AOA, the INU was updated with air data from the noseboom. When we started spending extended periods of time above 30° AOA, we got large values of sideslip from the INU which were not true sideslip, but were calculated due to drift caused by changes in wind direction and magnitude. This meant that we needed to continue to update the INU with air data all the way to 70° AOA. This led to the incorporation of an unusual noseboom configuration.

# X-31 High Alpha Conference

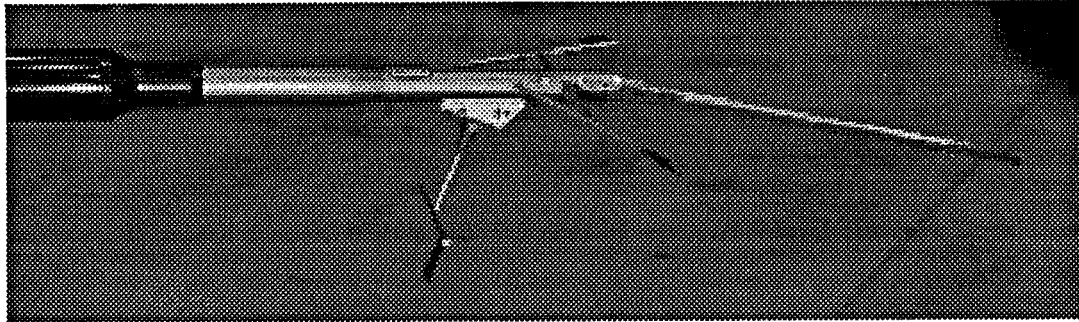
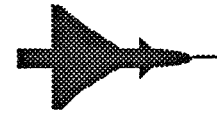

5805JEDC19

We have a Kiel type pitot-static probe instead of the standard NACA type probe in order to get better behavior at high AOAs. To get desired accuracy all the way to  $70^\circ$ , we actually bent the kiel probe down  $10^\circ$  relative to the noseboom. We also had to add a edge to rotate our sideslip vane down  $20^\circ$  from the noseboom. This was required to counter a 4 Hz oscillation of the sideslip vane which occurred at  $62^\circ$  AOA. Canting the vane down effectively lowered the AOA that the sideslip vane saw by  $20^\circ$  and thus eliminated the oscillations. With these modifications to the noseboom, we were able to use air data to update the INU throughout the entire AOA envelope. This eliminated the problem of INU calculated sideslip drift at high AOA.

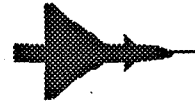

## ***Technical Lessons Learned***

### **Flight Control System**

- ▶ **Greater Control Power Required**
- ▶ **Multiple Control Law Changes**
- ▶ **Rapid Software V&V *The Key***

5605JEDC13

Many changes were made to the flight control system before we achieved the desired level of controllability. The departure taught us that more control power was needed to counter the yaw asymmetries. Fortunately, we had additional control power available. We were able to increase the thrust vector vane travel into the engine exhaust plume from 26 to 35°. But: this was a very big change, because with over 26° of travel into the plume, there was the potential for vane-to-vane impact. Once the vane travel was increased above 26°, only the software kept the vanes from impacting. The software did work and we haven't had a vane-to-vane impact.

Throughout the course of envelope expansion, as we learned more about the plane, many control law modifications were required. The main factor which forced these changes was the fact that the aerodynamics were different from what had been seen in the wind tunnel. Fortunately, we were able to make these changes very quickly and the envelope expansion process was rarely slowed down.

The key to our rapid incorporation of new control laws was the software V & V process. The V&V process was sped up by some of the factors that have been mentioned previously: we had the flight-hardware-in-the-loop simulation and aircraft on-site with engineering, and we had lots of pilots available for piloted sim V&V. One other item which helped tremendously was automated testing. Automated test cases were run for a variety of control inputs and flight conditions. Time history plots of data using the current software were overlaid with data from the new control laws. Engineers were then able to study these overlay plots to verify that the software change had the intended effect. Minor software changes were often made in under two weeks.

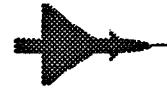

## ***Technical Lessons Learned***

### **Flight Test Technology**

- ▶ **Thrust Vectoring Clouds Build-Up Approach**
- ▶ **Pilot-Selectable AOA Limiter Beneficial**
- ▶ **Real-Time Kill Determination Saved Test Time**

5805JEDC11

We saw that having thrust vectoring clouded the traditional build-up approach. Traditionally, you would complete a test block at high altitude and then repeat the block at a lower altitude. This approach works fine for an aircraft whose control comes strictly from aerodynamic surfaces; since, for low airspeeds, the control power is primarily a function of dynamic pressure. So, the same calibrated airspeed can be flown at 30,000 ft before testing at 20,000 ft, for instance. However, if a large portion of your control power comes from engine thrust, you have a different situation: at high altitude, the air is less dense and the engine has lower thrust - directly lowering your control power. As you come down in altitude, you have more thrust and thus more control power. We saw that there were some maneuvers that we couldn't complete at 30,000 ft that we could do at 20,000 ft. This led us to modify our buildup approach. For instance, we would start a test block at 30,000 ft and proceed until our control margins got too low, based on control room strip chart analysis. Once this happened, we would re-start the block at 20,000 ft. If the control margins remained high enough, we would go all the way to 70° AOA, even though we may have only been able to test up to 50° AOA at 30,000 ft. This approach worked for us, but it did require good real-time analysis by our flying qualities and flight control engineers.

During one early flight, when our limit was still 50° AOA, one pilot inadvertently overshot to 62° AOA. This was caused primarily by high stick sensitivity. It was thought that the sensitivity would be okay for the tactical testing but that it was too high for the clinical envelope expansion. To overcome this problem, our engineers developed a pilot - selectable AOA limiter. This proved to be a major benefit during envelope expansion. The AOA limiter could be set in 5° increments between 30 and 70°. This not only took away the problem of inadvertent AOA overshoots, but it also greatly improved the repeatability of gathering test data, which in turn, simplified the data analysis.

For our tactical utility testing, we had both the X-31 and F-18 adversary aircraft instrumented. Both aircraft were equipped with C-band beacons to improve the accuracy of tracking by ground based radars. Using aircraft and space-position data, we were able to determine valid firing positions for simulated missile shots. This allowed us to tell the pilots whether or not they had scored a kill within seconds after they had squeezed the trigger. This saved valuable test time since the pilots would knock off the engagement once a kill was scored. This capability helped us to accomplish many more engagements per flight than would have been possible otherwise.

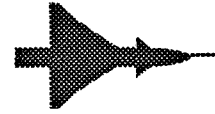

## ***Technical Lessons Learned***

### **Analysis Tools**

- ▶ **Improved Analysis of Model Fidelity**
- ▶ **Simulator Lagged Behind Flight Data**
- ▶ **3-D Visualization Tool Improved Understanding**

5805JEDC12

Concerning our analysis tools, we saw that the ability to drive the simulation with inputs from flight data greatly improved the process of evaluating the fidelity of the aircraft model. This capability, combined with the constant AOA provided by using the AOA limiter, allowed us to do direct time history overlays of flight data with simulator data. The overlay plots helped us to determine the corrections required to account for the yaw asymmetries. The fidelity of the simulation was quite good, but it DID always lag behind the flight data. This was most dramatically illustrated by the fact that the departure was not predicted ahead of time.

We found pseudo three-dimensional visualization programs to be very useful. These programs were able to show us what both aircraft were doing during close-in combat engagements. We used these programs both real-time and post-flight. Real-time, the program helped to enhance the situational awareness of the test team in the control room. The program was very helpful post-flight for pilot de-briefs, study by the engineers and for presentations such as this one, as I'll demonstrate in a few minutes.



# **X-31** High Alpha Conference

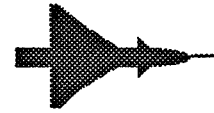

**Envelope Expansion *Not* the Goal**

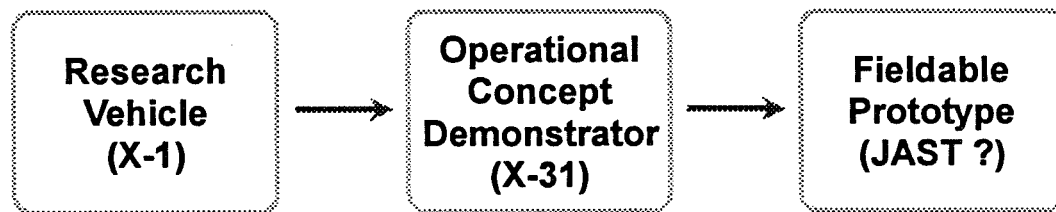

## **Final Objective**

*Investigate Tactical Benefits of the Technology*

5805JEDC4

I'd like to make some observations myself about what the program represents as a model for the future. It was not your typical "X" program strictly designed to prove what is possible. As an operational concept demonstrator, the program's prime directive was to demonstrate what application the technology and post stall maneuvering could have for future fighter designs. I would like to stress that since we also were tasked with taking a low cost, rapid, and off the shelf approach, we are not a fieldable prototype you sometimes see discussed as the future of R&D efforts; where you subject a piece of equipment to battlefield stresses. Put another way; we didn't want to just perform an experiment, we wanted to show implications, but we weren't prepared to lead the way in replacing current equipment.

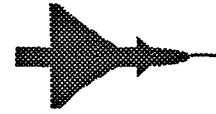

---

*Implications of this Approach*

Separate Pseudo - Operational Test Plan

.....

Adapted to What was Achievable

.....

**Brute Force** Fixes to Meet the Goal

5805JEDC3

For our international test team, this operational demonstrator concept meant we were running two parallel efforts. We had almost a separate, test planning venture underway that relied on simulation to try and get a feel for what the final, pseudo-operational testing might look like. We were counting on this close linkage with realistic manned simulation campaigns to prevent any expensive flight test pitfalls. But envelope expansion was taking a greater chunk of time and budget than we hoped, so the final Close in Combat test plan was scrubbed and adapted to what was realistically achievable within the program's remaining funding. Equally as important, was the give and take from the envelope expansion players who gave us only brute force solutions and the minimal acceptable speed and altitude combination to move ahead and meet the first cut demonstration goals.

# **X-31** High Alpha Conference

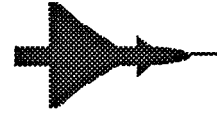

## **Video:**

### **X-31 Close-In Combat: Sample Engagements**

5805JEDC20

That's enough of the philosophical stuff, let's look at some real results. What you are about to see are two sample close in combat engagements between the X-31 and an F/A-18 adversary. The starting conditions for this first engagement is what we called the High Speed Line Abreast; referring to a starting condition of about 100 knots above our maximum post stall entry speed. As the engagement progresses, notice how the adversary pilot takes what I would describe as a "bite" so as to press the advantage and turn the fight into a rolling scissors, but seeing that, the X-31 pilot counters with a deep post stall maneuver that stops his down range travel coupled with a high velocity vector roll rate that brings the nose to bear threatening the adversary and forcing the fight down into what's been described as a funnel of minimum radius turns. Where the X-31, with it's higher agility is actually slower, performing smaller radius turns, and descending at a lesser rate than the adversary. Which allows him to bring the nose to bear for a close in guns kill represented by the blue trigger squeeze line.

This second engagement includes the HUD view and starts with the X-31 in a very defensive position with the adversary behind his wingline with his nose on. Performing a rapid, decelerating, post stall reversal the X-31 flushes the adversary out above and slightly in front. But notice, he must release the aggravated angle of attack condition to avoid falling too far below the adversary. At this point in the fight, the X-31 has extricated himself from the defensive situation and then slowly turns it to his advantage using some of the same capabilities and techniques described in the first engagement. Now switch your attention to the HUD display projecting in the upper right hand corner and you can sense how this high angle of attack velocity vector rolling capability looks to the pilot like a controllable flat spin.

# X-31 High Alpha Conference

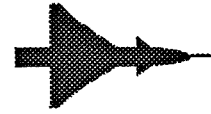

## *Implications of the Technology*

- ▶ Not Necessarily a *Revolution*
- ▶ New Possibilities for:
  - Pointing (*Killing*)
  - Positioning (*Driving the Fight*)
- ▶ CAREFREE Needs New Methods of Pilot Feedback
- ▶ Achievable Today without Major Trade-Offs

5805JEDC1

But on to the question of what it all means. All of the pilots on the program had strong military backgrounds. One point they agreed on is the X-31 does not necessarily represent a total revolution in air combat. They would not advocate trading off any other important fighter characteristics just to acquire this capability. Rather, they concluded that the enhanced pitch pointing and velocity vector maneuvering provided by post stall opened new options for the pilot to use in close in combat. These options involved using post stall maneuvering as a repositioning tool to drive the fight, or as a way to optimally rotate and point the vehicle for a weapons employment when the opponent can't counter you. But you must use it in a selective and timely manner in order to be successful.

One other important point to consider that isn't immediately obvious from the movie. The X-31 is the only aircraft designed from day one to operate in the post stall arena. This design has resulted in an aircraft that has virtually carefree handling throughout it's entire envelope. With carefree handling comes a problem of having cues of your energy state. Unlike most conventional aircraft, there are no changes in buffet level or flying qualities to provide the pilot with a seat of the pants gut feel of how he's maneuvering his aircraft. So how to interject those tacit feedback cues back into the cockpit operator will be a challenge for future designs.

One issue future designers will not have have to wrestle with though is the penalty of thrust vectoring incorporation. The F-16 MATV has ably demonstrated that incorporation of 3 dimensional vectoring is achievable today without any significant trade-offs.

# X-31 High Alpha Conference Thrust Vectoring Benefits

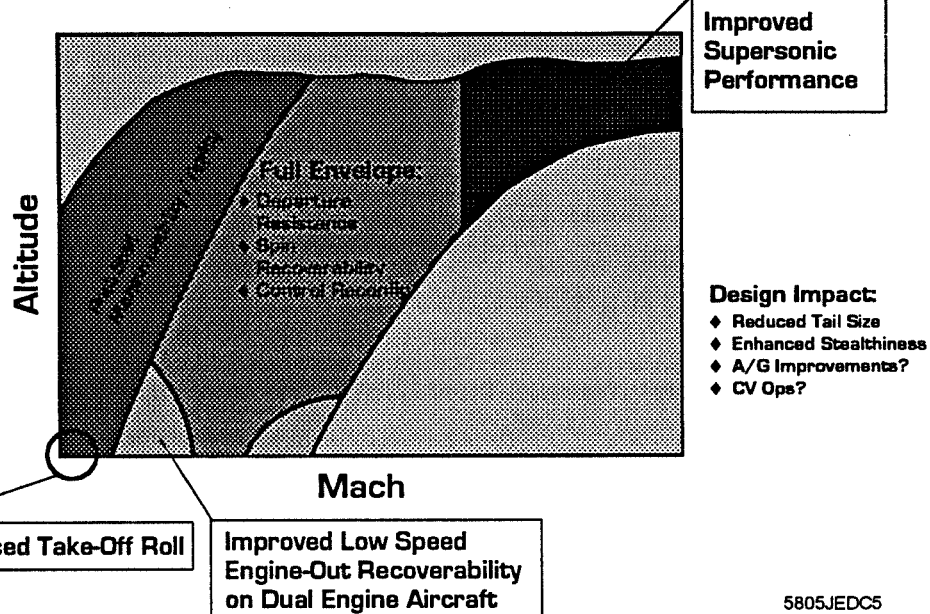
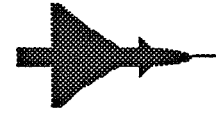

The one unfortunate problem with 3 dimensional thrust vectoring is that it has become synonymous with flying controllably beyond the lift barrier; thus extending the flight envelope only to the left. Please keep in mind that it has applications throughout the flight envelope. In the middle as a stall/spin preventer or recovery device. In the high/fast region for enhanced directional stability and in the low slow region where carrier pilots are always looking for more control power, wherever they can find it.

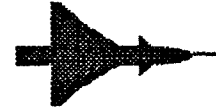

---

***Future Testing Possibilities***

**ARPA Support**

- HMD / SIM Links

**JAST Support**

- *High / Fast*
- *Low / Slow*

5805JEDC2

So where are we now? That is the \$6.4 million dollar question. Let's just say that it's my firm desire and hope that the program can continue. There are plans in place to use us for another ARPA sponsored effort that relates to information technology and fusing real and virtual targets over multiple sites via computer networks. We have a Helmet Mounted Display system which would prove useful for this testing.

And there appears to be interest in having some near term thrust vectoring experiments performed in both corners of the envelope. So keep watching the aviation trade publications for word of our progress.

Thank you for your interest, and I can take a couple of questions.

**PAPER NOT AVAILABLE FOR PREPRINT**

**Aerodynamic Development and Effectiveness Evaluation of the X-31 Thrust Vectoring System, Hans-Ulrich Georg, Deutsche Aerospace AG, Germany**

14P3

1995107829  
323981

N95-14243

1607  
P. 14

# **X-31 Quasi-Tailless Flight Demonstration**

**By:**

**Peter Huber, Deutsche Aerospace**

**Harvey Schellenger, Rockwell**



## **OUTLINE**

- **What is Quasi-Tailless**
- **Objectives**
- **Aerodynamic of Tailless X-31**
- **Quasi-Tailless Control Law**
- **Flight Test Results**
- **Summary**

## WHAT IS QUASI-TAILLESS

Quasi-tailless stands for an in-flight simulation of an aircraft without a vertical tail, respectively with a vertical tail reduced in size. The lateral / directional stability characteristics of a tailless / reduced tail configuration are achieved by feeding back sideslip, roll rate and yaw rate via destabilization gains to rudder and ailerons.

Thrust vectoring is used for directional augmentation and control to reestablish desired lateral / directional flying qualities.



### QUASI-TAILLESS FLIGHT DEMONSTRATION



#### WHAT IS QUASI-TAILLESS

- **A flight control system mode that uses rudder and ailerons to destabilize the aircraft in order to obtain directional stability characteristics as if the vertical tail were actually removed respectively reduced in size**
- **Thrust vectoring is used for directional control to reestablish desired lateral/ directional flying qualities**

## OBJECTIVES

The primary objective of the quasi-tailless flight demonstration is to demonstrate the feasibility of using thrust vectoring for directional control of an unstable aircraft. By using this low-cost, low-risk approach it is possible to get information about required thrust vector control power and deflection rates from an inflight experiment as well as insight in low-power thrust vectoring issues.

The quasi-tailless flight demonstration series with the X-31 began in March 94. The demonstration flight condition was Mach 1.2 in 37500 feet. A series of basic flying quality maneuvers, Doublets, Bank to Bank Rolls and Wind-up-turns have been performed with a simulated 100% vertical tail reduction.



### QUASI-TAILLESS FLIGHT DEMONSTRATION



#### OBJECTIVES

- **Demonstrate the feasibility of using thrust vectoring to control a directional unstable aircraft**
- **Defining required TV control power and required deflection rates**
- **Gaining experience with thrust vectoring at lower power settings**

## AERODYNAMIC OF TAILLESS X-31

An aerodynamic database for the reduced tail and tailless configurations was created by adding incremental (tail off - tail on) values of static and damping coefficients to the basic aero model. The basic aero was from wind tunnel data corrected by flight test Parameter Identification results. The increments were created from a combination of wind tunnel data and computed aerodynamics for tail-on and tail-reduced/off. The increments were for various percentages of tail height removed from the basic X-31 vertical tail planform.

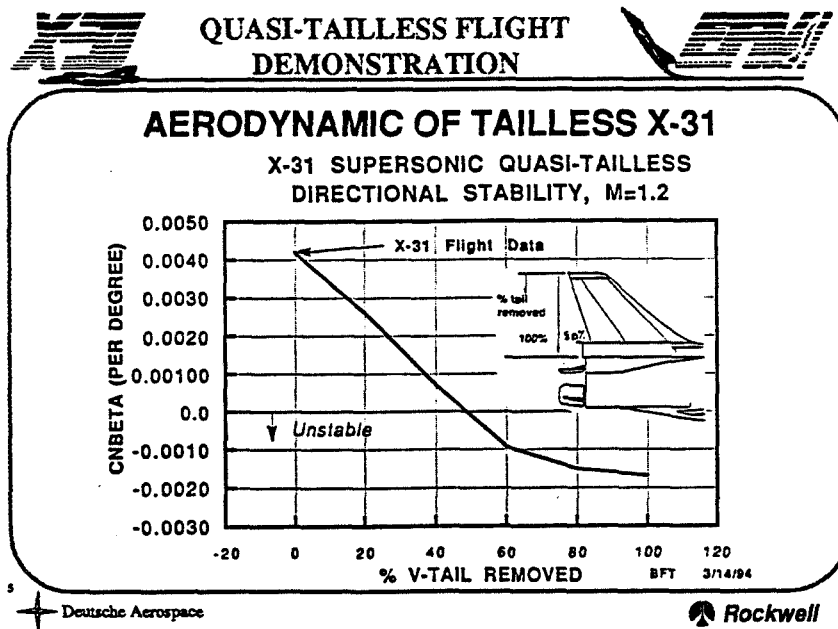

## LEVEL OF INSTABILITY

The graphic shows the level of directional destabilization, essentially the root of the dutch roll mode versus vertical tail reduction (100% is equivalent to no tail). Above 30% tail reduction the destabilized aircraft shows a positive eigenvalue. The instability increases rapidly between 30% and 70% and reaches a maximum value of 290 ms time to double amplitude at 100% tail reduction, which has been demonstrated by the X-31 at a supersonic flight condition.

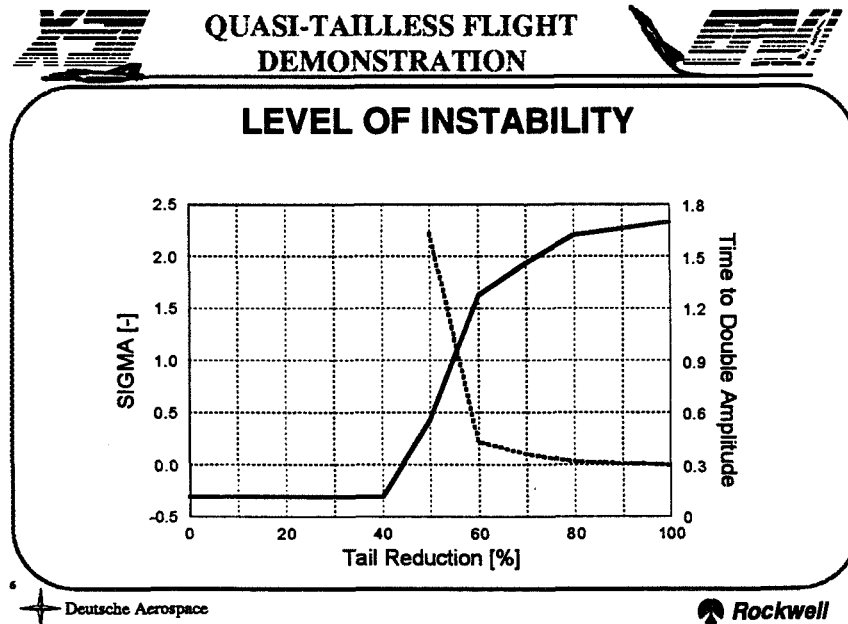

## QUASI-TAILLESS CONTROL LAW

Due to the unique X-31 control law design with its integrated thrust vectoring control, the quasi-tailless experiment could be performed without a major software change. The following features have been implemented. The existing augmentation via the rudder can be reduced to a desired level, or switched off completely. A destabilization feedback to rudder and ailerons has been introduced using sideslip, roll rate and yaw rate. Destabilization-gains representing different levels of destabilization (respectively tail sizes) were accessible by the pilot providing a build-up capability during the flight demonstration. A safety disengagement feature was included, that provides automatic disengagement of the quasi-tailless control mode if a system failure occurs or predetermined envelope parameters are exceeded.



### QUASI-TAILLESS FLIGHT DEMONSTRATION



#### QUASI-TAILLESS CONTROL LAW

The following features have been implemented

- Shutting off the existing augmentation to the rudder
- Introduction of a destabilization feedback to rudder and aileron
- Redistribution of augmentation and forward path command to thrust vectoring
- Additional lead-lag filter in the thrust vectoring feedback path to improve stability margins
- Safety disengagement if specified envelope parameters are exceeded

## QUASI-TAILLESS BLOCK DIAGRAM

The block diagram illustrates the principle of the in-flight simulation of a tailless aircraft.

The sensed and filtered aircraft states, sideslip, roll rate and yaw rate, are fed back through a destabilization gain  $R$  to rudder and ailerons. This loop represents the quasi-tailless aircraft which is controlled by a feedback gain  $K_{TL}$  and a forward path  $F_{TL}$  using thrust vectoring and ailerons.

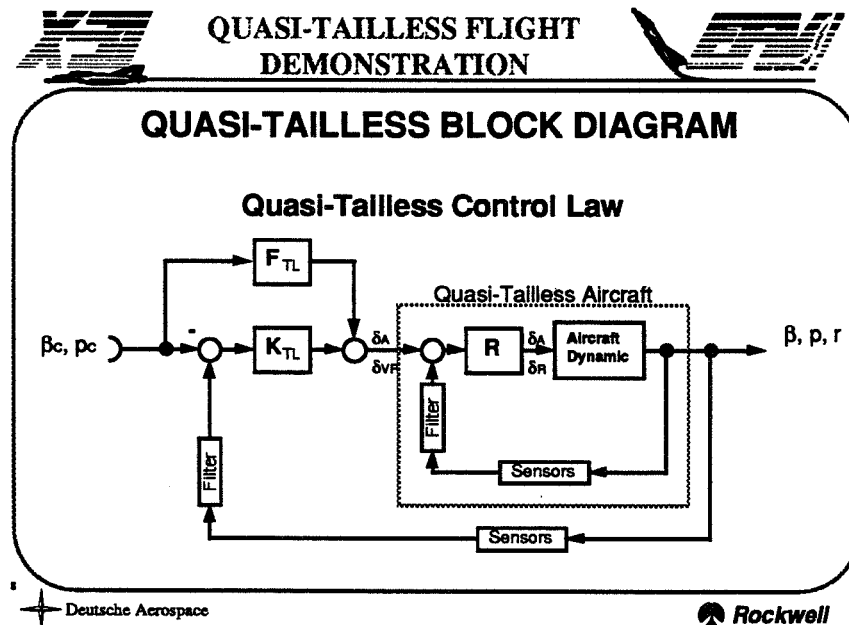

## QUASI-TAILLESS BLOCK DIAGRAM (cont)

This block diagram shows in detail how destabilization and restabilization is mechanized.

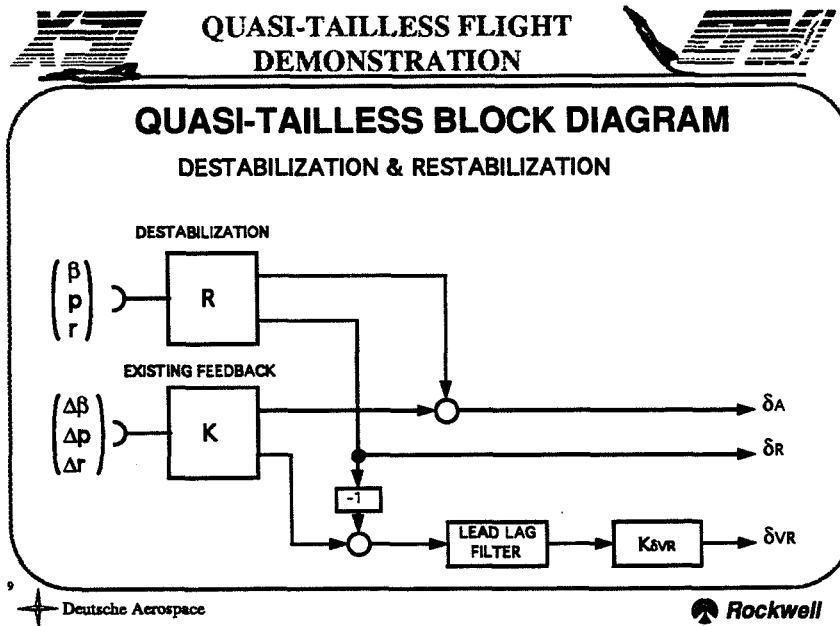



## DESTABILIZATION GAIN DESIGN

The destabilization gain matrix R is being calculated by matching the poles of the 4th order system matrix of the tailless aircraft.

Starting with matching the elements of the low order quasi-tailless system matrix (A+BR) and the tailless system matrix, the resulting gains are adjusted in order to achieve the tailless system poles with the high order quasi-tailless system.



### QUASI-TAILLESS FLIGHT DEMONSTRATION



#### DESTABILIZATION GAIN DESIGN

Destabilization Gain Matrix R determined by  
Matching the Poles of the 4th Order System Matrix of  
the Tailless Aircraft

$$\begin{array}{ccc} (A + BR) & \Leftrightarrow & A_{\text{Tailless}} \\ \text{HOS} & & \text{LOS} \end{array}$$

## FLIGHT TEST RESULTS

This diagram shows Dutch-Roll frequency and damping at the quasi-tailless demonstration flight condition evaluated via a LOES identification method. The basic X-31 has a Dutch Roll Frequency of 5.8 rad/s and a damping of 0.4.

It can be seen, that destabilization leads to lower frequency and damping values. 20% vertical tail reduction has been demonstrated in flight in the Destabilization-only Mode.

Tail reduction and restabilization via thrust vectoring leads to lower frequencies and higher damping. The Flying Qualities of the basic aircraft could not be maintained, because of an additional lead-lag filter in the thrust vectoring feedback path.

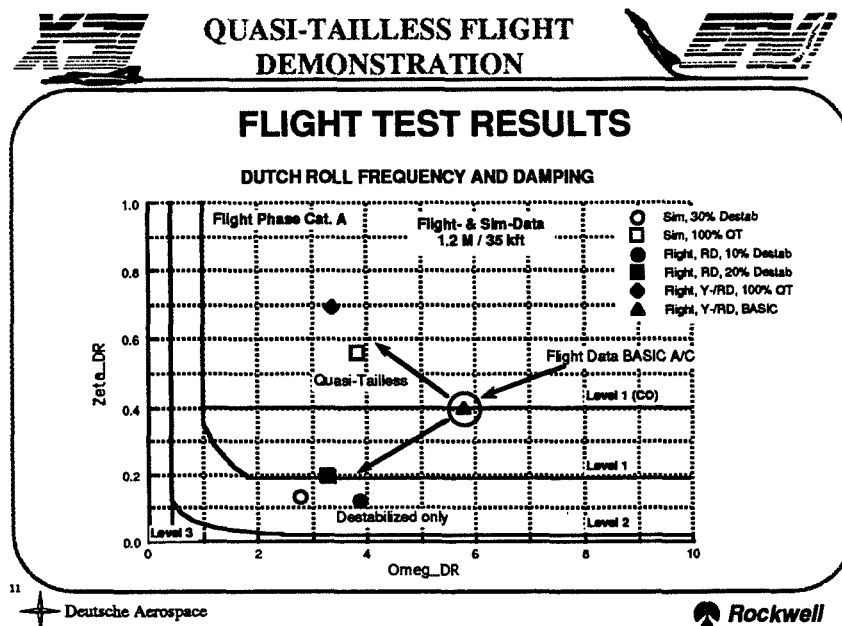

## FLIGHT TEST RESULTS

Time history results of a roll doublet with 100% tail-off show excellent agreement between the quasi-tailless flight data and the non-linear quasi-tailless simulation driven by the flight pilot inputs. The rudder destabilization and thrust vectoring yaw stabilization can be seen in the first figure. The second figure adds the simulated response of the tailless X-31 (quasi tailless destabilization replaced by tailless aerodynamics model) to demonstrate the effectiveness of the quasi-tailless function in representing a tailless aircraft.

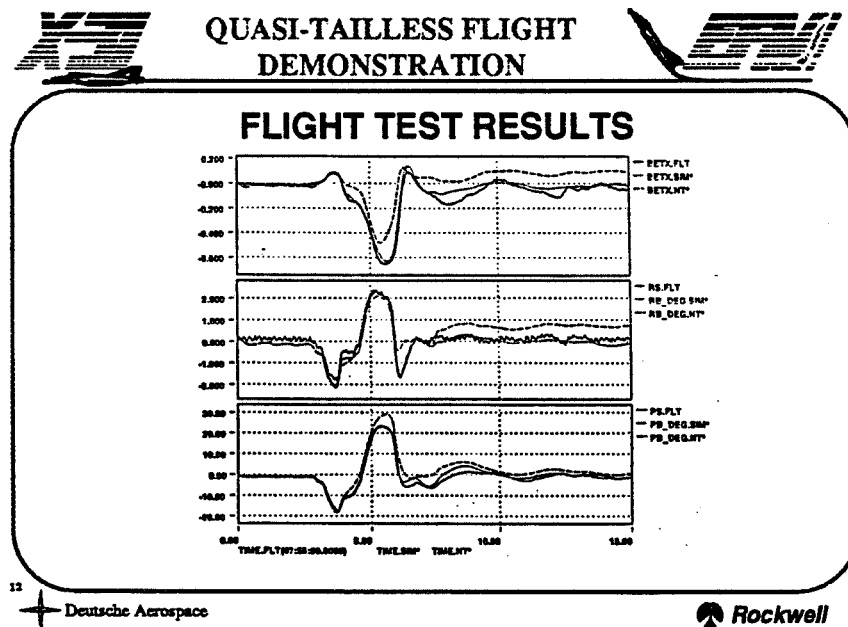



# QUASI-TAILLESS FLIGHT DEMONSTRATION

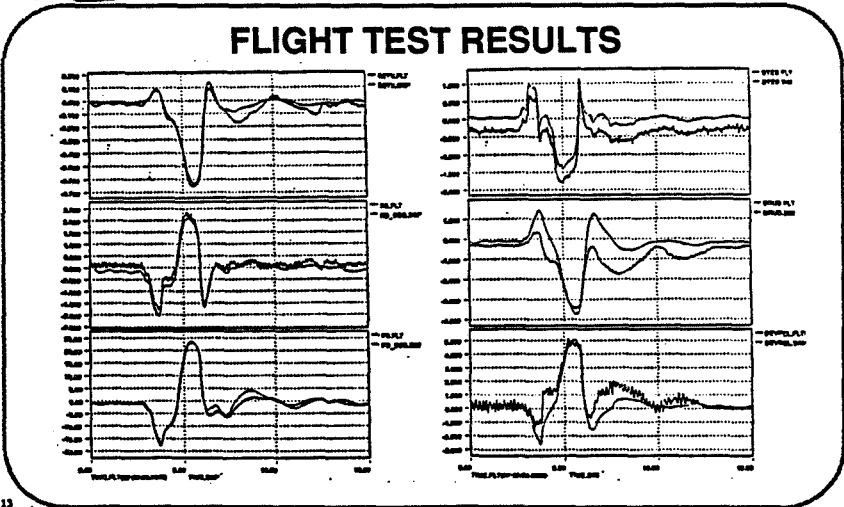

## Summary

The X-31 quasi-tailless demonstration of tailless flight at supersonic speed has been a success. Flight test and supporting simulation have demonstrated that the quasi-tailless approach is effective in representing the reduced stability of tailless configurations. Destabilization to a level of almost neutral directional stability was flight tested. Quasi-Tailless destabilization/stabilization with thrust vectoring was flight tested in a build-up to a level representing complete removal of the X-31 vertical tail and rudder. The flight time histories show excellent agreement with simulation. Good correlation of quasi-tailless and a true tailless X-31 aero model in the X-31 non-linear simulation validate the concept.

The flights also demonstrated that thrust vectoring, already integrated into the X-31 flight control system for conventional and post-stall flight, could be effectively used to stabilize a directionally unstable configuration and provide control power for maneuver coordination. The X-31 program plans to continue to explore thrust vectoring stabilization and control of reduced directional stability configurations with the next flights to begin in August. The same quasi-tailless control law structure will be used with new destabilization gains to begin tests to examine different levels of directional stability and aerodynamic control at subsonic speeds. Flight conditions will vary from high subsonic cruise to landing approach. Both cruise and landing configurations will be tested to provide a more complete picture of the critical design and flight conditions for future reduced tail/tailless aircraft.



### QUASI-TAILLESS FLIGHT DEMONSTRATION



#### SUMMARY

- **Quasi-Tailless Approach Is Effective in Representing Reduced Stability of Tailless Configurations**
  - Destabilization Up to 30% Tail Removed Has Been Flight-Demonstrated
  - Quasi-Tailless Up to 100% Tail-off Has Been Flight-Demonstrated
  - Simulation of Quasi-Tailless Matches Tailless Configuration
- **Thrust Vectoring Effective in Stabilizing and Providing Maneuver Coordination For Directionally Unstable Configuration at Supersonic Speeds.**
- **Flight Test and Analysis Will Continue With X-31 Subsonic Quasi-Tailless**
  - Subsonic Cruise Down to Landing Speeds
  - Cruise and Landing Configurations
  - Next Flights With New Destabilization Gains Planned for August

14

# **Control Laws and Handling Qualities**

**PAPER NOT AVAILABLE FOR PREPRINT**

**High Alpha Handling Qualities and Agility Flight Research on the F/A-18 High Alpha Research Vehicle, Keith D. Wichman, Joseph W. Pahle, and R. Joe Wilson, NASA Dryden Flight Research Center, Edwards, CA, and Patrick J. Connelly and John W. Kelly, PRC Inc., Edwards, CA, and Marilyn E. Ogburn, NASA Langley Research Center, Hampton, VA**

20pg

1995107830

N95-14244

323986

25-02

16093

P. 19

# **X-31 High Angle of Attack Control System Performance**

**By:**

**Peter Huber, Deutsche Aerospace  
X-31 Chief Engineer**

**Patricia Seamount, NASA Dryden  
X-31 Flight Controls Engineer**





## High Angle of Attack Control System Performance



### Overview

- FCS Performance Goals
- FCS Description
- Envelope Expansion
- Cleared Envelope
- High Alpha Flying Qualities
- Conclusion

2

 Deutsche Aerospace



The design goals for the X-31 flight control system were:

- Level I handling qualities during post-stall maneuvering (30 to 70 Degrees angle-of-attack).
- Thrust vectoring to enhance performance across the flight envelope.
- Adequate pitch-down authority at high angle-of-attack.

Additional performance goals are discussed.

A description of the flight control system will be presented, highlighting flight control system features in the pitch and roll axes, and X-31 thrust vectoring characteristics.

The high angle-of-attack envelope clearance approach will be described, including a brief explanation of analysis techniques and tools. Also, problems encountered during envelope expansion will be discussed.

This presentation emphasizes control system solutions to problems encountered in envelope expansion. Other papers discuss in detail the aerodynamic fixes that were used in conjunction with the control system fixes to achieve the program goals.

An essentially "care-free" envelope was cleared for the close-in-combat demonstration phase.

High angle-of-attack flying qualities maneuvers are currently being flown and evaluated. These results are compared with pilot opinions expressed during the close-in-combat program, and with results obtained from the F-18 HARV for identical maneuvers. The status and preliminary results of these tests will be discussed.



## High Angle of Attack Control System Performance



### Flight Control System Performance Goals

- **Level 1 Flying Qualities**
- **Departure Avoidance**
- **Carefree Post Stall Maneuvering**
- **Clear Envelope for Close-in-Combat Tactical Utility Evaluation ASAP**



Original performance goals included achieving Level 1 flying qualities throughout the flight envelope.

Other goals emerged with initial envelope expansion and insight into aircraft aerodynamic characteristics as a result of NASA Langley Research Center drop model tests. A spin mode found in these tests and re-discovered in Langley's wind tunnel and free-to-roll tests made engineers cautiously approach high angle-of-attack envelope clearance.

The High Incidence Kinetic Roll (HIKR) mode is a roll-dominated spin mode, rarely seen in spin testing. Free-to-roll tests indicated that both high alpha and high sideslip values along with unstable  $C_{lp}$  trigger the mode. Therefore, a departure resistant aircraft was an important flight control system performance goal.

Providing a carefree post-stall maneuvering envelope for the close-in combat tactical utility evaluation as soon as possible was the primary project goal. Both aerodynamic and flight control system solutions were applied to problems discovered during envelope expansion, a timely and cost-effective approach.



## Flight Control System Description

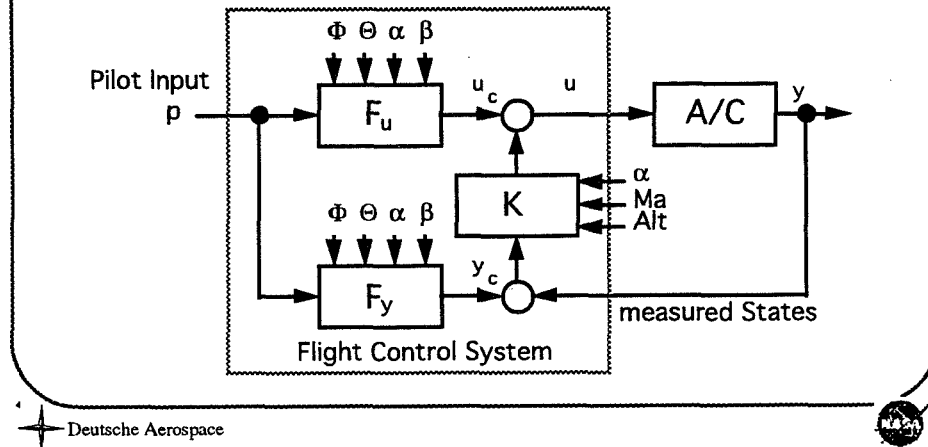

The three main external control system interfaces are the pilot command vector (stick, pedal), the sensed feedback vector ( $\alpha$ ,  $q$ ,  $\beta$ ,  $p$ ,  $r$ ) and the actuation command vector (canard, symmetrical and differential trailing edge flap, rudder, and thrust deflection in pitch and yaw).

The control law blocks consist of a linear feedback Matrix  $K$  and the nonlinear feedforward Matrices  $F_u$  and  $F_y$ . The feedback gains are calculated by using the optimal linear digital regulator design.

There is an additional integral feedback of angle-of-attack, as well as an integral feedback of wind axis roll rate and sideslip above  $30^\circ$  angle of attack.

Additional elements are the inertial and engine gyroscopic coupling compensation and the gravity effect compensation.



## High Angle of Attack Control System Performance



### **X-31 FLIGHT CONTROL CHARACTERISTICS**

- **ROLL ABOUT VELOCITY VECTOR**
  - **AIRCRAFT CONTROL IN FLIGHT PATH AXIS SYSTEM**
    - Angle of attack command -> pitch stick
    - Velocity vector roll rate command -> roll stick
    - Sideslip command -> pedal
- **COMMAND SHAPING BASED ON AVAILABLE CONTROL POWER**
- **INERTIAL- AND GYROSCOPIC-COUPLING COMPENSATION AND GRAVITY COMPENSATION**
- **INTEGRATION OF THRUST VECTORING**

 Deutsche Aerospace



The X-31 design was oriented towards aircraft control at high angles-of-attack from the beginning, therefore a unique approach was chosen - aircraft control in the flight path axis system.

The pilot input is translated into an angle-of-attack command or load factor command at high dynamic pressure (pitch stick), wind axis roll rate command (roll stick) and sideslip command (pedal).

In order to achieve carefree maneuvering and departure resistance the maximum possible command is based on the available control power. In addition inertial and engine-gyroscopic coupling compensation, as well as gravity compensation has been included.

Thrust vectoring has been integrated as a control effector, equivalent to aerodynamic control surfaces.



## High Angle of Attack Control System Performance



### Pitch Command Characteristics

AoA-command characteristic

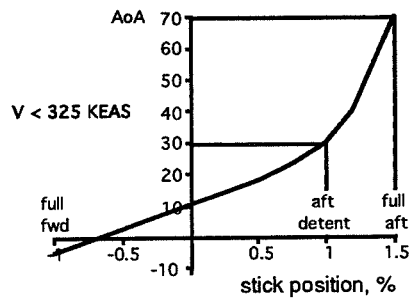

nz command characteristic

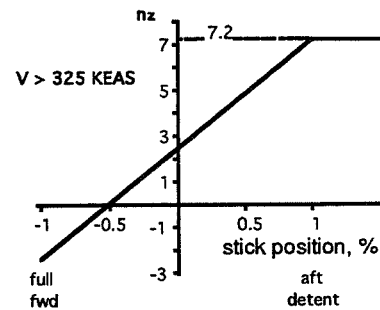

Deutsche Aerospace



The X-31 flight control system is an angle-of-attack command system, changing to an nz-command system above the corner speed. Corner speed as defined in this context is the airspeed where limit load factor is reached at 30 degrees angle-of-attack.

In addition to the angle-of-attack command generation which is based on the pitch stick position a steady state pitch rate command is calculated based on the actual flight condition.



## High Angle of Attack Control System Performance



### Roll Command Characteristics

ROLL RATE COMMAND CHARACTERISTIC

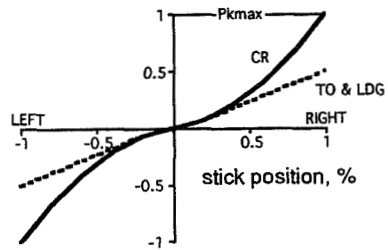

MAX ROLL RATE COMMAND

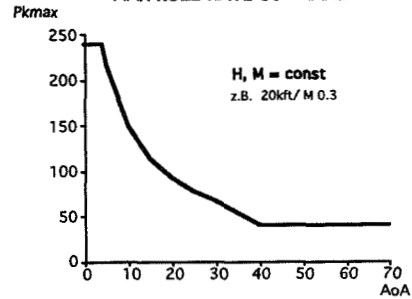

Lateral stick position commands roll rate about the velocity vector, also referred to as the wind axis. The maximum possible roll rate command depends on the available control power at the actual flight condition, i.e. it is a function of altitude, Mach number, dynamic pressure and angle-of-attack.



## High Angle of Attack Control System Performance



### Thrust Vectoring

- **Integration of Thrust Vectoring as an Equivalent Moment Generator in Pitch and Yaw**
  - TV operation transparent to the pilot
- **Three Vane Solution**
  - Low weight, low cost
- **Control Power and Deflection Rate Meet Performance Goals**
  - max. jet deflection  $\geq 15^\circ$
  - max. jet deflection rate  $\approx 40^\circ/\text{sec}$
- **180 Flight Hours of Troublefree Operation**

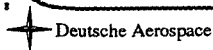

One of the unique features of the X-31 control law is that thrust vectoring is integrated as a moment generator in pitch and yaw equivalent to aerodynamic control surfaces. This means that the aerodynamic surfaces and thrust vectoring can be blended in and out without changing the aircraft behavior as long as the aerodynamic surfaces are effective. Thrust vectoring is used for yaw control at high angles-of-attack where the rudder is ineffective.

A three-vane thrust vectoring configuration was chosen as a low weight, low cost solution at a time when an engine with a swivelling nozzle was still unavailable.



## High Angle of Attack Control System Performance



### Envelope Clearance Maneuvers

- **1-g Maneuvers**
  - Level Decels
  - Bank to Bank Rolls
  - 360° Velocity Vector Rolls
  - Pitch Steps
- **Elevated-g Maneuvers**
  - WUTs, Split-S
  - J - Turns
- **Departure Resistance**
  - Diagonals/Diagonals w/Reversals



Envelope expansion began at high altitude (35,000 feet MSL), proceeded out in airspeed (Mach 0.3 - 0.7 in tenth increments) and down in altitude (20,000 then 13,000 feet MSL), increasing dynamic pressure and post-stall entry condition g's. Alpha values were increased in five-degree increments, from 30 to 70°, increasing to 10° increments as system confidence increased.

Initial 1-g maneuvers included level decelerations to show any large asymmetries in yaw and/or roll, half and full-stick bank-to-bank rolls, 360° velocity vector rolls both to the left and right. The velocity vector rolls gave indications on how well inertial and gyroscopic coupling compensation worked, and if there were any roll command overshoots. Abrupt pitch steps were performed to assess any pitch rate or alpha dot effects on flying qualities.

More dynamic maneuvers followed the 1-g phase, beginning with symmetric pulls (wind-up turns, split-S) and proceeding to more dynamic maneuvers (J-turns).

If aircraft performance was satisfactory through the 1-g and elevated-g flight phases, departure resistance maneuvers were flown. The diagonals and diagonals with reversals were the last expansion maneuvers to be flown before the envelope was cleared for tactical utility.





## **Post Flight Analysis Using Batch Simulation**

- **Non-linear, 6 DOF Digital Simulation**
- **Aerodynamic, propulsion, actuator, atmospheric models**
- **Easy to modify for sensitivity studies, Flight Control System studies**
- **Ability to add aerodynamic derivative deltas to check control power**

11

Deutsche Aerospace



Satisfactory flying quality performance was judged in two parts: 1) Control room pilot/near real-time assessment and, 2) Post-flight analysis.

A vital analysis tool was the X-31 batch/real-time simulation, a non-linear six degree-of-freedom FORTRAN simulation containing aerodynamic, propulsion, control system, atmospheric and actuator models.

This versatile tool was used in many ways. Simulating envelope expansion points gave pilots and engineers an expectation of aircraft response, and thus the ability to respond quickly to unexpected aircraft behaviour during the flight. The simulation was used to check control surface activity as a function of sensor noise. Effects on flying qualities of wake or jet wash encounters were also simulated. Flight control system changes e.g. fader time constants, or integrator surface authority could be quickly checked in the simulation, making it an invaluable tool for trouble-shooting, or bounding problem areas.

The simulation could be driven by pilot/flight control system inputs from flight data. The response was plotted against the measured aircraft response. Differences in rates, motions, surface deflections were assigned to unmodelled or mismodelled aerodynamic derivatives in the simulation. Called "deltas", these aerodynamic derivative differences between baseline simulation and flight data could be added to the simulation.

Adding  $C_{n\dot{\alpha}}$  and  $C_{l\dot{\alpha}}$  deltas derived from flight data to the baseline simulation provided insight into control power limitations and aircraft motion in the presence of large yawing and/or rolling asymmetries.



## High Angle of Attack Control System Performance



### Asymmetry Evaluation

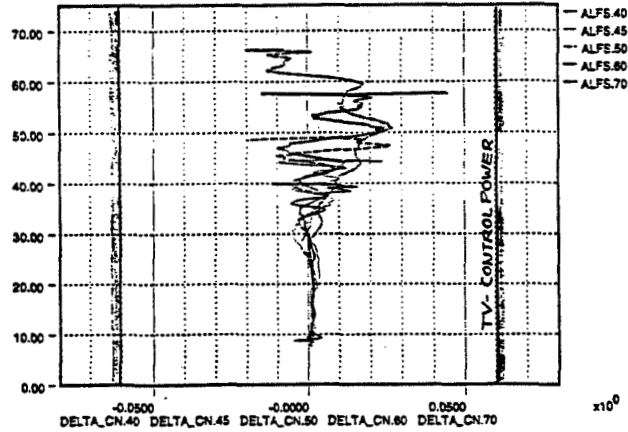

The control derivatives were assumed to be modelled correctly in the simulation. These effects were subtracted out from the total yawing and rolling moment coefficients,  $C_n$  and  $C_l$ . For most flight cases where large yawing and rolling moments were encountered, roll rate, yaw rate and sideslip values were small, hence moments were assumed to be static asymmetries.

The graphic shows an overlay plot of five pullups to different target-angles,  $\Delta C_{n\alpha}$  versus angle of attack in comparison to TV control power available at that flight condition. The largest asymmetries occur around 50°.



## High Angle of Attack Control System Performance



### Simulation - Flight Time History Comparisons

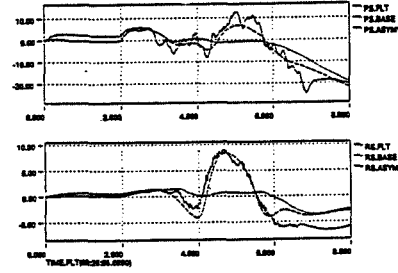
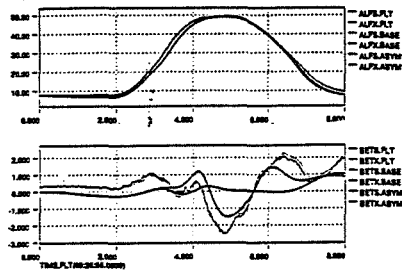

13

Deutsche Aerospace



Time history comparisons of baseline simulation,  $C_{n0}$ ,  $C_{l0}$  deltas added to the baseline simulation and flight data indicate a better match with the asymmetry deltas added to the baseline simulation.



## Problems Found in Flight

- **Pitch Trim Mismatch**
  - Reduction of Roll Control Authority and Pitch Recovery Margin
- **High Angle of Attack Asymmetries**
  - TEF Surface Saturation
  - TVV Surface Saturation
- **Velocity Vector Roll Rate Overshoots**



Envelope expansion flights were halted periodically by problems encountered during expansion into higher dynamic pressure maneuvers. Primary problems were trailing edge flap and thrust vector vane surface saturation caused by large rolling and yawing moments. Roll rate command overshoots were also of concern.

Trailing edge flaps served dual-duty as moment generators in pitch and roll. Differential trailing edge flap was the only roll moment generator. Close watch was kept on the trailing edge flap deflection and roll rate command; saturation of the trailing edge flaps would effect the ability to recover from high alpha.

Thrust vector vane saturation was also of concern as it controls yawing moments above 45 degrees alpha.



## **Control Law Solutions**

- **Gain adjustment based on updated Aerodynamic**
- **Roll Rate and Sideslip Integrators in the PST regime**
- **TVV Deflection Limit Increased**
- **Maximum Roll rate command adjusted**



In order to achieve carefree PST maneuvering control surface saturation must be avoided. Both aerodynamic and control law changes were used.

Aerodynamic changes to the aircraft included aft and forebody strakes and nose blunting to regain the desired trailing edge pitch trim position, and to reduce high angle-of-attack asymmetries.

Control law changes were aimed at retaining tight control and increasing yaw control power.

Gain adjustments were made based on updated high angle of attack aerodynamic derivative data. In addition integrators were added to the roll rate and sideslip feedback to achieve tighter control of sideslip and velocity vector roll rate in the presence of aerodynamic asymmetries.

Increasing the thrust vector vane maximum deflection limit from 26 degrees to 35 degrees improved yaw control power.

Limiting wind axis roll rate command in the post-stall regime proved to be an acceptable compromise of roll performance and controllability.



## High Angle of Attack Control System Performance

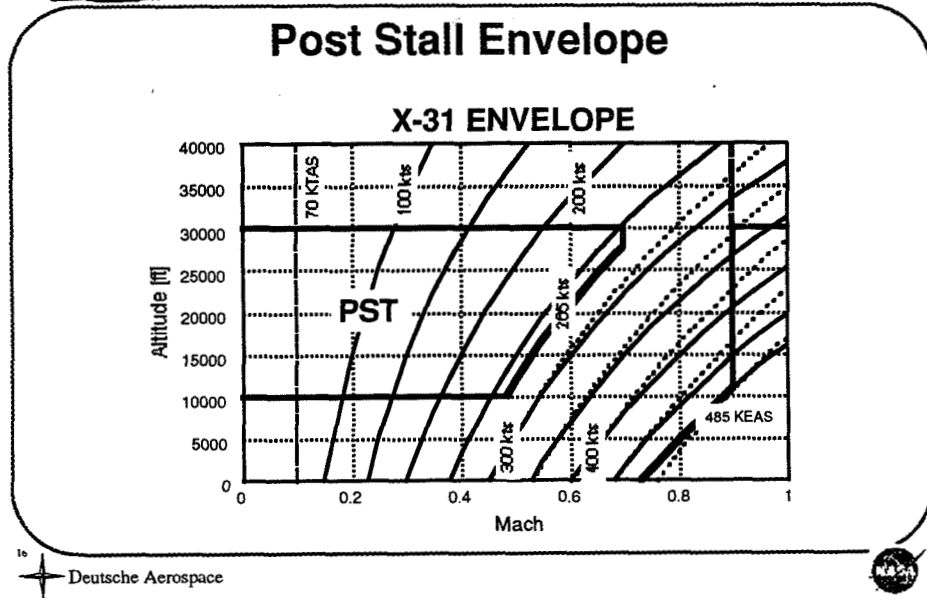

The aircraft was finally cleared for essentially carefree PST maneuvering between 13,000 feet and 30,000 feet, reaching from a 6g PST entry at 265 KEAS, Mach 0.7 down to 70 KTAS.

To date, pilot inputs during CIC are less severe than departure resistance maneuvers flown during envelope clearance.



## Flying Qualities

- Time and Frequency Domain LOES Analyses
- In-Flight Pilot Ratings of Selected STEMs
- Using Performance Criteria from F-18 HARV
- Non-LOES based Analyses



Throughout the envelope expansion time domain LOES analysis was performed to confirm that conventional Level 1 Flying Quality Requirements were met. However, above 45° alpha the data scatter increases significantly and alternative ways have to be considered.

The X-31 is flying selected maneuvers from the Standard Evaluation Maneuver Set (STEMS) and collecting in-flight pilot comments and Cooper-Harper ratings. Initial flights use performance criteria established by the F-18 HARV. Ratings from the X-31 will be correlated with close-in-combat data, a unique data resource for high alpha flying qualities analysis. F-18 HARV and X-31 ratings and comments for the same STEM will also be compared.

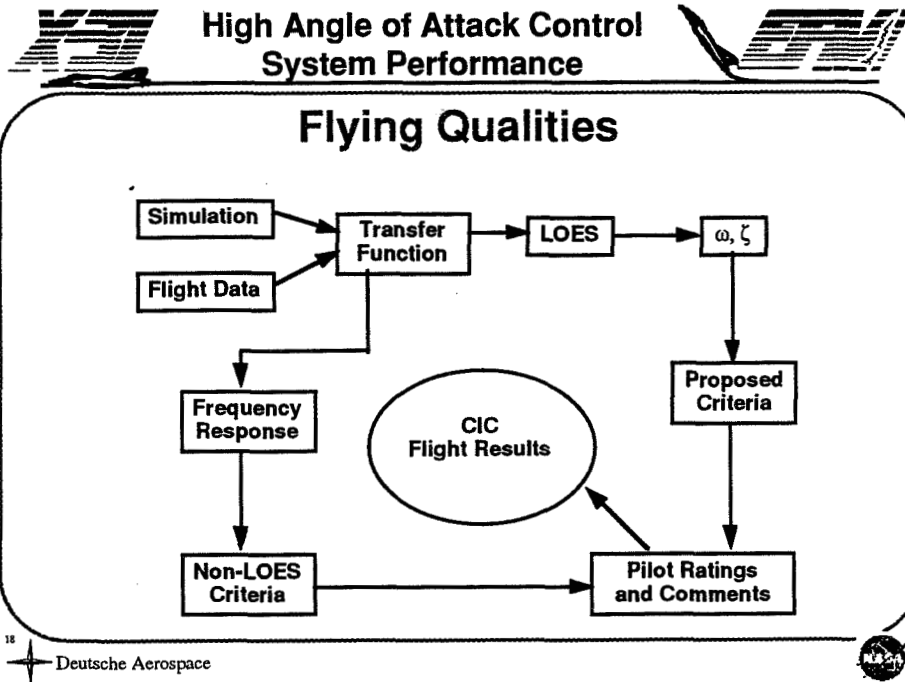

Flying qualities analyses focus on tying the STEMS Cooper-Harper ratings to criteria historically used in the conventional envelope, e.g. Neal-Smith, and Smith-Geddes. Additionally, flying qualities predictions based on lower order equivalent system (LOES) models, both in the time and frequency domain, will be compared with the actual pilot ratings.

Pilot comments and Cooper-Harper ratings from the STEMs will be compared with the pilot opinions expressed during X-31 CIC. This will give confidence that the STEMs can be used to predict the suitability of flying qualities for high angle-of-attack close-in-combat.

The correlation of handling quality ratings with LOES predictions will be compared with the same correlation done for the HARV.





## High Angle of Attack Control System Performance

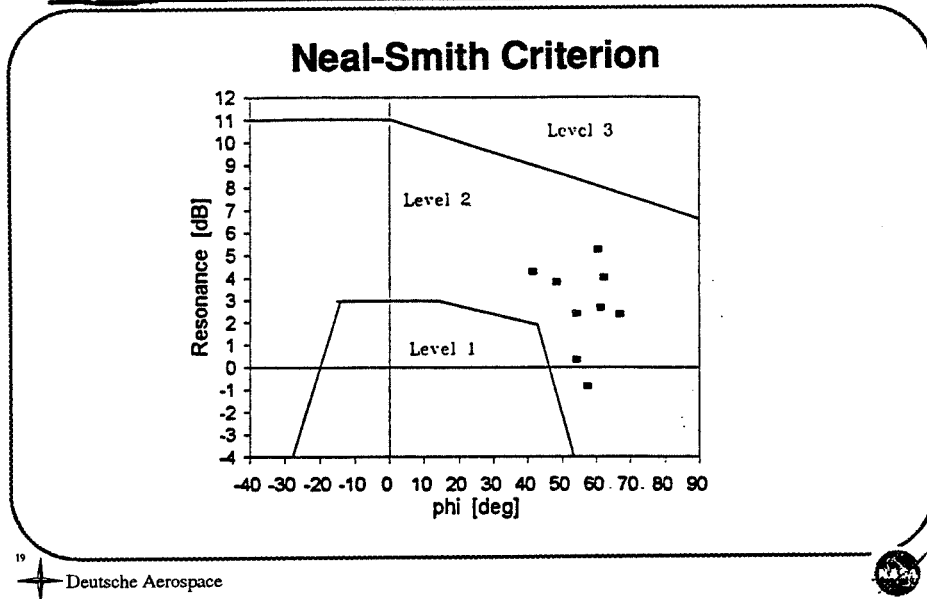



## High Angle of Attack Control System Performance



### Conclusions

- **Aircraft cleared for essentially unrestricted PST maneuvering**
- **Successful Close-in-Combat flight demonstration**
- **Good handling qualities with Level II tracking in the PST regime**
- **High angle-of-attack flying qualities contribution**

21

 Deutsche Aerospace



In summary, the X-31 has met its flight control system performance goals, delivering the desired close-in-combat envelope, enabling the completion of over 200 successful close-in-combat engagements, and making a unique and significant contribution to understanding high angle-of-attack flying qualities.

**FLIGHT TEST RESULTS OF THE F-16 AIRCRAFT MODIFIED  
WITH THE AXISYMMETRIC VECTORING EXHAUST NOZZLE**

Copyright © 1994 by Lockheed Fort Worth Company  
All rights reserved. Published by NASA with permission.

**PAUL D. ANNA  
LOCKHEED FORT  
WORTH COMPANY**

**DAVID S. KIDMAN  
416TH FLIGHT TEST  
SQUADRON**

16 P3

525989

1995/0723/

N95-14245

10-15  
P. 15

This paper presents the results of the envelope expansion phase of the F-16 Multi-Axis Thrust Vectoring (MATV) program. The objectives and test approach will be presented followed by results of testing with the initial control law configuration. The revised flight control laws will be discussed followed by test results with the revised control laws. Additional testing added to the program, nose-chines, parameter identification maneuvers, and the extended range angle of attack cones will also be briefly discussed.

## OVERVIEW

TEST APPROACH

OBJECTIVES

RESULTS OF TESTING WITH INITIAL FLIGHT CONTROL LAWS

REVISION OF THE FLIGHT CONTROL LAWS

RESULTS OF TESTING WITH REVISED CONTROL LAWS

ADDITIONAL TESTING

The flight test program was a three phase effort. Phase I functionally verified the aircraft and systems within the current F-16 Category I angle of attack limitations, Phase II expanded the angle of attack envelope utilizing the thrust vectoring system, and Phase III provided a tactical utility assessment and demonstration of the expanded maneuvering envelope. The program attempted to quickly expand the useable F-16 envelope from the current 25 degrees angle of attack to beyond 80 degrees and attain its final goal of 1 V 1 and 1 V 2 fighter engagement scenarios. Flight testing began in July 1993 and continued through March 1994.

## **TEST APPROACH**

### **PHASE I - FUNCTIONAL CHECK FLIGHTS**

**AIRWORTHINESS  
ENGINE OPERABILITY IN STANDBY  
AIRSTARTS  
DEPARTURE RECOVERIES**

### **PHASE II - ENVELOPE EXPANSION**

**OPEN LOOP MANEUVERS  
CLOSED LOOP MANEUVERS**

### **PHASE III - TACTICAL UTILITY ASSESSMENT**

**FUNCTIONAL MANEUVER DEVELOPEMENT  
OPERATIONAL ASSESSMENT  
FLIGHT DEMONSTRATIONS**

The stability and control portion of the F-16 Multi-Axis Thrust Vectoring (MATV) flight test program was designed to achieve the following objectives:

**Clear an expanded maneuvering envelope to enable a meaningful tactical utility assessment**

**Assess capability of AVEN/FLCS combination to provide stability and control power in the expanded envelope**

**Assess the handling qualities and maneuvering performance of the MATV aircraft in the expanded envelope**

**Determine stability derivatives of the MATV aircraft with and without a nose-chine**

The most important of these objectives was to provide a maneuvering envelope to be used in the tactical utility assessment as well as VIP demonstrations. In order to achieve this goal, an aggressive yet safe test approach was devised.

## **OBJECTIVES**

**CLEAR AN EXPANDED MANEUVERING ENVELOPE TO ENABLE A MEANINGFUL TACTICAL UTILITY ASSESSMENT**

**ASSESS CAPABILITY OF AVEN/FLCS COMBINATION TO PROVIDE STABILITY AND CONTROL POWER IN THE EXPANDED ENVELOPE**

**ASSESS THE HANDLING QUALITIES AND MANEUVERING PERFORMANCE OF THE MATV AIRCRAFT IN THE EXPANDED ENVELOPE**

**DETERMINE STABILITY DERIVATIVES OF THE MATV AIRCRAFT WITH AND WITHOUT A NOSE-CHINE**

Envelope expansion maneuvers were conducted between 20,000 and 35,000 feet altitude. In order to achieve the goal of providing a cleared tactical maneuvering envelope for Phase III, this testing attempted to verify that the F-16 MATV aircraft was controllable and the F110 engine was operable throughout the flight regime with no restrictions on pilot control or throttle inputs. If pilot input restrictions were required due to undesirable or uncontrollable aircraft or engine response to specific inputs, those input limitations would be used during Phase III of the program.

The accompanying chart depicts the envelope expansion maneuvers. Testing began at the higher altitude block of 30k-35k feet altitude to allow for sufficient time for recovery if a departure occurred. Open loop maneuvers, defined as test maneuvers designed to assess the airframe and flight control system dynamic response to defined pilot inputs, included stabilizations and doublets. These were initially performed in military power, although this is the area of least control power from thrust vectoring, beginning in military power made sense from a propulsion standpoint due to improved stall margins.

Testing then proceeded to maximum afterburner points. This testing included a repeat of the stabilizations and doublets and added pushover/pullups, lateral stick reversals, yaw pedal reversals, 360-degree rolls, both lateral stick and yaw pedal, wind-up turns, and 360-degree rolls at elevated-g, both lateral stick and yaw pedal. This concluded the open loop block maneuvers at the high altitude block and testing proceeded to closed loop maneuvers.

Closed loop maneuvers were defined as test maneuvers designed to assess the aircraft system response to pilot inputs performed as part of a specific mission related task and included maximum pitch rate maneuvers, maximum yaw rate maneuvers, pitch, roll, and yaw capture and tracking maneuvers, and yaw/roll cross control maneuvers all in maximum afterburner. Throttle transients were then performed and concluded the testing at the 30k-35k feet altitude block.

Testing then continued at the lower altitude block of 20k-25k feet and included open loop maneuvers in military power and maximum afterburner, as well as closed loop maneuvers in both military and maximum afterburner. Provisions were made in the test program to allow for one revision to the flight control laws.

## ENVELOPE EXPANSION MANEUVERS

### OPEN LOOP MANEUVERS

ANGLE OF ATTACK STABILIZATIONS  
 PITCH, ROLL, YAW DOUBLETS  
 PUSHOVER / PULLUP  
 LATERAL STICK REVERSALS  
 YAW PEDAL REVERSALS  
 LATERAL STICK 360 DEGREE ROLLS  
 YAW PEDAL 360 DEGREE ROLLS  
 WIND UP TURNS  
 360 DEGREE LOADED ROLLS

### CLOSED LOOP MANEUVERS

MAXIMUM PITCH RATE  
 HORIZONTAL  
 PULL UP  
 SPLIT S  
 LIMITER TRANSIENT  
  
 MAXIMUM YAW RATE  
 VERT PLANE REVERSALS  
 HAMMERHEAD TURN  
 J TURN  
 ROLL/YAW CROSS CONTROL  
 PITCH CAPTURES  
 BANK ANGLE CAPTURES  
 YAW CAPTURES

As planned, envelope expansion testing began at the high altitude block in military power with open loop maneuvers. Stabilizations and doublets were successfully performed from 5 to 30 degrees angle of attack in 5 degree increments with thrust vectoring active. Results from the next point, a 35 degree stabilization were not as favorable. The accompanying figure shows a time history of this maneuver. As angle of attack approaches 35 degrees, a rapid nose-slice of about 18 degrees to the right occurs. This is the classic sideslip departure inherent to the F-16, due to reduced directional stability, with one exception, angle of attack is well contained and the aircraft recovers with a nose-down command. Yaw nozzle saturation in military power was insufficient to oppose this nose-slice tendency.

## MIL POWER STABILIZATION

35 DEGREES 35,000 FEET

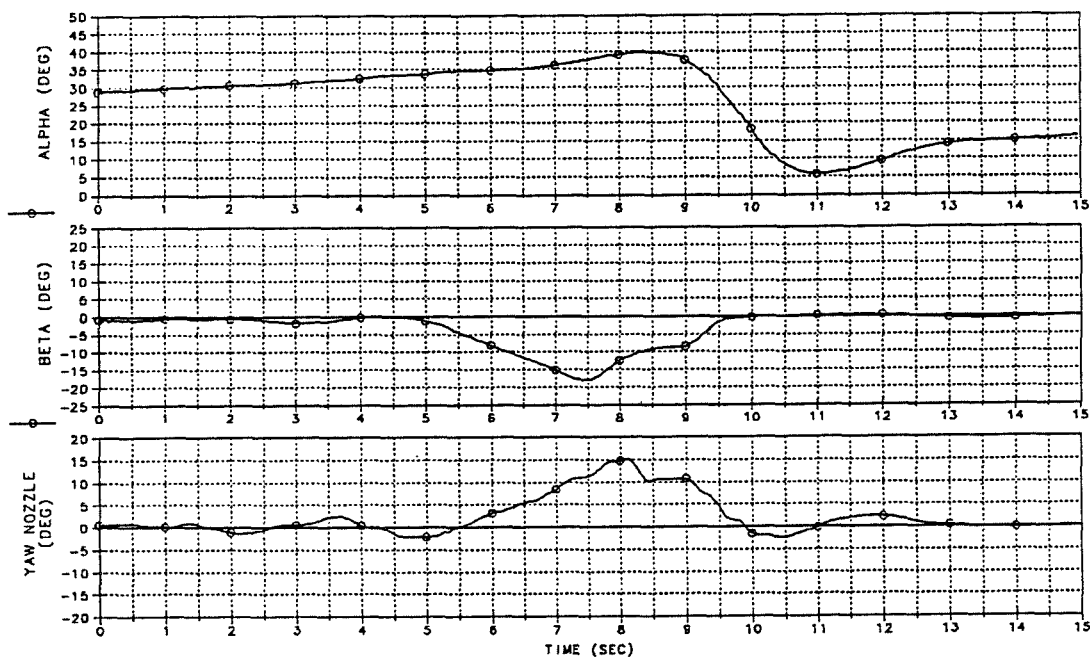



A brief control room discussion resulted in a decision to attempt the same maneuver in maximum afterburner in hopes of reducing the nose-slice with increased yaw control power. The accompanying figure is the time history for this maneuver. Once again the nose-slice was evident at about 35 degrees, but this time sideslip was more contained, between 10 and 15 degrees, and angle of attack was easily controlled. Additional yaw power was available to reduce this sideslip, however due to bias in sideslip measurement and relatively low sideslip feedback gains, the system allowed this sideslip to occur. As a result, the remaining maneuvers in military power at the high altitude block were deleted and testing at this altitude proceeded using maximum afterburner.

Angle of attack stabilizations were performed up to the maximum obtainable, about 70 degrees. Although sideslip oscillations of 10-15 degrees were prevalent at all angles of attack, and these oscillations were less than desirable, the aircraft was controllable and testing proceeded. The rest of the open loop maneuvers were performed per the test plan up to 70 degrees with the exception of the yaw and roll doublets which could not be performed due to the sideslip oscillations.

## MAX POWER STABILIZATION

35 DEGREES 35,000 FEET

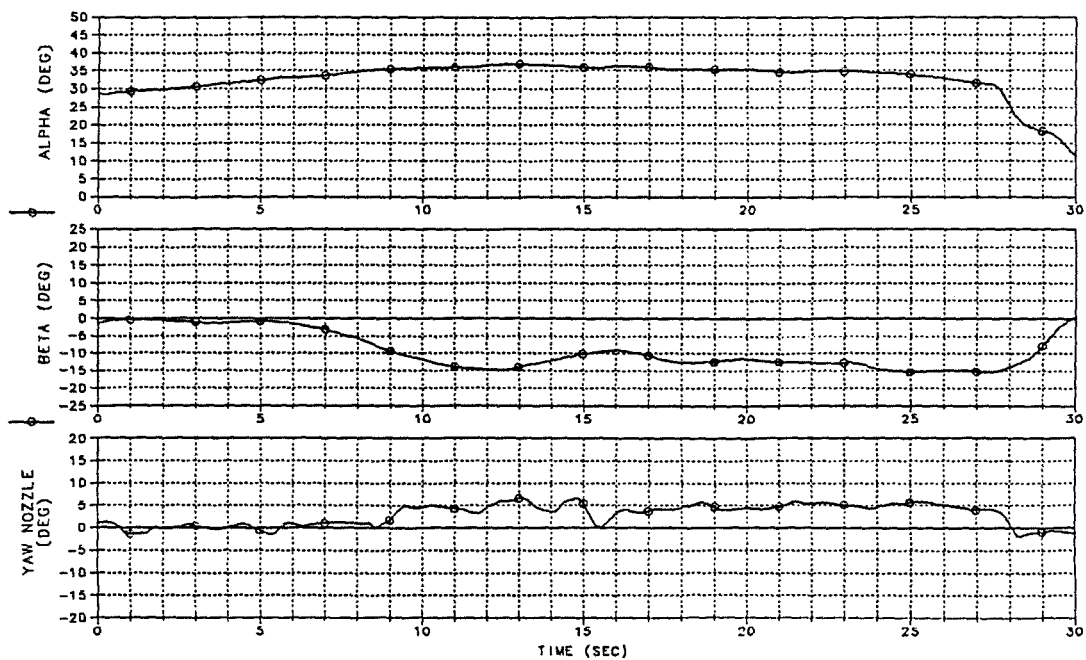

Pitch response during the push-pull maneuvers was very good with the ability to maintain and capture a given angle of attack precisely. The accompanying figure depicts this capability during a 70 degree push-pull. Control power, limited by control laws and never available power, was more than adequate. Wing rock and nose-oscillations were evident during the pitch maneuvers but did not significantly hinder the completion of the maneuver.

## MAX POWER PUSHOVER / PULLUP

70 DEGREES 35,000 FEET

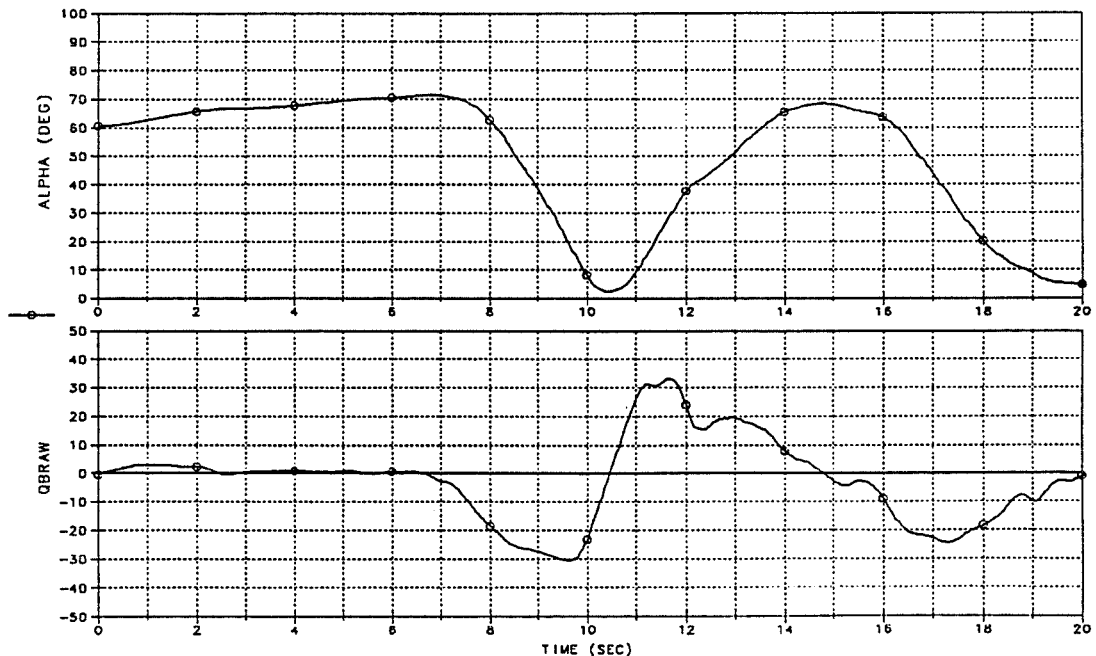

Results of roll and yaw maneuvers were not as impressive as pitch maneuvers. Lateral stick and yaw pedal reversals (30 to 30 degrees of bank or 90 to 90 degrees of heading) often resulted in overshoots of the intended bank angle or heading change. This was especially evident in the 35-50 degree angle-of-attack range, where aircraft response relied heavily on control authority from the flaperons and rudder. Roll hesitation or reversals were also evident in this angle-of-attack regime. One anomaly noted was a bias between the FLCS sideslip from the INS source as compared to the corrected noseboom sideslip. This is shown during a 35 degree angle of attack stabilization in the accompanying figure. This bias was attributed to the point at which the winds were locked for calculation of INS sideslip and was updated in the revised control laws.

## SIDESLIP MEASUREMENT COMPARISON

MAX POWER 35 DEGREE STABILIZATION

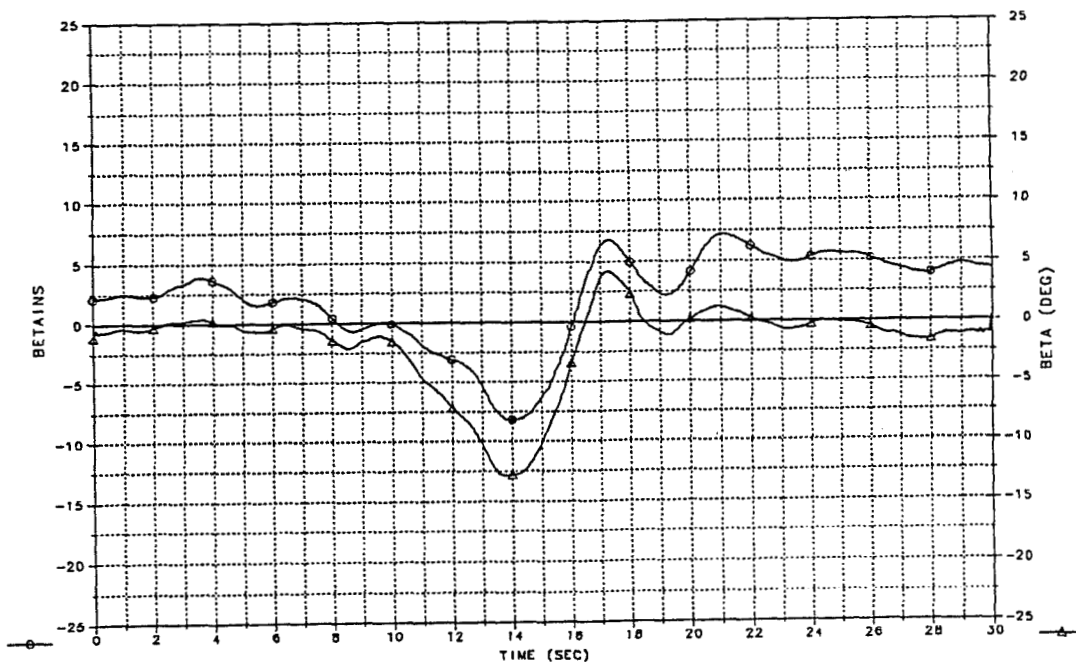

After completion of the planned testing in the 30k-35k feet altitude block, testing progressed to the lower block of 20k-25k feet. It was anticipated that the increase in thrust at this altitude would improve the less than desirable lateral-directional handling qualities observed at the higher altitude. In addition, work was already underway on revisions to the control laws and since the plan was to perform the rest of the test program at 20k-25k feet, it made sense to see the results at this altitude before finalizing any control law changes.

Testing at the lower altitude began using military power. As was expected, the aircraft response was similar to the results of the 30k-35k maneuvers in maximum afterburner, since engine thrust is comparable at these conditions. Testing progressed to maximum afterburner maneuvers, the accompanying figure is a time history of an angle of attack sweep. The increased thrust and control power became evident at these conditions. The initial nose-slice as angle of attack approaches 35 degrees was reduced to about 8 degrees compared to over 15 degrees in military power.

## MAX POWER AOA SWEEP

25,000 FEET

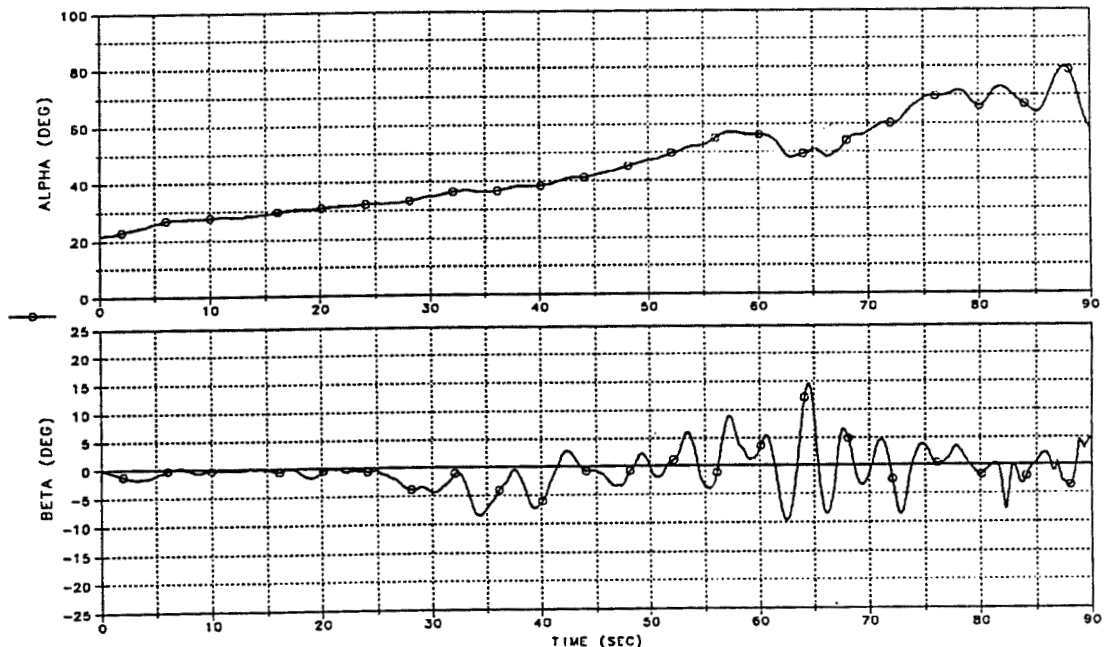

Numerous modifications were made in the revised flight control laws to improve handling qualities with emphasis on the lateral-directional axes in the 35 to 55 degree angle of attack region. Two types of modifications were included. First, any change that would definitely result in improved handling qualities was fixed in the new software, such as the calculation of INS angle of attack and sideslip and the normalization of gain schedules with thrust. Second, were modifications that allowed for changes to be pilot selectable in flight, such as the multiplier on the sideslip feedback gain and eliminating lateral stick inputs at high angles of attack. The accompanying chart lists the revised flight control law modifications.

## REVISED FLIGHT CONTROL LAWS

### MODIFICATIONS FIXED IN REVISED OFF

- IMPROVEMENTS TO INS ALPHA / BETA ESTIMATOR
- NORMALIZING GAIN SCHEDULES WITH THRUST
- INCREASED AILERON-RUDDER INTERCONNECT GAIN

### IN FLIGHT PILOT SELECTABLE MODIFICATIONS

- REDUCED ROLL STICK GRADIENT
- AOA LIMITER OF 80 DEGREES
- DIFFERENTIAL FLAP UP ONLY FOR ROLL CONTROL
- NO LATERAL STICK COMMAND AT HIGH AOA
- NO RUDDER COMMAND AT HIGH AOA
- ADJUSTABLE BREAK POINT FOR CONVENTIONAL TO BODY-AXIS YAW-RATE COMMAND
- ADJUSTABLE GAIN MULTIPLIERS FOR
  - SIDESLIP FEEDBACK
  - SIDESLIP RATE FEEDBACK
  - ROLL RATE FEEDBACK
  - YAW RATE FEEDBACK

A slow angle of attack sweep, pitch roll, and yaw doublets as well as lateral stick and yaw pedal reversal were performed as abaseline with the revised flight control laws at 20k-25k feet altitude. The accompanying figure shows a comparison of sideslip versus angle of attack for the original and revised flight control laws. This data was obtained from maximum afterburner slow angle of attack sweeps. Note that not only was the magnitude of the nose-right excursion between 35 and 40 degrees reduced by about 35 percent, but also the random nose-wandering was eliminated.

Optimization of the control laws then proceeded evaluating yaw response at the higher angles of attack and roll response at the mid angles of attack utilizing open loop maneuvers. Compromises were required to gain a balance in aircraft response in these two regions, but satisfactory results were achieved and testing proceeded to closed loop maneuvering. Only one change was made to the options during this testing for satisfactory aircraft response. The accompanying two figures are time histories for a cobra, J-turn, helicopter, and a hammerhead. These type of maneuvers were considered the building blocks of post-stall tactical maneuvering. At this point, the envelope-expansion was considered complete and the aircraft was ready for the tactical utility assessment.

## SIDESLIP COMPARISON

MAX POWER AOA SWEEPS  
REVISED AND ORIGINAL OFPS

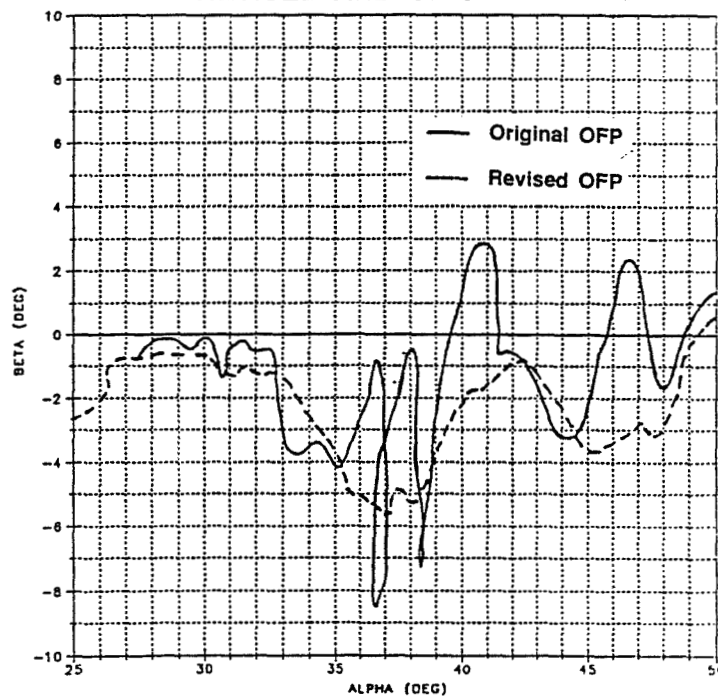

# COBRA MANEUVER

MAX POWER 20,000 FEET

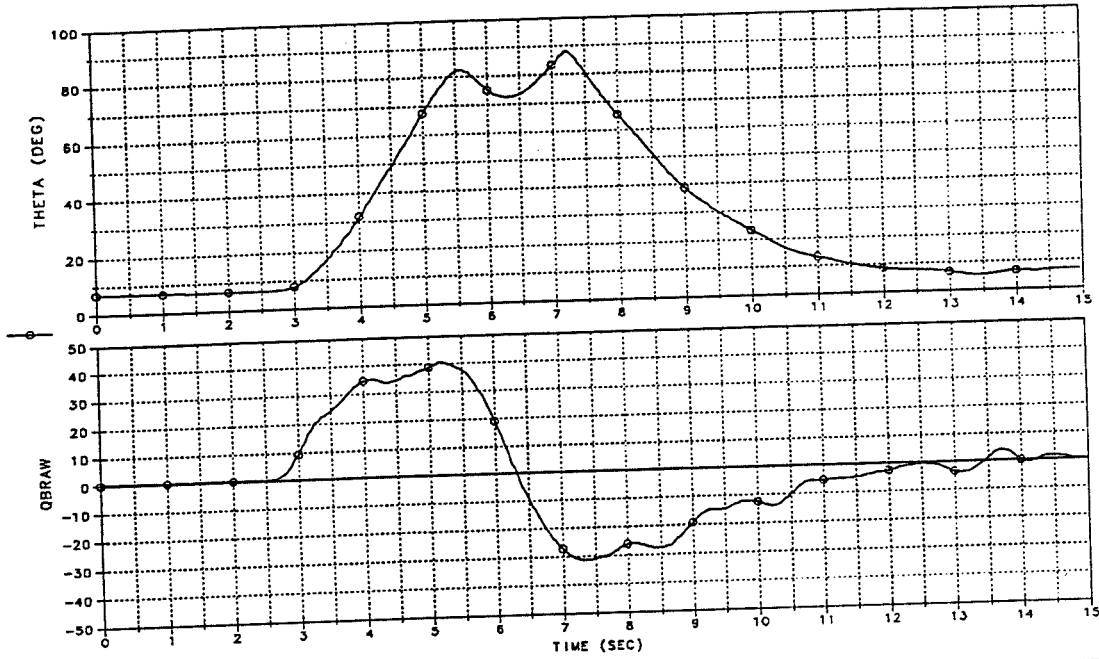

# HELICOPTER MANEUVER

MAX POWER 25,000 FEET

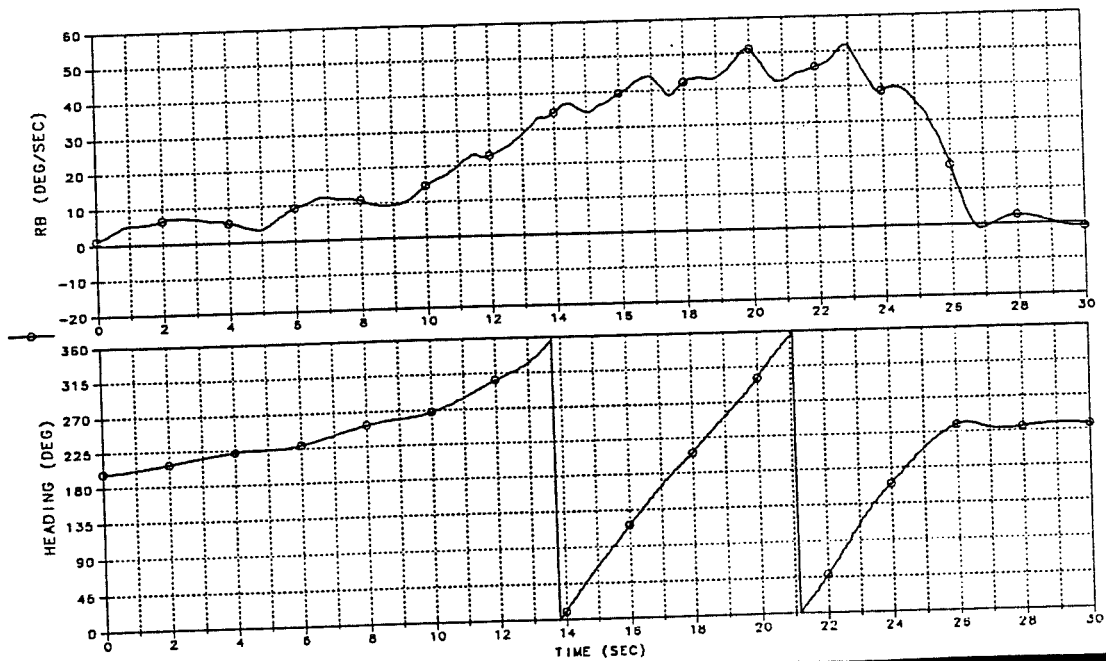

The unique capabilities of the MATV aircraft presented the opportunity to flight test potential improvements for high angle of attack flight. Although not part of the original test plan, several flights were allocated to test a nose-chine designed by Wright Laboratory and perform maneuvers designed to allow for parameter identification with and without the nose-chine in an effort to improve the F-16 simulation database. In addition, an extended range angle of attack cone was designed to evaluate its capabilities.

Wind tunnel data suggested a potential improvement in directional stability in the 30 to 40 degree angle of attack region. Although flight test results were not very encouraging, data was collected for parameter identification. This data as well as additional data from the program is being analyzed under a separate contract for Wright Laboratory in an effort to improve the high angle of attack data base for the F-16.

The additional testing with the extended range angle of attack cone did not require any dedicated flights. The standard angle of attack cones for the F-16 have a local flow angle range of -30 to 70 degrees while the extended range cones have a range of -180 to 180 degrees. Limited analysis of this data indicates that the extended range cones have good potential to be utilized up to moderately high angles of attack with no degradation in the normal flight envelope.

## ADDITIONAL TESTING

### NOSE-CHINE DESIGNED BY WRIGHT LABORATORY

WIND-TUNNEL DATA SUGGESTED LATERAL-DIRECTIONAL IMPROVEMENTS

FLIGHT TEST DATA HAS BEEN COLLECTED

### PARAMETER IDENTIFICATION MANEUVERS

WITH NOSE-CHINE

WITHOUT NOSE-CHINE

### EXTENDED AOA RANGE CONE

POTENTIAL FOR MODERATELY HIGH AOA USAGE



The envelope expansion phase of the MATV flight test program was very successful with an unrestricted envelope for use in the tactical utility assessment provided in a minimum amount of time. The envelope was cleared in only six weeks and 20 flights with the original flight control configuration. Revised flight control laws were available within a month and these control laws were optimized and the envelope cleared within two weeks and only ten flights.

Several factors were key to achieving these results. Extensive flight simulations in a high fidelity handling qualities simulator were performed. This allowed for optimization of control laws and provided insight into the development of effective maneuver definitions and the unique flight test techniques required to evaluate thrust vectoring technology. Lessons learned from other high angle of attack programs were solicited and provided valuable information. The flight test team was a small integrated team with all parties in agreement from the beginning to be a team committed to common goals and objectives. The acceptability of flight test results were based upon real-time data analysis by the team and qualitative assessment by the pilots as opposed to correlation with predicted results. The use of in-flight pilot selectable control law options provided an extremely efficient means of optimizing handling qualities. The use of a time-proven airframe was indispensable, at any time the pilots could revert back to a known configuration. These factors provided for an efficient and effective envelope expansion phase and allowed the program to proceed to its primary goal of evaluating the tactical utility of thrust vectoring.

## SUMMARY

### EXPANDED ANGLE OF ATTACK ENVELOPE

CLEARED IN ONLY 20 FLIGHTS AND 6 WEEKS

REVISED CONTROL LAWS AVAILABLE WITHIN ONE MONTH

CONTROL LAWS OPTIMIZED IN 10 FLIGHTS AND 2 WEEKS

### KEY FACTORS IN SUCCESS

EXTENSIVE SIMULATION

LESSONS LEARNED FROM OTHER PROGRAMS

SMALL INTEGRATED TEST TEAM

REAL-TIME DECISIONS ON ACCEPTABILITY OF RESULTS

IN-FLIGHT PILOT SELECTABLE CONTROL LAW OPTIONS

TIME PROVEN AIRFRAME

20 pg

323992

1995107832

N95-14246

# FLIGHT VALIDATION OF GROUND-BASED ASSESSMENT FOR CONTROL POWER REQUIREMENTS AT HIGH ANGLES OF ATTACK

57-02  
16095  
p. 20

**Marilyn E. Ogburn, Holly M. Ross, John V. Foster**  
NASA Langley Research Center  
Hampton, VA

**Joseph W. Pahle**  
NASA Dryden Flight Research Center  
Edwards, CA

**Lt. Charles A. Sternberg (USN)**  
**Capt. Ricardo Traven (CAF), James B. Lackey**  
Naval Air Warfare Center  
Patuxent River, MD

**Troy D. Abbott**  
Virginia Polytechnic Institute & State University  
Blacksburg, VA

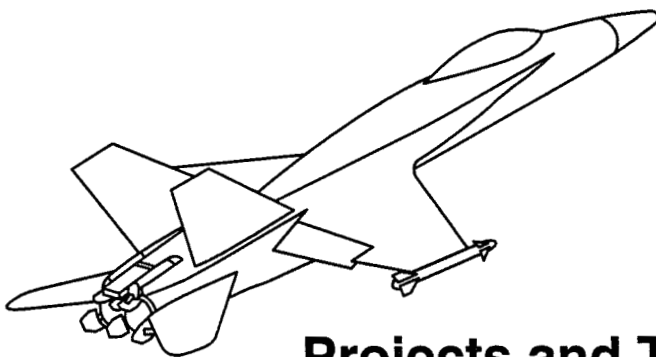

**High-Angle-of-Attack  
Projects and Technology Conference  
NASA Dryden Flight Research Center  
Edwards, CA  
July 12-14, 1994**

## OUTLINE

This paper presents a review of an ongoing NASA/U.S. Navy study to determine control power requirements at high angles of attack for the next-generation high-performance aircraft. This paper will focus on recent flight test activities using the NASA High Alpha Research Vehicle (HARV), which are intended to validate results of previous ground-based simulation studies. The purpose of this study will be discussed, and the overall program structure, approach, and objectives will be described. Results from two areas of investigation will be presented: (1) nose-down control power requirements and (2) lateral-directional control power requirements. Selected results which illustrate issues and challenges that are being addressed in the study will be discussed including test methodology, comparisons between simulation and flight, and general lessons learned.

## OUTLINE

- Introduction *Presenter: Marilyn Ogburn*
- Approach, status, and flight test objectives
- Issues for control power flight validation
- Results from nose-down requirements study
- Results from lateral-directional study *Presenter: Holly Ross*
- Concluding remarks

## USE OF CONTROL POWER DESIGN GUIDELINES FOR PRELIMINARY DESIGN

In recent years, significant advances have been made in key technologies for high performance military aircraft to meet demands for increased tactical effectiveness. These advances include novel controls for high angles of attack, reduced radar signature, improved propulsion systems, and materials. As a result, designers of the next-generation fighter aircraft are faced with new challenges in designing configurations with unprecedented levels of maneuverability throughout a greatly expanded flight envelope as well as superior cruise performance and low radar signature.

During the preliminary design stage one of the key tasks is controls integration where the goal is to provide sufficient control power to achieve the desired stability and control characteristics throughout the desired flight envelope. This is a critical element in preliminary design because increasing control power typically results in increased weight and complexity and therefore can have a major effect on the overall configuration design. For example, nose-down pitch control requirements at high angles of attack can determine the longitudinal control sizing, weight and center of gravity, structures, and hydraulic system requirements. Therefore, careful integration of controls is essential in order to achieve the design goals while maintaining a balanced and affordable design.

As illustrated in the figure, the controls integration process typically involves a series of assessments and modifications where tradeoffs are made between control power and mission performance. The designer must know the impact of changes in the available control power on mission performance in order to determine the appropriate tradeoff. Therefore, comprehensive, well-understood guidelines are required that allow an assessment of the configuration's performance.

## USE OF CONTROL POWER DESIGN GUIDELINES FOR PRELIMINARY DESIGN

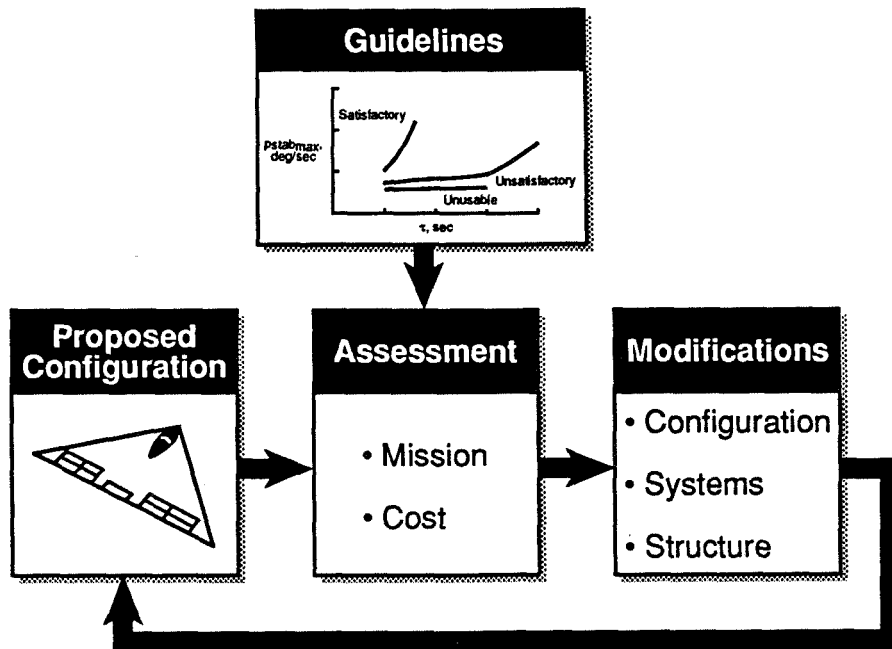

## STATUS OF CONTROL POWER DESIGN GUIDELINES

Currently, there are many well-accepted control power design guidelines for low angles of attack; however, there are few comprehensive, flight-validated guidelines for high angles of attack for either the longitudinal or lateral-directional axes. In recent years numerous studies have been undertaken to determine high-angle-of-attack control power and flying qualities requirements. These studies have provided critical handling qualities design guidance and exposed the need for further analysis of the complex, non-linear flight dynamics issues and the need for flight-validated control power design guidelines.

## STATUS OF CONTROL POWER DESIGN GUIDELINES

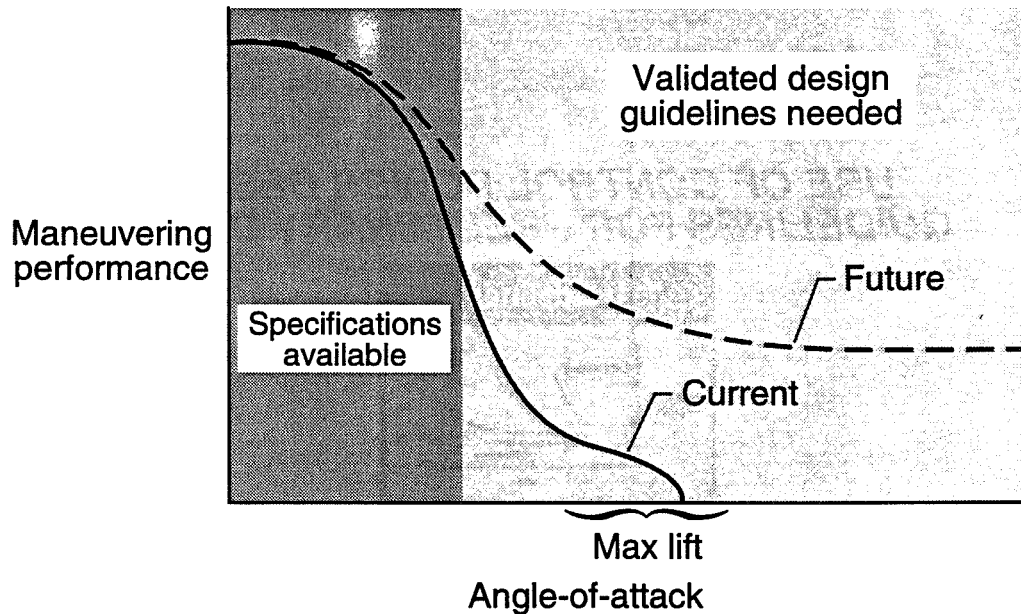

## APPROACH, STATUS, AND FLIGHT TEST OBJECTIVES

A joint NASA/U.S. Navy program has been in progress since 1990 to develop these guidelines. Throughout the program there have been extensive interactions with the U.S. Air Force and industry as well as the participation of academia (Virginia Polytechnic Institute and State University).

The general approach to this program is shown in the figure and involves extensive piloted simulation studies, the results of which are used to develop preliminary guidelines. Flight testing is then performed to validate the ground-based results. The final product of the program will be flight-validated design criteria and specifications for flight test demonstration. A variety of unique methodologies has been developed as part of this program, including those relating to the test maneuvers and ratings of the response.

The primary objectives of flight testing in this program are to: (1) validate the test methodology used during piloted simulation studies and (2) validate the quantitative simulation results and refine the design guidelines. Careful attention must be paid in the flight tests to ensure that the maneuvers and rating process utilized for ground-based simulation are appropriate for the flight evaluation and produce accurate evaluations of the desired response characteristics. In addition, flight testing provides additional insight into the design issues.

A comprehensive evaluation of nose-down pitch control requirements is nearly complete and has included piloted simulation testing and flight validation. Starting in October 1991, over 110 nose-down maneuvers have been tested using the NASA F-18 HARV and a U.S. Navy F-18. An assessment of lateral-directional control power requirements for tactical maneuvering is currently in progress. To date, a comprehensive database from piloted simulation has been generated and preliminary flight validation has been initiated involving 17 maneuvers using the NASA F-18 HARV.

### APPROACH

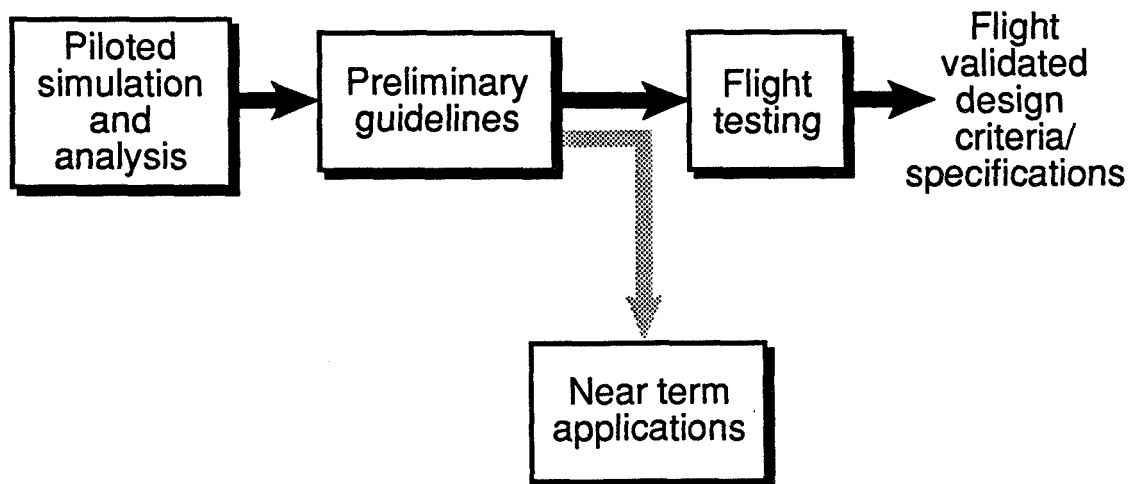

## ISSUES FOR CONTROL POWER FLIGHT VALIDATION

In the process of developing preliminary control power design guidelines and evaluating them in flight tests, numerous issues have been addressed that will be illustrated in this paper using results from the simulation studies and flight tests. The general issues include maneuver selection, performance of the maneuvers in flight, and quantification of the pilot's opinion of the maneuver response.

The selection of maneuvers which isolate the response characteristics of interest was considered to be a critical element in this study. Several factors were taken into account in the maneuver selection process, including: (1) the definition of the mission, including whether the primary design issue is related to the safety of flight and/or tactical (offensive and/or defensive) applications, and the relevance of open-loop maneuvers (i.e. does not involve a capture of final conditions) versus closed-loop tasks, (2) the minimum set of critical flight conditions sufficient to define guidelines that are applicable to the entire high-angle-of-attack flight envelope, and (3) the maneuver attributes required to generate figures of merit from which guidelines can be easily developed. Issues were also addressed that were of particular concern for the successful performance and evaluation of the flight test maneuvers. These issues included: (1) testability (i.e. overall ease of performing a maneuver), (2) achievement of initial conditions, (3) maneuver performance criteria, (4) parametric variations of aircraft response, and (5) the evaluation of motion effects. Finally, an appropriate rating methodology was required that was easy to use and provided a comprehensive assessment of the pilot's opinion of control power requirements. Selected results from the nose-down and lateral-directional control power evaluations will be used to illustrate these issues.

## ***ISSUES FOR CONTROL POWER FLIGHT VALIDATION***

- Selection of maneuvers
- Performance of maneuvers in flight
- Rating methodology

## MANEUVERS FOR ISOLATION OF CONTROL POWER CHARACTERISTICS

One of the challenges associated with the establishment of control power design criteria is the development of evaluation maneuvers which isolate the characteristics of interest at critical flight conditions, are simple to execute, and minimize extraneous effects that could complicate the analysis of the results. The maneuver used in the evaluation of the requirements for nose-down pitch control power which was found to be the most relevant for isolating the pitching moment coefficient characteristics was a pushover from stabilized, unaccelerated, trimmed, wings-level flight at high angles of attack. Performing the maneuver at these conditions minimizes dynamic and kinematic effects, as well as thrust and performance effects, so that the changes in angle of attack are due almost solely to the nose-down moment generated by the application of nose-down controls. The results of the simulation study were derived from the pilots' comments and a statistical analysis of the correlation between the numerical ratings and response characteristics. These results indicated that although several figures of merit are considered by a pilot during a recovery from high angles of attack, the recovery is judged primarily by the short-term response characteristics and that one of the key figures of merit was the initial pitch acceleration ( $\dot{q}$ ) as an immediate indication of control moment capability. For the establishment of pitch control power design criteria, it is clear that, in the absence of significant angular rates, pitch acceleration bears a strong relationship to pitch control power because it is directly proportional to static pitching moment coefficient ( $C_m$ ). The results of the simulation study showed that the maximum pitch acceleration obtained within one second of the initiation of the forward stick command correlated very closely with pilot rating. These simulation results were used to develop a preliminary set of design guidelines which are shown in the figure and are being evaluated in flight tests.

Results from the HARV tests versus pilot rating are shown in the figure for two types of maneuvers performed with parametric variations of the nose-down control power capability: (1) pushovers and (2) recoveries to a low angle of attack from zoom climb (high pitch attitude, low airspeed) conditions. The zoom climb maneuver usually results in an initial increase in angle of attack following the nose-down command which is due to a decrease in the flight path angle which occurs at these conditions; therefore, the pitch response is not as directly associated with pitch control power as the pushover maneuver. However, the use of this maneuver allows the opportunity to determine whether the pilot's opinion is based on the short-term response in recoveries from high pitch attitude, low airspeed conditions. The figure shows that the flight results for both maneuvers agree well with the simulation study results, confirming the importance of the short-term pitch response as the primary figure of merit for the pilot's opinion.

## MANEUVERS FOR ISOLATION OF CONTROL POWER CHARACTERISTICS

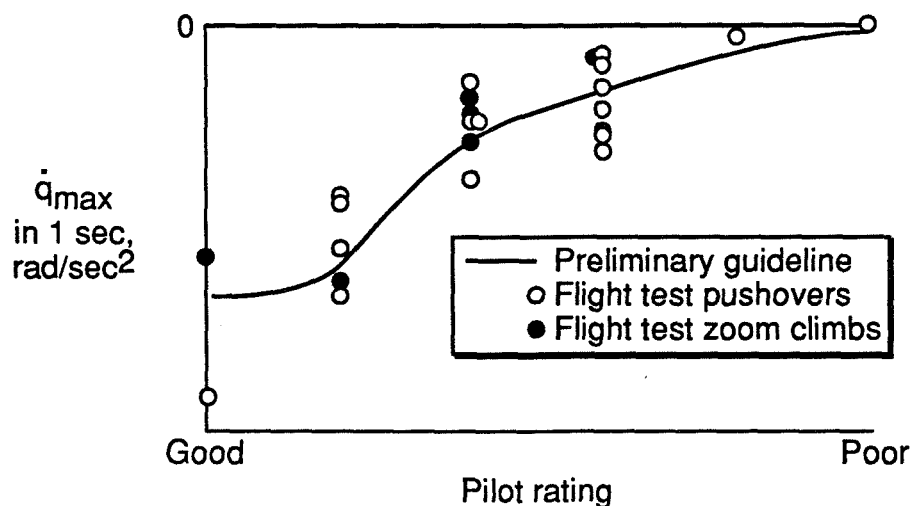



## FIGURE OF MERIT CONSIDERATIONS

An important issue regarding the analysis of flight and simulation results for the evaluation of candidate control power design criteria is the establishment of figures of merit to be used in evaluating the aircraft response characteristics. In order to accurately determine the characteristics the pilot uses to judge the aircraft response, as many potential figures of merit as possible should be considered. They can be compared by characterizing them according to the strength of their relationship to the parameter under design and an appropriate time scale. Although for some control power design considerations the short-term figures of merit are more closely associated with the aircraft control moment characteristics, longer term figures of merit should also be considered in case they are a primary influence on the pilot's opinion. For example, the time to recover the aircraft is a long-term figure of merit that has been evaluated for its impact on the pilot's opinion of nose-down pitch response during recoveries from high angles of attack to the recovery angle of attack of 10 degrees.

The figure shows the HARV flight test results for the time to recover ( $t_{rec}$ ) versus pilot rating for the same pushover and zoom climb maneuvers shown in the previous figure. The previous figure showed the short-term figure of merit,  $\dot{q}_{max}$  in 1 sec. This figure shows a long-term figure of merit, time to recover to 10 degrees angle of attack. The figure shows that, although there is some association between the time to recover and the rating, the correlation is not nearly as close as it is for the short-term pitch acceleration figure of merit. In particular, for the maneuvers that were judged to have poorer responses, the range of recovery times was quite large. This range of values would not be accounted for by considering the angle of attack at which the nose-down command was initiated. Note that the zoom climb maneuver was useful for generating longer recoveries for the purpose of evaluating this figure of merit. These results thus provide additional evidence that for nose-down pitch control power, the long-term response has only a secondary effect on the pilot's opinion.

## FIGURE OF MERIT CONSIDERATIONS Long-Term Figure of Merit

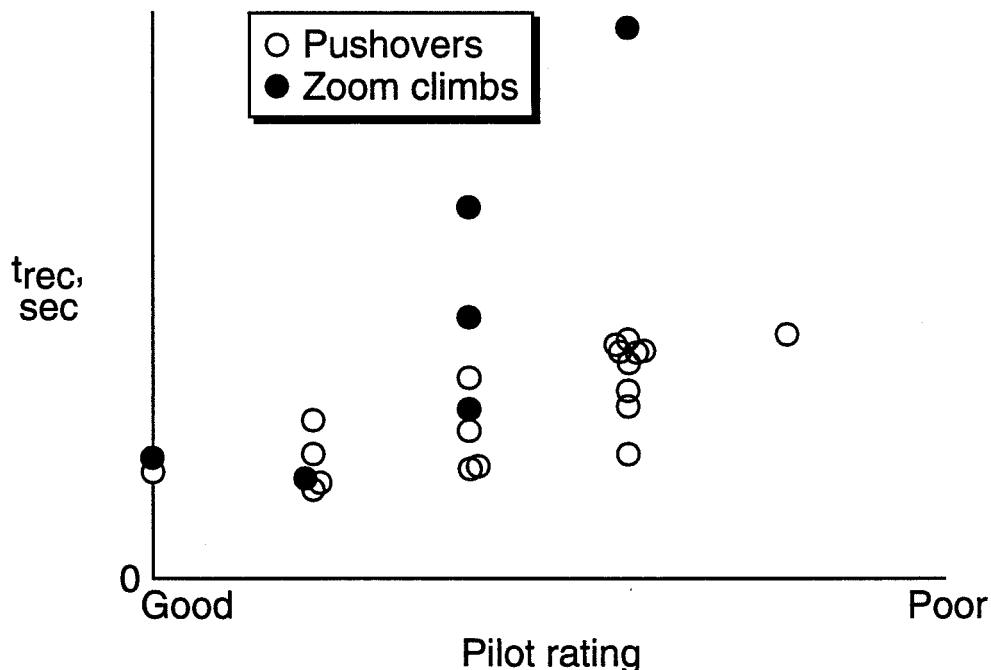

## INFORMATION REQUIRED TO MINIMIZE WORKLOAD TO STABILIZE AT HIGH ANGLES OF ATTACK

A lesson learned from the flight tests performed in an early phase of the nose-down pitch control flight program was that there is a way to minimize the workload required for the pilot to stabilize the airplane at an unaccelerated, trimmed condition at high angles of attack. For some of these flights, a specific target pitch attitude angle of 15 degrees was used to match the primary value used in the simulation study. In the simulation study, the initial conditions for the maneuvers, including the required throttle settings, were calculated and pre-set by the computer so that the pilot only needed to perform the maneuver itself. The figure shows the general trend of the pitch attitude values that correspond to the trimmed conditions ( $\theta_{trim}$ ) for a range of angle of attack ( $\alpha$ ) and throttle settings such that there are no net forces or moments acting on the airplane. The method used in some of the early flight tests for achieving these initial conditions required that the pilot vary the thrust to stabilize at the pitch attitude of 15 degrees. During the flights, it was found that establishing the required test conditions for angle of attack and pitch attitude using this method was very difficult because the pilot had to "close the loop" on trim airspeed with the throttles to stabilize the flight path angle. The pilot workload required to accomplish this task had a tendency to distract the pilot's attention from the initial portion of the maneuver and may have affected his ratings. For most of the flight test maneuvers flown on the HARV, the throttle setting and initial angle of attack were specified, and initial pitch attitude values for trimmed conditions which were based on the simulation math model were provided in order to minimize this workload.

## INFORMATION REQUIRED TO MINIMIZE WORKLOAD TO STABILIZE AT HIGH ANGLES OF ATTACK

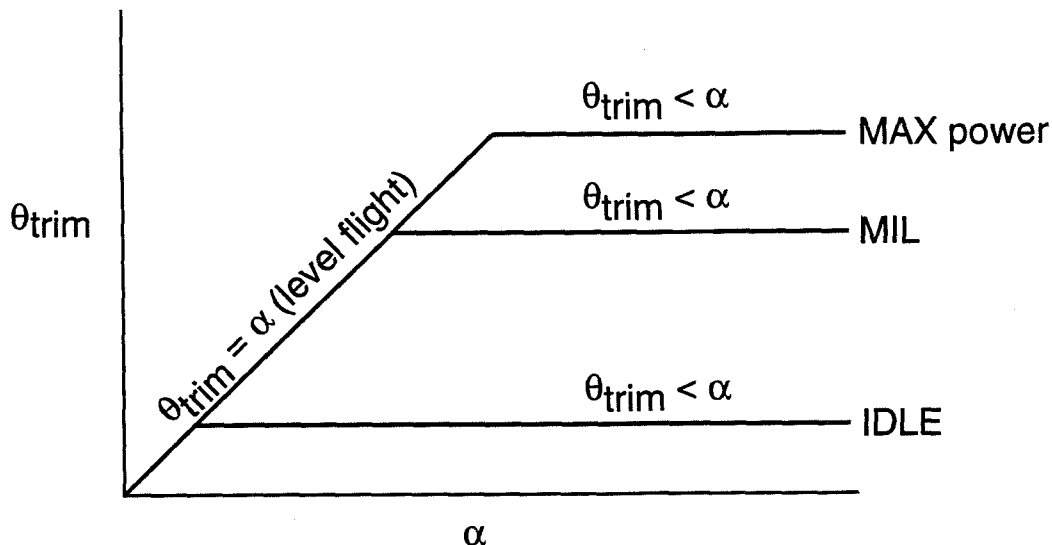

## PARAMETRIC VARIATIONS OF RESPONSE CHARACTERISTICS

One of the objectives of the flight tests has been to validate the nose-down pitch control design guideline values that were derived from a simulation study that involved parametric variations of the nose-down response. Various methods can be used in flight tests to vary the airplane motions in response to pilot inputs. The initial conditions of the maneuver, including angle of attack, angular orientation, dynamic pressure, power setting (particularly in conjunction with a thrust vectoring system), and center of gravity position, in addition to the magnitude of the pilot's input can all be used to vary the response. Some of these methods offer more flexibility for specifying the response than others such that the desired range of response can be achieved, and any nonlinear motions which can complicate the assessment of the response are minimized.

The HARV is uniquely suited for the flight investigation of control power requirements because of the wide range of nose-down pitch response available through the use of its thrust-vectoring system combined with the normal aerodynamic tail control. A research flight control system has been integrated into the basic F-18 flight control system for research testing. The vehicle can, in effect, be used as a variable stability airplane by taking advantage of the capability to vary parametrically and systematically control law features within the research flight control system. By varying certain control law values, the pitch response magnitude and shaping were specified to provide pitch acceleration responses that varied over a much wider range of magnitude than those of earlier flight tests performed on an F-18 without a thrust vectoring system. Time histories which show the range of response that was achieved in flight with the application of a full nose-down command ( $\delta_{stk}$ ) and the variation of several parameters, including control law values, are shown in the figure. A specific code number was designated for each set of control law values, which were programmed in the research flight control system and engaged by the pilot's selection of the code in the cockpit; however, the pilot did not know the corresponding control law values. The use of codes minimized the possibility that the pilot had pre-conceived expectations of the pitch responses and there was no particular ordering of the maneuvers with respect to the level of response. These tests were therefore more "blind" than those performed without the use of the coded control law variations.

## PARAMETRIC VARIATIONS OF RESPONSE CHARACTERISTICS

### Parameters that Affect Longitudinal response

- Initial conditions
  - Angle of attack
  - Pitch attitude
  - Dynamic pressure
  - Center of gravity location
- Power effects
  - Throttle setting
  - Thrust vectoring
- Magnitude of pilot input
- Control laws

### Range of Response Achieved in Flight

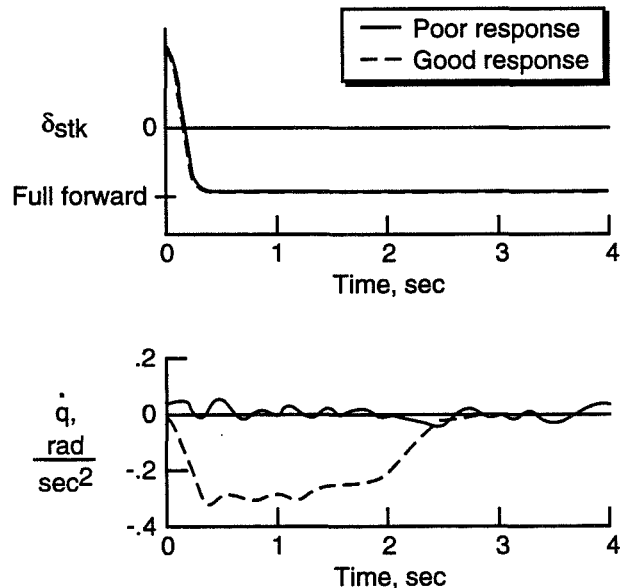

## EFFECT OF MOTION ON PREFERRED PITCH RESPONSE CHARACTERISTICS

Some useful information was obtained from the pilot comments and flight data regarding the effect of motion cues in flight which were not available in the simulation studies. Two noteworthy motion characteristics were experienced in some of the pushover maneuvers that were performed to evaluate the nose-down pitch response. The first characteristic that was sometimes experienced was that the pilot felt the nose of the airplane might "tuck under" through the vertical before the airplane could be completely recovered, although this never occurred. This feeling was experienced only in maneuvers that had a good nose-down response and were initiated at relatively low pitch attitudes and/or high initial angles of attack. The second motion characteristic related to the desired response shaping following the initial peak pitch acceleration, and is illustrated in the figure. In the simulation study, which involved parametric variations of static pitching moment coefficient, continuously increasing pitch rate ( $q$ ) was provided for the entire recovery which approximated a pitch acceleration command system. During this study, the pilots stated that this type of response was highly desirable as it made the response predictable and simplified the rating decision. In flight, however, for the better, more tactically desirable responses, a rapid increase in pitch rate to a constant high value (i.e. a pitch rate command system) was preferred over a continuously increasing pitch rate. This preference was not revealed in the simulation study due to the lack of good cues at high angular rates. For those cases with poor initial response, however, in the simulation study and in flight, a continued pitch rate increase was considered to be more appropriate to give the pilot increasing confidence that the aircraft would recover.

## EFFECT OF MOTION ON PREFERRED PITCH RESPONSE

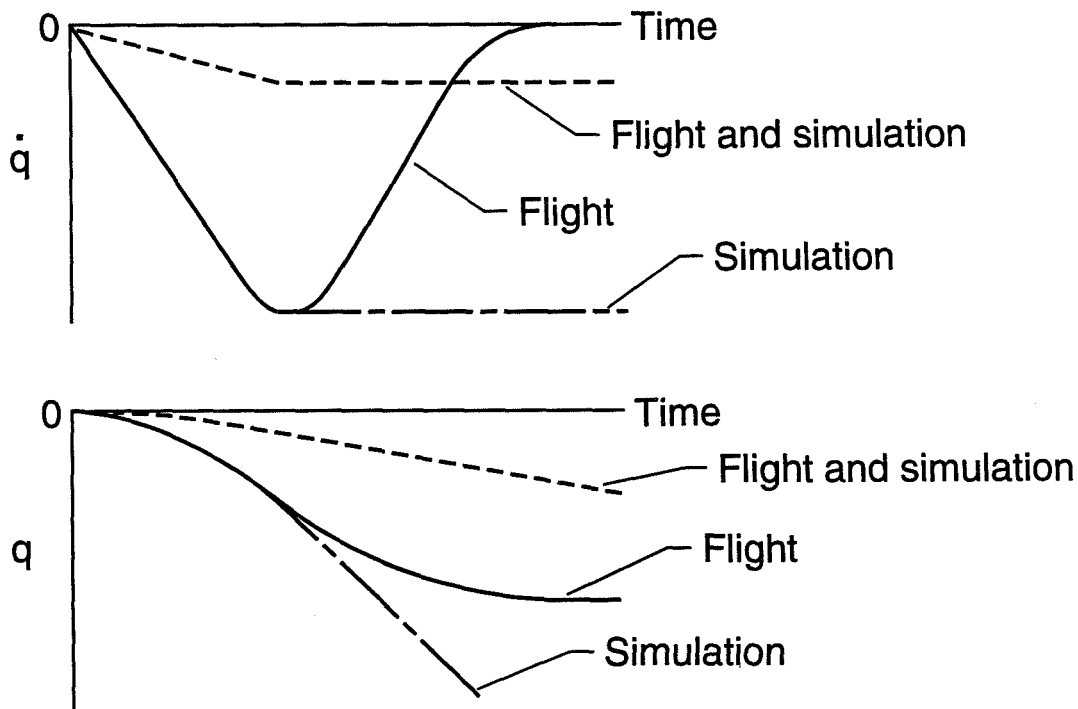

## FLIGHT TEST MANEUVER DEVELOPMENT

Flight test maneuvers must be developed properly in order to ensure that the flight validation is done in an efficient manner and that the maneuvers are easy to perform. In a ground-based simulator, conditions can be set up that may not be easily achieved in flight. The success of the flight validation suffers if the maneuvers are more difficult to perform and are therefore not repeatable. The maneuvers must involve pilot techniques that are simple enough to be successfully repeated many times by one or more pilots so that individual maneuver attempts and pilot techniques do not significantly affect the aircraft response. The initial conditions must also be easily achieved so that valuable flight time is not wasted in setting up the maneuvers. These attributes also improve the agreement between ground-based simulation and flight results.

In the lateral-directional control power study, much effort was devoted to maneuver development. Because flight test validation was planned, one of the maneuver requirements was that the maneuvers should be easy to perform in flight. Maneuvers that did not meet that requirement were modified. Piloted ground-based simulation was used very successfully for this maneuver development. The maneuvers that were developed were a lateral gross acquisition, an offensive loaded reversal, and a defensive roll. These maneuvers involved well defined pilot technique that was easy to repeat.

Results from the HARV flights indicated that the maneuvers developed in the simulator could be used to efficiently perform the tests and that they were repeatable in flight. The pilots stated that they were able to perform the maneuvers in flight just as they had in the simulator with very few modifications. Any needed adjustments to the maneuvers in flight were easily performed because the pilots were so familiar with the timing of the maneuvers from their experience in the simulator.

## ***FLIGHT TEST MANEUVER DEVELOPMENT***

### **Challenge:**

- Develop maneuvers that can be easily and efficiently tested in flight

### **Issues:**

- Pilot technique well defined and repeatable
- Initial conditions easily achieved in flight

### **Results:**

- Piloted simulation very valuable for maneuver development and training
- Maneuvers easily executed and repeated in flight

## USE OF TARGETS

The maneuvers developed in the lateral-directional study were intended to be tactically relevant and thus required the use of a target. For each maneuver, the task of the target aircraft was carefully developed using piloted ground-based simulation. These tasks were designed so that they would be easily executed in flight tests. Target aircraft in flight tests must be used efficiently so that flight time is not wasted. To do this, the target must have a well-defined task and initial conditions for the maneuver that are easily achieved. The target's task must also be repeatable so that its motion is consistent for multiple test points.

The three maneuvers developed in the simulation study were the lateral gross acquisition, offensive loaded reversal, and defensive roll. In the lateral gross acquisition maneuver, which was originally developed by McDonnell Douglas Aerospace (MDA), the target flies ahead of and slightly above the test aircraft. The target then enters a constant speed descending turn. This maneuver was easy to perform in flight and produced a repeatable target for the test aircraft to follow. For the offensive loaded reversal, the target begins co-altitude with the test aircraft and maintains straight and level flight throughout the maneuver, thus this target task is very easy and very repeatable. In the defensive roll, the test aircraft is in a defensive position initially, so the task of the chase aircraft is to be an offensive threat and is positioned at the test aircraft's 4 or 8 o'clock position with 50-100 knots of closure speed. The test aircraft performs the defensive roll and the threat aircraft zoom climbs in an attempt to remain offensive. The maneuver is complete when the test aircraft's pilot regains situational awareness after performing the roll. The role of the attacking aircraft is merely to pose a threat and to provide relative positioning cues.

The results from the HARV flights showed that these tasks were simple and effective for assessing the lateral-directional response and were therefore useful and efficient flight test tasks. No significant changes needed to be made to the tasks during the flight tests. The pilot comments indicated that the initial conditions were easy to achieve and repeatable, resulting in the efficient use of flight time. The target provided the test aircraft with a repeatable task that could be used to consistently judge the roll performance of the aircraft in terms of its mission effectiveness.

## USE OF TARGETS

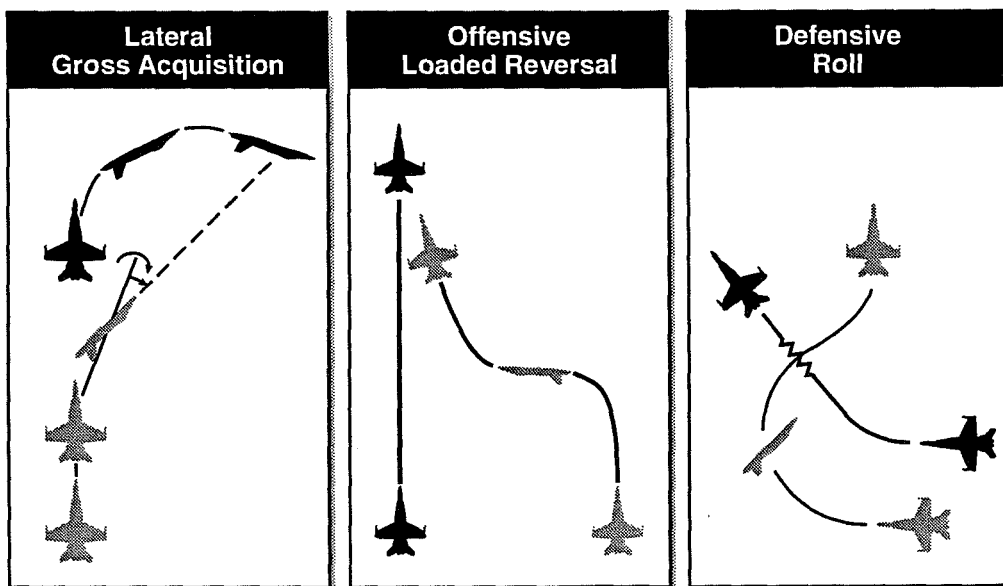

## RATING METHODOLOGY

The rating methodology developed for any control power study must be able to properly isolate and evaluate the particular response characteristics of interest. If the proper rating methodology is not used, critical information can be lost or overlooked. For the lateral-directional control power study, the level of roll performance was the primary focus of the pilots' assessments. In order to effectively isolate and evaluate the roll performance, two distinct maneuver phases were defined; open-loop maneuvering and closed-loop handling qualities. The open-loop maneuvering phase was defined as the part of the maneuver during which the pilot holds a nearly full lateral stick input and is therefore commanding a large amplitude change in the aircraft's position or attitude. During this phase the pilot judges characteristics such as roll acceleration, peak roll rate, roll mode time constant, and the time to roll, all of which are characteristics that describe the roll performance. This open-loop phase continues until the pilot takes out the lateral stick input and begins to perform a closed-loop target capture. Once the pilot is in the loop, he is performing a more precise, smaller-amplitude task, and evaluates the handling qualities of the configuration.

Pilot comments indicated there was no difficulty in separating the roll performance from the handling qualities, so this rating approach was used very successfully during the development of the simulation data base. The pilots used this same method during the flight tests and commented that the use of this approach was equally successful in flight and that no changes would be needed for further flight validation.

## RATING METHODOLOGY

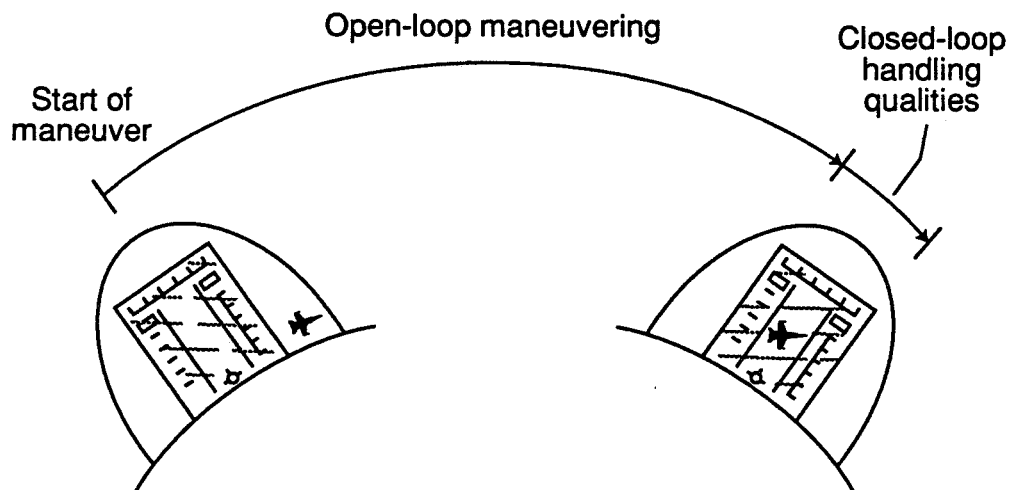

## ROLL PERFORMANCE CLASSIFICATION

A unique rating approach was developed for the purposes of the lateral-directional study to separately evaluate the open-loop and closed-loop portions of the evaluation maneuvers. The roll performance classification (RPC) scale was developed during the ground-based simulation study and has been used to rate the open-loop roll performance based on the perceived mission effectiveness of the configuration. For maneuvers that involve a target capture, the Cooper-Harper scale has also been used to evaluate only the closed-loop handling qualities. The RPC scale has four different categories of roll performance based on mission effectiveness, and the pilot chooses the category that best agrees with his comments about the roll performance. The determination of mission effectiveness is left to the pilot's judgment based on his background and experience. This scale is a simple rating tool that has been easy for the pilots to use. By separately rating the open- and closed-loop characteristics, a good understanding of the overall lateral-directional characteristics was obtained as well as insight into the trade-offs that occur between roll performance and handling qualities.

The RPC scale was used very successfully during the development of the ground-based simulation data base, and the pilot comments from the flight tests indicated that no problems arose from using the RPC scale in flight. Pilot comments also indicated that the RPC scale was useful for evaluating the roll performance in terms of mission suitability and that the Cooper-Harper scale was easily used for separately evaluating the handling qualities. RPC ratings given during the flights were consistent between the pilots and correlated well with their comments.

## ROLL PERFORMANCE CLASSIFICATION

Roll Performance for Mission Effectiveness	Improvements in Roll Performance	Numerical
Enhancing - Tactically superior	None warranted	1
Satisfactory - Mission requirements met	May be warranted, but not required	2
Unsatisfactory - Mission requirements not met	Required	3
Unacceptable- Tactically useless	Mandatory	4



## CLOSED-LOOP HANDLING QUALITIES CRITERIA

Criteria for evaluation of the closed-loop handling qualities were defined that were representative of realistic tactical situations, easy for the pilot to judge if they were met, and could be used consistently in both simulation and flight for maneuvers that involved a target capture. For this study the pilots used the Cooper-Harper scale to rate the closed-loop handling qualities during the target capture portion of the maneuver. Because this study focused on the lateral-directional characteristics, the longitudinal capture was not evaluated. Vertical acquisition bars spaced 80 mils apart were used on the heads up display (HUD) instead of the standard reticle so that the longitudinal position of the target at capture was not a factor. Thus, the pilot's workload was only in the lateral-directional axes. This method had previously been used successfully in a MDA handling qualities study.

According to the criteria set early in the study, one overshoot of the target beyond the vertical bars was judged to constitute adequate capture performance when using the Cooper-Harper scale. Early simulation results showed that for certain combinations of steady-state roll rate and roll mode time constant, a large amplitude overshoot would occur. The pilot comments indicated that even though they were able to complete a successful capture after the initial large overshoot, they did not believe that the capture dynamics were adequate. Therefore, a second, wider set of vertical bars 160 mils apart was added to the HUD, and the capture criteria were modified so that an overshoot larger than the 160 mil outer bars was no longer considered to be adequate. The capture was only considered to be adequate if there were no overshoots outside of the 160 mil bars. The pilots felt that this method gave a more accurate assessment of the capture dynamics and that it was easy to use.

For the flight tests, the vertical bars were programmed on the HARV HUD. According to the pilot comments, the use of the double vertical bars worked as well in flight as they did in the simulator, and no changes were deemed necessary in order to use the bars in further flight evaluations. The pilots also stated that the bars were easy to use in flight and were much more useful for determining a lateral capture than a reticle alone. The 160 mil bars enabled the accurate evaluation of the magnitude of the overshoots. The pilots commented that using the double bars allowed them to more accurately assess the handling qualities of the airplane.

## CLOSED-LOOP HANDLING QUALITIES CRITERIA

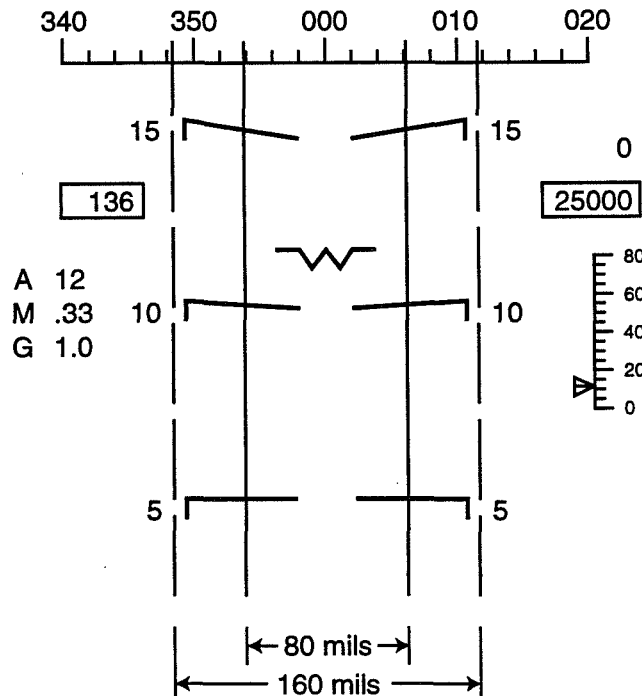

## EFFECT OF MOTION ON ASSESSMENT OF LATERAL-DIRECTIONAL RESPONSE

As has been previously stated, the effects of motion can cause discrepancies between ground-based simulation results and flight results. For maneuvers that produce high rates and accelerations or highly dynamic maneuvers, motion cues in flight may significantly influence the pilot's evaluation of the maneuver.

The maneuvers that have been used in the lateral-directional control power study involve high-angle-of-attack rolls about the velocity vector, and it was not known if motion cues would affect the evaluation of this type of unconventional maneuver. One of the purposes of the flight tests was to validate the test methodology, a part of which involved the investigation of the effects of motion on the pilot comments and ratings. The dynamic model that was used during the ground-based simulation provided a generic first-order response in the lateral-directional axes. Parametric changes in the steady-state roll rate and roll mode time constant were made to vary the response characteristics. The ratings for each flight maneuver were compared to the ratings given in the simulator for a response with the same steady-state roll rate and roll mode time constant as the flight data point. The figure shows the comparison of RPC ratings from the simulation and flight tests for the lateral gross acquisition maneuver at 30 degrees angle of attack with the research flight control system (RFCS) off and on and at 45 degrees angle of attack with RFCS on. The simulation and flight test data correlated well indicating that the motion cues present in flight did not have a significant influence on the pilots evaluation of the roll performance.

The pilot comments indicated that the motion effects in flight were not significant and that the maneuvers in flight felt just like they did in the simulator. Prior to the flight tests, the pilots had flown the maneuvers in the simulator repeatedly and had become acclimated to the high-angle-of-attack visual "coning" effect. Apparently, during these maneuvers, the rates and accelerations in flight were low enough that the visual cues were more dominant than the motion cues. Thus, the motion was not disorienting to the pilots and had very little impact on their ratings and comments.

## EFFECT OF MOTION ON ASSESSMENT OF LATERAL-DIRECTIONAL RESPONSE

### Lateral Gross Acquisition

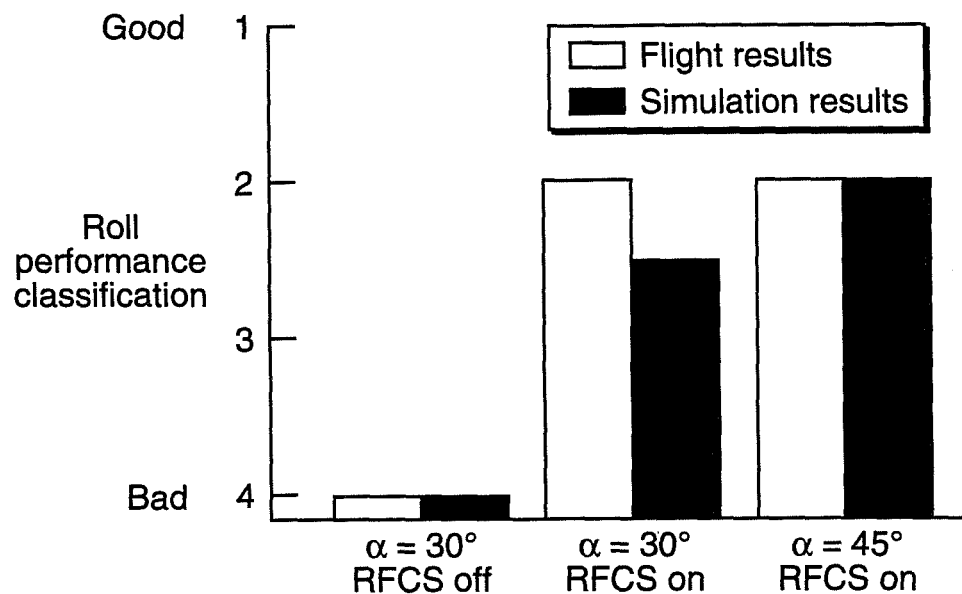

## CONCLUDING REMARKS

The results of flight tests are being used to validate test methodology and design guidelines for control power requirements at high angles of attack that were derived from the results of simulation studies. Several issues and challenges were addressed in order to successfully develop the guidelines and perform the flight test evaluations. Careful attention was paid to the development of appropriate maneuvers for isolating the aircraft response characteristics that are the most relevant to control power design. A variety of figures of merit have been examined in order to determine which characteristics had the greatest influence on the pilot opinion of the response. Numerical rating methodologies were developed and validated in flight in order to quantify the pilot opinion of the response and enable statistical correlation of his opinion with candidate figures of merit. Experience from previous flight tests and simulation was beneficial for assuring the success of setting up and performing the evaluation maneuvers in flight. Several methods were used in flight to achieve parametric variations of the aircraft response in a systematic way. Some motion effects were encountered in flight which resulted in minor differences in pilot opinion of the response from those of the simulation study.

Additional work remains to be done in order to complete the development of these high-angle-of-attack control power requirement studies for high angles of attack. Analysis of the existing flight and simulation data will continue so that the validation and refinement of the numerical design guideline values can be completed. Control power requirements based on the results of these studies will be proposed for future revised military specifications for flying qualities.

## CONCLUDING REMARKS

- Flight validation of simulation-derived control power guidelines in progress
  - Guideline development issues addressed concerning development of evaluation maneuvers, figures of merit, and rating methodologies
  - Flight test challenges addressed, including maneuver set-up/performance, parametric variations of response, and evaluation of motion effects
- Post-flight test activities planned
  - Continue analysis of flight and simulation data
  - Complete validation/refinement of numerical guideline values
  - Propose requirements for future flying qualities MIL SPEC revisions

## NASA/NAVY CONTROL POWER PUBLICATIONS AND PRESENTATIONS

### Nose-Down Pitch Control (HANG) Publications:

1. Nguyen, Luat T.; and Foster, John V.: Development of a Preliminary High-Angle-of-Attack Nose-Down Pitch Control Requirement for High-Performance Aircraft. NASA TM 101684, February 1990.
2. Ogburn, Marilyn E.; et. al.: High-Angle-of-Attack Nose-Down Pitch Control Requirements for Relaxed Static Stability Combat Aircraft. NASA High-Angle-of-Attack Technology Conference, NASA Langley Research Center, Hampton, VA, October 30-November 1, 1990. NASA CP-3149, 1992, Volume I, Part 2, Paper No. 24.
3. Ogburn, Marilyn E.; Foster, John V.; and Hoffler, Keith D.: Use of Piloted Simulation for High-Angle-of-Attack Agility Research and Design Criteria Development. AIAA Flight Simulation Technologies Conference, New Orleans, LA, August 12-14, 1991. AIAA Paper No. 91-2954.
4. Ogburn, Marilyn E.; Foster, John V.; and Hoffler, Keith D.: Application of Piloted Simulation to High-Angle-of-Attack Flight-Dynamics Research for Fighter Aircraft. AGARD Symposium on Piloted Simulation Effectiveness, Brussels, Belgium, October 14-17, 1991. AGARD-CP-513, Paper No. 29.
5. Ogburn, Marilyn E.; et. al.: Status of the Development of High-Angle-of-Attack Control Margin Requirements. NASA High-Angle-of-Attack Projects and Technology Conference, NASA Dryden Flight Research Facility, Edwards, CA, April 21-23, 1992. NASA CP-3137, Volume 2, pp. 99-147.
6. Hadfield, Christopher A. (Capt., CAF): High Angle of Attack Handling Qualities Rating Scales. Thesis presented for the Master of Science degree from the University of Tennessee, Knoxville, TN, May 1992.
7. McNamara, W. G.; et. al.: Navy High Angle of Attack Pitch Control Margin Requirements for Class IV Aircraft. NAVAIRWARCENACDIV Technical Memorandum 91-167 SA, June 25, 1992.
8. Lackey, J.; et. al.: Flight Test Validation of Navy High-Angle-of-Attack Pitch Control Margin Requirements for Class IV Aircraft. NAVAIRWARCENACDIV Technical Memorandum 92-2 SA, July 27, 1992.
9. Lackey, James B.; and Hadfield, Christopher A. (Capt., CAF): Pitch Control Margin at High Angle of Attack - Quantitative Requirements (Flight Test Correlation with Simulation Predictions). AIAA Flight Test Conference, Hilton Head, SC, August 24-26, 1992. AIAA Paper No. 92-4107.
10. Ogburn, Marilyn E.; and Foster, John V.: Development of High-Angle-of-Attack Nose-Down Pitch Control Margin Design Guidelines for Combat Aircraft. NASA LaRC Workshop on Guidance, Navigation, Controls, and Dynamics for Atmospheric Flight, NASA Langley Research Center, Hampton, VA, March 18-19, 1993. NASA CP-10127, December 1993, pp. 293-322.
11. Lackey, J.; and Prater, D. (Lt., USN): Limited Navy Flying Qualities and Performance Evaluation of the NASA F/A-18 HARV. NAWC-AD Technical Memorandum 93-11 SA, June 21, 1993.
12. Ogburn, Marilyn E.; et. al.: Status of the Validation of High-Angle-of-Attack Nose-Down Pitch Control Margin Design Guidelines. AIAA Atmospheric Flight Mechanics Conference, Monterey, CA, August 9-11, 1993. AIAA Paper No. 93-3623.

**Lateral-Directional Control (HAIRRY) Publications:**

1. Foster, John V.; Ross, Holly M.; and Ashley, Patrick A.: Investigation of High-Alpha Lateral-Directional Control Power Requirements for High-Performance Aircraft. AIAA Atmospheric Flight Mechanics Conference, Monterey, CA, August 9-11, 1993. AIAA Paper No. 93-3647.

**Presentations:**

1. "High-Alpha Nose-Down Pitch Control Requirements Study". Program review presented at NASA-Langley Research Center, Hampton, VA, December 13, 1989.
2. "High Angle-of-Attack Nose-Down Guidelines (HANG)". Program review presented at NASA-Langley Research Center, Hampton, VA, April 11, 1990.
3. "NASA/Navy High-Alpha Nose-Down Control Margin Requirements". Program review presented at the Naval Air Warfare Center, Patuxent River, MD, July 25, 1990.
4. McNamara, William G.: Pitch Control Margin Guidelines for RSS Tactical Jet Aircraft. Presented at the Society of Flight Test Engineers 22nd Annual Symposium, August 5-9, 1991.
5. "High-Alpha Nose-Down Pitch Control Requirements Study". Program review presented at the Naval Air Systems Command, Washington, DC, March 12, 1992.
6. "HANG: High-Angle-of-Attack Nose-Down Pitch Control Requirements Study". Program review presented at the Naval Air Warfare Center, Patuxent River, MD, April 27, 1993.
7. "HAIRRY: High Angle-of-Attack Investigation of Requirements for Roll and Yaw". Program review presented at the Naval Air Warfare Center, Patuxent River, MD, April 27, 1993.

14 pg

199507833

N95-14247

323994

## High Angle of Attack Flying Qualities Criteria for Longitudinal Rate Command Systems

David J. Wilson and Kevin D. Citurs  
McDonnell Douglas Aerospace  
McDonnell Douglas Corporation

John B. Davidson  
Dynamics and Control Branch  
NASA Langley Research Center

58-02  
16096  
8-14

### Abstract

This study was designed to investigate flying qualities requirements of alternate pitch command systems for fighter aircraft at high angle of attack. Flying qualities design guidelines have already been developed for angle of attack command systems at 30°, 45°, and 60° angle of attack, so this research fills a similar need for rate command systems. Flying qualities tasks that require post-stall maneuvering were tested during piloted simulations in the McDonnell Douglas Aerospace Manned Air Combat Simulation facility. A generic fighter aircraft model was used to test angle of attack rate and pitch rate command systems for longitudinal gross acquisition and tracking tasks at high angle of attack. A wide range of longitudinal dynamic variations were tested at 30°, 45°, and 60° angle of attack. Pilot comments, Cooper-Harper ratings, and pilot induced oscillation ratings were taken from five pilots from NASA, USN, CAF, and McDonnell Douglas Aerospace. This data was used to form longitudinal design guidelines for rate command systems at high angle of attack. These criteria provide control law design guidance for fighter aircraft at high angle of attack low speed flight conditions. Additional time history analyses were conducted using the longitudinal gross acquisition data to look at potential agility measures of merit and correlate agility usage to flying qualities boundaries. This paper presents an overview of this research. Complete documentation will be available in late 1994 through the NASA Contractor Report entitled "Flying Qualities Criteria for Longitudinal Rate Command Systems at High Angle of Attack."

### High Angle of Attack Flying Qualities Criteria for Longitudinal Rate Command Systems

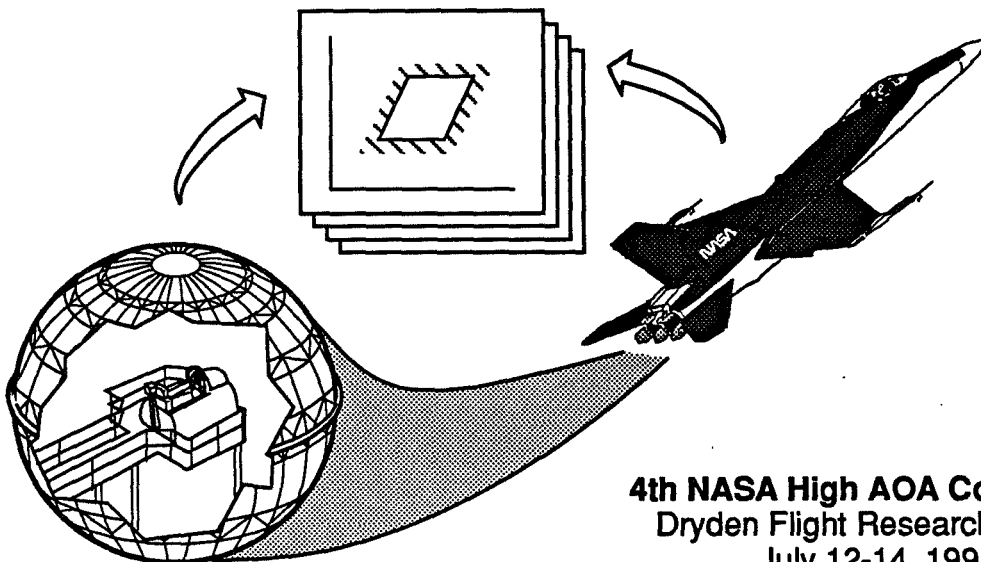

4th NASA High AOA Conference  
Dryden Flight Research Center  
July 12-14, 1994

## Acknowledgements

This research was supported by the NASA Langley Research Center, Dynamics and Control Branch, Aircraft Dynamics and Control Division under the Aircraft and Spacecraft Guidance and Control Task Order Contract, number NAS1-18763. We would like to thank the pilots who enthusiastically participated in this research. We received excellent cooperation and support from these pilots: Mr. Philip Brown and Mr. Mike Phillips of NASA Langley; Lt. Hal Murdock of the USN; Capt. Rick Traven of the CAF; and MDA engineering pilot Mr. James Buckley. A great deal of credit also goes to Mr. Don Fogarty, Mr. Stuart Alsop, and the MDA simulation support staff for assisting with the simulations. Finally, thank you to Mr. Joe Boland and Mr. Greg Compton for their technical assistance during this research.

## Introduction

NASA Langley Research Center sponsored the development of flying qualities design guidelines for longitudinal rate command systems at high AOA. McDonnell Douglas Aerospace (MDA) conducted this research by studying AOA rate and pitch rate command systems. Three piloted, fixed-base simulation entries were used to investigate requirements at 30°, 45°, and 60° AOA. Flying qualities tasks which are representative of high AOA fighter aircraft air combat maneuvering were used during these simulations. Specifically, longitudinal gross acquisition and tracking tasks, similar to those used during AOA command system testing, were also adequate for the evaluation of rate command systems. Pilot evaluations were conducted for several variations in longitudinal dynamics. Testing was designed to isolate differences in desired dynamics between rate command system types, isolate effects of AOA on desired dynamics, and identify the sensitivity of pilot opinion to higher order dynamics. Both rate command system types were evaluated at various angles of attack. The AOA rate command system was tested with response orders of 0/1, 0/2, and 1/2 to determine the impact of low order and higher order responses. Pilot comments, Cooper-Harper Ratings (CHR), and Pilot Induced Oscillation (PIO) ratings were gathered. The resulting criteria can be used for longitudinal design guidance of rate command system control laws at high AOA.

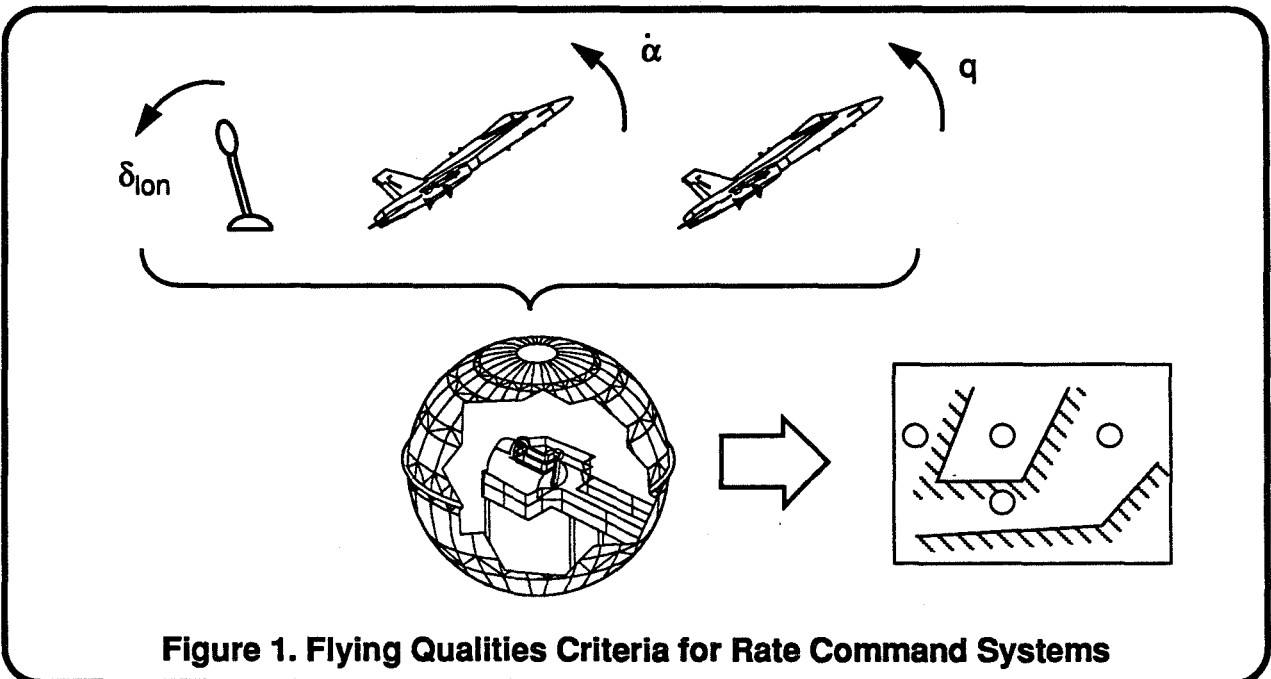

**Figure 1. Flying Qualities Criteria for Rate Command Systems**

## Simulation Setup

Three simulation entries were conducted in the MDA simulation facility during this research. A fixed-base, 40 foot domed simulator with F-15 hardware was utilized. This cockpit contained primarily F-15C hardware; however, the stick spring cartridges were replaced with cartridges similar to those on the F-15 STOL and Maneuvering Technology Demonstrator (S/MTD). The F-15 S/MTD cartridges consist of a single longitudinal and a single lateral gradient. A single longitudinal gradient was desired for the rate command system testing. A Gould SEL 32/97 computer with dual processors was used to drive the simulation at a 60 Hz update rate. The total time delay from stick input to visual scene update was approximately 100 msec.

Visual cues were provided by a Compuscene IV computer image generation system. The Compuscene image was projected on the forward 180° of the dome with a high resolution inset projected directly in front of the pilot. A video projected F-15 was used to represent an air-to-air target. The visual and aural cues in this simulation were of high fidelity; however, motion cues were not simulated. Due to the unique motion environment of high AOA flight, motion-based simulation and/or flight testing is needed to confirm the criteria presented in this paper.

## Aircraft Model

This study was designed to isolate and test a fighter aircraft's primary response characteristics. There are many non-linearities associated with any particular aircraft at high AOA. However, this study was meant to be generic and applicable to both current research aircraft and future aircraft designs. As a result, a low order, closed-loop aircraft model was used during the simulation tests. This model allows the user to quickly and easily specify the performance and dynamic response to be simulated. The closed-loop dynamics can be directly specified and hence, multiple variations in dynamic responses can be investigated quickly. The lift and drag characteristics of the simulated aircraft were similar to modern fighter aircraft. Maximum lift occurred around 38° AOA. Aircraft-specific control effectors and stability characteristics were not modeled.

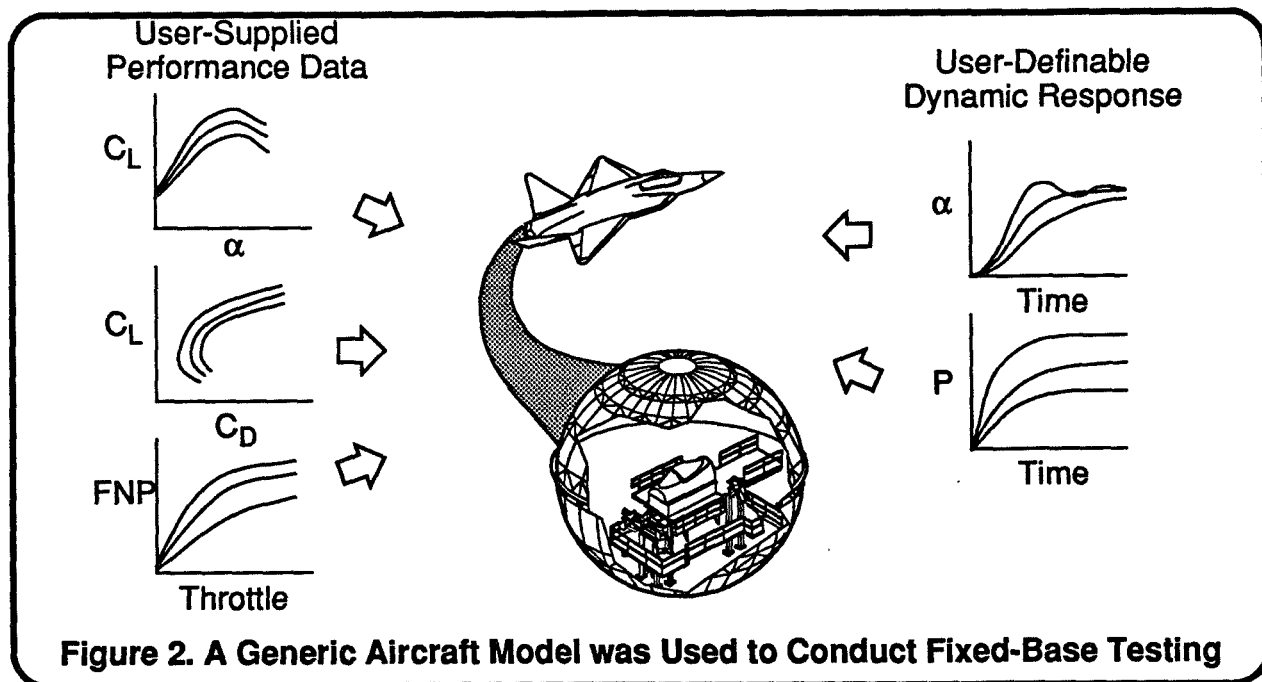

Figure 2. A Generic Aircraft Model was Used to Conduct Fixed-Base Testing



## Longitudinal Gross Acquisition Flying Qualities Task

Gross acquisition and tracking tasks were tested to isolate different maneuvering requirements and pilot inputs for air-to-air combat. These tasks were structured to provide repeatable flying qualities data while testing phases of tactically relevant maneuvering such as would be experienced during rapid point and shoot or low speed scissors maneuvers. These tasks were originally designed for simulator use but have been modified for a flight test environment.

The gross acquisition task was designed to exercise rapid, large amplitude maneuvering. During this task, the pilot expects to use a large longitudinal stick input and wants to be able to command a high pitch rate to minimize the time required to get to the target. Such maneuvering exists when a pilot pulls through a large nose angle change to engage a target. As a result, this task focuses on desired pitch rates and the overall time to accomplish the task. Another important aspect of the gross acquisition task is the ability to stop the pipper near the target and transition to tracking. To isolate the acquisition and capture characteristics from tracking, the pilots terminated the task when the target was stabilized within error bars displayed on the HUD.

A description of the longitudinal gross acquisition task is shown in Figure 3. Both aircraft are initialized at 15,000 ft altitude in a tail-chase condition. The target aircraft was digitally controlled to execute a descending right-hand spiral turn. The evaluation pilot was asked to roll to match the maneuver plane of the target, hesitate, and time his pull so that the capture portion of the maneuver occurred near the test AOA. After completing the capture, the pilot unloaded and partially rolled out to allow the target to increase separation. The pilot could then perform another acquisition by rolling, stabilizing, and pulling to the target. The pilots performed many aggressive acquisitions of the target aircraft to evaluate the gross acquisition capabilities. Each pilot attempted various control strategies to determine the pitch rate and capture performance of each configuration. The pilots evaluated their ability to capture the target within the error band, and they judged the time that was required to perform the acquisition. A specific value of time was not chosen for the "desirable time" or the "adequate time" in the CHR performance standards so that the pilots could base that decision on their experience.

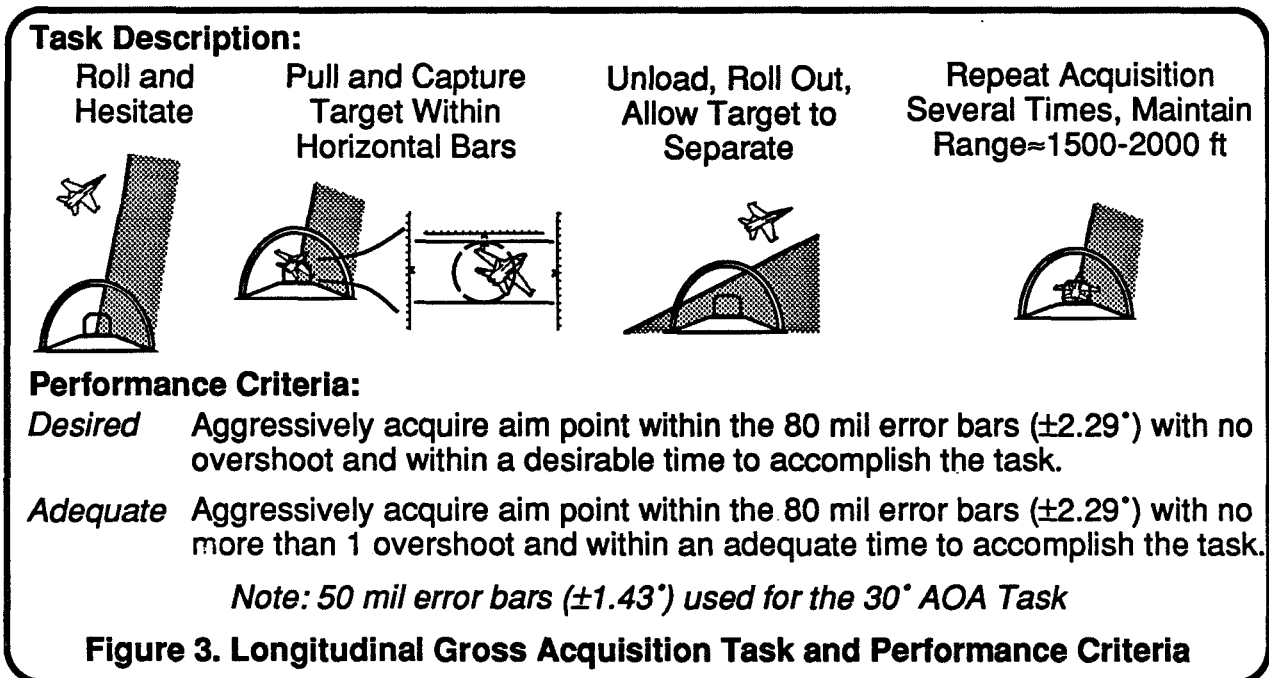

## Longitudinal Tracking Flying Qualities Task

The longitudinal tracking task was developed to test precise pipper control. Fine tracking will probably not occur for a long duration at post-stall angles of attack, but some degree of precision will be necessary for weapon delivery. During tracking, the pilot expects to use only slight control stick inputs to generate small corrections in pitch. The ability to precisely control the aircraft's pipper while following a maneuvering target is a highly desired tracking feature. The tracking task was implemented with a steady target and no turbulence, so the pilot also evaluated his ability to move the pipper to new aim points on the target. The advantage of a steady target is that a pilot is able to easily discern the aircraft response to stick input from any independent target motion. Reticles of 10 mil and 50 mil diameter were drawn around the gun pipper as a measure of tracking performance.

Both aircraft are initialized in an 80° banked turn for the tracking task. The target started above, to the right, and ahead of the evaluation aircraft. The target was also initialized with a heading difference as would occur in a turn. This setup was developed to decrease the amount of time required to achieve stabilized tracking. The tracking task also was started at a higher altitude than the acquisition task to provide a longer evaluation time. The setup used during this research was optimized for simulator testing. A modified setup has been developed for in-flight testing.

A description of the longitudinal tracking task is shown in Figure 4. During the tracking task, the target aircraft performed a descending spiral turn. The evaluation pilot was asked to establish a stabilized tracking position on the target. The acquisition was not done aggressively and was not done for evaluation. The pilots tested their ability to tightly track a desired aim point, make precise corrections, and aggressively move the pipper to a new aim point. The pilots were using a 10 mil diameter reticle as a performance standard when they were performing point tracking. They were making aim point changes of approximately 50 mils when they were exercising nose-to-tail and tail-to-nose corrections. Each pilot was allowed several runs to identify deficiencies in the configuration and attempt various control strategies.

### Task Description:

Target Initially  
40° Nose High

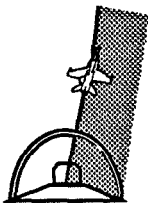

Stabilize in  
Tracking Position



Conduct Precise  
Tracking

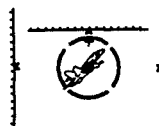

Aggressively  
Change Aim  
Points

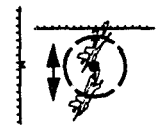

### Performance Criteria:

*Desired* No objectionable PIO.  
Pipper within  $\pm 5$  mils ( $\pm 0.29^\circ$ ) of aim point 50% of the task and within  $\pm 25$  mils ( $\pm 1.43^\circ$ ) the remainder of the task.

*Adequate* Pipper within  $\pm 5$  mils ( $\pm 0.29^\circ$ ) of aim point 10% of the task and within  $\pm 25$  mils ( $\pm 1.43^\circ$ ) the remainder of the task.

Figure 4. Longitudinal Tracking Task and Performance Criteria

## Rate Command System Models and Dynamics Tested

Combinations of AOA rate, pitch rate, 0/1 order, 0/2 order, and 1/2 order command systems were used during the pilot evaluations. Various response orders were tested to determine an acceptable range of high AOA rate responses. A 1/2 order response was tested because it represents the classical, low AOA, heart-of-the-envelope pitch rate response that results from a load factor or AOA command system. A 0/1 order system was tested because research within MDA has identified control law design approaches which achieve this response at high AOA, and this research indicates that a 0/1 order response may be preferred for rate systems. Finally, a few 0/2 order responses were included to test a rate response order that is the same as the classical AOA response order tested in previous AOA command system research at high AOA. These models were used to determine desired ranges of pitch time constant ( $\tau_{\dot{\alpha}}$  or  $\tau_q$ ), rate sensitivity/maximum attainable rate ( $K_{\dot{\alpha}}$  or  $K_q$ ), short period frequency ( $\omega_{sp}$ ), short period damping ( $\zeta_{sp}$ ), and lead time constant ( $\tau_L$ ).

A nose-down bias was added to the pilot command because other research has shown the desire for nose-down rate resulting from neutral longitudinal stick. The nose-down bias was only desired at high AOA, so it was blended in between 15° and 20° AOA. Variations in the amount of bias were tested using the gross acquisition task prior to the criteria development testing. This initial testing showed that 15 deg/sec was adequate for the acquisition task. The nose-down bias was set equal to the stick sensitivity ( $K_{\dot{\alpha}}$  or  $K_q$ ) during the tracking testing. This was done so that a 1 inch stick deflection resulted in zero rate regardless of the dynamics being tested. As a result, the pilot was able to avoid the stick breakout forces while tracking.

An Euler compensation term was added to the pitch rate command system so that the aircraft would generate additional pitch rate in a turn rather than hold a constant nose position. Flying qualities experience on existing aircraft with pitch rate command systems has shown the need to use Euler-compensated pitch rate. Some qualitative evaluations were conducted prior to the first simulation to compare Euler-compensated pitch rate to pure pitch rate. The evaluation pilot preferred Euler-compensated pitch rate, so it was used during all three simulations.

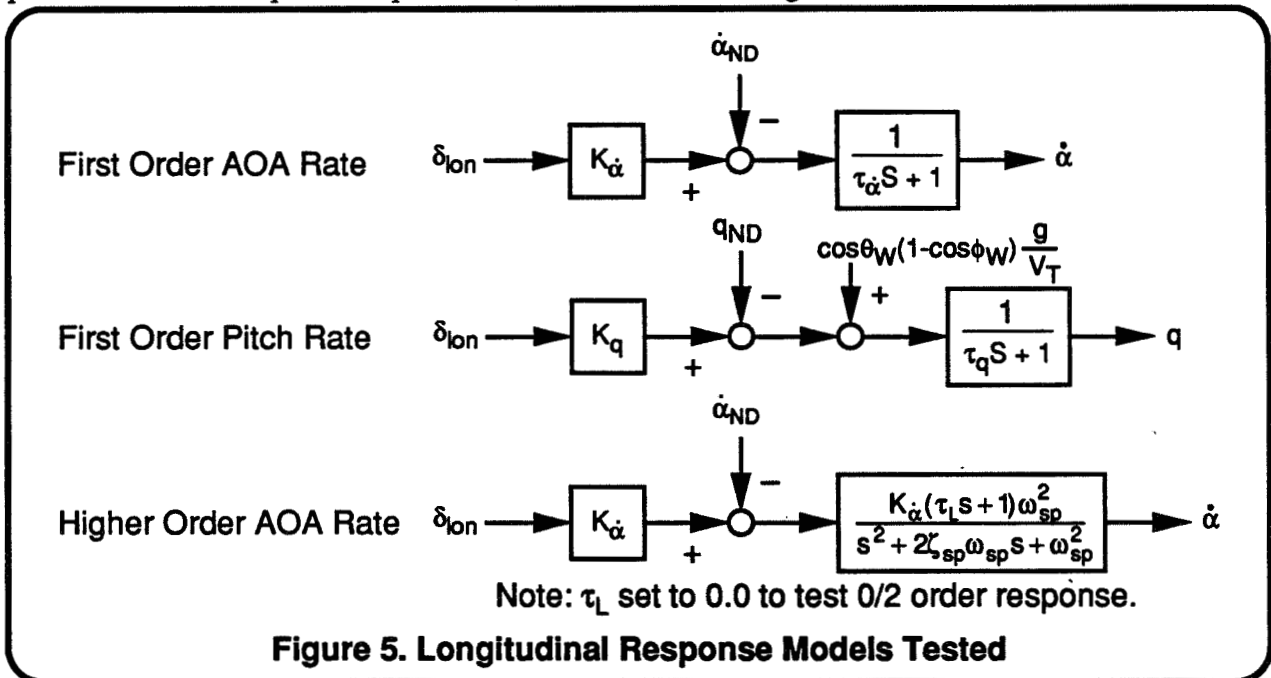

## Rate Command System Test Approach

This research was designed to test longitudinal rate command systems at high AOA and develop design guidelines that can be used on future fighter aircraft. In particular, AOA rate and pitch rate command systems were tested at 30°, 45°, and 60° AOA. These test conditions were selected to correspond with previous AOA command system research. The order of the response was also varied to determine allowable ranges of dynamics for different response orders. Results were organized as "first order" and "higher order" testing to simplify documentation. However, the actual testing was not segregated by type, and the pilots were not informed of the order of dynamics being tested. In this paper, first order testing will refer to the 0/1 order AOA rate and pitch rate systems, and higher order will refer to the 0/2 and 1/2 order AOA rate testing.

A great deal of simulation time would have been required to fully test all combinations of command system types for both the gross acquisition and tracking tasks at all three angles of attack. Therefore, a more efficient experiment was designed to isolate each effect of interest. The overall simulation test approach used is shown in Figure 6. Each of the oval elements indicates a test matrix consisting of variations in dynamics. The lines connecting test matrices indicate data comparisons which can be made to isolate effects of response order, angle of attack, and response type. This test approach was used with both the gross acquisition and tracking testing except that tracking was not conducted at 45° AOA due to time limitations.

The primary testing was conducted at 60° AOA with 0/1 order AOA rate command systems. The remaining test matrices were designed to identify trends with respect to this primary matrix. The low order AOA rate command system testing at 60° AOA was selected as the primary matrix for several reasons. First, the 0/1 order model required only two dynamic parameters to be varied thereby greatly reducing the total test time. Additionally, pilot comments from the first simulation indicated that the 0/1 order response was desirable. The 60° AOA test condition was selected as the primary condition so that the results could be compared to the most recent AOA command system work where additional agility analyses had been conducted. Also, 60° AOA represents the largest amplitude and most aggressive of the tasks.

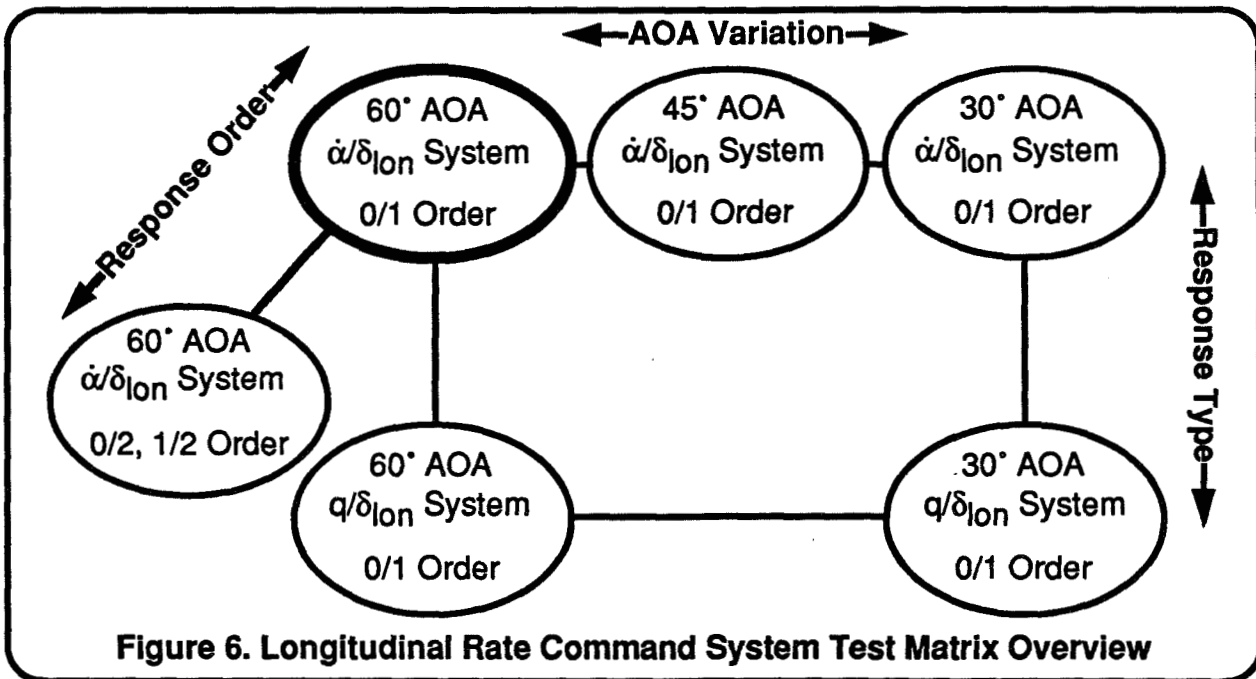

**Figure 6. Longitudinal Rate Command System Test Matrix Overview**

### Comparison of Test Data Across AOA

The test matrix overview shown in Figure 6 was designed to isolate any AOA dependency of the gross acquisition and tracking Level 1 regions. Longitudinal acquisition testing was conducted at 30°, 45°, and 60° AOA with AOA rate command systems and with pitch rate command systems. Tracking testing was conducted at 30° and 60° AOA. The flying qualities of both command system types were examined for any dependency upon AOA. No significant AOA dependency was identified for either acquisition or tracking using either AOA rate or pitch rate command systems. The following is a brief example showing a comparison of pilot ratings for the tracking task. Pilot comments were compared in a similar fashion but will be omitted in this paper for brevity.

Cooper-Harper ratings for the AOA rate command system tracking tests are compared at 30° and 60° AOA in Figure 7. The three configurations used for comparison represent a slice through the primary test matrix. These configurations include a Level 1 configuration, an overly sensitive configuration, and an overly sluggish configuration. The individual and average Cooper-Harper ratings agree very well for configurations 454 and 465. The average CHR for configuration 457 shows a change between 30° and 60° AOA. However, less variation is observed if individual ratings for each pilot are compared. The only rating that is significantly different is the rating of 6 given by Pilot C at 30° AOA. However, the repeat evaluations of 4 and 3 given by Pilot C agree exactly with the ratings given at 60° AOA. Pilot comments for the configurations shown in Figure 7 were also compared to search for AOA dependency. In summary, the pilot comments for each of the three configurations are very similar between the two test angles of attack. This indicates that the pilots perceived a very similar response at 30° AOA and 60° AOA for each set of dynamics.

Comparisons similar to this were made using the pitch rate command system data and data from acquisition testing. Overall results indicate that the flying qualities of rate command systems at high AOA are independent of angle of attack.

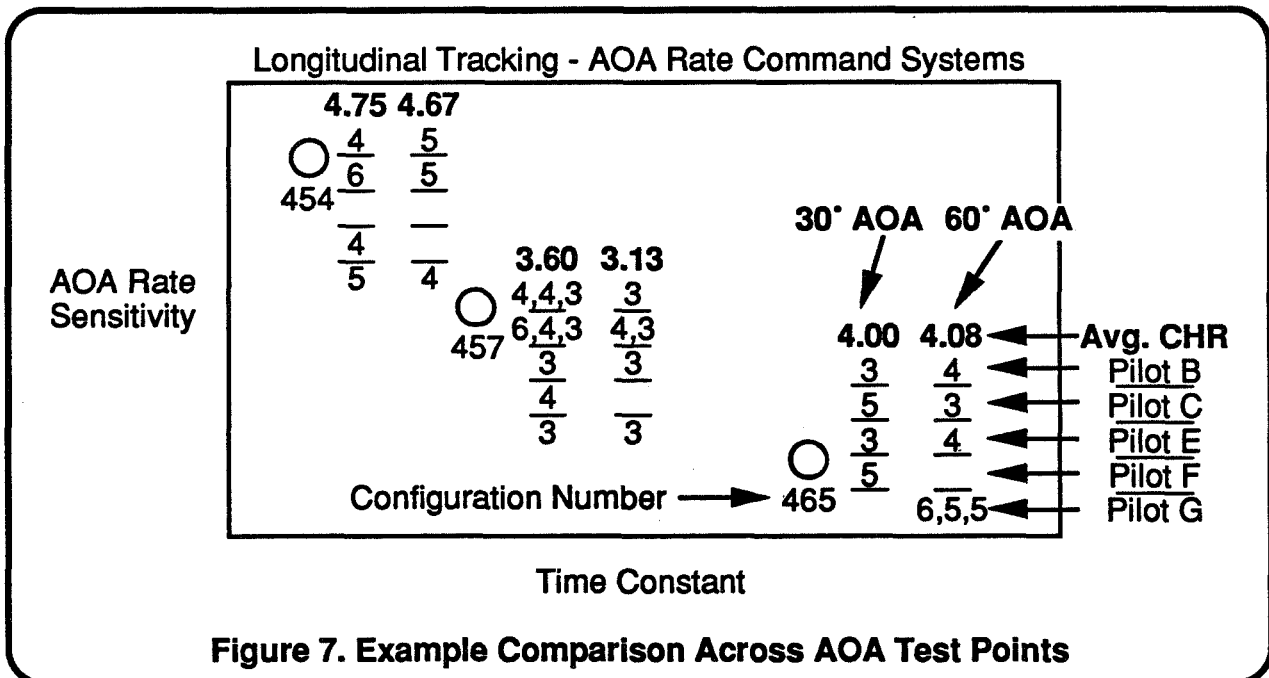



## Gross Acquisition Flying Qualities Criteria for First Order Systems

The first order AOA rate command system data gathered at 60° AOA was used to define a region of Level 1 dynamics. The maximum attainable AOA rate and the time constant were varied over a wide range during testing. Figure 9 shows the results of the evaluations, typical pilot comments, and defines criteria boundaries for the Level 1 region.

The longitudinal gross acquisition Level 1 region is characterized by comments indicating a predictable, controllable capture of the target and a desirable time to accomplish the task. Configurations that were on the high side of the Level 1 region bordered on overly sensitive responses and some pilots experienced bobbles during the capture. The overall time was still good even though some pilots had to reduce their gains to avoid the bobble tendency. As a result, the upper Level 1-2 boundary indicates an increase in the pilot workload or a degradation in capture precision. The right-hand Level 1-2 boundary tended to indicate configurations that had more of an overshoot tendency.

The lower Level 1-2 boundary was typically determined by the pilot's perception of a tactically desirable time to accomplish the acquisition task. When a low maximum rate was combined with a quick time constant, then the pilot had enough acceleration to perform an accurate and predictable capture. However, the pilots considered these configurations deficient from the consideration of time required. Configurations with low rate and long time constant had a large lag in initial response and the attainable rate was too low. If a slow time constant was tested with a high maximum rate, the pilot had an overshoot tendency. This is because the pilot could develop a fairly high rate but the maximum acceleration was deficient, and it took too long to stop. The pilots tended to use less than full stick or take it out very early to compensate. The configurations with quick time constants and high maximum rates resulted in very sensitive responses that have a PIO potential. These configurations have a higher maximum acceleration capability than desired for this closed-loop flying qualities task.

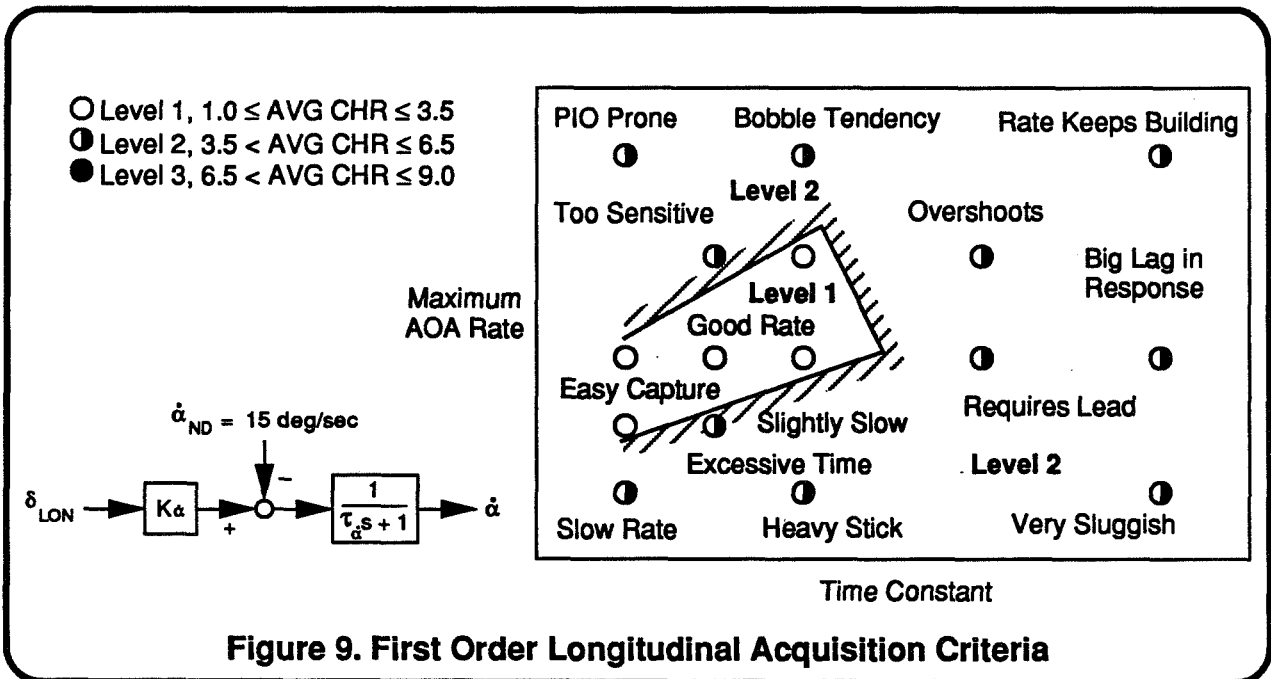

## Gross Acquisition Flying Qualities Criteria for Higher Order Systems

Variations in higher order dynamics were also investigated. Preliminary guidelines have been developed from this data; however, there was not enough test time available to develop a complete set of higher order criteria. Response orders of 0/2 and 1/2 and variations on the lead time constant, short period frequency, and short period damping were tested. The 0/2 order systems were found to be very undesirable because of the large lag in initial response. The 0/2 order response was improved by significantly increasing the short period frequency, but pilot comments indicated that the response was still not desirable. The 1/2 order testing was accomplished by taking two slices through the three-dimensional test space. The first slice was conducted by fixing short period damping. The second slice was tested by fixing the lead time constant. In both test matrices, the variations were made relative to a first order system to determine pilot acceptance of increasingly non-first order responses.

Figure 10 shows the results of the Cooper-Harper evaluations, typical pilot comments, and defines tentative guidelines for the Level 1 regions. The Level 1 boundary was based on the average CHR 3.5 line and the pilot comments but should be treated as a preliminary guideline because of the limited number of configurations evaluated. The pilots were able to achieve the desired time to acquire and were able to stop precisely on the target within the Level 1 regions. Configurations with a low short period frequency resulted in a sluggish initial response regardless of the lead time constant that was selected. If the short period frequency was too high, the response was too quick and bouncy. As the short period frequency and the lead time constant were simultaneously increased beyond Level 1 values, the pilots had increasing difficulty with overshoots. Finally, the response was PIO prone at extreme values of either short period frequency or lead time constant. The data indicates that the damping must be increased with increasing frequency to maintain Level 1 flying qualities. Configurations with low damping resulted in less precise captures. The severity of the response also depends upon frequency. If a low damping is combined with a low frequency, the response tends to be sluggish and imprecise. However, a sensitive and bouncy response occurs if a low damping is combined with a moderate to high short period frequency.

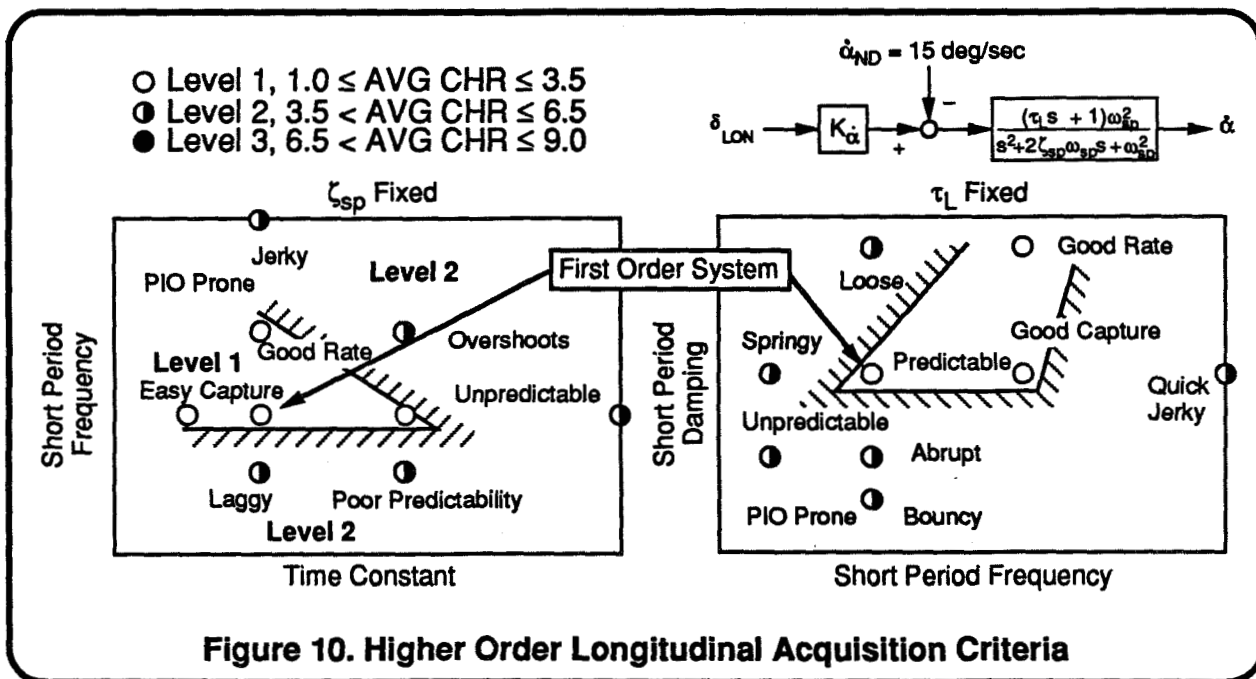



## Tracking Flying Qualities Criteria for First Order Systems

Longitudinal tracking Level 1 flying qualities regions were developed in a similar manner as that used for the acquisition criteria. Data gathered at 60° AOA with the AOA rate command system was used to develop the region shown in Figure 11. For the tracking testing, the AOA rate sensitivity and the time constant were varied over a wide range. The resulting Cooper-Harper evaluations and pilot comments were used to define the criteria boundaries.

The pilot ratings and comments for tracking indicate a large Level 1 region. However, the preferred sensitivity is dependent upon time constant. Dynamics within the Level 1 region received comments indicating solid, precise spot tracking and the ability to predictably make corrections of approximately 50 mils. A very quick, abrupt response resulted if the time constant was reduced below the minimum Level 1 boundary. Pilots had problems making small, predictable changes for these systems. Configurations around the upper Level 1 boundary had too much rate capability (sensitivity) to precisely track and pilots occasionally experienced bobbles. The pilots also had to reduce their gains during the aim point changes to avoid PIO. Therefore, the upper Level 1 boundary indicates an increase in workload and a degradation in tracking precision. The right-hand Level 1 boundary indicated too much lag in initial response. This manifested itself in a piper response that seemed to wander during spot tracking or resulted in overshoots during aim point corrections. The lower Level 1 boundary was determined by the perception of a tactically desirable time to make aim point changes. The spot tracking tended to be good, but the pilots noted that the configuration would be too slow to track an active target.

Neither a minimum nor a maximum was identified for the AOA rate sensitivity. However, pilot comments indicated that configurations with low sensitivity would not be desirable for tracking an actively maneuvering target because of the slow response and the large stick inputs required to make corrections. It is also recommended that stick sensitivities not exceed the range tested in this experiment. The pilot comments indicate that, even with the right time constant, configurations with the highest stick sensitivity tested are on the borderline of being too sensitive and a very aggressive, high gain pilot could have PIO problems.

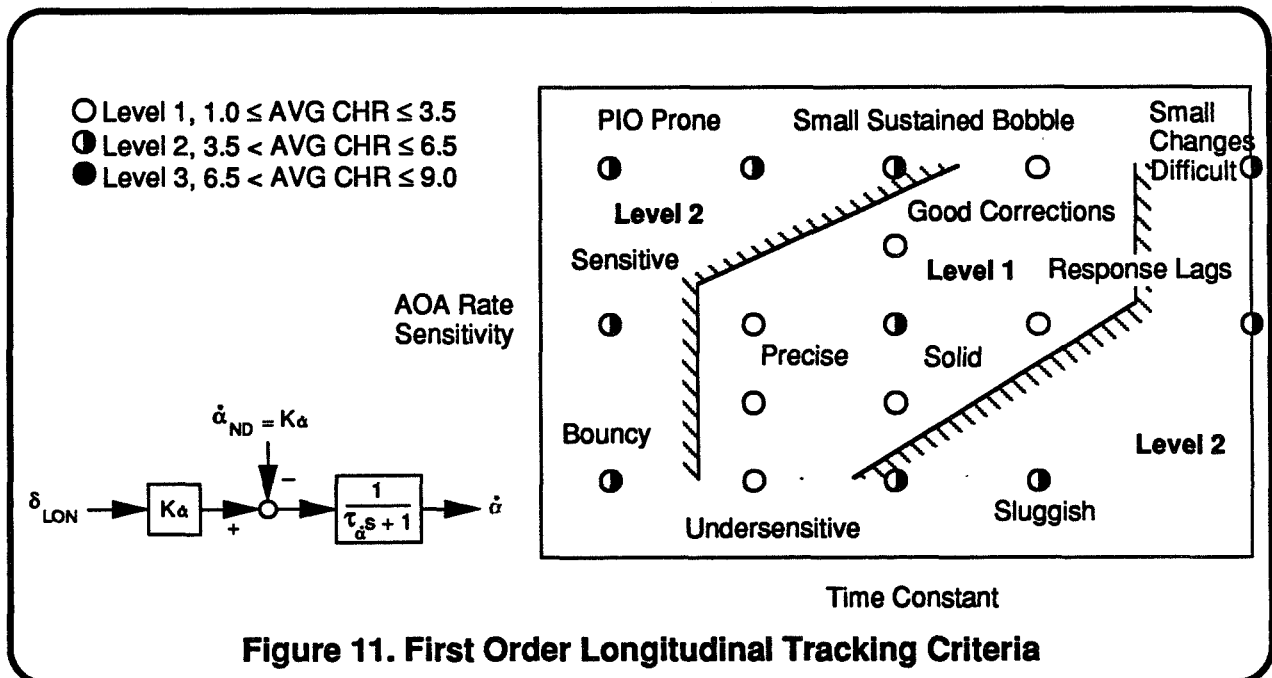

## Tracking Flying Qualities Criteria for Higher Order Systems

Variations in higher order dynamics were also investigated using the tracking task. Preliminary guidelines have been developed from this data; however, there was not enough test time available to develop a complete set of higher order criteria. Response orders of 0/2 and 1/2 and variations on the lead time constant, short period frequency, and short period damping were tested. Just as with the acquisition testing, the 0/2 order systems were found to be very undesirable because of the large lag in initial response. The 1/2 order testing was accomplished by taking two slices through the three-dimensional test space. The first slice was conducted by fixing short period damping. The second slice was tested by fixing the lead time constant. In both test matrices, the variations were made relative to a first order system to determine pilot acceptance of increasingly non-first order responses.

Figure 12 shows the results of the Cooper-Harper evaluations, typical pilot comments, and defines tentative guidelines for the Level 1 regions. The Level 1 boundary was based on the average CHR 3.5 line and the pilot comments but should be treated as a tentative guideline because of the limited number of configurations evaluated. A relatively small range of variation was found to be allowable for short period frequency and lead time constant. The pilots were able to achieve desired spot tracking and 50 mil aim point changes within this region. Configurations with a low short period frequency resulted in a sluggish response regardless of the lead time constant that was tested. If the short period frequency was increased too much, the response was too sensitive. As the lead time constant was increased beyond Level 1 values, the pilots also perceived an increase in the sensitivity of the response. If both the short period frequency and the lead time constant were simultaneously increased beyond Level 1 values, then the response became sensitive, oscillatory, and PIO prone. A dependency between desired short period frequency and damping was identified. Just as with the acquisition task, pilots desired higher short period damping as the frequency was increased. And finally, low values of short period damping resulted in poor tracking.

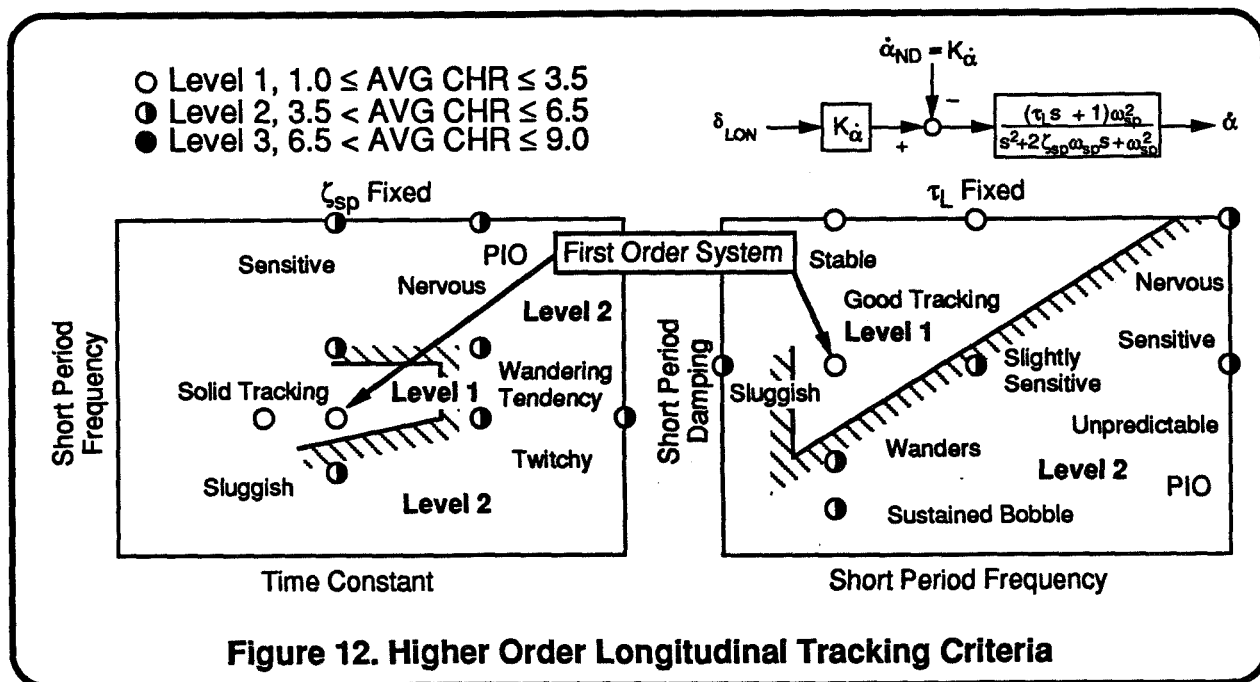

**Figure 12. Higher Order Longitudinal Tracking Criteria**

## Summary

This investigation was conducted to determine flying qualities requirements for AOA rate command and pitch rate command systems at high AOA. Previous research had been conducted for AOA command systems at 30°, 45°, and 60° AOA. These angles of attack were also studied during this investigation. Piloted simulation verified that the flying qualities tasks used for AOA command systems could be used for rate command system criteria development. Pilot evaluations were conducted for a wide range of rate command system dynamics. Pilot comments, Cooper-Harper ratings, and PIO ratings were used to develop flying qualities criteria for longitudinal acquisition and tracking tasks.

Both AOA rate and Euler angle compensated pitch rate command systems were evaluated. The AOA rate system was tested with different response orders to determine the desirability of low order and higher order responses. Response orders of 0/1, 0/2, and 1/2 were tested. A wide range of closed-loop dynamics were tested for each of the variations in response type, response order, and AOA. Evaluation of the flying qualities data indicates that the Level 1 region of dynamics is independent of response type (AOA rate or pitch rate) and angle of attack. This simplifies the design guidelines because it means that one set of criteria can be developed for rate command system control law design at high AOA. The same criteria can be used for AOA rate command as is used for pitch rate command systems and the desired dynamics do not need to be scheduled with AOA. The primary criteria defines desired regions of maximum rate/rate sensitivity and time constant. Additional guidelines were developed for higher order dynamics. It was found that 0/2 order rate responses were not desired for the acquisition or tracking tasks. Desirable regions of dynamics were identified for 1/2 order responses. Guidelines were developed from this data to define acceptable ranges of short period frequency, short period damping, and lead time constant. However, these should be used more for trend information because they represent two-dimensional slices through a large three-dimensional design space.

The criteria presented in this paper and the previous AOA command system criteria are the result of extensive testing; however, additional research is needed for high AOA flying qualities design guidelines. Pilot comments during this testing indicated slight preferences between the AOA rate command and pitch rate command systems for the tasks investigated. A study to identify the relative merits of rate command and AOA command systems for tactical maneuvering at high AOA is needed to help a control law designer choose the best approach for a fighter aircraft design. A wider range of maneuvers and simulated air combat engagements should be used to directly compare rate command and AOA command systems at high angles of attack. Such a study would expose implementation issues for each command system for a full envelope design and would solicit pilot opinions over a much wider range of maneuvering than used in this study.

These flying qualities criteria (and the AOA command system criteria) were developed in fixed-base simulations and therefore need to be validated in flight. Aggressive high AOA maneuvering can result in large rotational and linear accelerations at the pilot's station. Therefore, flight test data is required to determine how much the flying qualities boundaries will shift with the addition of motion cues. Motion-based simulations may also provide useful correlating data for some of the tasks. In-flight testing with aircraft such as the NASA HARV, F-15 ACTIVE, X-29, and X-31 is needed to fully determine the effect of motion cues on the Level 1 regions defined in this paper.

PAPER NOT AVAILABLE FOR PREPRINT

NASA1-HARV Control Law Evaluation Using Flight Test Data, Pat Murphy, Frederick J. Lallman, Aaron J. Ostroff, John B. Davidson, Barton J. Bacon, Eugene A. Morellis, and Michael G. Tison, NASA Langley Research Center, Hampton, VA and Keith D. Hoffler, VIGYAN, Inc., Hampton, VA and Michael D. Messina, Lockheed Engineering and Sciences Company, Hampton, VA

20pg

1995107834

323997

N95-14248

signature

16097

R 19



**VISTA / F-16  
MULTI-AXIS THRUST VECTORING (MATV)  
CONTROL LAW DESIGN AND EVALUATION**

**W. D. ZWERNEMAN  
B. G. ELLER  
Lockheed Fort Worth Company**

13 July, 1994

1



## **OVERVIEW**

**PROGRAM SUMMARY**

**CONTROL LAW OBJECTIVES / APPROACH**

**MODES / STATES OF OPERATION**

**FUNCTIONAL CONTROL LAW DESCRIPTION**

**SIMULATION**

**FLIGHT TEST**

**CONCLUSIONS AND RECOMMENDATIONS**

The Multi-Axis Thrust Vectoring (MATV) program has been a joint effort by Lockheed Fort Worth Company (LFWC), Wright Laboratory (WL), General Electric (GE), the Air Force Flight Test Center (AFFTC), and the 422nd Test and Evaluation Squadron (TES). The program consisted of integrating a multi-axis thrust vectoring nozzle system with the Variable Stability In-flight Simulator Test Aircraft (VISTA)/F-16 aircraft. The integrated system was used in flight test to demonstrate flight envelope expansion above the normal F-16 angle-of-attack (AOA) limits and to evaluate potential tactical benefits gained by utilizing thrust vectoring in air-to-air combat.



## **PROGRAM SUMMARY**

**MATV WAS A COOPERATIVE EFFORT BETWEEN WRIGHT LAB, GENERAL ELECTRIC, AFFTC AND LOCKHEED FORT WORTH**

**OBJECTIVE: DEMONSTRATE THE TACTICAL UTILITY OF MULTI-AXIS THRUST VECTORING**

- **Develop Integrated Flight Control / Propulsion System Designed to Expand F-16 AOA Envelope**
- **Install Vectoring Nozzle (AVEN), Vector Electronic Controller (VEC) and MATV DFLCC OFP on VISTA / F-16 Aircraft**
- **Perform Aggressive Ground Test and Flight Test Program**

The objective of the MATV program was to utilize multi-axis thrust vectoring to expand the F-16 AOA limits into the post-stall regime and to evaluate the tactical benefits gained by utilizing expanded AOA in air-to-air combat. For the MATV program a new control law mode was developed which commands thrust vectoring to augment the aircraft's aerodynamic control power. The additional control power is used to provide high AOA maneuverability. The MATV control laws were primarily developed using LFWC's off-line (non-piloted) and on-line (piloted) handling qualities (HQ) simulation tools. Additionally, the HQ simulator was used to perform an extensive piloted evaluation of the MATV control laws prior to finalizing the flight test control law configuration. This evaluation was an integral part in the development of the initial flight test control laws and flight test maneuvers/techniques.



## **CONTROL LAW OBJECTIVES / APPROACH**

### **OBJECTIVES**

- Design Control Laws Utilizing Thrust Vectoring to Enable Controlled Flight at AOA Greater than 30 Degrees
- Determine Vectoring Nozzle Requirements
- Determine Military Utility of Thrust Vectoring

### **APPROACH**

- Definitive High AOA Handling Qualities / Agility Metrics Not Available
- Evaluate Different Command Structures in Simulator
- Conduct Piloted Simulations with Operational Pilots to Evaluate Utility



The figure below illustrates the relationship between the modes and states of operation for the MATV system. The arrows indicate the possible directions from which modes and states can be entered or exited.

The MATV system was designed to provide the pilot with two primary modes of operation: the KILL mode and MATV mode. The pilot toggles between the two modes using the "Kill-Standby" switch on the sidestick controller. With the KILL mode selected the engine hydraulics center the nozzle to zero and baseline F-16 control laws are in place. This is a fail-safe mode used for low altitude operation, in particular for takeoff and landing flight phases. Note that by placing the Kill-Standby switch in the KILL position, the aircraft can be returned to the KILL mode from any one of the states in the MATV mode. This is an important safety feature for the MATV aircraft.

From the KILL mode, the MATV mode is selected by placing the Kill-Standby switch in the Standby position. In the MATV mode, three pilot-selectable states are available. The state which is entered when the MATV mode is first selected is the STANDBY state. In this state the FLCS commands the nozzle to zero and baseline F-16 control laws are used (as in the KILL mode). The pilot can transition to the next state, ACTIVE LIMITER ON, by depressing a button on the multi-function display set (MFDS). The Active Limiter On state is the first FLCS state in which thrust vectoring is utilized. However, this state was primarily provided for potential air-to-ground configuration control law enhancements. The FLCS will only command pitch nozzle to augment the elevator if FLCS AOA limits are exceeded. Otherwise, baseline F-16 control laws are used.

The final MATV state is selected by toggling the "pinky" switch on the sidestick controller. In this state, referred to as ACTIVE LIMITER OFF or MATV LIM OFF, pitch and/or yaw thrust vectoring is used to control the F-16 to very high AOA.

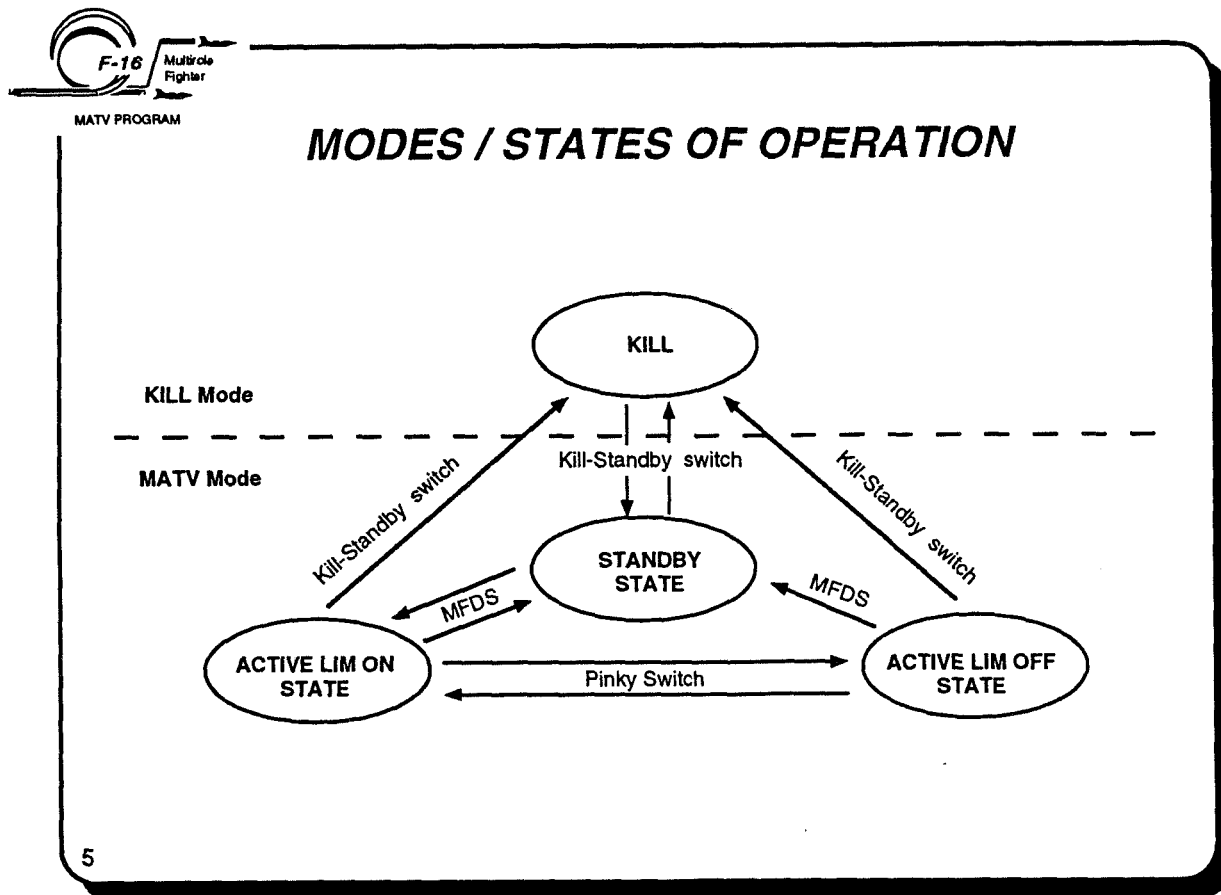

The next two charts describe the LIM OFF state for the pitch axis of the MATV FLCS. The chart on this page gives a functional description of the control laws. A simplified block diagram illustrating the MATV LIM OFF pitch axis control laws is given in the chart on the following page. More specifically, these charts describe the pitch axis for airspeed less than 300 knots. Above 300 knots the flight control laws automatically blend back to the baseline F-16 configuration. This is necessary since load factor limits prevent high AOA maneuvering above 350 knots.

From the block diagram on the following page it can be seen that the pilot's stick force command (in pounds) is converted to a pitch rate command ( $q$ , in degrees/sec) and the error signal produced between the pitch rate command and pitch rate feedback is fed to a proportional plus integral element. Some AOA feedback is also present but only enough to slowly decrease AOA when the pilot releases the stick at high AOA. This gives the aircraft's pitch axis a stable feeling at very high AOA flight conditions encountered in this mode. Note also that the pitch axis nozzle command is blended in as a function of airspeed. Above V high (300 knots) only the elevator receives the pitch axis commands. The nozzle command is blended out at the higher airspeed because the elevator alone provides adequate pitch control power above 300 knots. Below V low (100 knots) the pitch nozzle and elevator receive equal commands. This maximizes the use of the available pitch axis control power at very low airspeed. It also allows for a direct comparison between the pitch axis nozzle and elevator actuator dynamic response characteristics at low airspeed since both surfaces are responding to the same command.

(continued on next page)



MATV PROGRAM

## **FUNCTIONAL CONTROL LAW DESCRIPTION ACT LIM OFF STATE - PITCH AXIS**

**PITCH RATE COMMAND SYSTEM BELOW 300 KCAS**

**MINIMUM AMOUNT OF AOA FEEDBACK INTRODUCED ABOVE 20 AOA**

**PILOT USES MFDS TO SELECT THREE LEVELS OF AOA FEEDBACK**

- No AOA limit
- 100 Degree AOA Limit
- 80 Degree AOA Limit

**PADDLE SWITCH DEPRESSED PROVIDES 50% INCREASE IN PITCH RATE COMMAND LIMIT (MONGO MODE)**

**AT VERY LOW AIRSPEED (< 20 KNOTS) OR VERY HIGH AOA (> 140 DEG), TRANSITION TO PURE PITCH RATE COMMAND SYSTEM OCCURS**

6



The next two charts describe the LIM OFF state for the roll axis of the MATV FLCS. The chart on this page gives a functional description of the control laws. A simplified block diagram illustrating the MATV LIM OFF lateral axis control laws is given in the chart on the following page. The control laws shown are only applicable for AOA greater than 25 degrees. Below 25 degrees AOA the MATV lateral control law blends back to the baseline F-16 configuration. Also note that starting at 45 degrees AOA ( $\alpha_{blend} = 0$ ) and up to 60 degrees AOA ( $\alpha_{blend} = 1$ ) the roll stick command to the roll control surfaces is faded out and sent to the yaw axis instead. This command is summed in with the rudder pedal command in the yaw axis. Therefore, the MATV pilot can use the roll stick to control the yaw axis at AOA's greater than 60 degrees. Since the rudder pedals can perform the same function, the pilot can choose between the rudder pedal and roll stick for yaw control above 60 degrees AOA.

The simplified block diagram on the following page illustrates that the MATV lateral axis is a stability axis roll rate command system. The difference between the roll stick command and stability axis roll rate feedback is sent to the roll surface command mixer. The roll surface mixer performs the following functions:

1. Calculates the aileron-to-rudder and aileron-to-yaw nozzle interconnect gains.
2. Distributes the roll command to the appropriate control surfaces: flaperon, differential tail, rudder, and yaw nozzle.
3. Limits the surface commands based upon the available roll and yaw control power.

The roll surface command mixer outputs are then sent to the surface actuators.



## **FUNCTIONAL CONTROL LAW DESCRIPTION**

### **ACT LIM OFF STATE - ROLL AXIS**

**STANDARD F-16 CONTROL LAWS BELOW 25 AOA**

**BLEND TO PERFECT ROLL COORDINATION SCHEME (ZERO SIDESLIP) BETWEEN 35 AND 45 AOA**

- **Yaw Nozzle and Rudder Used to Coordinate Roll Control**

**ROLL STICK COMMANDS BODY AXIS YAW RATE ABOVE 60 AOA**

See word description on previous page



## SIMPLIFIED ROLL AXIS BLOCK DIAGRAM ACT LIM OFF STATE - AOA > 35 DEG

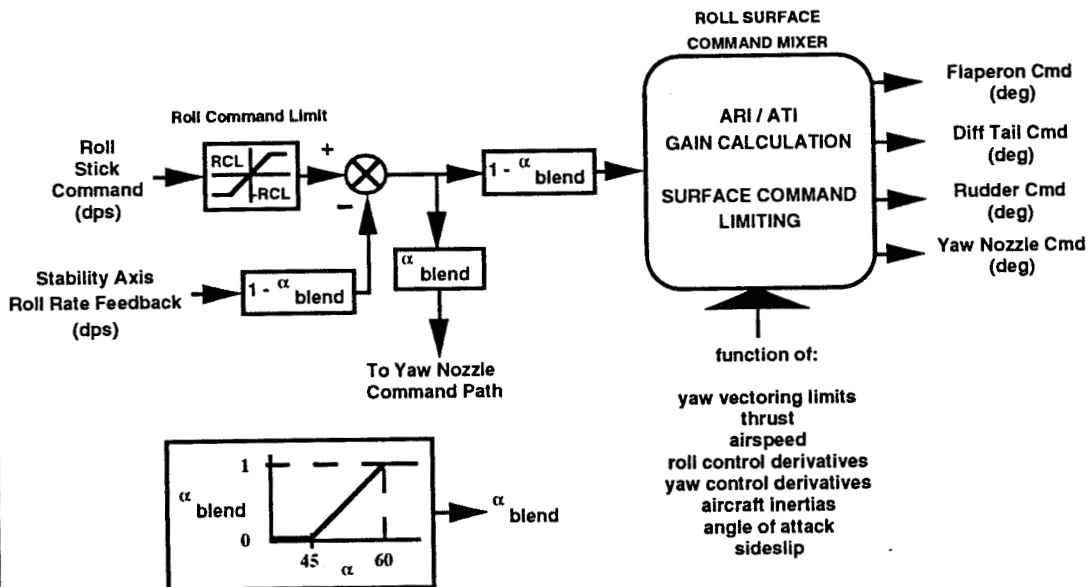

A functional description of the MATV directional axis control laws is given in the figure below. The control laws are described for three AOA regions: AOA less than 45 degrees, AOA between 45 and 60 degrees, and AOA greater than 60 degrees. Note that the yaw axis control laws between 45 and 60 degrees are blended as a function of AOA between those described for less than 45 degrees AOA and greater than 60 degrees AOA. For AOA less than 45 degrees, three features of the MATV LIM OFF yaw axis are described. First, the rudder pedal command is not faded above 15 degrees AOA as is done for the baseline F-16 control laws. Secondly, the rudder pedal commands both yaw nozzle and rudder below 250 knots. These two features give the pilot control of the yaw axis at low airspeed below 45 degrees AOA. Finally, sideslip feedback to the rudder and yaw nozzle is introduced above 25 degrees AOA. The sideslip feedback augments the directional stability of the F-16 in a region where the free airframe directional stability is low or even unstable. It also counters the buildup of large steady-state sideslips during high AOA rolling maneuvers, thereby preventing adverse rolling moments due to the powerful dihedral effect.

Above 60 degrees AOA, the rudder pedals command yaw nozzle only. In this region, the rudder is ineffective and therefore is not used. Also, for AOA greater than 60 degrees, the directional axis has blended to a body axis yaw rate command system. Finally, the sideslip feedback introduced above 25 degrees has been faded out at 60 degrees. This is accomplished since the F-16 directional stability improves above 60 degrees AOA and the accuracy of the sideslip feedback source is questionable at very high AOA's.



## FUNCTIONAL CONTROL LAW DESCRIPTION

### ACT LIM OFF STATE - YAW AXIS

<u>AOA&lt;45</u>	<u>45&lt;AOA&lt;60</u>	<u>AOA&gt;60</u>
<ul style="list-style-type: none"> <li>• Rudder Pedal Command Not Faded Above 15 AOA</li> <li>• Rudder Pedal Commands Rudder and Yaw Nozzle Below 250 KCAS</li> <li>• Sideslip Feedback Above 25 AOA</li> </ul>	<p><b>B L E N D</b></p>	<ul style="list-style-type: none"> <li>• Rudder Pedal Commands Yaw Nozzle Only</li> <li>• Body Axis Yaw Rate Command System</li> <li>• No Sideslip Feedback</li> </ul>

For the MATV program, an inertially based AOA and sideslip estimator was synthesized to provide sideslip and AOA feedback outside the current range of the hardware AOA and sideslip sensors. A functional description of the estimator is given in the Figure below.

The figure below illustrates how the aircraft inertial velocities and attitudes are first used to compute the earth axis wind velocities for a region where the AOA cone and sideslip measurement is valid. These wind velocities are then held constant when AOA or sideslip is outside of the valid AOA cone and sideslip measurement range. While the winds are held constant, the aircraft's velocities and attitudes are used to compute the extended AOA and sideslip feedback signals necessary to control the F-16 at very high AOA's.

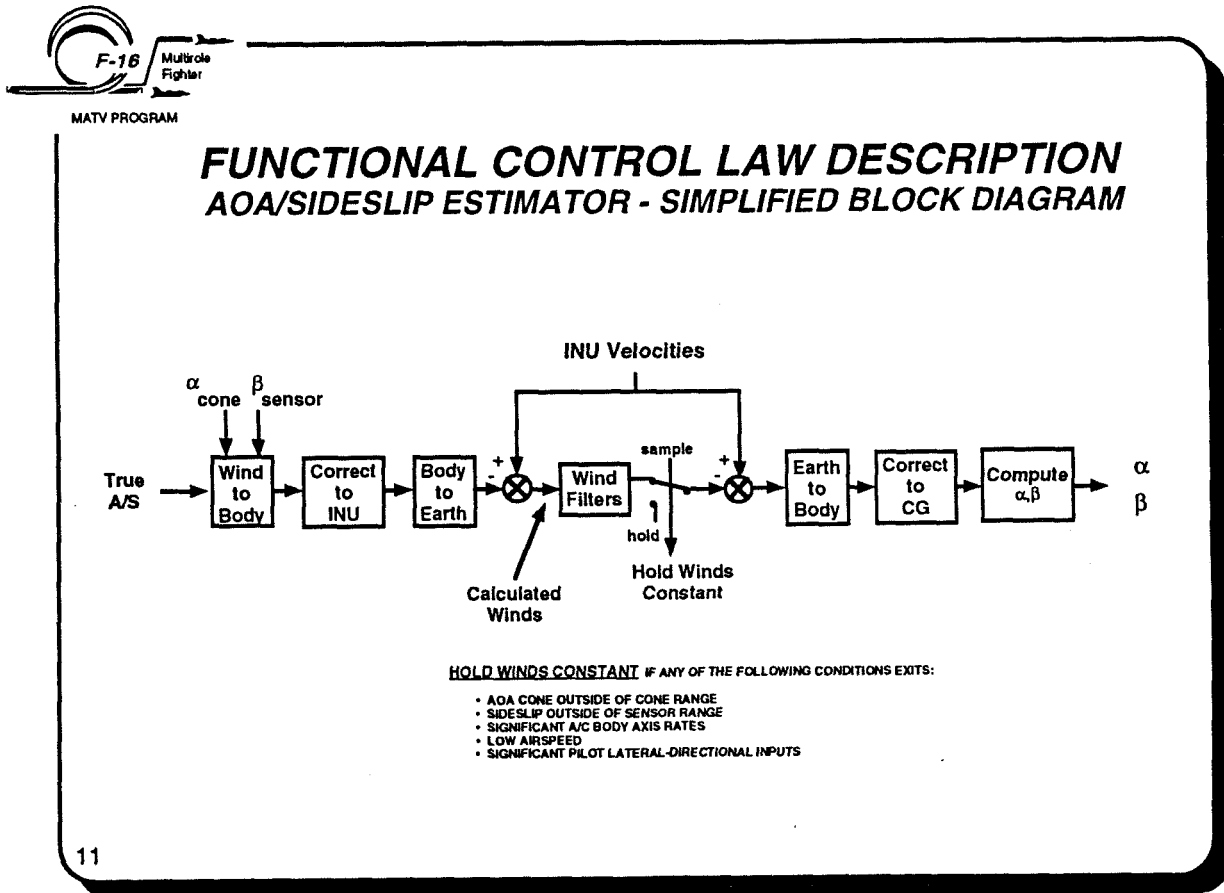

A concentrated piloted evaluation was flown in the HQ simulator during the months of October and November 1992. The primary objective of this evaluation was to assess potential areas of improvement within the MATV control laws that could be incorporated prior to first flight.

Test maneuvers used during the piloted simulation were adopted from a preliminary flight test plan. Using planned flight test maneuvers during the evaluation provided additional pilot training and further aided in the development of the final flight test plan. Maneuver entry conditions, realizable parameter capture and tracking envelopes, and maximum expected aircraft angles and rates were identified.

The maneuvers were flown at 25K and 35K feet altitude in MIL and MAX A/B power. The altitudes were consistent with the actual flight test altitude blocks. The power settings were limited to MIL power and above because that was a restriction for the flight program.



## **SIMULATION - PILOTED EVALUATION TEST MANEUVERS**

<u>Axis</u>	<u>Test Maneuver</u>
Longitudinal	Angle of Attack Stabilizations Throttle Transients Angle of Attack Captures Pitch Attitude Captures/Tracking Zero Airspeed Pull/Pushes
Lateral-Directional	Bank Angle Reversals Heading Angle Reversals Steady Sideslip/Yaw Heading Angle Captures Zero Airspeed Roll/Yaw
Combined	Target Acquisition



Longitudinal results of the piloted simulation exercise are summarized in the chart below. The pitch rate/AOA response deficiencies were primarily due to varying pitch rate command limits with airspeed and direction (nose up versus nose down). The command limits were modified to provide a more consistent pitch rate response (30 deg/sec in the normal mode, 45 deg/sec in the 'Mongoo' mode) over a wider range of velocities. An additional schedule was introduced as a function of load factor that prevented load factor excursions above the specified limit. The negative pitch rate command limit was increased to match the nose up authority at very low speeds.

Pitch attitude/AOA capture difficulties were attributed to the varying pitch rate and a lack of sufficient pilot cueing. The AOA indication on the HUD did not provide a means for the pilot to identify the target AOA. The HUD was modified so that the pilot could designate a target AOA using a staple alongside the AOA ladder. All the pitch attitude captures were performed using a target. The limited vertical field of view in the simulator resulted in the target being outside the pilot's field of view at the initiation of the pull.

The pitch tracking tasks were modified during the evaluation to force the pilot to track the target aircraft at AOA's between 30 and 80 degrees. These modifications primarily consisted of adjusting the relative airspeeds between the test and target aircraft.



## SIMULATION - PILOTED EVALUATION RESULTS (LONGITUDINAL)

<u>Area of Improvement</u>	<u>Characterized By:</u>	<u>Corrections Made:</u>
Pitch Rate/AOA Rate	<ul style="list-style-type: none"> <li>- Sluggish at 250 KCAS when Compared to 150 KCAS</li> <li>- Sluggish Nose Down with Pitch Hesitations</li> <li>- Significant Increase in Commanded Rate as Airspeed Bleeds Off</li> </ul>	<ul style="list-style-type: none"> <li>- Decreased Command Limit Sensitivity to Airspeed</li> <li>- Increased Nose Down Authority</li> </ul>
Pitch Attitude/AOA Captures/Track	<ul style="list-style-type: none"> <li>- Excessive Overshoots</li> <li>- Pitch Oscillations due to Nozzle Limiting</li> </ul>	<ul style="list-style-type: none"> <li>- Improved Consistency Between Nose Up/Down</li> <li>- Improved AOA Cueing on HUD</li> <li>- Refined Test Maneuvers to Minimize Tracking Near Nozzle Limits</li> </ul>

C-3.

Lateral-directional results of the piloted simulation exercise are summarized in the chart below. The roll rates generated during the roll reversals and the bank-to-bank maneuvers were considered good for the AOA's being evaluated. The difficulties with these maneuvers centered on the inability to precisely stop or reverse the roll. Furthermore, there were a number of roll hesitations due to adverse sideslip and the pitch axis using the nozzle to counter AOA excursions.

The ability to stop and reverse the roll was improved by introducing a stability axis roll rate feedback to the lateral axis. The forward loop path gain was also increased to provide higher initial roll accelerations. The nozzle priority between the pitch and yaw axis was adjusted to give equal priority between the axes, thus, reducing the roll hesitations identified.

The aircraft's response to pedal inputs typically resulted in pedal rolls in the mid-AOA range (30 to 50 degrees) and pure yawing maneuvers above 60 degrees AOA. The yaw response exhibited hesitations due to the pitch axis using the nozzle to counter AOA excursions. The priority modification noted above provided a smoother more consistent yaw rate. Another potential problem identified for the yaw axis was that both the lateral stick and the rudder pedals both commanded body-axis yaw rate above 60 degrees AOA. If the pilot used the lateral stick to correct body axis roll variations during a yawing maneuver, he could potentially cancel the yaw rate commanded by the pedals.



MATV PROGRAM

## **SIMULATION - PILOTED EVALUATION RESULTS (LATERAL-DIRECTIONAL)**

<u>Area of Improvement</u>	<u>Characterized By:</u>	<u>Corrections Made:</u>
<b>Roll Response</b>	<ul style="list-style-type: none"> <li>- Sluggish Roll Acceleration</li> <li>- Roll Hesitations</li> </ul>	<ul style="list-style-type: none"> <li>- Increased Roll Loop Gain</li> <li>- Increased Yaw Nozzle Priority</li> </ul>
<b>Roll Reversals/Bank Angle Captures</b>	<ul style="list-style-type: none"> <li>- Inability to Precisely Stop or Reverse Roll</li> </ul>	<ul style="list-style-type: none"> <li>- Introduced Stability-axis Roll Rate Feedback</li> <li>- Increased Yaw Nozzle Priority</li> </ul>
<b>Yaw Response</b>	<ul style="list-style-type: none"> <li>- Yaw Hesitations</li> <li>- Partial Cancellation of Pedal Commands with Lateral Stick Inputs</li> </ul>	<ul style="list-style-type: none"> <li>- Increased Yaw Nozzle Priority</li> <li>- Cut Out Lateral Stick Commands Above 60 deg AOA (not implemented)</li> </ul>

Flight test of the MATV system was conducted from July, 1993 to March, 1994. The first flight test phase consisted of functional check flights in Fort Worth and at Edwards Air Force Base (EAFB). The functional check flights verified safe non-vectoring aircraft operation. Phase II was the envelope clearance portion of the program. The objective for Phase II was to define an aircraft operational envelope for the tactical evaluation phase. The final phase of the flight test program was a tactical evaluation of the MATV capability by operational F-16 pilots from the 422nd Test and Evaluation Squadron. The purpose of the tactical evaluation was to collect data on the benefits of post-stall maneuvering.

Initial MATV flight test results demonstrated pitch axis handling qualities similar to those noted in the simulator and considered good. The lateral-directional handling qualities in the 35 to 45 degree AOA region were poor. However, the pilots were able to control the aircraft through this AOA region and even perform some limited maneuvering.

Above 45 degrees, the aircraft exhibited higher levels of lateral-directional stability and, consequently, better handling qualities. A nose right yawing tendency at these elevated AOA's resulted in an asymmetric yaw response to pedal commands. The general consensus from the flight test team was that the limited capability to maneuver in the 35 to 45 degree AOA region could potentially interfere with the tactical evaluation of the system.



## **FLIGHT TEST - RESULTS PRIOR TO OFP UPDATE**

<u>Angle of Attack Range</u>	<u>Longitudinal</u>	<u>Lateral-Directional</u>
30 to 55 degrees	Correlated Well with Simulator Predictions	Sideslip Excursions out to +/-15 Degrees Resulting in Inability to Roll Smoothly and Precisely
55 to Max degrees	Correlated Well with Simulator Predictions	Nose Right Yawing Tendency Resulting in Asymmetric Yaw Response

Because of poor lateral-directional flying qualities in the 35 to 45 degree AOA region, Lockheed chose to update the flight control laws in the middle of the flight test program. The traditional approach for this task consists of first updating the simulation aero data base to match flight test results. Then the updated sim is used to design the control law mods necessary to improve the flying qualities. Time and budgetary constraints on the MATV program disallowed this procedure. Therefore, Lockheed chose to pursue a 'dial-a-gain' approach to the control law update.

For the dial-a-gain approach, a set of critical flight control law feedback gains and paths could be varied by the pilot through the MFDS (as shown in the figure below). The gains included the beta and beta dot feedback gains, the yaw rate feedback gain at very high AOA and the stability axis roll rate feedback gain. The gains were varied over a range large enough to bound the flying qualities problem but yet small enough to preserve rigid body and structural mode stability margins. Paths that could optionally be left in or taken out included the lateral stick command to yaw nozzle at very high AOA's (above 60 degrees) and the rudder command path above 30 degrees AOA. The AOA range for which the directional axis transitioned from beta/beta dot feedback to yaw rate feedback could also be varied. Additionally, an option existed for using trailing-edge-flap only in the trailing edge up direction to roll the aircraft above 30 degrees AOA. The idea was that it is more efficient to 'kill' lift over a wing at high AOA than to generate lift.



## FLIGHT TEST - CONTROL LAW 'DIAL-A-GAIN' OFP UPDATE

CONTROL LAW OPTION (CLAW OPT)	TRIM DISC	AOA FEEDBACK (AOA7BLEV)	CONTROL LAW SETTING (CLAW SET)	BETA MULT (B MULT)	BETA DOT MULT (BDOTMULT)	STAB ROLL MULT (PSMULT)	DIFF SURF OPT (OPT DIFF)	YAW RATE MULT (YR MULT)	YAW CMD BREAK (YC BRK)	NO H AOA ROLL OPT (OPT H AOA)	NO RUDDER OPT (OPT RPR)
1	NORM	NORM	0 (NORM)	1.0							
			1	0.0							
			2	0.5							
			3	1.5							
4	2.0										
2	LEV1	NORM	0 (NORM)	1.0							
			1	0.0							
			2	0.5							
			3	1.5							
4	2.0										
3	LEV2	NORM	0 (NORM)			1.0	0				
			1			0.0	0				
			2			0.0	0				
			3			0.0	1				
4			0.0	2							
4	DISC	NORM	0 (NORM)					1.0			
			1				0.5				
			2				1.5				
			3				1.0				
4				1.5							
5	LEV1	NORM	0 (NORM)						40		
			1					35			
			2					45			
			3					50			
4					55						
6	LEV2	NORM	0 (NORM)							0	0
			1						1	0	
			2						1	1	
			3						1	1	
4							1	1			

**ADDITIONAL PVI NOTES:**

TRIM DISC switch in the NORM position selects a reduced/less sensitive roll stick command gradient (for AOA > 25 degrees only)  
 TRIM DISC switch in the DISC position selects the original (MATV first flight) roll stick command gradient

AOA FEEDBACK in NORM --> VERY HIGH AOA LIMITER not selected and "TRAILING-EDGE-FLAP UP ONLY" option not selected

AOA FEEDBACK in LEV1 --> VERY HIGH AOA LIMITER not selected and "TRAILING-EDGE-FLAP UP ONLY" option selected

AOA FEEDBACK in LEV2 --> 80 DEGREE AOA LIMITER selected and "TRAILING-EDGE-FLAP UP ONLY" option selected

The chart below summarizes the flight test results achieved following the control law OFP update.

First, a smooth, predictable roll response to lateral stick inputs was achieved in the 30 to 50 degree AOA region by optimizing the beta/beta-dot feedback gains. Second, the yaw rate feedback gains were selected based on heading angle captures performed at AOA's between 70 and 80 degrees. The nose right yawing tendency exhibited during the early flights was replaced by a slight nose left yaw tendency the was easily countered with pedal inputs. The final yaw response at the elevated AOA's was consistent for both left and right yaw commands.

The roll oscillations occurring around 55 degrees AOA were stabilized with the beta/beta-dot feedbacks. However, using beta and beta-dot feedback in the 55 to 60 degree AOA region degraded the yaw response to pedal inputs. Furthermore, the accuracy of the sideslip feedback source at the very high AOA's was questionable.

The decision was made to fade from the beta/beta-dot feedback to the yaw rate feedback between 50 and 60 degrees AOA. This fade region provided the best handling qualities improvements between 30 to 45 degree AOA region (CL<sub>max</sub>) and above 60 degrees AOA (yaw tracking using pedals). Flight in the 50 to 55 degree AOA regime typically occurred only as a transition from the CL<sub>max</sub> region to a yaw tracking region.



## FLIGHT TEST - RESULTS AFTER THE OFP UPDATE

<u>AOA Range</u>	<u>Longitudinal</u>	<u>Lateral-Directional</u>
30 to 50 degrees	Correlated Well with Simulator Predictions	Sideslip Excursions Typically Within +/-5 Degrees. Smooth and Predictable Roll Response.
50 to 60 degrees	Correlated Well with Simulator Predictions	Slight Wing Rock (+/-10 Deg.) at 55 Degrees AOA. Wing Rock Damped out at 60 Degrees AOA.
60 to Max degrees	Correlated Well with Simulator Predictions	Slight Nose Left Yawing Tendency That Was Easily Controlled. Smooth, Predictable Yaw Response to both Left and Right Pedal Inputs.

The tactical evaluation phase of the program was flown by pilots from the 422nd Tactical Evaluation Squadron stationed at Nellis Air Force Base. This evaluation consisted of 1V1 and 1V2 engagements between the MATV aircraft and two F-16's provided by the 422nd squadron. A limited number of 1V1 engagements against dissimilar aircraft (NASA F-18's) were also flown.

No control input (other than remaining between MIL and MAX power), aircraft rate, or aircraft attitude limitations were placed on the pilots during the tactical evaluation phase of the program. The pilots were able to maneuver the MATV aircraft without fear of aircraft departure. This ability to maneuver without fear of aircraft departure allowed the pilots to focus more on the tactical utility of the aircraft.

The handling qualities of the MATV system were not an issue during the tactical evaluation phase of the program. The pitch axis handling qualities were good. Lateral-directional flying qualities were adequate, requiring some pilot compensation to control the roll axis between 35 and 45 degrees AOA. Comprehensive results of the MATV tactical evaluation are classified and therefore are not covered in the contents of this presentation.



## ***FLIGHT TEST - TACTICAL EVALUATION PHASE***

**Tactical Evaluation Flown by Pilots from the 422nd Test and Evaluation Squadron Stationed at Nellis Air Force Base.**

- 1V1 and 1V2 Engagements
- Similar (F-16) and Dissimilar (F-18) Aircraft Engagements

**Standard Tactical Setups and Rules of Engagement Used...  
Bandits Allowed to Fly Their Best Fight.**

**No Control Input, Throttle Movement, Aircraft Rate, or Aircraft Attitude Limitations Imposed. Pilots Able to Maneuver Without Fear of Aircraft Departure.**

For the MATV program, a new control law was developed using multi-axis thrust vectoring to augment the aircraft's aerodynamic control power to provide maneuverability above the normal F-16 AOA limit. The control law architecture was developed using Lockheed Fort Worth's offline and piloted simulation capabilities. The final flight control laws were used in flight test to demonstrate tactical benefits gained by using thrust vectoring in air-to-air combat.

Differences between the simulator aero data base and the actual aircraft aerodynamics led to significantly different lateral-directional flying qualities during the flight test program than those identified during piloted simulation. Because of time and budgetary constraints, a 'dial-a-gain' flight test control law update was performed in the middle of the flight test program. This approach allowed for inflight optimization of the aircraft's flying qualities. While this approach is not preferred over updating the simulator aerodynamic data base and then updating the control laws, the final selected gain set did provide adequate lateral-directional flying qualities over the MATV flight envelope. The resulting handling qualities and the departure resistance of the aircraft allowed the 422nd pilots to focus entirely on evaluating the aircraft's tactical utility.



## **CONCLUSIONS AND RECOMMENDATIONS**

**Multi-Axis Thrust Vectoring Was Successfully Utilized to Augment the Aircraft's Aerodynamic Control Power to Provide Maneuverability Above the Normal F-16 AOA Limit.**

**Extensive Use of Piloted Simulation was Critical in the Development of the MATV Control Laws and the Refinement of Test Maneuvers.**

**The Ability to "Dial-a-Gain" in Flight Provided Acceptable Handling Qualities in the Presence of Extremely Tight Scheduling Constraints and Relatively Large Aerodynamic Uncertainties.**

**The Ability to Maneuver Without Control Input, Throttle Movement, Aircraft Rate, or Aircraft Attitude Limitations Allowed the 422nd Pilots to Successfully Evaluate the Tactical Utility of the System in a Relatively Short Time.**

26 pg

1995107835

N95-14249

323999

16090

p 26

# **MULTI-APPLICATION CONTROLS**

**robust nonlinear multivariable aerospace controls applications**

*Dale F. Enns*

**Honeywell Technology Center and University of Minnesota**

*Dan J. Bugajski*

**Honeywell Technology Center**

*John Carter, Bob Antoniewicz*

**NASA Dryden Flight Research Center**

**4th NASA HIGH ALPHA CONFERENCE**

**13 July 1994**



**MULTI-APPLICATION CONTROLS**  
**robust nonlinear multivariable aerospace controls applications**

*Dale F. Enns*

Honeywell Technology Center and University of Minnesota

*Dan J. Bugajski*

Honeywell Technology Center

*John Carter, Bob Antoniewicz*

NASA Dryden Flight Research Center

**ABSTRACT**

Control theory application has been advancing simultaneously with the increasing demands for performance, safety, and cost effectiveness in aerospace vehicles. Recent advances indicate that large portions of the requirements, model assumptions, and control laws can be reused across a variety of aerospace vehicles, including fighters, ASTOVL, launch vehicles, missiles, transports, unmanned aerial vehicles, and rotary wing vehicles. There are always unique features of any vehicle that make each application interesting, such as high angle-of-attack which is the subject of this paper, and precision tracking, autoland, transition in and out of hover, freewings, tilt rotor, and many others depending on the vehicle.

This paper will present the general methodology used to apply Honeywell's Multi-Application Control (MACH) and the specific application to the F-18 High Angle-of-Attack Research Vehicle (HARV) including piloted simulation handling qualities evaluation. Flight test evaluation is scheduled for late 1994. The general steps include insertion of modeling data for geometry and mass properties, aerodynamics, and propulsion data and assumptions; requirements specifications, e.g. definition of control variables, handling qualities, stability margins and statements for bandwidth, control power, priorities, position and rate limits. The specific steps include choice of independent variables for least squares fits to aerodynamic and propulsion data, modifications to the management of the controls with regard to integrator windup and actuation limiting and priorities,

e.g. pitch priority over roll, and command limiting to prevent departures and/or undesirable inertial coupling or inability to recover to a stable trim condition.

The HARV control problem is characterized by significant nonlinearities and multivariable interactions in the low speed, high angle-of-attack, high angular rate flight regime. Systematic approaches to the control of vehicle motions modeled with coupled nonlinear equations of motion have been developed. This paper will discuss the dynamic inversion approach which explicitly accounts for nonlinearities in the control design. Multiple control effectors (including aerodynamic control surfaces and thrust vectoring control) and sensors are used to control the motions of the vehicles in several degrees-of-freedom. Several maneuvers will be used to illustrate performance of MACH in the high angle-of-attack flight regime. Analytical methods for assessing the robust performance of the multivariable control system in the presence of math modeling uncertainty, disturbances, and commands have reached a high level of maturity. The structured singular value ( $\mu$ ) frequency response methodology will be presented as a method for analyzing robust performance and the  $\mu$ -synthesis method will be presented as a method for synthesizing a robust control system.

The paper will conclude with the author's expectations regarding future applications of robust nonlinear multivariable controls. The MACH methodology is currently being applied to the MCT/F-16 (features similar to AFTI and MATV versions of the F-16) by Lockheed Ft. Worth Co. and also to the F-117 by Lockheed Advanced Development Co. in the Air Force program "Application of Multivariable Control Theory to Aircraft Control Laws" (MCT). It has been applied to the McDonnell Douglas DC-X initial flight tests and the future rotation maneuver (0 to 360 degrees angle-of-attack). MACH is also being applied to the Daedalus Research Inc. Slaved Tandem Freewing (STF) which is a Vertical Launch and Recovery UAV that transitions between hover to wing-borne flight, for inner stabilization and outer trajectory control loops.

# INTRODUCING ... MACH

## Multi-Application Controls

- Multi-Application

- fighters: F-18, X-31, F-16, F-117A, F-15, YF-22
- transports: MD-11, L-1011
- guided weapons: EMRAAT, JDAM, APM
- launch vehicles: DC-X, AGNC
- unmanned aerial vehicles: STF-9B

- Control

- dynamic inversion for  $\dot{x} = F(x, u)$
- $\dot{y} = f(x, u) \equiv a(x) + b(x)u \Leftrightarrow u = g(x, \dot{y})$
- CV =  $y$ , defn.  $\Rightarrow$  zero dyns.  
where  $x = \begin{bmatrix} y \\ z \end{bmatrix} = \begin{bmatrix} \text{control variable} \\ \text{zero dyns.} \end{bmatrix}$
- desired dyns. (connections with ESS and LQ gains)
- act. pos. and rate limits and intgr. windup
- cmd. limits s.t. stable equil. always possible

- Methodology

- requirements (HQ, robustness, priorities, atm. dist., ...)
- model (mass, geom., aero., and propul. data lists)
- design (flt. control exper., dyn inv.,  $\mu$ -synthesis)
- analysis ( $\sigma$  and  $\mu$ )
- implementation (automatic code generation)

# TOPICS

## Multi-Application Control (MACH)

Feature	F-18 HARV	X-31	F-16 MCT	F-117	YF-22	STF UAV	DC-X rocket	Precision Weapon	F-15 HIDEK	L-1011
lstsq										
dyn inv										
cv										
daisy chain										
cmd limits										
priorities										
maneuvers										
HQ simul.										
$\mu$ anal.										
CONTROLH										

## Dynamic Inversion Block Diagram

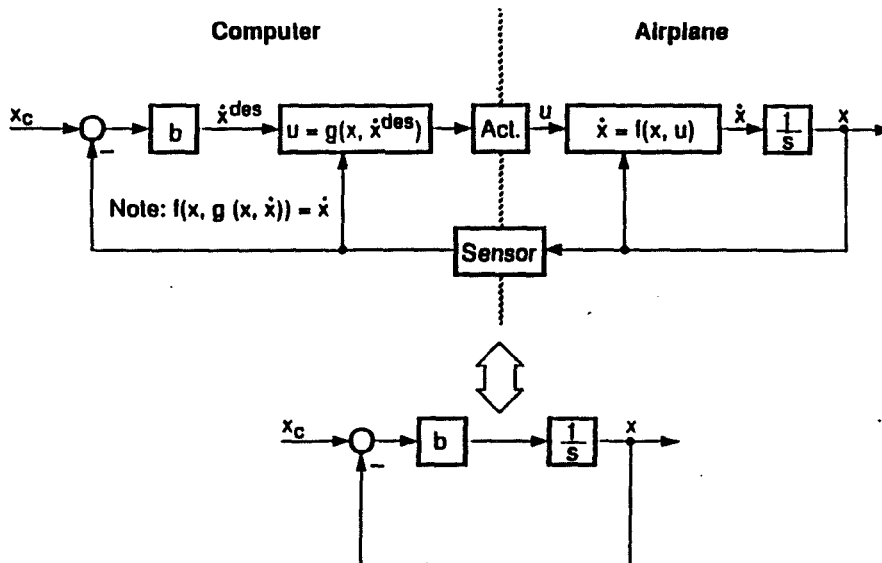

# DEFN. OF CONTROL VARIABLES CAN BE CONTROVERSIAL

- Definitions for Significant Airspeed

- LCV = roll rate (about velocity)
- MCV =  $C^*$  blend of  $q$  and  $nz$  or  $\alpha$  - trim( $h, V, \text{attitude}$ )
- NCV = blend of yaw rate and  $\beta$  - trim( $V, \text{attitude}$ )

- Definitions for Negligible Airspeed

- LCV = roll rate (about body axis)
- MCV = pitch rate (about body axis)
- NCV = yaw rate (about body axis)

- Alternate Definitions

- Euler Attitudes and Cartesian Coordinates for Hover
- $\alpha$  and  $\beta$
- $V, \chi, \gamma \rightarrow \text{Position } (\xi, \eta, h)$

- Issues

- want magnitude of MCV small in equilibrium flight to minimize pilot trim button activity
- want zeros of  $MCV/\delta_e(s)$  to be minimum phase because they will be closed loop poles
- small  $k_V$  and  $k_\gamma$  to stabilize phugoid

$$\begin{aligned}
 - \text{MCV} = & q + \frac{\bar{q} S C_{L\alpha}^{Ref} \alpha}{m V_c} - \frac{g}{V_c} \\
 & \frac{+g}{V} (\cos\gamma - 1) \\
 & + k_V \frac{S C_{L_{max}}}{m V_c} (\bar{q} - \bar{q}_{trim}) + k_\gamma \frac{g}{V_c} \sin\gamma
 \end{aligned}$$

# LEAST SQUARES MODELS

- Minimize  $\sum_k (C_k - \hat{C}_k)^2$
- By Fitting Parameters (linear solution to least squares problem)

- Aerodynamic

- nonlinear in  $\alpha$  and Mach  
(1 or 2 dimensional) table lookups
- drag quadratic terms if needed
- linear in body rates and aero surfaces

$$\hat{C}_k = C_k(\alpha) + C_{k_q}(\alpha) \frac{q\bar{c}}{2V} + C_{k_{\delta_e}}(\alpha) \delta_e \quad k = D, L, m$$

$$\hat{C}_k = C_{k_\beta}(\alpha) \beta + C_{k_p}(\alpha) \frac{pb}{2V} + C_{k_r}(\alpha) \frac{rb}{2V}$$

$$+ C_{k_{\delta_a}}(\alpha) \delta_a + C_{k_{\delta_r}}(\alpha) \delta_r \quad k = Y, l, n$$

- Propulsion

- function of throttle, altitude and airspeed

# DAISY CHAIN

- **Compromise Between Computational Complexity & Perf.**
  - primary controls used up to rate and position limits
  - then auxiliary controls used to assist as achievable
- **Linear With Position Limits**
  - Solution is known for  $y = Bu$  s.t.  $U_{\min} \leq u \leq U_{\max}$   
(have to minimize  $\|y - Bu\|$  when  $u$  on limits)  
(rectangular and non-rectangular limits)  
but solution may be computationally intensive, so
  - Approx. Solution for  $u_{\text{prim}}$  and  $u_{\text{aux}}$   
subject to the same limits, but work with smaller problem  
scalar, and  $2 \times 2$  and  $2 \times 3$  solutions
- **Linear With Rate Limits**
  - $\max(U_{\min}, u_{\text{old}} - r_{\text{lim}} T_s)$  and  $\min(U_{\max}, u_{\text{old}} + r_{\text{lim}} T_s)$
  - Perhaps not ideal for dynamic case  
(Current A.F. Ph.D. research)
- **Wide Range of Options Available**
  - ganging of surfaces prior to applic. of daisy chain
  - 3 chains with dynamic compensation for X-29
  - natural to incorporate forebody controls

# Daisy Chains ...

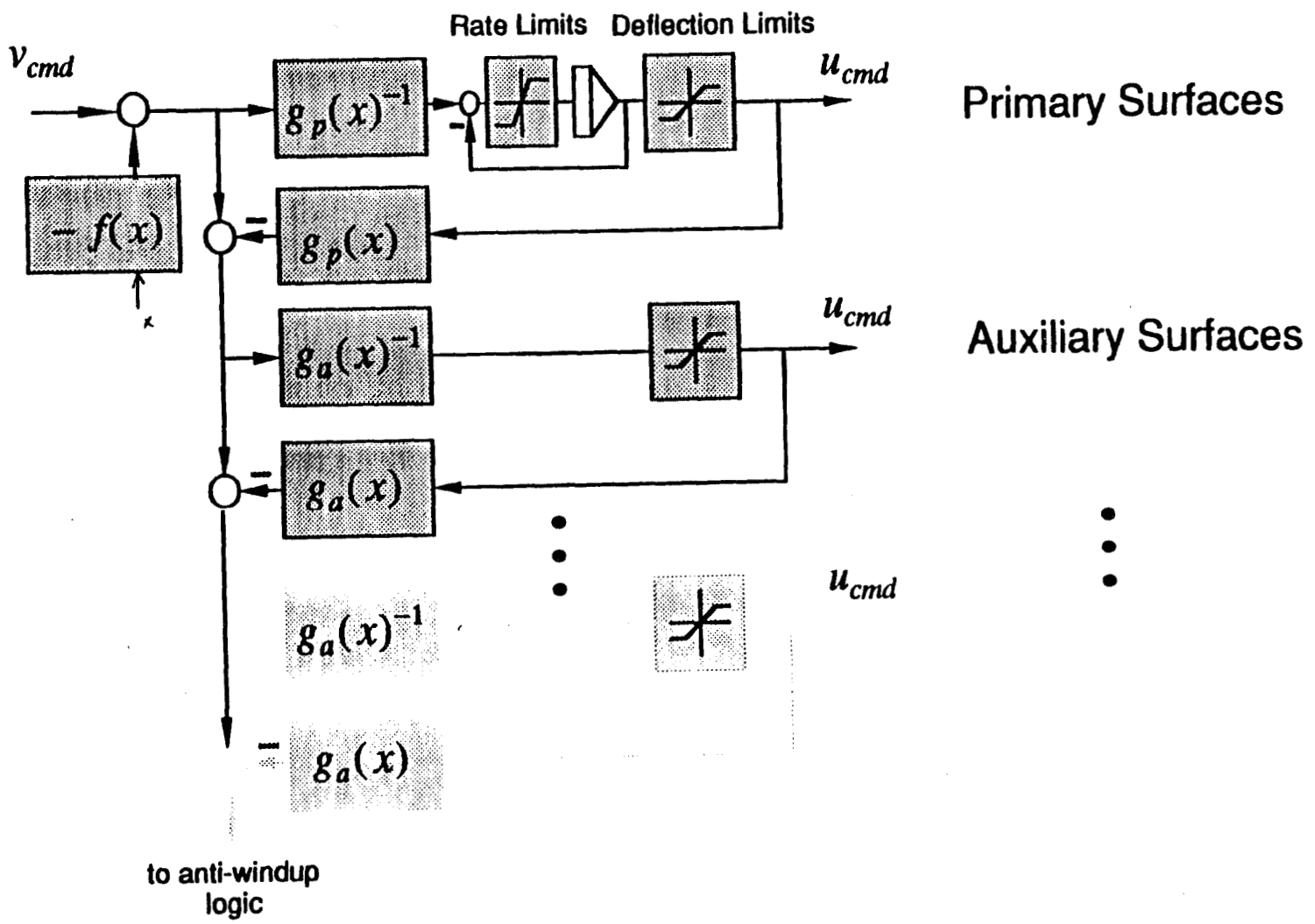



# F-18 HARV

- High Angle-of-Attack Flight Control
  - nonlinear aerodynamics ( $-10 \text{ deg} < \alpha < 100 \text{ deg}$ )
  - nonlinear rate and position limits
  - nonlinear equations of motion
- Aerodynamic Control Surfaces (primary)
  - aileron, rudder, diff. horiz. tail
  - horizontal tail
- Pitch, Roll, and Yaw Thrust Vectoring (auxiliary)
- ADA Code Generated Automatically with CONTROLH
  - Write Control Law in "Familiar Controls Language"
  - Benefit When Control Law Developed in Same Language
  - Use Translator To Obtain ADA or C or ...
  - Benefit When Control Law Developed in Same Language
  - Demonstrated With Daisy Chain Portion of MACH
- Scheduled for Flight Test in December 1994

## Handling qualities / Simulation Results

---

Cooper Harper ratings for a target tracking task on the Dryden piloted simulation - altitude 25000 feet

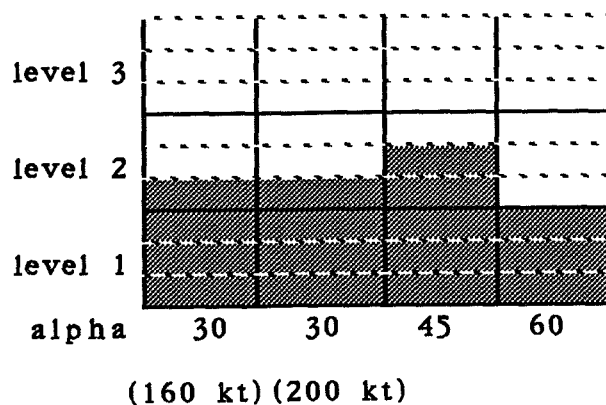

**Criteria**      **Desired:** No objectionable PIO. Pipper within 5 mils of aim point 50% of the task and within 25 mils of aim point for the remainder of the task.

**Adequate:** Pipper within 5 mils of aim point 10% of the task and within 25 mils of aim point for the remainder of the task.

## Handling qualities / Simulation Results

Cooper Harper ratings for a target tracking task on the Dryden piloted simulation - altitude 25000 feet

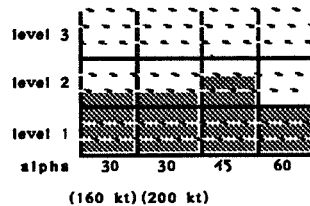

**Criteria**      **Desired:** No objectionable PIO. Pipper within 5 mils of aim point 50% of the task and within 25 mils of aim point for the remainder of the task.

**Adequate:** Pipper within 5 mils of aim point 10% of the task and within 25 mils of aim point for the remainder of the task.

This figure represents the results of a longitudinal and lateral tracking task performed on the Dryden simulation. The Dryden simulation has the ability to display target aircraft moving through a preprogrammed trajectory. In this case, the target starts at the altitude, 1500 feet in front of the HARV aircraft. The target aircraft rolls into a turn, uses maximum afterburner, and pulls to 30 degrees angle of attack. The aircraft then maintains that angle of attack throughout the maneuver, while adjusting the nose attitude to maintain either 160 kts (for 30 alpha 160 kt tracking and 45 alp tracking) or 180 kts (for 60 alpha tracking). The HARV aircraft rolls in behind the target aircraft using military power, and advances the throttles to maximum afterburner. Longitudinal and lateral tracking is performed by taking a lagged position to the target and then "pulling up" to track the target at the prescribed angle of attack. The Cooper Harper rating scale is then used to evaluate the pilots' ability to perform the task.

These results give an initial indication that adequate to desired handling qualities can be achieved using the Dynamic Inversion control design technique. Further work is being performed on this control law in the Dryden simulator to improve the tracking and handling qualities characteristics of this control law.

# Handling qualities / Simulation Results

Cooper Harper ratings for simulation tasks on the Dryden  
piloted simulation - altitude 25000 feet

## Theta Captures .4 Mach 1g

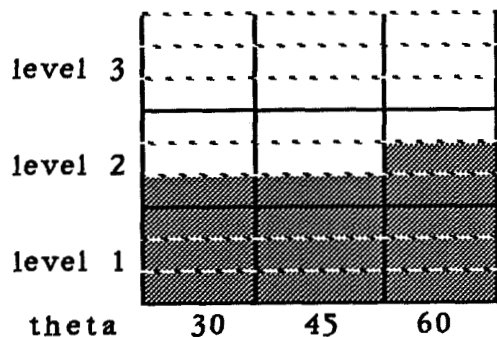

Criteria:            desired    adequate  
theta:            +/- 4 deg    +/- 7 deg

## 1 g 360 deg Roll / Heading Captures

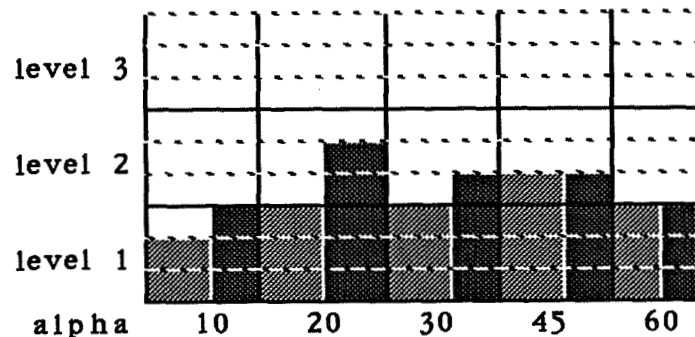

Criteria:            desired    adequate  
alpha:            +/-5 deg    +/-8 deg  
phi/ heading:    +/-10 deg    +/-20 deg

## Nz / Heading Captures

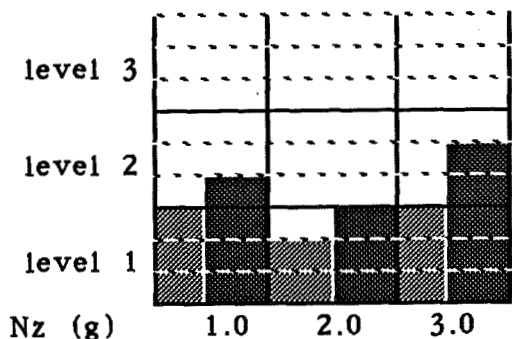

Criteria:            desired    adequate  
Nz:                +/- .2 g    +/- .3 g  
heading:        +/- 2 deg    +/- 6 deg

## Loaded Rolls .4 Mach

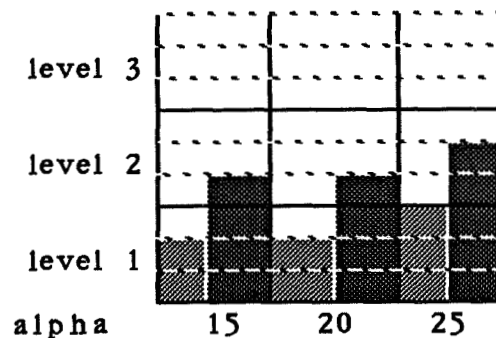

Criteria:            desired    adequate  
alpha:            +/-5 deg    +/-8 deg  
phi:                +/-10 deg    +/-20 deg

## Handling qualities / Simulation Results

Cooper Harper ratings for simulation tasks on the Dryden  
piloted simulation - altitude 25000 feet

### Theta Captures .4 Mach 1g

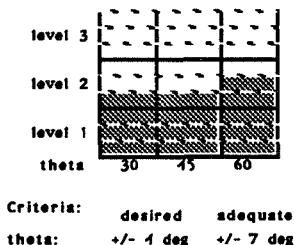

### 1 g 360 deg Roll / Heading Captures

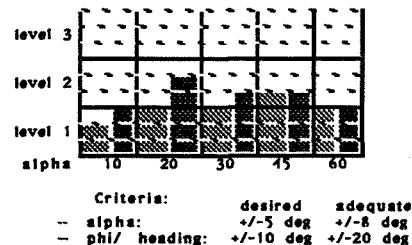

### Nz / Heading Captures

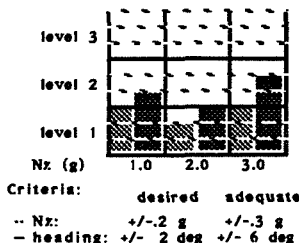

### Loaded Rolls .4 Mach

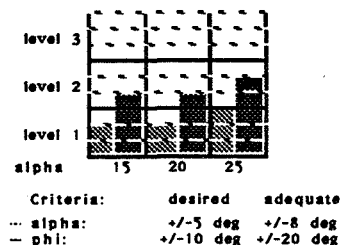

This figure represents a preliminary piloted evaluation of the NASA 2 control laws in the Dryden simulation. This piloted simulation has no pilot motion cues a limited visual field of view. These tasks were performed with a single HARV project pilot. The four tasks were as follows, all flown at 25000 feet:

#### Theta Captures :

The aircraft is trimmed at .40 Mach, 25000 feet at 1 g. The pilot then aggressively attempts to capture 30, 45, and 60 degrees pitch angle. The Cooper Harper rating scale is then used to evaluate the ability of the pilot to capture the prescribed bank angle with a minimum of overshoot within the desired or adequate criteria.

#### 1 g 360 deg phi/heading Captures:

The aircraft is trimmed at 25000 feet, 1 g, at the angle of attack shown. The pilot performs a 360 degree roll (heading change above 45 degree alpha) and then captures either wings level or a specified heading. Two Cooper Harper ratings are then used to evaluate the pilots' ability to maintain angle of attack and to capture the ending bank or heading angle.

#### Nz / Heading Captures:

The pilot performs a constant load factor turn at 25000 feet. Two Cooper Harper ratings are used to evaluate the aircraft ability to hold load factor and capture a 90 degree heading angle increment.

#### Loaded Rolls:

The aircraft is rolled at .40 Mach 25000 feet into a 90 degree bank angle at the prescribed angle of attack. The pilot then attempts to capture 90 degrees of opposite bank angle. Two Cooper Harper ratings are used per maneuver to evaluate the pilots' ability to hold angle of attack and capture the final bank angle.

The results of this study give an indication that adequate to desirable handling qualities can be achieved with the Dynamic Inversion flight control law architecture.

# X-31

- High Angle-of-Attack Flight and Trajectory Control
  - post stall maneuvers for tactical advantage
  - nonlinear aerodynamics ( $-10 \text{ deg} < \alpha < 100 \text{ deg}$ )
  - nonlinear rate and position limits
  - nonlinear equations of motion
- Aerodynamic Control Surfaces
  - wing t.e. and l.e. (inboard and outboard), rudder
  - canard
- Pitch, and Yaw Thrust Vectoring
- Maneuvers
  - Trajectory Optimization (Well, et. al., 1982 AIAA JGCD)
    - minimum time to turn
    - for different initial and final conditions
    - point mass assumptions
  - Dynamic Inversion of 6DOF rigid body equations
    - to determine realistic performance
    - establish demanding flight control law test cases

# Application of Multivariable Control Theory to Aircraft Control Laws

---

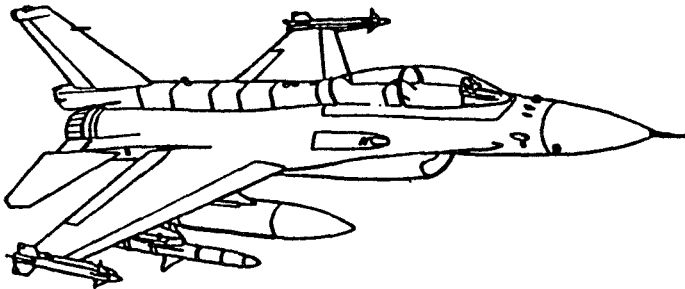
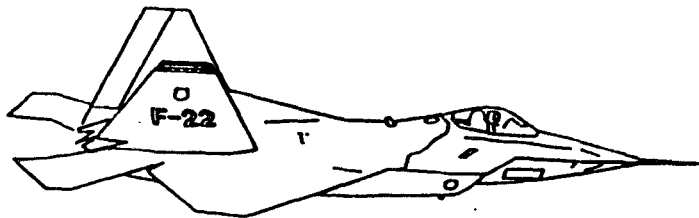
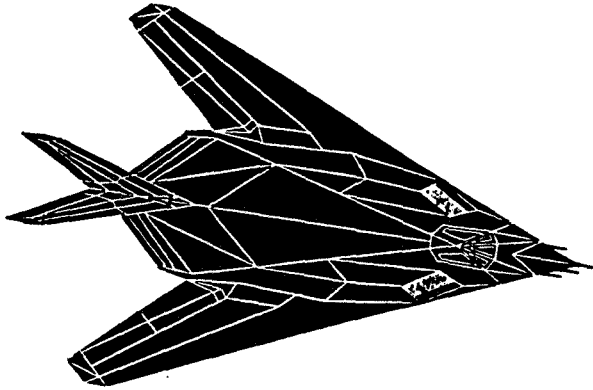

**Sponsor:** U. S. Air Force

**Team:** Honeywell, Lockheed Ft. Worth Company,  
Lockheed Advanced Development  
Company

**Objective:** Develop Design Guidelines

**Three Design Methods:**

- Dynamic Inversion
- Mu Synthesis
- Eigen-structure Synthesis

**Three Aircraft:**

- F-117
- YF-22
- MCT/F-16

**Four Maneuvers:**

- Flat Turns while strafing
- High  $\alpha$  bank captures
- Rapid pullup  $\alpha$  limit and bank capture
- Evaluated g bank-to-bank roll

**Honeywell**

## F-16

- Flight Control for Flat Turn and High  $\alpha$  Bank to Bank
  - include  $YCV = V\dot{\chi}$  for flat turn together with LCV, MCV, NCV
  - nonlinear aerodynamics ( $-10 \text{ deg} < \alpha < 100 \text{ deg}$ )
  - nonlinear rate and position limits
  - nonlinear equations of motion
- Aerodynamic Control Surfaces (primary)
  - aileron, rudder, vertical canard, diff. horiz. tail
  - horizontal tail
- Pitch and Yaw Thrust Vectoring (auxiliary)
- Pilot Command Limits
  - position and rate limits
  - anti-windup for integrators
  - pitch priority over roll
  - $p$  Command (or lateral stick) Limit
    - to prevent pitch departure
    - to prevent yaw departure



# F-117A

- Flight Control With Pilot Command Limits ( $\alpha$ ,  $p$ )
  - nonlinear aerodynamics ( $\alpha$ , Mach)
  - nonlinear rate and position limits
- Aerodynamic Control Surfaces
  - elevons and rudders
  - options to exploit inboard and outboard (for primary and auxiliary)
- Pilot Command Limits
  - $\alpha$  limiter
  - $p$  Limit
    - to prevent pitch and yaw departures
    - to satisfy hinge moment constraints
- Pullup to  $\alpha$  limit and Roll to 80 deg (with and without rudder failure)
- Approach and Landing
  - need to shut down integr. in control law when gear down
  - manual and not optimized for autoland

## YF-22

- Flight Control for
  - High  $\alpha$  Bank Capture
  - Elevated g Bank to Bank Roll
- Aerodynamic Control Surfaces
  - aileron, rudders, diff. horiz. tail
  - horizontal tail, flaperons, leading edge flaps
- Pitch Thrust Vectoring
- U.S. Air Force Program In Progress
  - Application of Multivariable Control Theory To Aircraft Control Laws
  - Honeywell, Lockheed Ft. Worth Company, and Lockheed Advanced Development Company
  - First Draft of Design Guidelines Avail. 1 October '94  
ESS, MACH, and MUSYN

## STF-9B

- Slaved Tandem Freewing
- Flight and Trajectory Control of VLAR UAV
  - mechanical implementation of key stabilization element
  - wide cg margin for fixed GCS requirements
  - transition from hover or thrust-borne to flight or wing-borne flight and back to hover
- Aerodynamic Control Surfaces
  - canards in prop wash
  - wing t.e. flaps

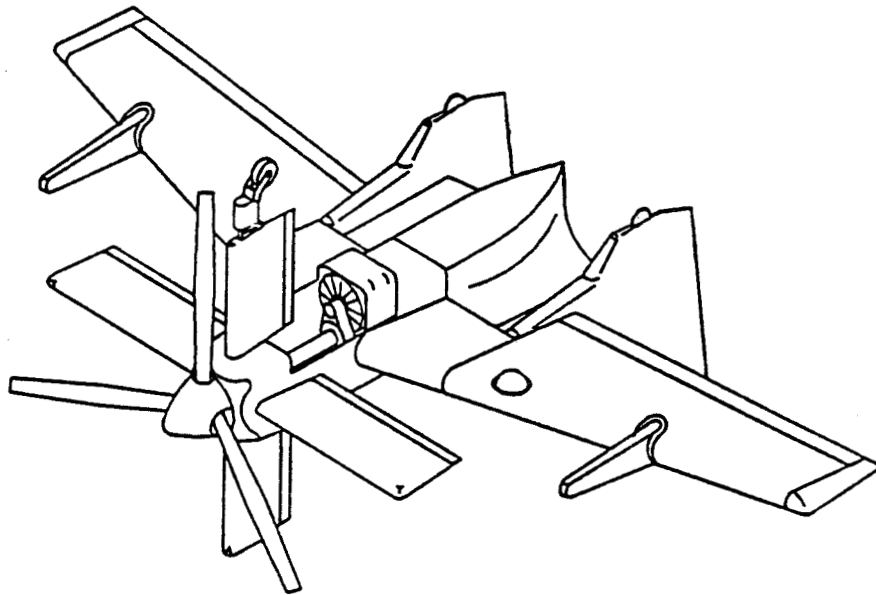

# DC-X

- High Angle-of-Attack and Zero Speed Flight and Trajectory Control
  - nonlinear aerodynamics ( $-180 \text{ deg} < \alpha < 180 \text{ deg}$ )
  - nonlinear rate and position limits
  - nonlinear equations of motion
- Engine Gimbal Thrust Vectoring (primary)
- Aerodynamic Body Flaps (auxiliary)
- Trajectory Control Demonstrated
  - Cartesian Coordinates ( $\alpha$ ,  $\gamma$  not defined for low speed)
  - Use  $\delta$  to control  $\theta$  to control  $\xi$ , and  $T$  to control  $h$
  - Use LQ to select gains for hover flight condition  
desirable stability margins and closed loop poles
  - Use robustness theory and bound for airspeed  
singular value frequency response test
- Trajectory Control Imagined
  - Re-entry from orbit like NASP  
energy and 3D position mgmt.
  - Rotation Maneuver Prior to Hover and Vert. Landing  
early demonstration of MACH reusability

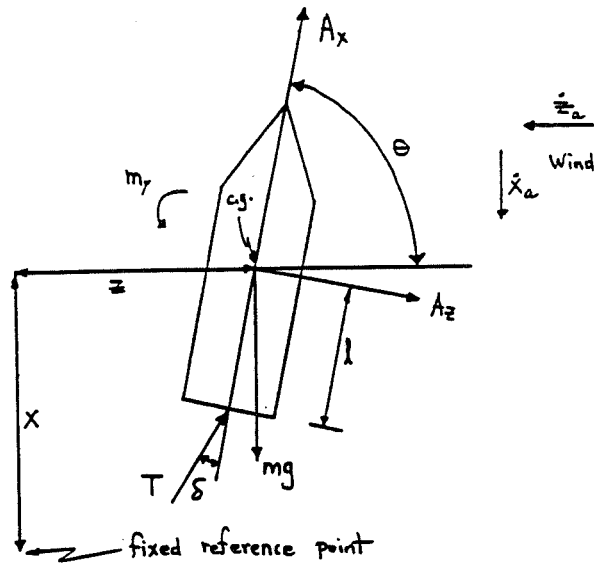

$$m\ddot{x} = T \sin(\theta - \delta) - mg - A_z \cos\theta + A_x \sin\theta$$

$$m\ddot{z} = T \cos(\theta - \delta) + A_x \sin\theta + A_z \cos\theta$$

$$I_{yy} \ddot{\theta} = T l \sin\delta + m_y$$

$$\bar{q} = \frac{1}{2} \rho [(x + \dot{x}_a)^2 + (\dot{z} + \dot{z}_a)^2]$$

$$A_x = \bar{q} C_{Lx}(\alpha)$$

$$\alpha = \theta + \tan^{-1} \left( \frac{\dot{z} + \dot{z}_a}{\dot{x} + \dot{x}_a} \right)$$

$$A_z = \bar{q} C_{Lz}(\alpha)$$

$$m_y = \bar{q} S L \left( C_{m\alpha}(\alpha) + C_{m\dot{\alpha}} \frac{L \dot{\theta}}{2\sqrt{(\dot{x} + \dot{x}_a)^2 + (\dot{z} + \dot{z}_a)^2}} \right)$$

rotation to near hover, b4, Fri Feb 7 07:45:16 CST 1992

xh plane from pos y axis

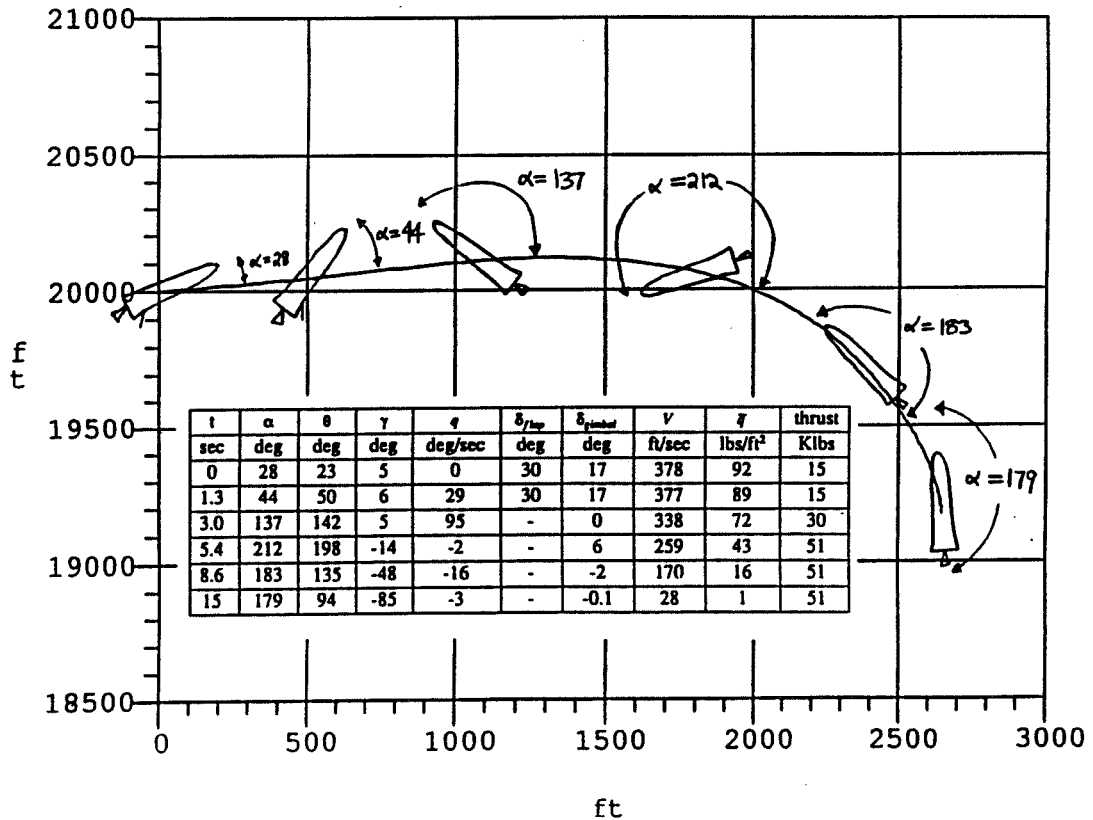

# Precision Weapons

- JDAM, EMRAAT, APGM
- Flight and Trajectory Control of Precision Guided Weapon
  - miss distance and impact angle constraints
  - skid to turn so  $CV = \text{accels.} \perp \text{Velocity}$
- Controls
  - aerodynamic fins
  - thrust vectoring
  - reaction control

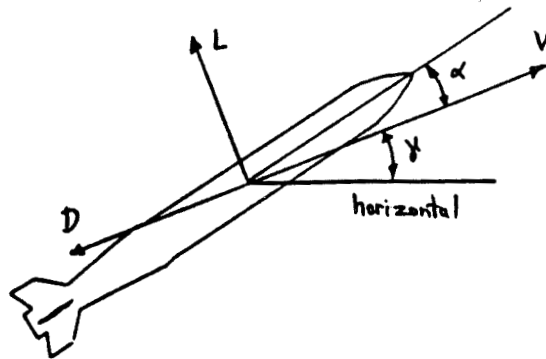

• Target/Munition Kinematics ( $\gamma_i = -60 \text{ deg}$ )

$$\xi = (h_T - h) \cos \gamma_i - [(x_T - x) \cos \chi_T + (y_T - y) \sin \chi_T] \sin \gamma_i$$

$$\dot{\xi} = V [-\sin \gamma \cos \gamma_i + \cos \gamma \cos(\chi - \chi_T) \sin \gamma_i]$$

$$\ddot{\xi} = V \dot{\gamma} [-\cos \gamma \cos \gamma_i - \sin \gamma \cos(\chi - \chi_T) \sin \gamma_i] + \dot{V} [-\sin \gamma \cos \gamma_i + \cos \gamma \cos(\chi - \chi_T) \sin \gamma_i]$$

$$+ V \dot{\chi} [-\cos \gamma \sin(\chi - \chi_T) \sin \gamma_i] + V \dot{\chi}_T [\cos \gamma \sin(\chi - \chi_T) \sin \gamma_i]$$

• Desired Acceleration Towards Line

( $\omega_\xi = 2 \text{ rad/sec}$ ,  $\zeta = 0.7$ )

$$\ddot{\xi}^d = \text{limit} [ -\omega_\xi^2 \xi - 2\zeta \omega_\xi \dot{\xi} ]$$

where limits depend on min and max angle-of-attack

• Desired Flight Path Angular Rate

(approximate dynamic inversion because assumes  $\chi = \chi_T$ )

$$\dot{\gamma}^d = \frac{-\dot{\xi}^d}{V \cos(\gamma_i - \gamma)}$$

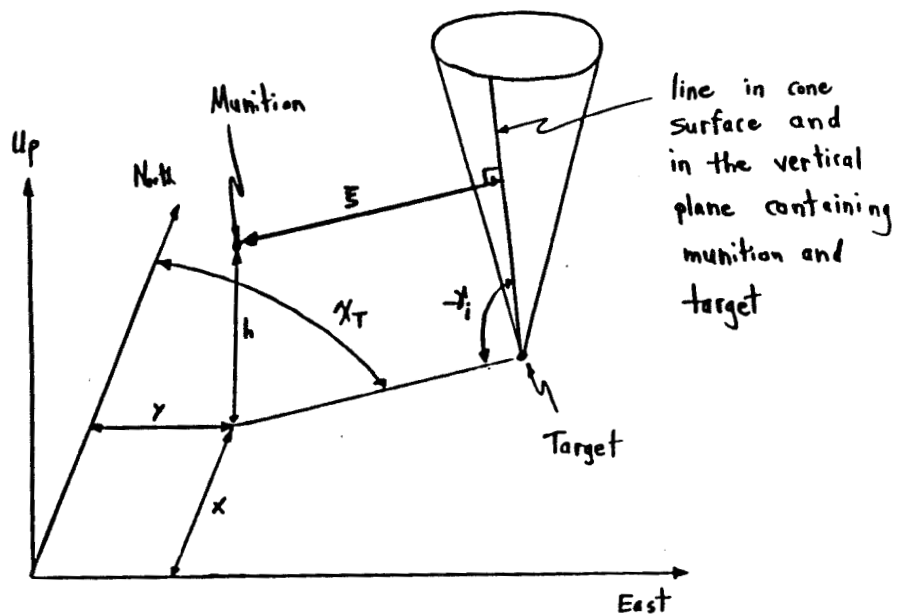

# F-15 HIDE C

- Supersonic Flight Control and Cruise Optimization
  - inner and outer loops to hold Mach and altitude
  - Open Loop Mach 2,  $h = 45\text{K ft}$   
 $\omega_{sp} = 6.2 \text{ rad/sec}$ ,  $\zeta_{sp} = 0.16$ ,
  - Dynamic Inversion Bandwidth Gains Adjusted  
Bode Loop Design Crossover Freq. =  $5 \text{ rad/sec} < \omega_{sp}$   
In Conflict With Large Stability Margins and  
IMPACT Design Rule Established  
Between P+I gains and Bode  $\omega_c$ , PM, and  $V_c$
- Aerodynamic Control Surfaces
  - horizontal tail and variable inlet geometry
- Outer Loops Closed Around (Manual) Inner Loops
- Minimize Cruise Trim Drag
- Autothrottle and Redundant Pitch Controls

# L-1011

- Wide Body Commercial Jet Transport
- Flt. and Traj. Control for Cruise Optimization
  - Mach and altitude hold
  - redundant longitudinal controls
  - aerodynamic models too inaccurate for perf. opt.
  - motivates real time approach
- Controls
  - horizontal tail and elevator
  - symmetric aileron
- Search over Redundant Controls
  - while  $CV = \text{constant}$ , in this case Mach and altitude
  - but  $\alpha$  and trim drag varies
  - to minimize throttle setting

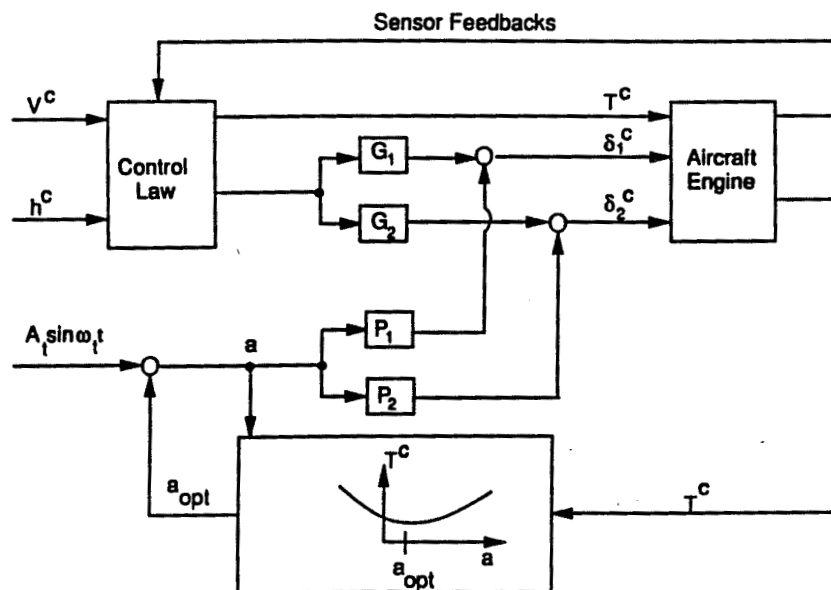



# **SUMMARY**

- **Dynamic Inversion Offers an Attractive Alternative Flight Control Design Methodology**
  - gain scheduling replaced with models
  - easy to iterate and update
  - easy to re-use
- **Full State Info and On-board Models Made Possible by Current Instrumentation and Flight Computers**
- **Design Examples Illustrate Potential**
- **Further Theoretical Support Needed in Areas of Robustness Analysis and Synthesis (linear/nonlinear) and Characteristics of Zero Dynamics and Daisy Chain**

20pg

1995107836 N95-14250  
324001

16099

P-19

**COMBAT AGILITY MANAGEMENT SYSTEM  
(CAMS)**

**ANDREW SKOW  
WILLIAM PORADA**

**EIDETICS AIRCRAFT, INC.  
TORRANCE, CALIFORNIA**

**NASA FOURTH HIGH-ANGLE-OF-ATTACK CONFERENCE  
DRYDEN FLIGHT RESEARCH CENTER  
EDWARDS, CALIFORNIA**

**JULY 12-14 1994**

## **COMBAT AGILITY MANAGEMENT SYSTEM (CAMS)**

The proper management of energy becomes a complex task in fighter aircraft which have high AOA capability. Maneuvers at high AOA are accompanied by high bleed rates (velocity decrease), a characteristic that is usually undesirable in a typical combat arena. Eidetics has developed under NASA SBIR Phase I and NAVAIR SBIR Phase II contracts, a system which allows a pilot to more easily and effectively manage the trade-off of energy (airspeed or altitude) for turn rate while not imposing hard limits on the high AOA nose pointing capability that can be so important in certain air combat maneuver situations. This has been accomplished by incorporating a two-stage angle-of-attack limiter into the flight control laws. The first stage sets a limit on AOA to achieve a limit on the maximum bleed rate (selectable) by limiting AOA to values which are dependent on the aircraft attitude and dynamic pressure (or flight path, velocity and altitude). The second stage sets an AOA limit near the AOA for  $C_{lmax}$ . One of the principal benefits of such a system is that it enables a low-experience pilot to become much more proficient at managing his energy. The Phase II simulation work is complete, and an exploratory flight test on the F-18 HARV is planned for the Fall of 1994 to demonstrate/validate the concept. With flight test validation, the concept should be seriously considered for incorporation into future fighter aircraft.

E I D E T I C S

---

## **COMBAT AGILITY MANAGEMENT SYSTEM (CAMS)**

### **PRESENTATION OUTLINE**

- **MOTIVATION**
- **CONCEPT DESCRIPTION**
- **DEVELOPMENT APPROACH**
- **CURRENT STATUS**
- **POTENTIAL FUTURE APPLICATIONS**

## COMBAT AGILITY MANAGEMENT SYSTEM (CAMS)

Fighter agility is sometimes expressed as the ability of an aircraft to change its maneuver plane. The important parameters that determine the level of agility are typically expressed as a combination of energy-maneuverability and transient controllability or "point and shoot" capability. Energy-maneuverability is defined as the dynamic interchange between kinetic (based on velocity) and potential (based on altitude) energy gained or lost and the change in flight path or flight path curvature (turn rate, etc.). Managing the available energy optimally for any given combat situation is a very difficult and taxing task for all pilots, particularly for those who are relatively inexperienced. If a fighter is engrossed in high angle of attack maneuvers, it is very easy to lose velocity or "bleed energy" at a rate that will shortly put him at high risk. Bleed rates of 30 - 40 knots/sec<sup>2</sup> are not uncommon. One means of restricting the bleed rate is to limit angle of attack, and, therefore reduce the drag. But scheduling the AOA limit is not optimum for all flight attitudes (flight path angles). The "optimum" limit will depend on whether the maneuver is a level turn, a pull-up, slit-s, etc. And, usually, there is no override capability available to the pilot.

CAMS is designed to improve this situation and to make it easier for the pilot to manage his energy intelligently and to significantly reduce his work load. This concept utilizes a two-stage AOA limiter that is overridable by the pilot with an automatic reset under specific conditions. The following charts will review the development of CAMS and discuss the future potential for application.

E I D E T I C S

---

## COMBAT AGILITY MANAGEMENT SYSTEM

- **AGILITY IS TYPICALLY THOUGHT OF AS A COMBINATION OF:**
  - ENERGY-MANEUVERABILITY
  - TRANSIENT CONTROLLABILITY
  
- **ENERGY-MANEUVERABILITY IS DEFINED AS THE DYNAMIC INTERCHANGE BETWEEN:**
  - KINEMATIC AND POTENTIAL ENERGY GAIN OR LOSS
  - FLIGHT-PATH CURVATURE
  
- **MANAGING YOUR AIRCRAFT'S AVAILABLE ENERGY WHILE MANEUVERING AGGRESSIVELY IN AIR-TO-AIR COMBAT AGAINST MULTIPLE ADVERSARIES IS A VERY DIFFICULT TASK.**
  - AIRSPEED "BLEED" RATES OF GREATER THAN 30-40 KNOTS/SECOND ARE TYPICAL
  - TACTILE CUES ARE REDUCED DUE TO ADVANCED AERODYNAMICS
  
- **ANGLE OF ATTACK LIMITERS CAN PROVIDE SOME "ENERGY MANAGEMENT" HELP TO A PILOT**
  - SCHEDULING IS NOT OPTIMUM FOR ALL FLIGHT ATTITUDES
  - PILOT OVERRIDE IS USUALLY NOT POSSIBLE DUE TO DEPARTURE CONCERNS
  
- **COMBAT AGILITY MANAGEMENT SYSTEM (CAMS) IS DESIGNED TO MAKE IT EASIER FOR A PILOT TO MANAGE THE DYNAMIC TRADE-OFF BETWEEN ENERGY AND MANEUVERABILITY**
  - USES A THREE-STAGED "ADAPTIVE" ANGLE-OF-ATTACK LIMITER TO CONTROL AIRSPEED LOSS RATE
  - PROVIDES FOR PILOT OVERRIDE AND AUTOMATIC RESET

## F/A-18 MANEUVERING DIAGRAM 15,000 FT ALTITUDE

The F/A-18 maneuvering diagram for 15,000 ft altitude is shown below. If we initiate a level turn at maximum turn rate, or at  $M=0.63$ , as shown on the chart, we can consider that the aircraft is going to up the chart below at  $M=0.63$  (with steadily increasing angle of attack) until it reaches the "corner speed" at a turn rate of approximately 20 deg/sec. From that point, holding the angle of attack for maximum lift (approximately  $34^\circ$ ), the Mach number and turn rate decrease, for example, to 4 deg/sec at  $M=0.2$ . One of the important aspects of performing a level turn as just described is the loss in velocity, or bleed rate that accompanies it. The chart following this illustrates the change in turn rate with loss in bleed rate and will serve to illustrate why CAMS is important.

E I D E T I I

## F/A-18 MANEUVERING DIAGRAM 15,000 FT ALTITUDE

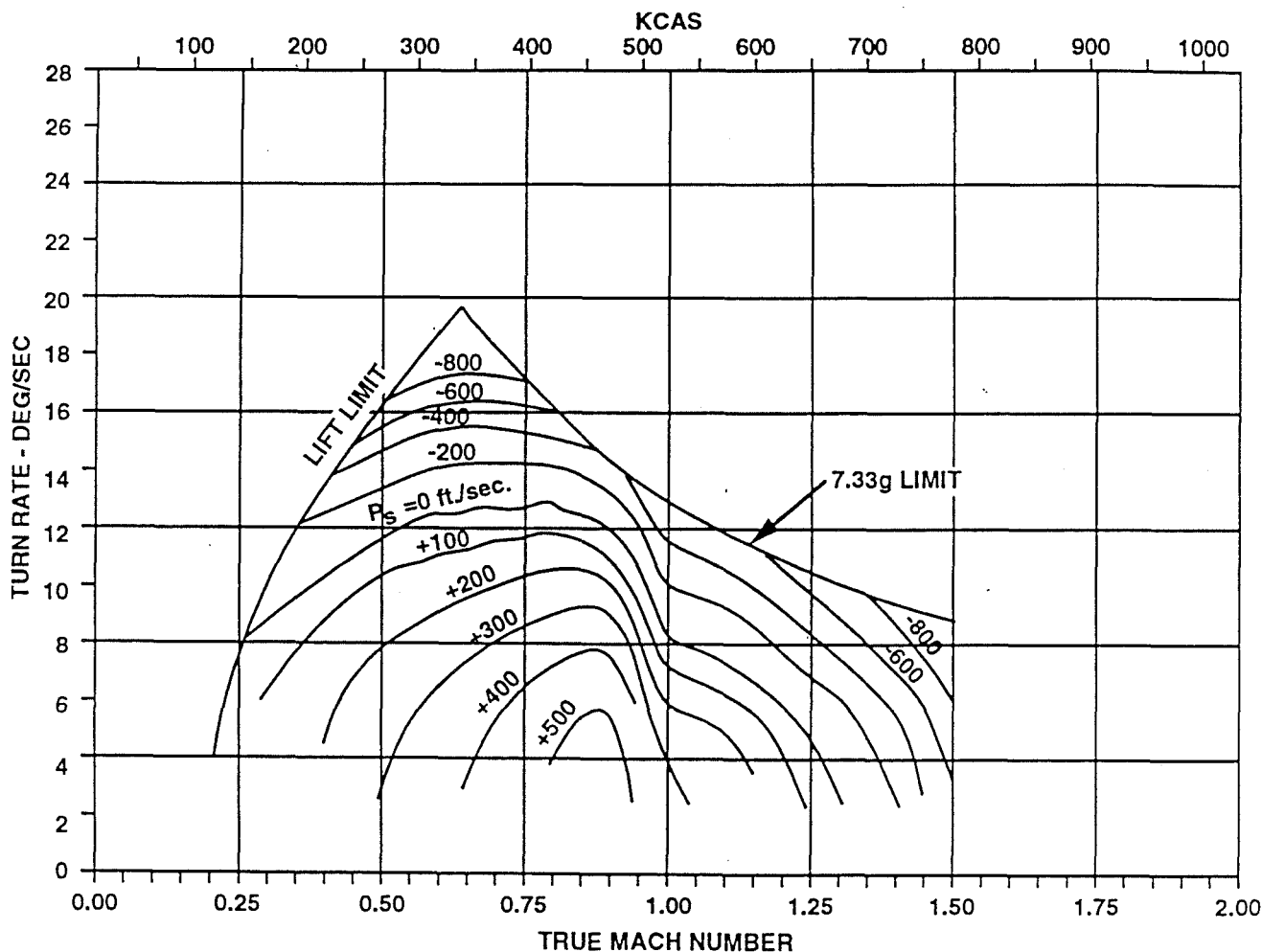

## F/A-18 TURN RATE VS BLEED RATE 15,000 FT ALTITUDE

This chart shows the turn rate plotted versus bleed rate as a result of a level turn performed as described in the previous chart, i. e., rapidly increasing angle of attack at a constant Mach number of 0.47 (corner speed for 15,000 ft altitude) and then holding AOA for maximum lift (approximately 34°). The chart shows several important points. As you increase the turn rate the proportional penalty that must be paid in bleed rate is increasing. Increasing angle of attack beyond that for maximum lift (approximately 34°) would result only in an increase in bleed rate and no benefit in turn performance. Holding AOA for maximum lift results in a decreasing bleed rate, but at the expense of reduced turn rate. The purpose of CAMS is to help pilot to "optimize" his bleed rate so that he can accomplish the maximum turn rate integrated over the course of the entire maneuver. Obviously, increasing angle of attack prior to maximum lift will increase the turn rate, but will cost in terms of bleed rate, resulting in a final velocity that may be too low. CAMS can help by automatically limiting the maximum bleed rate (by limiting AOA, with pilot selectable override options).

E I D E T I C S

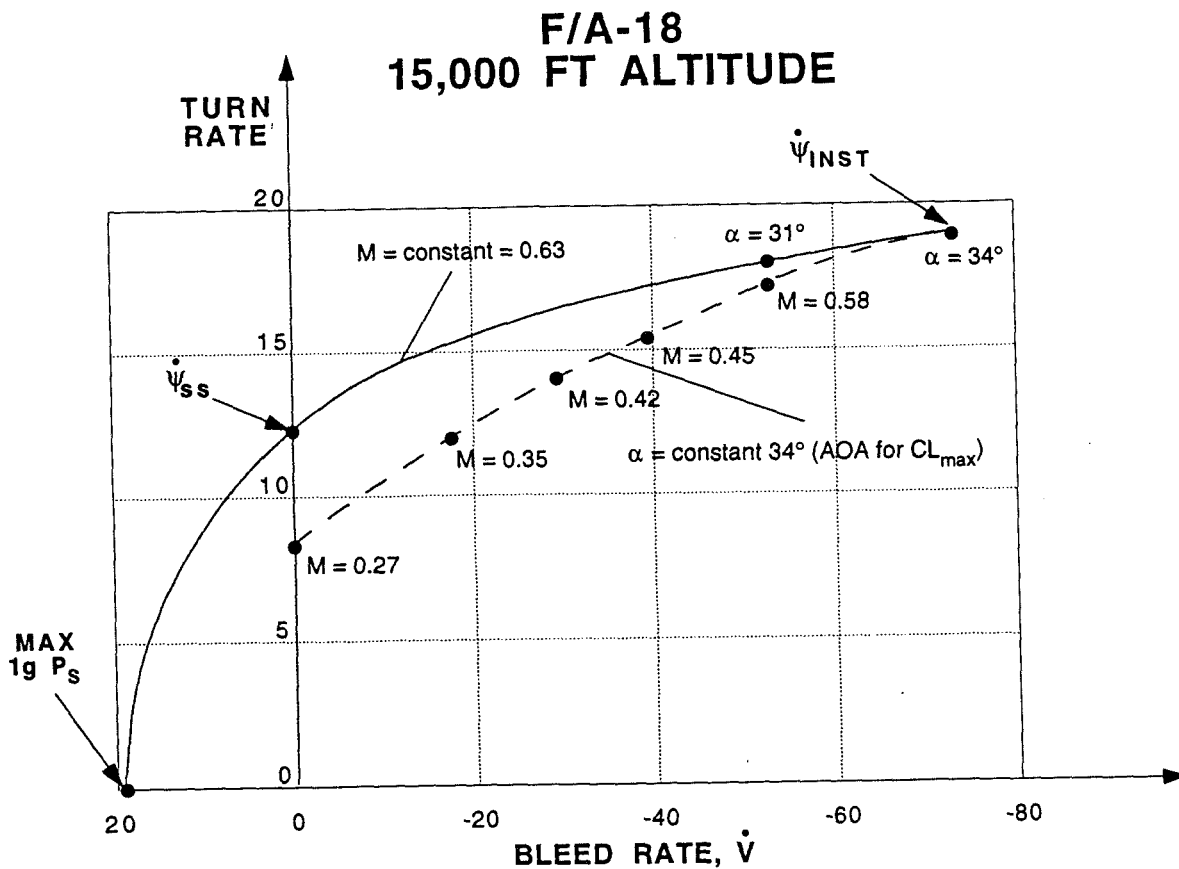

## F/A-18 LIFT AND DRAG M=0.6

The plots below show lift coefficient plotted versus angle of attack and drag coefficient. The primary point illustrated is related to the discussion in the last chart, which shows clearly that a small increase in angle of attack near maximum lift (to gain additional lift) can result in a large penalty in drag (resulting in a large increase in bleed rate). If angle of attack is pushed beyond maximum lift, of course there is a loss of lift (and turn rate) and an excessive increase in drag. To maximize the effectiveness of a maneuver, and, in particular, to choose the best turn rate without losing excessive velocity, is difficult. CAMS is designed to prevent the pilot from flying into a situation that is far from the optimum and will leave him vulnerable.

E I D E T I

## F/A-18 LIFT AND DRAG M=0.6

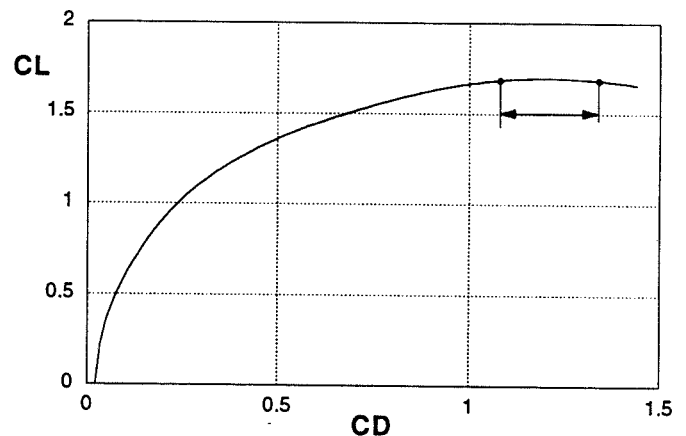
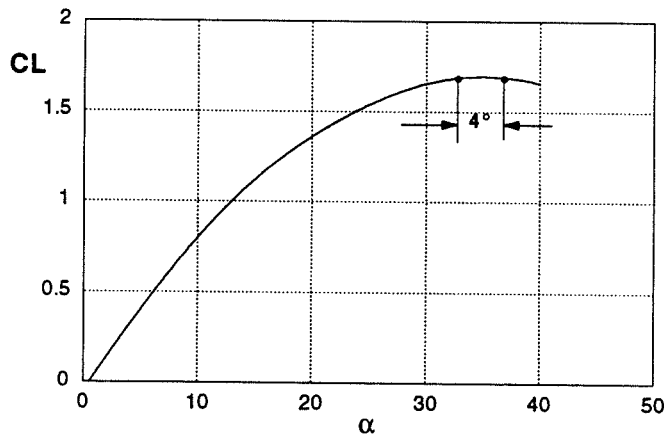

# CAMS

## MODES OF OPERATION

This chart illustrates the many modes of CAMS that were investigated and could be implemented. The key outcome of this study are highlighted by the shaded boxes. The first stage or mode is focused on limiting the bleed rate to some value chosen based on either simulation studies or by experience in flight. The second stage or mode is limiting angle of attack to that just below that for maximum lift. The third mode, related at post-stall (at angles of attack beyond maximum lift) is focused simply on limiting the angle of attack to a range where the aircraft is controllable.

E I D E T I C S

## CAMS

### CAMS MODES OF OPERATION

Mode	Dynamic Characteristics					
	$N_z$	$\alpha$	$C_L$	$P_s - \dot{V}$	Turn Rate	Nose Rate
1. AOA - limiting for 'optimum' energy/velocity bleed rate	Limited to less than $N_{zMAX}$ below some Mach No.	Limited to less than $C_{LMAX}$ , Typically $15^\circ - 25^\circ$	Less than $C_{LMAX}$ @ Typically $L/D = 4 - 6$	Limited to 'optimum' bleed rate	Less than maximum	Less than maximum
2. AOA - limited to max turn rate	Structural Limit ( $N_{zMAX}$ ) above corner, $N_z$ for max lift below corner	Limit to $N_z$ $N_{zMAX}$ or $C_{LMAX}$	Maximum lift below corner	Large bleed rates when on limiter	Maximum capability throughout conventional envelope	Maximum available above corner -- equal to turn rate below corner
3. Post Stall Maneuvering	$N_{zMAX}$ above corner	Limit to controllable AOA ( $70^\circ?$ )	Less than $C_{LMAX}$ when above AOA for $C_{LM}$	Very large bleed rates above AOA for $C_{LM}$	Maximum capability throughout expanded envelope	Maximum capability throughout expanded envelope



## DEVELOPMENT APPROACH

A number of algorithm approaches were discussed in the Phase I effort, but the most promising concepts resulted in the following approaches:

- Scheduled AOA limit as a function of flight condition.
- $P_S$  limiting.
- Bleed rate limiting.

In the Phase I study, Eidetics demonstrated the feasibility of these three approaches by modifying the F-16 flight control system. The latter two concepts are effectively forms of an adaptive AOA control where AOA is commanded by an outer loop closure on  $P_S$  or bleed rate. The first concept is just a modification of the aircraft's nominal flight control system angle of attack limiter. For the Phased II effort, the three concepts were mechanized into an F-18 six degree of freedom real-time flight simulation. The control system design effort involved generating linear state space models at trim points throughout the flight envelope of the aircraft. Continuous system loop closure design was then done at each trim point using *EASY5*, a Boeing controls design software tool.

A comprehensive review of existing published data on the subject of agility management was done. Most of the reports discussed various metrics defining agility, however, did not address a flight controls application to agility management.

---

E I D E T I C

## DEVELOPMENT APPROACH

## CONTROL LAW IMPLEMENTATION

The intended implementation objective of CAMS is that it be non-flight critical where the system is a stable addition to the aircraft's nominal control law set. The implementation is viewed as a separate stand-alone algorithm which does not interfere with the operation of the basic aircraft flight control system. The implementation also exhibits no adverse effects on the aircraft flight characteristics since the system acts as a limiter (not an augments) on the basic system. Stability and good handling qualities can easily be achieved with the variety of sensed quantities available on the F-18 and with good controls simulation and analysis tools at Eidetics. The implementation also allows override of CAMS and on/off capability as well.

E I D E T I C S

---

## CONTROL LAW IMPLEMENTATION

- **LOW RISK - CAMS IS A STABLE CONTROL SYSTEM ADDITION THAT OPERATES AS A LIMITER ON THE AIRCRAFT'S NOMINAL CONTROL LAWS.**
- **EXHIBITS NO ADVERSE EFFECTS ON THE AIRCRAFT FLIGHT CHARACTERISTICS.**
- **DOES NOT INTERFERE WITH THE OPERATION OF THE BASIC AIRCRAFT FLIGHT CONTROL SYSTEM.**
- **CAPABILITY TO OVERRIDE OR DISENGAGE CAMS IS PROVIDED.**

# CAMS CONTROL LAW MECHANIZATION

The desired implementation of the CAMS algorithm is shown in the figure below. Input to the CAMS control law requires sensor information, bleed rate (or  $P_S$ ) level, and override commands from the cockpit. The output from the algorithm supplies a limit value on the nominal system control laws. This limit value may be a total tail command or a forward path error limit, either of which could be mechanized. For the Phase II study, a limit on the forward path error implemented. When the limit is exceeded by the nominal system, the nominal system set of feedbacks and commands are cut off which allows the CAMS control law to close the loop around the airframe. The system returns to normal operating state when the signal drops below the CAMS limit value.

E I D E T I C

## CAMS CONTROL LAW MECHANIZATION

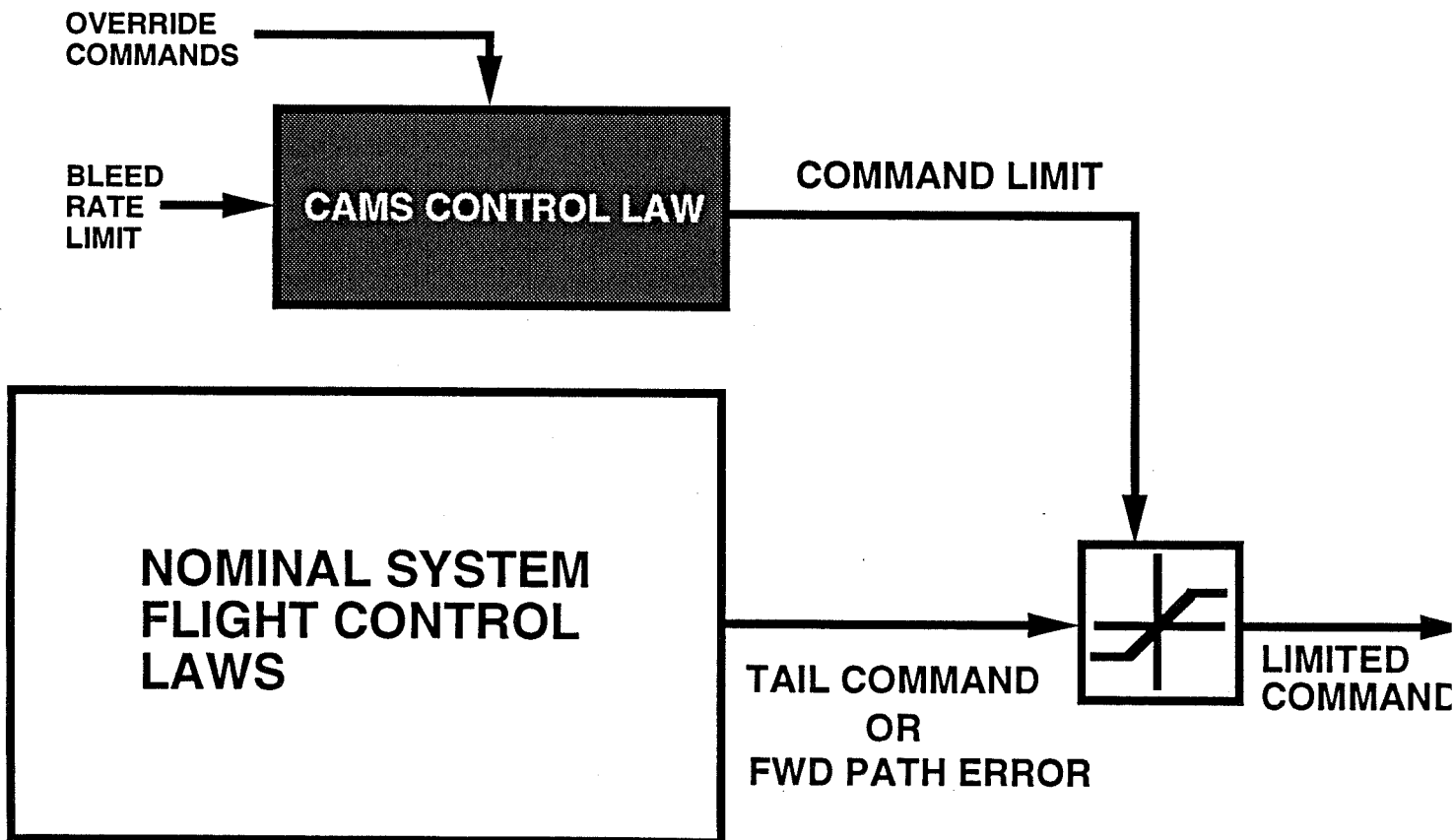

## DESIGN APPROACHES CONSIDERED

The three types of limiters studied in the Phase II effort were designed and implemented in Eidetics F-18 simulator. It was found that the scheduled angle of attack limiter type, which does not directly control bleed rate or  $P_S$ , is non-adaptive to changes in atmospheric conditions, aircraft weight and cg, or changes in thrust level. The angle of attack limit is then based on off-line analysis for a fixed set of conditions. The implementation of this type of system may also require altering the nominal system flight control command path and/or feedback quantities.

The remaining two systems mentioned, direct  $P_S$  control and direct bleed rate control, are adaptive to changes in conditions. The system is implemented as a separate sub-system element that only acts as a limiter on the nominal flight control system. The  $P_S$  controller, however, does not modulate AOA with flight path orientation since  $P_S$  is a measure of applied forces on the vehicle only. The bleed rate controller, however, does modulate AOA with flight path orientation. As flight path increases, the AOA is commanded to lower values to hold a desired amount of bleed rate. In descending flight, the AOA command is increased.

E I D E T I C S

---

## DESIGN APPROACHES CONSIDERED

- **SCHEDULED ANGLE OF ATTACK LIMITER**
  - DOES NOT DIRECTLY CONTROL BLEED RATE OR  $P_S$ .
  - NON-ADAPTIVE - BASED ON OFF-LINE ANALYSIS FOR A FIXED SET OF CONDITIONS.
  - BASIC SYSTEM COMMAND PATH AND/OR FEEDBACK QUANTITIES ARE ALTERED.
  
- **DIRECT  $P_S$  CONTROL**
  - IMPLEMENTED AS A SEPARATE SUB-SYSTEM CONTROL ALGORITHM.
  - ADAPTIVE CONTROL - LOOP CLOSURE ON  $P_S$  TO MODULATE AOA.
  - DOES NOT ALTER BASIC SYSTEM LOOP STRUCTURE.
  - DOES NOT ACCOUNT FOR CHANGES IN FLIGHT PATH ORIENTATION.
  
- **DIRECT BLEED RATE CONTROL**
  - IMPLEMENTED AS A SEPARATE SUB-SYSTEM CONTROL ALGORITHM.
  - ADAPTIVE CONTROL - LOOP CLOSURE ON BLEED RATE TO MODULATE AOA.
  - DOES NOT ALTER BASIC SYSTEM LOOP STRUCTURE.
  - ADAPTIVE TO FLIGHT PATH ORIENTATION.

# PILOT-VEHICLE INTERFACE

A number of pilot-vehicle interface options were designed for evaluation in real-time combat simulations. These options consisted of the following:

- Override Options (switch locations and method of operation)
- Audio Cues
- Hud Symbology

Four different override options were explored to determine pilot preference and feasibility of implementation into an actual aircraft. Audio cues such as tones/voice call-outs and HUD symbology were incorporated as well. Subjective test data was gathered to determine the usefulness of these cues and displays.

---

E I D E T I I

## PILOT-VEHICLE INTERFACE

- OVERRIDE OPTIONS
- CUES AND DISPLAYS

# OVERRIDE OPTIONS

Four types of override options were mechanized in the simulation as follows:

- Two Position Toggle Switch
- Push-to-Override
- Push-to-Engage
- Latched Switch

The two position toggle was implemented as a select/de-select switch located in the center of the control stick. The switch when flipped in the "down" position overrode both the CAMS  $P_S$  (or bleed rate) and the AOA limit simultaneously. The switch in the "up" position engaged full operation of CAMS. The push-to-override version was implemented as two switches with CAMS being *engaged* as the default; the switch on the throttle overrode  $P_S$  only and the right button on the stick overrode both the  $P_S$  and the AOA limit.. The push-to-engage option also used the throttle and stick switches with CAMS being *disengaged* as the default; the throttle switch engaged the  $P_S$  limit only and the stick switch engaged the AOA limit only. Both the push-to-override and the push-to-engage options required the pilot to hold down the switches. With the latch switch version, CAMS was engaged by default. A momentary depression of the only the throttle switch disengaged a limit if on or approaching that limit (either  $P_S$  or AOA). A limit is re-engaged if either  $P_S$  or AOA drops some percentage below its respective limit. Both limits are re-engaged if the stick is displaced more than 80% forward as well.

E I D E T I C S

## OVERRIDE OPTIONS

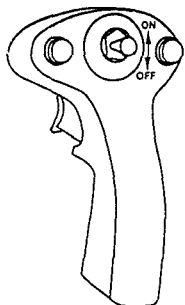

### • TWO POSITION TOGGLE

- SELECT / DE-SELECT TYPE.
- OVERRIDES BOTH  $P_S$  AND AOA LIMITS SIMULTANEOUSLY.

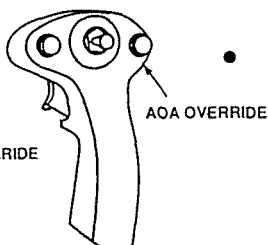
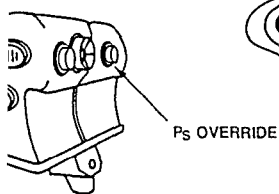

### • PUSH-TO-OVERRIDE

- $P_S$  AND AOA LIMITS ARE ENGAGED BY DEFAULT.
- PUSH AND HOLD THROTTLE SWITCH TO OVERRIDE THE  $P_S$  LIMIT ONLY.
- PUSH AND HOLD STICK SWITCH TO OVERRIDE BOTH  $P_S$  AND AOA LIMITS.

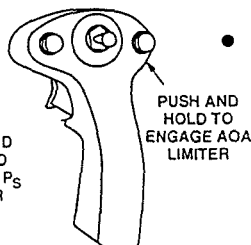
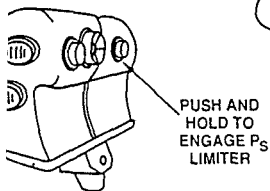

### • PUSH-TO-ENGAGE

- $P_S$  AND AOA LIMITS ARE DISENGAGED BY DEFAULT.
- PUSH AND HOLD THROTTLE SWITCH TO ENGAGE  $P_S$  LIMIT.
- PUSH AND HOLD STICK SWITCH TO ENGAGE AOA LIMIT.

### • LATCHED

- $P_S$  AND AOA LIMITS ARE ENGAGED BY DEFAULT.
- DEPRESS MOMENTARILY TO DISENGAGE A LIMIT IF ON OR APPROACHING THE LIMIT.
- A LIMIT IS RE-ENGAGED IF EITHER  $P_S$  OR AOA FALLS BELOW ITS LIMIT.
- BOTH LIMITS ARE RE-ENGAGED IF THE STICK IS DISPLACED MORE THAN 80% FORWARD.

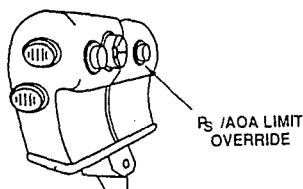

## CUES AND DISPLAYS

Aural cues were mechanized in the simulation. Tones were incorporated to indicate to the pilot that he was either approaching or riding on a CAMS limit. The following tones were incorporated as follows:

- Pulsing Low: Approaching a  $P_S$  limit.
- Steady Low: Riding a  $P_S$  limit.
- Pulsing High: Approaching AOA limit.
- Steady High: Riding AOA limit.
- No Tones: Post stall or well below CAMS limits.

Steady tones take precedence over the pulsing tones. AOA limit tones take precedence over the  $P_S$  tones.

E I D E T I

---

## CUES AND DISPLAYS

- AURAL CUES

- CAMS LIMITER TONES:

- PULSING LOW: APPROACHING  $P_S$  LIMIT.
- STEADY LOW: RIDING  $P_S$  LIMIT.
- PULSING HIGH: APPROACHING AOA LIMIT.
- STEADY HIGH: RIDING AOA LIMIT.
- NO TONES: POST STALL OR WELL BELOW CAMS LIMITS.
  
- *STEADY TONES TAKE PRECEDENCE OVER PULSING TONES.*
- *AOA TONES TAKE PRECEDENCE OVER  $P_S$  TONES.*

- AIRSPEED CALLOUT:

- VOICE CALLOUT OF AIRSPEED IS COMMANDED FOR BLEED RATES GREATER THAN 100 KNOTS/SEC.
- AIRSPEED CALLOUT IS DONE IN 50 KNOT INTERVALS.

# CUES AND DISPLAYS (CONT)

## HUD Symbology

The HUD symbology concept was drafted to allow pilots visual feedback as to how far they are from a CAMS limit. The symbology flashed to indicate when the pilot was "riding" on a limit. Characters and lines were minimized for easy addition to current air-to-air HUD combat displays.

The  $P_s$  bar was aligned on the throttle side of the display. The bar was normalized between zero and the selected bleed rate. If the pilot was riding on the limit, the  $P_s$  limit basket flashed and the pilot had to override the limit to allow greater bleed rate.

The AOA limiter symbol was centered around the aircraft velocity vector marker. For slowing approaching Alpha  $C_{LMAX}$ , a collapsing equilateral triangle was used which began as a straight line with rotating ends. As Alpha  $C_{LMAX}$  was approached, the triangle closed, and the triangle continued to flash as the pilot rode the limit.

E I D E T I C S

## CUES AND DISPLAYS (cont.)

### • HUD SYMBOLOGY

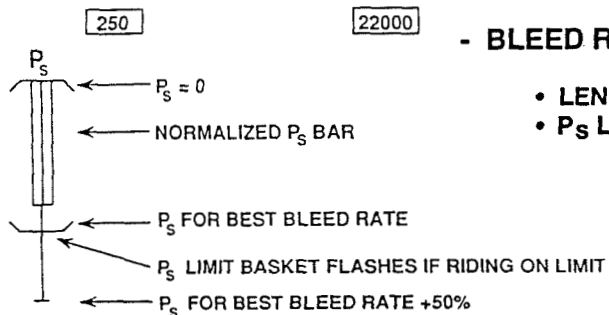

### - BLEED RATE OR $P_s$ ANALOG BAR

- LENGTH OF BAR INDICATES HOW FAR FROM  $P_s$  LIMIT.
- $P_s$  LIMIT "BASKET" FLASHES TO INDICATE RIDING THE LIMIT.

### - AOA LIMITER SYMBOL

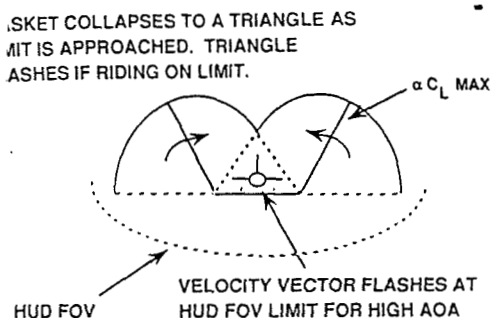

- CLOSING TRIANGLE AROUND VELOCITY VECTOR INDICATES APPROACHING THE AOA LIMIT.
- VELOCITY VECTOR AND TRIANGLE FLASHES WHEN RIDING THE AOA LIMIT.



# PVI EVALUATION

In order to determine and recommend an optimum PVI design and validate it for final implementation for final testing, many elements were considered in the analysis. The areas which were included in the analysis flow were, hardware availability in a typical operational fighter aircraft, human factors considerations which involved pros and cons of the PVI options, subjective data which included pilot questionnaires and pilot comments, and finally objective data which showed combat performance of each option.

The hardware availability portion of the analysis consisted of reviewing different flight manuals and talking to operational pilots to get recommendations. Consideration was given to unused or scarcely used switches which do not interfere with any systems operations, and the use of a switch where mistaken identity is less likely to occur. The F-18 was chosen as a good example of a current fighter with a typical set of complicated switchology, to be used for comparison with the CAMS PVI options tested. A switch on the throttle, the "Raid" switch, is rarely used in close-in combat, is the best candidate for override implementation.

In conclusion of the PVI test the Latched PVI system was determined as the overall best compromise based on hardware availability, pilot comments and combat performance.

E I D E T I

## PVI EVALUATION

### CONSIDERATIONS

- **HARDWARE AVAILABILITY**
- **HUMAN FACTORS - PROS AND CONS OF PVI TYPE**
- **SUBJECTIVE DATA - PILOT QUESTIONNAIRES**
- **OBJECTIVE DATA - COMBAT PERFORMANCE**

### STUDY RESULTS

- **LATCH TYPE OVERRIDE AS THE BEST CANDIDATE.**
- **"RAID" SWITCH ON THROTTLE GRIP OR LEFT BUTTON ON STICK AS AVAILABLE SWITCH LOCATIONS FOR OVERRIDE ON THE F-18.**

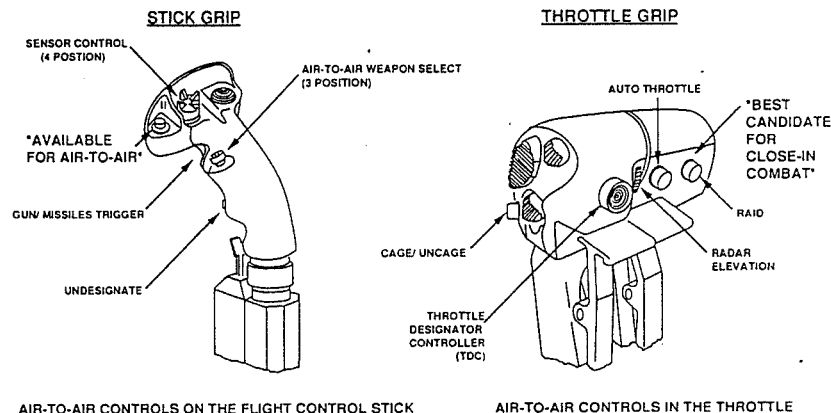

## GROUND BASED SIMULATOR TESTING

Three ground based simulator tests were performed in order to measure the combat effectiveness of CAMS. The tests were run against a digital adversary with identical aerodynamic and thrust performance as the F-18 but did not have CAMS. The principle reason for using the digital adversary was that it provided a stable opponent, free from variability and performance errors. In order to keep the pilots from repeating the same behavior every trial, the starting conditions were varied from trial to trial. The following tests were done:

- 1) PVI Test: Evaluated each PVI option and effectiveness of cues/displays.
- 2) Limiter Test: Evaluated three limiter types optimized for the type of scenarios flown.
- 3) Preferred Concept: Tested candidates from 1) and 2) to determine combat effectiveness.

The combat effectiveness of CAMS was then determined by collecting subjective data (questionnaires) and objective data (wins & losses).

E I D E T I C S

---

## GROUND BASED SIMULATOR TESTING

### 1) PVI TEST - 1 v 1

- 450 TRIALS WITH 3 PILOTS AND 5 CONFIGURATIONS
  - BASELINE F-18
  - 2 POSITION TOGGLE
  - PUSH-TO-OVERRIDE
  - PUSH-TO-ENGAGE
  - LATCH

### 2) LIMITER TEST - 1 v 1

- 288 TRIALS WITH 2 PILOTS AND 4 CONFIGURATIONS
  - BASELINE F-18
  - HARD AOA LIMIT
  - P<sub>S</sub> LIMIT
  - BLEED RATE (VTDOT) LIMIT

### 3) PREFERRED CONCEPT TEST - 1 v 2

- 270 TRIALS WITH 3 PILOTS AND 3 CONFIGURATIONS
  - BASELINE F-18
  - CAMS WITH OVERRIDE
  - CAMS WITH NO OVERRIDE

## CURRENT STATUS

The CAMS system has been shown, by conducting many piloted simulator runs with F-16 and F/A-18 aircraft, to significantly enhance combat effectiveness when properly used. These simulator studies showed that one of the key ingredients to the success of CAMS is pilot acceptance of a bleed rate limiter and, also, the choice of the proper Pilot/Vehicle interface, or "switchology" to set and override the limiter. The Phase II simulation work is complete and shows strong evidence that CAMS is a technology that has great potential benefits. The planned flight validation effort on the F-18 HARV is a necessary next step to provide the confidence to seriously consider the application of the technology to future aircraft. Combat maneuvers defined from simulation studies will be flown by HARV with and without the CAMS system operational, and an evaluation will be made to assess the benefits of CAMS for a typical combat scenario.

ORIGINAL PAGE IS  
OF POOR QUALITY

E I D E T I C

---

---

## CURRENT STATUS

- 1) GROUND BASED SIMULATOR RESULTS - COMPLETE (SBIR II)
- 2) EXPLORATORY FLIGHT TESTS WITH F-18 HARV - FALL 1994

### DRYDEN CONTRACT TO EIDETICS

#### OBJECTIVE

DEMONSTRATE/VALIDATE THE SBIR II "CAMS" SIMULATION RESULTS - SHOW POTENTIAL FOR LOW-RISK APPLICATION TO FUTURE (OR PRESENT) FIGHTER AIRCRAFT

#### APPROACH

INCORPORATE CAMS SYSTEM LOGIC INTO HARV'S RESEARCH FLIGHT CONTROL SYSTEM (RFCS)

USE EIDETICS VIRTUAL DOME SIMULATOR (ARENA) TO SELECT SPECIFIC COMBAT-TYPE MANEUVERS TO BE FLOWN WITH HARV

COMPARE ABILITY TO PERFORM SPECIFIC FLIGHT TASKS WITH AND WITHOUT CAMS IN OPERATION

ASSESS THE ADVANTAGES (DISADVANTAGES) OF CAMS FOR AIR COMBAT - HEAVY RELIANCE ON PILOT COMMENTS AND ASSESSMENTS

## POTENTIAL FUTURE APPLICATIONS

Potential application of CAMS on near-future fighter aircraft include the F-22 and F-18 E/F, and, in the more distant future, JAST. It can also be considered for application to existing fighter aircraft through modest changes to existing flight control systems. The workload for modern fighter pilots is not decreasing. The continuing addition of more information to assimilate and process in the heat of combat is taxing the ability of most modern pilots to keep up. For the inexperienced pilot, in particular, one of the major and most important task, of course, is keeping tabs on his energy state. Getting too slow while maneuvering can be very high risk. CAMS provides a means to manage aircraft energy efficiently, while, at the same time, does not impose hard angle of attack limits.

## POTENTIAL FUTURE APPLICATIONS

F-22

F-18 E/F

JAST

PRESENT FIGHTER A/C

# REPORT DOCUMENTATION PAGE

Form Approved  
OMB No. 0704-0188

Public reporting burden for this collection of information is estimated to average 1 hour per response, including the time for reviewing instructions, searching existing data sources, gathering and maintaining the data needed, and completing and reviewing the collection of information. Send comments regarding this burden estimate or any other aspect of this collection of information, including suggestions for reducing this burden, to Washington Headquarters Services, Directorate for Information Operations and Reports, 1215 Jefferson Davis Highway, Suite 1204, Arlington, VA 22202-4302, and to the Office of Management and Budget, Paperwork Reduction Project (0704-0188), Washington, DC 20503.

1. AGENCY USE ONLY (Leave blank)	2. REPORT DATE July 1994	3. REPORT TYPE AND DATES COVERED Conference Publication
----------------------------------	-----------------------------	--

4. TITLE AND SUBTITLE Fourth NASA High Alpha Conference	5. FUNDING NUMBERS  WU 505-68-30
--	--

6. AUTHOR(S)	
--------------	--

7. PERFORMING ORGANIZATION NAME(S) AND ADDRESS(ES)  NASA Dryden Flight Research Center P.O. Box 273 Edwards, California 93523-0273	8. PERFORMING ORGANIZATION REPORT NUMBER  H-2007
--	--

9. SPONSORING/MONITORING AGENCY NAME(S) AND ADDRESS(ES)  National Aeronautics and Space Administration Washington, DC 20546-0001	10. SPONSORING/MONITORING AGENCY REPORT NUMBER  NASA CP-10143 Volume 2
---	---

11. SUPPLEMENTARY NOTES  
This document is a preprint for a conference held at NASA Dryden Flight Research Center, July 12-14, 1994. Conference Chair Donald Gatlin; Technical Chair Victoria Regenie; Administrative Chair Everlyn Cruciani.

12a. DISTRIBUTION/AVAILABILITY STATEMENT  Unclassified—Unlimited Subject Category 02	12b. DISTRIBUTION CODE
---	------------------------

13. ABSTRACT (Maximum 200 words)

The goal of the Fourth High Alpha Conference, held at the NASA Dryden Flight Research Center on July 12-14, 1994, was to focus on the flight validation of high angle-of-attack technologies and provide an in-depth review of the latest high angle-of-attack activities. Areas that were covered include, high angle-of-attack aerodynamics, propulsion and inlet dynamics, thrust vectoring, control laws and handling qualities, tactical utility, and forebody controls.

14. SUBJECT TERMS  Aerodynamics; F-18 HARV; High angle of attack; X-31 aircraft	15. NUMBER OF PAGES 249
	16. PRICE CODE A11

17. SECURITY CLASSIFICATION OF REPORT Unclassified	18. SECURITY CLASSIFICATION OF THIS PAGE Unclassified	19. SECURITY CLASSIFICATION OF ABSTRACT Unclassified	20. LIMITATION OF ABSTRACT Unlimited
---	--	---	---