

1995707835

N95-14249

323999

16098

p. 26

MULTI-APPLICATION CONTROLS

robust nonlinear multivariable aerospace controls applications

Dale F. Enns

Honeywell Technology Center and University of Minnesota

Dan J. Bugajski

Honeywell Technology Center

John Carter, Bob Antoniewicz

NASA Dryden Flight Research Center

4th NASA HIGH ALPHA CONFERENCE

13 July 1994

MULTI-APPLICATION CONTROLS
robust nonlinear multivariable aerospace controls applications

Dale F. Enns

Honeywell Technology Center and University of Minnesota

Dan J. Bugajski

Honeywell Technology Center

John Carter, Bob Antoniewicz

NASA Dryden Flight Research Center

ABSTRACT

Control theory application has been advancing simultaneously with the increasing demands for performance, safety, and cost effectiveness in aerospace vehicles. Recent advances indicate that large portions of the requirements, model assumptions, and control laws can be reused across a variety of aerospace vehicles, including fighters, ASTOVL, launch vehicles, missiles, transports, unmanned aerial vehicles, and rotary wing vehicles. There are always unique features of any vehicle that make each application interesting, such as high angle-of-attack which is the subject of this paper, and precision tracking, autoland, transition in and out of hover, freewings, tilt rotor, and many others depending on the vehicle.

This paper will present the general methodology used to apply Honeywell's Multi-Application Control (MACH) and the specific application to the F-18 High Angle-of-Attack Research Vehicle (HARV) including piloted simulation handling qualities evaluation. Flight test evaluation is scheduled for late 1994. The general steps include insertion of modeling data for geometry and mass properties, aerodynamics, and propulsion data and assumptions; requirements specifications, e.g. definition of control variables, handling qualities, stability margins and statements for bandwidth, control power, priorities, position and rate limits. The specific steps include choice of independent variables for least squares fits to aerodynamic and propulsion data, modifications to the management of the controls with regard to integrator windup and actuation limiting and priorities,

e.g. pitch priority over roll, and command limiting to prevent departures and/or undesirable inertial coupling or inability to recover to a stable trim condition.

The HARV control problem is characterized by significant nonlinearities and multivariable interactions in the low speed, high angle-of-attack, high angular rate flight regime. Systematic approaches to the control of vehicle motions modeled with coupled nonlinear equations of motion have been developed. This paper will discuss the dynamic inversion approach which explicitly accounts for nonlinearities in the control design. Multiple control effectors (including aerodynamic control surfaces and thrust vectoring control) and sensors are used to control the motions of the vehicles in several degrees-of-freedom. Several maneuvers will be used to illustrate performance of MACH in the high angle-of-attack flight regime. Analytical methods for assessing the robust performance of the multivariable control system in the presence of math modeling uncertainty, disturbances, and commands have reached a high level of maturity. The structured singular value (μ) frequency response methodology will be presented as a method for analyzing robust performance and the μ -synthesis method will be presented as a method for synthesizing a robust control system.

The paper will conclude with the author's expectations regarding future applications of robust nonlinear multivariable controls. The MACH methodology is currently being applied to the MCT/F-16 (features similar to AFTI and MATV versions of the F-16) by Lockheed Ft. Worth Co. and also to the F-117 by Lockheed Advanced Development Co. in the Air Force program "Application of Multivariable Control Theory to Aircraft Control Laws" (MCT). It has been applied to the McDonnell Douglas DC-X initial flight tests and the future rotation maneuver (0 to 360 degrees angle-of-attack). MACH is also being applied to the Daedalus Research Inc. Slaved Tandem Freewing (STF) which is a Vertical Launch and Recovery UAV that transitions between hover to wing-borne flight, for inner stabilization and outer trajectory control loops.

INTRODUCING ... MACH

Multi-Application Controls

- Multi-Application

- fighters: F-18, X-31, F-16, F-117A, F-15, YF-22
- transports: MD-11, L-1011
- guided weapons: EMRAAT, JDAM, APGM
- launch vehicles: DC-X, AGNC
- unmanned aerial vehicles: STF-9B

- Control

- dynamic inversion for $\dot{x} = F(x, u)$
- $\dot{y} = f(x, u) \equiv a(x) + b(x)u \Leftrightarrow u = g(x, \dot{y})$
- CV = y , defn. \Rightarrow zero dyns.
where $x = \begin{bmatrix} y \\ z \end{bmatrix} = \begin{bmatrix} \text{control variable} \\ \text{zero dyns.} \end{bmatrix}$
- desired dyns. (connections with ESS and LQ gains)
- act. pos. and rate limits and intgr. windup
- cmd. limits s.t. stable equil. always possible

- Methodology

- requirements (HQ, robustness, priorities, atm. dist., ...)
- model (mass, geom., aero., and propul. data lists)
- design (flt. control exper., dyn inv., μ -synthesis)
- analysis (σ and μ)
- implementation (automatic code generation)

TOPICS

Multi-Application Control (MACH)

Feature	F-18 HARV	X-31	F-16 MCT	F-117	YF-22	STF UAV	DC-X rocket	Precision Weapon	F-15 HIDECC	L-1011
lstsq										
dyn inv										
cv										
daisy chain										
cmd limits										
priorities										
maneuvers										
HQ simul.										
μ anal.										
CONTROLH										

Dynamic Inversion Block Diagram

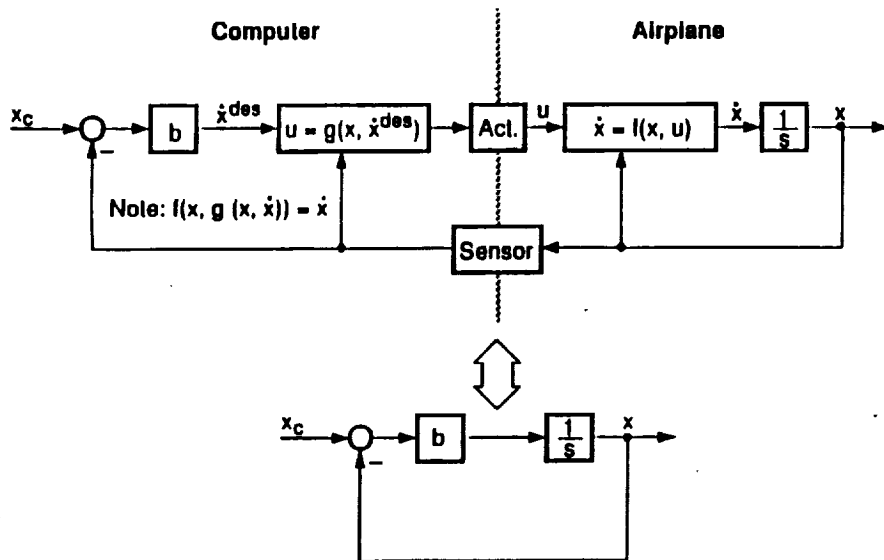

DEFN. OF CONTROL VARIABLES CAN BE CONTROVERSIAL

- Definitions for Significant Airspeed

- LCV = roll rate (about velocity)
- MCV = C_* blend of q and nz or α - trim($h, V, \text{attitude}$)
- NCV = blend of yaw rate and β - trim($V, \text{attitude}$)

- Definitions for Negligible Airspeed

- LCV = roll rate (about body axis)
- MCV = pitch rate (about body axis)
- NCV = yaw rate (about body axis)

- Alternate Definitions

- Euler Attitudes and Cartesian Coordinates for Hover
- α and β
- $V, \chi, \gamma \rightarrow$ Position (ξ, η, h)

- Issues

- want magnitude of MCV small in equilibrium flight to minimize pilot trim button activity
- want zeros of $MCV/\delta_e(s)$ to be minimum phase because they will be closed loop poles
- small k_V and k_γ to stabilize phugoid

$$- MCV = q + \frac{\bar{q} SC_{L_\alpha}^{Ref} \alpha}{mV_c} - \frac{g}{V_c}$$

$$\frac{+g}{V} (\cos\gamma - 1)$$

$$+ k_V \frac{SC_{L_{max}}}{mV_c} (\bar{q} - \bar{q}_{trim}) + k_\gamma \frac{g}{V_c} \sin\gamma$$

LEAST SQUARES MODELS

- Minimize $\sum_k (C_k - \hat{C}_k)^2$
- By Fitting Parameters (linear solution to least squares problem)
- Aerodynamic
 - nonlinear in α and Mach
(1 or 2 dimensional) table lookups
 - drag quadratic terms if needed
 - linear in body rates and aero surfaces

$$\hat{C}_k = C_k(\alpha) + C_{k_q}(\alpha) \frac{q\bar{c}}{2V} + C_{k_{\delta_e}}(\alpha) \delta_e \quad k = D, L, m$$

$$\hat{C}_k = C_{k_\beta}(\alpha) \beta + C_{k_p}(\alpha) \frac{pb}{2V} + C_{k_r}(\alpha) \frac{rb}{2V} \\ + C_{k_{\delta_a}}(\alpha) \delta_a + C_{k_{\delta_r}}(\alpha) \delta_r \quad k = Y, l, n$$

- Propulsion
 - function of throttle, altitude and airspeed

DAISY CHAIN

- **Compromise Between Computational Complexity & Perf.**
 - primary controls used up to rate and position limits
 - then auxiliary controls used to assist as achievable
- **Linear With Position Limits**
 - Solution is known for $y = Bu$ s.t. $U_{\min} \leq u \leq U_{\max}$
(have to minimize $\|y - Bu\|$ when u on limits)
(rectangular and non-rectangular limits)
but solution may be computationally intensive, so
 - Approx. Solution for u_{prim} and u_{aux}
subject to the same limits, but work with smaller problem
scalar, and 2×2 and 2×3 solutions
- **Linear With Rate Limits**
 - $\max(U_{\min}, u_{\text{old}} - r_{\text{lim}} T_s)$ and $\min(U_{\max}, u_{\text{old}} + r_{\text{lim}} T_s)$
 - Perhaps not ideal for dynamic case
(Current A.F. Ph.D. research)
- **Wide Range of Options Available**
 - ganging of surfaces prior to applic. of daisy chain
 - 3 chains with dynamic compensation for X-29
 - natural to incorporate forebody controls

Daisy Chains ...

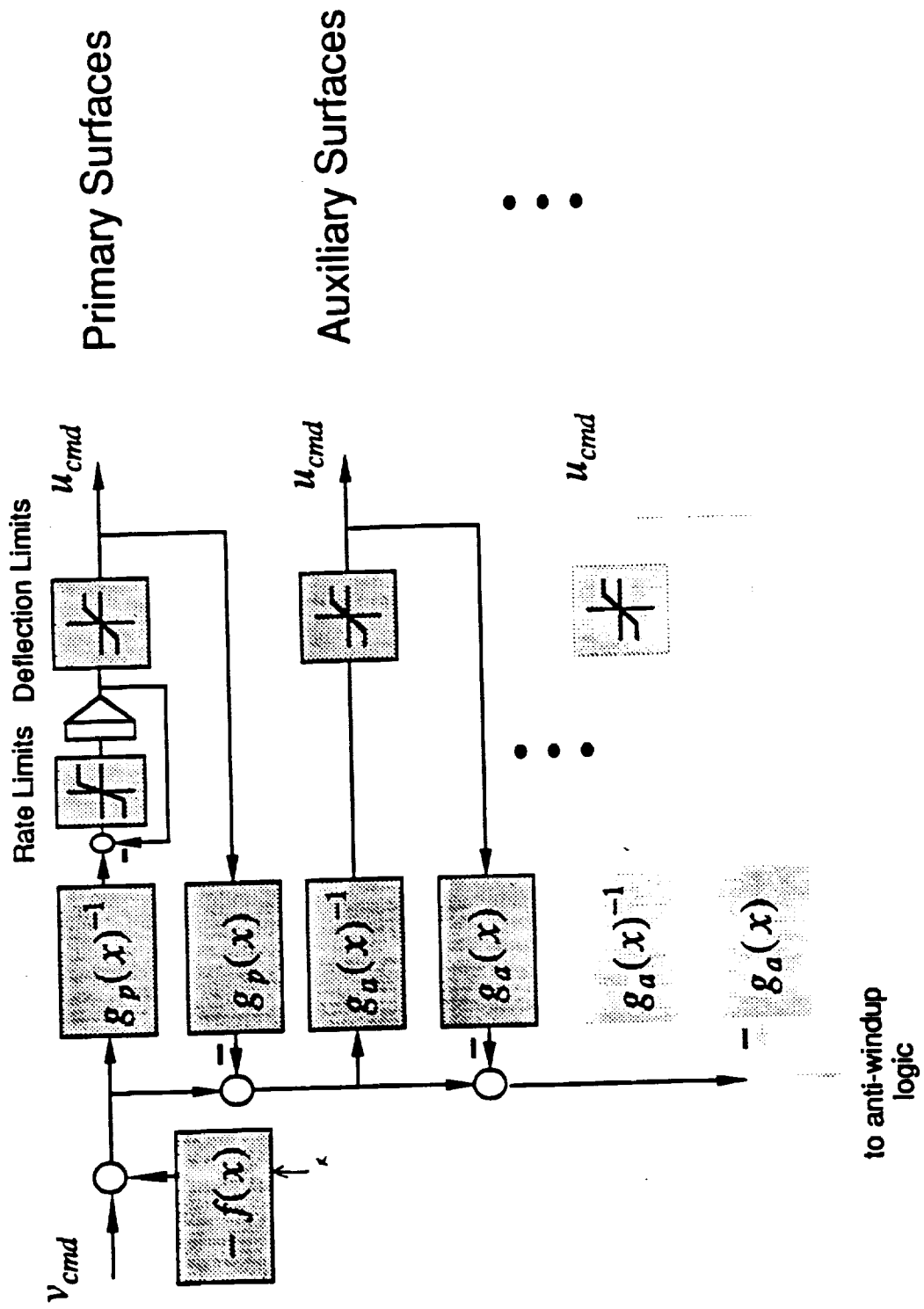

F-18 HARV

- High Angle-of-Attack Flight Control
 - nonlinear aerodynamics ($-10 \text{ deg} < \alpha < 100 \text{ deg}$)
 - nonlinear rate and position limits
 - nonlinear equations of motion
- Aerodynamic Control Surfaces (primary)
 - aileron, rudder, diff. horiz. tail
 - horizontal tail
- Pitch, Roll, and Yaw Thrust Vectoring (auxiliary)
- ADA Code Generated Automatically with CONTROLH
 - Write Control Law in "Familiar Controls Language"
 - Benefit When Control Law Developed in Same Language
 - Use Translator To Obtain ADA or C or ...
 - Benefit When Control Law Developed in Same Language
 - Demonstrated With Daisy Chain Portion of MACH
- Scheduled for Flight Test in December 1994

Handling qualities / Simulation Results

Cooper Harper ratings for a target tracking task on the Dryden piloted simulation - altitude 25000 feet

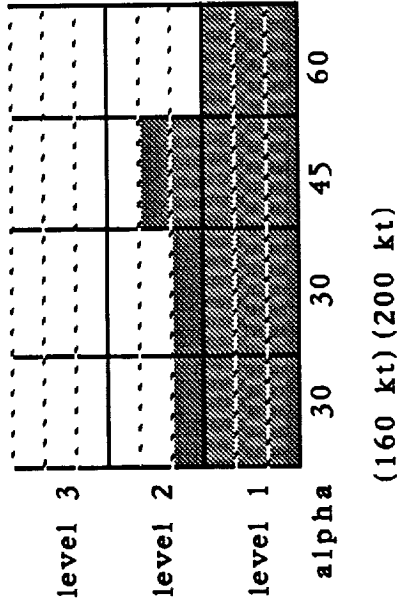

- Criteria Desired: No objectionable PIO. Pipper within 5 mils of aim point 50% of the task and within 25 mils of aim point for the remainder of the task.
- Adequate: Pipper within 5 mils of aim point 10% of the task and within 25 mils of aim point for the remainder of the task.

Handling qualities / Simulation Results

Cooper Harper ratings for a target tracking task on the Dryden
piloted simulation - altitude 25000 feet

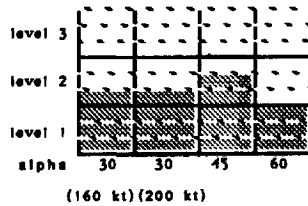

Criteria Desired: No objectionable PIO. Pipper within 5 mils of aim point 50% of the task and within 25 mils of aim point for the remainder of the task.

Adequate: Pipper within 5 mils of aim point 10% of the task and within 25 mils of aim point for the remainder of the task.

This figure represents the results of a longitudinal and lateral tracking task performed on the Dryden simulation. The Dryden simulation has the ability to display target aircraft moving through a preprogrammed trajectory. In this case, the target starts at the altitude, 1500 feet in front of the HARV aircraft. The target aircraft rolls into a turn, uses maximum afterburner, and pulls to 30 degrees angle of attack. The aircraft then maintains that angle of attack throughout the maneuver, while adjusting the nose attitude to maintain either 160 kts (for 30 alpha 160 kt tracking and 45 alp tracking) or 180 kts (for 60 alpha tracking). The HARV aircraft rolls in behind the target aircraft using military power, and advances the throttles to maximum afterburner. Longitudinal and lateral tracking is performed by taking a lagged position to the target and then "pulling up" to track the target at the prescribed angle of attack. The Cooper Harper rating scale is then used to evaluate the pilots' ability to perform the task.

These results give an initial indication that adequate to desired handling qualities can be achieved using the Dynamic Inversion control design technique. Further work is being performed on this control law in the Dryden simulator to improve the tracking and handling qualities characteristics of this control law.

Handling qualities / Simulation Results

Cooper Harper ratings for simulation tasks on the Dryden piloted simulation - altitude 25000 feet

Theta Captures .4 Mach 1g

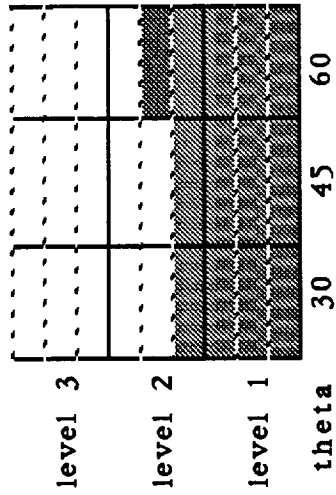

Criteria: desired adequate
 theta: +/- 4 deg +/- 7 deg

1 g 360 deg Roll / Heading Captures

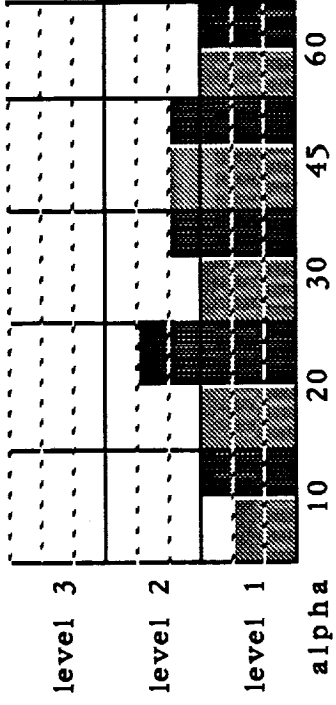

Criteria: desired adequate
 alpha: +/-5 deg +/-8 deg
 phi/ heading: +/-10 deg +/-20 deg

Nz / Heading Captures

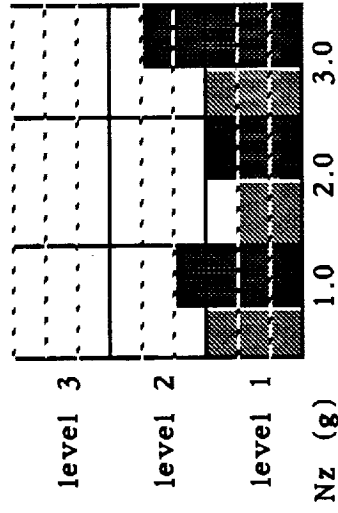

Criteria: desired adequate
 Nz: +/--.2 g +/--.3 g
 heading: +/- 2 deg +/- 6 deg

Loaded Rolls .4 Mach

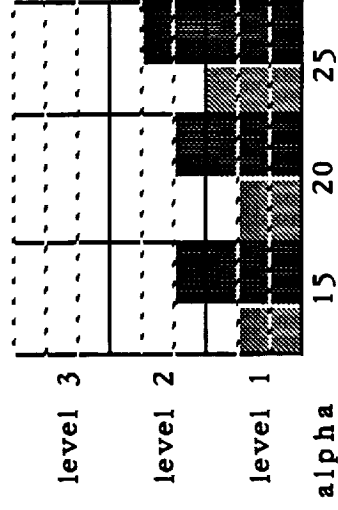

Criteria: desired adequate
 alpha: +/-5 deg +/-8 deg
 phi: +/-10 deg +/-20 deg

Handling qualities / Simulation Results

Cooper Harper ratings for simulation tasks on the Dryden
piloted simulation - altitude 25000 feet

Theta Captures .4 Mach 1g

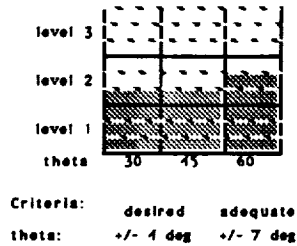

1 g 360 deg Roll / Heading Captures

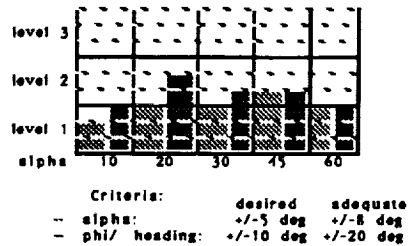

Nz / Heading Captures

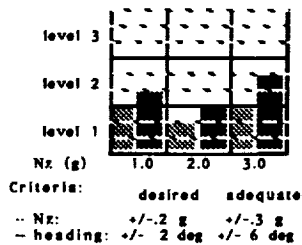

Loaded Rolls .4 Mach

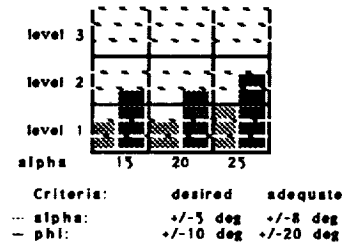

This figure represents a preliminary piloted evaluation of the NASA 2 control laws in the Dryden simulation. This piloted simulation has no pilot motion cues a limited visual field of view. These tasks were performed with a single HARV project pilot. The four tasks were as follows, all flown at 25000 feet:

Theta Captures :

The aircraft is trimmed at .40 Mach, 25000 feet at 1 g. The pilot then aggressively attempts to capture 30, 45, and 60 degrees pitch angle. The Cooper Harper rating scale is then used to evaluate the ability of the pilot to capture the prescribed bank angle with a minimum of overshoot within the desired or adequate criteria.

1 g 360 deg phi/heading Captures:

The aircraft is trimmed at 25000 feet, 1 g, at the angle of attack shown. The pilot performs a 360 degree roll (heading change above 45 degree alpha) and then captures either wings level or a specified heading. Two Cooper Harper ratings are then used to evaluate the pilots' ability to maintain angle of attack and to capture the ending bank or heading angle.

Nz / Heading Captures:

The pilot performs a constant load factor turn at 25000 feet. Two Cooper Harper ratings are used to evaluate the aircraft ability to hold load factor and capture a 90 degree heading angle increment.

Loaded Rolls:

The aircraft is rolled at .40 Mach 25000 feet into a 90 degree bank angle at the prescribed angle of attack. The pilot then attempts to capture 90 degrees of opposite bank angle. Two Cooper Harper ratings are used per maneuver to evaluate the pilots' ability to hold angle of attack and capture the final bank angle.

The results of this study give an indication that adequate to desirable handling qualities can be achieved with the Dynamic Inversion flight control law architecture.

X-31

- High Angle-of-Attack Flight and Trajectory Control
 - post stall maneuvers for tactical advantage
 - nonlinear aerodynamics ($-10 \text{ deg} < \alpha < 100 \text{ deg}$)
 - nonlinear rate and position limits
 - nonlinear equations of motion
- Aerodynamic Control Surfaces
 - wing t.e. and l.e. (inboard and outboard), rudder
 - canard
- Pitch, and Yaw Thrust Vectoring
- Maneuvers
 - Trajectory Optimization (Well, et. al., 1982 AIAA JGCD)
 - minimum time to turn
 - for different initial and final conditions
 - point mass assumptions
 - Dynamic Inversion of 6DOF rigid body equations
 - to determine realistic performance
 - establish demanding flight control law test cases

Application of Multivariable Control Theory to Aircraft Control Laws

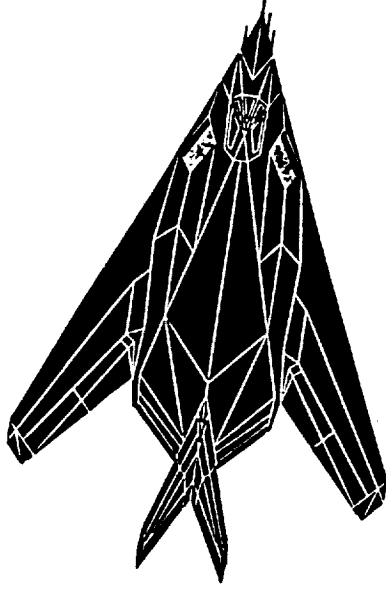

Sponsor: U. S. Air Force

Team: Honeywell, Lockheed Ft. Worth Company,
Lockheed Advanced Development
Company

Objective: Develop Design Guidelines

Three Design Methods:

- Dynamic Inversion
- Mu Synthesis
- Eigen-structure Synthesis

Three Aircraft:

- F-117
- YF-22
- MCT/F-16

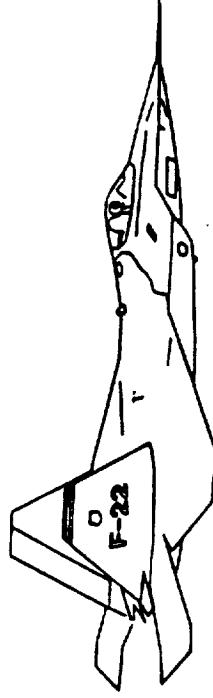

Four Maneuvers:

- Flat Turns while strafing
- High α bank captures
- Rapid pullup α limit and bank capture
- Evaluated g bank-to-bank roll

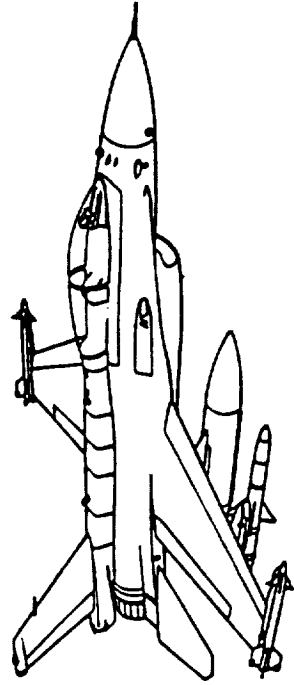

Honeywell

F-16

- Flight Control for Flat Turn and High α Bank to Bank
 - include $YCV = V\dot{\chi}$ for flat turn together with LCV, MCV, NCV
 - nonlinear aerodynamics (-10 deg < α < 100 deg)
 - nonlinear rate and position limits
 - nonlinear equations of motion
- Aerodynamic Control Surfaces (primary)
 - aileron, rudder, vertical canard, diff. horiz. tail
 - horizontal tail
- Pitch and Yaw Thrust Vectoring (auxiliary)
- Pilot Command Limits
 - position and rate limits
 - anti-windup for integrators
 - pitch priority over roll
 - p Command (or lateral stick) Limit
 - to prevent pitch departure
 - to prevent yaw departure

F-117A

- Flight Control With Pilot Command Limits (α , p)
 - nonlinear aerodynamics (α , Mach)
 - nonlinear rate and position limits
- Aerodynamic Control Surfaces
 - elevons and rudders
 - options to exploit inboard and outboard (for primary and auxiliary)
- Pilot Command Limits
 - α limiter
 - p Limit
 - to prevent pitch and yaw departures
 - to satisfy hinge moment constraints
- Pullup to α limit and Roll to 80 deg (with and without rudder failure)
- Approach and Landing
 - need to shut down integr. in control law when gear down
 - manual and not optimized for autoland

YF-22

- Flight Control for
 - High α Bank Capture
 - Elevated g Bank to Bank Roll
- Aerodynamic Control Surfaces
 - aileron, rudders, diff. horiz. tail
 - horizontal tail, flaperons, leading edge flaps
- Pitch Thrust Vectoring
- U.S. Air Force Program In Progress
 - Application of Multivariable Control Theory To Aircraft Control Laws
 - Honeywell, Lockheed Ft. Worth Company, and Lockheed Advanced Development Company
 - First Draft of Design Guidelines Avail. 1 October '94
ESS, MACH, and MUSYN

STF-9B

- Slaved Tandem Freewing
- Flight and Trajectory Control of VLAR UAV
 - mechanical implementation of key stabilization element
 - wide cg margin for fixed GCS requirements
 - transition from hover or thrust-borne to flight or wing-borne flight and back to hover
- Aerodynamic Control Surfaces
 - canards in prop wash
 - wing t.e. flaps

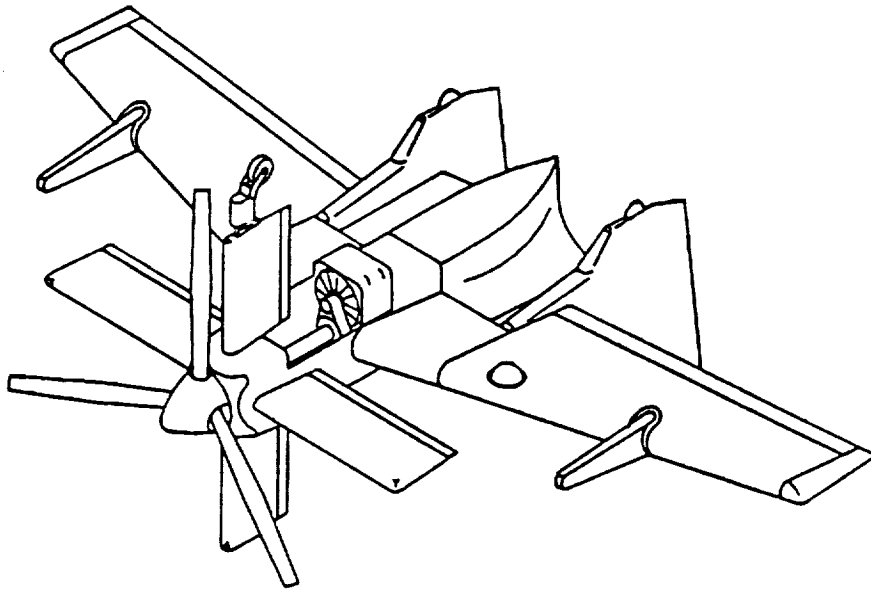

DC-X

- High Angle-of-Attack and Zero Speed Flight and Trajectory Control
 - nonlinear aerodynamics ($-180 \text{ deg} < \alpha < 180 \text{ deg}$)
 - nonlinear rate and position limits
 - nonlinear equations of motion
- Engine Gimbal Thrust Vectoring (primary)
- Aerodynamic Body Flaps (auxiliary)
- Trajectory Control Demonstrated
 - Cartesian Coordinates (α, γ not defined for low speed)
 - Use δ to control θ to control ξ , and T to control h
 - Use LQ to select gains for hover flight condition
desirable stability margins and closed loop poles
 - Use robustness theory and bound for airspeed
singular value frequency response test
- Trajectory Control Imagined
 - Re-entry from orbit like NASP
energy and 3D position mgmt.
 - Rotation Maneuver Prior to Hover and Vert. Landing
early demonstration of MACH reusability

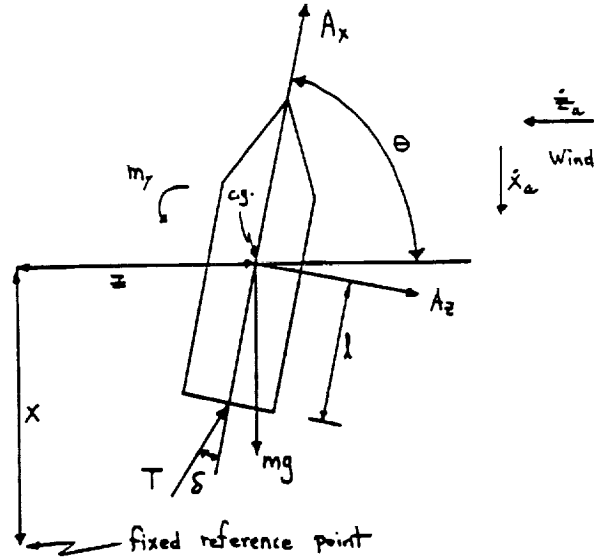

$$m\ddot{x} = T \sin(\theta - \delta) - mg - A_z \cos\theta + A_x \sin\theta$$

$$m\ddot{z} = T \cos(\theta - \delta) + A_x \sin\theta + A_z \cos\theta$$

$$I_{yy} \ddot{\theta} = T l \sin\delta + m_y$$

$$r = \frac{1}{2} \rho [(x + x_0)^2 + (z + z_0)^2]$$

$$A_z = \bar{q} S C_z(\alpha)$$

$$\alpha = \theta + \tan^{-1} \left[\frac{x + x_0}{z + z_0} \right]$$

$$A_x = \bar{q} S C_x(\alpha)$$

$$m_y = \bar{q} S L (C_m(\alpha) + C_{m_0} \frac{L \dot{\theta}}{2 \sqrt{(x + x_0)^2 + (z + z_0)^2}})$$

rotation to near hover, b4, Fri Feb 7 07:45:16 CST 1992

xh plane from pos y axis

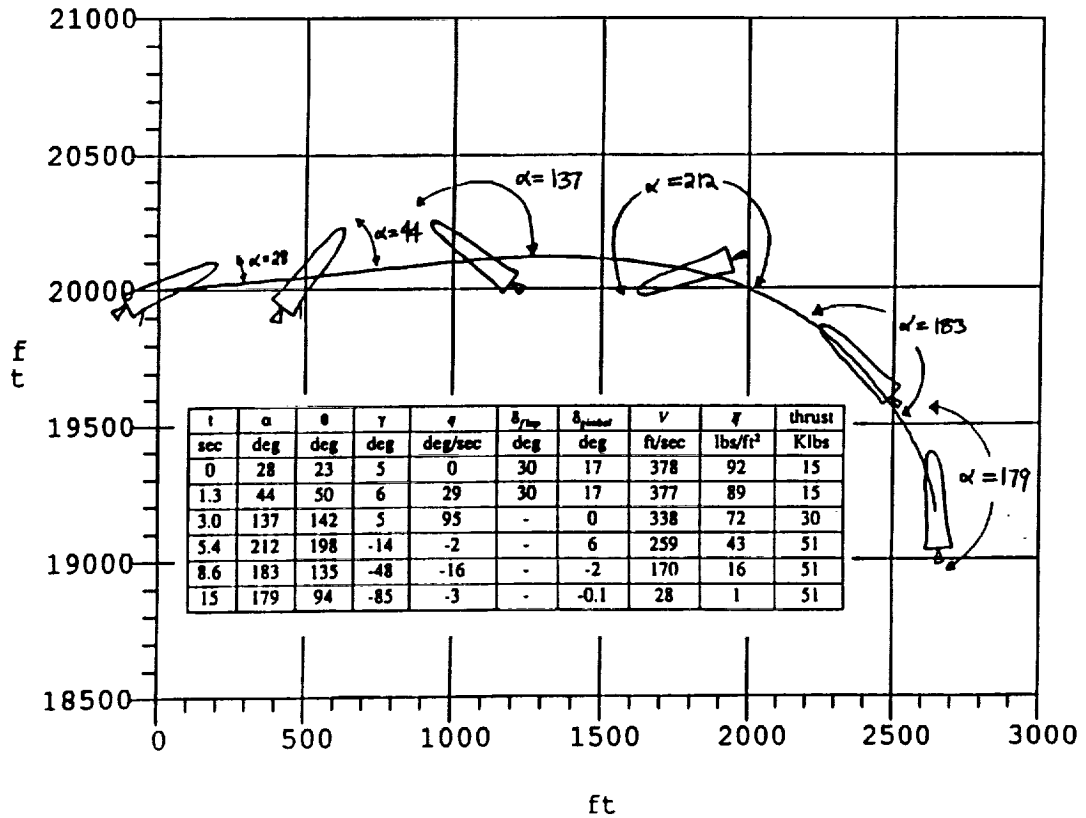

Precision Weapons

- JDAM, EMRAAT, APGM
- Flight and Trajectory Control of Precision Guided Weapon
 - miss distance and impact angle constraints
 - skid to turn so $CV = \text{accels.} \perp \text{Velocity}$
- Controls
 - aerodynamic fins
 - thrust vectoring
 - reaction control

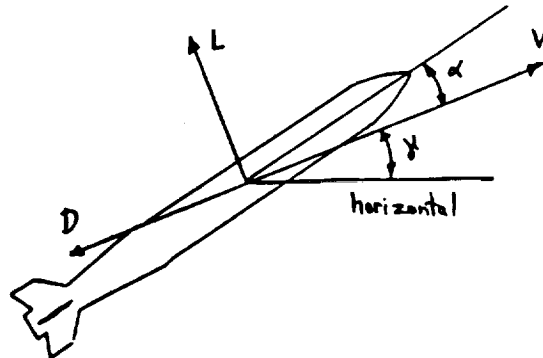

• Target/Munition Kinematics ($\gamma_i = -60 \text{ deg}$)

$$\begin{aligned} \xi &= (h_T - h) \cos \gamma_i - (x_T - x) \cos \chi_T + (y_T - y) \sin \gamma_i \sin \chi_T \\ \dot{\xi} &= V [-\sin \gamma_i \cos \gamma_i + \cos \gamma_i \cos(\chi - \chi_T) \sin \gamma_i] \\ \ddot{\xi} &= V \dot{\gamma} [-\cos \gamma_i \cos \gamma_i - \sin \gamma_i \cos(\chi - \chi_T) \sin \gamma_i] + \dot{V} [-\sin \gamma_i \cos \gamma_i + \cos \gamma_i \cos(\chi - \chi_T) \sin \gamma_i] \\ &\quad + V \dot{\chi} [-\cos \gamma_i \sin(\chi - \chi_T) \sin \gamma_i] + V \dot{\chi}_T [\cos \gamma_i \sin(\chi - \chi_T) \sin \gamma_i] \end{aligned}$$

• Desired Acceleration Towards Line

($\omega_\xi = 2 \text{ rad/sec}$, $\zeta = 0.7$)

$$\ddot{\xi}^d = \text{limits} \{ -\omega_\xi^2 \xi - 2\zeta \omega_\xi \dot{\xi} \}$$

where limits depend on min and max angle-of-attack

• Desired Flight Path Angular Rate

(approximate dynamic inversion because assumes $\chi = \chi_T$)

$$\dot{\gamma}^d = \frac{-\ddot{\xi}^d}{V \cos(\gamma_i - \gamma)}$$

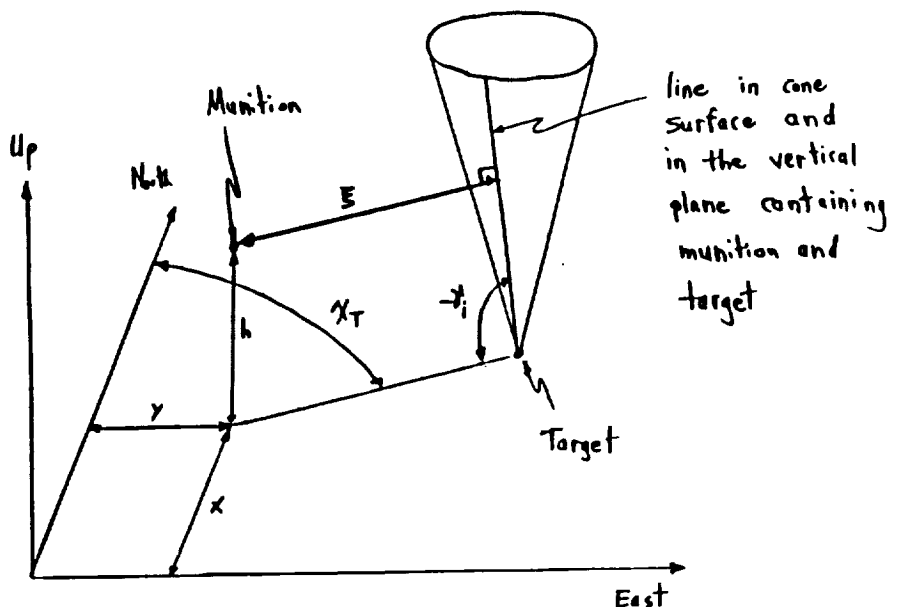

F-15 HIDE C

- Supersonic Flight Control and Cruise Optimization
 - inner and outer loops to hold Mach and altitude
 - Open Loop Mach 2, $h = 45\text{K ft}$
 $\omega_{sp} = 6.2 \text{ rad/sec}$, $\zeta_{sp} = 0.16$,
 - Dynamic Inversion Bandwidth Gains Adjusted
Bode Loop Design Crossover Freq. = $5 \text{ rad/sec} < \omega_{sp}$
In Conflict With Large Stability Margins and
IMPACT Design Rule Established
Between P+I gains and Bode ω_c , PM, and V_c
- Aerodynamic Control Surfaces
 - horizontal tail and variable inlet geometry
- Outer Loops Closed Around (Manual) Inner Loops
- Minimize Cruise Trim Drag
- Autothrottle and Redundant Pitch Controls

L-1011

- Wide Body Commercial Jet Transport
- Flt. and Traj. Control for Cruise Optimization
 - Mach and altitude hold
 - redundant longitudinal controls
 - aerodynamic models too inaccurate for perf. opt.
 - motivates real time approach
- Controls
 - horizontal tail and elevator
 - symmetric aileron
- Search over Redundant Controls
 - while $CV = \text{constant}$, in this case Mach and altitude
 - but α and trim drag varies
 - to minimize throttle setting

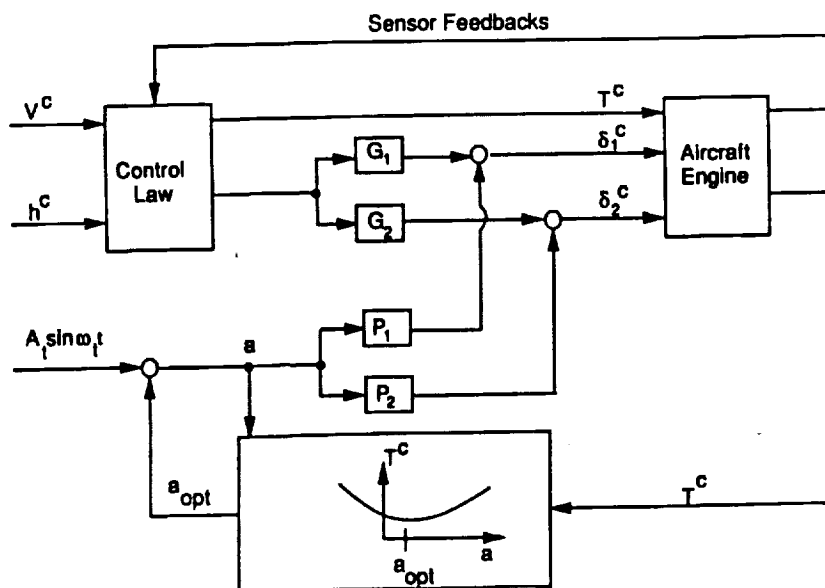

SUMMARY

- **Dynamic Inversion Offers an Attractive Alternative Flight Control Design Methodology**
 - gain scheduling replaced with models
 - easy to iterate and update
 - easy to re-use
- **Full State Info and On-board Models Made Possible by Current Instrumentation and Flight Computers**
- **Design Examples Illustrate Potential**
- **Further Theoretical Support Needed in Areas of Robustness Analysis and Synthesis (linear/nonlinear) and Characteristics of Zero Dynamics and Daisy Chain**